

EX LIBRIS

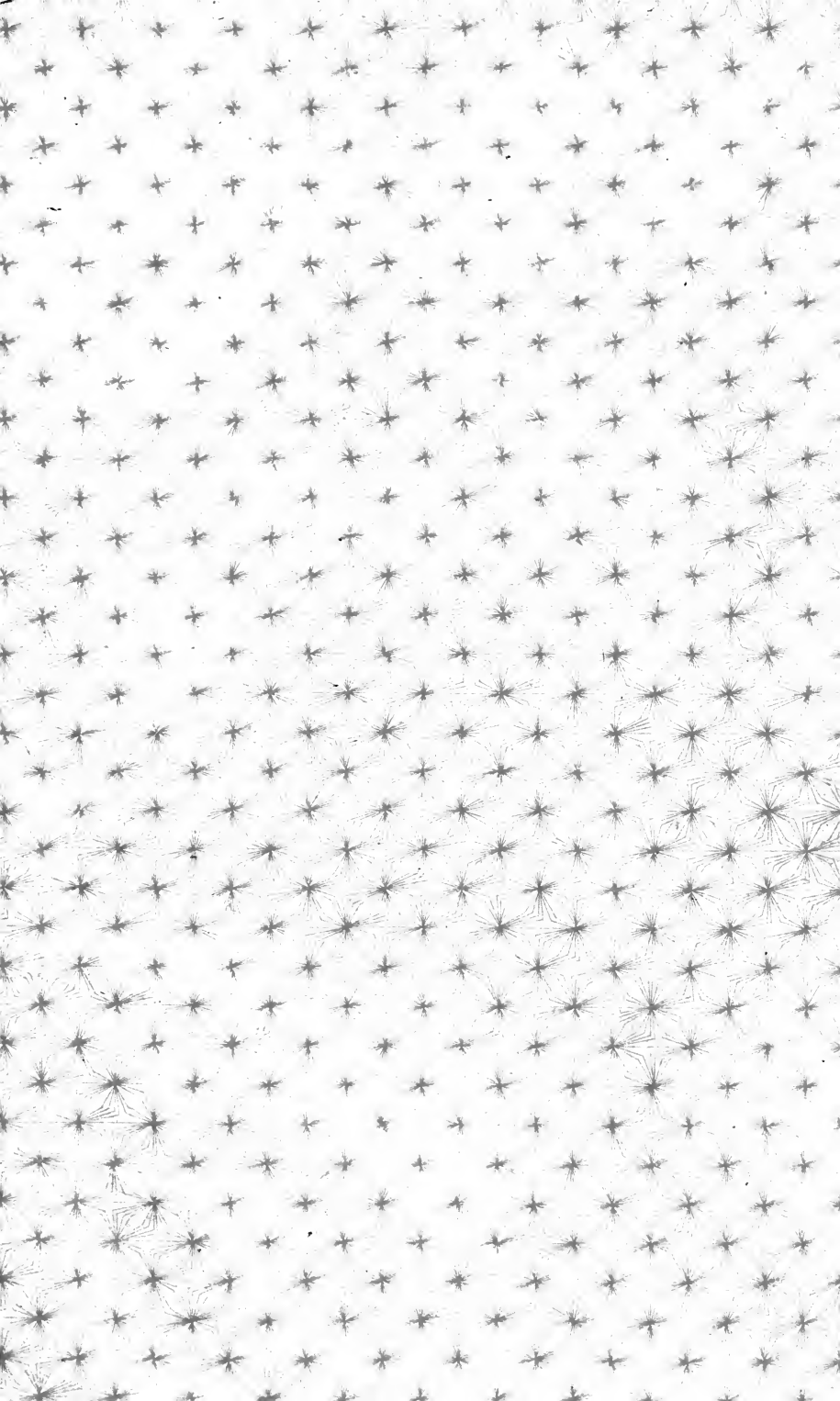



RAILROAD CONSTRUCTION,

BY

CHARLES LEE CRANDALL, M. C. E.

PROFESSOR OF RAILROAD ENGINEERING, CORNELL UNIVERSITY; MEMBER
OF THE AMERICAN RAILWAY ENGINEERING ASSOCIATION

AND

FRED ASA BARNES, M. C. E.

ASSISTANT PROFESSOR OF RAILROAD ENGINEERING, CORNELL UNIVERSITY;
MEMBER OF THE AMERICAN RAILWAY ENGINEERING ASSOCIATION

FIRST EDITION

SECOND IMPRESSION—CORRECTED

McGRAW-HILL BOOK COMPANY, INC.

239 WEST 39TH STREET, NEW YORK

6 BOUVERIE STREET, LONDON, E. C.

1913

7-22-13
e9.

COPYRIGHT, 1913, BY THE
MCGRAW-HILL BOOK COMPANY

THE
MCGRAW-HILL
BOOK COMPANY

PREFACE

This book had its beginning in some notes on railroad construction which were first prepared about twenty-five years ago and were issued in mimeograph form for the use of students in the College of Civil Engineering at Cornell University. These notes have required frequent revision in order to keep them abreast of ever changing practice, but so much has been done in the last few years in the direction of standardizing construction that the time now seems opportune for enlarging them into a book for general use.

The discussions in engineering associations and in the technical papers have done much to stimulate interest and develop effort. They have also tended to standardize practice by suggesting to each engineer the adoption of the good features of the standards of other railroads, which were improvements upon and applicable to his own road.

The method adopted by the American Railway Engineering Association of assigning topics to committees for investigation and report, the report to be presented at the annual convention for general discussion, has accomplished much in this direction.

In this work an attempt has been made to present to the reader glimpses of the field and to impress upon him something of the spirit of the work.

It is hoped that problems, such as will awaken interest and suggest the viewpoint of the engineer, will be freely used in teaching the subject. The references should then stimulate the student to do outside reading and aid the busy young engineer in obtaining special information in handling work.

ITHACA, N. Y.,
January, 1913.

CONTENTS

	PAGE
PREFACE	v
CHAPTER I	
INTRODUCTORY	1
General—Estimates—Outline of Construction—Right of Way— Clearing and Grubbing—Classification—Shrinkage—Pay Quanti- ties Mass Diagram—Overhaul.	
CHAPTER II	
EARTHWORK	15
General Methods—Analysis of Cost—Loosening—Shoveling— Spreading and Dressing—Keeping Roads and Gangways in Order —Superintendence, Timekeeping and Water Carrying—Wheel- barrows—Drag Scrapers—Fresno Scrapers—Wheel Scrapers— Maney Scrapers—Elevating Graders—Carts—Wagons—Steam Shovels—Analysis of Cost, Big Shoal Cut-off—Steam Shovels for Light Work—Drag Line Excavators—Hauling with Cars and Dinkey Locomotives—Hauling with Cars and Horses—Steam Shovel and Standard Equipment.	
CHAPTER III	
ROCK EXCAVATION	54
General Methods—Drilling, General—Hand Drilling—Power— Piston Drills—Air Hammer Drills—Well Drilling Machines— Rotary Drills—Explosives—Principles of Blasting—Loading and Hauling.	
CHAPTER IV	
TUNNELING	87
Location—Examination of Site—General Methods of Excavation —Classification—Form of Section and Lining—Tunnels through Hard Rock—European Examples—American Examples—Rates of Progress—Cost of Rock Tunnels—Tunnels through Loose Ground—The Belgian Method—The Baltimore Belt Railroad Tunnel—The English Method—The Austrian Method—The Pilot Method—The Cut and Cover Method—Submarine Tunneling— The Shield Method—The St. Clair River Tunnel—The Subaqueous Section of the Detroit River Tunnel—The New York Tunnel Extension of the Pennsylvania Railroad—Tunnel Ventilation.	

CHAPTER V

MASONRY	1
Masonry, General—Quarrying Stone—Dressing Stone—Mortar—Laying Stone—Concrete, Proportions and Materials—Concrete, Mixing and Placing—Concrete Forms and Reinforcement.	

CHAPTER VI

FOUNDATIONS	1
Foundations, General—Examination of Site—Safe Loads for Various Materials—Methods of Increasing the Bearing Capacity of Soils—Cribbs—Coffer-dams—Caissons—Piles—Pile Driving—Pumps and Pumping.	

CHAPTER VII

CULVERT AND BRIDGE MASONRY	1
Standard Structures—Waterway for Culverts—Pipe Culverts—Stone Box Culverts—Stone Arch Culverts—Plain Concrete Arch Culverts—Reinforced Concrete Culverts—Rail Floor Culverts—Retaining Walls—Bridge Piers—Bridge Abutments.	

CHAPTER VIII

TRESTLES AND BRIDGES	2
Wooden Trestles—Principles of Construction—Standard Wooden Trestle Plans—Quantities and Cost—Comparison of Wooden Trestle and Embankment—Wooden Trestles with Ballast Floors—Steel Trestles—Reinforced Concrete Trestles—Wooden Bridges—Steel Bridges—Open Bridge Floors, Ballasted Bridge Floors—Wooden Piers and Abutments—Highway Crossings.	

CHAPTER IX

TRACK MATERIAL AND ROADBED	3
Ballast—Ties—Rails—Rail Joints—Tie Plates and Rail Fastenings—Turnouts—Drainage—Track Laying—Grade Crossings—Cattle Guards—Fences.	

CHAPTER X

ESTIMATES AND RECORDS	4
Preliminary Estimates, Earthwork—Preliminary Estimates, Structures—Location Estimates—Monthly and Final Estimates—Right of Way Maps—Cost of Location Surveys—Capitalized Cost of Structures—Durability of Structures—Protection of Iron from Rust—Wood Preservation—Valuation of Railroads.	

INDEX	5
-----------------	---

RAILROAD CONSTRUCTION

CHAPTER I

INTRODUCTORY

1. General.—The essentially commercial nature of a railroad is emphasized in the Introduction of the authors' Field Book for Railroad Surveying. The interdependence of the three periods—investigation and design, construction, and operation, through which it and other business projects must pass, is there pointed out, and the student should again read the first five articles of that Introduction.

The present work deals directly with the second or construction period, but its use for preparing preliminary and location estimates in studying location problems during the period of investigation and design (location), will perhaps be even greater than for construction. For the locating engineer must consider methods of grading and their relative costs as well as the cost and durability of structures in locating his line and placing the grade line on the profile.

Thus the resident engineer on construction may find himself more or less restricted as to choice of methods or structures, in which case the book would be used for the more narrow, but no less important, purpose of getting the work done properly at minimum cost. For it must be realized that the major part of the invested funds are expended in building the plant during the construction period, and this expenditure should be wisely made.

2. Estimates.—Twenty-five years ago, few contractors and practically no engineers had any definite data on unit costs of doing work, and the common method of estimating was by the use of contract or "going prices," as the basis for a guess in which the attempt was made to allow for variations in conditions, prices of material and labor, hauls, etc. But as competition increased, it became necessary for a contractor to be able to figure costs more and more accurately and this naturally led to analyses of costs.

For it is evident that in grading, for instance, the effect of change of material upon the cost of loosening can be more closely estimated than its effect upon the total cost.

For some years contractors considered their cost data a part of their stock in trade, and it is only in recent times that such data have been more freely published. Many of the published data have, however, been useless because of failure to record conditions, prices of labor and materials, etc.

In making an estimate, the total cost may be considered to be made up of the following items:

1. Overhead expenses.
 - a. General management and engineering.
 - b. General office force.
 - c. General office supplies.
 - d. General miscellaneous expenses.
2. Development expenses.
 - a. Management and engineering.
 - b. Labor.
 - c. Supplies.
 - d. Materials.
3. Plant and tool expenses.
 - a. Interest.
 - b. Depreciation.
 - c. Repairs.
4. Field expenses.
 - a. Management and engineering.
 - b. Labor.
 - c. Supplies.
 - d. Materials.
 - e. Miscellaneous.
5. Profit to contractor.

Overhead expenses are those which cannot be charged up to a single job, such as salaries of general officers and office force, office supplies, etc. Telephone and telegraph expenses, postage, rent, traveling expenses, advertising, insurance, charity, etc., salaries of steady pay men while idle and interest and depreciation of idle plant would be charged to general miscellaneous expenses.

Development expenses are those incurred in opening up the work, such as putting up temporary buildings, constructing roads,

opening quarries, transporting and erecting plant. Also, cost of dismantling plant and moving it to storage, cleaning up site, etc.

Under plant and tool charges, the item of interest is readily determined, but it must be distributed over the number of working days in a year, which varies with the location and kind of work and must be estimated. The charge per working day must then be distributed over daily output, also estimated.

Plant repairs are estimated from experience. In spite of current repairs, however, the plant gradually depreciates or wears out. This charge for depreciation is not so easily determined. A plant becomes second-hand the moment it is paid for and if to be used only for a single season and then sold, the depreciation may be 40 to 50 per cent.

Normally a plant would wear out in service and the difference between its first cost and scrap value divided by its life in years would give the charge to be taken care of each season.

Sometimes a plant becomes more or less obsolete through improvement in design and therefore depreciates very rapidly. It is, of course, difficult to foresee and allow for this.

Again a plant may be so special as to have only a small value when the particular work in hand is completed. This was true of much of the machinery used on the Chicago Drainage Canal. In this case the difference between first cost and scrap value must be distributed over the output for the job.

Rental charges are intended to cover interest, depreciation and profit and hence may be used in estimating as extreme values of interest and depreciation. Rental prices are given in some cases.

The field expense is often given as the cost of doing a piece of work and even then it may be the result of a special run with everything in good order and conditions favorable for making a record and not an average for the whole job.

Labor is a most uncertain item, as it varies greatly in price and efficiency. Supplies and materials may usually be estimated quite closely by getting prices and freight rates. Sources of materials, such as sand, gravel, stone, etc., should be carefully investigated and cost at the job estimated.

Miscellaneous field expenses cover telephone and telegraph, transportation of men, fire insurance, employers' liability insurance, photographs, postage, etc.

The profit to the contractor will depend upon the competition

and risks involved. Ten to 15 per cent. on materials may be fair on a job where 25 to 30 per cent. on labor might not be too much.

The risk as to materials to be encountered should be taken by the railroad company if low bids are expected. The risks as to efficiency of foremen and management, accidents, unfavorable weather, delays in delivery of materials, etc., properly belong to the contractor and his success will depend largely upon his skill in taking care of these factors.

When a company does its own work, it apparently saves the profit to contractor and part of overhead expenses, but field costs are apt to be greater. In fact, the good showing made by company forces is sometimes due to failure to charge the work with overhead expenses, or even plant expenses, except repairs, in some cases.

3. Outline of Construction.—Assuming that the location estimates have shown that a projected railroad is likely to prove a profitable investment and that the promoters are able to command the necessary funds and have decided to build the line, one of the first steps after obtaining the charter is to secure the right of way and other lands required for the road, its terminals, stations, etc.

Then the roadway must be formed by clearing away obstructions, grubbing out stumps and roots and bringing the surface to grade, *i.e.*, making the cuts and fills. Before this grading can be completed, culverts and bridge abutments must be built, and finally bridges, trestles and buildings are constructed and the track laid and ballasted. Tunnels or large cuts, if required, should be started as early as possible in order to avoid delay in opening the line to traffic. Bridge material, especially for large structures, should be ordered early for the same reason.

The above outlines the main features of railroad construction in their usual order, but in practice all of the operations mentioned are likely to be going on simultaneously at different points on the line.

4. Right of Way.—Rights of way are sometimes donated, especially if the owners are anxious to secure the construction of the line, but more often the strips of land necessary have to be purchased, and in some cases they can be acquired only by exercising the right of eminent domain. Donations and options on lands to be purchased should be secured as early as possible, for prices will invariably increase as time goes on, if the construc-

tion of the line becomes more certain. Accurate right of way maps should be prepared and all titles to real estate should be accompanied by the county clerk's certificate and examined by a competent lawyer.

Prices at which land can be purchased for railroad purposes will be from one to two times the market value in cities and from one to three or four times in the country. It is generally recognized that higher prices are justifiable, partly on account of the greater value of the land for the special purpose and partly on account of the lower value of contiguous lands in consequence of their proximity to the road.

If land must be acquired by exercising the right of eminent domain, *i.e.*, "condemned," the total cost will usually be much greater than even the maximum values given above, as the cost of the court proceedings and the compensation of commissioners must be paid in addition to the appraised value of the land, which is usually high on account of the fact that the owner is forced to part with his property.

5. Clearing and Grubbing.—Clearing and grubbing are sometimes lumped together with the grading in letting the contract, but they are best kept separate and will, therefore, be treated here as part of the preliminary work, leaving the most important part of the preparation of the roadway, *i.e.*, the grading, to be considered in Chapters II and III.

Specifications for clearing usually require the removal from the right of way and station grounds of all trees, brush and other obstructions to the grading, except as reserved.

Brush and other refuse must be burned or otherwise disposed of, but timber must be saved in the form of saw logs, cut into cord wood and piled, or made into ties as may be specified. The tops of stumps under embankments must be at least 2.5 ft. below grade.

Grubbing, *i.e.*, the removal of stumps and roots, is usually required over all places where excavation occurs and between the slope stakes of all embankments less than 2.5 ft. in height.

Payments for both clearing and grubbing are sometimes by the acre, but are usually by the "square" of 100 ft. on a side, or fraction thereof, actually cleared (or grubbed). The removal of isolated trees or buildings is often contracted for separately.

The cost of clearing and grubbing will depend upon the number of trees per unit of area and their size, the extent and character

of other obstructions and the disposition to be made of the materials and refuse.

The following data on clearing and grubbing for a boulevard, given by D. J. Hauer in Engineering-Contracting, Vol. 27, p. 93, 1907, will aid in making an estimate. There were nine acres covered with brush (everything up to 6 ins. in diameter), and with trees from 6 ins. to 3 ft. in diameter.

The trees and brush were cut down and the small stumps and stubs grubbed out with a mattock. The tree stumps, 1212 in all, were first blasted and then the remains and roots were grubbed. The brush and leaf wood were piled and burned and the timber cut into saw logs and cord wood.

Laborers, mostly Italians, were paid \$1.25 per day (10 hours), and two foremen, \$2.50 each.

		Analysis of Costs		Total	Per acre
Distribution					
Chopping down trees and brush,	Foreman,	\$20.00			
	Laborers,	149.61		\$169.61	\$18.84
Piling and burning brush, and grubbing small stuff,	Foreman,	10.00			
	Laborers,	129.74		139.74	15.53
Making cord wood,	Foreman,	10.00			
	Laborers,	81.25		91.25	10.14
Blasting,	Foreman,	62.50			
	Laborers,	116.23			
	Fuse,	24.10			
	Caps,	9.39			
	Dynamite,	188.72			
	Judson powder,	262.65		663.59	73.73
Grubbing after blasting,	Foreman,	40.00			
	Laborers,	277.36		317.36	35.26
Grinding axes, Tools,				5.87	0.65
				81.00	9.00
Totals,				\$1468.42	\$163.15

This gives \$0.55 per stump for blasting and \$0.26 for grubbing, or a total of \$0.81.

These figures do not include superintendence and timekeeping as the contractor gave the work his personal supervision and kept his own time; nor is any allowance made for overhead charges.

Mr. Hauer also cites figures for the clearing and grubbing of about 260 acres of reservoir site for the water works of Columbus, Ohio, from a paper by Mr. Julian Griggs before the American Society of Municipal Improvements, see *Municipal Engineering*, Vol. 31, p. 341, 1906. In this case the trees were somewhat larger and a stump puller was used as well as dynamite to remove the stumps. The total cost was \$159.60 per acre, and the distribution checks fairly well with the example given in detail above. The contract price was \$70 per acre. Superintendence and time-keeping amounted to 2.6 and 1.1 per cent., respectively, of the total cost.

Circular No. 25, Bureau of Plant Industry, U. S. Dept. of Agriculture, by Harry Thomson, issued 1909, gives valuable data on methods and costs of clearing land in the Pacific Northwest.

6. Classification.—In contracting for grading at unit prices, it may be divided according to material, as rock, earth, etc., or it may be let without classification. The former is more common, and it should result in lower prices, as it places the risk for the material upon the owner, where it belongs. The latter reduces labor in making measurements and estimates, but it increases the danger of doing the easy part of the work and then throwing up the contract.

A minute classification gives opportunity for disputes and litigation as the percentages of the different classes are not usually susceptible to exact measurement, but must be estimated, thus opening the way for serious differences of opinion.

This danger is much lessened by the use of a small number of clearly defined classes and the American Railway Engineering Association gives (Manual, 1911 edition) for ordinary use three classes, but recognizes the necessity of special classes, to be clearly defined also, in some localities.

The three classes, solid rock, loose rock and common excavation, are defined in the Manual as follows:

“Solid rock shall comprise rock in solid beds or masses in its original position which may best be removed by blasting, and boulders or detached rock measuring one cubic yard or over.

“Loose rock shall comprise all detached masses of rock or stone of more than one cubic foot and less than one cubic yard, and all other rock which can be properly removed by pick and bar and without blasting, although steam shovel and blasting may

be resorted to on favorable occasions in order to facilitate the work.

“Common excavation shall comprise all other materials of whatsoever nature that do not come under the classification of solid rock, loose rock or such other classification as may be established before the award of the contract.”

Common excavation is subdivided into loam, strong, heavy soils and stiff clay or cemented gravel in analysing or estimating the cost of excavation with men and teams, but a steam shovel will handle all of these and even loose rock at about the same cost.

Hardpan, or earth which cannot be plowed with a four-horse team, is now generally omitted from the classification on account of the difficulty of separating it from the common excavation.

Cemented material, wet gumbo and marl are some of the special classes occasionally used.

For deep cuts, borings or test pits would be necessary for reliable data, but they are not customary for railroad work, and as generally made they are frequently misleading.

7. Shrinkage.—Earth when freshly excavated usually occupies more volume than when in place, the excess varying from 10 to 30 per cent. or more, depending upon the material, being least for clean sand or gravel and greatest for dense mixtures of clay and gravel. This loose earth generally becomes more compact as it is placed in the fill, the amount depending upon the method of making the embankment, and it then continues to reduce in volume, rapidly at first and then more slowly as time goes on, so that as a rule it finally occupies a less volume than in place.

This shrinkage must be allowed for both in figuring upon the distribution of the earth and in making the embankments, and the American Railway Engineering Association recommends the following allowances, Manual, 1911 edition, p. 35.

“For green embankments, shrinkage allowance should be made for both height and width.

“The shrinkage allowance should be as follows:

For black dirt, trestle filling, 15 per cent.

For black dirt, raising under traffic, 5 per cent.

For clay, trestle filling, 10 per cent.

For clay, raising under traffic, 5 per cent.

For sand, trestle filling, 6 per cent.

For sand, raising under traffic, 5 per cent.”

Solid rock will swell about 70 per cent. from cut to fill.

On account of the uncertainty in the percentage of shrinkage it is customary to measure earthwork in excavation and if it is to be measured otherwise, as is sometimes more convenient, the method should be clearly specified. The usual unit is the cubic yard. Banks made in more or less even layers extending the full width and compacted by the horses and vehicles used in making them are more stable and shrink less after construction than those made by dumping over the end.

No inclined layers of clay or other impervious material should be allowed to form in a bank or to remain at the base of one without deep furrowing on account of the danger of slides.

8. Pay Quantities.—In locating a railroad and in drawing the grade line on the profile an attempt is made to use, so far as is practicable, the material taken from the cuts in making the fills, the price paid for the excavation including hauling and placing in the embankment. As the lead increases the cost increases, until finally, for each method of handling the material, the cost is doubled as compared with the short lead. Beyond this limit, called the economic lead, it is cheaper to waste at the cut and borrow at the fill than to transport and the yardage handled then becomes the sum of the remaining cuts and fills (plus shrinkage).

It is evident that this limit depends upon the method of handling the material which should, therefore, be considered during location.

Having decided upon the method, or methods considering different parts of the line, the pay quantities must include all of the excavation and such portions of the embankments, with shrinkage added, as are beyond the economic lead. If at any point the fills, with shrinkage allowance, within the economic lead are in excess of the cuts, as they should be on the average for a properly located line, they would determine the yardage rather than the cuts.

In considering borrow or waste, it should be remembered that waste material should be used in widening the banks or in making fills for an extra track, even at a somewhat increased cost, rather than wasted above grade and that extra material should be obtained by widening cuts or preparing for an extra track rather than from borrow pits when practicable. Also that when borrow pits are used the leads should be measured along routes which will allow of easy turning and of suitable gradients up the sides of the embankments.

9. Mass Diagram.—One of the simplest methods of determining the most economical method of distributing the material in grading is by means of the mass diagram, or Bruckner's curve. This is constructed by starting at the left or zero end of the profile or other convenient point, say one past which no material will be transported, and adding the yardage algebraically, station by station, allowing for shrinkage on fills. The totals are plotted at the corresponding stations, or plusses for grade points, and a smooth curve drawn through the points thus found as in Fig. 1. Straight lines joining the points would mean that the yardage increments were assumed proportional to the distance.

The method of construction gives to the curve the following properties:

(a) An upward inclination of the curve from left to right indicates excavation, a downward inclination, embankment, and maximum and minimum points, grade points. Thus, Fig. 1, $A'B'$ indicates excavation, $B'G'$, embankment and B' and G' , grade points.

(b) Cuts and fills balance between the points of intersection of any horizontal line with the curve, leads being to the right where the curve is above the line and to the left where it is below.

Thus the cut from D to B will make the fill from B to E , and that from F to G , the fill from G to E .

(c) Since the cut BD makes the fill to E , the last of the cut at D is moved to E , a distance $D'E'$, while the last of the cut from F is moved a distance $F'E'$. Equal distances will give the minimum average lead for the fill, as this allows of taking the material for each part of the fill from the nearest point. Hence in making a fill from adjacent cuts, or in utilizing the material from a cut in adjacent fills, the minimum average lead is found by raising or lowering the horizontal closing line until the adjacent intercepts are equal.

(d) The area between the curve and an intersecting horizontal line will be the product, lead times yardage, for the material between the two points of intersection. For since by (c) the material in the cut, *e. g.*, from B to D , will just make the fill from B to E , the material represented by the increment dz to the ordinate at D must be moved from D to E , a distance $D'E'$, giving for lead times yardage the area $dz \times D'E'$. Similarly for the other increments giving for the total area, lead times yardage as stated above.

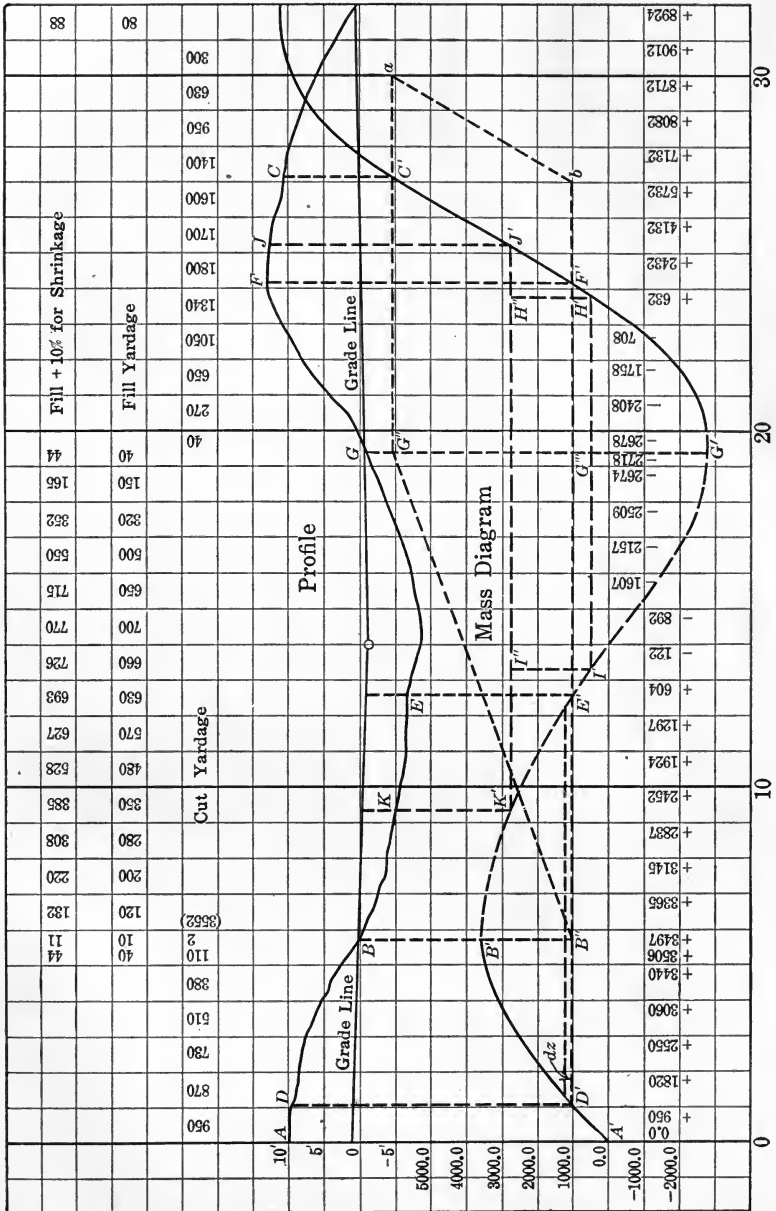

Fig. 1.—Mass Diagram.

If area be divided by yardage, the quotient will be the average lead for the portion taken. The yardage for any cut or fill (not containing partial sections) will be the difference of the ordinates at the ends.

Hence to find the average lead where the material from a cut is utilized in making an adjacent fill, or vice versa, find the area between the closing line and the curve by planimeter or by Simpson's rule and divide by the grade point ordinate or total yardage.

In the case of side-hill work, *i.e.*, both cut and fill between adjacent sections and no grade point, only the difference of quantities is used. The balanced quantities in each length are thus ignored. The lead for this material will depend upon the longitudinal and transverse slopes; it will generally be small and can be neglected without serious error.

To find the average lead for all the material, including the side-hill work, add to the area found from the mass diagram the product of the balanced yardage or side-hill work by its lead and divide by the total yardage.

The total yardage for the cut AB , Fig. 1, is 3552, while the maximum or grade point ordinate at B is only 3506, less by 46 cu. yds. If D be taken at sta. $1+08$, $D'E'$ will be 1020 above the zero line and the area $D'E'B'$ will be 1 868 700 cu. yd. ft.

Adding 46×10 for the side-hill product, 10 being assumed for the lead,

$$\begin{aligned} \text{Total area} &= 1\ 869\ 160 \\ \text{Total yardage} &= 3\ 552 - 1020 = 2\ 532 \\ \text{Dividing, } 1\ 869\ 160/2532 &= 738 \text{ ft.} \end{aligned}$$

If the side-hill work be omitted,

$$1\ 868\ 700/2486 = 752 \text{ ft., average lead.}$$

If the side-hill lead be omitted,

$$1\ 868\ 700/2532 = 738 \text{ ft.}$$

The maximum lead, $D'E'$, = stas. $[12 + 50 - (1 + 08)] = 1142$ ft.

If the material from C to F is to be wasted uniformly along the fill, GB , draw the horizontal $C'G''$ and join $G''B''$. The area $C'G''B''F'$ divided by the ordinate $G''G'''$ will give the average lead.

If this material is to be wasted at the grade point, G , divide the area $C'G''G'''F'$ by the yardage $G''G'''$ for the average lead.

If wasted on the side at a constant lead, aC' , draw the horizontals, aC' and bF' and the curve ab for the yardage lead area.

The profile and mass diagram thus give complete data as to pay quantities, disposition of the material and maximum and average leads. These together with the notes on classification which were taken in the field, allow of a close estimate of unit prices and total cost.

10. Overhaul.—Sometimes instead of showing the maximum and average leads and allowing the contractor to fix his prices to correspond, a limit is set for free haul and the contractor is allowed to name a price per cubic yard per station for overhaul.

There are different definitions for overhaul; the one adopted by the American Railway Engineering Association requires the limit of free haul to be fixed so as to include the grade point and balance the cut on the one side with the fill, plus proper shrinkage allowance, on the other. All material within this free haul limit is omitted from further consideration. The distance from the center of gravity of the remaining excavation to the center of gravity of the resulting embankment, less the free haul, is the overhaul.

When material is obtained from borrow pits along the embankment and runways are constructed under the direction of the engineer, the haul is determined by the distance the team necessarily travels. The overhaul is determined by subtracting the free haul from one-half the round trip distance.

To find the overhaul from the mass diagram, draw the horizontals giving the greatest lead or haul and the free haul, the distance between them will give the yardage for overhaul; draw verticals through the ends of the free haul line to meet the maximum haul line. The sum of the areas between these verticals and the mass diagram curve will give the overhaul product, lead times yardage. If the overhaul is required, divide the overhaul product by the overhaul yardage.

Thus in Fig. 1, for the cut GJ which would make the fill to K , $J'K'$ gives the greatest haul, $H'I'$ the free haul, $H'H''$ or $I'I''$ the overhaul yardage and the sum of the areas, $H'H''J'$ and $I'I''K'$, the overhaul product.

If numerical work is preferred, find the free haul limit by adding the yardage each way from the grade point, allowing shrinkage for the fills and keeping the quantities balanced until

the free haul limit is reached. This will require using plusses with the corresponding yardages for the final result.

Beyond this free haul point in the cut, multiply the yardage of each volume by the distance of its center of gravity from the near end of the free haul limit, add the products and divide by the corresponding yardage for the overhaul at the cut end. Find how far this material will extend in the fill and determine the distance of its center of gravity from the near end of the free haul limit as above. The sum at the two ends will give the total overhaul.

For heavy work, this method is often preferred to the graphic as being more accurate unless an inconveniently large scale is used.

REFERENCES

Cost Keeping and Management Engineering. H. P. Gillette and R. T. Dana, 1909.

Economics of Contracting. D. J. Hauer, 1911.

Contracting Practice, a series of articles by DeWitt V. Moore. *Mun. Eng.*, Vols. 40 *et seq.*, 1911-12.

Field System. Frank B. Gilbreth, 1908.

Ashokan Dam. Methods of Estimating used by the Engineers of the Board of Water Supply. *Eng. Rec.*, Vol. 57, p. 181, 1908. Criticism of above Methods, and Estimates of the Board of Advisory Engineers to the Commissioners of Accounts. *Eng.-Cont.*, Vol. 29, pp. 99, 111, 1908.

A System of Cost Keeping, with extended discussion. Myron S. Falk, *Trans. Am. Soc. C. E.*, Vol. 64, p. 401, 1909.

Engineers' Estimates of Costs. S. Whinery. *Eng. News*, Vol. 52, p. 119, 1904.

Editorial discussions, an abstract of the circular mentioned at the end of § 5 and a series of articles from bulletins of Washington Agr. Exp. Sta., Puyallup, Wash., on clearing logged-off lands in the Pacific Northwest. *Eng. and Cont.*, Vol. 36, pp. 245 *et seq.*, 1911.

Methods and Costs of Removing Stumps from a Reservoir Site. V. F. Hammel. *The Contractor*, March 1, 1911. Reprinted in the *Cornell Civil Engineer*, Vol. 19, p. 197, 1910-11.

Uniformity of Requirement and Clearness of Specification in Agreements for the Graduation of Railroads. W. F. Dennis. With extended discussion on classification, overhaul, etc. *Trans. Am. Soc. C. E.*, Vol. 58, p. 321, 1907.

Definition of Terms, Specifications, Clearing and Grubbing, Overhaul Clause, etc. *Manual Am. Ry. Eng. Assoc.*, 1911.

CHAPTER II

EARTHWORK

11. General Methods.—The methods of handling earth include the plow and pick for loosening, with the occasional use of explosives, hand casting and the use of wheelbarrows and drag scrapers for hauling short distances, with wheel scrapers, carts, wagons and cars for longer distances, up to the limit in each case at which it would be cheaper to waste and borrow rather than to transport.

While these are the standard methods, using men and horses, there is a growing tendency toward the use of the steam shovel for loosening and loading and of cars for transporting, on account of the increasing cost of, and difficulty in obtaining and managing, labor.

With so many different methods of handling the material, and such variations in its quality and in the hauls or distances transported, an analysis of methods and costs is necessary for a proper understanding of the subject. The analysis by Trautwine which has been published for so many years in the *Civil Engineer's Pocket-book* is probably the best known; he gives the credit for first developing the subject to Elwood Morris.

The development of special machinery to take the place of hand labor, which was given such an impetus in the construction of the Chicago Drainage Canal, and the increasing use of cost-keeping and the principles of scientific management, which has received so much attention of late, have enlarged and systematized the data available. These features have been developed by Gillette and others in various books and technical papers, so that now many data of actual costs under well-defined conditions are available and for a given case analyses of costs by different methods can be made and their results compared.

Weather conditions, efficiency of labor and management and the variations of the material from that shown in the outcrop or by the test pits or borings will exert modifying influences and introduce elements of uncertainty and of interest.

12. Analysis of Cost.—The labor item of field expenses, see § 2, may be considered to be made up as follows:

1. Loosening.
2. Loading.
3. Hauling, including emptying and returning.
4. Spreading and dressing.
5. Keeping roads or gangways in order.
6. Superintendence, timekeeping and water carrying.

Often two or more of these items are combined, as loosening and loading in steam shovel work, loading and hauling in wheelbarrow work, etc. The list should be used in connection with § 2 to insure that no items are forgotten.

13. Loosening.—All materials excepting possibly sand require loosening for shovels or scrapers and it will often be economical to loosen even sand, especially for shoveling. Loosening is commonly done with picks or plows but explosives may be used to advantage under some conditions.

The cost is usually greater with picks than with plows, but their use is necessary in cramped situations and may be advantageous in others, such as working at a face, etc. Picks and mattocks, are also used in dressing, see § 15, and finishing slopes and roadbed, although the latter may often be finished to grade or surface more cheaply by the use of a Shuart grader or road machine.

While costs are less with plows, much more room is required for manipulation, engineer's stakes are more apt to be disturbed, and more smoothing up will be necessary. The advantages of plowing are also often partially neutralized, especially in small cuts, by allowing men and teams to trample over the freshly plowed earth.

For these reasons it will often be cheaper to use picks than plows in light cuts and especially in side-hill work. The dressing may then be taken care of as the material is loosened.

Loosening by explosives is often economical in working at a high face or for heavy side-hill cuts. In the first case, holes are made with augers, churn drills, or a well-drilling outfit, in a row back from the face. They are sprung with dynamite, loaded with black powder, and fired simultaneously.

Large side-hill cuts are sometimes chamber blasted. That is, a small tunnel is driven into the hill to the proper depth and

then turned at right angles. The right-angled section is loaded, the stem filled and the charge fired. Much of the material may be blown below grade or it may have to be hauled away, depending on local conditions.

A man with a pick will loosen about 15 cu. yds. of stiff clay, or cemented gravel, 20 of strong, heavy soil, or 30 of common loam, per 10-hour day. With wages at 15 cents per hour, these quantities give the following costs for labor, except foremen, for loosening with picks:

Stiff clay or cemented gravel,	10.0 cents per cu. yd.
Strong, heavy soils,	7.5 cents per cu. yd.
Loam,	5.0 cents per cu. yd.

A two-horse team with plow and driver and an extra man to hold will loosen about 250 cu. yds. of strong, heavy soil per 10-hour day or about 400 of ordinary soil. With very hard material requiring a pick-pointed plow, Fig. 2, with two teams and an



FIG. 2.—Pick-pointed Plow.¹

extra man to ride the beam, about 180 cu. yds. can be loosened. With wages at \$3.50 per day for team and driver and \$1.50 for man, these data would give the following costs for labor, except foreman, for loosening with plows:

Stiff clay or hardpan,	5.6 cents per cu. yd.
Strong, heavy soils,	2.0 cents per cu. yd.
Loam,	1.25 cents per cu. yd.

¹ Climax Road Machine Co., Marathon, N. Y., cost about \$20. Oct., 1911.

For high banks of cemented gravel, Gillette, *Earthwork and Its Cost*, p. 152, gives the charge of black powder which is used in loading at one pound for from 2 to 3 cu. yds. of gravel.

Cost data for loosening by explosives are not available for general application as in the other methods.

14. Shoveling.—Earth may be cast short distances with shovels, the cost being about the same for limits of 5 to 10 ft. horizontally or 4 to 7 ft. vertically. For somewhat greater distances it may be recast, the unit cost being about 80 per cent. if a platform or other suitable bed is provided from which to shovel. This is frequently done in taking material from a pit too deep for one cast. Platforms are also often used in mine tunneling and might well be used in cuts when the material is broken down from a face.

Shoveling is also required in loading wheelbarrows, carts, wagons, or cars for transporting longer distances. The material should be thoroughly loosened and often a second plowing will be more than repaid in the reduced cost of shoveling.

The quantity loaded per man will depend upon the material, the extent to which it has been loosened, the height to which it must be raised and upon so proportioning the gang that the shovelers will not have to wait for either material or vehicles. For loading into an ordinary wagon or cart, 24 cu. yds. per 10-hour day is about the upper limit for light material or material well loosened, 18, for material at the face of a cut which has been broken down onto a good surface for shoveling and 15, for rather heavy plowed earth.

At \$1.50 per day, these would give the following costs for labor, except foreman, of shoveling:

Light or well loosened material,	6.25 cents per cu. yd.
Face broken onto good surface,	8.25 cents per cu. yd.
Heavy plowed earth,	10.00 cents per cu. yd.

In *Engineering-Contracting*, Vol. 32, p. 139, 1909, it is stated that experiments on a number of pieces of work involving the handling of thousands of yards of excavation have shown the long handled shovel much superior to the short for handling earth. Men can do more work with less effort and can stand more nearly erect. It is stated that the long handle is used in Europe and the West, and the short handle in the East.

The round-pointed shovel enters the earth easier than the

square and is generally used except in shoveling from a platform when a square-pointed scoop should be used unless the material has to be cast a considerable distance.

15. Spreading and Dressing.—A bankman will spread in 6-in. layers about 75 cu. yds. of average earth which has been dumped from carts or wagons, the cost therefore being 2 cents a cubic yard with wages at \$1.50 per day. For a railroad bank, it is usually only necessary to keep the surface smooth enough to drive over until grade is reached, in which case half a cent per cubic yard should be sufficient if the work is so planned that the bankman will be kept busy, *i.e.*, at least 300 cu. yds. must be

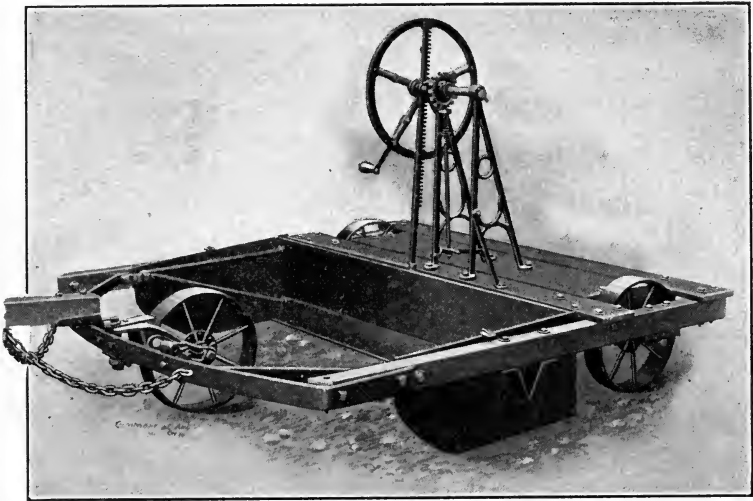

FIG. 3.—Shuart Grader.

delivered at the bank each day. If the earth is hauled in carts and dumped over the edge of the bank, about one-quarter of a cent per cubic yard should still be allowed for keeping the dumping place in order.

Earth in large quantities can be spread by a team and road machine or Shuart grader,¹ Fig. 3, for from one-half to three-quarters of a cent per cubic yard.

¹ Ohio Road Machine Co., Oberlin, O. Cost about \$48. Dec., 1911. Road machines cost from about \$125 up. The Little Yankee Digger resembles the Shuart grader but has teeth for loosening in advance of the blade.

Sometimes, as in highway work, the banks are required to be tamped. This can be done by hand in six-inch layers for 6 cents per cubic yard with labor at \$1.50 and at from one-half to one cent with horse-drawn rollers, teams at \$3.50.

In dressing railroad earth slopes from 125 to 150 sq. yds. per man per day is a fair average on construction work. This would make the cost about 1 cent per square yard. The cost per cubic yard would, of course, depend on the lightness of the work, the amount of material handled not being a proper criterion on account of the time spent in smoothing and skimming.

16. Keeping Roads and Gangways in Order.—Roads over fresh fills are especially difficult to keep in order during periods of wet weather. Ditches should be dug to drain off the water and ruts should be filled as poor roads enormously increase the cost of hauling.

Trautwine suggests so much per cubic yard per station of lead, say 0.1 cent, instead of the usual allowance per cubic yard.

17. Superintendence, Timekeeping and Water Carrying.—These items vary with local conditions but half a cent per cubic yard will usually cover all three.

It is poor economy to attempt to save on superintendence. Good foremen are scarce and they should receive good pay as poor foremen are expensive at any price.

18. Wheelbarrows.—The wheelbarrow is used for excavating small quantities of material and in cases where it is impracticable to use carts or scrapers on account of the cramped situation or deep mud in which horses could not work. It is also valuable for moving stony soil over short distances. Run plank or "gangways" should be provided and usually each man should load his own barrow.

The load is about $1/14$ cu. yd. for wheeling up slopes, as is generally necessary, but it may reach $1/10$ for level ground.

A study of the available data would indicate that the time for loading a cubic yard may be taken at 0.6 hour for the heavy soils and 0.5 for loam, while the time for wheeling, including dumping, adjusting the plank and other unavoidable delays, may be taken at $1/3$ hour per cubic yard per 100 ft. for wheeling up slopes and $1/4$ hour for level ground.

Adding the cost of picking from § 13 gives the following costs for labor, except foremen, for picking and loading, with wages at 15 cents per hour.

Stiff clay or cemented gravel,	19.0 cents per cu. yd.
Strong, heavy soil,	16.5 cents per cu. yd.
Loam,	12.5 cents per cu. yd.

to which should be added $3\frac{3}{4}$ to 5 cents for each 100 ft. of lead, depending upon the slope.

19. Drag Scrapers.—The ordinary No. 2 drag scraper,¹ Fig. 4, is a steel scoop weighing about 100 lbs., which will hold from 1/7 to 1/9 cu. yd., place measurement. It is drawn by a two-horse team which will travel at the rate of about 2.5 miles per hour, or cover 100 ft. of haul per minute including loading and dumping, the haul making allowance for the extra distance required for turning at the pit and dump and being greater than the lead or straight line distance.

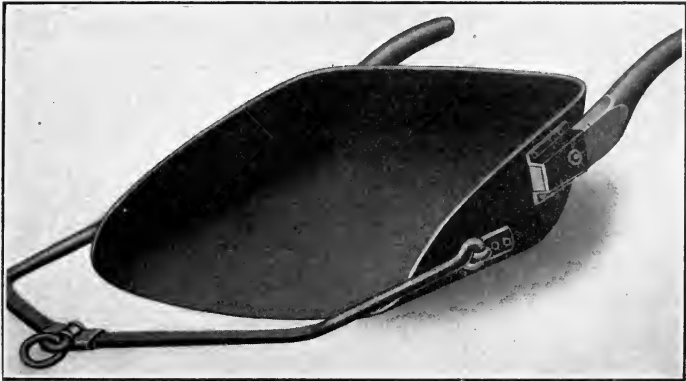

FIG. 4.—Drag Scraper.

An extra man is required to hold in loading while the driver usually dumps his own scraper. As a man can load for two or more teams, depending upon the lead, it is advisable to work the scrapers in gangs. The material should be well loosened so that the scoop will fill readily.

J. W. Brown, *Engineering Record*, Vol. 26, p. 151, 1892, gives the following data based on the average cost of scraper work in Iowa. In making low embankments from side ditches with 6-ft. berms he makes the following assumptions:

Distance, center of ditch to center of bank, 33 ft. Seven to ten trips per cubic yard. Sixty cubic yards per 10-hour day

¹ Cost \$4 to \$5, according to size. Oct., 1911.

good average work. Plow team generally required to loosen the material, one plow to six scrapers. Two horses per plow required in light soil, four or more necessary in compact soil, average three at \$6 per day with driver and man to hold. Field expenses, except management, and maintenance for loosening, loading, and dumping, 360 cu. yds.

Three-horse team with driver and plowman, loosening,	\$6.00
Three men holding scrapers, loading,	4.50
One man dumping,	1.75
One foreman,	2.50
Maintenance, plows and scrapers,	0.90
Total,	<u>\$15.65</u>

This gives 4.35 cents per cubic yard. The cost of hauling at \$3.50 per day for team and driver is 5.83 cents, giving a total cost of 10.18 cents per cubic yard for the lead of 33 ft.

For double the lead, or 66 ft., the yardage would be reduced to 40 per scraper per day, requiring 9 teams or \$31.50 for hauling, while for a lead of 100 ft. the number of teams must be increased to 12 or the cost to \$42.00, the other expenses remaining the same except that maintenance would be increased to \$1.08 and \$1.44, respectively, giving 8.75 cents and 11.66 cents for hauling and an increase of .05 cent and .15 cent for maintenance.

For the above prices and material these data give the following rule for field expenses, except management, and maintenance for the drag scraper:

To a fixed cost of 7.2 cents per cubic yard add 9 cents per 100 ft. of lead with 20 ft. as a minimum value to allow for turning.

For stiff clay 25 to 30 per cent. should be added to the above.

20. Fresno Scrapers.—The fresno scraper,¹ Fig. 5, is an improved form of drag scraper invented in California and used mainly in the West. The four-horse scoop is 5 ft. long laterally and only about 18 ins. wide from cutting edge to rear, the former giving large capacity and the latter easy filling. Two- and three-horse sizes are also made. The horses are driven abreast by one driver. The four-horse scraper weighs from 275 to 310 lbs. Many fresno loads at the dump have been compacted into a box with a rammer and found to run from 12 to 16 cu. ft. in average

¹ Cost at Stockton, Cal., Holt Mfg. Co., in carload lots, July, 1911; two-horse, \$14; three-horse, \$14.50 and four-horse, \$15.50 each.

earth where the lead was not so great that much material was lost in transit.¹

A rope should be tied to the handle so that the driver can jerk it and right the bowl at the pit ready for loading. In tough soils it is generally well to have one man with each string of fresnos to load.

The editors of *Engineering-Contracting*, Vol. 32, p. 442, 1909, give the following rules for estimating cost, based on a study of a large number of data:

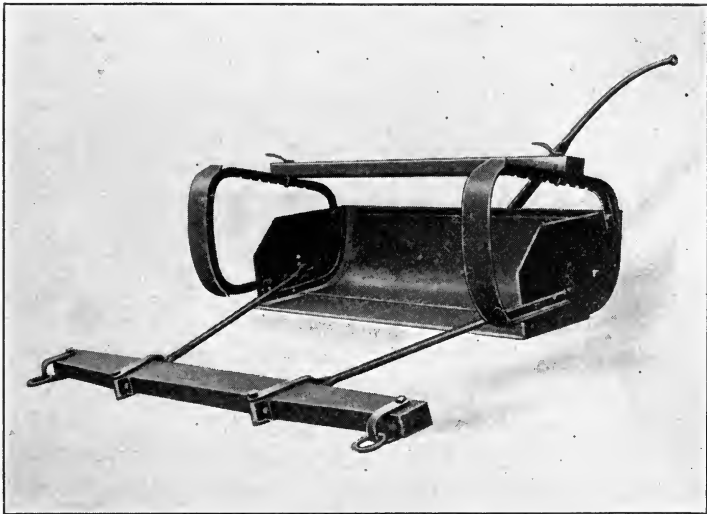

FIG. 5.—Fresno Scraper.

When the daily wage of a driver is \$2 and that of each of the four horses is \$1 a total of \$6 per fresno per 10-hour day, the average cost, not including plowing, trimming or superintendence will be as below:

To a fixed cost of 4 cents per cubic yard add 2 cents per 100 ft. of lead.

The fixed cost includes traveling the extra distance and the slower speed in loading, the shifting to newly plowed ground, etc. The hauling cost is based upon a traveling speed of 200 ft. per minute when not delayed by loading, dumping, etc., and upon an average load of $1/2$ cu. yd., with 50 ft. as the minimum lead.

¹W. N. Frickstad in *Engineering-Contracting*, Vol. 32, p. 366, 1909.

If the soil is not of a kind that heaps up and drifts well in front of the scraper, the average load will probably not exceed $1/3$ cu. yd., particularly on long hauls. This would change the rule to:

To a fixed cost of 4 cents per cubic yard add 3 cents for each 100 ft. of lead.

The editors believe that the horses can be crowded so as to do about the same amount of work in an 8-hour day as in a 10-hour day, or that the cost per cubic yard would be but slightly affected, but experience in the East with 8-hour days would hardly warrant this belief.

They state that the cost of plowing ordinarily ranges from $3/4$ cent to 1.5 cents per cubic yard, foreman's wages, from $1/2$ to 1 cent and dressing roadbed and slopes about $1/2$ cent per square yard of surface trimmed.

If the cost of plowing, dumping, maintenance and superintendence be added on the basis of § 19, *i.e.*, \$10.25 for 360 cu. yds., with $1/4$ cent per cubic yard for maintenance, the fixed cost would be increased by 3.1 cents, giving:

To a fixed cost of 7.1 cents per cubic yard add 2 cents per 100 ft. of lead, or

To a fixed cost of 7.1 cents per cubic yard add 3 cents per 100 ft. of lead, according as the material heaps up and drifts in front of the scraper.

This allows the driver \$2 per day instead of \$1.50 and requires him to load his own scraper, thus increasing the cost about $1/2$ cent per cubic yard per 100 ft. of lead, and reducing it $1\frac{1}{2}$ cents independent of lead, as compared with § 19.

21. Wheel Scrapers.—With the wheel scraper,¹ Fig. 6, the steel scoop is hung between two wheels with broad tires and it can be lowered and filled, raised or dumped, while the team is in motion.

The capacity, place measurement, ranges from about $6\frac{1}{2}$ cu. ft. for the No. 1 to $12\frac{1}{2}$ for the No. 3, while the loads actually carried are about 0.2, 0.25, 0.4 cu. yd., respectively, for the three sizes. These loads can be increased for long leads by finishing with shovels when the material does not fill readily.

The dead load varies from 350 to 800 lbs. according to size. A snatch team is generally used in loading all but the No. 1,

¹ Good Roads Machinery Co., Marathon, N. Y. Approx. cost, No. 1, \$25; No. 2, \$38; No. 3, \$42. Dec., 1911.

even then shovelers are necessary if the box is to be filled in tough clay. In scraper, as in other work, the details must be carefully studied and given attention if economical results are to be secured. Thus the plow should be set to cut 10 to 12 ins. deep, or to such a depth that the scoop will be heaping full after traveling but a few feet. The rear portion of the pan will not fill well with shallow plowing. The furrows should be close together, and if the soil is heavy it should be plowed twice. The bottom of the cut should be kept level so that the scoop will lie flat and not tilted.

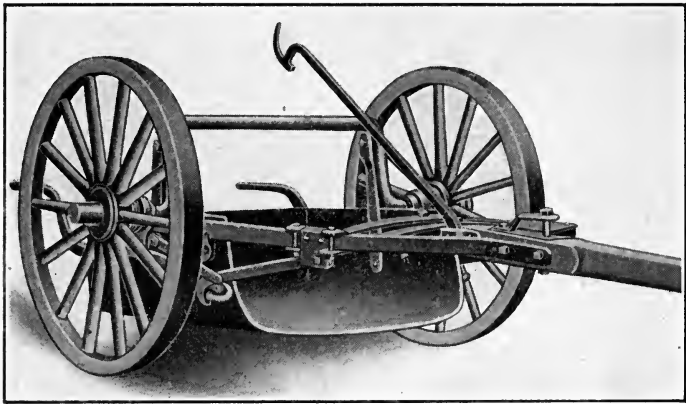

FIG. 6.—Wheel Scraper.

It has become common in most sections to use a three-horse snatch team instead of a two-horse. It is claimed that it would be better and more economical to use a four-horse, as the scoops could be filled with less shoveling. Two men are used for the snatch team, one to hook and unhook, the other to drive.

The No. 1 wheeler for leads of 75 to 200 ft., or for steep slopes, is not fully appreciated. It is as cheap and handy to operate as the drag scraper, since the driver can load and dump, while the load carried is about double.

J. W. Brown, *Engineering Record*, Vol. 26, p. 151, 1892, as the result of experience in Iowa, gives the same costs, not including scraper teams and drivers, for handling 360 cu. yds. of earth with the No. 1 wheeler as were given for the drag scraper in § 19, except that the 90 cents for maintenance is increased to \$1.40. He assumes four loads per cubic yard and about 100 ft. of lead per minute while traveling, or 60, 40 and 30 cu. yds. per scraper

per day for leads of 100, 200 and 300 ft., respectively, requiring 6, 9 and 12 wheelers for transporting the 360 cu. yds. over the respective distances. He also increases maintenance slightly for the longer leads.

These values would give for the No. 1 wheeler at \$3.50 per 10-hour day, for average soil:

To a fixed cost of $7\frac{1}{2}$ cents add 3 cents for each 100 ft. of lead, with 75 ft. as a minimum.

For leads over 300 ft. Mr. Brown uses No. 3 wheelers with two men to hold a scraper (requiring one extra holder) and a two-horse snatch team to aid in loading. To move the 360 cu. yds. per day he uses eight wheelers for a lead of 400 ft., 10 for 500, 12 for 600, 14 for 700, and 16 for 800, the limit to which he considers it advisable to go with wheel scrapers.

Adding \$3.50 for the snatch team, \$1.50 for the extra man to hold and \$0.90 as lead increases for extra wear to the fixed cost of § 19 will give a total of \$21.15 per day, or 5.88 cents per cubic yard for the fixed charge. Adding to this \$3.50 per scraper for the different leads and dividing by 360, the number of cubic yards moved, will give the cost for hauling. The cost per cubic yard is given quite closely by the following:

To a fixed cost of $5\frac{1}{2}$ cents add 2 cents for each 100 ft. of lead within the limits of 300 to 800 ft.

For a No. 2 the cost would be given approximately by the following:

To a fixed cost of $6\frac{1}{2}$ cents add $2\frac{1}{2}$ cents for each 100 ft. of lead within the limits of 200 to 500 ft.

Good roads are essential to economy, especially with the No. 3 wheeler.

These are for average conditions. For light material \$4.50 per day could be saved for the No. 1 wheeler by having the drivers hold their own scrapers, while for heavy clay, a three- or four-horse snatch team with an extra man to hook and unhook would be needed for the No. 3, instead of the 2-horse team. Four horses might also be needed for the plow team.

Scrapers are used to some extent for loading cars and wagons through a platform, over which the teams are driven and the material dumped through an opening. (See § 25.)

22. Maney Scrapers.—These are four-wheeled scrapers¹ with

¹ Maney Mfg. Co., E. St. Louis, Mo. Barron and Cole Co., New York. Cost about \$250. Dec., 1911.

scoops having a normal capacity of about a cubic yard. The front wheels are 30-in. gage and turn under the side frames, which are arched to clear, as shown in Fig. 7. The rear wheels are large and do not track with the front ones.

The rear end of the scoop is suspended from the frame by short chains. The front end has a bail pivoted to the bottom corners with chains passing over a shaft carrying sprocket wheels driven from the rear axle, a clutch enabling the shaft to be thrown in or out of gear. The driver sits at the rear and handles the levers for controlling the scoop so that no extra men

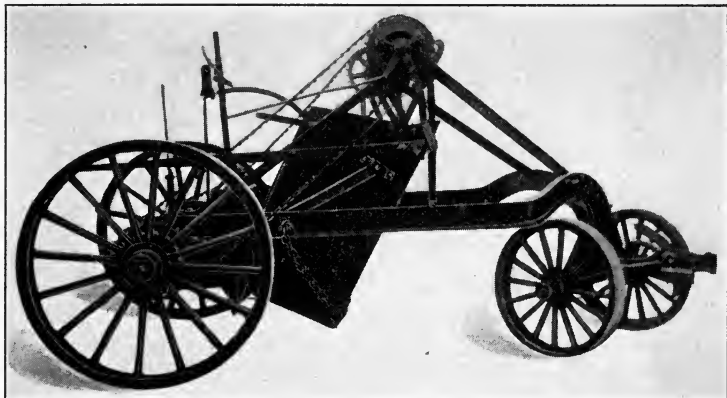

FIG. 7.—Maney Scraper.

are required in loading, dumping or spreading. In loading, the forward end of the scoop is lowered, an end gate at the rear retaining the material. When loaded the front end is raised by throwing in the clutch which is released automatically when the scoop is level. For dumping, the chains are wound still farther, thus tilting the scoop backward and allowing the material to slide out clear of the end gate. The material can be dumped in a heap or spread as desired.

From two to four horses handle the machine, according to the work and the roads, but a four-horse snatch seam is generally used in loading. Hard ground should be plowed unless a traction engine is used in loading.

Wells Brothers, contractors of St. Louis, state that on the South Branch Canal of the Klamath irrigation project in Oregon (U. S. Reclamation Service), *Engineering News*, Vol. 63, p. 592,

1910, the 170000 cu. yds. handled cost 14 cents per cubic yard, including the cost of moving to and from the work which amounted to about \$2000.

From original surface to top of dyke averaged about 14 ft. The canal was built in the embankment and the bottom of the finished canal was 8 ft. above the original surface of the ground. The entire embankment went up in 6-in. lifts, each lift being sprinkled. The specifications called for rolling each lift with a grooved roller, but they were not enforced as it was found that the wheels, not tracking, packed the material better than the roller, as they would reach the low places which the roller would not touch.

The average haul was 400 ft. from pit to dyke. After 18 ins. were removed from the borrow pit, hardpan requiring eight to ten head to plow was met with and this continued to the bottom of the pit, or for 5 ft.

Assumed cost of plowing per day:

Nine horses at \$1,	\$9.00
Four men, two to drive, two to hold,	6.00
Total,	<u>\$15.00</u>

If 180 cu. yds. were plowed, § 13, this would give 8.3 cents for plowing the hardpan, while the cost of moving to and from the work as given above was about 1.2 cents. Assuming 77 per cent. hardpan would give about 6½ cents for the scraper work proper for the haul of 400 ft.

At Las Animas, Col., an irrigation canal, 50 ft. wide and deep enough to carry 5 ft. of water, was excavated by W. A. Colt & Sons with Maney scrapers, Engineering-Contracting, Vol. 35, p. 619, 1911. The material was a hard adobe clay which was loaded at first with a snatch team and later with a traction engine and cable. The cost of the team outfit as given was:

Four scrapers at \$260.00,	\$1040.00
Twelve animals, including four on snatch team,	3000.00
Total,	<u>\$4040.00</u>

COST OF OPERATION WITH SNATCH TEAM

Twelve animals, feeding per day,	\$9.00
Four men on machines at \$2,	8.00
One pitman,	2.50
One dumpman,	2.50
One snap man,	2.50
Total,	<u>\$24.50</u>

With this outfit and an average haul of 250 ft., 600 loads of 1 cu. yd. each were handled per day of 10 hours, costing about 6 cents per cubic yard.

The driver sat in front, where he could better attend to the team and did not load or dump as indicated in the description of the machine.

The use of the traction engine increased the cost of the outfit to \$5040. The traction engine remained stationary in loading. A horse was used to drag the cable from the engine to the farthest point for loading and the cable was then wound in on the drum of the engine as each scraper load was taken.

The cost of operation with the engine in place of the snatch team was as follows:

Four men on machines at \$2,	\$8.00
Eight animals, feeding per day,	6.00
One dumpman,	2.50
One pitman,	2.50
One snap man,	2.50
One cable man,	2.00
One clutch man,	2.00
One engineman,	3.00
Coal,	5.00
Haul of water,	2.00
Total daily expense,	<u>\$35.50</u>

With this method about 1000 loads per 10-hour day were averaged on a 250-ft. haul, costing about 5 cents per cu. yd.

One cubic yard, scoop measurement, per load would give about $\frac{3}{4}$ cent per cubic yard, place measurement, per 100 ft. of lead as the cost of hauling. This would give for the cost of labor, superintendence and maintenance as determined from these two pieces of work, for loading, transporting and dumping, approximately as follows:

To a fixed cost of 4 cents add $\frac{3}{4}$ cent for each 100 ft. of lead.

It should be noted that the above rule is obtained from only two pieces of work both for irrigation. Irrigation suggests a dry climate and good roads for construction during the working season, conditions which do not always prevail in the East.

The price for labor and teams averages about \$1.50 and \$3.50, respectively, for the Colorado work, with snatch team, but it is a little more with the traction engine.

None of the scrapers work well in very stony ground, especially if the stones are flat.

23. Elevating Graders.—Earth may be loaded into wagons or wasted directly alongside as in ditch work, by means of the elevating grader,¹ Fig. 8. The machine is hauled by horses or traction engine. The plow turns the dirt onto the transverse belt which delivers it into wagons if to be hauled or onto the ground if wasted.

To load well onto the belt, the material must be fairly free from stones and roots and have some cohesion. There must be plenty of room for handling the machine and for loading the wagons if used.

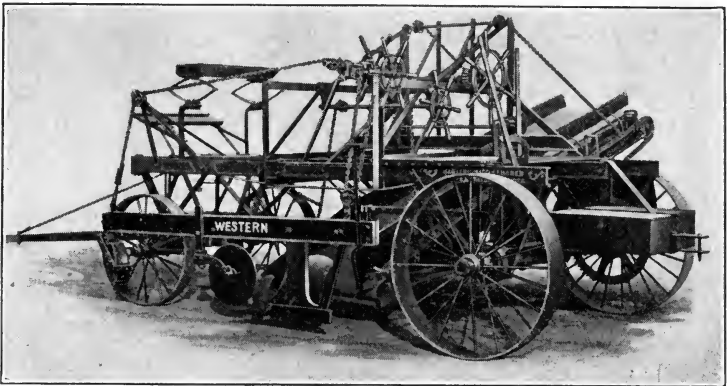

FIG. 8.—Elevating Grader.

An analysis of the cost of moving earth with elevating graders and dump wagons for the Stanley Lake Dam, near Denver, Colorado, is given in the *Engineering Record*, Vol. 60, p. 659, 1909. The material handled was largely surface soil and clay, underlaid by a thin stratum of sand and gravel. It was moved about 1000 ft., in $1\frac{1}{2}$ -cu. yd. dump wagons over a fairly level surface and put into dikes having a finished top width of 30 ft. and a height of 30 at the lowest point of the valley crossed. No snatch team was necessary in pulling onto the dikes.

In computing the cost of labor, the wages paid were increased 50 cents per day per man for board, when furnished, including

¹ Western Wheeled Scraper Co., Aurora, Ill. Cost about \$1000. Dec., 1911.

Sundays. Feed for the horses and mules was calculated at 82 cents per head per day, also including Sundays. No depreciation was charged on stock. The regular working day was 10 hours.

The work was done in the summer and autumn, when there was little interference from rain. A plow was necessary for loosening in some cases. Three elevating graders were used, while most of the work was in progress, one drawn by a traction engine, one by 12 head of stock (horses or mules) and the other by 14 head. The traction engine did not work to advantage on account of bad water for the boiler and slippery ground for traction part of the time.

The standing force distributed over the entire work, was made up as follows:

	Cost per day.
One walking boss at \$125 per month, plus board,	\$5.31
One foreman at \$100, plus board,	4.34
One foreman at \$75, plus board,	3.38
One timekeeper at \$75, plus board,	3.38
One blacksmith at \$60, plus board,	2.81
One blacksmith's helper at \$1.75 per day,	1.75
Two corral men at \$45 per man,	4.46
One water boy at \$1.75 per day,	1.75
Total per day,	<u>\$27.18</u>

The dump wagons cost \$3.64 per 10-hour day for two horses and driver and \$4.46 per day when three horses were used, including 25 cents for depreciation in each case. For a lead of 500 ft., 7 wagons were found to give greatest efficiency. For each additional 100 ft. it was considered that one wagon should be added. The average load was considered to be $1\frac{1}{4}$ cu. yds. as measured in the embankment.

The 12-horse grader force was made up as follows:

	Cost per day.
Elevator man at \$45 per month, plus board,	\$2.43
Pilot man at \$35 per month, plus board,	1.85
Plowman at \$45 per month, plus board,	2.23
Push man at \$30 per month and board,	1.65
Dumper at \$2 per day,	2.00
Feed for 12 head of stock,	9.84
Depreciation,	1.50
Total per day,	<u>\$21.50</u>

Similarly for the traction engine and grader; engineman, \$4.27; fireman, \$2.74; pilot man, \$1.78; plowman, \$2.16; dumper, \$2:

Total per day,	\$12.95
Fuel, 1½ tons at \$3,	4.50
Hauling water,	3.44
Hauling coal,	1.72
Oil and depreciation,	3.50
Total per day,	<u>\$26.11</u>

For August and September the average cost per cubic yard for the traction engine was 13.7 cents.

The wagon hours per cubic yard were about .164 and the average haul about 960 ft. Cost of hauling at 36.4 cents per wagon hour equals 6 cents. This would give the following for the cost per cubic yard, bank measurement, including field expenses, depreciation and repairs:

To a fixed cost of 7.8 cents add .62 cents for each
100 ft. of haul.

A similar analysis for the horse-drawn machines for August gives the following:

To a fixed cost of 7.4 cents add .64 cents for each
100 ft. of haul.

In estimating haul, allowance must be made for the extra travel required in following up the grader to load and in loading and turning.

As an example of high cost, due in part to unfavorable conditions, D. J. Hauer, Engineering-Contracting, Vol. 25, p. 104, 1906, gives the following average costs per cubic yard for seven railroad jobs.

Loading,	10.0 cents.
Hauling, average lead 800 ft.,	12.7 cents.
Dumping,	2.9 cents.
Water boy,	0.2 cents.
Foreman,	1.0 cents.
Total,	<u>26.8 cents.</u>

It is claimed that the management of the work was good except in one case. The wages were \$1.50 per 10-hour day, with \$4.60 for two-horse team and driver and \$6.25 for three-horse team and driver. No allowance appears to have been made for interest and depreciation.

It should be noted that the grader is not well adapted to taking out a railroad cut. The grader and wagon alongside require a width of about 25 ft. which prevents finishing a single track cut without wasting material, and prevents teams from passing while a wagon is loading when the width is less than 33 ft. As the cut narrows, a ridge forms in the center which cannot be reached with the wagon alongside. This material must then be dropped on the side and again picked up for loading.

24. Carts.—The one-horse cart,¹ although not used so much as formerly, is economical for short leads when shovel loading is employed and is convenient in turning and in dumping over the end of an embankment. Five is a suitable number of shovelers for loading, two on each side and one in the rear. They can load a cart with $1/3$ cu. yd. in $2\frac{1}{2}$ minutes, while about 1 minute is required for turning and dumping, making a total of, say, 4 minutes per trip, allowing for turning into place for loading.

A driver can attend to two carts, by dumping one while the other is being loaded, for leads up to 300 ft. For greater leads he can attend to two by taking them both together to the dump. At \$1 per day for a horse and \$1.50 for a driver this would give for 100 ft. of lead per minute and 3 trips per cubic yard:

$7/8$ cent per 100 ft. of lead, driver to 2 carts.

$1\frac{1}{4}$ cents per 100 ft. of lead, driver to 1 cart.

For the fixed cost,

Four minutes per trip,	3½ cents.
Shoveling, § 14, average material,	9 cents.
Plowing, § 13,	2 cents.
Dump, § 15,	½ cent.
Foreman and maintenance,	1 cent.
Total per cubic yard,	16 cents.

This gives for field expenses, except management and maintenance:

To a fixed cost of 16 cents, add $7/8$ cent for each 100 ft. of lead.

With one driver per cart, the 4 minutes will cost 5 cents giving:

To a fixed cost of $17\frac{1}{2}$ cents, add $1\frac{1}{4}$ cents for each 100 ft. of lead.

This is upon the supposition that the number of carts is so

¹ Cost about \$40, Dec., 1911.

proportioned to that of the shovelers that both can be kept busy, otherwise the cost may be much greater.¹

25. Wagons.²—These have an advantage over carts for long leads on account of the larger load, but they are at a disadvantage in turning.

The slat-bottom box used for grading with an ordinary wagon is 3 by 9 by 1 ft. giving a capacity of 1 cu. yd. of loose earth, or about 0.8 cu. yd., place measurement. This is a full load for temporary roads over soft earth and up steep pitches, as in most railroad work. For long hauls over hard roads, as in road improvement and city work, additional side boards are much used, increasing the load to $1\frac{1}{4}$ to $1\frac{1}{2}$ cu. yds., place measurement.

The slat-bottom box has about 3 by 4-in. slats for the bottom and requires a man at the bank to aid the driver in dumping, which takes about $1\frac{1}{2}$ minutes for the 0.8-cu. yd. or 3 minutes for the $1\frac{1}{2}$ -cu. yd. load.

Patent dump wagons are rapidly coming into use and they can be dumped and the bottom closed again for loading without stopping the team.

Enough men should be put in the pit to load a cubic yard in about 5 minutes. This would give at 35 cents per hour for team and driver, 3 cents for loading time, or about 4 cents total for loading and dumping time with slat-bottom wagons. If inconvenient to use so many shovelers an extra wagon may be loaded while the team is going to the dump so that by shifting the lost time can be kept about the same.

If the earth is plowed and shoveled, as in § 24, with foreman and maintenance increased to $1\frac{1}{2}$ cents this would give for field expenses, except management, and maintenance for a speed of 2.5 miles per hour, or 220 ft. per minute when traveling:

To a fixed cost of 17 cents, add $\frac{1}{2}$ cent for each 100 ft. of lead, for loads of 1 cu. yd., place measurement.

For different loads the amount to add for each 100 ft. of lead would be as follows:

Load of 0.8 cu. yd.	add 0.66 cents per 100 ft.
Load of 1 cu. yd.	add 0.53 cents per 100 ft.
Load of 1.5 cu. yd.	add 0.35 cents per 100 ft.
Load of 2 cu. yd.	add 0.26 cents per 100 ft.

¹ See Engineering-Contracting, Vol. 25, p. 63, 1906, for itemized costs of earth excavation on seven different pieces of work by D. J. Hauer.

² Cost of slat-bottom box wagon about \$75, of patent dump wagons from \$90 to \$125 according to make and size. Dec., 1911.

Frequently wagons can be loaded with scrapers dumping through a platform cheaper than with shovels. The following data are taken from Engineering-Contracting, Vol. 27, p. 36, 1907, for the cost of excavating a street of a western city to a depth of about 2 ft., using a plow and drag scrapers.

A 10 by 12-ft. platform was built with a floor of 2-in. plank on 6 by 6-in. stringers high enough to give a clearance of about 7.5 ft. An opening 2 ft. square was left in the center through which the material was dumped automatically by the front end of the scraper catching on a cleat nailed in front of the hole. This aided but did not do away with the dumpman. There were two inclined runways. The approach was steep and soon banked with earth; the run off was on a 15 per cent. gradient. The street gradient was 6 per cent. and the material was hauled down grade an average distance of 120 ft. in direct line. The platform had to be moved from time to time.

The wagon loads averaged 2 cu. yds. in place and a wagon was filled by 12 scraper loads in less than 6 minutes, or at the rate of more than 20 cu. yds. per hour.

The labor cost, except foreman, of loading per hour was as follows:

One plow team,	\$0.40
One man holding plow,	.20
One man holding scraper,	.20
One man at dump,	.20
Five scraper teams,	2.00
Total for 20 cu. yds.,	<u>\$3.00</u>

or 15 cents per cubic yard.

The No. 1 wheel scraper should give better results than the drag scraper for this lead.

26. Steam Shovels.—The standard machine for loading large quantities of material is the power shovel. It is usually operated by steam, but sometimes by electricity. It will handle earth, loose rock and even cemented material without loosening. Solid rock must, of course, be blasted and it will often prove economical to loosen cemented material and loose rock.

The ordinary shovel, Fig. 9, is usually mounted on standard gage trucks and provided with propelling chains. The boom swings through an angle somewhat over 180 degrees.

Jacks outside the tracks are used at the front corners to give a broader base for stability while at work. Some of the smaller

shovels, Fig. 10, p. 43, are balanced on a car and can swing through a full circle. Some of the makers mount these on traction wheels, as shown, for highway and street work, cellar excavation, etc. Shovels with short booms are also made for tunnel and mining work.

The dipper dumps through a door at the bottom and for light material its capacity is sometimes increased by providing an



FIG. 9.—Marion 70-ton Steam Shovel.

extension or lip in front. For hard material dippers are fitted with steel teeth. Heavy machines with smaller dippers than for earth are usual for hard digging and for handling large boulders.

Steam shovels are usually operated by three men, the engineman or runner, the cranesman and the fireman. The engineman controls the raising and lowering of the dipper and the swinging of the boom, while the cranesman regulates the depth of cut or "bite," releases the dipper from the bank when full and dumps the load. Pitmen, usually four to six, prepare for and move the short sections of track forward, operate the jacks and chocks in moving, etc.

An excellent analysis of the cost of steam shovel work and discussion of the factors affecting the same are given in a Handbook of Steam Shovel Work published by the Bucyrus Company, South Milwaukee, Wis., 1911, it being a report by the Construction Service Company, based on records and time studies given in full for forty-five Bucyrus shovels working under different conditions as to material, depth of cutting, size of cars, number of cars in a train, management, etc.

On page 13 a formula is given for cost of loading cars, in cents per cubic yard, place measurement, for shovel work only, including plant expenses, and labor (except superintendence) and materials of field expenses, in which

d = time in minutes to load 1 cu. ft., place measurement.

c = capacity of one car in cubic feet, place measurement.

f = time shovel is interrupted to spot one car.

e = time shovel is interrupted to change trains.

g = time required to move shovel.

L = distance of one move of shovel in feet.

M = minutes per shift less loss for accidental delays.

A = area of excavated section in square feet.

R = cost per cubic yard on cars.

n = number of cars per train.

C = shovel expense in cents per shift.

From these,

$$R = \frac{27C}{M} \left(d + \frac{f}{c} + \frac{e}{nc} + \frac{g}{LA} \right)$$

Using estimated values of C and A and the average values given below (or estimated ones) for the other terms except M and d , a plate of cost curves may be plotted for any value of LA showing the relation between R and d for various values of M .

To estimate C , a \$14,000 shovel¹ is assumed on page 13 of the Handbook with the following data:

	Cost per year
Depreciation, 4½ per cent.,	\$653.34
Interest, 6 per cent.,	840.00
Repairs, when working one shift, ²	2000.00
	<hr/> \$3493.34

¹ Cost of 70-C Bucyrus shovel at South Milwaukee about \$9300. Dec., 1911.

² Willard Beahan, First Asst. Engr., L. S. and M. S. Ry., states that for their 15 shovels the cost per year is from \$100 to \$1000, with an average of

Per year of 150 working days, or \$23.29 per working day,	\$23.29
Shovel runner,	5.00
Cranesman,	3.60
Fireman,	2.40
One-half watchman at \$50 per month,	1.00
Six pitmen at \$1.50,	9.00
One team hauling coal, water, etc., half day, say,	2.50
Two and a half tons coal at \$3.50,	8.75
Oil, waste, etc., say,	1.50
Cost per day, C/100,	<u>\$57.04</u>

The depreciation is found by distributing the difference between first cost, assumed at \$150 per ton, and scrap value, \$10 per ton, over the life of the shovel, assumed as twenty years.

It is stated that "The cost of repairs should be apportioned to the work turned out rather than considered as a function of the age of the shovel. It will be higher for rock than for earth-work and higher for badly broken rock than for well blasted material."

In assuming 150 working days per year, allowance has been made for bad weather, lack of continuous work, transportation of plant, etc. The actual number will be greatly affected by local conditions.

The fuel consumption assumed for the heavy shovel used checks fairly well with some data given by Gillette, Handbook of Cost Data. His values for coal and water per 10-hour day vary from $3/4$ ton and 1500 gals. for a 35-ton shovel with a $1\frac{1}{4}$ -cu. yd. dipper to $2\frac{1}{4}$ tons and 4500 gals. for a 90-ton shovel with a 3-cu. yd. dipper.

The average shovel move, L , was 6 ft. A varies with the depth and width of cut. For example, values of 250, 500 and 1000 sq. ft. are used in the Handbook in computing cost curves. The larger the volume, LA , per shovel move the less the cost per cubic yard. The width of cut and L are fixed by the reach of the shovel.

In increasing the depth to increase A , the danger of landslides should be considered as also the height of the loading track if

\$350 each. The ages range from one to twenty-one years, with an average of eight. They repair shovels thoroughly once a year and at no other time. The running repairs are made by the crew on their own time between the annual repairs. A tool car is furnished with appliances for repairs and all the extras liable to wear out or break.

cars are handled in trains alongside the shovel, see §§ 27 and 30. On the other hand if the depth reaches a certain minimum, varying with the material, such that the dipper will not fill in one raise, the cost will also be increased by increasing d , the time required to load a cubic foot.

The time, d , required to load 1 cu. ft. depends upon the material, the depth of cutting, the shovel and the capacity of its dipper, as well as upon the skill and cooperation of the engineman and cranesman. These men must work together perfectly or costs will be seriously affected.

The results of the tests taken, show that the average time to load 1 cu. yd., place measurement, is about $10\frac{1}{2}$ seconds for iron ore, 12 for sand, $18\frac{1}{2}$ for clay and earth and $31\frac{1}{2}$ for rock. These were with average dipper capacities, place measurement, of 1 cu. yd. for rock, $1\frac{1}{4}$ for earth and sand, $1\frac{1}{2}$ for clay and $2\frac{1}{3}$ for iron ore. The average ratios of place measurement to water measurement for the dippers were 0.94 for iron ore, 0.56 for sand, 0.61 for clay, 0.53 for earth and 0.43 for rock.

The time, f , for spotting cars is usually zero, as it is done while the shovel is turning and digging. This is where the train is alongside and moved a car length at a time without switching.

The capacity, c , is taken as 4 cu. yds., water measurement, or 2.5, place measurement, for ordinary contracting work where 10 car trains of side dumping cars are most common, or $n=10$.

The time, e , the shovel was interrupted to change trains averaged 4 minutes.

The average time, g , required to move the shovel averaged 8 minutes. It depends upon the skillfulness and cooperation of the crew and pitmen, and should be done according to a definite schedule, an example of which is given on page 365 of the Handbook.

The time lost by accidental delays, to be subtracted in finding M , averaged about $7\frac{1}{4}$ per cent. for brick clay, $8\frac{1}{2}$ for sand, gravel and iron ore, $17\frac{1}{2}$ for earth, clay and loam from railroad borrow pits and crushed stone from quarries, and 20 for rock cuts on railroad work; with a maximum of about 40 per cent. for borrow pits of earth and 56 for rock cuts. These delays may be due to the condition of the material or to breakdowns or to accidents.

Thus, wet clay often clogs the dipper teeth and sticks in the

bucket. Delays are most frequent, however, in handling rock, especially if it has not been properly broken. Large pieces have to be "chained out" or broken by mud capping or block-holing and blasting, thus seriously delaying the shovel. Small air hammer drills can be used to advantage in block-holing as the hole can often be drilled on the side of the stone away from the shovel and the stone broken by light charges. Every effort should be made, however, to properly break the rock with the original blasts. Holes a few inches too shallow or with the bottoms not properly loaded often leave ridges which must be drilled and blasted before the track for the shovel can be laid.

Delays due to breakdowns should be minimized by keeping duplicate parts liable to breakage on the job and training the men to make repairs quickly. The shovel should be carefully inspected each night and parts liable to break the next day replaced.

It should be noted that the use of the average values of the various factors will give only what may be considered standard cost curves. But estimated values, or actual ones from time studies, are easily used, thus making it possible to vary conditions and determine what plan of operations gives the best results.

The formula shows clearly that delays, either e , f and g , or those which reduce the value of M , increase R , the cost of loading, and they may also increase the cost of transportation. The best efforts of the management should therefore be directed toward reducing these, both by the use of proper general design and plan of operation, and by careful supervision during the progress of the work.

On page 37 of the Handbook, costs in cents per cubic yard, or values of R , are plotted. The means are:

Iron ore,	1.6 range 0.8 to 2.2
Sand and gravel,	1.85 range 0.5 to 3.2
Clay,	2.2 range 1.1 to 3.8
Earth and glacial drift,	2.6 range 1.8 to 3.8
Rock,	4.7 range 1.5 to 12.7

27. Analysis of Cost, Big Shoal Cut-off.—An excellent analysis of cost of steam shovel work on the Big Shoal Cut-off of the C. B. & Q. Ry., by J. C. Sesser, Engr. of Const., is given in Bulletin No. 81, American Railway Engineering Association,

Nov., 1906, also Proceedings, Vol. 8, p. 324, 1907. The equipment consisted of

- One 65-ton Bucyrus steam shovel.
- Two switch engines, weight on drivers, 30 tons.
- Forty-three 5-cu. yd. dump cars.
- One Jordan spreader.¹

The shovel began work April 27 and finished Nov. 2.

Total number of 10-hour day and night shifts worked,	228
Shovel laid up, due to rain or Sundays (shifts),	57
Delayed, account moving shovel or failures (shifts),	23
Waiting for grading temporary tracks,	11
Percentage of days of shovel service, shovel delayed,	25
Cubic yards handled,	251711
Cubic yards per car,	335
Cubic yards per shift,	1104

The length of lead averaged $1\frac{1}{2}$ miles. The material was dumped from a temporary trestle and it consisted of wet clay taken from a wet cut of an average depth of 15 ft.

SUMMARY OF COST

	Total	Per cu. yd.
Equipment, etc.,	\$ 2732.71	\$ 0.010
Steam shovel and train service,	22350.99	.089
Temporary trestle,	9007.80	.036
Track and trackwork,	12438.42	.050
Supervision and engineering,	610.38	.002
Total,	\$47140.30	\$0.187

The scale of wages for the day shift was: per hour, trackmen and dumpmen 16 cents, pitmen 19 cents; per day, enginemen \$4, firemen \$2.40; per month, watchman, timekeeper and pumper, \$45, assistant foreman and shovel fireman \$55, track foreman \$75, cranesman \$90, shovel engineman \$125.

The equipment included the water supply, bunk houses for the men, 10 per cent. depreciation on the value of the second-hand shovel and cars and 5 per cent. on the spreader and the second-hand switch engines.

The trestle was 2961 ft. long and of an average height of 40 ft.

¹ The Jordan spreader, O. F. Jordan Co., Chicago, Ill., is used in double tracking, raising or widening banks, clearing snow, etc. It consists of a heavy flat car provided with wings, hinged in front and controlled by air for height, inclination with the horizontal and angle with the car, the extreme range being about 22 ft. horizontally from the rail. The standard gage 80000-lb. capacity costs about \$5000. Dec., 1911. The Western Wheeled Scraper Co. makes a lighter spreader for standard and for 3-ft. gage.

It was built of second-hand material, except the bracing, and to carry a loaded train of 5-cu. yd. dump cars. The stringers were recovered and the balance of the material left in place. Mr. Sesser believes that the cost could have been materially reduced had 12-cu. yd. cars been used.

At times the cars were loaded on a track 9 ft. higher than the shovel track, with the track centers 22 ft. Loading at this height was slow and there was danger of wrecking the cars on account of lack of clearance for the empty dipper. Seven feet difference in elevation between the shovel and loading tracks allows rapid work and gives better results.

The force required for the shovel consisted of an engineman, cranesman, fireman and six pitmen, with a general foreman for the entire work.

The total cost for loosening and loading (not including spotting cars) would be about as follows:

Depreciation, 10 per cent. of \$5000,	\$500.00
1040 tons coal at \$1.48 per ton,	1539.20
Labor,	6228.54
Water, assumed 1/2 of total,	136.30
Bunk houses, 1/3 of total,	381.62
Oil, etc., assumed 1/2 of total,	481.31
Superintendence and engineering, assumed 1/2 of total,	305.19
Total,	<u>\$9572.16</u>

Dividing by 228, the total number of shifts actually worked, cost per shift, \$41.98.

Dividing the cost per shift by the cubic yards per shift, 1104, cost per cubic yard, 3.7 cents, for loosening and loading, and this apparently covers plant expenses, except interest, and field expenses.

28. Steam Shovels for Light Work.—For light work or for loading into wagons or small cars a small shovel is often preferable. It is estimated, for example, that the Thew 13-ton full swing shovel¹ with traction wheels and 5/8-cu. yd. dipper, Fig. 10, can be operated for \$13.50 per 10-hour day, as follows:

Engineman,	\$ 5
Fireman,	2
Two pitmen,	3
Fuel at \$4 per ton,	2
Supplies and repairs,	1.50
Total,	<u>\$13.50</u>

¹ Thew Automatic Shovel Co., Lorain, O. Cost about \$3750. Dec., 1911.

It is claimed that it will excavate some 35 cu. yds. per hour in ordinary soil, while if the engineman does his own firing and but one pitman is used the cost can be reduced to about \$7 and the capacity will be about 25 cu. yds. per hour.

Allowing 1 minute delay per load in getting the one-cubic yard wagons into place and a little extra time for moving, this would give 20 cu. yds. per hour, or 200 per day for the full crew. Divid-

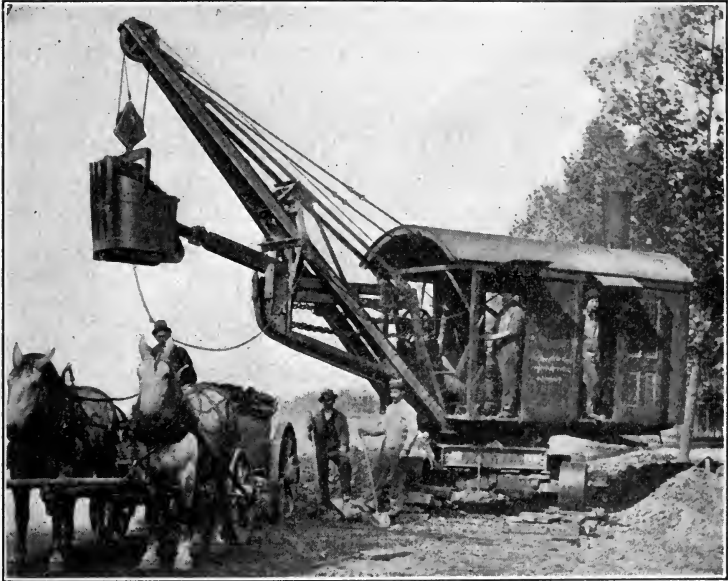

FIG. 10.—Thew Shovel.

ing \$13.50 by 200 would give $6\frac{3}{4}$ cents per cubic yard for loosening and loading. This does not include delays, depreciation or interest.

In *Engineering-Contracting*, Vol. 25, p. 107, 1906, a record is given of cellar excavation in New York City where 2-cu. yd. wagons were loaded with one of these shovels with 5 dipperfulls each, in a little more than 3 minutes where the shovel turned 180 degrees to dump. It took $1\frac{1}{2}$ minutes for the wagon to drive in and out, giving a total of 5 minutes per load, or 120 loads per day, when work could be carried on continuously. The wagons were heaped on account of the material having to be disposed of

by barges at so much per wagon load regardless of size. They were assumed to carry 2 cu. yds., giving 240 cu. yds. per 10-hour day. The cost, including three pitmen, was \$14.50 per day with no allowance for supplies and repairs. Placing these at \$1.50, as in the above estimate, would give 6.7 cents per cubic yard, with no allowance for delays, interest and depreciation.

The shovel began at the surface and dug an inclined roadway down to grade some 9 to 10 ft. below the curb. This was used by the wagons until the remainder of the cellar was excavated, when a timber trestle was built, excavation completed, and the shovel brought out under its own power. Three-horse teams were used.

In loading wagons or small cars with a shovel the desirability of loading through a platform or hopper has been suggested. It would save time in waiting for wagons and save cost in scraping up material spilled over. The hopper would have to be portable and an attendant would be required to operate the gate. For description of one used in cellar excavation, see *Engineering-Contracting*, Vol. 28, p. 331, 1907.

29. Drag Line Excavators.—In one type the bucket is operated by a locomotive crane and its reach on either side of the track is limited by the length of the boom. This can be used for excavating a cut and wasting on the side or loading into wagons or cars or for making an embankment from side ditches. In the other type the bucket is operated by a hoisting engine which may be either fixed or placed on a car. The reach is extended to from 1200 to 1500 ft. by anchoring a pulley through which the rehauling or hauling line is passed and dragging the bucket along the ground, loading toward or from the engine as may be desired, the former being preferable. An inclined plane or loading platform is necessary for loading cars.

A description of the Page bucket used with the crane will show the method of control. The hoisting line passes over a pulley at the top of the boom and is attached to the bail which supports the closed or rear end of the bucket, Fig. 11. The drag line comes out from near the bottom of the boom and ends in a ring from which chains run to the bottom corners of the open end, while a short length of cable runs from the ring to a pulley at the top of the bail and down to a chain sling across the open end of the bucket. When the drag line is taut the sling supports the open end of the bucket, when loose the bucket dumps. For

descriptions of buckets used with the other type with rehauling lines instead of hoisting lines, see *Engineering News*, Vol. 52, p. 349, 1904; Vol. 55, p. 119, 1906; Vol. 57, p. 324, 1907; *Engineering-Contracting*, Vol. 35, p. 476, 1911.

The T. A. Gillespie Co., on the Barge Canal at Palmyra, N. Y., put a Brown hoist locomotive crane with 50-ft. boom at work digging a channel 60 ft. wide on top with an average depth of about 10 ft. and a length of 2600 ft. *Engineering-Contracting*,

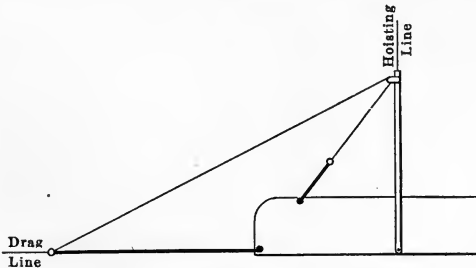

FIG. 11.—Page Scraper Bucket.

Vol. 35, p. 556, 1911. During the first 12 working days about 6000 cu. yds. were excavated according to the state engineer's estimate. There were two crews employed, each made up as follows:

One engineman at \$100 per month.

One fireman at \$50 per month.

Four laborers at \$1.60 per day.

A standard Page bucket of 1 cu. yd. capacity was used. The material was a yellow clay for about 5 ft. in depth with gravel and blue clay below. The average cost has been about 9½ cents per cubic yard, the material being wasted on the side. This probably covers the labor, except foreman, and supplies of field expenses, but not plant expenses as the crane was purchased for handling concrete.

A detailed estimate of cost for a lead of 400 ft. with a 3-cu. yd. dipper was given in *Engineering News*, Vol. 52, p. 349, 1904. The cost of plant was placed at \$3700, the cost of operation, including interest, depreciation, repairs, labor and supplies, at \$30.51 per day, and the cost per cubic yard 7.53 cents.

30. Hauling with Cars and Dinkey Locomotives.—On new construction this is the standard method of hauling material excavated with steam shovel. The usual gauge is 3 ft. The cars

are side dump of 3 or 4 cu. yds. capacity¹ the latter weighing about 6000 lbs. The dinkey² weighs from 8 to about 30 tons, all on drivers. This light weight allows the use of rails of from 16 to 40 lbs. per yard. With 5-ft. ties about 6 by 6 ins. in section, it makes a light track which can be easily shifted at cut or dump as required.

The rolling friction on this light track is from 20 to 30 lbs. per ton and probably more in starting on dirty track. The dinkey can exert a pulling force of about one-fourth of its weight. The

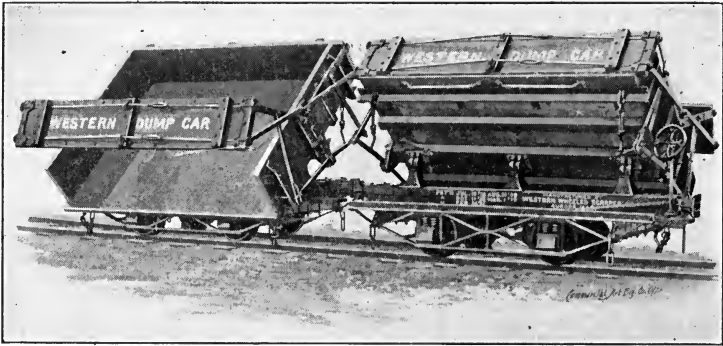

FIG. 12.—Western Four-yard Car.

¹ Western Wheeled Scraper Co., Aurora, Ill. Cost of 4-cu. yd. 3-ft. gage, side dump car about \$175; of 3-cu. yd., about \$165. Dec., 1911.

² Davenport Locomotive Works, Davenport, Iowa. Cost of 4-wheel connected saddle tank; 9-ton, about \$2500; 18-ton, about \$3000; 4-wheel engine with 8-wheel tender, about \$8000. Dec., 1911.

The following rental rates were quoted by an equipment company, July, 1911.

Four-cu. yd. 3-ft. gage Western cars,	
First month,	\$ 10.50
Second month,	10.20
Third to fifth month inclusive,	9.60
Sixth to eighth month inclusive,	9.00
Each month thereafter,	8.40
Twelve-ton dinkey,	
First month,	\$141.00
Second month,	132.00
Third to fifth month inclusive,	117.00
Sixth to eighth month inclusive,	101.00
Each month thereafter,	93.00

speed is about 5 miles per hour when loaded and 8 to 9 when empty or on down gradients with smooth track.

If the gradient onto the fill can be limited, say to 6 per cent. by slight grading and blocking, it will be as cheap to raise and shift the track as to build a light trestle. The trestle can usually be built of round timber, two posts per bent, with sawed stuff for stringers, or possibly stringers and bracing. The locomotive is kept at the rear and not run onto the trestle.

In order to take out the whole section of a deep through cut without breaking up the train in spotting cars, the first cut is taken through inside the slope stakes so as to partially undercut the side slope. The return cut is taken next to it and the process repeated until the other slope is reached, as shown in Fig. 13.

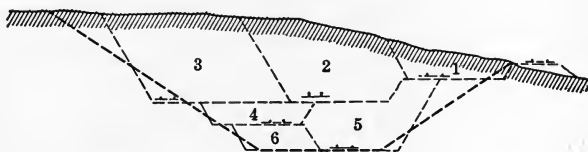

FIG. 13.

For each new cut, the loading track is moved into the preceding shovel cut.

If the loading track can be laid outside the first cut on a 6 per cent. gradient or less by slight grading and blocking, the shovel can load direct into the cars. If not, the shovel can waste inside the cut where the material will be loaded on the return cut, or some other method may be used in making the first cut or for disposing of the material.

The depth of cut should be varied to reduce the gradient, the greatest with the shovel on the bottom of the trench being fixed by the clearance required under the dipper for the open door to clear the cars. This depth can be increased by the amount the dipper will cut below the shovel track by carrying this track on blocking. The shovel track is in short lengths, 6 ft. being common, and requires blocking up level when the shovel is working to allow the dipper boom to swing freely.

If through cutting becomes necessary a side track can be laid behind the shovel and each end connected to the running track to receive the train of empties. These cars can be spotted one by one opposite the shovel, using a horse, and the loaded

ones pulled beyond the switch to make up the loaded train for the dump. If the shovel is cutting on both sides so that there is room in the cut, a similar loading track on the other side will allow of spotting a car on one side while loading on the other, Fig. 14.

In grade reduction where a cut must be deepened under traffic, if the running track can be used for loading, the shovel can be started at one end on the side and kept to the new grade until prevented by clearance in loading when the distance below track would be constant until the new grade is again reached. After

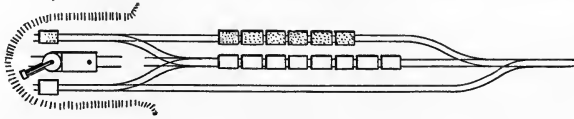

FIG. 14.

cutting through, track would be laid and connected at the ends with the old running track. The old track would then be taken up and the shovel in returning could cut lower where required on account of loading on a lower level.

For heavy traffic it would be more economical to build a loading track on one side, 3-ft. or 30-in. gage, possibly shifting the regular track to make room. The first cut would then be outside the new track; the new track would then be shifted and the second cut taken between the new and old tracks. This second cut would make a place for the old track when the other side of the cut could be excavated.

It is readily seen that each steam shovel cut is a special problem requiring careful study to decide where and how it is best to cut in, what depth of cut to take and what arrangements to make for hauling the material.

One dinkey is often used with a $1\frac{1}{2}$ -cu. yd. shovel for leads up to 1000 ft. With six cars and three or four dumpmen the train can be dumped in about two minutes so that good results can be obtained. For longer leads, a second engine would be required for spotting cars, with cars enough for two trains, one dumping while the other is loading. The length of train and weight of engine should increase with the lead when the work is heavy enough to warrant it.

In § 27 the cost of equipment and steam shovel service for the Big Shoal Cut-off is given as 9.9 cents per cubic yard, while

that for the shovel was computed from the data given at 3.7 cents. This would leave 6.2 cents for train service for two 30-ton engines and 43 5-cu. yd. dump cars handling 1101 cu. yds. per day, average lead $1\frac{1}{2}$ miles. This cost would not be appreciably affected within the limits of 1000 ft. and 2 miles, the upper limit of lead for this train with 1100 cu. yds. per day.

The cost for temporary trestle is not affected by lead but depends on height and length of fill. It is claimed by Mr. Sesser that the cost per cubic yard of fill for heights from 20 to 60 ft. is nearly constant.

The cost for track labor is given at \$11582.31 and that of track supplies \$7338.76, but only \$856.11 of this was charged up, being depreciation and actual cost. This would give a fixed cost of about 2 cents per cubic yard and about 2 cents per cubic yard per mile of lead, but the item is quite variable.

Had the trestle not been used a percentage of its cost of 3.6 cents per cubic yard would have to be added to trackwork for the extra grading and shifting made necessary.

After the roadbed has been graded and the materials delivered, track with 30-lb. rails can be laid for about \$100 per mile and taken up and reloaded for one-half as much.

31. Hauling with Cars and Horses.—The 2-ft. gage 1-cu. yd. capacity cars¹ weigh about 1000 lbs. each and the $1\frac{1}{2}$ -cu. yd. cars about 1350, so that one horse can draw 3 loaded cars if favored slightly by the gradient for the heavier cars. Fifteen to 20-lb. rails are heavy enough, with plank or round timber ties. A side track is put in at the cut and two trains are used the same as for dinkey engines. For hand loading both tracks should extend into the cut and be used alternately to save work in switching. Allowing the driver six minutes for dumping and one minute at the cut, the fixed cost, at \$1.50 for the driver and \$1.00 for the horse, would be 1 cent per cubic yard for the heavier cars, 1 cu. yd. place measurement, while the cost per 100 ft. of lead would be 0.14 cent, giving for the cost of hauling per cubic yard:

To a fixed cost of 1 cent add 0.14 cent for each
100 ft. of lead.

For level or slightly rising track, requiring the 0.8 cu. yd., place measurement, cars, this would become:

¹ Ernst Wiener Company, New York. Cost for 1-cu. yd. capacity car about \$60, for $1\frac{1}{2}$ -cu. yd., about \$75. July, 1911.

To a fixed cost of $1\frac{1}{4}$ cents, add 0.18 cent for each 100 ft. of lead.

This assumes a dumping trestle and no trackwork or depreciation. The trackwork would cost much less than for the shovel and dinky, especially at the cut. One cent plus 0.2 cent per 100 ft. of lead should cover ordinary conditions. With no dumping trestle $1\frac{1}{2}$ cents per cubic yard should be added for spreading and about 1 cent for extra shifting of track. This would give for the cost of transportation:

To a fixed cost of 4.5 cents add 0.34 cent for each 100 ft. of lead, or

To a fixed cost of $4\frac{3}{4}$ cents add 0.4 cent for each 100 ft. of lead, according as 3 or 2.4 cu. yds. are hauled per train.

To this must be added the cost of loosening and loading.

For longer leads a 10-car train with three horses may be used. This will require a man to aid in dumping, while if the work is a through cut extra switching will at times be required on account of the difficulty of getting the whole train length into position for shoveling. Assuming 10 minutes time dumping and switching, the cost would be about the same as for the three-car train. The advantage would be in keeping up the daily output for long leads without an excessive number of trains. Loading can be done by steam shovel if desired but not so economically as with larger cars unless the work is light. If a dumping trestle is used a pulley should be attached to it and the train drawn out by the team walking toward the cut. When the train is drawn back, the rope is unhitched at the end of the solid fill in position for use for the next train.

The aerial dump is sometimes used for supporting the track in making fills. One at Andover, N. J., F. E. Cudworth, Engineering-Contracting, Vol. 34, p. 58, 1910, for a fill 2400 ft. long had three wooden towers, one at grade, 60 ft. high and two 150 ft. high with tops 100 ft. above grade. These supported a cableway with two spans, one 1000 and the other 1200 ft. long. The cradle which carried the track was suspended from the main cables by U plates and wire rope hangers, which could be moved forward and adjusted as the fill was made.

The total cost of dumping and placing the material in the embankment, including the erection of the aerial dump, all building material left in place and depreciation on that recovered, was placed at 4 cents per cubic yard.

32. Steam Shovel and Standard Equipment.—Standard gage flat cars and ballast cars are used on maintenance work in widening cuts and fills, filling old trestles, reducing gradients, distributing ballast, etc. The flat cars are unloaded by a plow drawn by cable. This can be done by setting the brakes on the train and attaching the locomotive to the cable, by attaching the cable to the track and starting up the train, or by using an engine with winding drum on the front car, steam being taken from the locomotive. The first method distributes the load over the train length, the second concentrates it, while the third is flexible as the motion of the plow is independent of that of the train. Aprons between the cars prevent the material from dropping onto the track. A center timber bolted along the floor serves as a guide for a center plow dumping on both sides, while a sideboard held by the usual stakes, serves when a side dumping plow is used.

The flat car without sideboards or with a sideboard on one side is lower than the ordinary ballast car and hence is better for hand loading.

The ballast or patent dump cars are dumped through doors operated by air from the brake system. For the heavy cars, inclined floors rather than tilting bodies make them self cleaning. The capacities of the flat and ballast cars range from 10 to about 30 cu. yds.

The cost of loading with steam shovel and hauling on good track with large cars is less than with the small cars and poor track used on new work, provided the forces can be so adjusted as to keep all busy.

Usually, however, the work must be done subject to interruption from traffic so that a careful study of conditions must be made in order to estimate costs.

W. Beahan, First Asst. Engr., L. S. & M. S. Ry., in a letter dated October, 1911, places the cost of their grading for third and fourth track, using standard equipment and a haul not exceeding 5 miles, including loading, hauling, unloading and leveling ready to lay the ties about as follows per cubic yard:

Borrow pits or cuts with 15-ft. face,	\$0.11
Earth cuts, 3 to 10 ft. deep,	.15
Shale cuts, all blasted,	.21
Other rock cuts all blasted and requiring breaking up by blockholing,	.25

This includes labor and supplies as follows:

Foreman per month,	\$75.00
Laborers per hour, 10-hour days,	0.15
Steam shovel crew, 8 men per 10-hour day,	25.00
Train service, labor and supplies per day,	28.00

Interest, depreciation, explosives and overhead charges are not included. The repairs for shovel probably are included as the labor was performed by the shovel crew.

Mr. Beahan states that, in moving a short distance where overhead obstructions will allow, they sometimes let the dipper rest on a flat car, remove the jack arms and haul the shovel with the work train. But that usually it is best to take the shovel down even for moving a short distance, and they estimate that it will cost \$100 to take a shovel out of one cut and put it in another, although they can occasionally do it for \$50.

A. J. Himes, Engr. of Grade Elim., N. Y. C. & St. L. R. R. Co., gives the cost of moving a shovel about 3½ miles through the City of Cleveland in August 1911 as follows:

Labor:	
Taking down,	\$23.26
Moving,	49.11
Setting up,	23.27
	<u>\$95.64</u>

Work train service:	
Placing cars to load parts and helping to take down,	\$10.20
Moving shovel and bunk cars,	8.50
	<u>18.70</u>
	<u>\$114.34</u>

The cost of shipping the above shovel from Ashtabula to Cleveland and setting up in April, 1909, is given as follows:

Freight: Shovel and three cars at \$19.50,	\$78.00
Boarding car and tool car at \$22.50,	45.00
Lost time shovel crew,	8.84
Setting up shovel,	31.47
	<u>\$163.31</u>

On new work, the cost of moving from the railroad to the site would be in addition to that of setting up, or taking down and setting up, as above. This may be over highways or across country. A track is required with force sufficient to take up and move forward ahead of the shovel. The shovel can be moved

with its own power if the gradients are not too steep. If too steep for adhesion, one end of a rope can be anchored ahead, the other end wound around the driving axle and the running gear started.

No general estimate of cost can be given on account of the variation in conditions. On page 118 of the Handbook of Steam Shovel Work, it is stated that a 70-ton shovel was moved 1600 ft. in 8 hours by the shovel crew, 16 men, foreman and one team at a total cost of \$34 or 2.12 cents per foot.

REFERENCES

Earthwork and its Cost, 1903. Handbook of Cost Data, 1910. H. P. Gillette.

Earth and Rock Excavation. Charles Prelini, 1905.

Steam Shovels and Steam Shovel Work. E. A. Hermann, 1894.

The Chicago Main Drainage Canal. C. S. Hill, 1896.

Comparative Cost of Earthwork. A. P. Davis. Eng. Rec., Vol. 57, p. 628, 1908.

Depreciation Allowances on Equipment for Construction Work, U. S. Gov. Depts. Eng. News, Vol. 62, p. 621, 1909.

The Cost of Steam Shovel Work in Railway Betterment. S. T. Neely. Eng. News, Vol. 56, p. 142, 1906.

Methods of Constructing a Ninety-five-foot Fill across Papio Valley on the Union Pacific Railway; a Comparison of Costs of Excavation by Old and Modern Outfits. Eng.-Cont., Vol. 35, p. 560, 1911.

Cumberland-Connellsville Connection of the Western Maryland. G. L. Fowler. Ry. Age Gaz., Vol. 50, p. 270, 1911.

Excavating and Conveying Machinery in Contract Work. Eng. Mag., Vol. 28, p. 520. 1905.

CHAPTER III

ROCK EXCAVATION

33. General Methods.—Rock in place may be loosened by pick, bar and sledge, or by explosives. The former method is confined to seamy and soft rock and to trimming to grade and surface, leaving the latter as the standard method for heavy work. Explosives are generally used in drill holes, but sometimes in chambers or tunnels for breaking up large masses.

If the material is finely broken the same methods of loading by hand or steam shovel and of transporting may be used as for earth. For coarsely broken material including one-man and two-man stones, the advantage for hand loading of a skip or low truck onto which the heavy pieces can be rolled is much greater than for earth.

Rock is fully as variable as earth in quality and in the difficulties of loosening and handling. This in connection with the greater unit cost, the more expensive plant usually required and the different explosives available make necessary an even more careful analysis than for earthwork.

This chapter gives the more important methods available with the general principles involved and examples and analyses of cost, but the conditions are so variable that no set of rules will take the place of actual study and experiment by one familiar with such work. Hence the final selection of the method to be used and particularly the design of the plant and layout should never be entrusted to one not experienced in rock excavation.

34. Drilling, General.—Holes are made by giving suitable drills either rotary or percussive motion by means of hand or mechanical power. Rotary motion is used in hand work for boring holes in earth, coal or even soft rock, with augers somewhat resembling those used for wood.

In power drilling, rotary motion is generally used for drills with annular bits fitted with diamonds or steel points for cutting the rock or under which hardened steel shot are used for wearing it away by abrasion. This leaves a central core which may be

raised and examined, thus giving knowledge of the material. This method is used in Europe for tunneling but is not in favor in this country except for prospecting and investigating material for tunnel work, foundations, etc.

Percussive or striking motion causes the more or less chisel-like bit to strike a series of blows and thus chip and pulverize hard material while soft material is simply pushed aside. This method is more commonly used than the rotary for both hand and power drilling.

In percussive drilling, the drill is rotated slightly between blows to make the blow effective and to keep the hole circular. Hand-drilled holes are apt to become "rifled" or three-cornered, especially if care is not taken in starting them. This defect may be serious in quarry work on account of the tendency of the rock to break in the direction of the corners of the hole.

Water is generally used in drilling, except in very shallow holes such as are used for plug and feather work in quarries. In core drilling, it is forced down inside the drill rod and rises on the outside, bringing the powdered rock with it. With percussive drilling of down holes, the water is usually poured in and it serves to keep the powdered rock in suspension, except in some shales where a thick mud is formed which badly cushions the blow. With up holes the dry powder often runs out rather freely, but a water jet could frequently be used to advantage. Some power drills are provided with a jet which discharges at the bit, thus materially increasing their efficiency for both up and down holes. Air jets are sometimes used, especially for small shallow holes.

Aitkin says that the use of water in the hole will reduce the time of drilling trap rock 30 per cent. and Dana and Saunders, *Rock Drilling*, claim that water washout jets will increase the efficiency from 30 to 100 per cent. under normal conditions (power drilling).

Without jets, the sludge must be removed from time to time by the use of a rod with a spoon end or with a broomed stick. Before charging, the hole should be cleaned out.

The influence of the size of hole upon the rate of drilling has never been accurately determined. Some data on experiments with power drills, *Engineering News*, Vol. 51, p. 566, 1904, tend to show that the rate decreases approximately as the 1.8 power of the diameter.

This seems reasonable when we consider that most of the work consists of chipping and pulverizing the rock in the hole, which work would vary, theoretically, with the area, while work is also done in reaming or detaching rock around the circumference, which work would vary, theoretically, as the circumference or diameter.

For loading with the ordinary dynamite cartridge, the hole must have a diameter at the bottom of about $3/4$ in. and the rate of reduction need not exceed $1/8$ in. in 2 ft., even in the hardest rock. This reduction in size may be minimized by careful sharpening, with special attention to the reaming edges. For black powder blasting, holes must be made much larger, unless they are first "sprung" with dynamite.

Bits of hand drills usually have a single cutting edge while those of power drills have two, or more, giving the cross, X, Y, Z, rosette, or other special form. The X bit was designed to prevent rifling, which sometimes occurred with the ordinary cross bit, by making the cutting edges strike in the same place only twice per revolution. Since the introduction of sharpening machines, the cross bit is returning to favor as the machine makes a better cutting edge and properly forms the reaming edges.

The cutting edges may be high-centered, low-centered or flat. For handwork they are usually somewhat high-centered or convex, though the only advantages seem to be in starting a hole and in a slightly lessened danger of breaking off the ears, while there is a disadvantage in the tendency to follow seams. It is easier to form as it approaches more nearly the shape to which a bit wears in service.

The low-centered bit cuts rapidly, but of course wears rapidly as most of the work in drilling is near the circumference of the hole. The ears are also much more likely to break.

The strength of the ears is also affected by the clearance angle, or angle made with the axis, 8 degrees giving a much longer and stronger ear than 16.

In addition to the proper forming of the bit, careful and uniform tempering is necessary requiring a good blacksmith. On large jobs the power sharpener will give better and more uniform results, thus decreasing the cost of drilling as well as of sharpening.

Round or octagonal steel is common for drill rods for handwork while cruciform steel is also used for power drills. The bit may be from 30 to 100 per cent. larger than the rod, depending

upon the rock. Five-eighths to 1-in. stock is used for one-hand hammer drilling while rods up to 1½-in. may be used for two-hand and churn drilling. About the same limits apply to steel for percussive power drills of the various sizes.

35. Hand Drilling.—A rotary drill or auger may be used for boring holes in soft material by hand as mentioned in the preceding paragraph, but hammer and churn drills are the two common means of drilling holes in rock by hand.

In hammer drilling one man may work alone, holding the drill with one hand and striking it with a 4- or 5-pound hammer in the other, or one man may hold the drill and one, two or even three, strike with 10-pound hammers, using both hands. Energy is wasted in compressing the face of the hammer and head of the drill and in internal work. This waste becomes greater as the mass of the drill rod is increased with the deepening of the hole.

In drilling horizontal or up holes, the blow of the hammer is not as effective as for down holes. Gillette quotes the results of Professor Hofer and others showing that the rate of drilling a horizontal hole is a little less than half that of a down hole and that the rate for up holes is still less.

The losses of energy in hammer drilling mentioned above are lessened in churn drilling as the drill itself is raised and is under motion in striking the blow, thus utilizing more of the energy in useful work. Thus churn drilling is more effective and cheaper than hammer drilling for down holes but it requires greater skill, particularly in starting the holes.

For shallow holes and starting deep ones, the short rod would be too light for effectiveness and additional weight is obtained by enlarging the drill rod at the middle, giving what is known as the ball-drill. Two men are used in churn drilling when the rod becomes too heavy for one to handle and for very deep holes a light staging may be built over the heads of the men on the ground to support one or more additional men.

Power drills have been so widely introduced that few data on hand drilling are now published. Gillette gives the following from his observations on hammer drilling 6-ft. vertical holes with three men, one holding and two striking. Starting bit was 1½-in.

	Lin. ft. in 9 hours.	Cost per foot.
Granite,	7	75 cents.
Trap (basalt),	11	48 cents.
Limestone,	16	33 cents.

The cost is based on a rate of \$1.75 for nine hours and does not include cost of sharpening drills, which would add from 5 to 8 cents per lineal foot.

These outputs seem quite conservative though the name given rock in published records often does not indicate its quality and usually many important data regarding conditions are omitted.

The following data on the cost of hammer drilling for open cut work on the Grand Trunk Pacific R. R. were given by Mr. G. C. McFarlane in *Engineering-Contracting*, Vol. 28, p. 301, 1907. Holes were 1½-in. for entire depth, sometimes as much as 30 ft. Three men worked in a gang, one holding and two striking, until the hole was 6 to 8 ft. deep, after which all three would strike, the rebound of the drill turning it sufficiently to keep the hole fairly circular.

The output per gang in drilling 10- to 14-ft. holes in dark hornblende averaged 29 ft. per day, 10 hours, while in red granite and trap and diabase, the averages were 20 ft. and 18 to 19 ft., respectively (depth of hole not given, probably quite variable).

At \$2.25 per 10-hour day for drillers and an average cost of 9 cents per foot for labor and fuel in sharpening, the costs were: dark hornblende, 32 cents, red granite, 42 cents and trap and diabase, 44 cents per foot of hole. Drillers were paid 45 cents per foot, not including sharpening, on part of this work.

Two strikers and one holder averaged 15 ft. per 10-hour day in drilling 7½-ft. holes for a small cut in mica schist on Manhattan Island, New York. Starting bit was 1½-in., and finishing bit 1¼-in. Labor cost of drilling at \$2.00 per day was 40 cents per foot, or, including sharpening bits, as above, say 48 cents per foot, *Engineering-Contracting*, Vol. 28, p. 199, 1907.

Shallow holes used in block-holing large fragments and for plug and feather work in splitting rock in quarries usually cost more per lineal foot on account of time lost in moving from place to place and in selecting rock as well as difficulty in starting the larger number of holes. This work is usually done by one man with a hammer drill though Gillette claims that an expert with a churn drill could do it more cheaply.

On the Grand Trunk Pacific work mentioned above, the output of a gang of three drillers on holes varying from 5 ins. to 5 ft. 8 ins.

in depth varied from 5 ft. 11 ins. to 17 ft. 6 ins. per day and averaged 10 ft. 5 ins. in red granite. The labor cost of drilling was therefore 65 cents per foot and cost of sharpening was 9 cents per foot as before, giving a total of 74 cents, or about 75 per cent. more than for the deep holes.

Gillette gives 50 to 60 5/8-in. holes 2½ ins. deep as a fair day's work in drilling plug and feather holes in granite, including driving the plugs. Assuming 60 holes and a wage rate of \$2.25 as on the Grand Trunk Pacific work, would give a labor cost of about 20 cents per foot for 5/8-in. holes, or 82 cents per foot for 1¾-in. holes if cost varies as 1.8 power of the diameter, § 34. Adding, say 8 cents for sharpening would give 90 as compared with 74 cents for the Grand Trunk Pacific work on which the holes averaged 15 ins. in depth.

For churn drilling, Trautwine gives the following rates for 3-ft. vertical holes, 1¾-in. starting bit, one man drilling and 10-hour shifts.

Solid quartz,	4 ft. in 10 hours.
Tough hornblende,	6 ft. in 10 hours.
Granite or gneiss,	7.5 ft. in 10 hours.
Limestone,	8.5 ft. in 10 hours.
Sandstone,	9.5 ft. in 10 hours.

These large and shallow holes were evidently for black powder blasting. Gillette, Rock Excavation, gives the following data for churn drilling on railroad work in western Ohio, obtained from Mr. W. M. Douglass of the firm of Douglass Brothers, contractors. For 30-ft. holes in blue sandstone, three drillers were used the first day (10 hours) for putting down 18 ft. of hole and four the second day for the remaining 12 ft., giving 70 hours of labor at 15 cents, or 35 cents per foot. In brown sandstone 70 to 80 hours were required. The holes were 2¾-in. at the top and 1½-in. at the bottom. Steam drilling holes 20 ft. deep in the same stone cost 12 cents per foot, including everything except interest, depreciation and drill sharpening.

36. Power.—On inside work for mines and tunnels drills are commonly operated by compressed air, although hydraulic and electric power have been much used in Europe for tunnel work and the latter to some extent in this country. For short tunnels and open work steam is much used and gasoline has been utilized in some cases.

Most drills will operate on either steam or air, and as the exhaust is at nearly full pressure a cubic foot of one is practically equivalent to a cubic foot of the other. Some authorities claim that 10 per cent. greater pressure is required for steam for the same number of strokes per minute.

It requires 1184.3 heat units (BTU) to change 1 lb. of water at 32° F. to 4.9 cu. ft. of saturated steam at a gage pressure of 75 lbs. per square inch.¹ For 100 cu. ft. this would require 24 160 BTU.

For air, 3000 BTU is required for the isothermal compression (constant temperature) of a quantity which will make 100 cu. ft. at a gage pressure of 75 lbs. at 60° F. For adiabatic compression (without cooling), 3890 BTU will be required for the 100 cu. ft. measured at 60° F.²

Water is used for cooling during compression so that the actual BTU supplied would be between the two extremes, while the actual volume used at the drill would correspond to the lower temperature, unless a re-heater is used near the drill.

Using the smaller value would give a ratio of 8 to 1 in favor of compressed air. If, however, a steam engine is used in driving the compressor, the combined efficiency is not much more than 10 per cent. so that the 3000 BTU for the 100 cu. ft. of air would require about 30 000 in the steam used for the engine, thus making the steam drill 20 to 25 per cent. cheaper, neglecting transmission losses which would be greater for steam.

Steam is thus more economical of fuel for compact plants where transmission lines are short and for longer lines where it will pay to lag the pipes, as in more permanent installations. For long pipes, radiation losses are heavy even with lagged pipes, but leakage is more apt to be discovered than with air.

While the use of steam reduces plant and development expenses by saving the purchase and installation of a compressor,

¹ Kent's Pocket-book, 8th ed., p. 840.

² Kent, p. 606. The theoretical HP minutes required to compress 1 cu. ft. of free air isothermally is given at 0.1160, and the compressed volume as 0.1639 cu. ft. With 778 ft. lbs. per BTU and 33 000 ft. lbs. per HP minute, this would give,

42.42 BTU per HP minute,

4.922 BTU for 0.1160 HP minutes, for 0.1639 cu. ft.,

3000 BTU for 100 cu. ft.

Similarly for adiabatic compression, p. 605.

the use of air allows a longer life for the hose; reduces the danger of breakage of the drill parts by unequal expansion; gives exhaust air which aids in ventilation for inside work and is pleasanter than exhaust steam in the open; reduces care of transmission lines in cold weather and, in some cases, avoids the necessity of employing licensed enginemen for drill runners—men who usually know little about placing holes or drilling.

If instead of steam, water or electric power or a gasoline engine is to be used, air becomes a necessity, except with the hydraulic or electric drill. Air may also be convenient for other purposes about the work, as for small hammer drills, removing sludge from holes, etc.

The longer transmission lines made possible by the use of air may allow the location of the power plant at a point more convenient to fuel supply, and thus secure increased efficiency by concentration as well as by cheaper fuel. This is illustrated by the contractor's plant for the Wachusett dam described in *Engineering News*, Vol. 50, p. 467, 1903. One thousand horse power was developed at a central plant one and a quarter miles from the dam and half a mile from the quarry. Air was piped to both and eighty different machines were operated at one time.

For another illustration see *Engineering News*, Vol. 54, p. 679, 1905, where 2400 boiler HP was generated and air was piped the full length of the work, some nine miles.

Gasoline power is sometimes used for operating well-drilling machines and rotary drills, and for compressing air for drills, steam shovels, etc. It often has advantages in portability and cheapness of plant and fuel.

Electric power may be purchased, or generated by hydraulic, steam or gasoline plants for direct application to drills or to drive a compressor plant at a distance from the source of power. It has great advantages for long distances on account of low cost of line and small transmission loss.

Hydraulic power may be used directly in rotary drills, as in the Brandt, § 40.

No figures are available for general application for either hydraulic, gasoline or electric power, but the following table gives results of the use of air, electric and hydraulic power in tunnel driving in Europe. *Engineering-Contracting*, Vol. 35, p. 12, 1911.

System of drill	Rock	Cubic inches rock removed per minute	HP at main shaft
Brandt hydraulic.....	Gneiss,	7.26	45
	Granitic gneiss,	7.08	45
Compressed air.....	Dolomitic limestone,	4.27	25
	Dolomitic limestone and werfen schist,	3.91	14
	Werfen schist,	4.58	15
Electric crank percus- sion.	Limestone, hard, with calcite,	3.85	5
	Gray limestone and werfen schist,	4.70	5

If we consider the limestone to be about two-thirds as difficult to remove as the gneiss and neglect the first case under compressed air we would get the following for the HP per cubic inch of gneiss removed per minute,

Hydraulic,	6.2
Compressed air,	5.1
Electric,	1.8

These results bear out the claims for efficiency of electric power in use and transmission.

The above article gives a comparison of the different methods of which the following is an abstract:—The cost of installation for electric power is relatively low and transmission line can be rapidly constructed. Simplicity of power application and its convenience for lighting are also of advantage. The disadvantages are the high cost of repairs due to the heavy shock of the return stroke and the necessity of having a trained staff to care for the machinery, which gives high operating costs aside from power.

The hydraulic machine on the other hand runs smoothly, hence low repairs, it produces no dust and the power is regulated very simply, while the water spray may be utilized for reducing dynamite fumes. The disadvantages are the large amount of power used and the very high cost of installation, especially if

water under a high head is not available and compression pumps have to be used.

The advantages of air drills are strong percussive action, ease of manipulation, low repair cost, ventilation and cooling of working face, easy removal of chips, possibility of using air for other purposes. The disadvantages are low efficiency and rather high cost of installation.

It must be recognized that cost of power is only one factor and the figures given in the first table show that much more rapid progress is made with the hydraulic drill, showing it to be especially adapted to rapid driving of headings for long tunnels in hard rock, while the other methods give about the same progress in medium rock.

Attempts have been made to combine the advantages of electricity and air by transmitting the electric power and using it to compress air near the working face, using one compressor for about four drills, but no figures are available on the results. Another method is seen in the electric air drill or pulsator in which each end of the drill cylinder is connected by a short hose (less than 8 ft.) to the end of a single-acting air cylinder. The pistons of these air cylinders are connected 180 degrees apart to a shaft driven by an electric motor. In starting the motor, the air pressure in each cylinder falls below atmospheric during a portion of the stroke and a little valve provided will admit more or less air until sufficient is supplied, about 30 lbs. average, but under control of the operator.

No valves are required and no water jackets, while the power required at the power house is from one-third to one-quarter as much for the same work as for an air drill of equivalent capacity.

The above discussion should serve to emphasize the necessity for a careful study of a given case to determine the best method of generating, transmitting and utilizing power, remembering that first costs must often be sacrificed to secure rapidity of construction, particularly in extensive work.

37. Piston Drills.—The percussion rock drill is commonly of the piston type; that is, the drill is rigidly attached to the piston and reciprocates with it. It is usually mounted on a tripod, as shown in Fig. 15, but it is also used on columns, quarry bars and drill carriages.

The crank shown at the top of the drill actuates the feed screw by which the cylinder is moved forward as the hole is deepened.

This feed screw is about 2 ft. long so that the drill rod has to be removed and replaced by a longer one every 2 ft. depth of hole. The rotation of the rod or bit is accomplished automatically on the return stroke.

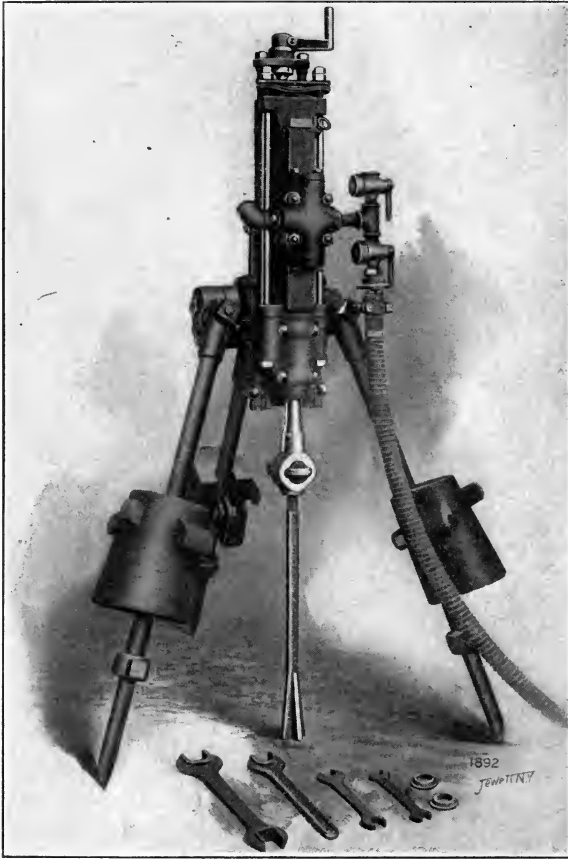

FIG. 15.—Sergeant Rock Drill.

The cost of drilling may be analyzed in much the same way as was the cost of loading with the steam shovel. For this purpose let,

R = cost in cents per foot of hole.

D = depth of hole in feet.

d = time in minutes to drill one foot.

C = cost per shift in cents.

L = length of feed screw in feet.

t = time in minutes to change bits.

S = time in minutes to shift drill and set up.

M = minutes per shift actually worked, *i.e.*, length of shift less time lost through breakdowns, bit sticking in hole, waiting for blasting, mucking, etc.

From these,

$$R = \frac{C}{M} \left(d + \frac{t}{L} + \frac{S}{D} \right)$$

The cost, C , must include interest and depreciation (or rental) of plant and repairs in addition to fuel, water, supplies and labor for operation of central plant and drills.

The cubic feet of air per minute for different altitudes and for different numbers of drills may be taken from the tables of a manufacturer, but the boiler power required will depend upon the engine and compressor as well as upon transmission losses. The two-stage compressor with intercooler is commonly used for large plants but the engines differ greatly in efficiency.

That the plant should be ample to maintain a high pressure at the drills and that transmission lines should be of ample size is well shown by the results of some tests in South Africa quoted in *Engineering News*, Vol. 51, p. 566, 1904.

“The following table gives the average results of thirteen drills having 3¼-in. cylinders and using 3-in. bits.”

Air pressure, lbs. per sq. in.,	80-70	70-60	60-50	50-40	40-35
Lin. ins. drilled per min.,	1.3	1.1	1.0	0.6	0.5
Cu. ft. free air per min.,	124	117	100	70	60
Cu. ft. free air per lin. ft. of hole,	95.3	106.4	100.0	116.4	120.0
Cu. ft. free air per cu. in. of hole,	13.3	14.8	13.8	15.0	16.6

Thus the plant must be selected for the service required, but the following data may be used for preliminary estimates of cost.

Steam boilers commonly cost from \$350 for small plants to \$250 for large ones per drill for either steam or air and their installation will cost from \$20 to \$40 more when not permanently housed. Compressors cost from \$350 to \$400 per drill and their installation about the same as for boilers.

Depreciation and repairs may be taken from 7 to 9 per cent. annually for both boilers and compressors under normal con-

ditions, *i.e.*, wearing out in service. Taxes and insurance may be taken at about 2 per cent.

Drills, complete with tripod mountings and accessories, cost from \$85 to \$100 per inch diameter of piston, $3\frac{1}{4}$ -in. being a common size. With an assumed life of three years, depreciation would be $33\frac{1}{3}$ per cent. per year, while repairs run from 30 cents per shift for a large number of drills and efficient management to 75 cents on small jobs.

Cost, depreciation and repairs of transmission lines must be estimated separately for each case; also the cost of transporting plant.

Except where given per shift, interest, depreciation and repairs must be distributed over the number of shifts per season, normally say from 150 to 200 days for outside work in northern localities, or according to the amount of work a contractor can find to do in the case of a contractor's plant.

Gillette estimates 43 lbs. of coal per hour for a single $3\frac{1}{4}$ -in-drill operated by steam direct, if power is transmitted through 200 ft. of 1-in. pipe, and 150 lbs. additional for getting up steam and drawing fires, giving 580 lbs. per 10-hour shift and he uses 660 lbs. in an example of cost. Where a number of drills are operated by an efficient plant he claims that the consumption may run as low as 250 lbs. per drill per day. But he gives some results of tests for thirty-one $3\frac{1}{4}$ -in. drills at the Rosé Deep mine where 43 lbs. of coal per drill per hour were used with an efficient plant consisting of horizontal return tubular boilers, compound engines and two-stage compressor.

The following may be taken as an example of the determination of *C* for a single-drill plant operating by steam direct from a portable boiler.

Interest,	
Boiler, 6 per cent. on \$350,	\$21
Drill, 6 per cent. on \$300,	18
Depreciation, repairs and insurance,	
Boiler, 10 per cent. on \$350,	35
Drill, except repairs, 35 per cent. on \$300,	105
Transportation of boiler, say,	20
	<hr/>
Total,	\$199

Or, per shift, assuming 150 per year,	
Interest, depreciation, etc., say,	\$1.35
Drill repairs,	0.75
Drill runner,	3.50
Drill helper,	2.00
Fireman,	2.50
Coal, 600 lbs. at \$4 per ton delivered,	1.20
Hauling water, say,	0.50
Blacksmithing and nipping, 30 bits at 5 cents,	1.50
	<hr/>
Total, <i>C</i> /100,	\$13.30

An estimate for a large plant would be made up in a similar manner, adding interest, depreciation and installation of compressors if used. Fuel would depend upon efficiency; 300 to 400 lbs. per drill per day would be approximately correct for preliminary estimates. Repairs per drill would drop to say 40 to 50 cents per shift. Fireman's wages would be distributed over the number of drills as well as wages of compressor man if air were used. With the single drill plant it is assumed that the driller and helper do their own mucking, but with a large number of drills it would pay to save their time by having one mucker to, say, two to three drills to clear away for resetting. Cost of sharpening would be less, say 3 to 4 cents per bit.

The time in minutes, *d*, to drill 1 ft. of hole varies with the material, the size of hole, and the air pressure. Gillette gives the following table for drilling with 3½-in. machines using air or steam at 70 lbs. per square inch, starting bit about 2¾ in. and finishing bit about 1½ in.:

Soft sandstones, limestones, etc.,	3 mins. per ft.
Medium sandstones, limestones, etc.,	4 min. per ft.
Hard granites, sandstones, etc.,	5 min. per ft.
Very hard traps, granites, etc.,	6 to 8 min. per ft.
Soft rocks that sludge rapidly,	8 to 10 min. per ft.

These are fair average rates for deep holes under ordinary conditions and without water jets. The latter are especially valuable in the soft rocks which sludge rapidly. It must be remembered that the deeper the hole the larger must be its average diameter.

It is assumed in the above table that no time is lost from the bit sticking in the hole as it often does in seamy rock.

The time in minutes, *t*, to change bits varies from about four minutes when the men work rapidly to eight to ten minutes when

they work slowly. It may even be done in three minutes if the helper loosens the nuts as the driller screws back the feed screw so that it takes only about one minute to remove the bit from the hole. The hole may be pumped out in about one minute more and a new bit put in in the third minute.

The time, S , to shift the drill from one hole to the next, including the new set-up, varies greatly with the character of the surface and with the skill and energy of the crew. With a fairly level surface, S varies from five minutes for rapid work to twenty for deliberate work and it may be from thirty to forty for difficult set-ups on an irregular surface.

When the entire shift is used in drilling and the next in blasting and mucking, M equals the minutes per shift, assuming no lost time for break-downs or accidents or from the bit sticking in the hole. Otherwise the time lost in waiting for blasting and mucking must also be taken from the minutes per shift.

The length of feed screw, L , is usually about 2 ft. The influence of depth of hole, D , upon cost is readily determined by the use of the formula. It is especially important that this be done when shallow holes are necessary, as the increased cost per foot of such holes may seriously affect the accuracy of an estimate.

Some percussion drills may be set so as to use air expansively with a theoretical saving in air of 50 per cent. per stroke and some use air expansively on the return stroke and show an economy of about 25 per cent. These results have been confirmed with new drills but there are greater possibilities of leakage as the drill wears in service and less force available to withdraw the bit which may cause difficulty in cases where there is considerable friction or the drill steels are heavy. Thus, Weston, Rock Drills, 1910, says the latter type of drill promises good results but cannot be said to have established itself as a standard type.

A percussion drill operated directly by gasoline has been designed but no figures are available on its use.

The electric drill of the crank percussion type has already been discussed while the older solenoid type has not proven successful. A third type makes use of a detached motor connected to the drill by a flexible shaft but it is complicated and has not come into extensive use.

Where a large number of deep holes are to be drilled over a comparatively level surface the time lost in shifting the machine and in changing bits can be very materially reduced by mounting

a heavy drill between vertical guides from 6 to 20 or more feet in height, the whole apparatus being mounted on traction wheels, or on car wheels for temporary track. Thus bits require changing less frequently and the machine is easily and quickly moved. See *Engineering News*, Vol. 65, p. 600, 1911.

38. Air Hammer Drills.—The power hammer drill corresponds somewhat to the hand hammer drill in that the rod is not attached to the piston but is struck repeated blows either directly by the reciprocating piston or through an anvil block. It has developed rapidly in recent years from the pneumatic hammer used in riveting, etc. It may be of the same size as the piston drill and be mounted in the same way though it seems to be more successfully employed at present in the smaller sizes for use on columns or quarry bars or in the hand without mounting. This might be expected from the fact that the actions of the two types are similar in some respects to the hand hammer and churn drills though the true churn drill operated by power is found in the well-drilling machine, § 39. This also explains why it is better adapted to shallow holes.

The rotation of the bit is often accomplished automatically, except in the small hand drills in which it is done by hand. The large Lyner hammer drills have some excellent records to their credit for holes of moderate depth in tunnel driving, but it is believed that this is largely due to the use of the water washout jet which cools the bit and keeps the face of the rock clean so that no work is wasted in pulverizing the chips. Thus Gillette gives data showing that it drilled the second 2 ft. of a hole in soft porphyry in five minutes while a piston drill took nineteen. In granite he says that progress would be about the same as with the best piston drills but with increased air consumption.

As the bit is not withdrawn from the rock to any extent between blows there is less tendency for it to bind in the hole than in the piston type and perfect alinement is not so important. It is also claimed that the bits can be changed more quickly, but this advantage is at least small with the latest types of chucks. It is not so economical of power but rapid progress in drilling is a more important factor, especially in tunnel work.

The smaller drills are much used and they have great advantages for stopping in mines, for plug and feather work in quarries, and for block-holing; as, for instance, in steam shovel work when

the drill can be operated by a small compressor on the shovel, if air from a compressor plant is not available.

In plug and feather work in granite about sixty 5/8-in. holes, 3 ins. deep may be drilled per hour, being equivalent to about a day's work by hand.

39. Well Drilling Machines.—These are power churn drills which were primarily developed for well drilling but are now used to a considerable extent for large, deep blast holes. They are also used for prospecting, usually by wash borings, though some machines have a core drilling attachment. For hard rock, holes up to 20 ft. in depth can be drilled more cheaply with piston drills but the small holes, 1½ ins. at the bottom, require more springing than the large ones, from 3 to 6 ins.

For tough rock, springing is expensive, and even for a 20-ft. hole the charge may require separating in the hole to avoid blowing out at the bottom only and for good results in breaking the rock. In fact, if large enough, the holes may need no springing for this depth of face. For a higher face in softer rock, where drilling is most cheaply done with well drills, the 3-in. holes spring better than the 5- to 6-in., as much less of the energy is lost. Well drills are particularly adapted to deep holes in medium and soft rock where hand churn drilling becomes slow at about 20 ft. Hence cuts over 30 ft. deep, usually taken out in lifts not exceeding 20 ft. with hand drilling, may be taken out in one lift if well drilling machines are used. This reduces the cost of drilling per foot of hole and it is claimed that the rock breaks better with less explosive per cubic yard and steam shovels work to a much higher face.

The machines are mounted on traction wheels and may be self propelled if desired. Four to eight HP is required for holes up to 150 ft. and 5½ ins. is a common diameter of hole, it being claimed that this size can be drilled most rapidly on account of the possibility of securing proper weight and strength of tools to secure rapid work and obviate losses due to vibration and breakage of parts. The advantage of the 3-in. hole mentioned above has led some makers to develop a special machine for that size which has proven very efficient. One of these averaged two 24-ft. holes in solid brown sandstone in 10 hours, at a cost for labor, fuel and water of 12½ cents per foot, while the cost for hand churn drilling had been 38 cents. In softer blue sandstone

it averaged 60 ft. of hole per day, Engineering News, Vol. 51, p. 587, 1904.

With 5½-in. bits, a common portable machine drilled three holes 18 ft. deep or one 65 ft. deep per day on some work for the Pennsylvania Railroad, Engineering News, Vol. 50, p. 274, 1903. In clay or soapstone 100 ft. could be drilled, but in hard limestone only 5 to 10 ft., showing that it is not adapted to hard rocks, though this was near the bottoms of deep holes.

The steam machine is usually operated by two men, a drill runner and a helper and tool dresser, who also fires the engine. The cost of operation per day for labor and supplies is made up as follows:

Operator,	\$3.50
Helper,	2.00
Blacksmithing, say,	.50
Coal, 500 lbs. at \$4 per ton, delivered,	1.00
Water, 4 to 10 bbls., say,	.25
Rope,	.50
Oil, say,	.25
	<hr/>
Total,	\$8.00

With air, gasoline or electric power one man with the occasional assistance of a helper could run the machine. Well drills cost about \$1100 and their life may be estimated at about 10 years.

40. Rotary Drills.—As already noted, rotary types of drills have not come into use in this country for rock excavation, but the Brandt hydraulic machine has been used to a considerable extent in Europe for tunnel work. As applied in the Simplon tunnel, these were mounted on a carriage in groups of three. Water under heavy pressure, 60 to 80 atmospheres at drills, rotates the drill rods at five to ten revolutions per minute and forces the cutting edges against the rock, withdraws the drills from the holes and actuates the plungers on the thrust bar which gives rigid support to the drills.

The bits consist of hollow steel tubes of 1½-in. bore and 3-in. external diameter fitted with three or four short, hardened steel teeth with ¼-in. clearance on each side, giving a 3½-in. hole. These bits are threaded to extension rods of various lengths and pressed against the rock with a force of about ten tons so that the rock is cut away in much the same way that wood is cut by a saw.

The exhaust water may be allowed to escape through a hose at the bottom of the drill but most of it is used after the hole is well started by passing it through the drill rod so that it washes away the pieces of rock and keeps the bit cool. No core was formed except in the hardest rock.

The time required to drill one hole, usually about $4\frac{1}{2}$ ft. deep, varies greatly, but the heading, $6\frac{1}{2}$ by $9\frac{1}{2}$ ft. was advanced in gneiss 16 ft. per day at the Italian end and 20 to 21 ft. at the Swiss end; averages for one month. In more friable rock, an advance of as much as 34 ft. was made in 24 hours.

For additional details, see Engineering News, Vol. 50, p. 175, 1903; Prelini, Earth and Rock Excavation, p. 63, 1905.

Core drilling for prospecting or investigating material for foundations, tunnel work or other construction may be done with a diamond drill, or one fitted with steel points or under which hardened steel shot are used. The diamond drill is best adapted to the hardest rocks, while it is claimed that the larger core taken by the others is apt to give a better record in seamy rock. The bit of the diamond drill consists of an annular piece of steel with projecting black diamonds or carbons set in the edges.

In soft material, a casing is driven around the rod so that wash borings may be taken if desired, and to prevent the material from caving. Water is forced down inside the drill rod and rises on the outside, bringing the fine material with it. Core barrels are usually about 10 ft. long and the core is removed in sections as the rods are changed.

Much trouble may be encountered from boulders, caving in of soft material, loss of water through seams, necessitating reaming the rock and casing the hole down to the seam, breakage and loss of drill rods and casing and carbons.

The cost varies greatly with the local conditions, materials and difficulties encountered. Twenty-five holes on the Deep Waterways Survey 30 to 200 ft. (average 100) deep averaged \$3.14 per foot. A rental of \$300 per month was paid for the outfit, and the wear of bits and carbons was extra. Carbons cost \$36.50 per carat and were considered worn out when reduced to less than one carat. When new they averaged about two carats. Core was 15/16-in. in hard rock and 13/16-in. in shales and soft rock.

The following table shows the distribution of the time:

Sinking casing (earth 552 ft.),	325 hours	17 per cent.
Drilling rock, 1910 ft.,	753 hours	41 per cent.
Delays,	386 hours	20 per cent.
Moving 38 times,	356 hours	19 per cent.
Holidays and storms,	60 hours	3 per cent.
	<hr/>	<hr/>
Totals,	1880 hours	100 per cent.

Following are the average rates while actually drilling:

Kind of rock	Ft. per hour	Kind of rock	Ft. per hour
Quartzite,	1.7	Sandstone,	3.0
Limestone,	2.5	Shale,	5.0

The time consumed in raising cores increases with the depth of the hole, but as the holes were approximately the same average depth the above values indicate fairly well the relative hardness of the rock penetrated.

For additional details, see *Engineering News*, Vol. 50, p. 83, 1903.

In the calyx core drill there is a sudden enlargement of the channel for the water carrying the particles of rock at the top of the calyx, a sort of sheath, so that these settle back into it and can be examined, thus giving a duplicate record where a core is also taken. The bit is fitted with long steel teeth, the Davis bit, or hardened steel shot are used under an annular bit. The saw teeth will cut quite hard rock as the drill seems to have a jumping action so that it chips the rock much the same as a chisel.

H. C. Kittredge gives the following data on drilling four test holes in argillaceous slate rock with clay seams and covered with earth of a coarse gravelly nature, in *Engineering News*, Vol. 65, p. 330, 1911.

Hole	Earth	Rock	Total depth
1	12.0	15.0	27.0
2	5.0	19.2	24.2
3	5.4	50.4	55.6
4	13.7	56.7	70.4
			<hr/>
		Total,	177.2

The expenses were as follows:

Coal, 7.5 tons, at \$5,	\$37.50
Hauling drill to and from work, 23 miles,	30.00
Hauling coal, 6 miles at \$2 per ton,	15.00
Hauling water, 1/4 to 3/4 mile,	99.25
Labor, drillman \$3, fireman \$2.50,	217.40
Board for drillman and fireman, 39 days,	48.00
	<hr/>
Total, 177.2 ft. at \$2.52 per ft.,	\$447.15

A 2½-in. core was taken. Considerable time was spent in driving a steel casing through the gravel and making a tight connection at the rock. The clay seams also interfered with the action of the steel shot and necessitated removing the bit frequently for cleaning.

41. Explosives.—Explosives are compounds which evolve large volumes of heated gases when “fired,” *i.e.*, when chemical reaction is induced by ignition or shock. The ratio of the volume of the gases to that of the original explosive is affected by the temperature produced and both volume and temperature depend primarily upon the chemical composition of the explosive but they are also influenced by the size and shape of the grains. For the voids fix the amount of contained air, which has a cushioning effect, and its moisture tends to lower the temperature of the gases. Moisture in the hole also cools the gases and therefore a hole should be thoroughly dried before charging in order to get the best results.

While the power of the explosive is governed by the volume of gases produced, its effect varies with the rapidity of their production. Thus explosives may be divided into two general classes:

1. Slow or rending, called low explosives.
2. Quick or shattering, called high explosives.

Blasting powder is a typical example of the first class and nitroglycerin of the second, while the explosives in common use vary from one to the other. Low explosives leave a residue of about half their volume, while high ones are practically all converted into gases.

Low explosives are often fired by ignition, while high ones are exploded by the shock due to the detonation of a small quantity of a still higher explosive, usually a fulminate of mercury, in a suitable cap or exploder. Much depends upon a proper detonation, and part of the charge will be wasted if the

caps are too weak for an instantaneous explosion. Low explosives are subject to the same loss, and their power may be greatly increased by detonation, as for instance using dynamite to detonate gunpowder. In both cases of incomplete explosion, the rock yields before the whole charge is exploded and the remainder of it is wasted, often giving off noxious or dangerous gases which are not produced with perfect explosion.

Black or blasting powder is a coarse grained powder which explodes at 560° F. and burns much more slowly than the fine grained gun or rifle powders. The common grade consists of 73 per cent. Chile saltpeter (NaNO_3), 16 per cent. charcoal and 11 per cent. sulphur. India saltpeter, KNO_3 , is used for gunpowder but rarely for blasting as it is much more expensive. It has the advantage of not absorbing moisture, but this is of little importance as the grains are glazed and whole kegs are apt to be used at once. Blasting powder is graded according to the size of the grains, largely for the purpose of securing uniform results.

Nitroglycerin consists of about one part pure glycerin, three parts nitric and five parts sulphuric acid. It evaporates rapidly at 158° F. and even at 104 will lose about 10 per cent. in a few days. It is an active poison and will cause headache in some persons if touched by the finger. The fumes are also dangerous especially in cases of incomplete detonation. This is a great disadvantage on inside work. It freezes at from 40 to 50° F. and explodes at 300 to 400, according to impurity, if slowly heated in large quantities, or burns without explosion in small quantities.

Decomposed nitroglycerin is very dangerous and all free acid should be removed after making in order to avoid this. It has a greenish color when decomposed and should be at once destroyed by pouring into a strong solution of sal soda and stirring with a wooden paddle.

Nitroglycerin is now used mainly in the form of dynamite, *i.e.*, when absorbed by some porous material which is either an explosive or merely inert. This increases its safety and allows of varying the strength to meet the requirements in different cases. Dynamite was discovered by Dr. Alfred Nobel in 1867, four years after he had first used nitroglycerin as a blasting agent. He used kieselguhr, a silicious earth which consists chiefly of the skeletons of various species of diatoms.

This infusorial earth was found to be an excellent absorbent or dope for percentages of nitroglycerin from 40 to 75, but below 40 per cent. the powder could not be exploded and above 75 the mass became pasty and the nitroglycerin was apt to exude and a single drop from a cartridge might cause a disastrous explosion.

By substituting an active dope for the inert one, explosives of higher power than 75 per cent. and lower than 40 were made, and the combined force was greater than that of the two explosives used separately, probably due to detonation of the lower explosive as well as of the nitroglycerin.

These principles are well illustrated in the composition of two different grades (75 and 40 per cent.) of Hercules Powder:

Nitroglycerin,	75 per cent.	40 per cent.
Potassium nitrate,	2.1	31.
Potassium chlorate,	1.05	3.33
Magnesium carbonate,	20.85	10
Sugar,	1	15.67
	<hr/>	<hr/>
Total,	100.00 per cent.	100.00 per cent.

The magnesium carbonate is an inert dope while the potassium nitrate and chlorate are active ones. Wood pulp or meal, sawdust, kieselguhr, sulphur, resin, charcoal and pitch are also used as dopes in other brands.

Blasting gelatin consists of 90 to 98 per cent. nitroglycerin solidified by means of gun cotton. It is a solid plastic jelly which does not absorb water or leak nitroglycerin and hence can be used under water and in tropical climates. It freezes at 35 to 40° F., however, and is then more sensitive to shock. It is used either directly or in making gelatin dynamite, an explosive which can be made about 25 per cent. stronger than No. 1 or 75 per cent. dynamite by using 80 per cent. blasting gelatin and an explosive dope consisting largely of sodium nitrate.

Ammonium nitrate is used in making the ammonia dynamites which are slower acting than straight dynamites and hence give more heaving or rending action. They are safer to handle, transport, and store than the straight dynamites, but they take up moisture very readily and must therefore be carefully stored.

Ammonia and gelatin dynamites require stronger detonation than straight dynamites. The selection of exploders is best left to the manufacturers who should be able to recommend such as to give the best results with each kind of explosive.

Thus it is seen that dynamites varying widely in power and rapidity are available for use, and by keeping one of low power and one of high on the job any desired strength may be obtained by varying the ratio of high to low grade cartridges in the drill hole. After the best grade has been determined it will be better to obtain it directly.

Many low freezing dynamites are now on the market but it is not claimed that they will not freeze if kept for a long time at a temperature below about 35° F. On the other hand explosives should not be long subjected to temperatures above 90° F.

Frozen dynamite must be thawed for use as it cannot be effectively detonated. This must not be done over a stove or in water as the nitroglycerin is apt to leak in thawing and many accidents have happened during the process. A dry heat should be used with temperatures between 60 and 90° F. and explosives should not long be subjected to such dry heat as they lose the contained moisture and become more sensitive to shock.

The freezing of explosives containing nitroglycerin has led to the development of various other compounds. Nitro-starch is used in Trojan and various other coal powders.

Joveite, another safety explosive, consists of nitro-naphthaline, nitro-phenol and nitrate of soda. It is a free running powder resembling corn meal in appearance and it does not freeze or deteriorate with heat. It can be made waterproof and charged in cartridges which can be exploded only with a strong cap. It may also be charged in bulk by pouring into the holes. It has displaced dynamite with a saving in cost on much of the rock work in cities such as that at the New York Central yard in New York. Grade for grade, from 20 to 60 per cent., Gillette claims that it is superior to dynamite in hurling power though slower. Another important advantage is that it produces no noxious fumes. It cannot be exploded by hammering with iron upon iron, firing bullets into it, or by ignition, and as it does not freeze there is no danger from thawing.

Virite is another new safety explosive which has been used for heavy railroad work in Canada and to some extent for stumping in the United States. It is claimed to be much more powerful than black powder and superior in hurling power to dynamite while at the same time breaking the rock well. It is non-freezing and cheap but not waterproof.

42. Principles of Blasting.—The common or crater theory of blasting was developed in the days of black powder and rests upon the assumption of homogeneity of structure of the rock and that the power of the explosive must be proportional to the volume of rock thrown down. Thus Drinker assumes that with

one free face, as in Fig. 16, the angles of the sides of the crater with the face will be 45 degrees with black powder, and therefore the volume of the cone or crater will equal $1.05 l^3$, where l is the line of least resistance, bd . This assumes the charge concentrated at b . Drinker says that if the hole be bored along the line of least resistance, bd , the charge will blow out with black powder. The assumption that the work is proportional to the volume of rock dislodged and that therefore the amount of explosive required is proportional to l^3 is incorrect, as only part of the work is expended in breaking up the rock and that part which shears it off from the mass along the sides of the cone is not proportional to l^3 but to l^2 , *i.e.*, the area of the sides, even with a charge exactly

sufficient to shear and break the rock. Thus the longer the line of least resistance the smaller the power necessary per unit of volume of rock.

In practice part of the energy of the explosive is also expended in imparting motion to the rock, in heating the rock and in imparting motion to the surrounding air. These effects will increase with the depth of the hole if the charge be kept proportional to l^3 .

Thus the crater theory breaks down even for homogeneous material, but it has some value in studying the effect of additional free faces. Thus Drinker shows that with two free faces equally distant from the charge, not only will two cones be broken but also one-half of each corner and so on, so that for a cube with six free faces the whole will be broken. He gives the ratios of the volumes broken with from one to six free faces as,

1, 2.2, 3.5, 4.9, 6.2, and 7.6, respectively,

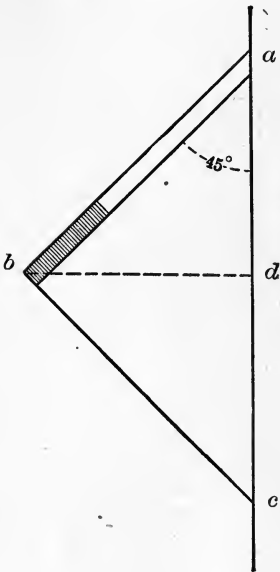

FIG. 16.

showing that the utility of additional free faces is more than in direct proportion to their number.

With angles of 45 degrees the line of least resistance, db , is 0.71 ab , or about three-fourths of the depth of the hole, which fact has given rise to the rule, easily disproved by experiment, that the line of least resistance must never be more than three-fourths the depth of the hole.

Finally, solid homogeneous rock and single shots are not usual so the common rules fail utterly for the conditions met with in practice, and while they should be kept in mind it must be remembered that the object is to break the rock in the desired manner at the least possible total cost and not at the least cost for explosives alone.

Thus the method to be adopted depends primarily upon

1. The material,
2. The methods of drilling,
3. The explosives available,
4. The condition in which the material is desired.

The material differs widely in character and in the aspect in which it is presented. It may be brittle, friable material like shale, or tough soft rock like some of the sandstones, or very hard and brittle like trap. Again it may be solid, or badly fissured, or simply have planes of weakness.

Generally speaking the explosive will be most effective if its force is exerted in a direction perpendicular to the strata. This is well illustrated at the quarry of the Edison Portland Cement Co. where the spacing of holes in the rows parallel with the strata is about double that in the rows perpendicular to them, with same amounts of explosive. An open seam, or even a plane of weakness, may often be taken advantage of as an additional free face, though seamy rock sometimes wedges badly.

The method of drilling may restrict one in properly placing the holes. With strata 2 ft. or more thick the best effect will be given by a hole parallel with the stratification, and in any case the charge should be located in a single strata if possible in order to avoid loss through seams. The placing of the drill holes will also depend upon their relative positions.

One is not usually restricted in the explosives available and can select such as give the best results. This will depend to a large extent upon the effect desired. Black powder is used in

quarrying dimension stone where large blocks are wedged off without shattering by using light charges in rows of holes. Low grade dynamites with air space, *i.e.*, expansion tamping, are sometimes used for the same purpose.

Black powder is cheaper than dynamite and hence is also used in brittle, friable rock like shale which does not require heavy shock in order to break it for loading by steam shovels. The holes usually need springing with dynamite in order to give room for a sufficient charge of black powder.

Dynamite and other high explosives are used in springing holes, tunnel driving, etc., where it is necessary to concentrate the charge at the bottom of the hole and for rock requiring heavy shock to shatter it. Even with dynamite some tough rocks will come down in large blocks which require mud capping or block-holing before they can be handled with a shovel. In working a high face, the charge may often be separated in the hole to advantage. Good results have been obtained in some cases by using blasting powder and dynamite in alternate rows of holes.

It is sometimes stated that it is unnecessary to tamp high explosives, but while they have some effect even if practically unconfined, as in mud capping boulders, yet their power is best utilized in a dry hole with no air space and solid tamping.

Dynamite is usually charged in cartridges and all of these except the one containing the cap may be split by cutting with a sharp knife if the dynamite be thoroughly thawed. This allows the charge to be pressed tightly together in the hole with a wooden tamper. In charging explosives in bulk care must be taken that grains do not adhere to the sides of the hole. Black powder may be charged in paper bags or through a tube or by means of a long handled spoon. In wet holes, the cartridges require waterproofing with paraffine unless a waterproof explosive is used.

The first part of the hole should be loosely tamped. Clay is about the best material but sand and brick or stone dust are also good. The hole should be completely filled to secure the best results.

Electric firing is cheaper, safer and surer than fuse firing and is necessary when the simultaneous explosion of two or more shots is desired.

The above principles are intended to give some idea of the

necessity for careful study and experiment to determine just what combination of depth of hole, distance from face and grade of explosive will best give the desired results in bench work. In headings and shafts the placing of the holes will be the more important factor. The following examples will serve to illustrate some of the principles.

For a shale cut on the Pennsylvania Railroad, Engineering News, Vol. 50, p. 274, 1903, 25-ft. holes $5\frac{3}{8}$ ins. in diameter and 25 ft. apart were sprung with 7 to 10 sticks of 40 per cent. dynamite. Each chamber was then charged with eight 25-lb. kegs of blasting powder and a series of holes fired at one time by electricity, thus thoroughly shattering the shale.

Four holes, 13 ft. apart, 13 ft. from the face and 40 ft. deep, were drilled by a cyclone well drill in solid sandstone and sprung with dynamite. They were then loaded with 275 lbs. of dynamite to each hole and fired simultaneously, throwing down 1387 cu. yds. of stone. Drilling cost 30 cents per foot by contract and explosives \$171.87, or a total of 16.8 cents per cubic yard. For three additional test holes of the same dimensions the cost was 13.7 cents per cubic yard. Engineering News, Vol. 63, p. 24, 1910.

Chamber blasting, with gopher or coyote holes, is sometimes used in quarrying rock for crushing, as at the Linton Prison stockade in Oregon, Engineering News, Vol. 63, p. 528, 1910, where 54 800 cu. yds. of solid basaltic formation (rhyolite) were thrown down by 8 000 lbs. of No. 2 Trojan powder charged in a coyote hole, or 6.85 cu. yds. per pound of explosive.

Some very large blasts have been used in heavy side-hill rock cuts, as in the Stigerwalt's blast on the Pennsylvania Railroad. Well drills were used for deep vertical holes at the back line and rock drills for so-called snake or lifter holes driven in horizontally at the bottom. There were 80 well drill holes averaging 115 ft. in depth, and 123 rock drill holes none less than 30 ft. deep. The holes were sprung, allowed to cool, charged with 225 tons of explosive and fired simultaneously with the result that 240 000 cu. yds. of rock were loosened of which 175 000 were thrown clear of the work, Engineering News, Vol. 54, p. 677, 1905. Total cost was \$75 318 or about 30 cents per cubic yard. This was only one of a large number of blasts on this work.

In other cases, gopher holes have been used for a similar purpose. The above method would seem better where it is

desired to work to a certain line, while gopher holes are better adapted to work where the object is simply to obtain a large amount of rock. Thus to secure rock for the Morena dam in California 19,475 tons of powder were used in a gopher hole to displace 180,000 tons of granite, at a cost of $4\frac{1}{4}$ cents per ton. For details of loading and plan of work, see *Engineering News*, Vol. 62, p. 723, 1909.

Methods and costs for tunnel work are given in Chapter IV, while an excellent description of methods and analyses of costs of breaking boulders, by D. J. Hauer, will be found in *Engineering News*, Vol. 53, p. 3, 1905.

43. Loading and Hauling.—Rock can be hand loaded, hauled and dumped at about the same cost per unit of volume as for earth, if the flat bottom wagon box be excepted. This would add about 70 per cent. to the corresponding prices for earth, the amount by which the volume is increased in changing from solid to loose. The weight per unit volume would be less for the loose rock than for earth. The cost of loading by steam shovel is discussed in §26 and some data are given in §32.

Excellent data on rock work is given by C. S. Hill, *The Chicago Main Drainage Channel*, 1896.¹ The rock section was 160 ft. wide at the bottom and channelers were used to separate the canal prism. This required excavating in lifts usually less than 12 ft., the maximum depth of cut of the channeler.

On Section 9, hand labor was extensively used. The rock was broken down by blasting with dynamite a row of 26 2-in. holes, 2 ft. deep, placed transversely across the canal. About 1 lb. of explosive was required per cubic yard. The muck was loaded by hand into $1/2$ -cu. yd. cars and hauled to the spoil bank in 12-car trains for the top lift and 10-car trains for the lower lifts. About 30 men were worked on each face loading cars, and five men sledging large rocks, and one foreman managed the work. Two teams were used in the pit to haul the trains to and from the foot of the incline. Two of the inclines were double and one single, the first working two faces and the second but one. A hoisting engine and cable handled the trains up the incline. On the dump, five men and two teams cared for the cars hauled up each incline. Two trains were used for each face, so there was no delay waiting for empty cars. The limit of haul was about 1000 ft.

¹ Reprinted from *Eng. News*, Vols. 33 and 34, with additional matter.

The output in cubic yards per 10-hour shift of all three inclines as furnished by the contractors for a period of five months in 1895 is as follows:

Month	Double faces	Hoists, 2 each.	Single hoist,	One face
	No. 1	No. 2	No. 3	No. 3
March,	488	516	570	
April,	488	484	538	
May,	494	442	...	242
June,	508	495	...	247
July,	521	518	...	229
Average per hoist,	499.8	491	554	239
Average per face,	249.9	245.5	277	239
Average per man,	6.94	6.82	7.69	6.65

It is stated that in comparing these figures with those obtained for cableway and cantilever crane outputs, if the cost of plant be considered, the inclined hoist with cars was one of the most economical methods of excavating rock used on the canal.

On Section 10, tram cars, hauled up cable inclines, were used for the upper lift and to some extent for the lower ones. The force consisted of 36 loaders,¹ 1 foreman, 1 engineman, 1 switchman, 1 cableman and 5 men on the spoil bank. The average output per loader per day was from 7 to 8½ cu. yds.

On Section 1 an air hoist was used for the heavy pieces as an aid in hand loading, but no cost data are given.

Lidgerwood traveling cableways and traveling cantilever cranes and derricks were used. The skip resting on the ground with an open end and low sides made a better record for hand loading than the small dump car, the output per man hour averaging about 1 cu. yd. for the skip and 0.7 cu. yd. for the car. But these machines are for wasting on the side or loading standard cars, rather than for making fills from cuts as in railroad work.

The following analysis, by Mr. Langhead, Resident Engineer, C. C. extension of the Western Maryland Ry., for an output of 37 100 cu. yds. in 30 working days of 10 hours each, is given in *Engineering News*, Vol. 65, p. 608, 1911.

The cut was about 800 ft. long at grade, the upper 50 ft. in height had been removed, leaving about 35 to be taken out. A switchback was necessary 950 ft. from the mouth of the cut and

¹36 men—viz. 30 loaders, 5 sledgers and 1 foreman.

the track to it was on a -3.5 gradient. The haul between centers of gravity of cut and fill, measured along the track, was 1600 ft. Midway on the switchback there was a passing siding, open at both ends, on which the empty up train waited on its way to the shovel for the loaded one to pass.

The track was maintained in such good condition by one foreman and 4 laborers that it was possible for a 16-ton dinkey to haul twelve 4-cu. yd. cars at high speed. The dump gang of 1 foreman and 8 laborers kept the dump in good condition. A trestle on the up-hill side of the center line was used to start the fill. The down-hill rail was elevated so that it was not ordinarily necessary to chain the cars to the trestle in dumping. The track was shifted onto the fill as it became necessary.

During the first half of the period, the material was a hard sandstone which broke into large boulders in blasting and this required frequent chaining of the cars to the trestle. There were 16 000 cu. yds. of this material. During the second half of the month the material was a black shale, and 21 100 cu. yds. were moved.

The shovel was shifted five times, and about 500 ft. each time. The surface left each time was in good condition for moving the shovel back for the new cut; and when the dinkey track was moved but little surfacing was required.

The equipment consisted of a 70-ton Bucyrus shovel, two 16-ton Vulcan dinkey locomotives, twenty-four 4-cu. yd. Western dump cars, 54 tons of 60-lb. rails and a cyclone well driller. The contractors were the J. B. Carter Co., and the excellent showing for the month was chiefly due to M. Douglas, the contractor's superintendent.

Total expense of shovel including pay of superintendent, walking boss, shovel and dinkey crews and all other labor.

Labor,	\$3 623
Explosives,	302
Trestle,	229
Coal,	235
Oil and waste,	32
Water,	112
Interest on plant,	110
Depreciation,	460
	<hr/>
Total,	\$5 103
Total yardage,	37 100
Cost per cu. yd.,	\$0.1375

It should be noted that this is a record month after the plant had been installed, the cut opened up, the work well organized and apparently the weather conditions good.

REFERENCES

- Rock Excavation, Methods and Costs. H. P. Gillette, 1907.
Tunneling. H. S. Drinker, 1882.
Rock Drills. E. M. Weston, 1910.
Rock Drilling. Dana and Saunders, 1911.
The Blasting of Rock in Mines, Quarries and Tunnels. A. W. & Z. W. Daw, 1898.
A Primer on Explosives for Coal Miners. C. E. Munroe & C. Hall, 1911. Bull. No. 17, Bur. of Mines, Wash., D. C. Abstracted in Eng.-Cont., Vol. 33, p. 10, 1910.
Methods used on Preliminary Work on Catskill Reservoirs. J. S. Langthorne, 1910.
A Hand Power Rotary Drill. Eng. News, Vol. 52, p. 294, 1904.
The History of the Rock Drill. W. L. Saunders. Eng. Rec., Vol. 61, p. 751, 1910.
The Electric-Air Drill. W. L. Saunders. Eng.-Cont., Vol. 29, p. 318, 1908.
A Direct Acting Gasoline Rock Drill. Eng. News, Vol. 60, p. 575, 1908.
Deep Hole Rock Drilling on the State Barge Canal (Piston Drills). L. I. Wightman. Eng. News, Vol. 66, p. 370, 1911.
The History of the Air Hammer Drill. H. L. Sinclair. Eng. News, Vol. 57, p. 430, 1907.
Comparative Tests of Large and Small Hammer Rock Drills (Tunnel Work). J. B. Lippincott. Eng. News, Vol. 61, p. 449, 1909.
Plug Drills. Eng. News: Vol. 50, p. 301, 1903; Vol. 53, p. 606, 1905; Vol. 55, p. 277, 1906.
Well Drills for Railroad Grading through Rock. Eng. Rec., Vol. 63, p. 87, 1911.
Well Drills, etc., Pa. R. R. Eng. Rec., Vol. 52, p. 674, 1905. Eng. News; Vol. 50, p. 274, 1903; Vol. 54, p. 677, 1905; Vol. 55, p. 419, 1906.
Well Drilling Methods. I. Bowman. Wat. Sup. Paper No. 257, U. S. G. S. Abstracted in Eng.-Cont., Vol. 35, p. 515, 1911.
A Drill Hole Reamer (for Chambering). Eng. News, Vol. 52, p. 286, 1904.
Diamond Drill Borings, etc., Catskill Aqueduct. Eng. News, Vol. 59, p. 359, 1908; Vol. 63, p. 414, 1910; Vol. 65, p. 339, 1911. Eng. Rec., Vol. 57, pp. 522, 557, 1908.
Borings for Panama Railroad Dock at Cristobal. E. B. Karnopp. Eng. News, Vol. 63, p. 691, 1910.
Methods and Costs of Core Drilling. Eng.-Cont., Vol. 35, p. 562; Vol. 36, pp. 91, 345, 375, 1911.
Methods of Determining the Depth and Slope of Deep Drill Holes. Eng.-Cont., Vol. 35, p. 448, 1911.

Precautions for Maximum Safety and Effectiveness in Blasting. Eng. News, Vol. 64, p. 304, 1910.

Some Principles Governing the Blasting of Rock. Eng.-Cont., Vol. 35, p. 422, 1911.

Subaqueous Rock Excavation; Buffalo Harbor, Portsmouth Navy Yard, Port Colborne Harbor. Eng. News, Vol. 54, pp. 1; 105, 121; and 158; respectively.

A Large Blast on the Lackawanna Cut-Off. Eng. Rec., Vol. 63, p. 269, 1911.

A Large Dynamite Blast at Manila Harbor; Fatal Asphyxiation by the After Fumes. Eng. News, Vol. 51, p. 88, 1904.

The Stone Crushing Plant of the Dolese and Shephard Co. Eng. Rec., Vol. 60, p. 103, 1909.

CHAPTER IV

TUNNELING

44. Location.—Tunnels may be used at divides in order to reduce gradients by securing low summits, or at sharp spurs to reduce curvature and distance. They may also be required for separating grades in getting well into large cities and to prevent interference with navigation in crossing large rivers.

In England they have apparently been used to conciliate land owners, where in crossing valuable estates there was strong opposition to surface lines, while in Europe and on the Canadian Pacific they have been used for development in running up narrow valleys whose bottoms were too steep for the gradients adopted. This is done by constructing one or more turns of a helix in tunnel, thus gaining elevation at the expense of distance and curvature.

The depth of cutting at which a tunnel becomes desirable as compared with an open cut is given at from 60 to 70 ft. It depends not only upon relative costs of construction, but also upon maintenance and operation, thus requiring a special study in a given case. The relative costs of construction depend upon the difficulties met with in driving the tunnel and the lining required on the one hand, and upon the inclination of the slopes and the material upon the other.

Track work is cheaper in open cut on account of more room and better light, but a tunnel well built (and well lined with masonry when required) is more permanent than the slopes of the ordinary deep cut. This means cheaper maintenance except for track and greater freedom from landslides.

The freedom from snow in a northern climate is also of advantage. On the other hand a tunnel if long is disagreeable on account of poor ventilation, while the results of an accident are liable to be more serious than in an open cut.

Tunnels of the second class (in large cities) are not justified on the basis of economy of construction and operation, but on the basis of developing and expediting traffic. Their recent develop-

ment has been in connection with electric locomotives, the elevated structure or depressed track with bridges for cross streets usually having preference with steam locomotives on account of the difficulty in ventilating tunnels, especially with heavy traffic.

45. Examination of Site.—The cost of a tunnel (with lining when required) increases with the softness of the material and with the amount of water; hard, solid rock usually being the cheapest.

If the tunnel is not very long or deep, an examination of the outcrops in the vicinity will give a good general idea of the material and the amount of water which may be expected. This should be made by an experienced geologist, and even then results have shown that the conclusions cannot be accepted as final. Borings along the line of the work (or along the side of the tunnel if subaqueous) give the most reliable data, but even these must be made by one of experience in the work if the results are to be accepted as reliable.

A knowledge of the inclination of the strata is necessary in predicting from surface indications the material along different portions of the line. Inclined strata usually increase the danger from slips and cave-ins and give unsymmetrical pressures on the timbering required during construction and on the permanent lining.

The presence of water can be inferred from a study of the hydrographic basin of the locality. Water follows the pervious strata, as sand and gravel, and is deflected by the impervious, as clay and most of the rocks unless badly fissured. Ground high above the tunnel with porous strata opening to the surface will usually give plenty of water and heavy pressure, especially if the water comes through the rock crevices.

Among the most treacherous and difficult materials met with in tunneling, may be mentioned laminated wet clay, which may exert great pressure by swelling; shales which swell and disintegrate upon exposure to air or water; dry fine sand or gravel which will run like a fluid, and water bearing sand or other fine detrital material.

46. General Methods of Excavation.—Unless a tunnel is very deep or short, excavation is generally carried on from intermediate shafts as well as from the ends. The use of shafts increases the amount of excavation and generally the cost of construction, drainage and haulage, as the water must be pumped and the

material excavated from the shaft raised to the surface, except in the rare cases where the shafts are horizontal.

The object in using shafts is to hasten the time of completion in order to secure earnings as soon as possible rather than to continue the payment of interest on dead capital.

After construction, the shafts are closed unless the tunnel is so long that some of them are needed for ventilation.

The general method is to drive a heading or small tunnel at the top or bottom and afterward enlarge to full section. This is sometimes driven the entire length before the enlargement is begun, and then the enlargements are carried on simultaneously from the portals, and shafts if any, and frequently from "break-ups" (English method) located midway between the shafts.

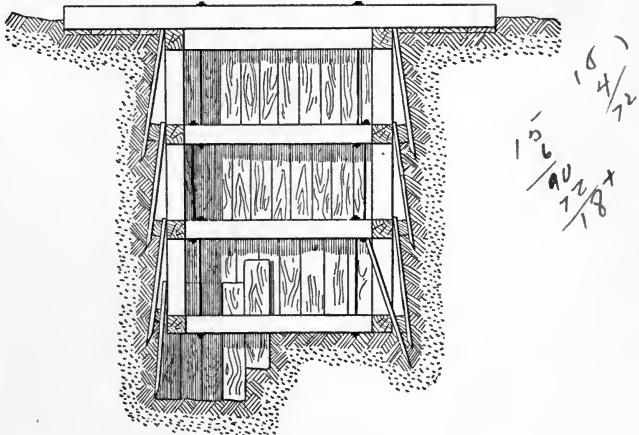

FIG. 17.—Shaft Timbering.

This full length heading determines the character of the material and allows the alinement to be checked in advance of the enlargement, besides providing drainage and allowing the full capacity of the track through the heading to be utilized when more advantageous than the hoisting apparatus at the shafts.

A heading should be 7 ft. high and from 6 to 8 ft. wide, so that two men can stand up and work at the face and so that a material car can be run without disturbing the wall strutting.

Temporary or construction shafts are usually rectangular with the longer dimensions about twice the shorter and parallel with the axis of the tunnel. This allows of separate compartments

for hoisting and for the pumping and ventilating pipes, so that the pipe system can be inspected and repaired without interfering with the regular hoisting work. About 9×9 ft. is a minimum for the shaft.

In sinking through fairly firm material where lining is required, a horizontal frame of heavy timber is set at the top and supported; poling boards some 4 ft. long are driven around the outside as the excavation proceeds until the next frame can be put in place and the second set of poling boards started as shown in Fig. 17.

The frames are spaced by corner posts and tie rods may be required as shown, to prevent settlement. Care must be taken to disturb the earth outside the poling boards as little as possible and to leave no voids to develop slips and heavy pressure.

In this country, shafts are usually placed over the center for greater convenience in hoisting and in transferring alinement to the tunnel, but French engineers usually prefer them on the side with a transverse gallery to the tunnel. Permanent shafts are more often cylindrical and are lined with brick or concrete.

When the depth is not great, shafts are sometimes inclined for greater convenience in hauling material.

47. Classification.—For tunnel work, materials may be divided into hard rock, soft rock and soft soil.

The hard rocks have sufficient cohesion for vertical slopes when cut to any depth, and if they are not affected by the atmosphere, the tunnel can often be left without lining. Granite, gneiss, feldspar and basalt are of this class, but sometimes, and especially if mixed with pyrites, they will disintegrate upon exposure and thus require lining.

With machine drills and modern explosives, hard rock is the cheapest and safest material through which to drive a tunnel. A top or a bottom heading may be used for the advance section, according to the size of the tunnel, and other considerations, the top being most common in this country and the bottom in Europe.

The soft rocks have less cohesion and they are always affected by the atmosphere. They require to be supported by timbering during excavation and to be protected by a strong lining to exclude air, support the pressure and prevent the fall of fragments. Sandstones, laminated shales, mica schists and all schistose stones, chalk and some volcanic rocks belong to this group. Some of the boulder clays and cemented gravels might

be included for tunnel work. Explosives are required and the methods of driving are much the same as for hard rocks.

The soft soils are composed of detrital materials and they may be excavated without explosives, although these are sometimes used. Heavy timbering is required during construction to support the pressures and lagging or poling boards to prevent caving, while strong lining is required. Gravel, sand, shales, clay, quicksand and peat are proverbially treacherous, while some of the laminated clays when wet are equally so.

There are four general methods in use in Europe for the ordinary loose soils, viz.:

(1) The Belgian method, in which the roof arch is constructed and afterward underpinned by the side walls. In doing this a top heading is driven and then widened each way to the springing lines where longitudinal plank are placed upon which to build the arch. The bottom center is next excavated and then the bottom sides as the arch is underpinned by the side walls.

(2) The German method, in which a central core is used for support in timbering. Two bottom headings in which to start the side walls, or a central top heading may first be driven. The extension around the periphery may be up from the bottom headings or down from the top one. The lining is continued up from the foundations in the side headings.

(3) The English and Austrian methods, in which after the heading is driven, the entire section is excavated for a short distance before beginning the lining. In the English, the miners and masons work alternately, the lining being built up from the invert (if used) or from the bottom in lengths of from 10 to 15 ft. In the Austrian, the length opened is sufficient to allow the miners to work continuously ahead of the masons, while the invert, when used, is built after the side walls and arch.

(4) The Italian method was intended for very soft ground, but has not come into use in this country. The lower portion of the tunnel is excavated and the lining, including the invert, built. This part is then refilled except a narrow passageway for the material car, the upper portion is then excavated and the lining completed.

For subaqueous tunnels through silt or other porous material, or for quicksand and large quantities of water, a metal shield having the cross section of the outside of the tunnel lining, and driven forward by hydraulic jacks, is much used. The lining is

built under cover of the rear and compressed air is usually necessary to keep out water and to aid in holding up the face of the excavation.

For shallow tunnels, such as may be used in grade separation in city streets it is frequently better to excavate from the surface, build the lining and fill around it, by the cut and cover method, than to excavate as a tunnel.

48. Form of Section and Lining.—The dimensions recommended by the American Railway Engineering Association, as given in the Manual, are shown in Fig. 18. It will be noted that

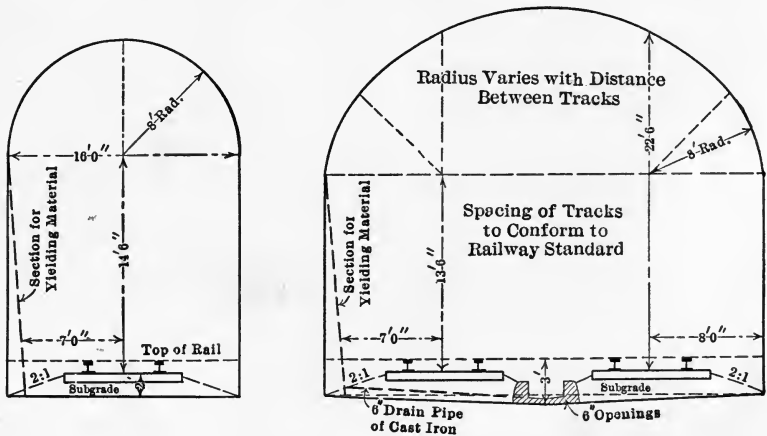

FIG. 18.—Inside Dimensions.

for double track the width is increased by the distance between track centers, some 12 to 13 ft. while the height over track centers is the same as for single track.

For curved track, the tunnel is widened and displaced from center to give the same clearances. Concrete is recommended for the permanent lining, except where, owing to local conditions, the material will be injured before it has time to harden.

If brick lining is used, the arch for a horizontal distance of 5 ft. on each side of the center line of each track should be laid with vitrified brick in rich portland cement mortar.

Many of the older tunnels have been built with much smaller clearances than the above, especially the subaqueous and those used in grade separation.

The shape and thickness of a tunnel lining cannot be computed except for shallow depths, since the pressures exerted are indeter-

minate for great depths, owing to the varying arch action of the material. The less disturbance during construction, the lighter the pressure. Disturbance is lessened or prevented by promptly shoring, and by filling all vacant spaces outside the lining. If the material lacks cohesion, and especially if full of water, straw may be required with tight poling boards to hold it in place.

For soft material, curved side walls are common in Europe, giving a horseshoe section; side walls, inclined when necessary to resist horizontal thrust, are more common in this country. When the bottom is too soft to carry the side walls without large footings the invert is used to distribute the pressure over the entire base and to prevent the horizontal pressure from crowding the side walls together.

Subaqueous tunnels through silt or other soft, water-bearing material are circular in section and have cast iron linings in segments with inside flanges for bolting together as placed.

49. Tunnels Through Hard Rock.—The common method is to drive a heading and then enlarge to full size as for earth; in

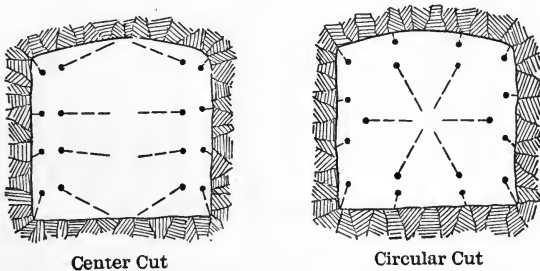

FIG. 19.—Center and Circular Cut.

Europe this is driven at the bottom, while in this country it is customary to drive at the top. In attacking the heading two methods are in use, the circular cut and the center cut; in the former some four to six holes from 4 to 6 ft. deep are driven as elements of a cone with circular base. Around the base a set of holes is drilled perpendicular to the face inclosing a cylinder, and around this a set inclosing a second cylinder, if necessary to secure the proper section. The sets are fired in order, the first throwing out the cone and allowing the material to expand laterally from each of the others. In the center cut method, the one principally used in this country, the holes are drilled some 15 to 20 ft. deep in vertical rows, the first two converging toward

each other so as to blast out a wedge which is gradually enlarged to full size by the other holes.

For hard rock, American engineers usually prefer a heading the full width of the tunnel, as it gives more room for working and allows of deeper holes for blasting. In loose or fissured rock which requires timbering a small heading is necessary.

50. European Examples.—For a description of the methods used in constructing the Mt. Cenis and the St. Gothard railroad tunnels in Europe, reference is made to Prelini's *Tunneling*, 1901. The former is 7.9 miles long; double track; driven from the ends by bottom headings; begun in 1857 and opened for traffic in 1872. The latter, $9\frac{1}{4}$ miles long, was enlarged from a top heading which was kept from 1000 to 3000 ft. ahead of the enlargement. It was ten years in building (1872–1882) and was lined throughout with rubble for the side walls, and brick for the arch.

For the Simplon, 12.4 miles long, a bottom heading was driven and timbered and shafts 50 meters apart extended up to the top of the tunnel. From these shafts, a top heading was extended each way full width, then deepened to the roof of the bottom heading and finally the bottom widened to the full width. The bottom heading served for transportation during the enlargement.

The tunnel was driven for single track, while a bottom side heading was driven for a parallel tunnel to contain the second track. This was connected at intervals to aid in ventilation and in the transportation of materials. See Stauffer, *Modern Tunnel Practice*, 1906, or Prelini.

The headings of the Loetschberg Tunnel met March 31, 1911, within less than five years from the time of commencement. As the length in rock is about 47 675 ft.; it makes a world's record for rapidity of execution. The total rock excavation was about 1 000 000 cubic yards, *Railway Age Gazette*, Vol. 51, p. 16, 1911; *Engineering News*, Vol. 66, p. 164, 1911.

51. American Examples.—The Busk tunnel, described in *Engineering News*, Vol. 32, p. 245, 1894, is a single-track tunnel on the Colorado Midland, 9394 ft. long, which was begun in 1890 and completed in 1893.

The material penetrated was gray granite of irregular character; some being difficult to drill; some disintegrating upon exposure and requiring lining; and some full of seams and faults and requiring support for the detached fragments. Large cavities filled with mud were found in a few places.

About 78 per cent. of the tunnel had to be timbered. The dimensions of the cross section and of the timbering are shown in Fig. 20.

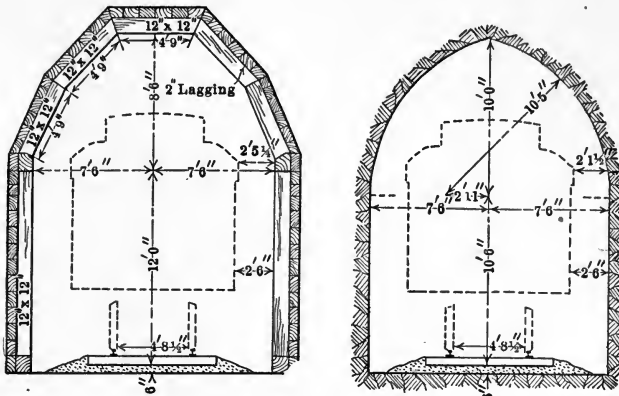

Loose Rock

Solid Rock

FIG. 20.—The Busk Tunnel.

Double Timbering was used in heavy Ground

A full width top heading 7 ft. high was driven, using 8 holes each 12 ft. deep, center cut, for the first blast, and holes parallel to the axis for blowing out the remainder. The method of excavating the bench was nearly the same as that for the heading.

The progress was as follows:

Driving headings,	118	days.
Average daily progress, two headings,	8.4	feet.
Greatest progress in one month,	337	feet.
Ave. daily progress, same month, 31 days,	10.87	feet.
Greatest monthly progress, one end, 28 days,	202.5	feet.
Average daily progress, same month,	7.23	feet.
Greatest monthly progress on bench,	218	feet.
Greatest daily average on bench,	7.79	feet.

The contractor's estimate for excavating and timbering was as follows (the work was let by contract and completed by the railroad company):

Excavating 9 393.66 lineal feet at \$62.50,	\$587 103.75
Enlargement for timbering, 32 575 cu. yds. at \$2.50,	81 437.50
Cost of timber,	81 690.00
Cost of labor on timbering, 2 723 000 ft. B. M. at \$12,	32 676.00
Total,	<u>\$782 907.25</u>

Or cost per foot \$83.34.

The following machinery was used:

At the Ivanhoe end, three 100-HP boilers, two 20×24-in. Ingersoll compressors, one 20×24-in. Norwalk compressor, a 10-HP engine and dynamo for lighting, a 20-HP engine and a No. 6 Baker blower for supplying fresh air through a 14-in. pipe. In the tunnel, three pumps were used for drainage as the gradient was down toward the Busk end.

At the Busk or east end, there were three 80-HP boilers, two 20×24-in. Ingersoll compressors and a 10- and a 20-HP engine driving the dynamo and blower, respectively. Four 3½-in. Ingersoll Eclipse drills were used in each heading and two on the bench, a total of twelve in the tunnel.

A 20-in. gage dinkey engine capable of hauling nine 3-cu. yd. dump cars was used at each end. Coke was used for fuel with no inconvenience to the men in the tunnel.

In driving the Canadian Pacific spiral tunnels in the Kicking Horse River Valley, Engineering News, Vol. 64, p. 512, 1910, the method where timbering was not required was to drive a full top heading, keeping it some 10 to 12 ft. ahead of the bench (which was kept as nearly vertical as possible) and to shoot the heading and bench at the same time.

After a shot, the drillers cleaned back from the heading far enough to set up and start drilling, while the shovel was moved up and started mucking. The shovel gang would finish about the time the drillers had finished the heading and the down holes of the bench. The shovel was then moved back about 150 ft. and the lifter holes in the bench were drilled.

When the drilling was finished, the drills and accessories were moved back and the cut holes in the heading loaded for springing. These cut holes were sprung, then charged and fired. Then the side rounds and lifters of the heading and all the bench holes were shot at one time.

This method of keeping the bench close to the heading allowed the greater part of the heading muck to be thrown back with the bench muck and removed directly with the shovel. Where timbering had to be used in the heading as driven, the bench was kept about 50 ft. back. The heading was mucked by hand, the material being carried in cars to the face of the bench and dumped. The permanent timber plates were put in (see Fig. 21), each segment trimmed off, lagged and wedged up.

Before shooting the bench, the wall plate was well supported

and the last full length post protected by old timbers. Just enough bench was shot each time to allow another full post to be put in.

The general plan in driving the heading was to put in two rows of cut holes, about 12 ft. deep and sloped so as to nearly meet. The side holes and lifters were about 10 ft. deep. The distances of the side holes from the perimeter were varied as much as 2 ft. depending on the character of the rock.

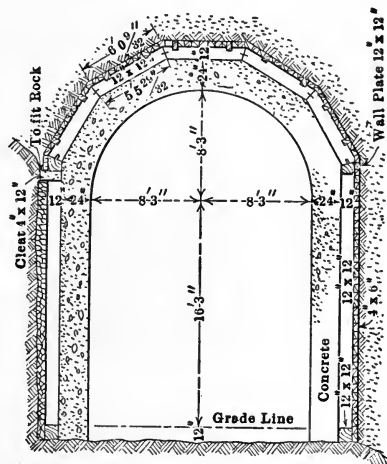

FIG. 21.—Concrete Lining.

The bench had a row of down holes about 8 ft. from the face and about 10 ft. deep and a row of lifter holes in from the bottom of the face 12 ft. deep, so pointed as to go 1 ft. below grade. The aim was to break 8 ft. of heading and the same amount of bench each round.

The drilling was difficult, owing to the brittle and semi-fractured condition of the rock, which caused the drills to jam. The number of drills was increased to the space limit, still the drilling fixed the rate of progress.

The shovels were the standard No. 20 Marion, with special short booms and dipper arms and rock dippers with Panama teeth. They were set close to the side of the tunnel and the air was piped to the boiler as an equalizer rather than directly to the engines.

The Gunnison tunnel of the Reclamation Service, Engineering News, Vol. 60, p. 228, 1908, about 10½ ft. wide by 12½ ft.

high inside the lining, and 30 582 ft. long, is interesting on account of the difficulties encountered during construction, and on account of the progress records made. Work was stopped for six months on account of the inrush of water (and \$15 000 was spent on extra pumps and piping), and for another six months by flow of hot water and carbonic acid gas. The latter was met by driving an inclined shaft with two lines of ventilating pipes served with blowers furnishing 12 000 cu. ft. of air per minute. Even then the temperature was 90° F. for the next 2000 ft.

At frequent intervals, inrushes of water would break in from the sides and face bringing hundreds of yards of sand which buried everything for 500 to 600 ft.

Layers of hard material were underlaid by beds of disintegrated sandstone which would loosen and threaten the safety of the heading force. Once, threatened by water and gas a mile from the nearest point of egress, the workmen deserted.

52. Rates of Progress.—The following is given in Engineering Record, Vol. 61, p. 800, 1910:

Some Records of American Hard Rock Tunneling

Name	Section feet	Best month's work	Rock	Average for several months	Explosive per cu. yd. pounds
St. Paul's Pass, C. M. & P. S. Ry.....	19x24	385	Laminated quartz..	12 mths. 272	5.4*
Ouray, Col.....	7½x7½	359	Hard rock....	5 mths. 342	7.0
Los Angeles Aqueduct, No. 27.	9x10	464	Medium hard granite.	4 mths. 348	3.2
Los Angeles, Elizabeth.	464	Gneissoid granite..		
Kellogg.....	9x11	354	Quartzite.....		
Gunnison.....	11x12	449	Granite gneiss....	300	
Roundout Siphon.....	17½ circ.	488	Hudson Riv. shale		3.0
Chicago Water Works	16 circ.	468	Limestone, close grained.	11 mths. 369	
Buffalo Water Works	12x15	390	Flint limestone....	6 mths. 354	3.0

* Heading only.

Many suggestions have been made for expediting the work, generally to the effect that we adopt European methods in the use of the bottom heading, the drill carriage and shallow holes; but none of these methods seem to appeal to those in active charge of the work on account of the belief that they are unduly expensive.

It is estimated from data given in a paper describing the construction of the Bergen Hill tunnels of the Pennsylvania Railroad near New York City, Transactions, American Society Civil Engineers, Vol. 68, p. 97, 1910, that over five times as many men were employed on the Simplon tunnel with less than four times the excavation progress and a smaller proportion of lining progress. This extra cost may be justified for a long tunnel on account of the loss of interest on invested capital, but it is not for one of ordinary length.

On the Buffalo waterworks tunnel, when the organization had been so perfected as to permit the use of three drilling shifts per day the average progress was increased over 90 ft. per month at an increased cost for labor and materials of less than \$2000 and with no increase in overhead charges.

The use of the drill carriage expedites the work of setting up the drills in the heading, but necessarily implies a bottom heading.

In nearly all the tunnels noted in the table each shift completed one round, and the holes drilled were the deepest possible for them to drill and complete their work. The next step would be for each shift to drill two rounds, but this is impossible for hard rock with any method now in use. It appears to be impracticable to leave part of the work of one shift for the next, as in attempting to get four rounds with three shifts. The problem is usually in handling muck and not in drilling if the organization is good and efficient tools are used.

On the Ouray tunnel, a 96 per cent. dynamite was tried without benefit, while in the Cripple Creek and Roosevelt drainage tunnels better progress and lower cost were attributed to the use of stronger explosives.

In the Roundout, which had the record until Sept., 1911, the bench was kept 50 ft. back from the heading to allow room for the heading muckers, and it was excavated in one shift. Four 3½-in. Ingersoll-Rand drills, mounted on two vertical columns, were used in the heading and two on tripods for the bench.

The average number of holes in a heading was 22, divided into six cut holes, six side or relief, and ten rim or trimming holes as shown in Fig. 22. The cut holes were 10 to 12 ft. deep, and the others from 8 to 10, depending on the amount of rock to be broken.

The bench rounds were 4 ft. apart and averaged four holes

each. Two rounds of bench were shot with the cut holes while the side trimming holes were loaded and shot successively, making three shots for a complete advance in which 175 to 200 lbs. of 60 per cent. dynamite was used.

A track of 30-in. gage extended from the bottom of the shaft to the bench with switches at intervals of 1000 ft. and two tracks at the bench. The heading muck was wheeled out on an elevated running board while the bench muck was loaded directly.

All of the men except the muckers received one per cent. extra on their wages for each 5 ft. of advance per month in excess of 225 ft.

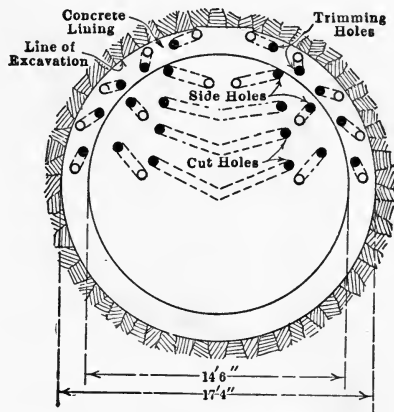

FIG. 22.—Heading Holes.

The Roundout record was beaten by an advance of 523 ft. of tunnel during Sept., 1911, for the Walkkill, also on the Catskill aqueduct, and this is claimed as the American record for hard rock tunnels of large size. Twelve-ft. steel was used for the cut holes and 10-ft. for the side round holes, resulting in an average advance of 8.7 ft. per 8-hour shift with two shifts per day. In order to drill three lengths in an 8-hour shift, two drillers and helpers came on four hours before the regular drilling shift, mucked back for the heading and set up the columns and drills for the drilling shift.

The rock usually shot fine, giving mostly shovel muck and requiring no back firing. The bench muck was shoveled directly into cars, while the heading muck was wheeled out over runways supported on metal struts wedged across the tunnel.

53. Cost of Rock Tunnels.—In Engineering News, Vol. 61, p. 128, 1909, a detailed statement is given of the cost of driving and lining a tunnel about 390 ft. long through bluish gray sandstone of medium hardness. The yardage was 3.6 per lineal foot (corresponding nearly to a heading); the concrete lining was 8 ins. thick and no timbering was required. The work was for the U. S. Reclamation Service in Montana.

Driving per foot,	\$15.04
Trimming,	2.63
Concrete lining,	10.45
	<hr/>
Total cost per foot,	\$28.12

This includes superintendence, labor and materials, with labor (mucking and mining) at about \$3.00 per day. A small portion of the tunnel required timbering from the floor over the crown and this increased the cost per foot of the first two items from \$17.67 to \$24.92, and made the total \$35.37 per foot.

The cost per cubic yard, exclusive of lining, was \$4.91 for the first and \$6.92 for the second.

The cost of a tunnel about 700 ft. long on the Kanawha and Michigan Railway is given in Engineering News, Vol. 61, p. 11, 1909, as follows:

Excavation including timber lining, per foot,	\$82.00
Concrete sidewalls, incl. forms and reinforcements, per cubic yard,	8.50
Brick walls and arch, incl. centering, per cubic yard,	9.00
Concrete portals and back filling, incl. forms, per cubic yard,	8.18

Width of tunnel 17 ft. 8 ins., height 22 ft. above top of rail. Material mostly blue shale. The heading, which extended to the plumb post caps, was driven from each end and the timber arch put in as the work progressed, using the caps as temporary sills. No unit prices for labor are given.

In Engineering News, Vol. 64, p. 340, 1910, it is stated to be common practice on new lines to sublet tunnels under 600 ft. long to hand drillers, and that the cost per foot for single track is often as low as \$35. For hard rock, it is difficult to get hand drillers at reasonable rates and steam drills can be used with but half of the fuel of air drills and they cause no inconvenience up to 300 to 400 ft. from the portal. In using steam, the benches are kept close up with the heading, the heading and top bench are

drilled with one set of columns and the exhaust steam is piped outside.

The Hunter Brook Tunnel of the Catskill Aqueduct was begun in the fall of 1909, Engineering Record, Vol. 64, p. 358, 1911. The top heading and bench method were used until late in May, 1910, with an average monthly progress of 84 ft. at the north end and 126.5 ft. at the south end, with a labor cost of \$6.63 per cubic yard. The management was then changed and a bottom heading on grade 8 ft. wide and 9 ft. high was tried, the top and then the sides to be stoped out. This permitted only one line of track in the heading and the mules could not take out the muck fast enough. The heading was then driven the full width of 15 ft. to make room for the second track (not advisable with proper electrical equipment for hauling). It was driven with four 3½-in. Ingersoll-Rand drills mounted on two columns. The cut holes and lifters were driven 6 to 7 ft. and the breakers 5 ft. Steel slick sheets were laid back from the breast 20 ft. before blasting. The round was shot with 60 per cent. Forcite in rotation with fuses and caps. The holes almost always broke to the bottom which they do not do with battery shooting.

Immediately after the blast four picked muckers mucked back the heading. They were paid \$2.50 to \$3.00 per shift for clearing the heading with a bonus for quick work. They worked in a split shift and would clear in about 3 hours, so that about 6 hours constituted a day's work for them.

The powder averaged 7.5 lbs. per cubic yard for tough rock, which was broken fine enough for shoveling. July 15 to Aug. 15, 1911, the progress was 289 ft. at a labor cost of \$3.29 per cubic yard, overhead charges, powder and haulage not included. For the five months ending Aug. 15 the cost was \$3.40, including blacksmithing but not hauling.

Regular heading 8-hour shifts

Shift boss,	\$5.00
4 drill runners at,	3.50
4 helpers at,	2.25
Muck boss,	3.50
8 muckers at,	2.00
1 nipper at,	2.00

The timber gang for the stope (top heading) consisted of a foreman, two timber men and two helpers working on day shifts only. They put up the temporary platform consisting of

bents of 10 by 12-in. posts with 12-in. round caps placed 3 ft. centers and heavily lagged on top. A gap of 30 ins. was left over each track and covered by cross lagging which was removed as required in caving the muck pile into the cars. The lagging was $7\frac{1}{2}$ ft. up and the heading $9\frac{1}{4}$, leaving clearance for blasting down without breaking the timbers. Three stopes were always in operation, drilling in one, mucking in one and trimming in one. From March 15 to Aug. 15, 1911, a yardage almost equal to that of the bottom heading was stoped from the top, but at a labor cost, include blacksmithing, timber platform, and maintenance of only \$1.69 per cubic yard, making the average labor cost for completed section \$2.45 on cars. The powder consumption in stoping was 2.5 lbs. per cubic yard.

The regular timber gang followed the trimmer placing the permanent sets. Wall plates were unnecessary.

In Engineering Record, Vol. 64, p. 427, 1911, it is stated by Mr. Lavis that the usual price for railroad tunnels in rock in this country is \$4 per cubic yard, and that if they do not get the rock loaded on cars at a labor cost of \$2.50 they must lose money. In the Buffalo waterworks tunnel the work was done under compressed air in three 8-hour shifts with an average monthly progress of 300 ft. for six months in difficult work at a labor cost of \$2 per cubic yard.

Two tunnels were recently driven under the Erie Canal at Buffalo. In one 126.3 ft. of heading, with bench 15 ft. wide and $12\frac{1}{2}$ ft. high, was driven in a week, with a force of one heading foreman, five drill runners, five helpers, one nipper, one muck foreman and fourteen muckers, at a cost of \$193.50 per day, for 146 cu. yds., or \$1.32 per cubic yard. In the other, the progress was 108 ft. and the cost \$1.55. These are given as normal, not record rates.

On one tunnel contract the overhead charges were over \$200 per day, the power cost over \$350, and the unit cost ran up to \$7.50 per cubic yard; yet they were striving to cut down mucking gangs, change drilling shifts to work as few men as possible and to do away with foremen. By adding a few men and rearranging shifts the yardage was run up from 250 to 550 cu. yds. per day and the cost per cubic yard dropped automatically.

54. Tunnels through Loose Ground.—Loose ground is intended to cover all material between solid rock and quicksand. For this

material heavy timbering (or a shield) will usually be required with poling boards to hold the earth from caving or flowing in, especially if water is present.

It is usually impossible to account for all the material removed by the gross cross-section on account of caving and on account of the settlement and compression of the timbering. This disturbance often extends to the surface and it may cause damage to pavements, pipes or buildings if under a city street.

The cost and difficulties will usually be greater than for solid rock, especially if water is present.

55. The Belgian Method.—In this method the top section is first excavated and the arch built for the support of the roof before taking out the bottom portion and building the side walls. Prelini states that the usual heading bents with vertical

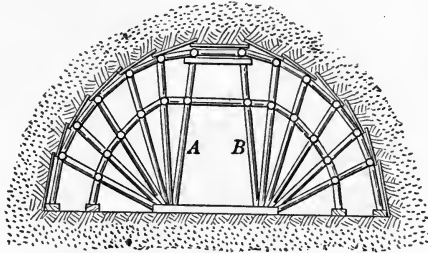

FIG. 23.—Arch Timbering.

posts are used to support two longitudinal bars which carry the transverse poling boards, and that in the enlargement each way from the heading the vertical posts are replaced by the inclined posts *A* and *B*, Fig. 23. The strutting thus consists of longitudinal bars as shown, supported by inclined struts placed in rows from 3 to 6 ft. apart, depending on the pressure developed.

In building the arch the longitudinals are propped from the lagging or centers and the inclined struts removed as required. When reached by the masonry, the longitudinals, and the poling boards when feasible, are removed and the space behind the masonry rammed full of earth or stone to prevent settlement and to distribute the pressure over the arch.

In taking out the arch centering, horizontal struts should be inserted before excavating the bottom center to prevent the arch from being pressed in before the side walls are built.

The side bottoms are removed in alternate sections to permit strutting the heavy plank along the springing lines to support

the arch while the remaining material is removed. Portions of the side walls are then built to support the arch, when the struts are removed and the side walls completed.

In soft material there will be considerable settlement of the arch before it can be supported by the side walls and invert. If this is uniform and without deformation, it can be allowed for in setting the centering and by keeping the lengths independent, *i.e.*, without bonding the adjacent sections.

The objections to the system, aside from that of building the arch on a yielding foundation, are poor drainage and the concentration of pressures by the use of the radial struts. With the top heading the water from it has to be carried over the lower workings. This could be avoided by a bottom heading as in the English and Austrian methods but in soft ground this would tend to loosen the material which supports the arch until underpinned. Also that the material to be excavated is accessible only in small masses which increases cost, while the underpinning of the arch is quite generally condemned. The system, however, continues in favor with Belgian and French engineers and contractors, and it is said to have given excellent results at the St. Gothard, a tunnel which was driven at a high rate of speed. For arching a tunnel quickly through loose rock, or rock requiring but little support, Drinker places this method superior to any other known.

56. The Baltimore Belt Railroad Tunnel.¹—This may be taken as an illustration of the German method for soft ground. It was 8350 ft. long and was built under the principal business section of the city on Howard street with buildings on each side from three to eight stories high. The soil was chiefly sand, with seams of gravel, clay and loam, with more or less water. The greatest depth to the crown was about 70 ft. The work was contracted in 1890, and at the time it was claimed to be the largest soft ground tunnel ever driven. It was 27 ft. wide and 22 ft. high, maximum dimensions after lining, while the necessary excavation was from 3 ft. to 5 ft. greater.

The estimated cost was \$1,750,000 and the estimated land damages \$1,000,000. The shallower portions could have been built more cheaply by making an open cut, then lining and filling, but the street had to be kept open for traffic and only one of the five shafts used was allowed in the street.

¹ Eng. News, Vol. 26, pp. 557, 585, 1891; Vol. 29, p. 457, 1893.

The method used in excavating was to drive two bottom side headings, and a central top heading from which the enlargements were carried both ways to the side headings. The bottom headings were about 8 ft. by 8 ft. They were advanced by driving poling boards outside the cap and posts of the bent as usual, while face boards at the front were used for most of the work. Two miners and a helper could advance 50 to 90 ft. per month, working in 10-hour shifts; ordinarily they did not work more than 25 ft. in advance of the top heading. This gave drainage for the material in driving the top heading.

In enlarging to full section after the top heading was driven the segmental arch system of timbering was tried. The timber was sawed 12 by 12-in. in 6-ft. segment lengths, set close without sheeting and supported by struts resting on footing pieces on the earth center core. Iron poling boards were used in front of the timber but they could not be pushed into proper position, some slanting up and some down so that the timbering soon became badly out of shape, and so low at the top that the brick lining could not be built to the proper height.

The English system of timbering was then adopted, the bars being bricked in instead of drawn forward as described in § 57, and some other modifications were made. The side headings gave support to the ends of the cross sills while furnishing drainage and allowing the side walls to be carried up and the arch completed before the center core was removed, as shown, Figs. 24 and 25.

Dry stone packing over the arch gave better results than rubble masonry or earth packing. The arch was built of five rings of brick well bonded, except for the heaviest ground where eight were used.

The work on the wet portions of the tunnel was facilitated by draining the ground in advance of the headings. Driven wells were put down in the street and pumped, a 6-in. pipe being the most common size. On one section of about 200 ft. the pressure of water was so great as to wash in the earth despite the packing of hay and cement. Perforated 6-in. pipes were driven radially into the side of the tunnel and liquid cement was forced into the earth. The radius of penetration was about 10 ft. from the pipe, and the effect was to solidify the ground and stop the flow of water.

After beginning the work an invert was found necessary in

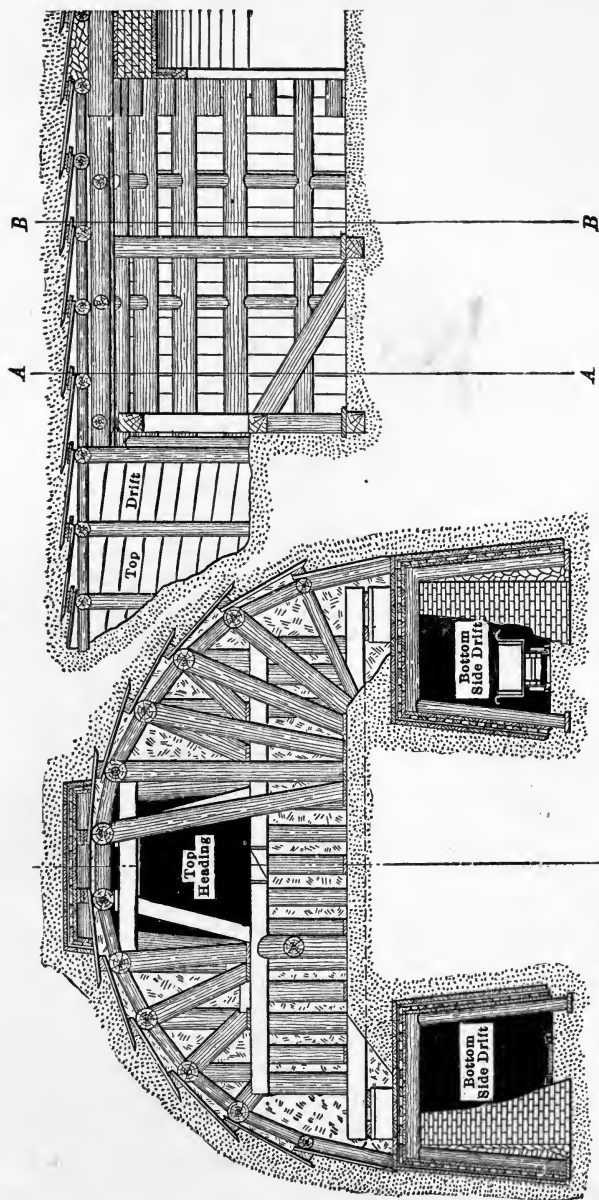

Half Transverse Section on *B-B*
 Fig. 24.—Baltimore Belt Railroad Tunnel.

Half Transverse Section on *A-A*

some places and the plans were changed to include it for the entire length of tunnel. Where the ground was sufficiently stable two 12 by 12-in. timbers were placed transversely across the tunnel and keyed between longitudinal timbers or wedges resting against the side walls. They were from 2 ft. to 10 ft. apart depending on the ground. Short sheet piles were driven outside the transverse timbers, the earth was excavated, an 8-in. layer of concrete laid and the brick masonry invert of three rings constructed.

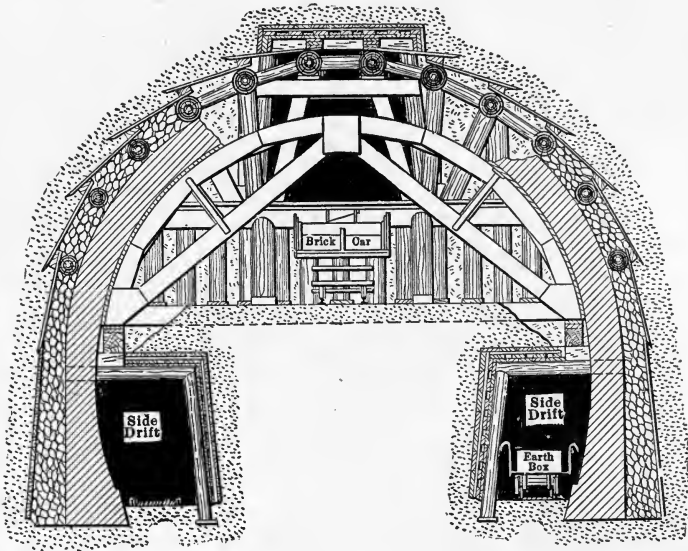

FIG. 25.—Baltimore Belt Railroad Tunnel.

Where the ground would not permit excavating near the side walls until the center was protected, the area between these timbers was divided into three parts by sheet piling parallel with the side walls, the center was excavated and the invert laid, afterwards the ends were completed up to the side walls. In the worst places the bottom had to be covered with a sheeting of 1½-in. plank held down by struts and the invert built upon it.

Every effort was made to avoid taking out material outside the tunnel section, and to prevent settlement of the material overhead. But the supports of the roof bars had to be changed three times and the timbering compressed each time in taking

up the load. Even after the load was transferred to the brick arch, the crown settled from 2 to 6 ins. due to the compression of the mortar joints. The settlement at the street level was usually from an inch to a foot, but it reached 18 ins. in some cases. Sewer, gas and water pipes were cracked, but no building foundations were seriously injured.

The center core is the essential feature of this, the German method. It is economical in timbering as compared with the full section excavation, while in soft ground there is less danger with the small openings than where large faces are presented. Cheap transportation is claimed on account of the possibility of using four tracks, one on each side and two on top of the core, but with masons at work in the side headings they would be too cramped to be of much value.

The disadvantages are poor ventilation, and cramped, expensive work in the side headings, difficulty in alining the side walls and for soft material danger of their crowding in when the core is removed preparatory to building the invert. Drinker states that the method has been practically abandoned in Germany.

While the Baltimore tunnel was successful, it is probable that a roof shield or some other type of construction would now be used under similar conditions.

57. The English Method.—This method is well described in Gripper's *Railway Tunneling in Heavy Ground*, 1879. He assumes a tunnel a mile long through material requiring heavy timbering during construction and heavy permanent lining. To reduce the time of construction five shafts are excavated, one at each portal and three between, so as to divide the distance into four equal parts. A bottom heading is driven through from the shafts and faces of the end cuts and supported by bents of caps and posts about 4 ft. centers with longitudinal poling boards. This checks the alinement, provides drainage, and allows spoil and materials to be handled through the portals as well as the shafts.

In enlarging to full section the shafts give eight faces directly while four enlargements or break-ups midway between the shafts are started, adding eight more faces. Openings are made through the open cut material down to the heading so that the spoil can be loaded directly onto the cars without shoveling.

The shafts are 9 by 9 ft. in the clear with horizontal timber

frames about 4 ft. apart supporting the vertical poling boards which are driven one by one as the shaft is deepened.

In enlarging, a narrow upper heading is driven and the reasons given for not driving this at first and thus saving the expense of the bottom heading are that the height at which to place the caps to allow for the settlement of the timbering before the roof arch is in place will vary with the heaviness of the ground and can only be determined as the enlargement proceeds;¹ if too great allowance is made, extra material is excavated and the space must be refilled above the lining; if too small allowance is made the timbers will not clear the lining and the roof must be remined requiring much extra work; again the bottom heading gives better drainage and cheaper loading of the spoil.

As a basis of attack for the enlargement, the top heading is driven about 20 ft. (where the lining is put in in 15-ft. lengths) and supported by bents and poling boards as usual. The large end of a heavy log or drawing bar is then pulled up into the heading and supported by an inclined strut as shown, Fig. 26. The rear end would be similarly supported for the first length and from the top of the completed lining thereafter. The caps of the bents being supported by the drawing bar, the posts on one side are removed and the earth mined and a second drawing bar put in place and supported like the first. Transverse poling boards are driven over the bars to support the roof. Similarly the posts are removed on the other side and a third drawing bar placed.

Either five or seven drawing bars, depending on the material, are thus placed and propped when a cross trench is dug for the upper sill extending well out at the ends and leaving room for the 15-ft. length of lining. The sill is brought in in two parts and scarf spliced at the center. The drawing bars are propped from this sill by posts in a vertical plane and the sill is braced from the rear to take the earth thrust of the face. The excavation is continued and the roof supported by longitudinal timbers and poling boards down to about the springing lines. To reduce back filling these timbers crowd into the space occupied by the lining and are removed one by one as the masonry is built up to support the poling boards. To support the poling boards at the front end of the masonry, short projecting timbers are built

¹ Drinker calls for $3\frac{1}{2}$ ft. from bottom of cap to top of arch for soft ground.

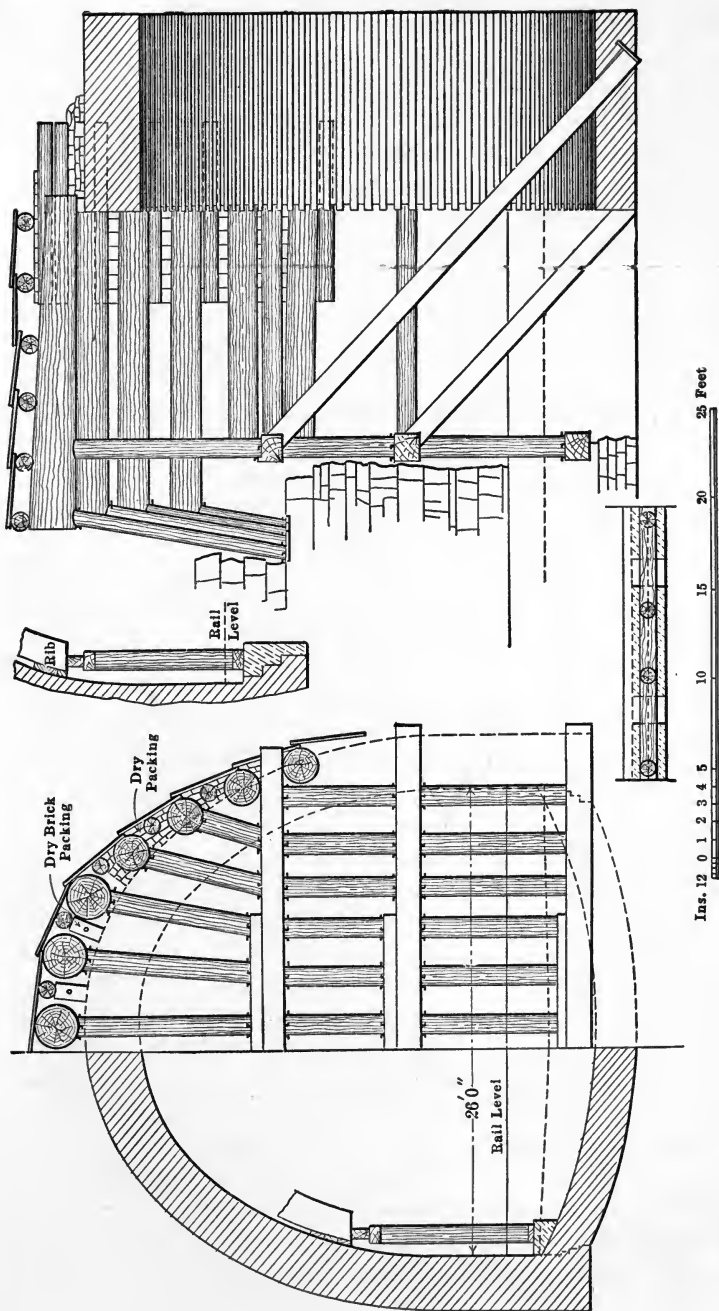

FIG. 26.—The English Method.

in as the larger ones are taken out. Between the drawing bars these short timbers are supported by the dry brick packing piers, leaving the rear ends of the drawing bars in pockets so that they can be drawn ahead when the front supporting props are removed.

Excavation is then made for the middle sill, digging longitudinal trenches and shoring with inclined struts as may be necessary in undermining the upper one. The bottom one is placed similarly and the excavation completed up to the plane of the sills and strutting.

Excavation is carried on at another face while the masonry lining is being built and the heading extended 15 ft.

In building the lining the side walls are carried up to the springing lines of the arch and the invert put in place if the ground is soft enough to require it. The frames for the centering are then set at the proper height to allow for settlement and the lagging plank added one by one as the bricks are placed, the masons standing on a staging inside the arch. When the two sides of the arch approach to within about 2 ft. one mason begins at the back end to close up the keystone using transverse lagging plank one by one as he backs out.

By making the lengths square at the ends without bonding, each section can be built as high as may be necessary to allow for settlement. In pulling the drawing bars forward in excavating the next length, the front ends are lowered which relieves them of the roof load. The cavities over the arch left for these bars are filled with dry packing.

58. The Austrian Method.—In this method, as given by Drinker, a bottom heading is first driven which provides drainage, and if carried through, aids in ventilation and allows of checking the alinement. The bents are supported by longitudinals, while inclined struts prevent the face pressure from tilting them backward. The top heading is next constructed as shown in Fig. 27, building from below upward.

The widening is begun at the top and extended each way to the springing lines, using spar timbering (or the American timber arch system for loose rock) with longitudinals and bracing from the upper heading. The excavation for the side walls is then made. This timbering of the full area having been finished in sections of 6, 9 or 18 ft., according to the ground, the masonry lining is constructed. The props to the roof timbers are removed as required, the latter being temporarily supported from the

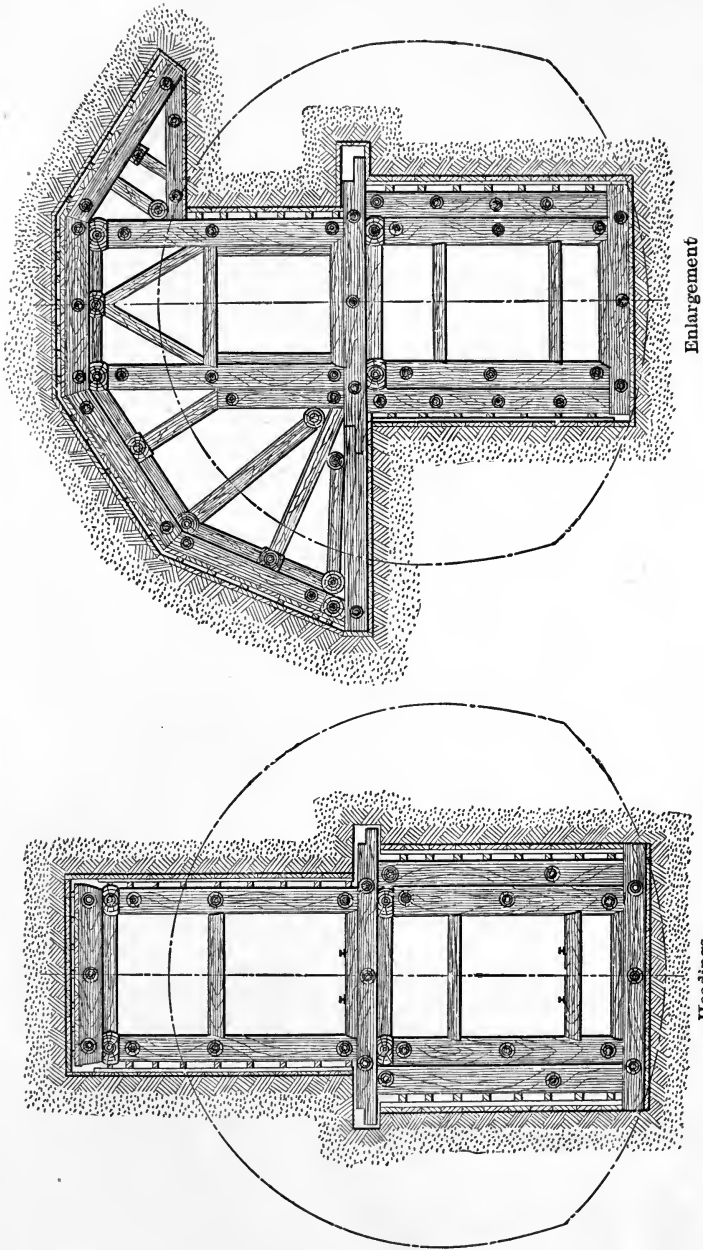

FIG. 27.—The Austrian Method.

lagging until they can safely be removed. The invert is built last.

The strength of the timbering and the provision for crosswise and longitudinal connection of the sets, without the concentration of pressure on any portion of the base, are the main features of the method.

There is sufficient room for the masons to do good work, but they are not so free as with the English method, and the masonry is apt to cost more, as also the timbering and excavation. It would thus seem advisable to reserve the method for the few cases of soft ground where the English method is not applicable.

59. The Pilot Method.—This method was used by Anderson and Barr in the construction of the Brooklyn relief sewer in 1892. Transactions, American Society of Civil Engineers, Vol. 26, p. 484, 1892. The depth to invert varied from 37 to 90 ft., the diameter inside the brick lining from 13 to 15 ft., while the route was under paved streets in a populous district and through sand and gravel. The sand was sometimes dry and fine, but usually damp enough to stand well.

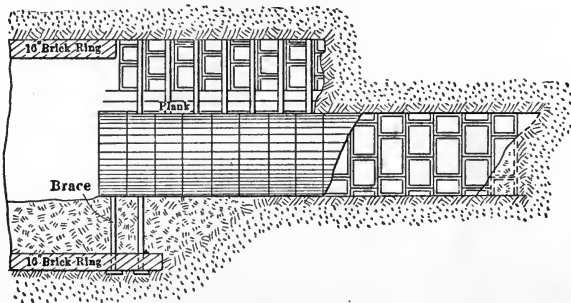

FIG. 28.—The Pilot Method.

The pilot was cylindrical, Fig. 28, about 6 ft. in diameter with rings 2 ft. long, each ring consisting of six steel plates with inside riveted flanges; enough for 40 ft. in length was used for a heading.

Shafts about 18×24 ft. were sunk and the first two rings set up in the bottom and blocked to line and grade. The sheeting was then bored through on the line of the pilot ring and iron poling boards placed from the crown down to within 2 ft. of the center as the timber was taken out. A half width plate was bolted on at the top, then wooden poling boards worked in down

to the center and a half width plate put in on each side. Another half plate was put in at the top and the sides again filled out, the front face was then bulkheaded and the three full plates put in to fill out the bottom half. This completed a ring. The next ring was put on in a similar manner, breaking longitudinal joints with the first.

The pilot was guided by wooden wedges on the center line for direction and at the right distance below the roof to allow the center heading man to stand on it and put in the heading plates.

When the pilot was well underway, the heading was started over it by boring the sheeting along the outer line of the brickwork. The heading plates were then bolted together in two rings and set up in the shaft, and the roof worked ahead. The rings were 1 ft. long and they were carried down as far as much side pressure was felt. At each second ring a bulkhead was built down in front and braces put from the last ring to the pilot. When the heading was at least 15 ft. from the shaft, or from the tothing of the last section, a 10-ft. section of brickwork was put in. In excavating for this 10-ft. length, longitudinal planks were placed on either side below the iron heading plates and braced from the sides of the pilot.

60. The Cut and Cover Method.—For tunnels near the surface, this method is often safer and less expensive than driving as a tunnel. For city streets, provision must be made for the traffic for a part or the whole of the width, except for certain hours during the night.

If traffic can be excluded for a short distance over the whole width of the tunnel, a single trench can be excavated and strutted, the side walls and roof built, the top refilled and well tamped, and the street surface restored. If from only a portion of the width, the trenches for the side walls can be excavated and the walls built one at a time. If the roof is to be a longitudinal arch, it can be sprung from the side walls and carried up in longitudinal strips corresponding to courses of voussoirs as the trenches are worked toward the center by widening on one side and back filling on the other, the centering or lagging being supported on the unexcavated material under the arch ring.

If the roof is to be supported by transverse beams extending from wall to wall and the area between adjacent beams cannot be

opened, a movable bridge or platform can be used, over which the traffic passes and under which the excavation is made, the beams inserted and the arches between them built and back filled.

For a portion of the Boston Subway, transverse sections the full width of the tunnel and 12 ft. wide were partially excavated at night and then bridged with heavy timber flush with the street surface, this surface including street railway tracks. Under these bridges the excavation was completed, the lining built and the top filled in 12 ft. lengths. The method shown in Fig. 29 and used in Washington Street was similar to the above. The trenches were dug in short sections and bridged; the posts set up and the side walls built, and the street surface removed and the roof beams and wooden bridging put across. The trenching and bridging were done at night.

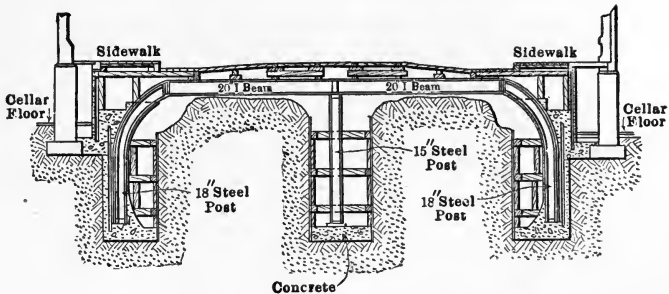

FIG. 29.—The Cut and Cover Method.

Water, gas and sewer pipes, if above the roof grade, can be supported during construction and buried in the back fill without serious disturbance. If within the section of the finished tunnel, they would have to be moved, a difficult operation in the case of sewers if it involves a change of grade, as inverted siphons are not desirable. Advantage is frequently taken of the construction of the subway to provide room for pipes, electrical conduits, etc., where they can be reached without disturbing the street surface. For illustrated descriptions of the Boston Subway, see the Reports of the Rapid Transit Commission.

61. Submarine Tunneling.—On account of the certainty of water in permeable material the geological examination of the site should be supplemented by borings carried to the bottom of the tunnel, but on the side to avoid holes which would give

direct communication to the water above. Wash borings are customary for soft material, while occasional dry cores are preferable for rock.¹

If the material is impermeable and the roof a good distance below the bed of the stream, it is probable that the method best adapted to the material if above water could be used with a fair degree of safety, although with slightly greater danger from sudden inrushes of water and mud.

If the material is permeable, and especially without cohesion, like silt or quicksand, compressed air and some form of shield would be necessary. The use of compressed air would require a bulkhead with air lock in the shaft or approach tunnel and a compressor plant of suitable capacity in addition to the facilities required for excavating and lining, pushing the shield forward, and for handling the water and spoil. With loose material, if the roof is thin, it will be necessary to blanket the stream bed with clay to allow of sufficient air pressure to hold the water in check at the bottom of the face where the static pressure is greater than at the top, the difference increasing with the size of the tunnel.

Compressed air is sometimes used to keep out water and reduce the amount of timbering required where the material is not soft or porous enough to require a shield.

62. The Shield Method.—The English engineer Brunel is given credit for the invention of this method which was tried under his direction as engineer for the first Thames tunnel about 1823. The first shield failed for lack of strength. The second was rectangular in section, about 22 ft. by 37½ ft., made up of thirty-six cast iron frames so articulated that each could be pushed forward independently 6 ins. at a time. The weight was 120 tons, and it was driven for several months at the rate of 2 ft. per 24-hour day. The tunnel was completed in 1843 at a cost of about \$5600 per lineal yard. The lining was brick, built under cover of the shield.

In 1864 and 1868, Barlow, also an English engineer, took out patents covering the main features of the modern shield with cast iron lining for the tunnel and grout outside to fill the void due to the slightly larger diameter of the shield. The main features of the Barlow patents were put into practical

¹ See Eng. News, Vol. 65, p. 339, 1911, for a description of inclined drill holes under the Hudson for the Catskill Aqueduct.

shape by Greathead, who took the contract for the Tower subway under the Thames in 1869. The tunnel, about 7 ft. in diameter, was through clay with a minimum cover of 22 ft. under the river.

About this same time Beach was constructing a tunnel under Broadway, New York, through loose sandy soil with a shield modeled from Barlow's in which hydraulic rams were used for the first time in moving forward. The diameter was 8 ft. and the lining of brick, the thrust of the jacks being distributed by timber bearing blocks.

For a further description with cuts, see Tunnel Shields, etc., by W. C. Copperthwaite, 1906.

For subaqueous tunnels through silt and soft materials a cast iron lining in segments with inside flanges is used and the shield is circular in section. One of the Hudson river shields of the Pennsylvania railroad is shown in Fig. 31, page 125.

The front end or working chamber is divided into cells of suitable size, usually three in height for a single track railroad tunnel, for attacking the face. These cell walls serve to stiffen the shield and preserve the section. The cutting edge may be a right section, or it may be visor shaped as in the figure. The central portion which contains the hydraulic jacks, pumps, etc., is called the body. It is separated from the working chamber by a diaphragm with suitable openings for men and materials, which can be closed when necessary for protection. They should be low enough from the top to form an air trap in case of an inrush of water.

The rear end or tail should be long enough so that about two rings of lining can be bolted on under cover.

The jack cylinders are connected to the shell by plates, angles and rivets sufficient to transmit the thrust in moving forward. In stiff clay a jacking force of 4 to 5 tons per square yard of frictional area has usually been found sufficient. Pistons 5 to 6 ins. in diameter are used in this case with a water pressure of about 1000 lbs. per square inch, a pressure which can be supplied with hand pumps if necessary. In soft material a jacking force of 18 to 20 tons per square yard is required. Pistons 6 to 7 ins. in diameter are used with a pressure of 4000 to 6000 lbs. per square inch, necessitating power pumps. The jacks can be operated independently and this usually gives sufficient control of line and grade in pushing forward.

The cutting edge is reinforced by a ring of angle iron or cast iron. The outside of the shield should be smooth to reduce friction. It is sometimes slightly tapered with the same object in view, but in firm material extra grout is then required outside the lining.

If the bottom of the shield strikes rock while the top is in soft material it is often necessary to pole out in front and form a roof and possibly sheet the face, to allow of drilling and blasting in front of the working chamber. Where this is foreseen the shield is sometimes made visor shaped.

For a description of roof shields used under city streets in Paris, and in Boston, see Copperthwaite or Prelini. The Boston shield for a double track subway had a top length of 14 ft., a width over all of $29\frac{1}{2}$ ft., and a height of about $8\frac{1}{2}$ ft. from shield track to crown. The thickness at the crown was 3 ft. 8 ins. to the shell or top cover plate. It weighed about 22 tons and cost about \$6000. It was driven forward by ten jacks at the rate of 9 ft. per day of 24 hours under normal conditions, the jacks reacting against $2\frac{1}{4}$ -in. cast iron bars built into the roof masonry, with an average total pressure of some 500 tons. Headings were driven and the side walls built in advance for the support of the track which carried the shield.

63. The St. Clair River Tunnel.—This tunnel was constructed under the river at Port Huron, Mich., in 1888–90. It is one of the first large tunnels built in this country in which a shield was used. The river bed is composed of sand and gravel underlaid with soft clay which in places was only 38 ft. thick. Under the clay there is a bed of shaly rock containing an abundance of natural gas.

Open cuts were extended from each side until within a distance of 6000 ft., when a shield, 15 ft. 3 ins. in length and 21 ft. 6 ins. in external diameter, was placed in each and driven through the soft clay toward the other. When the river section, 2300 ft. long, was reached, bulkheads with air locks were constructed in the tunnel behind each shield and an air pressure of from 10 to 28 lbs. per square inch maintained at the face until the shields met.

The diaphragm of the shield was placed 4 ft. from the rear end and there were two openings through it near the bottom, each about $4\frac{1}{2}$ by 6 ft. This left a large working chamber and the girders or partitions dividing into cells were placed 4 ft. from the diaphragm, thus allowing the spoil to be thrown down from the working platforms in front of the openings.

The tunnel lining was made up of cast iron segments with inside flanges for bolting together under cover of the shield.

Work was carried on day and night in 8-hour shifts with 75 men, it is said at each working face, 26 of whom were engaged in excavation. In good material excavation was extended in front of the shield far enough to allow two sections of lining to be put in when the shield was moved forward, but usually no unprotected face was allowed, while at times the clay would flow through the door in the diaphragm and was loaded directly into the skips without previous handling. The ground in front of the shield was always tested some 10 ft. ahead by a shell auger.

No cost data are available.

64. The Subaqueous Section of the Detroit River Tunnel.¹—This tunnel displaced a ferry from Detroit to Windsor for the Michigan Central Railroad. Various schemes for bridges and tunnels had been under consideration at different times since 1867. In 1872 headings were started on both sides of the river, but they were abandoned when within several hundred feet of meeting. The greatest obstacles were sulphur gas and sulphur water under a head higher than that of the river.

The river varies in depth from 18 to 48 ft. Below this depth, the clay of varying degrees of hardness extends to bed rock about 90 ft. below water surface.

The method finally adopted was to sink two steel tubes side by side in sections in a dredged channel and then connect them up and surround with concrete for the double track tunnel.

The tubes are 23 ft. 4 ins. in diameter, built of 3/8-in. steel plates riveted and ship-calked. They were built in sections 262½ ft. long, except the section containing the sump which was 238½ ft., and the closing section at the Windsor end which was 64½ ft. They were sunk in pairs, 26-ft. centers, each for a single track. Stiffening rings of 4 by 4-in. angles, spaced 12 ft. centers, were riveted inside and stiffened by radiating rods.

Steel diaphragms 1/4 in. thick were spaced 12 ft. apart on the outside to form pockets for the concrete in connection with the planking attached to the vertical edges as shown, Fig. 30. Most of the trench excavation was done with a clam shell bucket

¹ See Paper by W. S. Kinnear, with discussion, *Transactions American Society Civil Engineers*, Vol. 74, p. 288, 1911.

of 3 cu. yds. capacity, the dipper dredge not being satisfactory. The bottom of the trench was tested for line and grade by sweeping a 24-in. I-beam, 48 ft. long, suspended under a derrick scow.

A grillage of I-beams was placed at each joint to support the ends of adjacent tubes until the foundation concrete could be deposited. Under each corner of the grillage a 10 by 10-in. by 10-ft. spud was attached which was driven down by a pile driver hammer until the grillage reached grade when let down by derricks from a scow. Concrete was then deposited until it gave support to the beams.

For sinking, the ends of the tubes were fitted with watertight bulkheads, while four air cylinders were attached, two to each tube, for floating to position and for aid in sinking.

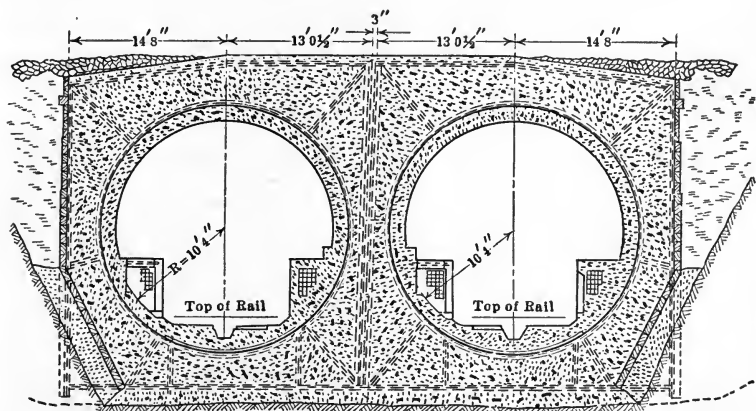

FIG. 30.—Detroit River Tunnel.

When submerged, the tube section and air cylinders occupied about one-eleventh of the area of the river section, and developed a pressure due to the current as computed from formula of 80 tons, which required anchorage up stream.

Line and grade were given from shore by sighting on a mast at each end of the twin tube and the tubes were adjusted by manipulating the holding lines. The position was held by divers shimming up the ends from the grillages and anchoring to them by turnbuckle arrangements.

On top of each tube at the west end a pilot pin 6 ft. long and 6 ins. in diameter was attached which fitted into a socket on the east end of the preceding section. The pin was tapered near the

end and slotted to receive a key which when driven locked the tubes together and secured a tight joint by means of rubber gaskets. This connection was made by divers.

After the twin tube was secured in place, the concrete was deposited through tremies. The usual order was to fill one of the pockets near the east end, then the foundation course for the entire length and width of the section, then a pocket near the center. The air cylinders were then removed and the other pockets filled. Three tremies were used, one on each side and one between the tubes, and the concreting was continuous for each pocket as nearly as possible. The concrete was thin enough to flow with the end of the tube under the surface so that the great mass of the concrete did not come in contact with the water.

The work of backfilling the trench outside the sheathing was begun as soon as two sections of tubes had been concreted. Gravel was used at the bottom and clay excavated by the dredge for the upper portion with riprap above the clay where the concrete came above the original river bottom.

After five sections of tubes were placed, unwatering was begun at the west end and followed by the concrete lining.

The west end of the tube section extends about 65 ft. west of the old shore line, the excavated trench forming a small bay some 55 to 60 ft. deep. To connect with the approach section, this bay was cut off by a coffer-dam and the water pumped out, the excavation was then extended to the approach tunnel shaft, 55 ft. from the coffer-dam, using heavy bracing. The lining was then built, waterproofed with ten layers of felt and eleven of pitch applied alternately and the trench filled.

At the east end the approach tunnel immediately adjacent to the subaqueous section was completed under compressed air up to the actual point of connection, and the extrados of the concrete section covered by a steel plate which was bent over the end of the section, thus providing a watertight joint similar to that between the sections of tubes. The trench was then excavated up to the plate, the tube section $64\frac{1}{2}$ ft. long put in place and the 10-in. gap closed by a special joint easily put together by divers. The closure was then sealed by the deposit of concrete.

To prevent an inrush of water when the end was uncovered, three heavy concrete bulkheads, 50 ft. apart, were built as a part of the approach tunnel close to the end.

As compared with the shield and compressed air, the labor cost for the tube section is much less, but the cost for materials is greater. It is estimated that on this work the saving was \$2 000 000 as compared with the shield. The cost for divers was about one-half of 1 per cent. of the total; their actual physical labor consisted in attaching the tube sections and detaching the air cylinders.

For a description of the plant and the details of the work reference is made to Mr. Kinnear's article and the discussions brought out by it, especially that of Mr. Hoff.

No cost data are available except as just given.

65. The New York Tunnel Extension of the Pennsylvania Railroad.—The estimated cost of this work including the Harrison and Sunnyside interchange yards is given as \$100 000 000. Volumes 68 and 69 of the Transactions of the American Society of Civil Engineers are given up to a description of the work. The tunnels include two single-track tunnels through Bergen Hill and under the North River and Thirty-second Street to the station yard at Tenth Avenue in Manhattan; thence from the east end of the yard, partly three-track and partly twin tunnels, to First Avenue; thence as four single-track tunnels under the East River to the Sunnyside Yard on Long Island from 3000 to 4200 ft. east of East River.

The single-track tubes under the North and East Rivers are of the most interest in this connection.¹ They were the first for heavy high-speed traffic to be constructed through so soft and treacherous material. That under the North River was saturated clay and sand, fairly homogeneous, but unstable; that under the East River was not homogeneous, consisting of quicksand, sand, boulders, gravel, clay and bed rock. This gave rise to frequent blow-outs through fissures opened in the river bed, and the bottom of the river over the tunnel had to be blanketed continuously with clay to check the flow of the escaping air.

The lining for the river sections is a cast-iron tube, 23 ft. outside diameter, made in segments with inside flanges for bolting together, and lined with concrete, giving a normal thickness of 2 ft. from outside of shell. A concrete bench is placed each side

¹ Transactions of the American Society of Civil Engineers, Vol. 68, 1910. Papers by Messrs. C. W. Raymond, C. M. Jacobs, A. Noble, B. H. M. Hewett, W. L. Brown, J. H. Brace, F. Mason and S. H. Woodard, members of the society.

of the track extending 1 ft. above the center and giving 11 ft. 8 ins. between benches for the passage of trains. These benches contain ducts for electric cables and protect the lining in case of derailment. This restricted cross-section has secured adequate ventilation by the operation of trains, while a complete ventilating plant is provided for unusual conditions such as the stoppage of trains.

In passing from rock to soft ground, the cast iron plates of the shell were replaced by steel plates, while longitudinal reinforcement was added in the concrete lining for the North River tunnels.

The tubes with the live or train load added are lighter than the material displaced and provision was made for putting down screw piles through the bottoms of the North River tubes. Experience with the smaller Hudson tubes farther down the river and other considerations led to the conclusion that they were not necessary and that they might possibly be undesirable so they have not been used.

The shields, Fig. 31, were thrust forward by twenty-four hydraulic rams capable of exerting a pressure of 3400 tons at a hydraulic pressure of 5000 lbs. per square inch. With a 30-lb. air pressure in the tunnel this would give a total of 4400 tons. The shield was fitted with a single hydraulic erector for placing the segments of the lining and with hydraulic sliding platforms, giving a total weight of 194 tons. The hood was removable, being used in sand, gravel and ballast and removed for silt.

The shafts on both the New Jersey and Manhattan sides extended into rock far enough for full rock cover for the tunnel for over 200 ft. toward the river. At these points shield chambers were made for the erection of the two sets of shields about 6100 ft. apart; the shields were then erected and driven to meet under the river.

Compressed air at from 25 to 40 lbs. per square inch was used after the shields emerged from full rock face. This, of course, required a bulkhead with air locks in each tunnel back of the shield to hold the pressure.

In the construction of the Hudson tunnels farther down the river, it had been possible to shove the shields through the silt with all the doors in the front closed, displacing the material and making rapid progress owing to the absence of mucking. In trying this with the larger tunnels of the Pennsylvania it was found that they could be kept down to grade only by opening the

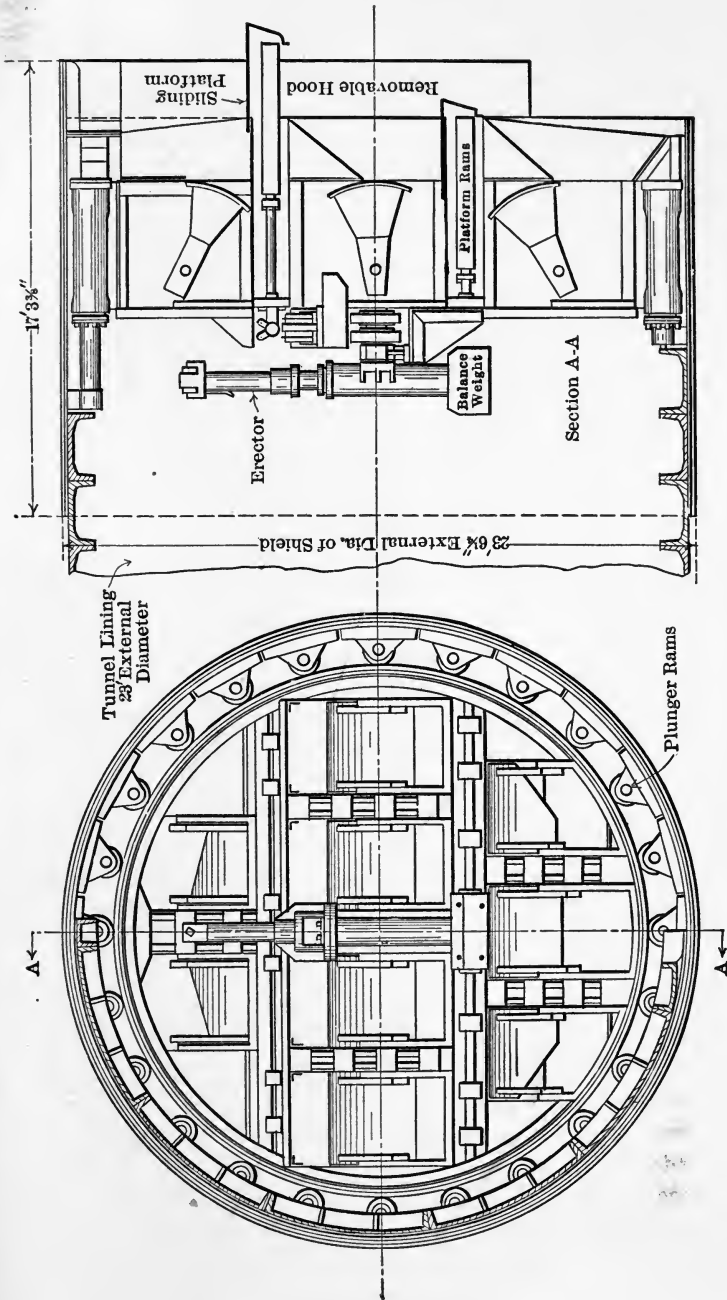

FIG. 31.—Shield North River Tunnel.

lower doors and taking in about 33 per cent. of the material displaced by the shield. Owing to this rising of the shields the weight of the cast iron lining was increased from 9609 to 12 127 lbs. per ft., giving 31 469 lbs. for the finished tunnel, or 42 869 with the maximum train load, as compared with 41 548 for the displaced silt assumed at 100 lbs. per cubic foot.

The greatest advance in a month at one face was 545 ft., and the average per heading was 18 ft. per 24 hours, working three 8-hour shifts.

Test holes through the bottom of the tunnel were carried to and into the rock, the greatest depth to rock being 302.6 ft. below mean high water, or some 210 ft. below grade, and at about the center of the river. Rods were inserted into the rock through these holes and it was found that the tunnels rose and fell with the tide, the average depression at high tide being about 0.008 ft. in the average tide of about 4.38 ft. This was not changed by the addition of the concrete lining.

The average settlement of the tunnels during construction and lining was 0.34 ft. between bulkhead lines. Since construction it has been constantly decreasing and it appears to have been due almost wholly to the disturbance of the material.

The East River Division embraced the permanent shafts in Manhattan and Long Island City, the four single-track tunnels between these shafts and their extension eastward in Long Island City to East Avenue, including in all about 23 600 ft. of single-track tunnels.

In letting the contract a fixed amount was named as contractor's profit and an estimated amount for total cost. The management of the work, with some unimportant restrictions, was placed with the contractor. If he came under the estimate he was to have one-half the saving, if he exceeded it, he was to pay one-half the excess up to one million dollars, the extent of his liability. This required an audit of the contractor's books by the railroad company and a careful system of cost keeping by the company's engineers.

The two Long Island shafts, each 40 by 74 ft. in plan and covering two tunnels, were sunk as pneumatic caissons to 78 ft. below mean high water, 54 ft. being through rock which did not prove to be sound enough to permit of stopping the caissons near its surface as intended. After reaching grade the bottom was sealed, the roof of the working chamber removed and the shields

erected on timber cradles in position to be shoved forward under the river.

The roof of the working chamber was then re-erected about 8 ft. above the tunnel openings. It contained an 8-ft. shaft with ladder and elevator cage for men and 1-cu. yd. tunnel cars. At the top were two standard tunnel locks forming a tee with the shaft. After applying air pressure the bulkhead closing the opening for the tunnel was removed, temporary rings of iron lining were erected across the shafts for the jacks to shove against and the shield started toward the river.

On the Manhattan side, rock was reached above the tunnel roofs and the caissons were extended into it and sealed. The rock was of such quality that the shafts were extended to grade and the tunnels started in each direction without air pressure or erecting the roofs of the working chambers. The shields were then erected in the shafts and pushed eastward about 60 ft. into the tunnels and the cast-iron lining erected as the shields advanced.

To close the space between the lining and the rock so that a bulkhead and air locks could be built in each tunnel, and air pressure applied, a concrete wall was built at the portal, and after about twenty permanent rings had been erected in each tunnel, two rings were pulled apart at the tail of the shield and a second masonry wall or dam was built. The space between the two dams was filled with grout. To prevent the lining from slipping under air pressure, 5/8-in. plates with slotted bolt holes were inserted in eighteen of the joints and these were driven outward to project about 5 ins. when clear of the shield and become embedded in the grout.

In excavating the full rock section after the shield was started three general methods were tried; the bottom heading, the full face and the center heading. For the first, the heading about 8 ft. high and 12 ft. wide, was driven as near grade as possible and a concrete cradle set in about 10-ft. lengths on which to advance the shield. In enlarging to full size, the drills were mounted in the forward compartment of the shield.

The full face method was about the same as the first, except that the bottom heading and the enlargement were in short lengths, allowing of only 2½ or 5 ft. of cradle to be placed at a time. It was only used where the rock was not considered safe for a heading.

In both these methods mucking was by hand and slow, as the material had to be passed through the doors or chutes of the diaphragm. Later while two of the shields were shut down, openings were cut through the diaphragms at the bottom so as to allow the tunnel cars to pass through, while at Long Island City openings were provided in erecting the shields. To take advantage of this change the heading was raised and the bottom taken out as a bench, while the drills in the heading were turned upward and a top bench was also drilled and fired. This left so little excavation at the top that the muck was allowed to fall on the tracks whence it was quickly cleared away. This is the center heading method and it was the most satisfactory for the full rock sections.

The part earth, part rock, sections were probably the most difficult to excavate. The hood (see Fig. 31, page 125) with poling boards and breast boards was the most satisfactory. The voids behind the boards were filled as far as possible with marsh hay or bags of sawdust or clay.

In providing for the junction of the shields those from the Manhattan side were stopped at the edge of the reef some 1700 ft. from the shaft. Before making the final shove special polings for each were placed to form a bell-shaped excavation to receive the Long Island shields. The rear ends rested over the cutting edge and allowed of the removal of the hoods. A temporary bulkhead of concrete and clay bags was built at the face of the excavation as a precaution against blow-outs when the shields were close together. An 8-in. pipe was then driven through the bulkhead to check alinement and grade before the shields were shoved together. The errors in the surveys were negligible, but it had been difficult to keep the shields in position so that careful handling was required to bring the cutting edges together.

Some data on capacity and cost of power plant are given and also on cost of operation. For the East River some unit costs are given in which the overhead charges are separated from the direct labor costs.

For a discussion of these, reference is made to the Transactions as the subject is too large for consideration here.

66. Tunnel Ventilation.—For short tunnels, natural ventilation due to external air currents and to a difference in temperature between the inside and outside air will usually be sufficient. If a shaft is reached the difference in height between the portal and

top of shaft will be available in developing air currents due to difference in density. The difference in temperature will be greatest in winter and summer and least in spring and fall. It can be increased when necessary by a flame or steam jet in the shaft.

If compressed air is used for power at the face, the exhaust will give a supply of fresh air which will aid, or it may even be sufficient for ventilation. Thus in the St. Gothard, no provision was made for artificial ventilation until the tunnel had been driven over 1000 meters in from each end, the 3472 cu. ft. of air (reduced to atmospheric pressure) used per minute for power having served the purpose.¹

It is stated that the records of the air supply for the East River tunnels² proved that any supply beyond 2000 cu. ft. (or 33 cu. ft. per man per minute) had no beneficial effect upon health; that on two occasions for two consecutive weeks the supply ran as low as 1000 cu. ft. without increasing the number of cases of bends. The amount of CO₂ in the air was measured daily. The average ranged between 0.8 and 1.5 per cent., while the extremes were from 0.3 to 4.0 per cent.

It is stated that at atmospheric pressure the expired air contains 5.6 per cent. of CO₂, and that at 30 lbs. or 3 atmospheres, absolute, the same amount of CO₂ would form only 1.86 per cent.; and if the percentage of CO₂ does not exceed 1 per cent. no ill effects will arise. This is ten times as much as generally specified, namely, 0.1 per cent., and greatly reduces the amount of compressed air necessary, which can be calculated approximately from the following:³

$$\text{Cubic feet per man hour} = \frac{80}{\text{Permissible increase in CO}_2, \%}$$

Thus if the atmosphere contains 0.04 per cent. CO₂ and the percentage in the tunnel is allowed to reach 0.10 per cent., the percentage or increment is 0.10 - 0.04, giving

$$\text{Air required per man hour} = \frac{80}{0.10 - 0.04} = 1333 \text{ cu. ft.}$$

or about 22 cu. ft. per minute.

The air consumption per horse or mule is about four times as great as per man.

¹ Simm's Practical Tunneling, p. 325.

² Trans. Am. Soc. C. E., Vol. 68, p. 269, 1910.

³ Caisson Disease and its Prevention, by Henry Japp, Trans. Am. Soc. C. E., Vol. 65, p. 13, 1909.

From observations taken as soon as possible after a blast in the St. Gothard Tunnel,¹ it was estimated that the cloud of smoke from the blast occupied a volume of from 320 to 400 cu. ft. per pound of dynamite. From $1\frac{3}{4}$ to $2\frac{1}{2}$ lbs. were required per cubic yard of rock removed, giving for the 300 cu. yds. excavated per day, say, $400 \times 2 \times 300 = 240\,000$ cu. ft. per day, or 167 cu. ft. per minute. The air from the compressors was over 20 times as great, while the bell exhausters when installed withdrew 16 500 cu. ft. a minute or 100 times as much, causing a current inward from the portal.

It is desirable to clear out the fumes quickly after a blast on account of the danger of breathing them and also to avoid delay in mucking. This is sometimes done by reversing the current in the supply pipe and exhausting the fumes directly instead of fouling the air for the whole length of the tunnel. For long tunnels, the blowers must be arranged in series in order to develop sufficient pressure.

For tunnels in operation with steam locomotives, the English practice appears to be to allow 29 cu. ft. of poisonous gas per pound of coal, to dilute this 500 fold and to remove the mixture in the interval between trains. Thus Francis Fox, M. Inst. C. E.,² assumes a tunnel 1 mile long, with five-minute intervals between trains in each direction, the engines burning 32 lbs. of coal per mile, and finds for the volume of air required

$$\frac{29 \times 500 \times 32}{2.5} = 185\,600 \text{ cu. ft. per minute,}$$

so that the CO_2 will not exceed 0.2 per cent.

For electric traction in the Pennsylvania tunnels, provision has been made to supply 50 000 cu. ft. of air per minute with fans, enough to completely change the air in the tubes three times per hour.³ This is on the basis of 50 cu. ft. per passenger, and is for emergencies, the piston action of the train in the close-fitting tube having proved ample in operation.

For short tunnels requiring mechanical ventilation, it has usually been considered better to exhaust the foul air at the center.

For long tunnels it is usually better to force air in at one end

¹ Engineering (London) Vol. 19, p. 380, 1875.

² The Ventilation of Tunnels. Abstract of Paper read before the Institution of Civil Engineers. Eng. News., Vol. 42, p. 131, 1899.

³ Trans. Am. Soc. C. E., Vol. 69, p. 300, 1910.

and the Saccardo system has been successful in doing this. The method consists in extending the tunnel some 15 to 20 ft. back from the portal by a structure of timber or masonry, the inside surface of which represents minimum clearance and extends some 3 ft. into the tunnel. Around this a shell is built forming an air chamber, Fig. 32, extending from the fan so as to form an injector.

In the Baltimore railroad tunnels this system was applied at Pennsylvania Avenue¹ by placing the fans directly above the tunnel outside the portal, the air blast being directed downward into a chamber surrounding the top and sides of the tunnel. This chamber gradually diminishes in size to form a nozzle so

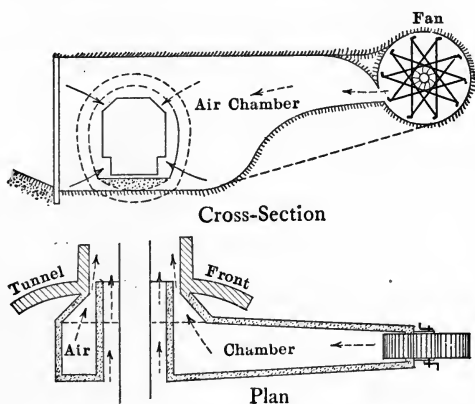

FIG. 32.—Saccardo System of Fan Ventilation.

that the air is discharged into the tunnel in the direction of the axis. The area of the nozzle is 90 sq. ft., the width is 4 ft. 7 ins. under the fans and tapers to 2 ft. 10½ ins. at the bottom of the sides and to 10½ ins. at the top of the arch.

Two Sirocco fans are used of the double-inlet multivane type, 10½ ft. in diameter and 10½ ft. wide, rated at a capacity of 450 000 cu. ft. of air per minute at a velocity of 1056 ft. per minute, when driven at 104 revolutions per minute. They require 190 HP per fan and are driven by electric motors. The entire equipment, including fans at North Avenue of 200 000 cu. ft. per minute capacity, would change the air in the tunnel every 47 minutes.

¹ Eng. Rec., Vol. 64, p. 618, 1911.

In *Engineering News*, Vol. 65, p. 252, 1911,¹ the ventilation of long railway tunnels is discussed, taking up mainly European practice. In long tunnels ventilated from one end, blowing in air is technically more advantageous than drawing it out, and it is better to blow in the direction against the trains running uphill, as the smoke will be driven back away from the crew. For long tunnels, it is claimed that it would be advisable to have a double installation at one end of the tunnel, able both to blow air in and to draw it out; advantage could then be taken of any natural current in the tunnel. It is estimated that as compared with the single-acting Saccardo system, this would increase the efficiency by 10 to 15 per cent. and reduce the power required by 40 to 45 per cent.

The main object of a ventilating plant is to benefit trainmen, trackmen and passengers, but it must not be forgotten that it contributes very materially to the preservation of track, especially if there is sulphur in the coal, while the dry rail and fresh air aid in keeping up the power of the locomotive and in preventing stalling.

REFERENCES

- Tunneling, Explosive Compounds, and Rock Drills. H. S. Drinker, 1882.
Tunneling. Charles Prelini, 1912.
Modern Tunnel Practice. F. W. Simms, Revised and Enlarged by D. K. Clark, 1896.
Modern Tunnel Practice. D. M. Stauffer, 1906.
Railway Tunneling in Heavy Ground. C. F. Gripper, 1879.
Tunnel Shields and the Use of Compressed Air in Subaqueous Work. W. C. Copperthwaite, 1906.
Emploi du Bouclier dans la Construction des Souterrains. Raynold Legouez, 1897.
Subways and Tunnels of New York. Gilbert, Wightman and Saunders, 1912.
Tunneling under the Hudson River. S. D. V. Burr, 1885.
The Severn Tunnel. T. A. Walker, 1888.
Air and Ventilation of Subways. George Soper, 1908.
Tunnel Under Beacon Hill. 17th Report, Boston Transit Commission, 1911.
Report on the Hoosac Tunnel, 1863, 1866-69.
Chicago River Tunnels, their History and Method of Reconstruction.

¹ Abstract of a report on the Construction, Ventilation and Operation of Long Tunnels, presented at the International Railway Congress, at Berne, Switzerland, in 1910. Published in the November issue of the Bulletin.

W. T. Artingstall. Jour. West. Soc. Engrs., Vol. 16, p. 869, 1912. See also Eng.-Cont., Vol. 33, p. 356, 1910; Vol. 35, p. 391, 1911.

The Detroit River Tunnel. Eng. Rec., Vol. 60, pp. 678, 719, 1909; Eng. News, Vol. 63, p. 318, 1910; Eng.-Cont., Vol. 36, p. 246, 1911; Trans. Am. Soc. C. E., Vol. 74, p. 288, 1911.

Subways Under the Seine. Eng. News, Vol. 55, p. 177, 1906; Vol. 57, p. 400, 1907; Vol. 65, p. 590, 1911.

East Side Tunnel and its Approaches at Providence, R. I. E. P. Dawley. Jour. Assoc. Eng. Soes., Vol. 42, p. 293, 1909.

Soft Ground Tunneling Without Compressed Air, Catskill Aqueduct. C. M. Gould, Eng. Rec., Vol. 66, p. 145, 1912.

Tunnel Construction, Buffalo Waterworks. Eng. News, Vol. 65, p. 153, 1911.

Cost of Three Single-track Tunnels. Eng.-Cont., Vol. 28, p. 113, 1907.

The Scranton Tunnel of the Lackawanna and Wyoming Valley Railroad. G. B. Francis and W. F. Dennis. Trans. Am. Soc. C. E., Vol. 56, p. 219, 1906.

The Philadelphia Tunnel of the Baltimore and Ohio Railroad, Its Cost and Construction. W. W. Thayer. Trans. Am. Soc. C. E., Vol. 26, p. 529, 1892.

Design of Railway Tunnels with View of Economy in Maintenance and Operation. Eng. News, Vol. 63, p. 646, 1910.

Dates of Opening the Alpine Tunnels. Eng. News, Vol. 58, p. 615, 1907; Eng.-Cont., Vol. 35, p. 8, 1911.

Construction of the Simplon Tunnel. Eng. News, Vol. 50, p. 134, 1903.

The Laramie Poudre Tunnel in the Colorado Mountains. Eng. Rec., Vol. 63, p. 44, 1911.

Cost of Lining a 1000-ft. Railway Tunnel. Eng.-Cont., Vol. 28, pp. 36, 100, 1908.

Tunnel Lining of the Catskill Aqueduct. Eng. News, Vol. 67, p. 820, 1912.

Steel Centers and Lagging for the Construction of Concrete Tunnel Lining. Eng.-Cont., Vol. 29, p. 124, 1908.

Record of Tunnel Ventilation. Proc. Am. Ry. Eng. Assoc., Vol. 13, p. 398, 1912.

Ventilation of the Pennsylvania Tunnels, New York City. Ry. Age. Gaz., Vol. 53, p. 212, 1912.

Ventilation in the New York Subway. Trans. Am. Soc. C. E., Vol. 57, p. 227, 1906.

Ventilating Plant, West Shore Tunnel at Weehawken. Eng. Rec., Vol. 66, p. 158, 1912.

Ventilation of Tunnels. C. S. Churchill. Trans. Am. Soc. C. E., Vol. 54, Part C, p. 525, 1905; also Francis Fox, Vol. 54, Part C, p. 553, 1905.

CHAPTER V

MASONRY

67. Masonry, General.—The Manual of the American Railway Engineering Association includes in masonry all construction of stone or kindred substitute materials, in which the separate pieces are placed together with or without cementing material, or are encased in a matrix of firmly cementing material.

The subdivision for which it gives specifications are:

Bridge and retaining wall masonry,	{ Ashlar stone. Rubble stone.
Arch masonry,	{ Ashlar stone. Rubble stone.
Culvert masonry,	Rubble stone.
Dry masonry,	Rubble stone.
Plain concrete,	
Reinforced concrete.	

The ashlar stones are cut to plane beds of full dimensions, without overhang, with builds cut back far enough for good vertical face joints. Rock face is common for the exposed sides. The face is made up of headers and stretchers, the former bonding back into the wall and the latter showing the longest dimension in the face.

The courses may be carried through the wall with dressed horizontal joints but with rough vertical joints, except near the faces as already indicated, or the interior may be filled with concrete.

The coping or top protection course should have close-fitting vertical joints, and the stone should be held together by cramp irons or otherwise to prevent the joints from opening and admitting water.

Rubble may be field stone or roughly rectangular quarry stone and is laid irregularly or in courses giving common or coursed rubble masonry, respectively.

Only rough, hammer dressing is required and spalls are used to save mortar in making the joints.

The main difference between arch masonry and bridge masonry is in the arch ring in which the joints are cut normal to the soffit

or interior surface, giving wedge-shaped rather than rectangular stone.

A culvert being a small covered passage for water under a roadway or embankment, culvert masonry can usually be built cheaper than bridge masonry.

Dry masonry is used to some extent for retaining walls and culverts. For retaining walls it has a distinct advantage in providing drainage, and if the stones are large and rectangular, excellent results can be secured. For culverts the danger of washouts is increased, especially if the water rises above the top of the cover.

Concrete has largely replaced stone masonry in railroad construction, due to the high wages of stone cutters and masons, the low cost of portland cement and the use of machinery for mixing, in addition to its general adaptability to modern conditions. Reinforced concrete is taking the place of stone masonry on the one hand and of steel and timber structures on the other.

68. Quarrying Stone.—In opening a quarry, a vertical face should be exposed and the soil and weathered rock removed. For ashlar or dimension stone, the usual method is to drill a row of holes parallel with the face and break off a long rectangular piece by the plug and feather method or by light charges of explosive. This long piece can be broken up into the desired sizes by the plug and feather method. It is desirable to free one or both ends in advance by a channeling machine or by trenching back with explosives.

If a portion of the stone can be used for backing or for concrete or rubble masonry, the use of a less number of deeper holes with heavier charges will often prove economical.

Sedimentary rock occurs in distinct layers and these are usually divided by vertical joint planes about at right angles. If the courses are thin, they can be quarried with bars and wedges if shaken up a little with black powder. The beds are often smooth but the vertical joints will require considerable dressing unless for rubble. The thickness of the stone will be determined by that of the layers, which is different for different depths and may vary for different parts of the same layer.

In metamorphic rock the division into layers and the joint planes are less marked though still sufficient to give the directions in which the rock will break most readily. These directions must be considered in getting out stone though in most granites the

exact positions of the planes may be neglected and the thickness adapted to the character of the masonry, up to the capacity of the derricks or other appliances for handling, large stone costing less per cubic yard for dressing.

Broken stone for concrete would be excavated, or quarried, by the methods of rock excavation of Chapter III.

The cost of quarrying and loading stone for a slope wall on the Erie Canal is given as 80 cents per cubic yard of wall, in Engineering News, Vol. 49, p. 525, 1903. The stone was a thin-bedded limestone rather shaley, and was barred and wedged out with the use of little or no powder. There was very little plug and feathering as the stone split readily under the hammer. There was a foreman at \$2.50, and four workmen at \$1.50 per day. The average output per man, per 10-hour day, was 2.2 cu. yds.

Seventy cents per load was paid for hauling $2\frac{1}{2}$ miles over a good, hard gravel road with no upgrades, the driver helping to load and unload. This added about 45 cents per cubic yard of slope wall, while there was a quarry rental of 10 cents, giving a total of \$1.25, delivered. It took two laborers 15 minutes to pass up 1.55 cu. yds. (slope wall measurement) to the driver to stack on the wagon, while the driver alone would roll off the stones or unload in 7 minutes. The team would walk at the rate of $2\frac{1}{2}$ miles per hour and they would trot part of the way back to make up for the lost time loading and unloading. The quarry required very little stripping.

On a similar contract 750 cu. yds. of stone for slope wall were quarried at \$1.10 per cubic yard, the stone being a grit or shaley limestone. Wages \$1.50 per 10-hour day. The haul was $1\frac{3}{4}$ miles and six trips were made per day, hauling $1\frac{3}{4}$ cu. yds. per load at a cost of 35 cents per cubic yard. The stone thus cost \$1.45 delivered, per cubic yard of wall.

The cost of quarrying, loading, hauling and placing aboard scows, 56 115 tons of rubble and 16 866 tons of capping stone of silicious limestone for the Buffalo breakwater, from May to September, 1903, as given by Emile Low in Engineering News, Vol. 52, p. 347, 1904, was

Labor,	33 cents.
Coal,	4 cents.
Explosives,	2 cents.
Miscellaneous,	5 cents.
	—
Total, per ton,	44 cents.

A ton is given as 12 cu. ft., which would make the cost 3.7 cents per cubic foot, or \$1 per cubic yard of solid stone.

This is exclusive of cost of plant, overhead charges and depreciation, in a quarry which had been opened and operated for several years.

The plant consisted of 14 machine drills; 9 derricks; 4 50-HP steam boilers; 6 hoists; 1 boiler for steam pump; 2 steam pumps; 1 dinkey locomotive; 50 narrow-gage cars; 68 skips; blacksmith shop; car repair shop; track, etc. The basis for common labor was 15 cents an hour.

The contract price for dimension sandstone, f. o. b., as given for the arch culvert, § 71, was \$1.50 per cubic yard measured in the work. The scale of wages is given for laying the masonry.

The cost of quarrying three dimension granite in a sheet quarry¹ on the coast of Maine is given by Gillette.²

	Cost per cu. yd.
Enginemen, at \$2 a day (of 9 hrs.),	\$0.20
Steam drillers, at \$2.00,	0.20
Drill helpers, at \$1.50,	0.15
Blacksmiths, at \$2.75,	0.14
Blacksmiths' helpers, at \$1.75,	0.09
Tool and water boys, at \$1,	0.16
Quarrymen, at \$1.75,	1.09
Laborers, at \$1.50,	1.15
Foremen, at \$3,	.15
Superintendent, at \$8,	.20
Coal, at \$5 ton,	.45
Explosives,	.25
Other supplies,	.30
	<hr/>
Total,	\$4.53

To this should be added plant rental, quarry rental and stripping.

In computing yardage for the rough stone the blocks are measured on their least dimensions so that there should be no shrinkage in the wall.

69. Dressing Stone.—For rubble work the dressing is done with a stone hammer and it consists in knocking off the sharp corners and the largest projections on the beds and faces so that

¹ A sheet quarry has few or no vertical joints, and is divided into layers or sheets by joints nearly horizontal.

² Rock Excavation, p. 209, 1904.

the stone will be roughly rectangular. Mortar, or mortar and spawls, is then depended upon to distribute the bearing over the beds and mortar and spawls to fill the vertical joints.

For ashlar and dimension stone for heavy masonry, 3/8- to 5/8-in. joints, extending over the entire surface, are used for the beds and back about a foot from the face for the builds.

The exposed surfaces are usually rock face, the edges being pitched to the nominal plane of the face and the rock projection being limited to about 4 ins. beyond the face. Along the quoins or corners of the wall draft or chisel lines 1½ to 2 ins. wide are carried up to secure the proper vertical alinement or batter.

For architectural or monumental work 1/4-in. joints and tooled or even polished faces are used, materially increasing cost. Mouldings are also used which increases the cost of labor and the waste in cutting. Some stone cuts readily when first quarried and loses moisture or sap and hardens on exposure.

When the stones are carefully wedged out with plug and feathers in large blocks of nearly the required shape and size, Trautwine estimates that from one-sixth to one-quarter of the rough block will generally not more than cover waste when fully dressed. In blocks averaging 1/2 cu. yd. quarried by blasting, from one-fourth to one-third will not be too much to allow for waste for stone of medium character as to splitting. About the last allowance should be made for well-scabbled rubble. The smaller the stones, the greater must be the allowance for dressing.

When freight forms an important item, it thus becomes expedient to have the stones dressed at the quarry, unless the chips can be used to advantage, as for concrete.

Trautwine estimates that a stone cutter will take out of wind, and then fairly patent hammer dress¹ about 8 to 10 sq. ft. of plane face in hard gray granite per 8-hr. day, or twice as much of such inferior dressing as is usually given to the beds and builds, and generally to the faces also of bridge masonry, when a very fine finish is not required. In good sandstone or marble he can do about one-quarter more than in granite. Of finest hammer-finished granite he can do only 4 to 5 sq. ft.

Gillette quotes the Kankakee Stone and Lime Co. as placing

¹ The patent hammer has two faces, each made up of steel plates or chisels 1/12 to 1/6 in. thick, clamped in the head to give a face about 2¼ by 1½ ins. These cut in parallel lines in striking a blow.

the cost of dressing limestone, in 1890, bush-hammered or drove work, at 25 cents per square foot, with wages at \$3 per day.

He gives from his own experience the cost of cutting granite face stone for a dam in Northern New York to lay with beds and joints 5/8-in. thick. The stone were quarry faced and averaged 1½ by 3 by 2 ft., or about 1/3 cu. yd., with 18 sq. ft. of beds and end joints. A blacksmith, at \$2.50, and a helper at \$1.50, sharpened the points and plug drills for 8 stone cutters. The total cost per cubic yard was as follows:

Stone cutters at \$4 per 8 hrs.,	\$12.00
Blacksmithing,	1.20
Banking stones and plugging off faces,	1.80
Sheds and tools,	0.80
Superintendence,	1.20
	<hr/>
Total,	\$17.00

or 31½ cents per square foot.

Some of the joints were dressed to lay 1/4-in. joints, which added \$6 per cubic yard to the cost.

Cost data on quarrying and cutting 5567 sq. ft. of face stones of hard, coarse-grained granite for the Pathfinder dam in Wyoming was given in the Reclamation Record for July, 1908.¹ This shows a unit labor cost of \$0.91 per square foot and a unit supply cost of \$0.16, making a total for labor and supplies of \$1.07 per square foot. The face stones penetrate an average of 3 ft. into the dam, making a total cost of \$9.63 per cubic yard. This does not include plant charges and cost of steel, oil and blacksmith coal. It is stated that the average rate of wages paid was high.

Machine stone saws, cutters, planers, grinders, and polishers are extensively used in large stone yards with considerable reduction in cost.

70. Mortar.—Portland cement has nearly replaced lime and natural cement in making mortar for masonry structures, except buildings, on account of the small difference in cost as compared with the difference in value where strength and reliability are required.

From 5 to 10 per cent. of lime is usually added in laying brick to make the mortar work better under the trowel. It decreases the cost and usually has but little effect upon the strength.

The sand should be of hard material and sharp, clean and coarse, or with such a mixture of fine and coarse grains as to give

¹ Eng.-Cont., Vol. 30, p. 27, 1908.

a minimum of voids; the voids ranging from 30 to nearly 40 per cent. for natural sand when saturated and rammed, while they can be reduced to nearly 20 per cent. by proper mixing. Crushed quartz, granite and limestone reach about the upper limit, the screenings, dry and well shaken, about the lower limit for voids.

In proportioning cement mortar the following laws, as stated by Baker,¹ govern, viz:

1. For the same cement and the same sand, the strength increases with the amount of cement in a unit of volume of the mortar.

2. For the same proportion of cement in a given volume of mortar, the strongest mortar is that which has the greatest density.

The actual strength depends upon the strength of the cement, the character of the sand, and upon the adhesion of the cement to the sand. The tensile strength in pounds per square inch as found from laboratory tests with standard Ottawa sand² at 28 days is about as follows:

Neat	1 to 1	1 to 2	1 to 3	1 to 4	1 to 5
750	690	450	300	200	150

A barrel of American portland cement weighs 376 lbs., four 94-lb. sacks, and contains about 3.6 cu. ft. The volume loose is from 20 to 40 per cent. greater, so that the practice of calling a sack a cubic foot assumes that the cement is partially packed. A cubic foot of paste requires rather more than 100 lbs. of cement, with about 30 lbs. of water, for the consistency used by masons. The volume of mortar is always greater than the sum of the volumes of the paste and aggregate solids, but the ratio is variable.

In making estimates the following may be used to find the quantities required for a cubic yard of compact plastic mortar, the aggregate with 38 per cent. voids being measured loose and the cement so packed that a sack will make a cubic foot.

CEMENT AND SAND IN CUBIC FEET FOR A CUBIC YARD OF MORTAR

	Neat	1 to 1	1 to 2	1 to 3	1 to 4	1 to 5	1 to 6	1 to 8
Cement,	30.4	15.2	10.4	7.9	7.4	6.1	5.1	4.0
Sand, cubic feet,	0	16.7	22.9	26.2	27.3	27.8	28.3	28.9
cubic yards,	0	0.62	0.85	0.97	1.01	1.03	1.05	1.07

¹ Masonry Construction, 10th ed., p. 110, 1909.

² This sand may be obtained from the Ottawa Silica Company at 2 cents per pound, f.o.b. cars, Ottawa, Ill.

The mortar per cubic yard of masonry can be computed for ashlar and brickwork from the dimensions of the stone or brick and the thickness of the joints. It averages from about 5 per cent. for 1/4-in. joints with 18-in. courses for ashlar, to about 12 per cent. for 1/8-in. joints to 40 per cent. for 1/2-in. joints for brickwork when the interior vertical joints are filled.

For rubble masonry of irregular shaped stones the joints will average about 35 per cent. of the volume. For well-shaped flat stones they will average from 15 to 20 per cent. Spalls if well bedded in mortar will make just as good filling for vertical joints as mortar, with a very appreciable saving in cost.

The mason's habit is to fill the joint with dry spalls and then plaster over the top with mortar for the bed of the next course, and for brickwork to leave all the inside vertical joints open merely filling those showing on the face to a depth of a couple of inches.

The function of mortar is to exclude water, to distribute the pressure over the joints, and for brick and rubble work to supplement the bond and increase the mutual support. The latter requires full joints, while the exclusion of water for masonry in many locations requires the mortar to be non-absorbent and impermeable as well. This requires enough fine ground cement to completely fill the voids in the sand, thorough mixing and placing at the consistency for maximum density, the mortar retaining air if too dry and water if too wet, either increasing volume. Pointing with good mortar will make up to some extent for poor mortar or unfilled joints in laying.

The labor cost of mixing mortar is not usually separated from that of supplying the masons with mortar and stone discussed in the next article. The cost for water and sand and for delivering and housing cement depends upon local conditions, while that for cement can be obtained from market quotations.

71. Laying Stone.—With well-shaped rubble stone not requiring a derrick, a mason with helper to mix mortar and bring stone, can lay 4 to 5 cu. yds. per 8-hr. day at a cost of about \$1 per cubic yard with wages at \$3 and \$1.50 per day, respectively. Little or no hammer dressing will be required.

If stone larger than two man stone are used, or if the height is greater than can be reached from a low staging, the cost of installing and operating a derrick for two or more masons would be added. The derrick could be operated by hand, gasoline or steam power according to cost.

In *Engineering News*, Vol. 49, p. 525, 1903, it is stated that in laying 750 cu. yds. of second class slope wall, 12 ins. thick, joints $1\frac{1}{2}$ ins. thick as a maximum, stone allowed to fall away 4 ins. back of face, not laid in courses, but an excellent wall, the cost was as follows: For the first few days, with new hands, each laid $2\frac{1}{2}$ cu. yds., and later 3 cu. yds., giving 60 and 50 cents, respectively, with wages at \$1.50 per 10-hr. day. Some skilled slope layers at \$2.50 per 10-hr. day readily laid 5 cu. yds. per day with a helper to each four layers. Thus 600 cu. yds. were laid in 130 layer days and 35 helper days, half of the layers being skilled men and half common laborers, at a cost of 52.1 cents per cubic yard. There was no foreman in constant attendance as each man's work was between slope boards placed about 20 ft. apart with their lower edges on grade, and easily measured. A portion of the work was sublet at 50 cents, to two of the masons who had been averaging 5 cu. yds. each per day and from that time on they averaged $7\frac{1}{2}$ cu. yds. per day.

On another contract where the wall was 16 ins. thick, four masons at \$2.50 and four laborers at \$1.50 averaged 60 cu. yds. of fair slope wall per 10-hr. day.

The following analysis of cost for 613 cu. yds. of culvert masonry is made by E. D. Hill.¹ The culvert, a 6-ft. arch, was built preparatory to filling a 70-ft. railroad trestle in Putnam county, Indiana, in 1887. The stone was hauled from a sandstone quarry about two miles away, unloaded onto a timber shute and allowed to slide down to the site of the culvert. It was furnished at a contract price of \$1.50 per cubic yard for dimension stone, f.o.b., and measured in the work. The stone resembles the Berea stone of Ohio; it quarries in blocks of large size without flaw or seam, is at first soft and easily worked, but hardens on exposure.

COST OF ARCH CULVERT, 613 CUBIC YARDS OF MASONRY

Items	Total cost	Cost per cu. yd.
Cutters and helpers,	1370.48	\$2.24
Templets, bevels, etc.,	11.00	.01
Repairs, cutters tools,	52.39	.09
Water boy,	11.75	.02
Total, cutting stone,	\$1445.62	\$2.36

¹Eng. News, Vol. 21, p. 525, 1889.

Masons, laying stone,	\$384.87		.63
Helpers to masons,	453.66		.74
Mortar mixer,	121.72		.20
Track laying,	7.70		.01
Water boy,	11.75		.02
Derrick, stone shute, etc.,	14.63		.02
Arch centers, erected,	37.65		.06
Total, laying,		\$1031.98	1.68
Pointing,		30.00	.05
Total, labor,		\$2507.60	\$4.09
170 bbls. portland cement,	542.50		
30 bbls. Louisville cement,	28.75		
		571.25	.94
7 car loads sand,		38.50	.06
613 cu. yds. stone at \$1.50,		919.50	1.50
Total, material,		1529.25	2.50
		4036.85	6.59
Concrete,	\$43.75		
Excavating found. and drainage,	260.77		
Sheet piling,	19.69		
Timber for drain trough,	2.59		
Extra allowance on sheeting stone,	20.00	346.80	0.57
Total,		\$4383.65	\$7.16

Cement, 125 lbs. per cubic yard of masonry, or $2\frac{2}{3}$ cu. yds. of masonry per barrel of Louisville, of 300 lbs., and $3\frac{1}{3}$ cu. yds. per barrel of portland of 400 lbs.

Wages per 10-hour day: foreman, \$3.50; cutters, \$3.00; carpenters, \$2.50; mortar mixer, \$1.50; laborers, \$1.25; water boy, \$0.50.

An analysis of the cost of the Brooklyn anchorage of the Williamsburg Bridge by F. L. Pruyn is given in Engineering-Contracting, Vol. 27, p. 40, 1907. This anchorage consists of a large block of masonry 150 by 182 ft. and 114 ft. high, resting on a pile and timber grillage covered with 14 ft. of concrete, the excavation being 40 ft. deep. The interior contains three tunnels and two wells in connection with the steel anchor chains, which required considerable careful setting in placing the stones.

The stone was unloaded at the dock from barges onto cars and hauled by cable to the site of the work. The mortar was machine mixed.

The labor rates were: foreman, \$5; masons, \$3.20; signal men, \$2; laborers, \$1.50. The masons worked an 8-hour day, all others a 10-hour day.

The following items were distributed over the total 44 053 cu. yds. of masonry:

Delivering stone, per cubic yard,	\$0.23
Mixing and delivering mortar,	0.20
Delivering spalls,	0.02
Setting stone,	0.94
Steam,	0.14
Plant,	0.77
General expenses,	0.49
	<hr/>
Total,	\$2.79

Adding this cost, \$2.79, to that for the stone given below will give the total cost per cubic yard for each class of masonry.

Granite facing, \$16.66 at 94 per cent.,	\$15.66
Six-cut granite, \$28.67 at 98 per cent.,	28.05
Granite backing, \$14.47 at 88 per cent.,	12.75
Limestone facing, \$7.25 at 94 per cent.,	6.80
Limestone backing, \$5.00 at 85 per cent.,	4.25

It is assumed that the first cost given was at the dock and that the reduction as masonry is due to the volume of the mortar.

The backing stones were roughly squared of the same thickness as the face stones and with about 3-in. vertical joints. The face joints of the rock faced ashlar were $2\frac{1}{2}$ in. and of the six-cut stone $\frac{1}{4}$ in.

72. Concrete, Proportions and Materials.—Plain concrete consists of mortar mixed with a coarse aggregate, as broken stone, gravel, etc. The coarse aggregate is added to reduce cost, but it may increase strength as well. The laws governing the proper proportions for concrete are similar to those for mortar, § 70, and are also stated by Baker as follows:

1. For the same sand and the same coarse material, the strongest concrete is that containing the greatest per cent. of cement in a unit volume of concrete.

2. For the same per cent. of cement and the same aggregate,

the strongest concrete is made with that combination of the sand and aggregate which gives a concrete of the greatest density.

The second law requires the cement to just fill the voids of the sand, and the resulting mortar to just fill those of the coarser aggregate, for if they do not the density will be diminished due to voids, while if either cement or mortar overfills, the density will be diminished because the cement paste and mortar both are less dense than concrete.

The second law in connection with the corresponding one of § 70 shows that it is economical of cement to select aggregates both coarse and fine, each with minimum voids. The minimum voids can be found approximately by trial but better by the sieve analysis method.¹

Experiments seem to show that broken stone makes a stronger concrete than gravel, and that gravel concrete is more easily compacted and has fewer cavities, so that other things being the same it is denser and more nearly waterproof.

In the specifications given in the American Railway Engineering Association Manual, 1911 edition, proportions of 1:9 and 1:6 are given for plain and reinforced concrete, respectively, unless otherwise specified, in which the aggregate is made up of fine and coarse materials measured separately, but so proportioned as to give maximum density.

Sand, crushed stone or gravel screenings, graded from fine to coarse, passing a 1/4-in. screen, with not more than 6 per cent. passing a sieve with 100 meshes per inch, is specified for the fine aggregate. Material such as crushed stone or gravel which is retained on a screen with 1/4-in. mesh, and graded from the smallest to the largest sizes, is specified for the coarse. No maximum dimensions are given but a 2 to 2½-in. ring for broken stone and a little larger size for gravel for plain concrete and a 3/4- to 1-in. ring for reinforced concrete are about as great as practicable.

For massive work, large stones may be added, if evenly distributed, thoroughly bedded and entirely surrounded by concrete, at the option of the engineer, giving rubble concrete at a considerable reduction in cost.

The working stresses specified in the Manual are based upon a crushing strength of at least 2000 lbs. per square inch in cylin-

¹ See Taylor and Thompson's Concrete, Plain and Reinforced, pp. 183-215, 1909; Eng. News, Vol. 54, pp. 598-601, 1905; Trans. Am. Soc. C. E., Vol. 59, pp. 90-145, 1907.

ders 8 ins. in diameter and 16 ins. long, at 28 days under laboratory conditions of manufacture and storage.

The materials required for a cubic yard of concrete will be about as follows:

Proportions	Cement sacks	Sand cu. yds.	Stone cu. yds.	Total aggregates cu. yds.
1 to 6	5.36	0.41	0.81	1.22
1 to 9	3.68	0.42	0.84	1.26
1 to 12	2.84	0.43	0.86	1.29

73. Concrete, Mixing and Placing.—The railroad specifications in the Manual referred to in § 72 require the use of a machine mixer, preferably of the batch type,¹ wherever the volume of the work will justify the expense of installing the plant. The requirements are that the product delivered shall be of the specified proportions and consistency and thoroughly mixed.

Batch mixers of about 1/4 cu. yd. capacity, run with gasoline engines, are light and portable and are much used for city and road improvement work.

The expense for fuel, oil and maintenance with a man at \$2 per day to operate the machine should not exceed \$4. The daily output, when operated to capacity, should be at least 50 cu. yds. in place, giving a cost for fuel and labor of 8 cents per cubic yard for mixing only, with no allowance for delays.

If the job is small the large labor cost will be in handling the materials to the machine and the concrete to the forms. Shoveling the stone and sand, some 1½ cu. yds., into a hopper from which they can be drawn batch by batch as required and delivering cement, would cost, §§ 14, 72, some 14 cents, while if the concrete is wheeled to the forms, dumped and tamped, 20 cents or more would be added according to lead and tamping.

If a hopper is not used the stone and sand would probably be loaded into wheelbarrows which would be run up and dumped each time for a batch. This would probably increase the labor cost of handling and the machine cost of mixing.

¹ There was considerable objection to the adoption of this clause when reported by the committee, and it was claimed that some of the continuous mixers give uniform results.

As the yardage for a structure increases, the total cost per cubic yard of concrete can be decreased by increasing the size and capacity of the mixer, by providing bins for the sand, stone and cement so placed that the charging can be done with a minimum of, or entirely without, hand labor, and by providing an elevator and chute or other suitable system for depositing the concrete. This would increase the development, plant and depreciation expenses and reduce those for labor.

Thus the labor cost per day for mixing concrete for the foundations of some blast furnaces in Pittsburgh from raw material in cars on siding platform to mixed concrete in cars on delivery track is given as follows:¹

1 foreman and engineman at \$3.00,	\$ 3.00
1 fireman at 2.00,	2.00
15 laborers at 1.50,	22.50
	<hr/>
Total labor,	\$27.50

The product is given as approximately 400 cu. yds. when running normally with two mixers. This would give 6.9 cents per cubic yard, or with the editors version of 800 cu. yds. for three 8-hr. shifts per day, 10.4 cents per cubic yard.

The materials were delivered on three side tracks with a bin under each high enough so that they were handled by gravity to the mixed concrete in buckets on the flat cars on the delivery track. The buckets were handled at the work by a traveling derrick.

For hand mixing the specifications given in the Manual call for a watertight platform of sufficient size to accommodate men and materials for the progressive and rapid mixing of at least two batches of concrete at the same time. The batches are not to exceed 1/2 cu. yd. each.

In mixing, the fine aggregate is spread evenly upon the platform, then the cement upon the aggregate and these mixed thoroughly until of an even color. The water necessary to mix a thin mortar is then added and the mortar spread again. The coarse aggregate is thoroughly wetted if dry, and then added to the mortar. The mass is then turned with shovels or hoes until thoroughly mixed and all aggregate covered with mortar. At the option of the engineer, the coarse aggregate may be added before, instead of after, adding the water.

¹ Eng.-Cont., Vol. 28, p. 77, 1907

The cost of mixing and placing by hand will depend upon the relative positions of the materials, mixing board and place of deposit. For short distances wheelbarrows are economical, if nearly level runways can be secured. If the concrete must be elevated a derrick with dumping bucket or an elevator on which the wheelbarrow can be run by one man at the bottom and taken off by another at top will usually be cheaper than inclined runways. For longer distances carts or tram cars will be more economical than wheelbarrows.

The labor cost of mixing where the material has to be turned six times to make it uniform Gillette places at 30 cents and that of spreading and heavy ramming at 15 cents with labor at 15 cents per hour. The cost of wheeling to and from the mixing board will depend upon the lead as given in § 18. The cost of foreman will depend upon the output of the gang.

The following is an example of low cost due to favorable conditions and good management.¹

The usual gang for each mixing board consisted of 4 men wheeling gravel; 4 mixing; 1 wetting; 2 depositing and leveling; and 2 tamping. A steam pump was used to drain the foundation pit and supply water for mixing.

Labor cost of placing concrete in four lock foundations, about 4000 cu. yds. in all, on the Illinois & Mississippi Canal in 1897.

Foreman, 0.210 hour at 30 cents,	6.30 cents.
Laborers, 3.339 hours at 15 cents,	50.09 cents.
Pump runner, 0.179 hours at 20 cents,	3.58 cents.
Water boy, 0.087 hours at 7½ cents,	0.65 cents.

Total labor cost per cubic yard,	60.62 cents.
----------------------------------	--------------

The average cost would usually be about \$1 per cubic yard.

74. Concrete, Forms and Reinforcement.—In designing in concrete, especially reinforced, the forms should be kept in mind as they often form an important portion of the cost. Where parts can be duplicated and the forms built with reference to taking apart and using again a reduction in unit cost can usually be effected. Metal forms may be economical in this case, but timber is the most common, spruce and Norway or yellow pine being satisfactory. For exposed faces the plank should be planed to uniform thickness and placed with joints horizontal to suggest

¹ Eng.-Cont., Vol. 26, p. 197, 1906.

horizontal courses if the marks are not removed. It is safer to use a cove or other molding to round off all exposed corners.

The forms should be true to line and surface, with joints tight enough to prevent leakage of cement and of sufficient strength to withstand the hydrostatic pressure of the concrete. The tendency is to mix wet, and to deposit continuously in sections to form a monolithic mass when practicable, otherwise in horizontal layers. A bevel edge of one board against the square edge of the next makes a satisfactory joint. The surface is usually lubricated with soap or oil to prevent sticking to the concrete, unless a finishing coat is to be added.

The amount of lumber required per cubic yard of concrete depends upon the number of square feet of surface and upon the size of the studding and the amount of bracing required to hold it in place; also upon the number of times the forms or the lumber can be used. The surface per cubic yard is easily computed. For the studding and bracing sketch plans should be made as the basis for an estimate. The labor cost for forms would be some \$8 per thousand feet B.M. for plain work like bridge piers, with carpenters at \$2.50 per day, and for resetting about one-third as much.

For reinforcement both structural, 60 000 lbs. ultimate, and high carbon, 88 000 lbs. ultimate, steels are used to aid in carrying tension and shear in concrete beams and to aid in carrying compression in columns and to some extent in beams, and to prevent cracks from temperature stresses and from unequal settlement. Less metal is required with the high carbon steel but the deformation is greater on account of the greater unit working stresses. Plain and deformed bars both have their advocates. The only difference recognized in the Manual, § 72, is in allowing a greater bond stress between steel and concrete for the deformed.

The use of reinforcement adds to the unit cost of the concrete under the American Railway Engineering Association's specification by requiring a richer mixture, § 72; it adds to the cost of placing on account of the restricted spaces for tamping and to the cost for forms because of the complicated shapes and the reduced yardage.

Unless it reduces the yardage in a greater ratio than it increases the unit cost its use would only be justified by greater security against settlement or temperature cracks.

There have been many failures of concrete in sea water and

many successes as well. For success a dense compact mortar is necessary. The cement must be sound, finely ground, with but little of the sulphates and magnesia and a minimum of free lime. The mixture should be at least a 1:2:4, with sand and coarse aggregate with minimum voids. Some advocate the addition of pozzuolana to combine with the free lime, others believe it to be inert. The mixture should be wet.

No serious objection is made to sea water for mixing, although fresh is preferred, but the concrete should be allowed to harden in air before exposure to sea water. One or two surface coats of neat cement will aid in making the surface impermeable.

If reinforcement is to be used it should be cleaned of oil, scale and rust and given a coating of neat cement just before being imbedded in the concrete. The concrete should then be thoroughly tamped around the steel.

If these precautions are taken there is ample experience to show that concrete, both plain and reinforced, can be made which will be durable when exposed to sea water even in cold climates.¹

In repairing the sea wall at Lynn, Massachusetts, recently, the cement gun was used successfully in restoring the surface which had become disintegrated. The dry cement, sand and small stone are carried through a hose by compressed air, moistened at the nozzle, and forced into place with a nozzle velocity claimed to correspond to a pressure of 35 lbs. per square inch. The coating is dense, adheres strongly, and is very non-absorbent,—qualities which are essential for durability when exposed to sea water.

While the data given are sufficient for making an estimate of materials and cost when the local conditions are known, the following general averages will be an aid for preliminary estimates.

In *Engineering-Contracting*, Vol. 25, p. 174, 1906, F. R. Charles, Richmond, Indiana, gives the cost of hand-mixed concrete by day labor, moved to place in wheelbarrows. The proportions were 1:2½:5½ rubble concrete where the large stones were on the ground and cost only the labor required to place them.

The first work was for a bridge abutment and six river piers

¹ Condensed from Report to the International Congress of Navigation, on the Preservation of Reinforced Concrete in Sea Water, by Lieut. Edward Burr; abstracted in *Eng.-Cont.*, Vol. 38, p. 114, 1912.

on the Miama river at Fernold, Ohio. The piers were put down by coffer-dams. The stone was procured on the site and crushed by a portable crusher run by a traction engine. The stone cost 10 cents per cubic yard, which with the cost of fuel and rent of engine and crusher made a total of about \$1 per cubic yard. The sand was obtained close to the site. The cement was hauled ten miles. These gave:

COST OF MATERIALS AND LABOR PER CUBIC YARD OF CONCRETE IN PLACE

Cement, 1.16 bbls. at \$2.10,	\$1.58
Sand,	.35
Stone,	.75
Lumber,	.64
Tools and hardware,	.20
Labor at \$1.75 per day,	2.78
	<hr/>
Total, per cubic yard,	\$6.30

The term labor includes 15 cents per cubic yard for pumping. Three other pieces of work on bridge masonry are given, with costs for materials and labor of \$6.08, \$7.16, and \$7.23, respectively.

From records kept in constructing telephone conduit and other concrete work, Mr. Clarence Mayer¹ finds from 6000 mixings, including 1445 cu. yds. of concrete, under five different foremen, that the average cost of machine mixing per cubic yard was 34 cents.

From 1100 hand mixings, including 1481 cu. yds. of concrete under four different foremen the average cost was 53 cents. Wages for nine hours; engineman, \$3, laborers, \$2.

The data were secured without the knowledge of the foreman. The cost includes that of moving mixing boards and mixer, of getting tools, etc., in starting, but cost of supervision and overhead expenses are not included.

In Engineering Record, Vol. 61, p. 163, 1910, a table of costs is given for thirty-eight reinforced concrete highway bridges built in 1909 under direction of the Illinois Highway Commission. The spans range from 7 to 60 ft. The average costs per cubic yard of concrete were:

For forms,	\$1.96 with range from \$0.83 to \$3.95
For steel in place,	1.74 with range from 0.80 to 3.10
For mixing and placing,	1.37 with range from 0.72 to 2.72
Total cost, including materials,	9.41 with range from 6.11 to 14.88

¹ Eng.-Cont., Vol. 29, p. 221, 1908.

REFERENCES

- A Treatise on Masonry Construction. I. O. Baker, 1909.
- Principles of Reinforced Concrete Construction. Turneaure and Maurer, 1909.
- Reinforced Concrete. J. P. Brooks, 1911.
- Concrete, Plain and Reinforced. Taylor and Thompson, 1909.
- Reinforced Concrete. Buel and Hill, 1906.
- Concrete and Reinforced Concrete Construction. H. A. Reed, 1907.
- Concrete Construction. Gillette and Hill, 1908.
- Manual of Reinforced Concrete and Concrete Block Construction. Marsh and Dunn, 1908.
- Engineers' Pocket Book of Reinforced Concrete. E. L. Heidenreich, 1908.
- Concrete System. F. B. Gilbreth, 1908.
- Cement and Concrete. L. C. Sabin, 1907.
- Diagrams for Design of Reinforced Concrete Structures. G. F. Dodge, 1910.
- Concrete Costs. Taylor and Thompson, 1912.
- A Treatise on Cement Specifications. Jerome Cochran, 1912.
- Dimension Stone Quarrying. W. L. Saunders, Trans. Am. Soc. C. E., Vol. 25, p. 501, 1891.
- Methods and Records of Winter Quarrying. Eng. Cont., Vol. 37, p. 375, 1912.
- Economic Layout of Concrete Plant. Eng. News, Vol. 67, p. 340, 1912.
- Large Portable Plant for Crushing, Mixing and Placing Concrete on the Catskill Aqueduct. Eng.-Cont., Vol. 34, p. 496, 1910.
- Subaqueous Concrete Work. H. R. Lordly. Trans. Can. Soc. C. E., Vol. 24, p. 122, 1910. Abstracted in Eng. News, Vol. 64, p. 149, 1910.
- The Construction Plant for the Gatun Locks and Dam. Eng. News, Vol., 65, p. 183, 1911.
- Method of Mixing and Placing Concrete for a Tunnel Lining. Eng.-Cont. Vol. 28, p. 328, 1907; Vol. 30, p. 3, 1908.
- Traveling Steel Forms for Tunnel Side Walls. Eng.-Cont., Vol. 30, p. 5, 1908.
- Collapsible Steel Forms for Concrete Tunnel Lining. Eng. Rec., Vol. 66, p. 1123, 1912.
- New Iron Form for Concrete Arches and Pipe. Ry. Age Gaz., Vol. 52, p. 1123, 1912.
- Discussion on Harbors, including Piers, Foundations and Depositing Concrete under Water. Trans. Am. Soc. C. E., Vol. 54, part A, p. 361, 1905.
- Special Concrete Structures of the Hudson River Tunnels. Wm. Torrance, Proc. West. Soc. Engrs., Vol. 13, p. 632, 1905.
- Reinforced Concrete Structures for Railways. A. O. Cunningham, Cornell Civ. Eng., Vol. 13, p. 87, 1905.
- Bridge and Concrete Steel Construction. E. Thacher, Cornell Civ. Eng., Vol. 10, p. 1, 1902.

CHAPTER VI

FOUNDATIONS

75. Foundations, General.—To secure permanent and adequate support for a structure as economically as possible is the problem of the engineer in considering the foundation. Permanency requires provision against damage from frost or scour as well as the preservation of the substructure itself. Frost may generally be guarded against in rock by permanently excluding water from the foundation bed but in other materials it usually necessitates going below the frost line. Depth of foundation is the usual means for protecting against undermining though piling or riprap is much used, often as an additional precaution.

Rock and many firm soils give adequate support if built upon directly and even the softer soils will sustain light loads. If the load is greater than the soil can safely carry its bearing capacity may be increased by one of the methods described in § 78; the area of the foundation may be increased; piles may be driven either to support the load largely by friction or as columns extending through to better material; or other means of reaching better material such as cribs, coffer-dams or caissons may be used. Some of these latter expedients are also necessary for work below water.

The preservation of the substructure requires the proper use of durable materials. Timber was formerly much used and is durable if below water, except where subject to attack by the teredo. It is now being replaced to a very large extent by concrete and steel.

The determination of the loads involves consideration not only of the dead load, including the substructure, and live load, including impact, but also effects of wind, impact from floating ice or other drift and thrust of ice in freezing.

With so many different conditions to be met, different materials upon which to build and different methods available, the complexity of the problem mentioned above may be readily appreciated as well as the fact that not more than an outline of the

principles and processes of foundation work can be attempted here.

Perhaps the most important principle is that it is not safe to take it for granted that all the uncertain conditions will be favorable, as money will often be saved ultimately by preparing for the worst conditions, highest floods, etc.

76. Examination of Site.—The first step to be taken is to make a thorough subsurface examination of the site. On important work such examination is often a prerequisite to the definite location of the structure or the results may lead to a relocation with large resulting economy. The cost of this work is always a very small proportion of the total cost and it should never be omitted on work of any importance as foreknowledge of the conditions to be encountered will often enable one to more than save the cost of the examination in better adapting the plans to those conditions and in the reduction of bids due to reducing the uncertainties.

The all too common practice of building foundations on "force account," *i.e.*, cost plus percentage basis, and throwing the responsibility for both design and construction upon the contractor without furnishing him adequate information is certainly not an economic one.

For shallow work on land, for ordinary loads, test-pits may be dug, but for heavy ones a knowledge of the underlying strata is desirable. Sometimes subsurface conditions may be predicted with sufficient accuracy from the geological formation at the site or from a knowledge of the materials met with in other excavations in the locality. Well records are often of value in this connection.

For moderate depths, soundings to bed rock may be made by driving a rod or pipe, though care must be taken not to mistake a boulder for solid rock. Adjacent soundings over an area will usually enable one to avoid such error as an erratic result would be apt to show. The pipe has an advantage in that samples of the material may be taken in firm soil. In soft soil a smaller pipe inside may be used to wash out the material, thus enabling wash borings to be taken.

In firm soils free from boulders, borings may be made with a common wood auger or with some form of earth auger fitted to bring up samples of the soil, while for soft soils the boring may be taken inside a pipe or casing. This method thus gives knowl-

edge of the material but not of its compactness. The cutting bits may be fastened to sections of pipe which are added as the hole deepens. The pipe or rod may be turned by levers or by means of Stillson wrenches and holes over 100 ft. deep have been bored by this method.

Well-drilling machines, § 39, are sometimes used for test holes for wash borings and some machines have a core-drilling attachment, though rotary drills, § 40, are generally used for core-drilling. These give more accurate determinations of the nature of the material if dry cores are occasionally taken, as some materials suitable for a foundation are so changed by water that they would be considered unfit. Hence core drilling is recommended, especially for foundation work, though care is still necessary in interpreting results. Thus cores of rock differing from the ledge rock for the locality would usually indicate a boulder. For this reason and on account of danger from cavities in limestone and overhang in other rocks it is best to drill part of the holes at least a considerable distance into the rock.

The cost of making borings at Toronto, Canada, with a 1½-in. wood auger mounted on ¾-in. gas pipe in 6-ft. sections was as follows, *Engineering-Contracting*, Vol. 32, p. 118, 1909:

	Average depth	Cents per ft.
1. Heavy blue clay, 10 ins. red clay on top,	25.3	32.9
2. Made ground,	22.5	55.4
3. Fine running clayey sand,	32.3	28.9
4. Heavy clay,	21.7	34.7
5. Heavy blue clay,	32.0	28.8

The heavy clay required three men to turn the auger. Labor cost \$2 per day, materials 10 per cent. and teaming and blacksmithing 5 per cent. of the total. The force consisted of one recorder and three laborers. The auger required removing from the hole and cleaning every 8 to 12 ins., which took considerable time.

In the Empire Hand Drill the boring is done with an auger or other suitable tool inside a casing which supports a platform on which the men operating the tools stand. Other men (or a horse) on the ground rotate the casing which is provided with a cutting edge and keeps a little in advance of the tools. About 40 test holes averaging 59½ ft. deep were sunk through sand and gravel

with occasional strata of clay on Long Island at a cost of about 40 cents per foot. Engineering-Contracting, Vol. 29, p. 71, 1908.

Drill tests, with a diamond drill taking a 2-in. core, for the Chicago and Northwestern Railway bridge across the Missouri River at Pierre, South Dakota, cost about \$1 a foot according to an article in Mine and Quarry by F. H. Bainbridge, Res. Eng., reprinted in Engineering-Contracting, Vol. 30, p. 352, 1908.

Thirty-three holes were put down aggregating 2379 ft. of which 1456 ft. were in sand, gravel and boulders and 923 ft. in rock, mostly shale.

For other examples of costs with well-drilling machines and rotary drills see §§ 39 and 40.

77. Safe Loads for Various Materials.—Nearly all ledge or "bed" rock in its natural position, will safely carry any structure that can be built upon it but many soils vary in bearing capacity according to their condition and the load which should be given them also varies with the structure, the settlement allowable, etc. Thus hard dry clay will bear heavy loads while if saturated it will, unless confined, squeeze out in all directions under moderate ones. Sand makes an excellent foundation if confined while if unconfined it may act like soft clay, especially if fine and full of water.

Unstable soils such as silt and quicksand will bear only light loads in their natural state, practically by flotation. Settlement is usually great under such conditions, but may do no harm if uniform and if proper provision is made for it. In fact it is impossible to entirely eliminate settlement with soils and it is uneven settlement which causes the most damage. This fact should be kept in mind especially in providing foundations for high structures as unit pressures are usually greater and uneven settlement more dangerous.

If the structure is such that vibration due to live loads or machinery reaches the foundation, a larger factor of safety should be used. This will rarely happen in railroad structures except for pile and low frame trestles, culverts under low fills, etc., though the effects of wind and ice may produce sudden and heavy changes in pressure on the foundations of piers.

Keeping these considerations in mind the following table will serve as a guide in designing foundations though in close cases, especially for important structures, actual tests should be made, and then good judgment used in selecting a proper factor of

safety, remembering that the load per unit on a large area should be less than that on a small one on account of the smaller proportion of support from adjacent material.

SAFE LOADS FOR VARIOUS MATERIALS IN TONS PER SQUARE FOOT¹

Kind of Material	Min.	Max.
Rock, the hardest in thick layers, in native bed,	200
Rock, equal to best ashlar masonry,	25	30
Rock, equal to best brick masonry,	15	20
Rock, equal to poor brick masonry,	5	10
Clay, in thick beds, always dry,	6	8
Clay, in thick beds, moderately dry,	4	6
Clay, soft,	1	2
Gravel and coarse sand, well cemented,	8	10
Sand, dry, compact and well cemented,	4	6
Sand, clean, dry,	2	4
Quicksand, alluvial soils, etc.,	0.5	1

A common method of testing is by using a 12×12-in. mast surmounted by a platform to carry the load, the whole being steadied by guys or by wedges lightly driven when in a small caisson. See *Engineering Record*, Vol. 65, p. 584, 1912. Another method, used at the Congressional Library, Washington, D. C., is to support the platform on four legs. These methods can be used only in foundation pits or caissons.

A method of testing through a pipe before excavating is described in *Engineering Record*, Vol. 62, p. 71, 1910. The same method was used in testing the material for foundations of the Municipal Building as described on p. 46 of the same volume. This latter test was followed up by a test on one of the full-sized piers, *Engineering Record*, Vol. 63, p. 196, 1911.

The area of the pier was about 90 sq. ft. while the test was on an area of about 1 sq. ft. The latter gave a settlement of nearly an inch under 10 tons per square foot, while the former settled only a little over 1/2 in. under 15 tons per square foot, thus illustrating the effect of difference of area mentioned above.

78. Methods of Increasing the Bearing Capacity of Soils.—As already stated, foundations in soils must be carried deep enough to avoid danger of damage from frost or, in some cases, from scour. If at this depth the character of the material is such that it will not quite carry the load with safety, it may be improved in bearing capacity by various means.

¹ *Masonry Construction*, I.O. Baker, 10th. ed., p. 342, 1909.

One of the simplest expedients is to take advantage of the greater compactness and better confinement of the material at increased depths. Sometimes a thorough drainage of the material is possible and sufficient for the purpose, if provision is made for permanently excluding the water. For light loads removal of the soil to a depth of 2 or 3 ft. and replacing it with gravel or even ramming in sand and gravel will give good results. Again, the load may be brought within allowable limits by using footings to reduce the unit pressure.

These expedients failing, the soil may be made more compact by driving small, short piles close together, say 6-in. ones 6 to 10 ft. long on about 3-ft. centers, either leaving them in place, if below ground-water level, or pulling them and ramming wet sand into the holes, thus obtaining "sand" piles. The ramming enlarges the holes, thus further compacting the soil. The sand also arches and transfers more of the load to the surrounding soil than the wooden pile. Both piles and soil are loaded in either case. The former practice with wooden piles was to bring their tops to a level, fill thoroughly with sand between them and then build a tight wooden platform over the whole area. Present practice with both sand and wooden piles is to deposit a solid bed of concrete over and around their tops.

79. Cribs.—These are structures built up of timbers placed across each other at right angles in alternate layers and more or less open according to purpose. They are used for bank protection, for temporary work in coffer-dams, § 81, etc., and for permanent foundations below the low water line, either on caissons, § 81, or on a grillage on piles. Either round or squared timbers are used, the latter being usually preferred as they require less framing. Their first cost, however, may be enough greater to more than overcome this advantage, particularly for the more open cribs. In either case the timbers should be securely drift bolted together at the intersections.

Cribs are commonly started on shore and then launched, floated into place and gradually sunk by loading the open spaces, usually with loose rock or concrete, the top being added to at the same time. About one-third of an all-timber structure will remain above water and the loading must be sufficient to overcome this bouyancy, while in sinking through soil the skin friction must also be overcome.

With an irregular rock bottom, the crib may be fitted to the

rock as shown in Fig. 36, page 164, though for foundation work it may answer to level up the bottom with loose rock or gravel unless the current is strong. Cribs alone should be used on an earth bottom only where there is little or no current, unless protected by riprap or piling or carried to sufficient depth to prevent undermining. Soft material may sometimes be removed and the bottom leveled by dredging, while at others filling may be employed for leveling up the bed. For sinking through soil the bottom of the crib should be provided with cutting edges and the material dredged out through open wells as for the Poughkeepsie bridge where cribs were sunk over 100 ft.

Variations in design, size and local conditions make it difficult to give very definite cost data. Cribs of round timber in the West cost about 15 cents per lineal foot of timber in place. Framing and placing timber in cribs ordinarily cost from \$5 to \$15 per 1000 ft., B.M., \$10 being a fair estimate for average conditions. The cost of materials for stone or concrete filling may be estimated from the data already given or from quotations, while the cost of transporting and placing depends on local conditions.

80. Cofferdams.—For ordinary depths, foundation and other work under water may be carried on “in the dry” by enclosing the site with a coffer-dam and pumping out the water. Knowledge of the underlying strata is necessary to the proper design of the dam, as a thin stratum of porous material may be cut off while a thick one is certain to give excessive leakage and may lead to the adoption of some other method. On account of the batter of the masonry, the size of the coffer-dam depends partly on the depth to which it is necessary to go and it should be at least sufficient to provide ample clearance around the footings.

The top of the dam should be high enough to prevent its being overtopped by waves or ordinary floods and it is often made wide enough to carry runways or even machinery, though cribs or scows are also used for the latter purpose. The dam should, of course, be as nearly watertight as possible and of sufficient strength to resist the pressures to which it will be subjected. Special protection upstream such as protective piling, ice-breakers, etc., may be required.

For very shallow water with little or no current, a bank of clayey earth may fulfill the above conditions if the excavation is not deep and soft or porous material be removed before depositing

the earth. Bags of earth on the inside permit a decrease in the size of the enclosure. A-frames laid on one leg and sheeted on the other, with canvas or earth over the sheeting, are also used for shallow water particularly for the unwatering of considerable areas.

Coffer-dams are most commonly constructed, however, of either wooden or steel sheet piling. The former was once the only kind available and has been used for depths up to 35 or 40 ft. Since the advent of steel piling, wooden piling has been largely replaced by it for depths over 15 to 20 ft., and the steel piling has been used for depths up to 75 or 80 ft.

The wooden sheet pile should be sharpened from one side only and driven with the longer side next the preceding pile. This, if the tops are held together, gives fairly tight joints for the plane rectangular section. Leakage may be reduced by driving boards over the joints, or tongued and grooved lumber may be used if hard driving is not required.

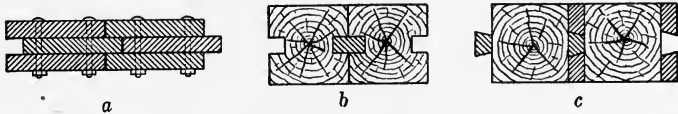

FIG. 33.—Wooden Sheet Piling.

For greater strength and better joints, three planks spiked or bolted together as in Wakefield or triple-lap sheet piling, (a) Fig. 33, or heavy timbers with splines, (b) and (c) Fig. 33, may be used. The common type is shown at (b) while (c) shows an improved type with the splines spiked to the timbers. The dovetail holds the pieces together and gives a tight joint. This piling was used on the highway bridge over the Potomac at Washington, D. C., and it is stated that there was practically no leakage even for the pivot pier where the water was 30 ft. deep. *Journal American Society of Engineering Contractors*, Vol. 3, p. 91, 1911.

A few types of steel piling are shown in Fig. 34. It will be noted that some are built up of standard shapes while others are the product of special rolls. The ordinary Friedstedt piling has Z-bars only on every other channel instead of on all as shown, while the Fargo is similar but uses a single Z-bar on each channel, thus obtaining a stiff free edge on every pile instead of on every

other one as in the ordinary Friestedt. Some types require special shapes at angles and a bending of the web for curves, the latter being extremely difficult in the field and reducing the salvage value of the piling. Other types are adapted to curved coffer-dams and some are also adapted to turning angles. This flexibility is of particular advantage in getting around boulders or other obstructions.

The stiffness of steel piling depends upon the section, but it is generally stiffer and more reliable than wooden sheet piling. The joints interlock so tightly that the leakage, if appreciable, can be stopped with earth, sand or manure. The sheets are held tightly together by the interlocking joints, and can thus be

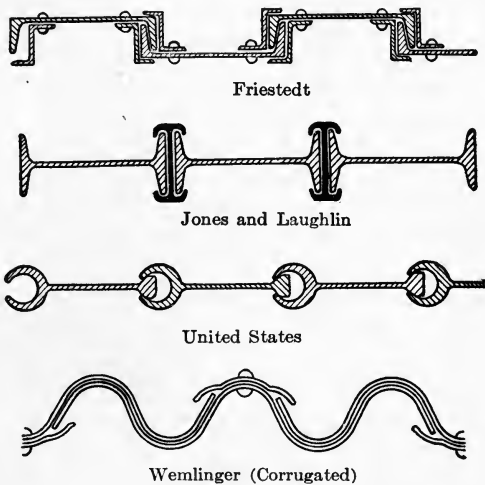

FIG. 34—Steel Sheet Piling.

readily spliced by driving one sheet on top of another. Steel piling may also be more easily pulled and it is often used repeatedly. It also has a much higher salvage value.

Small quantities of short wooden piling may often be most economically driven with a maul but for large quantities it will usually pay to rig up a small driver using a block of wood for the drop hammer. For the longer wooden piles and for steel piles in easy ground the ordinary drop or steam hammer, § 83, could be used while steel piles in hard ground require heavier hammers.

Sheet piling should preferably extend well into an impervious stratum, though this is often impossible as in founding on a seamy rock or a thick bed of porous gravel or sand. In such cases the material may be dredged out if the pumps are unable to control the leakage, and the bottom sealed with concrete deposited under water, as in caisson work, § 81. It will, of course, sometimes prove more economical to use some other method of doing the work.

With sheet piling, the simplest form of coffer-dam consists of a single row of piles, with earth banked outside unless the piling itself be fairly watertight. The excavated material, if dredged out and suitable for the purpose, may be used for this filling but material must be obtained from the bank in case it is desired to excavate in the dry. In cases where there is likely to be subterranean flow, as in limestone regions, the bank of earth is particularly desirable as its base covers considerable area. A disadvantage is its tendency to be carried away if there is any current, though it may often be successfully protected by bags of earth or riprap. As the water deepens the amount of fill required increases rapidly until, for each set of local conditions, a depth is reached at which it becomes more economical to build the double-wall coffer-dam with clay or puddle filling between the walls. Soft and especially porous material should be removed from between the walls before depositing the puddle. A mixture of clay and gravel makes the best puddle as a small leak in the clay will often be stopped by the gravel falling into it before any damage is done. Water is especially apt to find its way along braces or ties between the two walls. A wisp of hay or hemp or a rag around the brace or tie close to each wall will often prevent this. Leaks through the puddle may often be stopped by ramming it with sticks or driving heavy timbers into it. At other times clay cores rammed into the cavity through a pipe, or auxiliary sheeting placed around the leak and filled with puddle may be necessary. Leaks always add to the cost of the work by causing delay and increasing the pumping required as well as being expensive to repair.

With ordinary wooden sheet piling the thickness of the puddle wall for imperviousness should be from one-sixth to one-fourth the height depending on the kind of sheeting and importance of the work. The heavier types of wooden piling and steel

piling are more impervious and are used for varying depths without clay or puddle.

For small structures a single guide frame may give sufficient bracing or even the piles alone may stand if the excavation is not carried too near them. Additional frames may be added below as the process of unwatering and excavation goes on and it will

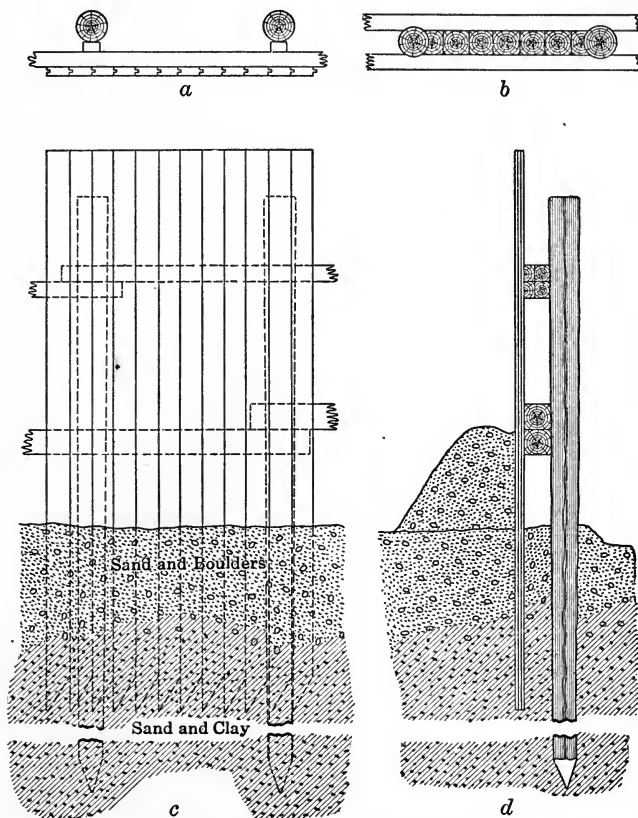

FIG. 35.—Sheet Pile Cofferdam.

usually be best to have at least one frame sunk directly below the upper frame in order to properly guide the piles. These frames may be held in position by the sheet piles but guide piles with waling pieces are common and are necessary for the greater depths.

Waling pieces on both sides of the guide piles with the sheeting driven between them as at *b*, Fig. 35, are sometimes used but the

single waling piece shown at *a* is more common. The elevation and cross section for the latter scheme are shown at *c* and *d*, respectively. The distance between guide piles, size of waling pieces and thickness of sheeting must be adjusted to each other and to the local conditions. For the double-wall dam the outer wall is braced by frames connected at intervals by rods or braces to the frames supporting the inner wall.

For unwatering large areas cribs may be used to support the waling pieces, the simplest form being the alternate crib type where cribs alternate with open spaces in a single row, but the waling pieces and sheeting are continuous. This type of coffer-dam depends on gravity to resist overturning and a solid row of

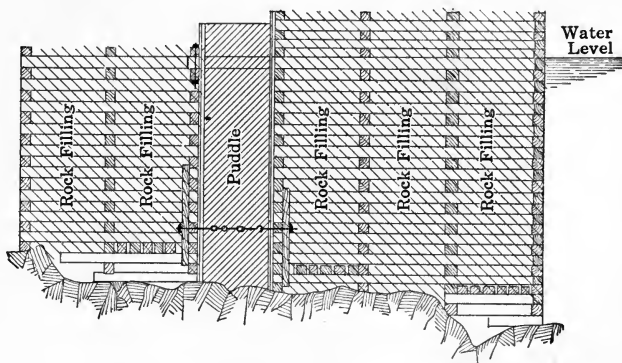

FIG. 36.—Crib Cofferdam.

cribs may be necessary, or even a double row with the puddle wall between as in Fig. 36, which shows a section of part of the coffer-dam used in the rapids of the Niagara river, *Engineering News*, Vol. 54, p. 561, 1905. Other types depending largely upon gravity for stability are such as were used in raising the battleship *Maine* and at the lock at Black Rock, near Buffalo, N. Y. In the former an oval of twenty-two 40- and 50-ft. cylinders, with fillers in the outside angles, was formed of 70-ft. Lackawanna steel piling, *Engineering News*, Vol. 64, p. 424, 1910. In the latter the same type of piling was used for the construction of two walls 30 ft. apart with connections across every 30 ft., dividing the coffer-dam into cells, *Engineering News*, Vol. 60, p. 394, 1908.

For considerable depths caissons are sometimes used for cof-

fer-dams, as at the Hauserlake dam in Montana, *Engineering News*, Vol. 65, p. 743, 1911.

It need hardly be pointed out that failures are even more expensive than leaks and should be guarded against by careful design and the use of good judgment based on experience in planning and executing the work. With liberal factors of safety, the pressure outside may usually be treated as hydrostatic, but careful account must be taken of the probable behavior of the material to be dealt with under all and particularly the worst contingencies which may arise.

Prices of timber for piling or bracing and of steel piling are best obtained from quotations for the particular locality. The cost of framing and placing timber in cribs was given in the preceding article and costs of piles and pile driving are given in § 83.

81. Caissons.—The term caisson was probably first used in foundation work to designate a watertight box in which the masonry was constructed, thus sinking it to place on the prepared foundation bed after which the sides of the box could be removed. At present, if unqualified, it would usually be taken to mean an inverted box in which excavation is carried on under compressed air although this is more properly called a pneumatic caisson. Open casings or wells from which the material is removed by dredging are sometimes called coffer-dams and sometimes open caissons, preferably the latter as the former gives the impression that the excavation is carried on in the dry.

The first type of caisson is very seldom used at present although the removable coffer-dam used with pneumatic caissons and cribs as described below resembles it in many respects. A modern type of pneumatic caisson as used on the McKinley Bridge over the Mississippi River at St. Louis, Missouri, *Cornell Civil Engineer*, Vol. 18, p. 132, 1909–10, is shown in Fig. 37. In earlier types the cutting edge was constructed of timber and the roof of the working chamber consisted of several layers of heavy timbers laid close together and carefully calked. The crib, extending from the roof of the working chamber to the base of the masonry, was also largely of heavy timbers.

With the change in relative cost of timber and concrete it has become economical to eliminate as much of the wood work as possible and thus it will be noted that in Fig. 37, steel and concrete constitute the greater part of the caisson and crib;

except the sheeting, which is extended upward to form the removable coffer-dam in which the neat work is started. For larger caissons the working chamber may be divided into parts by additional cutting edges. Caissons are commonly started on shore and then launched, towed to place and sunk by concreting or filling with rock. Care should be taken to have the caisson properly located before the cutting edge enters the river bed as errors are rather difficult to correct after the caisson is grounded.

In excavating the material, fine silt and especially sand may be blown out by air pressure through the pipes *S*. This, of course, reduces the pressure and is apt to increase the seepage unless the supply of air is adequate. In small caissons the reduction of pressure causes considerable vaporization, thus interfering

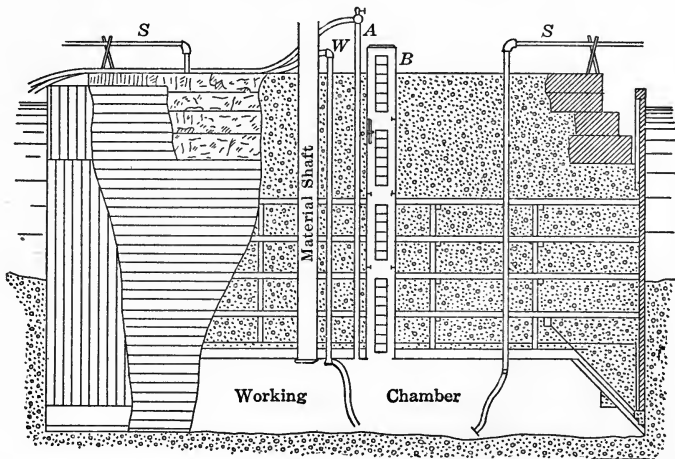

FIG. 37—Pneumatic Caisson.

with the work. For these reasons muck ejectors, sand or mud pumps, using an auxiliary air supply or water under pressure are frequently used. Water is frequently necessary in loosening the soil and may be admitted by the pipe *W*.

Hard material may be dredged out through an open water column with its lower end in a sump, the men simply pushing the material into the sump, or it may be locked out through the material shaft.

In Fig. 37, pipe *A* supplies the air and the shaft *B*, with ladder and air lock, is for the use of the "sand hogs," or workmen.

After the caisson has reached the proper depth so that the foundation is satisfactory the working chamber is usually filled with concrete locked in through the material shaft though sometimes it is only partially filled to seal it and the remainder of the space is filled with sand. In any case the concrete should be allowed to set before the air pressure is removed. The shafts may also be filled if desired.

The pneumatic caisson has the advantage that it can be sunk through any material as boulders and even sunken logs and drift which would stop a crib or cylinder can be removed in this process. Another advantage is that the foundation bed can be thoroughly examined and cleaned if necessary before depositing the concrete. It is a fairly rapid method as the pier is being built as the caisson sinks but it becomes quite expensive at great depths as the men get high wages for short periods of work on account of the great pressure and it cannot be used for depths over about 100 ft.

Open caissons or cylinders have been used to a considerable extent for piers as well as for foundations for buildings. In the latter case they are sometimes fitted with a jetting shoe. Sunken logs which interfere with the sinking of the cylinder may sometimes be blasted and the same method is often successful with boulders though the latter may sometimes be dropped into a hole out of the way by jetting. The services of a diver are expensive but are sometimes necessary, and even then it will occasionally happen that the sinking has to be abandoned entirely.

Open caissons are often sealed with concrete deposited under water and then pumped out, thus requiring ample strength to resist crushing. For this reason and also to give weight to overcome the skin friction they are sometimes lined with concrete as they are sunk. The published values of skin friction vary from 200 to 900 lbs. per square foot, this wide divergence probably being due to the difficulty of accurately measuring it. The usual values are from 400 to 600 lbs. Excessive skin friction may often be reduced by loosening up the soil around the caisson by means of powerful jets.

The cost of three pneumatic caissons and bridge piers is given in detail in *Engineering-Contracting*, Vol. 27, pp. 204, 220, 1907. The depth below ground level was moderate, averaging a little over 40 ft., and the cost, excluding masonry and concrete,

varied from about \$9 to \$11 per cubic yard of material removed, which the editors claim is a fairly rational unit, much more so than the usual lineal foot of depth. The cost of making and sinking the caissons for the North pier of the Williamsburg bridge was about \$14 per cubic yard, the maximum depth reached being 107.5 ft. below water and 56.5 ft. below ground level, *Engineering-Contracting*, Vol. 26, p. 33, 1906. In the first case above the water was quite shallow so that if masonry and concrete be added the total cost per cubic yard in the second case is approximately double that in the first, largely on account of the height of pier necessary in the deeper water. This illustrates the necessity of estimating the masonry and concrete separately even for preliminary estimates and for accuracy a careful study of the detailed estimates referred to above should be made.

82. Piles.—Sheet piles, except those of concrete, have already been discussed under coffer-dams, § 80, for which they have their principal use. The concrete ones are coming into use to quite an extent for permanent work in docks and wharves. They are usually rectangular in section and may be interlocked by bedding plates in the concrete with joints like the United States steel piling, Fig. 34, page 161.

The use of short wooden and sand piles for compacting the material of foundation beds has been discussed, § 78, so this article will be confined to the treatment of bearing piles. These are of either wood or concrete and are extensively used for pile trestles, § 96, and for foundations for other trestles, as well as for abutments and piers and the foundations of masonry structures.

The common method of founding on wooden piles is to cut the tops off level and cover with a grillage upon which the masonry is built. Since for permanent construction, timber cannot be used above low water, this operation may be quite an expensive one. This fact has led to the adoption of the concrete pile in many cases, as the heads of these piles may be left extending into the concrete of the pier. The advocates of concrete piles point out not only the saving of the expensive work of sawing off the piles and constructing the grillage below water and of constructing coffer-dams in which to start the masonry, but also the fact that a concrete pile has a greater bearing capacity than a wooden one and hence fewer are needed

for a given load, which fact offsets to some extent their greater unit cost. In foundations on land, the excavation of material to below the water line is sometimes avoided.

Adequate exploration of the soil, possibly the driving of test piles and even the application of test loadings should precede the decision as to length and size of piles. This should be followed by a detailed analysis of costs by the two methods in deciding between timber and concrete.

The specifications recommended by the American Railway Engineering Association in the Manual include in the railroad heart grade white, burr and post oak, longleaf pine, Douglas fir, tamarack, eastern white and red cedar, chestnut, western cedar, redwood and cypress.

They must be butt cut above the ground swell, preferably when the sap is down, from sound trees giving close-grained timber, free from defects which impair strength and durability. A uniform taper is required and no short bends allowed. A straight line between centers of butt and tip must lie within the pile at all points. Knots must be trimmed close and the bark removed soon after cutting.

For round piles the minimum diameter of tip is 9 ins. up to 30-ft. lengths; 8 ins. from 30 to 50 ft.; and 7 ins. for over 50 ft. The minimum diameter at one-quarter the length from the butt is 12 ins. and the maximum diameter of butt 20 ins. with at least $10\frac{1}{2}$ ins. heart wood.

For square piles practically the same requirements hold for the side of the square as for diameter above and it is also required that they show at least 80 per cent. heart on each side at any cross section.

The railroad falsework grade includes many other kinds of wood, in fact any sound timber that will stand driving. The requirements for the size of tip and butt, taper and lateral curvature are the same as for the railroad heart grade. Unless otherwise specified they need not be peeled, and no limits are specified as to the diameter or proportion of heart wood.

Concrete piles are either precast or molded in place and there are many patented kinds, mostly of the precast type. This type has the advantage of allowing an inspection and curing of the concrete before it is put into the ground, but the pile may be injured in driving. For the piles molded in place, a casing is usually driven, although in the compressol system, the hole is

made by simply dropping a weight repeatedly until the desired depth is reached. This hole is then filled with concrete, which is compressed and even expanded laterally by the use of a pear-shaped weight.

The casing used is withdrawn as the hole is filled for some types and left in with others. The latter practice is preferable and the casing should be sufficiently strong to resist the pressures tending to collapse it, including those due to driving adjacent piles, and it should be examined by lowering an electric light into it before filling.

Precast piles are of various designs and types of reinforcement. Ample strength to stand handling and driving and low first cost are the main requirements. Some types are particularly well adapted to the use of the water jet for sinking. Tapering the pile increases its bearing capacity if due to skin friction.

83. Pile Driving.—Piles are commonly driven into place by means of either a drop-hammer or steam-hammer pile driver. In suitable soils, they are sometimes jettted into place though the water jet is more commonly used to facilitate driving, particularly with concrete piles. For forcing a few piles into muddy or silty soil, direct pressure from applied loads, possibly also with the assistance of a jet, may be the most economical means to use and, as already stated, a small number of short piles may sometimes be advantageously driven with a maul. For large numbers it would usually pay to rig up a driver and heavy driving requires the use of a machine driver.

The drop-hammer driver consists essentially of a weight or hammer and upright guides or "leads," 20 to 30 ft. long, between which it slides. The hammer is raised by means of a rope or cable passing over a pulley at the top of the leads.

For light driving, an improvised driver with a block of wood for the hammer and operated by men or a horse may be used. For ordinary driving, metal hammers weighing from 1000 to 3000 lbs., usually about 2000, are used and are operated by horses or steam. For operation by men and horses, and sometimes for steam, the rope or cable is attached to a nipper which automatically engages the hammer when lowered upon it and drops it when tripped. The tripping device may be set at any height and 6 to 14 blows per minute are possible by this method.

For steam driving 20 to 30 blows per minute may be delivered

by using a friction clutch on the drum of the hoisting engine in which case the rope is attached directly to the hammer. The height of fall may be varied at will without the loss of time necessary in changing the trip. The fall of the hammer is not free, however, and some of the energy is used each time in unwinding the cable and rotating the drum. The much greater number of blows more than compensates for this disadvantage as piles usually drive more easily if kept in motion. A skillful operator can often catch the hammer on the rebound, thus securing maximum speed. He can also apply friction on the descent and hence should be carefully watched when testing for penetration on contract work, particularly if there is very little excess length to the piles. A metal block or follower is often used between the hammer and the pile. This also slides in the leads and has a recess in the bottom for the head of the pile, thus tending to keep it in position. It is fastened to the hammer by means of chains when not in use.

With the steam-hammer, the steam cylinder is supported in a vertical position by a metal frame or weight resting directly on the pile and the weighted piston rod, or in some cases the cylinder, pounds the head of the weighted pile. The older types were single acting, that is the steam simply raised the weighted piston and it fell by gravity. The more modern types are double-acting, the steam both raising the weight and increasing the force of the blow. These are more compact, lighter and operate more rapidly. Sixty to 80 blows per minute are possible with the steam-hammer, thus keeping the pile in practically continuous motion. The stroke is usually about 3 ft. and the weight varies according to the work as in the drop-hammer driver. The steam-hammer may be used in leads but a great advantage is that it may also be swung from a cable by derrick or crane, thus making it more flexible and adaptable to different conditions.

In pile driving, a large proportion of the time is necessarily lost in getting the pile into place, moving the driver, etc., and every effort should be made to reduce these losses to a minimum. With horse driving, two horses or two two-horse teams should be used so that one is returning to the driver while the other is hauling up the hammer. They should be utilized while the driver is being moved in snaking piles into position, handy to the driver, etc.

In driving on land, the leads are usually mounted on skids and rollers should be utilized as much as possible in moving the

driver. For work in water, leads, engine and boiler are mounted on a scow which makes the shifting much more rapid than for a land driver. For trestle work, particularly for repairs and renewals, the railroad pile driver, Fig. 38, is much used. This is mounted on a flat car and can travel under its own power. It can drive a full bent ahead of the track and at either side as desired for protection work, double tracking, etc. Its great disadvantage on new work is that a bent must be sawed off, capped, and stringers and track extended before it can move

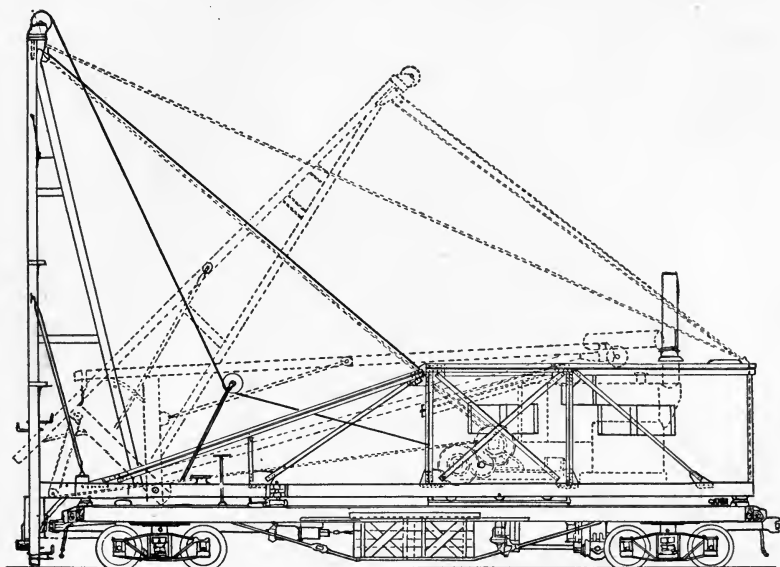

FIG. 38.—Railroad Pile Driver.

forward. Still it saves blocking and temporary track for a land driver and is quickly moved after the track is prepared for it.

Pendulum leads for driving batter piles are recommended by the Committee on Wooden Bridges and Trestles of the American Railway Engineering Association, though some engineers prefer to point the pile on one side and draw the heads together to secure the batter. The leads should fold by power and when folded there should be no projection beyond the drawheads, as this would require an idler. The committee also recommends the steam-hammer and water-jet apparatus as desirable for a railroad pile driver.

In jetting, water under pressure is discharged at the point of the pile. Some concrete piles are cast with a hole for the water at the center, while for others and for wooden piles, a pipe is necessary. Formerly this pipe was frequently attached to the pile but better results are usually obtained by leaving it free so that it may be churned up and down. The feed pipe should be at least 2 ins. in diameter to reduce friction and this diameter should be less at the jet to increase velocity. The volume of water and pressure required vary with the soil, the jet being most effective in light soils, sand and fine gravel. In clay the tendency of the jet is to make a small hole but by moving it around, considerable assistance to driving may be obtained. Sometimes two jets are desirable and occasionally an extra jet part way up the pile will assist in its lubrication. The pressure should be at least 100 lbs. per square inch and in difficult material pressures of twice that amount have been used.

In considering the load which a pile will safely carry two cases occur. In the first the pile passes through soft material and is supported mainly or entirely at the point by a hard stratum or a large portion of the pile extends above the surface of the ground as in pile trestles. These piles should be investigated as columns either free or braced as the case may be.

In the second and more usual case, the pile is supported mainly by skin friction which is not so easily determined and may change. It is an accepted fact, that under ordinary circumstances a pile increases in bearing power even after a short period of rest but if driven in clay and subjected to vibration, water may work its way down along the pile and considerably decrease its bearing power. Perhaps the most accurate means of testing bearing power is to apply test loads to piles under exactly the same conditions as those in the finished structure. This, however, would be quite an expensive process and the simplest and most convenient way is to use the effect of the last blow or average of the last few blows in a formula. The best known and most used formulas for this purpose are the Engineering News formulas:

$$P = \frac{2Wh}{s+1} \text{ for a drop-hammer driver.}$$

$$\text{and } P = \frac{2Wh}{s+0.1} \text{ for a steam-hammer driver}$$

(single acting).

Where P is the safe load in pounds, W the weight of the hammer in pounds, h the fall of the hammer in feet and s the penetration under last blow (or average as mentioned above) in inches. Neglecting the constants in the denominators, the formulas give a safe load equal to one-sixth the theoretical resistance according to a formula in Church's Mechanics, while the effect of the constants is to increase the factor of safety. These formulas are also used for piles acting as columns under ordinary conditions of driving.

In measuring s the head should not be broomed and the hammer should not bounce as this decreases the effective height of fall by the height of rebound for elastic bodies or by about twice the height for the inelastic bodies used. For best results, s should diminish uniformly. It is sometimes desirable to use test blows after a period of rest. For driving with steam using the friction clutch, the loss in h may be computed by use of weight of drum and its radius of gyration or from the time of fall.

Jetted piles in most soils give maximum values for piles of same form and penetration. Test blows should be given and s measured in important cases. Where piles are supported by skin friction a considerable taper seems to increase the bearing power. Wooden piles need not be pointed for driving in soft material but in ordinary material they drive better if pointed to a 4- to 6-in. square.

For very hard driving, shoes are sometimes necessary and if used they should form an integral part of the pile. A surface layer of hard material may sometimes be removed to advantage or a metal mandril may be driven through the hard layer and then removed and the pile put into place and driven. The same scheme may be employed for starting piles too long to go in the leads or jetting may be employed for the same purpose.

As already stated, jetting is usual to facilitate the driving of concrete piles and to prevent overdriving of timber piles. Special driving heads with blocks of wood or air or rope cushions are used for driving concrete piles.

A common specification is to require a value of s of not over 1 in. under the blow of a 2000-lb. hammer falling 20 ft., but sometimes it is stated that piles must be driven to "refusal" under the same blow. Such a requirement frequently leads to overdriving as does also the requirement of putting in a fixed length. It is better to leave the matter to the judgment of the engineer

than to make such rigid requirements. Generally speaking, further driving is likely to injure the pile when the hammer commences to rebound, especially if the pile kicks and staggers under the blow.

Quotations on lumber for sheeting, etc., and on timber piles may be found in the monthly price list of engineering materials published in the Engineering News. Both can be purchased locally to advantage in many places and piles are sometimes cut from right of way or other railroad property, or under contract with land owners. Cutting and trimming costs about a cent a foot for labor, to which must be added handling, hauling and freight, and purchase price, if any. For steel sheet piling, quotations may be obtained from the respective manufacturers. Concrete piles are also patented and are usually put in under contract with the firms owning the patents who furnish designs and estimates.

The detailed cost of making 21 666 concrete piles on the Panama Canal is given in Engineering News, Vol. 66, p. 301, 1911. Type or size of pile and amount of reinforcement is not given. The cost, including estimated plant and overhead expenses, ranged from \$1.20 to \$1.40, and averaged \$1.35 per lineal foot.

The cost of driving depends on the type and size of pile, character of the soil and method used, including the management of the work. The best results require the proper adaptation of these factors to each other. Sheet piling for coffer-dams or trenches is usually put in on force account or paid for as part of the excavation in lump sum, but the data below will be useful for estimates. Piling for foundations is also frequently paid for by lump sum, while for trestling the payment is generally by the lineal foot, either of pile delivered, of pile driven, *i.e.*, left in place after being cut off to grade, or of penetration. The cost of driving per pile is more nearly constant, however, and thus would seem to be a fairer unit for estimates.

Some data on costs of pile driving were given by Victor Windett in a paper before the Western Society of Engineers, Journal, Vol. 16, p. 789, 1911, an abstract of which will be found in Engineering and Contracting, Vol. 35, p. 709, 1911. With labor at \$0.314 per hour, 1102 ft. of trenches were sheathed with 2-in. stuff 10-12 ft. long, driven by hand with a maul and assistance of a water jet through sand at a labor cost of \$3.70

per thousand ft. B.M., \$0.305 per lineal foot of trench or \$0.013 per square foot penetration.

Four hundred and five pieces of triple lap sheeting, averaging 23 ft. long, were driven for a foundation pit through 15 ft. of sand into soft clay by two No. 1 Vulcan steam-hammers in 19 days. Jet was used in sand. The unit labor costs were \$2.24 per pile, \$0.098 per lineal foot of pile and \$10.84 per thousand ft. B.M. Five days were used in moving to and from the work which increased the cost considerably.

Ninety-six foundation piles, 20 ft. long, were driven through hard clay by a crew of ten men with a 3000-lb. drop-hammer at a labor cost of 17 cents per lineal foot. Freight, supplies and piles cost 15 cents, giving a total of 32 cents per lineal foot.

The ordinary pile driver crew with rates of pay is given as follows:

Foreman, \$0.58 $\frac{1}{2}$ per hour,	\$4.80
1 Engine runner, \$0.55 per hour,	4.40
1 Fireman, \$0.37 $\frac{1}{2}$ per hour,	3.00
1 Winchman, \$0.45 per hour,	3.60
1 Leadsman, \$0.45 per hour,	3.60
3 Ground men (or deck hands), \$0.40 per hour,	9.60
1 Coal passer, \$0.25 per hour,	2.00
1 Pile hooker and trimmer, \$0.37 $\frac{1}{2}$ per hour,	3.00
	<hr/>
Total, labor crew,	\$34.00
Auxiliaries, 6 men,	15.00
Proportion of pumping station labor for jetting,	2.00
Field Superintendence,	2.75
	<hr/>
Total, field labor,	\$53.75

With a marine driver, the Great Lakes Dredge and Dock Co. drove 9896 piles averaging 33 lin. ft. delivered and 21 lin. ft. driven in 137 days, with a 3500-lb. drop-hammer operated by steam, with friction clutch on drum with the following costs, the force being as above except that tug service cost \$15.00 per day.

Distribution	Per lin. ft. piling	Per lin. ft. penetration
Labor,	\$0.029	\$0.0453
Supplies and repairs,	*0.015	*0.0235
Piles,	*0.125	*0.1962
	<hr/>	<hr/>
Total, "field" expense,	\$0.169	\$0.265

* Estimated.

The soil was sandy for a few feet and below that a fairly soft clay. Piles stood out of the water on the average 12 ft., undriven.

84. Pumps and Pumping.—The selection of pumps requires consideration of the amount of water to be handled and the lift as well as the adaptability of the plant to future work. The condition of the water may require consideration though it is practically always more or less dirty on foundation work. In some cases, however, the pump is used for dredging and must be able to handle large quantities of material with the water.

The amount of water depends on the leakage which cannot be accurately known beforehand, but which can often be reduced if excessive.

Due to this uncertainty and to the fact that small units are more portable and adaptable to varying requirements, it is more important that ample power be provided than ample pumping capacity in a single unit. The unwatering of large coffer-dams is often most economically performed by large capacity centrifugal pumps, after which a small steam jet or syphon or a pulsometer may suffice to take care of the leakage.

A square wooden-box lift pump may be improvised on the job for removing a small amount of water from a shallow pit or trench or a sheet metal boat pump 8 to 10 ft. long may be purchased at from \$5 to \$10. The common diaphragm pump is much more effective for amounts of water which can be handled by hand pumping.

The heavy rubber diaphragm acts as a plunger and is fitted with a simple lift valve such that sand and even small gravel pass through without clogging. The valve is easily removed and the body of the pump cleaned in case it becomes clogged, which would very seldom happen if the screen is kept on the end of the suction hose. The 2½-in. suction has a capacity of 25 gals. per minute and the 3-in. suction, 58 gals. per minute; the list prices being \$20 and \$26, respectively, according to Fowler.

The simplest steam pump is the steam jet which works on the principle of an injector and may be improvised on the job, though more efficient results would be obtained by one of the standard makes.

Fowler gives 120 gals. per minute as the capacity of a 3-in. discharge Van Duzen jet at 30 ft. head, requiring an 18 HP boiler with 50 lbs. per square inch steam pressure. List price

is \$36 without piping. Sizes vary from 1/2 in. discharge, capacity about 3 gals. per minute to 5-in. with capacity of 200 gals. per minute.

One of the most convenient pumps for removing water in foundation work is the pulsometer which consists essentially of a casing with two chambers so arranged that steam forces the water out of one chamber and then condenses in it producing a vacuum, thus drawing in a new charge. By means of simple valves, the chambers operate alternately giving a pulsating effect which, however, is scarcely noticeable at the discharge. Its convenience lies in the facts that it is light and requires no foundation, being swung by a hook. It can be supplied with steam by means of a flexible hose and hence is easily moved as may be necessary for blasting, etc. No belts or bearings are required and valves are easily renewed. The casings last indefinitely except where pumping water with sand or other abrasive materials for which special carborundum lining may be obtained. The general impression is that it is wasteful of steam, but Professor Ewing, Heat Engines, claims that it does not compare unfavorably with small steam pumps in that respect. Capacities vary from 20 to 2000 gals. per minute, with weights of 95 to 3800 lbs. and list prices of \$90 to \$1200.

For handling large quantities of water at low heads and particularly for dredging, centrifugal pumps are more common. These are preferably direct connected to shaft of steam engine, steam turbine, gasoline engine or electric motor, and show higher efficiencies for heads up to about 30 ft. than the reciprocating types which are not adapted to handling dirty water. Efficiencies vary from 10 to 50 or 60 per cent. on construction work, being usually lowest for small plants where expert care and supervision is usually lacking and highest for large plants requiring better machinery and the services of skilled mechanics.

Water carrying sand should be conveyed through pipes having long radius bends rather than sharp angles as the pipes wear out rapidly at angles.

REFERENCES

- Ordinary Foundations. C. E. Fowler, 1905.
Foundations. W. M. Patton, 1906.
Allowable Pressures on Deep Foundations. E. L. Corthell, 1907.
Specifications for Foundations of Bridges. Theodore Cooper, 1902.
Removing Spoil from Caissons by Hydraulic Elevator and by Pneumatic Muck Ejector, Eng. & Cont., Vol. 36, pp. 33 and 297, respectively, 1911.
The Substructure of the Municipal Bridge over the Mississippi at St. Louis, Mo. S. W. Bowen, Eng. News, Vol. 65, p. 320, 1911.
The New Bridge Crossing the Mississippi River at Clinton, Ia. Chicago & Northwestern Ry. T. H. Bainbridge, Eng. News, Vol. 61, p. 63, 1909.
Experiences with Sheet Steel Piling in Hard Soils. Wm. Fargo, Eng. News, Vol. 57, p. 374, 1907.
What Sometimes Happens to Wooden Piles during Driving. Julian Griggs, Eng. News, Vol. 61, p. 44, 1909.
Reinforced Concrete Caissons for Breakwaters and Piers;
At Algoma, Wis. W. J. Judson, Eng. News, Vol. 60, p. 421, 1908.
Development and Use. W. J. Judson, Eng. News, Vol. 62, p. 34, 1909.
At Kobe, Japan. W. J. Judson, Eng. News, Vol. 65, p. 647, 1911.
The Sinking of the Piers for the Grand Trunk Pacific Bridge at Fort William, Ont., with discussion. H. L. Wiley, Trans. Am. Soc. C. E., Vol. 62, p. 113, 1909.
Locomotive Crane with Attachment for Pile Driving, Eng. & Cont., Vol. 36, p. 544, 1911.
Concrete Piles and Concrete Piling Equipment, with discussion. M. M. Upson, Jour. Am. Soc. Eng. Confs., Vol. 4, p. 203, 1912.

CHAPTER VII

CULVERT AND BRIDGE MASONRY

85. Standard Structures.—In railroad construction and operation there are many structures which have about the same conditions to fulfill on different parts of the line and this has led to the adoption of standards by most of the railroad companies. The advantages of uniformity in construction and in order bills of material, and the increased convenience and rapidity with which repairs and renewals can be made by keeping material in stock, outweigh the saving in direct cost of construction which might be secured by a more minute adaptation to the special local conditions.

So important has the subject become that a considerable portion of the work of the American Railway Engineering Association is devoted to the perfection of standards for operation and management as well as for construction and structures. Some of the other societies are working in the same direction. Work of this character is doing much to improve practice and to place the manufacture of machinery and supplies on a commercial basis rather than on special order so that mills and factories can run during dull seasons with the certainty that on the return of the demand the product will meet the specification.

86. Waterway for Culverts.—In leaving openings for drainage on a line of average traffic provision should be made for the large floods which occur at intervals of from ten to twenty years, it being much cheaper to repair an occasional washout due to a cloudburst or phenomenal freshet than to pay interest and depreciation on the extra cost required to make all the structures on the line large enough to be perfectly safe for all flood contingencies. For heavier traffic where the losses from interruption of service and possible loss of life would be greater, further provision should be made as additional insurance against loss.

With the old type of construction where many of the fills and all the short span openings were crossed at first by wooden pile trestles there was opportunity to study high water and the effect

of freshets before the permanent construction was built, and thus determine the proper sizes for waterway.

If nearby openings can be found on the same draw or stream, their size in connection with high water marks will be an excellent guide for the new structure, as each watershed has special characteristics. There is a growing tendency, however, to make a survey of the drainage area, including surface slopes and character of soil, and to use a run off formula for determining the maximum flow.

The most extensive investigation of waterway openings ever made on any American railroad was by Chief Engineer Dun of the Santa Fe. The watershed areas were accurately determined and observations as to required waterway areas carefully taken during many years. When the table was published in 1906,¹ Mr. Dun stated it had been in use fifteen years and that in general it had been found sufficient, and especially up to a drainage area of five square miles. In 1903, however, some floods in Western Kansas were noted which exceeded the table from 200 to 300 per cent. Also in 1905 there was a series of floods near Fort Madison, Iowa, that far exceeded the table. Mr. Dun believed these floods to be rare exceptions for which it would not pay a railroad company to provide.

The observations upon which the table is based were taken on streams in Southwestern Missouri, Eastern Kansas, Western Arkansas, and Southeastern Oklahoma. In all this region steep, rocky slopes prevail and the soil absorbs but a small percentage of the rainfall.

The table² is plotted, Fig. 39, for Missouri, Kansas and Eastern Oklahoma north of Purcell, where the yearly rainfall is about 40 ins. and the greatest monthly, from 12 to 16 ins. from records covering from ten to twenty-five years. For Illinois, east of Streator, use 60 and west 80 per cent. For Texas and Eastern Oklahoma south of Purcell, add 5 per cent. for areas from 1 to 22 square miles, 10 per cent. from 24 to 50, 15 per cent. from 25 to 95, 20 per cent. from 100 to 120, 25 per cent. from 130 to 140, and 50 per cent. for drainage areas of 150 square miles and above. For New Mexico, subtract 2 per cent. for areas from 1 to 4 square miles, 3 per cent. from 4 to 8½, 6 per cent. from 9 to 24, etc., reaching 43½ per cent. at 900 square miles.

¹ Jour. West. Soc. Engs., Vol. 11, p. 146, 1906.

² For table see, Proc. Amer. Ry. Eng. Assoc., Vol. 10, p. 977, 1909.

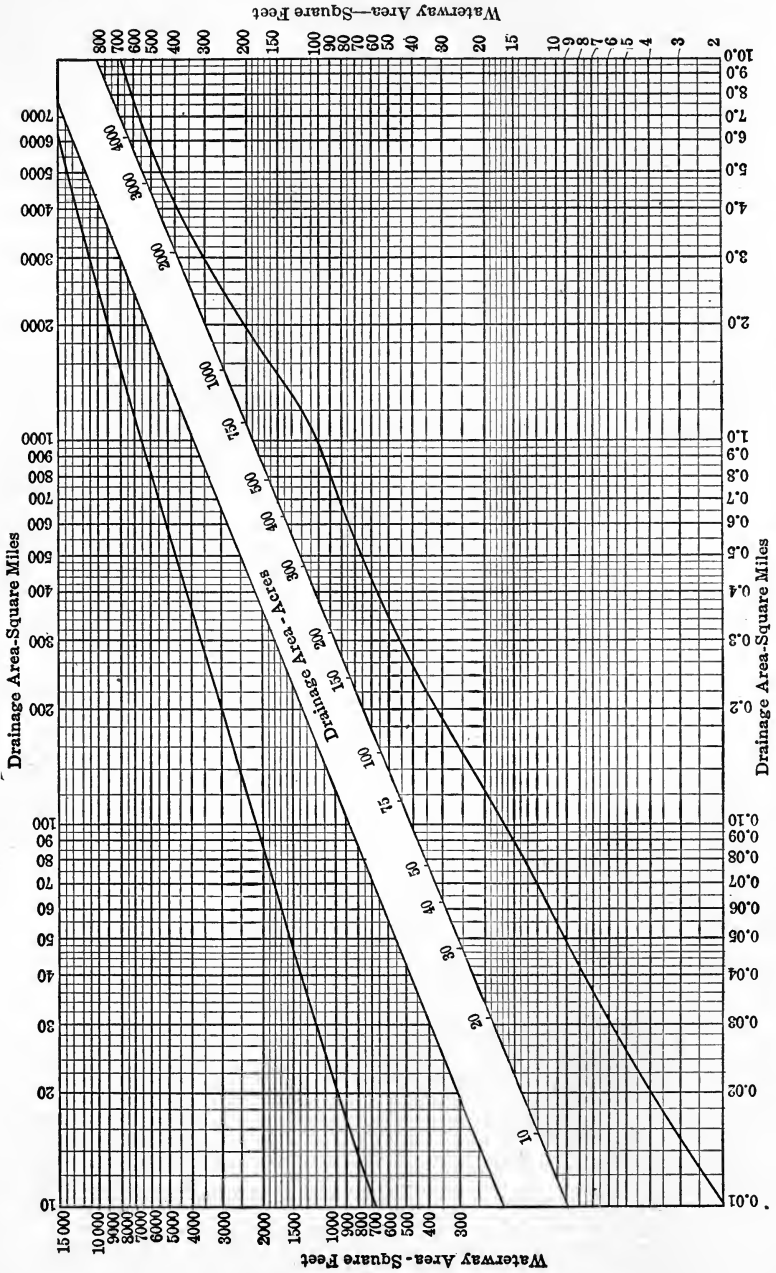

Fig. 39—Dun Waterway Areas. For limitations, see page 181.

For a diagram taking into account more of the details of the drainage area, the Burkli formula for storm water sewers, as worked out and plotted by Professor Pence,¹ is given, Fig. 40.

The formula is,

$$Q = crS^{\frac{1}{2}}A^{\frac{2}{3}}$$

where Q = discharge in cubic feet per second.

c = runoff coefficient depending on the nature of the surface.

r = rainfall rate, cubic feet per second per acre during period of heaviest rainfall.

S = average slope of drainage area in per cent.

A = Area drained in acres.

= 640 times area drained in square miles.

Professor Talbot, from a study of the rainfall data accumulated by the government weather bureau,¹ has found that quite uniformly throughout the United States the rate of rare maximum rainfall may be expressed by

$$y = 6 / (x + 0.5)$$

and the rate of ordinary maximum rainfall by

$$y = 1.75 / (x + 0.25)$$

where y is the rate in inches per hour for the time, x in hours. The rate y is only 0.8 per cent. less than r so that it can be replaced by r in the formula when more convenient.

In applying these formulas, x should be taken about equal the time required for the water to reach the structure from the most distant portion of the area, thus making r depend upon the slope and character of the surface, and upon the size and shape of the area.

When these are not observed the following values suggested for storm-water sewers will serve as a guide for the value of r .

For well built up districts,	3.5 to 5
For suburbs, all paved,	2.0 to 4
For suburbs, partially paved,	1.5 to 3
For country towns where it is permissible to let water from unusual storms stand for a time,	1.0 to 2

¹ Proc. Amer. Ry. Eng. Assoc., Vol. 10, p. 1012, 1909.

² The Technograph, p 104, 1891-92.

In using the diagram, Fig. 40, the following values are suggested for c ,

For flat sandy soil or cultivated land,	0.25 to 0.35
For gentle slopes, absorbent ground,	0.35 to 0.45
For wooded slopes, compact ground,	0.45 to 0.55
For mountainous and rocky country or non-absorbent surfaces,	0.55 to 0.65

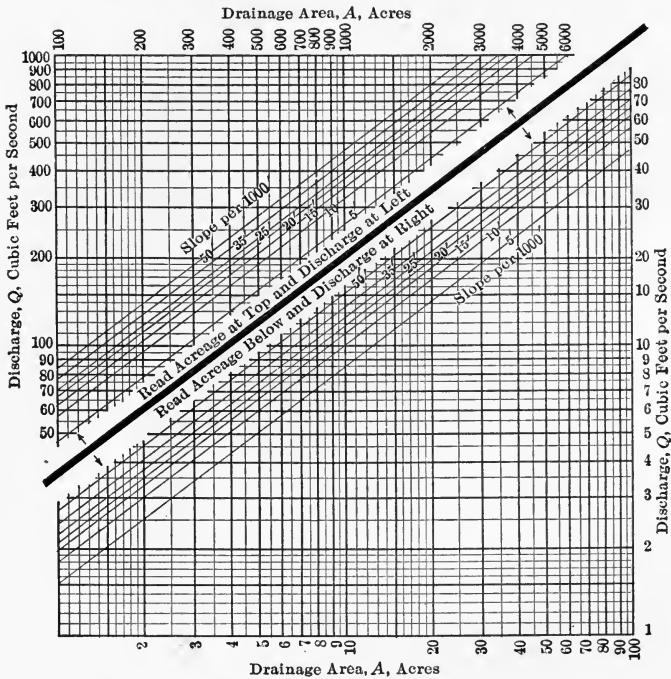

FIG. 40—Diagram of Storm Water Flow.

By Burkli's formula, with $c=r=1$. Choose values of c and r for the district to be drained, and multiply Q obtained from diagram by cr .

The velocity of flow through a culvert having a head of water or a fall, or a combination of both equal to h , is given approximately by the formula,

$$v = \sqrt{\frac{2gh}{1.5 + fl/R}}$$

and $Q = v$ times area in square feet

where $v =$ velocity in feet per second.

$g =$ the acceleration due to gravity, = 32.2 ft. per second in a second.

Q = quantity of water in cubic feet per second.

f = coefficient of friction as defined in Church's Mechanics,
and equals $\frac{2g}{A^2}$ where A is Chezy's coefficient.

l = length of culvert in feet.

R = hydraulic radius in feet (or hydraulic mean depth)
obtained by dividing the area of cross-section of the
water flowing in the culvert by the wetted perimeter.

The constant 1.5 in the formula may be reduced to 1.0 for a culvert with rounded or gradually converging approach; to 0.5 for a velocity of approach equal to that in the culvert, and to zero for a combination of these circumstances.

For clean cast iron, smooth concrete, brickwork or timber,

$f = 0.00608 / (4 R)^{0.168}$, which gives,

$f = .005$ for $R = 0.5$ to 1.5

$f = .004$ for $R = 1.5$ to 6

$f = .003$ for $R = 6$ to 15

For incrustated cast iron, smooth rubble, concrete, rough timber, etc.

$f = 0.011 / (4 R)^{0.16}$, which gives,

$f = .010$ for $R = 0.5$

$f = .007$ for $R = 3$ to 6

$f = .009$ for $R = 1$

$f = .006$ for $R = 10$ to 15

$f = .008$ for $R = 1.5$ to 2.5

The term $f l / R$ can thus be neglected except for long culverts with small values of R .

87. Pipe Culverts.—Double thick glazed sewer pipe is much used for small openings under fills of moderate depth. When laid without a concrete bed, as is quite common, the undisturbed earth should be carefully scraped out, with places for the hubs, so that the pipe will be bedded for the semi-circumference. Fine material should then be used for the first foot or more of covering and be well tamped at the sides to give lateral support to prevent spreading under vertical load as the fill settles.

Considerable slope should be given to the pipe and clear drainage at the lower end to prevent water from standing and freezing in the pipe. Three inches in 12 ft. is given as the minimum slope for cast-iron pipe for New York Central Standards. The center should generally be laid high to allow for the greater

settlement of the foundation under the higher portion of the fill. The lower end of the pipe should be protected from undercutting by paving or by an apron of concrete, when not protected by a pool.

The sewer pipe list is:

9 ins. inside diam.	26 lbs. per ft.,	\$.60
12	45	1.00
15	63	1.35
18	84	1.90
20	99	2.25
24	130	3.25
30	226	5.50
36	330	7.00

The discounts quoted in the Engineering News price list of August 1, 1912, for carload lots, f.o.b. factory, were: up to 24 in. inclusive, 87 per cent.; 30-in., 79 per cent.; 36-in., 77 per cent. The discounts for second quality pipe suitable for culverts would be some 5 per cent. greater. Freight rates between important centers are also given in the monthly price list.

Concrete pipe can be made at about the same cost as sewer pipe for the small sizes and at less cost for the larger ones.

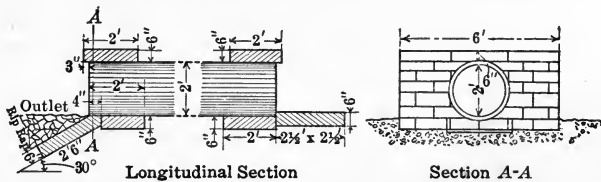

FIG. 41.—Missouri Pacific Railroad Protection for Tile Culvert.

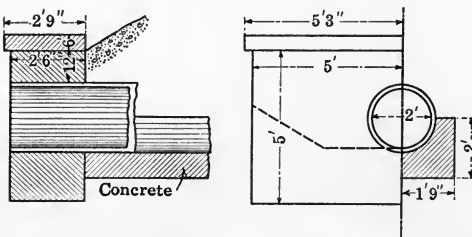

FIG. 42.—Kansas City and Omaha Railroad Standard Tile Culvert.

On the Missouri Pacific Railroad end walls were used with concrete aprons above and below to prevent undercutting as shown in Fig. 41 for a 24-in. pipe.

On the Kansas City and Omaha Railroad the foundations for the end walls were made deeper and the pipe laid in a bed of concrete as shown, Fig. 42.

The masonry in cubic yards for the different diameters was as follows:

Diameter of pipe, Size, feet,	14-in. 6×3.5×2	16-in. 8×4×2	20-in. 10×4.5×2½	24-in. 10×5×2.5
Coping,	0.54	0.71	0.97	1.07
Two end walls,	2.93	4.45	6.98	8.47
Total,	3.47	5.16	7.95	9.54
Concrete per lineal foot,	0.07	0.10	0.136	0.18

The coping was 6 ins. thick and projected 3 ins. on the front and ends.

Sewer pipe has been quite largely replaced by concrete for railroad culverts although it gives good service when properly laid and protected.

Cast iron and steel pipes are also used for culverts. The steel pipe should be heated and immersed in a preparation of coal tar for protection from rust. It is often used without end walls or other protection from undercutting as it is made in long lengths and suffers less injury from undercutting than sewer pipe.

The cast iron pipe for ordinary sizes is in 12-ft. lengths.

The weights per foot are about as follows:

Diam.	Wt. per ft.	Diam.	Wt. per ft.
12-in.	60 lbs.	30-in.	240 lbs.
16	88	36	320
20	118	42	400
24	175	48	510

The water pipe is quoted at \$25 per ton of 2000 lbs. at the foundry.¹ Second quality, suitable for culverts, can usually be obtained at a reduced price.

The end walls used on the Santa Fe Railroad are as shown below and on Fig. 43. The dimensions shown on the figure are the same for all sizes.

Parts	18-in.	24-in.	30-in.	36-in.	48-in.
Thickness under coping,	2' 0"	2' 0"	3' 0"	3' 0"	3' 0"
Length of wall,	6 6	7 6	9 6	10 6	13 6
Length of coping,	7 6	8 6	10 6	11 6	14 6
Bottom of coping above opening,	1 3	1 3	1 3	1 3	1 3
Distance x on elevation,	1 0	1 0	1 6	1 6	2 0

¹ Aug., 1912.

For good results, the pipe between the walls must be carefully bedded and the fill tamped on the sides both for strength and to prevent seepage.

Where the creek or drainage channel is above the upper end of the culvert, it can be deepened and paved using a steep slope, or a catch-basin can be excavated and walled up to the height of the channel to prevent scour.

To prevent the pipes from pulling apart due to the settlement of soft ground under the weight of the fill, tie rods with turnbuckles are sometimes put through and hooked over the ends. This method can often be used to pull together the joints of an old culvert without digging it up. Old bridge timbers and ties

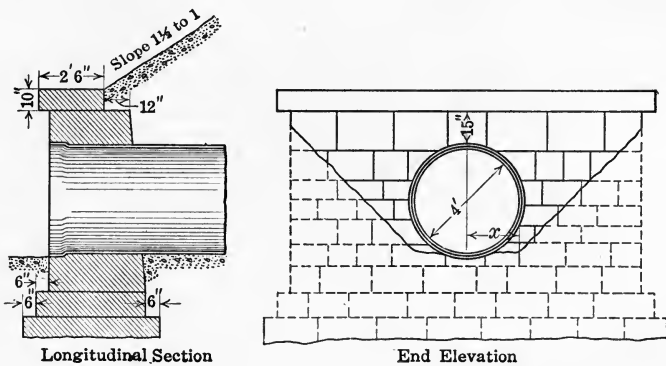

FIG 43.—Sante Fe Railroad Standard Cast Iron Pipe Culverts.

can be used for a grillage foundation if below ground water level, or masonry piers can be built under the joints. Uniformity of settlement is desired, but the more rigid the culvert the greater the load thrown upon it by the settlement of the adjacent fill.

88. Stone Box Culverts.—These have largely given way to concrete, but where good local stone is available the rubble stone masonry culvert is usually cheaper. If well built of durable stone, on good foundations protected from undercutting, and with sufficient waterway, they are very permanent. It was the practice on some roads to use dry masonry, but this increases the danger from washouts when the culvert is flooded and is not good practice where mortar can be readily obtained. End walls, perpendicular to the trunk, or wing walls flaring out, usually at

angles of about 30° as shown for arch culverts, Fig. 46, p. 192, are desirable at the upper end for protection against water cutting the bank or following the masonry through under it outside the culvert. They may be omitted at the lower end if necessary to reduce cost, provided the water does not set back to soften the bank. The omission increases the length of the trunk, but may be desirable in preparation for double track.

For deep, narrow gulches, Wellington recommends placing the culvert above the bottom on one side of the stream and reducing the transverse slope to save length of culvert. This requires adequate protection from undercutting unless on rock in returning the water to the old channel, and may require rock fill or rock protection for the fill up to the height of the culvert, the cost of which should be considered in comparing the two methods.

The span is limited to about 4 ft. by the strength of the cover stone. This requires a double box for a waterway larger than about 4 by 5 ft.

The standards compiled for the West Shore and Ontario and Western railways include the following stone box culverts:¹

WEST SHORE SINGLE BOX CULVERTS, FIG. 44

Opening	Thickness		Trunk per ft.	Paving		End walls
	Side wall	Center wall		per ft.	ends	
2 × 2½	2	0.51	0.26	0.66	9.47
2½ × 3	2	0.60	0.28	0.83	12.08
2½ × 3½	2½	0.81	0.32	0.93	16.40
3 × 4	3	1.15	0.37	1.19	23.92
4 × 5	3½	1.65	0.44	1.75	41.27

DOUBLE BOX CULVERTS, FIG. 45

2 × 2½	2	2	0.86	0.41	1.34	12.49
2½ × 3	2	2	0.98	0.44	1.67	15.34
2½ × 3½	2½	2	1.22	0.48	1.85	20.58
3 × 4	3	2½	1.78	0.57	2.44	30.96
4 × 5	3½	3	2.57	0.70	3.55	51.48

The dimensions are in feet and the quantities in cubic yards. The opening is given by width times height. The cover stones are 10 ins. thick for the widths of opening up to 3 ft., 12 ins. thick for the 3-ft. and 15 ins. thick for the 4-ft. span. Their lengths are 4½ ft. for the 10-in., 5½ for the 12-in. and 6½ ft. for the 15-in.

¹ Engineers' Book of Tables, compiled by the Graphic Co., N. Y., 1882.

The paving is 1 ft. thick and extends under or a little beyond the side walls but not under the end walls. It is protected at each end by a curb. This allows the foundation area between the end walls to be paved while there is plenty of room to work, while the side walls will aid in holding it in place. The objection urged to this method is that if part of the paving is cut out, the

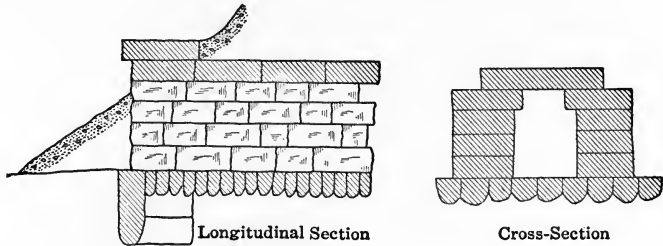

FIG. 44.—West Shore Railroad Single Box Culvert.

other portions will be washed from under the walls and the culvert will cave in. For larger culverts the practice of building the side walls and then paving might be preferred as allowing of deeper foundations for the walls without serious injury to the pavement. The thickness of end wall is assumed to be 2 ft. for the first and second, $2\frac{1}{2}$ for the third, 3 for the fourth, and $3\frac{1}{2}$ for the fifth single and double box culverts, respectively. The end wall foundations should be a little thicker to allow of

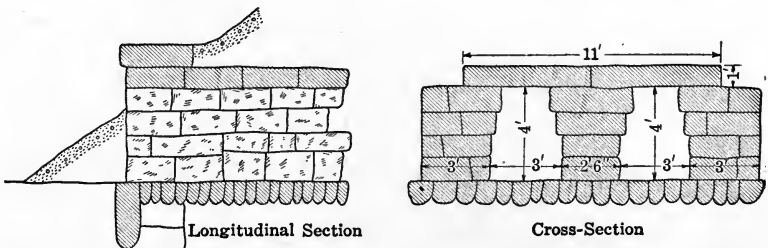

FIG. 45.—West Shore Railroad Double Box Culvert.

squaring up the neat work or exposed wall. The depth should extend below frost but the yardage given does not allow of more than about 3 ft. if the length is made sufficient to protect the opening from dirt with a $1\frac{1}{2}$ to 1 slope.

The trunk or barrel is the portion between the end walls including the paving. Its length as seen from Fig. 44, is the width

of the fill at about the height of the bottom of the coping, that is, the width of roadbed plus three times the fill to top of coping for the usual $1\frac{1}{2}$ to 1 side slopes if the slope of the culvert be neglected.

For total yardage, multiply trunk per foot and paving per foot by width of roadbed plus three times depth to bottom of coping and add to the sum of the products the paving ends and the end walls. For final estimates the transverse slope should be taken into account.

The paving is given separately because if laid dry the cost per cubic yard would be less than for the walls, while on rock bottom it could often be omitted.

For methods of estimating cost per cubic yard of masonry, see §71. To this should be added the cost for excavation and for the foundation work if any is necessary in addition to that provided on the plans.

89. Stone Arch Culverts.—The West Shore and Ontario and Western Standards referred to in §88 include the following list of arch culverts. The dimensions which are common to all the spans are shown on Fig. 46. Those which are not common are given below and may be referred to by letter:

WEST SHORE STONE ARCH CULVERTS

Letter	Span						
	6 ft.	8 ft.	10 ft.	12 ft.	14 ft.	17 ft.	20 ft.
A	3'	4'	4' 6"	5'	5' 6"	6' 3"	6' 10"
B	2 6"	3 6"	4	4 6"	5	5 6	6
C	5	6 6	8	9 6	11	13 6	15
D	1	1	1 2	1 4	1 6	1 9	2 0
E	3	3	4	4	4 2	4 5	4 8
F	11	14 6	16 9	20 6	24 6	30 3	36 0
G	3 7	3 9	4	4	4	4	4 3
H	11 2	14 3	16 4	19 6	23 6	28 6	33 8
I	0 8	0 6	0 8	0 10	1 6
Yardage per foot of trunk,	1.32	2.29	3.24	4.40	5.63	7.66	9.95
Yardage ends,	35.6	56.8	83.6	118.9	163.1	244.0	349.5
Found. area per foot trunk,	8	10	11	12	13	14.5	15.7
Foundation area, ends,	112	153	217	251	312	402	525

The length of trunk is the width of the fill at the height of the base of the coping. The yardage does not include the foundation and no provision is made for paving. From the foundation area per foot of trunk and the foundation area of the ends the cubic feet of foundation is readily found for any desired depth. The depth would be determined, in part at least, by danger of undercutting

as it would be unsafe to trust to paving for the longer spans if the current is rapid. For the short spans a timber grillage or a layer of plank extending under the walls and across the span is often used to prevent scour and distribute the load if the bottom is soft and always under water. If sometimes dry, a layer of reinforced concrete would be more durable than timber.

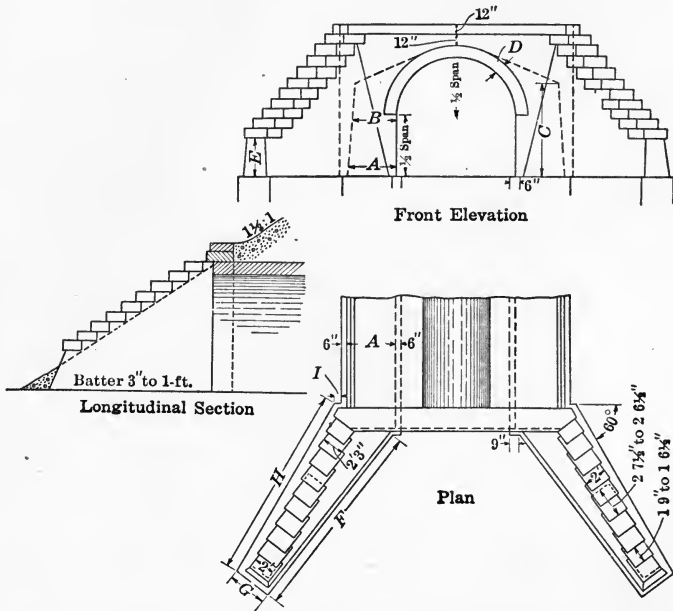

FIG. 46.—West Shore Railroad Arch Culvert.

Squared rubble laid in cement mortar will give strong durable culverts. For the arch ring the stone should be dressed to radial bed joints, thinning down to about $3/4$ in. for the larger spans. Hard burned brick can often be used with economy as the upper surface of the ring and spandrel filling should be plastered with portland cement mortar and thoroughly waterproofed. A layer of gravel or broken stone next to the masonry will then allow the water to work down to weep holes provided at the ground surface, without injury to the structure.

The full centered arch is not adapted to vertical loading. When used for the larger spans the spandrel filling between the spandrel walls should have inclined joints and be bonded into

the arch ring so that the real arch will be flattened to correspond with the equilibrium polygon or curve of pressures.

In using these standards it should be remembered that they were designed when train loads were lighter than at present, and that for the larger spans the live load has a greater proportionate effect in determining dimensions than the settlement of fill and other extraneous causes which through experience have led to the design of the smaller spans. While accepting them for preliminary estimates the designs should be analyzed for stability before being used in actual construction.

For cost of a sandstone arch culvert, see § 71. In Engineering-Contracting, Vol. 25, p. 17, 1906, the cost is given for a stone arch culvert built some distance from the original channel and afterwards connected by a new channel. The excavation was carried $4\frac{1}{2}$ ft. below water level under protection of a coffer-dam built of 2 by 8-in. by 7-ft. sheet piling driven by hand. The excavation was done by men with shovels and wheelbarrows. The stone was sandstone scabbled at the quarry, and but little work was done on the beds. They were laid in mortar and were handled by two steam derricks.

	Total	Per cubic yard
Materials, including lumber,	\$ 931.97	\$ 1.88
Labor, including some \$600 for excav.,	2589.50	5.22
General,	530	1.07
Profit to contractor,	1526.72	3.08
Stone, 481.9 cu. yds. at \$6.82,	3284.95	6.62
	\$8863.14	\$17.87
Total, 495.9 cu. yds. at \$17.87,		

To this must be added the freight from La Porte, Indiana, on 57 carloads of stone, 272.4 cu. ft. per car, weighing 157 lbs. per cubic foot. The scale of wages was, stone cutters, \$3; carpenters, \$2; laborers, \$1.50; teams, \$3.

90. Plain Concrete Arch Culverts.—The standards for several railroads for spans from 3 to 20 ft. were published in the Proceedings of the American Railway Engineering Association, Vol. 10, p. 1345, 1909. The arches were full centered and the types resemble that of the West Shore and the Ontario and Western railroads, § 89, quite closely. Those for the Union Pacific have the smallest yardage per foot of trunk, those for the New York Central and Hudson River the largest and those for the Erie next

to the largest. Those for the Erie are given. Dimensions common to all the spans are shown on Fig. 47. Those which are not common are given below and may be referred to by letter. It may be noted that the wing walls are vertical on the face and battered on the back and set up close to the culvert opening. This does away with the shoulder at the entrance to the culvert and increases the flow and reduces the danger of obstruction by drift. The vertical face increases the danger of

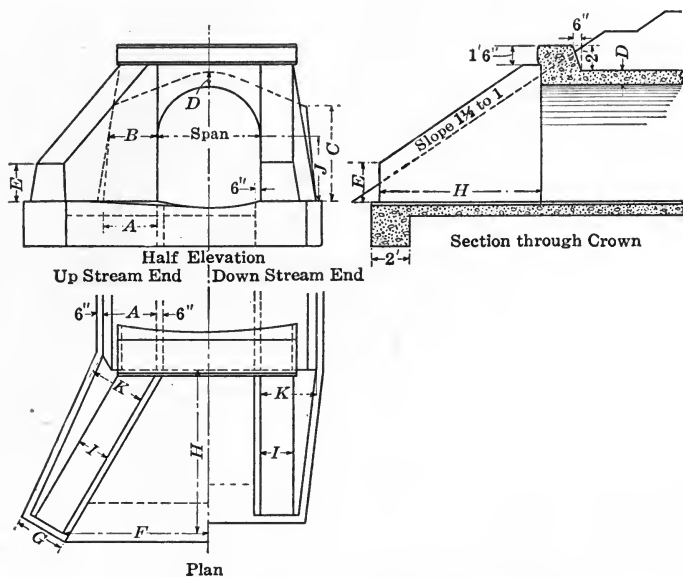

FIG. 47.—Erie Railroad Standard Plain Concrete Arch Culverts.

tilting on an earth foundation by moving the resultant thrust nearer to the outer edge of the foundation.

The minimum depth of fill over the crown is 3 ft., while if the side slopes are assumed to intersect the back faces of the spandrel walls 1 ft. above the crown, it will about make up for the increased thickness due to the batter in computing length of trunk or barrel. For spans 6 ft. and over the width of the coping is 2 ft. 10 ins. and the projection 4 ins. For shorter spans no coping is used. The floor is flat and 9 ins. thick for spans 5 ft. and less, and curved with a versed sine of 9 ins. and a thickness of 12 ins for spans greater than 5 ft.

DATA FOR ERIE RAILROAD STANDARD CONCRETE ARCH CULVERTS
SEE FIG. 47

Letter	Span in feet					
	3	4	5	6	8	10
A	2' 6"	2' 9"	3' 0"	3' 10"	4' 3"	4' 8"
B	2 2	2 3	2 6	3 6	3 10	4 2
C	4 0	4 0	3 6	6 0	7 6	9 1
D	0 9	0 10	0 11	1 0	1 1	1 2
E	6 1	6 6	6 5	3 0	3 0	3 0
F	1 6	2 0	2 6	8 6	11 3	14 1
G	3 6	3 9	4 0	3 10	4 0	4 2
H	4 11	5 6	5 5	9 6	12 7	15 9
I	2 0	2 0	2 0	2 6	2 6	2 6
J	4 0	4 0	3 6	4 0	5 0	6 0
K	2 6	2 9	3 0	3 4	4 3	5 2
Area,	13.3	18.7	22.1	39.8	67.5	102.3
Barrel,	0.873	1.034	1.117	1.979	2.784	3.703
Paving (a),	0.055	0.083	0.111	0.185	0.260	0.333
Paving (b),	0.60	1.10	1.31	7.50	12.70	20.38
Curtain,	0.30	0.44	0.059	1.48	2.00	2.63
Portals,	11.00	13.2	13.8	28.7	48.2	74.5

Letter	Span in feet				
	12	14	16	18	20
A	5' 2"	5' 7"	5' 11"	6' 4"	6' 8"
B	4 7	4 11	5 3	5 8	6 0
C	10 8	12 3	12 9	13 3	13 10
D	1 3	1 5	1 6	1 6	1 7
E	3 0	3 0	3 0	3 0	3 0
F	16 10	19 9	21 8	23 7	25 6
G	4 3	4 3	4 4	4 4	4 4
H	18 10	22 1	23 9	25 3	26 11
I	2 10	2 10	2 10	2 10	2 10
J	7 0	8 0	8 0	8 0	8 0
K	6 0	7 0	7 5	7 10	8 4
Area,	144.2	193.3	233.5	276.9	323.4
Barrel,	4.792	5.998	6.703	7.598	8.087
Paving (a),	0.408	0.482	0.556	0.630	0.704
Paving (b),	29.23	54.68	65.11	76.29	88.86
Curtain,	3.04	5.48	6.00	6.70	7.30
Portals,	105.2	158.3	186.7	212.0	242.6

Area; area of discharge in square feet.

Barrel; concrete in barrel per lineal foot in cubic yards.

Paving (a); paving in barrel per lineal foot in cubic yards.

Paving (b); paving between wing walls in cubic yards.

Curtain; curtain walls 1 ft. deep in cubic yards.

Portals; two portals (wing walls and parapets).

The yardage for the trunk or barrel does not include foundations. The spandrel coping data were omitted for spans less than 6 ft. The radii for the first three arches are 1/2 ft. greater than the half span. The other arches are full centered.

For a long concrete culvert it would be desirable to divide the trunk into 40 to 60 ft. sections by joints to avoid cracks due to unequal settlement.

The cost of forms is readily estimated when the conditions are known but the following will aid for preliminary estimates.

For a 6-ft. highway arch culvert requiring 15 cu. yds. of concrete there were required,

200 ft. B.M. lumber at \$20,	\$ 4
Hauling to work,	3
Carpenter 4 days at \$2.50,	10
	<hr/>
Total,	\$17

For a 12-ft. full centered arch culvert¹ about 200 ft. long and containing 1217 cu. yds. of concrete, on the Nashville, Chattanooga and St. Louis Railway the labor for building forms cost \$0.55 per cubic yard of concrete, and for tearing them down and backfilling \$0.10. Wages averaged \$2.20 per day including foreman.

About 15 000 ft. B.M. of dressed lumber was used for the front side of the arch and bench walls and 21 000 ft. B.M. of rough lumber for the back side of the bench walls, bins and platforms. Old car sills were used for the studding.

91. Reinforced Concrete Culverts.—These show no economy in first cost in comparison with the plain concrete arch under ordinary conditions for material and labor. The flat roof is of advantage for low fills as it requires less head room than the arch and is more satisfactory than a double box in stone or plain concrete.

The standards for several roads are given in the Proceedings of the American Railway Engineering Association, Vol. 10, p. 1380, 1909. Those for the Nashville, Chattanooga and St. Louis cover spans from 4 to 10 ft. inclusive, and are given in part below. The Illinois Central extends the spans to 16 ft.

Reinforced concrete girders are used for spans from about 15 to 30 ft. and arches for greater spans if masonry is to be used.

¹ Eng.-Cont., Vol. 26, p. 12, 1906.

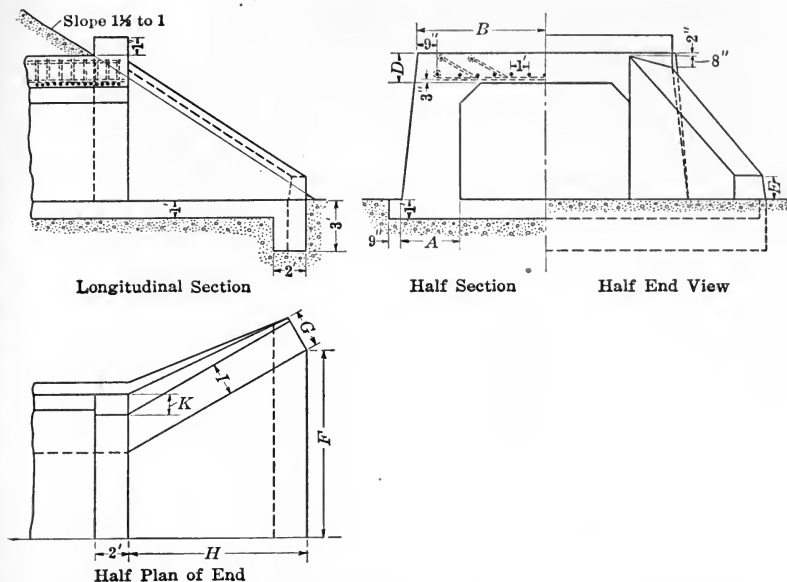

FIG. 48—Nashville, Chattanooga and St. Louis Railroad Standard Reinforced Concrete Culverts.

DATA FOR NASHVILLE, CHATTANOOGA AND ST. LOUIS RAILROAD REINFORCED CONCRETE CULVERTS. SEE FIG. 48

Letter	Span times height						
	4×3	4×5	6×4	6×6	8×6	8×8	10×10
A	1' 9"	1' 9"	2' 6"	2' 6"	3' 0"	3' 0"	3' 6"
B	3 9	3 9	5 0	5 0	6 0	6 0	7 6
D	0 10	0 10	0 11	0 11	1 2	1 2	1 4
E	1 00	1 0	1 6	1 6	1 6	1 6	1 6
F	2 00	2 0	5 9	7 6	8 8	10 4	13 3
G	1 9	1 9	2 3 3/4	2 2 1/2	2 3	2 2 1/2	2 1 3/4
H	5 0	9 0	4 10	7 10	8 3	11 3	14 6
I	1 9	1 9	2 0	2 0	2 0	2 0	2 0
K	0 0	0 0	0 11	0 11	1 2	1 2	1 2
Area,	12	20	24	36	48	64	99
Barrel (a),	0.963	1.222	1.497	1.829	2.258	2.628	3.790
Barrel (b),	21	21	66	66	100	100	190
Portals,	8.11	16.0	16.4	28.4	31.5	47.1	71.9

Barrel (a) gives the concrete per lineal foot in cubic yards.
 Barrel (b) gives the metal per lineal foot in pounds.

The lower longitudinal reinforcement of 1/2 in. bars spaced 12-in. centers is used for all the spans. The upper longitudinal reinforcement of 1/2 in. bars is used for only the 8- and 10-ft. spans, spaced 10 and 12 ins., respectively. The transverse reinforcement, both upper and lower, is spaced 3-in. centers for the center section and 8-in. centers for the end sections. The size varies with the span from 9/16 to 19/16 in. One-third the bars are straight, one-third bent up near the side walls, and one-third nearer the center, as shown on the half section.

The down stream ends are in line with the body of the culvert. This requires slightly less masonry and simplifies the forms. The flaring wings might afford some protection to the fill from back water but not to the extent that they protect the fill on the up-stream side, while they have no effect in increasing the capacity of the culvert.

The forms for these culverts should cost no more, possibly slightly less, than for the arch culverts, but the cost per cubic yard of concrete will be greater because of the smaller yardage. The cost of materials per cubic yard of concrete will be greater if the specifications of the American Railway Engineering Association are used, the cost of placing will be greater, and to these must be added the cost of material and labor for the steel fitted and secured in place. Of course the steel reduces by its volume the bulk measurement of the concrete.

The plans for these culverts show no reinforcement except in the roof. Those for the other roads show both longitudinal and transverse reinforcement for sides and bottom as well. The longitudinal reinforcement is for protection from cracks due to stresses developed by temperature changes or unequal settlement. The transverse reinforcement reduces the quantity of concrete required to resist the stresses due to the loading and earth pressures.

92. Rail Floor Culverts.—The New York Central and Hudson River Railroad Company has taken advantage of the low scrap value of old rails in designing a floor or culvert roof for use in low fills where a considerable waterway is required. See Fig. 49.

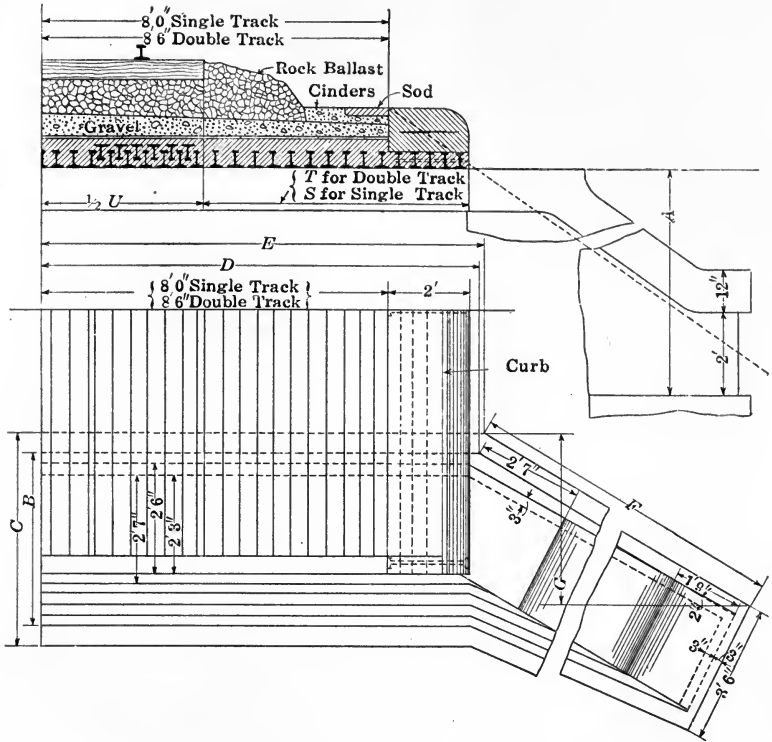

FIG. 49.—New York Central Railroad Rail Floor Culverts.

NUMBER OF RAILS REQUIRED IN FLOOR

These are alternates for the different weights and not additive

Span, feet,	4	5	6	7	8	9	10	11	12
Section U,									
60-lb. rails,	24	24	24	30	30	32	40	46	
70-lb. rails,	21	21	21	21	25	27	33	39	42
80-lb. rails,	19	19	19	19	19	23	27	31	37
100-lb. rails,	18	18	18	18	18	18	18	22	24
Sections,				<i>S</i>	<i>T</i>	<i>M</i>	<i>m</i>		
60-lb. rails,				18	20	12	3		
70-lb. rails,				15	17	10	3		
80-lb. rails,				13	14	9	2		
100-lb. rails,				13	14	9	2		

M is the distance between ties on double tracks and is figured with tracks 12 ft. centers. When tracks are more than 12 ft.

centers add the number of rails in column *m* for each additional foot. In the columns *M*, *S* and *T* there will be two rails each 5 ft. longer than the span to receive the tie rods as shown. All the other rails will be 4 ft. longer than the span in each case.

DIMENSIONS OF ABUTMENTS

<i>A</i>	<i>B</i>	<i>C</i>	<i>D</i>	<i>E</i>	<i>F</i>	<i>G</i>
4'	2' 10''	3' 10''	10' 1''	10' 3''	7' 1''	3' 6½''
5	3 ¾	4 ¾	10 1½	10 ¾	8 10½	4 5½
6	3 8½	4 8½	10 1½	10 ¾	10 7½	5 ¾
7	4 1¾	5 1¾	10 2	10 4	12 4½	6 2¼
8	4 7	5 7	10 2	10 4	14 1½	7 0¼
9	5 0¼	6 0¼	10 2½	10 4½	15 10½	7 11¼
10	5 5½	6 5½	10 2½	10 4½	17 7½	8 9¼
11	5 10¾	6 10¾	10 3	10 5	19 4½	9 8¼
12	6 4	7 4	10 3½	10 5½	21 2	10 7
13	6 9¼	7 9¼	10 4	10 6	22 10½	11 5¼

Columns *D* and *E* are for single track 16-ft. roadbed. For double track add one foot more than distance between track centers.

MASONRY FOR BOTH ABUTMENTS IN CUBIC YARDS

Height <i>A</i> , feet	Curb	Coping		Masonry		Footings	
		<i>a</i>	<i>b</i>	<i>a</i>	<i>b</i>	<i>a</i>	<i>b</i>
4	1.4	5.9	.185	15.4	.577	8.07	.284
5	1.4	6.6	.185	23.4	.815	9.74	.316
6	1.4	7.3	.185	33.2	1.087	11.51	.349
7	1.4	8.0	.185	44.7	1.391	13.38	.381
8	1.4	8.7	.185	58.1	1.728	15.35	.413
9	1.4	9.4	.185	73.4	2.097	17.42	.446
10	1.4	10.1	.185	90.6	2.500	19.58	.478
11	1.4	10.8	.185	109.6	2.932	21.84	.511
12	1.4	11.5	.185	130.5	3.398	24.19	.543
13	1.4	12.2	.185	153.3	3.896	26.64	.575

The coping and masonry *a* are for a 16-ft. roadbed, and they should be added to the curb for the total above the footings. The coping and masonry *b* are the increments per foot between the tracks in changing to double track. They should be multiplied by one plus the distance between track centers and added to that for the 16-ft. roadway for the total.

The masonry or wall under the coping can be concrete or second class stone masonry.

The quantities under footings are for a thickness of one ft.; they are to be multiplied by the actual thickness. The a and b columns have the same significance as given above.

The floor when concreted is to be 15 ins. thick and to be protected with coal tar pitch. In estimating the concrete for the floor the curb between the abutments should be included.

Paving should be added when necessary.

The concrete curb is to have joints not more than 5 ft. apart and with Roebing galvanized wire netting extending unbroken its full length, No. 10 wire, 1 by 2-in. mesh.

93. Retaining Walls.—There are two methods in use for designing retaining walls. In one the thickness is made a percentage of the height, varying from 20 or 25 to 50 per cent., according to estimated conditions. In the other the resultant of the earth pressure¹ and weight of wall is kept within the middle third down to the top of the footing, and near enough the center at the base to keep the pressure on the foundation at the toe within safe limits. The latter is preferable as the effect of surcharge, variations in the angle of repose of the material, and especially the distribution of the resultant pressure on an earth foundation, can be more accurately taken into account.

Drainage is essential for stability unless the wall has been built strong enough for fluid pressure. It is secured by gravel or broken stone next the wall extending down to weep or drainage holes at the base, combined with surface drainage when practicable. A dry wall is advantageous on this account. If the surface soil cannot be thoroughly drained, a frost batter at the top back of the wall will aid in reducing the thrust due to frost by allowing the expanding material to slide up the sloping surface.

For an earth foundation the toe and heel pressures should be equalized as nearly as practicable. This can be aided for a given weight of wall by a face batter and by toe footings. Both take land which the wall may have been built to save as compared with the natural slope. Using piles or otherwise increasing the bearing power at the toe, § § 78, 82, will aid and without using room in front. With reinforced concrete the footing can be carried back at the heel if more economical than an extension

¹ There is a tendency to use a percentage hydrostatic pressure to represent the earth pressure, as it slightly reduces the labor, and the actual value can be determined only approximately.

in front; the portion of the fill resting on this footing becomes integral with the wall and the resultant is moved back from the toe. This footing can be connected to the wall as a cantilever or by counterforts.

With stone masonry there is no serious difficulty with temperature stresses in long walls. With concrete the practice is to place vertical joints at intervals of 40 to 50 ft., and where practicable to carry up each section in a continuous operation to avoid planes of weakness and of seepage. The joints also aid in relieving stress and preventing unsightly cracks due to unequal settlement.

Stability against sliding must be examined. It can be increased by increasing the weight of wall, or wall and footing load, by increasing the depth of the whole or of a part of the foundation

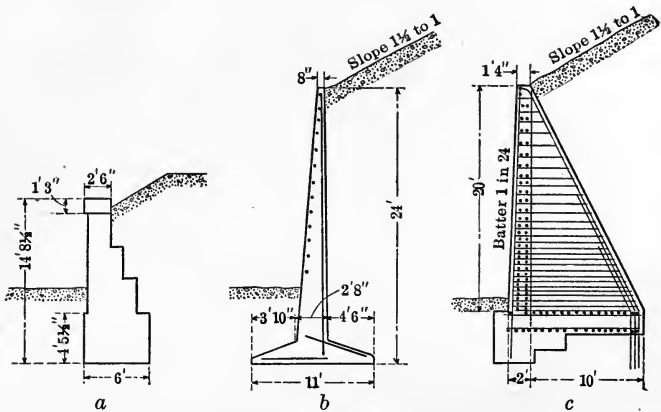

FIG. 50.—Retaining Wall Sections.

or by sheet piling in front. Sometimes dead men or anchorages are sunk in the fill below the line of natural slope and connected to the wall by tie rods protected by concrete. This method can often be used to save an old wall which is failing under its load.

In track elevation and subway work when crowded for width, vertical face walls are common with stepped or battered backs. Usually a face batter of at least an inch to the foot is used. Besides better distributing the pressure on the base it allows the wall to rotate outward slightly without giving an appearance of weakness due to overhanging.

The Committee on Masonry of the American Railway Engi-

neering Association, Vol. 10, p. 1317, 1909, gave cuts of quite a number of retaining walls which had rotated outward due to heavy toe pressure on the foundation. The faces were vertical and the backs stepped, the bases running from 40 to 47 per cent. of the height. One with base 40 per cent. of height is shown, Fig. 50*a*. The top rotated out 11 ins. The face of coping was 14 ft. from center of track and the surcharge is given as equivalent to 10 ft. of earth above the coping.

Fig. 50*b* shows a section of a reinforced concrete wall of the cantilever type built by the Louisville and Nashville Railroad, and Fig. 50*c*, a typical section of a reinforced concrete counterfort wall built by the Great Northern Railway.

The reinforced concrete wall will usually be cheaper than the stone masonry or plain concrete, estimates averaging some 25 per cent. less for walls of considerable height.

94. Bridge Piers.—In crossing a stream the width may be spanned by a single structure or by several, depending upon the relative cost of piers and lengthened spans and upon the obstruction which the piers would oppose to ice and drift, and possibly to navigation. For a low crossing with shallow water and firm material for a foundation the spans would be short, probably less than 100 ft., unless so short a length would increase the danger from floods. Deep water and expensive foundations, as on parts of the Mississippi and Missouri rivers, require long spans up to several hundred feet for economy, aside from the requirements of navigation. Estimates from assumed layouts may be necessary before making the final design.

Low piers in shallow water are usually rectangular in plan, the top being large enough to support the ends of the adjacent spans, and the side and end faces having a batter of about an inch to the foot. If this gives too great a unit foundation pressure, footings or piles are added, while riprap or other protection from scour will usually be required where rock is not reached.

The minimum top size for deck girders is about 4 by 10 ft.; for through girders, 4 by 19; and for through trusses 5 by 19 ft. As the height increases the pier should be analyzed and provision made for stresses resulting from the loads called for in bridge specifications, including those due to ice and flood and provision made for them in the foundation as well as in the pier itself.

NEW YORK CENTRAL AND HUDSON RIVER RAILROAD STANDARD BRIDGE PIERS, FIG. 51. QUANTITIES IN CUBIC YARDS

Single-track deck bridge with bridge seat 4 by 12 ft. under coping

Without starlings

Height, feet,	4	8	12	16	20	24	28	30
Foundation,	10	12	13	15	17	19	22	23
Body wall,	9	17	26	37	49	64	81	90

With upstream starling

Foundation,	17	19	22	26	29	33	37	39
Found. each foot addl. width pier,	2½	2½	2¾	3	3½	3½	3¾	4
Body wall,	10	20	32	48	66	89	112	125
Wall each foot addl. width pier,	2½	5	7	10	13	17	20	22

The masonry in the bridge seat is 4½ cu. yds., and the increment for each foot additional width of pier 1 cu. yd. The assumed depth of foundation is 4 ft.

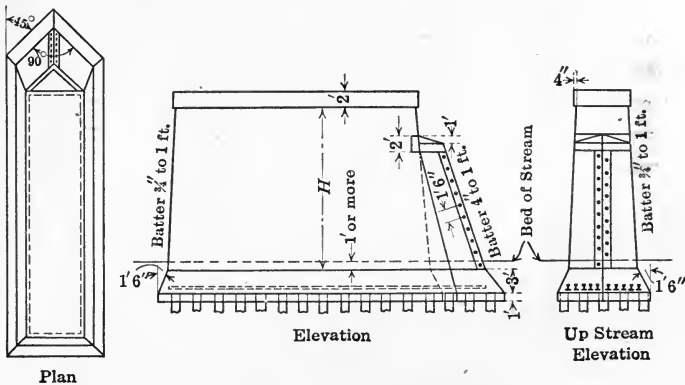

FIG. 51.—New York Central Railroad Standard Masonry Pier.

The width of bridge seat increases with the span as follows:

Span, feet	Width	Span, feet	Width
Up to 40	4' 0"	100 to 125	6' 0"
40 to 60	4 6	125 to 150	6 6
60 to 80	5 0	150 to 200	7 0
80 to 100	5 6	200 to 250	7 6

For double track the bridge seat is 25 ft. long. For through bridges the bridge seat is 4 by 22 ft. under the coping and for

double track 4 by 38 ft. The increments in yardage can be found by multiplying the area of the cross-section determined from thickness under bridge seat, batter and height, by the corresponding increment in length and reducing to cubic yards.

The bridge seat or coping is made of a 1:1:2 concrete, reinforced with No. 8 galvanized wire netting 1 by 2-in. mesh, or Clinton galvanized wire cloth 3 by 8-in. mesh. The body wall and foundation are made of 1:3:6 concrete. The starling is protected by an 8 by 8 by 3/4-in. angle iron anchored by 3/4-in. bolts.

Where soft material is found, old rails 10- to 12-in. centers are to be used as shown. Their weight in tons may be taken as 8 per

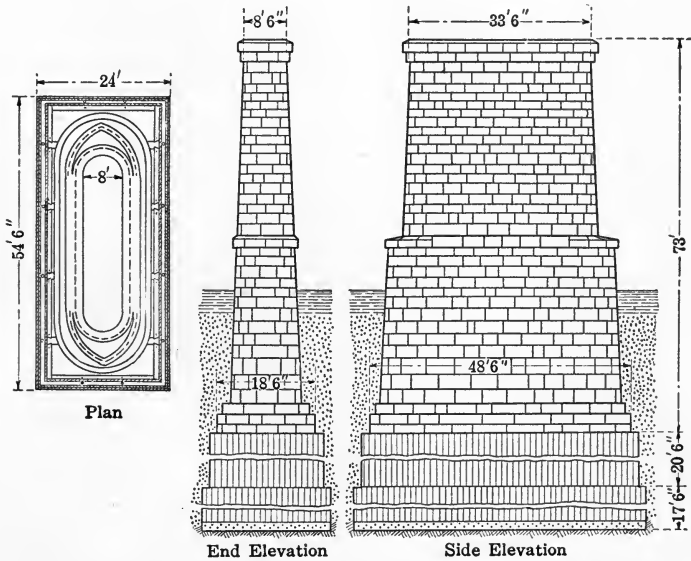

FIG. 52.—Pier of the Blair Crossing Bridge over the Missouri.

cent. of the masonry in the foundation in cubic yards when the foundation is 4 ft. deep. For soft ground or deep water requiring piling or other special methods, see Chapter VI.

The cutwater or starling extends above high water and often the batter between high and low water is flattened so that ice and débris will be pushed up and separated with less danger of gorging. The appearance of the pier can be improved and the

disturbance of the current diminished by adding a down-stream starling, making the pier symmetrical or nearly so.

For larger and more important piers the ends are rounded to the form of a semi-ellipse, or to two arcs of circles with radii longer than half the thickness so as to sharpen the ends. See Fig. 52.

Granite facing is used above low water for first-class work but first grade limestone and many of the sandstones are durable when built as first-class bridge masonry.

For concrete the up-stream portion if exposed to the action of swift currents should have stone facing up to about 3 ft. above high water.¹

The tendency is to carry the masonry up to the bridge seat even for high piers, but steel is sometimes used above high water when the height is great.

95. Bridge Abutments.—The function of a bridge abutment is to support the end of the bridge on the one hand and retain the end of the earth fill on the other. The usual type for stone masonry or concrete consists of a heavy wall forming a bridge seat, with the back portion carried up as a thin wall high enough to retain the ballast, and with wings at the ends extending up to the planes of the embankment side slopes and extending out to where the height is some 3 ft. These wings may be in the plane of the face of the main wall, but usually they make an angle of 30° with it. The U abutment with the wings extending back parallel with the axis of the bridge and the T abutment where the wings are brought together and extend back as the stem of the T, are favorites on some roads. Their economy should be most marked where the ground slopes up rapidly back from the main abutment and thus reduces the average height of the wings. For high parallel walls tie rods in vertical planes at intervals and protected by thin curtain walls can sometimes be used to advantage to take the thrust of the earth filling, while with reinforced concrete it may be economical to carry the road-bed on a floor rather than on a fill between these parallel walls.

¹ In an article in the *Engineering Record*, Vol. 63, p. 421, 1911, on masonry substructures Mr. E. K. Morse, Consulting Engineer of Pittsburgh, is quoted as saying that no river pier within the 60-mile limit has ever been constructed of solid concrete above low water line, and that the type of construction has not been cheaper than piers with stone shell and concrete core. He also states that he has not seen an all-concrete pier that is free from cracks; that time only can determine the amount of resulting damage.

With the common face batter of an inch to the foot, the weight of the bridge and the earth thrust when combined with that of the abutment may give a resultant which cuts the base near the middle third limit and tends to rock the wall outward if founded on earth. Increasing the batter or the projection of the footing increases the span and hence the cost for a given clearance. Increasing the supporting power at the toe by piles or otherwise would also add to the cost. A design to meet the conditions should thus be made.

With reinforced concrete for the ordinary type of wing wall abutment, Fig. 53, the tendency is to make it hollow and open

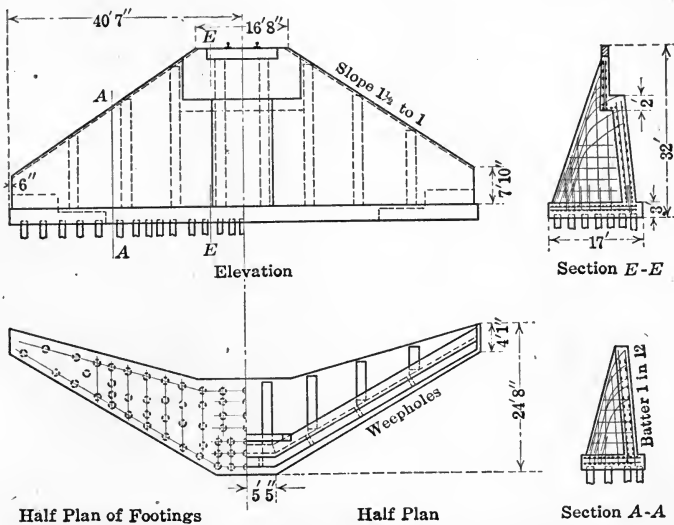

FIG. 53.—Reinforced Concrete Bridge Abutment.

from the back, connecting the foundation course, the curtain wall in front, the bridge seat course and the ballast wall behind it by counterforts at intervals with one under each bridge shoe. The fill rests on the footing between the counterforts and increases the heel pressure on the foundation, thus aiding in equalizing toe and heel pressures.

For the U type, tie walls may be used to relieve the parallel walls in carrying the earth thrust, or the area between them may be floored over to carry the roadbed and the walls opened by arches or replaced by columns.

The T abutment under similar treatment, Fig. 54, would

somewhat resemble the U type, that is, the stem is lightened by arches perpendicular to the roadway and the sections remaining, the piers for these arches including the abutment proper, are lightened by an archway running lengthways under the center line of the roadbed.

The U and T abutments are thus relieved of their function as a retaining wall but have instead to support the roadbed for the distance of the end slope of the fill.

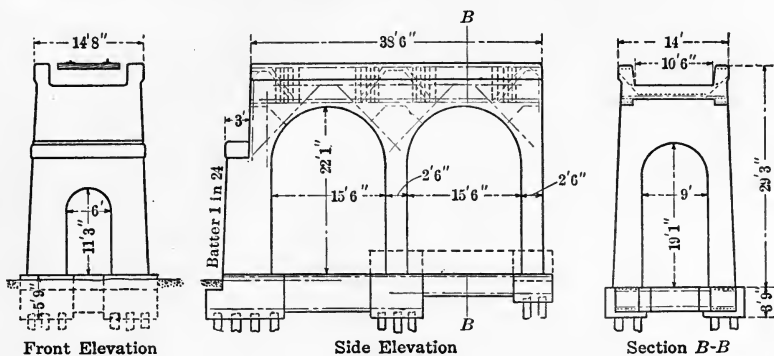

FIG. 54.—Reinforced Concrete Trestle Abutment.

For a comparative study of bridge abutments including a reinforced concrete trestle abutment, and Figs. 53 and 54, see, *The Design of Railway Bridge Abutments* by J. H. Prior, *Proceeding American Railway Engineering Association*, Vol. 13, p. 1085, 1912, or *Bulletin 140*.

He finds a considerable reduction in cost, especially for heights of 20 ft. and over, for those types with reinforced concrete, those which allow the fill to take its natural slope usually being the cheaper.

For approximate estimates the following quantities are given by Orrock, *Railroad Structures and Estimates*, p. 62, for single track, except for the 100-ft. span.

ABUTMENTS FOR DECK PLATE GIRDERS
QUANTITIES FOR ONE ABUTMENT IN CUBIC YARDS

Span feet	Height <i>H</i> , Fig. 55										
	10 ft.	14 ft.	18 ft.	22 ft.	26 ft.	30 ft.	34 ft.	38 ft.	42 ft.	46 ft.	50 ft.
20	28	64	114	180	265	370	498	650	829	1036	1274
40	30	68	118	184	269	374	502	654	833	1040	1278
60	...	72	124	190	275	380	508	660	839	1046	1284
80	...	75	130	198	283	388	516	668	847	1054	1293
100	...	78	136	207	293	398	524	678	857	1064	1302

ABUTMENTS FOR THROUGH BRIDGES
 QUANTITIES FOR ONE ABUTMENT IN CUBIC YARDS

Span feet	Height <i>H</i> , Fig. 55										
	10 ft.	14 ft.	18 ft.	22 ft.	26 ft.	30 ft.	34 ft.	38 ft.	42 ft.	46 ft.	50 ft.
100	38	84	139	208	294	398	526	680	857	965	1303
200	40	86	143	213	301	405	533	687	865	973	1311

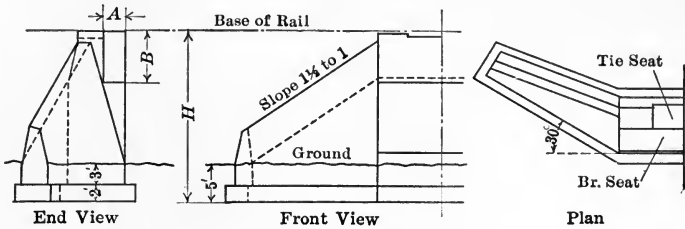

FIG. 55.—Bridge Abutment (Orrock).

The bridge seats for the above are as follows:

	20 ft.	40 ft.	60 ft.	80 ft.	100 ft.	150 ft.	200 ft.
Width A	2' 0"	2' 6"	3' 0"	3' 6"	4' 0"	4' 0"	4' 6"
Height B	3 9	5 6	8 0	10 0	11 0	5 6	6 0

The West Shore and the Ontario and Western Railroad Standards, § 88, give the following for double track, Fig. 56.

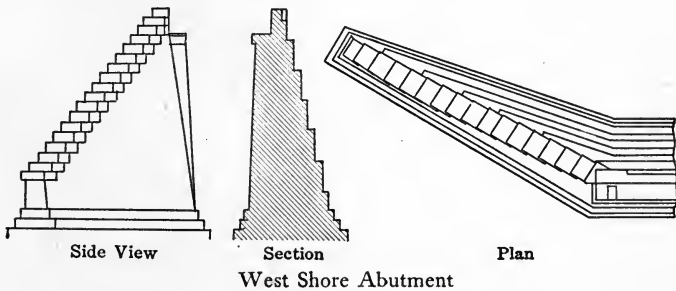

FIG. 56.

ABUTMENTS FOR THROUGH BRIDGES
 QUANTITIES FOR ONE ABUTMENT INCLUDING A 3-FT. FOUNDATION

Height	5 ft.	6 ft.	10 ft.	14 ft.	18 ft.	22 ft.	26 ft.	30 ft.
Cubic yards	29	36	77	133	209	306	425	569
Height	34	38	42	46	50	54	58	60
Cubic yards	740	919	1145	1394	1711	2049	2428	2632

The cost of construction of two wing wall railroad abutments of rubble concrete at Machent Pouce, Quebec, is given in Engineering-Contracting, Vol. 34, p. 93, 1910. There were 2480 cu. yds. of concrete. The gravel was hauled 1600 ft. from a pit which was stripped and opened by men with wheelbarrows. The rubble stone was taken from the bed of the stream, piled on the bank and hauled 1000 ft. on pole line to storage pile. From the mixer, the concrete was hauled in carts on runways supported by trestles; about 5000 cu. yds. of stone and concrete were handled by hoists operated by horses.

The costs per cubic yard were as follows:

Gravel,	\$0.644
Trestles and scaffolding,	0.264
Cement, cartage and storing,	2.357
Mixing and placing,	0.383
Setting up mixer,	0.136
Rubble stone in place,	0.463
Hoist,	0.100
Forms,	0.518
Miscellaneous,	0.151
	<hr/>
Total, per cubic yard,	\$5.016

This includes the plank but not the timber (33 600 ft. B.M.) used in the trestles. It also includes foremen but not interest, maintenance and depreciation of plant.

REFERENCES

Standard Designs of Reinforced Concrete Culverts of the C. B. & Q. R. R. Eng.-Cont., Vol. 26, p. 86, 1906.

Cost of Constructing Concrete Culverts. Eng. & Cont., Vol. 38, p. 293, 1912; Vol. 26, p. 12, 1906.

Concrete Pipe Culverts. O. P. Chamberlain, Jour. West. Soc. Engrs., Vol. 12, p. 81, 1907. Abstracted in Eng.-Cont., Vol. 27, p. 120, 1907.

Some Concrete Culverts and Small Bridges on the Slateford, Hopatcong Cut-off of the D. L. & W. R. R. Eng. News, Vol. 62, p. 347, 1909.

Rail Top Culverts. A. Reichman, Jour. West. Soc. Engrs., Vol. 6, p. 66, 1901.

Leamington Cut-off. O. S. L. Ry., Eng. News, Vol. 50, p. 251, 1903.

Laying and Repairing Cast Iron Culverts in Soft Ground. Eng. Rec., Vol. 62, p. 459, 1910. Eng. News, Vol. 64, p. 518, 1910.

Tests of Cast Iron and Reinforced Concrete Culvert Pipe. A. N. Talbot, Jour. West. Soc. Engrs., Vol. 13, p. 376, 1908. Abstracted in Eng. Rec., Vol. 57, p. 515, 1908.

- Corrugated Metal Culverts. Eng. Rec., Vol. 63, pp. 231, 287, 1911.
- Method of Making Culvert Extension in Widening the Roadbed of the N. Y. C. & H. R. R. Eng. & Cont., Vol. 37, p. 277, 1912.
- Railway Construction in Oklahoma. Trans. Am. Soc. C. E., Vol. 51, p. 424, 1903.
- Waterway for Culverts and Bridges. G. H. Brenner and Others, Jour. West. Soc. Engrs., Vol. 11, p. 137, 1906.
- Waterway for Culverts. Proc. Am. Ry. Eng. Assoc., Vol. 12, part 3, p. 490, 1911.
- Lateral Earth Pressures and Related Phenomena. Trans. Am. Soc. C. E., Vol. 53, p. 272, 1904.
- Earth Pressures. C. K. Mohler, Jour. West. Soc. Engrs., Vol. 15, p. 765, 1910.
- Cracking and Partial Failure of Abutments and Retaining Walls. C. K. Mohler, Eng. News, Vol. 64, p. 384, 1910.
- Location and Design of Retaining Walls. G. C. Clark, Trans. Am. Soc. C. E., Vol. 68, p. 347, 1910.
- Comparative Sections of Thirty Retaining Walls and some Notes on Retaining Wall Design. Eng. News, Vol. 64, p. 106, 1910.
- Some Details in Concrete Construction. L. J. Hotchkiss, Jour. West. Soc. Engrs., Vol. 12, p. 349, 1907.
- Heavy Concrete Piers and Abutments for the D. L. & W. R. R. at Hancock, N. Y. Eng. News, Vol. 66, p. 725, 1911.
- Design of Reinforced Concrete Abutments. T. M. Fysche, Trans. Can. Soc. C. E., Vol. 21, p. 173, 1907. Abstracted in Eng.-Cont., Vol. 29, p. 42, 1908.
- Cylinder Pier Bridge on the C. & N. W. Ry. W. H. Finley, Eng. News, Vol. 68, p. 748, 1912.
- The Substructure of the Piscataquis Bridge, and Analysis of Concrete Work. G. A. Hersey, Trans. Am. Soc. C. E., Vol. 61, p. 377, 1910.
- Cost of Constructing Concrete Abutments for a Railway Bridge. Eng.-Cont., Vol. 34, p. 92, 1910.

CHAPTER VIII

TRESTLES AND BRIDGES

96. Wooden Trestles.—The use of wooden trestles in place of culverts, short span bridges and high fills on new work has been a characteristic of American railroad construction.

The reasons for this are summed up in an editorial in the *Engineering News*, Vol. 18, p. 113, 1887, substantially as follows:

1. A well-built timber trestle, while it lasts, is a very solid and safe structure, and it lasts normally in good condition for from five to ten years while much hastily built masonry gives out in one or two years.

2. There is more time to determine accurately the size of opening needed and thus avoid needless washouts; besides well-built timber structures are less likely to wash out suddenly.

3. The time of construction is shortened materially, often an important consideration.

4. The masonry, when at last built, is almost certain to be better built and of better stone. Haul then is of less importance and there will be more time to secure good materials. The roads are few on which any large proportion of the original masonry is in good condition after ten years. This is especially true of the smaller structures, such as cattle guards and open culverts which are often so poor as to shake to pieces in a few months. The lesson that the smaller the structure, the larger and better dressed must be the stones composing it, if it is to be durable, is one which engineers are slow to learn.

5. It is easier to introduce long and high fills to be afterward filled by train, or replaced by masonry or iron, and thus to secure a better alinement and avoid rock cutting or other objectionable work.

6. A very large part of the total cost of the line in its permanent form is postponed for six to eight years past the trying years of early operation; thus not only saving the interest on the cost of the permanent work but going far to protect the company

from the danger of early insolvency, which has proved so deadly to many overconfident companies.

7. The only necessary disadvantages are the liability to decay and fire. To guard against the former is a mere question of inspection. The danger from fire is a real one and every year has its record of accidents resulting therefrom, but if the danger is real it is small. There are few such accidents and those mostly from gross carelessness. In proportion to their number, accidents from iron structures have been vastly more numerous and more fatal, and the same is true in substance of small masonry structures where the great liability to washouts is a serious matter.

The reasons given above will apply to-day in sections where timber is cheap, the country and traffic undeveloped, and the company with scarcely sufficient means to put the road in operation.

In improvements in alinement and gradients, or in building extensions and branch lines in a fairly well-developed country by a prosperous, well-established company, the conditions are different and the tendency is toward masonry structures with solid floors so as to give a continuous ballasted roadbed.

In improvements under heavy traffic, as in track elevation or depression, grade reduction, etc., timber trestles are usually necessary to carry the track until the permanent roadbed is completed.

97. Principles of Construction.—The floor system is supported by bents formed of piles or sawed timber. Pile bents are used for heights up to about 30 ft. From four to six piles are used per bent, with a diameter of from 10 to 18 ins. at the large end and from 6 to 10 ins. at the small or lower end. After driving, the tops are cut off to grade and a cap 12 by 12 ins., or larger, secured in place by about a 1¼-in. drift bolt at each pile. The stiffness of the piles and the anchorage of the floor system to the fill at the ends are usually depended upon for longitudinal stability. If the trestle is long and over about 20 ft. in height longitudinal bracing should be added either continuously or at intervals to provide for stresses due to starting and stopping trains.

Lateral stability is secured by about 3 by 12-in. sway bracing spiked or bolted to cap and piles, one on each side of the bent. The outside piles are also frequently battered.

Framed bents are usually composed of about 12 by 12-in. timbers. Four posts are used starting from the cap, two vertical and two with a batter of 3 ins. per foot, placed to support the cap under the track stringers. For high trestles additional posts are added as the width of the bent is increased due to the batter. This is done by dividing into stories by sills for one story which form caps for the one below, or by splicing the posts and using sash braces or horizontal planks bolted on each side of the bent at the joints corresponding to the heights of the stories.

The first method is the more common, but the load is transmitted through the sills perpendicular to the fiber so that the compression or settlement would be greater for a high trestle, while the renewal of the sills would be more difficult than that of the sash braces.

In either case the lower story bents can be put together on the ground, erected by a derrick and secured by the longitudinal bracing; the second story bents can then be put together on a floor at the top of the first and rotated to position, and the process repeated until grade is reached.

Sills resting on piles are usually drift bolted; dowel pins about 3 ins. in diameter if of wood, or from 1 to 2 ins. if of iron, are much better for the posts in putting the bents together if the trestle is to be maintained in wood on account of the greater ease in making repairs. The lower end ones should be driven with paint to prevent the entrance of water. The mortise and tenon is now seldom used on account of the greater cost.

Masonry piers, mud sills and the bottoms of trenches are used as well as piles to support the sill. The mud sills are from 4 to 6 ft. long bedded transversely and spaced to give the requisite bearing area.

Split sills and caps, notched into the posts and bolted, and cluster posts, are thought by some to give equal strength and durability; although they cheapen repairs they are not used extensively.

The members for the longitudinal bracing are long between supports, rendering them weak in compression, while the usual bolt, or spikes, for the end connection develops but a small percentage of the tensile strength of the timber. The usual section is about 6 by 10 to 12 ins.

The stringers are made deep for strength and narrow to secure better material than can be readily obtained when the cross-

section is large. When several stringers are placed together packing washers should be used on the 3/4-in. bolts holding them together to secure ventilation. Stringers two panels long and breaking joints, as in Fig. 58, are usually preferred but those only one panel long are used, Fig. 60.

The stringers may be bolted to the caps directly or through eye bolts as in Fig. 57, or held by notched corbels or by packing blocks as in Fig. 60, requiring blocks or angle irons attached to the caps to prevent side motion. Drift bolts are expensive in making repairs, or in correcting alinement when disturbed by unequal settlement.

The floor should be designed to carry a derailed train on the ties. This requires close spacing of ties, not over 5 ins. clear, guard timbers notched an inch onto the ties and bolted to about every third tie, or other means taken to prevent bunching by derailed wheels. The tie should not be less than 10 ft. long. An angle iron fastened to the inner corner of the guard timber will aid in preventing a derailed wheel from mounting, but inner guard rails spaced as shown, Fig. 57, are more effective as they tend to aline the truck and press on the back of the wheel flange which does not climb so readily.

Horizontal sway bracing is sometimes used between the caps of the bents to aid in preserving the alinement of the track. This has been found especially valuable where bents have to be skewed on account of a road crossing or stream or where the track is curved.

98. Standard Wooden Trestle Plans.¹—The Sante Fe railroad standard plans for the open deck trestle are shown in Figs. 57 to 59 inclusive.² They include the engine loads and corresponding unit stresses on the floor system and also bills of material. They are the result of several years' investigations and represent the experience acquired under the conditions existing on the road, but some of the unit stresses are above standard practice and should not be adopted without the careful supervision and inspection which has rendered them safe on that system.

Ties 8 ins. in depth are more common for wooden stringers and they would stand a more severe derailment. The 6-in. soft wood

¹ See Foster's *Wooden Trestle Bridges*, 3d edition, 1906, for a treatment of the subject.

² From *Proc. Amer. Ry. Eng. Assoc.*, Vol. 6, 1905.

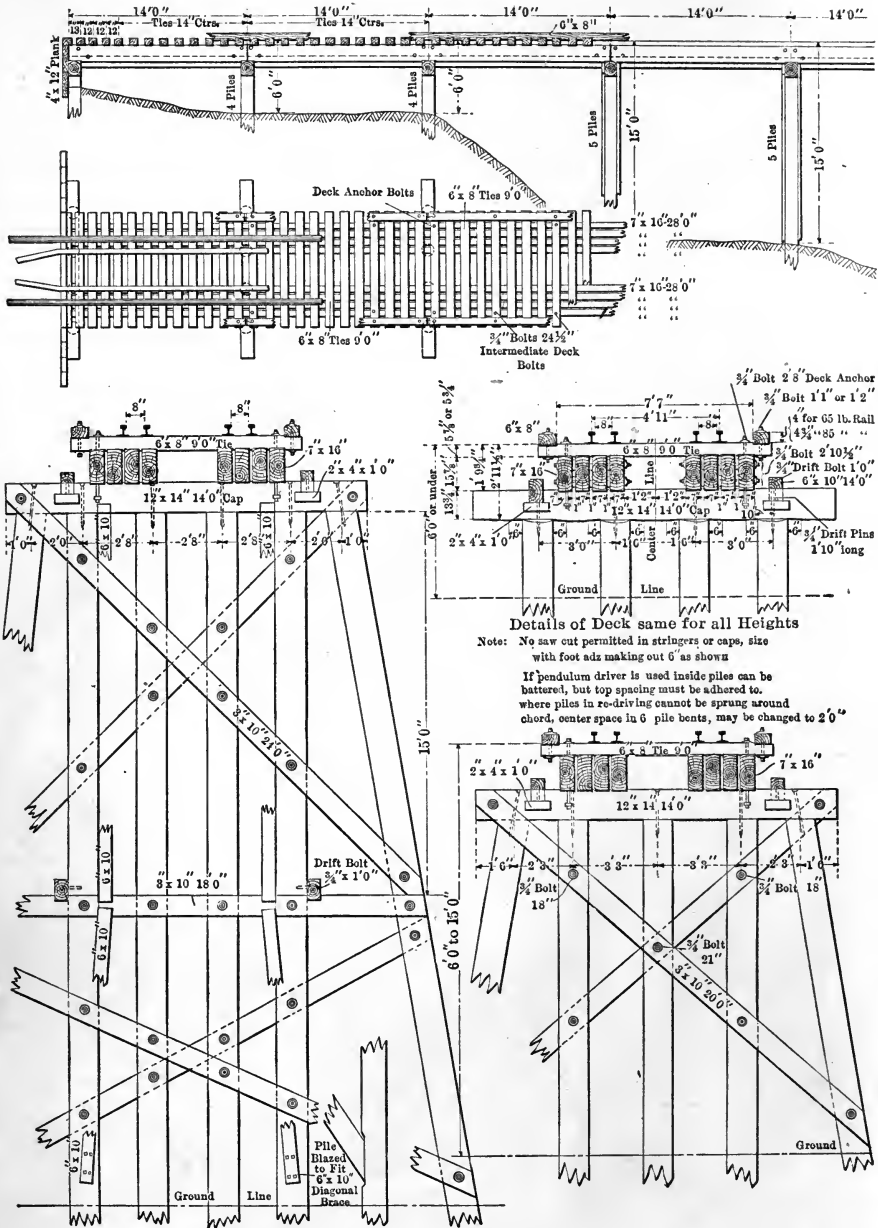

Details of Deck same for all Heights

Note: No saw cut permitted in stringers or caps, size with foot adz making out 6" as shown

If pendulum driver is used inside piles can be battered, but top spacing must be adhered to. where piles in re-driving cannot be sprung around chord, center space in 6 pile bents, may be changed to 2'0"

FIG. 57.

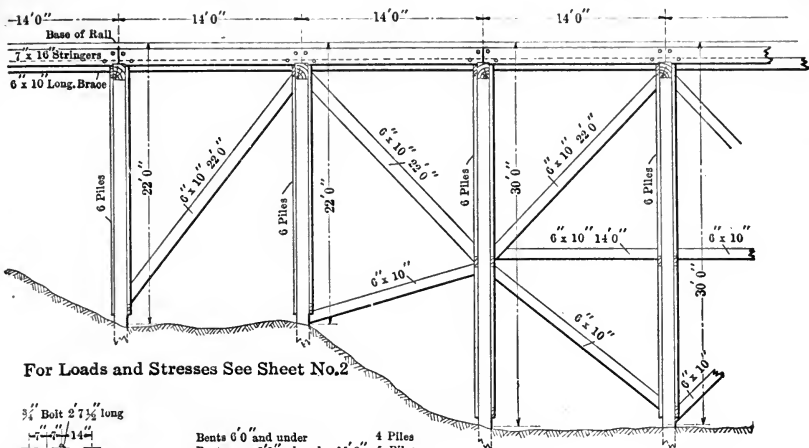

For Loads and Stresses See Sheet No.2

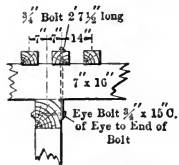

Bents 6'0" and under 4 Piles
Bents over 6'0" and under 15'0" 5 Piles
Bents over 15'0" 6 Piles
Maximum Height of Bent 50'0" Piles
15'0" Penetration, will be 30'0"

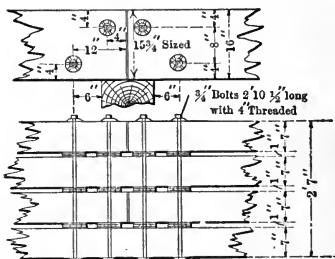

Inside of Stringer

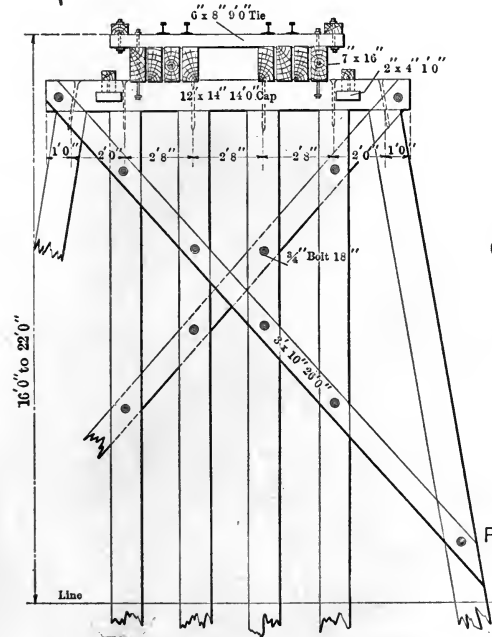

- ⌋ All timber or piling in which the original surface has been disturbed by saw, foot adze, axe, hammer or other means in framing, must have these fresh surfaces coated with Creosote before Assembling, and a barrel of creosote must be provided for each building gang.
- ⌋ The ties are to be run through a surfacer and made of absolute, uniform thickness. The working depth of ties is taken at 5/8" or 5/16" as timber will permit. All longitudinal bracing in lower story to be omitted where there is danger from drift. Caps and stringers, to be covered with galvanized iron. No.26 See detail sheet No.3.

Office Chief Engineer System No.1467
A. T. & S. F. RY. SYSTEM
STANDARD PLANS
FOR

PILE AND TIMBER TRESTLE BRIDGES

Topeka Kans. Scale 3/8"=1' and 1"=1 ft. January, 1904

Correct: *A. F. Robinson* Bridge Eng. System
Adopted: *James Dun* Chief Eng. System
Approved: *J. H. Hendrix* Third Vice President

Fig. 57.—(Continued).

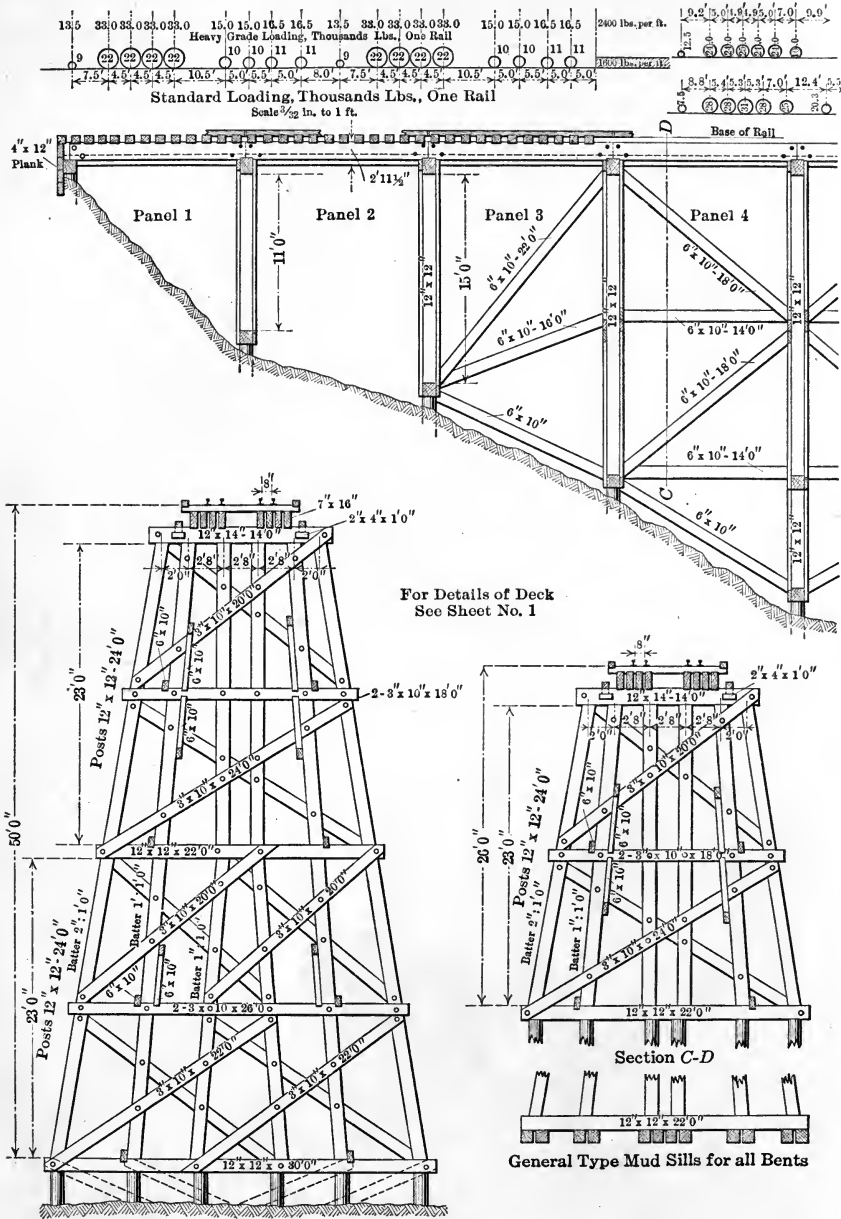

For Details of Deck See Sheet No. 1

Section on A-B

Piles 4' or more above Ground to be Braced as shown by Dotted Lines.

FIG. 58.

BILL OF MATERIAL FOR PILE TRESTLE
For Galvanized Iron, see note below table, page 221

Distance Base of Rail to top of Ground or Sill	Height of Bent, Base of Cap to Top of Sill	12"x12" Posts, Number and Length	12"x14" Caps Number and Length	12"x12" Sills, Number and Length	12"x12" Sub Sills, Num- ber and Length	Sway Bracing 3"x10"					3"x10" Sash Number and Length	6"x10" Hor. Brac. Number and Length	6"x10" Diag. Brac. Number and Length	Piles	Stringers 7"x16"-28'-0"	Guard Rail 6"x8"-14'-0"	Number of Ties 6"x8"-9'-0"	18" Sway Bracing Bolts 1/2" dia.	Deck Anchors, 2 Bolts 1 = 3/4"x3 1/2" and 1 = 1/2"x3 1/2" @ 17" D.	Intermediate Deck Anchor Bolts 3/4"x2'-0 1/2"	Guard Rail Bolts 1/2" dia. 1'-1" or 1'-2"	Stringer Packing Bolts 1/2" dia. 2'-10 1/2"	Drift Bolts 3/4" dia. 1'-10"	Drift Bolts 1/2" dia. 1'-0"	Packing Spools	Cast Washers 3/4" Bolt	Boat Spikes 7/8"x12"	Boat Spikes 1 1/8"x7"	Feet Board Measure	Weight of Iron in Pounds
						16'-0"	18'-0"	20'-0"	22'-0"	24'-0"																				
6'	3'		1 14'-0"											4	4	2	*12		2	2	4	8	8	4	2	24	44	6		
8'	5'		1 14'-0"											5	4	2	*12		2	2	4	8	8	5	2	24	62	6		
10'	7'		1 14'-0"											5	4	2	*12		2	2	4	8	8	5	2	24	62	6		
12'	9'		1 14'-0"											5	4	2	*12		2	2	4	8	8	5	2	24	62	6		
14'	11'		1 14'-0"											5	4	2	*12		2	2	4	8	8	5	2	24	62	6		
16'	13'		1 14'-0"											6	4	2	*12		2	2	4	8	8	6	2	24	68	6		
18'	15'		1 14'-0"											6	4	2	*12		2	2	4	8	8	6	2	24	68	6		
20'	17'		1 14'-0"											6	4	2	*12		2	2	4	8	8	6	2	24	68	6		
22'	19'		1 14'-0"											6	4	2	*12		2	2	4	8	8	6	2	24	68	16		
24'	21'		1 14'-0"											6	4	2	*12		2	2	4	8	8	6	2	24	104	16		
26'	23'		1 14'-0"											6	4	2	*12		2	2	4	8	8	6	2	24	104	16		
28'	25'		1 14'-0"											6	4	2	*12		2	2	4	8	8	6	2	24	104	16		
30'	27'		1 14'-0"											6	4	2	*12		2	2	4	8	8	6	2	24	104	16		

For Branch Lines 10 separators (Page 222) per panel

For Branch Lines 3 stringers per panel

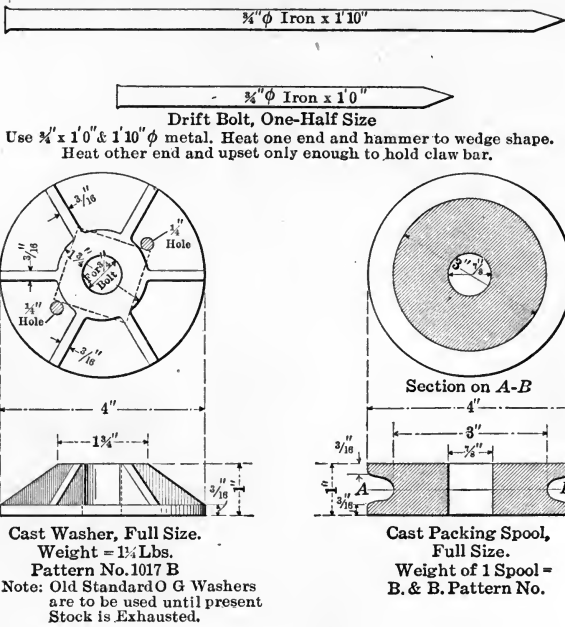

FIG. 59.

NOTE: Where Timber Trestle rests on Mud Sills see Plan page 218.

ALL DRIFT BOLTS MUST BE POINTED AND HEADED. SEE DETAIL ABOVE.

MATERIAL TO BE USED IN PILE AND TIMBER BRIDGES

Stringers.	Long Leaf Yellow Pine or Oregon Pine	Untreated
Piling.	Long Leaf Yellow Pine Spruce, New Mexico Arizona or New Mexico Native Pine Oregon Pine	Creosoted Zinc Treated Creosoted Untreated
Guard Rail and Ties.	Long Leaf Yellow Pine or Oregon Pine	Untreated
Other Material Except Mud-sills.	Long Leaf Yellow Pine, Arizona or New Mexico Native Pine Oregon Pine	Zinc Treated Untreated

NOTE: Long Leaf Yellow Pine will be used East of Denver and La Junta. West of La Junta to Mojave and Summit, Cal., Native Arizona or New Mexico Spruce or Pine will be used except stringers, guard rails and ties, which are to be Oregon Pine. West of Mojave and Summit, Cal., Oregon Pine will be used. All false work and temporary trestle work to be of the respective kinds of material, but untreated. Rio Grande and New Mexico Divisions will use native pine guard rails, zinc treated. Where framed bents rest on mud-sills, creosoted material may be used for these sills. Ties to be run through a *safracer* and made of absolutely uniform thickness, 5 1/2" or 5 3/4" as timber will permit.

NOTE: Angle bars must not be spiked in slots and rails must not be spiked too close to ends of angle bars where running of track would shear off spikes or split ties. The Plans show but 4 Piles in Dump Bents. Where there is very little penetration with sand or unstable covering for bed rock, the B. & B. Foreman is to use his own judgment as to the exact number of piles to be used in the end bent.

tie used will be cut so badly by one derailment, if the wheel flanges roll over it, that it must be removed.

The greatest pressure between stringer and cap is 330 lbs. per square inch; it is claimed that this could be increased to 500 lbs. without giving trouble.

The 7 by 16-in. stringers are retained as a commercial size with the purpose of increasing the number when required; besides those 18 ins. in depth cost more per thousand feet B.M. and it is more difficult to obtain the high grade of material desired. The large fiber stress, which includes no allowance for impact, has been in use on the line for years, with no record showing the breaking of more than one piece at a time under traffic. On their branch lines with light loads and few trains the stringers last but little, if any, longer than on the main lines.

In the bents the stresses are due to the transverse or lateral swinging of the engines, causing the bents to vibrate or wave from side to side; to the tractive force of the engines causing longitudinal movement; and to the vertical loading. In pile bents of usual height, as ordinarily built, no special provision is made for the horizontal forces. For high bents the longitudinal bracing, as usually designed, is so loose that small movements in the bents will always occur, and under heavy or fast traffic these movements will always increase.

The piles are so spaced that they can be driven in rebuilding without disturbing the stringers, and also so that the loading will be uniformly distributed.

All caps and stringers have their upper surfaces covered with galvanized iron as a protection from fire, and incidentally from the weather.

The inside guard rails shown have their ends brought together 15 ft. beyond the end of the trestle and held by two $3/4$ by 10-in. horizontal bolts gripping through a pine block between the rail ends and fastened down by anchor plates. These guard rails are used on main lines where excessive speed prevails for bridges over 100 ft. in length and on curves of 6° or more.

Only eight sizes of sawed timber are used and but one size of bolts and washers. This simplifies the order bills and reduces the size of the stock pile.

The standard framed and pile trestle plans of the Pennsylvania Lines West of Pittsburgh, Figs. 60 and 61, show a much heavier floor system and lower unit stresses than used on the Sante Fe.

All drift bolts to be 3/4" diameter, 20" long.
All screw bolts to be 3/4" diameter, with standard head and nut and cast washers.

SIZES OF STRINGERS FOR 15-FOOT SPANS.

Engine.		Maximum bending moment per rail with allowance for shock, ft. lbs.	Practical sizes to use		
Old name.	New name		White pine F = 1000	Oregon fir F = 1200	Yel'w pine F = 1500
O	D10A	90 500	3 8" x 18"	3 8" x 15"	2 8" x 18"
P	D13A	109 200	3 8 x 18	3 8 x 16	2 8 x 18
L	D16A	126 100	3 8 x 20	3 8 x 18	2 8 x 20
Mogul	F1	130 600	3 8 x 20	3 8 x 18	2 8 x 20
E	G2	86 700	3 8 x 16	3 8 x 15	2 8 x 16
X	G3	140 500	3 8 x 22	3 8 x 20	2 8 x 22
I	H1	89 300	3 8 x 16	3 8 x 15	2 8 x 16
S	H2	100 500	3 8 x 18	3 8 x 16	2 8 x 18
R 93	H3B	126 500	3 8 x 20	3 8 x 18	2 8 x 20
H 4	H4	151 200	3 8 x 23	3 8 x 20	2 8 x 22
100000 lb.	100000 lb	131 400	3 8 x 20	3 8 x 18	2 8 x 20
Steel Cars	Steel Cars	136 400	3 8 x 20	3 8 x 18	2 8 x 20
.....	G4A				

NOTE.—In general use only 8"x18" and 8"x20" stringers. Where 3 8"x20" sticks under each rail are not sufficient for a span of 14' 8", the span should be reduced, its length to be a multiple of sixteen (16) inches.

Super-elevation of one rail should be made by the piles or post. When the trestles consist of more than 3 spans, and where height of bent is 15 feet or over, the trestle should be braced longitudinally. **FRAMED TRESTLES.**—Stories should not exceed twenty-five (25) feet in height from center of sill to center of cap. Conditions as to grade, speed of trains, etc., should be considered in connection with longitudinal and other bracing. Trestles more than twenty-five (25) feet high will be the subject of special design, to be approved by the Chief Engineer. **PILE TRESTLES.**—Cross bracing should be used when the height exceeds twelve (12) feet. Conditions should be considered as in the case of framed trestles.

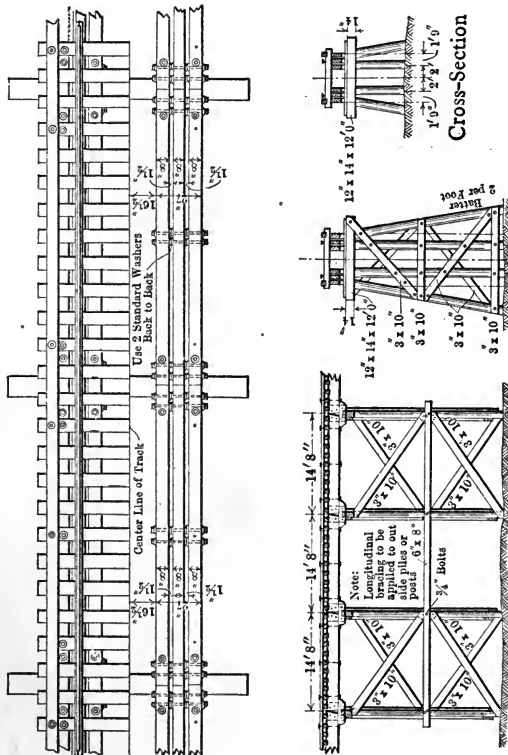

Side Elevation
Cross-Section
Cross-Section
Fig. 61.—Standard Trestle, Framed and Pile.
Pennsylvania Lines West.

The use of corbels or bolsters to preserve the continuity of the stringers without a length of two panels and breaking joints is unusual. The air space between stringers, maintained by packing washers, increases durability.

A bill of materials per panel length can be readily made up from the plans.

99. Quantities and Cost.—The editors of Engineering-Contracting, from a carefully prepared and tabulated bill of materials for the Northern Pacific Railway standard wooden trestle, have deduced the following formulas for preliminary estimates, Vol. 29, p. 104, 1908:

$$\begin{aligned} M &= 220 + 6 H \text{ for } H \text{ between } 20 \text{ and } 25 \\ &= 240 + 8 H \text{ for } H \text{ between } 25 \text{ and } 50 \\ &= 240 + 9 H \text{ for } H \text{ between } 50 \text{ and } 75 \\ &= 240 + 10 H \text{ for } H \text{ between } 75 \text{ and } 125 \end{aligned}$$

where M = feet B.M. in trestle, including deck, per lineal foot.

H = average height from ground to a point $3\frac{1}{2}$ ft. below base of rail.

The division into groups is due to the construction of high trestles in stories, each story being about 25 ft. The bents are 15 ft. 9 ins. centers. Each has four 12 by 12-in. posts, the outside posts having a batter of 3 ins. per foot and the inside posts a batter of 1 in. per foot. The deck consists of six 9 by 18-in. stringers, with 8 by 8-in. cross ties $13\frac{1}{2}$ ins. centers, and 5 by 8-in. guard rails, a total of 164 ft. B.M. per lineal foot of trestle.

For the deck there are 40 lbs. of wrought iron, 25 lbs. of cast iron, and 25 lbs. of galvanized iron, a total of 90 lbs. per 1000 ft. B.M. of timber, or 15 lbs. per lineal foot of trestle. For the bents and braces there are about 35 lbs. of wrought iron and a little less than 15 lbs. of cast iron per 1000 ft. B.M., a total of 50 lbs. per 1000, or 5 lbs. per foot B.M. of timber. This would give in pounds,

$$\text{Iron per foot of trestle} = 15 + .05 (M - 164).$$

If piles are used under the sills as for the Sante Fe, five would be required for the heights up to 25 ft. and six above that height. The average penetration will be from 12 to 18 ft., depending on the soil, requiring about 20-ft. piles.

For a pile trestle, four piles per bent,¹ bents 16 ft. centers, with 20 ft. per pile allowed for penetration and cut off.

$$\begin{aligned} \text{Lineal feet of piles per foot of trestle} \\ = (20 + H)/4 \end{aligned}$$

where H is the average height in feet to a point $3\frac{1}{2}$ ft. below base of rail.

$$\begin{aligned} \text{The sawed lumber per foot of trestle} \\ = 185 \text{ ft. B.M. for trestles under 15 ft. high,} \\ = 200 \text{ ft. B.M. for trestles 15 to 25 ft. high.} \end{aligned}$$

The iron weighs 16 lbs. per foot of trestle; 40 per cent. is wrought, 30 cast and 30 galvanized.

With bridge carpenters at \$2.50 per day it is stated that the cost for framing and erection including the handling of the iron, should rarely exceed \$10 per 1000 ft. B.M., while the cost of driving the piles is placed at 7 cents per lineal foot of pile (not per lineal foot of penetration). Freight or freight and cartage must of course be added to the cost of the material if delivery was not included in the purchase price.

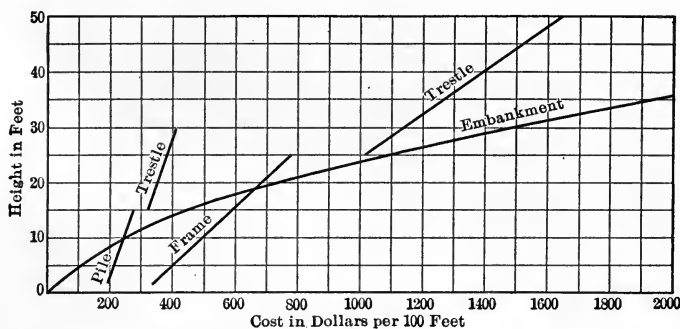

FIG. 62.—Comparison of Wooden Trestle and Embankment.

100. Comparison of Wooden Trestle and Embankment.—In cases where first cost must govern, the following comparison between embankment with 10 per cent. allowance for shrinkage and the Northern Pacific Railway trestle from the formulas of § 99 may be of interest. See Fig. 62.

For the fill the roadbed is 16 ft. with $1\frac{1}{2}$ to 1 side slopes, and

¹ Five piles are more common.

the cost is estimated at 20 cents per cubic yard. For the framed trestle the deck containing 164 ft. B.M. of timber and 15 lbs. of metal has been omitted in making comparison. It would cost \$492 for the lumber and \$45 for the metal, a total of \$537 per station of 100 ft. at the prices assumed of 3 cents per foot and pound for lumber and metal respectively. For the foundation, five piles per bent have been added for heights to 25 ft. and six piles for heights above 25 ft., at a cost of \$4 each on a basis of 16 ft. per pile at 25 cents per foot in place.

For the pile trestle the deck has been omitted as above and the piles figured at 25 cents per foot, allowing 20 ft. for penetration and waste.

Curves for actual unit costs can be readily plotted if desired.

It should be remembered that the cost of the fill will almost always be increased by a masonry structure for drainage which is saved during the life of the trestle. On the other hand, the trestle deck costs more for construction and maintenance and is less satisfactory than the ballast and ties on subgrade.

The trestle will require renewal in from seven to ten years, while the fill should cost nothing for maintenance after the first three or four years.

101. Wooden Trestles with Ballast Floors.—There are two general types, one having the stringers separated and covered with plank to retain the ballast and the other having the stringers placed close together so as to carry the ballast directly. The former type allows the stringers to be inspected more readily as the sides are accessible, and repairs or renewals can be made more easily for the same reason.

From five to six piles per bent are used with about 3 by 10-in. sway braces, the outside piles at least having a batter. The spacing for bents is from 12 to 14 ft. centers.

They first came into use in 1878 and no road reports having found it necessary to make any repairs of importance where all the timbers were creosoted, the amount of oil used being about 12 lbs. to the cubic foot.

The ballast should be broken stone or clean gravel so as to drain readily and coarse enough to not rattle through the cracks in the floor in dry weather.

An interesting comparison of yearly cost of creosoted ballast, and untreated open decks is made by A. F. Robinson¹ on the

¹Proc. Am. Ry. Eng. Assoc., Vol. 9, p. 253, 1908.

basis of cost on the Sante Fe Railroad and his conclusion is that the yearly cost is less for the ballasted deck with interest at 4 per cent., and a life of 28 years for the former and 7 for the latter.

The Sante Fe Railroad standard plans¹ call for bents 14 ft. centers, six piles per bent, outer piles battered, sway braced with 3 by 10-in. plank, and no longitudinal bracing. The floor is made up of eight 10 by 10-in. and twelve 8 by 14-in. stringers, laid close, with two joists at the sides to retain the ballast which is 10 ins. thick under the ties. On the Illinois Central Railroad standard plans the bents are 13 ft. 6 ins. centers, with two sets of sway bracing for heights from 20 to 35 ft. The stringers are 7 by 16 ins., spaced 18 in. centers, ten per panel, and the floor planks are 3-in. Six inches of ballast is used under the ties.

On the Harriman lines as built on the Southern Pacific² the floor planks are covered with prepared roofing laid with 3-in. longitudinal lap joints and turned down 5 ins. over the ends of the planks. After the joints are cemented and nailed an extra coat of 1 lb. of asphalt per square foot is applied and a thin layer of gravel or sand spread over it for protection. For trestles over one story high longitudinal girts are placed at intervals of 12 ft. measured from top of cap and at every sixth bent there is a tower framing. The piles are creosoted but none of the other timber is treated.

102. Steel Trestles.—The general type of construction is shown in Fig. 63. Usually the spans are alternately about 30 and 60 ft. without much regard to height of trestle; longitudinal bracing is placed under the 30-ft. spans joining the vertical bents in pairs forming towers capable of resisting the longitudinal forces due to starting and stopping trains on the track.

The open deck is carried by plate girders spaced to support the ties on the upper flanges; the bents are in vertical planes and the posts batter about 2 ins. per foot. Each post rests on a masonry pier some 4 to 5 ft. square at the top and large enough at the base to reduce the unit pressure on the foundation to a safe value. Anchor bolts are set to templet before the pier is built, and the masonry thus adds to stability in the case of wind pressure strong enough to produce tension in the post.

Ordinary bridge abutments are used at the ends for moderate heights. For greater heights, a "floating abutment" founded

¹ Proc. Am. Ry. Eng. Assoc. Vol. 9. p. 322, 1908.

² Eng. Rec., Vol. 62, p. 500, 1910.

near the top of the settled bank is sometimes used to save masonry, but some of the reinforced concrete types of § 95 or 103, which allow the fill to extend under the end of the trestle, are more in accord with present practice.

There are a number of formulas for weight per foot of steel in terms of height of trestle. As the range in values is considerable, curves are plotted for comparison and for aid in choosing values for use, Fig. 64.

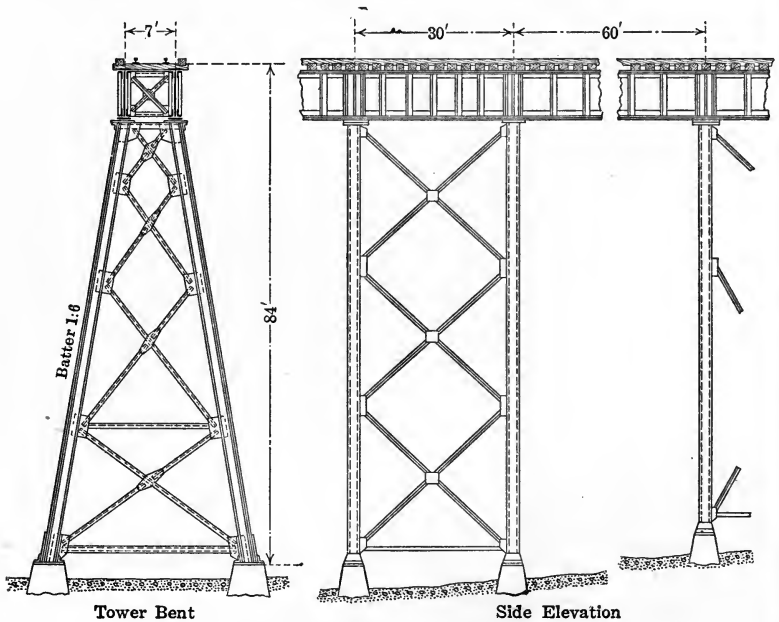

FIG. 63.—Steel Trestle with Plate Girder Spans.

1. C. P. Howard, Eng. News, Vol. 56, Sept. 13, inset, 1906, for Cooper's E 40 loading.

Weight per foot = 520 lbs. for height of 20 ft.,
 = 1200 lbs. for height of 60 ft.,
 = 1530 lbs. for height of 90 ft.

2. The above values with 20 per cent. added for Cooper's E 50 loading.

3. Editors, Eng.-Cont., Vol. 27, p. 270, 1907, for two 116-ton engines followed by 3000 lbs. per foot, spans 30 and 60 ft. alternating.

Weight per foot = $600 + 12$ times height.

It is claimed that this has been used in estimating the weight of many viaducts of different heights and has been found to give very close results except for heights as low as 20 to 25 ft.

4. H. G. Tyrrell, Eng. News, Vol. 44, p. 79, 1900, for two engines weighing 100 tons each followed by 4000 lbs. per foot. Unit stresses 10 000 and 12 000 lbs. per square inch.

Weight per foot,

Deck plate girder = $100 + 9$ times span,
 = 550 for spans of 30 and 60 ft.

Bents and bracing = 9 times height.

5. Electric railway trestles for 25-ton cars, or 2000 lbs. per lineal foot.

Weight per foot,

Deck plate girder = $30 + 5$ times span,
 = 260 for spans of 30 and 60 ft.

Bents and bracing = 6 times height.

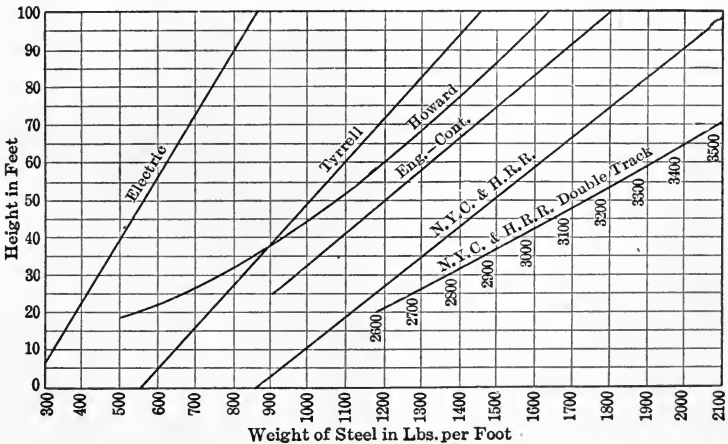

FIG. 64.

6. New York Central and Hudson River Railroad, courtesy of A. W. Carpenter, Engineer of Bridges.

Weight of tower only,

Single track trestles = $3\ 500 + 1\ 000$ times height.

Double track trestles = $20\ 000 + 2\ 000$ times height.

The curves, Fig. 64, are plotted for 30-ft. towers and 60-ft. spans on the basis of the 1904 specifications which call for a loading

of two Cooper E 40 locomotives followed by a train load of 4500 lbs. per lineal foot.

For the masonry for the piers $1\frac{1}{3}$ cu. yd. per lineal foot will give $7\frac{1}{2}$ cu. yds. per pier for spans of 30 and 60 ft., or piers 4 by 4 ft. at the top, $6\frac{3}{4}$ by $6\frac{3}{4}$ ft. at the base and 7 ft. high, sufficient for firm ground. For the abutments see § 95.

The detailed cost of erection for two steel trestles containing a total of about 700 tons of metal is given in Engineering-Contracting, Vol. 27, p. 270, 1907. It was \$7.47 per ton for the first and \$7.60 for the second, including \$1.13 and \$1.60, respectively, for the labor for two coats of paint. The framing and laying the floor, not included in the above, cost 70 cents per lineal foot for the first and \$1.20 for the second. For the cost of the steel work see § 104.

103. Reinforced Concrete Trestles.—Many of the low wooden trestles are on overflow land where the waterway is needed in times of flood. This prevents their being filled without expensive masonry for culverts, and when the demand for a continuous ballast roadbed became strong the wooden trestle with treated timber and ballast floor which had given such good service on the Louisville and Nashville, § 101, came into favor as shown by the large number built between 1897 and 1906.

Meanwhile reinforced concrete had come into use on railroad work and the Committee on Masonry of the American Railway Engineering Association at the convention in 1909 reported the names of three railroads which were using reinforced concrete trestles. In 1911 the committee reported that the results had been satisfactory and that the construction was on the increase, one road having constructed 83 reinforced concrete trestles aggregating 8359 lin. ft. of single track and another about 20 000 lin. ft., while others had adopted plans and begun construction.

Perhaps the practice of the Chicago, Burlington and Quincy Railroad as described by Mr. Cartlidge in a paper before the Western Society of Engineers¹ will best illustrate the methods in use. The standard plans provide for bents spaced 14, 15 and 16 ft. centers. The pile bents are limited to a height of 16 ft.

¹ Jour. Wes. Soc., Vol. 15, p. 543, 1910. Eng. News, Vol. 61, p. 546, 1909. See also Eng. Rec., Vol. 61, p. 548, 1910. Am. Ry. Eng. Assn., Bul. 130, p. 213, 1910.

from ground to base of rail and thin piers at greatly increased cost are used for greater heights.

Six 16-in. piles spaced 2 ft. 4 ins. centers, are used per bent. The caps are $2\frac{1}{2}$ ft. wide, $3\frac{1}{4}$ ft. deep and 14 ft. long, molded in place over the tops of the piles to a depth of about a foot. Two $\frac{3}{4}$ -in. square corrugated bars, one above the other, are placed in each side of the cap.

The piles are of two forms: rectangular cast, and Chenoweth rolled. The former are made in lengths up to 30 ft. The 30-ft. piles are 16 ins. square with 4-in. chamfers, tapering to about 8 by 8 ins. at the small end. The reinforcement consists of eight $\frac{1}{2}$ -in. bars with a spiral coil of wire of varying pitch, being smallest near the ends. The wire is wound on a mandrel and then put in the form and fastened to the $\frac{1}{2}$ -in. bars.

The Chenoweth pile has a reinforcement consisting of a spiral sheet of netting with the usual longitudinal bars. The netting, concrete and bars are placed on a platform and rolled up by machinery and wrapped with wire under sufficient pressure to give a dense mixture.

The floor slabs are also made in the yard and afterward moved to place. The form is made for the whole width of road-bed. One-half is filled out to a temporary partition, the partition is removed, a layer of paper placed against the concrete and the other half filled. Drainage holes are provided along the division line. U-bolts or stirrups are set in the upper part of the slab for convenience in handling with a locomotive crane.

For the piles a 1:3 mixture of cement and fine screened gravel or a 1:2:3 mixture using sand and fine stone screenings was used, while for the caps and slabs it was changed to a $1:4\frac{1}{2}$ with gravel or a 1:2:4 with sand and stone.

The piles are allowed to season for about 30 days and the slabs for about 60 before being used, keeping them well sprinkled during the period.

The piles are driven by a railroad drop-hammer, using a cushioned cap, and there has been but little trouble from breakage of the piles. The cost of driving has been found to be rather greater than for wooden piles. A water jet has been used where feasible with good results.

After the piles are driven and capped the slabs are placed on mortar beds on the caps, the deck joints filled with mastic and the deck waterproofed.

For structures of more than five or six spans longitudinal stability is secured by placing double bents at suitable intervals. These consist of two rows of piles carrying a cap of double the usual width.

For 25-ft. spans as in crossing streams where there is considerable ice and drift, thin piers are used, resting on wooden or concrete piles if a firm foundation cannot be reached.

The cost per lineal foot for single track structures is estimated as follows:

The Wabash Railway, under ordinary conditions, \$20 plus \$500 for the two abutments. If the abutments are omitted two additional spans will be required to cover the end slopes and the cost will be increased.

The Chicago Burlington & Quincy Railway for pile trestles as above described, \$30 to \$35. For trestles resting on thin piers with pile foundations \$40 and upward.

The Cleveland, Chicago, Cincinnati & St. Louis Railway, \$21 for the two structures already built. They use piers, and the sides of the deck are deepened to form girders to support the floor which has lateral reinforcement. Spans 20 ft. in the clear.

104. Wooden Bridges.—Throughout a large section of the country the wooden bridge has been replaced by several generations of metal bridges and these are giving way to masonry arches and reinforced concrete structures for the shorter spans. In the South and West, however, where good timber is available and transportation expensive, there is still a demand for timber bridges on new work.

The standard designs of the Oregon Pacific Railroad Howe Truss Bridges, published in *Engineering News*, Vol. 23, p. 402, 1890, show strain sheets and sizes of members for spans from 30 to 150 ft. The details are well worked out; the estimates of quantities are given in the table p. 235.

For the pony trusses, marked *p*, the portal bracing is from the outer end of the floor beam to the upper chord. For the deck bridges, marked *d*, two diagonal struts are placed in the cross-section, and for the through bridges, marked *t*, the portal bracing is as shown in Fig. 65 for spans of 90 ft. and over. The dead floor load is given at 500 lbs. per lineal foot. The timber is in feet B.M. and the iron in pounds. The first column for iron is for threads cut on straight bar, the second for ends upset to make up for depth of thread; use the one corresponding to the method used, not both.

QUANTITIES FOR OREGON PACIFIC RAILROAD. HOWE TRUSS BRIDGES

Span	Height of truss	Load per ft.		Estimate of quantities			
		Dead	Live	Timber	W. iron	C. iron	W. iron
30 <i>p</i>	9	860	5 060	10 165	2 170	970
30 <i>d</i>	9	860	5 060	6 750	1 930	1 210
40 <i>p</i>	11	900	4 600	13 358	2 960	1 070
40 <i>d</i>	9	900	4 600	9 362	3 280	1 550
50 <i>p</i>	11	950	4 200	19 025	5 610	2 880
50 <i>d</i>	11	950	4 200	12 861	4 710	2 830
60 <i>p</i>	12	1 040	3 860	22 785	6 790	3 660
60 <i>d</i>	12	1 040	3 860	20 702	5 900	3 830
70 <i>p</i>	13	1 100	3 640	29 931	9 260	8 260	8 210
70 <i>d</i>	13	1 100	3 640	27 617	8 420	7 980	7 610
80 <i>p</i>	14	1 120	3 600	35 388	11 660	9 790	10 260
80 <i>d</i>	14	1 120	3 600	32 764	10 190	9 730	9 129
90 <i>p</i>	15	1 220	3 560	42 709	15 170	12 530	13 440
89½ <i>t</i>	25	1 220	3 560	41 883	17 880	12 260	15 150
90 <i>d</i>	15	1 220	3 560	40 690	13 220	12 710	11 820
100½ <i>t</i>	25	1 300	3 500	48 892	22 580	14 290	18 950
100 <i>d</i>	18	1 300	3 500	46 454	18 040	13 990	16 040
110 <i>t</i>	25	1 380	3 400	54 767	25 820	15 930	22 290
110 <i>d</i>	18	1 380	3 400	50 295	19 400	14 950	16 320
121 <i>t</i>	25	1 440	3 300	62 038	30 890	18 290	26 010
121 <i>d</i>	19	1 440	3 300	59 254	23 080	16 520	19 580
130 <i>t</i>	23	1 500	3 200	70 128	37 050	20 830	30 180
130 <i>d</i>	20	1 500	3 200	66 779	27 930	20 460	23 560
139 <i>t</i>	25	1 550	3 150	78 156	40 820	23 210	33 020
139½ <i>d</i>	21	1 550	3 150	76 323	32 640	23 260	27 360
150½ <i>t</i>	25	1 600	3 100	86 632	48 090	27 060	39 140
150½ <i>d</i>	22	1 600	3 100	86 053	39 630	27 140	33 390

The unit stresses are,

- Wrought iron, net section, 10 000 lbs.
- Wood, usually, 800 to 1 000 lbs.
- Shortest span, 500 to 800 lbs.
- Packed beam, max. section, net area, 800 to 1 000 lbs.
- Wood, compression, 1/6 to 1/8 breaking load by Smith's formula, $f = \frac{5000}{1 + .004 \frac{l^2}{b^2}}$

For the lateral system a uniform load of 150 and a live load of 150 lbs. per foot were taken on each system for the deck

spans, while for the through spans the live load was all placed on the lower system.

The lower chord splice is not shown in Fig. 65. The usual practice is to splice one chord piece in each panel, the ends abutting, with castings having lugs fitting into cylindrical holes or vertical grooves on each side of the piece and connected together by links or rods. The packing bolts, the rods of the

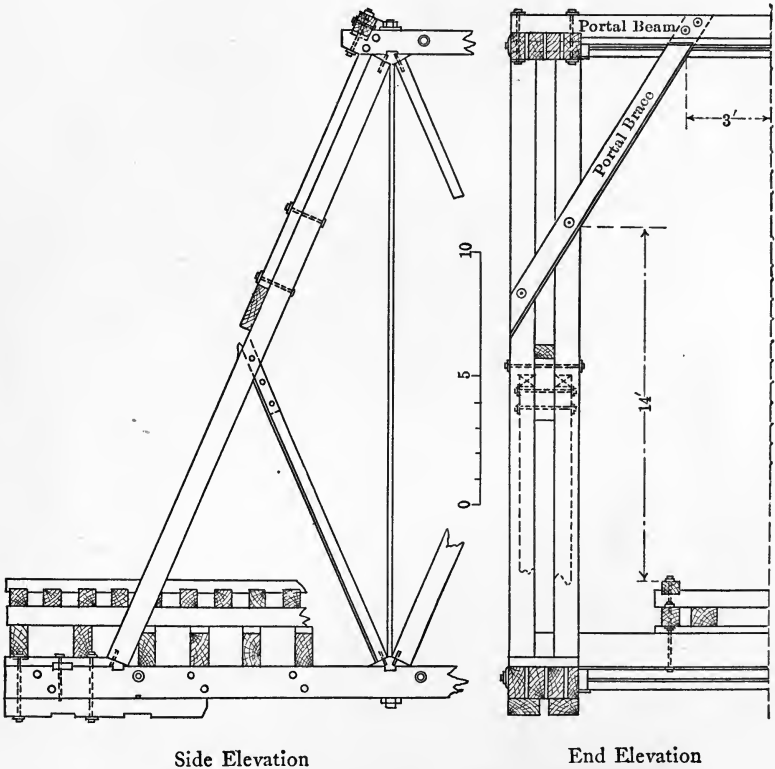

FIG. 65.—Portal Bracing, Oregon Pacific Howe Truss.

lower laterals and the brace blocks at the panel points tie the chord pieces together so that the tension is distributed and another stick can be spliced in the next panel.

The floor beams rest directly on the chord (or may be suspended underneath) so that the chord acts as a track stringer and as a chord. The panels are short, 11 ft. being about a maximum.

The cost of erection would be greater than for trestles as there is more work in framing and falsework will be required; \$15 per 1000 ft. B.M. should be ample to correspond with the \$10 of § 99 if 1/4 cent per pound is allowed for handling the iron.

In Engineering-Contracting, Vol. 28, p. 12, 1907, the cost of a Howe truss bridge of 130-ft. span is given as follows:

Falsework:

840 lin. ft. piles (20 piles) delivered at 8 cents,	\$67.20
840 lin. ft. piles driven at 12 cents,	100.80
24 000 ft. B.M. timber delivered at \$15,	360.00
24 000 ft. B.M. timber framed at \$7.50,	180.00
400 lbs. iron at 2½ cents,	10.00
Total,	<hr/> \$718.00

Bridge:

29 000 lbs. cast iron at 2 cents,	580.00
34 000 lbs. wrought iron at 2½ cents,	850.00
71 700 ft. B.M. timber at \$15,	1 075.50
130 lin. ft. bridge framed and erected at \$7.50,	975.00
Total,	<hr/> \$3 480.50

Summary:

Falsework, labor (by contract),	718.00
Pile abutments, materials,	268.50
Pile abutments, labor,	225.00
Howe truss bridge,	3 480.50
Train service,	50.00
Grand total,	<hr/> \$4 742.00

The contractor paid carpenters \$2.75 per day and helpers \$2.

The contract price for framing falsework and abutment timber was \$7.50 per 1000 ft. B.M., while that for the bridge lumber, \$7.50 per lineal foot, amounts to \$13.60 per 1000 ft. B.M. including handling the iron, or to \$11.40 if 1/4 cent per pound be allowed for the iron.

The same unit prices were paid for both material and labor for a 120-ft. span, which would increase the cost of labor per 1000 ft. B.M. for the bridge to \$14.28 for the 63 000 ft. used.

105. Steel Bridges.—These are standard for spans of from about 15 ft. up, with a tendency to raise the lower limit on lines of heavy traffic wherever the headroom and foundations will allow of a masonry arch, or those and the requirements of the waterway will allow of a series of arches.

There are several reasons for this:

a. The metal open-deck structure has always been built for the weight of rolling stock in sight, upon the assumption that no further increase was probable, if indeed it were possible. The result is that due to overloading and to some extent to poor design, the life of metal bridges has been but little greater than that of wooden bridges.

b. The masonry structure carries earth and ballast in addition to the live load, so that live load increments have a less percentage effect; besides there is a cushioning due to the fill which relieves the structure from some of the jarring effect and probably from some of the impact due to cumulative vibration. The renewals of well-built masonry arches on good foundations have been much less frequent than those of metal bridges.

c. The demand for a continuous ballast floor which makes a pleasanter riding track and does away with the bridge carpenter in track maintenance. Recently this demand has been met by using ballast on the metal structure, but this reduces the saving in first cost as compared with the masonry structure.

d. The rapid deterioration of modern steel by rust in many situations and the constant care and expense required for protection in others.

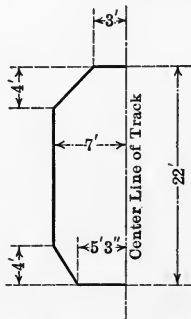

FIG. 66.—Bridge Clearance Diagram.

Steel bridges are almost always built by contract and at a pound price. The smaller railroad companies let the work on general specifications such as those published in the American Railway Engineering Association Manual; the larger companies have a bridge department and believe that the experience acquired in studying the deterioration of bridges in service enables them to design a better structure for their conditions than can be done by the bridge company.

The small company contracts the erection, the large company finds it safer and usually more economical to organize an erection gang and not allow an outside contractor to interfere with track and trains where traffic must be maintained.¹

The clearance for through bridges on straight track is shown on Fig. 66. On curves equivalent clearance is required.

There are many formulas for weight of steel per lineal foot, a few of which are given below and the results plotted in Fig. 67.

1. Tyrrell, Engineering-Contracting, Vol. 30, p. 195, 1908.

Weight of steel per lineal foot:

- 1a. Deck plate girders, $100 + 12$ times span.
- 1b. Through plate girders, $500 + 12$ times span.
- 1c. Through truss spans, $600 + 7$ times span.

For double track, add 90 per cent.

This is for Cooper's E 50 loading, two $177\frac{1}{2}$ -ton engines followed by 5000 lbs. train load per foot, and for spans from 30 to 230 ft., changing from girder to truss at about 100 ft.

2. Johnson, Bryan and Turneaure, Modern Framed Structures, Part I, Stresses, p. 116.

Approximate weight of steel per lineal foot:

- 2a. Deck plate girders, $100 + 12\frac{1}{2}$ times span.
- 2b. Through plate girders, $450 + 14$ times span.
- 2c. Truss spans, $700 + 8$ times span.

It is stated that riveted trusses of short span are likely to be somewhat heavier and pin-connected trusses somewhat lighter than given by the above. This is for two $182\frac{1}{2}$ -ton engines followed by 5000 lbs. train load per foot, approximately Cooper's E 50 loading, and for open floors.

The plate girders are used for spans from about 20 to 110 ft., riveted trusses from 100 to from 150 to 200 ft. and pin connected for longer spans, although practice is not uniform. For the deck plate girder the ties rest directly on the upper flanges, while for the through girder floor beams and stringers are required.

3. Merriman and Jacoby, Roofs and Bridges, Part I, p. 54.

Weight of steel per foot for Cooper's E 50 loading,

- 3c. $700 + 7$ times span, to
 $1000 + 10$ times span,

according to unit stresses and details.

¹ For specifications for the erection of railroad bridges, see Proc. Am. Ry. Eng. Assoc., Vol. 13, p. 83, 1912.

Formula furnished by Waddell and Hedrick, p. 55.

Weight of steel per foot,

$$3c'. 8.63(l+1.3 W-140)$$

where l = span in feet and W the weight in net tons of each of the two locomotives, Cooper's series.

For E 50 this becomes $783 + 8.63$ times span.

For E 40 subtract 398 lbs.

This is for single track pin connected through Pratt truss bridges from 180 to 350 ft. span. For double track add 85 per cent.

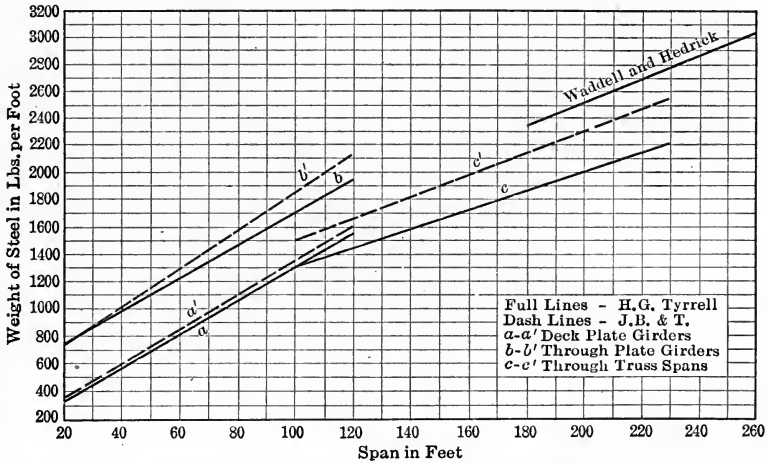

FIG. 67.—Weights per Foot of Steel Bridges.

4. For electric railroad bridges, Tyrrell gives the following, see No. 1:

4d. I-beam spans, 5 to 20 ft.,

$$50 + 5 \text{ times span.}$$

4c. Truss spans, 40 to 200 ft., live load 15-ton cars, or 1000 lbs. per foot,

$$200 + 0.8 \text{ times span.}$$

4c'. Truss spans, 20 to 180 ft., live load 30-ton cars, or 2000 lbs. per foot,

$$250 + 1\frac{1}{2} \text{ times span.}$$

4b. Deck plate girder spans, 2000 lbs. per foot,

$$30 + 5 \text{ times span.}$$

The cost of ordinary span railroad truss bridges is about $2\frac{3}{4}$ cents per pound, f.o.b., shop at Pittsburgh and for plate girder spans, $2\frac{1}{2}$ cents. For the basic price at other shops add the freight from Pittsburgh. To this must be added freight, or freight and cartage, erection, including falseworks, painting and the floor system—open deck or ballast, for the cost of the finished structure.

Falseworks can be approximately estimated as trestles with top at height of lower chord, and the cost of assembling and riveting the steel can be closely estimated on new work or where the traffic is light. Under heavy traffic the cost and risk are usually greater and various expedients are necessary to keep trains moving safely without serious interruptions to the work. Greater skill will be required to design and execute to meet these conditions than to economically provide strength and durability for the structure in service.

The following cost of erecting a riveted through span steel bridge of 155 ft. span, weighing 131 tons, by company forces is given in Engineering-Contracting, Vol. 27, p. 148, 1907.

Wages per 10-hour day were, foreman \$3.40; bridgemen, \$2.50; laborers \$2.00; hoisting engineman, \$2.50; fireman, \$2.00.

Time traveling to and from work,	\$40.00
Rigging blocks and erecting traveler,	122.90
Loading eng. on derrick car for erection,	19.70
Taking down traveler,	22.40
Picking up tools after erection,	10.00
Unloading bridge steel,	68.20
Painting inaccessible parts, 2 coats,	48.00
Erecting bridge trusses,	287.40
Removing old deck and pony bents to erect floor system,	25.90
Putting in steel floor system,	103.30
Getting tools, etc., ready for riveting,	10.00
Riveting,	247.00
Putting in machine fit bolts,	26.80
	<hr/>
Total labor,	\$1031.60
Removing old bridge,	200.00
Falsework,	1220.00
Bunk house,	40.00
Engineering and inspection,	585.00
	<hr/>
Total,	\$3076.60

The labor cost of erection was thus \$1011.90, or \$7.79 per ton.

The falsework cost \$7.86 per lineal foot which includes both labor and materials.

The labor cost of framing the deck was 60 cents per lineal foot of structure.

The labor cost of erecting a similar bridge of 180-ft. span, with company forces, is given on page 152 of the same volume at \$7.84 per ton, with 63 cents per lineal foot for the deck.

For painting, all new work is cleaned at the shop and given one coat of linseed oil or paint. Surfaces in contact due to riveting the pieces together are painted, while those inaccessible after erection are given an additional coat before leaving the shop. Painting should be done when the metal is dry and preferably above freezing.

In cleaning old work for repainting, the sand blast is probably the most effective, but it is expensive. The usual method is to scrape well and clean with wire brushes, a hammer sometimes aiding in loosening scale.

The cost of scraping and painting two railroad viaducts with lattice columns and lattice struts in towers in 1896 with two coats was given by A. S. Markley at a convention of the Association of Railway Superintendents of Bridges and Buildings.¹

Red lead at 4.9 cents per pound, lamp black at 8.5 cents, and boiled oil at 40 cents per gallon were used. The unit cost of labor is not given. Bridge No. 1 contained 719 tons of metal and bridge No. 2, 154 tons.

The following is a summary per ton of metal:

	No. 1	No. 2
Labor, scraping,	\$0.194
Labor, painting, 1st. coat,	.776	\$0.788
Labor, painting, 2d coat,	.517	.584
Material, two coats,	.602	.359
	<hr/>	<hr/>
Total, material and labor,	\$ 2.089	\$1.731
	<hr/>	<hr/>
	No. 1	No. 2
Red lead, first coat, lbs.,	4.95	3.25
Red lead, second coat, lbs.,	3.33	2.17
Boiled oil, first coat, gals.,	.246	.120
Boiled oil, second coat, gals.,	.222	.110

¹ Eng.-Cont., Vol. 29, p. 180, 1908.

106. Open Bridge Floors.—As stated in § 97 the safety of a trestle depends on having a floor which will support a derailed train on the ties. If the train can be kept on the ties it is also safe. The same is true for a deck bridge. For a through bridge it is necessary for the safety of both structure and train that the train be kept sufficiently near the center of the track to avoid striking the trusses.

Ordinarily the close spacing of ties and the outside guard timbers notched to prevent bunching, are the only precautions taken, but the inside guard rails as used on some of the Santa Fe Railroad trestles, § 99, are quite common.

With metal bridges, the flanges of the track stringers are narrow as compared with timber, requiring deeper ties to support wheels on the centers or ends on account of the longer lever arms. The distance between stringers ranges from about $6\frac{1}{2}$ to 8 ft. centers, the former being ample for stability for 10-ft. ties, while the latter gives a noticeable cushioning effect in relieving the bridge from the jarring action of the train, but requires a greater depth of tie for the same strength.

The Latimer rerailing device was strongly advocated at one time, but it never came into extensive use. The inside guard rails were placed about $1\frac{3}{4}$ ins. from the running rails and inclined planes of cast iron were placed at the entrance to these narrow flangeways to raise the wheel flanges high enough for the treads of the inside wheels to pass over the top of the rail as the guard rail crowded them over to the running rail. Corresponding inclined planes outside the running rails raised the flanges of the outside wheels level with the top of the running rail and allowed the inner guard rail to rerail them.

The guard timbers flared out at the ends opposite the guard rail frogs to deflect trucks more than half gage off center so they would be caught by the frog and drawn over for rerailing. Very heavy posts were set at the ends of the flared guards to catch cars too far off for rerailing and prevent their reaching the bridge.

The Jordan guard, used on the Michigan Central Railroad, consisted of three equidistant lines of rails between the running rails with ends bent down and passed through holes in plates at the ends of the bridge so as not to catch any broken or dragging parts. Thus, however badly broken the car, the guards form skidways and guides upon which the car or engine slides, if it

will not roll, so many rails close together tending to prevent any part from dropping down and catching on the ties.

It is related that a locomotive of a freight was taking water with the rear end of the train standing back on a trestle when a following train approached and the locomotive, partially supported by the Jordan guard, ran under the cars at the rear end of the standing train and threw them off the trestle with practically no damage except to the derailed cars.

On some of the elevated roads the inside guard rail, either as a rail or as an angle iron attached to the upper outer corner of a guard timber, is raised above the running rail and so close that the flanges of both wheels aid in preventing derailment. The inside guard rail is also used for high embankments on sharp curves and for other dangerous places.

If the bridge is on a curve the elevation of outer rail is usually taken care of in the floor, either by tapering the ties, shimming the outside rail, or bolting a joist on the top of the outside stringer.

Skew bridges, except for short spans, should not be used when practicable to avoid them at reasonable expense. The live load deflection rocks the train while on the bridge, and the unequal settlement of track on bridge and dirt foundation gives a side lurch at entrance and exit. The latter can be prevented by ending the stringers on the same tie, which will require extending them back different distances from the face of the abutment, and may require a special pier support isolated or built up from the foundations of the regular masonry.

The life of a timber deck is from 7 to 10 years depending on the traffic and the timber. The cost of framing has been given.

107. Ballasted Bridge Floors.—These came into use for short span bridges over city streets to deaden noise and protect from water and cinders. Transverse troughs of angles and plates, with the cross ties in the troughs were standard, but other forms came into use. Paint or asphalt was depended upon for protection from rust, but with poor results as the upper surface was inaccessible. This has led to the use of creosoted timber plank laid on metal stringers, to plate metal on stringers, to concrete slabs and reinforced concrete, and to protection of the metal with concrete.

It is claimed that failure in waterproofing has been due largely to faulty details, such as in flashing along webs of girders and

around corners and angles of steel work where there is a tendency for the material to separate from the metal, and to the formation of cracks. The only method of preventing cracks due to settlement, shrinkage and temperature changes is by reinforcement, and this is not always successful.

The methods of rendering the concrete itself waterproof do not appear to have been successful; those by asphaltting the surface of concrete or metal have been where proper precautions have been observed and drainage is provided so that there is no hydrostatic pressure; while those where layers of felt, or preferably burlaps mopped with asphalt are used, and covered with a course of brick or other protective layer appear to be successful under a greater range of conditions.

Where deep snows are common, it has been found necessary to put the flashing angles near the tops of the girders and to carry the waterproofing courses close up under them.

There has been a tendency to reduce the allowance for impact on account of the ballast but the experiments conducted by Committee XV of the American Railway Engineering Association showed no reduction in impact as compared with the open deck, although the jarring action was somewhat reduced.

For a paper tracing the development of the ballast floor, with comparative costs for different designs, and discussion, see *Journal of the Western Society of Engineers*, Vol. 10, p. 227, 1905, and for successful methods of protection, Vol. 17, p. 545, 1912.

108. Wooden Piers and Abutments.—These are common on new work where wooden bridges are used on account of the ease and rapidity with which they can be constructed. If low and on ground or in shallow water where piles can be driven three rows of piles for an abutment and four for a pier will be required. Guard piles may be required for protection from ice and drift or in exposed situations, a sheathing of plank with sway bracing and a cut-water may be necessary, as shown on the Santa Fe Railroad standards, Fig. 68.

For greater height the piles would be cut low and capped to support framed bents as in trestle work. Longitudinal bracing should be added joining the bents into a pier or abutment.

If built for construction work merely they should be located so that the permanent construction can be put in place with minimum disturbance of track and supports. If built to carry a

wooden bridge during its life, the permanent construction would receive less consideration.

Little or no fill should be placed against the abutment, but trestle spans used to cover the end slope of the fill.

Referring to Fig. 68, the planking is to extend above high water and ice. An 8 by 10-in. timber is required around the inside near the top, fastened to each pile by a $3/4$ -in. bolt. If the structure is high, additional ones should be placed about 10 ft. apart vertically.

The cut-water should be braced at high water and at the ice flow line with 12 by 12-in. pieces between the piles and notched into them $1\frac{1}{2}$ ins. as shown. The vertical timber is bolted at points 4 ft. apart with $3/4$ -in. bolts, and the rail is spiked at points 12 ins. apart on each side with spikes driven into $1/2$ -in. holes. The interior is usually filled with stones.

109. Highway Crossings.—Grade crossings are practically prohibited on new construction except for lines of light traffic with unimportant highways. Considerable pressure is being brought to bear for the elimination of those already in use.

This creates the greatest apparent burden in level country where the railroad track is several feet above the average surface for drainage and protection from snow. Natural drainage is expensive for an under-highway crossing with a clear headroom of 14 ft. or about 18 ft. below top of rail, while an over-crossing giving a railway clearance of 22 ft. from top of rail requires a height above track of about 25 ft. and a greater height above the highway.

On rolling ground advantage can often be taken of a hollow or ridge to reduce the cost of the approaches or to secure drainage.

The under-crossing would not differ from a railroad bridge except for the approaches and drainage. The minimum clear width would be from 12 to 14 ft. for farm crossings and unimportant highways and from 18 to 20 ft. for main country thoroughfares. So far as practicable a driver should be able to see approaching vehicles on the other side of the structure on account of the danger of collision.

The over-crossing would require a highway bridge, as in Fig. 69, or trestle over the tracks and extending down each way to where the height would warrant changing to a fill. The approach gradient should depend upon the maximum on the connecting highways; 2 per cent. being about a minimum for heavy city

traffic; 7 per cent. is about the maximum on which the New York State Highway Commission will place macadam; while 15 per cent. is common on roads of considerable travel in Western New York and 20 per cent. is used on cross roads.

The weight of steel per square foot of floor, including roadway and walks, is given as follows by Tyrrell:¹

With sidewalks,	$2.8 + \text{span}/11.3$
Without sidewalks,	$5 + \text{span}/9.5$

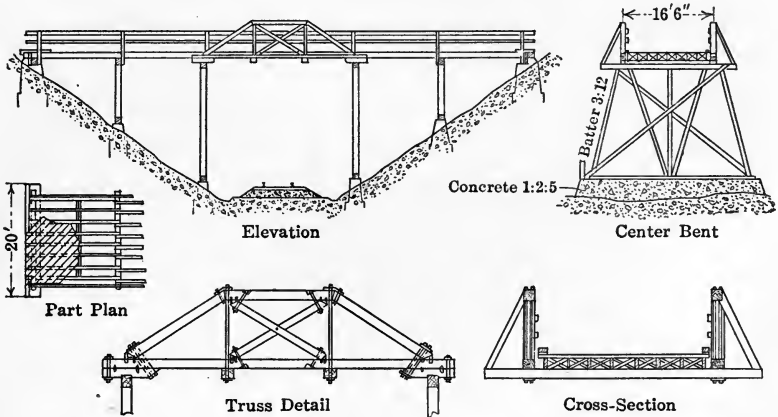

FIG. 69.—Carolina, Clinchfield & Ohio Ry., Standard Wooden Highway Bridge Crossing

This is for riveted trusses with timber joists and a floor composed of two layers of plank.

The assumed live load was 80 lbs. per square foot for trusses and 100 lbs. for floor beams, or a 6-ton wagon. The formulas were based on designs of through truss spans from 50 to 150 ft., for roadways from 14 to 20 ft. wide.

For plate girder spans from 20 to 80 ft. having 16 to 24-ft. roadway and the same loading as above,

Through plate girder,	$3 + \text{span}/4.25$
Deck plate girder,	$2.1 + \text{span}/5$

For highway bridges with solid floors, assumed to weight 150 lbs. per square foot,

Deck plate girder,	$3 + \text{span}/2.6$
Half through girder,	$3 + \text{span}/2.4$
Truss bridges,	$3 + \text{span}/4$

¹ Eng. and Cont., Vol. 30, p. 196, 1908.

If supported on bents as a trestle the plank floor spans would about correspond to the electric railway trestle of § 102, the bents and bracing weighing six times the height per lineal foot, and the solid floor to the steam railroad trestle the bents and bracing weighing nine times the height per lineal foot, except that less or possibly no longitudinal stability is required since the stresses are less and anchorage is provided at the ends. For the bents near the track the masonry piers for each bent should be combined in one of fairly good height with the ends rounded as a protection from derailed cars.

A substantial railing would be required on the fill as well as on the bridge.

For the solid floor, reinforced concrete arranged to protect the floor beams, the floor joists if used, and the lower chord, would give good results. For heavy traffic 3 to 4-in. creosoted wood-block pavement would make an excellent wearing surface, while for light traffic a wearing coat of concrete should give good results. There would be some danger from fire with creosoted plank as the base for the wood block and from rust with buckle plates and concrete for the base.

For single or double track, or where the tracks can be separated for piers, reinforced concrete bridges offer advantages in freedom from rust due to smoke.

For sites to which reinforced concrete through girder bridges are adapted the data for quantities of concrete and steel for some thirty highway bridges built under the direction of the Illinois State Highway Engineer in 1909, may be of value for preliminary estimates. The roadway is 16 ft. with one or two exceptions and the height of abutment ranges from 8½ to 18 ft. The greatest range is in the foundations, the quantities for which should be greater for stream crossings than for railroad crossings, and enough greater to more than make up for the larger clearance. The spans range from 10 to 60 ft.

They give per foot of span including abutments,

Concrete in cubic yards,	3.4 + .01 times span,
Steel in pounds,	182 + 4 times span.

REFERENCES

- Roofs and Bridges, Part III, Bridge Design. Merriman and Jacoby, 1912.
- Modern Framed Structures, Part I, Stresses. Johnson, Bryan and Turneure, 1910.
- Railroad Structures and Estimates. J. W. Orrock, 1909.
- Concrete Bridges and Culverts. H. G. Tyrrell, 1909.

Design of Highway Bridges. M. S. Ketchum, 1908.

Wooden Trestle Bridges. W. G. Foster, 1906.

Five Mile Trestle across Albemarle Sound, Norfolk and Southern Ry. Eng. News, Vol. 63, p. 455, 1910.

A Large Timber Trestle on the Pacific Coast Extension of the Chicago, Milwaukee and St. Paul Ry. Eng. News, Vol. 61, p. 307, 1909.

Wooden Bridges and Trestles. Proc. Am. Ry. Eng. Assoc., Vol. XII, Part I, p. 275, 1911.

Florida East Coast Extension Ry. Ry. Age Gaz., Vol. 52, p. 1037, 1912.

Temporary Trestle Work, Fla. East Coast Ry. Eng.-Cont., Vol. 28, p. 227, 1907.

The Penhorn Creek Viaduct of the Erie R. R. Eng. News, Vol. 64, p. 377, 1910.

Tinker's Creek Viaduct. Eng. Rec., Vol. 61, p. 385, 1910.

Erection Appliances for the Belly River Viaduct, Lethbridge, Alberta. Eng. News, Vol. 63, p. 209, 1910.

Reinforced Concrete Viaduct over Railway Yards at Seattle. Eng. News, Vol. 67, p. 519, 1912.

Cost of Erecting Three Steel Viaducts. Eng.-Cont., Vol. 27, p. 270, 1907.

Cost of Constructing Concrete Trestle and Three Concrete Bridges, with Abutments. Eng.-Cont., Vol. 29, p. 78, 1908.

Reinforced Concrete Trestles. Proc. Am. Ry. Eng. Assoc., Vol. 12, p. 517, 1911.

Methods of Waterproofing Concrete Steel Flooring for Railway Bridges, with some Figures on Cost. Eng.-Cont., Vol. 30, p. 288, 1908.

Waterproofing Concrete Structures on the C. B. & Q. Ry. Track Elevation. Ry. Age Gaz., Vol. 52, p. 307, 1912.

Bridge Renewals of the Penna. Lines West. Ry. Age Gaz., Vol. 53, p. 307, 1912.

Method and Cost of Constructing a Plate Girder Railroad Bridge, with Concrete Piers. Eng.-Cont., Vol. 27, p. 141, 1907.

Erection of the Kentucky River High Bridge. Eng. Rec., Vol. 63, p. 460, 1911.

Erection of the Willamette River Bridge. Ry. Age Gaz., Vol. 53, p. 382, 1912.

Construction of the Copper River Bridge. Ry. Age Gaz., Vol. 52, p. 191, 1912.

Detailed Cost of Erecting a 180-ft. Span Ry. Bridge. Eng.-Cont., Vol. 27, pp. 148, 152, 1907.

Data on Reinforced Concrete Highway Bridges. Twenty Highway and Twelve Railway Bridges, Including Yardage, Cost, etc. Eng.-Cont., Vol. 30, p. 152, 1908.

Cost Data on Reinforced Concrete Highway Bridges. Eng. Rec., Vol. 61, p. 162, 1910.

A Plain Concrete Arch Bridge. Eng. Rec., Vol. 63, p. 255, 1911.

An Analysis of Concrete Bridge Failures. Eng. Rec., Vol. 61, p. 528, 1910.

CHAPTER IX

TRACK MATERIAL AND ROADBED

110. Ballast.—This is selected material used between the ties and subgrade. Its purposes are to distribute the pressure on the ties more uniformly over the native material forming the subgrade and to make it possible to line and surface the track under any weather conditions which may obtain for the locality. Thus ease of track work, durability and stability are the characteristics sought.

Broken stone is usually given first place on account of its durability and stability. It drains well and is but slightly affected by weather conditions unless filled with snow and ice. It is, however, expensive for track work, as it is difficult to get even support for the ties in working to line and surface, and a small lift in track cannot be made without breaking up the bed under the ties.

The stone is broken in a crusher to pass about a $2\frac{1}{2}$ -in. ring and the fine material up to about $\frac{1}{2}$ in. should be screened out. The crusher can be set high or the broken stone carried up by an elevator and allowed to pass over a revolving screen which will remove the fine material, discharge the large pieces at the lower end and allow those of the desired sizes to pass through into elevated bins from which they can be loaded on cars without shoveling. By using two sizes, the large for the bottom and the small for the top around the ties, good drainage may be secured and the disadvantages in surfacing largely reduced.

Granite, trap, many of the limestones and occasionally a sandstone will break into pieces which are fairly cubical and make durable ballast. Stone which breaks into flat or angular pieces is not satisfactory.

Stone ballast should be handled with forks rather than with shovels to avoid dirt which interferes with drainage and encourages the growth of weeds besides being dusty. It is becoming the standard on trunk lines running fast and heavy passenger trains on account of its stability and freedom from dust, but it is not an economical ballast to place on a soft or wet roadbed.

The cost varies greatly in different parts of the country, from 45 to 75 cents per cubic yard, f.o.b. at the crusher, being a fair average. The labor cost of placing under track and tamping will be from 15 to 25 cents per cubic yard. The cost of hauling by train and dumping from ballast cars will depend upon distance, density of traffic, etc.

Gravel is the material in most general use on account of its wide distribution and its many good qualities. The feeling is quite general among railroad engineers that for ordinary traffic, track can be kept in better line and surface than with broken stone. As a mass it is more elastic, easier on ties and rolling stock and less noisy, while track can be maintained in first class condition at less cost.

The size that will pass through about a 1½-in. mesh is considered best, although a larger size will give good results if combined with smaller stone and coarse sand. Fine sand or clay will retard drainage and encourage the growth of weeds; washing is sometimes resorted to with good results.

Camp¹ places the limits of cost commonly met with at 15 to 40 cents per cubic yard in place in completed track, 10 to 15 cents of which is due to handling the gravel after it is delivered on or at the side of the track. This includes the labor of placing it under the track, shovel tamping, filling in and dressing off.

Slag and burnt clay are used as substitutes for broken stone, the former when available at blast furnaces on account of lower cost and the latter in sections where broken stone can only be obtained by a long haul.

The slag is preferred when poured so that it will spread out in thin layers. In this way it becomes hard and brittle and will break easily. It should contain but little free lime. In track it has about the same characteristics as broken stone and it is used in the same manner.

The burnt clay is obtained by burning gumbo or other suitable clay free from sand with coal slack. A side track is extended out to the bed, a long pile about 4 ft. wide of old ties or other wood is made alongside and covered with coal slack and then with gumbo. The pile is set on fire and alternate layers of slack and clay added as the lower layers burn out. The final height may reach 10 ft. and the width 20 ft. In dry weather 4 to 5 cu. yds. may be obtained from a ton of slack. The cost in the pile will

¹ Notes on Track.

run from 25 cents per cubic yard up. Sometimes a steam shovel, traveling belt or other mechanical device is used in handling the clay and in loading the ballast.

The ballast is light and absorbs water readily. It is claimed to be nearly as durable as broken stone, easier to clean from weeds and cheaper in renewing ties, while the ties will last longer.

Locomotive cinder is the cheapest ballast for track work as the material is light and easily tamped. It holds up well for moderate traffic but is dusty. One of its best uses, however, is in filling wet places to supply drainage and prevent heaving by frost.

Dirt ballast is often used on new construction, and on lines of light traffic it may be many years before better material is supplied. For light traffic track can be kept in fair condition during dry weather, but in wet weather with a clay soil, it is impossible to keep the beds of the ties dry enough to carry the loads without settlement and churning. In cold weather when the ground freezes, the ties will heave unequally requiring frequent shimming to keep the trains on the track.

The depth of rock ballast required to produce uniform pressure on the subgrade with ties 7 by 9 ins. by $8\frac{1}{2}$ ft., spaced 2 ft. centers, is about 24 ins. as determined by experiments on the Pennsylvania Railroad¹ and by Director Schubert. The former experiments also showed that the lower 14 to 18 ins. could be replaced with cinders without appreciably affecting the results.

111. Ties.—The timber cross tie is 8 ft. long with a tendency to increase to 8 ft. 6 ins. for heavy traffic. The usual thickness is from 6 to 7 ins., $6\frac{1}{2}$ to 7 ins. would be better, while the minimum face should be about 6 ins. for pole ties and 8 ins. for those with rectangular section. The thickness should be uniform so that ties can be renewed without disturbing the old beds; differences in width can be provided for by varying the spacing to keep the bearing area per foot of track constant up to the limit for narrow ties which would interfere with tamping.

It is claimed that the best time for cutting trees is during the winter as the small amount of sap then in the wood will largely dry out in seasoning before the weather becomes warm enough for it to ferment and start decay. For coniferous woods slow growth on high lands in dense forests, and for hard woods rapid

¹ Proc. Am. Ry. Eng. Assoc., Vol. 13, p. 98, 1912. Methods of tests for stone and for percentages of clay, etc., in gravel ballast are also given.

growth on low lands more in the open are supposed to furnish the most durable timber for a given species, the mature tree in either case being better than a very young or very old one. Pole ties, or those in which one tie per cut is obtained by hewing or sawing to thickness and leaving the other two sides rounded, are preferred to those where two or four are obtained per cut by splitting or sawing. Hewed ties are usually preferred to sawed ties as leaving the surface in better condition to resist decay, and perhaps also because the crooked cross-grained sticks are more apt to be thrown away.

White oak is placed at the head of the list of timber available in this country for durability from decay, holding spikes and freedom from rail cutting. Its life is from five to ten years depending upon traffic and climate and to some extent upon ballast. Burr or rock oak, chestnut oak, and red oak are placed in order of value, the life of the last not being more than one-half that of white oak.

Pine is next in importance on account of its abundance. The long leaf yellow pine will last nearly as long as white oak, the loblolly rather more than one-half as long and the southern pitch pine about a mean of the other two.

There are many of the other woods in use some of which as chestnut and cedar are durable but require tie plates for protection to secure full life, while others as hemlock, elm, etc., will decay in a few years unless treated.

All ties should be stripped of bark and allowed to thoroughly season before being put in track.

Oak and pine ties are quoted in the monthly price list published in the Engineering News. On many roads ties can be secured locally at less cost.

Experiments on many railroads with the European inverted trough-shaped steel tie have led to its rejection for various reasons, chief among which are lack of durability of tie and fastening and difficulty in properly tamping under the trough.

In 1904 some 1200 Carnegie I-beam steel ties were laid at Claytonia, Pennsylvania, and they were so satisfactory that at the close of 1910 about 566 000 had been laid. Those used on different roads but mainly on the Bessemer and Lake Erie in 1910 were 8½ ft. long and 5½ ins. deep, top flange 4½ ins. and bottom 8 ins. wide, with an average weight of 180 lbs. exclusive of fastenings. It is reported that these ties are doing excellent

service and that they are economical in view of track maintenance and probable life, the rate of corrosion of those first laid indicating a life of from 25 to 30 years. Reinforced concrete ties have not been found durable for main line, but a combination steel and wood tie gives promise of being satisfactory.

The timber tie is thus practically the only one in use in this country and effort is being made to prolong its life on the one hand and to increase the supply on the other. The first is secured by tie preservation to protect from decay and by tie plates to protect from wear under the rail, but for these to be effective the spike which increases both wear and decay will have to give way to the screw spike or some better fastening. For specifications for tie treatment see the American Railway Engineering Association Manual or § 130.

The efforts to increase the supply have been mainly in the direction of plantations of catalpa, locust, or other quick growing, durable woods, but the results have not been very satisfactory owing mainly to lack of proper care and management. The government forestry experts now recommend the purchase and improvement of cut over woodland as another method of eking out the supply.

112. Rails.—The weight of rail should depend upon the weight and speed of trains and upon the amount of traffic. Rails weighing 56 to 60 lbs. per yard (sectional areas of 5.6 to 6 sq. ins. if of iron, or 2 per cent. less if of steel) used to be standard, and the 60-lb. is still in use on lines with heavy rolling stock and heavy freight traffic. The present tendency is to use 90 and 100-lb. rails for heavy fast passenger traffic and not to drop below about 80-lb. for freight. The heavy rail reduces train resistance¹ and gives a smoother and safer riding track.

The American Society of Civil Engineers and the P. H. Dudley rail sections have probably been most used. The former is shown in Fig. 70 for a 90-lb. rail and the latter in Fig. 71, while the Standard P. S. 100-lb. is shown in Fig. 72 for a 100-lb. rail. For the first, 42 per cent. of the material is in the head, 21 per cent. in the web, and 37 per cent. in the base. The height and width of base are the same, while for the Dudley and P. S.

¹ Tratman, *Railway Track and Track Work*, 3rd ed., p. 71, states that experiments in which hauling a load of 378 tons at 55 miles per hour required 820 HP on 65-lb. rails, required only 720 HP on 80-lb. rails; while it was estimated that only 620 HP would have been required on 105-lb. rails.

types the height is greater. This is an advantage in rolling as the base will not cool so rapidly with reference to the head, but the ties will be cut more rapidly owing to the reduced bearing and

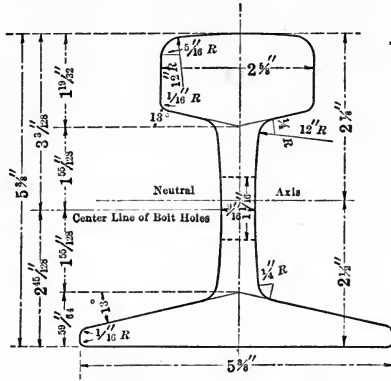

FIG. 70.—A. S. C. E. 90-lb. Rail.

greater leverage under side thrust unless tie plates are used. The head is thin and wide on each to maintain more equal temperatures in the different parts in rolling and to reduce the unit

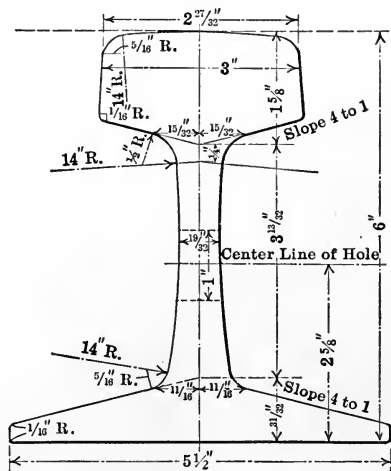

FIG. 71.—Dudley 100-lb. Rail.

pressure between wheel and rail. The recent tendency has been to thicken the base to still further equalize temperature in rolling.

The quality of the metal in the finished rail will depend upon

the chemical composition, the temperature of rolling and the work put upon the metal during rolling.

The chemical composition, to be determined from drillings taken from the ladle test ingot, is to be as follows in the American

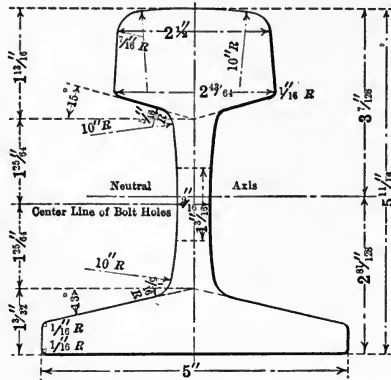

FIG. 72 —Standard P. S. 100-lb. Rail (Pennsylvania System)

Railway Engineering Association's specifications for carbon steel rails, Proceedings, Vol. 13, p. 565, 1912.

Elements	BESSEMER PROCESS		OPEN HEARTH PROCESS	
	70 lbs. and over, but under 85 lbs.	85-100 lbs. inclusive	70 lbs. and over, but under 85 lbs.	85-100 lbs. inclusive
Carbon,	0.40 to 0.50	0.45 to 0.55	0.53 to 0.66	0.63 to 0.76
Manganese,	0.80 to 1.10	0.80 to 1.10	0.60 to 0.90	0.60 to 0.90
Silicon,	not over 0.20	not over 0.20	not over 0.20	not over 0.20
Phosphorus	not over 0.10	not over 0.10	not over 0.04	not over 0.04

Carbon increases hardness and tensile strength and decreases ductility. The specified increase with weight of rail is probably partly due to a higher temperature during rolling and to less work per pound of metal in the process.

The manganese, according to Campbell, combines in part with the dissolved oxygen and passes off with the slag as an oxide when added as ferromanganese just before pouring. It is thus easier to add spiegel iron than ordinary pig iron to increase carbon since the manganese of the former prevents its oxidation. Manganese also tends to prevent the coarse crystallization due to phosphorus and sulphur and raises the critical temperature to which it is safe to heat the steel, for just as it resists the separa-

tion of the crystals in cooling from a liquid, so it opposes their formation when a high temperature increases molecular mobility.

The effect of silicon is small although in manufacture it acts like manganese as a flux and tends to prevent injury by oxidation.

Phosphorus tends to produce coarse crystallization and hence lowers the temperature to which it is safe to heat the steel; it also lowers the finishing temperature in order to prevent the formation of a crystalline structure during cooling. Its effect when cold, up to about .12 per cent. is to increase strength and hardness, but it renders the steel brittle under shock and should be kept at the lowest practicable limit.

In the Bessemer process as employed in this country, an acid lining is used in the converter and this prevents burning out either phosphorus or sulphur. The limit is thus fixed by that of the available ores.

In the open hearth method a basic lining is used and this allows of converting the phosphorus into a slag with lime, and the sulphur, with lime and manganese ore.

The basic open hearth method thus allows the use of cheaper ores and the reduction of phosphorus and sulphur to low limits. It also furnishes a more uniform product as the melt can be sampled and proportions corrected if found desirable before pouring. The open hearth rail is coming into use; the increased cost is about \$2 per ton.

The standard length has changed from 30 to 33 ft. after experimenting with lengths of 45 and 60 ft. Rail breakages have been numerous with the increased weight and speed of trains, and both rail makers and users are aroused to the gravity of the situation. That they are securing results will be appreciated by a study of the report of the Committee on Rail published in Volume 13 of the Proceedings referred to above.

113. Rail Joints.—The common angle bar splice, Fig. 73, comes in contact with the rail along the fishing surfaces under the rail head and on the rail base. By tightening the track bolts the bars are wedged in so that shear and bending moment due to wheel loads will be transmitted across the joint giving somewhat the effect of a continuous rail. To increase the strength and stiffness, the lower flanges may be widened opposite the joint and extended down below the rail base as in the 100 per cent. type, Fig. 74, the Bonzano, Duquesne, etc. In other forms a plate is placed under the joint as an extension of the lower flange of

one of the angle bars, or as a separate plate locked to the lower flanges of both bars.

Quite a number of rail joints were tested at the Watertown Arsenal under the direction of the Committee on Rail of the

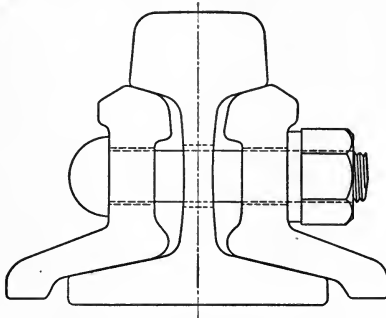

FIG. 73.—Angle Bar Splice

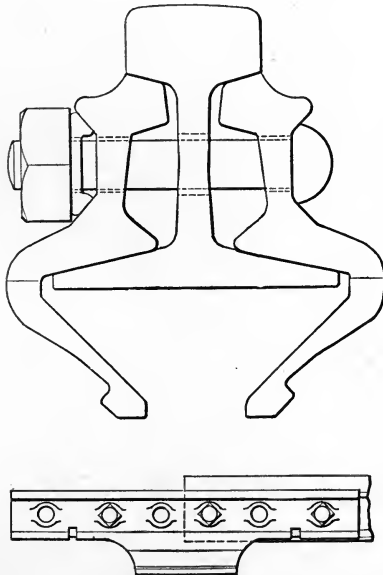

FIG. 74.—100 Per Cent. Type of Joint

American Railway Engineering Association and the results published in Bulletin 123, May, 1910. The span was 30 ins. Two joints of a kind were tested, one with a center load of 32 000 lbs. on the base, the other with an equal load on the head, the

rails were then inverted and the load increased to failure or to the capacity of the testing machine.

Below are given the data for the strongest and stiffest joint tested for the 100-lb. rail and for the strongest and stiffest angle bar joint for the 100-lb. and for the 80-lb. rail.

	Rail			Joint		
	100-lb.		80-lb.	<i>a</i>	<i>b</i>	<i>c</i>
	<i>a</i>	<i>b</i>	<i>c</i>			
Area full section,	9.82	10.02	7.84	13.6	6.74	6.74
Moment inertia,	43.80	49.0	27.78	47.2	9.36	9.33
Section modulus, normal,	14.85	15.69	10.58	15.	4.39	4.36
Section modulus, inverted,	15.64	17.00	11.11	12.24	5.14	5.12
Elastic limit, normal,	119 000	125 000	85 000	72 500	56 000	55 500
Elastic limit, inverted,	125 000	136 000	89 000	41 000		
Max. deflection, normal,	.013	.012	.020	.048	.065	.093
Max. deflection, inverted,	.013	.012	.020	.050	.052	.082
Ultimate, normal,				117 500	95 500	88 000
Ultimate, inverted,				87 500		

The 100-lb. rail *a* was an American Society section, the 100-lb. *b*, and the 80-lb. *c*, Dudley New York Central sections. The moments of inertia and section moduli are taken from Vol. 11, pp. 267 and 279 for the first and third and from Vol. 12, p. 146 for the second.

The section modulus normal is for the head and the inverted for the base of the rail. The elastic limit and the maximum deflection are inserted from computation for comparison with the joints, with an assumed elastic limit of 60 000 lbs. and a modulus of elasticity of 30 000 000 lbs. It may be noted that the joints compare more favorably with the rail in section modulus than in stiffness.

The bolt holes for the splice bars and the notches for the spikes to prevent rail creeping are usually punched, and this is one of the reasons why soft steel, about 0.1 carbon, is common, but one of the pairs of bars tested contained 0.63 per cent. carbon.

The length varies from about 2 ft. with 4 bolts to 3 ft. with 6 bolts although a length of 3½ ft. has been used. The short bar is used with a suspended joint midway between two ties, the bar reaching from tie to tie. The long bar is used with a three-tie joint, the ends resting on the outer ties with the joint on the center one.

The suspended joint is advocated as doing away with the pounding action due to a solid support under the rail and it is required for the splice bars which extend below the rail base at the joint; the three-tie joint is advocated as giving better support for the joint (which is the first part of the rail to go down under traffic) than the two-tie support and it is used on quite a number of the heavy traffic trunk lines.

With long bars a little wear of the fishing surfaces or looseness of the bolts has less effect in allowing angular motion, a consideration often overlooked.

The track bolts are usually $3/4$ to $7/8$ in. with round heads and elliptical section under the heads to prevent turning in the elongated holes of the splice bars. Various methods are used to prevent the nuts from rattling loose, among the most effective being the spring washer and the Harvey grip thread. The holes in the rails are drilled large enough to allow of temperature changes, the bolts acting only in tension to hold the fishing surfaces in contact with sufficient force to transmit bending moment.

Rail joints may be laid opposite or alternate. The former is common in the West and in Europe. It is advocated on the ground that since the tendency of track is toward low joints if they are put opposite no side lurch is given and the train is easier on track and passengers. The motion, however, is unpleasant and it is hard on draft rigging and on track, the blow if both sides go down being heavier than for only one.

On curves alternate joints will hold alinement much better as there is a solid rail opposite each joint to prevent the track from kinking due to springing the track somewhat to fit the curvature. Again, while it is cheaper to lay new track with opposite joints on tangents it is more expensive on curves due to having to cut and redrill each inner rail, rather than let the inner joints run ahead until a rail one foot or more shorter than the standard length can be used. Specifications provide for the acceptance of about 10 per cent. of the rails of lengths shorter than the standard by whole feet down to about 25 ft. because the cropping of the top of the ingot may prevent the remaining portion from cutting into full rail lengths.

114. Tie Plates and Rail Fastenings.—The white oak tie is about the only one which under fairly heavy traffic will resist rail wear until removed on account of decay. There is thus no

economy in treatment to prevent decay without protection from wear.

The tie plate has passed the experimental stage and has come into extensive use in protecting soft wood ties and in preventing rails from spreading, especially on curves where it is replacing the rail brace.

The tie plates of ten years ago were rolled thin, mostly with sharp ribs or flanges on the lower side lengthwise of the tie, which gave stiffness to the plate and held it in position by being pressed into the wood. Some of the plates were rolled lengthwise of the rail which allowed of a shoulder for the outside of the rail base, while the ribs on the underside were milled out in alternate sections leaving lugs to project into the ties. Some of the plates were so narrow that the spikes were driven on the sides and not through them.

As the result of a study of track fastenings with treated ties, the track committee of the American Railway Engineering Association conclude:¹

That tie plates with some form of fastening which can be removed and replaced at will are desirable.

That in shoulder tie plates the holes should be so placed that the base of rail bears only against the body of the fastenings.

That tie plates should be flat bottomed.

That the bearing surface should be proportioned by each road to the resistance of the wood most largely used. In general, plates 6 ins. wide for hard woods and 7 ins. for soft woods should be sufficient, but some roads report trouble with these widths.

That a plate with only a central bearing for the rail is suggested for trial as reducing the tendency to rock the tie under the action of a passing load.

On the Santa Fe Railway² the question of rail fastenings has been solved by the adoption of the screw spike. The economy of soft wood creosoted ties has been demonstrated after a thorough study of native woods and supplies from other countries.

The preparation for the spike is done before treatment by machinery mounted on a flat car. In the first operation, two 1½-in. holes are bored at each end of the tie; in the second, a coarse thread is cut in each hole; in the third, the prepared oak plugs are inserted; and in the fourth, the top of the tie is dressed

¹ Vol. 12, Part 1, p. 410, 1911.

² Eng. Rec., Vol. 61, p. 35, 1910.

to receive the tie plate and to distribute the pressure between the plug and tie. The road had eight miles of this track in January, 1910.

On the Hopatcong cut-off of the Lackawana Railroad, the ties are 7 by 9 ins. by $8\frac{1}{2}$ ft., each treated with $3\frac{1}{2}$ gallons of creosote. They are spaced 1 ft. 10 ins. centers with a foot of crushed stone under the tie. The tie plate,¹ Fig. 75, is the result of a long experience with track fastenings. The section is rolled as usual up to the finishing pass, leaving sufficient metal on top to form the lugs or shoulders. The upper roll for the finishing pass is recessed in such a way that the excess metal will be forced into the recesses, each revolution forming the lugs for seven or eight plates according to the diameter of the roll and the length of the plates. These long pieces are then sheared and afterwards punched, giving the form as shown. The small holes near the ends are for lag screws for attaching the plates before leaving the creosoting plant.

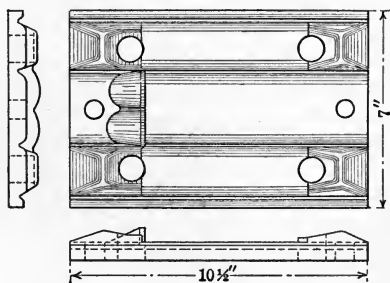

FIG. 75.—Lackawana Tie Plate.

The screw spikes are $\frac{7}{8}$ -in. diameter over the threads and $\frac{5}{8}$ in. at the root, with a length of $6\frac{1}{4}$ ins. under the head. The holes in the ties are $\frac{5}{8}$ -in. and they are drilled in the field. Two screw spikes, staggered, are to be used on tangents; an extra outside one on curves, while the fourth hole is saved for use when a spike breaks off in the tie.

The standard size of track spike is $\frac{9}{16}$ -in. square and 5 to $5\frac{1}{2}$ ins. long under the head. The weight, if $5\frac{1}{2}$ ins., is about $\frac{1}{2}$ lb. The head is usually oblong with the under side inclined to fit the rail base, or at about $13\frac{1}{2}$ degrees. The point is wedge-shaped the wedge extending back from $\frac{3}{4}$ to $1\frac{1}{2}$ ins. On account

¹ Eng. Rec., Vol. 63, p. 86, 1911.

of its convenience and low cost it has held the field against all comers for timber ties, until now it will probably be gradually crowded out by the greater safety and economy of the screw spike under present conditions.

The improved fastening for the Carnegie steel tie for the 100-lb. rail consists of a clip $1/2$ in. thick and 2 ins. wide resting on the tie for $2\frac{1}{2}$ ins. and projecting over the rail base $3/4$ in. and a $3/4$ -in. bolt extending up through the flange and clip with an oblong section $3/4$ by $1\frac{1}{8}$ in. The oblong holes and the shoulder against the rail base prevent the clip from turning.

For automatic signals involving track circuits, the tie must be insulated with fiber from bolts and rail. It is claimed that the 1000 insulated ties installed in 1906 have given no trouble.

115. Turnouts.—The principal parts of a turnout are a switch or switch rails, a frog, and lead rails connecting the switch rails with the frog. The switch rails are movable at one end so that car wheels may be guided along the main track or to the side track as may be desired. The frog provides flangeways at the intersection of the outer lead rail with the main rail so that the wheel flanges can pass through on either track.

With the stub switch the switch rails are regular main track rails with turnout ends unspliced and movable. Three or four gage rods are used to preserve relative positions and the end one is extended to a switch stand by means of which the rail ends are moved to connect with main rails or leads rails as desired. The fixed ends are spiked so that the rails are curved when sprung over to the lead rails.

Head chairs hold the lead and main rail ends in position, spaced about 5 ins. centers and allow the switch rails to slide between stops which prevent lip when set for either main line or side track.

The stub switch has practically gone out of use on account of the break of continuity at the head chairs, which prevent the transmission of shear or bending moment over the joint, makes a rough riding track and increases the danger of derailment due to lip or rail ends not being in line.

With the point switch, Fig. 76, the outer rails of the track as seen in facing the turnout are continuous, one along the main track and the other as the inner lead rail of the turnout; each is kinked slightly to protect the points of the switch rails which are placed between the continuous rails.

The switch rails are bent and planed so that the gage side of the head will be straight and the other side conform to a given spread at the heel and thickness at the point without cutting away the web. The Committee on Track of the Railway Engineering Association, Vol. 13, 1912, recommends a spread of $6\frac{1}{4}$ ins. between gage lines, a throw of 5 ins. at the first rod and a thickness of $\frac{1}{4}$ in. at the point which is afterward ground to $\frac{1}{8}$ in. and the top corner rounded. A $\frac{3}{8}$ -in. reinforcing bar is riveted to the web on each side and carried back as far as the heel connections will permit. The bottom of the switch rail is planed to fit on

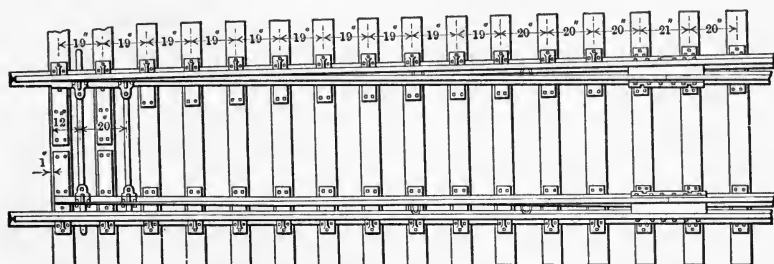

Fig. 76.—Point Switch.

base of stock rail where bases overlap, Fig. 77 *a*. Stop blocks are used as shown, Fig. 76, to support the free portion of the switch rail from the stock rail which has a brace at each tie. The supporting plates for the two rails are planed with a step to raise the top of the switch rail $\frac{1}{4}$ in. to provide for hollow tires. The top of the switch rail is planed down to be $\frac{1}{2}$ in. lower than the stock rail and this planing runs out or rises $\frac{3}{4}$ in. in the following distances:

Length of switch rail	Length of planing
33 ft.	12 ft.
22	9
$16\frac{1}{2}$	7
11	5

The above lengths of switch rail are arranged for cutting from 33-ft. rails.

The committee claims that when the corresponding switch angle exceeds one-fourth the frog angle, the switch point presents the worst feature in the alinement and there is an economic loss both in space occupied and in cost of turnout. On this

basis the committee recommends the following lengths of switch points:

- 16½ ft. for frogs over no. 6. and including no. 10
- 22 ft. for frogs over no. 10 and including no. 14
- 33 ft. for frogs over no. 14.
- 11 ft. for frogs no. 6 and under when required.

Frogs nos. 8, 11, and 16 are recommended as meeting all general requirements for yards, main track switches and junctions, with the object of eliminating other numbers and reducing the stock pile. The lengths shown in the drawings submitted are 13½, 17½, and 24 ft., respectfully, for the three numbers. The rails are all bolted through the webs, using fillers or washers for spacers, while for the rigid frogs the rail bases are riveted to a plate.

The spring frog is used for main line work where there is but little traffic on the side track on account of the better support of

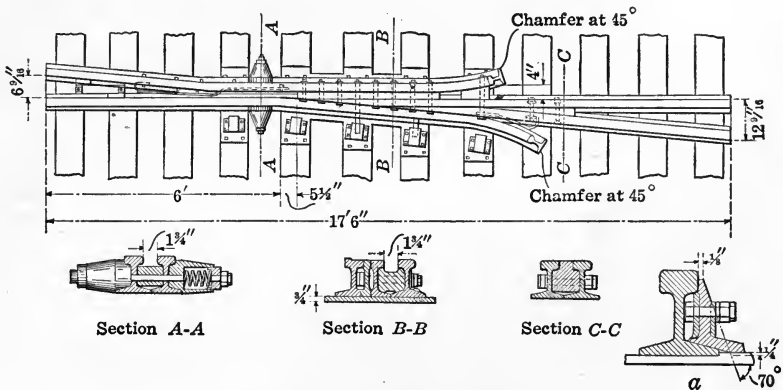

FIG. 77.—No 11 Spring Frog

the wheel treads at the frog point. For the side track, the spring yields to the pressure of the wheel flanges and the frog acts otherwise like a rigid frog. With hollow treads the wings receive heavy blows from wheels coming in the direction to reach the heel or wings first unless the latter are chamfered to inclined planes as shown in Fig. 77.

To protect the frog point and prevent derailments, a guard rail is necessary on each track with a flangeway of about 1¾ ins. to guide the wheels past the frog.

Where the turnout is on the outside of a curve, a guard rail is often placed in advance of the switch point to prevent the flanges from crowding and possibly getting behind the point, when set for main track. Cutting the side track point about 2 ft. short allows the guard rail to reach more nearly opposite the main track point.

For the switch ties if spaced about 20-in. centers, with two 7 by 10-in. by 14-ft. ties for the head block and 7 by 9-in. ties for the others, there will be required on the basis of 8 ft. length for single track about as follows:

No. 8 frog, 16½-ft. switch rail,	2700 ft. B.M.
No. 11 frog, 22-ft. switch rail,	3550 ft. B.M.
No. 16 frog, 33-ft. switch rail,	5000 ft. B.M.

The prices for timber, frogs and switch points are quoted in the monthly price list published by the Engineering News. The cost of switch stands including rods, lamps, etc., is placed at from \$25 to \$30, and the labor cost of laying and surfacing at \$50.

Manganese steel-tipped points and manganese steel insets and frogs are coming into use with marked economy at points of heavy traffic.

The turnout track instead of being extended as a siding or a branch line may connect with a parallel track forming a cross-over, which requires a duplication of frog, lead rails and switch rails on the other track. For infrequent use they should be set trailing to the direction of traffic.

The frogs at grade crossings are similar to those for turnouts, but they are made special with angles to fit the location and are not numbered and kept in stock.

116. Drainage.—Before laying track, drainage for the roadbed should be looked after carefully. It is assumed that sufficient waterway has been provided for the rainfall run off and that the grade line has been placed at least two feet above high water in completing construction to subgrade. This in general should take care of the fills unless additional protection from strong currents or wave action may be necessary at certain points, or fills have been made in marshes which continue to settle, due to compression or flow of soft underlying material.

Track drainage is assumed to apply only to the cuts or to fills so low that well-drained side ditches are necessary.

Wherever the transverse slope of the ground is toward the cut, a substantial ditch should be dug which will carry the water to a channel below grade and protect the side slope from surface water from outside the slope stakes. For a long shallow cut, this may require a gradually deepening ditch to secure the proper slope or it may sometimes be necessary to drain into the cut and enlarge one of the side ditches. If so this should be done by paving or concreting the channel down the side slope. If the side slopes are wet, the water can sometimes be cut off by shallow ditches outside the right of way, otherwise tile drains should be laid and in extreme cases the ditches partially or entirely filled with stone. The slope can be flattened by running the ditches diagonally when there is danger of wash.

The protection of the slopes by brush, planting shrubbery, sowing the seed or setting tufts of some of the wild grasses, or in exceptional cases by sodding, has been found expedient on many of the roads, the Pennsylvania probably taking the lead in this direction.

Raw clay slopes will wash and slough badly when soaked with water, constantly filling the ditches with mud and increasing the cost of track work in gradually removing the material required to flatten the slopes of a deep cut.

In excavation, the cut is made wide enough for side ditches, outside the roadbed proper, as shown, Fig. 78. In rock cuts, a depth of 6 ins. below the ballast or subgrade is sufficient for drainage if the ditch is large enough to carry the water, but the minimum width to the side slope should be 9 ft. for convenience in tie renewals, although 8 ft. is common in deep rock cuts on account of first cost. In a dry cut a ditch 9 ins. deep below subgrade is sufficient under ordinary conditions as it has to carry only the water falling within the side slopes, while the depth of ballast need be no greater than for the fill, and if this is 6 ins. under the ties, 18 ft. between slopes will still answer.

If the cut is wet the ditch should extend at least a foot below subgrade and a foot of ballast should be placed under the ties, requiring a width of 20 ft. between slopes. Where springs come up through the roadbed, it is usually difficult to keep the ballast dry and the track in surface. The remedy is to widen out the cut and slope away gradually to the bottom of the ditch, then to use a good depth of ballast the bottom of which is rather coarse rock unless cinders are available. About 18 ins. of ballast should

be used and the cut should be at least 22 ft. at subgrade. If the cut is through clay, deep, narrow ditches cannot be maintained and the remedy is to widen out with a slope so flat that the material will not flow out from under the ballast. A deep ditch is used for the ditch on the upper side of the highway in New York State Good Roads Construction, with a tile drain at the bottom and gravel or broken stone above to aid in drying out the roadbed leaving the regular ditch for surface water.

The above dimensions are for ditches at their highest points. If the track gradient is a 0.35 or more no enlargement will be necessary until required on account of the volume of water. If below 0.35 per cent. a summit point in the cut should be selected and a gradient of at least 0.35 (some specify 0.5) should be carried each way until the water can be discharged from the roadbed. This may require widening the cut in order to avoid undermining the roadbed.

The locating engineer sometimes forgets track drainage in making a long shallow cut on a flat gradient where the transverse slope is small.

The Manual of the American Railway Engineering Association shows the accompanying ballast section, Fig. 78, as an illustration

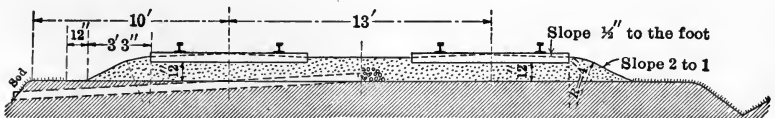

FIG. 78.—Roadbed Ballast Section

of good practice for Class A track with crushed stone or slag ballast on the firmest, most substantial and well-drained subgrades. The sodding of the roadbed shoulder and of the slopes of the ditch is recommended. For gravel, cinders, and chats, the slope below the arc with 4-ft. radius is changed to 3 to 1.

For Class B track the depth of ballast under ties is reduced to 9 ins. and the subgrade roadbed to 8 ft. from center of track, while for gravel, cinders and chats, the ballast may slope 1/2 in. per foot as for stone out to the arc with 4-ft. radius and then 3 to 1 as for Class A gravel, or it may curve down to the lower corner of the tie and then slope 3 to 1 reaching subgrade 2 ft. 3 ins. out from the end of the tie. For Class C track, the depth of ballast under the tie is reduced to 6 ins., the subgrade roadbed to 7 ft.

from center of track, and only cementing gravel and chert shown, dropping to lower corner of tie or having the slopes of Class B gravel as desired.

The object in dropping ballast to lower corner of tie is to drain the bed of the tie in case the ballast retains water.

117. Track Laying.—For new work, this is begun at points accessible by rail or water for convenience in transportation as the work proceeds. Usually an outfit train is fitted up for boarding and housing the working force and kept on a side track as near the front as feasible. The rails and fastenings, and the ties if they have not been secured locally and delivered along the right of way, are brought up by a supply train from the material yard, engine in the rear, and delivered at the front.

There are two general methods of handling the materials from supply train to track. One by unloading on the side of the track, and reloading as required on a four-wheeled car which is moved ahead by hand or team and kept at the end of the track, so that the carrying is reduced to about a rail length. The other by machinery connected with the supply train by means of which the materials are run forward on the train itself so that by keeping the front car up to the last rail joint they can be delivered, including unloading, at the proper point for use.

Before distributing the ties, a small grading gang should go over the roadbed and even the surface where necessary for drainage or for a uniform support of the ties to prevent the kinking of the rails before partial ballasting with earth.

The center line should be run and substantial stakes set at 100-ft. stations and at ends of transition and circular curves. On long tangents the odd stations may be omitted, while on sharp curves, the half stations should be marked.

In distributing ties a line is stretched one side to keep the ends even. If piled on the right of way they can be distributed by team and properly spaced so as to place a large tie for each rail joint. If brought up by train they can be distributed at night by team if necessary to drive on the roadbed (beginning at the far end and working toward the end of track), or during the day if the traveling is good on the right of way. They can also be distributed from the rail car if piled crossways and blocked high enough to allow the rails to be pulled out without disturbing them, but this requires carrying them forward a rail length by hand.

In laying rails, each is carried forward until the rear end can be placed between the loose angle bars of the preceding. It is then pushed back to place, alined, half bolted and partially spiked to gage and the car moved forward a half rail length. The rail is sometimes held by a clamp gage and the spiking all done behind the rail car.

A gang of surfacers is kept as near the front as possible to level up under ties before many trains pass.

Camp, Track, estimates that ~~where~~ the ties are hauled ahead by trains, 56 laborers, 3 foremen, and 11 teams with drivers should lay a mile of track in 10 hours under average conditions without hurrying. The force would be distributed about as follows:

4 men loading ties	12 spikers
10 teams hauling ties	6 nippers
6 men placing ties	1 spike distributor
8 men unloading and placing rails	1 bolt distributor and shim collector
2 head strappers	1 water boy
4 back strappers	1 team on rail car
	3 foremen

Total, 56 not including foremen.

Where the ties are run out on rail cars and carried ahead, one man carrying a tie as may be done with soft wood ties, 8 men are added and 9 teams subtracted from the force as given above.

This is for skeleton track which should be surfaced by taking materials from the edges of the roadbed before trains are allowed to pass. Frequently it is ballasted with earth and used for speeds up to 25 to 30 miles an hour during the period of thin traffic. If other ballast material is to be used it is brought on in ballast cars and dumped or dumped and spread. The track is then jacked up, alined and tamped to surface, but new track will settle unevenly and it will take some time to get it in smooth riding condition. Temporary side tracks need be only half tied while the boarding cars can be set out without putting in a turnout by temporarily unspiking and swinging the main track rails.

In double tracking, the roadbed can be smoothed with a spreader car (see § 27) and the ballast to the depth used under the ties, delivered in side dumping cars and spread giving a smooth bed on which to lay the ties. The ties and rails can be cheaply distributed from a construction train on main track or a track-laying machine can be used.

With track-laying machines, the rails with angle bars attached

and the ties are brought forward from the supply cars of the construction train to the front car or machine by power, the ties are carried over the upper chords of a cantilever truss projecting a rail length in advance of the car and delivered when they can be placed without disturbing the rail men. Each rail is carried forward and lowered so that it can be easily guided to position a little in front of the splice bars of the rail in place and then pushed back by hand and partially spiked, or in some cases held by bridle bars and spiked after the train has passed ahead. Some are self propelling, others have power for handling the material only and require a locomotive for the train.

The older machines are described and illustrated in Camp's Track, and one of the later ones in which air is used in handling the rail from car to track, in Engineering News, Vol. 58, p. 586, 1907. In the latter case the machine was used in tracklaying on an interurban line starting from Tacoma, Washington, and it is stated that from 2 to 2½ miles per day could be laid with the following force: 1 foreman, 4 men to operate the machine and feed ties and rails to the conveyor, 6 men to distribute and space ties, 4 strappers, 8 spikers, 4 nippers and one spike peddler.

An itemized cost account of laying track on the Frisco Line in Louisiana, with a Harris machine is given in Engineering-Contracting, Vol. 34, p. 111, 1910. Part of the supplies were brought 35 miles by the night crew which did some switching during the noon hour when the day crew was off. About 6000 ft. of full tied, bolted and spiked track was laid per day at a total cost of about \$200 per mile, the contract price being \$275. This included the switch work. It is claimed that an improvement in the bridle rods used could be made which would increase the output by 1000 ft. per day or reduce the cost to \$166 per mile for skeleton track.

118. Grade Crossings.—In railroad construction in this country grade crossings with highways have been the rule on flat ground both in country and city. With thin traffic and slow speed on single track, accidents were few, but as traffic and density of population have increased, the grade crossing in both city and country has become a serious source of danger to the public and of expense to the railroad companies.

Thus in a report submitted to the Public Service Commission by Commissioner Bassett¹ in 1910, it was stated that there were

¹ Eng. News, Vol. 63, p. 464, 1910.

457 places in Greater New York where steam railroads cross streets at grade, and that during the two and one-half years preceding January 1, 1910, 56 persons were killed and 100 injured at these grade crossings.

Under the New York State law providing for the elimination of grade crossings under which the company pays one-half, the state one-quarter, and the municipality or town one-quarter, nearly \$6 500 000 were expended during the first eleven years of its operation. A much larger sum has been spent in Massachusetts and grade-crossing elimination is in progress or under advisement in nearly all the large centers of population.

The committee on Crossings, etc., of the American Railway Engineering Association, Vol. 10, p. 878, 1909, divide grade crossings into four classes, as follows:

(1) Those where paving is required to conform to street specifications; (2) where no paving is required; (3) highways outside of towns; (4) farm crossings.

For (1) they recommend treated ties and stone or slag ballast not less than 12 ins. thick, placed in 3-in. layers each thoroughly rammed, or an 8-in. bed of 1-3-6 Portland cement concrete. With the ballast and outside the tracks, porous tile drains not less than 6-in. are called for, leading to drainage.

For stone block paving deeper than the height of rail a malleable iron or steel chair with base not less than 48 sq. ins. should be provided, the rail to be fastened through the chair to the tie with lag screws. An old rail or suitable form of rolled filler should be placed to form a 2-in. flangeway. The paving is limited by the top of the rail on the outside and by the filler set about 1/4 in. low on the inside. On long stretches of track, a special rail not less than 9 ins. deep with flangeway rolled in, tie plates and screw spikes can be advantageously used.

For brick and asphalt, a 4 by 6-in. treated timber fitted to expose a 3-in. top is placed 1/4 in. low outside the rail to limit the paving.

For (2) where no paving is required, plank not less than 3 ins. thick should be used and shimmed to 1/4 in. below top of rail outside, and inside if required. A 2-in. flangeway should be provided as for (1), with the ends widened to 4 ins., and the plank fitted to hold the metal in place without other fastening. The ends of the plank should be beveled and the plank outside the rail should be at least 10 ins. wide. Concrete, slag or other

suitable material should be used outside the planking. It can also be used in place of the inside planking, except for the plank next the guard on each side, where the requirements do not call for continuous planking.

For (3), highways outside of towns, the construction should be similar to that for minimum planking described above, and the crossing should be level for a distance of 5 ft. outside of the outside plank. On a fill, the approach grade should not exceed 6 per cent. The width of highway crossings should not be less than 16 ft.

For (4), the farm or private road crossing, ballast or other suitable filling should be brought level with the top of the rail between and for a distance of 3 ft. outside the rails, leaving a proper flangeway. The approach grades should not exceed 8 per cent. The width of crossing should not be less than 12 ft.

119. Cattle Guards.—The open pit guard with ties omitted and rails supported directly on stringers, if of sufficient depth and span, is effective in turning stock, but dangerous for derailed wheels and for employees or others walking the track at night. To remove these objections, ties have been added, but with the upper corners chamfered to make the footing insecure for stock. This introduces the danger of cattle slipping off the ties and becoming caught, where if struck they are almost certain to derail a train. In a design used by the Florida East Coast Railway the 8 by 8-in. ties and guard rails are laid on corner, and the ties are spaced $15\frac{1}{2}$ ins. centers. It is intended to be strong enough to carry derailed trucks and is said to be efficient in turning stock.

But the present tendency is toward eliminating all small openings in the roadbed and making the ballast continuous, and this leads to surface cattle guards.

A wooden slat guard used on the Illinois Central Railroad is shown in Fig. 79. It is made of 2 by 4-in. oak slats, put together in four sections, each held by three $\frac{5}{8}$ -in. bolts. Each section is held down at the end with a piece 2 by 6 ins. beveled to correspond with the bevel at the end of the slats, that at one end is spiked and that at the other held by lag screws for convenience in removal for repairs or track work.

The ballast should be partially removed between the ties, so that the slats will not have the appearance of a solid support. Camp advocates a length of at least 15 ft. as being more effective

in turning ranch stock than the length of 9 to 10 ft. in common use. Whitewashing the guard and the guard fences and placing the guard well out toward the highway from the fences so as to give opportunity for stock to turn aside rather than to walk into a pocket will increase the effectiveness of the guard.

Metal guards of various patterns are also in use.

The cost of wooden guards ready for use is from \$15 to about \$30, depending upon length and size of slats. The cost of metal guards of sufficient strength to be durable would be somewhat greater. To this must be added cost of placing and the cost of the fencing.

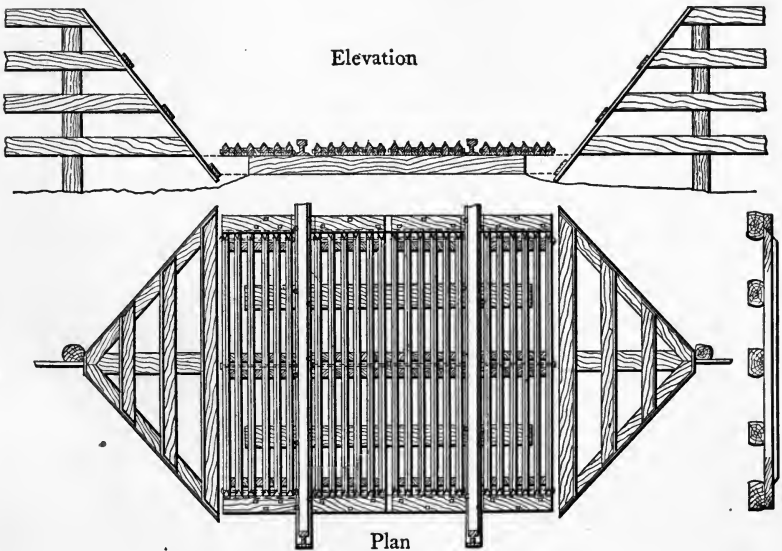

FIG. 79.—Wooden Surface Cattle Guard.

In *Engineering News*, Vol. 58, p. 87, 1907, an illustrated description is given of a cattle guard made by the Climax Stock Guard Company, of expanded metal placed on each tie, and of another where the ties are deep and protected by barbed wire which, it is claimed, will turn range cattle.

120. Fences.—It is always desirable and usually necessary to fence the right of way when on private ground and not in a public street. The post and board fence has given way to the post and wire in most localities.

The American Railway Engineering Association Manual gives

specifications for three classes of smooth wire fences $4\frac{1}{2}$ ft. high with wooden posts. Preference is given to smooth wire, but if barbed wire is used, a heavy smooth wire, or a plank at the top of the fence is recommended.

For the three classes of smooth wire fence, galvanized no. 9 gage is used throughout except for the top and bottom longitudinal wires of Class 1 which are no. 7 gage. The longitudinal wires are all coiled; the spacing, commencing at the bottom, is Class 1—3, 4, 5, 6, 7, 8, 9 and 9 ins.; Class 2—5, $6\frac{1}{2}$, $7\frac{1}{2}$, 9, 10 and 10 ins.; Class 3—14, 14 and 14 ins. The bottom wire is to be placed above the ground 3, 6 and 12 ins., respectively, for the three classes. The stay wires are spaced 12, 22 and 22 ins., respectively.

Intermediate posts are to be 8 ft. long and not less than 4 ins. in diameter at the small end, and end posts 9 ft. long and 8 ins. in diameter; round posts are preferred.

The posts are to be set with the large end down, the end posts 4 ft. deep and the intermediate ones 3 ft., with spacing from $16\frac{1}{2}$ to 33 ft., depending upon the nature of the ground and the service required. Gates are necessary at farm or private crossings.

Complaint has been general in regard to the poor service obtained from galvanized wire. It is stated that in order to procure better protection it is necessary to secure an increased uniform thickness of the zinc coating and to insure that the galvanizing is intact after the wire has gone through the fence-weaving machines. It is recommended that a second coat of zinc be applied to the fence after it is manufactured.

The no. 7 wire weighs 439 lbs. per mile, and contains 12.05 ft. per pound, the no. 9, 306 lbs. and contains 17.24 ft. per pound. The staples are to be made of no. 9 galvanized wire, 1 in. long for hardwood, 108 per pound, and $1\frac{1}{2}$ ins. for soft wood, 72 per pound. The top wire is to be double stapled.

Galvanized wire nos. 0 to 9 is quoted, f. o. b. Pittsburgh, in less than car load lots at \$1.95 per 100 lbs., September 1912.

In Bulletin No. 144 of the Railway Engineering Association, it is stated that the tendency to use reinforced concrete posts is increasing and that the figures prevailing for the most popular form now on the market is from 18 to 22 cents. The prevailing cost for wood posts of the most durable kinds of timber native to the road is from 12 to 15 cents. Several forms of metal posts

are being made, and it is claimed by a large manufacturer that they will have a life of at least thirty years and can be delivered at reasonable distances at 23 cents f. o. b. line of road.

Camp, Track, p. 825, estimates that under average conditions the labor of building a barbed wire fence four strands high, posts 16 ft. apart, is about 13 days work (10-hr. day); with posts 12 ft. apart 16 days; with top board and four wires, posts 12 ft. apart, 18 days. For a fence with a different number of wires allow about 8 hrs. labor for each wire. Experienced fence men working by contract will build about 50 per cent. more fence per day than the same number of ordinary track laborers engaged on the work only a short time each season.

The average cost for labor in erecting 22 miles of Page woven wire fence, posts 17 ft. apart and set 3 to 3½ ft. in the ground, was 17.2 cents per rod as shown by the reports of the fence gang of a certain railroad. The surface was generally rough and uneven and a great many anchor posts had to be used. The cost stated, covered the labor of loading and unloading new material, removing the old fence and piling or burning it, and the time used in moving the fence gang from point to point.

REFERENCES

- Railway Track and Track Work. E. E. R. Tratman, 1908.
Notes on Track. W. M. Camp, 1903.
Railroad Construction, Theory and Practice. W. L. Webb, 1909.
Report of Committee on Ballast. Proc. Am. Ry. Eng. Assoc., Vol. 13, p. 95, 1912. Abstracted in Eng-Cont., Vol. 36, p. 167, 1911.
Handling Stone Ballast. Eng. Rec., Vol. 66, p. 318, 1912.
Steel Ties on the Bessemer and Lake Erie R. R. Ry. Age Gaz., Vol. 53, p. 742, 1912.
Notes on Railway Ties. Eng. News, Vol. 66, p. 705, 1911.
A combination of Steel and Concrete Ties on the Pittsburgh, Ft. W. and Chi. R.R. Eng. News, Vol. 63, p. 205, 1910.
Machine for Boring and Trimming Ties and Driving Screw Spikes. Eng. News, Vol. 66, p. 458, 1911.
Insuring Soundness in Steel Rails. R. W. Hunt, Ry. Age Gaz., Vol. 53, p. 464, 1912.
Method and Cost of Rail Renewal. D. A. Wallace, Eng-Cont., Vol. 34, p. 192, 1910.
A Study of Seventeen Good Service Rails. Proc. Am. Ry. Eng. Assoc., Vol. 13, p. 573, 1912. See also, Rail Failures, p. 230 and Vol. 12, part 2, 1911.
Special 110-lb. Rails for Heavy Curves and Grades on the Lehigh Valley R. R. Eng. News, Vol. 68, p. 779, 1912.

Track Development for High Speed Train Service. Eng. News, Vol. 64, p. 260, 1910.

Track on German Railroads. Eng. Rec., Vol. 61, p. 132, 1910.

Track Construction in the Detroit River Tunnel. Eng. Rec., Vol. 61, p. 282, 1910.

Track and Track Laying on the Canadian Transcont. Ry. Eng. News, Vol. 67, p. 1208, 1912.

Building and Maintaining Railroad Crossings. Eng.-Cont., Vol. 30., p. 456, 1908.

A Review of Track Elevation in Chicago. Eng. News, Vol. 61, p. 610, 1909.

Track Work, Sparta, N. W. Ry. Ry. Age Gaz., Vol. 52, p. 382, 1912.

Clearance and Grade Requirements for Carrying Highways over or under Railway Lines. Trans., Can. Soc. C. E., Vol. 24, p. 151, 1910. Abstracted in Eng.-Cont., Vol. 34, p. 150, 1910.

A New Type of Cattle Guard. Ry. Age Gaz., Vol. 52, p. 921, 1912.

Committee Report on Signs, Fences and Crossings. Proc. Am. Ry. Eng. Assoc., Vol. 11, pp. 1229-1248, 1910.

The Construction of Concrete Fence Posts. U. S. Dept. Agriculture. Farmers' Bulletin, no. 403. Office Public Roads.

The Corrosion of Fence Wire. Farmers' Bulletin, no. 239. U. S. Dept. Agriculture. Office of Public Roads.

CHAPTER X

ESTIMATES AND RECORDS

121. Preliminary Estimates, Earthwork.—The object of a preliminary survey is to aid in fitting the located line to the ground, and where more than one preliminary is necessary, to also aid in deciding between different routes. As the data are only approximate, rapidity and freedom from cumulative errors are more important than extreme accuracy.

The earthwork is usually obtained directly from the profile, using center heights and tables or diagrams. Lyon's Tables¹ are used to quite an extent where close results are desired, as for ground level transversely they give the true volume by the prismoidal formula, using the end center heights for arguments. For ground inclined transversely, corrected center heights can be taken from the auxiliary table given and the true volume found for the corresponding solid. This modified solid, however, will usually be smaller than the true solid; thus the error is cumulative.

A table of level cuttings is given in nearly every field book on railroad surveying and for ground fairly level transversely this will give about as good results as Lyon's Tables, unless the center height is changing rapidly. The yardage taken for the middle height will give the volume by middle areas; that by averaging those given by the end heights will give the volume by averaging end areas. The former will average too small, the latter too great, so that the latter is preferable as tending to make up for the neglect of the transverse slope where the difference in accuracy is worth the extra labor. The inaccuracy can be reduced in either method by taking shorter sections where the center height is changing rapidly.

For sections less than 100 ft. long, the tabular quantities must be multiplied by the lengths expressed in stations.

To take account of the transverse slope it should be measured with hand or slope level, or estimated, and tables used giving

¹ W. and L. E. Gurley, Troy, N. Y.

yardage with center height and transverse slope as arguments. If none are available, one can be readily computed for the given roadbed and side slope by the following formula:

Volume in cubic yards per station,

$$V = \frac{100 (a+c)^2}{27 s(1/s^2 - \tan^2 A)} - \frac{100 ab}{54}$$

where *a* is the altitude of the grade triangle; *c*, the center height; *s*, the slope ratio, horizontal to vertical; *A*, the angle of transverse slope; and *b*, the width of roadbed.

0'	
100	
200	
300	
400	
500	
600	
700	
800	
900	
1,000	10'
1,100	
1,200	
1,300	
1,400	
1,500	
1,600	
1,700	
1,800	
1,900	
2,000	20'
2,100	
2,200	
2,300	
2,400	
2,500	
2,600	
2,700	
2,800	
2,900	
3,000	30'
3,100	
3,200	
3,300	
3,400	
3,500	
3,600	
3,700	
3,800	
3,900	
4,000	
4,100	
4,200	
4,300	
4,400	
4,500	
4,600	
4,700	
4,800	
4,900	
5,000	40'
5,100	
5,200	
5,300	
5,400	
5,500	
5,600	
5,700	
5,800	
5,900	
6,000	50'
6,100	
6,200	
6,300	
6,400	
6,500	
6,600	
6,700	
6,800	
6,900	
7,000	60'
7,100	
7,200	
7,300	
7,400	
7,500	
7,600	
7,700	
7,800	
7,900	
8,000	

FIG. 80.—Cubic Yards per Station. 16 ft. Roadbed, 1½ to 1 Side Slope.

The second or subtractive term is due to the grade prism between the side slopes produced and the roadbed. If the transverse ground slope cuts the roadbed, giving part cut and part fill, the area of the grade triangle will be less than *ab*, and the proper correction must be made in finding its volume.

For slopes of over five or six degrees the correction becomes considerable and is cumulative.

For more rapid work with ground nearly level transversely, it is customary to cut off an end of profile paper and at distances

below the zero for fills, or above for cuts, corresponding to the center heights for 100, 200, etc., cu. yds. per station taken from a table of level cuttings, to draw horizontal lines and note on them the corresponding quantities. This is then used as a scale on the profile, but the cubic yards per station are read rather than the center cuts or fills. Thus, Fig 80, if the center fill is 18.2 ft., the cubic yards per station will be 2900. If the transverse slope has been taken, a scale can be drawn on

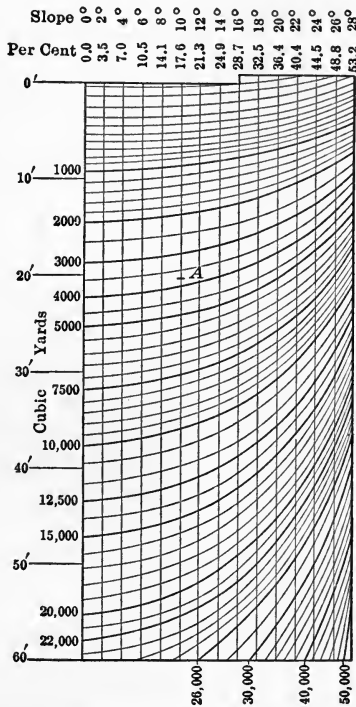

FIG. 81.—Cubic Yards per Station, with Transverse Slope.

celluloid or tracing cloth by means of which the corrected yardage can be read. Vertical lines are drawn at a convenient spacing and each numbered with the corresponding transverse slope, starting from zero at the edge. The points for the yardage scale for zero slope are plotted, as on Fig. 80, then those for the 4°, 6°, etc., slopes and the corresponding points joined as shown, Fig. 81, for Plate A profile paper (vertical scale 20 ft. per inch) roadbed 16 ft., side slopes 1½ horizontal to 1 vertical. For a cen-

ter height of 20 ft. as shown at *A*, the fill for a 10° slope = 3750 cu. yds. per station, or 350 cu. yds. more than for ground level transversely.

It is assumed that the classification was noted by the locating engineer and levelman when in the field so that from the approximate lead, as found in taking quantities from the profile, unit prices and costs can be determined.

122. Preliminary Estimates, Structures.—In comparing alternates, structures common to all can be omitted. For a total estimate to subgrade the structures must, of course, be included.

Quantities of material and labor, or methods of obtaining them, have been given in previous chapters. These, in connection with local conditions and prices, should be sufficient for an estimate for a short line. For a line requiring many structures or the comparison of different ones, the data can be simplified by computing total cost and tabulating or drawing curves for variation in height of fill, span, etc.

The cost can then be obtained by inspection and the effect of variations in condition readily seen. Data of this character are valuable in educating one's judgment in the field, where decisions are constantly being made in getting onto the ground for a preliminary, by avoiding a structure at the expense of a heavier fill, by increasing the cost of adjacent portions of the line to secure a right-angled crossing or better foundations for a bridge, etc.

Thus for the culverts, the cost for excavation for average conditions, the cost of the ends and the cost of the trunk can be combined and tabulated with span and depth of fill as arguments. Similarly for the bridge masonry, steel superstructure and floor, ballast or open as the case may be.

It is also convenient to have the cost of earthwork per station tabulated in terms of depth of cut or fill for comparing alternates in the field. Alternates involving a change in distance require an allowance for the difference in length of roadbed, ballast, ties and rails, the cost of which per foot can be obtained from Chapter VIII.

123. Location Estimates.—After the line is located and cross-sectioned¹ the earthwork should be computed station by station and entered on the profile together with the classification

¹ On many roads unless the work is heavy, the location estimates are made up from the profile and the cross-sectioning is done later by the resident engineer.

as estimated during location, and as supplemented by borings or test pits at points where necessary for a proper layout for construction.

The mass diagram can then be constructed as described in § 9, and the distribution of the material shown. This requires a study of the best methods of handling the material in view of the classification, quantities and leads, and the effect upon them of borrow and waste.

The extent to which trestling and bridging will be used in place of fills must have been assumed in finding the ground on location and fixing the grade line on the profile. The more accurate quantities determined from the cross-sections may modify this somewhat in constructing the mass diagram. The excavation and embankment required for the approaches of highway and farm crossings should be included.

This leaves the ditching on the uphill sides of cuts, the ditching for the drainage of the ground underneath or for the protection of fills, and the ditching for the care of water at highway crossings and for passing drainage through culverts which are forced by the grade line below the bed of the channel on one or both sides of the roadbed. These can as well be kept separate as the yardage would seldom affect the quantities within the slope stakes.

It also leaves the excavation for the foundations of structures which can be estimated with the structures, and the reduced volumes of the fills due to the space occupied by the culverts which, when important, should be allowed for in the mass diagram.

The location notes of high water marks, drainage openings of nearby structures, and estimates of drainage areas and character of foundations will allow of close estimates of the cost of drainage structures before the final surveys and designs are made. The farm crossings and cattle passes will depend upon how the individual farms are cut by the line, it often being cheaper to purchase or arrange a transfer of an outlying corner than to construct and maintain a crossing. The highway crossings are determined by the location and grade crossings are now seldom built except for light traffic, even when not prohibited by law. The location notes of the stations at which timber and property lines cut the alinement, together with the notes as to the character of timber and of real estate allow of estimates for clearing and grubbing and right of way.

Size 8 x 13 inches

*ESTIMATE FOR TRACK CONSTRUCTION
A. B. & C. R. R. CO.

Form M. W. 2100

TRACK ESTIMATE DIVISION

Work At
 Date of Estimate 19..... Maximum Grade Away From Main Track %
 Total Length of Track in Ft. Maximum Grade in Direction of Main Track %
 Total Clearance Length Ft. Made by
 Maximum Curvature Degrees Min.
 Width of Roadbed on Fills Ft., in Cuts Ft. (Title)

ITEM	DESCRIPTION	AMOUNT	UNIT PRICE	COST	CREDITS FOR OLD MATERIAL	Chargeable to
Waylads	Acres	Ac.				
Clearing	Squares (100 Ft. x 100 Ft.)	Sq.				
Moving Track		Ft.				
.. Buildings						
.. Fence	Kind	Rods				
Grubbing	Squares (100 Ft. x 100 Ft.)	Sq.				
Grading	Cu. Yds. of	Cu. Yds.				
Pipes	Kind Size	Lin. Ft.				
Drain Tile				
Culverts				
Bridges	Lin. Ft.				
Ties	(Class) Treated					
..				
Rail	Lbs. per Yd.	Tons				
..				
..				
Angle Bars	Class Lb. Length	Pairs				
..				
..				
Boils	Size	Kegs				
..				
Nut Locks	Kind	Boxes				
Spikes		Kegs				
Rail Braces						
Tie Plates						
* Ballast (in Place)	QUARRY PIT	Cu. Yds.				
† Turnouts Complete						
..				
Turnouts without Switch Ties						
..				
..				
Switch Ties	For No. Turnout	Sets				
..				
Slip Switches	Wt. Lb., No.					
Derails Complete	Kind					
Railroad Crossings	Wt. Lb., Style					
Railroad Crossing Timbers		Ft. BM				
Cattle-Guards (state kind)		Sets				
Road Crossings		Ft. BM				
Signs (state kind)						
Fences (state kind)		Rods				
Wing Fences		Pairs				
Interlocking						
Telegraph and Telephone						
Signals						
Battery Wells						
Parlog	Kind	Sq. Yds.				
Sewers	.. Size					
Water Mains					
Fire Hydrants	.. No. of Nozzles					
Man Holes	Size					
Catch Basins	..					
Bumping Posts	Style					
Tunnels						
Labor (state character)						
..				
..				
Handling Material						
Freight on ..						
	TOTALS					
Eng'r and Supt.						
	Estimated Gross Cost					
	Less Credits					
	NET ESTIMATED COST					
	The Expense is Chargeable to					
	Maintenance Account					
	Betterment ..					
	Additions ..					

* State kind of Ballast and Quarry or Pit from which it is to be taken if possible.
 † Use Item. Turnouts Complete, in estimate for track, to be paid for entirely by this Company

The accompanying estimate blank for track construction taken from the American Railway Engineering Association Manual will aid in including all necessary items for finished track. The size is 8 by 13 ins.

124. Monthly and Final Estimates.—Construction work is usually done by contract, the company letting in large contracts and the general contractor subletting different portions to contractors having equipment or experience specially adapted to the particular work, *e.g.*, wheel scraper work, rock excavation, heavy steam shovel work requiring track and dump cars, etc.

The line is divided into sections about 10 miles long and each allotted to a Resident Engineer whose duties are to lay out the work as required from time to time by the contractors, to oversee construction, to take note of classification and to measure up quantities if let on unit prices, and to make up monthly and final estimates of work. He will report directly to the Division Engineer, the Principal Assistant Engineer, or the Chief Engineer, according to the organization and the extent of the work.

In order to do this properly, full notes should be entered day by day giving all data which would prove of value in case of inquiry from headquarters or dispute with the contractor. It is customary to mail a weekly progress report to the Chief Engineer and to the Principal Assistant Engineer, giving the average number of men and teams at work each day during the week on each section, and the progress made.

The monthly estimate is made out the first day of each month in triplicate, showing the total amount of work performed up to the end of the preceding month, entering the quantities in each cut and fill and in each structure separately.

The corresponding quantities for the preceding month should be placed underneath, one by one, and subtracted for the quantities for the current month. The quantities for each cut, fill or structure should be placed on a separate line and designated.

A profile of the located line will be made up and used as a monthly progress profile. On this the surface line is shown for each cut and fill at the end of each month, and the space for the month colored according to the monthly index. The progress on structures can be shown by noting date of commencement and percentage done for each month. This profile is forwarded with the estimate to allow the Division Engineer or other officers to whom he reports to complete their copies and check with the

estimate. This profile is to be returned before the end of the month for the surface line and data of the next estimate.

On some roads each monthly estimate must include a comparison with the location estimate. For the final estimate the Rules for Location and Construction of the Northern Pacific, by E. H. McHenry, 1899, require the final notes to be written in ink in the standard record book furnished by the company. The record to contain cross-section notes and all other data pertaining to the calculation of quantities, classification in detail, ground and grade elevations, alinement, and material or labor accounts, and the data for every item in the final estimate. A summary is required giving the final estimate in mile sections. The record is to be kept up as far as possible, while work is in progress, and turned in to the Assistant Engineer at the close and finally checked in the office of the Division Engineer.

125. Right of Way Maps.—During location and construction many minor changes are made and discrepancies occur, so that the alinement, structures and right of way as they exist on the ground may differ appreciably from those given by the records. On this account it is often considered necessary to make an accurate re-survey in order to show the position of the actual center line and structures and to locate and monument the right of way and other property lines.

For this purpose the reference line may be taken parallel with the track on tangents and these parallels extended to intersect for short curves or connected by traverses for long ones. This will allow of working on smooth ground without interference from trains. Long tangents should be extended each way from the central portion and adjusted to best fit the track and structures. This adjustment can often be made in the field, but if there are discrepancies it had better be left for the office.

All instrument hubs in prolonging straight lines should be double plunged to eliminate error of collimation and all angles swung clockwise twice, turning back by the lower motion without setting to zero for the second swing and recording both the single and double angle.

The reference line should be taped twice and each measurement corrected for temperature. If the distance between instrument points is more than about 400 ft., intermediate points should be taken in taping. Intermediate instrument points should be taken, when necessary, for the convenient location by

angle and distance, of structures, property line monuments or proposed track monuments. So far as feasible, these should be located from the reference lines parallel to the tangents, extended where necessary, rather than from the connecting traverses.

In towns and cities where additional land has been acquired for railroad purposes, it is well to include, for future reference, as many of the city monuments as are connected with the land owned, or streets crossed. All the property monuments should be in place so that they can be referenced, rather than the points where they are to be set, leaving only the track monuments to be placed afterward.

For the short curves, the corrected angles between tangents and the measured external distances will furnish data for the corrected curves. For the long curves, the external distances can be computed by connecting traverses with the middle points of the curve (known with sufficient accuracy from the location notes), or if only track distance is required, the lengths can be directly measured along the center line from perpendiculars set off with the transit near the tangent points.

Track monuments can be set on center line or at a fixed offset distance, the latter being preferable so far as disturbance of monument and of instrument in track work is concerned, while both methods are in use. They should be placed at the ends of transition curves, or of circles, according to alinement, and at intermediate points when necessary for convenient sighting from one to the other.

The correction to the length of the field tape under a 10- or 12-lb. pull should be obtained from time to time by comparison with a standard tape kept for the purpose. This correction should be to the actual length when supported, and to the projected lengths when suspended in 50-ft. and in 100-ft. lengths, although the latter should not be used for accurate work unless the tension is carefully applied by spring balance.

These corrections are best applied as the temperature at which the tape is standard for the different conditions. Thus a new Chicago 100-ft. tape when compared under a 12-lb. pull with a standard was found to be when supported;

first half, short 0.0050 ft., second half, short 0.0032 ft.;

and to project when supported at the ends and center,

first half, short 0.0137 ft., second half, short 0.0170 ft.;

and when supported at the ends only, 0.0922 ft. short.

The coefficient of expansion is about 0.000 006 2 for 1° F., which would require 16° change in temperature for 0.01 ft. change in length, while the length of the standard was given at 62° F.

These would give for the field tape under a 12-lb. pull:

Length supported,		
First half,	49.9950 at 62°,	50 ft. at 78°
Second half,	49.9968 at 62°,	50 ft. at 72°
Length projected, supported at ends and center,		
First half,	49.9870 at 62°,	50 ft. at 103½°
Second half,	49.9888 at 62°,	50 ft. at 98°
Length projected, supported at ends,		
	99.9093 at 62°,	99.9 ft. at 47°

The azimuth of the line should be obtained from observation on Polaris (or upon the sun during the summer season when it is north of the equator) at intervals of say 20 miles. If the latitude cannot be obtained from maps to within one or two minutes it should be observed for use in reducing the observations and in computing the convergence in meridians.

An accurate line of levels should be run for grades and for bench marks at intervals of say one-half mile. With equal front and back sights limited to from 300 to 400 ft. there should be no difficulty in securing differences of elevation to 0.02 ft. into the square root of the distance in miles. Sea-level datum should be used when obtainable.

The data obtained should be sufficient for the land maps and for the track maps, the former containing the property lines, monuments, etc., and the latter the data with reference to structures, rails, track layouts, etc. For a description of the former, see Frye's *Railway Right-of-way Surveying*, and for the latter, including sample maps, see the *American Railway Engineering Association Manual*.

126. Cost of Location Surveys.—These vary widely with the topography and with the requirements to be met in fitting the line to the ground, that is, whether short tangents, sharp curvature and heavy gradients, which are easily fitted to the ground and which give a minimum capitalized cost for construction and operation for a light traffic and high rate of interest, are to be used, as in much of the early railroad construction in this country, or whether the longest tangents, least curvature and flattest gradients which the country economically affords, for a

heavy traffic and low rate of interest, are to be used, as in the case for much of the location at the present time. The cost will also vary with the methods employed, and with the ability and energy of the engineer conducting the work.

W. S. McFetridge, M. Am. Soc. C. E., in a paper on "Some Extensive Railroad Surveys, and Their Cost per Mile,"¹ states that the work included 1400 miles of preliminary lines and 600 miles of location in West Virginia, Ohio and Southwestern Pennsylvania. It was found that in Ohio 0.5 per cent. gradients and 4° maximum curves were possible, while 0.3 per cent. on one division and 1.0 per cent. east-bound and 0.5 per cent. west-bound on the other division with 8° curves on each were possible for the other lines. These required long, continuous gradients in places.

The U. S. Geological Survey maps were used so far as available for the broad general survey of the country. Camp outfits were not used, the parties boarding at houses along the line.

The greatest number of miles of preliminary run in a day by one party was seven, and of location, four and a half, the location averaging over a mile per day on some parts and three-fourths on other parts. The limit was usually fixed by the amount of clearing which could be done.

The total cost per mile of completed survey, including office rent, purchase of instruments and supplies, general expenses, all salaries, field expenses and the preparation of final maps, plans, profiles, and estimates with everything in readiness to make contracts for the line, is given as follows:

Company ²	Miles of surveys			Total cost	Cost per mile	
	Prelim.	Locat.	Total		a	b
L. K. R. R.	428.19	193.85	622.04	\$25 076.83	\$40.31	\$129.36
Z. M. & P.	509.03	105.23	614.26	19 812.77	32.25	188.28
B. & E. R. R.	241.75	113.70	355.45	20 466.68	57.58	180.00
P. B. & T. R. R.	84.56	38.17	122.73	6 651.98	54.20	174.28
B. & N. R. R.	162.51	151.29	313.80	19 249.94	61.34	127.23
Totals	1426.04	602.24	2028.28	\$91 258.20	\$45.00	\$151.53

¹ Transactions, Am. Soc. C. E., Vol. 65, p. 105, 1909.

² The surveys were conducted under different railroad charters.

The cost per mile, a , is the average cost including preliminaries, while b is the average cost per mile of location. The costs given include the total charge against engineering from the inception of the project to the beginning of construction.

The monthly salary list was as follows:

Beulshitt

Asst. engr. in charge, \$125 to \$150		Rear flagman,	\$40
Transitman,	85 100	Stakeman,	35
Levelman,	75	Axemen (two to five),	30
Rodman,	65	Topographer,	65
Head chainman,	50	Tapemen (two),	45
Rear chainman,	45	Draftsman (part time),	60

The expenses per party were from \$35 to \$40 per day in addition to the salaries.

The average cost per mile as determined from a study of the daily reports of field parties is given as follows:

	Preliminary	Location	Location, including preliminary
L. K. R. R.,	\$25	\$ 74	\$ 99
Z. M. & P. R. R.,	23	79	102
B. & E. R. R.,	35	105	140
B. & N. R. R.,	31	94	125

In the discussion of the paper in the same volume, Mr. Lavis states that the costs of the field work of the preliminary and location lines agree quite well with those on the Choctaw, Oklahoma and Gulf Railroad which resulted in the construction of more than 800 miles of railroad and the actual location of as many more miles of line which were not built.

Mr. Beahan¹ states that for many years it has been generally considered that \$100 per mile fairly represents the cost of location in the United States. This includes the reconnoissance and preliminaries. He quotes an experienced locating engineer as placing the average cost in easy prairie country at \$50 per mile and in timber country at \$150 for final located line.

The detailed costs are given for five lines of the Missouri Pacific Railway located in 1886 and 1887, the lowest being

¹Field Practice of Railroad Location, W. Beahan, 1909.

\$30.17 per mile, and the highest \$57.43. For the last three lines the distribution of accounts was as follows:

Salaries,	\$4 452.19
Subsistence of men,	1 285.16
Team hire,	513.25
Expenses, traveling and incidental,	332.72
Fodder for stock,	223.15
Outfitting, renewals and repairs,	217.35
Fuel,	142.87
Medicine,	44.10
Sundries, including lumber for stakes,	182.75
Error to balance,	9.71
	<hr/>
Total,	\$7 403.25

He notes that salaries are 60 per cent., and subsistence about 17½ per cent. of the total cost and intimates that liberal feeding may lower the cost per mile.

127. Capitalized Cost of Structures.—In comparing the cost of a temporary structure with that of a more permanent one, one of the best methods is to compute the principal which if placed at interest would build and perpetually maintain each structure. The one which requires the smaller principal will, if all considerations can be put on a money basis, be the more economical.

Thus, if for the first,

C = first cost.

M = cost of maintenance every n th year.

R = cost of renewal, including all damages from delay to traffic, etc., every m th year.

r = rate of interest.

P = principal required for perpetual maintenance, assuming the conditions to remain constant.

$$P = C + \frac{M}{(1+r)^n - 1} + \frac{R}{(1+r)^m - 1}$$

since \$1 will amount to $(1+r)^n$ at compound interest, or will earn $(1+r)^n - 1$, in n years.

Similarly for the second structure,

$$P' = C' + \frac{M'}{(1+r)^{n'} - 1} + \frac{R'}{(1+r)^{m'} - 1}$$

Uncertainty as to future requirements will discriminate against the permanent construction, as unfitness rather than lack of durability may shorten its life to less than that of the

temporary construction. On the other hand, a low rate of interest will discriminate against the temporary construction in making the renewal term large by decreasing the denominator. The former is especially important on account of the ever changing requirements in railroad work, whereby the permanent construction of today becomes inefficient or inadequate tomorrow and must be replaced before it has reached its limit of durability.

If a greater rate of interest has to be paid for the first few years, as is the case with most new enterprises, it can be allowed for as below.

Let r_1 be the excess in rate for n_1 years ($n_1 < n$). There will be $(P - C)$ dollars to be placed at interest or on which interest will be saved, for n_1 years. This will earn in excess of P_1 as given above,

$$(P - C)(1 + r_1)^{n_1} - (P - C), \text{ in } n_1 \text{ years.}$$

The present worth of this, found by dividing the amount of one dollar for the period, will be

$(P - C) - \frac{P - C}{(1 + r_1)^{n_1}}$ which is to be subtracted from the value of P as first found.

If n_1 is greater than n , the above present worth will be a little too great on account of allowing interest on M after it has been used in maintenance. The correction is easily made if important.

In comparing the economy of a double track open deck iron trestle with that of a masonry arch viaduct for the Canadian Pacific Railway passenger terminal at Montreal, the following estimates were made¹ and on the basis of these in part at least the viaduct was chosen.

Iron trestle:

Cost per foot complete,	\$77.00
Timber deck, per foot, life 8 years,	8.00
Painting per foot, life 5 years,	0.80
Inspection and adjustment per foot, yearly,	0.04

Masonry viaduct:

Cost per foot, life indefinite,	\$92.00
Maintenance two lines of track and renewal of timber guards, yearly,	0.15

Interest was assumed at 5 per cent. and the life indefinite for the iron and masonry.

¹ Eng. News, Vol. 19, p. 158, 1888.

Substituting in the formula,

Capitalized cost of iron trestle per lineal foot,

$$= 77 + \frac{8}{(1.05)^8 - 1} + \frac{0.80}{(1.05)^5 - 1} + \frac{.04}{(1.05)^1 - 1}$$

$$= 77 + 16.77 + 2.90 + 0.80 = 97.47$$

Capitalized cost of masonry viaduct per lineal foot,

$$= 92 + \frac{0.15}{1.05^1 - 1} = 92 + 3 = 95$$

It should be noted that in making this comparison \$16.77 is required to maintain the trestle floor, ties, guard timbers, etc., while the ties are wholly omitted from the viaduct.

It may also be noted that during the season of 1912 a portion of the viaduct was taken down on account of a rearrangement of the terminal. This would release the \$20.47 set aside for the maintenance of the trestle and the \$3 for the viaduct, the present worths of which would be \$6.35 and \$0.93, respectively. These would reduce the capitalized costs for 24 years to \$91.12 for the trestle and \$94.07 for the viaduct.

A high rate of interest would also tend to favor the trestle as a smaller sum would be required to be placed at interest to take care of maintenance.

In comparing steel and creosoted pine ties on German railways the permanent way and traffic inspector, Mr. Biedermann, concludes¹ that the pine tie on hard broken stone ballast has a life of 18 to 20 years, and the steel tie scarcely more. He places the cost of the pine tie at \$1.05 and of the steel tie at \$1.64.

Assuming the life of the first to be 18 and that of the second 20 years, with interest at 5 per cent.

Capitalized cost per tie,

$$\text{Creosoted pine, } 1.05 + \frac{1.05}{(1.05)^{18} - 1} = \$1.80$$

$$\text{Steel, } 1.64 + \frac{1.64}{(1.05)^{20} - 1} = \$2.63$$

These values do not include maintenance, and probably not placing in track.

¹ Proc. Am. Ry. Eng. Assoc., Vol. 13, p. 963, 1912.

128. Durability of Structures.—Considerable data upon durability have already been given in describing the different methods and materials used in construction.

In the Proceedings of the Association of Railway Superintendents for 1899, tables are given showing the life of pile and bridge timber as reported from the experience on different railroads in the United States, mainly from the central and northern portions. These give for:—

Piles driven in dry ground: Cedar, 16 to 20 years; chestnut, 12 to 18 years; white oak, 8 to 12 years, with range from 5 to 20; long-leaf yellow pine, 10 years; tamarack, 8 to 12 years; spruce, 4 to 8 years.

Bridge and trestle timber exposed to the weather: Long-leaf southern pine, 8 to 18 years; white pine, 8 to 16; white oak, 8 to 18; spruce 5 to 10.

Bridge and trestle timber protected from the weather and well ventilated, 40 to 50 years.

The supply of white pine and white oak is practically exhausted for bridge timber, while Douglass fir and western hemlock are used in the Northwest.

The most satisfactory protection is by housing both top and sides, but galvanized iron over chords and stringers, if properly maintained, will nearly double life besides affording protection from fire. Creosoting has come into use for bridge and trestle floors and to some extent for the piles and timbers of ballasted deck wooden trestles. The life of the latter is shown in § 101 to have been at least 34 years, while Mr. Robinson assumes 28 years for the ballasted creosoted deck in comparison with 7 years for the untreated open deck in studying relative economy.

For metal bridges, iron and steel, the life should be at least 50 years, if the details are properly designed, the stresses kept well within the elastic limit of the material and the metal protected from rust. The increase in the weight and speed of trains has been almost continuous from the beginning and this has overloaded the bridges and developed weakness in the details. This has necessitated careful watching, frequently strengthening, and finally replacing the structure by one of better design and of ample capacity for present traffic but without anticipating future requirements.

Engineering-Contracting, Vol. 30, p. 227, 1908, gives as fairly representative of this condition a list of ten railroad bridges built

between 1877 and 1889 inclusive, which had a life ranging from 13 to 22 years, with an average of 18 years. With interest at 5 per cent. only 41½ cents could be spent in anticipating future requirements to save spending \$1 on new construction at the end of the 18-year period. In view of the uncertainty of future requirements and the probable development of the art of bridge construction, it is doubtful if more money could have been economically spent in increasing the durability of these structures, notwithstanding the almost universal criticism of the so-called short-sighted policy in vogue.¹

The contract with the railroads crossing the Chicago Drainage Canal provides for the payment of a sum of money to the owners of the bridges, the interest on which will maintain the structures. The following from the Santa Fe contract² will furnish data on cost of maintenance.

The annual cost of painting shall be estimated at 0.03 cent per pound of iron and steel, not including the floor system.

The annual cost of renewal of ties and guard rails shall be estimated at \$5 per 1000 ft. B.M.

The annual cost of inspection and minor repairs, such as tightening rivets, adjusting truss rods, and minor repairs to floor systems, including general inspection, shall be estimated at 20 cents per lineal foot of track.

The annual depreciation and liability of accident of the iron and steel is estimated at 1.5 per cent. The last would require a life of 30 years for the metal structures with interest at 5 per cent.

In comparing timber with masonry structures it is the custom to regard the masonry as permanent. With well-built masonry of durable stone, not overloaded and on a good foundation, this assumption is fairly correct, as with life of 40, 50, or 60 years, the renewal term at 5 per cent. would be only 16½, 9½, or 6 cents per dollar. Much of the railroad masonry, however, goes to pieces, due to poor construction, settlement of foundations,

¹ Wellington, *Economic Theory of Railway Location*, states that "it is for practical reasons so exceedingly dangerous as to amount to absolute folly, for an average American corporation, even of the more prosperous kind, to look ahead for more than three to—at most—ten years for the rapidly increasing traffic which is to justify an increase of present expenditure over what the prospects of the present and the immediate future will justify."

² Jour., Wes. Soc. of Engrs., Vol. 4, p. 327, 1899.

vibration from trains, frost action, etc., so that poorly built masonry should be classed with timber in considering durability.

Concrete, plain and reinforced, has largely replaced stone masonry in railroad work. Its durability, as compared with stone masonry, is still an open question, some considering it superior, others inferior. Whatever the final outcome, the fact remains that the ease with which it can be constructed by any one has led to much careless work and many failures, some of them on important work, which had or should have had skilled supervision.

The *Engineering Record*¹ in discussing the durability of engineering structures states that "in the design of concrete structures it has been the practice to assume for them a very long life, but that many of them, both plain and reinforced, are short lived is becoming very evident. This is particularly true of concrete irrigation works. The ordinary life of timber construction when exposed to variations of moisture, as in flumes and similar works, is from 6 to 8 years, with a much longer life of individual structures under peculiar conditions. In recent irrigation works built by the government and by individuals reinforced concrete has been widely used. Some of it, it is certain, will not last as long as timber."

129. Protection of Iron from Rust.—In the last article the durability of metal bridges was considered from the standpoint of wearing out from use and overload. Much structural metal fails from rust. Some of this could be prevented by cleaning and painting at suitable intervals, some is inaccessible after erection and on some the exposure is too severe for protection by paint.

As the result of a well planned series of investigations undertaken by a number of independent workers, much progress in the chemistry of corrosion has been made.

The electrolytic theory affords a logical explanation of the facts observed. Thus if two metals are immersed in an electrolyte and connected by a circuit as in a primary battery the one which is electropositive to the other, or has a higher solution tension, will dissolve and oxidize, while the other will remain practically unchanged. Thus iron is electropositive to nickel, lead, copper, tin and antimony, and will tend to precipitate them from solutions of their salts, while it is electronegative to zinc

¹ Vol. 66, p. 622, 1912.

and aluminum, and would be precipitated by them from solutions of its own salts. Zinc thus makes a better coating for iron than tin, because if the coating is broken the electrical action set up by moisture will protect the iron at the expense of the zinc until the coating disappears, while with the tin the coating is protected at the expense of the iron. Where the difference in solution tension is small, as with iron and tin, the action will be slow.

In applying the electrolytic theory to iron, it should be remembered that the metal combines readily with or dissolves nearly all the other elements, that manganese, carbon, silicon, sulphur and phosphorus are always present, and that there is always a tendency to segregation. Manganese especially affects the electrical conductivity, and manganese and sulphur combined, the electrical potential, so that with segregation the conditions are favorable for corrosion.

Investigators believe that great improvements in manufacture will be made as soon as the principles governing the rate and kind of corrosion on different types of iron are well established. The so-called ingot iron for *terne* plates and other purposes not requiring great strength is a case in point, as it has been shown to corrode more slowly and uniformly and with less tendency to pit than structural metal.

There are three general methods of protection: (a) Protective coatings of other metals; (b) magnetic oxide surfaces formed by acting on the metal; (c) paint coatings.

Of the protective coatings of other metals, zinc is most important. It is the most electropositive metal available and will protect at its own expense so long as it is kept in contact with the iron. The coating should be thick for durability.

The magnetic oxide surface is produced by superheated steam with or without other substances, while some of the chromates as of potassium and lead have the power to form a thin coating of oxide which will resist corrosion for some time after the paint is removed. This is of interest in connection with the selection of pigments for paint coatings.

As above indicated some of the pigments used for paint retard corrosion and are called inhibitive, others accelerate and are called stimulative.

From the investigations which have been made, Heckel¹ states

¹ Corrosion and Preservation of Iron and Steel. Cushman and Gardner, p. 175, 1910.

that "the more advanced manufacturers are now engaged in working out a new mode of procedure in the painting of steel. The theory is that rust-stimulating pigments should never be placed in contact with the steel surface, but that an inhibitive priming coat should always intervene. This inhibitive coating may be suitably compounded of the chromes, zinc oxide, white lead, red lead, willow charcoal, etc., among the inhibitors, or of any of the neutral or indeterminate pigments reinforced with a small proportion of the stronger inhibitors, such as zinc chrome, zinc oxide, zinc and lead chrome, etc.

Over this priming coat the air- and moisture-excluding coats can then be safely applied; these coats being designed for protection only, with regard to inhibitive qualities."

SECOND INSPECTION, STEEL PLATE TEST PANELS AT ATLANTIC CITY, N. J.
JUNE 28, 1911¹

American vermilion (basic chromate of lead),	10.0
Chrome green,	9.8
Lead and zinc chromate,	9.7
Zinc chromate,	9.5
Zinc and barium chromate,	9.5
Black oxide of iron,	9.5
Sublimed white lead,	9.0
Prussian blue,	9.0
Sublimed blue lead,	8.8
Willow charcoal,	8.8
Composite paint,	8.8
Prussian blue,	8.5
Composite formula,	8.5
Orange mineral,	8.3
Red lead,	8.3
Composite paint,	8.2
Bright red oxide of iron,	8.1
1 coat zinc chromate; 1 coat iron oxide,	8.1
Venetian red,	8.0
Composite paint,	8.0

The Paint Manufacturers Association of the United States erected at Atlantic City in Oct., 1908, over 500 test panels which consist of steel plates $24 \times 36 \times \frac{1}{8}$ ins. which have been given 50 single pigment paints, together with several special paints, each being painted out three-coat work upon six panels of three different grades of metal. They are exposed to the severe action of the coast atmosphere. The pigments were out of the same

¹ Eng. Rec., Vol. 64, p. 254, 1911.

lots used in the preliminary laboratory tests on inhibitors. They were ground in a vehicle composed of two parts raw linseed oil and one part pure boiled oil.

On June 28, 1911, the second inspection was made by a subcommittee of four members, each rating the 50 plates according to the amount of rust apparent, as well as on the degree of checking, chalking, scaling, cracking, peeling, loss of color, and other signs of paint failure.

The above table gives those in which the average rating was 8.0 or more. This inspection as well as the previous ones show that the pigments of the inhibitive type are superior to the others.

It is stated that Cushman's new process for producing chromitized inhibitive pigments has lowered the cost of American vermilion and made it available in large quantities for use in moderate-priced paints.

Investigators are agreed upon two points—that iron cannot rust in air or oxygen unless water is present, or in water unless oxygen is present. Thus iron buried deep in the ground, or several feet below the surface of water free from acids will last indefinitely without other protection.

For iron, inaccessible after erection, encasing in concrete is much used and is considered effective where the fine material is in contact with the metal. Cinder concrete has not been successful where moisture is present.¹ For overhead bridges where there is plenty of clearance, concrete is successful in protection. If the clearance is so small that the cinders from the smoke stack strike the concrete, painted plank resist the abrasion better.

130. Wood Preservation.—The growing scarcity of timber has lead many of the railroad companies to install plants for wood preservation for the treatment of ties and timber for structural purposes. The Manual of the American Railway Engineering Association recognizes creosote oil and zinc chloride as effective wood preservatives when properly applied and when used under proper conditions. They call attention to the keeping of accurate records in order to obtain data as to the merit of different methods and processes and to the fact that mechanical protection must go hand in hand with preservation in order to realize the benefits of the treatment.

¹ See Eng. News, Vol. 63, p. 65, 1910, and Ry. Age Gaz., Vol. 50, p. 1025, 1911, for examples of rapid deterioration of steel work.

To secure successful treatment, the timber should be properly grouped as to species, proportion of heartwood and sapwood, and condition with respect to moisture. Most woods can be best treated after being air-seasoned.

In operating with zinc chloride, the strength of the solution should be varied from time to time to conform with the conditions of the ties, so as to inject the required quantities, but in no case should the strength exceed 5 per cent. These ties should dry for some time before they are put in track, to harden the outer surface. This is preferably done in piles arranged to secure drying without checking.

It is recommended that certain sections of track be selected for making accurate tests covering the life of treated and untreated ties of various kinds of timber and under different treatments rather than to attempt to keep records of all ties in track. The ties inserted in this test section should be marked with dating nails.

In order to judge of the penetration, borings should be made in not less than six ties in each cylinder load, and holes should be plugged with creosote turned plugs. All material should be framed and holes bored as far as possible before treatment.

For creosote oil, the specifications call for the best obtainable grade of coal-tar creosote, free from other oils, tars or substances foreign to pure coal-tar. The specific gravity, temperature at which it is completely liquid, distillate, etc., are specified, as also the apparatus for performing the tests. The general requirements of the specifications for the treatment state that ties shall not be treated until air-seasoned. The method of piling green ties is specified, and the suggestion made that it is best to determine by experiment the weight per cubic foot at which each class will best receive treatment, and then to weigh for treatment, being careful not to allow over seasoning or deterioration. Ties treated in the same run shall be as nearly as possible uniform in character of timber and degree of seasoning. They shall be separated into groups according to permeability as ascertained by experiment, and no ties shall be put into cylinders which do not conform to the requirements as to shakes, checks, etc.

If ties are thoroughly air-seasoned, a vacuum not less than 24 ins. of mercury shall be maintained for at least 10 minutes, after which the preservative shall be admitted without breaking the vacuum.

When ties not thoroughly seasoned must be treated, and are to be treated with metallic salts, the ties shall be placed in cylinders, the door closed and live steam admitted at such a rate as to secure 20 lbs. of steam pressure within 30 to 50 minutes the pressure to be maintained from one to five hours, depending upon the condition of the timber, but the pressure at no time shall be allowed to exceed 20 lbs. During steaming, a vent shall be kept open at the bottom to permit the escape of air and condensed water from the cylinder.

When ties that are not seasoned must be treated with creosote, either long steaming or seasoning in hot creosote oil within safe limits of heat must be resorted to. When the steaming is completed the steam shall be blown off and a vacuum of not less than 24 ins. produced, if at sea level, or a corresponding value if above sea level, the vacuum to be maintained for at least one-half hour and the preservative admitted without breaking the vacuum.

For zinc-chloride treatment, the amount injected shall be equivalent to 1/2 lb. of dry soluble zinc chloride per cubic foot of timber. The solution shall be as weak as can be used and still obtain the desired absorption; it shall not be stronger than 5 per cent. The cylinder shall be entirely filled with preservative at a temperature of at least 140°, and maintained full while the pressure is on, an air vent being provided for releasing the air coming from the charge. Zinc chloride shall be slightly basic and free from free acid.

For the zinc-tannin treatment the zinc chloride injection shall be the same as for the zinc-chloride treatment. After this the ties shall be allowed to drain for 15 minutes, and 2 per cent solution of tannic acid, made by mixing 6½ lbs. of 30 per cent extract of tannin with 100 lbs. of water, run in and a 100-lb. pressure maintained one-half hour. This shall then be run off and a 1 per cent. solution of glue admitted to the cylinder and a 100-lb. pressure maintained for one-half hour.

For plain creosoting, the creosote oil shall be heated to a temperature of not less than 160° and maintained at this temperature during injection. The cylinder shall be entirely filled with preservative, an air vent being used to remove the air coming from the charge. At least once during each week samples of oil shall be taken from the cylinder during the treatment and the water in the oil determined. If it exceeds the specified amount,

a correspondingly greater quantity shall be injected; the excess being limited to 6 per cent.

In the zinc-creosote emulsion treatment an emulsion of zinc chloride and creosote oil, the latter being at least 10 per cent. of the whole, shall be admitted and pressure maintained until the desired absorption is obtained. This amount shall be sufficient to leave in the wood an equivalent of 4/10 lb. of dry soluble zinc chloride and $1\frac{1}{4}$ to $1\frac{1}{2}$ lbs. of creosote per cubic foot.

The creosote oil used shall be as nearly as possible of the same specific gravity as the zinc-chloride solution. It shall preferably contain a large percentage of tar acids and a small percentage of naphthalene. An effective stirring apparatus must be used in the storage tank and preferably also in the cylinder.

For the two-injection zinc-chloride treatment 3/10 lb. of zinc chloride per cubic foot is first injected. The zinc chloride is then run out and creosote oil injected to the amount of 3 lbs. per cubic foot.

The temperature for injection is 140° for all the methods except the plain creosote, and the pressure 100 lbs. except where the quantity of antiseptic is specified.

The zinc-chloride process is low in first cost, and satisfactory in a dry climate. The glue and tannin are added to prevent the zinc chloride from leaching out; the creosote may be considered as added for the same purpose, or the zinc chloride may be considered as added to the creosote to reduce cost.

Creosoting is the standard method for bridge timber and its use for ties is increasing. The quantity varies from 6 to 12 lbs. of creosote oil per cubic foot for ties, to 10 to 20 lbs. for timber and piling.

131. Valuation of Railroads.—This book may be said to be based upon the premise that railroads are commercial propositions, built to earn interest on the capital invested, reference having been made to that fact at the very outset. Also a considerable part of its contents is devoted to the determination of that part of the capital invested in construction. For these reasons and also because the engineer is more and more frequently called upon to make valuations of existing properties it seems pertinent to conclude with a brief discussion of the principles underlying the determination of what constitutes a fair valuation and a fair return.

A discussion of the causes of the present relations between the railroads and the public and the consequent demand for valuations would lead us too far afield for the present purpose. Suffice it to say that several states have already completed appraisals and that on the recommendation of the Interstate Commerce Commission and the Railroad Securities Commission a bill has recently passed the House of Representatives giving the former authority to make a physical valuation of all the railroads in the United States.

The subject is presented in the Transactions of the American Society of Civil Engineers, Vol. 72, p. 1, by H. E. Riggs and discussed by twenty-five other members.

The objects assigned are divided into two general classes: Those relating to the public interests, and those relating to the interests of the company.

The first are required as a basis for legislation relative to:

(a) Taxation of Corporations.—Such were the valuations in Michigan and Wisconsin.

(b) Rate Regulation.—This prompted the work in Minnesota.

(c) Limitation of Capitalization to Guard Against Dishonest Securities.—The regulation of the issue of stocks and bonds prompted the Texas valuation.

The second are made in order to guide large investors, to secure a basis for sale, purchase or reorganization, and to secure justice to honestly administered corporations.

The commercial method of valuing a property by capitalizing net earnings seems to have little or no place in engineering valuations, especially as net earnings would be affected by both taxes and rates, one of which we are seeking to determine.

Practice seems to be to include in the valuation,

1. Physical or tangible property.
2. Non-physical or intangible elements of value.

The first generally means the cost of reproduction of the tangible property with allowances for depreciation and appreciation and including those costs necessarily connected with construction such as engineering, etc. In the Washington appraisal the attempt was made to determine also the original cost, but this would seem impossible in the absence of complete records.

The general method of securing the value of the physical property is to first make an office inventory of all property,

sometimes depending largely on sworn statements of the officers of the road. Then the inventories are checked up in the field, the inspector usually noting the depreciation factor at the same time. The results are then worked up in the office, using unit prices for the year in which the appraisal was made, or the average of the last five or ten years.

The non-physical element was held by Professor Adams to include:

The franchise { to be a corporation.
to use public property.

The possession of traffic not exposed to competition.

The possession of traffic through connections.

The benefit of economies due to density of traffic.

The value due to organization and vitality of industries served.

The difficulties attending a proper determination of both elements of value will be easily appreciated and the reader is referred to the above article and discussion for details.

There is much difference of opinion also as to what constitutes a fair return on investment in railroad properties but the general view is that the rate should depend upon the risks involved. With old established lines, conservatively managed, the risks are not great.

The whole problem is very complicated and requires the exercise of good judgment and much patience on each side as the interests of both public and railroads require that former abuses be prevented but that rates be such as will keep alive the spirit of progress and enterprise which has characterized the railroad business.

It is gratifying to note that the attitude of hostility toward all appraisals which the roads held at first is giving way to a spirit of cooperation due largely to the fairness with which most railroad appraisals have been conducted.

Commissions and courts also show an increasing tendency to be fair and thus we are able to agree with Mr. Riggs that "the great mass of intelligent people wish only fair dealings with the corporations" and that "the public service corporation which is honestly financed and honestly operated need have little fear of ultimate justice" while the one "which is administered, not to render service to the public, but to permit stock speculators to reap a harvest, can hardly hope for the same brand of justice."

REFERENCES

- Railway Location Surveys and Estimates. F. Lavis, 1906.
Railway Right of Way Surveying. Albert I. Frye, 1904.
Manual for Resident Engineers. Molitor and Beard, 1903.
Engineering Rules and Instructions for the Northern Pacific Ry., 1899.
Corrosion and Preservation of Iron and Steel, with Bibliography. Cushman and Gardner, 1910.
Painting to Prevent Corrosion. A. H. Sabin, 1898.
Valuation of Public Utilities. H. Floy, 1912.
Railway and Engineering Review:
Construction of the Idaho and Northern Ry., Vol. 51, p. 475, 1911.
Construction of the Oregon Trunk Ry., Vol. 51, p. 223, 1911.
Construction Work on the Spokane, Portland and Seattle Ry., Vol. 49, pp. 808, 851, 871, 1909.
Construction of the Western Pacific Ry., Vol. 50, p. 223, 1910.
Construction of the Kansas City, Mexico and Orient Ry., Vol. 50, p. 414, 1910.
The Canadian Transcontinental Railway. Detailed account of Location and Construction. Eng. News, Vol. 67, p. 1208, 1912.
The Cumberland-Connellsville Extension of the Western Maryland Ry. Ry. Age Gaz., Vol. 50, p. 270, 1912.
Construction of New Lines of the Algoma, Central and Hudson Bay R. R. Eng. Rec., Vol. 65, p. 638, 1912.
Itemized Cost of the Northern Pacific Ry. System as Estimated by its Chief Engineer. Eng.-Cont., Vol. 29, pp. 226, 271, 1908.
Preservation of Structural Timber. Eng. Soc. W. Penna. Vol. 26, p. 427, 1910.
Preservation of Timber. Am. Ry. Eng. Rev., Vol. 51, pp. 874, 900, 1911.
Treating Seasoned and Unseasoned Ties. Eng. News., Vol. 67, p. 241, 1912.
Tendencies in Tie Preservation. Ry. Eng. Rev., Vol. 50, p. 966, 1910.
Economic Comparison of Railway Ties of Different Materials. Eng. News, Vol. 64, pp. 302, 540, 1910.
Creosoting Plant of the Buffalo, Rochester and Pittsburgh Ry. Eng. Rec., Vol. 64, p. 406, 1911.
Committee Report on Wood Preservation. Am. Ry. Eng. Assoc., Vol. 12, part 3, p. 425, 1911.
Methods of Protecting Iron and Steel against Corrosion. Jour. Franklin Institute, Vol. 165, p. 449, 1908.
Capitalization of Railroads. Ry. Eng. Rev., Vol. 51, pp. 354, 376, 1911.
Methods of Determining the Life of Public Utilities. Eng. and Cont., Vol. 38, p. 448, 1912.
Valuation of Railroads in New Jersey. Ry. Age Gaz., Vol. 53, p. 243, 1912; Eng. News, Vol. 68, p. 334, 1912.
Conflicting Theories of the Valuation of Public Service Companies. Eng. and Cont., Vol. 38, p. 648, 1912.
The Appraisal of Public Service Properties, as a Basis for the Regulation of Rates. Trans. Am. Soc. C. E., Vol. 75, p. 770, 1912.

The Principles Governing a Railroad Appraisal of an Unusual Nature
Eng. Rec., Vol. 65, p. 174, 1912.

A Living Rate for Railways. Ry. Age Gaz., Vol. 52, p. 10, 1912.

The Organization for and Methods and Results of Physical Valuation in
Nebraska. Eng. and Cont., Vol. 36, p. 694, 1911; Vol. 38, p. 136, 1912.

The Physical Valuation Department of the Nebraska State Ry. Comm.
Eng. News, Vol. 68, p. 300, 1912.

Valuation of Railroad Properties, Texas. Trans. Am. Soc. C. E., Vol.
52, p. 328, 1904.

Railroad Appraisal and Taxation in New Jersey. Eng. News, Vol. 68,
p. 334, 1912.

INDEX

A

- Abutments, masonry, 206
 - quantities. 208
 - reinforced concrete, 207
 - wooden, 245
- Accidents, grade crossing, 272
- Aerial dump, 50
- Aggregates, concrete, 145
- Air, tunnel ventilation, 129
 - compared with steam, drilling, 60
 - compressors, cost, 65
 - drills, 60
 - power required, 62
 - hammer drills, 69
- Alpine tunnels, 94
- American examples, tunneling, 94
- Analysis cost, earthwork, 16
- Arch culverts, concrete, 193
 - cost of forms, 196
 - quantities, 195
 - stone, 191
 - cost, 142, 193
 - dimensions, 191
 - quantities, 191
- Arch masonry, 134
- Areas, drainage, 283
- Ashlar masonry, 134
- Atlantic City paint tests, 298
- Auger, earth, 54, 154
- Austrian method, tunneling, 91, 112
- Average lead, earthwork, 12
- Azimuth, track survey, 288

B

- Ballast, 251
 - cars, 51
 - cost, 252
 - depth, 253

- Ballast, floors, bridge, 244
 - trestle, 228
 - section, 269
 - size, 251, 252
- Ballasting track, 271
- Baltimore Belt Railroad Tunnel, 105
- Bearing capacity of soils, 157
- Belgian method of tunneling, 91, 104
- Bergen Hill tunnels, 99
- Bessemer rails, 258
- Big Shoal Cut-off, 40
- Bill of materials, wooden trestles, 221, 224
- Bits, drill, 56
- Black, or blasting powder, 75
 - use of, 79
- Blasting, 78
 - chamber, 81
 - crater theory, 78
 - examples, 81
 - methods, 79
 - charging holes, 80
 - firing, 74, 76, 80
 - tamping, 80
 - stumps, 6, 7
 - theory, 78
 - See also Rock Excavation and Tunneling.
- Blasting gelatine, 76
 - powder, 75
 - use of, 79
- Block-holing, drilling, 58
 - for steam shovel work, 40
- Boilers, steam, cost, 65
- Borings and soundings, 54, 154
 - auger, earth, 54, 154
 - calyx core, 72, 73
 - costs, 72, 155
 - diamond drill, 72
 - for earthwork, 8, 283
 - for foundations, 154
 - for tunnels, 88, 116

- Borings, pipe, 154
 wash, 117, 155
 with well drilling machines, 155
 Borrow, and waste, 9
 pits, 9
 overhaul from, 13
 Boston Subway, 116
 Brandt hydraulic drill, 71
 power for, 62
 Bridges, ballasted floor, 244
 clearance diagram, 238
 elevation outer rail, 244
 impact allowance, 245
 methods of erection, 238
 open floor, 243
 Oregon Pacific Howe truss, 234
 portal bracing, 236
 rerailing devices, 243
 skew, 244
 steel, 237
 waterproofing floors, 244
 weight per foot, steel, 239
 wooden, 234
 cost, 237
 Bridge masonry, 134
 abutments, 206
 cost, 150, 210
 quantities, 208
 reinforced concrete, 207
 anchorage Williamsburg bridge,
 143
 piers, 203
 quantities, 204
 Broken stone ballast, 251
 cost, 252
 Bruckner's curve, 10, 11
 Bucket excavator, 45
 Burkli storm water formula, 183
 Burnt clay ballast, 252
 cost, 252
- C
- Caissons, 165
 open, 167
 pneumatic, 166
 Calyx core drill, 73
 Canadian Pacific spiral tunnels, 96
 Capacity, culvert, 184
 Capitalized cost of structures, 291
 Cars, flat, 51
 ballast, 51
 construction, or dump, 45, 49
 rental rates, 46
 Carts, one-horse, 33
 Castiron culverts, 187
 Catskill Aqueduct tunnel, 99
 Roundout, 99
 Wallkill tunnel, 100
 Cattle guards, 274
 Cement gun, 150
 Cement mortar, proportions, 140
 Center cut, tunnels, 93
 Center heights, earthwork, 279
 Chamber blasting, 81
 Chicago Drainage Channel, 82
 Churn drilling, 57
 cost, 59
 Cinder ballast, 253
 Circular cut, tunnels, 93
 Classification, earthwork, 7, 282
 Clearing and grubbing, cost, 5
 specifications, 5
 Cofferdams, 153, 159
 A-frame, 160
 crib, 164
 earth, 158
 sheet pile, 160, 162
 steel, 160
 wooden, 160
 Common excavation, 8
 Company work, 4
 Comparison, air and steam drilling,
 60
 pine and steel ties, 293
 viaduct and trestle, 292
 wooden trestle and embank-
 ment, 227
 Compressed air, use in tunnels, 92
 Computations, location, 282
 Concrete, bridge abutments, 207
 bridge piers, 206
 broken stone, *vs.* gravel, 145
 forms, 148, 196
 Erie R. R. arch culverts, 194
 Illinois highway bridges, 151
 in sea water, 150

- Concrete, materials, 145
 per cubic yard, 146
 mixing and placing, 146
 overhead crossings, 247
 proportions, 144
 reinforced culverts, 196
 reinforcement, 149
 reinforced, trestles, 232
 rubble, 145
 specifications, hand mixing, 147
 tunnel lining, 92
 vs. stone masonry, 296
- Construction, data, 285
 outline of, 4
 records, 286
- Contractor's profit, 2, 3
- Core drilling, 54, 72
 See also rotary drills.
- Corrections, field tape, 287
- Corrosion, iron, 296
- Cost data, 2
- Cost of, arch culverts, 193, 196
 ballast, 252
 blasting stumps, 6
 borings, foundation site, 155
 bridge abutments, 210
 bridge anchorage, 143
 bridge piers, 168
 carbons for diamond drills, 72
 clearing and grubbing, 5
 concrete arch culverts, 196
 highway bridges, 151
 piles, 175
 cribs, 159
 culvert masonry, 142
 dressing stone, 138
 drilling, hand, 57
 churn, 59
 hammer, 57
 plug and feather, 58
 drilling, power, 64
 calyx core, 73
 diamond, 72
 piston, 64, 66
 well drilling machines, 70
 earthwork, cars and dinkey, 49
 cars and horses, 50
 carts, 33
 crane, locomotive, 45
- Cost of, earthwork, drag line excavator, 45
 drag scrapers, 22
 dumping, aerial dump, 50
 elevating graders, 31
 Fresno scrapers, 23
 labor items, 16
 labor, supplies, temporary track, 49
 locomotive crane, 45
 loosening, 17
 Maney scrapers, 28
 moving steam shovel, 52
 roads and gangways, 20
 shoveling, 18
 spreading and dressing, 19
 steam shovels, 37, 40, 51, 83
 superintendence, etc., 20
 temporary trestles, 41
 wheelbarrows, 21
 wheel scrapers, 26
 work train service, 52
- explosives, 74, 81
 falsework, bridges, 237, 241
 fencing, 276
 forms for concrete, 149
 hauling, loading, rock, 82
 Howe truss bridges, 237
 land, 5
 laying slope wall, 142
 stone, 141
 loading rock, 82
 masonry anchorage, Williamsburg bridge, 143
 mixing concrete, 146, 150
 pile driving, 175
 pneumatic caisson, 167
 quarrying stone, 136
 rock tunnels, 101, 103
 Busk, 95
 Buffalo, under Erie Canal, 103
 Buffalo waterworks, 103
 Hunter Brook, 102
 Kanawha & Mich. Ry., 101
 reclamation service, 101
 sewer pipe culverts, 186
 steel bridges, 241
 surveys for location, 288

- Cost of, temporary trestle, 84
 track laying, 272
- Crane, locomotive, 45
- Creosote and zinc, 302
- Creosoting timber, 294, 300
- Crib coffer-dam, 164
- Cribs, 158
- Crossings, farm, 283
 grade, 272, 283
 highway, 247, 283
 overhead, 248
- Cross-sections, 283
- Culverts, analysis of cost, 142
 capacity, 184
 cast iron pipe, 187
 Erie R. R. concrete arch, 194
 N. C. & St. L. R. R. reinforced
 concrete, 197
 pipe, 185
 plain concrete arch, 193
 rail floor, 198
 reinforced concrete, 196
 stone arch, 191
 stone box, 188
 waterway, 180
 West Shore, 189
 C. C. Ext. of W. Md. Ry.,
 analysis, cost earthwork, 83
- Cut and cover method, tunneling,
 115
 Boston subway, 116
- Cuts, compared with tunnels, 87
 width for, 268
- D
- Dams, coffer-, 159
- Datum for levels, 288
- Davis bit, 73
- Deck girder, abutments, 208
 piers, 203
- Depreciation, 3
 drills, 66
 idle plant, 2
 steam shovel, 37, 42
 structures, 295
- Depth of ballast, 253
- Detroit River tunnel, 120
- Development expenses, 2
- Diagram, mass, 10, 283
- Diamond drilling, 72, 156
- Diaphragm pump, 177
- Dinkey locomotives, 45, 48
 rental rates, 46
- Dirt ballast, 253
- Discharge, culvert, 184
- Distributing ties, 270
- Ditches, side, 268
 roadbed drainage, 267
- Double, box culverts, 189
 tracking, 271
- Dragline excavators, 44
 operation of bucket, 44
 Page bucket, 44, 45
- Drainage, area, 183, 283
 dry cuts, 268
 grade crossings, 273
 retaining walls, 201
 track, 267
 wet cuts, 268
- Drawing bars, 110
- Dressing stone, 137
- Drift bolts, 222
- Drill, carriage, in tunnels, 98, 99
 holes, foundation sites, 156
 tunnel headings, 99
- Drilling, 54
 analysis of cost, 64
 annular bit, with hardened steel
 shot, 73
 bits and sharpening, 56
 effect of air pressure, 65
 effect of size of hole, 55
 hand, 57
 hand vs. steam, rock tunnels,
 101
 Hunter Brook tunnel, 102
 in tunnels, 99
 power for, 59
 Roundout tunnel, 99
 spiral tunnels, Can. Pac., 96, 97
 use of water in, 55
 Wallkill tunnel, 100
 with air hammer drills, 69
 with piston drills, 63
 with rotary drills, Brandt hy-
 draulic, 71

- Drilling with Davis calyx, 73
 diamond, 72, 156
 well drilling machines, 70
- Drills, hand and steam, rock tunnels, 101
 rotary, 54, 57, 91
- Drop-hammer, pile driving, 170, 233
- Dry masonry, 135
- Dump, aerial, 50
- Dun's Tables, waterway for culverts, 181
 diagram, 182
- Durability of structures, 294
 concrete, 296
 metal bridges, 238
 steel, 292, 294
 timber deck, 244
 wooden trestles, 228
- Dynamite, ammonia, 76
 comparison with Joveite, 77
 discovery of, 75
 gelatin, 76
 how made, 75
 size of holes for, 56
 thawing, 77
 use of, 80
 use in Ouray tunnel, 99
 volume of fumes from, 130
- E
- Earthwork, Chap. II., see Contents.
 classification, 7
 corrected center heights, 279
 mass diagram, 10
 measurement of, 9
 overhaul, 13
 pay quantities, 9
 preliminary estimates, 279
 shrinkage allowance, 8
 table, level cuttings, 279
 tables, preliminary, 279
 volume, from profile, 279
 end areas, 279
 graphic method, 281
 middle areas, 279
 transverse slope, 279
- Economic lead, 9
- Electric-air drills, 63
- Electric percussion drills, 68
 power required for, 62
- Electrolytic theory corrosion, 296
- Elevating graders, 30
- Elimination grade crossings, 273
- Embankment, vs. wooden trestles, 227
 forming, 9
 shrinkage, 8
- Empire hand drills, 155
- Engineer, resident, 285
- English method of tunneling, 91, 109
- Erection, method for steel bridges, 238
- Erie R. R., culverts, 194, 195
- Estimates, contractor's, Busk tunnel, 95
 final, 285, 286
 items for, 2
 location, 282
 methods of making, 1
 monthly, 285
 preliminary, earthwork, 279
 records, form for, 284
 stone quarried, 138
 structures, 282
- Examination, foundation site, 154
- Excavation. See also Earthwork.
 common, 7
 for caissons, 167
 rock, Chap. III., see Contents.
 tunnel, Baltimore Belt Ry., 105
 general methods, 88
- Excavator, drag line, 44
- Expenses, development, 2
 field, 2, 3
 overhead, 2
 plant and tool, 2, 3
- Exploders, selection of, 74
- Explosives, ammonia, and gelatin dynamites, 76
 amount per cubic yard, Hunter Brook tunnel, 105
 black or blasting powder, 75
 blasting gelatin, 76
 blasting stumps with, 6
 dynamite, 75
 Hercules powder, 76

Explosives, Joveite 77
 loosening earth with, 16
 nitroglycerin, 75
 tamping, 80
 thawing dynamite, 77.
 use of, 79, 90
 Virite, 77

F

Farm crossings, 274, 283
 Fastenings, rail, 261
 Fence, posts, cost concrete, 276
 wire, protection coatings, 276
 Fences, cost, barbed wire, 277
 smooth wire, 276
 woven wire, 277
 Fills, comparison with trestles, 227
 Final estimates, 285
 Floors, ballast for trestle, 228
 bridge, 244
 concrete slabs for, 233
 highway bridges, 248
 waterproofing, 244
 Footings, foundation, 158
 Form, for estimates, 284
 of tunnel section and lining, 92
 Forms, cost, for highway bridges,
 151
 for concrete, 148
 lumber for, 148
 requirements, 149
 Formula, volume earthwork, trans-
 verse slope, 280
 Foundation piles, 158
 Foundations, Chap. VI, see Contents.
 borings for, 155
 retaining wall, 201
 stone arch culverts, 191
 testing, 157
 trestles, 214, 227
 Freezing of explosives, 76
 Frogs, and switches, 266
 grade crossing, 267
 manganese, 267
 Fuel for, calyx core drills, 74
 drilling, 66, 67
 steam shovels, 38
 well-drilling machines, 71

G

Gasoline for drilling, 61
 General expenses, 2
 German method, tunneling, 91
 advantages, disadvantages, 109
 Baltimore Belt R. R., 105
 Gopher holes, blasting, 81, 82
 Grade crossings, 272, 283
 accidents, 272
 classification, 273
 construction, 273
 danger, 272
 elimination of, 273, 247
 in New York City, 273
 Grade triangle, earthwork, 280
 Graders, elevating, 30
 Grading, classification, 7
 Granite quarrying, 137, 139
 cost, 137, 139
 Gravel, for concrete, 145
 ballast, 252
 Grubbing, cost, 6
 specifications, 5
 Guard, Jordan, 243
 rails, 215
 for bridge floors, 244
 for frogs and switches, 267
 for trestle floors, 223
 timbers for bridges, 243
 Guards, cattle, 274
 Guide frames, coffer-dams, 163
 Gun, cement, 150
 Gunnison tunnel, 97

H

Hammer drills, air, 69
 hand, 57
 Hammer, pile driving, drop, 170
 steam, 171
 Hand drilling, churn, 59
 for foundation site, 155
 hammer, 57
 plug and feather, 59
 Hand mixing, concrete, 148
 Hardpan, 8
 Haul, free, and overhaul, 13
 Hauling rock, 82

- Hauling with, cars and dinkey loco-
motive, 45
cars and horses, 49
carts, 33
wagons, 34
- Heading holes, Roundout, 99
- Headings, tunnel, Busk rock, 94
Can. Pac., Spiral, 96
English method, earth, 109
hard rock, 93
methods of driving, 89
progress in driving rock, 95
size for earth, 89
for rock, 95
- Hercules powder, 76
- High water marks, 283
- Highway bridges, cost, reinforced
concrete, 151
floor protection, 249
live loads, 248
plan for timber, 248
solid floor, 248
weight of steel, 248
- Highway, crossings, 247, 283. See
Grade Crossings.
overhead bridges, 247
bridge bents, 249
plate girder bridges, 248
- Hole, size in drilling, 55
- Hopper, loading cars or wagons, 44
- Howe truss bridges, cost of erection,
237
quantities, stresses, 235
- Hunter Brook Tunnel, 102
- Hydraulic, drills, 61
jacks (or rams), 91, 118, 124
- I
- I-beam, steel ties, 254
- Impact allowance on ballast floors,
245
- Instrument work, right of way sur-
vey, 286
- J
- Jacks, hydraulic, use for shields, 91,
118, 124
- Jetting piles, 170, 173
- Joints, masonry, 141
rail, alternate or opposite, 261
splice bars for, 260
strength and stiffness, 260
supported, 261
suspended, 261
- Jordan guard, 243
- Joveite, 77
- L
- Labor, analyses of cost, 3
- Land, cost for railroad use, 5
- Latimer rerailing device, 243
- Large blasts, 81
- Laws proportioning, concrete, 144
mortar, 140
- Laying, stone, 141
track, 270
double tracking, 271
force required, 271
rails, 271
- Lead, economic, 9
average, 10, 12
free, 13
maximum, 12
- Levels, right of way surveys, 288
- Lidgerwood traveling cableways, 83
- Life of, metal bridges, 294, 296
timber, 296
deck bridges, 244
- Lining, tunnel, 92
Detroit River, 120
English method, 109, 112
N. Y. Ext. Penn. R. R., 123
- Live loads, highway bridges, 248
- Loading, earthwork, rock, 82
through cut, steam shovel, 47
through hoppers, 44
with elevating graders, 30
with hand shovels, 18
with scrapers, 35
with steam shovels, 37, 39, 42
- Loads, foundations, general, 153
safe, 156
safe for piles, 173
table of safe, 157
testing for, 157

Location estimates, 282
 profile for, 10, 285
 Location, surveys, cost per mile, 288,
 289
 of tunnels, 87
 Locomotive, cinder ballast, 253
 crane, 45
 dinkey, 45, 48
 Loetschberg tunnel, 94
 Loosening earth, cost, 17
 methods, 16
 Lumber, concrete forms, 148

M

Machines for track laying, 272
 Maintenance, cost of structures, 295
 Management expenses, 2
 Manganese, in rails, 257
 frogs, 267
 Maps, right of way, 286
 Masonry, 134
 anchorage Williamsburg bridge,
 143
 arch bridges, 238
 bridge piers, 203
 cost, bridge anchorage, 143
 culvert, 134, 180
 dry, 134, 188
 for pipe culvert, 187
 joints, 141
 mortar required, 141
 quantities, arch culverts, 191
 box culverts, 189
 rail floor culverts, 200
 rock faced, 138
 Mass diagram, 10, 283
 Materials, 3
 cost per cubic yard concrete,
 146, 151
 quantity for cubic yard con-
 crete, 146
 Santa Fe wooden trestles, bill
 of, 221
 track, ballast, 251
 Measurement, earthwork, 9
 Metal, cost repainting bridges, 242
 fence posts, 276

Metal, open deck steel bridges, 238
 protection of, 296
 steel ties, 264
 Method, increasing bearing capacity
 of soils, 157
 increasing tie supply, 255
 Mixing and placing concrete, 146
 cost of, 146
 specifications for, by hand, 147
 Monthly and final estimates, 285
 Monuments, property lines, 287
 track, 287
 Mortar, 139
 cement and sand per cubic yard
 of, 140
 proportioning, law of, 140
 quantity per cubic yard ma-
 sonry, 141
 Mount Ceniz Tunnel, 94
 Mucking, tunnels, Can. Pac. Spi-
 ral, 96
 Roundout, 100
 Wallkill, 100

N

Nitroglycerin, 75

O

Open, bridge floors, 243
 caissons or cylinders, 167
 deck or floor trestles, 229
 hearth, steel rails, 258
 Opening a quarry, 135
 Opposite or alternate rail joints, 261
 Oregon Pac. Howe Truss bridges,
 234
 Ouray tunnel, 99
 Overhaul, 13
 Overhead charges, 2
 Overhead crossings, 248
 tunneling, 103

P

Painting, cost and quantities, 232
 cost of, 295
 steel bridges, 242
 steel trestles, 232

- Paint tests, results of Atlantic City, 298
- Pay quantities, 9. See also Mass Diagram.
- Penetration, last blow for piles, 174
- Penna. Lines West, standard wooden trestles, 224
- Penna. R. R., N. Y. tunnel ext. of, 123
- Percussion drills, hand hammer, 57
hand churn, 57
power hammer, 68
power piston, 63
well drilling machine, 70
- Picks, loosening earth, 16
- Piers, bridge, 203
concrete, 151, 206
forms of, 205
quantities for, 204
- Pile and timber trestles, bill of materials, 220
material for, 222
quantities per foot, 227
- Pile bents, reinforced concrete, 234
wooden, 216
- Pile driver, 170
crew, 176
marine, 176
steam-hammer, 171
- Pile driving, 170
concrete piles, 233
costs, 175
drop-hammer, 177, 233
jetting, 170
railroad pile driver, 172
water jet, 175
- Piles, bearing power, 173
casing for concrete, 170
Chenoweth, 233
concrete, 168
cost data, 175
driving, 170
heads, 174
durability, 294
for foundations, 158
founding on, 168
per bent, trestles, 228
pointing, 174
- Piles, precast, 169, 170
reinforcement for, 233
safe load, 173
sand, 168
sheet, 160
specifications for wooden, 169
- Piling, cost of triple lap sheet, 176
steel sheet, 160
test piles, 169
wooden sheet, 160
- Pilot method of tunneling, 114
- Pipe culverts, 185
cast iron, 187
masonry for, 187
pulling apart, 188
slope for, 185
- Piston drills, 63
depreciation, 65
mounting, for deep holes, 68
repairs, 65
- Plant for quarrying stone, 137
- Plate girders, highway, 248
- Plow, unloading, 51
- Plows, loosening earth with, 16, 25
- Plug and feather work, drilling for,
by hand, 58
cost of, by hand, 59
with air hammer, 70
- Pneumatic caissons, 166
advantages of, 167
for shafts, P R. R. tunnels, 126
- Point switch, 264, 265
- Pole ties, 254
- Poling boards for, shaft sinking, 90
tunneling, 104, 106, 110, 128
- Portal bracing, Howe truss bridges, 236
- Portland cement, in mortar, 139
weight, 140
- Posts, fence, concrete, metal, wood, 276
- Powder, used in Hunter Brook tunnel, 102
- Power, for drills, 59
comparison, air, electric and hydraulic drills, 62
steam and air, transmission, 60
well drilling machines, 70
- Precast piles, 169, 170

- Preliminary estimates, 279
 earthwork, 279
 yardage, from profile, 280
 structures, 282
 Preservation, ballast bridge floors,
 244
 wood, 299
 Prismoidal formula, earthwork, 121,
 279
 Profile, location, progress, 285
 scale for yardage, 281
 Profit, contractor's, 2, 3
 Progress profile, 285
 Property line monuments, 287
 Protection, of iron, 296
 cleaning for repainting, 242
 cost, scraping, repainting, 242
 magnetic oxide surface, 297
 painting bridges, 242
 protective coatings, 297
 roadbed slopes, 269
 timber, 294, 300
 Provision for traffic, cut and cover
 tunneling, 115
 Puddling, coffer-dams, 162
 Pulsator, or electric-air drill, 63
 Pumps and pumping, 177
 centrifugal, 178
 hand, 177
 pulsometer, 178
- Q
- Quantities, bridge abutments, 208
 bridge piers, 204
 concrete arch culverts, 195
 rail floor culverts, 199
 reinforced concrete culverts, 197
 trestle piers, 232
 wooden bridges, 235, 237
 Quarrying stone, 135
 cost of, 139
- R
- Rail, creeping, 260
 elevation of outer on bridges,
 244
 Rail floor culverts, 198
 fastenings, 261
 Rail joints, alternate or opposite,
 261
 spikes, tie plates, 261
 strength, stiffness, 258, 260
 supported, suspended, 261
 Watertown Arsenal tests, 259
 Rail sections, A. S. C. E., 256
 Dudley, 256
 P. S., 257
 Railroad; bridges, corrosion, 238
 cost, 241
 pile driver, 172
 Railroads, cost of location, 289
 valuation of, 302
 Rails, Bessemer, open hearth, 258
 chemical composition, 257
 guard, 233, 243, 244, 267
 laying, 271
 length, 258
 quality of metal, 257
 spikes for, 261
 switch, 264
 tie plates for, 261
 use of heavy, 255
 Record of work, 286
 Records, construction, 286
 Reinforced concrete, abutments, 207
 culverts, 196
 data for N. C. & St. L. R.
 R., 197
 reinforcement for, 198
 highway bridges, 151, 249
 kind of steel required, 149
 masonry, 134
 pile bents, 232
 trestles, 232
 Reinforcement for concrete, 148
 steel required, 149
 Rentals, 3
 cars and dinkeys, 46
 diamond drills, 72
 Repairs, plant, 3
 drill, 66
 steam shovel, 37, 52
 Rerailing devices, bridge floors, 243
 Resident engineer, 285
 duties of, 285

- Resurvey, right of way maps, 286
- Retaining walls, 201
 earth pressures, 201
 rotation, 203
 stability, 202
 use of dry masonry, 135
- Right of way, acquiring, 4
 maps, 286
 reference line, 286
- Risks, responsibility for, 4
- Roadbed, ballast section, 269
- Roads and gangways, keeping in order, 20
- Rock, ballast, depth, 253
 cost of blasting, 81
 of drilling, 64, 72
 of excavation, 84
 of loading and hauling, 82
 definitions of loose, solid, 7
 driving shield through, 127
 excavation, general, 54
 swelling, 8
 tunnels, 90
- Rock excavation, Chap. III, see Contents.
- Rolling (or tamping) embankments, 20
- Roof, tunneling, cut and cover method, 115
 shields, tunneling, 119
- Rotary drills, 54, 62
 Brandt hydraulic, 71
 calyx core, 72
 diamond, 72
- Roundout tunnel, 99
- Rubble, concrete, 145
 masonry, 134
 dressing stone for, 137
 joints, 141
- S
- Safe loads, for foundations, 156
 for piles, 173
 table of, 157
- Saccardo system, ventilation, 131
- St. Clair River tunnel, 119
- St. Gothard tunnel, 94
- Salaries, 2
- Sand, quantities per cubic yard
 mortar, 140
 requirements, 139
 voids, 140
- Santa Fe wooden trestles, bill of materials, 220, 221
 loading, 218
 plans, 215
- Scrap value, 3
- Scrapers, drag, 21
 Fresno, 22
 Maney, 27
 wheel, 24
- Screw spikes, 262
- Seasoning ties, 301
- Sea-level datum, 288
- Sea water, concrete in, 150
- Sections, roadbed ballast, 269
 rail, 255
- Sewer pipe culverts, 186
- Shafts, tunneling, 89
 English method, 10
- Sheet piling, 160
 coffer-dams, 159-163
 guide frames, 163
 interlocking joints, 161
 steel, 160
 waling pieces, 163
 wooden, 160
- Shield, method, 117
 description of, 118
 history of, 117
 jack cylinders, 118
 St. Clair river tunnel, 119
- Shields, tunnel, 117
 Detroit River, 123
 jacking force required, 118
 N Y. tunnel Ext. Penna., 125, 127
 roof, 119
 use without excavating, 124
- Shoveling, earth, 18
- Shrinkage, 8, 227
- Shuart grader, 19
- Side ditches, 268
- Simplon tunnel, 94
- Sinking caissons, 167
- Site, examination of, for foundations, 154

- Site, examination of, for tunneling, 88
- Size of culverts, 181, 184
- Skew bridges, 244
- Skin friction for caissons, 167
- Slab floor, concrete trestle, 233
- Slag for ballast, 252
- Slope wall, cost of laying, 142
- Slopes, protection of, 268
- Soils, bearing capacity and methods of increasing same, 157
- tunnels in loose, 91
- Soundings for foundations, 154
- Specifications, hand mixed concrete, 147
- timber preservation, 300
- timber piles, 169
- Spreaders for earth, 18, 41
- Spreading and dressing earth, 19
- Spring frog, 266
- Springing holes for blasting, 80
- Stability of retaining walls, 202
- Standard, N. C. St. L. Ry., reinforced concrete culverts, 197
- structures, advantages of, 180
- wooden trestles, 215, 234
- plans, Penna. lines W., 224
- Santa Fe, 216, 229
- Steam, drop-hammer, driver, 170
- hammer pile driver, 171
- pumps, 177
- shovels, 35
- Big Shoal Cut-off, 40
- Can. Pac. tunnels, 97
- C. C. Ext. W. Md. Ry., 83
- for grade reduction, 48
- for light work, 42
- handling through cuts, 47, 48
- moving, 52
- repairs, 37, 52
- Steel bridges, 237
- cost of erection, 241
- durability, 294
- electric railroad, 240
- methods of erection, 238
- painting, 232
- weight per foot, 239, 248
- Steel, for drills, 56
- for reinforced concrete, 149
- sheet piling, 161
- ties, 254
- improved fastenings, 264
- trestles, 229
- open deck or floor, 229
- painting, 232
- weight per foot, 230
- Stone, arch culverts, 191
- dimensions, quantities, 191, 192
- broken, for ballast, 251
- box culverts, 188
- cost for bridge anchorage, 144
- cost of laying, 141
- dressing, 137
- quarrying, 135
- Storm water, Burkli's and Talbot's formulas, 183
- Strength, stiffness, rail joints, 260
- Stresses, bridge piers, 203
- Howe truss bridges, 234
- temperature, retaining walls, 201
- unit, 219, 235
- Stringers, spacing for bridge floors, 243
- for trestles, 214
- Structures, preliminary estimates, 282
- Stub switch, 264
- Structures, capitalized cost, 291
- durability, 294, 296
- maintenance, 295
- preliminary estimates, 282
- Subaqueous tunnels, 93
- Subletting, 285
- Submarine tunneling, 116
- Superintendence, timekeeping, water carrying, 20
- Suspended rail joints, 261
- Supplies, 3
- Supported rail joints, 261
- Surface cattle guards, 274
- Surfacing track, 271
- Surveys, cost of location, 288
- Switches, point, stub, 264
- Switch rails, length, 265

T

- Tables, forearth work, preliminary, 279
 for level cuttings, 279
- Tabulating data, preliminary estimates, 282
- T-abutments, 206
- Tamping, embankments, 20
 drill holes, 80
- Temperature corrections, field tape, 287
- Test, drilling, for foundations, 156
 holes, drilling, 72
 pits for earthwork, 8
 for foundations, 154
- Testing, for safe loads, 157
 paints at Atlantic City, 298
- Thawing dynamite, 77
- Theory of blasting, 78
- Tie plates, rail fastenings, 261
 recommendations Am. Ry. Eng. Assoc., 262
- Ties, cross, 253
 creosoting, 300
 creosoted, Hoptacong Cut-off, 263
 dimensions, timber, 253
 distribution, 270
 I-beam, 254
 inverted trough shaped, 254
 method of increasing supply, 255
 preparation, for rails, 262
 for screw spikes, 262
 steel, insulation, 264
 switch, 267
 trestle, 215
 with tie plates, 261
 zinc-chloride treatment, 301
 zinc-creosote emulsion, 302
 zinc-tannin treatment, 301
- Timber, bridge, 294
 cross-ties, growth, kinds, 253
 deck, life of bridge, 292, 294
 durability of, 294
 forms, concrete, 148
 preservation, 299
 ties, efforts to increase supply, 255
- Timber, time to cut, 253
- Timbering, tunnel, Austrian method 113
 Baltimore Belt R. R., 107
 Belgium method, 104
 English method, 111
 Hunter Brook, 102
- Timbering shafts, 90
- Track, bolts, 260
 construction, form for estimates, 284
 drainage, 267
 laying, 270
 force required, 271
 machines, 271
 preparation, roadbed, 271
 maps, 288
 materials, 251
 monuments, 287
 spikes, 262
 temporary, labor, supplies for, 49
 tie plates, for, 261
 work, protection, cuts and fills, 268
- Traction engine, use with elevating graders, 31
 use with Maney scrapers, 28
- Traffic, provision for, cut and cover tunneling, 115
- Transmission of power, attempts to improve, 63
 comparison of air and steam, 60
- Transverse slope, earthwork computations, 279
- Treated piles, 229
- Tremies, Detroit Riv. tunnel, 122
- Trestles, bents, 216, 230
 bills of material, 220, 221
 bracing, 214
 comparison, trestle and viaduct, 292
 concrete, floor slabs, 233
 standard plans, 232
 cost of floors, 232
 durability of timber for, 294
 Harriman lines, ballast floor, 229
 Ill. Central, ballast floor, 229

- Trestles, overhead crossings, 247
 pile driving, 172
 principles of construction, 213
 quantities and cost, 226
 reinforced concrete, 232
 abutments, 208
 slabs, 233
 Santa Fe, 216, 229
 steel, 229
 masonry for piers, 232
 painting, cost and quantity, 232
 reinforced concrete, 232
 weight per foot of, 230
 stresses in, 223
 stringers, 223
 temporary, see aerial dumps.
 Big Shoal cut-off, 41
 cost, C. C. Ext. W. Md., 84
 labor and supplies, 49
 wooden, 212
 construction of, 213
 standard plans, 215-226
 with ballast floors, 228
- Trestling for fills and bridging, 283
- Truss, Ore. Pac. Howe, 234
 portal bracing, 236
- Tubes, tunnel, N. Y. Ext. of Penna. R. R., 123
 settlement of, 126
 sinking in Detroit River, 120
- Tunnel headings, 93
 Alpine tunnels, 94
 spiral, Can. Pac., 96
 concrete lining, 97
 method of driving, 96
- Tunnels, Chap. IV, see Contents.
 Buffaol Waterworks, 99
 Busk, 94
 contractor's estimate, 95
 machinery used, 96
 progress, driving heading, 95
 timbering, 95
 compared with open cuts, 87
 difficult work on the Gunnison, 97
 North and East River Tubes, Penna., 123
 Ouray, 99
- Tunnels, records in hard rock, 98
 Walkkill, 100
 Roundout, 99
 section, Penna. R. R. in N. Y., 123
 settlement of tubes, 126
 Walkkill, 100
 through hard rock, 93
 through loose ground, 103
 Baltimore Belt R. R., 105
 method of excavation, 106
 timbering, 106
 Belgian method, 91, 104
 objections to, 105
 English and Austrian methods, 91, 109, 112
 German method, 91, 105
 Italian method, 91
- Tunnel, ventilation, 128
 air required, 129
 Saccardo system, 131
- Turnouts, 264
- U
- U and T bridge abutments, 206
 Uniformity in standard structures, 180
 Unit stresses, 219, 235
- V
- Valuation of railroads, 302
 Volume of earthwork, allowing for transverse slope, 280
 by end areas, 279
 by middle areas, 279
 formula for, 280
- W
- Wagons, loading with elevating graders, 30
 loading with scrapers, 35
 patent dump, 34
 slat bottom, 34

- Waling pieces, sheet piling, 163
 Walkkill tunnel, 100
 Walls, retaining, 201
 Wash borings, 155
 Waste, borrow and, 9
 Water, carrying, 20
 use in drilling, 55
 core drills, 72
 Lynner hammer drills, 69
 jet, pile driving, 172
 pipe for culverts, 187
 Waterproofing, bridge floors, 244
 concrete, 245
 Watertown Arsenal rail joint tests,
 259
 Waterway for culverts, 180
 Burkli's formula, 183
 diagram, 182
 Dun's table, 181
 rate maximum rainfall, 183
 Weight of steel highway bridges,
 248
 railroad bridges, 239
 trestles, 230
 Well drilling machines, 70, 155
 adaptation to deep holes, 70
 cost of operation, 71
 life of, 71
 use for blast holes, 81
 West Shore stone arch culverts, 191
 stone box culverts, 189
 bridge abutments, 209
 Wet cuts, 268
 Wheelbarrows for, concrete, 148, 150
 earthwork, 20
 Width of cuts, 269
 Williamsburg Bridge, anchorage, 143
 Wing wall abutments, 210
 Wire fences, 276
 Wood preservation, 299
 Wooden, box lift pump, 177
 bridges, 234
 cattle guards, 275
 cross ties, 253
 piers and abutments, 245
 pile bents, 213, 216, 217
 sheet piling, 160
 trestles, 212
 compared with embankment,
 227
 cost of erection, 227
 estimates, 226
 floors, 213, 228, 236
 foundations, 227
 piles for, 228
 principles of construction,
 213
 quantities and cost, 226
 standard plans, 215, 226
 with ballast floors, 228
 Work train service, 52
 Working stress, concrete, 145
- Z
- Zinc-chloride, wood preservative,
 299
 Zinc-creosote, 302
 Zinc-tannin, 301



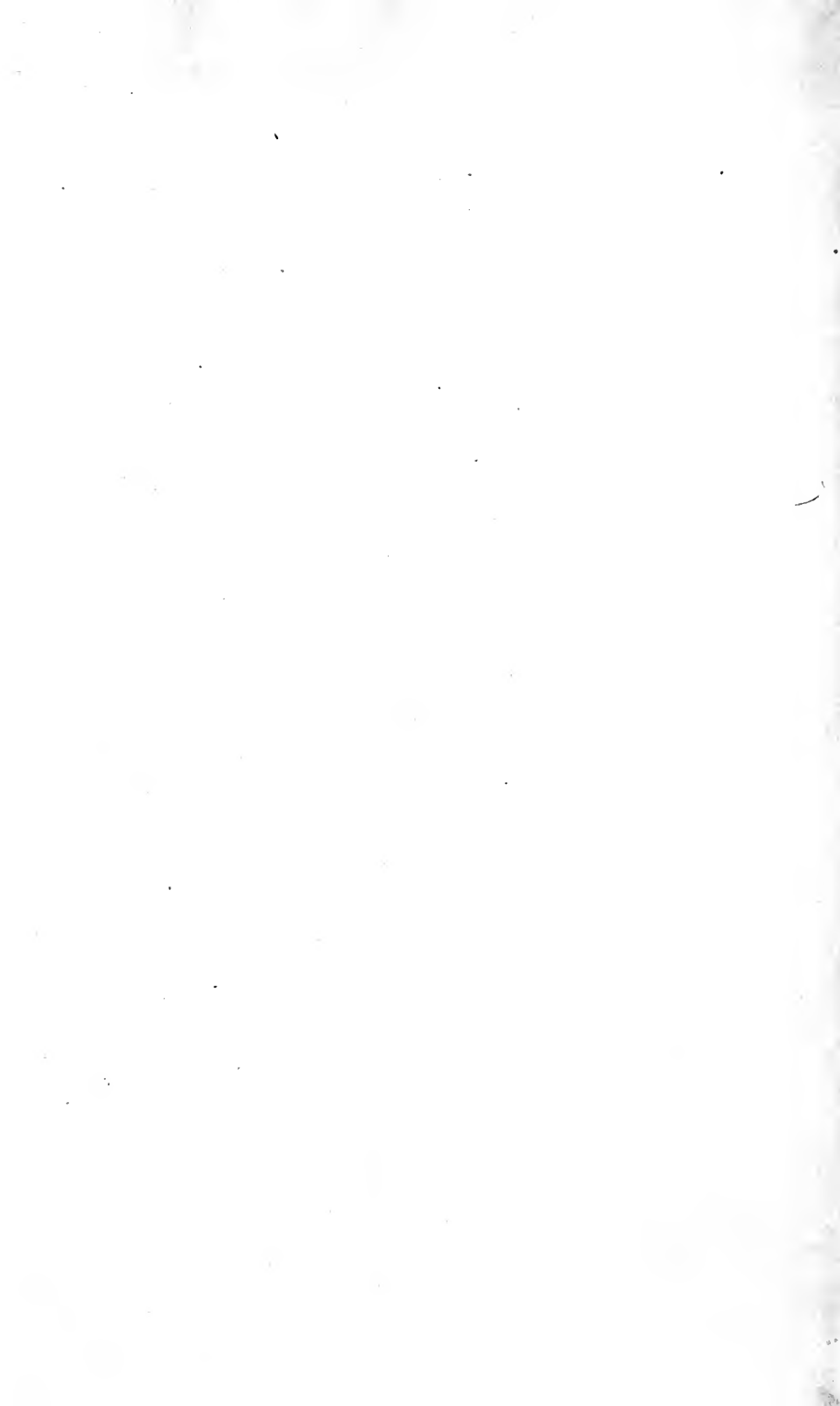

LIBRARY USE
RETURN TO DESK FROM WHICH BORROWED
LOAN DEPT.

THIS BOOK IS DUE BEFORE CLOSING TIME
ON LAST DATE STAMPED BELOW

MAY 10 1972

REC'D LD MAY 10 10 -10 PM 31

SENT ON ILL

APR 05 2001

U.S. DEPARTMENT OF AGRICULTURE

LD 62A-30m-2,'69
(J6534s10)9412A—A-32

General Library
University of California
Berkeley

1931

LD 21-100m-7,'39(402s)

347143

STF200

C.9

UNIVERSITY OF CALIFORNIA LIBRARY

