

4/6 NET

---

RECENT  
COTTON MILL CONSTRUCTION  
AND ENGINEERING

---

JOSEPH NASMITH.

---

# LIBRARY



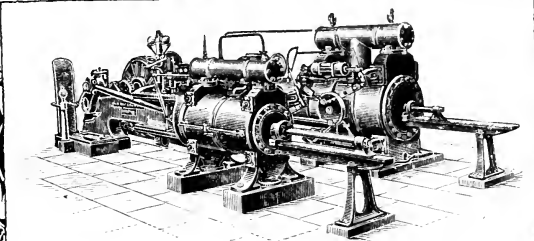

Telegrams  
**HICKS BOLTON**

# Hick, Hargreaves & Co. Ltd.

Speciality  
High Class Engines

**CORLISS ENGINES,**  
of every description up to 10000, H.P.  
**MILL GEARING IN ALL ITS BRANCHES,**  
**BELT & ROPE DRUMS,** to any size.  
**TURBINES HYDRAULIC MACHINERY,**  
**BARRING ENGINES,** the best in the Market

**STEEL BOILERS**

UP TO ANY PRESSURE

**TRIPLE EXPANSION MILL ENGINES**

Soho Iron Works & Phoenix Boiler Works

**BOLTON**

The HIGHEST AWARD for FEED-WATER HEATER at CHICAGO EXHIBITION has been granted to

# *GREEN'S*

IMPROVED PATENT FUEL

# *ECONOMISER*

.....

**SPECIALY CONSTRUCTED**

ON THE

MOST MODERN PRINCIPLE

FROM

Improved Strengthened Patterns

FOR

**HIGH PRESSURES.**

IN USE AT

ALL THE PRINCIPAL STEAM USERS THROUGHOUT THE WORLD.

**SPECIALITY FOR ELECTRIC LIGHT INSTALLATIONS**

~~~~~

ORIGINAL INVENTORS,

PATENTEES, AND

SOLE MAKERS:

**E. GREEN & SON LTD.,**

**2, Exchange Street, MANCHESTER.**

Works: WAKEFIELD.

Telegrams: "ECONOMISER."

RECENT  
COTTON MILL CONSTRUCTION  
AND ENGINEERING.

BY

JOSEPH NASMITH,

EDITOR OF THE "TEXTILE RECORDER"; AUTHOR OF "MODERN COTTON  
SPINNING MACHINERY" AND "THE STUDENTS' COTTON SPINNING."



JOHN HEYWOOD,  
DEANSGATE AND RIDGEFIELD, MANCHESTER.  
2, AMEN CORNER, LONDON, E.C.  
22, PARADISE STREET, LIVERPOOL.  
33, BRIDGE STREET, BRISTOL.

D. VAN NOSTRAND COMPANY,  
NEW YORK.

UB 722

179521  
N2

## P R E F A C E .

---

THE following pages are in great part a reproduction of a special article which appeared in the TEXTILE RECORDER for May, 1894. It had been represented to the author that there was need of some article from which accurate information relating to modern methods of mill construction could be obtained. This led to the work being done, and the manner in which a large edition of the TEXTILE RECORDER was taken up demonstrated the interest felt in it.

No claim is made for originality in the treatment of the subject, the book being avowedly a compilation of facts derived from actual practice. While this is so, it is, however, claimed that no similar collection has been made, and that the facts, being based upon personal and communicated observation, have not previously been put into a shape likely to be serviceable. It is perhaps necessary to say that the book is chiefly intended as an aid to those practically engaged in the cotton trade, and not for architects or engineers. Several of the tables have been specially calculated by the author. Since its appearance in the TEXTILE RECORDER the article has undergone considerable amplification.





## TABLE OF CONTENTS.

---

| CHAPTER |                                                            | PAGE |
|---------|------------------------------------------------------------|------|
|         | I.—INTRODUCTORY .....                                      | 7    |
| ,,      | II.—CONSTRUCTIONAL DETAILS.....                            | 17   |
| ,,      | III.—SLOW BURNING AND ONE-STOreyED BUILDINGS               | 35   |
| ,,      | IV.—COST, STRENGTH, AND FIRE RESISTANCE OF<br>FLOORS ..... | 46   |
| ,,      | V.—FIRE APPLIANCES : SPRINKLERS .....                      | 58   |
| ,,      | VI.—LIGHTING .....                                         | 76   |
| ,,      | VII.—HEATING, VENTILATION, AND HUMIDITY.....               | 84   |
| ,,      | VIII.—CALCULATION OF MACHINES IN MILL.....                 | 104  |
| ,,      | IX.—RECENT EXAMPLES OF MILLS .....                         | 109  |
| ,,      | X.—STEAM BOILERS .....                                     | 134  |
| ,,      | XI.—BOILER APPLIANCES .....                                | 153  |
| ,,      | XII.—STEAM ENGINES—GENERAL REMARKS .....                   | 166  |
| ,,      | XIII.— DO. RECENT EXAMPLES .....                           | 174  |
| ,,      | XIV.— DO. DO. ....                                         | 187  |
| ,,      | XV.—LIGHTING ENGINES AND OTHER ACCESSORIES...              | 207  |
| ,,      | XVI.—TURBINES .....                                        | 224  |
| ,,      | XVII.—GEARING—TOOTHED WHEELS .....                         | 233  |
| ,,      | XVIII.— DO. BELT DRIVING .....                             | 237  |
| ,,      | XIX.— DO. ROPE DRIVING .....                               | 243  |
| ,,      | XX.—SHAFTING AND BEARINGS .....                            | 255  |
|         | INDEX OF ILLUSTRATIONS .....                               | 273  |
|         | LIST OF TABLES .....                                       | 276  |
|         | GENERAL INDEX.....                                         | 277  |



# RECENT COTTON MILL CONSTRUCTION AND ENGINEERING.

---

## CHAPTER I.

### INTRODUCTORY.

PERHAPS in no other branch of textile work has a more marked advance taken place than in the character of the buildings used. As in other cases, the development has run concurrently with improvements in other directions, the result being obtained by the action of various forces at different times. There are well defined stages in the gradual evolution of the present type of mill building which can be very clearly ascribed to the influence of certain factors. In the early stages of the factory, as a separate place of manufacture, it was naturally located near the only source of power then available—a running stream of water. In this country the flow of water available is considerable and constant, but it rarely happens in any of the districts suitable for manufacture that the fall is considerable. In the early days of organised manufacturing, however, the factories which sprung up were all of small size, and the only motor available was the cumbersome water wheel, which was only capable of giving off a comparatively small power. Further, up to 1820, the machines were generally of limited dimensions, which can easily be understood when their partially manual character is remembered. Mills were, therefore, narrow and low, and were generally of a light construction. The ceilings were only from six to eight feet high, and the windows of small dimensions,

containing a number of little panes of glass. The illustration given in Fig. 1, representing Messrs. Swainson, Birley and Co.'s mill at Preston, which is reproduced from Baines's History, shows the best type prevailing so late as 1835. Until recent years there were a number of these old mills existing in Lancashire, but they have gradually become obsolete and disappeared. In Derbyshire, there are still some of them existing along the course of the Derwent, but as an element in the factory life of to-day they may be considered to be extinct. It is, however, an interesting fact to note that Messrs. Horrocks, Crewdson, and Company, Limited, of Preston, have two mills adjoining one another bearing dates a century apart, the later mill having been recently erected.

With the advent of the steam engine a new era began. The choice of situation became freer, and a millowner was able to locate his factory in any place convenient alike for himself and his operatives. The invention of the self-acting mule, which was entirely power driven, placed a new instrument in the hands of the spinner. By this time the whole of the machinery required to make cotton into cloth was adapted for power, and the first step was taken towards that acceleration of velocities which has since become so marked. Contemporaneously with the alteration in the size and character of the various machines induced by the march of invention, there began to be introduced new modes of manufacturing them. The use of machine tools was enlarged, owing to the great changes which took place in their construction by reason of the work of Roberts, Whitworth, and Nasmyth. The result was that machines were more perfectly constructed, the use of iron being largely extended. The two forces of greater skill on the part of the operative and improved constructional methods acted and reacted upon each other so as rapidly to alter the capacity and power of the machinery employed. Then there were the experiments of Mr. (afterwards Sir) Wm. Fairbairn, directed towards ascertaining the strength

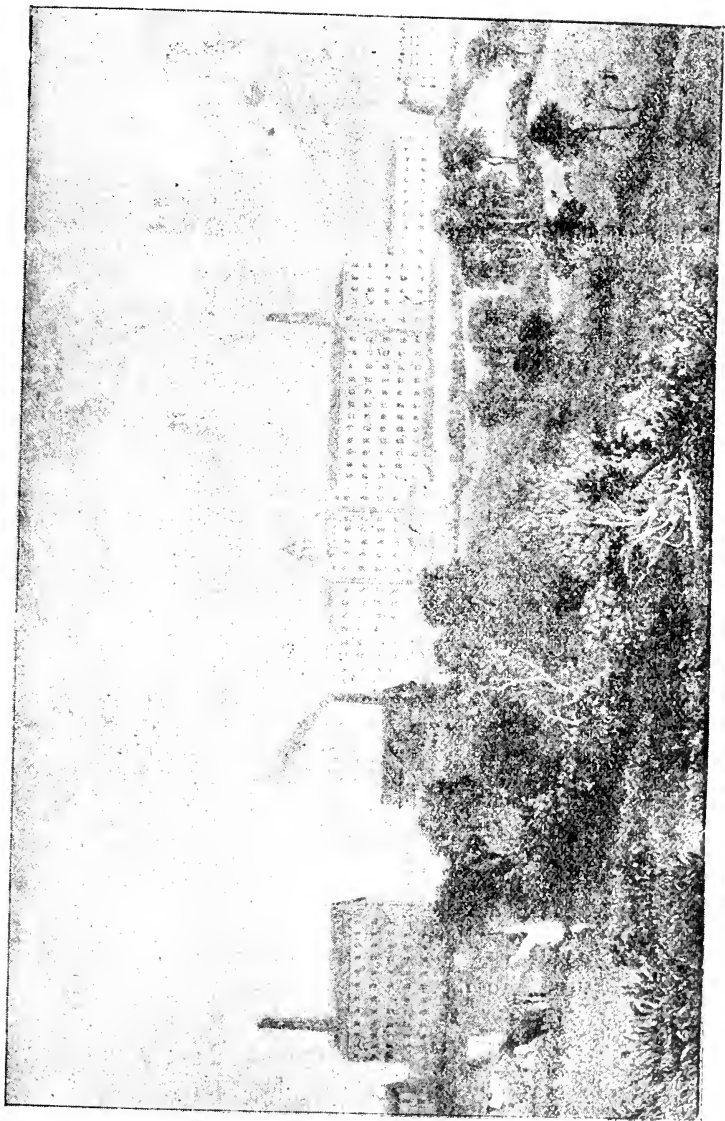

FIG. 1.

of cast-iron beams, which gave an impetus to the building of the so-called fireproof mill. Fairbairn himself built a large number of mills on this principle, but one or two failures occurred, which prevented the principle from spreading. Generally speaking, the English mills of what may be called the 1825-65 era were constructed with wooden floors, supported on transverse wooden beams, crossed by longitudinal joists, on to which two layers of floor boards were fixed. The ceiling was plastered on laths fastened to the joists, and the whole floor was thus a hollow timber construction of an exceedingly inflammable character. The size of the mills was, however, increased, and a type was evolved which, with slight alterations, remained constant until after the close of the American civil war.

Just before the year 1870 a beginning was made with the establishment of joint-stock spinning companies, stimulated by the establishment of the Sun Mill, Oldham, in 1868. The great success which attended this venture led to its wide imitation, and for a few years mills in Lancashire, and especially in Oldham, increased with great rapidity. Gradually they became larger in size, and a call was made on the machinist to provide machines of greater dimensions. In 1874 the ring-spinning frame was beginning to make its influence felt, and, owing to the large production possible by reason of the great speeds at which the spindles could be run, the necessity for higher velocities of mules became apparent. Both machines required more careful construction, and, dating from the introduction of the ring frame, a complete change has come over constructive methods. The economic rivalry of the various limited companies speedily led to the more complete organisation of their forces. It was found possible to manage mills containing many thousands of spindles in excess of those previously common with the same staff, and mills were accordingly designed with this factor in full view. Gradually the lengths of the machines in-

creased, and the mill was of necessity correspondingly enlarged. As a sequence to this there came a consideration of the method of providing light, so that a room 130ft. wide should not suffer in that respect. Gradually the ceilings became loftier, and the window area of greater importance. Thus, at the present day, in England, the cotton mill is distinguished by the enormous ratio of the window area to that of the wall. This will be fully demonstrated at a later stage. Nor did the whole consequence of the practices named end here. It being desirable to place the mules or frames transversely of the building, it was requisite that no obstruction from any internal cause should exist. Especially in the case of mules it was desirable that in the space in which the carriages ran—the “mule gate”—no pillars supporting the floors should be found. The rapid increase in the production of wrought-iron—and latterly steel—rolled girders placed in the hands of the mill architect a means which he was not slow to use, and restored the fireproof method of construction to the place it had partially lost. By skilful design, a floor has been evolved, which, while of large and comparatively unbroken area, is yet well supported, and, as will be demonstrated by actual examples, is well fitted for the purpose for which it was intended.

Thus, since the year 1870 there have been at work three factors of importance:—(1) The increased competition, arising from economic causes, tending to the enlargement of the size of machines so as to correspond to the limit of the operative's capacity. (2) The improvements in the constructive methods of machinists, resulting in the production of machines capable of running with steadiness at high velocities. (3) The provision of building materials which lend themselves to the construction of mills of large size. Each of these factors has played its part in the evolution of the type of cotton-mill building which it is hoped to illustrate in a very complete manner.

A similar process has been in operation with the

MUSEUM LIBRARY

machinery employed for the production and transmission of the motive power. Early in the century the type of steam engine used was, in most cases, the beam, which worked at very low steam-pressures. Gradually the latter rose, until a maximum of about 60lbs. to the square inch was used. The compound principle of using steam was generally adopted, but it is within quite recent years that the science of steam using has been adequately understood. The late Mr. Daniel Adamson experimented with quadruple expansion engines as applied to cotton mills many years before the possibility of its successful application became apparent. He failed because he had not the means of obtaining a sufficient steam pressure, but it is a high tribute to his prescience that he became the pioneer in the use of a material destined to place the required pressures within the reach of the engineer. As mild steel became improved its employment for boiler plates gradually grew, and the success of triple expansion engines in marine work turned the minds of mill engineers in the same direction. With the material at hand boilers were made to stand much higher pressures, and these were gradually introduced. The type of engine which superseded the beam, and was for many years the favourite, was the horizontal side-by-side compound, but this has slowly given way to the tandem type, either single or double, when triple or quadruple expansions are used with pressures ranging up to 200lbs. per square inch.

The change in the type of engine used is accompanied by a considerable variation in the character of the gearing employed. Up to the year 1876 it may be said that in Lancashire, with the exception of a few mills which were driven by belts, almost all the gearing employed was toothed. To-day all that is changed, and nearly every new mill is provided with rope gearing. It is not necessary to inquire at this point into the reasons for this procedure, which will be dealt with hereafter, and it is sufficient to note the fact. One



point may, however, be mentioned. The use of rope gearing has led to a considerable change in the arrangement of the modern mill, in which it is now the rule to make the rope race a dividing space between the main body of the mill and the scutching or blowing room. The reason for this procedure is twofold. First, the complete character of modern mixing and scutching machinery renders it desirable to arrange it so that the various machines will work conveniently together; and second, it is in this department that the risk of fire is greatest, so that it is an advantage to have a complete or partial separation of the two parts of the building. It will be shown, therefore, that in modern mills the rope race forms a division between the mixing and spinning departments.

In order that the improved methods of design and construction of mills may be fully appreciated, a brief description of some of the chief features and leading dimensions of one or two typical mills erected at different periods is given. In Dr. Ure's well-known work "The Cotton Manufacture of Great Britain" an illustration and description is given of a mill erected at Stockport in 1834 by a Mr. Orrell. This mill contained 12,498 throstle spindles, 14,928 hand mule spindles, and 7,984 self-actor spindles, in all 45,860. There were in addition 1,100 power looms and the necessary preparatory machines for both spinning and weaving. The building consisted of one main block with transverse wings at each end. The dimensions of the main spinning rooms were 280ft. long and 50ft. wide, and the height from floor to floor 11ft. 6in., leaving a mean height from floor to ceiling of 10ft. Each of the floors in the building was fireproof, and consisted of a series of  $\perp$  cast-iron beams, passing transversely of the mill and sustained about half way across by cast-iron pillars. From the transverse beams brick arches were sprung. These arches formed only a segment of a circle, and were about 9in. thick. Upon them the floor was laid, and was constructed of timber. The window

openings were 7ft. high by 5ft. wide, the sill being 3ft. 6in. from the floor level, but the lintel level with the ceiling. The windows were separated by brick piers 5ft. wide, so that the window area was in the ratio of about 1 to 4·5 of the wall surface. The mill was built with six storeys and an attic, the loom shed being of the usual type, and placed behind the main building. The engines used were each of 90 horse-power nominal, and the shafts in the various rooms were driven by an upright shaft running 58·8 revolutions per minute. The speed of the line shafts is not given, but would not exceed 120 revolutions.

The India Mill, at Darwen, erected by Messrs. Eccles, Shorrocks and Co., about 1870, was at that time considered to be one of the finest types of mill architecture. It was described in Mr. Evan Leigh's book, from which the particulars are extracted. It consisted of one main building, with six storeys, and was 330ft. long, 99ft. wide, and 90ft. high. It was, and is, distinguished by a chimney of a highly ornate character. It accommodated 48 pairs of mules, each containing 708 spindles, in all 67,968 spindles, with, of course, the whole of the preparatory machinery. The plan of the mill, as then arranged, provided for the blowing and scutching machines being placed on the ground floor. These comprised 2 openers, 8 scutchers each with 3 beaters and with lap machines combined, and 8 finishing scutchers with 2 beaters each. The first and second floor each contained 84 carding engines with 2 rollers and clearers, and 44 self-stripping flats, 6 drawing frames each 4 heads of 6 deliveries, 8 slubbing frames each of 90 spindles, 12 intermediate frames of 130 spindles each, and 24 roving frames of 180 spindles each, double geared. Each of the spinning rooms contained 12 pairs of mules, the remaining 12 pairs being placed in two small rooms at the end of the card room. It is only necessary to specially note that in this, a comparatively recent mill, the card room is divided, a practice which is now generally abandoned. The

character of the driving will be dealt with later ; but it may be mentioned that the boilers were of the Galloway type, and of steel.

The windows used had an area of 45 square feet in the two card rooms, 40 square feet in the first and second spinning rooms, and 35 in the third spinning room. The wall space between the adjoining window frames was 5ft. for the floors from the second to the fifth inclusive. The construction was of the fireproof type, the floors being supported on shallow brick arches sprung from transverse iron beams, supported by pillars, arranged in three rows longitudinally of the building. The distance of the pillars in each row from each other was 10ft., and between those in adjoining rows 22ft., a similar distance intervening between the pillars and the walls. This mill has been at work continuously since its erection, having been enlarged within the past few years, and the whole of its driving arrangements remodelled, but as it is a comparatively recent specimen of mill architecture of a now abandoned type, the above details will be of interest.

There is no feature in a modern cotton spinning mill more noticeable than the tendency which exists to get all the card-room machinery on one floor. When the number of spindles is large, this is only possible if the dimensions of the mill building are considerable, and it is often necessary and advisable to place alongside the card-room a small one-storey shed in which the machinery is partly placed. Thus, to cite as an example, a recently erected mill containing 73,052 spindles, the length of the entire structure is 245ft. and its width 134ft. 6in. The building is practically divided into two parts by the rope race, leaving the larger block 173ft. by 134ft. 6in. In this space the whole of the preparatory machinery is placed, excluding the mixing and scutching machines and four roving frames, each of 252 spindles. These, however, are placed on the same floor. It is obvious that no good end would be served by adopting this course if the mules became

so long as to necessitate extra attendance to mind them, but owing to the improvements in construction this is not the case. In the mill instanced the mules are made to contain as many as 1,304 spindles,  $1\frac{1}{8}$  in. gauge, going a total length of 127ft. 6in., which fit easily within the walls. A pair of mules of this length can be tended by a spinner and two piecers, who would be required if the mules contained only 1,000 or 1,100 spindles each.

There are many things which affect the design of a spinning mill. Among the determining features are (1) the counts of yarn to be spun ; (2) the type of machine used for spinning ; (3) the character of the site and its locality ; (4) the water supply available for all purposes ; (5) the facilities for handling and transporting the raw material and finished product ; (6) the character of the materials available for building ; (7) the style and construction adopted with reference to fire ; (8) the prime motor adopted ; and (9) the class of gearing used. It may be true that each of these points are affected by other considerations, all of which require weighing before a decision is come to, but it is not the purpose of this book to deal with all the reasons for taking a certain course, it being sufficient to define the essentials. One word, however, may be said in warning on the third point. The projector of a factory building ought to satisfy himself as to the soundness of the land prior to purchase, as any difficulty with the foundations of a mill of the great weight now erected may prove a very costly matter.

We must assume, however, that the whole of these points have been considered and settled, and that a mill of a defined type has been determined on. It may, perhaps, be safely said that at present there are two main types of factory buildings, viz.; the English and the American. In some features they approximate, while in others they vary considerably. The difference arises mainly from the different theory of construction adopted in order to avoid or diminish the risk of damage by fire. In each case the prevailing type has arisen naturally

out of the circumstances existing, but the results are widely diverse. The more recent type of English spinning mill is based upon what is known as the "fire-proof" constructive principle, while in the United States the construction adopted is that which is known as the "slow burning." Some particulars of each type will be given, and it will be a convenient course to deal first of all with the English mill. It may, perhaps, be pointed out before doing so that, with the necessary modifications to suit local circumstances, the English type is being adopted in many other countries, while some of its details are even incorporated into American designs. A general form will first be described, and will be followed by detailed explanations.

---

## CHAPTER II.

### CONSTRUCTIONAL DETAILS.

Looking then at Fig. 2, which is a partial vertical section of an ordinary type of mill, it will be seen that, as previously named, it consists of six storeys—a basement, ground floor, and four upper floors. It is surmounted by a flat roof with a parapet, and is provided with a tower holding a water tank for the sprinkler installation. The engine and boiler house are usually built out from the main buildings, but the rope race is used to divide the mixing and blowing rooms from that part of the mill intended for spinning. The basement floor is ordinarily used for storing yarn, and is arranged to act as a "conditioning" chamber. That portion of it which forms part of the blowing room building is utilised for miscellaneous storage, which sometimes includes cotton, but this is not an advisable or general practice. The ground floor forms in the main building the card room, and in the subsidiary building the scutching room. The first floor in the main building is a spinning room, and in the smaller one a mixing room. If the upper floors are continued in both

blocks they are filled with spinning machines. The heights of the various rooms are as follow :—Basement, 6 to 7 feet ; ground floor, 15 to 17 feet ; first floor, 13 feet ; second floor, 12 feet 6 inches ; and

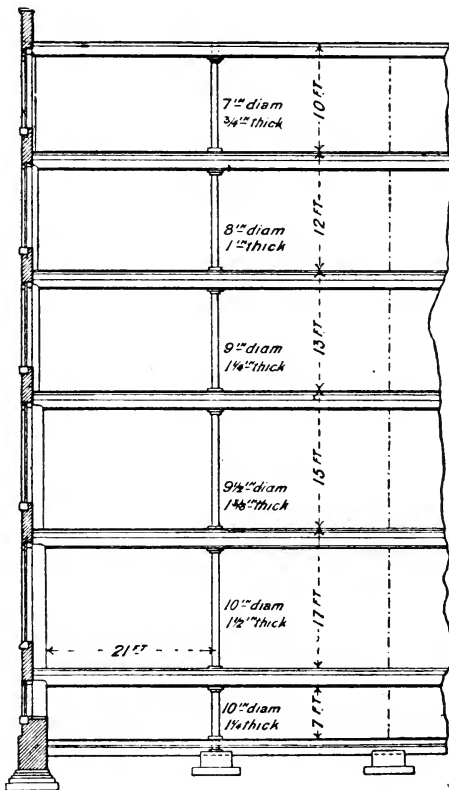

FIG. 2.

third floor, 12 feet. For a time there was a tendency towards rooms which were two or three feet higher than those detailed, but it is now the practice to go in for a moderate height which, while per-

mitting the proper lighting of the rooms, does not entail an excessive cubic capacity.

The columns which are usually employed in mill construction are generally similar to those shown in Figs. 3 and 4. They are ordinarily of cast iron, and are of a type which may be described as with flat fixed bases. The lowest of each line is carried by a cast-iron base plate bedded on a

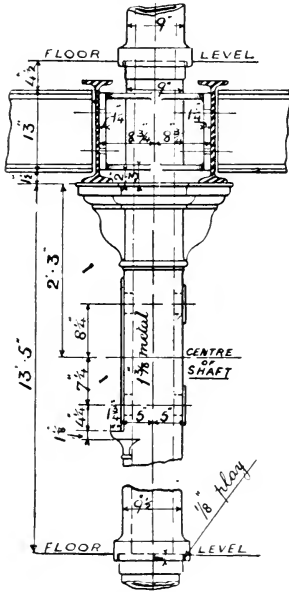

FIG. 3.

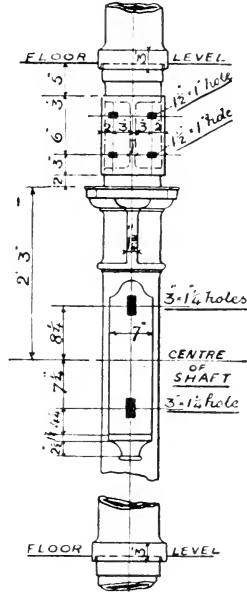

FIG. 4.

foundation stone. The plate has a socket bored at the bottom for the reception of the turned end of the column, and a raised cross is formed on the top of the plate fitting into the socket of the column, and turned on the ends of its arms to size, so that the column is kept quite steady, being practically fixed. It is essential that great care be taken to insist upon the accurate bedding and machining

of each column so that the line of thrust is perpendicular and not diagonal. Professor Hodgkinson, who, under the direction of Sir William Fairbairn, conducted a series of experiments, deduced the following formula for the strength of hollow columns of this character—

$$W = 44 \cdot 34 \frac{D^{3.5} - d^{3.5}}{L^{1.63}} \text{ where } D = \text{external diameter in inches, } d = \text{internal diameter in inches, } L = \text{length in feet, } W = \text{breaking weight.}$$

A table of the values of the 3.5 power of the diameters and the 1.63 power of the length is given herewith (see Tables 1 and 2).

TABLE 1.

Value—3.5 power of diameter.

| Diam. Inches. | Value.  | Diam. Inches. | Value.  | Diam. Inches. | Value.  | Diam. Inches. | Value.  |
|---------------|---------|---------------|---------|---------------|---------|---------------|---------|
| 6             | 529.09  | 7½            | 1155.35 | 9             | 2187.00 | 10½           | 3751.13 |
| 6¼            | 610.35  | 7¾            | 1295.85 | 9¼            | 2407.11 | 10¾           | 4073.14 |
| 6½            | 700.16  | 8             | 1448.15 | 9½            | 2642.61 | 11            | 4414.43 |
| 6¾            | 799.03  | 8¼            | 1612.83 | 9¾            | 2894.12 | 11¼           | 4775.66 |
| 7             | 907.49  | 8½            | 1790.47 | 10            | 3162.28 | 11½           | 5175.54 |
| 7¼            | 1026.08 | 8¾            | 1981.66 | 10¼           | 3447.73 | 12            | 5985.96 |

TABLE 2.

Value=1.63 power of length.

| Length in feet. | Value. | Length in feet. | Value. | Length in feet. | Value. |
|-----------------|--------|-----------------|--------|-----------------|--------|
| 6               | 18.55  | 10              | 42.66  | 14              | 73.82  |
| 7               | 23.85  | 11              | 49.83  | 15              | 82.61  |
| 8               | 29.65  | 12              | 57.42  | 16              | 91.77  |
| 9               | 35.92  | 13              | 65.42  | 17              | 101.30 |

The above formula, however, is not a very easy one to remember or work out, and that adopted by Mr. Lewis Gordon—

$$P = \frac{f s}{1 + a r^2} \text{ is much easier. In this } P = \text{breaking}$$

load of a column in tons,  $s$  = square inches sectional area,  $r$  = ratio of length to least diameter,  $f$  and  $a$  constants depending on the strength of the material. The value of  $f$  for round solid or hollow cast iron columns is 36, and  $a = \frac{1}{400}$ . In the case of mill columns the value of  $r$  usually ranges from 8 to



24, and, adopting Gordon's rule, the numbers in the second column of Table 3 give the breaking weight per square inch of sectional area of cast iron. These are extracted from a very valuable book on "The Design of Structures," by Mr. S. Anglin.

TABLE 3.

| Length.<br>of<br>Column<br>in<br>Diameters. | Breaking<br>Weight<br>in Tons<br>per<br>Sq. Inch. | Length<br>of<br>Column<br>in<br>Diameters. | Breaking<br>Weight<br>in Tons<br>per<br>Sq. Inch. | Length<br>of<br>Column<br>in<br>Diameters. | Breaking.<br>Weight<br>in Tons<br>per<br>Sq. Inch. |
|---------------------------------------------|---------------------------------------------------|--------------------------------------------|---------------------------------------------------|--------------------------------------------|----------------------------------------------------|
| 6                                           | 33·0                                              | 14                                         | 24·2                                              | 22                                         | 16·3                                               |
| 7                                           | 32 0                                              | 15                                         | 23·0                                              | 23                                         | 15·5                                               |
| 8                                           | 31·0                                              | 16                                         | 22·0                                              | 24                                         | 14·6                                               |
| 9                                           | 30·0                                              | 17                                         | 20·9                                              | 25                                         | 14 1                                               |
| 10                                          | 28·8                                              | 18                                         | 19·9                                              | 26                                         | 13·4                                               |
| 11                                          | 27·6                                              | 19                                         | 19·0                                              | 27                                         | 12·8                                               |
| 12                                          | 26·5                                              | 20                                         | 18·0                                              | 28                                         | 12·1                                               |
| 13                                          | 25·3                                              | 21                                         | 17·1                                              |                                            |                                                    |

Thus, if a column is 10ft. long, 10in. diameter, and 1in. thick, its strength is obtained as follows:—The area of the metal is 28·28 square inches, and the length being 12 times the diameter, the strength is  $28·28 \times 26·5 = 739·42$  tons.

A rule which is sometimes observed is to make the thickness of the metal one-twelfth of the diameter of the column, and General Morin gives the following thicknesses:—

|                      |                |       |
|----------------------|----------------|-------|
| From 7 to 10ft. long | a thickness of | ·5in. |
| „ 10 „ 13ft.         | „              | ·6in. |
| „ 13 „ 20ft.         | „              | ·8in. |

The deductions made from the table given above, however, will be found to be reliable. The strength of a round column is always determined by the least diameter, which, as columns are often taper, is important. It is necessary, of course, that the basement pillars are properly bedded, because, if they are not, flexure takes place, and the column is submitted to a double strain. The practice recommended by some writers of bedding the column in cement is not advisable where heavy loads are borne, because the resistance to crushing is much less than is that of stone. It is much better to

make a firm foundation for the base stone, and see that the pillar base plate is properly bedded, the use of a sheet of lead possessing advantages where there is any danger of uneven bedding.

As a rule, spinning mills in England are built of the usual red brick, 9in. by  $4\frac{1}{2}$ in. by 3in., a material which is always accessible, and which can sometimes be made on the site from the clay there existing. Well burned brickwork, properly set in mortar, will stand a load of two tons to the square foot, but if set in cement, three tons. The weight of a cubic foot of brickwork is for common bricks from 100 to 125lbs., 110lbs. being a fair weight. Red sandstone weighs about 133lbs., and Yorkshire stone about 155lbs. per cube foot. 1,000 bricks of English size make about 23.4 cubic feet of finished work. To ascertain the number of bricks required for different thicknesses of walls, let  $n$  = number of half-bricks ( $4\frac{1}{2}$ inches) in thickness of wall,  $a$  = superficial area in square feet, then  $n \times .0053 \times a$  = number of thousands of bricks required. Thus 200 square feet superficial of 9in. wall would take  $2 \times .0053 \times 200 = 2.06$ , or in other words, 2,060 bricks would be needed. The walls immediately above the footings are made from 2ft. 9in. to 3ft. 2in. thick between the windows, that portion of the wall below the windows being much thinner, usually about 12in. It will be understood that this practice varies in accordance with the type of window used, as will be presently shown. After the card room is passed the piers are made thinner by one brick,  $4\frac{1}{2}$ in., so that each spinning room is 9in. wider than the one below it.

The main use of the piers in this method of construction is to carry the ends of the beams which form part of the floor. There are two or three methods of forming the latter which may be here described, the idea being to make a floor of fireproof construction. The type of floor which was adopted in many cases is shown in Fig. 5. In this case the longitudinal cast iron beams used are 15in. deep at the ends near the columns and 20in.

deep in the centre, having a bottom flange 9in wide and 1in. thick, and a top flange of  $3\frac{1}{2}$ in. wide and 1in. thick, the web being  $\frac{3}{4}$ in. thick. These beams are made in lengths to fit between the columns, and are semi-circular at each end to fit the circular nipple of the pillar, the latter being provided with a flange to sustain the beam. By flanges and bolts the various beams are fastened together, so as to form a continuous girder across the mill, properly secured to and sustained by the columns. In the

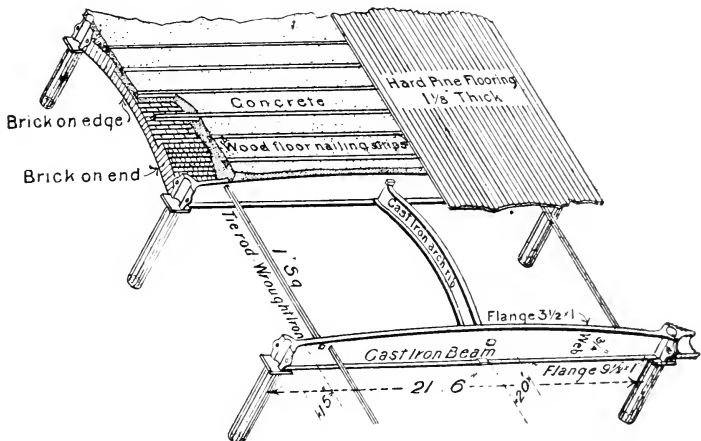

FIG. 5.

best practice the collar on the column and the girder ends are machined, so as to give a true base; and, as the column used for the next floor is socketed so as to fit on to the nipple of the one below and rest on the girder, it is easy to see that the machining is almost a necessity. The columns are circular and hollow, and vary from 8in. diameter at the lower end and  $7\frac{1}{2}$ in. at the upper, to 6in. and  $5\frac{1}{2}$ in. respectively. The columns used in the basement are made 8in. diameter throughout and 1in. thick, those in the card room floor being  $1\frac{1}{8}$ in. thick, the

difference being accounted for by the extra length. The thickness gradually diminishes in the upper storeys, but is never less than  $\frac{3}{4}$  in. These dimensions relate to the columns used in the example illustrated in Fig. 5, and, as shown in other examples, are subject to variation. The columns are placed 10ft. 6in. apart, transversely of the mill, and 21ft. 6in. longitudinally; the beams being tied together by rods at suitable intervals. From the bottom flange of the beams the brick arches are sprung. These arches are 9in. at the flanks, diminishing towards the centre. A layer of concrete is sometimes used to level the floor, and wooden battens 4in. by 3in. are secured in it at distances of 2ft. apart so as to permit of a timber floor being laid for the reception of the machinery. In one rather noteworthy case the floor was laid on small brick arches sustained on cast iron bearers, as described, without the intervening spaces between the arches being filled. The result was that when a fire did take place the open spaces below the flooring acted as flues, and the destruction of an ostensibly fireproof mill was complete. There are two chief objections to this type of floor. The arches are heavy and run longitudinally of the building, and there is a mass of unprotected cast iron work which is a source of great weakness. There is, further, the fact that the beams are fitted together in a way demanding more accurate work than is usually obtained in builders' iron structures. This type of floor, although there are many excellent examples in existence, has given way to others which are constructed with materials of a more convenient character.

A modification of this form of floor is found in the employment of longitudinal rolled beams with transverse beams bolted to them at distances of 3ft. apart. This permits of the formation of a series of curved arches, the chord of which is only 3ft. as against 10ft. 6in. in the cast iron type. The floor is thus considerably lightened, and the whole of the thrust is taken from the main girders. The same

objection can be made to this floor as to the preceding example, namely, that in one direction the columns are only 10ft. 6in. apart, which, in a mule mill especially, is a matter of importance. The general recognition of the value of an unobstructed floor, as far as it can be got, has led architects in

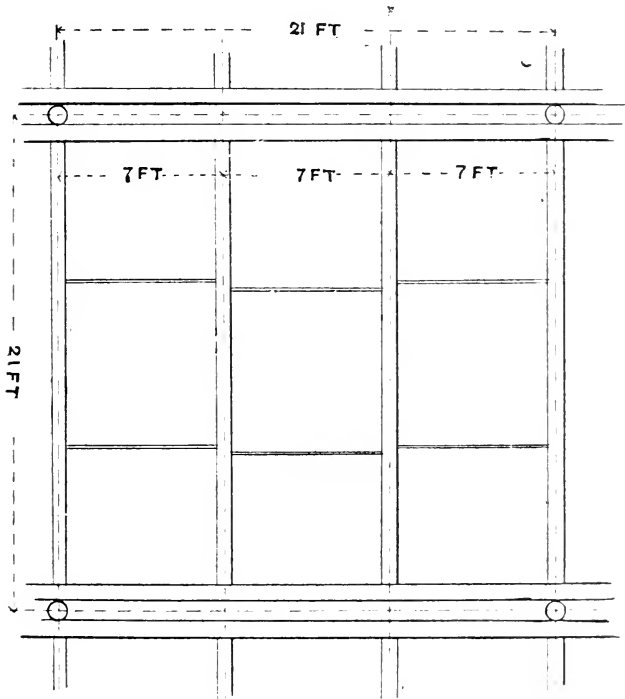

FIG. 6.

the more recent mills back to forms in which the greater distance of the pillars apart has again been restored, or in which the arched form of construction has been definitely abandoned.

Another form of floor with which Messrs. Stott and Sons are identified is shown in skeleton in Fig. 6, and

has been carried out with success in several large mills recently erected. It consists in an arrangement by which the brick arches used are transversely arranged, and is designed so that it is only necessary to place columns at intervals of 21ft. each way. The head of the column (see Figs. 3 and 4) is a broad flange supported by curved gussets  $1\frac{3}{4}$ in. thick. The sketch given in Fig. 3 shows clearly the construction of the column, and is taken from a recent example. The columns in the basement rest on a flat baseplate, which is bolted to foundation stones securely bedded, as has been previously described. The upper end of each column carries the girder flange, and the head passes up between the two girders and fits into a socket in the next column. The bottom of the socket and face of the column head are turned true, so that the columns rest on prepared true surfaces. The external diameter of the head is  $\frac{1}{8}$ in. less than the bore of the socket. The columns are each tapered  $\frac{1}{2}$ in. in their total length, which varies, of course, with the height of the room. The centre of the line shaft is 2ft. 3in. below the face of the girder flange, the shaft being borne by side pedestals secured to faces on the column. Some of the latter, being intended to carry countershafts only, have narrower faces, only 5in. wide. Special faces are also prepared to which to attach the longitudinal girders. The weight thrown upon the columns is necessarily great, and it depends upon the character of the construction how great it is. The area within the four columns and their attached beams is 441 sq. ft., the total load per foot being about 140lbs. Practically, therefore, the weight upon the basement columns in a four-storey mill on this computation would be about 110 tons. A cast iron column 10in. external diameter,  $1\frac{1}{4}$ in. thick, and 7ft. long will, if calculated by Table 3, safely carry a load of 1,031 tons, so that there would be a factor of safety of 9.4. A reduction of the area carried by the columns naturally diminishes the load on them.

Upon each arm of the flange a longitudinal rolled girder of I section, 16in. deep, with 6in. flanges, of the weight of 160lbs. to the yard, is placed. This will carry with a factor of safety of 4 and a span of 21ft. a distributive load of 23·2 tons, which is in excess of that required. These girders are fastened to the faces shown on the columns, and transverse joists, 13in. by 6in., are fixed to them at a distance from centre to centre of 7ft. The arch, which is light but strong, is sprung from the transverse joists, and the spaces between the arches are levelled with concrete. The flooring boards are laid on wooden battens, and in places where much wear occurs a covering of thin birch boards is fixed. The total depth of the floor is 19in. This type of floor provides wide bays and causes no obstruction in the "mule gate," while the run of the arches is transverse, thus offering no impediment to light. The floor is undoubtedly a good one, and has been carried out with considerable success.

The tendency is, however, growing in favour of the larger employment of concrete flat floors, without the use of brick arches. There is much to be said for this construction, which gives a remarkably substantial and strong floor. The mill of Messrs. J. and P. Coats, erected in 1886, was perhaps the first example of importance in this country, and the architects, Messrs. Morley and Woodhouse, now Mr. W. J. Morley, of Bradford, deserve the credit of the thorough construction which they adopted. The columns in this mill (see Fig. 7) are of cast iron, and are 21ft. apart longitudinally and 10ft. 6in. transversely, although this is not universally the practice throughout the mill. The heads of columns are flanged to receive the ends of rolled steel beams, which are 16in. by 6in. A circular nipple is carried above the flange, and has cast with it two wings or flanges, one on each side, over which the longitudinal girders pass and to which they are bolted. The upper end of the column, as in Fig. 3, forms a socket

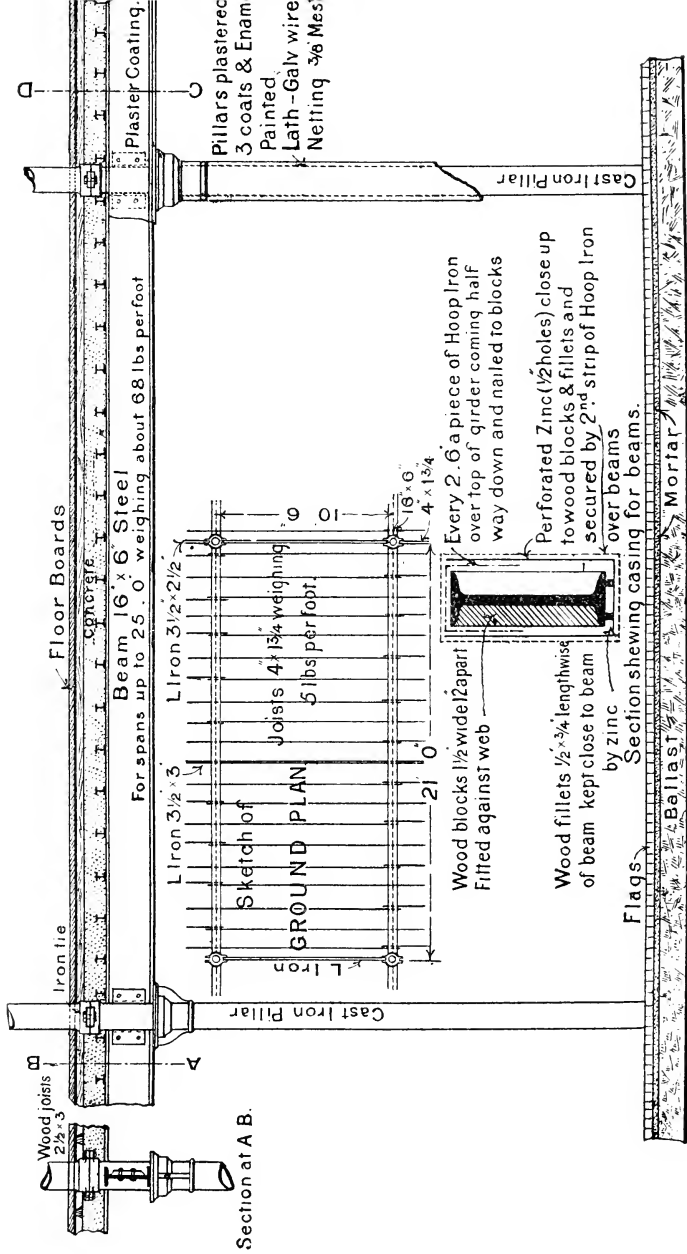

FIG. 7.



above these flanges into which the succeeding column fits, and tie rods are fixed at this point between opposite columns. The longitudinal beams, shown separately in plan, are crossed at right angles by light steel joints, 4in. by  $1\frac{3}{4}$ in., borne at their ends by angle steel bearers fixed to the beams. The space between the joists and above the beams is filled up with concrete 8in. thick, with a finish of Val de Travers cement above it. The concrete used consists of broken brick or stone and Portland cement in the proportion of 5 to 1. Wooden battens are laid on the concrete in cement, and the flooring boards are nailed on to them. The thickness of the boards is  $1\frac{1}{2}$ in., consisting of a thickness of 1in. deal planks topped with a covering of American maple boards, 3in. by  $\frac{1}{2}$ in. thick, which makes a floor which is extremely durable and solid. In the twisting mill the columns and ironwork were plastered with three coats of plaster on wire lathing, and the method of applying the casing to the beams is separately illustrated. The columns used in the mill are of unusual strength, those in the lower floor being 11in. diameter and 2in. thick. The next floor admits of a reduction of  $\frac{1}{2}$ in. diameter, the thickness being maintained. The dimensions for the upper storeys are 10in. diameter by  $1\frac{3}{4}$ in. thick; 9in. diameter and  $1\frac{1}{2}$ in. thick; 8in. diameter by  $1\frac{1}{4}$ in. thick; and 6in. diameter by 1in. thick respectively. The strength of the ground floor columns is 1,181·89 tons.

Another very good type of concrete floor, designed by Messrs. Potts, Son, and Pickup, of Manchester, and extensively carried out by them, is shown in section in Fig. 8. This firm has persistently pushed this floor, and to them is largely due its adoption for Lancashire mills. In this case the pillars used are 20ft. 6in. apart longitudinally of the mill and 14ft. 9in. transversely. The columns sustain steel girders 16in. deep, with 6in. flanges, between which are fixed, at distances of 1ft. 9in., steel joists  $5\frac{1}{2}$ in. deep, with 2in. flanges. The joists are carried by angle-iron bearers fastened to the beams, and at suitable

intervals one is secured to the girders by side angles and bolts, the concrete holding the rest securely. The space between the joists is filled

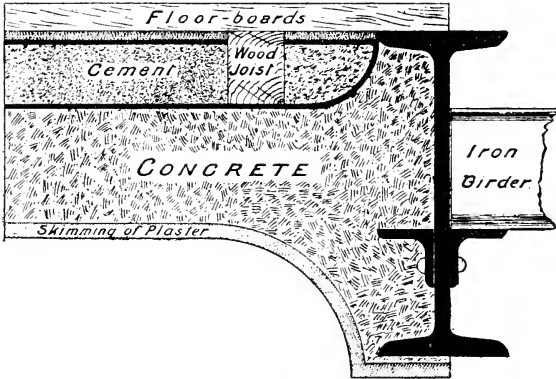

FIG. 8.

in with concrete 6in. thick, on the top of which is a finish of waterproof concrete lin. thick. The utility of this finish is tested by allowing the floor to stand under water for three days, to detect

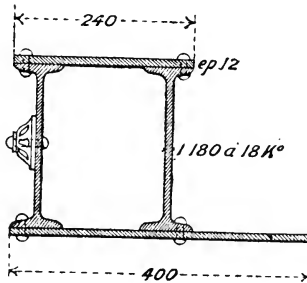

FIG. 9.

leakage. The concrete is carried below the joist  $\frac{1}{2}$  in., the total thickness being therefore 7 in. The method of finishing the concrete where it joins the

pillars is clearly shown. Battens are laid in the concrete to receive the flooring boards, which in all the spinning rooms are  $1\frac{1}{2}$  in. thick. The battens are always made wider at the bottom than at the top, so that the concrete forms a binder and prevents them from lifting. The joists extending to the walls are carried when necessary by the window lintel, constructed of steel, as shown in Fig. 9. The bottom plate is carried forward to sustain the joist, and the bolt heads are covered by a rose. It will have been noticed that when the transverse brick arch is used, and is sprung from cross girders 10ft. 6in. apart, a clear space of that amount between the necessary points of support is obtained. The support is found in the piers between the windows, the distance of 10ft. 6in., as shown in Fig. 31 (see p. 77), corresponding to that from centre to centre of piers. With a concrete floor such a procedure is not possible, as it is essential that the transverse joists shall be much nearer together. It is therefore necessary, in order to carry the load, to find ample support for the ends of the joists. This is found in the employment of the iron lintel, which is carried to the front so as to complete the latter, the dimensions being given in millimetres. This device gives an admirable support to the joists, and enables the floor to be well carried throughout. One advantage of this method of construction is that much of the thrust upon the walls is obviated, as the joists are merely sustained by the lintels, and are not built in. The centre of the frame is filled with concrete.

Another type of floor, shown in Fig. 10, which is adopted in America and carried out by the Carnegie Steel Company, is a variation on the ordinary concrete floor. In this case the vertical pillars are built of steel and the main girders are duplex, having joists or cross beams fixed to them by angle irons. The space between the cross girders is filled in by terra cotta moulded tiles set in cement while sustained below by movable stages. They are burnt hard, and form a light floor quite as impervious to fire as

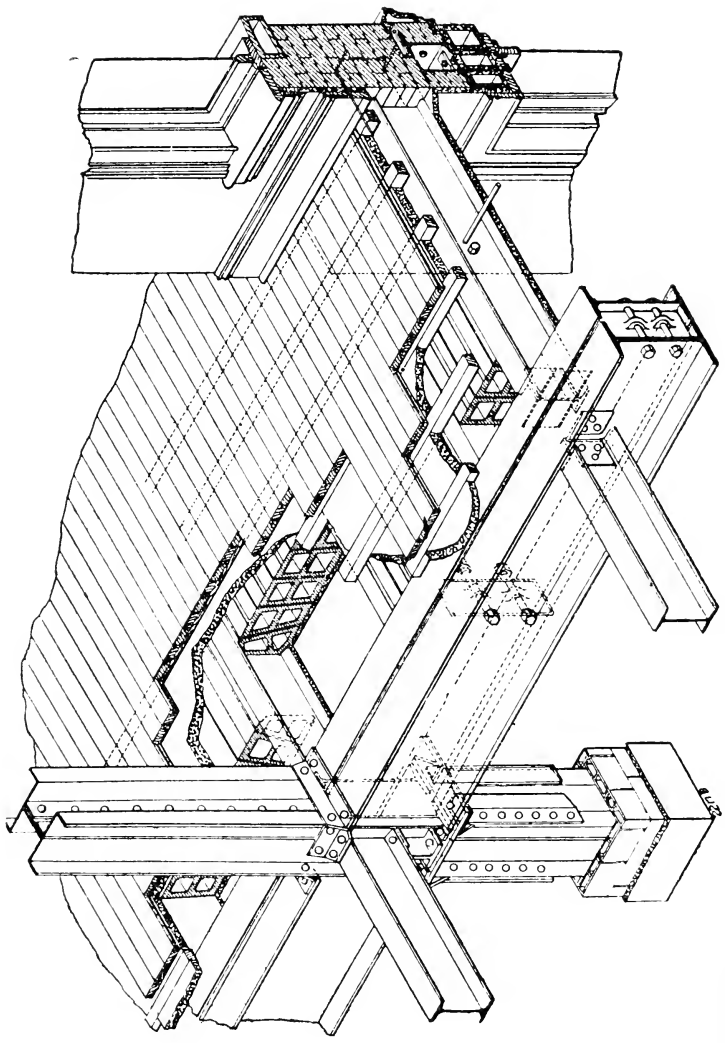

Fig. 10.

the ordinary type of concrete. A layer of concrete or cement two inches thick is laid on the top of this arch, on which the flooring battens are laid, and boards fixed as usual. The chief feature of this construction is that the whole of the weight of the building is carried by the steel columns, the walls for each being sustained by the transverse girders, and acting merely as filling pieces. A new form of floor has been devised and patented in France and elsewhere, which is known by the name of the Hennebique system. In its essence it is founded upon the utilisation of the principal characteristic features of steel and concrete. The tensile strength of steel is greater than its resistance to compression, while on the other hand concrete has little tensile but great compressive strength. The new system is ac-

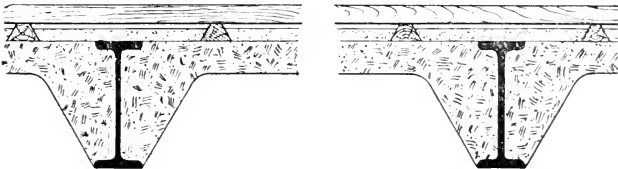

FIG. 11.

cordingly designed to utilise to the utmost these peculiar qualities of each material, and, as shown in Fig. 11, is characterised by the absence of the transverse joints which are one of the main features of the ordinary English floor. As the tendency towards flexure in concrete puts the material into compression, the inventor has proportioned the thickness of the floor to resist the weight put upon it. Referring, therefore, to Fig. 11 it will be seen the **I** longitudinal girders are embedded in concrete, thus forming a composite beam, the strength of which is created alike by the resistance to the tensile stress on the steel girder and that to the compressive stress put on the concrete. It is well known that this combination materially strengthens the resistance of the girders to flexure. As shown,

the distance from centre to centre of the beams which rest upon the pillars is 4 mètres 90 centimètres, or a little over 16 feet. The thickness of the concrete web or floor between the beams is 12 centimètres or 4.72 inches. In cases where it is desired to plank the floor a special skimming of cement is laid, in which the battens are embedded. To these the planks are fixed in the usual way. It will be noticed that the space between the supporting beams has no other strength than that created by the resistance to compression of the concrete, but the maker of this floor, M. Vermont-Caby, of Lille, states that this is sufficient to stand the ordinary stresses with ease, and to give a factor of safety of at least 10 to 1. The floor is said to be very rigid and strong. Some further remarks are made a little later.

Referring now to Fig. 2, and to what has been previously said, the basement floor is less lofty than those above it, and is used as a conditioning cellar. In order to fit it for this purpose, it is well prepared in puddle or concrete, so as to be impervious to water, and is provided with tramways to facilitate the transport of the skips. These tramways may be commended to the notice of mill-owners as occupying very little space, and being readily fixed, they materially reduce the cost of transportation within the mill. It may be mentioned here that they are as useful in the card and spinning rooms as in the basement. Upon the prepared floor are laid bricks, a short distance apart, allowing of the floor being covered with water to the depth of 2 or 3 inches, so as to leave the upper surface of the bricks dry. A special form of brick is sometimes used, which permits the ascent of the moisture while making an unbroken floor. This type of brick is afterwards referred to in dealing with the subject of humidity. The skips or baskets containing the cops or bobbins of yarn are thus kept out of actual contact with the water, while the heat of the room gradually evaporates the latter and causes the vapour to find its way

thoroughly into the yarn. Formerly it was the practice in England to make the roof of a mill of the ordinary type, timbered, slated, and glazed; but the most recent mills are now made with flat roofs. The upper surface of these is covered with a layer of asphalt, so as to form a watertight ceiling. A thin sheet of water is kept constantly on the roof as a protection against the effects of the weather on the asphalt. The cotton bales are unloaded by a special bale hoist, which consists of a crab, driven by power, which is used to hoist the bale and also to draw in and out a carrier bogie. The latter runs upon a cat-head, which projects sufficiently far to enable loading or unloading to be easily conducted. The bogie carries a chain pulley over which the chain passes to the snatch-block, so that the hook can be placed directly over the load. After the latter is raised, the bogie is run in, so as to land the bale in the storeroom.

---

### CHAPTER III.

#### SLOW BURNING AND ONE-STOREYED BUILDINGS.

Without pausing to consider at present the various points involved in the constructions described, we can proceed to deal with the "slow burning" construction adopted in America in lieu of the fire-proof type adopted here. The manufacturers of the United States have the enormous advantage of the counsel and guidance of the Boston Manufacturers' Mutual Fire Insurance Co., which, through its officers, collects and collates all kinds of information bearing upon the construction and preservation of mills. The present type of mill in that country, as in this, has been evolved, and the difference in aim in each case has given correspondingly varied directions to the constructive policy. In the United States the aim has been to provide a building which although not fireproof is not easily destroyed. In this country brick and iron have always been cheap; in the United States timber

has been at once easier to obtain and cheaper than iron. The result is that the efforts of American architects have been directed towards the most complete utilisation of the cheaper material, and a very admirable construction has been evolved. In the earlier stages of mill architecture in both countries the joisted floor was the universal one, but it was speedily found to be very easily destroyed by fire. Accordingly the solid floor has been the prevailing type for some years, and where it is unbroken by apertures for the passage of belts it has many merits. We are enabled to present a number of details of this style of construction.

In its chief features it is shown in Fig. 12, which is a partial transverse section of a mill so constructed. The walls are built of brick, and, as in this country, gradually diminish in thickness as the building ascends. The floors are carried by strong transverse timber beams 14in. by 12in., or two beams 14in. by 6in., which rest on wall plates, as shown. If two beams are used they are placed close together, but not actually in contact, so as to give a little ventilation. At 20ft. span these beams will carry safely a distributed load of 252cwt. At intervals the beams are supported by columns made of pine, from 8 to 10in. square. Tests made for the Boston Company showed that crushing occurred in pine columns at a pressure of 4,500lbs. per square inch, a load of 600lbs. per square inch being therefore taken as a safe one. It is preferable to use square columns on account of their greater area. The details of the method of sustaining the beams and pillars are given in the illustration. It is the ordinary practice to form in one piece a cast-iron cap and base for the upper and lower pillars, and secure them by a pintle also of cast iron. The base of the pillar should rest on an iron plate projecting above the floor level. On the beams are nailed flooring boards, breaking joints every three feet, and 3in. thick. The planks are tongued and grooved. These planks are long enough for two bays, and on them is spread a layer of cement or mortar  $\frac{3}{4}$ in.





thick, or two thicknesses of asbestos paper, and above this a second set of hard wood flooring boards  $1\frac{1}{2}$  in. thick, with broken joints, is fixed. The nails for securing the boards should be driven down and not up, as the ends within the building will condense moisture and drop. The roof is made nearly flat, and is rendered impervious to water by careful boarding, being also covered with waterproof felting. In some cases it is quite covered with gravel, which acts as considerable protection against fire. As shown, the roof planks overhang the walls, so as to weather well. A floor thus constructed has been shown to be difficult of destruction, and is also impervious to water, which, as it is a common practice to use automatic sprinklers, is a very important matter. If it is desired to get a more rigid floor, the top planks can be fastened on at right angles to those below, so as to act as braces. One special caution is given with reference to wooden beams by the Boston Company. It is—“Wherever and whenever solid beams or heavy timbers are made use of in the construction of a factory or warehouse, they should not be painted, varnished, oiled, filled, or incased in impervious concrete air-proof plastering or metal, for at least three years, lest fermentation should destroy them by what is called dry rot.” As the fire protection of a wooden building is much improved by covering all exposed timbers with lime plaster, laid preferably on wire netting, the value of this warning is obvious.

The most common practice in this country is to construct weaving sheds with the saw tooth roof, shown as applied to a spinning mill in Fig. 55. The construction of a weaving shed is comparatively simple, the chief points being light and a sufficiently good roof to keep out the rain. The method of construction adopted has the undoubted advantage of providing a building with a steady clear light, the incidence of which is such that no shadows are cast. In the northern hemisphere such a roof would be arranged so that the windows

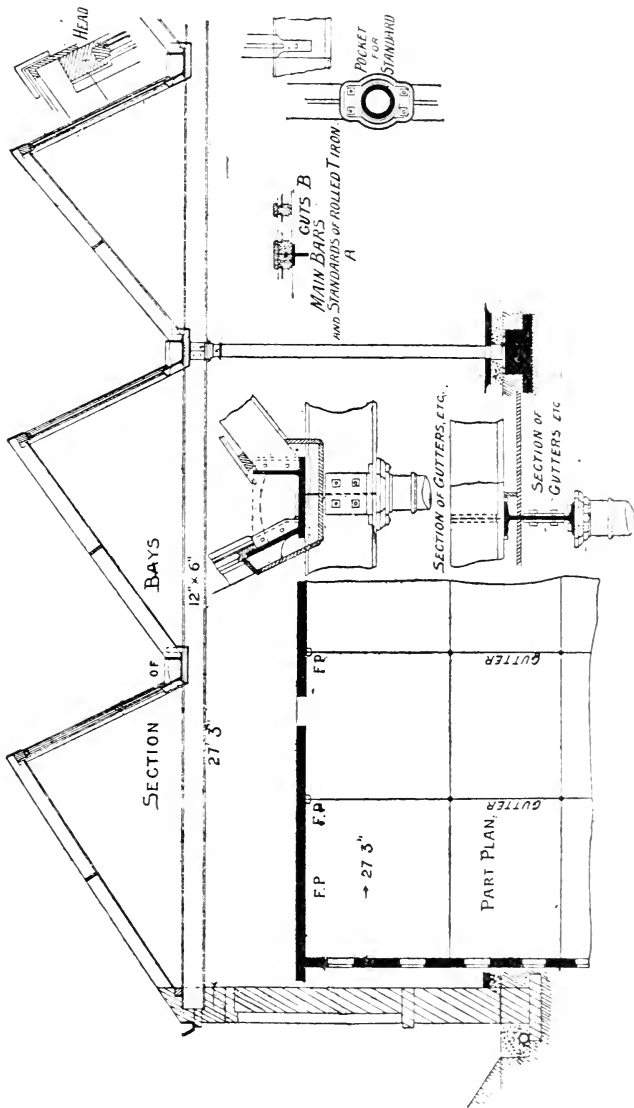

FIG. 13.

face the north, because in that case no direct sunlight falls into the shed. The north face of the roof is therefore, substantially, glass and wood, while the south face is slated on timber rafters and principals. It will be noticed, in Fig. 13, that the glass face is arranged at an angle of about  $30^\circ$  from the vertical, while the slated portion is about  $60^\circ$ . The valleys between each ridge are occupied by cast-iron gutters, which run transversely across the shed, and are supported by columns. The pitch of the bays and columns is usually from 10ft. 6in. to 12ft. 6in.; but the shed shown in Fig. 13 has been designed by the architect, Mr. W. J. Morley, of Bradford, with the columns 25ft. apart. They sustain longitudinal steel girders upon which the gutters are carried, and the latter are so constructed as to perform the double function of acting as water-courses and of beams by which the roof principals are carried. In the detailed drawings which, through the courtesy of Mr. Morley, are given, the method of forming the roof will be readily understood without much explanation, the aim being to get wide bays so as not to interfere with the floor space more than possible. This is a very important matter.

In some sheds recently designed by Messrs. Potts, Son, and Pickup for Messrs. Horrocks, Crewdson, and Co. Limited, and others, a very successful attempt has been made to obtain a clear floor space without sacrifice of light. The columns run in lines at intervals of 22ft., and carry longitudinal  $\Gamma$  girders. These sustain light girders of the Warren pattern, which practically form a frame for the roof, and from which the roof timbers are sprung. They are the full depth of the roof from the girder to the ridge, and the window frame is hung from them. The window is nearly vertical, and the underside of the slated roof is, of course, plastered and whitened. But the chief advantage claimed for this construction is that the distance between the columns transversely is 44ft., which

gives an unobstructed floor of 938 sq. ft. It will, of course, be understood that the span of each bay being 11ft., one girder is carried half way between each pair of columns. It is obvious that the angle at which the window is fixed will have a great influence upon the entrance of the light, and that when a window is, as in this case, nearly vertical, much of the light must of necessity be obtained by reflection. Diffusion is as important as direct inlet, and a uniformly clear light without glare is the desideratum. Vertical windows keep clean longer than those at an angle, but the matter is one affecting the whole design. It will be seen by the next example that in America a vertical light is relied on, but that it extends to all four sides.

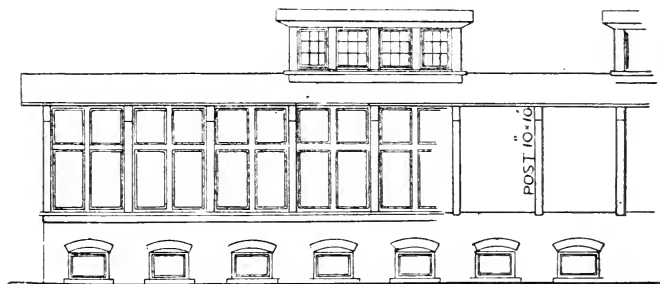

FIG. 14.

In the United States a special form of one-storey mill has been evolved which is very interesting. It has been named the "Monitor" type, from the fact that light is obtained by means of a raised central lantern called a "monitor." It is illustrated in Figs. 14 to 19, the drawings being those issued by the Boston Mutual Company. There are two types of this form of mill, one in which the brick wall is run up to the roof between the windows, and the other in which it is merely a stool carrying a wood and glass framing, as shown in Fig. 14. The basement floor is 8ft. 6in. from floor to floor, and is lighted by side windows placed

just above ground level. their sills 5ft. 6in. above the basement floor. The lower floor is carried by timber beams 16in. deep and 10in. wide, on which the flooring boards are laid, as shown in plan in Fig. 15. The floors consist of



FIG. 15.

a lower layer 3in. thick, topped by hard wood planking 1½in. thick. The roof (a plan of which is shown in Fig. 16), which consists of 3in. timbers, covered by gravel, terne plates, or pre-

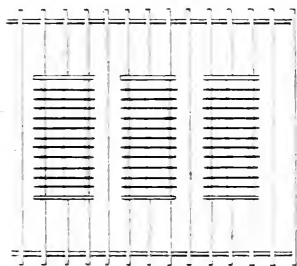

FIG. 16.

pared cotton duck, is borne by rafters 16in. deep and 10in. wide, supported by a knee fixed to the wall. A slight batter from the monitor outwards is given to the roof (see Fig. 17), and the monitor can be continuous. The columns carrying the roof, shown in

detail in Fig. 18, are 10in. square, made of pine, and resting upon an iron base, which in turn rests on the head of a cast iron pintle sustained by an iron plate fixed on the top of a brick pillar in the basement, 24in. by 16in. As shown, the ends of the floor beams are angled and rest upon the brickwork. The window frames are also illustrated in detail. They go right up to the roof, and are of the English type, much resembling the window shown in Fig. 31. From centre to centre of the posts the distance is 8ft., and the height from top to bottom of frame 10ft. The upper sash is divided, and each of them is hinged so as to swing, as shown in Fig. 18. The

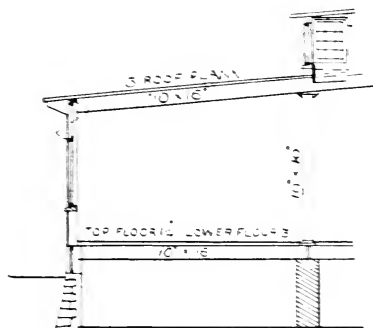

FIG. 17.

window posts rest upon iron caps or plates anchored in the wall. The window posts are 10in. square and are placed between the windows, and by means of ears, shown in dotted lines in the detailed drawings, the posts can be secured to the base plates. The posts are bored through the centre with a 1½in. hole for ventilation, and the rafters are sustained by an iron cap fixed upon the top of the pillar.

The "monitor" or lantern, shown in Fig. 19, is sustained by a beam 16in. deep by 5in., which is born by a knee fixed to the main outer posts and resting on the iron cap on the pillar. From the roof, posts 5in. square are carried up, fitting into

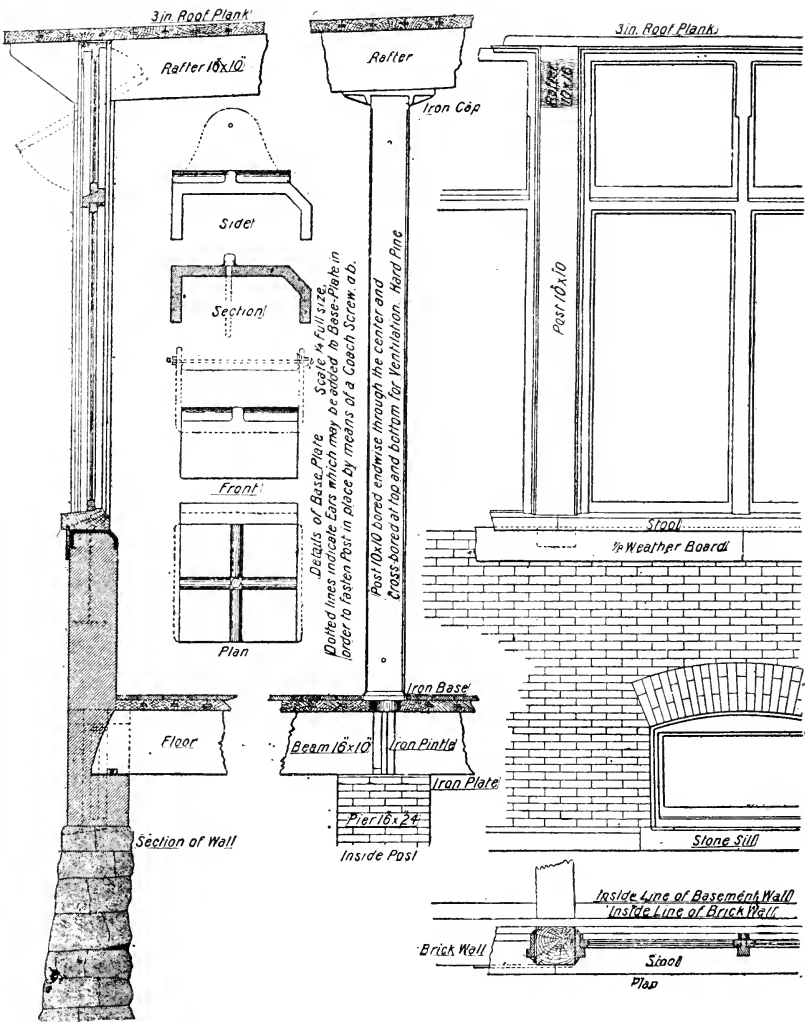

FIG. 18.



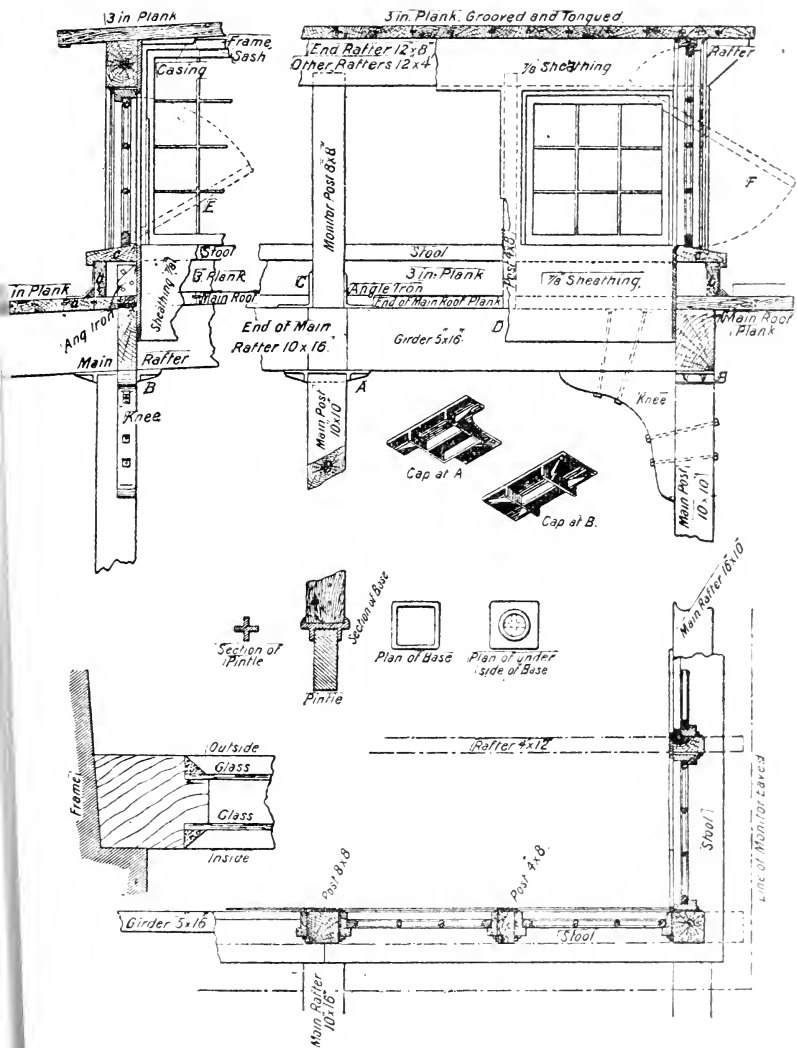

FIG. 19.

the rafters of the monitor. The end rafters are 12in. by 8in., and the others 12in. by 4in., and carry the roof timber. The ends of the rafters project so as to permit the roof to be carried out for weathering purposes. Upon the rafters a plank 4½in. deep by 3in. thick is secured, on which a stool 2in. thick and 10in. wide is placed to carry the window frames. The window sashes can be hung either as shown on the right of Fig. 19, or on the left, and are constructed in the manner illustrated in enlarged detail at the left hand bottom corner, with bevelled edges, so that they fit whether wet or dry. These details have been given in order to illustrate an ingenious method of timber construction, which has been very carefully thought out. It is obvious that the details of construction can be varied in accordance with the circumstances and material at the disposal of the constructor, but there is generally no difficulty. Rubble walls are necessarily employed in some cases, and then it is essential that all caps or pads should be firmly fixed and anchored, a remark which applies to all wall boxes for the reception of shaft bearings.

---

## CHAPTER IV.

### COST, STRENGTH, AND FIRE RESISTANCE OF FLOORS.

It is obvious that as compared with the American type of building the English type is much the heavier. This applies with greater force to concrete floors made of broken brick or stone and cement, and in a lesser degree to those in which coke breeze—that is, the riddled and washed small coke from gas works—is used. It has been objected that the latter is not fireproof, and, while this may be conceded so far as the material itself is concerned, it has been shown that when the cement is properly mixed with the breeze in proper proportions, the concrete so formed is impervious to fire. There is, of course, the risk which always attends the use of an inflammatory material, that it may not be

properly protected, and this must be kept in mind. On the other hand, the weight of the floor is considerably reduced. The weight of the solid timber floor shown in Fig. 12, is said to be about 18lbs. per square foot, and its cost in the United States about 14d. per square foot. On the other hand, the weight of the fireproof floor, with heavy brick arches and cast iron beams, is from 115 to 120lbs. per square foot, and its cost about 18d. per foot. The substitution of steel girders and cross-beams reduces alike this weight and cost. The steel and concrete floor shown in Fig. 8, weighs about a hundred pounds per square foot, and costs approximately 16d. per foot. The American type of fireproof floor (Fig. 10) costs in that country a little more than the last named, but could be more cheaply produced in this country, where the steel joists are lower in price. The cost of this floor for a total load of 125lbs., is stated to be for a floor space of 200 feet, about 15½d. per foot, and its weight 54lbs. per square foot. The Hennebique floor, shown in Fig. 11, weighs 279 kilos. per square mètre, or 56·8lbs. per square foot, and its cost is said to be 12 francs per mètre, or about 11d. per square foot. It is, therefore, clear that while there is no great disparity in cost between four of these representative classes of floor, there is a great difference in the weight per square foot. This, of course, is not unimportant, as it implies a proportionately heavy load upon the columns, more especially those on the lower floors, which in the event of a fire might lead to their breakage if weakened by heat. In this respect the American terra-cotta floor has some advantages, and is worthy of consideration, but much can be done by protecting the ironwork with plaster or cement. The rigidity of the concrete floor is greatly in its favour, because it ensures a base for the machine almost without tremor, and one in which deflection is practically absent. The strength of the transverse joists when set in concrete is increased by one-third, which is valuable.

The joists and rolled girders used in this country are, as have been intimated, of  $\text{I}$  section, and the steel is usually capable of standing a tensile strain of from 26 to 28 tons per square inch of section, but occasionally rises to 32 tons. The resistance to crushing is practically equal to the tensile strength, but the shearing strength is only about three-fourths of that. Lloyd's test for shipbuilding steel is a minimum tensile strength of 27 tons to the square inch and a maximum of 31 tons, with an elongation prior to breaking of 20 per cent in 8 inches long. The test strip, after being heated to redness and cooled in water at a temperature of 82° F., must bend double round a curve with a diameter equal to three times the thickness of the strip. The French Admiralty test provides for a tensile strength of 28 tons for plates  $\frac{3}{4}$  in. and upwards thick, and 28½ tons if thinner; the elongation being 20 per cent on 8 inches. The tensile strength of wrought-iron joists is from 20 to 24 tons per square inch. In Table IV. particulars are given of steel girders of  $\text{I}$  section, as made by Messrs. Dorman, Long & Co., Limited, of Middlesborough, and calculated by Mr. Myles Cooper, of Manchester.

TABLE 4.

| Weight per foot in lbs. Approximate. | Dimensions, inches. |                   |            |         | Distributed Load in tons carried per foot in following fractions of breaking strain. |                   |                   |
|--------------------------------------|---------------------|-------------------|------------|---------|--------------------------------------------------------------------------------------|-------------------|-------------------|
|                                      | Depth.              | Width of flanges. | Thickness. |         | $\frac{1}{3}$ rd.                                                                    | $\frac{1}{4}$ th. | $\frac{1}{5}$ th. |
|                                      |                     |                   | Web.       | Flange. |                                                                                      |                   |                   |
| 64.50                                | 16                  | 6                 | .64        | .82     | 649.17                                                                               | 487.41            | 389.92            |
| 42                                   | 15                  | 5                 | .45        | .62     | 422.80                                                                               | 317.10            | 254.00            |
| 57                                   | 14                  | 6                 | .59        | .81     | 541.51                                                                               | 391.97            | 313.57            |
| 43                                   | 12                  | 5                 | .58        | .65     | 322.75                                                                               | 242.66            | 193.66            |
| 45.50                                | 10                  | 6                 | .58        | .70     | 306.35                                                                               | 229.84            | 183.87            |
| 31.50                                | 10                  | 4½                | .41        | .66     | 212.01                                                                               | 159.01            | 127.20            |
| 25                                   | 8                   | 4                 | .42        | .56     | 131.86                                                                               | 98.89             | 79.11             |
| 16                                   | 6                   | 3                 | .34        | .50     | 63.21                                                                                | 47.40             | 37.92             |
| 11                                   | 5½                  | 2                 | .36        | .38     | 34.69                                                                                | 26.01             | 20.81             |
| 15.25                                | 5                   | 3                 | .40        | .46     | 48.85                                                                                | 36.64             | 29.31             |
| 8.50                                 | 4                   | 1¾                | .37        | .35     | 19.50                                                                                | 14.60             | 11.70             |

For dead loads, such as are common in a mill, not less than one-fourth the breaking strain should be taken, but if rolling loads are needed, then one-

fifth should be used. It is not advisable to use one-third only. Suppose the girders to be borne at distances of 20·5ft. apart and to be 16in. by 6in., the load per foot which they should carry would be —if one-fourth be taken— $\frac{487\cdot41}{20\cdot5} = 23\cdot7$  tons. The

area sustained with columns placed 20ft. 6in. by 14ft. 9in. apart is 302 sq. ft., and if the load be taken at 140lbs. per square foot the load on the girders is 18·75 tons per foot, which is well within the strength named, and is indeed equal to the load taken at one-fifth breaking strain. The weight of wrought-iron rolled joists is about 5 per cent, and the strength from 25 to 30 per cent, less than those of steel.

The preservation of a correct alignment in spinning machinery is known to be of importance, and this is secured with much more certainty in the English than in the American type. In the instructions issued by the Boston Mutual Manufacturers' Association, a table compiled by Mr. C. J. H. Woodbury is given, which is based upon a deflection to the extent of a curve with a radius of 1,250ft., assuming the modulus of elasticity of Southern pine to be 2,000,000lbs. The calculations made must be based upon this table, because anything beyond the standard deflection will affect the working of the machinery. A portion of the table to suit beams from 8in. to 14in. deep, and of spans from 10ft. to 20ft. is given. It will be understood that the loads are for each inch of width in the beam :—

TABLE 5.

| Span feet. | DEPTH OF BEAM IN INCHES.         |    |    |     |     |     | Deflection in inches. |       |
|------------|----------------------------------|----|----|-----|-----|-----|-----------------------|-------|
|            | 8                                | 9  | 10 | 11  | 12  | 13  |                       | 14    |
|            | LOAD IN POUNDS PER FOOT OF SPAN. |    |    |     |     |     |                       |       |
| 10         | 46                               | 65 | 89 | 113 | 154 | 195 | 244                   | ·1200 |
| 11         | 38                               | 54 | 73 | 98  | 127 | 161 | 202                   | ·1452 |
| 12         | 32                               | 45 | 62 | 82  | 107 | 136 | 169                   | ·1728 |
| 13         | 27                               | 38 | 53 | 70  | 91  | 116 | 144                   | ·2028 |
| 14         | 23                               | 33 | 45 | 60  | 78  | 100 | 124                   | ·2352 |
| 15         | 20                               | 29 | 40 | 53  | 68  | 87  | 108                   | ·2700 |
| 16         | 18                               | 25 | 35 | 47  | 60  | 76  | 95                    | ·3072 |
| 17         | 16                               | 22 | 31 | 43  | 54  | 68  | 84                    | ·3468 |
| 18         | —                                | 20 | 27 | 38  | 49  | 60  | 75                    | ·3888 |
| 19         | —                                | 18 | 25 | 35  | 44  | 54  | 68                    | ·4332 |
| 20         | —                                | —  | 22 | 32  | 40  | 49  | 61                    | ·4800 |

On this basis the safe load for the span previously named would be 130 cwts. as against 252 cwts., which is the figure if deflection be neglected. On the other hand, the action of flame upon thick wooden beams or columns is slow, the charring of the surface acting as a protection to the centre, so that a long time elapses before the beam is so weakened as to be dangerous. As compared with unprotected ironwork, the solid timber slow-burning floor is much superior, but in comparison with protected iron, steel, and concrete floors, it has no such superiority. Recent figures tend to show that the difference in cost between timber and fireproof floors even in America is becoming less, so that there will be probably a considerable increase in the use of the latter. While this is so there remains the fact that in countries where timber is plentiful and cheap the American method of construction possesses sufficient advantages to justify its adoption, especially if applied to buildings of one or two storeys.

As the question of the load on a mill floor is of importance, we give a few weights and measures of various machines and articles which will be useful. It will, of course, be understood that the figures given form approximations to the actual, but there will be slight variations with different machinists.

TABLE 6.

| Article.                                                           | Superficial Measurement.     | Weight, Cwts.<br>of 112lbs. |
|--------------------------------------------------------------------|------------------------------|-----------------------------|
| Cotton bale .....                                                  | 8 ft. ....                   | 4·5                         |
| "    "    compressed                                               | 4·1 ft. ....                 | 4·9                         |
| Crighton opener, single                                            | 12 ft. by 5 ft. 10 in. ...   | 65                          |
| "    "    double                                                   | 18 ft. 2 in. by 5 ft. 10 in. | 98                          |
| Crighton opener, single,<br>combined with single<br>scutcher ..... | 24 ft. 10 in. by 6 ft. 9 in. | 108                         |
| Crighton opener, double,<br>combined with single<br>scutcher ..... | 31 ft. by 6 ft. 6 in. ....   | 150                         |

TABLE 6 (Continued).

| Article.                                                 | Superficial Measurement.                      | Weight, Cwts.<br>of 112lbs.                                                           |
|----------------------------------------------------------|-----------------------------------------------|---------------------------------------------------------------------------------------|
| Scutching and lap machine for 40in. cards                |                                               |                                                                                       |
| Single, with feed                                        | For three laps—<br>14ft. 2in. by 6ft. 6in.    | } 65                                                                                  |
| Double .....                                             | For three laps—<br>21ft. 6in. by 6ft. 6in.    |                                                                                       |
| Carding machines—                                        |                                               |                                                                                       |
| Revolving flat, 38in. laps ...                           | 10ft. by 5ft. 6in. ....                       | 45                                                                                    |
| Roller and clearer, 45in. cylinder, 36 in. on wire ..... | 9ft. 3in. by 5ft. 6in....                     | 42                                                                                    |
| „ 45in. by 40in....                                      | 9ft. 3in. by 5ft. 10in.                       | 48                                                                                    |
| „ 50in. by 48in....                                      | 10ft. by 6ft. 6in. ....                       | 52                                                                                    |
| „ double, 45in. by 40in. ....                            | 15ft. 7in. by 6ft. 6in.                       | 62                                                                                    |
| Drawing frames—                                          |                                               |                                                                                       |
| Width of frame.....                                      | 4ft. to 5ft.....                              | } Per delivery,<br>5 to 5½                                                            |
| Length of gearing...                                     | 2ft. 6in. to 3ft.....                         |                                                                                       |
| Gauges, per delivery                                     | 1ft. 2in. to 20in. ....                       |                                                                                       |
| Combing machines—                                        |                                               |                                                                                       |
| 6 heads .....                                            | 13ft. 2in. by 3ft. 6in.                       | 31                                                                                    |
| 8 heads .....                                            | 16ft. by 3ft. 6in. ....                       | 40                                                                                    |
| Lap machines .....                                       | 7ft. by 4ft. 6in. ....                        | 20                                                                                    |
| Derby doublers, 19in.                                    | 12ft. by 6ft. 6in. ....                       | 42                                                                                    |
| Slubbing machines—                                       |                                               |                                                                                       |
| Width of frame.....                                      | 4ft. 6in.....                                 | } From 1.06<br>to 1.3 per<br>spindle<br>(longest<br>frames<br>lightest<br>p'r sp'le). |
| Length of gearing...                                     | 3ft.....                                      |                                                                                       |
| Gauges .....                                             | 4 spindles in 16in. ...                       |                                                                                       |
|                                                          | 4 „ „ 18in. ...                               |                                                                                       |
|                                                          | 4 „ „ 20in. ...                               |                                                                                       |
| Intermediate frames—                                     |                                               |                                                                                       |
| Width of frame.....                                      | 3ft.....                                      | } From .7 to<br>.9 per<br>spindle<br>(longest<br>frames<br>lightest).                 |
| Length of gearing...                                     | 3ft.....                                      |                                                                                       |
| Gauges .....                                             | 4 spindles in 16in. to<br>19½in. ; 6 spindles |                                                                                       |
|                                                          | in 18in. to 21in....                          |                                                                                       |
| Roving frames—                                           |                                               |                                                                                       |
| Width of frame .....                                     | 3ft.....                                      | } From .6 to<br>.66 per<br>spindle.                                                   |
| Length of frame.....                                     | 3ft.....                                      |                                                                                       |
| Gauges .....                                             | 8 spindles in 18in. to<br>23in. ....          |                                                                                       |

TABLE 6 (Continued).

| Article.                                                  | Superficial Measurement.                                                                                                   | Weight, Cwts.<br>of 112lbs.                                                                                                              |
|-----------------------------------------------------------|----------------------------------------------------------------------------------------------------------------------------|------------------------------------------------------------------------------------------------------------------------------------------|
| Jack frames—                                              |                                                                                                                            |                                                                                                                                          |
| Width of frames.....                                      | 3ft.....                                                                                                                   |                                                                                                                                          |
| Length of gearing ..                                      | 3ft.....                                                                                                                   |                                                                                                                                          |
| Gauges ..                                                 | 10 spindles in 22 $\frac{1}{2}$ in. ;<br>12 spindles in 22in.<br>or 24in.....                                              | } .53 per<br>spindle.                                                                                                                    |
| Self-acting mule—                                         |                                                                                                                            |                                                                                                                                          |
| Width of headstock..                                      | 5ft. 3in. to 5ft. 6in....                                                                                                  | } From .14 to<br>.22 per<br>spindle,<br>according<br>to gauge<br>& length.                                                               |
| Width over pair of<br>mules .....                         | 20ft. 6in.....                                                                                                             |                                                                                                                                          |
| Gauges.....                                               | 1 $\frac{1}{8}$ in., 1 $\frac{1}{4}$ in., 1 $\frac{3}{8}$ in.,<br>1 $\frac{1}{2}$ in. ....                                 |                                                                                                                                          |
| Ring spinning frames—                                     |                                                                                                                            |                                                                                                                                          |
| Gearing, one end....                                      | 2ft. 6in.....                                                                                                              | } From .2 to<br>.22 per<br>spindle.                                                                                                      |
| " both ends...                                            | 4ft.....                                                                                                                   |                                                                                                                                          |
| Width, 1 tin roller..                                     | 2ft. 9in.....                                                                                                              |                                                                                                                                          |
| " 2 " ..                                                  | 3ft. 6in.....                                                                                                              |                                                                                                                                          |
| Gauges .....                                              | 2 $\frac{1}{2}$ in., 2 $\frac{5}{8}$ in., 2 $\frac{3}{4}$ in.....                                                          |                                                                                                                                          |
| Doubling winding<br>machine—                              |                                                                                                                            |                                                                                                                                          |
| Width of frame .....                                      | 3ft. 4in. ....                                                                                                             | } .3 to .5 per<br>bobbin.                                                                                                                |
| Gearing and frame<br>ends .....                           | 1ft. 9in. ....                                                                                                             |                                                                                                                                          |
| Gauges for bobbins )<br>4in., 4 $\frac{1}{2}$ in., 5in. ) | 2 bobbins in 6in.,<br>6 $\frac{1}{2}$ in., 7in. ....                                                                       |                                                                                                                                          |
| lift .....                                                |                                                                                                                            |                                                                                                                                          |
| Ring doubling<br>machines—                                |                                                                                                                            |                                                                                                                                          |
| Width of frame.....                                       | 3ft.....                                                                                                                   | } Dry, .22 per<br>spindle ;<br>Scotch,<br>wet, .23<br>per spl. ;<br>English,<br>wet, .28<br>per spl. ;<br>Flyer<br>frame, .4<br>per spl. |
| Gearing, one end....                                      | 2ft. 8in.....                                                                                                              |                                                                                                                                          |
| " both ends..                                             | 4ft. 9in.....                                                                                                              |                                                                                                                                          |
| Gauges .....                                              | 2 $\frac{1}{2}$ in., 2 $\frac{3}{4}$ in., 3in., 3 $\frac{1}{4}$ in.,<br>3 $\frac{1}{2}$ in., 3 $\frac{3}{4}$ in., 4in..... |                                                                                                                                          |
| Cop reel, 40 hanks.....                                   | 12ft. 9in. by 2ft. 7in..                                                                                                   | 3.25                                                                                                                                     |
| Bobbin reel, double 40<br>hanks .....                     | 13ft. 4in. by 4ft. ....                                                                                                    | 7                                                                                                                                        |
| Bundling press .....                                      | 3ft. by 2ft. ....                                                                                                          | .11                                                                                                                                      |
| Gassing frame—                                            |                                                                                                                            |                                                                                                                                          |
| Width of frame .....                                      | 3ft. 2in.....                                                                                                              | } .37 per light                                                                                                                          |
| Gearing, etc. ....                                        | 2ft. 10in. ....                                                                                                            |                                                                                                                                          |
| Gauge .....                                               | 2 lights in 5 $\frac{1}{2}$ in. ....                                                                                       |                                                                                                                                          |



TABLE 6 (Continued).

| Article.                           | Superficial Measurement.                                         | Weight, Cwts.<br>of 112lbs.  |
|------------------------------------|------------------------------------------------------------------|------------------------------|
| Cop winding frame—                 |                                                                  |                              |
| Width of frame .....               | 5ft. to 5ft. 6in.....                                            | } .13 to .18<br>per spindle. |
| Gearing, etc. ....                 | 1ft. 7in.....                                                    |                              |
| Gauge .....                        | 4 spindles in 5in.....                                           |                              |
| Bobbin winding<br>frame—           |                                                                  |                              |
| Width of frame .....               | 5ft. to 5ft. 6in.....                                            | } .14 to .19<br>per spindle. |
| Gearing, etc. ....                 | 1ft. 7in.....                                                    |                              |
| Gauge .....                        | 4 spindles in 5in.....                                           |                              |
| Drum winding frame—                |                                                                  |                              |
| Width of frame .....               | 3ft. 8in.....                                                    | } .41 to .62<br>per drum.    |
| Gearing, etc. ....                 | 2ft.....                                                         |                              |
| Gauge bobbins, 5in.<br>lift .....  | 6 $\frac{3}{4}$ in. ....                                         |                              |
| Pirn winding frame—                |                                                                  |                              |
| Width of frame .....               | 4ft. 6in. ....                                                   | } .16 to .21<br>per spindle. |
| Gearing .....                      | 1ft. 9in. to 2ft. 6in. ...                                       |                              |
| Gauge .....                        | 2 spindles in 4 $\frac{1}{2}$ in. to<br>4 $\frac{3}{4}$ in. .... |                              |
| Sectional warping<br>machine ..... |                                                                  |                              |
| Do. with creel.....                | 11ft. 3in. by 7ft. 3in..                                         |                              |
| Beaming machine .....              | 16ft. by 7ft. 6in. ....                                          | 18                           |
| Slasher sizing machine.            | 38ft. 6in. by 9ft. 6in.                                          |                              |
| Circular warping ma-<br>chine—     |                                                                  |                              |
| 12yds. swift .....                 | 19ft. by 12ft. ....                                              | 12.25                        |
| 20yds. swift .....                 | 27ft. by 20ft. ....                                              | 14.75                        |
| Looms—                             |                                                                  |                              |
| Light calico 40in. ...             | 6ft. 8in. by 3ft. 9in...                                         | 13.5                         |
| Drop box 40in. ...                 | 7ft. 6in. by 3ft. 10in..                                         | 15.5                         |
| Folding machines .....             | 6ft. 9in. by 6ft. 3in...                                         | 16                           |

There is, of course, in addition to these weights, the weight of material in the machines, the work-people, bobbins and other accessories, and the shafting. With the ordinary number of work-people and quantity of stock, the weight (neglecting cotton warehouse and blowing room) will be about 14lb. per spindle, so that the total load will run out about 44lb. per foot in a ring mill and 38 to 40 in a mule mill, this being, of course, exclusive of the floor and gearing.

The question as to the fireproof condition of a mill is one which is of the highest importance. It is obviously a waste of money and worse to go in for an expensive form of construction, involving the enormous weight of a modern concrete floor building, when the building is left in even a partially unsafe state. There is no fact more capable of proof than that of the destructibility of buildings in which the weight is taken by unprotected ironwork. The whole matter resolves itself into one of the quantity of combustible material which is present. It is quite true that modern English machinery, with the exception of the mule, comprises little woodwork, but is, on the contrary, very free from combustible material. Thus it may be that the possible heat which can be attained in a fire is not enough to so weaken the iron columns as to destroy the building, but there is always the danger. The possibility of a stream of water striking one side of a highly heated column during the progress of a fire is always present, and a cracked column from that cause is sufficient to bring the whole fabric down. A wooden beam or column, 10 or 12in. square or round, can be burned in for a depth of 2in. without so seriously weakening it as to imperil the fabric. So far as the protection against burning out is concerned there is little to choose between the solid plank and the fireproof floor, except that the weight of the latter, under the circumstances named, constitutes a danger. This, of course, is subject to the condition that the solid plank floor is unbroken by belt holes, which is not always the case in America, where driving through the floor from below is a very favourite practice, as shown in Fig. 20. This represents one of the weaving rooms of the Merrimack Manufacturing Company, at Lowell. Given, however, the unprotected condition of the ironwork, then the destruction of the edifice is rendered more possible. The remedy clearly is, therefore, to cover all ironwork with some material which is a bad conductor of heat, and which will resist alike the effect of fire and water. In Messrs.

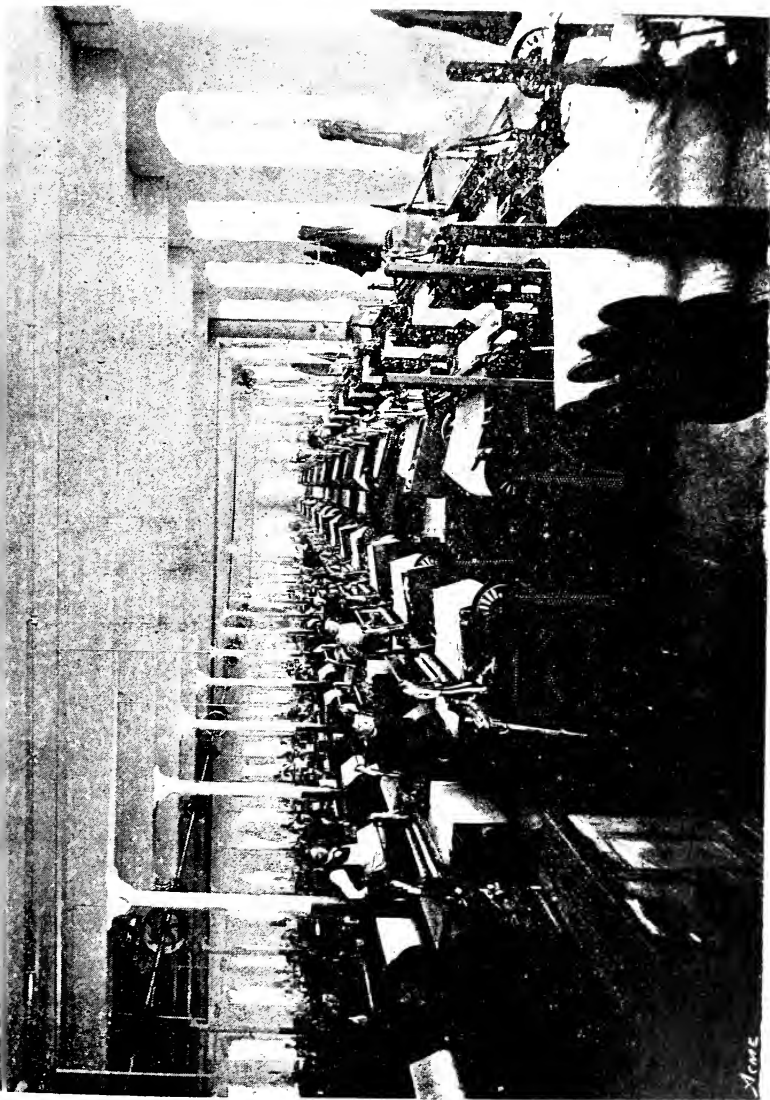

FIG. 20.

Acme

Coats' mill, previously mentioned, all the ironwork, columns included, is protected ; and in the Castle Mill, at Stalybridge, all the ironwork except the columns is similarly protected by a coating of plaster laid on wire netting. Special forms of netting are made for the purpose, to which the plaster adheres very tenaciously. The advantages of cast-iron columns from a constructive point of view are so great that their use is desirable if they can be rendered safe, which, with the small amount of combustibles present, they may be considered to be. The prevailing type of cast-iron column also suffers from the fact that it is rarely cast on end, but nearly always on its side ; and, while it is true that the result is generally a good one, it is impossible to guarantee an even thickness of metal throughout, although the strength is generally such as to leave a margin of safety. It is always desirable to retain the right to drill the columns to ascertain the thickness of metal at various points. Hitherto no architect has been bold enough to use in mill construction the built steel columns which have been employed in other forms of constructive work. The extra resistance to flexure possessed by a carefully designed steel column seems, however, to point this out as the next step to be taken in fighting fire risks. Another point of some importance is the question of side-thrust on the walls in the event of fire. It is contended on behalf of concrete floors that, owing to the nature of the material, end-thrust of the beams is obviated, but this is a matter which has not been determined by actual experience and cannot be settled authoritatively until it has. At the same time experiments, carefully made with a section of a steel and concrete floor made exactly like that used for a large mill, show that the transmission of heat through a floor of this type is very slow and that its expansion under a fierce blaze is very slight. It may be concluded that a concrete and steel floor, sustained by suitable columns with the whole of the exposed ironwork protected, gives a construction possessing

on the whole a balance of advantages. It is rigid, strong, and practically indestructible, but is heavy, thus necessitating a strong structure. As a matter of fact, in the economy of a mill in which the machines used are so long, a rigid floor is practically an essential. Any deflection or destruction of the alignment is a fertile source of a loss of power, and more may be lost in money value in this way than would repay the extra outlay two or three times. It is, however, worth considering whether a freer use of the honeycombed tiles shown in Fig. 10 would not give as rigid and secure a floor as the heavier type shown in Fig. 9. In the opinion of the writer it would, and more especially if joined to the system of sustaining the whole building on protected steel columns and girders, so that the wall of each floor is practically independent. The matter is one of cost simply, and should be so considered.

A minor point in relation to this matter is that of the construction of the doors. In most mills these are what are styled fireproof—that is, are made entirely of iron. Their strength, however, is such that under a fierce flame they would warp. In Messrs. Coats' mill, previously referred to, all the doors were of wood, being completely covered with tinplate to prevent the direct attack of the flame, a course which was also followed with the door frames. The American door is made of two thicknesses of matchboards, not more than 4 in. wide, laid at right angles and nailed together. They are covered by tinned plates, lock-jointed and nailed under the joint, the sheets being bent round the door, so as to have no seams on the edges. The doors are hung on sloping rails, and are kept open by fusible solder attachments which melt at a temperature of 162° F. Doors so formed and protected have been shown to be practically indestructible with ordinary fires.

Although not really a part of fire prevention, the use of iron ladders and landings outside the mill is one which is widely adopted to facilitate escape in the case of fire. Analogous to this matter is that of

the material used in the construction of the stairs. The various plans hereafter given show the position of these in an ordinary mill, and in Lancashire it is the practice to make the treads and risers of Rochdale flagstones. It is well known that under the influence of heat this speedily splinters, and as the staircase is well adapted to act as a chimney, a fire breaking out in any of the lower rooms might have a disastrous effect in this way. By the adoption of steel bearers and concrete treads this danger is obviated, and in the case of Messrs. Coats' mill the concrete is covered by boarding. It may be that the staircase requires to be employed as a means of exit, so that it is highly important to ensure its safety. The cost of a concrete staircase will not exceed a good flagged one.

---

## CHAPTER V.

### FIRE APPLIANCES : SPRINKLERS.

Within the past few years the practice of fitting mills with devices for extinguishing fires has become largely extended. In most modern mills a special service of pipes is laid up the staircases to the upper floors, and on each floor nipples, on to which hose pipes can be screwed, are provided. These pipes are coupled up to a steam fire pump, so as to be always ready for use. In addition to this, filled fire buckets are kept in suitable places, although it is not always noticed that they are filled. According to *Cassier's Magazine*, a superintendent in one of the large New England mills, who had found it difficult to keep the fire pails full and in good order, some time ago adopted the following interesting expedient: The hooks carrying the pails were fitted up with pieces of spring steel, strong enough to lift the pail when nearly empty, but not sufficiently so to lift a full pail. Just over each spring, in such a position as to be out of the way of the handle of the pail, was set a metal point connected with a wire from an

open circuit battery. So long as the pails were full, their weight, when hung on their hooks, kept the springs down, but as soon as one was removed or lost a considerable portion of its contents by evaporation, the spring on its hook would rise, coming in contact with the metal point, thus closing the battery circuit and ringing a bell in the manager's office, at the same time showing on an annunciator where the trouble was. As the bell continued to ring until the weight of the delinquent pail was restored, it was impossible to disregard the summons, and no more reason was found to complain of the condition of the fire buckets. But the most modern application, and the one which is most distinctive, is found in the extended employment of sprinkler heads. Of these there are several types, the Grinnel being probably the most widely known. The principle of the various sprinklers is generally the same, but their details vary somewhat.

In arranging an installation of sprinklers, regard must be had to the country in which they are being fitted up. Thus, in a climate where extreme cold is likely to be experienced during a great part of the year, it is desirable to take special precautions against freezing, and what is known as the "dry pipe" system is preferable. If, on the other hand, a warm climate is the rule, precautions must be taken to avoid evaporation of the water supply, and the wet pipe can be used. As a general rule, sprinklers should be placed at a distance of ten feet apart, and, as with an ordinary head of water the spray discharged will cover a radius of eight or ten feet, 100 square feet will thus be served. Any specially dangerous places should be provided with an extra number of sprinkler heads, so that the danger is minimised, and the first row of sprinklers should not be more than five feet from the wall. Owing to recent improvements, not only do the sprinklers protect the floor, but their discharge is so arranged that it strikes upwards, and protects the ceiling also. The most important matter after the fixing of the heads is the provision of the necessary

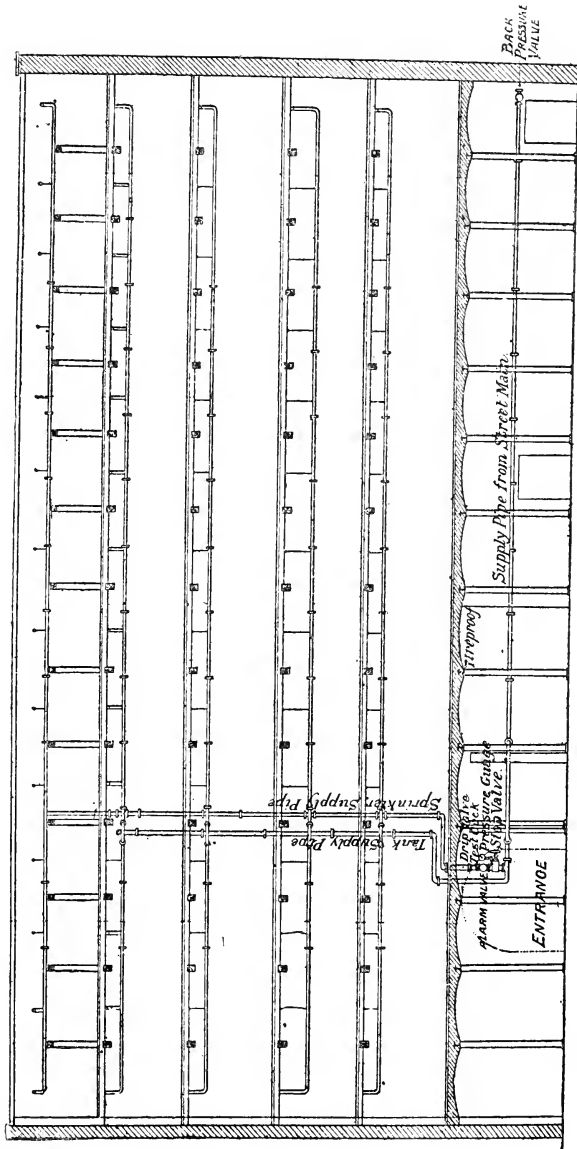

FIG. 21.



water supply. It is always considered desirable to have two sources of supply, but of these an elevated tank should always be one. This is usually placed in a tower, the altitude of which is such that the

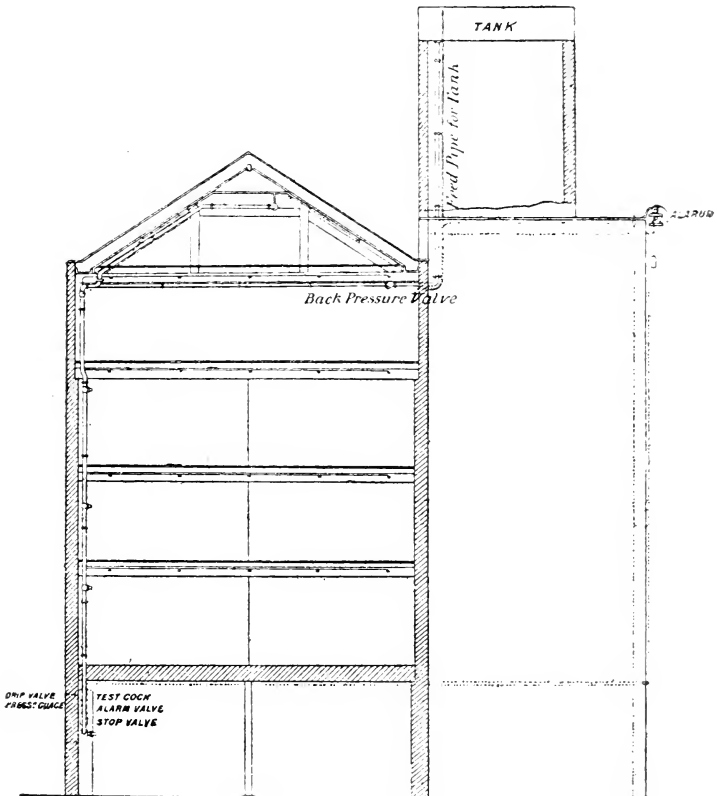

FIG. 22.

base of the tank is not less than fifteen feet above the highest sprinkler head, and a minimum pressure of seven pounds to the square inch is desirable. The weight of a column of water lin. square and

12in. high being .434, the pressure per square inch can be calculated by multiplying the head in feet by that number. This tank should always be kept filled with water, and arrangements must be made to ensure this. The following is a table giving the minimum capacity of the tank for the specified number of sprinkler heads:—

TABLE 7.

| Greatest number of sprinklers on any one floor or on corresponding floors of communicating buildings. | Minimum capacity of tank in gallons. |
|-------------------------------------------------------------------------------------------------------|--------------------------------------|
| Exceeding 200.....                                                                                    | 7,500                                |
| Not exceeding 200.....                                                                                | 6,500                                |
| "    "    150.....                                                                                    | 5,000                                |
| "    "    50.....                                                                                     | —*                                   |

\* 100 gallons per sprinkler for the greatest number of sprinklers on any one floor or communicating floors, but in no case less than 3,000 gallons.

As a secondary source of supply, water from the town's mains may be used if sufficient to give the required pressure on the highest floor, or one of the special automatic pumps, such as the Worthington, may be used. The chief point to remember is that it is absolutely requisite to have an ensured supply under all circumstances. It is necessary to provide a check valve which shall exclude water from the secondary source of supply until the pressure from the primary source has fallen below its normal amount. The general arrangements of a sprinkler installation are shown in Figs. 21 and 22, and in sectional elevations, longitudinal and transverse. The sizes of pipes to be used for conveying the water are given in the following table, which is the official one:—

TABLE 8.

| Size of Pipe.<br>Inches. | Sprinklers<br>allowed. | Size of Pipe.<br>Inches. | Sprinklers<br>allowed. |
|--------------------------|------------------------|--------------------------|------------------------|
| $\frac{3}{4}$            | 1                      | 3                        | 46                     |
| 1                        | 3                      | $3\frac{1}{2}$           | 78                     |
| $1\frac{1}{4}$           | 5                      | 4                        | 115                    |
| $1\frac{1}{2}$           | 9                      | $4\frac{1}{2}$           | 125                    |
| $1\frac{3}{4}$           | 14                     | 5                        | 150                    |
| 2                        | 18                     | 6                        | 200                    |
| $2\frac{1}{2}$           | 28                     |                          |                        |

The minimum size of the main pipes must be determined by the greatest number of sprinklers in any one floor or corresponding floor of communicating buildings. The size of the distributing pipes must be determined by the number of sprinklers which each is intended to serve.

The table following is the one adopted by the Boston Mutual Manufacturer's Company, and it will be noticed varies from the preceding one, but is probably better for the American type of building.

TABLE 9.

| Diameter of Pipe. Inches. | Sprinklers allowed. | Loss by friction in feet head. | Diameter of Pipe. Inches. | Sprinklers allowed. | Loss by friction in feet head. |
|---------------------------|---------------------|--------------------------------|---------------------------|---------------------|--------------------------------|
| $\frac{3}{4}$             | 1                   | 1.31                           | $2\frac{1}{2}$            | 28                  | 2.6                            |
| 1                         | 3                   | 2.64                           | 3                         | 46                  | 2.9                            |
| $1\frac{1}{4}$            | 6                   | 2.34                           | $3\frac{1}{2}$            | 70                  | 3.1                            |
| $1\frac{1}{2}$            | 10                  | 2.70                           | 4                         | 95                  | 4.1                            |
| 2                         | 18                  | 2.80                           |                           |                     |                                |

All sprinkler installations are fitted with an alarm gong, placed outside the building, and so arranged that on a decrease of the water pressure, such as that caused by the opening of a single sprinkler, the alarm is sounded. It is necessary that a stop-cock shall be placed in a suitable position, so as to be easily closed, and capable of being locked up, and pressure gauges to show the pressure in the pipes must also be provided. The essential features in connection with this instrument may be thus summarised. An unailing supply of water from two sources should be provided. A pressure of at least 7lbs. must be on the *highest* head. The discharging capacity of a sprinkler head with an ordinary orifice can be calculated by the following formula:  $\cdot 55 \sqrt{p}$ ;  $p$  = head in pounds per square inch. The result is the number of cubic feet discharged per minute. Thus, if the head be 7lbs., the discharge would be, assuming the orifice to be  $\frac{1}{2}$ in. with an area of  $\cdot 1963$ in.,  $\cdot 55 \sqrt{7} = 1.45$  cub. ft. If the head be equal to say 40lbs., then under the same

conditions the discharge would be 3.48. No greater distance than 10ft. must exist between adjoining heads, and this should be less in dangerous places. The following table was given in a recent article by Mr. Woodbury in *Cassier's Magazine* as applied to the American standard type of construction, one row of sprinklers being placed in the centre of each bay:—

TABLE 10.

| Bay's<br>width<br>in feet. | Water pressure over<br>20lbs. per sq. in. |                    | Water pressure less than<br>20lbs. per sq. in. |                    |
|----------------------------|-------------------------------------------|--------------------|------------------------------------------------|--------------------|
|                            | Medium<br>hazard.                         | Special<br>hazard. | Medium<br>hazard.                              | Special<br>hazard. |
| 12 ...                     | 8ft. apart.                               | 7ft. apart ...     | 7ft. apart.                                    | 6ft. apart.        |
| 11 ...                     | 9ft. „                                    | 8ft. „ ...         | 8ft. „                                         | 7ft. „             |
| 10 ...                     | 10ft. „                                   | 9ft. „ ...         | 9ft. „                                         | 8ft. „             |
| 9 ...                      | 11ft. „                                   | 10ft. „ ...        | 10ft. „                                        | 9ft. „             |
| 8 ...                      | 12ft. „                                   | 11ft. „ ...        | 11ft. „                                        | 10ft. „            |

A pressure indicator and one showing the height of water in the tank must be fixed, as also an alarm gong capable of being tested. The following are the requirements for a good sprinkler. It should be certain and prompt in action, quite free from leakage under working pressures, have distributing power over a large area, act at a temperature as low as is convenient, be simple in construction, strongly made, so as not to be easily damaged, and be arranged so as to be readily tested. The evidence of the past few years has shown sprinklers to be of the utmost value in the prevention of incipient fires, and no mill is properly equipped without them. With them the wooden floor is comparatively safe, without them the fireproof floor is of lessened value; while, if a mill is built with fireproof floors and is further protected by sprinklers, the danger of serious damage by fire is rendered a remote one.

The water delivery of any pump can be calculated easily by knowing first the diameter  $D$  of the plunger in inches, the length of stroke in inches  $S$ ,

and the number of strokes made per minute  $N$ . The area of the plunger is  $.7854D^2$  or  $A$ , and the delivery is in cubic inches per minute  $A S N$ , in cubic feet per minute  $\frac{A S N}{1728}$ , and in gallons per minute  $\frac{A S N}{277.27}$ . It is better to have a slow speed

for pumps than a fast one, and anything over 70ft. per minute is to be deprecated. It will be understood that the formula just given applies to a single pump, and that the results obtained must be multiplied by two when a duplex pump is used. The diameter of a pump plunger can be ascertained

by the formula  $D = \sqrt{\frac{G}{.034 S N}}$ ,  $G$  = number of

gallons per minute, or  $\sqrt{\frac{F}{.00545 S N}}$  = number of

cubic feet delivered per minute:  $G = .16045$  cubic feet, a cubic foot of water weighing 62.32lbs., and being equal to 6.232 gallons. By means of these data the delivery and dimensions of a pump can be easily arrived at. The loss by friction in clean pipes without bends is .000296lbs. per yard, but this amount can be rapidly increased if the pipes are dirty. There is, in cases where water has to be raised, a certain resistance to be overcome, and, irrespective of any power required to account for friction or resistance within the pump, this must be allowed for in the case of a pump used either for fire or sprinkler purposes.

The Worthington fire pump, of which an illustration is given in Fig. 23, has been largely used by many firms in connection with sprinkler installations. It is one of that class of pumps which give a large delivery at a slow piston speed. The steam valve is an ordinary slide, which for this purpose is probably the best type to use, as the liability of sticking is much minimised. The valve spindle is actuated by a vibrating arm worked from a cross

head at the end of the spindle, so that an easy but effective movement is given to it. The plunger works through a metallic ring or barrel which is bored so as to make a good fit, and so fixed in the pump that it can be easily taken out and replaced at will. The ring is fitted midway of the casing, and has a water space all round it. The suction

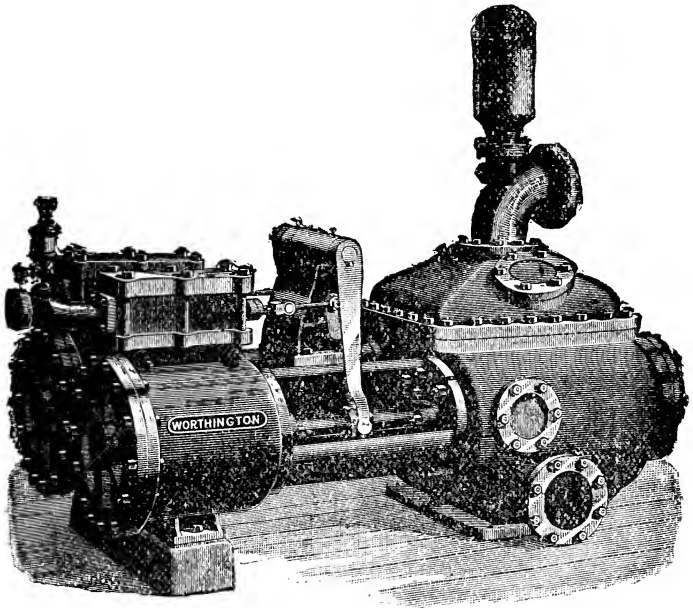

FIG. 23.

valves are at the lower part of the casing, so that any grit or mud has a chance to fall before entering the barrel, thus avoiding damage. The delivery valves are at the top of the casing, and the course given to the water is nearly a straight one. The valves are all of large area, and can be readily examined and replaced. In the fire pump the speed can be

increased to a large extent if desired without in any way leading to knock or concussion, owing to the absence of tappets and the peculiar action of the steam valve. It is made with two cylinders, and each steam valve is opened by the action of the adjoining piston, so that the water valves have time to close prior to the delivery of the water. Thus it is a duplex double acting pump, with the cylinders and barrels placed side by side, and each controlled by its fellow. In applying this fire pump to a mill where it is desired to have it act automatically, a pressure regulator is provided, which maintains in the pipes a uniform pressure, a slight fall in which, owing to the opening of a sprinkler head, at once admits steam to the valve and starts the pump. The pressure fixed is in most cases a little below that in the town's mains, if these are used for one source of supply, and as the pump has no dead centres it starts readily at any point. An automatic drainage attachment is also fitted to the steam cylinders to avoid accidents. These pumps can be made to deliver from 80 to 1,270 gallons per minute, according to size, or from .4 to 5.15 gallons per stroke of *each* plunger.

The Merryweather Vertical Mill Fixed Steam Fire Engine, illustrated in Fig. 24, has been supplied to the Staines Linoleum Company for the protection of their new works. It is specially suitable for fixing in mills and factories provided with steam power, the size of the cylinders being such that the full power of the pump may be obtained when using steam at as low a pressure as 20 to 30 lbs. per square inch. Thus the engine is available for use during the night or on Sundays, when the fires are banked up and the boiler pressure has fallen. It is constructed on the lines of Merryweather and Sons' Steam Fire Engine as used in the London Brigade, but arranged vertically, thus economising space. The pump is direct acting, and has a long stroke and a heavy flywheel, whereby a very even motion is secured. It is cast in one piece with the frame, the barrels and valve seats

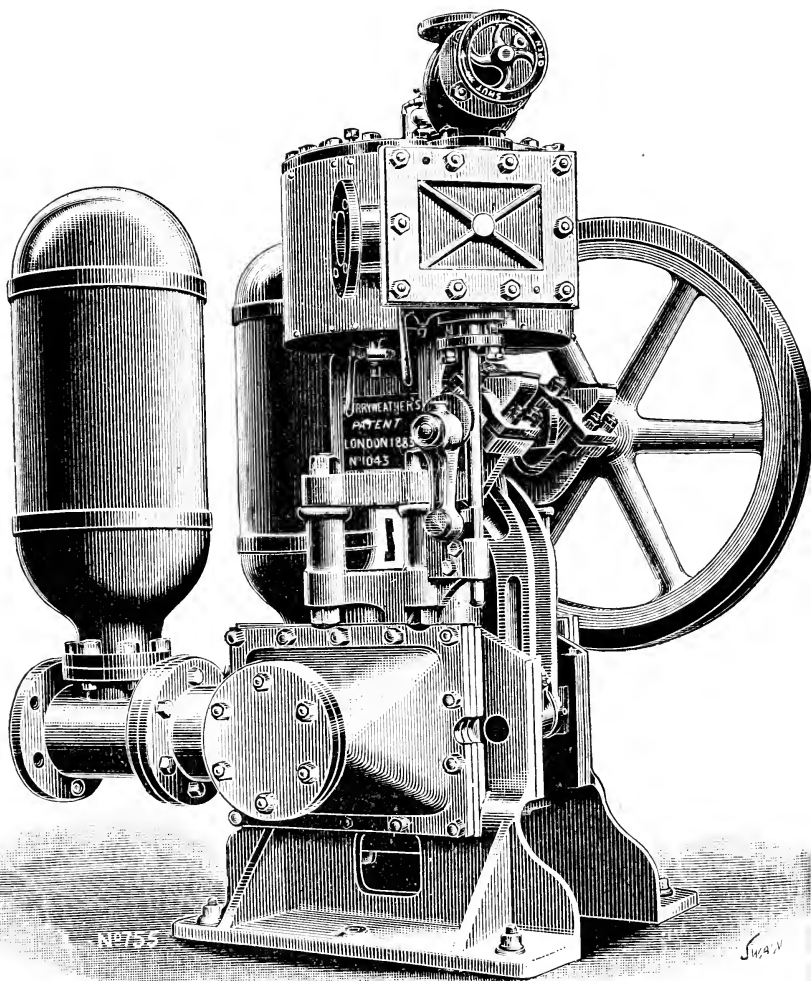

FIG. 24.



being of gun metal and the valves of india-rubber of special form, as used in the "Greenwich" engines. The whole of the interior of the pump may be quickly examined by removing four nuts. The suction and delivery outlets may be arranged to suit the position in which the pump is placed. The pump may be connected direct to the fire main throughout the building, and screwed outlets for the attachment of hose may also be provided.

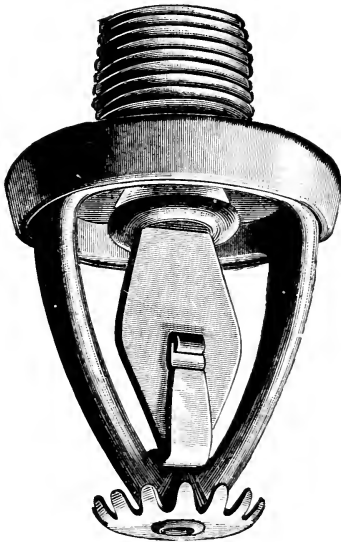

FIG. 25.

The Grinnell automatic sprinkler, Figs. 25 and 26, which is the most extensively used and widely known, has the peculiar feature of a spring diaphragm, forming the valve seat. The opening of the Grinnell is half an inch in diameter, and the flexible diaphragm surrounds it. The valve was until recently formed with a pad of soft metal, which is pressed against the lip of the diaphragm, and so closes it. The valve was kept in position by a stirrup and lever, the

stirrup being fulcrumed on the oval yoke, and the lever fixed to the yoke at its lower end by fusible solder. Many hundreds of thousands of Grinnell sprinklers made in this way have been put into use and proved useful on occasion, but the exposure of rolled brass levers to the influences existing in mills where gas is used as an illuminant was found to result unfavourably. Accordingly the valve now consists of a hemispherical

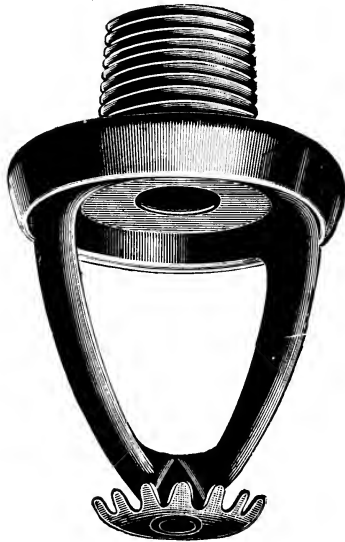

FIG 26.

disc of glass, which is made to fit tightly on to the spring diaphragm by a thin ring of Babbitt metal placed round the orifice. To avoid corrosion and adhesion, the diaphragm is made of German silver. The valve is held in position by a strut, also made of German silver, which consists of three metallic pieces soldered together and sustained by the yoke. The latter carries the deflector or splash plate, and the strut is entirely protected by solder, so that every moving part of

it is rendered proof against corrosion. There are two features in the Grinnell sprinkler which at the time of its introduction were novel and valuable improvements. The one is the large orifice provided, which was in striking contrast to the practice previously followed, and ensured an ample discharge from each head. The next point is the use of the deflector or splash plate, which provided in a simple but effective manner a means whereby the

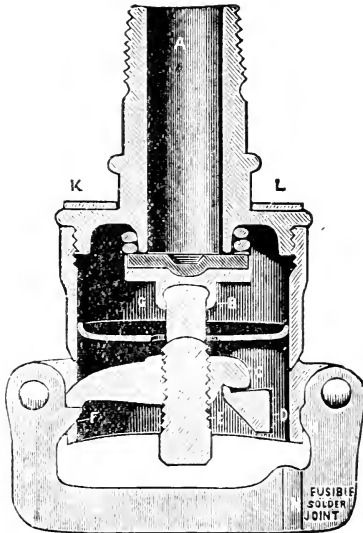

FIG. 27.

water was distributed evenly over a large area. By the adoption of this deflector in some form or other most sprinklers have since been distinguished, and by slightly altering its shape the direction of the spray can be determined. The distinctive feature of the Grinnell, however, is found in the elastic diaphragm, which, owing to the fact that the water can pass behind it, always remains tight, being in fact tightened by an increase of pressure. Further, if water hammer occurs, this, it is claimed, is

entirely taken up and cannot cause a strain on the strut. It ought not to be forgotten that these features stand to the credit of Mr. Grinnell.

The Witter sprinkler, shown in Figs. 27 and 28, consists of a body A, the upper part of which is tubular, and is closed by a valve B held up to its position by a screw E pressing against the underside of the bridge C. The bridge C is detached, being arranged so that one end rests upon a shoulder

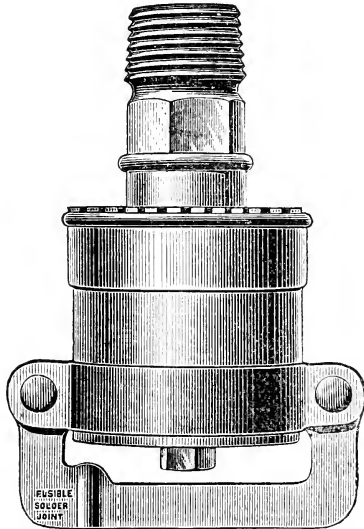

FIG. 28.

formed in the lever F and the other upon a cross-piece D fastened in the case. F and H are two levers, each pivoted at one end, and soldered together by fusible solder at their free ends N. A set-screw E is fixed in the bridge C, as shown, and is set so that when the toe of C rests upon the shoulder in F the valve B is pressed against its seat and closes the orifice. The action is as follows:—When the fusible solder melts, F and H drop away and C falls from under the valve B. The water

then rushes through the orifice into the chamber G and finds its way through the holes formed at the top and bottom of the chamber surrounding the tubular portion of A. By a deflector K L the spray is distributed. It is claimed for the Witter that the strain on the solder is diminished, and the sprinkler can be tested when desired, which is a feature of some importance.

The Wallworth sprinkler (Fig. 29) made in this country by Mr. S. Walker, of Radcliffe, has its valve

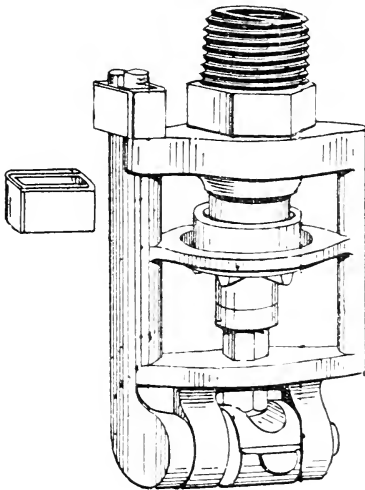

FIG. 29.

seat formed of a flat upper disc, having a special composition beneath it, and also acting as a deflector. The valve spindle is guided by a cross-bar attached to the frame, and is in two parts, screwed one within the other, so that it can be lengthened as desired. Its lower end is hollowed, so as to engage readily with the hollowed end of a lever pivoted at the lower part of the frame of the sprinkler. When the lever is rotated on its centre the hollowed end acts as a cam and forces the valve on its seat. The lever

has a long leg, which, when in a vertical position, has its upper extremity *above* the valve orifice. A fixed horn is formed on the sprinkler body, and when the lever is raised a link can be passed over it and the horn, so securing it. The link is in two pieces, secured together by fusible solder, and as the lever is a little in tension when the solder is melted, the spring is sufficient to release the valve instantaneously. The Wallworth has two advantages: (1) its efficiency can be at any time tested by a spirit lamp, which can be used to fuse the link, and so prove the sprinkler to be in condition; (2) the pressure on the valve can be accurately adjusted. Further, the solder seal being *above* the water level is not subject to any chilling from this cause.

The Titan Sprinkler, which is made by Messrs. Geo. Mills and Co., of Radcliffe, is shown in Fig. 30 as closed. It consists of a cylindrical body, in which is fixed a collar bored in the centre, through which the spindle of the deflector passes. The lower end of the body is formed into a valve seat, and the inside of the deflector is filled with a soft metal which closes the aperture well. A dished cap is screwed on to the lower end of the body, which serves the purpose of covering the deflector and valve, and at the same time acts as a support to the levers holding up the valve. An internal flange or lip is formed on the lower part of the cap, and on this cap one end of a channel-shaped lever rests, the other end resting on a second straight lever, which is also fulcrumed on the lip, but at the other side. The second lever passes through a gap cut in the cap and rests on a shoulder or flange of a small collar through which a tube passes. The tube has a flange at its upper end which rests upon a small bracket formed on the outside of the cap. The flange of the tube rests on a boxwood washer, and the outer collar is soldered to the tube by fusible solder, a second boxwood washer being interposed between the end of the lever and the sealed collar. The proportions of the two levers are such that the strain on the fusible solder is but a

small fraction of the weight on the valve, this forming one of the features of this sprinkler. The other chief feature is found in the employment of the boxwood washers, which, being non-conductors, prevent the joint from being affected by the

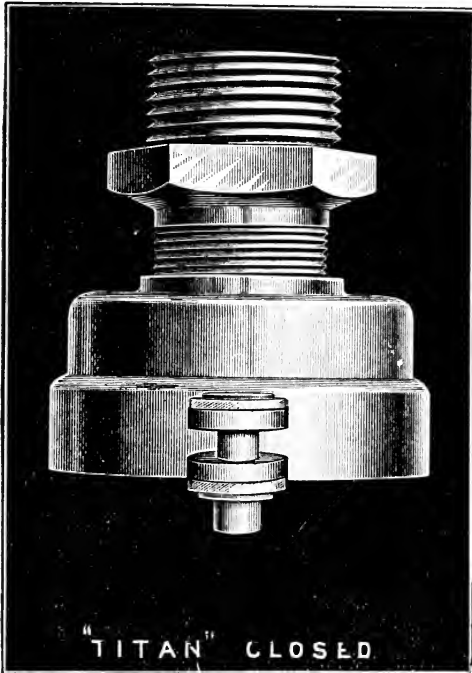

FIG. 30.

chilling action of the water increasing its sensitiveness. When the tubular joint is melted the support is taken from the deflector, which immediately falls and allows the water to flow. The deflector spindle has a collar on its upper end which supports it on the collar fixed in the body.

## CHAPTER VI.

## LIGHTING.

The question of lighting is a most important one, and deserves a good deal of attention. In England the light is usually grey, and it is very rarely that there it is bright and clear, such as is usual in other parts of the world. The necessity which, therefore, exists for a large window area in this country does not prevail in all others. At the same time it may be said that when the very wide rooms named are used, some extra provision for lighting is necessary. In the United States, for instance, there is an approximation to the English type of window, which is also being adopted on the Continent in some measure. Lighting is not the only thing to think about in designing a window. There is, in addition, the very important matter of the radiation of heat which takes place from glass. For instance, in Russia and other countries where excessive cold exists, double windows are the rule, and it is very easy to see why this should be so. The radiation from a large window is necessarily great, and when the external temperature is very low, the loss of heat must be proportionate. On the other hand, in countries where ample sunshine and intense heat prevail, as in India, the window area must be contracted to limit the quantity of heat passed into the room, as otherwise the conditions would become intolerable. The size of the windows used is, therefore, limited in two ways, each of which, however, affects the problem of planning. This matter is further referred to at some length in the next chapter. With reference to the quality of the glass used, this is ordinarily either sheet or rough plate, each of which entails the loss of a considerable percentage of the available light. Messrs. Coats used in their mill polished plate, which is probably the best medium available. At the same time, there are some kinds of rolled plate which are very useful in producing a diffused rather than a bright light, and



thus avoiding shadows. There is, therefore, plenty of room for the exercise of thought on the subject, and in giving two or three sketches of windows common in this country, it must be understood that they may possibly require altering if used elsewhere.

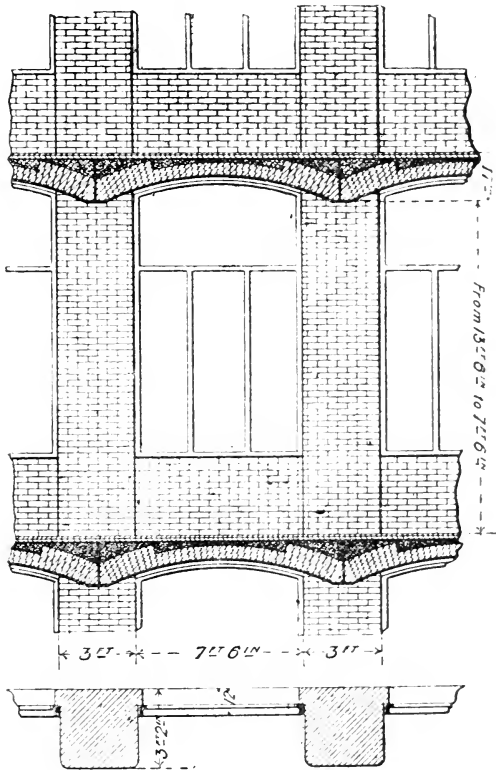

FIGS. 31 AND 32.

The window shown in Fig. 31 is a very common English type. It will be noticed that the windows are separated by brick piers 3ft. by 3ft. 2in., which project outwards, the window itself being 7ft. wide

and from 7ft. to 11ft. high. It is carried up, as shown, practically to the level of the ceiling, so that the light can travel easily across the room. One point may be specially mentioned. If the transverse section in Fig. 32 is looked at, it will be noticed that the brick piers are arranged so as to have an internal "reveal." In other words, the window frame is fitted into its place from without, and not from within the building, and is received by the projecting brick provided for the purpose. The reason for this procedure is found in the enormous area of the window, which, when subjected to the pressure of a high wind, would, if it is urged, be liable to blow in if fixed from within. On the other hand, there are many windows with outside reveals and large areas, which are securely fixed. The upper sash of the window is made as a trausom, so as to be easily opened for ventilating purposes.

The window designed by Messrs. Potts, Son, and Pickup for their latest mills is shown in Fig. 33. as arranged for the end wall. It will be seen that it consists of an iron or wood frame 9ft. 3in. wide, with the window head square, and having above it the iron lintel previously referred to. The pier between the window frames is, in this case, 5ft. 6in. wide and about 3ft. thick, and carries the end of one of the longitudinal beams, which are placed 14ft. 9in. apart. Lengthwise of the mill the special construction of the lintel, previously referred to, enables the cross joists, carrying the floor, to be sustained at any point where necessary. The height of the window depends, of course, upon that of the room; but assuming it to be applied to a room 15ft. high, then the window area would be 139 square feet. This area, it will be seen, is not so much broken as the example in Figs. 31 and 32, the stanchions being of comparatively small size. The window sill, as shown, forms a string course around the building. A flat-headed window, such as this, is naturally best when used in conjunction with a flat concrete floor, and when so used gives an admirable diffusion of light throughout the room.

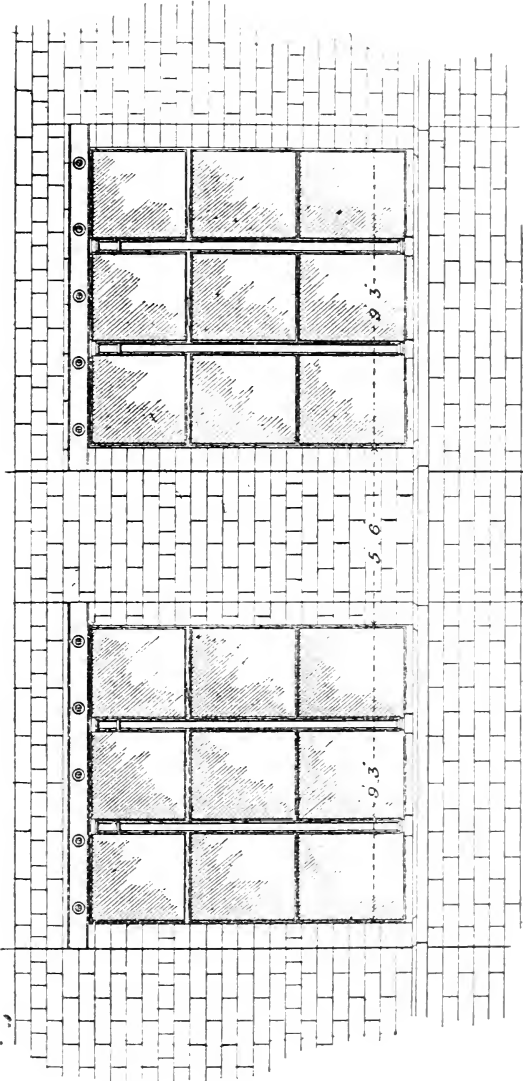

FIG. 33.

A new system of construction, called the "Praray," is being introduced into the United States, by Mr. C. R. Makepeace, of Providence (Rhode Island), which has for its object the provision of a large window area. This is obtained by the employment of an angular window and a reduction of the brick piers, which practically makes them merely pilasters, as shown in Figs. 34 and 35, and the difficulty with which the constructor is at once met in this case is that of carrying the upper floors entirely independently of the walls. As shown in Fig. 12, the ordinary American construction provides for the ends of the main timbers being carried by the walls, and of necessity this involves the provision of piers of sufficient strength. In the Praray construction the

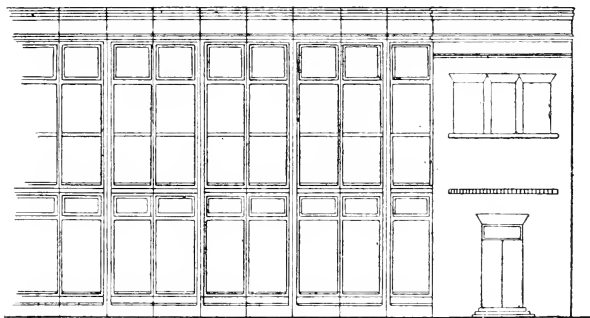

FIG. 34.

floors are carried on independent columns, which are placed, as shown in the plan view in Fig. 35, in the angle of the window. The brick piers may be solid, or, as shown, hollow so as to serve for ventilating or heating flues, and the window frames are angularly disposed, so that the light freely enters from either direction. In the arrangement as proposed the window is the entire height of the room, which appears to the writer to be alike unnecessary and detrimental, as there is no need of light near the floor level, while the danger of breakage is increased. If the window terminated about 3ft. 6in. from the

floor all necessary purposes would probably be served. As designed, however, 86 per cent of the wall area is glass and only 14 per cent of brick,

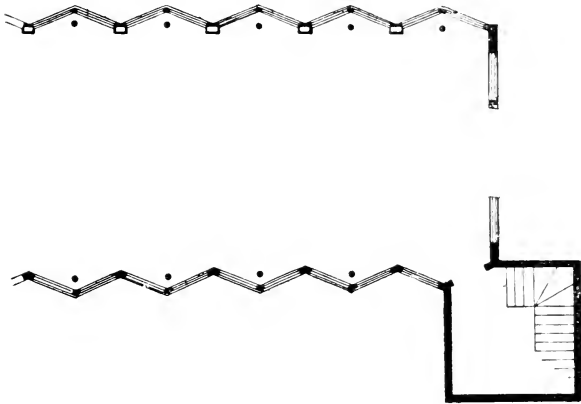

FIG. 35.

which it will be admitted is an unusual proportion. The section given, Fig. 36, shows clearly the arrangement of a two-storey building, the hot air flue being in the right hand corner.

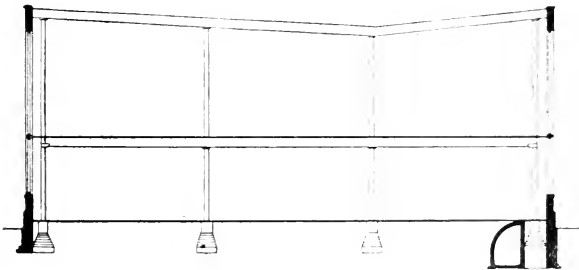

FIG. 36.

With regard to artificial light the most customary one is gas, but the employment of the electric light is gradually being extended in this country and elsewhere. It is admittedly a better light for

the purpose, and in cost is said to have proved as cheap as gas for large installations. The following are the principal rules which are laid down by the insurance offices, in carrying out electrical lighting installations. The dynamo must be fixed in a dry place, and must not be exposed to dust or fly. It must be left quite clean and the bearings well oiled. The coils and conductors must be perfectly insulated, and, if possible, the dynamo itself should be on an insulating bed. All the conductors must be well and firmly supported, be laid so as to be conveniently got at for inspection, and should be marked in some way for identification. It is customary to lay the conductors in troughs and cover them by flat wooden strips. The switchboards must be made of slate, and all the switches and commutators so constructed that they can, after being moved, be left without producing a permanent arc or heating. The main circuits must each be provided with a fusible safety catch. The proportioning of the wires must be so carried out that they are correct for the current and for the changes of current from larger to smaller. Safety catches, firing at 150° F. must be provided and enclosed in cases formed of incombustible material. The heating of wires is a sign that they are too small for their work. The permissible limits of safe current for lighting is fixed by the Fire Risk Committee at 1,000 ampères per square inch of sectional area. The ampère is the unit of current, and is obtained by dividing the electro motive force by the resistance of the conductor, or technically, the volts by the ohms. The intensity of current wanted by an ordinary 16-candle power lamp is equal to from about .6 to 1 ampère, and in cases where a number of lamps are in circuit, it is more convenient to use a conductor with a number of strands. All the circuits should be complete in themselves, and must not be made up by the use of gas and water pipes. Outside uncovered metallic wires must be insulated for two feet on each side of each supporter, which is also

insulated, and if they are carried over roofs must be seven feet clear above the ridge. All the joints must be made perfect, both electrically and mechanically. Underground cables must be easy of access for inspection and repairs, and all the wires laid inside must be efficiently insulated. Where a wire passes through a partition or is liable to be abraded, it must be protected by a special casing, and all wires laid out of sight must be protected, and their position indicated. Arc lamps must be guarded by globes, which are themselves protected by wire netting.

The lamps which are most usually employed for the purpose of lighting cotton mills are of the incandescent type, usually 16 candle power, and are suspended from the ceiling by the conducting wires. The following description of a recent installation will supplement the foregoing abstract of the rules, and will give some idea of the method of carrying them into effect.

As a recent example, a description of an electric installation put in by Messrs. J. H. Holmes and Sons, of Newcastle-on-Tyne, is given. In all, 800 incandescent lamps of 16 candle power have been fitted within the mill, 132 in each spinning room, 80 in each cardroom, and 50 in the mixing and reeling rooms, and 400 lamps of 200 candle power without it. A "Castle" dynamo, with an output of 57,500 watts, and capable of supplying 900 16-candle power lamps, is driven from the shafting by a friction clutch at a speed of 450 revolutions per minute, which is slower than that sometimes run. A small pilot dynamo, with an output of 25,200 watts, and capable of supplying 395 lights, and driven by an independent engine, is also fixed. The electrical efficiency of these machines is 96 per cent, and the commercial efficiency 92 per cent. The dynamos are compound wound, and the electrical pressure is the same for any number of lamps. This provides the power for three circuits, which light the engine and boiler houses, the offices, staircases and passages, and

about one-third of the lamps in each room. By a special arrangement of switchboard, any room in the mill can be put into circuit with the pilot dynamo, which is capable of fully lighting two rooms. The main use of the latter, however, is to provide light prior to starting and after stoppage. The main switchboard, which is made of polished slate, is near the dynamo, and there are eight main switch connections taken to a corresponding number of cut-outs, which act if an excess of current of 150 per cent over the normal occurs. The mains are carried on each side of the mill, so as to give a uniform pressure, and wherever a branch wire is placed a cut-out is inserted. Each row of lights has a separate switch. The wires are laid in wooden grooved cases and covered with a wood capping, and the lamps are suspended from the ceiling.

---

## CHAPTER VII.

### HEATING, VENTILATION, AND HUMIDITY.

The necessity for some improved method of heating, ventilating, and humidifying the atmosphere of mills is becoming yearly more admitted. The necessity is greater abroad than in England, where there is, as a rule, a sufficient amount of humidity in the air. But as competitive conditions become more intense it is found that it is as essential to have a uniformity in this respect as in others. While the readings of a hygrometer during a week will show, if an average be taken, the relative humidity to be, say, 85, a detailed examination of the record will demonstrate that there will be a variation in the same day of as much as 12 degrees. Thus there may be prevailing during that period conditions which are widely divergent, and as there must be some definite amount which is the best, it follows that all these conditions cannot be so. What is desired, therefore, is uniformity in the relative humidity, and it is this factor which is causing



the wide adoption of instruments for this purpose in Great Britain. Where a dry air prevails, so that the relative humidity averages less than that required to produce the best results, it becomes more imperative to employ some artificial means of obtaining it. In most cases it has been the practice to be content with simply injecting or discharging into the room the required amount of moisture, but the method of combining it with a similar discharge of the required volume of fresh air is slowly coming into vogue. The large range of temperatures which exists in the United States has probably led to more drastic treatment of this problem than has hitherto been adopted here. The more common practice in heating is to employ high-pressure steam, conveyed in ranges of wrought-iron pipes suspended from 7 to 8 feet above the floor level. These pipes use steam at a pressure of from 60° to 100° F, and are capable of giving off a large amount of heat. The area which it is necessary to provide to heat a room of any given capacity naturally varies according to circumstances. One rule which is given is to provide one square foot of heating surface for each 100 cubic feet. Another is to provide one square foot for each 10 square feet of glass or for each 120ft. of wall space. The rule laid down by the Boston Mutual Company is one lineal foot of 1½ in. pipe for each 70 cubic feet of air. These rules are obviously subject to adjustment to suit various circumstances, and are only approximate. The advantage of high-pressure steam lies in the fact that the condensation per square foot is greater than with lower pressures, which implies the emission of more heat units per square foot.

There is necessarily a certain loss from the transmission of heat through the walls and windows of any building, the amount varying directly with the difference between the temperature within and without the building. The German Government have gone into this question with the usual Teutonic thoroughness, and have laid down a rule and a number of coefficients which are of high importance.

The formula they use are as follows :  $H = SC (T - t)$  where  $H$  = heat lost ;  $S$  = transmitting surface in square feet ;  $C$  = coefficient of transmission ;  $T$  = temperature inside building in degrees Fahrenheit ; and  $t$  = temperature outside building in degrees Fahrenheit. The coefficients  $C$  are as follows, dealing only with those applicable to mill buildings. For each square foot of wall, 9in. thick, 0.43 ; 14in. thick, 0.29 ; 18in. thick, 0.24 ; 23in. thick, 0.21 ; 24in. thick, 0.20. For 1 square foot of wooden floor of American type, as ceiling, 0.104 ; 1 square foot of fireproof floor boarded as ceiling, 0.145 ; 1 square foot of single window, 0.776 ; of single skylight, 1.118 ; of double window, 0.518 ; of double skylight, 0.621 ; and of door, 0.414. These are coefficients which are correct when the conditions are normal, but can with safety be increased if there are certain exposures, or if the building is only occasionally heated. These necessary allowances range from 10 to 50 per cent, and are greatest when during cold weather the building is heated intermittently. Assuming, however, that we are dealing with a spinning room, with a temperature of 85° F., and an outside air temperature of 25° F., a difference of 60° F., then, by our formula, if the number of square feet in a single window be as in the case of Fig. 33, the amount of heat transmitted is  $H = 139 \times .776 \times 60 = 6471.84$  units. In this way the transmission through the walls, ceilings, and floors could be calculated, and it would be thus easy to ascertain how much heat must be supplied in order to recoup the loss. The case taken is, of course, a severe one, but worse are likely to arise elsewhere. An examination of the coefficients will show how large a part in cold countries thick walls, double windows, and small window areas play in the conservation of heat. There is another matter which requires mention on this head, viz., the fact that ceiling transmission may play an important part in the abstraction of heat. For instance, in a slate roofed weaving shed with nothing on the bare slates, within or

without, the temperature would soon be diminished by radiation through the roof only; and when to this is added the large glass area always present, it will be seen that the area of heating surface required is greatly increased. In a spinning mill, where the various rooms are kept practically of the same temperature, the transmission through the ceilings and floors may be neglected except in the top floor; but it is obvious that the abstraction of heat through the windows and walls cannot be neglected. It follows, therefore, that this transmission requires the careful attention of designers, and although the empirical rules given previously will probably be sufficient for practical purposes, the coefficient stated will prove the absolute necessity for discretion in constructing and arranging plants for heating.

The quantity of air which can be heated by 1lb. of steam, condensed into water and discharged at any temperature, can be calculated by the following formula. The specific heat of air is relatively to water .2379, whence 4.2034lbs. of air can be heated at the same expenditure of heat as 1lb. of water.

Let  $T$  = Heat units contained in 1lb. of steam at any absolute pressure.

$t$  = Heat units in 1lb. of water of condensation.

$W$  = Weight of one cubic foot of dry air at initial temperature.

$V$  = Volume of air which can be heated by 1lb. of steam.

$N$  = Number of degrees air must be raised.

$X$  = Volume of air raised required number of degrees by 1lb. of steam.

$$\text{Then } \frac{4.2034 (T-t)}{W} = V \text{ and } X = \frac{V}{N}$$

Having obtained the value of  $X$ , the number of lbs. of steam which are needed to heat any given space can be easily obtained. Thus, assuming that steam at 100lbs. absolute is used, containing 1213.4 heat units and condensed, the water then containing 212.9 heat units; that the initial temperature of the air is 40° F., at which the weight of one cubic

foot is  $\cdot 0794$  lbs. ; and that it is desired to raise it to  $80^{\circ}$  F., or  $40^{\circ}$  in all, then the formula works out  $\frac{4\cdot 2034 (1213\cdot 4 - 212\cdot 9)}{\cdot 0794} = 52966$  and  $\frac{52966}{40} =$

1324 $\cdot$ 15 cubic feet of air raised through  $40^{\circ}$  F. by the condensation of 1 lb. of steam. If now 50,000

cubic feet are to be warmed  $\frac{50,000}{1324\cdot 15} = 37\cdot 6$  lbs. of

steam are required for the purpose. The value of high pressure, as compared with low pressure, steam as a heating medium, depends entirely upon the additional condensation per hour from each square foot of surface. This is obtained by multiplying the difference in temperature between the air and steam at initial pressure, or between the terminal temperature of the condensed water and the initial temperature of the steam, by the number of heat units passed per square foot of surface per hour at any given temperature of the air, and dividing the product by the latent heat of steam at atmospheric pressure. It will be found that this amount rises with the initial pressure of the steam. With reference to the amount of heat emitted, Dr. Anderson gives a formula as follows:  $T =$  temperature of air,  $t =$  difference in temperature between steam and air,  $m =$  co-efficient of radiation, and  $u =$  total heat units emitted per square foot. The value of  $m$  for a coil of 2 in. galvanised wrought-iron pipes is 270 $\cdot$ 9, and for a coil of 4 in. cast-iron pipes, 121 $\cdot$ 7. Then  $u = m \times 1\cdot 00427^T (1\cdot 00427^t - 1) + 2853 \times \frac{1}{t} \cdot 233$ . It has been shown that the emission of heat from a cast-iron pipe 4 ins. diameter,  $\frac{1}{2}$  in. thick, and with an area of 1 $\cdot$ 309 square feet per lineal foot is 664 thermal units into air at  $62^{\circ}$  F., with a condensation of  $\cdot 99$  lbs. of steam at 115 lbs. absolute. The rule given by Mr. Robert Briggs for open pipe radiators is 1 $\cdot$ 8 unit per hour per square foot of heating surface per degree difference in temperature between the steam and air. Thus each square foot of wrought-iron pipe would, with steam at 100 lbs. absolute pressure,

at a temperature of  $327.7^{\circ}$ , if cooled to  $80^{\circ}$  F., yield  $247.7 \times 1.8$  units per hour = 444.86. Dividing this by the latent heat at atmospheric pressure, we get  $\frac{444.86}{965.7} = .46$  lbs. of steam condensed, which will enable the quantity required to be ascertained. The water of condensation is sometimes passed away by the employment of a steam trap of the usual construction, but is more often returned to the boiler by means of a special form of trap. In order to facilitate the necessary calculations, Tables 24 to 26 are given at the end of the volume, showing the properties of saturated steam, the weight, etc., of air, and the heat units in water. Table 11 gives the surface areas of various diameters of tubes per foot run:—

TABLE 11.

SURFACE OF TUBES IN SQUARE FEET PER LINEAL FOOT.

| Diam.<br>in<br>Inches. | Thickness in Inches. |               |               |               |               |               |               |               |
|------------------------|----------------------|---------------|---------------|---------------|---------------|---------------|---------------|---------------|
|                        | 0                    | $\frac{1}{8}$ | $\frac{1}{4}$ | $\frac{3}{8}$ | $\frac{1}{2}$ | $\frac{5}{8}$ | $\frac{3}{4}$ | $\frac{7}{8}$ |
| 0                      | —                    | .0327         | .0654         | .0982         | .1309         | .1636         | .1963         | .2291         |
| 1                      | .2618                | .2945         | .3272         | .3600         | .3927         | .4254         | .4581         | .4909         |
| 2                      | .5236                | .5563         | .5890         | .6218         | .6545         | .6872         | .7200         | .7527         |
| 3                      | .7854                | .8181         | .8508         | .8836         | .9163         | .9490         | .9817         | 1.0145        |
| 4                      | 1.0472               | 1.0799        | 1.1126        | 1.1781        | 1.1781        | 1.2108        | 1.2435        | 1.2763        |
| 5                      | 1.3090               | 1.3417        | 1.3744        | 1.4399        | 1.4399        | 1.4726        | 1.5053        | 1.5381        |

Instead of adopting the plan of heating by suspended steam pipes, the practice of forcing into a factory air which has been previously heated and, if necessary, humidified, is being adopted. It entirely depends upon the source of supply whether any improvement is made in the ventilation or not. If the air is drawn in from without it is obvious that a complete change of that within the room will take place. If, on the other hand, the same air is used over and over again, the injection of moisture does not affect the ventilation. No delusion is greater than that which infers the establishment of healthy ventila-

tion merely by the presence of a large cubic area within a room. The removal of foul, and the replacement of it by fresh, air is absolutely essential to ventilation. This is recognised by the Cotton Cloth Factories' Act, and the plan generally adopted is to place air propellers in suitable positions throughout the room so as to extract the foul air. The usual method of fixing these is shown in Fig. 37, which is an illustration of the use of a "Black-man" propellor. The exit trunk is made of wood, and is provided with doors so hung that they close automatically, thus avoiding back draughts. The

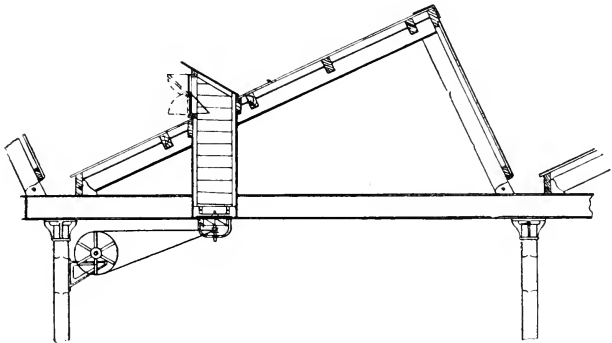

FIG. 37.

usual size of propellor for each 2,500 square feet of floor surface is 14in. diameter, and this will move from 1,000ft. to 1,500ft. of air per minute. The cost of providing air-propellers, including fixing and belting, ranges from £6 to £6 10s. each in this country. The ventilation of a sizing room is specially arranged, there being hoods over the drying cylinders, by which the steam is confined and conducted to an exit trunk fitted with baffles to prevent down currents. So far as spinning mills are concerned, the only rooms dealt with are the card-rooms, where in some cases air-propellers are fixed in the window near the cards to extract the fibre.

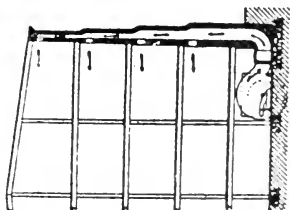
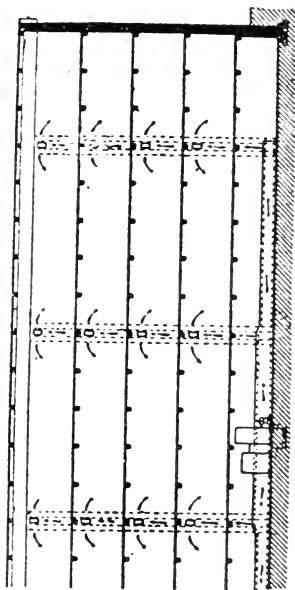
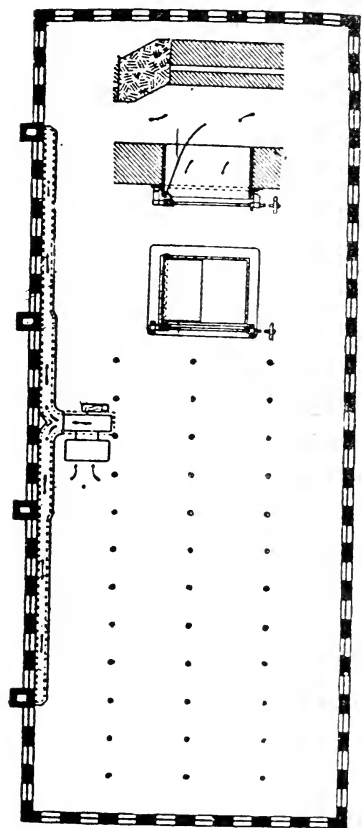
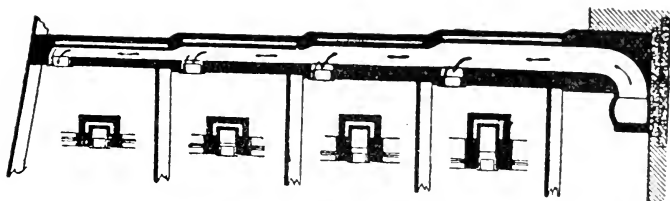

FIG. 38.

Although this tends to improvement, it is neither so scientific or effective as the more modern principle, which forces the air into the room. It is well known that the capacity of air for the reception and retention of moisture is greater when the air has been previously heated. Accordingly the practice is increasing of injecting air which is both warmed and charged with humidity. In Fig. 38 some sketches are given of an arrangement designed by the Sturtevant Company for application to a modern American mill. Although this is only devised to deal with the injection of heated air, it is perfectly easy to introduce into the air the required amount of humidity. In this way a perfect ventilation is obtained, and the air of the room kept at an even temperature.

The reason for the commencement of humidifying in this country was to enable the easier weaving of the heavily-sized calicoes. In the United States of America, and other districts where there is a prevalent dry atmosphere, the practice of introducing humidity into the air has long been known. Further, it has been discovered that there are certain places where the extra dryness of the air seriously militates against successful manufacture. In spite of this the growth of scientific methods of humidifying has been very slow. The flooding of the floors of spinning and weaving rooms with water is a recognition of the necessity for some provision of the sort, the operation here being a slow evaporation arising from the heat of the rooms. All these plans are crude and unsatisfactory, alike from the point of view of effectiveness and economy, and it is not, therefore, surprising that other modes were suggested. The first plan adopted was to inject steam into the room with pipes carried across, but the humidity necessary was obtained only at the cost of a largely increased temperature combined with the extensive deposition of moisture. As a result of the opposition to the injection of steam the Cotton Cloth Factories' Act was



passed, and fixed by its provisions the quantity of air to be supplied per head, and the maximum amount of humidity which was permissible. Six hundred cubic feet of fresh air per person was fixed as the air supply, and a schedule of maximum humidities was also drawn, which has been since slightly amended, the amended table being given as Table 12. The importance of the introduction of fresh air arises from the fact that it improves the condition of the atmosphere from a sanitary point of view, a considerable reduction in the volume of carbonic acid being effected. At this point it may be well to give a word of warning as to the form of hygrometer used. A standard instrument is made by Messrs. John Davis and Sons, Derby, of which Mr. Osborn says: "This firm has produced an excellent hygrometer, in which the glass of the tube magnifies the mercury column, so as to render the errors in taking the readings which arise from the ordinary thread-like columns impossible with ordinary sight." The essence of a correct hygrometer is the entire separation of the reservoir of water from the dry bulb thermometer, and it should be not less than 4 inches away. In many instruments sold for this purpose the construction is such that the position of the reservoir must affect the dry bulb thermometer. One form is sold in which a reservoir for cold water is provided between the two thermometers, thus exercising a decidedly chilling effect. Care must be taken to keep the reservoir of the wet bulb thermometer filled with water.

It should be carefully noted that the figures in Table 12 (see page 94) indicate the maximum limits, and do not mean that they must always be worked to. In all practical appliances for producing humidity in weaving sheds, therefore, there are two factors to be kept in view, the introduction of the defined volume of air, and the charging of it with the requisite moisture. For spinning rooms, the introduction of the air is not so essential. It can now be seen how it is proposed to effect these objects.

TABLE 12.

MAXIMUM LIMITS OF HUMIDITY OF ATMOSPHERE AT GIVEN TEMPERATURES.

| Grains of vapour<br>per cubic foot<br>of air. | Dry Bulb<br>thermom. readings,<br>Deg. Fahr. | Wet Bulb<br>thermom. readings,<br>Deg. Fahr. | Percentage of<br>Humidity.<br>Saturation = 100. | Grains of vapour<br>per cubic foot<br>of air. | Dry Bulb<br>thermom. readings,<br>Deg. Fahr. | Wet Bulb<br>thermom. readings,<br>Deg. Fahr. | Percentage of<br>Humidity.<br>Saturation = 100. |
|-----------------------------------------------|----------------------------------------------|----------------------------------------------|-------------------------------------------------|-----------------------------------------------|----------------------------------------------|----------------------------------------------|-------------------------------------------------|
| 1.9                                           | 35                                           | 33                                           | 80                                              | 6.6                                           | 68                                           | 66                                           | 88                                              |
| 2.0                                           | 36                                           | 34                                           | 82                                              | 6.9                                           | 69                                           | 67                                           | 88                                              |
| 2.1                                           | 37                                           | 35                                           | 83                                              | 7.1                                           | 70                                           | 68                                           | 88                                              |
| 2.2                                           | 38                                           | 36                                           | 83                                              | 7.1                                           | 71                                           | 68.5                                         | 85.5                                            |
| 2.3                                           | 39                                           | 37                                           | 84                                              | 7.1                                           | 72                                           | 69                                           | 84                                              |
| 2.4                                           | 40                                           | 38                                           | 84                                              | 7.4                                           | 73                                           | 70                                           | 84                                              |
| 2.5                                           | 41                                           | 39                                           | 84                                              | 7.4                                           | 74                                           | 70.5                                         | 81.5                                            |
| 2.6                                           | 42                                           | 40                                           | 84                                              | 7.65                                          | 75                                           | 71.5                                         | 81.5                                            |
| 2.7                                           | 43                                           | 41                                           | 84                                              | 7.7                                           | 76                                           | 72                                           | 79                                              |
| 2.8                                           | 44                                           | 42                                           | 85                                              | 8.0                                           | 77                                           | 73                                           | 79                                              |
| 2.9                                           | 45                                           | 43                                           | 85                                              | 8.0                                           | 78                                           | 73.5                                         | 77                                              |
| 3.1                                           | 46                                           | 44                                           | 86                                              | 8.25                                          | 79                                           | 74.5                                         | 77.5                                            |
| 3.2                                           | 47                                           | 45                                           | 86                                              | 8.55                                          | 80                                           | 75.5                                         | 77.5                                            |
| 3.3                                           | 48                                           | 46                                           | 86                                              | 8.6                                           | 81                                           | 76                                           | 76                                              |
| 3.4                                           | 49                                           | 47                                           | 86                                              | 8.65                                          | 82                                           | 76.5                                         | 74                                              |
| 3.5                                           | 50                                           | 48                                           | 86                                              | 8.85                                          | 83                                           | 77.5                                         | 74                                              |
| 3.6                                           | 51                                           | 49                                           | 86                                              | 8.9                                           | 84                                           | 78                                           | 72                                              |
| 3.8                                           | 52                                           | 50                                           | 86                                              | 9.2                                           | 85                                           | 79                                           | 72                                              |
| 3.9                                           | 53                                           | 51                                           | 86                                              | 9.5                                           | 86                                           | 80                                           | 72                                              |
| 4.1                                           | 54                                           | 52                                           | 86                                              | 9.55                                          | 87                                           | 80.5                                         | 71                                              |
| 4.2                                           | 55                                           | 53                                           | 87                                              | 9.9                                           | 88                                           | 81.5                                         | 71                                              |
| 4.4                                           | 56                                           | 54                                           | 87                                              | 10.25                                         | 89                                           | 82.5                                         | 71                                              |
| 4.5                                           | 57                                           | 55                                           | 87                                              | 10.3                                          | 90                                           | 83                                           | 69                                              |
| 4.7                                           | 58                                           | 56                                           | 87                                              | 10.35                                         | 91                                           | 83.5                                         | 68                                              |
| 4.9                                           | 59                                           | 57                                           | 88                                              | 10.7                                          | 92                                           | 84.5                                         | 68                                              |
| 5.1                                           | 60                                           | 58                                           | 88                                              | 11.0                                          | 93                                           | 85.5                                         | 68                                              |
| 5.2                                           | 61                                           | 59                                           | 88                                              | 11.1                                          | 94                                           | 86                                           | 66                                              |
| 5.4                                           | 62                                           | 60                                           | 88                                              | 11.5                                          | 95                                           | 87                                           | 66                                              |
| 5.6                                           | 63                                           | 61                                           | 88                                              | 11.8                                          | 96                                           | 88                                           | 66                                              |
| 5.8                                           | 64                                           | 62                                           | 88                                              | 11.9                                          | 97                                           | 88.5                                         | 65.5                                            |
| 6.0                                           | 65                                           | 63                                           | 88                                              | 12.0                                          | 98                                           | 89                                           | 64                                              |
| 6.2                                           | 66                                           | 64                                           | 88                                              | 12.3                                          | 99                                           | 90                                           | 64                                              |
| 6.4                                           | 67                                           | 65                                           | 88                                              | 12.7                                          | 100                                          | 91                                           | 64                                              |

There are two principal opposing schools on this subject, who each employ a special set of appliances. There are first, those appliances which produce a spray by the action of an air or water jet under pressure against an emerging stream of water ; each appliance being practically complete in itself and a series of the instruments being disposed about the room. In America, these are called with admirable directness "atomisers." In the second place there is that class of apparatus which charges the air with the moisture prior to injecting it into the room and distributes it by means of pipes.

The Drosophore, which is one of the first type, produces the necessary subdivision by the action of two water jets. Two nozzles (see Fig. 39), one descending and the other ascending, are placed exactly opposite each other. The aperture in the lower nozzle is slightly smaller than that in the upper one, but both are fed from the same source, with water at about 100lbs. pressure. The water emerging from the larger aperture is met by the ascending jet, and forced into a fine spray, while the force of the downward current is sufficient to create a rapid current of air, which, with the atomised moisture is discharged into the room, being distributed by the action of a dished plate. The method of arranging these instruments about a room is shown in Figs. 40 and 41, as applied to a ring spinning room and weaving shed respectively. The Drosophore has been largely adopted, and is made in two forms, one of which can be easily fixed into the windows, (see Fig. 40) so as to act, if necessary, as a ventilating apparatus. The water used can, if desired, be heated.

The second class of humidifying apparatus takes two forms. In the first a steam nozzle is fixed at the entrance to a tube connecting either to the outer air or to the room to be treated, and by means of which a combined mixture of steam and air is injected into the building. Mr. Roger Pye, of Blackburn, makes an appliance of this nature (see Fig. 42), and in his case he distributes the

combined air and vapour into the room by main pipes and branches from them (see Fig. 43). The pipes are made of zinc, and are provided with out-

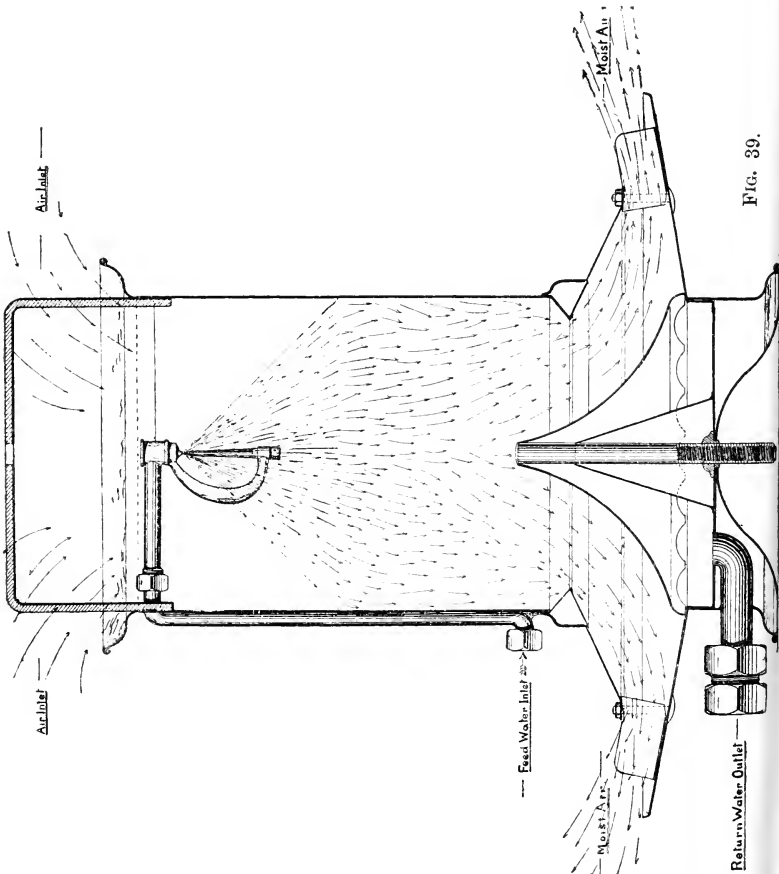

Fig. 39.

lets, the area of which can be closed by small slides in order to regulate the distribution. This device is simple and under control, and a water jet is supplied by which, if desired, a small quantity of

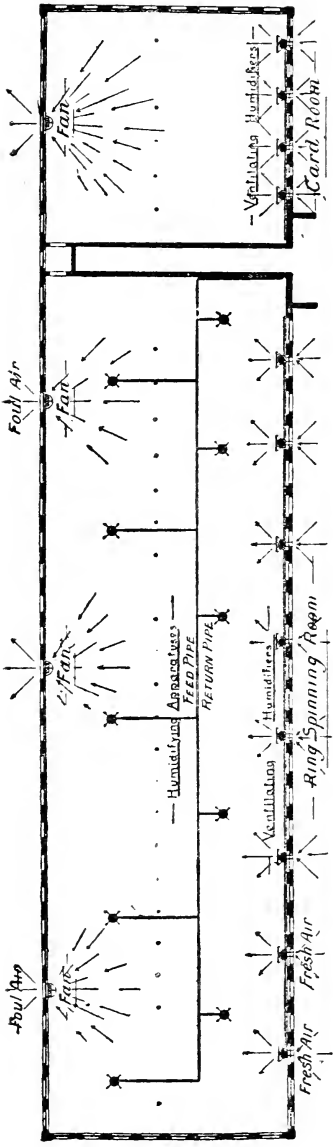

FIG. 40.

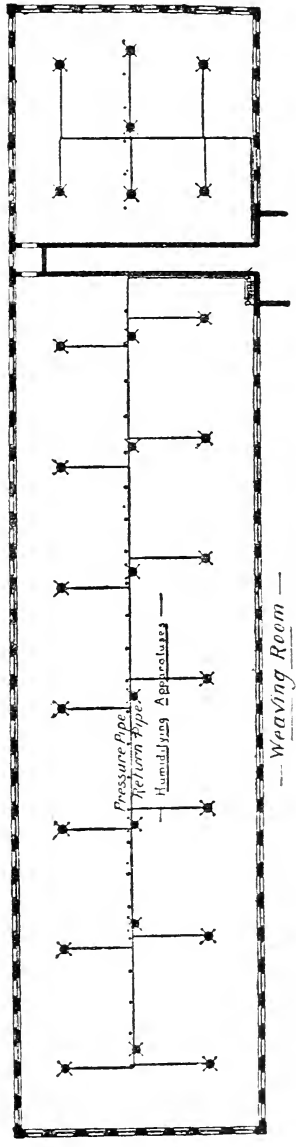

FIG. 41.

water can be injected. A test of the air of a weaving shed provided with this appliance before

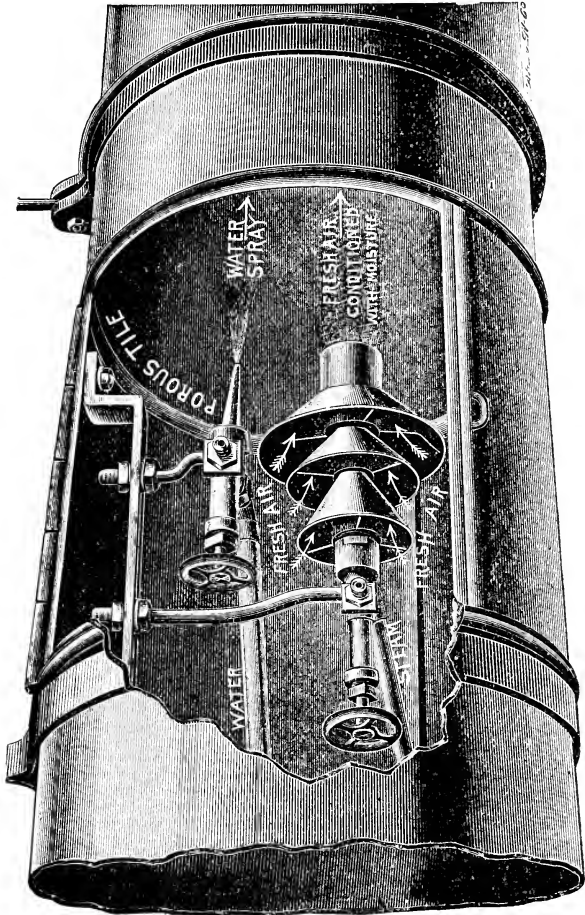
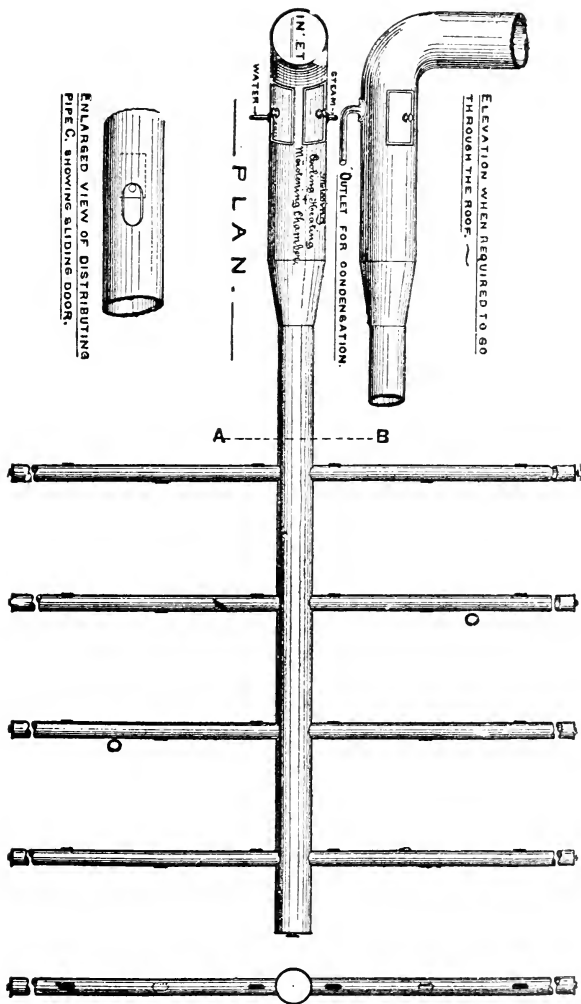

FIG. 42.

and after it was fitted showed 18·8 parts of  $\text{CO}_2$  per 10,000 before, and 7·6 after. A second shed provided with two fans per 1,000 looms, showed 14·1



ENLARGED VIEW OF DISTRIBUTING PIPE C. SHOWING SLIDING DOOR.



SECTION through A.B.

FIG. 43.

parts before, and 7 parts after application; and a spinning room with two fans to 22,000 spindles showed 15·7 before, and 6·2 afterwards. This is a fair sample of the purification obtained by the introduction of fresh warmed air, and must have a great influence upon the health of the operatives.

Another form adopted by Messrs. Jas. Howorth and Co., of Farnworth, is Lofthouse's apparatus, which is of the absorption type, and shown in Fig. 44. This consists, first, of a cylindrical vessel B, into which the air is drawn by the suction of a fan C placed beyond it. In this chamber the air can be heated by steam as it passes through. The hot or cold air, when taken from this chamber, is discharged by a pipe passing down the centre of a cylindrical vessel D. The pipe discharges a little above the bottom of the vessel, in which is always kept a certain depth of water, regulated by means of a ball tap, as shown at E. At the upper part of this vessel the discharge pipe leaves and is conveyed through the room which is being treated. In this pipe are placed the requisite number of discharging orifices, for each of which a small distributor is provided. The distributor is given a rotary movement by the passage of the air, and ejects it in all directions. The effect of this arrangement is that, whether heated or not, the air is sent with great force into the water, and produces in it a considerable disturbance, being practically passed through it. The result is that it is charged with moisture very thoroughly, and, when it leaves the vessel, contains a mixture of air and vapour in an intimate condition. The height of the second vessel is such that no drops of water can be carried over. It is quite true that there is a slight deposition of water which has not been absorbed by the air, but it is not great, and, what is important, it takes place in the conveying tubes, and the water does not find its way through the distributors. In connection with this apparatus it may be mentioned that by means of a special indicator it may be set so as to fix the quantity of moisture injected per hour.



Messrs. Howorth also make an apparatus of the spray type, which, however, in some respects partakes of the principle of the "Lofthouse." It consists of a cylindrical vessel, at one side of which

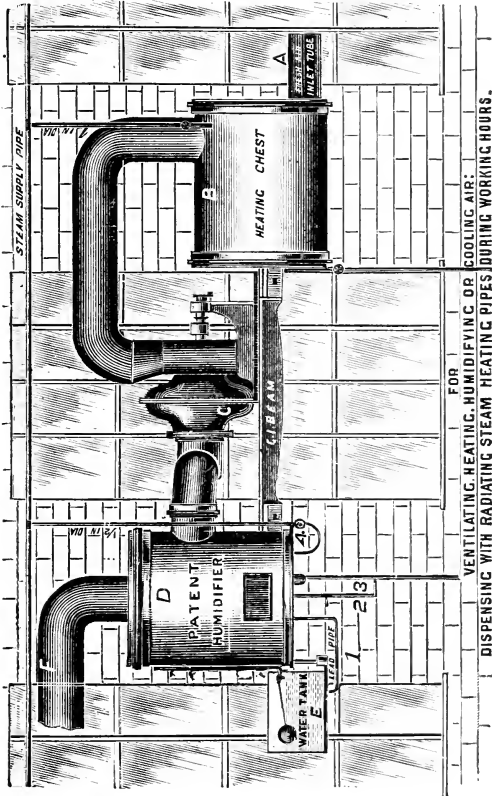

FIG. 44.

is a fan, and within which is a sprayer consisting of a drum provided with fins or vanes. This revolves at a quick speed, and as it dips into water at each revolution it produces a very fine and copious spray. The water is kept at a constant level by means of a

tank and ball tap. By means of a steam coil the water can be heated to any extent which may be desired, and the result is that as the air is driven through the spray it takes up a large volume of moisture, thus acting as an absorber. The humid mixture is then driven forward by a tube, and is delivered into the air by a sort of distributing tray, forming it into a broad current which rapidly spreads over the room. Although the water is heated to a considerable extent occasionally, the air enters the room at the ordinary temperature. This is very remarkable, and enables the apparatus to be used as a heating and ventilating device as well as a humidifier. The apparatus is arranged to be fixed to a wall so as to be out of the way, and will deliver up to five gallons of water per hour, all of which can be ejected into the room.

A very simple plan has been adopted by Messrs. Potts, Son, and Pickup in some recent examples. Beneath the floor, in lines extending under the looms along the shed, small trenches or culverts are formed, which are kept full of water. The culverts are made by a specially moulded brick, in the underside of which a semicircular groove is formed which is kept filled with water. The distance between the crown of the groove and the top of the brick is small, and it is found that the porosity of the brick allows the water to ooze through it, and thus be gradually absorbed by the air in the room. Two of these bricks are placed side by side, and as they come underneath the loom the moisture immediately affects the warps. It is obvious that this system is difficult to apply to a spinning room, but there are many other uses to which it is admirably suited. It involves, of course, the preparation of the floor, but the results have been found satisfactory. This system is also applicable to conditioning rooms.

The value of humidity in a textile factory is that it preserves the natural moisture in the fibre being treated, and enables it, as far as possible, to maintain its original condition. The heat of

spinning-rooms in cotton mills, for instance, is such that unless there was some vapour contained in the air, the amount of natural moisture, which is about 8 per cent, would very speedily be diminished. On the other hand it is equally necessary that the temperature of working should be high, in order to soften and render flexible the natural coating of wax surrounding the fibre.

It has been pointed out that there is a difficulty in maintaining an even degree of humidity if natural means only are employed; and, further, the usual method of heating mills has the disadvantage of drying the air. The presence of heated steam pipes in a room, especially if they are filled with high pressure steam, speedily leads to a drying of the air. This property has an immediate effect upon any fibres which are dealt with in such an atmosphere. In cotton an electrical condition is created, which causes the fibres to project outside the thread or roving, and thus escape being twisted into the yarn, which is weakened thereby. To avoid this trouble—which is greater abroad than in this country—humidification is absolutely necessary. It has been proved by repeated observations that when a uniform relative humidity is maintained the evenness of the weight and substance of the yarn is better obtained, and this is a matter of supreme importance.

As to the exact amount of humidity to be produced in any room, this is a point upon which nothing definite can be said. The amount needed is often lower than is sometimes thought to be necessary, but there are so many circumstances which affect the problem that it is quite impossible to give even an approximate rule. If, however, the form of the humidifier be determined on, then the ascertainment of the exact conditions is easy, and requires little, if any, trouble. The only thing to be noted is that the advantage of artificial humidity is that the required degree can be obtained with exactitude independently of the ordinary meteorological fluctuations. Accurate records which have been

kept demonstrate that when a proper degree of humidity is maintained, not only does the evenness of the thread produced improve, but the amount of waste made by the clearers is less. On the other hand, an excess of humidity causes licking, and tells against economical work.

---

## CHAPTER VIII.

### CALCULATION OF MACHINES IN MILL.

To illustrate for the guidance of readers the method of planning a cotton spinning mill for any particular counts, the following example is given:—The calculation is affected by two factors, the draft given in the various machines and the spindle speeds adopted. The production is affected by each of these, so that they must be fully considered. Assuming that 32's twist is to be spun, and that a start is made from a drawn sliver of .16 hank, then the hank slubbing being .625, intermediate roving 1.75, and roving 4 hank, the calculation for the machines would run out as follows:—With a spindle speed of 600 revolutions and a roller speed of 161 the production per hour would be 1.61lb. In like manner the intermediate frame spindles with a velocity of 800 revolutions and a front roller speed of 132 would each produce .56lb. per hour, and the roving spindles running 1,000 revolutions with a front roller speed of 119 would each produce .19lb. per hour. Putting the production of the mule at .018lb. per hour, and of the ring frame at .031lb. per hour each, with a spindle speed of 7,000 revolutions, then we are enabled to formulate the number of machines required to produce a given weight. To produce 30,000lbs. per week of 56 hours or 535.7lbs. per hour, 29,761 mule spindles or 17,358 ring spindles would be required. To produce the roving for these, allowing for waste say 5.3lbs. per hour, making altogether 541lbs. of roving wanted, 2,847 roving spindles are required. Now making an allowance of 10lbs. for waste,

551lbs. of intermediate roving is required, thus necessitating the use of 984 intermediate spindles. If 11lbs. be considered to be a fair allowance for waste, then to produce  $551 + 11 = 562$ lbs. hourly 340 slubbing spindles are needed. Plus waste 12lbs., 574lbs. of drawn sliver are required from the finishing head, so that with a production of 18.8lbs. per hour the number of finishing deliveries of drawing required are 30. If three passages are made 90 heads in all are required. Coming to the carding engines and allowing for the waste there made, which would not be less than 28lbs., we get the need for 602lbs. of carded sliver per hour. Assuming the production to be 850lbs. per week, or 15lbs. per hour, 40 carding engines are required. We have thus got the following as the needs of a mill of the capacity named. 29,761 mule spindles or 17,358 ring spindles, 2,847 roving spindles, 984 intermediate roving spindles, 340 slubbing spindles, 90 drawing heads, and 40 carding engines. To prepare the cotton for the carding engines three finishing and three breaking scutching machines would be sufficient, and by running an opener at its full capacity one vertical opener would suffice. In addition to these machines the usual bale breaking and mixing machines would be required.

Having got the above particulars, the next thing is to settle the size of the machines used, so as to get a convenient mill. Taking the mules, 28, each containing 1,095 spindles, could be used. These, if  $1\frac{3}{8}$ in. gauge, would be 131ft. long, and would necessitate a room of 137ft. internal width. Seven pairs of mules being in each room, its length would be about 165ft., so that the card room and basement would be 165ft. by 137ft., and in that space the cards, drawing frames, and all roving frames want disposing. This is a matter of planning which can be easily worked out from the known spaces occupied by the various machines.

If ring frames are employed instead of mules the planning will be affected, because the 17,358 ring spindles would have to be arranged so as to give

the most profitable results. As a rule in this country, at the ordinary high speeds, from 600 to 650 ring spindles can be attended to by one minder with the aid of the doffers. As there is a passage between each pair of machines, this means that the attendant could best manage the spindles on two adjoining frames. Thus a frame of 300 to 325 spindles would fulfil this condition, and these would occupy—if  $2\frac{5}{8}$  in. gauge—about 35ft. 6in. and 38ft. respectively. Placing two frames across the room, and allowing 8ft. for alleys, would give a building 79 or 84ft. wide. This will obviously affect the planning, and would probably render it necessary to have two card rooms instead of one. It will, of course, be understood that these instances are only given as examples to illustrate the procedure of planning. There are many other considerations which must be taken into account, such as, for instance, the class of cotton used, as this factor affects the quantity of finished material from a given weight. A change in the drafts of the various machines modifies their output, and so alters the proportions of each used, while the acceleration or diminution of the velocities still further affects the calculation.

In laying out a thread mill two sets of machines are required. It is customary in making thread to twist two ends of yarn together first, and, after re-winding, to twist three of the doubled threads together. In this way six-fold sewing thread is produced. This method of working implies the use of doubling winding machines. The output of these depends upon the counts which are wound, but an average speed of working is one in which 5,000 inches of each end of yarn is wound on to the bobbin per minute. In thread making this speed is exceeded; but assuming it to be correct, 139 yards of each end per minute will be wound. If two-fold thread is to be made, this would mean that 278 yards would be wound per minute. Thus the number of yards wound per week of 56 hours can be easily obtained by multiplying the number of

yards wound per minute by 3,360. From the product a percentage of from  $7\frac{1}{2}$  to 10 can be taken for stoppages, and the remainder being divided by 840 will give the number of hanks. By dividing the latter by the counts of single yarn, the output of the winding frames can be obtained. Thus let it be supposed that 50's two-fold are being wound, the weekly number of yards wound per bobbin will be  $2 \times 139 \times 3360 = 934,080 - 93,408 = \frac{841 - 672}{840} = 1002 \div 50 = 20.02$

lbs. per week. A ring doubling frame with a spindle speed of 6,000 revolutions per minute will produce of 50's 2-fold, with a twist of 25 turns to the inch, 16oz. per week, so that one drum of doubling winding is equal to 20 twisting spindles on this computation. In dealing with the re-winding, the 50's 2-fold must be looked upon as 25's single, and the computation of the output of the re-winding machines must be made on the basis of three ends of 25's yarn. This illustration will suffice to show the principle, but it is not possible to give an accurate statement of the output of doubled yarns, because the counts twisted and the number of turns per inch vary so much. The productions are, even with yarn of the same class, widely different, owing to the variation in the twist given. In addition to the machines named, the following are required for polishing and spooling. A winding frame for producing spools, a beaming machine, a cleaning machine, dyeing becks, or bleaching keirs, a second beaming machine, a beam polishing machine, a re-winding machine, and the necessary spooling machines. If soft thread is wanted the polishing machine is dispensed with. A polishing machine is capable of producing 120lbs. of 30's three-fold in 10 hours, and the plant named, less the polisher, will turn out 5,670lbs. per week of soft thread. A spooling machine of eight heads will produce 26 gross of 200yd. spools in  $10\frac{1}{2}$  hours, or 748,800yds. of thread. The equipment of a

thread mill is simple, but no uniform procedure can be laid down owing to the variation in the circumstances. If the doubled thread is for lace purposes it is cleared and gassed, and for these operations vertical spindle winding machines and gassing frames are required.

In planning a weaving shed regard must be had to the character of the cloth it is intended to weave. The output of a loom is determined mainly by two factors—the number of picks put in per minute and per inch. These are what determine the speed of the loom, and depend naturally upon the character of the work. Thus a plain calico or twill can be woven at a higher speed than a fancy or leno cloth. It is, therefore, essential to know the number of picks made as a preliminary to calculating the output per loom, and following that the number required. A fair output of plain cloth 30 inches wide from one loom is 250 yards in 56 hours. The other machines required to prepare the yarn for weaving are first:—Cop or bobbin winding machines to produce warper's bobbins 1·5 spindles to each loom, one beam warping machine to each 80 to 90 looms, and with a medium number of picks per minute, one slasher sizing machine for each 300 to 330 looms. To these must be added the necessary frames for drawing-in, etc. If the yarn has to be dyed reels are necessary for winding it into hank, drum winding machines for re-winding it on to warper's bobbins after dyeing, and pirn winding frames for preparing the weft for use in the shuttle. The output of a bobbin reel on 20's twist in a week of 56 hours is 800lbs.; of a cop reel in the same time 400lbs. A fair apportionment of the other machines named is as follows:—Pirn winding machine, 5 spindles to each loom; hank winding machine, 4 bobbins to each loom. If the warping is done, as is now somewhat common, on a sectional warping machine, one such machine can be provided for medium counts for each 60 looms. All these proportions must be varied in accordance with the



counts of yarn and permissible velocity. The examples given on pages 109 to 116 will further illustrate the range of machines required in a complete installation, and fairly represent the general arrangement of a weaving shed.

---

## CHAPTER IX.

### RECENT EXAMPLES OF MILLS.

In Fig. 45 a view is given of the Minerva Spinning Company's Mill, and in Fig. 46 a plan of the card room. This mill is designed to spin 40's twist and 65's weft yarn, the machinery being made by Messrs. John Hetherington and Sons, Limited, and has since it commenced work fully given good results. It was designed, so far as the mill building is concerned, by Mr. Sidney Stott, of Oldham. In another portion of this issue we give particulars of the engines. The mixing room is provided with the usual machinery, by which the cotton is fed to two combined single openers and single scutching machines, the openers being on the Crighton principle, and fitted with the special grids patented by Messrs. Hetherington. There are four single-beater intermediate scutching machines with lap attachment, and four single-beater machines for finishing the laps. The latter produce laps 38in. wide, to supply cards with that width of wire. The plan shows that the mixing and blowing rooms are divided from the main mill by the rope race. The carding engines, of which there are 93, are of the revolving flat type. The diameter of the cylinder is 50in., and, as has been said, they are 38in. wide on the wire. The flexible bend is trued up by the makers' special apparatus, and is fitted close up to the cylinder edge so as to obviate "blowing out." The flats are 104 in number, of which 42 are always at work, and they are clothed over their whole surface. The drawing frames are nine in number, each frame having three heads of

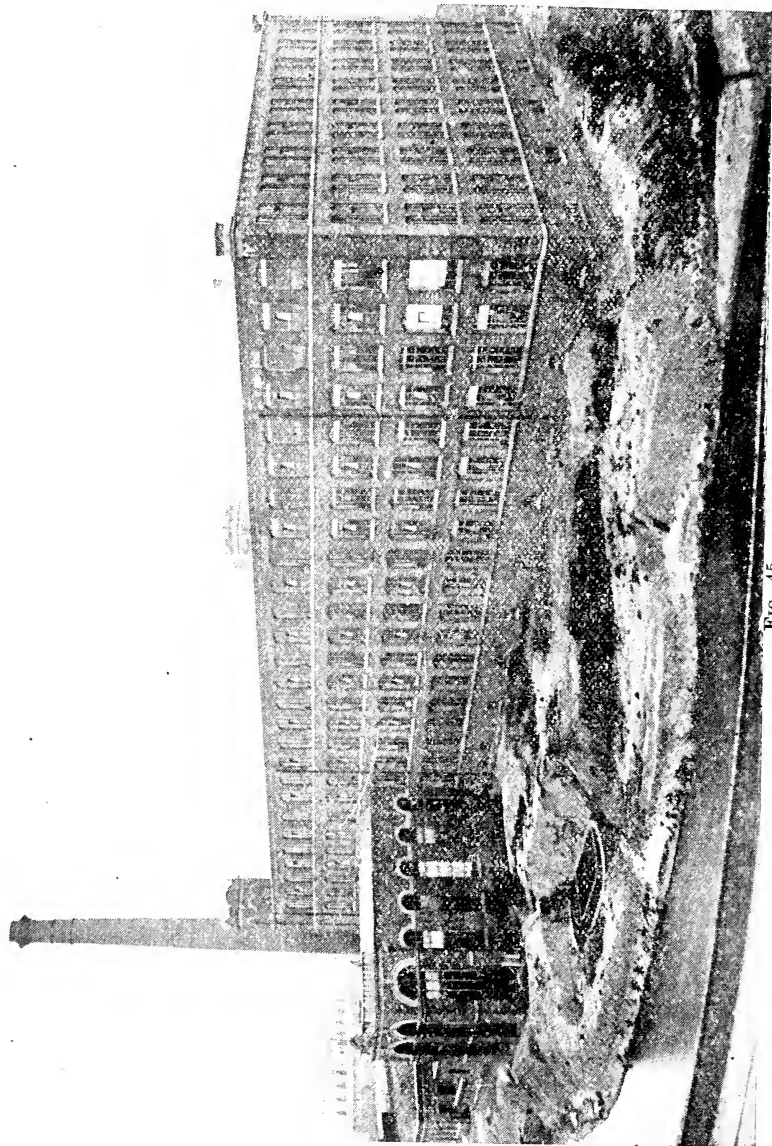

FIG. 45.

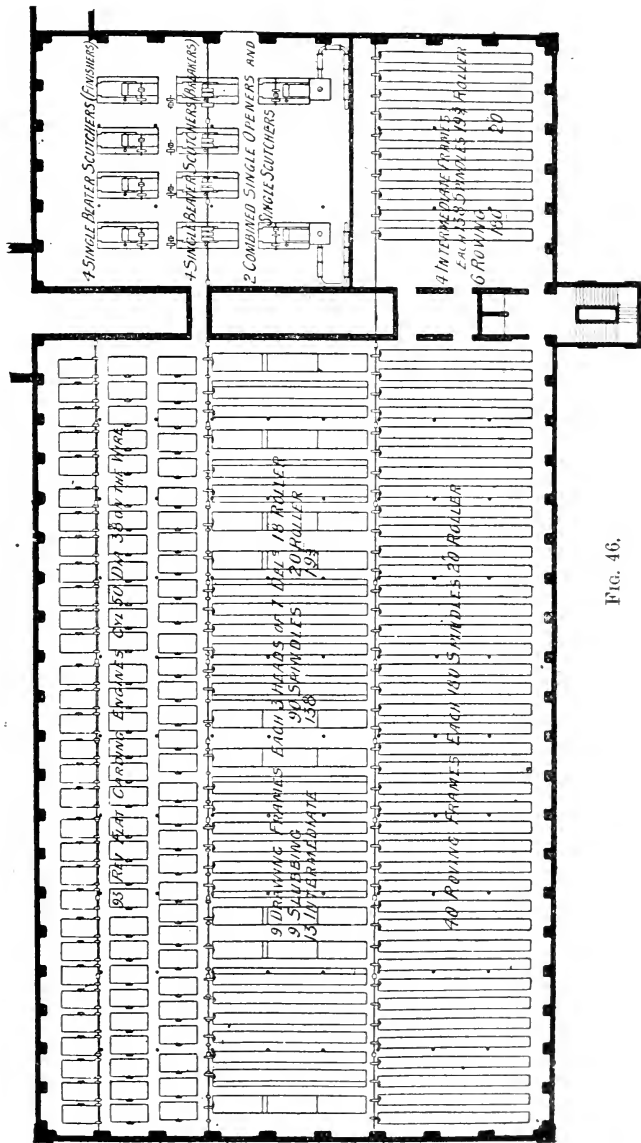

FIG. 46.

seven deliveries each, and 18in. gauge. They are fitted with front and back stop-motions, and single preventors. As will be seen from the plan they are conveniently placed among the slubbing frames, so that the drawings can be dealt with without undue labour. The slubbing frames are also nine in number, and have 86 spindles each, four spindles in 20in. Adjoining these are the intermediate frames, of which there are 13, with 132 spindles, six in 19 $\frac{3}{4}$ in. It will be seen that the drawing, slubbing, and intermediate frames occupy the same row, and the number of deliveries, or spindles, are such that all of them are as nearly as possible the same length, about 39ft. The roving frames are in the same room, and are 40 in number, each of them having 180 spindles, with eight spindles in 20in. This gauge makes the length of the roving frames over all 40ft. 6in. These frames have extra large cones, which are as far apart as possible, and there are several features of interest in them which space does not enable us to deal with. In the first spinning room there are 20 mules each with 1,320 spindles 1 $\frac{1}{2}$ in. gauge; in the second 16 mules each with 1,326 spindles 1 $\frac{1}{2}$ in. gauge, and 10 mules each with 1,086 spindles 1 $\frac{3}{8}$ in. gauge; and in the third room 26 mules each with 1,092 spindles 1 $\frac{3}{8}$ in. gauge. It is perhaps worth calling attention to the additional spindles which are fitted in the higher spinning rooms, as compared with those immediately below. The narrower gauge is of course used for spinning weft, there being in all 47,616, and the wider for the twist mules, of which there are 39,252. The total number is, therefore, 86,868. The mules used in modern mills have, during the past few years, been remodelled, and are much more simple and effective. They have also been so far strengthened that a much larger output is got and higher speeds obtained, which cheapens production. Summarising the machinery in this mill, therefore, the account runs thus:—

|                                      | Mule Spindles. |
|--------------------------------------|----------------|
| 2 vertical openers and scutchers =   | 1 to 43,434    |
| 4 intermediate scutchers .....       | = ,, 21,717    |
| 4 finishing scutchers .....          | = ,, 21,717    |
| 93 carding engines .....             | = ,, 934       |
| 63 finishing deliveries of drawing = | ,, 1,380       |
| 792 slubbing spindles .....          | = ,, 109.7     |
| 1,716 intermediate spindles .....    | = ,, 50.6      |
| 6,680 roving ,, .....                | = ,, 13        |
| 86,868 mule ,, .....                 | =              |

As was said, this mill has now been working for some time, and has during that period been successful, the production of 38's twist averaging  $30\frac{1}{2}$  hanks per spindle per week, and of 56's weft  $26\frac{3}{4}$  hanks.

In Fig. 47 a view of the Milton Spinning Company's mill at Mossley, designed by Messrs. Stott and Sons, of Manchester is given, and in Fig. 48 a plan of the card room. This mill has also been fitted with machinery by Messrs. John Hetherington and Sons, Limited, and was arranged to spin 46's weft from American cotton, but is actually spinning a very wide range of counts, from 12's to 70's weft. It will be observed that there is in this plan a deviation in the arrangement from that preceding. The mixing and blowing rooms do not occupy, as before, the whole of the ground floor at one end. There are in the former the usual feeding machines, which deliver to three combined openers and single scutchers, followed by five single beater intermediate, and five finishing scutching machines. There are 81 revolving flat cards of the same pattern as those previously named, with 50in. cylinders, 45in. on the wire. It will be seen that this mill is fitted with wide cards which, in some respects, are preferred for certain counts. The drawing frames are nine in number, each with three heads of eight deliveries and 18in. gauge. The arrangement of these frames relatively to the slubbers is similar to that previously described. Of the slubbing frames there are nine, each containing 96 spindles, 4 in 19in. The intermediate frames number 17, each of 144 spindles,

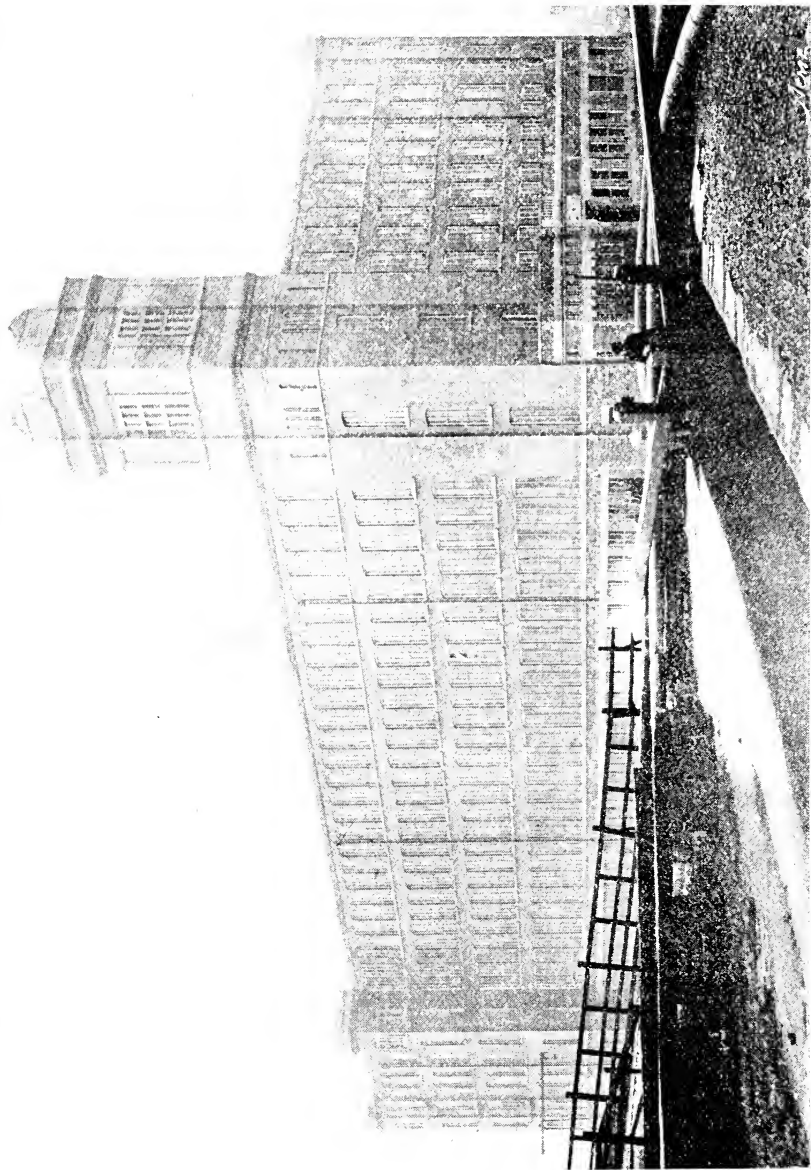

FIG. 47.

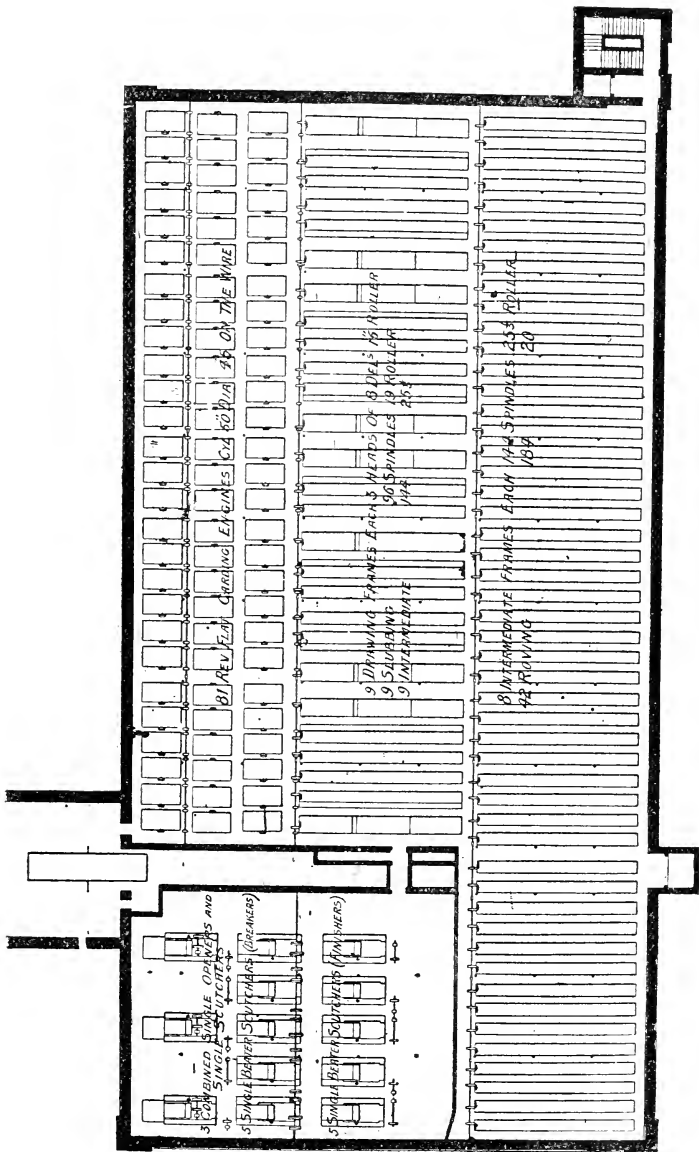

FIG. 48.

with 8 spindles in a box 25 $\frac{1}{2}$ in. gauge. The roving frames number 42, each of which has 184 spindles, and 8 spindles in a box 20in. gauge. As before, the lengths of these frames approximate, which is a very convenient practice. The mules are all designed for the spinning of weft yarns, and are contained in three rooms. In the first room there are 24 mules, each with 1,356 spindles 1 $\frac{1}{10}$ in. gauge, in the second 24, each 1,368 spindles, 1 $\frac{1}{10}$ in. gauge, and in the third 24, each having 1,344 spindles 1 $\frac{1}{8}$ in. gauge. It is somewhat noticeable that the number of spindles in each room very closely approximates, being, in the first room, 32,544, in the second, 32,832, and, in the third, 32,256, making a total of 97,632. An average production of 24 $\frac{1}{4}$  hanks per week of 70's weft is being obtained. Pursuing the same procedure as before, this mill contains :—

|                                     | Mule Spindles. |
|-------------------------------------|----------------|
| 3 opening machines .....            | = 1 to 32,544  |
| 5 intermediate scutchers .....      | = 1 ,, 19,526  |
| 5 finishing " .....                 | = 1 ,, 19,526  |
| 81 carding engines .....            | = 1 ,, 1,205.3 |
| 72 finishing drawing deliveries ... | = 1 ,, 1,343.7 |
| 864 slubbing spindles .....         | = 1 ,, 113     |
| 2,448 intermediate .....            | = 1 ,, 39.9    |
| 7,728 roving .....                  | = 1 ,, 12.6    |
| 97,632 mule .....                   |                |

The details of these two mills vary somewhat, but if the counts to be spun are taken into consideration, the variation is fully accounted for. The plan and arrangement of the card rooms in both instances is very good and compact.

In Figs. 49 to 52 illustrations are given of a mill plan supplied by Messrs. Howard and Bullough. The mill, when finished, will spin yarns from 20's twist to 44's weft. The general elevation of the mill is shown in Fig. 49, the card room plan in Fig. 50, the first floor plan in Fig. 51, and the second floor in Fig. 52. It will be noticed that the blowing room is separated from the main building, and is placed below the mixing room, in which there is first a bale breaker feeding to



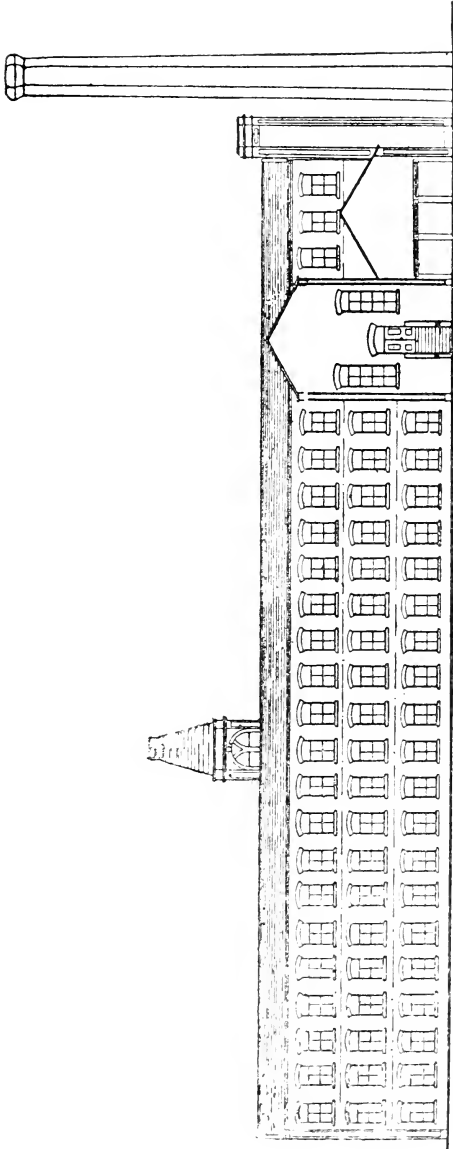

FIG. 19.

lattices which deliver the cotton into stacks. In the same room two hopper feeding machines, elsewhere described in this issue, are placed, these delivering by air trunks to two exhaust opening and lap machines combined. The laps thus formed are fed to four single beater intermediate scutching and lap machines, and the resultant laps are finished on four finishing scutching machines of like construction. In the card room there are 54 revolving flat cards, these having 50-inch cylinders 37 inches wide on the wire. The doffers of these cards are 26 inches diameter, and the machines are fitted with the appliances for setting, grinding, and slow driving of cylinder and flats, which are now commonly supplied, and are familiar to spinners. The drawing frames are, as shown in Fig. 50, disposed conveniently among the cards, so as to save labour as far as possible. They are fitted with electric stop motions, and are as ordinarily constructed by the firm. There are nine of these machines, each with three heads of six deliveries each. As the sliver makes three passages, there are necessarily 54 finishing deliveries. There are seven slubbing frames, disposed in one row between the cards and roving frames, but they are arranged in a peculiar way. Thus the two slubbing machines at the right-hand side serve three intermediate frames and nine roving frames which are opposite to them, which may be called group A. These frames are also specially arranged. Thus, beginning near the rope race, there are first four roving frames, then two intermediates, then three roving frames, one intermediate, and, finally, two roving frames. The next group B consists of two slubbers, three intermediates, and seven roving frames, the order being—starting from the last group—two roving, two intermediates, three roving, one intermediate and two roving frames. Group C consists of one slubbing, two intermediate, four roving frames, the intermediates being in the centre of the roving machines. Finally, in group D, the remaining two slubbing

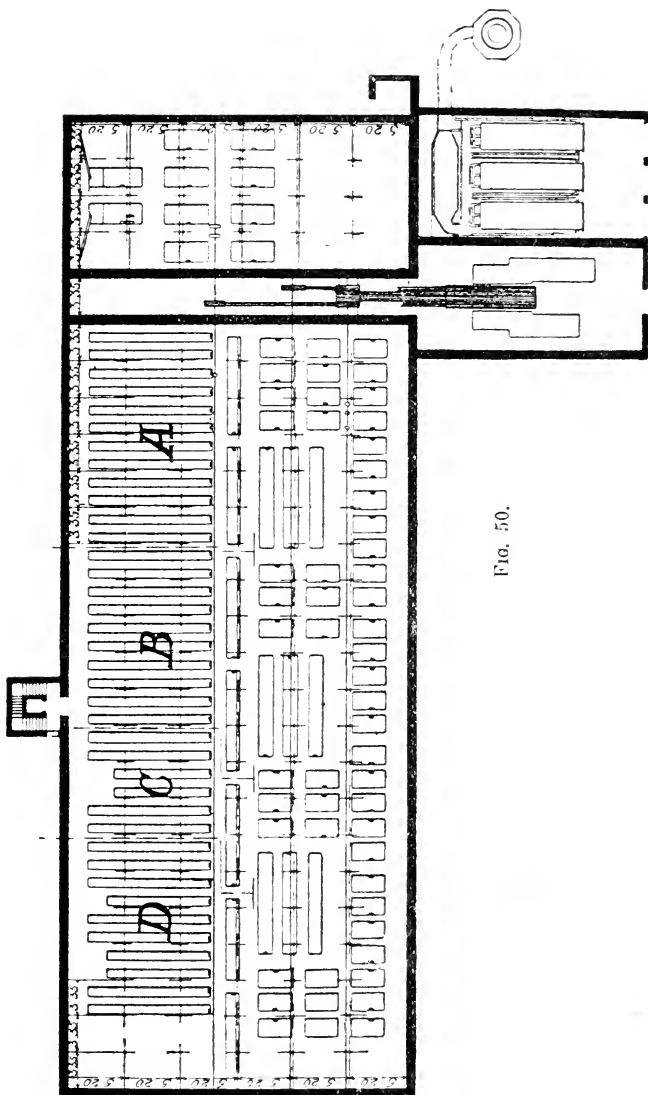

FIG. 50.

frames serve three intermediate and seven roving frames, the order of which is similar to those of the groups they resemble. It will be seen that this is a well thought out plan, and in its chief features requires some little comment. The disposition of the various machines relatively to each other enables the whole room to be worked with very little labour of carriage, as the successive stages follow one another perfectly. Further, the grouping of the roving machinery in the manner described enables the room to be worked in sections, so to speak, which, as will be noticed from the counts to be spun, is necessary.

The slubbing frames in group A have 72 spindles each or 144 in all; the intermediate frames 126 spindles each = 378; and the roving machines 160 spindles each = 1,440. In group B the arrangement is 2 slubbing machines of 76 spindles = 152; 3 intermediates of 126 spindles = 378; 7 roving machines of 160 spindles = 1,120. Group C has the following composition: 1 slubber 76 spindles; 2 intermediates of 100 spindles each = 200; 4 roving frames of 160 spindles = 640. Group D is made up as follows: 2 slubbers of 60 spindles = 120; 3 intermediates of 106 spindles = 318; and 7 roving frames of 160 spindles each = 1,120. The importance of this grouping will be made clear when the size and number of the ring frames and mules have been stated. The ring frames are disposed on the second floor, as shown in Fig. 52, and the mules on the first floor, as in Fig. 51. Of the former there are 28, each containing 380 spindles, or in all 10,640, these spinning 33's twist; 20, each of 348 spindles, or in all 6,960 spindles, spinning 20's twist; and 10, each containing 432 spindles, or 4,320 in all, spinning 24's weft. The 20 self-acting mules have each 900 spindles, or 18,000 together, and spin 44's weft. The set of speed frames in group A has the following production. The slubbing frames produce in 72 hours 107·16lbs. per spindle of 6 hank slubbing = 15,428lbs. The intermediate frames produce of 1·6 hank

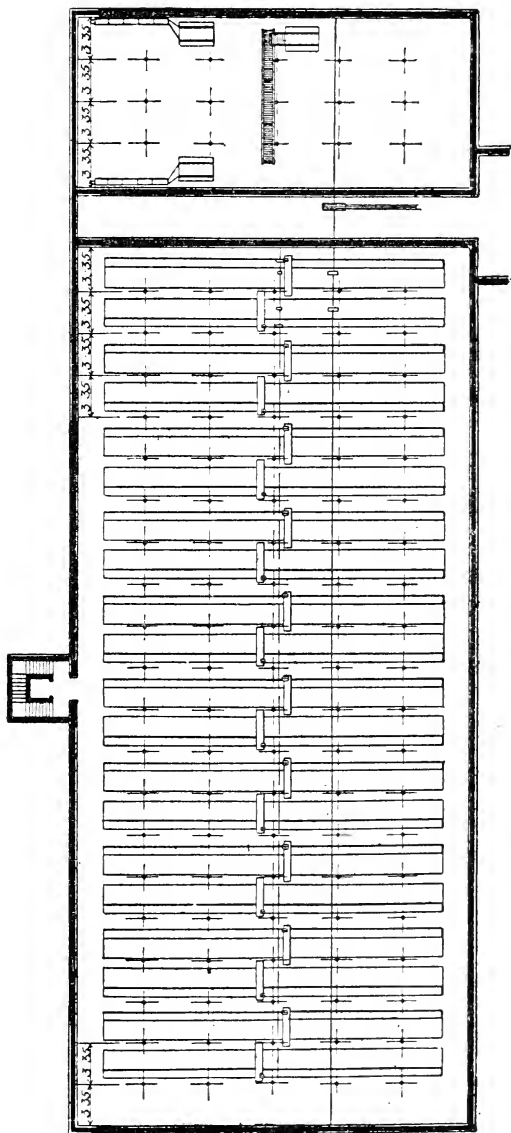

FIG. 51.

roving, 40·82lbs. per spindle, or 15,428lbs. in all per week; and the roving frames, 10·72lbs. per spindle of 4·75 hank roving, equal to a weekly output of 15,428lbs. These serve the 28 ring frames of 380 spindles, which produce 1·45 hanks per spindle of 33's twist, or 15,428lbs. weekly. Thus this set of machines forms a complete section, which can be practically separated from the rest of the mill and worked independently. The same thing occurs with the other groups, which may be thus tabulated:—

## GROUP B.

|                                                  |                   |          |
|--------------------------------------------------|-------------------|----------|
| Slubbing, 152 spindles, 126·85lb. per spindle of | ·5 hank=          | 19280lb. |
| Intermediate, 378 spindles, 51lb.                | ” ” ” 1·25 ”      | = ”      |
| Roving, 1,120 spindles, 17·23lb.                 | ” ” ” 3·25 ”      | = ”      |
| Rings, 6,960 spindles, 2·77lb.                   | ” ” ” 20's twist= | ”        |

## GROUP C.

|                                                     |                  |         |
|-----------------------------------------------------|------------------|---------|
| Slubbing, 76 spindles, 126·75lb. per spindle of     | ·5 hank=         | 9633lb. |
| Intermediate, 200 spindles, 48·17lb. per spindle of | 1·35 hank=       | 9633lb. |
| Roving, 640 spindles, 15·06lb.                      | ” ” ” 3·75 ”     | = ”     |
| Rings, 4,320 spindles, 2·23lb.                      | ” ” ” 24's weft= | ”       |

## GROUP D.

|                                                   |                  |           |
|---------------------------------------------------|------------------|-----------|
| Slubbing, 120 spindles, 107·25lb., per spindle of | ·6 hank=         | 12,870lb. |
| Intermediate, 318 spindles, 40·5lb.               | ” ” ” 1·6 ”      | = ”       |
| Roving, 1,120 spindles, 11·14lb.                  | ” ” ” 4·75 ”     | = ”       |
| Mules, 18,000 spindles, ·715lb.                   | ” ” ” 44's weft= | ”         |

In all it will be seen that 57,211lbs. of cotton are required weekly for this production, which the preparatory machines are quite capable of giving. The details given show the plan to be well conceived and executed, and demonstrate the different conditions prevailing in this country and elsewhere. The mill thus arranged gives practically four complete sets of machines, which enable the variety of work required to be produced economically without loss of power or labour. The card room especially is notable for that feature, and is as well arranged as is conceivable.

Fig. 53 is a perspective view specially prepared by the architects, Messrs. Potts, Son, and Pickup, of two mills erected for the Société Cotonnière d' Hellemmes, Lille. One of these mills has been at work two or three years, but the other, which is at right angles to it, is only now being erected. A cotton warehouse is placed in the space between

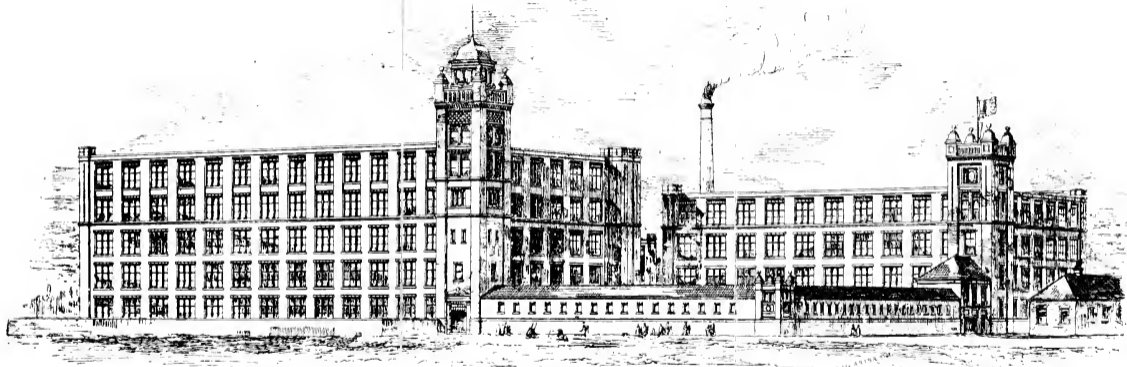
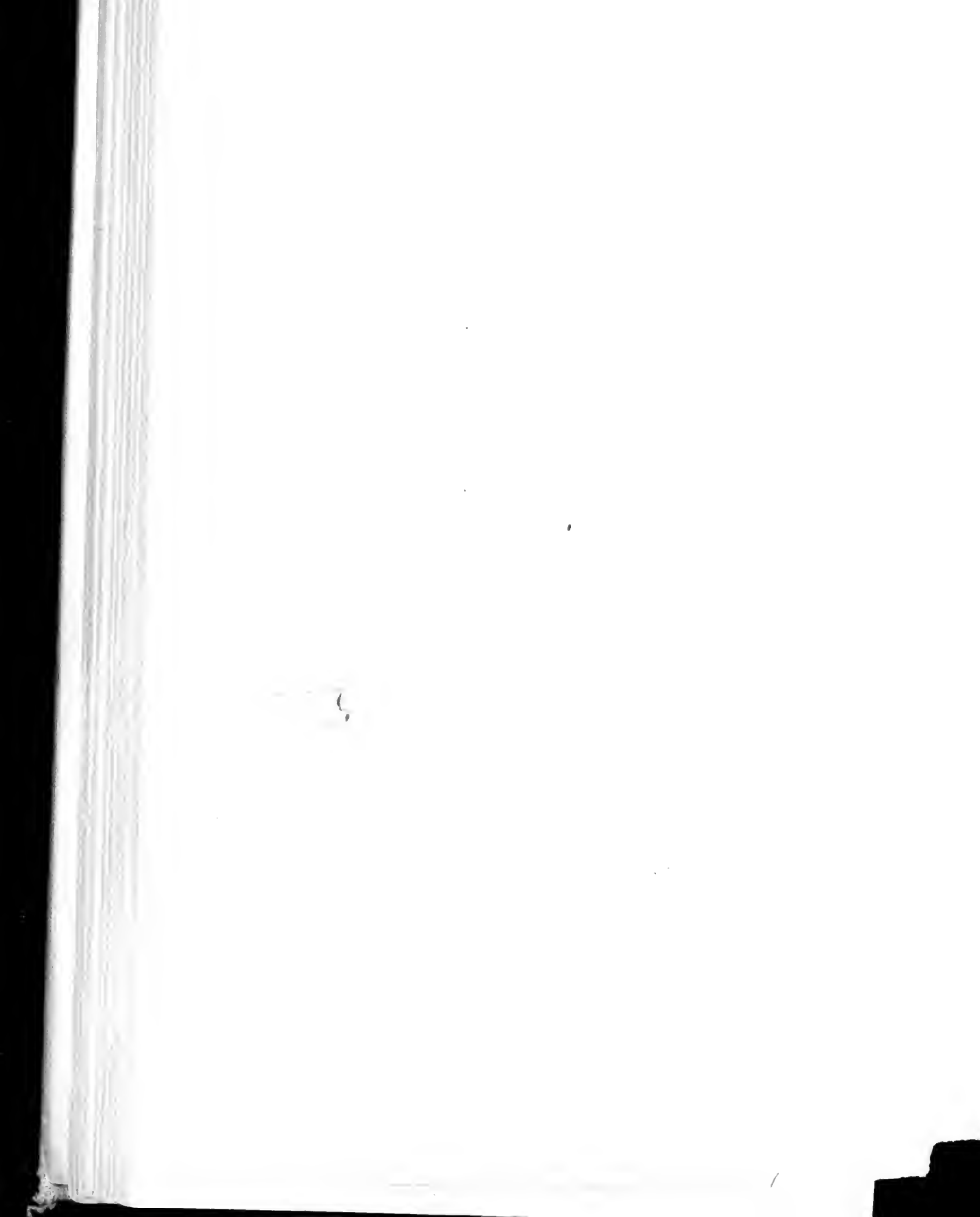

FIG. 53.





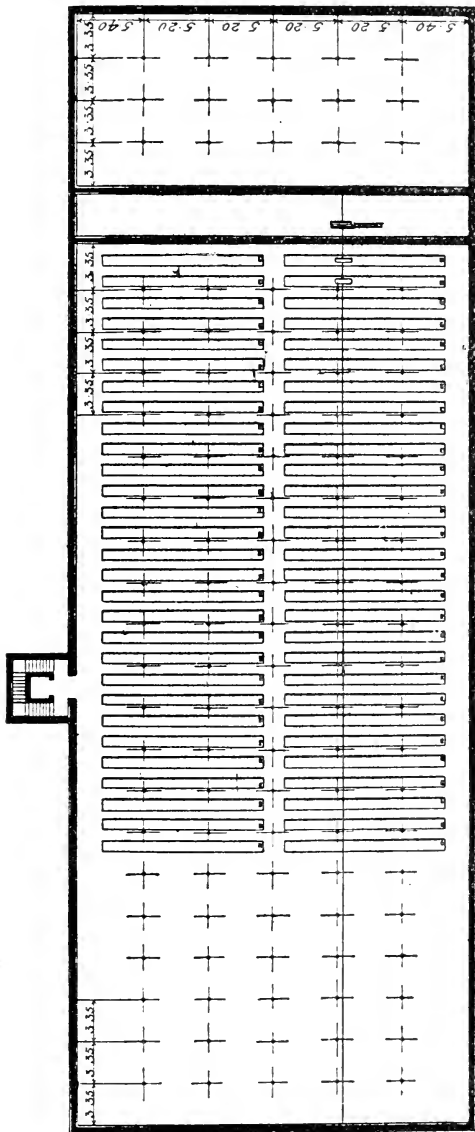

FIG. 52.

the two mills, this being one-storeyed. The mills are arranged for spinning 50's twist and 60's weft. It will be noticed that each is constructed with the window which has been illustrated, and so far as the fabric is concerned, it is of the steel and concrete floor type previously described. The whole of the machinery for both mills has been provided by Messrs. Dobson and Barlow, Limited. It consists of the usual series of machines for spinning these counts, but does not contain any combing.

Fig. 54 is a plan of the cardroom of the Beehive Spinning Mill now being erected near Bolton under the direction of the same architects. When finished, the mill will contain 118,000 mule spindles, and will be employed in spinning an average of 60's counts of yarn. As shown, the full scheme includes two mills, but only one is now being erected. This will have five storeys, and is in its general arrangement of usual construction. Reverting to the plan of the cardroom, it will be seen that adjoining the engine house, and extending outwards from the main building, is a shed in which the intermediate and roving frames are placed. The wall of the upper storeys at that side is carried by strong pillars and girders, thus giving ample access between the shed and cardroom, which practically become one. The engine house is also built out from the main block, and the rope race partially divides the blowing room wing from the card room. The blowing room contains 4 double opening machines of Messrs. Dobson and Barlow's well-known type, combined with hopper feeds, and six single-beater scutchers. There are 160 "Simplex" carding engines arranged along one side of the room, and driven by two line shafts placed as indicated. These cards have cylinders 50in. diameter, and are 39in. on the wire. In all, there are 36 drawing frames, of which 8 have one head each of eight deliveries, and 28 have each 2 heads of eight deliveries of 16in. gauge. There are, therefore, 512 deliveries of drawing. Following these machines are 16 slubbing machines, each containing 80



spindles, and of 8in. space. These are similar in construction to those described above, and supply 32 intermediate frames of 138 spindles each, and of  $6\frac{1}{2}$ in. space, and 42 roving frames, each containing 210 spindles, of  $4\frac{1}{4}$ in. space. The plan shows that the slubbing frames are shorter than the intermediate frames adjoining them, and that the space left is filled by four bobbin boxes conveniently placed. The total number of spindles is, as stated, 118,000. This card room is an instance of supplementing an otherwise inadequate floor space by a shed, in preference to making a second card room. This is a custom to be commended.

In Fig. 55 a plan of a one-storey mill arranged to spin, weave, dye, and finish cotton goods is given. This is the design of Messrs. Brooks and Doxey, and the mill from this plan was executed and furnished by them in Brazil. The chief feature in it, apart from its completeness, is the admirable arrangement which practically results in the cotton entering at one end, and then following a regular course until it emerges at the other end as finished cloth. The cotton enters the store, and after being subjected to seed-opening machines, passes into the ginning room, where it is freed from seeds, and is taken to the mixing room, in which there are three feed tables delivering to dust trunks. These convey it to three combined exhaust openers and scutchers, which supply five intermediate and five finishing scutchers. From these the laps pass directly into the card room, in which the carding machines, drawing, and speed frames are placed. In the same room there are all the ring spinning frames, both twist and weft. At the end of the ring room is the rope race, the engine being placed about midway, so as to form in a sense two wings, and adjoining the engine room in the first wing is a completely fitted mechanics' shop. After the yarn leaves the spinning room it passes into the winding and warping department. In this there are reeling, winding, warping, beaming,

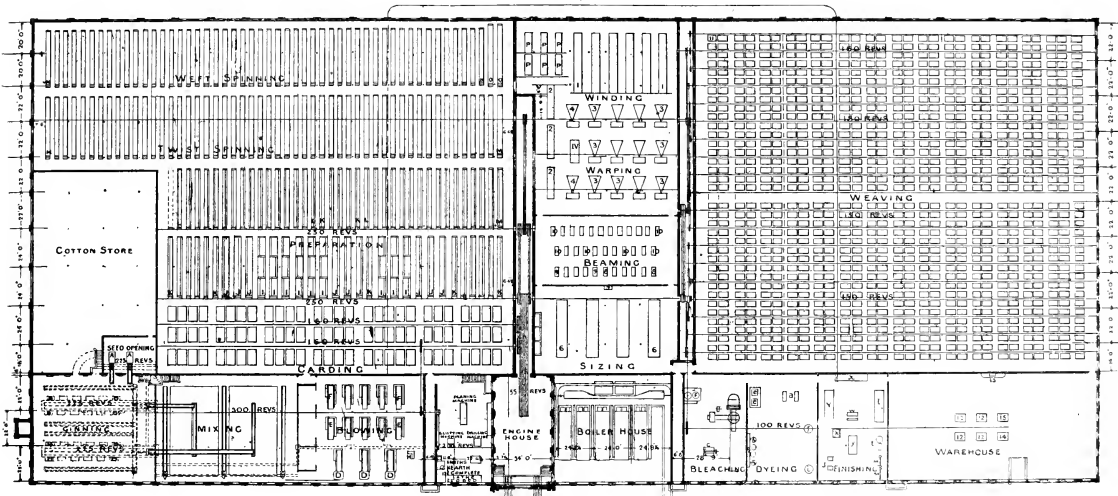
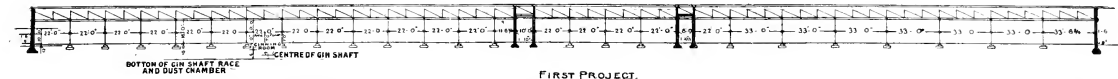

FIG. 55.





and sizing machines, the sizing room coming immediately behind the boiler room. From the sizing room access is got to the weaving shed, and this communicates with the bleaching, dyeing, and finishing rooms, and finally to the warehouse whence the cloth is despatched. Any one who has followed this description, along with the plan, will see that the cotton follows a regular course through the factory, and that there is literally no turning back with its accompanying labour. This is the cardinal feature of the plan, but it is a very meritorious one.

In all, this mill contains 33,536 ring spindles and preparation, and 1,000 looms and preparation, in addition to the finishing plant. Before detailing the machines used, it will be as well to notice the very complete driving arrangements. The engines and boilers occupy the centre of the building, the economisers being behind the boilers, and the chimney being brought to the front of the building. All the shafting is rope driven, and, as shown, the various line shafts in the ring room are independently driven. The cards and speed frames are driven directly from the line shafts, while the two sets of ring frames are driven from the line shaft by means of belts passing over gallows pulleys. The second motion shaft is carried across the sizing room, and forms one of the line shafts in the loom shed; but also acts as a counter from which the remaining lines in the shed, and in the dyeing and warping department are driven, a second rope race being provided for the purpose. This is a most convenient and compact arrangement, and serves the purpose of dividing the building into sections, which is not without value in case of fire. The light is obtained by an ordinary weaving shed roof, but it will be noticed that the lights are vertical, a most essential point in a climate of this character.

The machinery contained in this mill is as follows, taking it in departments :—

## SPINNING DEPARTMENT.

Two seed openers ; 24 double roller gins ; 3 feed tables ; 3 combined exhaust openers and scutchers ; 5 intermediate scutchers ; 5 finishing scutchers ; 80 revolving flat cards ; 1 waste picker ; 9 drawing frames, each three heads, of 8 deliveries ; 9 slubbing frames of 94 spindles ; 18 intermediate frames of 126 spindles ; 32 roving frames of 160 spindles ; 52 ring twist frames of 320 spindles,  $2\frac{3}{4}$ in. gauge ; 48 ring weft frames of 352 spindles,  $2\frac{1}{4}$ in. gauge ; 2 ring doubling frames of 320 spindles,  $2\frac{3}{4}$ in. gauge ; 6 double 40-hank reels.

## WEAVING DEPARTMENT.

Six winding frames of 336 spindles each ; 3 pirn frames of 100 spindles each ; 2 sectional warping machines ; 1 hank sizing machine ; 1 winding-off machine ; 4 sizing frames and 1 size mixer ; 6 drawing-in frames ; 5 looming frames ; 20 beam stands ; 1,000 looms ; 4 folding machines ; 1 cloth press, 1 bundling press, and 1 baling press ; 1 cloth marking machine.

## BLEACHING AND DYEING.

One kier, 4ft. by 40 by 4ft. 6in. ; 1 mixing machine and 1 hank washing machine ; 2 hank dyeing cisterns ; 2 indigo vats and 1 circular indigo mill ; 1 wringing post and four tubs ; 1/32 hydro-extractor.

## FINISHING.

Two sewing machines ; 1 three-bowl starch mangle ; 1 drying machine ; fittings for 3 starch boiling tubs ; 2 double hooking frames ; 1 damping machine, 1 belt stretcher, and 1 pasting table ; 1 three-bowl friction calender.

Fig. 56 is a plan of a second combined spinning and weaving mill, also provided with a finishing plant, and designed and furnished by Messrs. Brooks and Doxey, but smaller than the last example. It will be noticed that, with certain variations, the general scheme is not unlike the



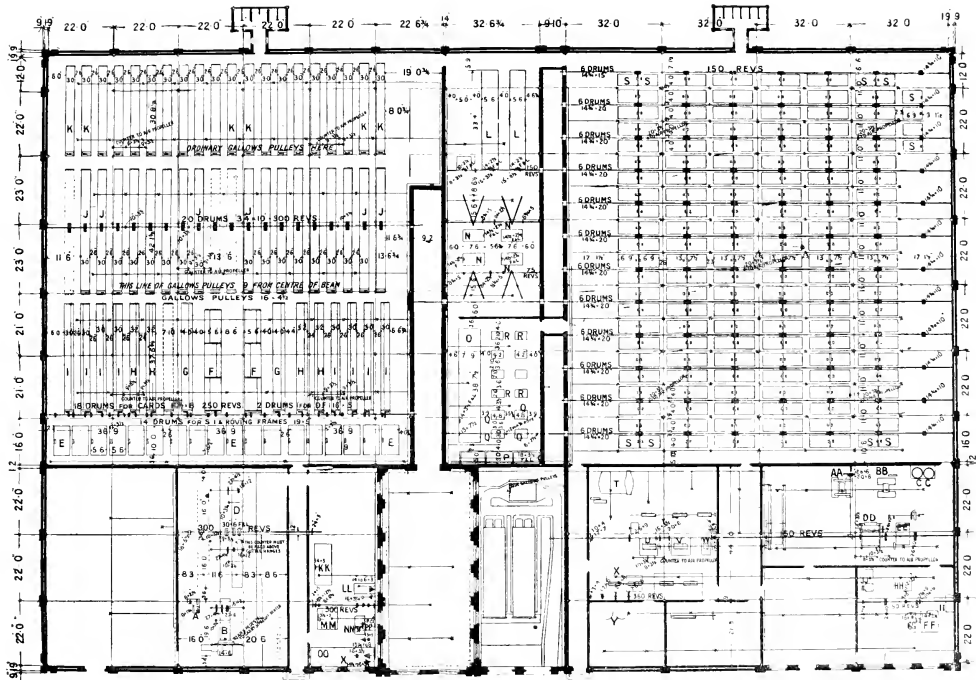

Fig. 56.



preceding example in the arrangements made to facilitate the forward movement of the material until it emerges from the warehouse. The cotton enters at the left-hand corner of the building, at which point the store is placed, and is fed to a combined opener and scutching machine, which prepares laps for subsequent treatment by a breaker and finisher scutcher respectively. In the card-room at the point adjoining the blowing room 18 revolving flat cards of the Wilkinson type are placed, these having 50in. cylinders 37in. wide on the wire. The slivers produced are dealt with by two drawing-frames, each having three heads of seven deliveries each. There are two slubbing frames, each containing 94 spindles and  $17\frac{1}{2}$ in. gauge, 4 intermediate frames of 126 spindles each and  $19\frac{1}{2}$ in. gauge, and 8 roving frames, with 380 spindles each and  $20\frac{1}{2}$ in. gauge. These supply the rovings for 16 ring spinning-frames, which contain 380 spindles each, and are  $2\frac{1}{2}$ in. gauge for twist spinning; and for 20 weft frames of 300 spindles, which are of  $2\frac{1}{4}$ in. gauge. Looking at the plan, it will be noticed that the slubbing, intermediate, and roving machines, which are respectively marked G, H, I, are driven directly from a line shaft running at 250 revolutions per minute, and so placed that the cards are also driven from it. The ring frames are driven from a line shaft running at 300 revolutions per minute by means of gallows pulleys. Both these shafts are driven directly from the main rope drum, the rope race forming a dividing chamber, as shown. Five air propellers are fixed in the roof of the shed so as to aid in the work of ventilation.

A second rope race is placed, as shown, and in that part of the building which is between these races the winding and warping machines are placed. These consist of two vertical spindle winding frames of 300 spindles each, intended to wind the yarn on to 5in. warping bobbins. Four beaming machines follow these, and one sizing machine, with a size mixer with three becks, is also placed, as shown, in a partially separated room. Four drawing-in frames

and eight beam stands complete the equipment of this part of the building. In the weaving shed proper there are 280 looms, with 38in. reed space, arranged, as shown, to be driven from line shafts, the pulleys on which are fixed in such positions that four looms can be driven from each. This gives a very compact arrangement. In the finishing room, seen at the left-hand corner of the loom shed, there are the following machines: One drying machine, a three-bowl water mangle, a two-bowl starch mangle, two starch tubs, a belt stretching machine, and a breaking and damping machine. The warehouse has the usual machines, viz., a cloth folder, a cloth press, a cloth marker, a jenny machine, and a small hydraulic press and pump. The mechanics' shop is placed alongside the engine house, which occupies the centre of the building, and contains a planing machine, an 8in. slotting machine, a drilling machine, a wheel-cutting machine, a 12in. slide lathe, and a small vertical engine.

The speeds of the various machines has been carefully arranged, and, as the following details will show, are designed to be high. The opener beater runs at 1,085 and the scutcher beaters at 1,518 revolutions per minute. The carding engine cylinders make 164, and the front roller of the drawing frame 355.5. The speed frames have the following spindle velocities: Slubbers, 664; intermediate, 812; roving frames, 1,199. The ring frames are arranged to revolve at 8,650 revolutions per minute.

It is, of course, true that this mill is designed for spinning and weaving what, to English readers, are coarse goods, but it has been thoroughly thought out for its purpose. Preparation has been made for the introduction of the electric light, and lamps are proposed to be hung in the positions marked with a cross. Both of the plans presented are excellent samples of that type of mill which is exceedingly useful in countries just beginning to spin and weave cotton, and may be said to mark the highest point of that stage of progress. In each case the plan is carefully devised and the details



ordinary medium counts from American cotton. These range from 32's to 40's twist and 40's to 50's weft, so that of all the mills illustrated this forms the one most typical of the staple Oldham trade. The engine house is placed as usual on one side of the mill, the rope race partially dividing the building into two sections. In order to accommodate the whole of the cards on one floor, part of them are placed in a small shed carried out at one side, the wall being carried for the upper storeys in a strong girder supported by pillars. The blowing room has the mixing room above it, and in the latter there is a bale breaker, with overhead lattice for stacking the cotton. The latter is fed to the opening machines by two porcupine openers with regulating apparatus and automatic feeders. These deliver by suitable dust trunks to two exhaust openers and lap machines combined. This combination of porcupine feed table, opener, and lap machine is being largely employed successfully, and forms a very effective arrangement. The addition of an automatic feeder makes it somewhat more complete. The laps from the openers are fed to four single beater scutchers, which in turn supply four finishing single beater scutchers, making laps suitable for 44in. cards. The carding engines are 96 in number, and are of the revolving flat type, having cylinders 50in. diameter, and 44in. wide on the wire. These are arranged as shown, and are driven from two line shafts fixed in the position indicated. The drawing frames are placed in sets of threes between the cards and roving machines, and number in all 15. Each contains four heads of four deliveries each, 17in. gauge, so that there are 240 deliveries in all, or 80 finishing deliveries. The slivers from the drawing frames feed 10 slubbing frames, each containing 98 spindles 18in. gauge, which supply 17 intermediate frames 140 spindles each,  $25\frac{5}{8}$ in. gauge. There are two sets of roving frames; one set, 20 in number, being  $20\frac{1}{2}$ in. gauge, and the other set, 24 in number, being 19in. gauge. Of the former,

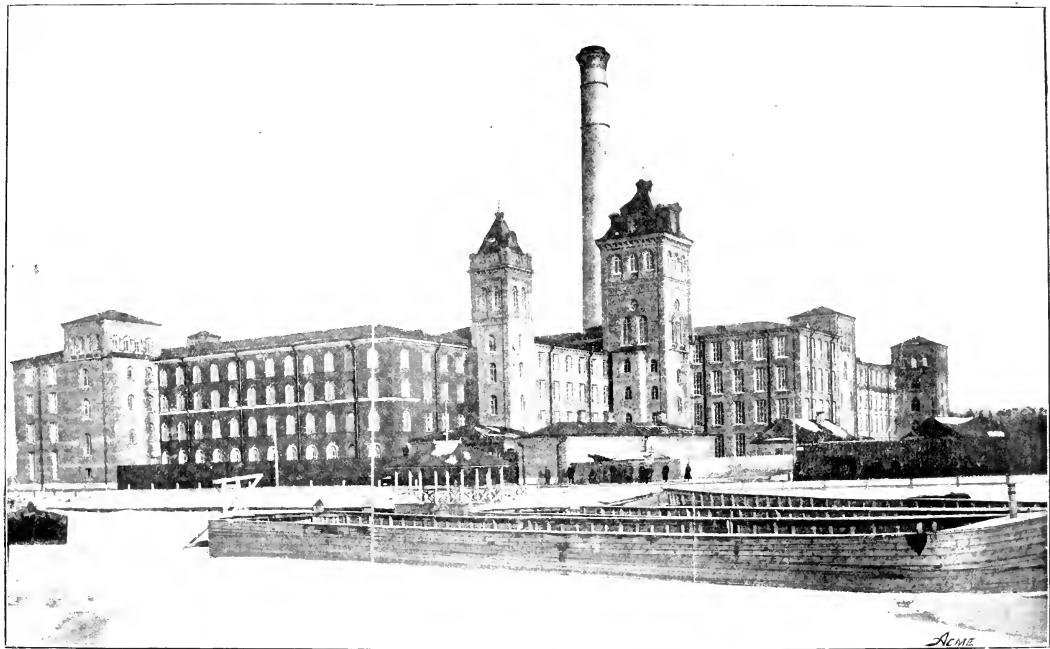

FIG. 58.

ordi  
The  
wef  
the  
The  
the  
ing  
the  
are  
the  
stro  
roor  
the  
head  
is fe  
oper  
mat  
trun  
com  
tabl  
emp  
arra  
mak  
the  
whic  
scut  
The  
the  
dian  
arra  
shaf  
fram  
card  
Each  
17in.  
80 fin  
frame  
98 s  
medu  
Ther  
in nu  
24 ir



18 contain 176 spindles each and 2 have 172 spindles each; while all the latter contain 192 spindles each. The mules are equally divided so far as numbers go between twist and weft, but there are more spindles devoted to spinning the latter. The twist mules number 38, containing in all 41,844 spindles, the gauge being  $1\frac{3}{8}$  in.; and the weft mules, which also number 38, contain 50,436 spindles, a total of 92,280. There are two things to note in this mill. The first is the fact that the cards are wider than those used in some of the other cases; and the second, that of all the instances given this one alone furnishes an example of a mill devoted to the typical Lancashire counts. The proportions of the machines to the mule spindles are as follows:—

|                                       |        |                 |
|---------------------------------------|--------|-----------------|
|                                       |        | Spindles.       |
| 2 openers .....                       | = 1 to | 46,140          |
| 4 breaker and 4 finisher scutches ... | = 1 „  | 23,070          |
| 96 carding engines .....              | = 1 „  | 961·2           |
| 80 finishing drawing deliveries ..... | = 1 „  | 1,153·5         |
| 980 slubbing spindles.....            | = 1 „  | 94·4            |
| 2,380 intermediate „ .....            | = 1 „  | 39              |
|                                       |        | Twist Spindles. |
| 3,512 roving „ .....                  | = 1 „  | 11·91           |
|                                       |        | Weft Spindles.  |
| 4,608 „ „ .....                       | = 1 „  | 10·94           |
| 41,844 twist mule „                   |        |                 |
| 50,436 weft „ „                       |        |                 |

In Fig. 58, a reproduction from a photograph of the Nevski Thread Mill, St. Petersburg, which belongs to a syndicate of English owners, is given. It is situated on the banks of the River Neva, which is shown as frozen over, and consists of two mills, the older one being in front and the newer one lying at the back. The latter was erected from the designs of Mr. W. J. Morley, Bradford, to whose courtesy the author is indebted for the loan of the photograph. It will be noticed that the windows of the

new mill do not show quite such a large area of glass as in England, the clear atmosphere rendering this unnecessary. It may be mentioned, however, that all the windows are double.

---

## CHAPTER X.

### STEAM BOILERS.

The boilers used in cotton mill practice in England are of the Lancashire type, with or without Galloway tubes, water tube boilers, although preferred elsewhere, not meeting with much favour here. In spite of the increase in steam pressures this style of boiler continues to be the favourite, and is now working at pressures up to 250lbs. to the square inch. Galloway tubes are generally specified, and their wide adoption is in itself testimony to their usefulness. The boilers are now universally made of steel, or so nearly so that the statement is practically true, and as more use has been made of this material the methods of manipulating it have improved. It is not too much to say that steel boilers are better made, and are more reliable than iron boilers formerly were. In order to enable our readers to appreciate the character of a modern boiler we give them a copy of a specification of a Lancashire boiler, intended to work habitually at a pressure of 200lbs. to the square inch, and which has been so working for about two years. A good specification is an important matter, and affords *primâ facie* evidence that the details have been thought out. The specification referred to was drawn by Mr. J. F. L. Crosland, the Chief Engineer of the Boiler Insurance and Steam Power Company, Limited, and the boiler was made to his approval. Attention is particularly called to the clause giving the tests to which the plates must be subjected.

## SPECIFICATION FOR A STEEL LANCASHIRE BOILER.

Working pressure 200lbs. to the square inch, to be delivered on its prepared seating. Length, 28ft. ; diameter, shell, 8ft. in eight or nine rings of one plate each, flues, 3ft. 2in. in at least 18 rings of one plate each ; shell plates,  $\frac{1}{8}$ in. ; straps, inside,  $\frac{5}{8}$ in., outside,  $\frac{3}{4}$ in. ; ends,  $\frac{1}{8}$ in. ; flue plates,  $\frac{1}{8}$ in. ; shell and gusset angles,  $5 \times 5 \times \frac{5}{8}$ . Circular seams double riveted, longitudinal seams butt jointed, treble riveted.

### CONDITIONS OF CONTRACT.

#### Drawings.

Before the work is put in hand the makers are to provide and supply a tracing on cloth to the owners, and also a similar tracing to their engineer for sanction and concurrence, each tracing drawn to scale with figured dimensions, showing clearly the general arrangement of boiler, mountings, setting, etc., and in addition detail tracings with figured dimensions of all mountings, and of the riveting, and of the staying of the ends, and notwithstanding any such sanction or concurrence, or the approval after inspection of the work by any representative of the said engineer or his representative, the contractors will be required at their own expense to make good any defects which may arise from faulty design, material, or workmanship during the period of twelve months after the boiler has been set to work.

It is to be understood, however, that in the event of the boiler being insured, the stipulation is not intended in any way to relieve the Boiler Insurance Company from the responsibility incurred upon them by the Policy of Insurance.

#### Material and Workmanship.

The workmanship must be of the best, and the material must be free from defects of any kind of the best boiler quality supplied by the steel makers. The boiler is to be open for inspection by the engineer or his representatives at any time during construction as well as on completion of the work, and to be tested and completed in every respect to the satisfaction of the said engineer.

#### Brand of Plates.

The plates must be made by the Siemens-Martin acid process, and the brand of the plates must be stated in the tender. The brand and tensile strength and elongation must also be clearly stamped on every plate in such a position that it can be seen from the outside of the boiler when finished, and the maker's certificate of the tensile strength of every plate must be forwarded.

### Margin for Variation.

It is to be understood that no plate will be passed for use in the boiler which is not fully up to the specified thickness and weight, and it is assumed that the margin usually allowed for variation in rolling the plates, say five per cent, will, in accordance with the practice of the best makers of boiler plates, be above the specified thickness and weight.

### Tests of Plates.

Strips from the steel plates and angles are to be provided by the contractor for testing in accordance with the direction of the engineer. All costs in connection with such tests to be defrayed by the contractor. The tensile strength of the steel for the shell, etc., cut lengthways or crossways, is not to be more than 30 tons per square inch, nor less than 26 tons, and that for the furnaces and flues is not to be more than 28 tons per square inch, nor less than 24 tons. In all cases the elongation is not to be less than 20 per cent in a length of eight inches.

Strips from the plates for the furnaces, flues, and angles are to be capable of being readily welded, and the strips from these and the plates for the shell are to be capable of being bent double cold to a radius of one and a half times the thickness of the plate without fracture, after having been heated red-hot, and slaked at that heat in hot water of a temperature of not more than 82 degrees Fahrenheit. Samples of the rivets are to be submitted to such test, both hot and cold, as to bending, breaking, flattening, etc., and applied in such a manner as may be considered necessary to prove their fitness for the service intended.

### Position of Mountings.

The maker of the boiler is to be entirely responsible for obtaining the particulars necessary to show the arrangement of setting, and for the position of the various mountings, details as to which must first be arranged by him with the purchasers, and then shown on the tracing before named.

### Bending.

The plates are to be bent cold.

### Punching and Drifting,

No punching is to be done for any purpose to any material used in the construction of the boiler, and drifting of the holes is under no circumstances to be resorted to.

### Planing.

All edges of all plates and butt straps without exception to be planed or machined.

### Fullering.

All seams to be fullered inside and outside (not caulked) after riveting.

### Scouring.

The plates and angles to be scoured entirely with a strong solution of sal-ammoniac to remove the black oxide from their surface before being put together.

### Placing in Position.

The price named in the index is to include the supply of the boiler with all mountings and fittings named in the specification properly jointed and fixed in their permanent positions, together with delivery in good condition on its prepared seating. The contractors to supply all skilled labour and all tackle necessary for placing the boiler on its prepared seating, but they do not supply any bricks, stonework, etc., nor undertake any mason's work, brickwork, joiner's work nor ironwork (other than the ironwork in connection with the boiler and its fittings) under this contract, and the purchaser is to provide all labourers' assistance. It is, of course, understood that the contractors will be afforded all reasonable facilities for placing the boiler in position, and will not be required to remove nor to replace any permanent obstruction, nor to pull down nor make good any stonework, ironwork, masonry, brickwork, nor joiner's work.

### Notice for Examination.

Notice is to be given to the engineer so that the work may be inspected—(1) When the plates are ready for bending in the rolls; (2) when the boiler is in process of being drilled; (3) when the riveting of the shell and flues is being done; (4) when the boiler is complete in every respect, and ready for final testing in the presence of the inspector.

## PARTICULARS OF PLATES, ETC., OF BOILER.

### Dimensions.

The boiler is to be 30 feet long and 8 feet in diameter, measured inside of the outer rings of plates with two internal flues each 3 feet 2 inches internal diameter except the second ring from the back end of each, which is to be tapered to 2 feet 7 inches, and the last ring which is to be 2 feet 7 inches parallel.

### Shell.

The shell is to be formed of eight or nine rings, as may be found most suitable for the arrangement of the various fittings, each ring being formed of one plate only. Each ring to be perfectly cylindrical and to have the longitudinal joints so arranged as to fall on the upper part of the shell, and in such a position that when the boiler is seated they will fall clear of the covering of the side flues and the gusset stay angles. The plates are not to be less than  $\frac{1}{2}$  in. thick,

33·25lbs. per square foot of the best quality of mild steel, and capable of satisfactorily sustaining all the tests previously specified.

### Circular Seams.

The circular seams are to be double-riveted, with lap joints.

### Longitudinal Seams.

The longitudinal seams are to be butt jointed, with straps inside and outside, and to be treble-riveted, six rows of rivets.

### Butt Straps.

The butt straps to be cut by the makers of the boiler out of boiler plates of the same quality as the shell plates, the inside straps to be not less than  $\frac{5}{16}$  in. thick, 25·5lbs. per sq. foot, and the outside straps to be not less than  $\frac{3}{4}$  in. thick, 30·6lbs. per square foot; they must be capable of satisfactorily complying with the tests specified. When placed in position the fibre in the shell plates and in the butt straps must be in the same direction.

### Ends.

The end plates are each to be in one piece, rolled full size to avoid welds or joints, not less than  $\frac{1}{16}$  in. thick, 33·15lbs. per square foot, turned on the edge, with holes for the flues cut out by machine. The plates are to be of the best quality of mild steel, and capable of satisfactorily complying with the tests previously specified. The front end plate is to be joined to the shell by an external steel ring. The back end plate is to be flanged for its attachment to the shell and to be double riveted thereto.

### Shell Angle Ring.

The angle ring for the front end of the shell is to be of the best quality of mild steel, not less than 5in. by 5in. by  $\frac{5}{16}$  in., and capable of satisfactorily standing the tests previously specified. It is to be welded solid at the joint, and fixed externally, and to be double riveted to the shell and end plate.

### Stays.

The ends are to be strengthened by means of five gusset stays at each end above the flues, and two at each end below the flues, all secured by double steel angles not less than 5in. by 5in. by  $\frac{5}{16}$  in., both to the ends and shell. The steel gusset plates to be not less than  $\frac{5}{16}$  in. thick, 35·7lbs. per square foot. The gusset angles and gusset plates must be equal in quality to the shell plates, and capable of satisfactorily standing the specified tests. The angles to be double riveted to the ends, gussets, and shell plates. The rivet holes for the stays in the shell plates are to be so arranged that the pitch is greater than the widest pitch in the longitudinal seams of

the shell. The bottom rivets in all the gusset stay angles on the end plates must be equidistant from the centre of the flues, and with the exception of those stays which are placed below the internal flues, the distance between the bottom rivets referred to above and the rivets joining the internal flues to the ends must not be less than 10 inches.

### Internal Flues.

Each internal flue is to be formed of at least eighteen rings so arranged that the circular seams do not fall in line with each other nor with those of the shell. The plates are not to be less than  $\frac{9}{16}$  in. thick, 23lb. per square foot, of the best quality of mild steel, and capable of standing the specified tests. Each ring to be formed of a single plate welded longitudinally by steam hammer and connected by flanges with solid caulking rings between of a thickness not less than the plates themselves, and the flanges for the attachment of the flues to the end plates are to be stiffened by means of steel angle plates not less than  $\frac{3}{8}$  in. thick, 15·3lb. per square foot, shrunk on, and flanged with the glue plates, and riveted to them by rivets about 5in. or 6in. pitch, or the flues may be attached to the ends by steel angle rings,  $3\frac{1}{2}$  in. by  $3\frac{1}{2}$  in. by  $\frac{5}{8}$  in. Each flange to be formed at one heat. All the rivets to be 2in. pitch.

### Rivet Holes.

The rivet holes in the shell and those for the gusset stay angles are not to be less than  $\frac{1}{4}$  in. diameter, and so spaced that the calculated value of the joint shall exceed 80 per cent, and those in the flues are not to be less than  $\frac{3}{4}$  in. diameter, drilled out of the solid plate; and wherever practicable this is to be done with the plates and angles in position. The holes are to be afterwards slightly counter-sunk under the rivet heads and the burr cleaned off between the plates. If from any cause they are at all unfair when the plates are drawn up together for riveting, they are to be rimmed perfectly true before riveting.

### Rivets.

All rivets to be capable of satisfactorily complying with the test requirements specified in a preceding clause. Steel rivets may be used for the shell, but Lowmoor rivets are to be used for the furnaces and flues throughout, and also in any parts of the boiler requiring to be hand riveted, but the riveting is to be done by machine wherever practicable.

### Hydraulic Test.

The boiler is intended to be worked at a pressure of 200lb. per square inch. It is to be tested by water pressure to the satisfaction of the engineer, both on completion at the makers and again after it has been seated at the purchaser's works, to 300lb. per square inch, with all mountings in

position except the safety valves, which must, however, before delivery be tested independently to the same pressure as the boiler. It is expected that every part will be tight, and that neither serious deflection nor indication of permanent set will be shown.

## MOUNTINGS AND FITTINGS.

### Manholes.

A strong wrought-iron raised frame, 16in. diameter of approved design, with suitable wrought-iron cover and bolts, to be attached to the boiler on the top outside; the manhole opening to be further strengthened by a steel doubling piece inside, of sufficient breadth to enable it to be attached to the shell by a row of rivets independent of those which pass through the manhole frame, and this row of rivets must be pitched 20 per cent wider apart than those in the longitudinal seams. The manhole frame to be attached to the shell by a double row of rivets passing through both the shell plate and the internal doubling plate.

A strong steel ring fitted with suitable steel cover, cross-bars, and bolts, and having an opening not less than 16in. and 12in., to be fixed on the inside of the front end plate round the manhole opening below the flues, and to be double riveted to the plate. The manhole frames, covers, and bolts to be of approved design, material, and strength, and both the frames and covers to be faced to make the joints steam tight with only a thin coat of red lead.

### Branches.

Wrought-iron branches to be double riveted on for all the mountings, and the flanges, to which the mountings are to be attached, are to be turned or planed. The position of the mountings will have to be arranged in accordance with preceding instructions.

### Stop Valves.

One steam stop valve 8in. diameter, of approved design and construction, the casing and cover to be of steel.

### Anti-priming Pipes.

A perforated cast-iron steam pipe is to be placed horizontally inside the boiler near the top, and connected with the branch for the stop valve.

### Safety Valves.

One direct spring loaded safety valve, Adam's or Turnbull's patent, 4in. diameter, accurately loaded to 200lbs., fitted with easing gear, and having a crossbar for turning it round on its seating; and one Hopkinson's "Hipress" valve of at least equal area, having an efficient and approved low water arrangement, and loaded to 200lbs. per square inch.



### Feed Valve and Pipe.

One check-feed valve  $2\frac{1}{2}$ in. diameter of approved design and construction, the casing and cover to be of steel, attached to the front end plate and connected to a pipe not less than 15ft. long carried forward horizontally into the boiler, parallel with the flues, and delivering the water at least 2in. above the level of the furnace crowns.

### Blow-off Tap and Pipe.

One  $2\frac{1}{2}$ in. blow-off cock, of approved design and construction, with compound gland, both the casing and plug to be entirely of brass and asbestos packed both in the casing and gland, and so constructed that the spanner cannot be taken off until the tap has been closed. The tap to be connected to a strong cast steel elbow pipe, of approved form and section, not less than 6in. internal diameter at its connection to the faced branch on the boiler, and not less than 1in. section of metal in the body.

### Water Gauges.

Two glass tube water gauges, of the best construction, Dewrance's or Hopkinson's heaviest pattern, made of gun metal, asbestos packed, with large water and steam thoroughfares, and arranged to shut off steam and allow the passages to be cleaned.

### Pressure Gauge.

One 10in. steam pressure gauge, Bourdon's own make, graduated to 300lbs., and having a thick red line at 200lbs., and arranged with the cock to open to the atmosphere when shut off from the boiler for the purpose of testing.

### Grate Bars.

One set of grate bars of deep section,  $\frac{1}{2}$ in. thick and having  $\frac{3}{4}$ in. air spaces, in three lengths for each furnace, with bearers, dead plates, and bridge plates, the total length of fire bars to be 6ft. 6in.

### Furnace Frames, etc.

Furnace frames and doors constructed for smoke prevention to be fitted, having at least two square inches of air space per square foot of fire grate.

### Dampers.

Dampers and frames, with all pulleys, chains, rods, and weights complete and fixed.

### Flue Doors.

Two flue doors and frames complete for access to the external flues.

### Foot Plates and Bearers.

Foot plates and bearers for covering the blow-off pit, the flooring plate in front of the blow-off recess to extend upwards behind the angle ring of the shell, and to be curved so as to fit the bottom of the boiler to prevent the ashes falling into the blow-off pit.

In order to illustrate the constructive details a number of sketches prepared to illustrate a paper read by Mr. James Shenton, of Hyde, in December, 1893, are given. Mr. Shenton is a practical constructor of boilers, of extended experience, and his

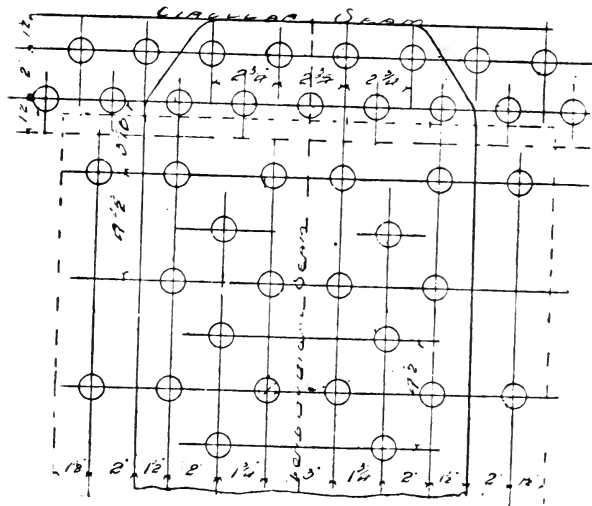

FIG. 59.

remarks are valuable. Figs. 59 and 60 are illustrative of the lap joints used for longitudinal seams. That in Fig. 59 is one most generally adopted, and has a strength of 83·3 per cent, while the example given in Fig. 60, which is designed and made by Mr. Shenton, gives an effective strength of 88·8 per cent. In addition to the extra strength this joint is advantageous because there is less space between the outer rivets and the butt strips are held down

better. Where the pitch is so wide as in Fig. 59, there is great difficulty in avoiding leakage between the rivets, on account of the large space. This is entirely obviated by the construction used in

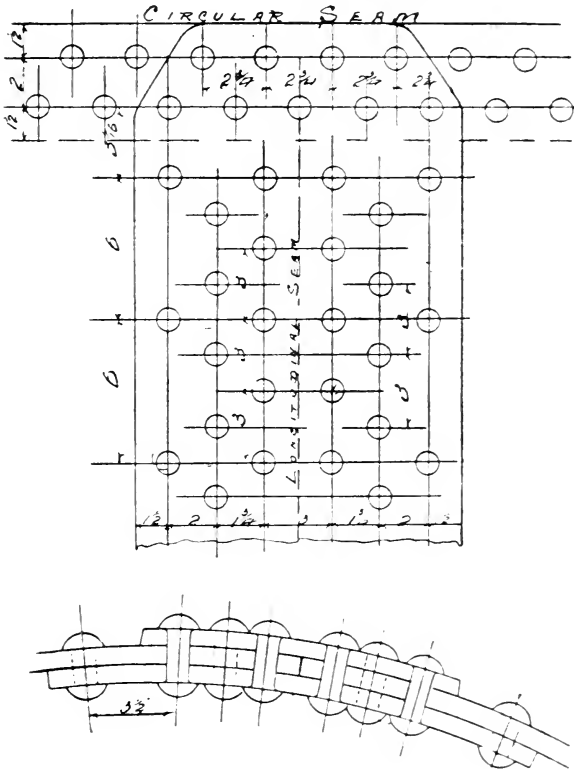

FIG. 60.

Fig. 60, which enables a tight joint to be got with very little caulking. Without endeavouring to instruct our readers as to the method of making a boiler, it will be sufficient to give a few hints as to the essential points of construction. It is necessary

that the shell plates at the butts shall be bent to a true circle. Unless this is done the butt straps will not lie close up to the plates, and leakage will take place at that point. This is shown in Figs. 61 and 62, which represent the two conditions. In a modern boiler-making establishment, the provision and utilisation of modern machine tools is a characteristic feature, and the setting out of the various rings for drilling is a thoroughly scientific operation. All holes should be drilled, and the edges of all plates planed to a proper bevel so as to be easily caulked. The caulking should be done with a tool which while fullering the edge of the plate does not groove the shell. Extreme care is taken to



FIGS. 61 AND 62.

ensure the drilling of all the holes in plates and straps to be fastened together, so that they will come exactly true with each other when being put together subsequently. In riveting, which should be done by power, the pressure must be put on in a line which is directly along the axis of the rivet, and should be retained until the rivet is cold, as only in this way can a tight joint be obtained. With regard to the flues, these are built up and put together in an equally thorough manner as the shell, each ring being welded along its longitudinal seams. The various types of corrugated or ribbed flues have not been largely employed in Lancashire boilers, but several types of expansion joints, such as the Bowling hoop, have been widely adopted. With one of

the simplest and most effective of these, the name of the late Mr. Daniel Adamson has been long associated. The method of setting out the front and back end plates of a boiler for the gusset stays and flues is shown in Figs. 63 and 64. These few remarks, in conjunction with the specification given, will enable readers to form an accurate idea of the necessary points in a well-made boiler,

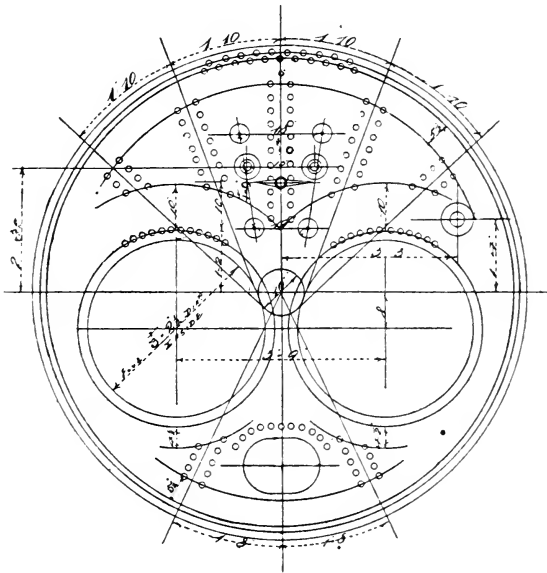

FIG. 63.

and they will be convinced of the care which is now taken in constructing a boiler of the Lancashire type.

The standard of power generally adopted for a boiler is that agreed upon by the engineers at the Centennial Exhibition in Philadelphia, which was the evaporation of 30lbs. of water per hour from an entering temperature of 212° F. when the steam



gases. It is a safe rule to calculate that the grate area should be at least equal to one-tenth the total heating area, although higher ratios are adopted. The proper size of a boiler is determined by the evaporation required, and can be calculated from the coal duty, which in turn determines the heating surface required. In the type of boiler under consideration, fourteen square feet of heating surface will be sufficient to evaporate one cubic foot of water.

In setting the boilers, the flues should be made large enough to allow a man to pass through them easily, and the undue contraction of the flues is very detrimental, as it renders inspection much more difficult. The smallest space should be at least a foot, and as a justification for this procedure it may be mentioned that it is better to have a moderate velocity of the gases, as in that way more heat is extracted from them. It is now the general practice to sustain the boiler on two seats, so as to form three flues under the boiler, one at each side and one in the centre. The use of a midfeather is dropped. In setting, care should be taken that all the seams are accessible for examination, and it is not desirable to cover too large a portion of the plates by the seatings. Especial care is needed to guard against leakage under the bearing surfaces, which is a fruitful source of corrosion, and no lime should be left in contact with the plates. The air required to burn good Lancashire coals, the calorific value of which is about 13,500 thermal units, is, according to Mr. Longridge, in practice, from 15 to 16lbs. per lb. of coal. This matter depends to some extent upon the character of the coal with regard to clinkering. If it is clean and burns well, then the smaller quantity of air is sufficient; if otherwise, the larger amount is required.

Mr. Longridge, at the conclusion of the paper named, gave the following hints to boiler users:—

(1) Get your boilers designed for the work they have to do, and not made 7ft. 6in. by 30ft., or 8ft. by 28ft., as the case may be, because it is

the fashion to have boilers of these particular dimensions.

(2) Don't stick to 6ft. grates if a shorter length is required to burn the coal at the rate of 16 to 21lbs. per hour.

(3) Reduce your draught as much as the nature of the coal and the smoke inspector will permit. Try and reduce it till the fire is hot enough to melt a piece of steel boiler plate.

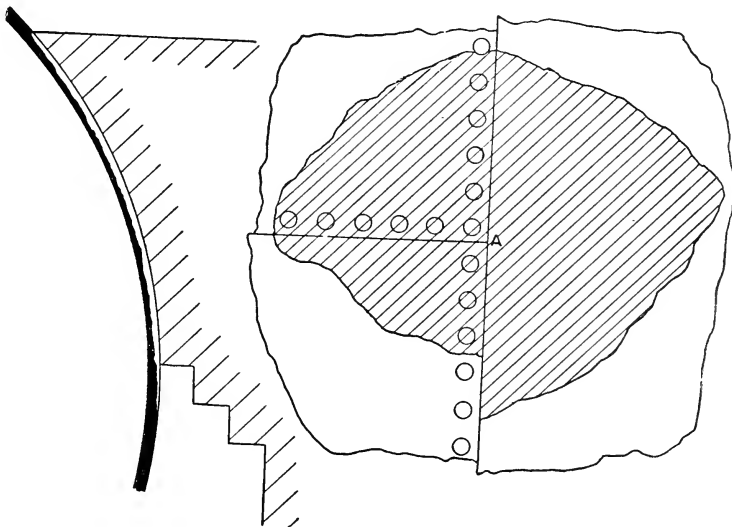

FIG. 65.

(4) Buy your coal dry and keep it dry. Weigh the ashes which come out of the furnaces as well as the coal that goes into them.

(5) Be most careful to stop up air leaks in the brickwork and between the brickwork and the boiler.

(6) Establish a gasometer for collecting gases from the flues and analyse them for carbonic acid, and try to get ten or twelve per cent of that gas in the samples by cutting down the draught. The



apparatus and its manipulations are of the simplest character, and the information gained will be of great practical utility, and will often lead to considerable economy.

It may perhaps be of service to detail a few of the causes of failure in mill boilers. Among these corrosion is a very common one. Internal corrosion is the result of acidity in the feed water, which is often caused by the employment of water heated by means of exhaust steam, especially if animal oils or fats are used as lubricants. There are, however, feed waters drawn from wells or collected by surface drainage which contain free acids, and in this case the introduction of some form of

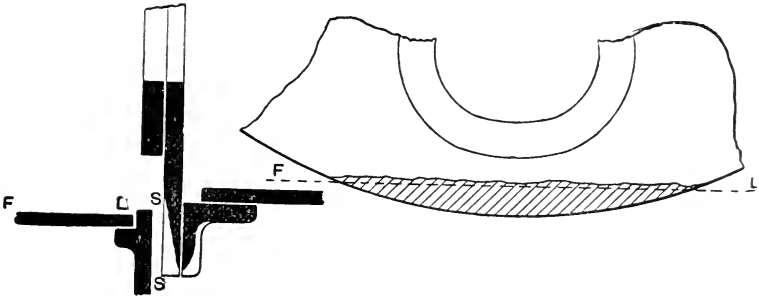

FIG. 66.

neutralising agent is essential. External corrosion is more frequent than internal, and is in most cases caused by dampness either caused by leakage or from imperfect drainage below the flues and settings. For instance, in the example shown in Fig. 65 there had been leakage at the seam which was covered by the seating, and the moisture had spread over a large surface, setting up active corrosion as shown. The composition of the gases evolved by the combustion of some classes of coal often actively aids in setting up corrosion, and the writer has had a very striking experience of the power of the combination of sulphurous coal and moisture to set up dangerous corrosion. Boiler owners should take care of leaks, and should also see that at the front of

the boiler, where the ashes are drawn from the furnace and cooled, no accumulation of moist ash is allowed to exist. Fig. 66 shows the result of this procedure. Grooving or channelling is another frequent occurrence, and is caused chiefly by the unequal heating of various parts of the boiler. This action causes a certain "work" of the plates, and thus produces strain in them, which rapidly forms a groove if any chemical corrosive is in the water. The grooves are mostly found about the angle rings of the front end plates, but if there is due elasticity in the ends they may be avoided.

As it is customary to test boilers by hydraulic pressure prior to putting them into work, a few words of warning may be given as to precautions necessary when this is done. Most owners are satisfied to know that the boiler has been thus tested to a pressure in excess of that at which it will work. As a matter of fact this is only a part of the precautions to be taken, and forms a source of danger unless carefully carried out. It is essential to success that the character of the material and construction should be carefully specified and scrutinised during construction, and although this is a matter involving some expense it is always advisable. Before a test is made by hydraulic pressure careful measurements of the boiler should be made, especially as regards the flues. When the pressure is applied, measurements should again be taken, and the deflection, if any, in the flues and end plates carefully noted. The tightness of the rivets and seams must be looked to, but, although a high standard has now been reached, the importance of an absolutely drop proof test may be easily exaggerated. In a well-made boiler in which the holes are drilled in position, and the rivets closed by power properly applied, leakage of the rivets is very infrequent, and a slight leakage of the seams is often only a small matter. The true test is the maintenance for a reasonable time of the pressure applied, and it is not uncommon to see it remain stationary for several minutes. After the water has been run off the

measurements of the parts should be again taken, in order to see if any permanent set has occurred. It is not an infrequent occurrence to find ovality in the flues, or bulging of the ends. If this is found to exist to any considerable degree it proves the boiler to be unfit for its intended duty. It is not detrimental, but quite the reverse, if the end plates bulge under pressure, because it proves that the staying is not so rigid as to prevent the ordinary expansion which takes place during work. It is inadvisable, especially with high pressure boilers, to subject them to too severe a test, and a test pressure, 75 per cent over the working pressure, is, in the opinion of the writer, the maximum which should be applied.

In order to ascertain the evaporative capacity of boilers, tests are made preferably under working conditions, and as many millowners may like to know the method of making these tests a few particulars are here given. It will be at once obvious that the two important factors are the consumption of coal and of water, and every endeavour ought to be made to arrive at these accurately. With regard to coal consumption, the course followed is to clean out the furnaces before beginning the test, and to have at its commencement a good fire of proper thickness. Care should be taken to have all the coal as dry as possible, and as nearly uniform in that respect as can be. It should be carefully weighed in lots of definite weight, say 1 to 5 cwts.—the time of doing so being noted—and the firing must be conducted in the ordinary way so as to maintain an even fire. At the conclusion of the test the fire must be left in the same condition as at the beginning, and all ashes should be carefully weighed, but it is advisable periodically to draw out the cinders from the ashpit and pass them through the fire in order to utilise all combustible matter. It is obvious that the obtainment of the same conditions at the beginning and end of a test is a matter requiring care, and a little error may thus

creep in. All the coal unused should be weighed, and deducted from the amount weighed to the stoker. The record therefore shows the number of pounds of coal used during the test, and the ashes remaining at the end, the difference between these being reckoned as the number of pounds of combustible. The water must be carefully measured. The height in the boiler gauge glasses at the commencement of the test is carefully noted, and some mark should be made, or measurement taken and noted of the height. At the termination of the test it is desirable to have the water at the same height, as otherwise a calculation must be made of the increase or decrease of the quantity of water in the boiler. This is a matter requiring care alike in manipulation and observation, but with a little pains an accurate result is possible. For measuring the feed water the best method is to provide two tanks, capable of holding a little over 100 lbs. of water or any other definite quantity, and of such a depth that a gauge glass can be fixed so that two points can be marked on it, between which the quantity of water named is contained. The feed water is supplied to the tanks by two ordinary plug taps, either of which can be used when necessary, one tank being filled while the other is being exhausted. The tanks are coupled together by a pipe, and a two-way cock is placed between them, so that the feed pump or injector can draw from either as needed. The tanks are both filled to the upper mark at the beginning of the test, and as the required quantity is taken from each, the time is recorded. At the end of the test the quantity of water drawn from the partially emptied tank is noted and added to the quantity previously used. A note of the temperature of the feed water must be taken at regular intervals, and the mean of the observations is taken as the temperature. The following is a sample of the headings of the observation sheet, but these may be varied at will:—

| COAL.            |       |         |                              | WATER.              |       |                            |
|------------------|-------|---------|------------------------------|---------------------|-------|----------------------------|
| No. of Weighing. | Time. | Weight. | Weight of Ash at Completion. | No. of Tank Emptied | Time. | Temperature of Feed Water. |
|                  |       |         |                              |                     |       |                            |

By dividing the weight of water used by the pounds of coal consumed, the evaporation per lb. of coal is obtained. The ash and cinder remaining should be carefully weighed and deducted from the weight of coal. The result is accepted as the amount of combustible matter. It is usual to estimate the evaporation from and at 212° F., and the following rule is used to calculate it.  $W$  = weight in lbs. water evaporated per lb. of fuel;  $t$  = mean temperature of water;  $H$  = total heat in British thermal units in the steam at a pressure calculated from 0° F, and  $E$  = equivalent evaporation from and at 212° F.:

$$E = W \frac{H - t}{966}$$

The thermal units will be found in a table at the end of the book. It must be understood that these remarks do not apply to the scientific test of a boiler, an operation requiring a large number of accurate observations, but merely to such a test as is required by a millowner.

## CHAPTER XI.

### BOILER APPLIANCES.

It is customary and advisable to place behind steam boilers a feed water heater or "economiser." Of these there is practically only in use in cotton mills to-day the type known as Green's. This, as made by Messrs. Green and Sons, Limited, is illustrated in Fig. 67, and consists of a series of vertical cast-iron pipes, arranged in sections and fixed at the top and bottom into hollow boxes. The

pipes are nearly 4in. bore, and are made of a thickness suitable to the pressure they have to with-

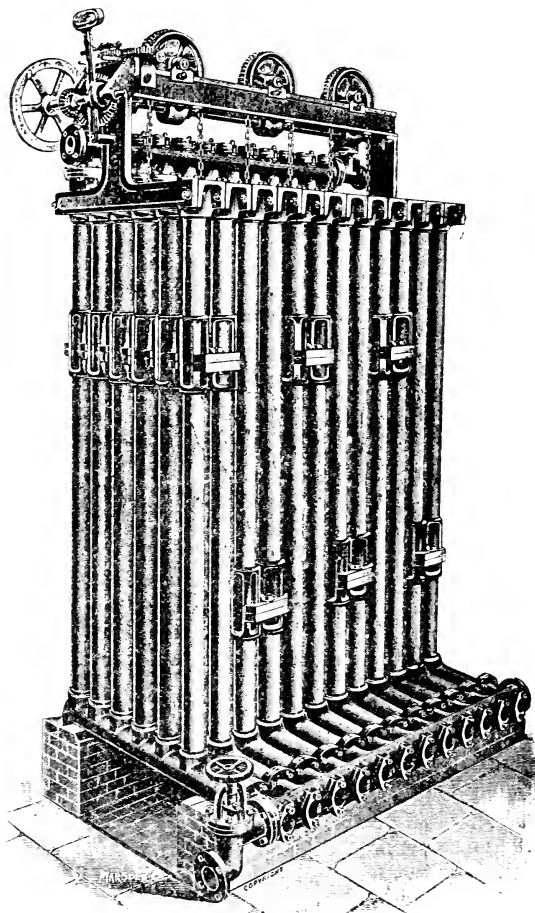

FIG. 67.

stand. The feed water enters the bottom box of each section, and rises until it flows out of the top box. The economiser is placed directly in the

course of the gases in the flue, the heat from which raises the water to a temperature varying from 250° to 300° F. It is not desirable to cool the gases to too low a temperature, as otherwise the chimney draught is injured. As a certain amount of soot is deposited on the outside of the pipes, cast-iron "scrapers," which are given a reciprocal vertical movement, are arranged to scrape it off continuously. Some ingenuity has been expended on the construction of these scrapers, so that they shall press keenly on the pipe, and thus remove the soot which may accumulate. The gain from the use of an economiser is two-fold. It lessens the amount of fuel needed to boil the water, and, by providing hot instead of cold feed water for the boiler, diminishes the strains on the latter. It is desirable that the feed water should not be too cold, as otherwise the aqueous vapour in the gases is condensed on the outside of the pipes at the bottom and produces corrosion, which is increased if there happens to be any sulphur in the coal. If there be eight pipes in a section, the space occupied is 6ft., and 4 sections occupy in width 3ft. 4in., 8in. being added for each additional section. An economiser contains about 8 pipes for each ton, and 4 pipes per ton of coal burnt are required. The capacity of each pipe and the corresponding space in the two boxes is 6 gallons.

There have been large numbers of appliances patented from time to time for the purpose of aiding in the mechanical stoking of the boilers. It is curious to note how the same idea occurs periodically in a slightly modified form. The devices used may be thus classified: Steam or air blasts, stoking machines, divided bridges, and forced draught appliances. Of these the latter at present is not in extended use, but is making considerable progress, the most favourable method being to close the ashpit and create a slight pressure in it. With reference to steam blasts these are applied at the front of the furnace, in which a steam nozzle is fixed, so that the induced current thus set up

increases the draught. For cases in which the chimney draught is bad, or when a sudden supply of steam is required, this class of appliances gives good results, but otherwise their employment is of doubtful economy. The plan of using a divided bridge has the merit of admitting air at that point, and thus aiding in the combustion of the evolved but unconsumed gases which are produced after stoking. When the fire has burnt through, however, and the volume of unconsumed gases decreases, there is, unless the air inlet is contracted, an excessive supply of air at this point, which carries away with it a number of heat units, thus producing no useful, but rather a wasteful, effect.

With regard to mechanical stokers these have been mainly of two classes—the coking and the sprinkling type. Of the latter Proctor's is the best known, and there is no doubt that it has rendered efficient service. The peculiar variable stroke of the shovel plate, which is characteristic of this stoker, is very effective, and gives a very good distribution of the coal over the grate area. There is no doubt, however, that the coking type is becoming more liked, more especially when combined with automatic feeding appliances. In this form of stoker the coal is first placed on the dead plate and is then carried forward by means of movable bars, which are given a combined vertical and horizontal movement. Under that treatment the coal is partially volatilized at the front of the furnace, and the gases evolved pass over a red fire at the back, by which they are consumed. In either of these types the coal is fed into a hopper at the front of the boiler, and falls by its own weight, the rate of delivery being regulated by feed rollers which also act as crushers. If they are used with judgment there is no doubt that stokers are economical devices, and the only thing to remember is that they must be strongly made so as to withstand the hard usage to which many of them are put. Among the more novel applications is



Andrews' Helix feeder. In this case the coal is supplied by a hopper, and is delivered into the path of revolving worms enclosed in troughs below the grate level. The result is that the coal is lifted into the fire from below, and all the gases have to pass through a red fire, being thus consumed. A very good fire is maintained in this way.

In some of the most modern plants it has been arranged that the work of feeding the hoppers is automatically performed. The coal is tipped into the bunkers, from which it is conveyed by spiral conveyors to an endless elevator, which tips it into a second conveyor passing across the boiler fronts at a point above the hoppers. It is carried along and delivered through suitable apertures into any of the series of hoppers. In this way the work of feeding the boilers is rendered practically an automatic operation, and the duties of the fireman are resolved into keeping the fire clean and level, and regulating the supply of feed water. In this connection it may be mentioned that the conveyor screw invented by Mr. Thomas Wrigley, of Todmorden, is a very good one. It consists of an endless worm of cast iron which, by an ingenious method of moulding, can be cast in almost any length. The quantity of coal delivered depends on the pitch of the worm, the depth of its thread, and the number of revolutions given to it. The elevators used for this purpose consist of a series of buckets fixed on to two parallel pitched chains driven by chain wheels of the ordinary type.

With a view of increasing the effective power of boilers, there have been several attempts to introduce forced draught, and one of the simplest methods is that made by Messrs. Meldrum Bros. In this the ashpits are closed, as shown in Figs. 68 and 69, by a cast-iron plate, which, with the small door fixed in it, is made to be an air-tight fit. In this front two special blowers are fastened, these consisting of a trumpet-shaped tube enclosing a steam nozzle. These are fed with steam from a pipe fitted into the boiler in the steam space, and the quantity

of steam passed can be regulated at will. There is no projecting part beyond the boiler except the steam pipe. A special form of fire-bar, with narrow air spaces, is provided, by means of which the smallest sized fuel can be dealt with without difficulty. With any form of small coal, and coal which is very hot, such as anthracite, the blower answers very well, and not only

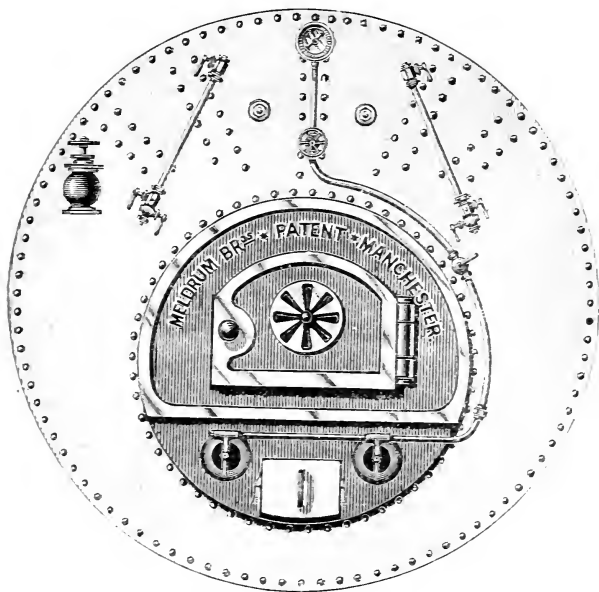

FIG. 63.

improves the combustion, but also keeps the bars cool. While it may be admitted that the quantity of water evaporated per lb. of coal used is not equal to that obtained with ordinary coal, yet the cheapness of the fuel used renders the cost of evaporation a very low one. The forced draught is only equal, usually, to 1 in. water gauge, but a pressure equal to 6 in. gauge can be got by this apparatus easily.

The safety valves employed in connection with steam boilers for cotton mill purposes are of two classes, mainly the lever and dead weight. One of the latter should always be used on each boiler. In some cases spring loaded safety valves have been adopted where high pressure steam is required. The area of safety valves depends upon two factors, the grate area and the pressure, the latter being

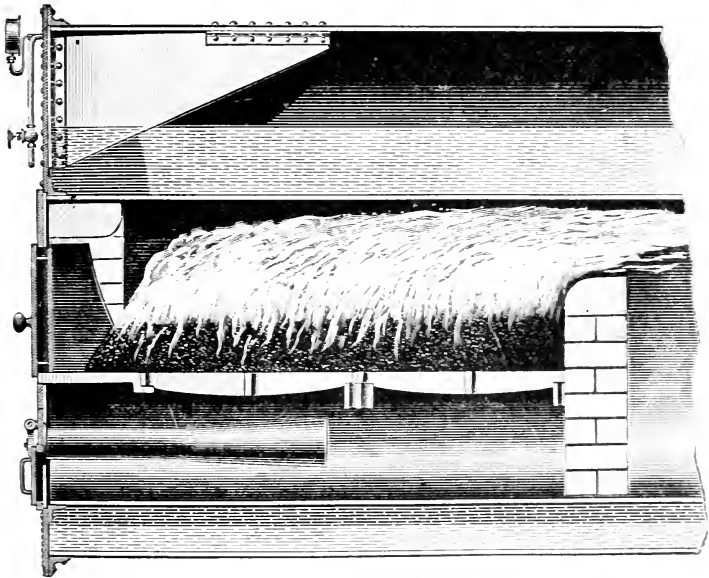

FIG. 69.

the most important. A boiler working at a low pressure requires a larger area of safety valve than one which works at a high pressure, because an increase of pressure implies a greater proportionate risk. The following formulæ give the method of obtaining the area of a safety valve for mill boilers: Where  $A$  = area of valve,  $G$  = area in square feet of grate, and  $P$  = absolute pressure,  $A = \frac{36G}{P}$ : or, when

the lift of a fourth of the diameter of the valve is allowed,  $A = \frac{4G}{P}$ . Spring safety valves are some-

times used, and where they are the following formula for the strength of the spring is given by the Board of Trade: Where S=load on spring in lbs., D=diameter of spring (centre to centre of coils) in inches, d=diameter or side of square of wire used, C=8000 for round and 11,000

for square steel, then  $d = \sqrt[3]{\frac{S \times D}{C}}$ . The area per square foot of grate is fixed by a table provided by the Board of Trade:—

TABLE 13.

| Boiler Pressure. | Area of Valve. | Boiler Pressure. | Area of Valve. | Boiler Pressure. | Area of Valve. | Boiler Pressure. | Area of Valve. |
|------------------|----------------|------------------|----------------|------------------|----------------|------------------|----------------|
| 80               | ·394           | 110              | ·300           | 140              | ·241           | 170              | ·202           |
| 85               | ·375           | 115              | ·288           | 145              | ·234           | 175              | ·197           |
| 90               | ·357           | 120              | ·277           | 150              | ·227           | 180              | ·192           |
| 95               | ·349           | 125              | ·265           | 155              | ·220           | 185              | ·187           |
| 100              | ·326           | 130              | ·258           | 160              | ·214           | 190              | ·182           |
| 105              | ·312           | 135              | ·250           | 165              | ·208           | 200              | ·174           |

If the lever type is used care must be taken to see that the levers are made of wrought iron, and that their proportions are such that the weight *must* be placed at the end of the lever. It is not advisable to make the levers too long, unless they are balanced. The length of the lever, etc., can be got by the following rule:—D=diameter of valve in inches; A=area of valve in square inches; W=weight of ball in pounds; L=length of lever in inches; P=blowing off pressure per square inch in pounds; B=fulcrum distance in inches. Then

$$B = D \text{ and } L = \frac{A B P}{W} ; W = \frac{A B P}{L}$$

The mitre of safety valves should not be more than  $\frac{1}{10}$  per inch of width.

The problem of incrustation is very often a serious one, especially if the sulphates of lime and magnesia are present. Carbonates can be more readily treated, and are more easily removed. Where the impurity in the water is carbonate of lime, by

a treatment with caustic lime prior to passing it into the boiler, it can be precipitated. A tank is needed for this purpose, and in most cases the addition to the feed water of 3 grains of caustic soda for each 4 grains of lime contained will be sufficient. For sulphates, 4 grains of soda ash for each 5 grains in the water will suffice, while, if both salts are found, caustic soda will precipitate both. It is desirable to avoid excess in this matter, which is one requiring intelligence. A composition has been introduced by the Boiler Enamelling Company, of Glasgow, which has the remarkable effect of depositing a thin enamel on the plates, and so preventing the adhesion of the incrusting matter. This appears to have a great probability of successful use in a large number of cases.

Some remarks have already been made with reference to the size of the flues underneath a boiler, but it may be said at this point that provided facility of access is obtained, and that their area is not less than the least internal chimney area, that is all which is necessary. In a few cases the chimney is so placed as to necessitate long flues, but this practice is generally abandoned. In most instances it may be expected that the flue gases will take the shortest course to the chimney, and it is therefore advisable, on account of the loss sustained by radiation, not to make the flues either too long or too large. The chimneys mostly used in Lancashire are round, special bricks being moulded for the purpose, and their height is ordinarily determined by the bye-laws of the local authorities, but is usually about 100ft. The determination of the outlet area of a chimney depends to a large extent on the amount of coal burned, and may be found by the formula where C = coal consumed per hour in lbs., and H = height in feet,

$A = \frac{.07C}{\sqrt{H}}$  Another rule is where W = cubic feet of water evaporated per hour  $\frac{224 \times W}{\sqrt{H}}$  In commen-

cing to build a chimney care should be taken to get the foundations properly laid. It is better to lay first of all a thick bed of concrete, and upon that the brick footings, the first course of which should be double the size of the interior of the chimney, and gradually taper to the diameter of the base. The pressure on the brick work should not be more than one ton to the square foot. No care can be too great in laying the foundation, and it is better to spend a good deal of money on a foundation than to have any risk of settling. The taper or batter of a chimney should be about  $\cdot3$  to  $\cdot35$  of an inch to each foot of height, and the thickness must not be less than one brick, 9in., at the top, this thickness being sufficient for about 25ft. from the top. Thence every 25ft. the thickness should be increased by  $4\frac{1}{2}$ in., and this is done by giving a series of set-offs inside the chimney, thus avoiding cutting the bricks. The courses are laid with bricks  $4\frac{1}{2}$ in. wide, and the necessary set-offs are maintained to any point until the minimum size is reached by reason of the batter, when an additional set-off is given. In order to give the necessary strength to the chimney, it is desirable to lay some of the courses of brick as stretchers and some as headers—that is, longitudinally and transversely. The practice of different architects varies in this respect, but Bancroft's rule is to lay 3 or 4 courses as stretchers and then put in a course of headers. It is also desirable to build a chimney in the summer time, and to allow ample time for it to settle. The height should not be pushed on too rapidly, and a prolonged settlement is desirable. The mortar joints should be well made and narrow, the practice of grouting the brickwork being very objectionable. At the lower part of the chimney, up to about half its height, a fire-brick lining is built, being separated from the brick wall by a cavity, the lining being in some cases strengthened by binding it to the chimney, although this is a practice which is not advisable.

The question of chimney draught is an important

one, as upon it depends the character of the combustion. Molesworth's rule for this is as follows: where  $V$  = velocity in feet per second,  $H$  = height of chimney in feet,  $T$  = temperature of air entering,  $T^1$  = temperature of external air,  $V = 36.5 \sqrt{H(T - T^1)}$ . When  $T$  and  $T^1$  represent the absolute temperatures, another authority gives the formula for velocity  $V = 8 \sqrt{H \left( \frac{T^1 - T}{T} \right)}$ , and the

discharge per second  $V \times A$  when  $A$  = the area of chimney orifice. The temperature of the flue gases need not rise above  $600^\circ\text{F}$ ., at about which point the maximum discharge of a chimney takes place when the external air is of a temperature of about  $60^\circ\text{F}$ . Generally the greatest discharge is obtained when the temperature is equal to double the external temperature + 461, but over a wide range of temperature, say, from  $600$  to  $800^\circ\text{F}$ . the ratio does not vary to any great extent, so that any increase over the former implies a waste of heat.

All chimneys should be protected by lightning conductors. Until a few years ago this subject was little understood, but the rules are now well established. The material used is now either copper tape or rope, the former from  $\frac{3}{4}$  to 2in. wide by not less than 12 W.G. thick, and the latter not less than  $\frac{5}{8}$ in. diameter, and made from wire 12 W.G. diameter. This material can now be got cheaply made of deposited copper, which is nearly pure, and has a very high electrical conductivity. Although it is dearer than iron, the advantages attending its use are so great that it is worth buying. All the joints used should be well made, and not only riveted but soldered. It is desirable to protect the rod for a few feet above the ground. The terminals should be well made, and a good form is a ball screwed on to a round rod fastened to the top of the chimney and to the conductor. Finely pointed needles can be screwed into the ball, and should not be less than six inches long. It is also desirable to protect them by nickel plating. It is

preferable to pass the conductor down the side of the chimney most exposed to rain, and to fix it firmly but not tightly. Where a metal cap is used on a chimney, a copper band with points at intervals can be passed round the top, this course being recommended. In fixing the conductor sharp curves should as far as possible be avoided, and if quite a straight line can be taken it is to be preferred. The earth connection is best made by the use of a large copper plate three feet square and  $\frac{1}{8}$  inch thick, buried in the earth several feet, and covered with cinders. To this the conductor is attached, and failing its employment, the latter may be laid for several yards in a trench filled with coke formed at the required depth. Care in observing the particulars given will ensure good results in practice.

The steam pipes used to convey the steam from the boiler to the engine have most commonly been made of cast iron, but on account of the high pressures which are now common this practice is undergoing modification. Although it is not impossible to make steam pipes of cast iron which are sufficiently strong to withstand safely the maximum pressures which are used, it is by no means the safest course to employ this material. Up to 100lbs. steam pressure, cast iron is safe enough, but above 150lbs. the weight of the pipe and the risky character of the material renders it better to look for a substitute. It has, therefore, become common, in dealing with these pressures, to make the pipes of steel plates, with a thickness of about  $\frac{5}{16}$  in. These are riveted in the same way as a boiler, but care should be taken to use rivets of a sufficient size, so that the necessary resistance is given to the pressure, as, unless this is done, fracture is not unlikely. The pipes being usually made in considerable lengths, so that it is not easy to replace a broken rivet. The joints require caulking, which involves a certain thickness of plate. It is now possible to obtain wrought-iron pipes of considerable diameter, which are welded,



electrically or otherwise, along the seams so as practically to form one piece. These are in all cases preferable to riveted pipes. If a long range of pipes is used, whatever be the material, it is essential that means be provided to take up the expansion. These are sometimes in the form of expansion joints, consisting of two large dished discs coupled at their edges and having the steam pipes fixed to their centres; and in other cases are made as sockets or sliding joints. These, of course, require packing, and provision must be made to prevent the two pipes from being drawn apart. It is equally necessary to provide means for drainage, and, where it is possible, to give a gradient, which should be taken advantage of to collect the water at one point and remove it by a steam trap. If possible the fall of the pipes should be towards the boiler. Condensation in uncovered pipes is very

TABLE 14.

WEIGHT OF CAST-IRON PIPES IN POUNDS PER LINEAL FOOT.

| Bore, Ins.       | THICKNESS IN INCHES. |               |               |               |               |               |       |                 |                 |
|------------------|----------------------|---------------|---------------|---------------|---------------|---------------|-------|-----------------|-----------------|
|                  | $\frac{1}{4}$        | $\frac{3}{8}$ | $\frac{1}{2}$ | $\frac{5}{8}$ | $\frac{3}{4}$ | $\frac{7}{8}$ | 1     | 1 $\frac{1}{2}$ | 1 $\frac{3}{4}$ |
| 1                | 3.0                  | 5.0           | 7.3           | 9.9           | —             | —             | —     | —               | —               |
| 1 $\frac{1}{4}$  | 3.6                  | 5.9           | 8.5           | 11.5          | 14.7          | —             | —     | —               | —               |
| 1 $\frac{1}{2}$  | 4.2                  | 6.9           | 9.8           | 13.0          | 16.5          | 20.4          | —     | —               | —               |
| 1 $\frac{3}{4}$  | 4.9                  | 7.8           | 11.0          | 14.5          | 18.4          | 22.5          | 27.0  | —               | —               |
| 2                | 5.5                  | 8.7           | 12.2          | 16.1          | 20.2          | 24.7          | 29.4  | 34.4            | —               |
| 2 $\frac{1}{2}$  | 6.7                  | 10.5          | 14.7          | 19.1          | 23.9          | 28.9          | 34.3  | 40.0            | 46.0            |
| 3                | 7.9                  | 12.4          | 17.1          | 22.1          | 27.6          | 33.2          | 39.2  | 45.5            | 52.1            |
| 3 $\frac{1}{2}$  | 9.2                  | 14.2          | 19.6          | 25.3          | 31.3          | 37.5          | 44.1  | 51.0            | 58.2            |
| 4                | 10.4                 | 16.1          | 22.1          | 28.3          | 34.9          | 41.8          | 49.0  | 56.6            | 64.4            |
| 4 $\frac{1}{2}$  | 11.6                 | 17.9          | 24.5          | 31.4          | 38.6          | 46.1          | 53.9  | 62.1            | 70.5            |
| 5                | 12.8                 | 19.7          | 26.9          | 34.5          | 42.3          | 50.4          | 58.9  | 67.6            | 76.6            |
| 5 $\frac{1}{2}$  | 14.1                 | 21.6          | 29.4          | 37.5          | 46.0          | 54.7          | 63.8  | 73.1            | 82.8            |
| 6                | 15.3                 | 23.4          | 31.9          | 40.6          | 49.7          | 59.0          | 68.7  | 78.7            | 88.7            |
| 6 $\frac{1}{2}$  | 16.5                 | 25.3          | 34.3          | 43.7          | 53.3          | 63.3          | 73.4  | 84.2            | 95.1            |
| 7                | 17.7                 | 27.1          | 36.8          | 46.7          | 56.8          | 67.6          | 78.5  | 89.7            | 101.2           |
| 7 $\frac{1}{2}$  | 19.0                 | 29.0          | 39.0          | 49.8          | 60.7          | 71.9          | 83.4  | 95.2            | 107.4           |
| 8                | 20.0                 | 30.8          | 41.7          | 52.9          | 64.4          | 76.2          | 88.3  | 100.8           | 113.5           |
| 8 $\frac{1}{2}$  | 21.6                 | 32.9          | 44.4          | 56.2          | 68.3          | 80.7          | 93.4  | 106.5           | 119.9           |
| 9                | 22.7                 | 34.5          | 46.6          | 59.0          | 71.8          | 84.8          | 98.1  | 111.8           | 125.8           |
| 9 $\frac{1}{2}$  | 23.9                 | 36.3          | 49.0          | 62.1          | 75.4          | 89.1          | 103.1 | 117.4           | 131.9           |
| 10               | 25.1                 | 38.2          | 51.5          | 65.2          | 79.1          | 93.4          | 108.0 | 122.9           | 138.1           |
| 10 $\frac{1}{2}$ | 26.3                 | 40.0          | 54.0          | 68.2          | 82.8          | 97.7          | 112.9 | 128.4           | 144.2           |
| 11               | 27.6                 | 41.8          | 56.4          | 71.3          | 86.5          | 102.0         | 117.8 | 133.9           | 150.5           |
| 11 $\frac{1}{2}$ | 28.8                 | 43.7          | 58.9          | 74.3          | 90.1          | 106.3         | 122.7 | 139.4           | 156.4           |
| 12               | 30.0                 | 45.5          | 61.3          | 77.4          | 93.6          | 110.6         | 127.6 | 145.0           | 162.6           |

NOTE.—For each Joint add one foot in length of the Pipe.

great, and it is therefore imperative that they shall be well drained. The weight of iron pipes depends on the thickness of metal used, but can be calculated by the following formula:— $D$  = outside diameter in inches;  $d$  = inside diameter;  $W$  = weight of a lineal foot; then  $W = 2.45 (D^2 - d^2)$  for cast iron and  $2.64 (D^2 - d^2)$  for wrought iron. To this should be added for cast-iron pipes the weight of one foot for each pair of flanges used. A rule given for cast-iron pipes to work at pressures up to 100 lbs. is  $d + 4$  = thickness in sixteenths of an inch. Table 14 (see page 165) gives the weight of cast-iron pipes calculated by the rule given.

---

## CHAPTER XII.

### STEAM ENGINES.—GENERAL REMARKS.

Not only have the boilers used in modern mills been greatly improved, but a like process has taken place with the engines. The science of using steam has become better understood, and full effect is now obtained from the heat contained in it. As is well known, the steam engine is a heat engine, and Carnot's well-known formula,  $\frac{T - T'}{T}$ , gives a means of calculating the work of a perfect heat engine.  $T$  = maximum temperature of the steam, and  $T'$  = minimum temperature. It is, of course, not possible to attain this theoretical efficiency in a steam engine, but there are many cases in which great improvement could be effected by a re-arrangement of the engines. A casual glance at the formula shows that the greater the difference in the temperatures the greater the power developed. It is not possible here and now to lay down the theoretical considerations which govern this question, and we must be content to give a few practical hints, which may be of service. The power required has now become so

large that except in weaving sheds there are not many simple—*i.e.*, one-cylindere—engines at work. What type of engine should be adopted is a question which cannot be easily answered, unless a full statement of the specific circumstances is forthcoming; but the principles upon which a mill-owner can proceed will be described. Briefly, it may be said that two things determine the point. First, there is cylinder condensation, caused by the fall of temperature owing to the expansion of the steam. Wherever this is excessive there is a distinct loss. Second, there is the existence of strains upon the crank pins, which vary considerably in amount when the whole of the work is done in one cylinder in which there is a large range of steam pressure.

The first of these points is important, because a considerable loss in the quantity of the steam used occurs when condensation is excessive. For instance, assuming that the cut-off in the cylinder of an engine took place after 15 per cent of the stroke was completed, the loss by condensation in a simple engine would be 32, in a compound 26, and in a triple-expansion engine, 24 per cent respectively. But important as this undoubtedly is, it is not more so than the second point named, the excessive initial strains thrown upon the crank pins when the whole work has to be done in one cylinder. It must be remembered that to obtain any great power, a cylinder of large size would be required, and the area of the piston would be so great that the influx of the steam would exercise an excessive pressure on the crank pin. For instance, if the power exerted on the pin be plotted out, it will be found that in a simple engine, the maximum and minimum pressures vary much more largely than they do in a compound engine, even if it be of the tandem single-crank type. If two engines, each developing 1,250 horse power, be taken as an example, in the one case a simple condensing with a 42in. cylinder, and in the other a tandem compound with a high-pressure cylinder 30in. diameter, and a low-pressure 50in.

diameter, both using steam at 80lbs. The initial stress on the crank pin in the simple engine is 110,836lbs., and in the compound engine 62,248lbs., a very considerable difference. It is clear that the additional strength required in the former will affect the design throughout, and will render it necessary to increase the weight of the moving parts in order to bring them up to their work. This implies more work and friction in the engine itself. The case for the simple engine would be still worse, if instead of a tandem a side by side compound engine had been selected as an example. Thus, alike on the ground of economy in working and in the avoidance of undue strains, a division of the steam expansion is desirable. It is not easy to determine when this process shall take place, but when the power required is moderately large, and the steam pressure used is over 70lbs., compounding will always pay. Up to 120lbs. pressure compound engines are best, and from 150lbs. to 200lbs. triple-expansion engines give good results.

Whatever may be the type of engine used it is never wise to diminish its usefulness by cutting down the first cost. A well designed and proportioned engine, constructed soundly and with due regard to accuracy, may appear to be dear, but it is fairly certain to be economical in the long run. An engine should be well balanced, with its working parts reduced to the least possible number, strong, yet not unduly heavy, and with its proportions properly arranged and calculated. When high pressures are used, it is imperative that a good rapidly-acting valve motion be applied, and the passages ought to be arranged so that the steam has quick access to the cylinder without loss of pressure. Full boiler pressure cannot, perhaps, be got on the piston, but it can be very nearly approached. It is equally important that, as there must be some space left between the piston at the end of its stroke and the valve, the exhaust valve shall close in sufficient time to enable the steam filling the space named to be compressed, and thus

raised to a temperature equal to or approaching that of the incoming steam. In this way the initial condensation of the steam is avoided. These conditions imply the existence of large areas in the valve ports, and such an arrangement of gear that these can be opened wide at once and closed instantaneously. Nothing is of more importance in a steam-engine than the unobstructed passage of the steam into the cylinder, and it is equally necessary that the exhaust valves open and close quickly, and that they are so arranged as to drain off any water at every stroke. In setting the valves regard must be paid to the terminal pressures, which, in a multiple expansion engine, are determined on in proportioning the cylinder areas. In this class of engine the provision of a receiver, either as a separate vessel or by duly proportioning the size of the steam pipes, is an absolute necessity if good work is to be got. The area of the receiver must be large enough to enable it to contain the whole of the steam discharged from the cylinder at each stroke. Although by compression it is possible to increase the temperature of the steam in the clearance spaces, this must not lead users to believe that these can be large without loss. On the contrary, the smaller the clearance spaces are the better for the engine. It will pay millowners to examine these points with regard to valve area and openings and clearance spaces, as they are two most important factors in economical work.

In large engines, and indeed in all engines using steam at a high pressure, it is desirable to have steam jackets to the cylinders. The loss by condensation being caused, as was said, by the cooling of the cylinder walls, it is highly important to protect these from cooling by radiation. The application of a steam jacket has been the great difficulty, but this is in a fair way for being overcome. In the engines made by Messrs. Sulzer Bros., of Winterthur, for instance, who have long had a reputation for their engines, steam jackets

are usual, and, as will be seen from some of the descriptions which follow, they are also used by some of the best English firms. It is certain that a distinct gain, though a small one, accrues from the use of a jacket, especially if it is fed by steam equal in temperature to that entering the cylinder. The condensation and re-evaporation which usually takes place is thus avoided. The usual practice with steam cylinders is to cover them with some form of non-conducting material in order to avoid cooling by radiation. Not only should the cylinders be clothed, but also all exposed steam pipes. There are numerous compositions in the market for this purpose, some of which are little better than mud bound together with a mixture of hay or other fibre. Among the best materials which are suitable for this purpose asbestos and slag-wool may be recommended, the latter being alike effective and cheap.

During recent years it has become usual to abandon the coal consumption per horse-power per hour as a measure of the efficiency of an engine, and to use instead the weight of steam taken. It is obvious that this is the better method, because it permits of an apportionment of the cost between the boiler and the engine. These are sometimes made by different persons, and the lumping together of the result may be unfair to either or both of them. It is much better, therefore, that the quantity of steam used should be taken as the measure of the efficiency of a steam engine. It is important, therefore, to see what the proper quantity is. In the Journal of the Franklin Institute for April, 1894, particulars are given of a test by Professor Thurston of a set of triple expansion pumping engines. The results of the test show that 11·678lbs. of steam per I.H.P. per hour were used at a fuel cost of 1·237lbs. These figures are very low, and were obtained by the employment of tubular boilers evaporating 8·906lbs. of water per 1lb. of coal. With a boiler of higher evaporative efficiency the coal consumption would be less. As

it is, the efficiency of the engine "is '668 of that of a Carnot cycle working through the same range of temperatures, or '77 of thermo-dynamic efficiency for the Rankine cycle of the ideal case." Professor Thurston says: "An engine which brings down the consumption of energy of heat and steam and fuel to the equivalent of 13,056 B.T.U. per hour, 217 per minute, per horse power, to 11'678 pounds of dry steam per horse power per hour, and to 1'25 or 1'35lbs. of fuel, giving an actual duty, watch by watch, for twenty-four hours, of 140,000,000 to 150,000,000 per 100lbs. of fuel actually consumed, with but moderate efficiency of boiler, and averaging the equivalent of 154,048,000 foot pounds per 1,000lbs. of dry steam at the engine, not only establishes a wonderful record, but marks off an era in the progress of the steam engine. This is probably about the limit for the century, and *twelve pounds of steam per horse power per hour*, a figure now known to be approximated by several engines, may be taken as the culmination of the progress of the nineteenth century." It may be said that this result was obtained in engines which developed 573'87 horse power with an average steam pressure of 121'6lbs., and the observations were taken by trained observers from Sibley College specially organised so as to provide four watches during the 24 hours continuous trial. It ought also to be mentioned that the cylinders were steam jacketed, being supplied, so far as the high-pressure and intermediate cylinders were concerned, with steam at boiler pressure, and the low-pressure with steam at 34lbs. The jacket steam for the first two cylinders was supplied directly and specially from the boiler, so that the temperature of the cylinder was well maintained. Some published tests of a triple-expansion engine made in Germany showed that with an initial pressure of 155'7lbs. the engine used 11'85lbs. of steam per I.H.P. Messrs. Sulzer Bros., in their catalogue, state their triple engines consume only 11—13lbs. steam per I.H.P. per hour. No facts are known

which justify the lower figure. As a matter of fact, there is grave doubt as to the maintenance during actual work of any use of steam less in amount than 12lbs. per I.H.P. per hour. In a recent careful and reliable test by Mr. Crosland of a set of mill engines at the Mutual Spinning Company Limited, at Heywood, the steam consumption was only 12.2 lbs. per I.H.P. per hour, which is the lowest yet ascertained during actual work in Lancashire. Details of this test are given at a later stage.

Compound engines are, of course, not so economical as triple expansion, but form a great advance upon simple engines. The consumption of steam in a good compound engine should be about 16lbs. and in a simple engine with condenser about 18lbs. per I.H.P. per hour. At one time engine makers in this country were reluctant to give any guarantee as to steam consumption in their engines, and it was made a matter of reproach that Continental engineers would do so readily. Now that is all changed, and any of the firms whose engines are illustrated will guarantee a certain steam consumption. This is the important point, and it should not be overlooked by millowners.

Another matter which may be mentioned before passing on is that of piston speed. Many years ago, when the Allen engine was introduced into England, and was tried at a piston speed of 800ft. per minute, it proved to be unsuccessful, and it was roundly declared that such speeds were impossible. It is curious to note that since the introduction of high pressures and multiple expansions the piston speed of stationary engines has gradually gone up until, as will be seen, they are now often as high as 660ft. per minute.

The favourite type of engine for cotton mill practice is the horizontal side by side, which probably gives the maximum economy combined with steadiness. In constructing this engine ample areas should be given to the working parts, and due provision made for lubrication. The pressure per square inch on a crank pin should never be



more than 800lbs., on the cross-head slides with good lubrication 400lbs., and on the main bearings 400lbs. or 500lbs. The speed of the steam in the main steam pipe should not be more than 2,500ft. per minute, and in the exhaust 4,500ft. If the engine is of jet condensing type, 25 to 30 times the weight of water is wanted for the weight of steam used; but this depends on the temperature of the former, which should not exceed 100°F. In some cases surface condensers are used, and in that event the following rule will be of interest: The combined area of the surface of the tubes should be equal to the area of the heating surface required  $\times .07$ . A simpler rule is that the tube surface needed is 2.5 to 3 square feet per I.H.P. If cooling reservoirs are constructed, they should be large and shallow rather than small and deep. The exact proportion naturally depends on the amount of cold water available. The reservoir should have a capacity equal to the volume injected into the condenser per day. The loss by evaporation has been estimated by Mr. Hurst to be from  $\frac{1}{8}$  in. to  $\frac{1}{4}$  in. per day in the summer, and from  $\frac{1}{16}$  in. to  $\frac{1}{12}$  in. in the winter. With regard to cooling appliances, there is room for improvement in this respect, and the question of area for condensing water is one of much interest in many places.

Having thus dealt generally with some of the points relating to engines such as are used in cotton mills, several examples of recent construction are given, so as to illustrate present day practice. In doing so it naturally happens that some similarity will exist between the various engines, the differences, which are important however, being mainly in the arrangements of the valve gear, etc. It will be understood that the engines are selected as recent examples only, and are not necessarily the most important engines made by the various firms.

## CHAPTER XIII.

## STEAM ENGINES—RECENT EXAMPLES.

The engine illustrated in Fig. 70 is one recently made and erected by Messrs. Hick, Hargreaves and Co., Ltd., and set to work at Messrs. A. Bromiley and Co.'s factory, Folds Road, Bolton, and although of comparatively small power, it possesses special features which are interesting. It is of the makers' well-known Corliss type, as regards the framing and the construction and valve gear of both cylinders. It is designed for a load of 400 I.H.P., and has cylinders 18in. and 32in. diameter by 4ft. stroke. The cylinder ratio is therefore 1:3.16. The speed is 70 revolutions per minute, or a piston speed of 560ft., and the boiler pressure 120lbs. per square inch. The steam is supplied by a 30ft.  $\times$  8ft. Lancashire boiler, also supplied by Messrs. Hick, Hargreaves and Co., Limited. Each cylinder is built up of four parts bolted together, a method of construction which involves some extra cost, but is recognised as securing important advantages. The cylinder is furnished with a liner, or working barrel, which is fitted into the outer casing, being held at one end by a lip taking into a recess formed in the casing. The other end of the liner is free to slide, and in a recess, made in the casing, a few turns of asbestos packing are placed, being surmounted by a ring of metal. When the valve case is bolted in position the ring and packing are thus secured. In this way there is perfect freedom of movement in the barrel. Both cylinders are jacketed on the principle, now generally employed by the makers, of making the whole steam supply to each cylinder pass through the jacket of that cylinder, this method preventing the cylinders being strained by unequal expansion, and securing a high measure of economy. One of the most novel and important features about the engine is the application of the makers' patent "swivel" bearings to

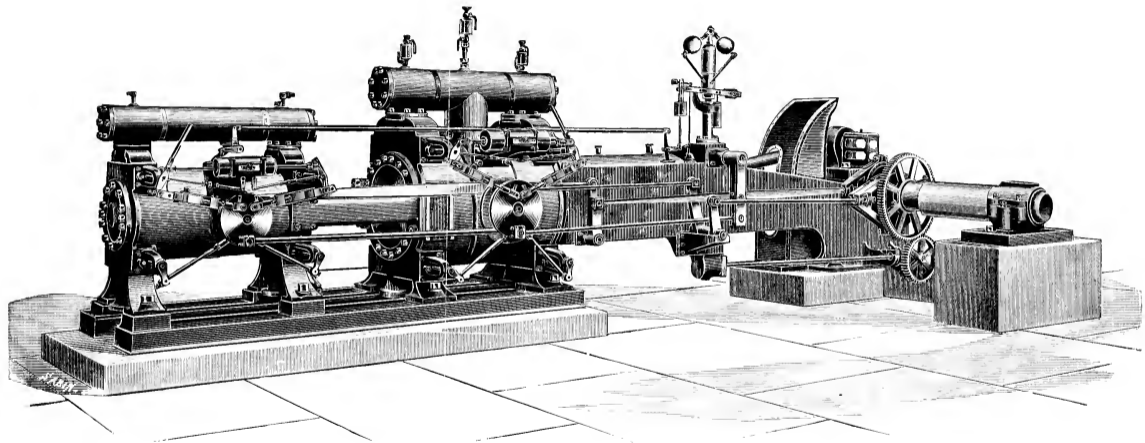

FIG. 70.



both crane necks and to the crank pin. These devices reduce the liability of hot necks or pins to an almost negligible quantity. The valve gear is of the "Ingand Spencer" type, in which wrist plates are employed, and so arranged as to secure the "dwell" of valves during the period of the greatest load. The steam and exhaust valves are driven by separate wrist plates, thus allowing of independent adjustment. As will be seen from the illustration, the design of the engine is of a very simple and straightforward character. The working parts and surfaces are liberally proportioned, and the high finish of the bright parts and the planished steel cylinder rings and crank race shields give the engine a very handsome appearance.



FIG. 71.

The power is transmitted by ropes, the drum being 15ft. diameter and grooved for 14 ropes. The engine is provided with a barring rack, through which the engine is moved by one of the makers' double cylinder barring engines. The engine is at present working with only a portion of the full load and with reduced boiler pressure, but the diagrams given (Figs. 71 and 72), though taken under these conditions, will serve to show the admirable character of the steam distribution. It is expected when full load is on that not more than 14lbs. of steam per I. H. P. will be required. Although this is a specimen of a comparatively small engine, it is none the less interesting, as it is an example of the characteristic method of construction carried out throughout by the makers.

As a contrast to the preceding, an illustration, Fig. 73, is given of a set of tri-<sup>ple</sup> expansion vertical engines of 1,000 h.p., also made by Messrs. Hick, Hargreaves, and Co. Although not being used for cotton spinning, they are work in Belfast, driving a fine flax spinning mill. The cylinders are inverted, the high and intermediate pressures being outside, and the low pressure in the middle. The high pressure cylinder is 14 in. diameter, the intermediate 29 in., and the low pressure 46 in., the stroke in each case being 4 ft. The cylinder ratios are thus—high to intermediate, 1 : 2.23 nearly; intermediate to low, 1 : 2.1; high to low, 1 : 5.86. The engine makes 80 revolutions per minute, which is equal to a piston speed of 640 ft. per minute. The construction of the cylinder and valve gear is,

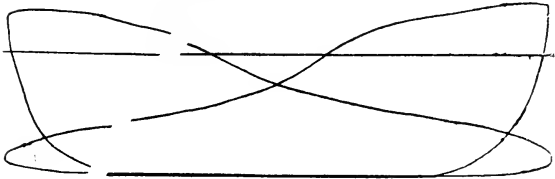

FIG. 72.

allowing for the variation in the design, similar to that of the preceding example, and does not require further comment, except that the cylinders are not jacketed. Knowles' supplementary governor is added to the engine, which enables an accurate and absolute control to be attained over the steam admission. The crank shaft is 12 in. diameter in the necks, and is built up in the manner common with marine engine shafts. Both it and the crank pins are, in accordance with the usual practice of the makers, bored from end to end. The crank-shaft and crank-pin bearings and the guide-blocks are lined with a special white metal, and the guide-bars are hollow, so as to provide for the circulation of water. Special indicating cocks are fitted, as also a novel indicating

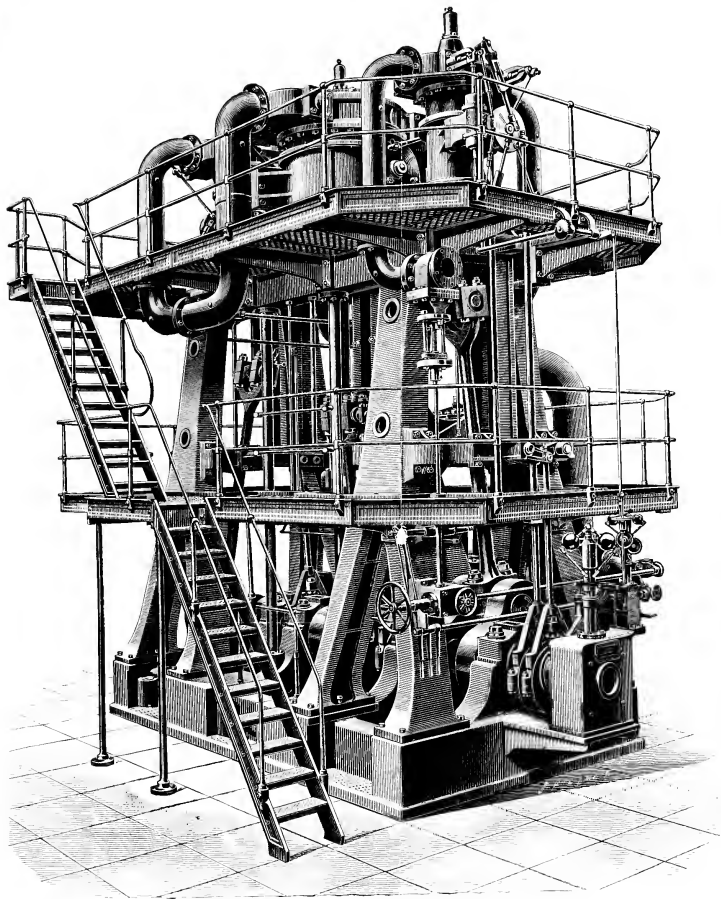
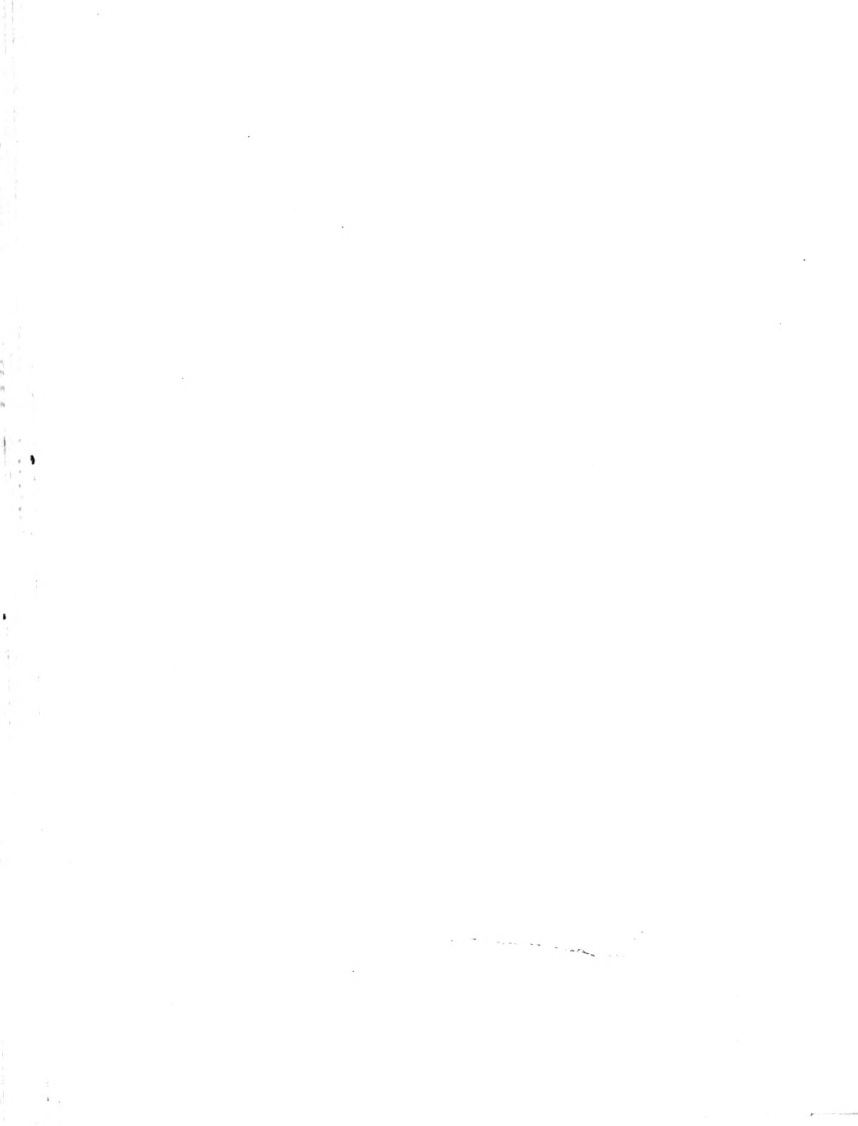

FIG. 73.





gear suggested by Mr. Wilson, the engineer superintending their erection. This consists of a spindle, running in centres and carrying a quadrant for the indicator cord, and a spiral blade kept in or out of contact with a roller moving with the crosshead by means of a spring. The gear can be easily put in or out of action. The engines have a vertical single acting air-pump, 32in. diameter and 16in. stroke, and a jet condenser driven by levers from the low-pressure engine. The rope drum is fixed on the shaft at the intermediate cylinder end, and is 16ft. diameter, being grooved for 36 ropes. In order to ascertain the character of the work of this engine, a test lasting  $5\frac{1}{4}$  hours was made by Mr. Wilson under working conditions. The mean indicated horse-power was 791.3, with a boiler pressure of 156lbs. per square inch, the vacuum obtained being 11.94lbs. In order to ascertain the percentage of priming, a known proportion of salt was added to the feed water, and the water of condensation collected out of the main supply pipe. This being tested by chemical reagents was found to give results which, on being proved, were shown to be very accurate. In this way it was ascertained that 12.79lbs. of steam per I.H.P. per hour was used, the consumption of coal—"Vivian's Thro' and Thro'"—being only 1.22lbs. It may be of interest to mention that the water evaporated from and at  $212^{\circ}$  F. was 12.11lbs. per lb. of coal, which for a Lancashire boiler, 28ft. by 7ft. 6in., is a high duty. The ratio of the grate area to the whole heating surface is 1:26.8, and a Green's economiser of 320 pipes was used, raising the feed to  $258^{\circ}$  F.

The engines illustrated in Fig. 74 were recently constructed and put to work by Messrs. Daniel Adamson and Co. at the Mill of the Minerva Cotton Spinning Company, Limited, a view of which has been previously given.

As will be noticed, they are of the horizontal tandem type, having two cylinders on each side of the main driving drum. The high and one low

right angles, on the opposite side. This arrangement is one which is largely adopted for engines of this class and duty, when perfectly steady turning is a necessity, as it secures a perfectly balanced engine and an equable distribution of the load on each crank pin.

The high pressure cylinder is 22in. bore, the intermediate pressure cylinder 36in. bore, whilst the two low pressure cylinders are each 40in. bore, all being 60in. stroke. The cylinder areas are, therefore—high to intermediate, 1 : 2·67 ; intermediate to low, 1 : 2·46 ; and the piston speed is 660ft. per minute. As now running, at 55 revolutions per minute, they will develop 1,500 horse-power with ease, with steam at 160lbs. pressure per square inch, for which pressure the boilers are loaded and the engines are proportioned. The power is given off from the engines by a main rope drum 30ft. in diameter, grooved for 40 ropes 1½in. diameter, the speed of the ropes being 5,185ft. per minute. The drum is built up, and its finished weight is 65 tons. It is cased in with polished pine, has an internal barring rack cast inside the rim, and is provided with one of the maker's automatic safety barring engines.

The general design of the engines themselves is of the type commonly known as the Corliss or Trunk Guide frame pattern, and they are of massive and strong construction. The portions of the frame nearest the cylinders have the slides for the crossheads cast therein, and these are bored out at the same time as the flanges for jointing to the cylinders are faced. At the end of the slides a substantial foot is provided for bolting the frames to the foundations, whilst at the end of the frames nearest the crank shaft a suitable flange is provided for jointing the frames to the crank shaft pedestals, which are cast separate and jointed to the frames with strong bolts. Between the two tandem cylinders on each side cast-iron distance pieces are fitted.

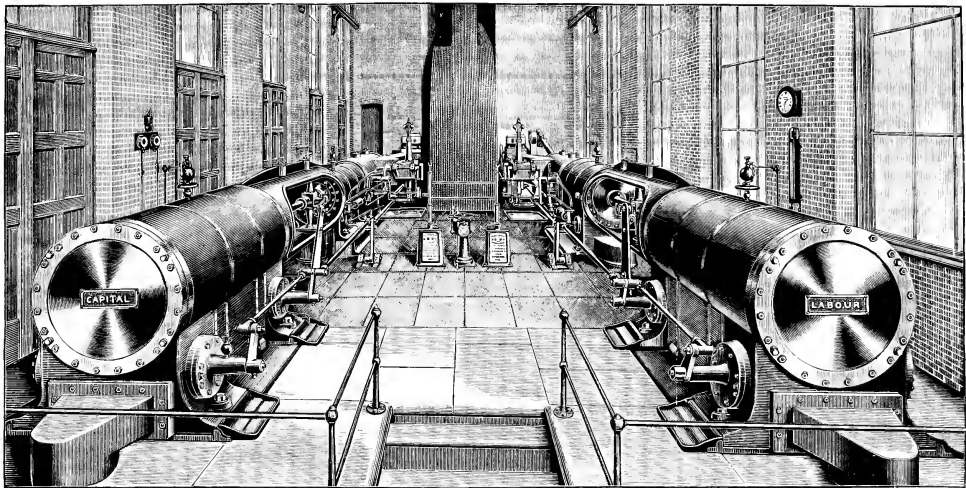
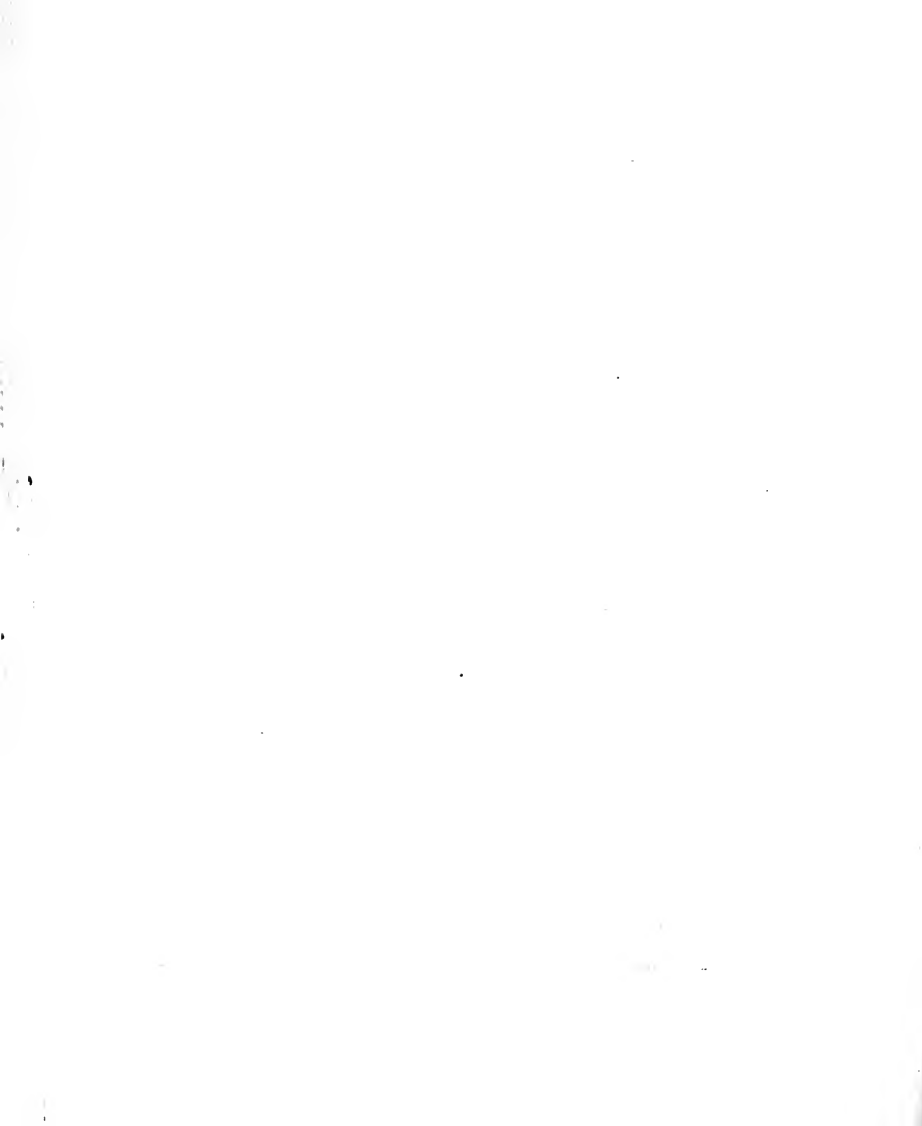

FIG. 74.



These have slides cast in them in a similar manner to the main frames, in which a crosshead, which is utilised as a coupling for the piston rods for the high and low pressure cylinders, and as a support for the rod, slides. The distance pieces are bored out for the crossheads and the flanges faced for jointing to the cylinders at one operation, the whole engine being thus jointed together with faced joints from the machines in true alignment. The distance pieces are made large enough to allow of the cylinder covers being removed and pistons examined, without disconnecting any other parts of the engines. All steam joints can be made good with the minimum of trouble, they being perfectly accessible without any disturbance of the structural parts of the engine. Advantage is taken of the coupling crosshead for driving the air pumps, which are fixed immediately underneath the distance pieces, and are of the usual single acting bucket type, driven direct from the crosshead by steel plate levers. The two low pressure cylinders are fixed upon separate cast iron frames, bolted securely to the foundations, provision being made for the low pressure cylinders to slide freely thereon, and thus accommodate themselves to the expansion and contraction of the engines when hot and cold. The crank-shaft pedestals are fitted with phosphor bronze steps, made in four parts, the two side sections being adjustable horizontally by means of wedges and screws fitted through the pedestal caps, whilst the top and bottom sections are turned and fitted into bored seats prepared for them, allowing their removal for examination or renewal with very little trouble and very slight lifting of the shaft.

The high and intermediate pressure cylinders are each fitted with automatic expansion gear, each being controlled by a separate and independent governor positively driven by gearing. The two low pressure cylinders are fitted with circular semi-rotating valves, one at each end of the cylinders, and of the makers' latest improved type.

"Wheelock" type. This gear was exhibited and obtained the highest awards at the Paris Exhibition in 1878, since which time it has been a speciality of Messrs. Adamson, and has been shown at most of the principal exhibitions with similar successful results. The gear is of the single eccentric type—the same eccentric being used for driving the steam and exhaust valves—and is arranged for giving automatic control of the expansion from zero to 75 per cent of the stroke of the piston, whilst retaining complete control of the periods of release and compression. The valves, which are of the flat-grid type, giving multiplicity of opening and small frictional surfaces, are driven by means of levers having a vibrating motion, keyed on the valve spindle, and are connected to the eccentric with adjustable coupling rods in the usual manner. The steam valves are driven from the exhaust valve levers by the "Wheelock" latch link and are tripped by cams, the valves being instantly closed by means of helical coil springs working in air compression cylinders, cushioned and noiseless in action. The cams receive a positive travel from the eccentric rod, and are varied and controlled by the governor, a resultant action being thereby obtained capable of tripping the latch link in every position of the gear, whether moving forward or backward. There are also provided, in suitable positions, safety cams which prevent the steam valves opening in case of accident to the governor. Both steam and exhaust valves are contained in one chest at each end of the cylinder, the seats of the valves being formed in a plug turned to fit the cylinder. The chests, being separate from the cylinder, can be made of specially hard and durable iron, enabling spare valves to be kept in stock, and obviating any wear in the cylinder casting. The valve spindles are of the Wheelock patent self-packing type, which dispenses entirely with the usual stuffing boxes and glands, and are also practically frictionless. The piston rods are of forged mild

steel, and their stuffing boxes are fitted with metallic packing throughout. The crank shaft is of Siemens-Martin mild steel, and has journals two diameters long, which are fitted with oil circulating pumps, to return all the oil used from a low level receiving cistern to a cistern fitted upon the pedestal caps, from which the supply of oil is regulated by means of a series of taps. The oil for lubrication is thus used over and over again, and is strained and sieved thoroughly at each change, this system of lubrication being found to keep the bearings in perfect condition with very little expenditure of oil. The main stop valve is fitted with "Tate's" patent electric stop motion, arranged to close the valve automatically in case of accident in the mill, to the different rooms with which it is connected. The cylinders and pipes are clothed with non-conducting composition, and the bodies of the cylinders finished off with planished steel sheets bound together with brass belts. They have a complete set of automatic and hand lubricators, indicator and drain taps, indicator gear, steam and vacuum gauges, and a complete set of oil catchers and drippers wherever required, and also handrails and guards round all dangerous places.

The engines shown in Fig. 75 are at use at the Castle Spinning Company Limited, Stalybridge, and are of the horizontal condensing triple expansion type made by Messrs. Yates and Thom, of Blackburn. They have a high pressure cylinder 21in. diameter, an intermediate cylinder 34in. diameter, and two low pressure cylinders each 39in. diameter, all made suitable for a stroke of 5ft. 6in. The ratio of the cylinder areas is thus, high to intermediate 1 : 2.33, intermediate to low 1 : 2.6. The piston speed is 660ft. per minute. They are capable of transmitting most economically 1,400 I.H.P. with a boiler pressure of 160lbs. per square inch and a speed of 60 revolutions per minute. The cylinders are arranged with the high pressure and one low pressure working on the right hand crank and the intermediate and other

using the strains on the respective crank pins. The fly rope pulley is 30ft. diameter; its peripheral velocity, 5,650 feet; it is turned and grooved for 32 ropes each  $1\frac{1}{8}$  in. diameter, and weighs about 52 tons.

The high pressure and intermediate cylinders have "Corliss" valves, and are fitted with a patent valve gear. The steam and exhaust valves are worked independently of each other by separate eccentrics and wrist plates, the steam valves of the high pressure cylinder being under the control of a powerful high speed governor for automatically adjusting the point of cut-off, which efficiently controls the speed of the engine. An improved automatic safety knock-off motion is attached to the governor gear for stopping the engine in case of accident. The low pressure cylinders are fitted with double ported slide valves at each end of the cylinders. The steam and exhaust ports of the cylinders as well as the pipes throughout are made of large area, thereby securing low steam velocities both for the admission and eduction of the steam from the cylinders, and at the same time ensuring free open passages for the steam to the condenser. These points reduce the initial loss to a minimum, and are of great importance for economical working.

The engine bed plates are of the box girder form, strong and massively constructed. The crank shaft pedestals are fitted with steps in four parts, and wedges and screws, affording all possible means for easy and efficient adjustment.

There is one set of condensing apparatus to each low pressure cylinder, each having a single acting vertical air pump fitted with cast-iron buckets of improved solid construction and multiple valve arrangement. Both of the air pumps, as well as the boiler feed pump, are worked by means of levers made of steel plates actuated from the piston rod crossheads of the engine.

The stop valve for starting the engine is conveniently placed in the steam pipe on the top of



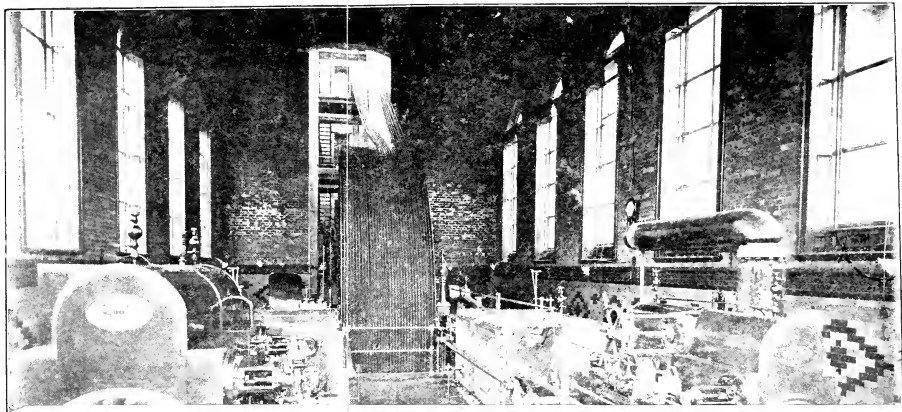



the high pressure cylinder, and is easily reached and manipulated from the engine house floor. The injection valve and other starting handles are all in close proximity to each other, an arrangement which is exceedingly handy and convenient for the engine attendant.

The important point of lubrication is one to which the engineers have given their special attention. All the cylinders and main journals are provided and fitted with handsome and efficient lubricators, those for the crank shaft being continuous, having in connection suitable pumps with filtering arrangements and cisterns. The crank pins are fitted with an effective centrifugal oiling arrangement.

The floor space around the engines is covered with cast-iron chequered floor plates, and gives a very neat appearance. Polished wrought-iron hand-railing, with pillars of good design, are fixed around the connecting rods, cranks and fly rope pulley, for protection against accidents.

One of Messrs. Yates and Thom's barring engines is provided, gearing into an internal spur rack cast on the inside of the rim of the fly rope pulley; it is arranged so that it runs automatically out of gear and ceases work immediately the main engine gains its speed. The engine has a fine massive appearance.

In Figs. 76 and 77 a plan and elevation of a set of triple expansion engines, made for the Park Road Spinning Company Limited, Dukinfield, by Mr. Benj. Goodfellow, of Hyde, are illustrated. The engines are capable of developing 1,500 I.H.P., and are designed to drive a mill which, when completed, will contain about 92,280 mule spindles, with all the necessary preparation required. They are of the horizontal triple compound condensing type, arranged with four cylinders, one high pressure, one intermediate pressure, and two low pressure, a compact arrangement which not only gives the highest results for regular turning, but an economy in steam and a symmetry which cannot be arrived

high hand engine, 42 in. diameter, and the intermediate pressure cylinder, which is placed on the left hand engine and abreast of the high pressure cylinder, is 35 in. diameter, and the two low pressure cylinders are 40 in. diameter, one placed behind the high pressure cylinder and one behind the intermediate pressure cylinder. The cylinder area is thus proportioned—High pressure to intermediate 1 : 2.52, intermediate to low 1 : 2.61, high pressure to low 1 : 6.6. All four cylinders are 5 ft. stroke, and the engines are now working at 60 revolutions per minute, with an initial pressure of 160 lbs. per square inch, the piston speed being thus 600 ft. per minute.

Each cylinder is fitted with Corliss valves, those on the high pressure cylinder being automatically actuated by the governor, which is further assisted by a compensating motion enabling the speed of the engines to be controlled with the least possible variation, notwithstanding the frequent alterations in the load and steam pressure. All the steam or admission valves are worked by Ramsbottom's improved trip motion, which is so fitted up as to dispense with the necessity of a catch gear, and the valves and their mechanism are so designed and constructed that they work with extremely little friction. The amount of power used to trip this gear is surprisingly small, and it is remarkably free and easy in action. Further, as it has no clutch to engage and disengage, it is well adapted for quick running engines. The gear does not, in addition, re-act upon the governor when tripping. As is common with Mr. Goodfellow's engines, the steam valves are all placed on the top sides of the cylinders and the exhaust valves at the bottom, this being a preferable arrangement to putting both admission and exhaust valves at the same side of the cylinder. The governor is of a high speed type, with centre weight and spring, and is fitted with the firm's im-

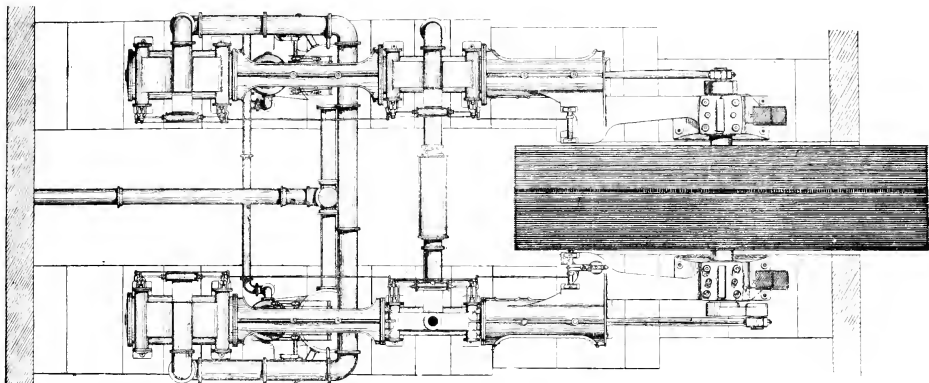
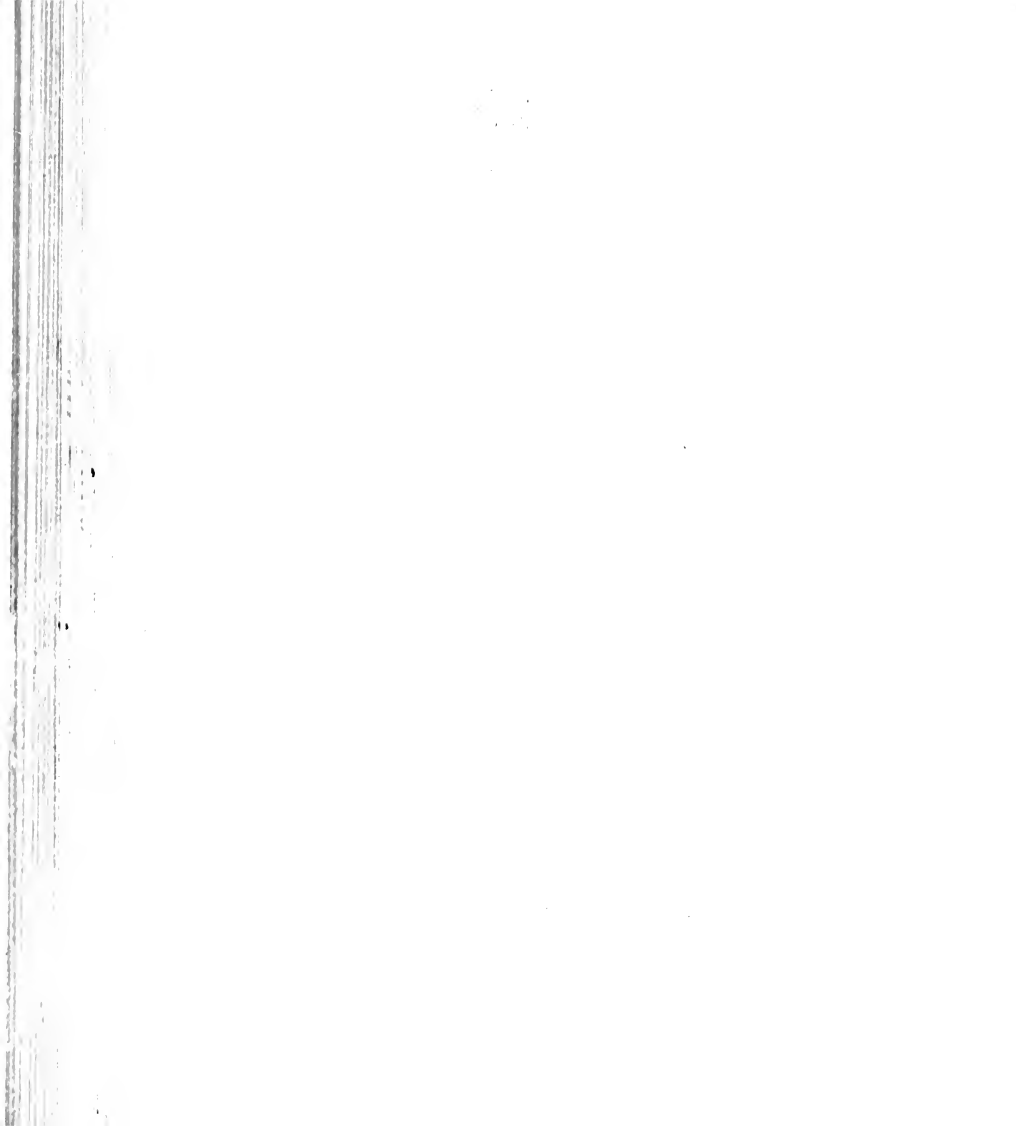

FIG. 76.



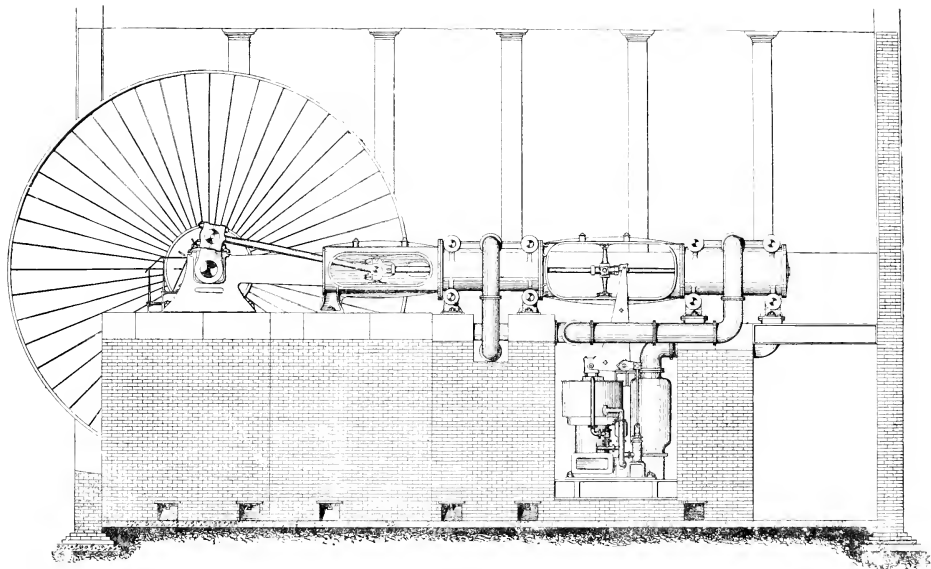
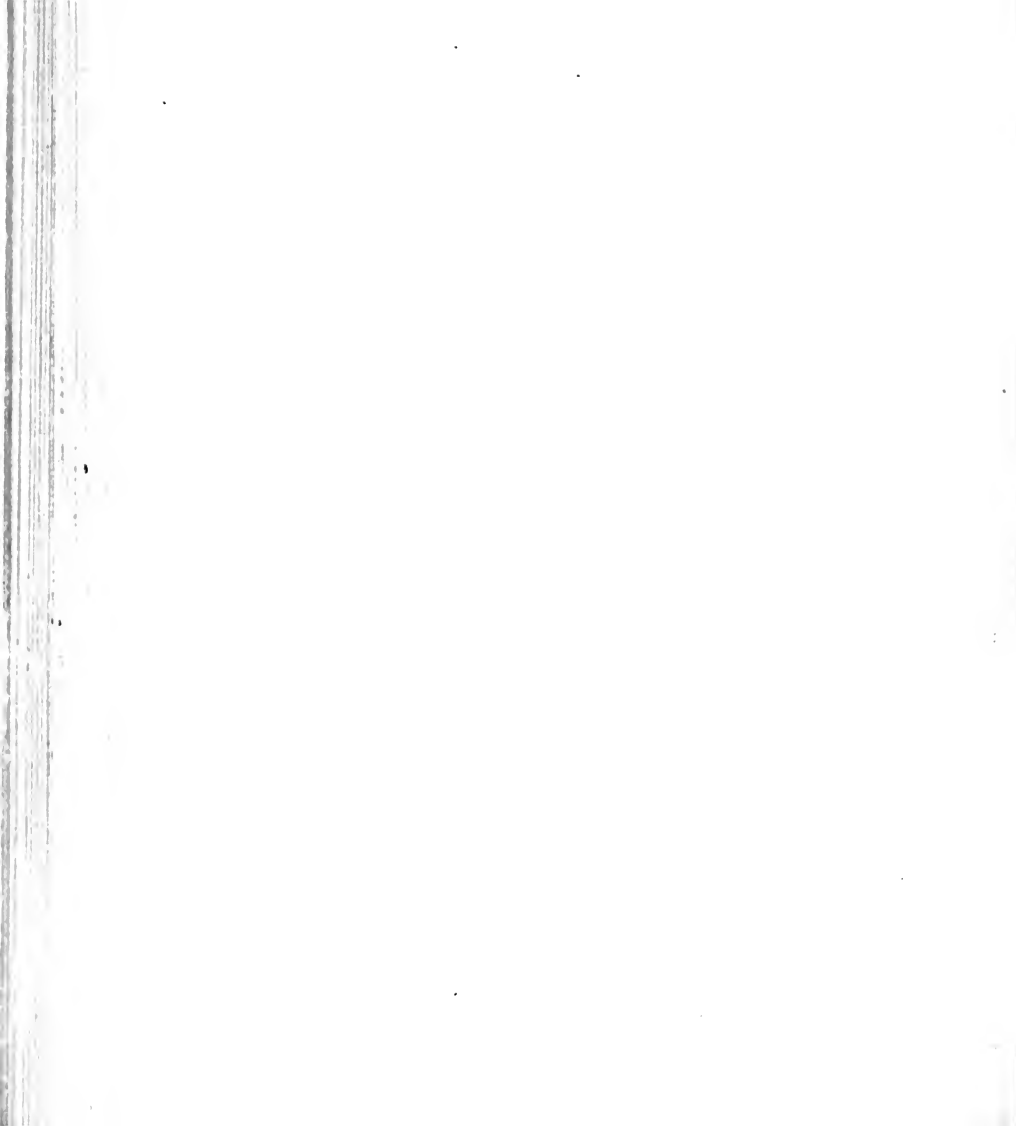

FIG. 77.





proved compensating gear for adjusting the point of cut-off to suit the load and the steam pressure, at the same time maintaining the normal speed of the engines. Attached to the governor is a knock-off, or stopping arrangement, which throws the valves out of gear and prevents them opening to admit steam into the cylinders, at the same time opening a valve which admits air into the condensers and so stops the engines in the shortest possible time.

The engines are fitted with two air pumps and complete condensing apparatus, so as to keep everything as truly balanced as possible, and, at the same time, should any accident occur either to one engine or the other at any time, the disabled parts may be readily uncoupled, and a large portion of the work be driven from one engine. As these engines are running at a rather high speed for engines of this class, the air-pump bucket has been made on the bucket and plunger principle, thereby getting a much steadier motion, in consequence of having a constant delivery of the overflow water, and practically dispensing with the knock from the pump, which is so very common in quick-running stationary engines. Each bucket and plunger derives its motion by means of the usual L levers, links, etc., as shown in Fig. 77, from a spider crosshead, sliding in a cast-iron distance piece, between the two cylinders. This distance piece acts as the stay from one cylinder to the other, and at the same time it forms the guide for the spider cross head. This arrangement requires a rather longer engine-house than when both cylinders are put together and the condensing apparatus put under the main slide bars, but the maker claims, with some justice, that it has the advantages of placing the condensing apparatus in a much more accessible position, does not cut an objectionable opening in the foundation at the crank-shaft end of the engine beds, and that by coupling the rods by means of the air-pump cross-head the cold low pressure rod is never worked through into the high pressure cylinder or *vice versa*. In

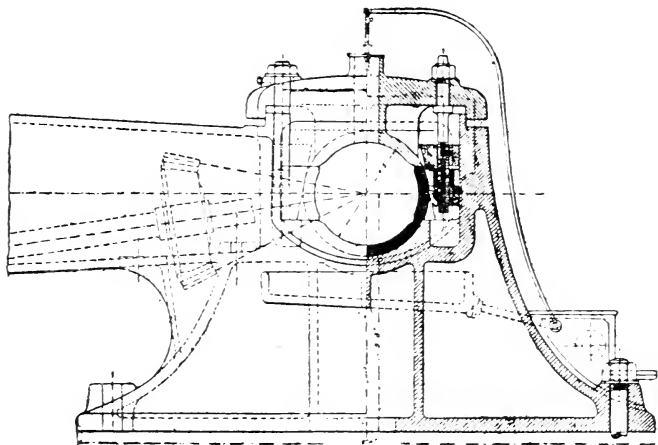

FIG. 78.

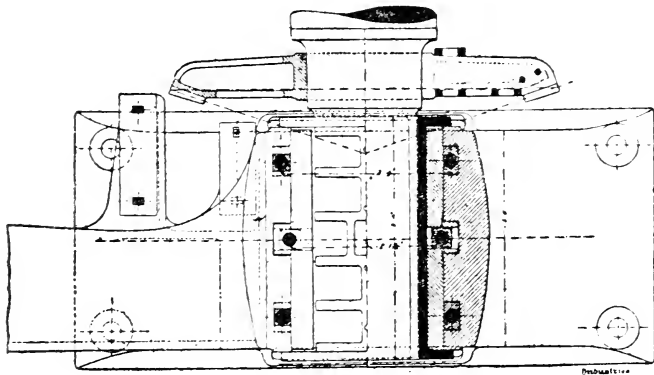

FIG. 79.

more convenient to have the piston rod in two pieces than in one long cumbersome one, as is very common in the other case.

The main bearing used is shown in partial section and plan in Figs. 78 and 79. It will be noticed the brass is divided, so that it can be set up by wedges and screws, and that provision is made for continuous lubrication. The crank shaft is made of Whitworth's fluid compressed steel, and the fly rope pulley is 30ft. diameter, grooved for 46  $1\frac{3}{8}$ in. ropes. It is made as two separate pulleys, *i.e.* there are two bosses, two sets of arms, and two sets of segments, each keyed on to the shaft with separate steel keys. There are some advantages in this arrangement, which has proved successful in practice. The face of the pulley is furnished with a rack, into which a barring engine is geared, and provided so as to be automatically disengaged when the main engine over-runs it. The engines will easily work with  $1\frac{3}{4}$ lb. of coal per I.H.P. per hour, including mill heating, and are a good sample of the most modern type. They are well calculated to do good service for many years and give entire satisfaction alike to the maker and user.

---

## CHAPTER XIV.

### STEAM ENGINE EXAMPLES.

*(Continued.)*

The engines, illustrated in Fig. 80, are being made for a cotton spinning mill in the East, by Mr. George Saxon, and are constructed on the four cylinder triple expansion tandem principle. The high pressure cylinder is 17in. in diameter, the intermediate 29in. diameter, and each of the two low pressure cylinders  $31\frac{1}{2}$ in. in diameter. The cylinder ratios are therefore, high to intermediate, 1 : 2.9 ; intermediate to low, 1 : 2.36. The stroke is 5ft., and when running at 60 revolutions per minute, or a piston speed of 660 feet, with a boiler pressure of 160lbs. per square inch, the engine is calculated to develop 800 I.H.P. The cylinders are arranged with one high pressure and one low pressure acting

pressure and the other low pressure on to the right hand crank, the load on the respective cranks by this means being equalised as nearly as practicable. The engines work on to two cranks set at right angles to each other. Strong cast-iron polished distance-pieces are fixed between the cylinders on each side.

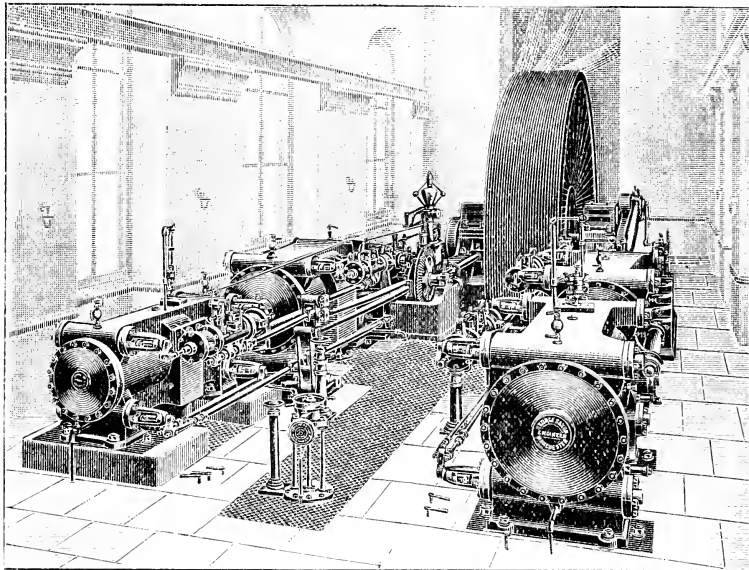

FIG. 80.

All the cylinders are fitted with Corliss valves actuated in a very simple and efficient manner. Each motion is provided with a tripping arrangement, and fitted with springs and air-cushioned boxes, and each valve can be independently adjusted. The trip gear to the high pressure cylinder is connected with and adjusted automatically by an efficient high speed governor, which is fitted with a

mercurial balance or regulator. The range of cut-off varies from nothing to three-fourths of the stroke. The trip gears fitted to the intermediate and two low pressure cylinders are similar to that fitted to the high pressure, the cut-off being adjustable and capable of being varied while the engine is at work. The valves are worked by four eccentrics set on two separate shafts between the low pressure cylinders and in front of the fly rope pulley, the shaft being driven by bevel gear from the crank shaft.

The pistons are fitted with steel spiral coil springs, the rods being of special mild steel and 3in. and 4in. diameter respectively. The crossheads are of hammered scrap iron fitted with mild steel gudgeons. The connecting rods are 12ft. 6in. long, centre to centre,  $6\frac{1}{4}$ in. diameter in the middle, and have the crank-pin ends forged solid. The cranks are of hammered scrap iron, neatly shaped all over, fitted with pins of special mild steel, and have journals  $6\frac{1}{2}$ in. diameter and 9in. long. The crank shaft is of special steel, and has journals 12in. diameter, 30in. long, swelled to 15in. diameter for the pulley seat. The main driving drum, through which the whole of the power of the engine passes, is built up in segments, with loose boss, fitted with mild steel turned and bored hoops, and loose arms bolted to the rim segments and cotttered to the boss. The drum is 25ft. diameter, and grooved for 15 ropes  $1\frac{3}{4}$ in. in diameter, with a rope speed of 4,712ft. per minute. It weighs 30 tons and is prepared with a rack cast on the inside of the rim for gearing with a double cylinder automatic steam barring engine. The pedestals of the crank shaft are adjustable by wedges, and are fitted with four steps of cast iron lined with Magnolia metal, which is a method adopted with great success by this firm, the steps being adjustable both horizontally and vertically. The beds are of a very strong box section, bracketed up to receive the front ends of the low pressure cylinders. They are recessed for the slide blocks, and are fitted with polished wrought-iron guide bars.

Two sets of condensing apparatus are provided, each comprising an air pump 24in. diameter, 20in. stroke, with a hot well cast on top, and fitted with a grid over, having a series of india-rubber valves, condenser, and footbox with valve. The air-pumps are worked from the main crossheads of the engine by steel plate levers connected by strong links, top and bottom.

The steam pipes are being made of electrically welded steel. The fittings comprise special metallic packed glands to all the cylinder covers, lubricators to the crank pedestals for continuous lubrication, radial lubricators to the crank pins, sight feed lubricators to cylinders and to all rotary and reciprocating parts, and planished sheet steel casings, with brass bands. There are also fitted spring relief valves and drain and indicator cocks, indicating gear, polished brass drippers under cranks, polished handrailing round cranks and along connecting-rods, etc ; a Moscrop speed and steam pressure recorder ; and, in connection with the starting valve, an electric stop motion, by which the valve may be closed and the engine brought to a stand from various parts of the mill in case of accidents.

In Fig. 81 an illustration, taken from a photograph, is given of a set of triple expansion engines made by Messrs. J. and E. Wood, of Bolton, for the Mutual Spinning Company. These are the engines previously referred to as having a low steam consumption. They are, as will be seen, of the horizontal double tandem type, having four cylinders. Of these the bore of the high pressure cylinder is 21in., the intermediate 33in., the two low pressures 35in. All the cylinders are without steam jackets, but are, of course, otherwise protected. The stroke of the engines is 6ft. and the velocity 53 revolutions, giving a piston speed of 636ft. The high pressure and right-hand low pressure cylinder form one engine, actuating one crank, while the intermediate and second low pressure cylinder actuate the other, which is placed at an angle of 90° to the right-hand crank. The

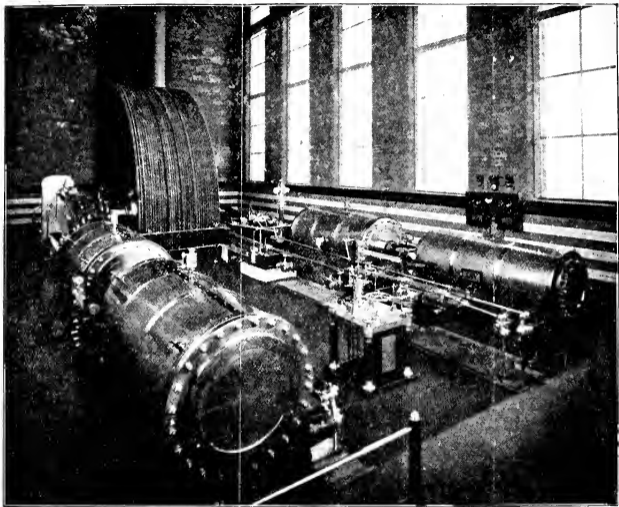
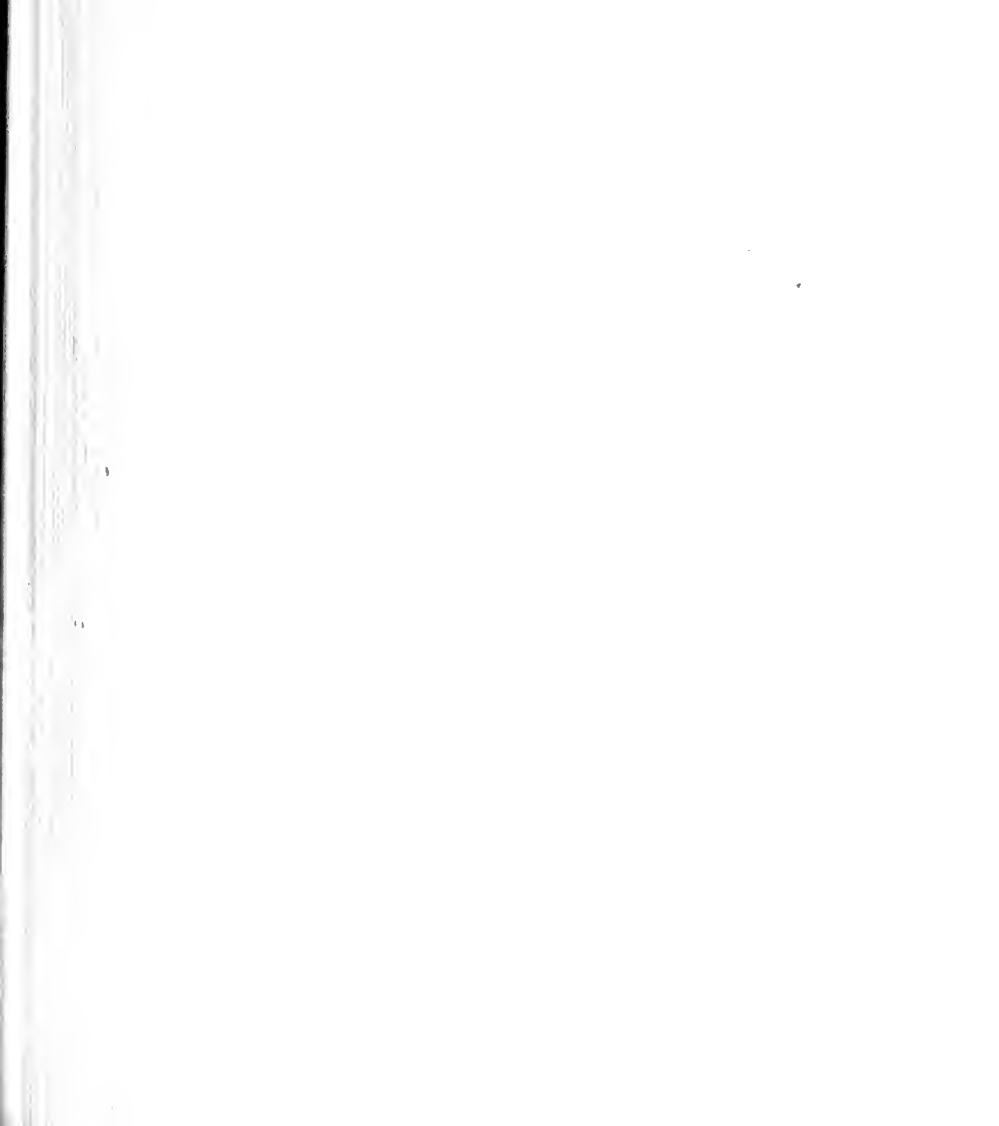

FIG. 81.





areas of the cylinders bear the following ratio:—High pressure to intermediate, 1:2·49; intermediate to low, 1:2·25; high pressure to low, 1:5·61. The effective areas of the pistons, in square inches, are as follow:—high pressure, 339·56; intermediate pressure, 848·05; left-hand low pressure, 937·26; right-hand low pressure, 947·59. The clearances of the cylinders are, in cubic inches, as follows:—High pressure, 920; intermediate, 2,714; left-hand low pressure, 3,337; right-hand low pressure, 3,373. The ratios of clearance spaces to the volume swept by piston are:—High pressure cylinder, ·0376; intermediate pressure cylinder, ·0444; low pressure cylinders, ·0494. The engines are fitted with Corliss valves, which are operated by the trip motion devised by the makers, which is of a very strong, simple, and effective character. The valves of the high pressure cylinder are controlled by a high speed governor of improved type. The piston rods for the high pressure and intermediate cylinders are  $4\frac{3}{4}$ in. diameter, those for the low pressure  $5\frac{1}{4}$ in. diameter at front and  $4\frac{3}{4}$ in. diameter at back of piston. The piston rod is well supported back and front by slide blocks of large area, and the engine generally is strongly and well made. These engines were made in 1892, and on the 5th, 6th, and 7th of September, 1893, Mr. J. F. L. Crosland made a thorough test of the engines, and some of the details of the results obtained by him are given. The boiler pressure was 156lbs. to the square inch, and was supplied by two Lancashire boilers, each 30ft. long and 8ft. diameter, with two flues, each 3ft. 2in. diameter, with 5 Galloway tubes in each flue. Behind the boilers an economiser with 288 pipes is fixed, which delivered the water to the boilers at a temperature of 304° F. The total heating surface of the two boilers is 2,016 sq. ft., and the combined area of the fire grates 66·5 sq. ft., thus giving a ratio of 30·31 to 1. In addition to this the heating surface of the economisers is 2,880 sq. ft. The boilers

was a Shaw slack, having a calorific value per lb. of 12,963 thermal units. The test was made under careful supervision, indicator diagrams being taken every 15 minutes, the whole trial lasting eight hours on two consecutive days. In Figs. 82 to 85 the indicator diagrams taken from these engines are given.

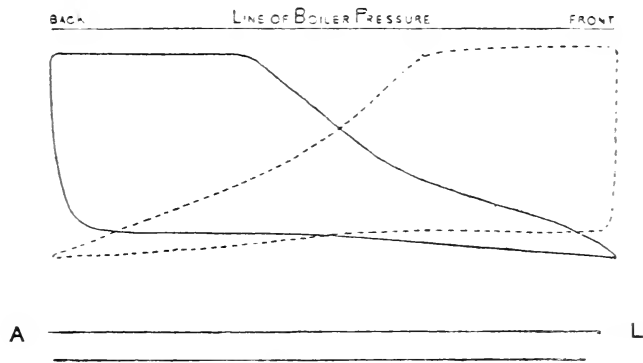

FIG. 82.

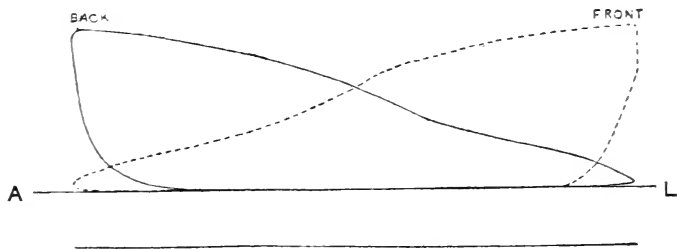

FIG. 83.

The trial showed that there was developed on the 5th September a power of 1,089.7 I.H.P., and on the 6th September 1,049.4 I.H.P. The division of labour on the two engines is very even, as on the 5th September the right-hand crank had exerted on it 542.2 I.H.P., and the left-hand crank 547.5. It

may be well to note that the horse power absorbed in friction was 242.2, the friction diagrams being taken when the belts were upon the loose pulleys. It is not necessary to go through all the details of this trial, but we may at once come to the salient points. The weight of steam and water supplied to the engine per I.H.P. per hour was on the 5th September 12.51lbs., and deducting from this the weight of water, a net weight of dry saturated steam is left of 12.2lbs. On the second day the amount was a little greater, being 12.25lbs., and the weight of dry coal

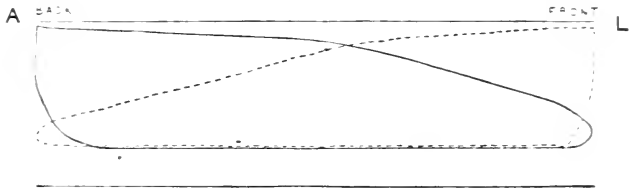

FIG. 84.

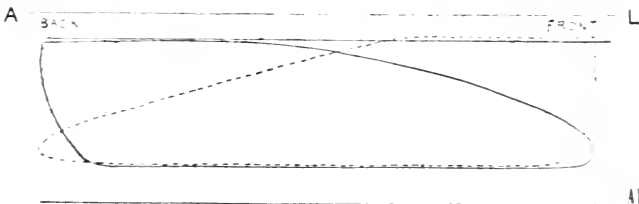

FIG. 85.

Absolute  
Vacuum

consumed per I.H.P. per hour was on the first day 1.37lb., and on the second day 1.38. At the cost of the coal used, which was 6s. per ton, 23.1 H.P. is supplied hourly for 1d. Looking at the engine as a thermal machine, and sticking to one day, September 5th, the heat supplied was 14,935 thermal units, of which 2,565 were converted into work, giving an efficiency of .172. A perfect heat engine working with the same range of temperature gives an efficiency of .279, so that the relative efficiency is .616. Compare this with Professor

was put at '668, and it will be seen that, accepting that test, the present engines, developing far higher powers, are practically as perfect. It is not necessary at this point to say anything with regard to the working of the boilers or economisers beyond noting that the equivalent evaporation at and from 212° F. was per lb. of coal burned 10·36lbs., that the economiser raised the water from an average temperature of 130° F. to 304° F., and that the percentage of effective work done by the boilers and economisers was 75·5. Both these results are satisfactory. It may safely be said that this test, which has been formally made and is beyond doubt reliable, establishes a result which is at once gratifying to the makers, and is the best yet recorded under like conditions for engines of this type.

In Fig. 86 an illustration is given of a pair of compound engines, designed to drive a load of 1,800 I.H.P. They were made by Messrs. Buckley and Taylor, and have the peculiarity, in these days, of being constructed with ordinary slide valves at each end of the cylinder. It is not often that compound engines of such large powers are now made for mill work, but the makers of the engines illustrated have constructed a number for Oldham cotton spinning mills, which are working with complete success and a remarkably low steam consumption. The cylinders of the engines shown have diameters of 26in. and 52in. respectively, or a ratio of 1 : 4. The stroke is 6ft., and the speed 50 revolutions per minute; the piston velocity being thus 600ft. per minute. The high pressure piston rod is steel, with a diameter of  $4\frac{3}{4}$ in., and the low pressure rod is  $6\frac{3}{4}$ in. diameter. The crank shaft is 17in. diameter and 34in. long in the necks, the body being 19in. and the wheel boss 24in. diameter. The shaft is, of course, made of steel. The cranks, which are set at an angle of 90° to each other, are made of best hammered scrap iron, and have bosses round the shaft 36in. diameter and

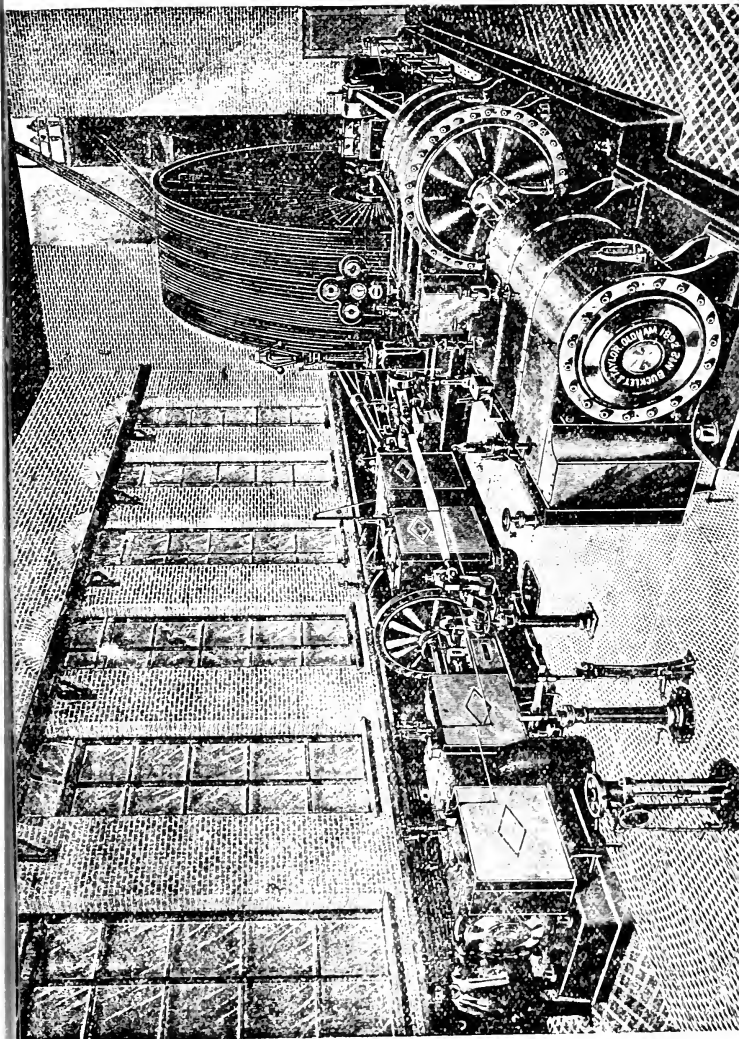

round the pin 21in. diameter, the thickness of the intervening web being 8in. The crank pins, which are made of steel, are 10in. diameter in the journals and 12in. long. The connecting rods are 18ft. long between centres, and are  $10\frac{1}{2}$ in. diameter at their largest part. The air pumps provided are worked by L levers, as usual, being 32in. diameter and 3ft. stroke. The condenser is of the ordinary jet type. On the crank shaft a rope pulley is fixed, which is 30ft. diameter, and is prepared for 40 ropes  $1\frac{3}{8}$ in. diameter each. The speed of the ropes is, therefore, 4,712ft. per minute, which is a very effective one. The feed pumps, which are fixed on the engine, are  $4\frac{1}{2}$ in. in bore, and have a stroke of 15in. A double-cylindereed barring engine is provided. The valve gear of these engines is of a type which has been looked upon as inferior by some engineers, but the diagrams obtained from a number of examples of this class do not show any signs of this. We present a set in Figs. 87 and 88 taken from an engine which is steadily working with an average coal consumption of  $1\frac{3}{4}$ lbs. per I.H.P. per hour, this including the production of the steam used for heating the mill. Although the merits of valves of the Corliss type cannot be denied, it is evident from the results given that there is still something to be said for the simple slide valve which, as was said, is still much favoured in the Oldham district.

In Fig. 89 the now well-known quadruple expansion engine, made by Messrs. John Musgrave and Sons, Limited, is illustrated, this being an end view of the engines made for the Peel Spinning and Manufacturing Company, of Bury. They have four cylinders: the first, a high pressure having a bore of 18in.; the second, the first intermediate cylinder, a bore of 26in.; the third, the second intermediate, a bore of 37in.; and the fourth, the low pressure, a bore of 54in. The cylinder ratios are therefore as follows: high to first intermediate 1:2.086; first to second intermediate 1:2.025; second intermediate to low pressure

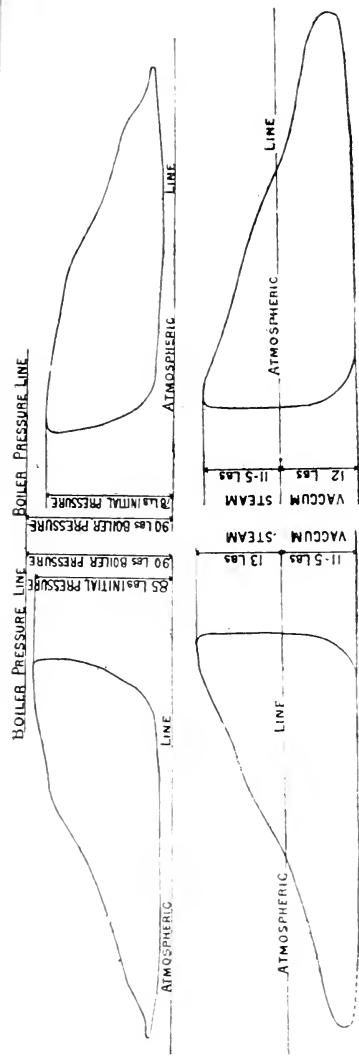

FIG. 87.

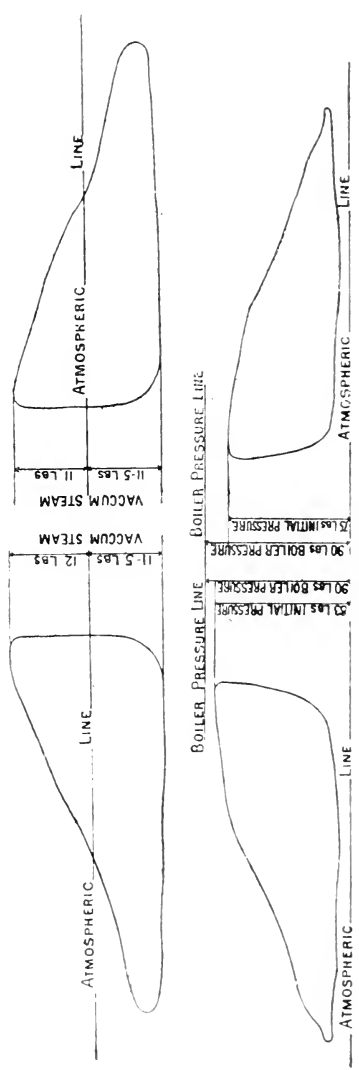

FIG. 88.

practically form two pairs, the high and first intermediate pressure cylinders being fixed on one standard and working on to one crank, and the second intermediate and low pressure cylinders being fixed on the other standard, and working on to the second crank, the rope drum being fixed between the two engines. The stroke of the pistons is 4ft. 6in., and the speed 80 revolutions per minute, thus giving a piston speed of 720ft. The peculiarity of the engines is the employment of a triangular connecting rod, coupled by links to each piston rod, and vibrating on a pin fixed in the ends of a pair of levers oscillating on a fixed centre on the framing. The result of this peculiar arrangement is that there is in a sense no dead centre in the engine, and side pressure on the guide bars is practically abolished. The vibrating levers have short tails formed, to which the air pump rods are coupled, the air pumps, of which there are two, having a diameter of 26in., with a stroke of 15in. The condenser is of the jet type. It should have been mentioned that the valves are of the Corliss type, fitted with the makers' patent trip gear, and—so far as those of the first two cylinders are concerned—controlled directly from the governor, which can vary the cut-off from zero to three-quarters of the stroke. The rope drum is 21ft. diameter, grooved for 36 ropes 1½in. diameter, which have a velocity of 5,280ft. These engines are most interesting, as being the first practical attempt since that of the late Mr. Adamson to apply quadruple expansion to mill engines.

The engines shown in side elevation in Fig. 90 are an example of the compound side by side horizontal engine, this view showing very clearly the general arrangement of air pump, etc. The engine illustrated was made for an Indian mill, and is arranged for a wheel drive. The high pressure cylinder is 35in. bore and the low pressure 60 inches, the ratio of their areas being 1 : 3 nearly. The pistons have a stroke of 7ft., which,



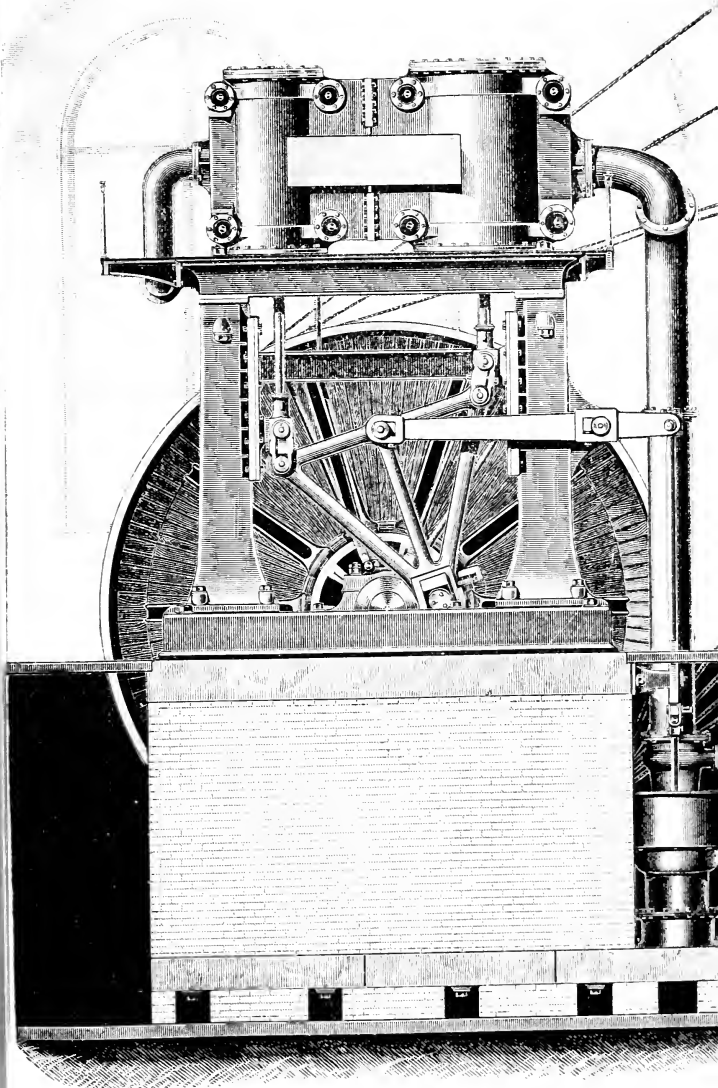
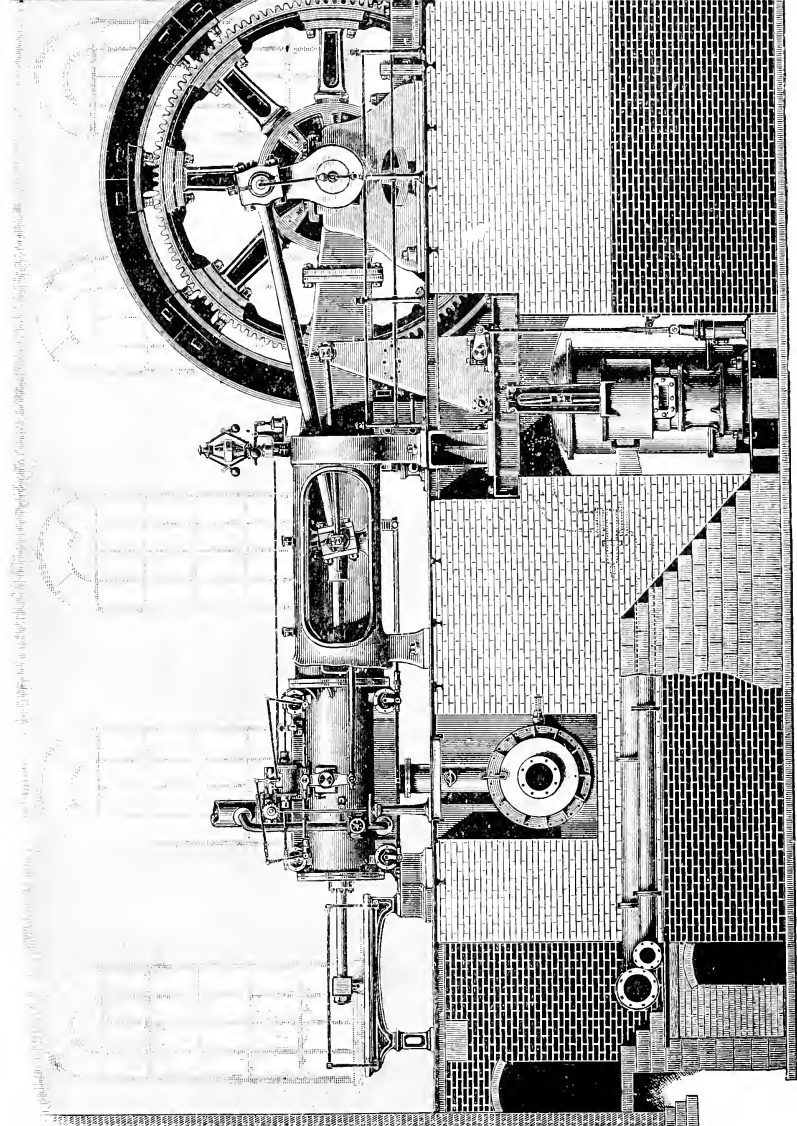

FIG. 89.



No 218

Fig. 90.

CITY CO. & ARTY CO. & HANCOCK.

as the number of revolutions per minute is 44, give a piston speed of 536ft. The pressure of steam used is 110lbs. This engine has a frame of the trunk pattern, the guides being formed in the frame. The piston rod is carried through the back of the cylinder, and carries a slide block sliding in guides which are independent of the cylinder. In most cases the makers prefer to supply a patented support for the piston rods, which consists of a roller turned with a circular groove to suit the rod, and revolving in a fixing which forms an oil chamber. The rod, when sliding, rotates the roller, and the lubricant carried upward by the latter reduces the friction considerably. The purpose of all classes of

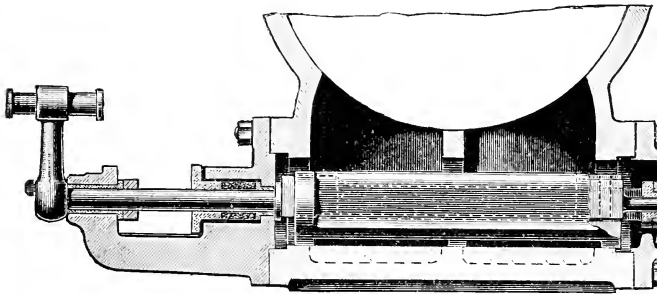
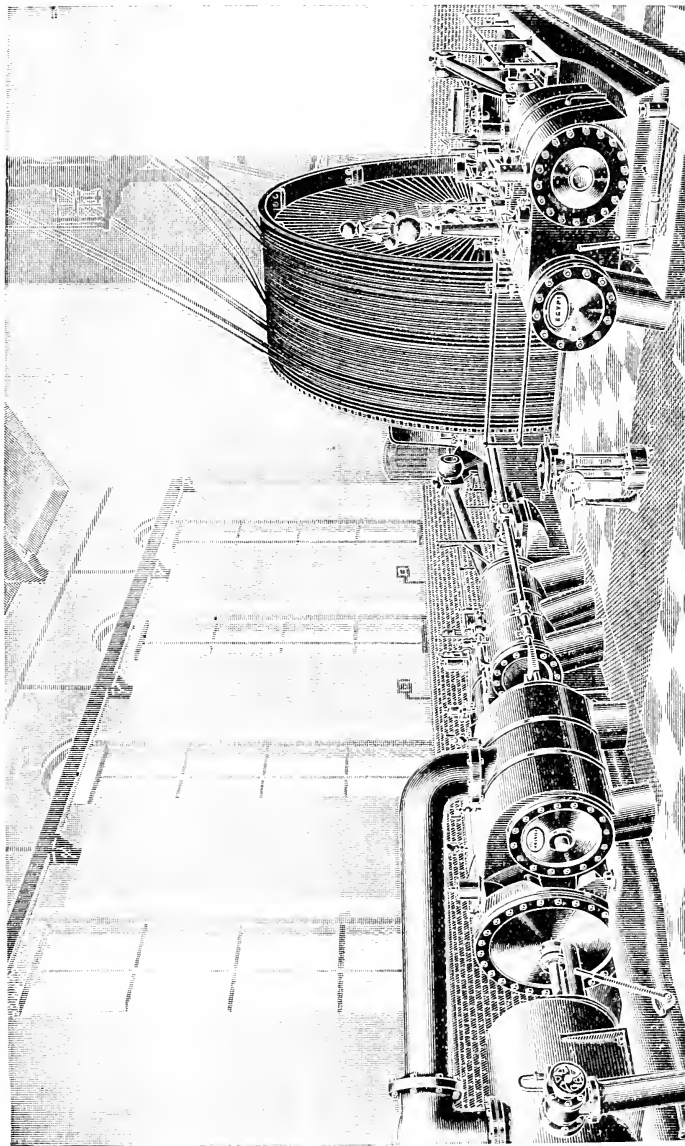

FIG. 91.

slides is to sustain the piston rod and piston and prevent the latter wearing the cylinder oval and the roller support has many claims for consideration. The valves used in this engine are of the Corliss type, and are directly controlled by a high speed governor. In order to avoid the grooving of the valves the arrangement shown in Fig. 91 is employed. In this the rotation of the valve automatically causes it to slide endways a little thus ensuring that it does not make two consecutive oscillations in the same place. In this way wear is prevented, and the life of the valve increased. The engine has two air pumps, each driven from the crosshead of one engine by means of links and

frames. The stroke of the air pump is 28in. and its diameter 30in. Between the two cylinders a receiver of ample area is placed. The crank shaft has a diameter in neck of 18in. and a length of bearing of 3ft. The fly-wheel has a diameter of 22ft. 6in., weighs 45 tons, and the spur-wheel is 17ft. 3½in. diameter. The latter gears into a pinion 6ft. 7½in. diameter. The spur-wheel has 128 teeth, and the pinion 49 each, having a pitch of 5⅓in. and a width of 20in. Through these, 1,800 horsepower is transmitted, the second motion shaft having a speed of 115 revolutions per minute. It ought perhaps to be said that the makers of this engine recommend a box bedplate in preference to a trunk of the pattern shown, but as many users prefer the latter, it is a convenient form to illustrate. A coal consumption of about 1.7lbs. per I.H.P. per hour can be obtained with this type of engine. A rack is fitted on one side of the fly-wheel into which the pinion of a small barring engine gears.

In Fig. 92 an illustration is given of a set of triple expansion engines constructed by Messrs. Pollitt and Wigzell, Limited. They are of a special type, the high pressure cylinder working on to one crank, and the intermediate and low pressure on to the other, the cranks being fastened on opposite ends of the same shaft. The high pressure cylinder is 19in. diameter, the intermediate 28½in., and the low pressure 46in. The cylinder ratios are therefore high pressure to intermediate, 1 : 2.25 ; intermediate to low pressure, 1 : 2.6 ; high pressure to low, 1 : 5.86. The stroke of all the cylinders is 5ft. 6in., and as the number of revolutions is 75, the piston speed is the high one of 825ft. per minute. The intermediate and low pressure cylinders are bolted together, one cylinder cover serving for the back end of the intermediate and the front end of the low pressure. There is one piston rod to the intermediate cylinder, and two to the low pressure cylinder, all connecting to one



on the wedge block system.

The valves employed on all the cylinders are of the piston type; and those used for the high pressure and intermediate cylinders are on Polliitt and Wigzell's patented principle, in which the cut-off valve is fitted inside the main valve. The valves fitted on the high pressure cylinder are directly controlled by the governor, while those of the intermediate cylinder are controllable by hand.

The crank shaft used in this set of engines is made of Whitworth's compressed fluid steel, the journals being 13in. diameter and 27in. long, while the body of the shaft is 19in. diameter. On this shaft are fastened two rope driving drums, fixed side by side so as practically to form one drum. Each of these is 22ft. diameter, and is grooved for 36 ropes  $1\frac{1}{8}$ in. diameter. At the speed named the velocity of the ropes is 5,183ft. per minute. The horse-power transmitted through each rope is about 37. The two fly-wheels together weigh 45 tons, so that there is an ample weight to ensure steady driving. There is provision made for the application of a barring engine of great power, this being made on Greenwood and Whiteley's patent.

The whole of the working parts are made as far as possible of steel, and the crank pins are of ample diameter and area. The beds are made of a massive pattern, and strength is the cardinal feature in this design. The air pump and condenser arrangements are of the usual class.

Engines of this type are at work at the Parkside Spinning Company's mill at Royton—one of the most successful concerns in Lancashire—driving machinery requiring 1,340 I.H.P. The description given will show that there are a few unusual features in these engines. There is first the arrangement generally as to driving, only one low pressure cylinder being used, and this being coupled with the intermediate to one crank, the high pressure cylinder forming the second engine. The second point of notice is the fastening together of the intermediate

and low pressure cylinders, which is a novel and unusual arrangement. The third point to note is the employment of piston valves, and particularly the adoption of an internal cut-off valve. There is also the high piston speed, which is greater than usual. There are thus several features of novelty and interest in these engines, and they are working with success at the mill named.

As an example of the best type of Continental engine, we are enabled in Figs. 93 and 94 to give an illustration of an engine made by Messrs. Sulzer Bros., of Winterthur, Switzerland. Messrs. Sulzer are acknowledged to be at the head of this department on the Continent, and it is not long since every Anglophobist engineer held them up as an example to follow, and a warning of the increasing competition from abroad. A careful comparison of results recently obtained with English engines will show that, despite some conservatism, they have nothing to fear from any quarter. At the same time it is well for engineers to be able to see what others are doing, because the Continental spinning manager is often a well-trained man, with a knowledge of engineering matters not to be lightly despised. By means of this he exacts conditions which the average Englishman does not think of, but which have the effect of stimulating the steam engine makers to greater exertion. Messrs. Sulzer adopt vertical lift valves, which are made with special care, and are placed above the cylinders, being provided with double conical surfaces, on which they are seated. They are balanced, so that little power is wanted to work them. The valves are placed at the ends of each cylinder, and are operated by cam followers which are placed on a longitudinal shaft driven from the crank shaft. The governor is driven from the same shaft, and controls the cut-off, having a range from zero up to 70 per cent of the stroke. The cylinders and covers are steam jacketed and are in addition protected by non-conducting material. The cylinders and jackets are provided

with safety valves and drain taps, and are also furnished with sight feed lubricators. To further avoid condensation the cylinder covers and pistons are turned and polished. The engine frame is of the trunk pattern, so arranged that the cylinder and crank shaft bearings are coupled. The slide blocks are large in area. The crank shaft bearings form part of the frame, the brasses being in four parts, which are adjustable by wedges, and efficient means of lubrication are provided. The air pump and condensing arrangements are of the usual type, and require no special comment. Referring to the question of steam consumption, the minima per I.H.P. per hour for the various types of engine are given by the makers in their catalogue as follows:—Simple condensing type, 17lbs. ; compound engines, 14lbs. ; triple expansion, 11lbs. The writer takes leave to doubt the latter figure, and would substitute 12lbs. for it. It is quite true that there have been many tests of engines made in which it is alleged the steam consumption has come down to nearly 11lbs., but it is important to note that few of these have been conducted in anything like a careful and scientific way. An engine made by Messrs. Hick, Hargreaves, and Co. for a Swedish mill is reported to have been tested for two consecutive days, and to have used only 11·23lbs. of water per I.H.P. per hour, including jacket drains. Had that test been conducted in such a manner that its records were accessible for criticism and the methods seen to be above reproach it would be the best result yet attained. As the matter stands, the facts prove that no mill engine has hitherto reached the limit of 11lbs. of steam, and that any large engine which in ordinary work consumes less than 13lbs. per I.H.P. may be looked on as in the first rank. It has been shown that this is the case with engines already at work.



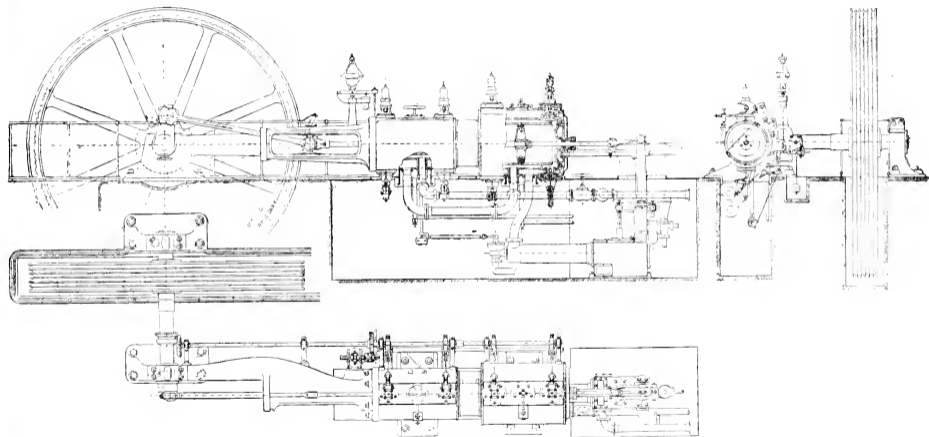

FIGS. 93 AND 94.



## CHAPTER XV.

## LIGHTING ENGINES AND OTHER ACCESSORIES.

Fig. 95 represents a compound side by side engine, two of which have been recently constructed for electrical purposes by the Burnley Ironworks Company Limited. They are non-condensing, but provision is made for the application of a condenser whenever desirable. Each engine is prepared to transmit about 190 I.H.P. having 14in. and 24in. cylinders, 3ft. stroke, the dynamo being driven from a fly-rope pulley 14ft. diameter, grooved for eleven  $1\frac{1}{4}$ in. ropes running at 90 revolutions per minute. The makers have applied their latest improvements in the Corliss gear and governor, and from recent very severe tests they claim that any variation in load will be readily compensated for. The engines are of the very best construction and workmanship, and are made on similar lines to the engines at the Burnley Electric Light Station, which we have had the opportunity of seeing. These, we were informed, run with economy and regularity under all conditions of load, and are everything that could be desired for the purpose. The success of the Burnley engines led to those illustrated being entrusted to the same firm. Much larger engines have been made by this company, but the present demand for steady and regular driving for electric purposes led us to deal with the one illustrated as likely to interest our readers.

In cases where the building is lighted by electricity, it is usual, and the better practice, to drive the dynamos by an independent motor. This is usually of the high speed inverted cylinder type, and economy of space is one of its chief features. At the Peel Mill, Bury, the engine used is one of the type of which the main engine is an example, and drives the dynamo through the intervention of a rope pulley. The "Globe" engine, made by the Globe

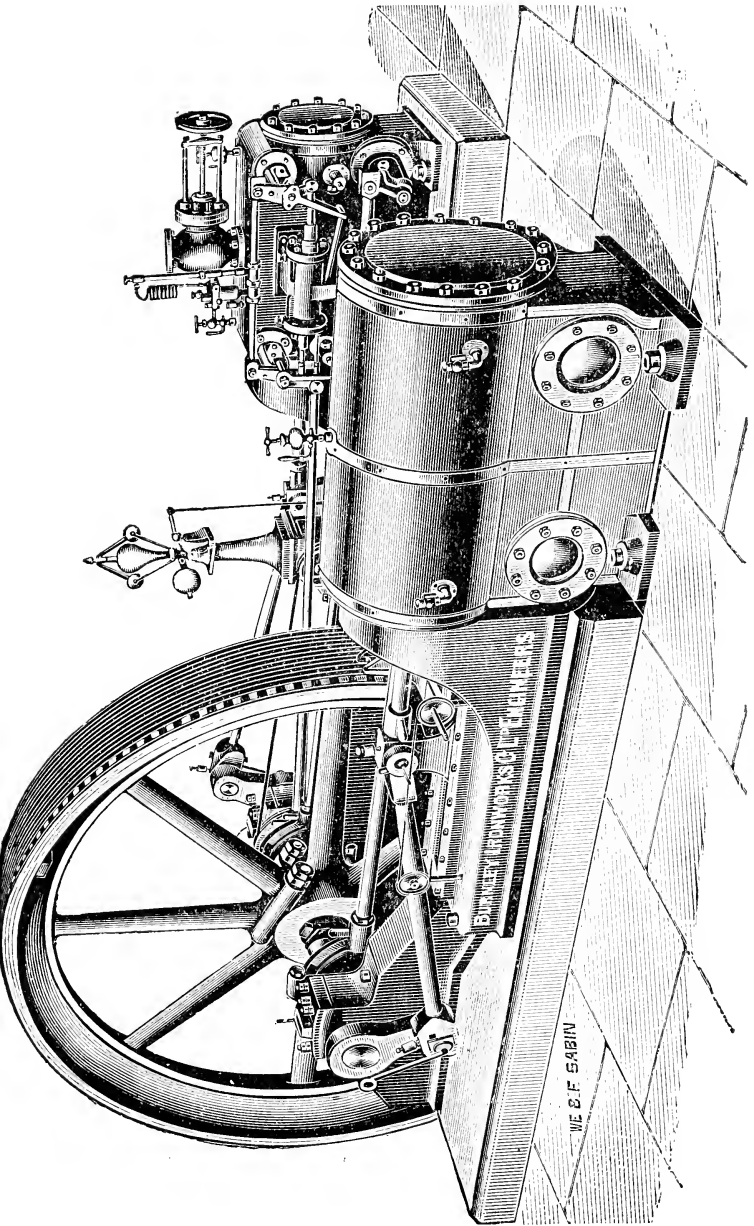

Fig. 95.

Engineering Company, Limited, is shown in Figs. 96 and 97, and is of the compound type. In the example illustrated, which at 250 revolutions per minute develops 300 H.P., the floor

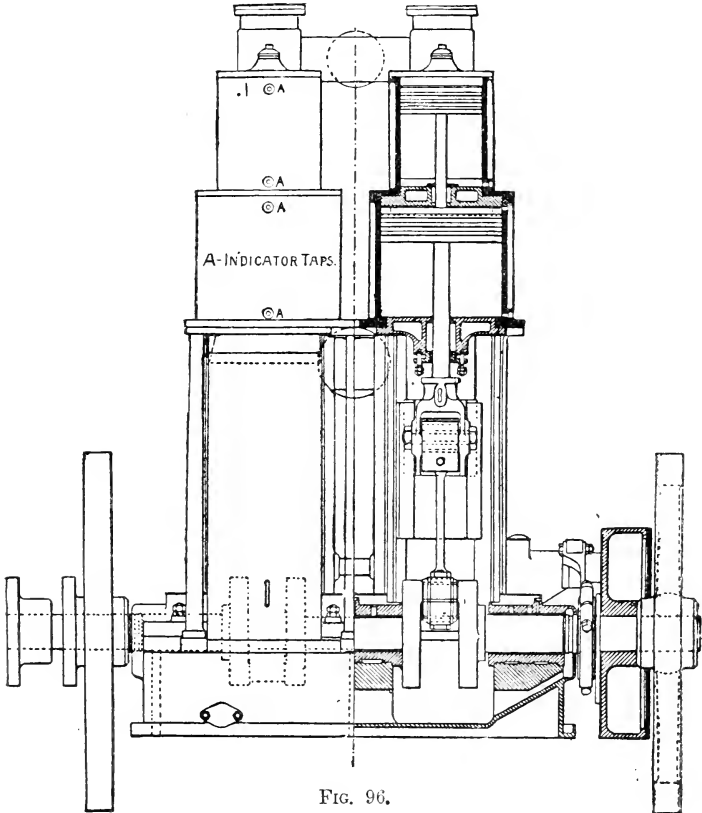

FIG. 96.

space occupied is 11ft. by 6ft. It is a compound condensing engine, although the condenser is not shown. The high pressure cylinders are superposed on the low pressure, and the steam is used

pressure piston, the engine completes one stroke, after which the opening of a valve connects the top and bottom of the cylinder, thus placing the piston in equilibrium during its ascent. When the steam is again admitted, that below the piston passes into the low pressure cylinder, and is treated in exactly the same way as in the high pressure, finally being taken to the condenser. The valves are of the piston type, and a glance at Fig. 97 shows that there are three to the two cylinders, which enables them to be set independently of each other. The impulse given to the piston is therefore all in one direction, and the steam cycle is as follows: Top of high pressure cylinder, bottom of high pressure cylinder, top of low pressure cylinder, bottom of low pressure cylinder, thence to condenser. A considerable expansion is obtained, and it is stated cylinder condensation is much reduced. The valves are driven from a rocking shaft, and are so coupled to it that one set balances the other. A centrifugal governor enclosed in an oil-tight casing controls the rocking shaft, and as it constantly revolves in oil the governor is very sensitive. In designing the engine care has been taken to make the parts light, and the valve rods and pistons are made from hollow steel bars. The cranks, like the valves, are set opposite to one another, so as to balance, and this specific feature has been carefully attended to. The bearings of the engine are of large area, and lined with Magnolia metal, and the bedplate, being a strong box casting, forms oil wells, into which the cranks dip at every revolution. The oil is thus sprayed over all the working parts. A sheet-iron case is provided to cover the whole of the working parts, and prevent the egress of oil; but is so fitted that it can be readily opened to permit access to the motion work. The piston rods are packed with a special metallic packing, consisting of rings of Magnolia metal, so held as to be free to move. The friction of the engine is thus reduced to a low point.

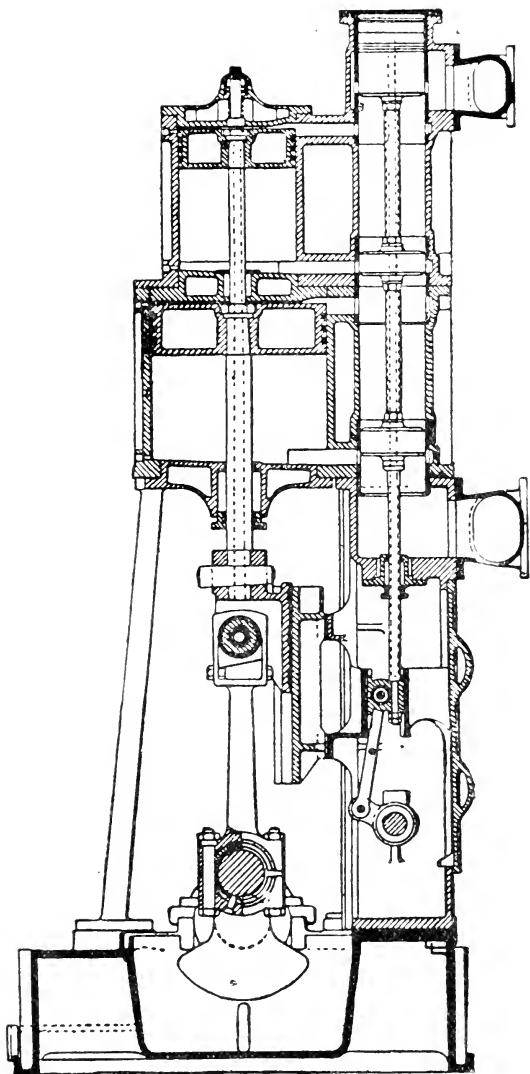

FIG. 97.

The Moscrop Recorder (Fig. 98), made by Messrs. Arundel and Co., which is now an indispen-



FIG. 98.



the rotation of an engine can be recorded. Its essential parts are a barrel which receives a movement synchronous with the hands of a clock, by the mechanism of which it is rotated. The barrel, in its movement, carries with it a paper band divided by transverse lines into spaces corresponding with definite intervals of time, and having also two or three longitudinal lines. Upon this paper—which is prepared for contact with a metallic marker—a marker wheel or pencil rests, being set so that when the engine is making its proper number of revolutions per minute, the wheel is directly over one of the longitudinal lines. The marker is connected with the slide of a centrifugal pendulum governor of a sensitive character, driven from the engine so that any divergence from the normal speed causes the marker to move either to one side or the other of this line. By observing the character of the line made, the uniformity of the velocity of the engine can be determined. It is now usual to make a record of the steam pressure upon the same band, so that the fluctuations in that can also be ascertained. So perfect is the mechanism of large mill engines, however, and so entirely are they under control, that although the steam pressure may and does vary considerably, the speed line shows an exceedingly small variation. The reduced diagram given in Fig. 99 is that taken from the engines of the Mutual Spinning Co., which have already been referred to. Each of the vertical spaces represents a period of five minutes. It is not too much to say that no single instrument has done so much towards improving the steadiness of the velocity of mill engines as the Moscrop Recorder.

In Fig. 100 we illustrate a form of lubricator specially made for steam engine cylinders. It consists of a cylindrical body, in which a piston having a hollow piston rod works, a stuffing box being fitted to prevent any escape of steam. The piston rod has a cap on its upper end, which can be removed, so that oil can be poured down the rod, and by means

of holes in it, find its way into the cylindrical body. At the lower end of the cylinder a valve is provided by which the steam is admitted below the piston, which is thus pressed up, and so displaces the oil, which in time finds its way out by the sight feed tube shown, in this way passing to the cylinder or steam pipe. The necessary provision is made for draining off the water of condensation when the cylinder is again to be filled with oil. It is claimed for this type of lubricator that no effect is produced by the bends in the feed pipe, however numerous; that the same lubricator can be made to feed two cylinders; and that the action is positive. It is clear that when the piston is at the top it acts as an indicator of the quantity of oil in the body. The valves are so arranged that any quantity of oil, from 1 to 200 drops per minute, can be fed, and as no condensed water touches the glass tubes they cannot become dirty. The lubricator is compact and strong, being made by

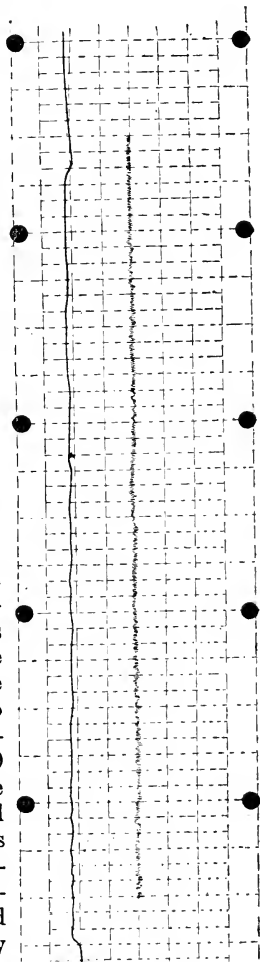

Fig. 99.

Before passing on, a few words may be said about steam engine indicators and their use. Properly employed, the indicator enables the working of an

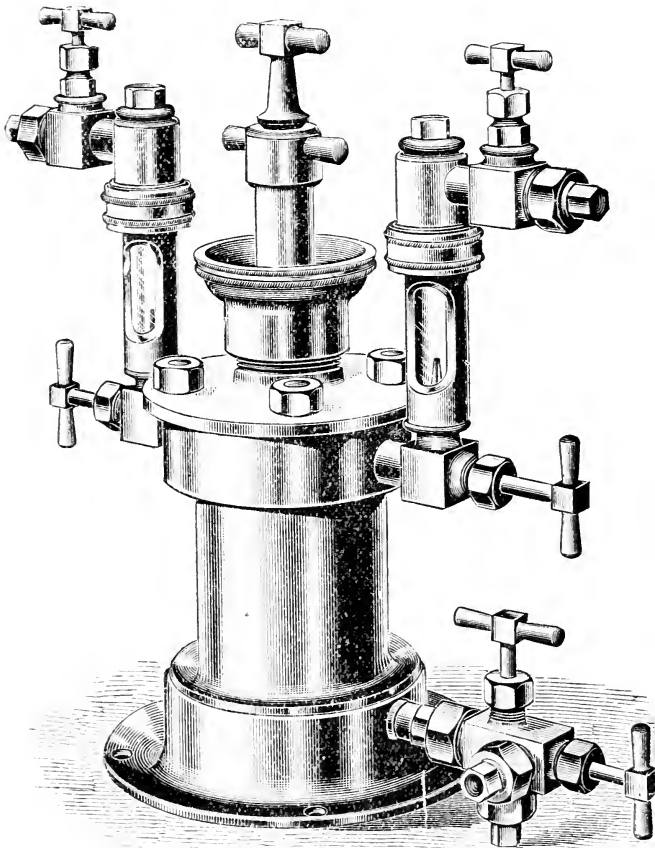

FIG. 100.

engine to be accurately understood, but unless some care is taken in its use, the diagrams obtained may be causes of very serious errors. Millowners

are often in doubt as to the class of instrument they should adopt, and on this point it may be said that for slow running engines the Richards is reliable. The great fault of that instrument,

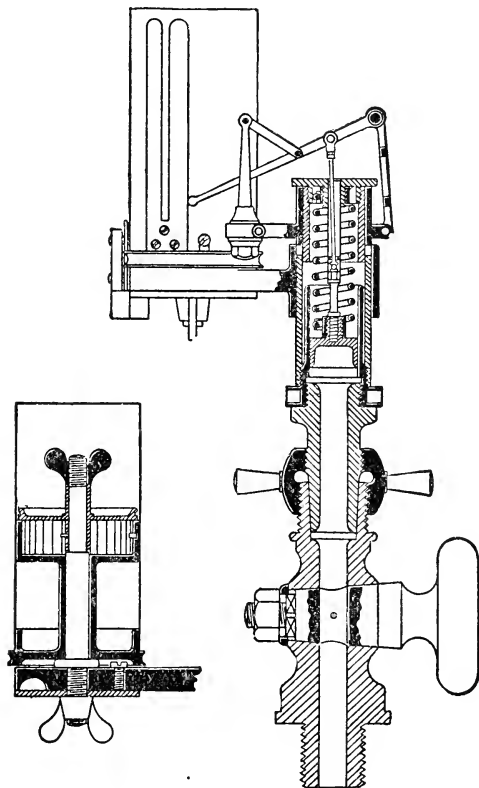

FIG. 101.

viewed from the modern standpoint, is, that the movement of the pencil on the paper is obtained by

high speed the inertia of the parts is so difficult to overcome that distorted diagrams result. Many other instruments have been introduced since, in which simpler pencil movements have been used, and the result has been a true diagram when run at high speeds. It has already been pointed out that the velocity of mill engines tends to increase, and there is, therefore, the greater need for caution

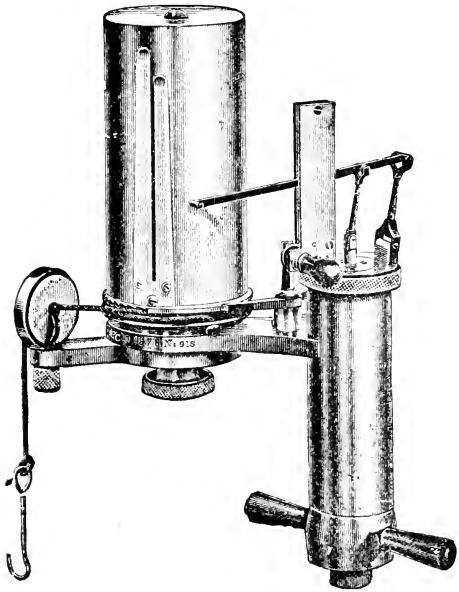

FIG. 102.

in this respect. It has been contended further that the relative velocities of the piston and pencil in the Richards' type are not uniform throughout the whole range of the instrument. The two instruments illustrated in Figs. 101 and 102, are respectively the Thompson and the Tabor, which are much more simple and reliable than their predecessors.

Having chosen the instrument to be used, the next thing is to apply it in the best manner. To

begin with, the instrument should be kept absolutely clean and lubricated by pure oil free from gum or acid. Then the movement of the pencil must be quite free, and so easy that the weight of its attached parts will cause it to fall. It is better to fix the indicator at each end of the cylinder alternately rather than in the middle, if circumstances will permit. If, however, this is not possible, then care should be taken that all the bends are easy, that there are not too many of them, and that the three-way cock used leaves a clear passage for the steam. The character of the reducing gear is an important matter. What is wanted is to get an accurate reduction and reproduction of the motion of the piston on the pencil, for which purpose it is essential that the cord in leading off to the indicator shall as nearly as possible follow the path of the piston. In some forms of gear, such as the long pendulous rod, the cord is continually assuming various angles. The "Lazy Tongs" type of pentagraph motion has some advantages, but by far the best form is found in the use of an endless cord passing over two pulleys rotating on pins at the ends of the slide. By fastening the cord to the cross head pin it is given a reciprocal motion similar to the piston, and so rotates the pulleys in each direction alternately. On the boss of one of the pulleys a smaller grooved pulley is fixed, on which the cord actuating the indicator is coiled. From this pulley the cord can be led so as to give a regular pull on the paper barrel in a horizontal or vertical line, so that all difficulties arising from varying angles are overcome.

Having ascertained that the instrument is in true working order, and that the parts are all free, it is fixed in position and the paper put on the barrel. It is now essential, before coupling up the drum, that the steam is admitted to the cylinder so as to

weight must not be put on the pencil, as otherwise its movement will be retarded. The steam is then admitted to the indicator and the pencil pressed against the paper, thus producing the diagrams. The diagram should not be taken during one stroke only, but the pencil must be kept in contact with the paper for several strokes. This is important, as there is very often a great deal of difference in diagrams produced during successive strokes. It must be remembered that as it is from the revelations of the diagram that any correct idea can be formed either of the power developed, or of the manner in which the engine is working, it is essential to take

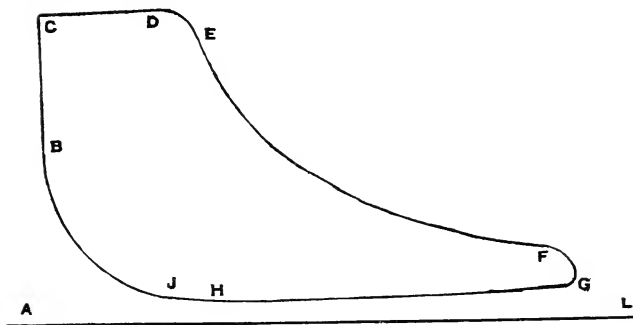

FIG. 103.

every precaution to obtain a correct figure. It is not necessary to have mathematically correct appliances, but accuracy is essential.

The illustration given in Fig. 103 will serve to enable the chief features of a good diagram to be seen. In this figure the line of atmospheric pressure is shown by the letters A L. The admission of steam begins at B, and if the valves are well set the pencil rises rapidly in a nearly vertical line until the point C is reached. The line BC is the "admission line." The line CD is the "steam line," and should, if the area of the valve ports be large enough for its purpose, be horizontal. At E the valve closes, and the sharpness of the corner indicates the character of the cut

off. From E to F the line shows the fall of the pressure caused by the expansion of the steam, and the nearer it approaches the theoretical line, plotted in accordance with the behaviour of a perfect gas under like conditions, the more perfectly is this part of the work done. At F the valve opens for the exhaust, and at G is fully open, G H being the "exhaust line." The exhaust valve begins to close at the point H, and is fully closed at J, when the work of compression takes place. The line J B is the "compression line." It is now possible to point out briefly the significance of some of the lines. If the line B C, instead of being vertical, inclines towards D, it is clear that the valve does not open sufficiently early, or, in other words, the "lead" is insufficient. If on the other hand at C there is a line projecting beyond the vertical, this is attributable either to too early an admission of steam, accompanied by its compression, or to a defect in the motion of the indicator. As shown in Fig. 103, the line C D is horizontal. If it falls away from the horizontal it indicates some obstruction in the free admission of the steam, arising either from insufficient area in the pipes or the improper setting or construction of the valves. The height of the line C D should be compared with the height of a line drawn to the same scale, representing the pressure of steam in the boiler. If it falls below that considerably it is necessary to look for the cause in the steam pipes, although it may arise from the contracted area of the valve port. Any fall from the horizontal line implies throttling or obstruction at some point between the source of supply and the cylinder. Dealing next with the expansion line, if the curve rises above the hyperbolic, it is attributable either to an improper admission of steam, or to re-evaporation of water produced by condensation. In some classes of valve gear leakage is difficult to avoid, while in others



of the parts or of water in the cylinder. Dealing now with the "exhaust line," this is affected by too early or too late exhaust. If the former, then instead of the line beginning to fall at F it does so earlier, and if the latter, the point F is carried forward, and the lowest point is not reached until the piston has made a good part of its return stroke. The line G H is broken and a curve is formed from F to some point more or less forward on G H. If there is insufficient compression, instead of the line J B being formed, G H is extended to a point vertical with B C, and a sharp corner is formed. If on the other hand the compression is too great, owing to too early closing of the exhaust valve, a loop is formed at the corner C of the diagram, although this may be caused by the use of too weak a spring. There are other distortions of the diagram which arise from various causes, mainly mechanical, but these are soon recognised after a little practice.

So far the subject has been dealt with only as regards faults in the setting of the valves, and the methods of determining the power of the engine can now be treated. On the atmospheric line (see Fig. 104), perpendicular lines A B, C D, are erected touching the two ends of the diagram. The distance between these lines is divided into eleven spaces, nine equal to each other and the two end ones equal to half the width. The readiest way of doing this is shown in Fig. 104. A rule is laid across the diagram as shown, so that a length of five inches touches the perpendiculars. Marks are made at a quarter inch from each of the perpendiculars, and then at each half inch between. Through these points perpendiculars are drawn, so that the measurements can be made. The mean height of the diagram between these lines is measured and is multiplied by the scale of the spring. This gives the mean pressure in pounds. Add all the results together and divide by 10, and the result is the mean pressure over the whole diagram. The horse power is calculated by the following formula :  $P = \text{mean effective pressure in lbs. ; } L = \text{the length of stroke in feet ; } A = \text{the area}$

of the piston in square inches ; and  $N$  = the number of strokes per minute. Then  $\frac{\text{PLAN}}{33,000}$  = indicated horse power (I.H.P.). The area of the figure can be obtained by various forms of planimeters, and among these an American invention, the Coffin Averager, is about the best. These devices undoubtedly save a little time, but are not always accessible.

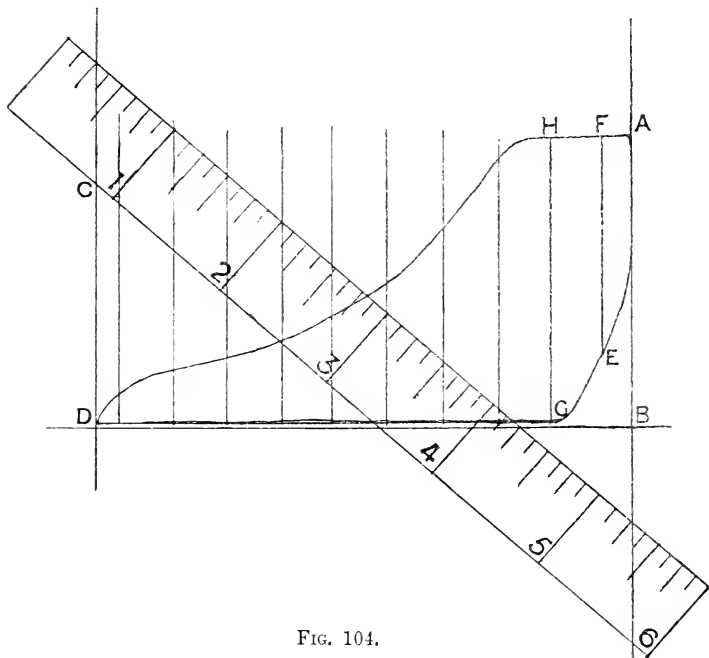

FIG. 104.

As has been said, the real test of the economy of an engine is the weight of steam used by it. This can be determined from the indicator diagram when

the indicator diagram. It is necessary to know accurately the volume of the clearance spaces in the cylinder, which can be arrived at by measurement, or more accurately by filling them with measured quantities of water. 13,750 cubic feet of steam per hour at 11b. pressure, is required to produce one horse power without clearance and without expansion. The greater the pressure the less the volume, and to ascertain the value of the volume required it is necessary to divide the 13,750 by the mean effective pressure in the cylinder. We will call this quantity  $V$ . The mean effective pressure in a multiple expansion engine is the sum of the mean pressure in all the cylinders, not merely in the high pressure. To arrive at this in a compound engine, it is necessary to multiply the pressure in the low pressure cylinder by the ratio of its area to that of the high pressure. This, if the mean effective pressure of the high pressure cylinder be 30lbs., and that of the low pressure 8 while the area of the latter is 3 : 1 of that of the high pressure, then the mean effective pressure of the two is  $(8 \times 3) + 30 = 54$ lbs. which is the quantity  $V$ . The formula is as follows : Let  $P$  = the percentage of stroke up to point of cut off ;  $C$  = percentage of clearance space to volume displaced by piston ;  $S$  = percentage of return stroke made when compression begins ;  $W$  = weight per cubic foot of steam at pressure when cut off ;  $w$  = weight per cubic foot of steam at the pressure of compression. Then  $V [(P + C) W - (S + C) w] =$  lbs. of steam at cut off per I.H.P. Assuming that  $V = 54$ lbs. ; that the cut off takes place at  $\cdot 25$  of full stroke ; that compression takes place when  $\frac{9}{10}$  of stroke is completed making  $S = 0\cdot 1$  ; that the clearance  $C = \cdot 05$  ; that the steam pressure at cut off is 60lbs. or 74\cdot 7 absolute ; the weight of a cubic foot of steam at that pressure is  $\cdot 175$ lb. ; and the pressure at compression 6lbs., or 20\cdot 7lbs. absolute, with a weight per cubic foot of  $\cdot 053$ lb. Then the weight of steam is obtained as

follows:—  $\frac{13750}{54} [(\cdot 25 + \cdot 05) \cdot 175 - (\cdot 1 + \cdot 05) \cdot 053] = 254\cdot 63 (\cdot 0525 - \cdot 00795) = 11\cdot 343$ .

This amount requires to be multiplied by a fraction in which the total steam, taken as 100, is the numerator, and the percentage of feed water accounted for by the indicator diagram, which is the total minus cylinder condensation, the denominator. According to Mr. A. G. Brown this is as follows:—

| Percentage of stroke at which cut-off takes place. | Percentage of Feed Water Accounted for in Diagram. |                                  |                                  |
|----------------------------------------------------|----------------------------------------------------|----------------------------------|----------------------------------|
|                                                    | Simple Engine Unjacketed.                          | Compound Engines Steam Jacketed. | Triple Expansion Steam Jacketed. |
| 10                                                 | 66                                                 | 74                               | —                                |
| 15                                                 | 71                                                 | 76                               | 78                               |
| 20                                                 | 74                                                 | 78                               | 80                               |
| 30                                                 | 78                                                 | 82                               | 84                               |
| 40                                                 | 82                                                 | 85                               | 87                               |
| 50                                                 | 86                                                 | 88                               | 90                               |

Applying this to the case given above we get  $\frac{100}{80} \times 11\cdot 343 = 14\cdot 178$  lbs. as the steam consumption per horse power per hour. If the cylinders are not jacketed, 5 per cent must be deducted from the percentages given, as there will be more condensation. The figures given are entirely supposititious, and are only intended to illustrate the method, so as to enable millowners to ascertain what the economy of their engines is.

## CHAPTER XVI.

### TURBINES.

advantage. Abroad the matter is different, and in Switzerland, for instance, the use of water power exists on a large scale. In some towns in the United States, notably Holyoke, Mass., where the Connecticut River has a considerable fall, the volume of water flowing down the river has, by means of dams, been utilised to provide a steady ample supply of water at constant pressure. The theoretical horse-power of a stream of water is obtained by the formula  $P = .001892 W H$ , where  $W$  = number of cubic feet of water flowing per minute, and  $H$  = total head from tail race in feet. It is sometimes a little difficult to accurately gauge the actual flow of water over a weir, but the following procedure will serve. Take a board of sufficient length and width to form a dam in the stream. In this, cut a rectangular notch not longer than two-thirds the width of the stream, but sufficiently deep to pass all the water to be measured. The bottom edge of this notch should be bevelled on the side facing down stream, so as to make it nearly sharp. Drive a stake into the bottom of the stream a little behind the weir, so that it is exactly

TABLE 15.  
FLOW OF WATER OVER WEIRS.

| Inches<br>Depth<br>on<br>Weir. | 0     | $\frac{1}{4}$ | $\frac{1}{2}$ | $\frac{3}{4}$ | $\frac{1}{2}$ | $\frac{5}{8}$ | $\frac{3}{4}$ | $\frac{7}{8}$ |
|--------------------------------|-------|---------------|---------------|---------------|---------------|---------------|---------------|---------------|
| 1                              | 0.40  | 0.47          | 0.56          | 0.65          | 0.74          | 0.83          | 0.97          | 1.03          |
| 2                              | 1.14  | 1.25          | 1.36          | 1.47          | 1.59          | 1.71          | 1.84          | 1.96          |
| 3                              | 2.09  | 2.12          | 2.26          | 2.60          | 2.64          | 2.78          | 2.93          | 3.06          |
| 4                              | 3.22  | 3.38          | 3.53          | 3.69          | 3.85          | 4.01          | 4.17          | 4.35          |
| 5                              | 4.51  | 4.68          | 4.85          | 5.02          | 5.20          | 5.38          | 5.56          | 5.74          |
| 6                              | 5.92  | 6.10          | 6.30          | 6.49          | 6.68          | 6.87          | 7.07          | 7.27          |
| 7                              | 7.46  | 7.67          | 7.87          | 8.07          | 8.28          | 8.49          | 8.70          | 8.91          |
| 8                              | 9.12  | 9.33          | 9.55          | 9.77          | 9.99          | 10.21         | 10.43         | 10.66         |
| 9                              | 10.88 | 11.11         | 11.34         | 11.57         | 11.80         | 12.04         | 12.27         | 12.51         |
| 10                             | 12.75 | 13.15         | 13.23         | 13.47         | 13.72         | 13.96         | 14.21         | 14.46         |
| 11                             | 14.71 | 14.96         | 15.21         | 15.46         | 15.72         | 15.98         | 16.24         | 16.49         |
| 12                             | 16.76 | 17.02         | 17.28         | 17.55         | 17.82         | 18.08         | 18.35         | 18.62         |
| 13                             | 18.89 | 19.17         | 19.44         | 19.72         | 20.00         | 20.27         | 20.56         | 20.83         |
| 14                             | 21.12 | 21.40         | 21.68         | 21.97         | 22.26         | 22.55         | 22.83         | 23.13         |
| 15                             | 23.42 | 23.71         | 24.01         | 24.30         | 24.60         | 24.90         | 25.19         | 25.50         |
| 16                             | 25.80 | 26.10         | 26.41         | 26.71         | 27.02         | 27.32         | 27.63         | 27.94         |
| 17                             | 28.26 | 28.57         | 28.88         | 29.19         | 29.51         | 29.83         | 30.14         | 30.46         |
| 18                             | 30.78 | 31.11         | 31.43         | 31.75         | 32.07         | 32.40         | 32.73         | 33.05         |

level with the crest. When the water has reached its full height, take a measurement by means of a square. The water should have a clear fall of six inches below the crest of the weir. By ascertaining the depth and width, and the velocity of the stream, the number of cubic feet per minute passing can be ascertained. Table 15 gives the flow over weirs of different depths in cubic feet for each inch of width. If the velocity be ascertained and careful measurements taken of the depth of a stream, the flow can be easily calculated. If the head be known the power can be easily arrived at in the following manner. The head regulates the velocity and pressure of the efflux of water, and Table 16 gives the theoretical velocity of water in feet per second, and the number of cubic feet discharged per minute through an orifice of one inch area. When the discharge  $D$  in cubic feet and head of water  $H$  are known, the power of a turbine can be obtained by the following formula:  $P = 0.1134 D \sqrt{H}$ , which gives the theoretical efficiency of water. The actual efficiency of a turbine is usually taken at .66 of the

TABLE 16.

## THEORETICAL VELOCITY AND DISCHARGE OF WATER THROUGH ORIFICES.

| Head in feet. | Velocity per second in feet. | Cubic feet per minute, area of orifice, 1 inch. | Head in feet. | Velocity per second in feet. | Cubic feet per minute, area of orifice, 1 inch. | Head in feet. | Velocity per second in feet. | Cubic feet per minute, area of orifice, 1 inch. |
|---------------|------------------------------|-------------------------------------------------|---------------|------------------------------|-------------------------------------------------|---------------|------------------------------|-------------------------------------------------|
| 1             | 8.02                         | 3.34                                            | 15            | 31.06                        | 12.94                                           | 28            | 42.43                        | 17.68                                           |
| 2             | 11.34                        | 4.73                                            | 16            | 32.08                        | 13.36                                           | 29            | 43.19                        | 17.98                                           |
| 3             | 13.89                        | 5.78                                            | 17            | 33.06                        | 13.77                                           | 30            | 43.93                        | 18.30                                           |
| 4             | 16.04                        | 6.68                                            | 18            | 34.02                        | 14.18                                           | 31            | 44.65                        | 18.60                                           |
| 5             | 17.93                        | 7.47                                            | 19            | 34.96                        | 14.57                                           | 32            | 45.37                        | 18.90                                           |
| 6             | 19.64                        | 8.18                                            | 20            | 35.87                        | 14.94                                           | 33            | 46.07                        | 19.20                                           |
| 7             | 21.22                        | 8.84                                            | 21            | 36.75                        | 15.31                                           | 34            | 46.76                        | 19.48                                           |

theoretical. In like manner water wheels if under-shot have an efficiency of  $\cdot35$ ; if breast  $\cdot55$  to  $\cdot56$ ; and if overshot  $\cdot68$ . Another rule for Jonval turbines is, if  $P =$  actual horse power,  $P = \cdot075 D H$ ; and for Fourneyron high-pressure turbines,  $P = \cdot079 D H$ . Table 15 is extracted from a catalogue of the Victor Turbine, which is very largely employed in the United States and this country. In other countries the force of water has been employed, and a full set of illustrations of a very high power turbine installation made by Messrs. W. Günther and Sons, of Oldham, for the cotton mill of the Compañia Industrial de Orizaba, Mexico, are given. This is, we believe, the largest installation applied to textile work existing, and its details will be interesting. In all there are five turbines of the Girard type, developing together 1,560 horse-power. The spinning mill is driven by two turbines of 425 horse power each; the weaving mill by one of 300 horse power; the dyeing, print, bleach, and finishing department by one of 250 horse power; while a fifth, of 160 horse power, supplies the whole power required for the electric lighting of the mill. The mill is built on ground lying nearer the level of the head than that of the tail water, and in order to overcome the difficulty thus created the turbines are placed in pits with a depth of 63ft. from the ground floor of the mill. The fall is in all 74ft., but the level of the head water is only 14 feet above the mill floor. The tail water is taken to the river by a tunnel. Separate pits are constructed for the turbines for the spinning and weaving mills, but those for the finishing and lighting are contained in the same pit. The head water is conducted along a concrete canal, arranged at one side of the mill, and the conducting pipes for the turbines are fed by means of separate channels at right angles to the main canal. In order to facilitate the working of the mill each channel has a separate sluice gate, so that any of the turbines can be shut off at will.

It has been said that the turbines are of the

Girard type. The reason for this selection is that turbines made on that principle need not necessarily be fed round their whole circumference, have a lower circumferential velocity, and permit of the diameter of the wheel being increased, while obtaining the required velocity without losing efficiency. The turbines are fitted as shown in Figs. 105 and 106, with a slide of the butterfly type, by means of which the necessary adjustment of the

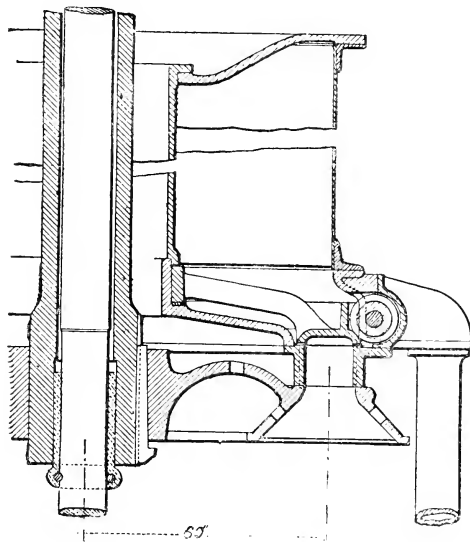

FIG. 105.

water inlet can be made by closing a certain number of ports. The slide is operated by the worm and circular rack shown, and can be operated from above by means of a hand wheel fixed on a pillar,



be observed that the ports occupy opposite quadrants. The regulation is completed by a throttle valve placed in the supply pipes, and worked by a governor placed in the turbine house. In starting, a small friction clutch on the hand wheel can be disengaged, and the throttle valve controlled by hand, so as to enable the turbines to be either stopped or started quickly.

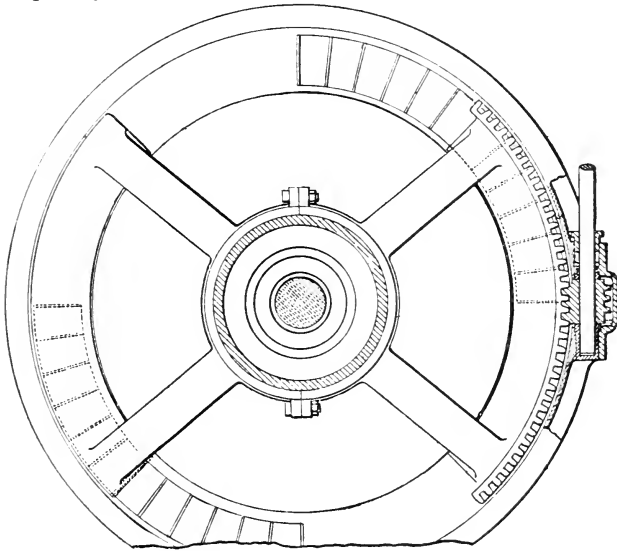

FIG. 106.

In forming the vanes, alike for the guides and wheel, the plan was adopted of constructing them of steel, bending them to shape, and then placing them in the mould and running the cast iron round them. They are thus accurately and strongly fixed in position, and a wheel is produced which has the advantage alike of being smooth, strong, and durable. For high falls this plan is recommended by the maker. The curvature of the blades is shown in Fig. 107.

The general arrangement of the spinning-mill turbines is shown in Figs. 108 and 109. It will be seen that they are vertically placed, and are sustained on substantial foundation plates. They are fed by pipes 54 in. in diameter, which, as shown, are carried up the pit until nearly level with the ground, and are then carried, as shown in Fig. 110, horizontally for a short distance, finally being turned upwards, so as to enter the flume. The curves given, it will be seen, are all easy, so as to lessen the friction considerably. The vertical range of pipes is sustained on a flat bottom, as shown, and the water enters the turbine by a branch at right angles. Despite the slight increase in loss by friction thus

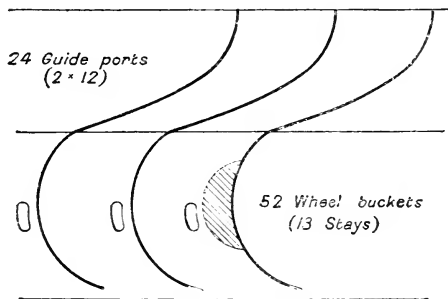

FIG. 107.

caused the constructional advantages arising are considerable. The power is transmitted from the wheels by a hollow cast-iron turbine shaft, the foot-steps of which are placed above the water level and enclosed in an oil-vessel. (See Fig. 111.) A fixed steel pillar enters the cast-iron shaft, which revolves round it. Wear of the footstep can be taken up by the screw shown, and it

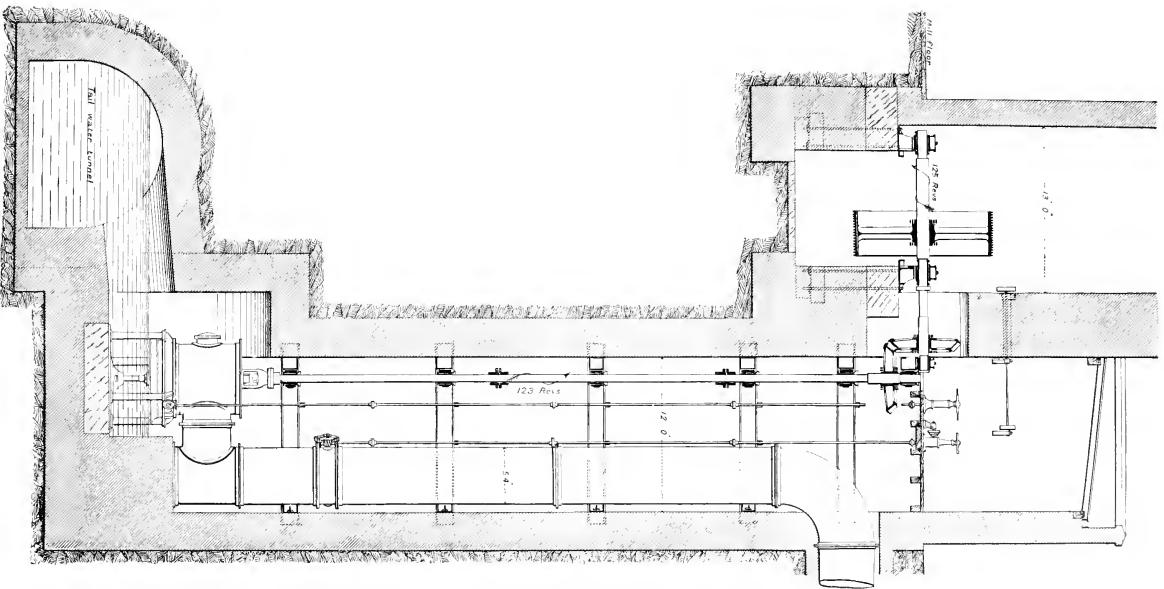

FIG. 108.



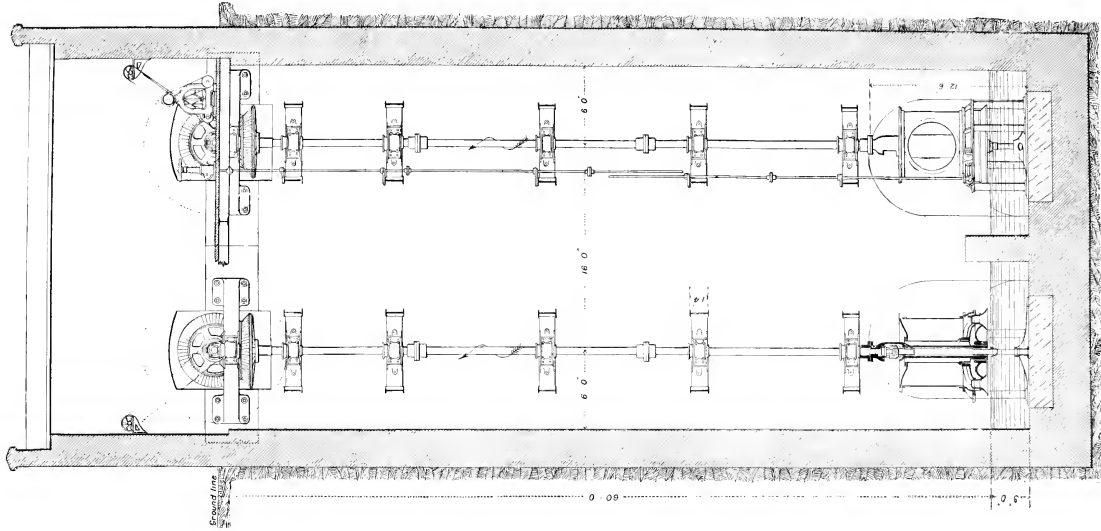

Fig. 109.



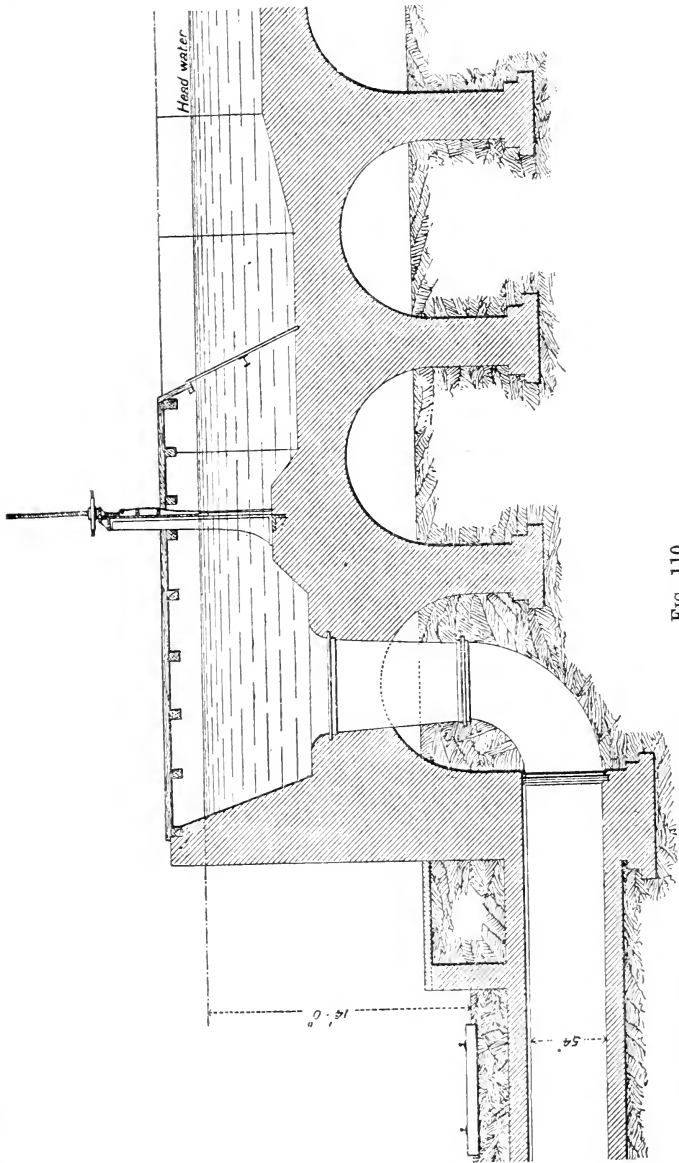
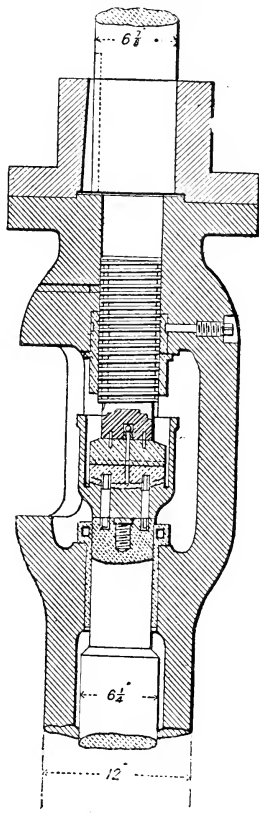

Fig. 110.

step can be examined and oiled easily, and effective lubrication is well provided for. The cast-iron shaft is coupled to a steel vertical shaft,  $6\frac{7}{8}$  in. diameter, which is sustained by bearings secured to





the weaving and finishing mill turbines have 48in. diameter wheels, and run at 153 revolutions; while the electric lighting turbine is only 30in. diameter, but has full injection, and a velocity of 240 revolutions. The larger turbines for the spinning mill use 4,060ft. per minute, and have an effective head of water of 73ft. after deducting loss by friction. The speed of the second motion shafts is 125 revolutions per minute, the power being transmitted by bevel wheels, 65 and 66 teeth respectively,  $3\frac{5}{8}$ in. pitch and 10in. wide, with a circumferential velocity of 2,120ft. On the second-motion shafts rope pulleys, 11ft. diameter, are placed, grooved for 18 ropes. The bearings alongside the pulley have journals 8in. diameter and 20in. long.

---

## CHAPTER XVII.

### GEARING—TOOTHED WHEELS.

It is not often in modern practice that wheel gearing is employed, but there are still a few cases in which this occurs. As the matter will be referred to subsequently, it is only necessary now to deal with the question shortly. The advantage of wheel gearing lies mainly in its positive nature, and the fact that if the teeth are properly shaped the loss by friction is not as great as with other forms. Except in cases where strength is of more importance than loss of power, helical teeth are not to be recommended, as the difficulty in moulding is very considerable. The shape and size of teeth is a matter which has received considerable attention at the hands of investigators. The strength of wheel-teeth is obtained by Box by the following formula  $S = P \times W \times 350$ , where  $P$  = pitch in inches,  $W$  = width of tooth. Molesworth's rule is, when the width of tooth is  $2\frac{1}{2}P$  to  $3\frac{1}{2}P$ ,  $H = 0.6P^2V$ .  $H$  = horse power transmitted, and  $V$  = velocity of pitch line in feet per second. In all the formulæ given the pitch is the circular pitch, because, convenient as diametral

pitch is in some respects, it is not so generally used or known. The proportions given by Professor Unwin for wheel teeth are now generally admitted to be exact practice, although a simpler table is sometimes used. They are stated by him as follows,  $P = \text{pitch} : -$

|                             |                                                  |
|-----------------------------|--------------------------------------------------|
| Total height of tooth....   | $\cdot 65P + \cdot 08$ to $\cdot 75P + \cdot 80$ |
| Depth below pitch line....  | $\cdot 35P + \cdot 08$ to $\cdot 40P + \cdot 08$ |
| Height above pitch line.... | $\cdot 30P$ to $\cdot 35P$                       |
| Side clearance .....        | $\cdot 06P + \cdot 04$ to $\cdot 04P + \cdot 06$ |
| Thickness of tooth.....     | $\cdot 47P - \cdot 02$ to $\cdot 48P - \cdot 03$ |
| Width of space .....        | $\cdot 53P + \cdot 02$ to $\cdot 52P + \cdot 03$ |

Professor Rodinella, in a recent communication to the Franklin Institute, gives the following data :

|                               |               |
|-------------------------------|---------------|
| Total height of tooth .....   | $\cdot 75 P.$ |
| Depth below pitch line .....  | $\cdot 41 P.$ |
| Height above pitch line ..... | $\cdot 34 P.$ |
| Side clearance .....          | $\cdot 07 P.$ |
| Thickness of tooth .....      | $\cdot 47 P.$ |
| Width of space .....          | $\cdot 53 P.$ |
| Thickness of rim .....        | $\cdot 50 P.$ |

It will be seen that these do not greatly differ from Professor Unwin's table. The thickness of the rim is sometimes taken at  $\cdot 45 P.$

Mr. Michael Longridge has for some years past strenuously contended that when considerable power is being transmitted by large wheels at velocities of 2,000ft. per minute and upwards, the depth of the teeth ought to be much less, and should not be more than  $\cdot 35P.$  Two examples of wheel teeth, one of which is actually working, as approved by him, are shown in Figs. 112 and 113.

Many wheels are now made shrouded, and this procedure undoubtedly adds to their strength, but

pitch used for mortice wheels in order to get the same strength as cast iron should be 1.26 times that when the latter is used. The question of the horse power transmitted by wheels is an important one. Messrs. John Musgrave and Sons, Limited, give

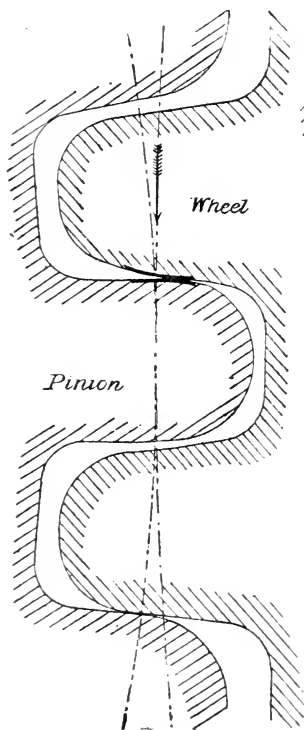

FIG. 112.

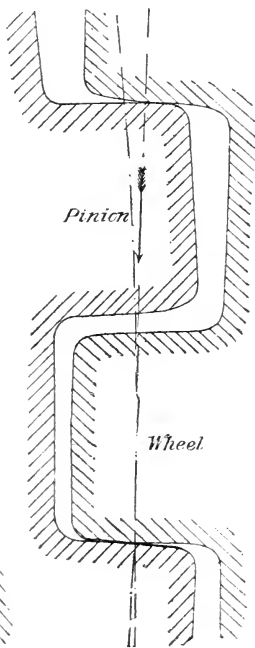

FIG. 113.

the following rules, where  $P$  = pitch,  $B$  = breadth of teeth in inches,  $V$  = velocity of pitch line in inches.  

$$\text{H.P.} = \frac{P^2 B V}{1000} \text{ for cast iron, or } = \frac{P^2 B V}{625} \text{ for cast steel.}$$
Molesworth's rule has already been given, and Hutton's is as follows:— $D$  = diameter

to pitch line, B = breadth in inches, P = pitch in inches, and N = number of revolutions per minute.

$$\text{H.P.} = \frac{P^2 B D N}{240}$$

The question as to the shape

of the teeth of the wheels is one which is not easy to answer. Epicycloidal teeth have been much in vogue, and if perfectly drawn and properly made they are undoubtedly the best form. The involute form, however, is much easier to make, and will work better under circumstances in which the epicycloidal form would fail, and is by some makers preferred. Much difference of opinion prevails as to the proper speed for toothed wheels, but in several very successful jobs, where the wheels have been running for a long time with little wear, a speed of from 1,800 to 2,000 feet per minute has been adopted. There does not appear to be any

TABLE 17.

HORSE POWER TRANSMITTED BY CAST-IRON TOOTHED WHEELS  
FOR EACH INCH OF WIDTH. FOR STEEL WHEELS HP  $\times$  1.6.

| Velocity of<br>Pitch Line<br>in feet per<br>minute. | PITCH OF TEETH IN INCHES. |     |                 |                 |                 |      |                 |      |      |      |      |
|-----------------------------------------------------|---------------------------|-----|-----------------|-----------------|-----------------|------|-----------------|------|------|------|------|
|                                                     | $\frac{3}{4}$             | 1   | 1 $\frac{1}{4}$ | 1 $\frac{1}{2}$ | 1 $\frac{3}{4}$ | 2    | 2 $\frac{1}{2}$ | 3    | 4    | 5    | 6    |
| 60                                                  | .033                      | .06 | .094            | .135            | .184            | .24  | .375            | .54  | .96  | 1.5  | 2.16 |
| 120                                                 | .67                       | .12 | .188            | .270            | .366            | .48  | .75             | 1.08 | 1.9  | 3.0  | 4.3  |
| 180                                                 | .10                       | .18 | .28             | .40             | .55             | .72  | 1.1             | 1.6  | 2.8  | 4.5  | 6.4  |
| 240                                                 | .13                       | .24 | .37             | .54             | .73             | .96  | 1.5             | 2.1  | 3.8  | 6.0  | 8.6  |
| 300                                                 | .17                       | .30 | .47             | .67             | .91             | 1.2  | 1.8             | 2.7  | 4.8  | 7.5  | 10.8 |
| 360                                                 | .20                       | .36 | .56             | .81             | 1.1             | 1.4  | 2.2             | 3.2  | 5.7  | 9.0  | 12.9 |
| 420                                                 | .23                       | .42 | .65             | .94             | 1.23            | 1.68 | 2.6             | 3.7  | 6.7  | 10.5 | 15.1 |
| 480                                                 | .27                       | .48 | .75             | 1.1             | 1.4             | 1.9  | 3.0             | 4.3  | 7.6  | 12.1 | 17.2 |
| 540                                                 | .30                       | .54 | .84             | 1.2             | 1.6             | 2.1  | 3.3             | 4.8  | 8.6  | 13.5 | 19.4 |
| 600                                                 | .33                       | .60 | .94             | 1.35            | 1.8             | 2.4  | 3.7             | 5.4  | 9.6  | 15.0 | 21.6 |
| 720                                                 | .40                       | .72 | 1.1             | 1.6             | 2.1             | 2.8  | 4.5             | 6.4  | 11.5 | 18.0 | 25.9 |
| 840                                                 | .47                       | .84 | 1.3             | 1.8             | 2.5             | 3.3  | 5.2             | 7.5  | 13.4 | 21.0 | 30.2 |
| 960                                                 | .54                       | .96 | 1.5             | 2.1             | 2.9             | 3.8  | 6.0             | 8.6  | 15.3 | 24.0 | 34.5 |

advantage in adopting higher velocities. The stress in the rim of a flywheel is a matter of importance, and affects all classes of gearing alike, but owing to the fact that the teeth of a wheel add to the weight, but are not a factor of strength, they must be neglected. The safe and easily remembered rule is to limit the peripheral velocity of any flywheel to 80ft. per second. Professor Unwin fixes the safe velocity at 96ft. per second. In constructing wheels, the question of the numbers of arms and segments required are subject to the same remarks as are made at the beginning of the chapter on Rope Gearing. Table 17 gives the approximate horse powers transmitted per inch of width by spur wheels running at different velocities.

---

## CHAPTER XVIII.

### GEARING—BELT DRIVING.

Coming now to deal with the second method of transmitting power, viz. : leather or cotton belts, it may be first remarked that for main drives involving the employment of very wide belts, this system has nearly become obsolete in this country. With wide belts, failure means the entire stoppage of the whole mill, while when ropes are used, the failure of a single one is not of much consequence. For main drives there is no doubt that ropes are preferred to belts, but there have been several large belts made for this purpose which have been from time to time adopted with the most complete success. The matter is otherwise within a mill. Here belts are very convenient, and it is only a question of their proper application. The pulleys used in the transmission of power are generally made of cast iron, in one piece when of small size, and in halves when large, or when desired to place easily on a shaft. In some cases the practice of swelling the ends of each length of shaft

is followed, but it is an unadvisable thing. It makes the shaft more expensive, and largely increases the difficulty of putting on pulleys. In order to meet this, however, the eye of the pulley is made large enough to pass over the swell, and is bored taper, so that by the introduction of three segmental tapered keys accurately machined the pulley can be easily fitted. When a pulley is in halves, it can be easily taken on or off, and can be partially fixed by making its bore a little less than the diameter of the shaft. A hollow key fitted subsequently makes it quite secure. During the past few years there has been an extended use of wrought-iron pulleys, which possesses many advantages. They are light, easily applied, strong, and possess a slight flexibility which enables them to take up shocks with ease. Originally the whole pulley, bars included, was made of wrought iron or steel, while other makers construct the bosses of cast iron. There does not appear to be much to be said for either procedure, pulleys of both classes working admirably when transmitting large powers. Above 20in. diameter, the wrought-iron pulley possesses many advantages, and it has, therefore, been largely adopted in driving cotton-spinning machinery at the high speeds now common. Generally speaking, the weight of wrought-iron pulleys is from one-half to two-thirds that of cast-iron pulleys, and as they are equally strong, this diminution in weight constitutes a considerable item in the economy of a mill. In addition to this factor the balance of a wrought-iron is better than that of a cast-iron pulley. A wrought-iron pulley arm must be looked upon as a cantilever fixed at the boss, and

fixing a pulley on the shaft it is enough for an ordinary size if a properly proportioned hollow key be used, but if much power has to be transmitted a sunk key, either driven or feathered, is necessary. It is sometimes urged that the construction of a wrought-iron pulley tells against its security, especially as regards the fixity of the arms. From the author's experience he is able to say that this is not a fact, as many instances are known to him of large pulleys working for many years successfully in places where they are subjected to repeated shocks. Messrs. Croft and Perkins have a rolled rim of peculiar section, it being strengthened in the centre where the nipple of the arm is inserted so as to increase the grip at that point.

With regard to the belts themselves, these are usually made of leather. The tenacity of leather varies from 3,000 to 5,000lbs. per square inch of sectional area. Single belts are usually from  $\frac{3}{16}$ ths to  $\frac{2}{5}$ ths of an inch thick, and as a rule they are worked at a stress of about 300lbs. per square inch of sectional area. The effective stress possible entirely depends on the strength of the joint, which is greatest when it is spliced and cemented. In splicing, an overlap of double the width of the belt must be given up to 3in. wide, 6in. to 8in. with belts from 3in. to 8in. wide, and  $1\frac{1}{4}$  times the width, for belts wider than this. For double belts the rule is to make the splice 10in. long with widths up to 10in., from 10in. to 18in. with widths up to 18in., and 18in. for all wider belts. If the belt is taken over guide pulleys, or if triple belts are used, the V splice should be used. The strength of a cemented joint has been put by Mr. H. A. Mavor as 842lbs. per inch of width, but the safe working stress is much less than this. Mr. Fred. W. Taylor has recently declared in the course of a very elaborate paper on this subject that for main drives, at velocities of from 4,000ft. to 4,500ft. per minute—which he considers the best and most economical—a total load of from 200lbs.

to 225lbs. per square inch of section, or 30lbs. per inch of width of double belt is the best. Messrs. Lewis and Bancroft, from some experiments on belts, deduced the following formula:  $V =$  velocity in feet per second,  $S =$  working strength of leather in lbs. per square inch, then  $V = \sqrt{28S}$ , and if any other material be used with a specific gravity of, say  $y$ , then  $V = 5 \frac{\sqrt{S}}{y}$ . They say that "the

velocity at which the maximum amount of power can be transmitted by any given belt is independent of its arc of contact and co-efficient of friction, and depends only upon the working strength of the material and its specific gravity." The working stresses commonly used in a European mill are much higher than that given by Mr. Taylor, being per inch of width, 50lbs. for a single leather belt, and 85lbs. for a heavy double belt. The velocities as a rule do not exceed 1,800ft. to 2,000ft. per minute, which are lower than the speeds given by Mr. Taylor,

TABLE 18.  
MEDIUM WEIGHTS PER LINEAL FOOT OF STRAPPING.

| Width. | 1 ft. |     | 2 ft. |      | 3 ft. |      | 4 ft. |      | 5 ft. |      | 10 ft. |       | 20 ft. |       | 30 ft. |       | 40 ft. |        | 50 ft. |        | 100 ft. |        | 200 ft. |         | 300 ft. |         | 500 ft. |          |          |         |
|--------|-------|-----|-------|------|-------|------|-------|------|-------|------|--------|-------|--------|-------|--------|-------|--------|--------|--------|--------|---------|--------|---------|---------|---------|---------|---------|----------|----------|---------|
|        | lb.   | lb. | lb.   | lb.  | lb.   | lb.  | lb.   | lb.  | lb.   | lb.  | lb.    | lb.   | lb.    | lb.   | lb.    | lb.   | lb.    | lb.    | lb.    | lb.    | lb.     | lb.    | lb.     | lb.     | lb.     | lb.     | lb.     | lb.      | lb.      |         |
| 12     | ·19   | ·38 | ·57   | ·76  | ·95   | 1·14 | 1·33  | 1·52 | 1·71  | 1·90 | 3·80   | 7·60  | 11·40  | 15·20 | 19·00  | 38·00 | 76·00  | 114·00 | 152·00 | 190·00 | 380·00  | 760·00 | 1140·00 | 1520·00 | 1900·00 | 3800·00 | 7600·00 | 11400·00 | 15200·00 |         |
| 10     | ·22   | ·44 | ·66   | ·88  | 1·10  | 1·32 | 1·54  | 1·76 | 1·98  | 2·20 | 4·40   | 8·80  | 13·20  | 17·60 | 22·00  | 44·00 | 88·00  | 132·00 | 176·00 | 220·00 | 440·00  | 880·00 | 1320·00 | 1760·00 | 2200·00 | 4400·00 | 8800·00 | 13200·00 | 17600·00 |         |
| 9      | ·25   | ·50 | ·75   | 1·00 | 1·25  | 1·50 | 1·75  | 2·00 | 2·25  | 2·50 | 5·00   | 7·50  | 10·00  | 12·50 | 15·00  | 30·00 | 45·00  | 60·00  | 75·00  | 90·00  | 180·00  | 270·00 | 360·00  | 450·00  | 540·00  | 1080·00 | 1620·00 | 2160·00  | 2700·00  |         |
| 8      | ·29   | ·58 | ·87   | 1·16 | 1·45  | 1·74 | 2·03  | 2·32 | 2·61  | 2·90 | 5·80   | 8·70  | 11·60  | 14·50 | 17·40  | 34·80 | 52·20  | 69·60  | 87·00  | 104·40 | 171·60  | 257·40 | 343·20  | 429·00  | 514·80  | 1029·60 | 1544·40 | 2059·20  | 2574·00  |         |
| 5      | ·33   | ·66 | ·99   | 1·32 | 1·65  | 1·98 | 2·31  | 2·64 | 2·97  | 3·30 | 6·60   | 9·90  | 13·20  | 16·50 | 19·80  | 39·60 | 59·40  | 79·20  | 99·00  | 118·80 | 237·60  | 356·40 | 475·20  | 594·00  | 712·80  | 1425·60 | 2138·40 | 2851·20  | 3564·00  |         |
| 3      | ·37   | ·74 | 1·11  | 1·48 | 1·85  | 2·22 | 2·59  | 2·96 | 3·33  | 3·70 | 7·40   | 11·10 | 14·80  | 18·50 | 22·20  | 44·40 | 66·60  | 88·80  | 111·00 | 133·20 | 266·40  | 399·60 | 532·80  | 666·00  | 800·00  | 1332·00 | 2000·00 | 2664·00  | 3332·00  |         |
| 3      | ·46   | ·80 | 1·20  | 1·60 | 2·00  | 2·40 | 2·80  | 3·20 | 3·60  | 4·00 | 8·00   | 12·00 | 16·00  | 20·00 | 24·00  | 48·00 | 72·00  | 96·00  | 120·00 | 144·00 | 288·00  | 432·00 | 576·00  | 720·00  | 864·00  | 1440·00 | 2160·00 | 2880·00  | 3600·00  |         |
| 3      | ·43   | ·86 | 1·29  | 1·72 | 2·15  | 2·58 | 3·01  | 3·44 | 3·87  | 4·30 | 8·60   | 12·90 | 17·20  | 21·50 | 25·80  | 51·60 | 77·40  | 103·20 | 129·00 | 154·80 | 309·60  | 464·40 | 619·20  | 774·00  | 928·80  | 1483·20 | 2224·80 | 2966·40  | 3708·00  |         |
| 4      | ·47   | ·94 | 1·41  | 1·88 | 2·35  | 2·82 | 3·29  | 3·76 | 4·23  | 4·70 | 9·40   | 14·10 | 18·80  | 23·50 | 28·20  | 56·40 | 84·60  | 112·80 | 141·00 | 169·20 | 338·40  | 507·60 | 676·00  | 844·80  | 1014·00 | 1352·00 | 1789·00 | 2312·00  | 2950·00  | 3688·00 |



which relate to American practice. With regard to other kinds of belting, hair belts have been extensively used, and some forms of this, as, for instance, the "Lancashire," which was the pioneer in this direction, have been shown to withstand some high test stresses. An official test in Belgium gave an ultimate stress of 5,000lbs. per square inch of section, which is a very exceptional strength, and proves the belt to be well adapted for heavy drives. Table 18 is Messrs. Cockhill's list of weights of single leather belts.

The coefficient of friction of a leather belt on an iron pulley is about .42, but the various experiments made demonstrate that there is an enormous variation in this factor, arising from the character and condition of belts and pulleys, the amount of slip, and atmospheric conditions. This variation will vitiate the value of many of the rules given to ascertain the power of belts, it being well known that most widely diverse results are obtained by using different rules. The position of the pulleys and the variation in the angle of the drive, sometimes the confined space in which belts work, all these factors have an influence on the power transmitted. For this reason, a number of empirical rules, more or less founded on observation, are commonly employed; some of those most in accord with common practice, are now given. If  $F$  = driving force,  $W$  = width of belt,  $V$  = velocity in

feet per sec.,  $HP = \frac{F}{550} \times W \times V$ . Nystrom's

rule is  $\frac{VF}{550}$ . Professor Thurston's  $W = \frac{7000 \times \text{H.P.}}{S \times V}$

where  $S$  = surface of smaller pulley covered. Professor Unwin says that a belt lin. wide, running 800ft. per minute, with an arc of contact of  $180^\circ$ , will transmit one horse power; or, more exactly, the power is .0727 H.P. for single and .1272 for double belts for each foot of velocity per second, the belt being lin. wide. Messrs. Harper, of Aber-

deen, give the following rule for single belting per 100ft. of velocity :—

|                     |               |               |               |               |               |   |                |                |                |                |                |
|---------------------|---------------|---------------|---------------|---------------|---------------|---|----------------|----------------|----------------|----------------|----------------|
| Inches wide.....    | 3             | 4             | 5             | 6             | 7             | 8 | 9              | 10             | 12             | 15             | 18             |
| H.P. transmitted... | $\frac{3}{8}$ | $\frac{1}{2}$ | $\frac{5}{8}$ | $\frac{3}{4}$ | $\frac{7}{8}$ | 1 | $1\frac{1}{8}$ | $1\frac{1}{4}$ | $1\frac{1}{2}$ | $1\frac{3}{4}$ | $2\frac{1}{4}$ |

For double belting multiply by  $1\frac{1}{2}$ . Messrs. Hoyt fix 1 H.P. per inch of width at 1,000ft. per minute. Mr. Robert Briggs, of the Yale and Towne Manufacturing Company, Connecticut, a most careful observer, uses the following method : D = diameter of driven pulley, W = width in inches of belt, R = revolutions per minute, DWR = P or driving power of the machine, which is spoken of in units. Then so many units are taken for each machine as determined.

The diameters of driving and driven pulleys should have a maximum ratio of 6 : 1, and the smallest should not be less than 100 times the thickness of the belt. The distance of their centres apart must depend upon the relative ratio of the diameters, and varies from 8 to 20ft. Pulleys, if rounded, as is always desirable if no moving of the strap takes place, should have a convexity equal to  $\frac{1}{4}$ in. to  $\frac{3}{8}$ in. for each foot of width. When wide belts are employed it is sometimes a good plan to perforate the rims, and this method has been patented in this country. This procedure is useful, as permitting the air to escape, and so maintaining the adhesion. The same advantage is derived by the use of link belts, but the extra weight of the latter tells against them. They have, however, the advantage of being very flexible and strong, and can be advantageously worked with small pulleys.

## CHAPTER XIX.

## ROPE DRIVING.

The most ordinary form of gearing adopted for modern spinning mills is rope. In applying this a large grooved pulley or drum fixed on the crank shaft takes the place of the spur wheel or belt pulley in other methods of driving. These pulleys are built up when of large size. Small-sized pulleys, say to 6ft. diameter, may be made in one piece; from that size up to 12ft. they are made in halves, which are fitted together with planed joints and subsequently bored and turned, but after that size has been passed it is the practice to build them up. The number of segments used depends to a great extent on the maker, but generally can be approximately ascertained by dividing the circumference in feet by 7.8, which gives results corresponding generally with practice. The boss is cast separately and bored to receive the arms, which are turned to fit, and are machined at the ends to take the segments of the rim. This is very clearly shown in Figs. 114 and 115, which illustrate a large driving drum 34ft. diameter, and grooved for 32 ropes  $1\frac{3}{4}$ in. diameter, made for the Astley Mill Company, Dukinfield, by Mr. B. Goodfellow. The number of grooves depends upon the power to be transmitted. The dimensions and form of the grooves are shown in the sketch given in Fig. 116, and are calculated from the following formulæ:—

Let  $d$  = diameter of rope in inches;  $P$  = pitch of grooves;  $D$  = depth of grooves;  $R$  = radius of bottom of grooves;  $W$  = width of mouth of grooves;  $V$  = thickness of flange between inner grooves;  $A$  = thickness of outer flange;  $S$  = depth from tip of outer flange to shoulder; and  $T$  = thickness through bottom of grooves. Then—

$$P = 1\frac{1}{4}d + \frac{1}{4}\text{in. or } + \frac{5}{16}\text{in.}$$

$$D = 1\frac{1}{4}d + \frac{1}{8}\text{in. or } + \frac{1}{4}\text{in.}$$

$$R = \frac{3}{8}d; \text{ and } W = d + \frac{3}{16} \text{ or } + \frac{5}{16}.$$

$$T = \frac{1}{2}d; \text{ and } A = \frac{1}{3}d + \frac{1}{15}.$$

$$S = d; \text{ and } V = \frac{1}{4}d.$$

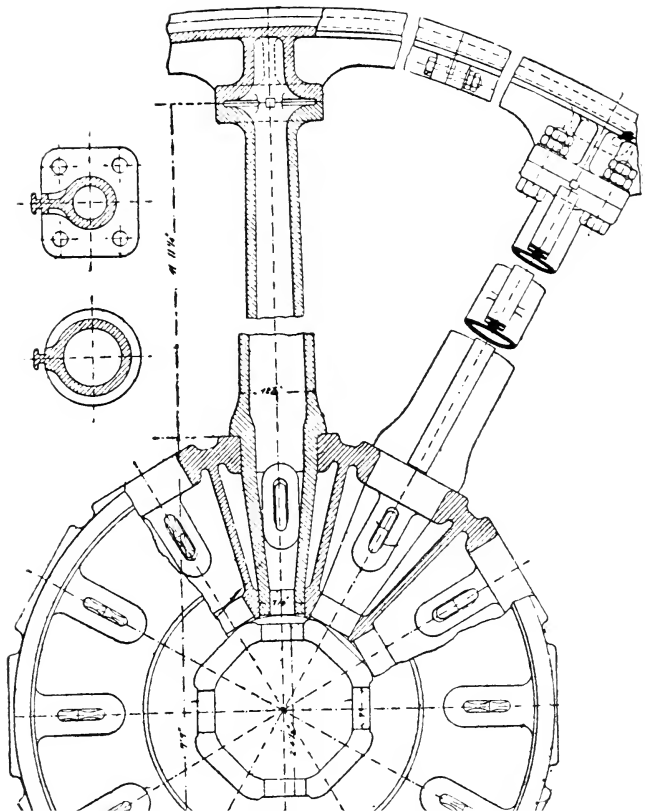

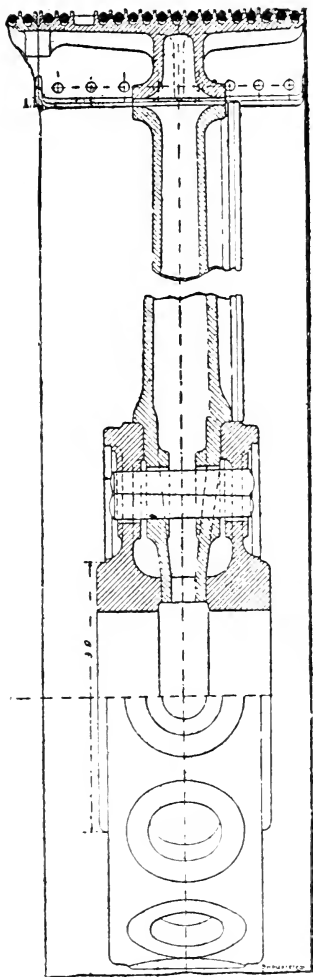

FIG. 115.

From these formulæ can be constructed the following table, which will give sufficiently accurate data of the principal dimensions, the smaller sizes being taken.

| Diameter of Rope = <i>d</i> .<br>Inches. | P<br>in.        | D<br>in.         | R<br>in.        | W<br>in.         | T<br>in.        | A<br>in.        | V<br>in.        | S<br>in.       |
|------------------------------------------|-----------------|------------------|-----------------|------------------|-----------------|-----------------|-----------------|----------------|
| 1                                        | $1\frac{1}{2}$  | $1\frac{3}{8}$   | $\frac{3}{8}$   | $1\frac{3}{16}$  | $\frac{1}{2}$   | $\frac{7}{16}$  | $\frac{5}{16}$  | 1              |
| $1\frac{1}{4}$                           | $1\frac{3}{16}$ | $1\frac{11}{16}$ | $\frac{15}{32}$ | $1\frac{7}{16}$  | $\frac{5}{8}$   | $\frac{1}{2}$   | $\frac{3}{8}$   | $1\frac{1}{4}$ |
| $1\frac{3}{8}$                           | 2               | $1\frac{7}{8}$   | $\frac{1}{2}$   | $1\frac{9}{16}$  | $\frac{11}{16}$ | $\frac{9}{16}$  | $\frac{7}{16}$  | $1\frac{3}{8}$ |
| $1\frac{1}{2}$                           | $2\frac{1}{8}$  | 2                | $\frac{9}{16}$  | $1\frac{11}{16}$ | $\frac{3}{4}$   | $\frac{9}{16}$  | $\frac{7}{16}$  | $1\frac{1}{2}$ |
| $1\frac{5}{8}$                           | $2\frac{1}{4}$  | $2\frac{1}{8}$   | $\frac{5}{8}$   | $1\frac{13}{16}$ | $\frac{11}{16}$ | $\frac{5}{8}$   | $\frac{7}{16}$  | $1\frac{5}{8}$ |
| $1\frac{3}{4}$                           | $2\frac{1}{2}$  | $2\frac{3}{8}$   | $\frac{3}{2}$   | 2                | $\frac{7}{8}$   | $\frac{5}{8}$   | $\frac{1}{2}$   | $1\frac{3}{4}$ |
| $1\frac{7}{8}$                           | $2\frac{5}{8}$  | $2\frac{1}{2}$   | $\frac{11}{16}$ | $2\frac{3}{32}$  | $\frac{11}{16}$ | $\frac{11}{16}$ | $\frac{17}{32}$ | $1\frac{7}{8}$ |
| 2                                        | $2\frac{3}{4}$  | $2\frac{5}{8}$   | $\frac{3}{4}$   | $2\frac{3}{16}$  | 1               | $\frac{3}{4}$   | $\frac{9}{16}$  | 2              |

With regard to the angle enclosed by the sides of the groove some makers, perhaps the majority, prefer it to be  $45^\circ$ , while others express an opinion that  $40^\circ$  is better, as there is less liability to wedging. The depth is sufficient to avoid all possibility of the rope reaching the bottom of the groove.

The formation of this groove accurately is of high importance, but it must be accompanied by equal care in the making of the rope. With regard to the latter more will be said hereafter. Ropes are, in this country, said to be of a certain diameter, by which is meant the diameter of a circle circumscribing the rope, while in America the size of the

the size of the different ropes employed, but whatever be the cause the effect is the same. Suppose, for instance, that a driving pulley is 30ft. diameter to the line which is intended to be the centre line of the rope, or that where it touches the sides of the groove. If this pulley revolves say 50 times per minute then it would have a peripheral speed of 4,712ft., which if communicated to a rope employed to drive a pulley 12ft. diameter would give the latter a speed of 125 revolutions. Assume now

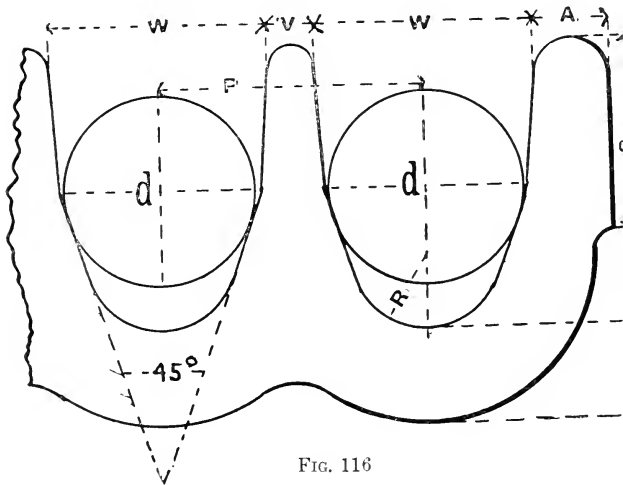

FIG. 116

that the grooves are so shaped or the rope so reduced that the diameter of the pulley on the driving line is only 29ft. 10in. and that of the driven pulley only 11ft. 10in., then the speed of the rope would be—at 50 revolutions per minute—4,687ft., and the driven pulley would make 126 revolutions. If, therefore, adjoining grooves established these two sets of conditions, it would follow that the rope deepest in the groove would tend to do the greater part of the work, although its size might be the least. Not only would the rope deepest in gear

tend to do most work, but the variation in the velocity of the ropes would lead to the establishment of friction, which is very injurious and destructive to their life. It is, by far, the most common thing for the fault to lie with the ropes, but it may happen that the grooves are not all accurately formed.

The ropes used in most cases are made of cotton, which is preferable to hemp for many reasons. The various strands lie more closely together, owing to the character of the material; the rope is more flexible and elastic, and its wearing power, if all things are considered, is greater. The construction of any rope is a matter of high importance. It must be strong, flexible, elastic, and able to resist undue extension. No material fulfils these conditions so perfectly as cotton, and for this reason cotton ropes are to be preferred. The alternate bending and straightening of a rope as it passes over the pulleys entails a good deal of work, and the more flexible it is the better are its working qualities. Strength is principally of service, in so far as it enables the rope to resist extension under its working load, and it is this quality which is perhaps the most valuable. It is, of course, impossible to resist extension entirely, but it is a factor of little importance if its ratio is the same with all the ropes of a set. It is not an uncommon thing to find all the ropes of a main drive sagging considerably near the end of a week's work, and in the interval between Saturday and Monday taking up so as to be quite tight. It is a thing worth



be as light as possible. The "Lambeth" rope is probably, for its size, the lightest made, although a four-stranded one. Its extension is also small, as is shown by Table 19, which, in order to render it intelligible to the ordinary reader, has been slightly changed from the form in which it was cast by Messrs. Kirkaldy and Sons, who have made some recent tests, of which these are the results.

TABLE 19.

| Circumference of rope, ins. | Diam. of rope, ins. | Weight per foot, lbs. | Stress in lbs. | Extension per cent. |
|-----------------------------|---------------------|-----------------------|----------------|---------------------|
| 3.86                        | 1.23                | .45                   | 1,280          | 1.4                 |
|                             |                     |                       | 2,560          | 4.2                 |
|                             |                     |                       | 3,840          | 7.0                 |
|                             |                     |                       | 5,120          | 9.5                 |
|                             |                     |                       | 6,400          | 11.4                |
|                             |                     |                       | 7,681          | 13.4                |
|                             |                     |                       | 7,981          | Broke               |
| 5.12                        | 1.63                | .72                   | 2,380          | 2.0                 |
|                             |                     |                       | 4,760          | 5.0                 |
|                             |                     |                       | 7,140          | 7.76                |
|                             |                     |                       | 9,520          | 10.20               |
|                             |                     |                       | 11,900         | 12.20               |
|                             |                     |                       | 13,872         | Broke               |
|                             |                     |                       | 1,490          | 6.34                |
| 4.26*                       | 1.35                | .54                   | 2,980          | 10.36               |
|                             |                     |                       | 4,470          | 13.40               |
|                             |                     |                       | 5,960          | 15.60               |
|                             |                     |                       | 7,450          | 17.60               |
|                             |                     |                       | 8,940          | 19.20               |
|                             |                     |                       | 10,430         | 20.80               |
|                             |                     |                       | 11,920         | 22.20               |
| 13,275                      | Broke               |                       |                |                     |

\* This rope was a three-strand one, with 120 16's throstle yarns spun from Egyptian in each strand.

It is important to note that, although these ropes showed certain extensions when the stress is applied, they recovered their length when it was taken off, thus demonstrating the elasticity of the material. The important point to remember is that the stress is much in excess of any working load, as will be shown.

The power exerted by ropes is a very important matter. To obtain its full effect, it is necessary to follow certain precautions in designing an installa-

tion. First, as shown in Fig. 117, the axis of no pulley should be in a higher position than  $45^\circ$  above a horizontal line drawn through the centre of the driving shaft. The reason for this procedure is that it is desirable that the upper side of the rope, which is, or ought to be, the idle side, should be allowed to form freely a catenary curve, or to "sag" between the pulleys. This establishes a larger arc of contact of the rope and pulley, and increases the power. The size of the pulleys used has been

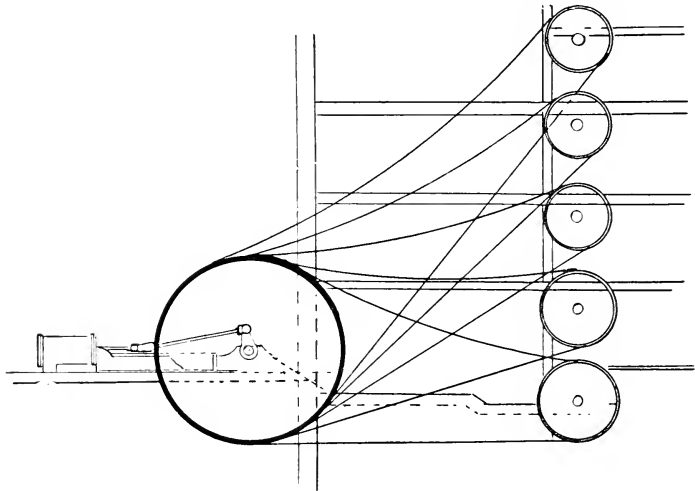

FIG. 117.

one, and designers of rope-drives may take it that there is room for a wise discretion in this matter. What should be remembered is that it is better to pass either a belt or rope used for driving over a large pulley than over a small one, and that, subject to the exigencies of the case, the larger the pulley used, the better for the band or rope.

With regard to the power developed by ropes, this is a matter in which nearly every man is a law to himself. All sorts of rules are given, but it may be stated that the subject depends mainly upon the life of the rope. That is to say that it is considered to be better to employ a moderate working tension, and thus enable the ropes to be used without undue fatigue. Three things affect this matter, the power transmitted, centrifugal force, and the loss caused by bending and straightening and the frictional resistance of the air. It is usual to assume that the loss by the third factor is about 20 per cent of the gross working stress. The centrifugal force is

calculated by the formula  $\frac{S^2 \times W}{32}$  when  $S$  = speed

in feet per second ;  $W$  = weight one foot of rope. Deducting these amounts from the gross working load per square inch, we are able to calculate the

H.P. transmitted by the formula  $\frac{V \times S}{33000}$  where

$V$  = velocity in feet per second and  $S$  = effective stress. These formulæ may be tabulated thus : Let

$G$  = gross stress allowed. Then  $G - \frac{G}{5}$  = working

tension or  $T$ . Then  $T - \left(\frac{S^2 \times W}{32}\right)$  = net working

tension or  $S$ , and  $\frac{V \times S}{33000}$  = H.P. exerted. It will be

seen that the whole matter rests upon the value of  $G$ , which has, in some cases, been fixed unduly high. The writer has proceeded in the calculation of Table 20, on the assumption that  $T = 200$  lbs., and by close comparison of the results of actual work

has found that this assumption is in accordance with facts. The table is as follows, and will be found to be safe and reliable :—

TABLE 20.

| Speed<br>per minute<br>in feet. | DIAMETER OF ROPES IN INCHES. |                 |                 |                 |                 |                 |                 |                 | 2    |
|---------------------------------|------------------------------|-----------------|-----------------|-----------------|-----------------|-----------------|-----------------|-----------------|------|
|                                 | 1                            | 1 $\frac{1}{8}$ | 1 $\frac{1}{4}$ | 1 $\frac{3}{8}$ | 1 $\frac{1}{2}$ | 1 $\frac{5}{8}$ | 1 $\frac{3}{4}$ | 1 $\frac{7}{8}$ |      |
|                                 | HORSE POWER TRANSMITTED.     |                 |                 |                 |                 |                 |                 |                 |      |
| 2500                            | 10·8                         | 13·4            | 16·7            | 20·5            | 24·3            | 28·5            | 33·2            | 38·1            | 43·4 |
| 2600                            | 11·1                         | 13·9            | 17·2            | 20·8            | 25              | 29·4            | 34·1            | 39·4            | 44·7 |
| 2700                            | 11·4                         | 14·3            | 17·7            | 21·7            | 25·7            | 30·2            | 35·3            | 40·6            | 46   |
| 2800                            | 11·8                         | 14·7            | 18·2            | 22·3            | 26·4            | 31              | 36·2            | 41·7            | 47·3 |
| 2900                            | 12·1                         | 15·1            | 18·7            | 22·9            | 27·1            | 31·9            | 37·2            | 42·8            | 48·6 |
| 3000                            | 12·3                         | 15·4            | 19·1            | 23·4            | 27·8            | 32·6            | 38·1            | 43·8            | 49·5 |
| 3100                            | 12·5                         | 15·7            | 19·5            | 24              | 28·4            | 33·4            | 39              | 44·8            | 50·6 |
| 3200                            | 12·9                         | 16·1            | 19·9            | 24·5            | 29              | 34              | 39·9            | 45·8            | 52   |
| 3300                            | 13·2                         | 16·5            | 20·3            | 25              | 29·6            | 34·8            | 40·8            | 46·8            | 53·2 |
| 3400                            | 13·4                         | 16·7            | 20·6            | 25·5            | 30·1            | 35·4            | 41·6            | 47·7            | 54·3 |
| 3500                            | 13·6                         | 16·9            | 20·9            | 26              | 30·6            | 36·2            | 42·3            | 48·6            | 55·2 |
| 3600                            | 13·9                         | 17·1            | 21·2            | 26·4            | 31·1            | 36·5            | 43              | 49·5            | 56   |
| 3700                            | 14·1                         | 17·3            | 21·5            | 26·8            | 31·5            | 37·1            | 43·6            | 50·2            | 56·8 |
| 3800                            | 14·2                         | 17·5            | 21·7            | 27              | 31·9            | 37·5            | 44·2            | 50·8            | 57·6 |
| 3900                            | 14·4                         | 17·7            | 21·9            | 27·3            | 32·2            | 37·9            | 44·8            | 51·4            | 58·2 |
| 4000                            | 14·5                         | 17·8            | 22·1            | 27·5            | 32·6            | 38·4            | 45·3            | 51·9            | 58·9 |
| 4100                            | 14·6                         | 17·9            | 22·3            | 27·8            | 32·9            | 38·7            | 45·8            | 52·4            | 59·6 |
| 4200                            | 14·7                         | 18              | 22·5            | 28              | 33·1            | 39              | 46·3            | 52·8            | 60·3 |
| 4300                            | 14·8                         | 18              | 22·6            | 28·1            | 33·3            | 39·3            | 46·6            | 53·2            | 60·6 |
| 4400                            | 14·9                         | 18·1            | 22·7            | 28·2            | 33·4            | 39·6            | 46·8            | 53·5            | 60·9 |
| 4500                            | 15                           | 18·1            | 22·7            | 28·3            | 33·5            | 39·7            | 47              | 53·8            | 61·2 |
| 4600                            | 15·1                         | 18·1            | 22·7            | 28·4            | 33·6            | 39·7            | 47·2            | 54              | 61·4 |
| 4700                            | 15·1                         | 18·1            | 22·6            | 28·4            | 33·7            | 39·8            | 47·4            | 54·2            | 61·5 |
| 4800                            | 15·1                         | 18              | 22·6            | 28·5            | 33·7            | 39·8            | 47·5            | 54·2            | 61·5 |
| 4900                            | 15                           | 18              | 22·5            | 28·5            | 33·7            | 39·9            | 47·6            | 54·3            | 61·6 |
| 5000                            | 15                           | 17·9            | 22·4            | 28·4            | 33·6            | 39·8            | 47·5            | 54·3            | 61·5 |

hundreds of feet the rope travels per minute, then, for the sizes of ropes given, multiply  $x$  by the figure given in second line.

|                      |    |                 |                 |                 |                 |                 |                 |                 |      |
|----------------------|----|-----------------|-----------------|-----------------|-----------------|-----------------|-----------------|-----------------|------|
| Size of rope, inches | 1  | 1 $\frac{1}{8}$ | 1 $\frac{1}{4}$ | 1 $\frac{3}{8}$ | 1 $\frac{1}{2}$ | 1 $\frac{5}{8}$ | 1 $\frac{3}{4}$ | 1 $\frac{7}{8}$ | 2    |
| Multiplier .....     | .3 | .4              | .5              | .6175           | .735            | .8675           | 1               | 1.155           | 1.31 |

Thus an inch rope running 3,000ft. per minute would develop  $30 \times .3 = 9$  H.P., and a 2-inch rope running 4,000ft. would develop  $40 \times 1.31 = 52.4$  H.P. In this calculation no regard is paid to centrifugal action at all. Messrs. Combe, Barbour, & Combe, of Belfast, who were the originators of rope driving, do not recommend a higher velocity than 4,000ft. per minute, and prefer one of about 3,500. Their rule is that a pulley, 4ft. diameter, and grooved for a rope 1 $\frac{1}{2}$ in. diameter, running at 100 revolutions per minute, will transmit 8 H.P. The working stress they use is 240lbs. per square inch.



FIG. 118.

With regard to the weight of ropes this is an important matter, and the following are those of "Lambeth" ropes:—

|                      |      |                 |                 |                 |                 |                 |                 |                 |       |
|----------------------|------|-----------------|-----------------|-----------------|-----------------|-----------------|-----------------|-----------------|-------|
| Diam. in inches...   | 1    | 1 $\frac{1}{8}$ | 1 $\frac{1}{4}$ | 1 $\frac{3}{8}$ | 1 $\frac{1}{2}$ | 1 $\frac{5}{8}$ | 1 $\frac{3}{4}$ | 1 $\frac{7}{8}$ | 2     |
| Wght. per ft. in lb. | .27  | .37             | .45             | .54             | .62             | .72             | .79             | .91             | 1.04  |
|                      | ozs. | lb.oz           | lb.oz           | lb.oz           | lb.oz           | lb.oz           | lb.oz           | lb.oz           | lb.oz |
| Weight per yd....    | 13   | 1 2             | 1 6             | 1 10            | 1 14            | 2 3             | 2 6             | 2 12            | 3 2   |

The following remarks are made by Mr. Hart on the question of splicing ropes. To make a long splice, unlay each end of the rope 5ft., cut out the small centre cord, on which the four strands have been laid, interlay the ends together in the same way as for a short splice (Fig. 118), but instead of

pushing the strands of one under the strands of the other, the splice is divided into parts and the four strands are spliced in different places (Fig. 119), care being taken to keep the rope equal in thickness in all parts. Unlay one of the strands and at the same time lay up the opposite strand in the vacant place for about four feet, care being taken to keep the turn in the strand. Tie the two strands temporarily. This we call the No. 1 strand. The next to it is No. 2 strand, which must not be worked until No. 3 is finished in the same manner as No. 1; but instead of laying it up for 4ft., 1ft. 6in. is sufficient. Lay up No. 2 strand and No. 4 strand in the same manner as No. 1 and No. 3 strands, but in the opposite direction. Shorten the strands

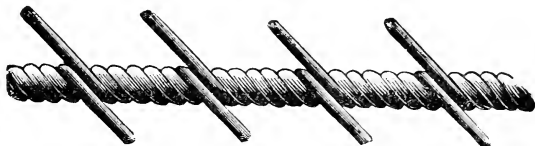

FIG. 119.

to equal lengths of about a foot. Remove the friction bands (or outside threads), and tie a double overhand knot on the tension strands, laying each end over twice with the marlinspike or splicing pin, and finish off by interlocking each end through the centre of the rope.

No blacklead should be applied to ropes, as it adds unduly to the weight, and an application of a special wax or shoemakers' heelball is much better

## CHAPTER XX.

## SHAFTING AND BEARINGS.

The power transmitted from the engine, whether by wheels, belts, or ropes, is utilised in the various rooms by means of shafts running longitudinally. If wheel gear is used the most ordinary method is to drive a vertical shaft sustained by a footstep, and by bearings close to the points at which the power is taken off. There has been a good deal of difficulty with geared mills, which has, in great part, been due to the fact that the work has not been so perfectly done as it might be, and partly to the difficulty of regulating the wear of the footstep and bearings. Wheel gearing wants especial care in construction, and this is not always given. In designing the footsteps they should be arranged so that there is not more than from 600 to 800lbs. pressure on the bearing portion. It is the best practice to fit the footstep with loose washers, always immersed in oil and free to revolve under the pressure of the shaft. These washers are alternately phosphor bronze and steel, and if properly designed and arranged the wear is very small. In designing the bearings sustaining the line and upright shaft it is desirable to make them strong and massive and fix them firmly to the wall. The *outer* ends of the shafts should be sustained by special bearings, if possible, and all the bearings ought to be capable of being easily set, so as to keep the wheels working on the pitch line. In the most modern practice there is an undoubted tendency towards higher velocities of shafting, and steel shafting has come into somewhat extensive employment. The resistance of shafting to torsion is found to vary as the cube of the diameter, but as it is necessary to take off the shaft between the bearings a certain amount of power, the diameter wants proportionately increasing. In many cases a calculation made on the basis named would result in the use

of a shaft which, with the ordinary length between the bearings, would result in flexure when the weight was applied. The diameter of shaft required to transmit any known power, allowing for the flexure caused by pulleys and belts, is obtained by the following rule, where  $D$  = diameter in inches;  $H$  = H P to be transmitted; and

$N$  = revolutions per minute,  $D = \sqrt[3]{\frac{65 H}{N}}$ . The

Unbreakable Pulley Co. give, as a rule, for wrought

TABLE 21.  
TRANSMITTED BY WROUGHT-IRON SHAFTING AT  
DIFFERENT VELOCITIES.

| DIAMETER OF SHAFT IN INCHES. |      |      |       |       |      |      |      |      |      |      |
|------------------------------|------|------|-------|-------|------|------|------|------|------|------|
| 3                            | 3½   | 4    | 4½    | 5     | 5½   | 6    | 6½   | 7    |      |      |
| 3-13                         | 3-99 | 4-98 | 6-13  | 7-44  | 10-6 | 14-5 | 19-3 | 25-1 | 31-9 | 39-8 |
| 6-26                         | 7-98 | 9-96 | 12-26 | 14-88 | 21-2 | 29   | 38-6 | 50-2 | 63-8 | 79-6 |
| 9-39                         | 11-9 | 14-9 | 18-4  | 22-3  | 31-8 | 43   | 58   | 75   | 95   | 119  |
| 12-5                         | 15-9 | 19-9 | 24-5  | 29-7  | 42-4 | 58   | 77   | 100  | 127  | 159  |
| 15-6                         | 19-9 | 24-9 | 30-6  | 37-2  | 53   | 72   | 96   | 125  | 159  | 199  |
| 18-7                         | 23-9 | 29-9 | 36-8  | 44-6  | 63-6 | 87   | 115  | 150  | 186  | 238  |
| 21-9                         | 27-9 | 33-8 | 42-9  | 52    | 71-2 | 101  | 135  | 175  | 223  | 278  |
| 24-9                         | 31-9 | 39-8 | 49    | 59-5  | 84-8 | 116  | 154  | 201  | 255  | 318  |
| 28-1                         | 35-9 | 44-8 | 55-2  | 66-9  | 95-4 | 129  | 173  | 226  | 287  | 358  |
| 31-3                         | 39-9 | 49-8 | 61-3  | 74-5  | 106  | 145  | 193  | 251  | 319  | 398  |
| 34-4                         | 43-9 | 53-8 | 66-3  | 80-2  | 127  | 174  | 230  | 300  | 372  | 476  |
| 37-4                         | 47-9 | 58-8 | 73-6  | 89-2  | 148  | 202  | 270  | 350  | 446  | 566  |
| 40-4                         | 51-9 | 62-8 | 78-6  | 95-2  | 169  | 232  | 308  | 402  | 510  | 636  |
| 43-8                         | 55-9 | 67-8 | 84-6  | 101-3 | 190  | 258  | 346  | 452  | 574  | 716  |
| 46-2                         | 59-9 | 71-8 | 89-6  | 108-3 | 212  | 290  | 386  | 502  | 638  | 796  |
| 48-6                         | 62-9 | 75-8 | 93-6  | 114-3 | 233  | 319  | 424  | 552  | 701  | 875  |
| 50-8                         | 65-9 | 79-8 | 97-6  | 120-3 | 254  | 348  | 460  | 600  | 764  | 952  |
| 52-8                         | 68-9 | 83-8 | 101-6 | 126-3 | 275  | 377  | 503  | 650  | 829  | 1034 |
| 54-8                         | 71-9 | 86-8 | 105-6 | 132-3 | 296  | 407  | 540  | 700  | 892  | 1112 |
| 56-2                         | 73-9 | 89-8 | 109-6 | 138-3 | 318  | 435  | 582  | 752  | 960  | 1194 |



iron,  $D = 4.2 \sqrt[3]{\frac{H}{N}}$ . For steel, when the calcula-

tion has been made from that formula, the diameter is found in one case, by multiplying  $D$  by .874, which is high, however, as .75 is a rule often adopted and found satisfactory. Another rule for

line shafts is  $\frac{D^3 \times N}{80}$ . Professor Unwin's rule is—

$HP = N \times .01163 D^3$ , and the results are about those usually accepted. Table 21 is calculated from this rule, which may be safely taken as giving the power transmitted by wrought-iron shafting.

It is essential that the bearings shall be properly spaced, and the formula by which the distance in feet is calculated, is—when pulleys are carried— $5 \sqrt[3]{D^2}$ . Table 22 will be of service.

TABLE 22.

| Diam. of Shaft.<br>in. | Distance of Bearings.<br>ft. in. | Diam. of Shaft.<br>in. | Distance of Bearings.<br>ft. in. |
|------------------------|----------------------------------|------------------------|----------------------------------|
| 2                      | 8 0                              | 3 $\frac{1}{4}$        | 10 6                             |
| 2 $\frac{1}{4}$        | 8 6                              | 3 $\frac{1}{2}$        | 11 0                             |
| 2 $\frac{1}{2}$        | 9 0                              | 3 $\frac{3}{4}$        | 11 9                             |
| 2 $\frac{3}{4}$        | 9 6                              | 4                      | 12 6                             |
| 3                      | 10 0                             |                        |                                  |

Line shafts are not often made larger than 4in. in spinning mills, so that this table will be sufficient.

The co-efficient of friction of turned shafting is stated by Webber at .066, and the power absorbed is obtained by the aid of the following formula: With ordinary—*i.e.*, intermittent—lubrication, the number of foot pounds absorbed per minute to overcome friction, when  $P$  = weight of shafting and pulleys + stress of belt,  $D$  = diameter of journal, and  $R$  = number of revolutions, is  $.0182 P D R$ , and with continuous oiling  $.0112 P D R$ . Another formula given by the Unbreakable Pulley Co. is  $.0157 P D R$ . The weight of shafting per foot in iron and steel is given in Table 23.

TABLE 23.

| Diameter<br>in inches. | Weight per foot lbs. |        | Diameter<br>in inches. | Weight per foot lbs. |        |
|------------------------|----------------------|--------|------------------------|----------------------|--------|
|                        | Iron.                | Steel. |                        | Iron.                | Steel. |
| $1\frac{1}{4}$         | 5.89                 | 8.007  | $3\frac{1}{4}$         | 32.1                 | 32.74  |
| 1                      | 5.02                 | 5.18   | $3\frac{1}{2}$         | 33.5                 | 34.17  |
| $1\frac{1}{2}$         | 10.5                 | 10.71  | 4                      | 41.9                 | 42.73  |
| $1\frac{3}{4}$         | 13.3                 | 13.56  | $4\frac{1}{4}$         | 47.3                 | 48.24  |
| 2                      | 16.4                 | 16.72  | $4\frac{1}{2}$         | 53                   | 54.06  |
| $2\frac{1}{4}$         | 19.8                 | 20.19  | $4\frac{3}{4}$         | 59.1                 | 60.18  |
| 3                      | 23.6                 | 24.07  | 5                      | 65.5                 | 66.81  |
| $3\frac{1}{4}$         | 27.7                 | 28.25  |                        |                      |        |

The table given shows that steel shafting is slightly heavier than iron; but as its strength is greater than that of iron, the same power can be transmitted by a lighter shaft. Thus a  $2\frac{1}{2}$  in. steel shaft is capable of transmitting as much power as a 3 in. wrought-iron shaft, and their weight compares as 16.72 : 23.6. Now, assuming that the revolutions are 150, and that in each case the weight of the pulleys between two bearings, plus the stress of the belts, is 400 lbs., we can see what is the relative advantage of the two styles of shafts. The smaller shaft would require the bearings to be spaced  $5\sqrt{2.5^2} = 9$  ft. 3 in., while the iron shaft requires only  $5\sqrt{3^2} = 10$  ft. 5 in. The weight of 9 ft. 3 in. of  $2\frac{1}{2}$  in. steel shafting is 154.66, and of the iron shaft, 245.8. Adding to these the assumed weight of pulleys, we get a load on the bearings of 554 lbs. and 645 lbs. respectively. If, therefore, the lubrication is continuous, the foot lbs. absorbed in overcoming friction in each case respectively are  $.0112 \times 554 \times 2.5 \times 150 = 2315$  and  $.0112 \times 645 \times$

the wisdom of the modern practice with regard to the use of steel shafts instead of wrought-iron.

In most cases the bearings used in cotton mill practice are of a very simple kind, being the standard pattern of plummer block. Where possible, side pedestals are employed, and these are fixed to the faces prepared for them on the columns as shown in Figs. 3 and 4. The standard plummer block has top and bottom brass steps fitted respectively in the body and cap, lubrication being provided by means of some form of lubricator fixed in the cap. In the side pedestal, the sole is vertical to the axis, and is made of such a length that it fits easily on the face of the column, and can be supported by a packing piece between the projecting rib and the bottom of the sole. In some cases, shafts are suspended by hangers attached to the beams, but this practice is not an ordinary one, except as a supplement. The most common length of the brasses is twice the diameter of the shaft, but varies from  $1\frac{1}{2}$  to  $2\frac{1}{2}$  times the diameter. Double the diameter is, however, better than a shorter length, and is more usual.

A large number of lubricating bearings of one kind or another have from time to time been devised, and among them may be mentioned Mohler's patent, of which many thousands have been constructed. This consisted of a collar made of cast iron, and fixed on the shaft. It was from  $\frac{1}{4}$  in. to  $\frac{1}{2}$  in. wide, and about  $\frac{3}{8}$  in. to  $\frac{3}{4}$  in. deep. The top and bottom brasses were grooved to enable the collar to revolve easily without touching, and each groove had a square hole in it at its crown. Through the hole in the bottom brass, the oil, contained in a reservoir formed in the body, entered, so that the collar always dipped into it. In the hole in the cap and top brass, a small sheet-iron scraper cut out to pass over the collar was placed, and as this just cleared the collar and shaft, it scraped the oil off the former and spread it over the whole surface of the journal.

A modification of this principle, embodying an

improvement on it, has been adopted by Messrs. Astin and Barker, of Todmorden, who have carried out a large number of sets of mill gearing for some of the more recent mills. In this pedestal the bottom brass rests on ribs formed in the body, the spaces between which are used as an oil reservoir, but the brass is not grooved internally. The top brass, however, has one or two narrow grooves formed in it, which act as guides for rings of wire or iron of small diameter. These rings are made with an internal diameter much larger than the shaft on which they rest. The outer portion of the brass is grooved slightly near its upper edge, so as to permit the ring to pass over the brass into the reservoir of oil below. The rotation of the shaft draws the ring round with it, but at a slower speed, and the ring carries with it a certain portion of oil, which is taken off by the shaft and distributed over the journal. When the journal is a long one two rings are used, and this principle is applied with perfect success to bearings 7in. to 9in. diameter used for second motion shafts. It is remarkable how speedily the oil is distributed, and it has been found quite unnecessary where these bearings are used to employ oil pumps to obtain a regular circulation. The use of oil pumps is common where there are long bearings, and bath lubrication, which this is, is the basis of the methods adopted for main bearings.

Whether because of the rigid floors which are employed in this country or not, the type of adjust-

itself to any deflection which may take place in the shafting gives a great advantage, and leads to a decrease of friction. A little thought will show that the value of this point may be easily exaggerated. For instance, suppose that an undue downward pull is exercised on two adjoining bays of shafting at the same time; that is, two lengths supported by two outer and one centre bearing. It is obvious that the deflection on one side of the centre bearing will tend to cause it to swivel in one direction, and that the deflection at the other side will have the like effect in the opposite direction. In point of fact swivel bearings cannot avoid what may be called cross friction, except when a shaft is only carried by two of them. The introduction of a third bearing, if there be deflection on each side of it, at once reduces the advantage derived from the freedom of the bearing. But while this is true, it is equally true that in a large number of cases where the conditions just named do not exist, this property of adjustability does play a considerable part in reducing the friction caused by deflection, and it is only the extreme and very absurd claims put forward for this type of bearing that render it necessary to give this warning. On other grounds, such as ease of erection and freedom of adjustment, the swivel or ball bearings constitute a great advance on the ordinary type, and it ought not to be overlooked that at the worst the friction set up will never be greater than that in the ordinary fixed bearing, while on the other hand it may be much less.

In Fig. 120 a cross section of a bearing of this type, made by the Unbreakable Pulley Company, is shown. This consists of a central bearing made of cast iron, and formed with a ball joint at its centre, so that it can move in any direction. It ought to be made clear at this point that in setting these bearings into line it is the absolute centre which is regarded, and not merely the centre of the bore at either end. That is to say, that, as the bearing is held by a ball joint midway of its length, it is the point of inter-

section of a vertical line described through the centre of the ball with the axis which is taken as the setting point of the bearing. This is important, because it is the power of swivelling or oscillating about its centre without that being disturbed, which constitutes the feature of this bearing. It will be clear that, unless this property existed, the value of an adjustable bearing is much diminished. The bearing shown is made of cast iron, accurately bored and made of ample length. The latter is important because of the diminution of the pressure per square inch which follows. As the true lubrication of a bearing is only effected when a film of oil is kept between the two parts, an undue pressure tends to shear it, and thus allow the two metals to come into contact. An enlargement of the bearing area, therefore, is of high value. In a valuable paper on the "Friction and Lubrication of Cylindrical Journals," Professor Goodman, of Leeds, made the following remarks: "Instead of taking the load per square inch as a basis in designing bearings, the author takes the number of thermal units a given area is capable of conducting away per minute. The result of several thousand experiments shows that a gun-metal bearing working on a steel axle will keep cool when one square inch of surface is allowed for every thermal unit conducted per minute.

Let  $P$  = total pressure in lbs. on the journal.

„  $u$  = assumed co-efficient of friction.

„  $S$  = speed of journal surface in feet per minute.

„  $A$  = nominal area of brass in square inches--*i.e.*,

Then the friction resistance..... =  $P u$   
 Foot lbs. of work done per minute... =  $P u S$   
 Thermal units generated per minute =  $\frac{P u S}{772}$

$$\text{Then } A = \frac{P u S}{772}$$

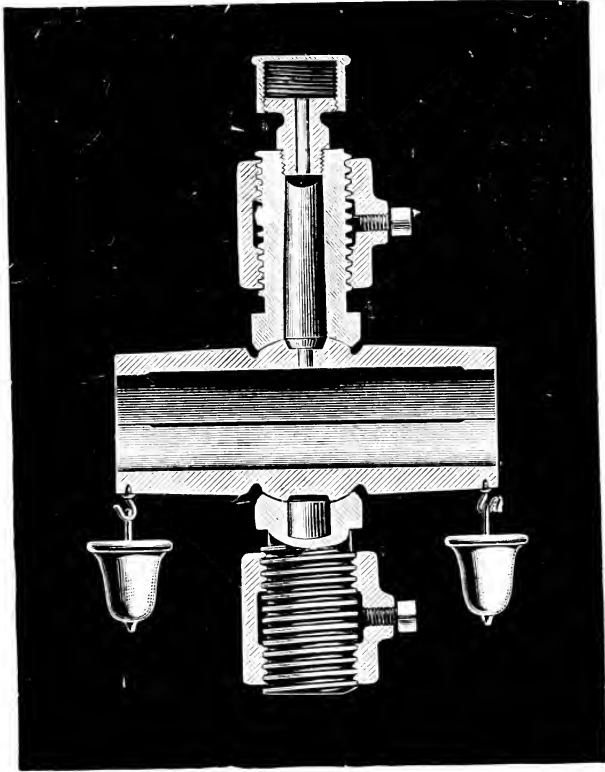
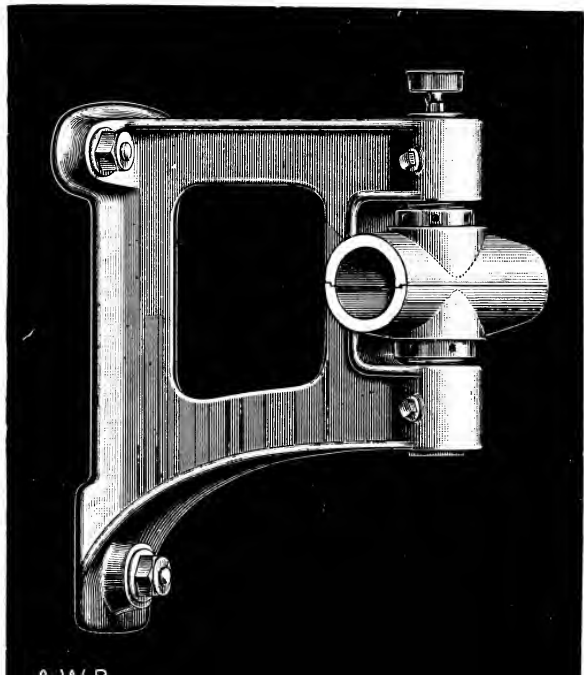

FIG. 120.

Wherever practicable, journals should be allowed a certain amount of end play, about one per cent of their length; they will then run more smoothly, and the journal will not wear in grooves." Reverting

now to Fig. 120, the surfaces in which the bearing proper is suspended are found at the ends of two plungers screwed on their outer surface, and fitting into rigid threaded eyes. The rotation of the screwed shanks enables a bearing to





be mentioned here that the use of Magnolia metal for bearings is increasing, and some recent tests of a 3in. shaft running in bushes  $4\frac{1}{2}$ in. long, with a load of 500lbs. per sq. in., and a speed of 183 revolutions per minute, show that after four hours the heat did not rise excessively, although oil was only used for ten minutes at the start.

In many cases—in fact, in the majority—it is the practice to so arrange the shafts that the cards are driven directly from the line. The roving frames are placed so that by a quarter twisted belt they can be driven directly from the shaft. This can easily be done if it is arranged that the point of delivery of the belt from each pulley is in the plane of the other pulley. As card rooms are now built of considerable height, this mode of procedure enables a long belt to be used, and naturally reduces its wear. It is often necessary to drive machines at some distance from the line shaft, while it is not desirable to employ counter shafts. When this occurs it is usual to employ guide pulleys, or, as they are often called, gallows pulleys, similar to those shown in Fig. 122. For instance, in the ring room of the Stockport Ring Spinning Company's Mill the ring frames are driven directly from the line shaft by long belts passing over gallows pulleys to driving pulleys of the frames. This is a most convenient course, and is often followed. Messrs. Astin and Barker make a gallows pulley in which the axis is of cast iron, being formed in one piece with the pulley, and revolving in a bearing of the self-lubricating type previously named.

There are three types of coupling used to fasten together the various lengths of shafting. These are known as the box or muff, the flange, and the compression. The muff coupling is simply a cylinder of cast iron bored to fit the ends of the shafts, and having keyways cut in it by which it can be keyed on to the shafts which meet end to end midway of its length. This coupling is most effective when the ends of the shafts are formed

with a half lap, but as this is more expensive it is not often done except where great strength is required. The proportions of these couplings are given by Molesworth as follows:—Where  $D$  = dia-

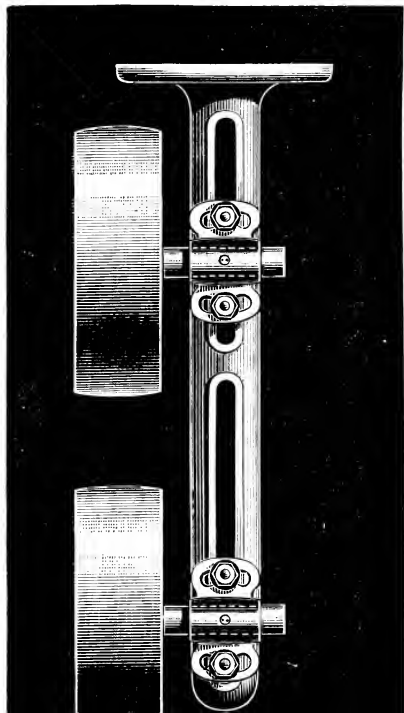

The face of each disc is turned so that they fit closely when the two shafts on which each is fixed are brought together. The couplings are fastened together by bolts accurately fitting bored and rimmed holes in the flanges. It is good practice to recess the flanges for the bolt heads and nuts, or to form a shrouding flange, so that they do not project beyond the surface, and cannot therefore become entangled with the cleaning rags or the clothing of the workman. Professor Unwin

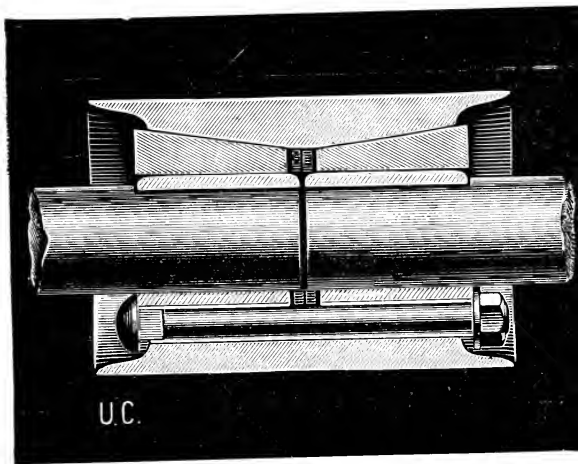

FIG. 123.

gives the following as proper proportions of this class of coupling:—If  $d$  = diameter of shaft,  $a$  = distance of centre of bolts from outside of boss,  $c$  = depth of recess for bolthead or nut,  $b$  = width of keyway,  $t$  = depth of keyway,  $n$  = number of bolts, and  $e$  = diameter of bolts

then  $n = 3 + 0.5 d$ ,  $e = \frac{0.62 d}{\sqrt{n}}$ ,  $a = 1.5 e$ ,  $c = 1.25 e$ ,  $b = 0.25 d + 0.125$ , and  $t = \frac{1}{2} b$ . For the thickness of the boss  $.4 d$ , diameter of boss  $d + .8 d$ , and for

the thickness of the flange from the inner face to bottom of bolt recess  $\cdot 3 d$ . The rule as given by Molesworth is  $d$  = diameter shaft,  $D$  = diameter of boss,  $F$  = diameter of flange,  $l$  = thickness of flange,  $L$  = length of boss,  $D = d + \sqrt{4 d}$ ,  $F = 3 d + 2$ ,  $l = \cdot 3 d + \cdot 4$ ,  $L = d + 1$ . The bolts in this form of coupling are of course in shear, and they may be made a little larger than the size stated. In order to keep the shafts in line with each other, it is often the practice to pass one shaft into its opposing coupling from  $\frac{1}{4}$  to  $\frac{1}{2}$  inch, but this is not always the case.

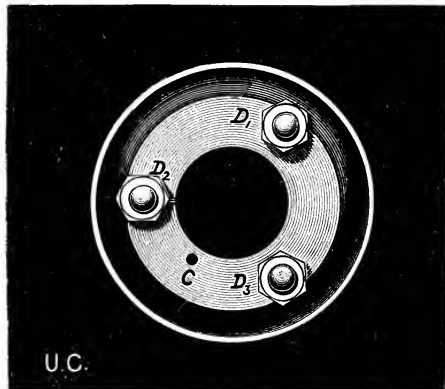

FIG. 124.

turned on a special mandrel. Round the inside of the shell and the outside of the cones three grooves equidistant from one another are formed, one of those in the cones being cut right through. Three bolts are passed through the coupling from end to end, and by screwing them up the two cones are drawn towards each other and are gradually closed on the shaft. It is clear that a coupling such as this will be self-centring, and will exercise a complete grip on the shaft.

It is not pretended that the foregoing remarks furnish complete information on all the various points treated. That has not been the intention, which has rather been to give millowners such practical hints and descriptions of completed work as were most likely to be serviceable. It is obvious that various subjects have been omitted, but it is confidently hoped that within its limits the book will have some value to those engaged in practical work.

TABLE 24.  
PROPERTIES OF SATURATED STEAM.

| Absolute pressure per square inch in lbs. | Temperature in °F of steam and water. | Number of British Thermal units from O° F per lb. |                  | Weight of one cubic foot of steam in lbs. | Volume one pound of steam in cubic feet. | Relative volume cubic feet steam from one pound water. |
|-------------------------------------------|---------------------------------------|---------------------------------------------------|------------------|-------------------------------------------|------------------------------------------|--------------------------------------------------------|
|                                           |                                       | Latent heat formation of steam.                   | Total in. steam. |                                           |                                          |                                                        |
| 1                                         | 102·1                                 | 1042·96                                           | 1145 0           | ·0030                                     | 330·36                                   | 20600                                                  |
| 2                                         | 126·3                                 | 1026·01                                           | 1152·2           | ·0058                                     | 172·08                                   | 10730                                                  |
| 3                                         | 141·6                                 | 1015·25                                           | 1158·8           | ·0085                                     | 117·52                                   | 7327                                                   |
| 4                                         | 153·1                                 | 1007·23                                           | 1169·1           | ·0112                                     | 89·62                                    | 5589                                                   |
| 5                                         | 162·3                                 | 1000·73                                           | 1163·0           | ·0138                                     | 72·66                                    | 4253                                                   |
| 6                                         | 170·2                                 | 995·25                                            | 1165·3           | ·0163                                     | 61·21                                    | 3816                                                   |
| 7                                         | 176·9                                 | 990·47                                            | 1167·3           | ·0169                                     | 52·94                                    | 3301                                                   |
| 8                                         | 182·9                                 | 986·25                                            | 1169·2           | ·0214                                     | 46·69                                    | 2911                                                   |
| 9                                         | 188·3                                 | 982·43                                            | 1170·8           | ·0239                                     | 41·79                                    | 2603                                                   |
| 10                                        | 193·3                                 | 978·96                                            | 1172·3           | ·0264                                     | 37·84                                    | 2360                                                   |
| 11                                        | 197·8                                 | 975·2                                             | 1173·7           | ·0289                                     | 34·62                                    | 2157                                                   |
| 12                                        | 202·0                                 | 972·2                                             | 1175·0           | ·0314                                     | 31·88                                    | 1988                                                   |
| 13                                        | 205·9                                 | 969·4                                             | 1176·2           | ·0338                                     | 29·27                                    | 1844                                                   |
| 14                                        | 209·6                                 | 966·8                                             | 1177·3           | ·0362                                     | 27·61                                    | 1721                                                   |
| 14·7                                      | 212·0                                 | 965·2                                             | 1178·1           | ·0380                                     | 26·36                                    | 1644                                                   |
| 15                                        | 213·1                                 | 964·3                                             | 1178·4           | ·0387                                     | 25·85                                    | 1611                                                   |
| 18                                        | 222·4                                 | 957·7                                             | 1181·2           | ·0459                                     | 21·78                                    | 1357                                                   |
| 20                                        | 228·0                                 | 953·8                                             | 1182·9           | ·0507                                     | 19·72                                    | 1229                                                   |
| 22                                        | 233·1                                 | 950·2                                             | 1184·5           | ·0555                                     | 18·03                                    | 1123                                                   |
| 25                                        | 240·1                                 | 945·3                                             | 1186·6           | ·0625                                     | 15·99                                    | 996                                                    |
| 30                                        | 250·4                                 | 937·9                                             | 1189·8           | ·0743                                     | 13·46                                    | 838                                                    |
| 35                                        | 259·3                                 | 931·6                                             | 1192·5           | ·0858                                     | 11·65                                    | 726                                                    |
| 40                                        | 267·3                                 | 926 0                                             | 1194·9           | ·0974                                     | 10·27                                    | 640                                                    |
| 45                                        | 274·4                                 | 920·9                                             | 1197·1           | ·1089                                     | 9·18                                     | 572                                                    |
| 50                                        | 281·0                                 | 916·3                                             | 1199·1           | ·1202                                     | 8·31                                     | 518                                                    |
| 55                                        | 287·1                                 | 912·0                                             | 1201·0           | ·1314                                     | 7·61                                     | 474                                                    |
| 60                                        | 292·7                                 | 908·0                                             | 1202·7           | ·1425                                     | 7·01                                     | 437                                                    |
| 65                                        | 298·9                                 | 904·2                                             | 1204·3           | ·1538                                     | 6·49                                     | 405                                                    |
| 70                                        | 302·9                                 | 900·8                                             | 1205·8           | ·1648                                     | 6·07                                     | 378                                                    |
| 75                                        | 307·5                                 | 897·5                                             | 1207·2           | ·1759                                     | 5·68                                     | 353                                                    |
| 80                                        | 312·0                                 | 894·3                                             | 1208·5           | ·1869                                     | 5·35                                     | 333                                                    |
| 85                                        | 316·1                                 | 891·4                                             | 1209·9           | ·1980                                     | 5·05                                     | 314                                                    |
| 90                                        | 320·2                                 | 888·5                                             | 1211·1           | ·2089                                     | 4·79                                     | 298                                                    |
| 95                                        | 324·1                                 | 885·8                                             | 1212·3           | ·2198                                     | 4·55                                     | 283                                                    |
| 100                                       | 327·9                                 | 883·1                                             | 1213·4           | ·2307                                     | 4·33                                     | 270                                                    |
| 105                                       | 331·3                                 | 880·7                                             | 1214·4           | ·2414                                     | 4·14                                     | 257                                                    |

TABLE 25.  
SHOWING VOLUME AND WEIGHT OF AIR AND SATURATED  
MIXTURE OF AIR AND VAPOUR AT DIFFERENT TEMPERA-  
TURES UNDER THE PRESSURE OF 30 INCHES OF MERCURY.

| Temperature<br>Degs. Fahr. | Volume of<br>dry air at<br>tempera-<br>ture named | Weight of a<br>cub. ft. of<br>dry air in<br>lbs. | Saturated mixture of air and vapour. |                                |                                 |
|----------------------------|---------------------------------------------------|--------------------------------------------------|--------------------------------------|--------------------------------|---------------------------------|
|                            |                                                   |                                                  | Weight of<br>Air in lbs.             | Weight of<br>Vapour in<br>lbs. | Weight of<br>Mixture<br>in lbs. |
| 0                          | ·935                                              | ·0864                                            | ·0865                                | ·000079                        | ·0867                           |
| 10                         | ·955                                              | 0843                                             | ·0847                                | ·00012                         | ·0849                           |
| 15                         | ·965                                              | ·0838                                            | ·0838                                | ·00015                         | ·0840                           |
| 20                         | ·975                                              | ·0830                                            | ·0829                                | ·00018                         | ·0932                           |
| 25                         | ·986                                              | ·0821                                            | ·0820                                | ·00023                         | ·0824                           |
| 30                         | ·995                                              | ·0813                                            | ·0811                                | ·00028                         | ·0815                           |
| 32                         | 1·000                                             | ·0807                                            | ·0808                                | ·000304                        | ·0812                           |
| 35                         | 1·006                                             | ·0804                                            | ·0802                                | ·00034                         | ·0808                           |
| 40                         | 1·0162                                            | ·0797                                            | ·0794                                | ·000408                        | ·0800                           |
| 42                         | 1·022                                             | ·0791                                            | ·0791                                | ·00044                         | ·0798                           |
| 45                         | 1·0264                                            | ·0789                                            | ·0786                                | ·00049                         | ·0794                           |
| 48                         | 1·032                                             | ·0784                                            | ·0781                                | ·00054                         | ·0789                           |
| 50                         | 1·037                                             | ·0781                                            | ·0777                                | ·00058                         | ·0787                           |
| 52                         | 1·040                                             | ·0778                                            | ·0774                                | ·00063                         | ·0787                           |
| 55                         | 1·047                                             | ·0773                                            | ·0770                                | ·00069                         | ·0780                           |
| 58                         | 1·053                                             | ·0769                                            | ·0765                                | ·00077                         | ·0777                           |
| 60                         | 1·057                                             | ·0766                                            | ·0761                                | ·00082                         | ·0774                           |
| 62                         | 1·061                                             | ·0763                                            | ·0758                                | ·00088                         | ·0772                           |
| 65                         | 1·067                                             | ·0759                                            | ·0753                                | ·00097                         | ·0770                           |
| 68                         | 1·073                                             | ·0754                                            | ·0748                                | ·00108                         | ·0765                           |
| 70                         | 1·077                                             | ·0751                                            | ·0744                                | ·00114                         | ·0763                           |
| 72                         | 1·081                                             | ·0747                                            | ·0741                                | ·00122                         | ·0761                           |
| 75                         | 1·087                                             | ·0784                                            | ·0736                                | ·00134                         | ·0758                           |
| 78                         | 1·093                                             | ·0740                                            | ·0731                                | ·00147                         | ·0755                           |
| 80                         | 1·098                                             | ·0737                                            | ·0728                                | ·00157                         | ·0753                           |
| 85                         | 1·108                                             | ·0731                                            | ·0719                                | ·00182                         | ·0749                           |
| 90                         | 1·118                                             | ·0724                                            | ·0710                                | ·00212                         | ·0745                           |
| 95                         | 1·128                                             | ·0717                                            | ·0701                                | ·00245                         | ·0742                           |
| 100                        | 1·138                                             | ·0711                                            | ·0691                                | ·00283                         | ·0739                           |

NOTE.—According to M. Regnault, air expands  $\frac{1}{491.13}$  part  
of its volume for every  $1^{\circ}$  of heat.

TABLE 26.

NUMBER OF THERMAL UNITS IN ONE POUND OF WATER.

| Temperature. | No. of Units. | Temperature. | No. of Units. | Temperature. | No. of Units. |
|--------------|---------------|--------------|---------------|--------------|---------------|
| 40           | 40·001        | 115          | 115·129       | 190          | 190·543       |
| 45           | 45·002        | 120          | 120·149       | 195          | 195·697       |
| 50           | 50·003        | 125          | 125·169       | 200          | 200·753       |
| 55           | 55·006        | 130          | 130·192       | 205          | 205·813       |
| 60           | 60·009        | 135          | 135·217       | 210          | 210·874       |
| 65           | 65·014        | 140          | 140·245       | 215          | 215·939       |
| 70           | 70·020        | 145          | 145·275       | 220          | 221·007       |
| 75           | 75·027        | 150          | 150·305       | 225          | 226·078       |
| 80           | 80·036        | 155          | 155·339       | 230          | 231·153       |
| 85           | 85·045        | 160          | 160·374       | 235          | 236·232       |
| 90           | 90·055        | 165          | 165·413       | 240          | 241·313       |
| 95           | 95·065        | 170          | 170·453       | 245          | 246·398       |



## INDEX OF ILLUSTRATIONS.

| FIG.  |                                                      | PAGE |
|-------|------------------------------------------------------|------|
| 1     | Swainson, Birley, and Co.'s mill .....               | 9    |
| 2     | Vertical section of mill .....                       | 18   |
| 3-4   | Front and side elevation mill columns .....          | 19   |
| 5     | Cast-iron fire-proof floor .....                     | 23   |
| 6     | Skeleton steel joist floor.....                      | 23   |
| 7     | Coats' mill floor .....                              | 28   |
| 8     | Section steel and concrete floor .....               | 30   |
| 9     | Iron lintel .....                                    | 30   |
| 10    | Carnegie steel and tile floor .....                  | 33   |
| 11    | Steel and concrete floor without joists .....        | 33   |
| 12    | American type of building .....                      | 33   |
| 13    | Section of weaving shed .....                        | 33   |
| 14    | Elevation of Monitor building .....                  | 4    |
| 15    | Roof plan of do. ....                                | 4    |
| 16    | Floor plan of do. ....                               | 4    |
| 17    | Section of part of do. ....                          | 4    |
| 18    | Details of wall of do. ....                          | 4    |
| 19    | Details of Monitor .....                             | 4    |
| 20    | View of American weaving room .....                  | 5    |
| 21    | Longitudinal section, mill, showing sprinklers ..... | 6    |
| 22    | Transverse do. do. ....                              | 6    |
| 23    | Worthington steam pump .....                         | 6    |
| 24    | Merryweather do. ....                                | 6    |
| 25    | Grinnell sprinkler closed .....                      | 6    |
| 26    | Do. open .....                                       | 6    |
| 27    | Witter sprinkler, section .....                      | 6    |
| 28    | Do. elevation .....                                  | 6    |
| 29    | Walworth sprinkler closed .....                      | 6    |
| 30    | Titan sprinkler closed .....                         | 6    |
| 31-32 | Elevation and cross section, window .....            | 6    |
| 33    | Potts, Son, and Pickup's window .....                | 6    |
| 34-36 | "Praray" window .....                                | 6    |
| 37    | Position of air propellor .....                      | 6    |
| 38    | Sturtevant system of ventilation ..                  | 6    |
| 39    | Section Drosophore .....                             | 6    |
| 40-41 | Plan of rooms, with humidifiers fixed .....          | 6    |
| 42    | Pye's humidifier .....                               | 6    |
| 43    | Plan do. ....                                        | 6    |

|                                                                                  | PAGE    |
|----------------------------------------------------------------------------------|---------|
| 44 Lighthouse's humidifier.....                                                  | 101     |
| 45 Perspective view Minerva mill .....                                           | 110     |
| 46 Plan card room do. ....                                                       | 111     |
| 47 Perspective view Milton mill .....                                            | 114     |
| 48 Plan card room do. ....                                                       | 115     |
| 49-52 Elevation and plans of mixed mill arranged by Howard<br>and Bullough ..... | 117-123 |
| 53 Perspective view mill at Lille .....                                          | 122     |
| 54 Plan card room Beehive mill .....                                             | 125     |
| 55 Brazilian mill, by Brooks and Doney plan .....                                | 126     |
| 56 Do. do. ....                                                                  | 128     |
| 57 Plan card room Park Road mill .....                                           | 131     |
| 58 Nevski thread mill .....                                                      | 133     |
| 59 Ordinary treble-riveted lap joint .....                                       | 142     |
| 60 Improved do. ....                                                             | 143     |
| 61-62 Defective and correct butt joint .....                                     | 144     |
| 63 Setting front end boiler .....                                                | 145     |
| 64 Do. back do. ....                                                             | 146     |
| 65 Corrosion of boiler plates .....                                              | 148     |
| 66 Do. bottom plates .....                                                       | 149     |
| 67 Green's economiser .....                                                      | 154     |
| 68 Maudrum's forced blast, front view .....                                      | 158     |
| 69 Do. sectional view.....                                                       | 159     |
| 70 Hicks Hargreaves, and Co's compound engines .....                             | 174     |
| 71-72 Indicator diagrams of do. ....                                             | 175-6   |
| 73 Inverted cylinder triple expansion engines .....                              | 176     |
| 74 Wheelock do. ....                                                             | 177     |
| 75 Yates and Thom's do. ....                                                     | 181     |
| 76 Plan Goodfellow's do. ....                                                    | 183     |
| 77 Side elevation do. do. ....                                                   | 183     |
| 78-79 Main bearing for do. do. ....                                              | 186     |
| 80 Saxon's do. ....                                                              | 188     |
| 81 Mutual Spinning Co's do. ....                                                 | 190     |
| 82-85 Do. indicator diagrams from. ....                                          | 192-3   |
| 86 Buckley and Taylor's compound engines .....                                   | 195     |
| 87-88 Indicator diagrams of do. ....                                             | 197     |
| 89 Quadruple expansion engines .....                                             | 199     |

| FIG.   |                                        | PAGE |
|--------|----------------------------------------|------|
| 107    | Curvature of blades of turbine .....   | 229  |
| 108-9  | Vertical elevations of turbines .....  | 230  |
| 110    | Arrangement of sluice gates .....      | 231  |
| 111    | Section of footstep .....              | 232  |
| 112-13 | Wheel teeth .....                      | 233  |
| 114    | Partial elevation of rope pulley ..... | 234  |
| 115    | Side do. do. ....                      | 235  |
| 116    | Diagram of rope pulley grooves .....   | 236  |
| 117    | Do. arrangement of drive .....         | 237  |
| 118-19 | Splices for ropes .....                | 238  |
| 120    | Swivel bearing for shafts .....        | 239  |
| 121    | Side swivel bearing .....              | 240  |
| 122    | "Gallows" or guide pulleys .....       | 241  |
| 123-4  | Sellar's shaft coupling .....          | 242  |

# INDEX TO TABLES.

---

| TABLE                                                    | PAGE |
|----------------------------------------------------------|------|
| 1 Value of 3.5 power.....                                | 20   |
| 2 Value of 1.63 power .....                              | 20   |
| 3 Breaking weight of columns .....                       | 21   |
| 4 Dimensions and safe loads of steel rolled joists ..... | 48   |
| 5 Deflection of wooden beams .....                       | 49   |
| 6 Dimensions and weights of machines .....               | 50   |
| 7 Capacity of tank for sprinklers.....                   | 62   |
| 8 Size of pipes for sprinklers .....                     | 62   |
| 9 American do. do. ....                                  | 63   |
| 10 Distance apart of sprinklers .....                    | 64   |
| 11 Surface area of tubes .....                           | 89   |
| 12 Maximum limits of humidity .....                      | 94   |
| 13 Safety valve areas .....                              | 160  |
| 14 Weight of cast-iron pipes .....                       | 165  |
| 15 Flow of water over weirs .....                        | 225  |
| 16 Theoretical discharge of water .....                  | 226  |
| 17 Horse-power of wheels .....                           | 236  |
| 18 Weights of leather belts.....                         | 240  |
| 19 Tests of Lambeth ropes.....                           | 249  |



|                                                        | PAGE |
|--------------------------------------------------------|------|
| Boilers, steam, specification for.....                 | 135  |
| "    standard of power of.....                         | 145  |
| "    safety valves for.....                            | 159  |
| "    steam pipes for .....                             | 164  |
| Brazilian spinning and weaving shed .....              | 126  |
| Brickwork, weight and dimensions of .....              | 22   |
| Buckley and Taylor's compound engine ...               | 194  |
| Burnley Ironworks Co.'s electric lighting engine ..... | 207  |

## C

|                                                          |     |
|----------------------------------------------------------|-----|
| Calculation of machines required for spinning mill ..... | 104 |
| "    "    "    thread mill .....                         | 106 |
| "    "    "    weaving shed .....                        | 108 |
| "    "    "    indicator diagrams.....                   | 221 |
| "    "    "    weight of steam per I.H.P. ....           | 222 |
| Carnegie type fireproof construction .....               | 31  |
| Cast-iron " " .....                                      | 23  |
| Causes of damage to boilers .....                        | 149 |
| Characteristics of cotton ropes .....                    | 248 |
| Chimneys, construction of.....                           | 161 |
| "    draught of.....                                     | 162 |
| "    lightning conductors for .....                      | 163 |
| Coal consumption of boiler.....                          | 146 |
| Coats' mill floor .....                                  | 27  |
| Coefficients of transmission of heat .....               | 86  |
| Columns for mills, design of .....                       | 19  |
| "    "    strength of .....                              | 25  |
| Concrete, use of .....                                   | 27  |
| Condensation in steam cylinders .....                    | 167 |
| "    water required for .....                            | 173 |
| Conditioning cellar, arrangement of.....                 | 34  |
| Construction of stairways .....                          | 58  |
| Cost and weight of floors .....                          | 46  |
| Cooling reservoirs .....                                 | 173 |



|                                             | PAGE |
|---------------------------------------------|------|
| Fire-extinction, Worthington pump for ..... | 65   |
| "    Merryweather    " .....                | 67   |
| Flange couplings, proportions of .....      | 266  |
| Flow of water over weirs .....              | 225  |
| Flywheels, safe speed of.....               | 237  |
| "    stress in rim.....                     | 237  |
| Friction of shafting.....                   | 257  |

## G

|                                                    |     |
|----------------------------------------------------|-----|
| Gearing, wheel.....                                | 233 |
| "    belt .....                                    | 237 |
| "    rope .....                                    | 243 |
| Girders, strength and weight of rolled steel ..... | 48  |
| Globe high-speed engine .....                      | 208 |
| Goodfellow's triple expansion engine .....         | 183 |
| Grinnel sprinklers .....                           | 69  |
| Grooves of rope pulley, proportions of.....        | 243 |
| "    "    shape of .....                           | 246 |
| Günther's turbines .....                           | 227 |

## H

|                                            |     |
|--------------------------------------------|-----|
| Heating by steam pipes.....                | 84  |
| Heat, coefficients of transmission of..... | 86  |
| "    loss by transmission.....             | 86  |
| "    units radiated .....                  | 88  |
| Hennebique type of mill floor .....        | 33  |
| Hick, Hargreaves' engine .....             | 174 |
| History of mill development.....           | 8   |
| Howard and Bullough's mill plan.....       | 116 |
| Humidifier, Drosophore .....               | 95  |
| "    Lofthouse's .....                     | 100 |



|                                                      |      |
|------------------------------------------------------|------|
| Indicator diagrams, features of .....                | PAGE |
| "    "    calculation of .....                       | 219  |
| "    "    computation of steam consumption from..... | 221  |
| Iron window lintels .....                            | 222  |
|                                                      | 3    |

L

|                                       |    |
|---------------------------------------|----|
| Lambeth cotton ropes, weight of ..... | 25 |
| "    "    strength .....              | 24 |
| Lap joints for steam boilers .....    | 14 |
| Leather belts, strength of .. .. .    | 23 |
| "    splicing .....                   | 23 |
| "    weight of.....                   | 24 |
| "    power transmitted by .....       | 24 |
| Lighting, electric .....              | 8  |
| Lightning conductors, rules for ..... | 16 |
| Lintels, iron window .....            | 3  |
| Lofthouse's humidifier .....          | 10 |
| Lubricating bearings .....            | 23 |
| Lubrication of bearings .....         | 2  |
| Lubricator, steam cylinder.....       | 2  |

M

|                                            |     |
|--------------------------------------------|-----|
| Machines, weight and measurement of .....  | 1   |
| Meldrum's forced blast .....               |     |
| Merryweather fire pump .....               |     |
| Mill, history of development of type ..... |     |
| "    determining features of plan .....    |     |
| "    general scheme of.....                |     |
| "    columns .....                         |     |
| "    American type of .....                |     |
| "    weaving, type of .....                |     |
| "    monitor type, one-storeyed .....      |     |
| "    windows .....                         |     |
| "    heating appliances for .....          |     |
| "    examples of modern .....              | 109 |
| "    boilers.....                          |     |
| "    engines .....                         |     |
| Milton Mill .....                          |     |
| Minerva Mill .....                         |     |
| Monitor, one-storey mill.....              |     |
| Mortice wheels.....                        |     |
| Moscrop Recorder .....                     |     |
| Muff couplings .....                       |     |
| Musgrave's engine .....                    |     |

N

|                         |  |
|-------------------------|--|
| Nevski Thread Mill..... |  |
|-------------------------|--|

## P

|                                                | PAGE |
|------------------------------------------------|------|
| Park Road Spinning Mill .....                  | 131  |
| Pipes, steam, construction and weight of ..... | 164  |
| "    size of sprinkler .....                   | 62   |
| Piston speeds .....                            | 172  |
| Pollitt and Wigzell's engine .....             | 202  |
| Potts' fireproof floor .....                   | 29   |
| Power of turbines .....                        | 226  |
| Power transmitted by wheels .....              | 236  |
| "    "    belts .....                          | 241  |
| "    "    ropes .....                          | 251  |
| "    table of rope.....                        | 252  |
| "    transmitted by shafting.....              | 256  |
| "    calculation for shafting .....            | 257  |
| "    "    of indicator diagram .....           | 221  |
| "    "    of boiler .....                      | 145  |
| "    absorbed by friction of shafting .....    | 257  |
| Praray window .....                            | 80   |
| Propellers, use of air .....                   | 90   |
| Pulleys, belt.....                             | 237  |
| "    wrought-iron belt.....                    | 238  |
| "    proportions of belt .....                 | 242  |
| "    proportions of rope .....                 | 243  |
| "    grooves of rope, proportions of .....     | 243  |
| "    "    shape of.....                        | 246  |
| Pump, water delivery of.....                   | 65   |
| "    Worthington fire.....                     | 65   |
| "    Merryweather .....                        | 67   |
| Pye's humidifier .....                         | 98   |

## R

|                                          |     |
|------------------------------------------|-----|
| Radiation of heat .....                  | 88  |
| Recorder, Moscrop's Speed .....          | 212 |
| Reducing gear for indicator .....        | 218 |
| Relative cost and weight of floors ..... | 46  |

|                                            |     |
|--------------------------------------------|-----|
| Sellar's coupling .....                    | 20  |
| Shafting, arrangement of .....             | 21  |
| "    bearings for .....                    | 21  |
| "    couplings for .....                   | 21  |
| "    power transmitted by .....            | 22  |
| "    power absorbed by friction of .....   | 22  |
| "    weight of .....                       | 22  |
| Shape of wheel teeth .....                 | 22  |
| Société Cottonière d'Hellemmes Mill .....  | 1   |
| Sprinklers, general arrangement of .....   |     |
| "    water supply for .....                |     |
| "    size of pipes for .....               |     |
| "    discharge of water by .....           |     |
| "    Grinnell .....                        |     |
| "    Witter .....                          |     |
| "    Wallworth .....                       |     |
| "    Titan .....                           |     |
| Stairways, construction of .....           |     |
| Steam boilers (see under letter B) .....   | 135 |
| "    engines (see under letter E) .....    | 166 |
| "    engine indicator (see letter I) ..... | 215 |
| "    pipes, weight of .....                |     |
| "    heating, rules for .....              |     |
| Steel girders, strength of .....           |     |
| Stott's fireproof floor .....              |     |
| Strength of mill columns .....             |     |
| "    wheel teeth .....                     |     |
| "    cotton ropes .....                    |     |
| "    leather belts .....                   |     |
| Stress on flywheel rim .....               |     |

T

|                                              |  |
|----------------------------------------------|--|
| Tabor Indicator .....                        |  |
| Teeth of wheels, shape and strength of ..... |  |
| Theoretical efficiency of steam engine ..... |  |
| "    discharge of water .....                |  |
| Thompson Indicator .....                     |  |
| Titan Sprinkler .....                        |  |
| Transmission of heat, loss by .....          |  |

V

|                                          |  |
|------------------------------------------|--|
| Velocity of wheels .....                 |  |
| "    belts .....                         |  |
| "    ropes .....                         |  |
| Ventilation of mills by propellers ..... |  |
| "    "    American system .....          |  |

## W

|                                                | PAGE |
|------------------------------------------------|------|
| Water buckets, use of.....                     | 58   |
| " supply for sprinklers .....                  | 61   |
| " delivery of pumps .....                      | 65   |
| " evaporated by boiler .....                   | 145  |
| " condensing quantity required .....           | 173  |
| " flow over weirs .....                        | 225  |
| " theoretical discharge of .....               | 226  |
| Weaving shed construction .....                | 38   |
| Weight of brickwork.....                       | 22   |
| " machines .....                               | 50   |
| " steam per I.H.P., estimation of .....        | 222  |
| " belts .....                                  | 240  |
| " cotton ropes.....                            | 249  |
| " shafting .....                               | 258  |
| Weirs, water flow over .....                   | 225  |
| Wheels, cast iron.....                         | 233  |
| " mortice .....                                | 235  |
| " proportions of .....                         | 236  |
| " power transmitted by .....                   | 235  |
| " shape and strength of teeth of .....         | 233  |
| " stress on rim of .....                       | 237  |
| Windows, design of .....                       | 77   |
| " Praray.....                                  | 80   |
| Wooden beams, safe loads, and deflection ..... | 49   |
| Wood's engine .....                            | 190  |
| Wrought iron pulleys.....                      | 238  |

THE UNBREAKABLE  
PULLEY & MILL GEARING CO., L

# Specialties

STEEL SHAFTING  
UNIVERSAL COUPLINGS,  
**SWIVEL BEARINGS**  
FRICTION CLUTCHES,  
WROUGHT-IRON PULLEYS  
LARGEST MAKERS IN THE WORLD.

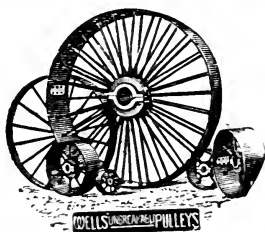
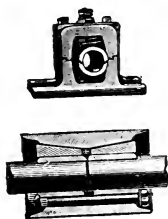

## Each perfect of its kind

24, WEST GORTON, MANCHESTER  
And 56, Cannon St., LONDON, E.C.

# W. T. GLOVER & CO.,

## SALFORD, MANCHESTER.

LONDON: 39, Victoria Street, Westminster, S.W.

GENERAL ENGINEERS, MACHINISTS, MILLWRIGHTS, &c.

REPAIRS TO MILLS, &c., &c.

MAKERS OF ROPE, TWINE, AND BRAID MACHINERY.

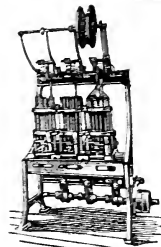

Braid Machine.

Tubular and  
Spindle  
Banding  
Machines.

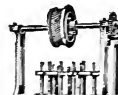

Smallware Machinery.  
Balling, Winding & Warping  
Machines.

Spinning Machines.  
Wire-Winding Machines.  
Wire-Twisting Machines.

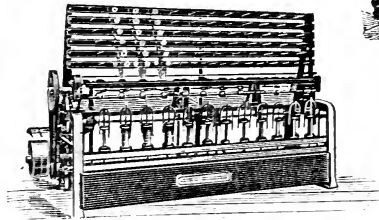

Wire-twisting Machine.

SHAFTING,

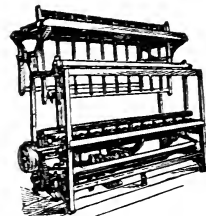

Loom.

Drilling  
Machines,  
Tools, and  
other  
Specialities.

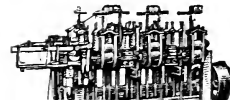

# JOSEPH STUBBS

Machine Maker and Ironfounder,  
**MANCHESTER.**

**WORKS:**  
Mill Street Works, Ancoats.  
Branch Works, Openshaw.  
**LONDON OFFICE:**  
35, Queen Victoria Street, E.C.

Telegrams: "Winding, Manches  
(Ancoats Works,  
Telephone No. } Openshaw Work  
Manchester Exchange, No. 12  
Tuesdays and Fridays.

---

*NOTE.—All Communications to be addressed to MILL STREET WORKS,  
ANCOATS, MANCHESTER.*

---

## **MAKER AND PATENTE** OF ALL CLASSES OF

Winding, Doubling, and Clearing Frames, St  
Motion Winders for ordinary Bobbins, or w  
Quick Traverse for Tubes. Gassing Frames  
Cotton, Worsted and Silk Yarns. Reels for Co  
Ring Throstle or other Bobbins. Yarn Prepar  
Machines. Yarn Presses for all purpos  
Warping Mills, Adjustable Yarn Clearers, &

*NOTE.—The above Machines (Newest Construction) may be s  
operation in Showroom at my Mill Street Works.*

---

## **HIGH-CLASS CASTING** FOR ALL PURPOSES, **ORDINARY, ANNEALED, AND MALLEABLE**

# LAMBETH COTTON ROPES

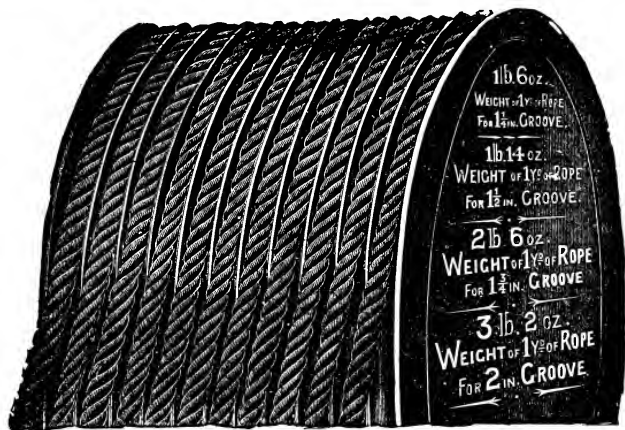

They are firmly made and very solid, containing more actual yarn for a given diameter than is usual ; and being made from pure Egyptian Throstle Yarn, without any weighting material, are light in weight.

Also **DRUM, RIM, SCROLL, SPINDLE, RING SPINDLE, TAPE** and **TUBULAR BANDINGS** to any description for Cotton Mills.

---

**THE LAMBETH COTTON ROPES** are of unique design and construction, superseding all other Cotton Ropes **FOR MAIN DRIVING.**

---

TENSION AND FRICTION accurately measured for and provided against, and the ROPES fitted exactly to the working part of the grooves of the Pulley.

---



# CURTIS, SONS & CO

(JOHN HETHERINGTON & SONS LTD., Proprietors),

PHOENIX WORKS, CHAPEL STREET, MANCHESTER  
ANCOATS,

## MAKERS OF ALL KINDS OF WOOLLEN MACHINERY

Including Carding Machines for Worsted, with Four Lickers-in and Two Cylinders for Botany and Fine Wools; Two Lickers-in and Two Cylinders for Medium Wools; One Licker-in Breast and Two Cylinders for Camel Hair, Mohair, &c.; Woollen Carding Machines on the Belgian principle, consisting of Scribbler, with Breast and One Cylinder Intermediate, with Taker-in and One Swift, and Carder, with Taker-in and One Cylinder, fitted with Improved Tape Condenser.

Carding Machines for Carpet Yarns, Heavy Woollens, Shoddy, Mungo, Felts and Blankets, fitted with Automatic Feeds for Scribbler, and other Blamires Lap Feed or Scotch Feed, either "ordinary straight" or "diagonal".  
**Automatic Feeds Fitted to Old Scribblers.**

Condensers of all kinds applied to old Machinery, including Single Stripper, with "ordinary" or "Tandem" rubbers; Single Doffer Double Stripper, with "ordinary" or "Tandem" Rubbers; Double Doffer Double Stripper, with "ordinary" or "Tandem" rubbers; also Tape Condensers.

Self-Acting Mules for all kinds of Woollens, Mungo, Shoddy, Blankets and Flannels; any pitch from 1½ in. to 3½ in.

**Carding and Spinning Machinery for Silk Noils.**

### ALSO MAKERS OF

**Crighton Vertical Single and Double Openers.**  
Openers, with Cylinder, one or two beaters combined, and Lap Machine.  
**Single and Double Scutchers**, with Lap Machines attached, complete with and Improved Regulation Motion, for producing laps of uniform weight.

**Carding Engines (Single or Double)**, with rollers and clearers.  
**Carding Engines**, either all Flats, or a union of Rollers, Clearers, and I.

**Self-stripping on our own Patent Principle.**  
**Carding Engines**, with Revolving Flats, including all our patented improved  
**Grinding Machines and Grinding Rollers.**  
**Sliver Lap Machines and Derby Doublers.**  
**Heilmann's Cotton Combing Machines.**

**Drawing Frames**, with Front and Back Stop-motions, and full Can-stop motions, positive and instantaneous in action.

**Slubbing, Intermediate, Roving, and Fine Jack Frames** from new terms, with our Patent Winding Motion, Patent Revolving Bushes, Short or Long Spindle Collars.

**Ring Throstle Frames**, with (or without) inclined Stands, Sliding Thread Rabbeth Spindles, and the most recent improvements.

**Flyer Throstle Frames**, on the most approved principle, Patent Footsteps, &c.  
**Self-acting Mules**, for fine or medium counts, with special arrangements for counts. Complete with our improved Band Taking-in Motion, Strap-reel Motion, &c., &c.

**Mule Twiners**, on the most approved English and French principles.  
**Ring Doubling Frames.** **Flyer Doubling Frames.** **Cotton V. Machinery.**

**Winding Frames**, with or without Stop-motions, for all classes of yarn.

### ESTIMATES GIVEN ON APPLICATION

Attendance on LEEDS and HUDDERSFIELD EXCHANGE on TUESDAY  
BRADFORD on THURSDAYS.

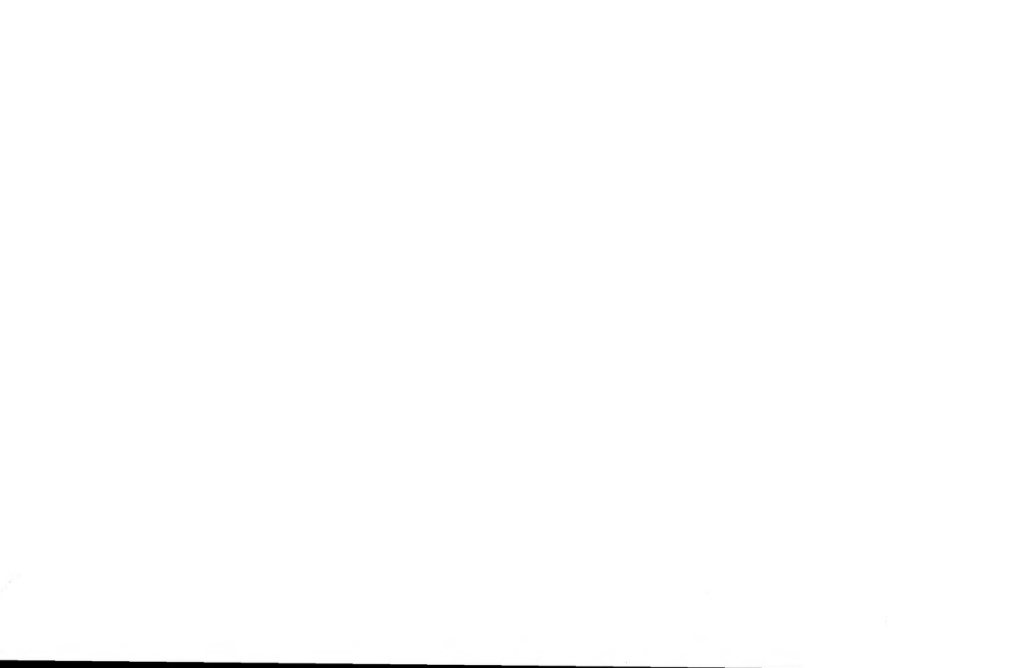

# JOHN HETHERINGTON & SONS L<sup>TD</sup>

**Machinists and Engineers,**  
**ANCOATS, PHOENIX, AND HOPE WORKS, MANCHESTER, ENGLAND.**

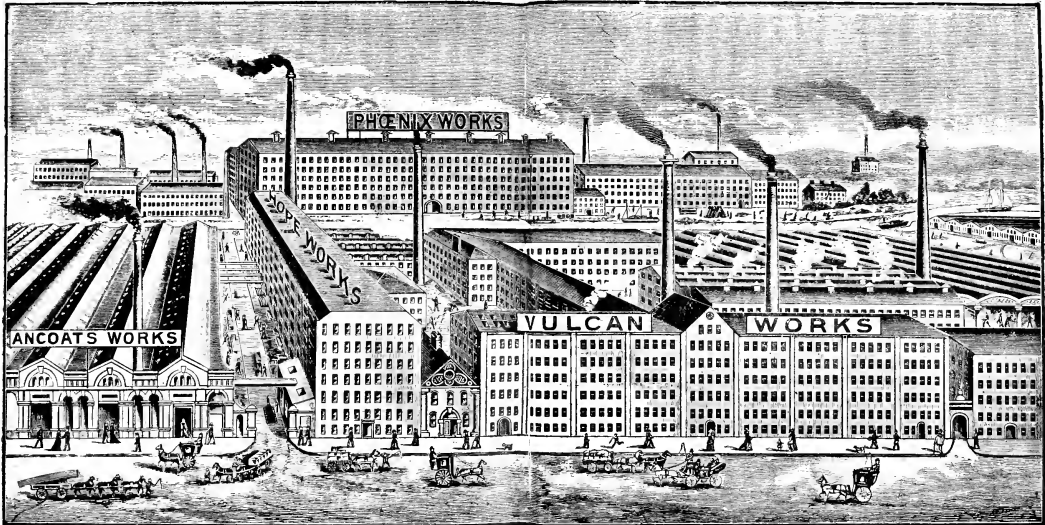

**MAKERS OF ALL KINDS OF**

**Cotton, Woollen, Worsted, and Silk Machinery.**

# Metallic Drawing Roll Co.

REGISTERED OFFICE:—

LIMITED.

**20, Arcade Chambers,  
St. Mary's Gate, MANCHESTER.**

---

MANUFACTURERS OF

## PATENT METALLIC DRAWING ROLLS

---

Between Three and Four Hundred Firms are now using these Rolls, and over 30,000 deliveries have been supplied.

This Roll is applied to Old as well as New Machinery, and in most of the New Machinery now being ordered, the

**PATENT METALLIC ROLL IS SPECIFIED.**

---

**TEN POINTS IN FAVOUR**

OF THE

**PATENT METALLIC DRAWING ROLL.**

1. THE PATENT METALLIC ROLLS are perfectly made, being ground down to extreme accuracy in size; hence we start with and maintain at all times a perfect roll, working without friction on rollers which will last almost in-
5. THE IMPERFECT OR "CUT WORK" arising from imperfectly varnished rolls, or dry rolls because of lack of oil, is entirely eliminated.
6. THE COST OF ROLL COVERING, roll varnishing, delays because of sliver

# THE "DROSOPHORE"

For Moistening the Air in Cotton, Wool, Silk, Flax and Jute Mills, Bleacheries, Paper Mills, &c.

Over  
8,000  
Machines

IN  
Use.  
Patented  
IN ALL  
Countries.

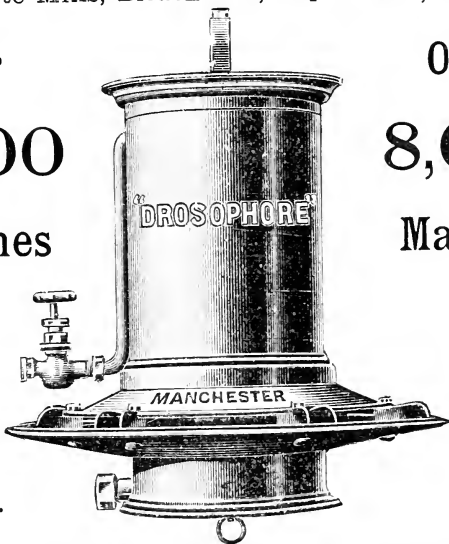

Over  
8,000  
Machines  
IN  
Use.  
Registered  
Design

**GIVES THREE TIMES MORE HUMIDITY THAN ANY ON THE MARKET**

CHEAPER, more EFFICIENT, & higher CAPACITY than any other Apparatus in the market. No STEAM is used. Admits fresh air from the outside, which is washed and purified and can be moistened to any desired degree, either warm or cold.

The ATMOSPHERE of Spinning Rooms or Weaving Sheds where the "DROSOPHORE" is in use is PERFECT, and there is no bad work even in the driest and hottest or climate.

It STRENGTHENS the YARN, and destroys troublesome ELECTRICITY, and PRODUCTION is INCREASED about 5 per cent.

**IT IS INDISPENSABLE IN ALL MILLS.**

Installations can be seen working in all the principal Manufacturing Centres in the United Kingdom and abroad.

Our system is being adopted by all the leading Textile Firms.

It is recommended by the Leading Medical Authorities.

The "DROSOPHORE" is the only HUMIDIFIER which has stood the Test of the Market.

**Beware of Imitations—Bringing Discredit on our System**  
**FURTHER INFORMATION PROMPTLY GIVEN ON APPLICATION.**

**THE NEW AUTOMATIC SPRINKLER, Cheaper**  
**Better than any other, DEFIES COMPETITION**

The "DROSOPHORE" CO. LTD., 22, 23 and 24, ARCADE CHAMBERS  
**ST. MARY'S GATE, MANCHESTER.**

AGENTS: Russia, Spain, Portugal—J. HETHERINGTON & SONS Ltd., Manchester.  
India—J. HETHERINGTON & SONS Ltd., Manchester.  
America and Canada—WM. FIRTH, 220, Devonshire Street, Boston, U.S.A.

HIGHEST  
AWARD,



GOLD  
MEDAL,

TO  
— **ROGER PYE,** —  
FOR  
**PYE'S PATENT UNIQUE HUMIDIFIER & VENTILATOR**

Atmosphere of suitable Humidity and Temperature guaranteed either Summer or Winter. The only **Humidifier** and **Ventilator** which **Reduces** the Temperature in hot weather while working,

**Reduces** Carbonic Acid Gas **more** than any other **System**, thereby creating a **healthier atmosphere** for the operatives.

**NO DRIPPINGS—THEREFORE SUITABLE FOR THE FINEST WORK**

**ROGER PYE,**

Practical and Consulting Ventilating and Heating Engineer,  
**69, Darwen Street, BLACKBURN.**

---

ESTABLISHED 1859.

**JNO. SWAILES & SONS,**  
PATENTEES, COP TUBE MANUFACTURERS, MACHINISTS, &c.

Sole Makers of **SWAILES' Patent Tubing Apparatus**, either permanent or portable, which is acknowledged after numerous tests by masters and workpeople to be the best for placing Cop Tubes on the Spindles of Mules, Twiners, Ring Frames.

THIS PAMPHLET, POST FREE, FROM  
LANCASHIRE PATENT BELTING  
AND HOSE CO.,  
MANCHESTER.

*"FACTS ARE STUBBORN  
THINGS."*

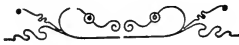

A FEW

PLAIN

FACTS

**ABOUT "HAIR" BELTING**

FOR

POWER

USERS

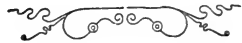

BY THE

PIONEERS

OF THE INDUSTRY

D  
A.L.  
ATOR  
her  
ich  
ely  
WORK  
gineer,  
NS,  
, &c.  
ither  
mer-  
cing  
umes,  
atent  
other  
bbins  
ufac-  
ry of  
ching  
only  
Patent  
pindle  
HAM.  
Tuesday  
No. 42.

# TEXTILE FACTORIES

OF EVERY DESCRIPTION

Designed, Erected           

AND

           Fully Equipped

IN ANY PART OF THE WORLD,

AND HANDED OVER, IF DESIRED,

In Full Working Order



National Telephone No. 2. Telegraphic Address: "WILSON, BARNSLY"  
 A B C Code Used. ESTABLISHED 1852. A 1 Code Used

# WILSON & CO

Attendance:  
 Royal Exchange,  
 Manchester,  
 Tuesdays & Fridays.

**BARNSLY LIMITED,  
 BARNSLY,**

Attendance  
 Bradford Exch  
 Mondays  
 and Thursdays

And 15, MARKET STREET, MANCHESTER (opposite Royal Exchange)

MAKERS OF EVERY DESCRIPTION OF  
**BOBBINS**  
 Required in the various Textile Industries.

INVENTORS AND PATENTEES OF  
**PATENT STEEL FLANGE PROTECTORS FOR WARPING  
 WINDING, GASSING BOBBINS, &C.**

Preventing Breakage or Opening of Flanges and Securing Permanent Smooth Ends

**PATENT PROTECTORS for RING DOUBLING & TWISTING BOBBINS**

Ensuring Complete Protection from Driving Studs on Spindles.

NOTE.—Old Bobbins may be fitted with this Latest Improvement  
 nominal cost, making them almost as good as new.

**PATENT RINGS OR HOOPS FOR RING TWIST BOBBINS & RING WEFT BOBBINS**

A Neat and Reliable Preventative of Splitting of these fragile Bobbins.

MAKERS OF ALL KINDS OF  
**CARD ROOM BOBBINS**

For Long or Short Collar Frames. Fitted with Patent Steel Shields.

Makers of **RING TWIST & WEFT BOBBINS**  
 FITTED WITH PATENT BRASS SHIELDS.

EVERY DESCRIPTION OF  
**ENAMELLED BOBBINS**

Of Superior Quality.—Specially Prepared for Conditioning Yarn on the Bobbin  
 IMPERVIOUS TO STEAM, MOISTURE, OR OIL. Send for Samples

PRINCIPAL MAKERS OF  
**BARLOW & LEACH'S New Patent Triple Combination Ring Bobbin**  
 The Latest Improvement in this Class of Bobbin.

**WILSON & CO. BARNSLY LIMITED** hold the largest Stocks of  
 Timber carefully selected and thoroughly seasoned, and ensure absolute uniformity  
 in dimensions and perfect accuracy in Fit and Balance on Spindles.

SAMPLES & PRICES ON APPLICATION TO BARNSLY

# TINKER, SHENTON & CO.

## HYDE, near MANCHESTER.

ESTABLISHED 1872.

Telegraphic Address :—" DUPLEX, HYDE."

Telephone No. 21.

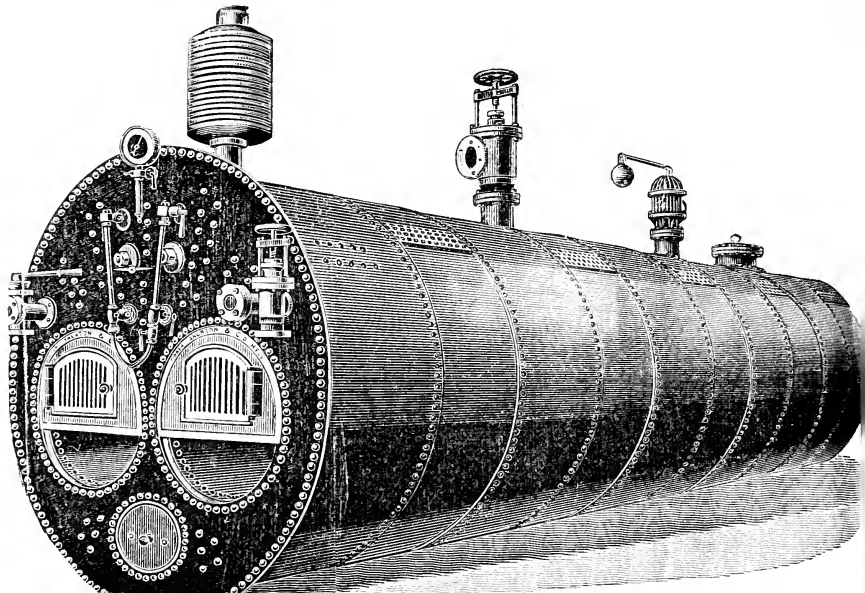

# WILSON BROS., LTD.

MAKERS OF EVERY DESCRIPTION OF

BOBBINS, TUBES, CREEL  
SKEWERS and SHUTTLES.

ESTABLISHED 1823.

THE LARGEST AND MOST COMPLETE BOBBIN WORKS IN THE WORLD

Awarded 16 Highest Prize Medals for  
Excellence of Manufacture.

ORIGINAL INVENTORS AND MAKERS OF  
STEEL AND BRASS SHIELD PROTECTORS

Which are successfully applied to Card Room Bobbins of all sizes  
and diameters. Beaded or straight.

CREEL SKEWERS

are fitted with Patent Metal Tips of Brass or Malleable Iron.

RING BOBBINS FOR TWIST AND WEAVE

are shielded with Brass or Steel Protectors of various kinds.

WARPING BOBBIN FLANGES

made unbreakable by a simple applied Steel Binder, which adds scarcely  
any to the weight of the Bobbin.

SHUTTLES IN BOXWOOD, CORNELL & PERSIMMON

made to suit either for Cops or Pirn Bobbins.

WILSON BROS. are Sole Licensees and Users of the

PATENT ENAMEL PROCESS,

which renders Wood Bobbins impervious to Steam or Moisture used in  
conditioning yarn.

ADDRESS:—

Bobbin Works—CORNHOLME MILL, TODMORDEY

Also at GARSTON, LIVERPOOL.

Show Room—14, Market Place, MANCHESTER.

# BUTTERWORTH & DICKINSON,

GLOBE AND SAUNDER BANK IRON WORKS.

**BURNLEY.**

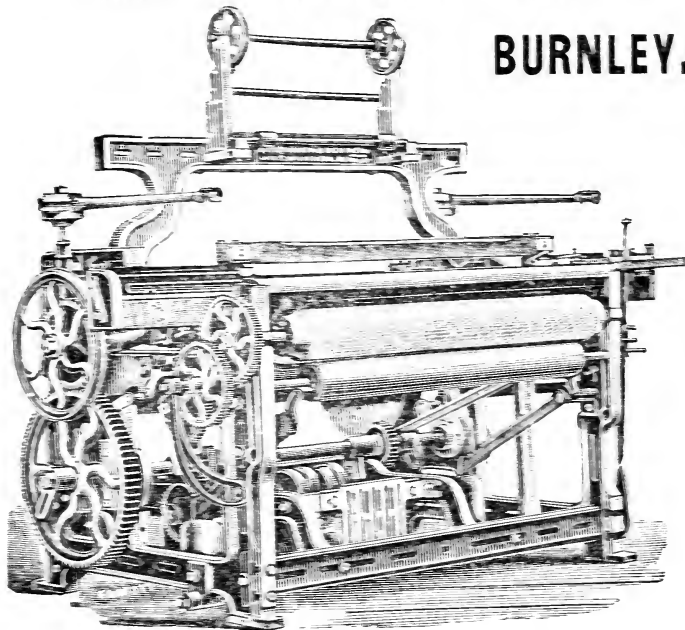

Makers of all descriptions of

# LOOMS.

Telegraphic Address "Platts, Oldham." Telephone No. 19

# PLATT BROS. & CO. L<sup>td</sup>

MACHINISTS,

Hartford Works, Oldham.

MARSHES OF THE F. & M. CO. LIMITED -

**IMPROVED COTTON BALE BREAKERS**

PATENT "EXHAUST" OPENERS,

SCUTCHERS, WITH PATENT PEDAL REGULATORS

PATENT AUTOMATIC HOPPER FEEDING MACHINES

PATENT

REVOLVING SELF-STRIPPING FLAT CARDING ENGINES  
CARDING ENGINES FOR COTTON, WOOL, WORSTED, SILK AND WASTE

PATENT CONDENSERS FOR WOOL, COTTON AND COTTON WASTE  
DRAWING, SLUBBING, INTERMEDIATE AND ROYING FRAMES

PATENT SELF-ACTING MULES & TWINERS

PATENT RING SPINNING FRAMES FOR WARP AND WEFT

RING DOUBLING FRAMES FOR COTTON, WOOLLEN  
WORSTED AND SILK.

Improved Machinery for  
PREPARING, COMBING, ROYING AND SPINNING WOOL  
ON BOTH THE FRENCH AND BRADFORD SYSTEMS.

Machinery for Preparing and Spinning Barchant or Waste

BOYD'S PATENT STOP-MOTION TWISTERS

**POWER LOOMS.**

Plain and Fancy, for Cotton, Linen, Woollen, Worsted, &c.

PREPARING MACHINERY FOR WEAVING.

Reeling, Winding, Warping, Strapping, Beaming and Dressing Machines for  
Linen and Jute Yarns, and Spinning Machines for Carpet Yarns

# WILLIAM RYDER,

Bee Hive Works, BOLTON.

MANUFACTURER OF ALL KINDS OF

## FLUTED ROLLERS

Iron, Steel and Case-hardened.

PLAIN and LOOSE BOSS TOP ROLLERS

## SPINDLES & FLYERS

(Flyers of Steel) of every description,  
for Cotton, Silk, and Woollen  
Spinning.

MULE SPINDLES.

Licensed Maker of  
RING  
SPINDLES,  
WITH  
WOODMANCY'S  
PATENT COMBINED  
OIL TUBE AND  
HOLDER.



Telegraphic  
Address—

“BEEHIVE,  
BOLTON.”

Telephone No. 55.

Manchester  
Exchange,  
Pillar P.

GENERAL  
TOOL  
MAKER.

*Inventor, Patentee and Maker of*

Telegraphic Address :

"ASA, OLDHAM."

Telephone

No. 7, OLDHAM.

# ASA LEES & CO

LIMITED,

## Soho Iron Works

### OLDHAM.

---

*MANCHESTER OFFICE (Open Tuesdays and Friday)*

**27, HOPWOOD AVENUE.**

---

MAKERS OF

## ALL KINDS OF MACHINE

FOR

Preparing, Spinning, and Doubling Cotton and W

---

SOLE AGENTS FOR THE CONTINENT OF EUROPE

## BAERLEIN & Co.,

— 12, Blackfriars Street, Salford

### MANCHESTER,

To whom all Communications relating to Continental Business should be addressed.

---

AGENTS FOR INDIA :—

## BRADBURY, BRADY & CO., Bruce Lane, Fort, B

# Frictionless Engine Packing

**COMPANY**

(SMALL & PARKES),

Cable Mills, Glasshouse St., Oldham Rd.,

**MANCHESTER.**

---

REGISTERED  
TRADE  
MARK.



REGISTERED  
TRADE  
MARK.



For Economy of Fuel Use

# MELDRUM'S PATENT FORCED DRAUGHT FURNACES.

*Highest Testimonials from Cotton Spinners, Wool Manufacturers, and other Textile Factories where large numbers are at work.*

EQUAL EVAPORATION FROM INFERIOR FUELS AS FROM BEST COALS UNDER ORDINARY DRAUGHT.

Over 2,000 Working.

EASY CLINKERING. Perfect Control over Fires. Bars last four times as long. RESULTS GUARANTEED.

## MELDRUM BROS.

ATLANTIC WORKS, CITY ROAD.

## MANCHESTER,

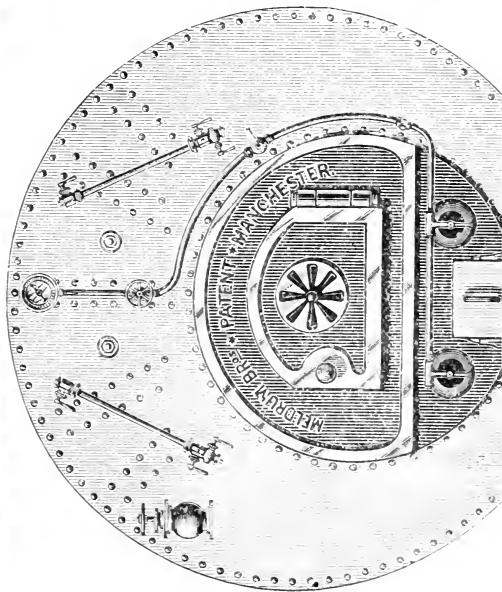

And 16 Union Court Old Broad Street.

"SAXONS, OPENSHAW."

No. 959.

# GEORGE SAXON,

Openshaw Engineering Works,  
MANCHESTER.

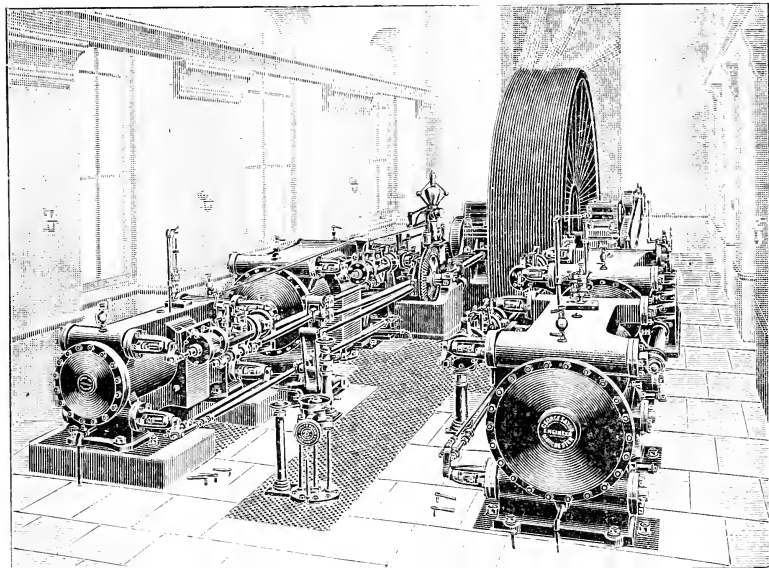

# NEW PATENT HOPPER FEED

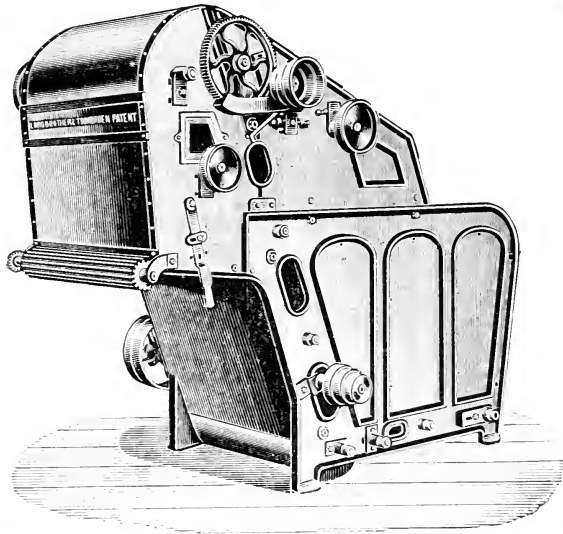

# LORD BROTHERS

**TODMORDEN,**

MAKERS OF MACHINERY

— FOR —

OPENING, CLEANING,  
CARDING, SPINNING  
AND WEAVING COTTON

Telegraphic Address:  
"LORDS, TODMORDEN."

Telephone (National)  
No. 6.

MANCHESTER EXCHANGE, Tuesday and Friday, No. 12 Pi

# JOHN HEYWOOD'S TECHNICAL WORKS.

- SLIDE RULE INSTRUCTOR.** For instruction on Chadwick's Improved Slide Rule, containing New and Important Rules upon the present practice of Engineering. For the use of Engineers, Millwrights, Mechanics and Artisans, Mill Owners, Cotton Spinners, Calico Printers, Bleachers and Finishers, Colliery Proprietors, Blacksmiths, Moulders, and Steam Users generally. By JOHN CHADWICK. This book gives a greater variety of Rules and Questions and useful information upon the subject than has been before published in any work on the Slide Rule. Cloth, 2s. A new and vastly improved Rule has been designed and prepared for this book. It is box wood, with steel slide. Every figure has been accurately checked and verified. Price 7s. 6d.
- YOUNG'S (S.) PRACTICAL ARITHMETIC** Containing Rules and their application to Merchants, Cotton Spinners, Manufacturers, and Mechanical Calculations useful to Artisans in general. New Edition. Cloth lettered, 3s. 6d. Young's Key to Arithmetic. Cloth, 4s.
- SOUND, LIGHT, AND HEAT.** Specially prepared (by ALFONZO GARDINER, Head Master of a Leeds Board School) for Science Classes, Grammar, Private Training, and other Schools, carefully revised, with numerous additions, in accordance with the New Syllabus of the Science and Art Department. An Appendix contains the Examination Papers set during the last ten years, with answers and full solutions of all the mathematical questions. Eighteenth Edition, Revised. Cloth, stiff, 204 pp., 1s. 6d.
- HANDBOOK TO COTTON SPINNING.** Compiled for the general use of young Carders and Spinning Overlookers. By J. E. HOLME. Corrected and Revised by C. P. BROOKS, M.S.A., Senior Honours Medallist; Lecturer on Cotton Spinning, Weaving, and Designing at the Blackburn Technical School. Fcap. 8vo, cloth gilt, Second Edition, 2s. 6d.
- HANDBOOK FOR THE USE OF COTTON MANUFACTURE STUDENTS.** By C. P. BROOKS, M.S.A., Honours Medallist, late Lecturer on "Cotton Manufacture and Weaving and Pattern Designing" at the Blackburn Technical School. Third Edition. Crown 8vo, paper cover, 60 pp., sewn, 1s.
- PRESTWICH'S YOUNG MAN'S ASSISTANT TO COTTON SPINNING.** Revised and Enlarged. Containing a Collection of Useful and Practical Calculations (with Remarks and Observations) in connection with Modern Cotton Spinning, Doubling, Plain and Skein Reeling, Making Up, Weaving, etc., each Rule being given with Examples fully worked out in a plain, simple, and easy manner. Also some useful Calculations, with Explanations on the Steam Engine and Boiler, for the use of the Engineer. Cloth, gilt lettered, 4s. 6d.
- MODERN BLEACHING AND FINISHING.** By a PRACTICAL BLEACHER. Illust. Cloth, 2s.
- PRACTICAL PATTERN MAKING AND MOULDING.** By W. H. WILSON. For Students, Artisans, and Engineers. A thoroughly *practical* work, illustrated with over 300 Engravings and numerous examples of most modern and approved methods of workmanship.
- SYNOPSIS OF CONTENTS.**—Examples of Geometry. Selection of Tools and Timber. Green Sand, Dry Sand, and Loam Moulding. Machine Tool Work. Rope and Speed Pulleys.

# PROCTOR'S Mechanical Stoker

# 50

PER CENT of Orders received are from old Customers, many of whom have had the Stoker working 10 Years.

20 per cent. MORE DUTY. 10 to 15 per cent. IN ECONOMY.

## GUARANTEED REMEDY FOR SMOKE NUISANCE.

The First and only Inventor of the Radial Shovel with Tappet and Spring.

The ONLY MOVING BARS BEFORE the PUBLIC that can be WORKED in THREE DIFFERENT WAYS:—

- 1st—As SELF-CLEANING.
- 2nd—Can be put in and out of gear and worked intermittently.
- 3rd—As HAND-MOVING BARS.

Sole Patentee of Steam Bearer to Prevent the Bar Ends Burning.

— LARGEST NUMBER OF REFERENCES IN THE TRADE. —

The Stoker has been before the Public over 17 Years and is protected by 10 different Patents.

WRITE FOR FULL PARTICULARS,

# J. PROCTOR,

— HAMMERTON STREET IRON WORKS,  
BURNLEY.

**OODFELLOW,**

Maker of

20

1G.

DATE DUE

FEB 17 1980

MAR 21 1980

ES AND FOR ALL PURPOSES.

N2 200 0

ADVERTISEMENTS.

**THE**  
**"NON-DRIP" SHAFT BEARING**  
 (ETCHELLS' PATENT),  
**BEST AND CHEAPEST.**

OF ALL SIZES AND FOR ALL PURPOSES.

**RAILWAY FOUNDRY, LEEDS.**

Telegrams :—" LOCO, LEEDS."



