





**A MICROFILM PUBLICATION**

**[WWW.NARA.GOV](http://WWW.NARA.GOV)**



# IMAGE EVALUATION TEST TARGET (QA-3)

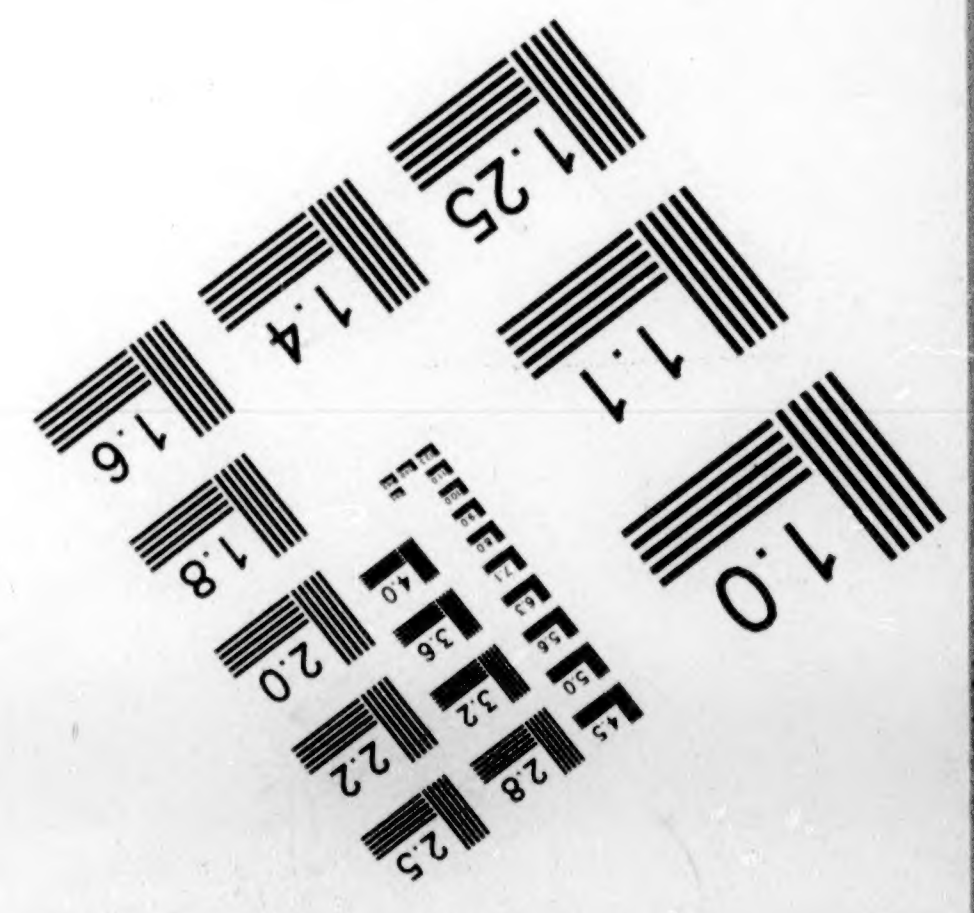
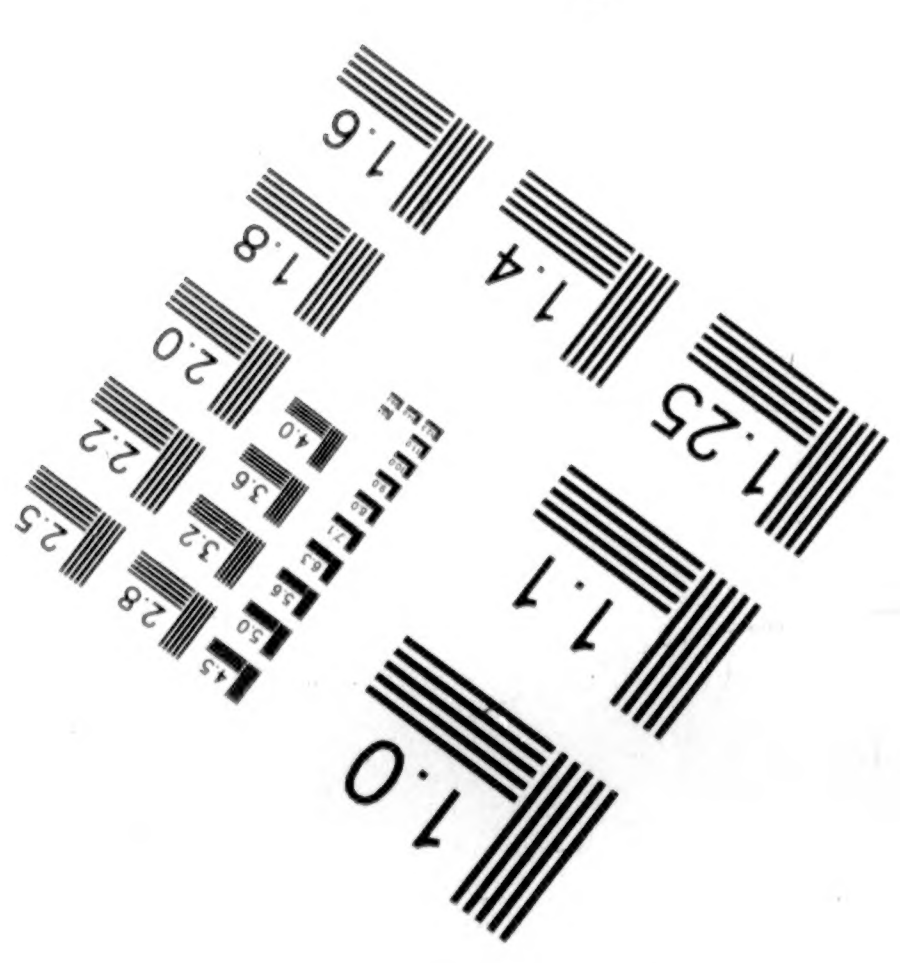
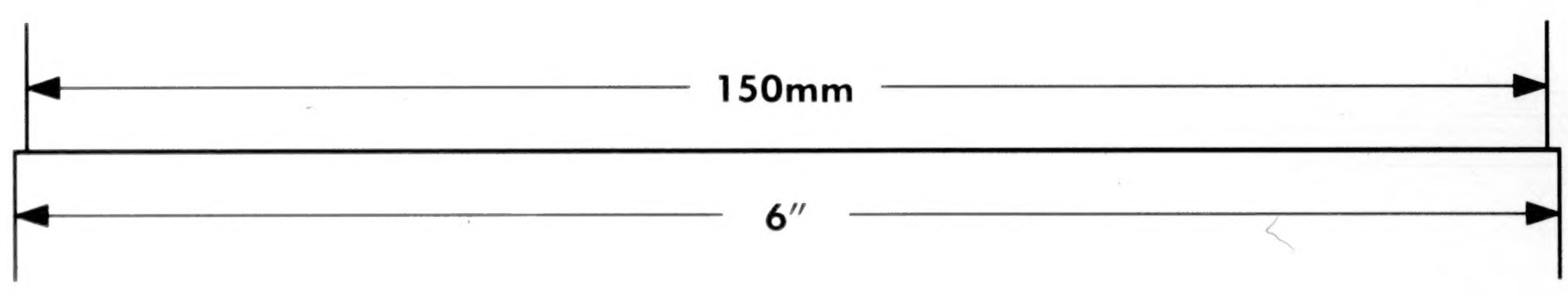
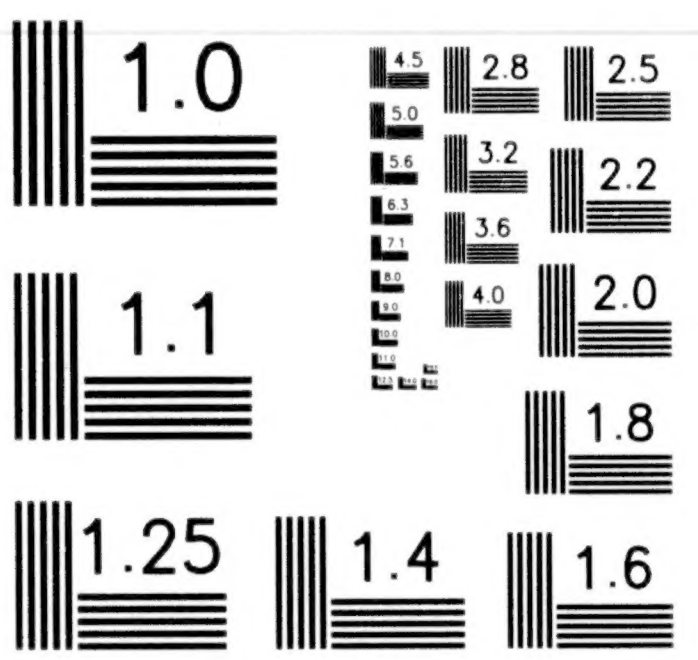
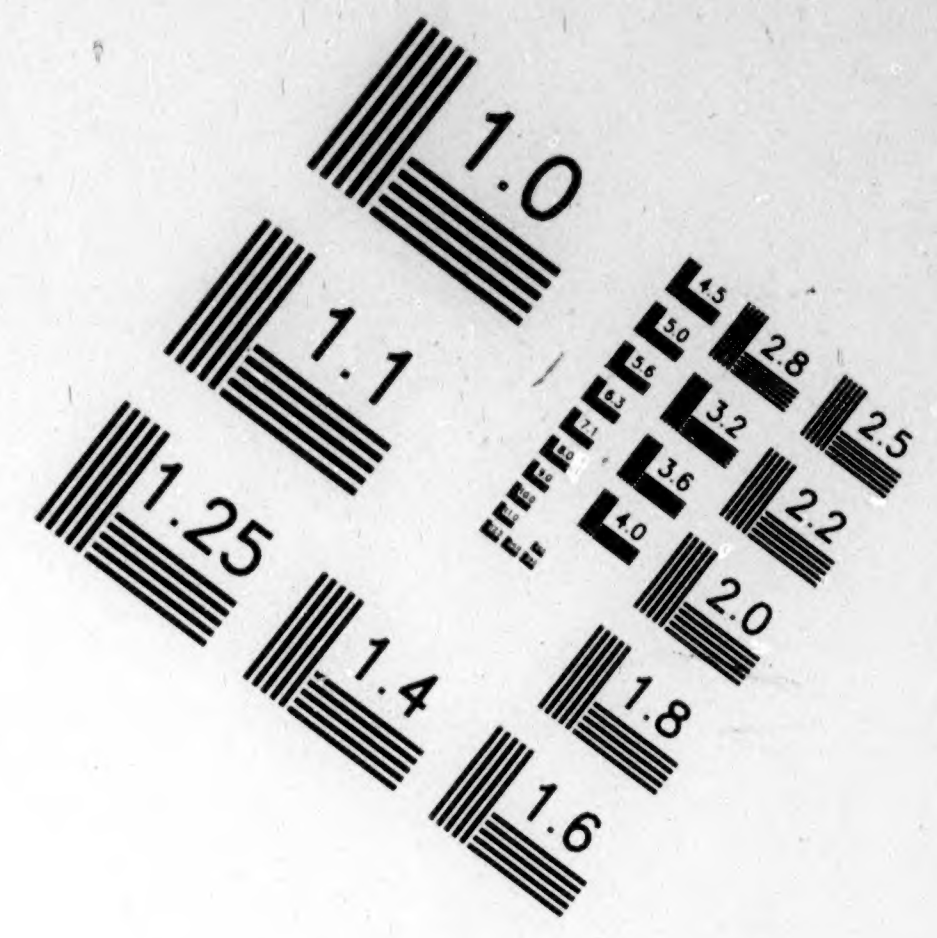
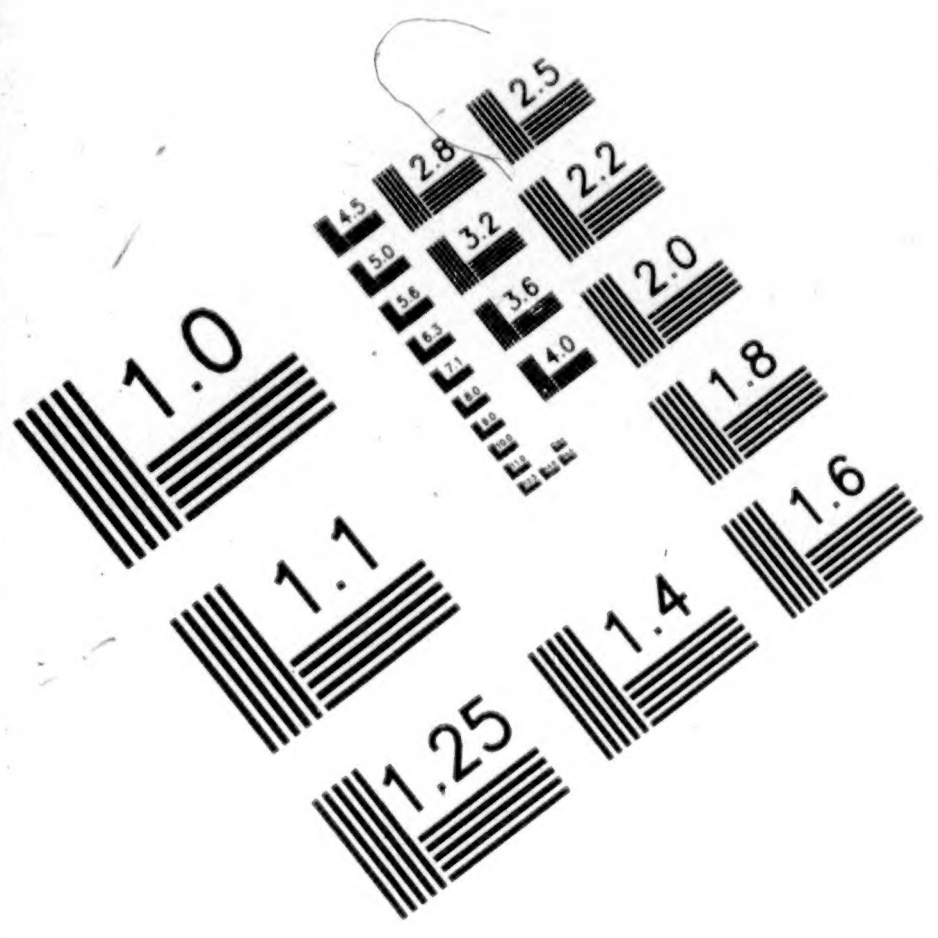

**APPLIED IMAGE, Inc**  
 1653 East Main Street  
 Rochester, NY 14609 USA  
 Phone: 716/482-0300  
 Fax: 716/288-5989

© 1993, Applied Image, Inc., All Rights Reserved









MICROFILMED BY  
THE NATIONAL ARCHIVES  
8601 ADELPHI ROAD  
COLLEGE PARK, MD 20740

OPERATOR

C.F.S.

DATE FILMED

REDUCTION RATIO

10-23-02

10x

FILM EMULSION NUMBER

2461 0651 012 01

PROJECT NUMBER

ROLL NUMBER

M1902

15



**MICROCOPY**

**1902**

**ROLL**

**15**

NATIONAL ARCHIVES AND RECORDS ADMINISTRATION  
M I C R O F I L M P U B L I C A T I O N S

M1902

RECORDS OF THE FIELD OFFICES FOR THE DISTRICT OF  
COLUMBIA, BUREAU OF REFUGEES, FREEDMEN, AND  
ABANDONED LANDS, 1865-1870

United States Congress  
and  
National Archives and Records Administration  
Washington, DC  
2002



NATIONAL ARCHIVES AND RECORDS ADMINISTRATION  
MICROFILM PUBLICATIONS

NATIONAL ARCHIVES AND RECORD ADMINISTRATION  
FREEDMEN'S BUREAU PRESERVATION PROJECT

This National Archives microfilm publication is part of a multiyear project to microfilm the field office records of the Bureau of Refugees, Freedmen, and Abandoned Lands (Freedmen's Bureau). The project was made possible by the United States Congress through The Freedmen's Bureau Records Preservation Act of 2000 (Public Law 106-444). When completed, all of the field records for the States of Alabama, Arkansas, Delaware, Florida, Georgia, Kentucky, Louisiana, Maryland, Mississippi, Missouri, North Carolina, South Carolina, Tennessee, Texas, Virginia, and for the District of Columbia will be available on microfilm. For microfilm availability and description, consult the current edition of the National Archives publication *Microfilm Resources for Research: A Comprehensive Catalog*. You can also view the National Archives microfilm locator on our web site at [www.archives.gov](http://www.archives.gov).

Acknowledgments

Eric Bechtel	Gail Harriman	Loreta Sieh
Tia Brisco	Brenda Kepley	Clarence J. Simmons
Tynetta Dempsey	Michael F. Knight	Rebecca Sullivan
Anne Elam	Denise McAdams	Reginald Washington*
Thomas Ferrell	Douglas McRae	Richard Whittington
Jane Fitzgerald	Kathy Miller	Marlon Wise
Benjamin Guterman**	Stephanie Richmon	

Civil War Conservation Corps (CWCC) Volunteers  
Directed by Budge Weidman and Russ Weidman

\* Reginald Washington wrote the introductory materials.

\*\* Benjamin Guterman edited the introductory materials.



NATIONAL ARCHIVES AND RECORDS ADMINISTRATION  
MICROFILM PUBLICATIONS

### INTRODUCTION

On the 21 rolls of this microfilm publication, M1902, are reproduced the previously unfiled records of the District of Columbia field offices of the Bureau of Refugees, Freedmen, and Abandoned Lands, 1865-1870. Some pre-Bureau records dated 1863 and 1864 are included. These records consist of bound volumes and unbound records, containing materials that include letters and endorsements sent and received, monthly reports, registers of marriages, and employment registers. These records are part of the Records of the Bureau of Refugees, Freedmen, and Abandoned Lands, Record Group (RG) 105, at the National Archives Building in Washington, DC.

This film series completes the reproduction of all Bureau records created in the District of Columbia between 1865 and 1872. Many of these records were reproduced in 1978 and 1980 in National Archives Microfilm Publications M1055, *Records of the Assistant Commissioner for the District of Columbia, Bureau of Refugees, Freedmen, and Abandoned Lands, 1865-1869*, and M1056, *Records of the Superintendent of Education for the District of Columbia, Bureau of Refugees, Freedmen, and Abandoned Lands, 1865-1872*.

### HISTORY AND ORGANIZATION

The Bureau of Refugees, Freedmen, and Abandoned Lands, also known as the Freedmen's Bureau, was established in the War Department by an act of Congress on March 3, 1865 (13 Stat. 507). The life of the Bureau was extended twice by acts of July 16, 1866 (14 Stat. 173), and July 6, 1868 (15 Stat. 83). The Bureau was responsible for the supervision and management of all matters relating to refugees and freedmen, and of lands abandoned or seized during the Civil War. In May 1865, President Andrew Johnson appointed Maj. Gen. Oliver Otis Howard as Commissioner of the Bureau, and Howard served in that position until June 30, 1872, when activities of the Bureau were terminated in accordance with an act of June 10, 1872 (17 Stat. 366). While a major part of the Bureau's early activities involved the supervision of abandoned and confiscated property, its mission was to provide relief and help freedmen become self-sufficient. Bureau officials issued rations and clothing, operated hospitals and refugee camps, and supervised labor contracts. In addition, the Bureau managed apprenticeship disputes and complaints, assisted benevolent societies in the establishment of schools, helped freedmen in legalizing marriages entered into during slavery, and provided transportation to refugees and freedmen who were attempting to reunite with their family or relocate to other parts of the country. The Bureau also helped black soldiers, sailors, and their heirs collect bounty claims, pensions, and back pay.

The act of March 3, 1865, authorized the appointment of Assistant Commissioners to aid the Commissioner in supervising the work of the Bureau in the former Confederate states, the border states, and the District of Columbia. In the District of



NATIONAL ARCHIVES AND RECORDS ADMINISTRATION  
MICROFILM PUBLICATIONS

Columbia, field office operations began in June 1865, when Col. John Eaton, Jr., was appointed Assistant Commissioner with headquarters in the city of Washington. Brig. Gen. J. C. Fullerton succeeded Eaton in December 1865 and served until February 7, 1866. Brig. Gen. Charles H. Howard, brother of Commissioner Howard, then served as the Assistant Commissioner until the position was discontinued in December 1868. Bvt. Maj. David G. Swaim then supervised operations until October 1869, when virtually all Bureau functions, except education, were terminated.

The Assistant Commissioner for the District of Columbia was responsible for Bureau affairs in the District, the Freedmen's Village in Virginia and the farms south of the Potomac, and the Government farms in St. Marys County, Maryland. In September 1865, Alexandria, Fairfax, and Loudon Counties, Virginia, were added to his jurisdiction. In August 1866, Loudon was transferred to the Assistant Commissioner for Virginia, and Alexandria and Fairfax Counties were transferred similarly in March 1867. In the same month, West Virginia was placed under the jurisdiction of the Assistant Commissioner for the District of Columbia. He was also responsible for Bureau affairs in Montgomery, Prince Georges, Anne Arundel, Charles, Calvert, and St. Marys Counties in Maryland. In January 1868, Washington and Allegheny Counties, Maryland, were added, and in August 1868, the remaining counties of Maryland and the State of Delaware were added to his jurisdiction. Although the officers in the neighboring Maryland and Virginia counties reported to the Assistant Commissioner of the District of Columbia, their records are among those of the subordinate officers for Maryland or Virginia.

While the work performed by Assistant Commissioners in each state and the District of Columbia was similar, the organizational structure of staff officers varied from jurisdiction to jurisdiction. In the District of Columbia, the Assistant Commissioner's staff consisted of a superintendent of education, an assistant inspector general (from time to time he served as the assistant adjutant general), an assistant quartermaster and disbursing officer, a superintendent of marriages, and a surgeon in chief. Subordinate to these officers were the assistant superintendents, or subassistant commissioners as they later became known, who commanded the subdistricts. For administrative purposes, agents were assigned to the various counties of Maryland, Virginia, and West Virginia. Within the District of Columbia, a subassistant commissioner was appointed to supervise Bureau activities for the communities of Georgetown and Washington. In 1868 Montgomery and Prince Georges Counties were added to his jurisdiction. A subassistant commissioner was also assigned to Alexandria County in January 1866; he reported to the Assistant Commissioner until responsibility for the supervision of the county was transferred to Virginia authorities. In addition to county agents and subassistant commissioners, local superintendents were appointed to supervise such Government projects as Barry Farm, located south of the Anacostia River, and the Sothron Farm in St. Marys County, Maryland. These farms were purchased with Bureau funds to aid freedmen in buying farmland. Other local superintendents were assigned to administer



NATIONAL ARCHIVES AND RECORDS ADMINISTRATION  
MICROFILM PUBLICATIONS

Freedmen's Village and schools and hospitals. Occasionally, the Bureau retained military officers in a civilian capacity after the termination of their military service. For a list of known District of Columbia subordinate field office personnel and their dates of service, see the Appendix.

The Assistant Commissioner corresponded extensively with both his superior in the Washington Bureau headquarters and his subordinate officers in the subdistricts. Based upon reports submitted to him by the subassistant commissioners and other subordinate staff officers, he prepared reports that he sent to the Commissioner concerning Bureau activities in areas under his jurisdiction. The Assistant Commissioner also received letters from freedmen, local white citizens, state officials, and other non-Bureau personnel. These letters varied in nature from complaints to applications for jobs in the Bureau. Because the assistant adjutant general handled much of the mail for the Assistant Commissioner's office, it was often addressed to him instead of to the Assistant Commissioner.

In a circular issued by Commissioner Howard in July 1865, the Assistant Commissioners were instructed to designate one officer in each state to serve as "general Superintendents of Schools." These officials were to "take cognizance of all that is being done to educate refugees and freedmen, secure proper protection to schools and teachers, promote method and efficiency, correspond with the benevolent agencies which are supplying his field, and aid the Assistant Commissioner in making his required reports." In October 1865, a degree of centralized control was established over Bureau educational activities in the states when Rev. John W. Alvord was appointed Inspector of Finances and Schools. In January 1867, Alvord was divested of his financial responsibilities, and he was appointed General Superintendent of Education. In August 1865, Rev. John Kimball was appointed superintendent of education for the District of Columbia and served until replaced by Maj. D. G. Swaim in October 1869. Maj. W. L. VanDerlip succeeded Swaim in December 1869 and remained in the position until August 1870, when educational activities in the District of Columbia were discontinued.

Because the jurisdiction of the superintendent of education for the District of Columbia included areas other than the District itself, his records include reports and correspondence relating to schools in Maryland, West Virginia, Delaware, and parts of Virginia.

An act of Congress, approved July 25, 1868 (15 Stat. 193), ordered that the Commissioner of the Bureau "shall, on the first day of January next, cause the said bureau to be withdrawn from the several States within which said bureau has acted and its operation shall be discontinued." Consequently, in early 1869, with the exception of the superintendents of education and the claims agents, the Assistant Commissioners and their subordinate officers were withdrawn from the states and the District of Columbia.



NATIONAL ARCHIVES AND RECORDS ADMINISTRATION  
MICROFILM PUBLICATIONS

For the next year and a half the Bureau continued to pursue its education work and to process claims. In the summer of 1870, the superintendents of education were withdrawn from the states, and the headquarters staff was greatly reduced. From that time until the Bureau was abolished by an act of Congress approved June 10, 1872 (17 Stat. 366), effective June 30, 1872, the Bureau's functions related almost exclusively to the disposition of claims. The Bureau's records and remaining functions were then transferred to the Freedmen's Branch in the office of the Adjutant General. The records of this branch are among the Bureau's files.

Constrained by limited resources, Southern opposition, and the politics of Reconstruction, the Bureau faced an enormous challenge in its efforts to assist the freedmen and refugees. Its relief efforts, without question, saved thousands of southerners from starvation. Its attempts to assist freedmen to become self-sufficient, to provide public education, administer justice, and, to a lesser degree, to provide land, all worked with varying degrees of success to lessen the difficulties during the transition from slavery to freedom. One of the Bureau's greatest legacies is the body of records it created and received during the course of its operations. These records are arguably some of the most important documents available for the study of the Federal Government's policies, efforts to reconstruct the South, and Southern social history and genealogy.

**THE FREEDMEN'S BUREAU IN THE DISTRICT OF COLUMBIA**

The major activities of the Freedmen's Bureau field office in the District of Columbia generally resembled those conducted in other states. The Bureau provided relief from poverty and destitution, provided transportation and employment for needy freedmen, worked with benevolent societies in the establishment of schools, provided assistance in legalizing slave marriages and various legal matters, and worked with black soldiers and sailors in obtaining back pay, bounty payments, and pensions.

To relieve problems of destitution and poverty and to aid the aged, orphans, and infirm in the District of Columbia and Virginia, the Bureau offered various forms of assistance. The Bureau established an asylum at the Freedmen's Village in Arlington, Virginia, for destitute men, women, and children. It was located across the Potomac River from Washington, DC, on the estate formerly owned by Robert E. Lee. It originated with the War Department in 1863 as a "model community" for the freedmen in the Washington area and was continued by the Freedmen's Bureau for destitute freedmen. Also, under the auspices of a women's campaign, "National Appreciation of the relief of destitute colored women and children," the Bureau constructed a building for the Colored Orphans Home of Washington, DC. In addition, the Brooklyn Home for Children of Freedmen, under the direction of the African Civilization Society, received aid from the Bureau to allow temporary relief for freedwomen to look for employment. When "The Farm School for colored boys"



NATIONAL ARCHIVES AND RECORDS ADMINISTRATION  
MICROFILM PUBLICATIONS

in the District of Columbia ceased its operations on June 14, 1867, the Bureau provided homes for inmates, and assisted others who returned to their parents.<sup>1</sup>

As a part of its ongoing relief efforts, the Bureau also issued rations to both the Freedmen's Hospital in the District of Columbia and Abbott Hospital at Freedmen's Village. Up to a 3-day supply of rations was given to freedmen who sought employment outside the city, and rations were given to those destitute refugees and freedmen who weren't considered permanent residents of Washington. In 1866 Congress authorized a special relief appropriation of \$25,000 for the poor in the District of Columbia, and an additional expenditure of \$15,000 in 1867. A Special Relief Commission headed by Robert Reyburn, surgeon in chief of the District of Columbia, was established by Assistant Commissioner Howard to administer the appropriations. The Commission provided food, clothing, and other essentials to both blacks and whites in the city. The Commission maintained registers of applicants who applied for relief and forwarded weekly reports of its operations to the Assistant Commissioner. The Assistant Commissioner also received additional reports relating to rations, clothing, and medicine issued by other Bureau officials.<sup>2</sup>

One of the major challenges facing Freedmen's Bureau officials in the Washington, DC, field office was to reduce the number of freedmen in the city who depended on the Bureau for assistance. When the Civil War began, thousands of freedmen flocked to the capital city from the surrounding areas of Maryland and Virginia. After Congress abolished slavery in the District of Columbia in 1862, thousands more migrated to the city, causing overcrowding, destitution, and significant increases in unemployment. A census taken by the Bureau in the winter and spring of 1866 revealed a black population of more than 31,000 in Washington and Georgetown, many of whom were unable to find work. To relieve the Government of the burden of providing support for these individuals and to encourage independence, Assistant Commissioner Charles Howard solicited the help of Northern aid societies in Philadelphia, PA; Boston, MA; New York; and Providence, RI. Howard believed that if large numbers of freedmen in the District of Columbia could secure employment in other parts of country, conditions would improve for those who remained. To carry out his plan, Howard established employment offices in both the District of Columbia and Northern cities and provided rations and free transportation for interested freedmen to prospective employers. Employment offices (a.k.a., "intelligence offices") were established in various parts of the capital, and the

---

<sup>1</sup> These Bureau relief projects are explained in Annual Reports of the Assistant Commissioners, District of Columbia, October 10, 1867, [pp. 27-30], Records of the Commissioner, Records of the Bureau of Refugees, Freedmen, and Abandoned Lands, Record Group (RG) 105, National Archives Building (NAB).

<sup>2</sup> Ibid., [pp. 30-31]. See also Register of Ration Requests and Weekly Reports of Operations of the Special Relief Commission, *Records of the Assistant Commissioner for the District of Columbia, Bureau of Refugees, Freedmen, and Abandoned Lands, 1865-1869* (National Archives Microfilm Publication M1055, roll 16).



NATIONAL ARCHIVES AND RECORDS ADMINISTRATION  
MICROFILM PUBLICATIONS

Bureau hired several employment agents and paid the rent of employment offices in New Jersey; Providence, RI; Hartford, CT; and Boston, MA. In many instances, employment agents traveled with freedmen to the North and took them to the employment office or the employer. Officials in charge of employment offices in Washington; Alexandria, VA; and northern employment offices forwarded trimonthly and monthly reports of their operations to the Assistant Commissioner. The Assistant Commissioner also received reports from local agents regarding destitute freedmen.<sup>3</sup>

By October 1867, the Bureau had provided resettlement transportation for more than 9,000 freedmen from the District of Columbia. Many others received help finding homes in Maryland and Virginia, to where transportation was not required. However, in spite of the Bureau's claims of reducing the dependency of the black population in the District of Columbia, poverty and unemployment remained an issue. In a circular issued October 5, 1867 (Circular Number 6), Howard, probably realizing the shortcomings of the employment program, limited transportation to orphans and women with small children, thus gradually closing employment offices in and around the city.<sup>4</sup>

To further deal with the continued problem of poverty and unemployment, and to remove freedmen from some of the most deplorable living conditions in the District of Columbia and Alexandria, Virginia, the Bureau set aside certain buildings under its control as tenements. Several barracks in and around Washington were provided for some 350 families, and in Alexandria accommodations were made for more than 100 families. Families were charged a moderate rent, amounting to nearly a third of what they had paid to their former landlords for filthy shanties and huts. For those who could not find work at an adequate wage to support their families, Assistant Commissioner Howard ordered Bvt. Col. S. P. Lee, superintendent of Alexandria, Fairfax, and Loudon Counties, to rent some 550 acres of land at Camp Distribution (near Alexandria) for tenements. Land was sub-rented to heads of families in lots from 5 to 40 acres, at a cost to the Government of \$800 per year. Small lots were also rented to freedmen in Arlington and St. Marys County, Maryland.

Superintendents of the barracks forwarded monthly reports of occupying tenants to the Assistant Commissioner. The reports provided the name and occupation of the head of the family, the number in the family, the number of rooms occupied, the rate of rent per month, the amount(s) of rent paid, and the amount of rent in arrears.<sup>5</sup>

---

<sup>3</sup> Senate Ex. Doc. No. 6, 39th Cong., 2nd Sess., Serial vol. 1276, p. 39; Annual Reports of the Assistant Commissioners, District of Columbia, October 10, 1867, [pp. 23-26]; William H. Williams, *The Negro in the District of Columbia during Reconstruction*, Howard University Studies in History, No. 5 (Washington, DC: 1924), pp. 33-37.

<sup>4</sup> Annual Reports of the Assistant Commissioners, District of Columbia, October 10, 1867, [pp. 25-26].

<sup>5</sup> Senate Ex. Doc. No. 6, 39th Cong., 2nd Sess., Serial vol. 1276, pp. 36, 37. See also Monthly Reports of Bureau Tenants, M1055, rolls 20 and 21.



NATIONAL ARCHIVES AND RECORDS ADMINISTRATION  
MICROFILM PUBLICATIONS

In an effort to assist freedmen in securing land, the Bureau provided funds for the purchase of 375 acres of property south of the Anacostia River known as the "Barry Farm." Portions of the land were sold to freedmen in 1-acre lots. Freedmen were required to make monthly payments for 2 years before they received full ownership of the property. The Bureau cleared the roads leading to the lots and provided lumber and assistance in the construction of houses. By the fall of 1867, the Bureau reported that at least 180 lots had been sold and some 90 houses were either complete or under construction. With the help of the Bureau, freedmen at the "Barry Farm" project built a school on one of the lots.<sup>6</sup>

The educational efforts of the District of Columbia field office were similar to Bureau operations in other states. The Bureau, by and large, assisted with construction, rental, and repair of school buildings, while benevolent societies provided teachers and paid their salaries. The Bureau also provided free transportation for teachers and assisted them in getting government rations at cost. The superintendent of education, Rev. John Kimball, forwarded monthly school reports to Bureau headquarters and received monthly school reports from subordinate officers and from superintendents of schools sponsored by benevolent societies. In the District of Columbia, the Bureau worked closely with the board of trustees appointed by an act of Congress on May 21, 1862 (12 Stat. 407), to "aid in the support of the colored race." The Trustees provided lots upon which the Bureau erected several school buildings. In 1866 the Assistant Commissioner reported that in his district there were more than 70 schools and over 6,000 students being taught by 132 teachers. There were 15 night schools and 20 Sabbath schools with slightly more than 3,000 students. There were 45 day schools (including industrial schools) conducted in buildings provided and furnished by the Bureau.<sup>7</sup>

The educational efforts of the Bureau's field office in its Maryland areas of jurisdiction were hampered by a system of illegal apprenticeship of school-age children. In direct conflict with the Civil Rights Act of 1866 (14 Stat. 27), black children were being bound to their former owners for indefinite periods of time with the help of Maryland government officials. An estimated 10,000 black children were bound out as apprentices between 1864 and 1867. The Bureau, however, through writs of *habeas corpus* and other court actions, fought vigorously to have these children released. By 1868, the intense efforts of the Bureau had largely ended the

---

<sup>6</sup> Annual Reports of the Assistant Commissioners, District of Columbia, October 10, 1867, [pp. 19-21].

<sup>7</sup> Monthly Reports of the superintendent of education, superintendents of aid society-sponsored schools, and subassistant commissioners or agents in Maryland and West Virginia, *Records of the Superintendent of Education for the District of Columbia, Bureau of Refugees, Freedmen, and Abandoned Lands, 1865-1872* (National Archives Microfilm Publication M1056, rolls 12 and 13), RG 105; Senate Ex. Doc. No. 6, 39th Cong., 2nd Sess., Serial vol. 1276, p. 38. See also William H. Williams, *The Negro in the District of Columbia during Reconstruction*, especially pp. 25-30.



NATIONAL ARCHIVES AND RECORDS ADMINISTRATION  
MICROFILM PUBLICATIONS

apprenticeship system in Maryland.<sup>8</sup>

Although the illegal apprenticeship system hindered the Bureau's educational activities in Maryland, the agency still managed to provide assistance with the construction and repair of school buildings and protection of and transportation for teachers. To increase the Bureau's visibility and to gauge the interest of freedmen in the establishment of schools, Superintendent Kimball traveled to various counties in Maryland, holding meetings on the benefits of education and the Bureau's intention to provide aid for schools. In addition, the Bureau worked hand in hand with private benevolent societies, such as the Baltimore Association, the American Missionary Association, and the Freedmen's Union Association, to sustain freedmen schools during a period when white opposition to black schools in Maryland was intense and support for such schools was nonexistent. From October 1867 to October 1868, the Bureau provided aid and assistance to 80 schools in Maryland.<sup>9</sup>

West Virginia maintained a system of free education, but whites controlled funds for schools and the employment of teachers, and schools for blacks and whites were required by law to be separate. Bureau officials worked closely with the West Virginia superintendent of free schools in the establishment of schools for freedmen. As in Maryland, Bureau officials traveled throughout West Virginia counties, advising freedmen of its support and plans for building freedmen schools. Similar to other areas under its jurisdiction, the Bureau supplied funds for buildings, and teachers were generally paid from public funds, contributions from blacks, and aid from benevolent societies. By 1868, with cooperation mostly from freedmen themselves, the Bureau was able to establish 9 schools in West Virginia. Although there were no laws in Delaware by October 1868 for the support of black schools, the Delaware Association, with assistance from Northern societies, sustained some 23 schools in various parts of the state. The Freedmen's Bureau provided assistance in the construction of 12 of the school buildings.<sup>10</sup>

Safeguarding rights and securing justice for freedmen was of paramount concern to the Freedmen's Bureau. Following the Civil War, several Southern states enacted a series of laws commonly known as "black codes," which restricted the rights and legal status of freedmen. Freedmen were often given harsh sentences for petty crimes and in some instances were unable to get their cases heard in state courts. In a circular issued by Commissioner Oliver Otis Howard on May 30, 1865, Assistant

---

<sup>8</sup> Annual Reports of the Assistant Commissioners, District of Columbia, October 10, 1867, [pp. 3-9]; W. A. Low, "The Freedmen's Bureau in the Border States," in *Radicalism, Racism, and Party Realignment: The Border States during Reconstruction*, ed. Richard O. Curry, (Baltimore: John Hopkins Press, 1969), p. 247.

<sup>9</sup> W. A. Low, "The Freedmen's Bureau in the Border States," pp. 247-49. Annual Reports of the Assistant Commissioners, District of Columbia, October 10, 1868, [pp. 11-13, 15-24].

<sup>10</sup> Annual Reports of the Assistant Commissioners, District of Columbia, October 10, 1868, [pp. 26-30]. See also W. A. Low, "The Freedmen's Bureau in the Border States," p. 257.



NATIONAL ARCHIVES AND RECORDS ADMINISTRATION  
MICROFILM PUBLICATIONS

Commissioners were authorized, in places where civil law had been interrupted and blacks' rights to justice were being denied, to adjudicate cases between blacks themselves and between blacks and whites. In the District of Columbia and Maryland, the civil process of law had not been interrupted, and unlike many areas of the South under the Bureau's jurisdiction, no freedmen's or provost courts were in operation. The Bureau did however, provide legal assistance to freedmen in civil and criminal cases in the both the District of Columbia and Maryland. This was done especially in instances where freedmen lacked counsel and in cases where Bureau officials felt that freedmen were wrongly convicted or imprisoned. Court cases involving freedmen in Alexandria, VA, were handled by provost courts until June 10, 1866, when the Virginia legislature abolished laws that did not allow blacks to sue or be a party to a suit, or testify in cases in which they were involved. In 1868, the Assistant Commissioner reported that nearly 900 cases had been attended to by the Bureau. A large percentage of the cases involved incidents in Maryland.<sup>11</sup>

The Freedmen Bureau's field office in the District of Columbia made a special effort to assist freed men and women in legalizing marriages that they had entered into during their enslavement. Continuing a practice that had been started by Northern missionaries and Army clergy, Rev. John Kimball, who served as the superintendent of marriages for the District of Columbia, advised freedmen of the act of Congress of July 25, 1866 (14 Stat. 236), relating to slave marriages. The act stipulated that all persons who recognized each other as man and wife prior to the act were now legally married. Superintendent Kimball and his assistants issued marriage licenses and certificates and forwarded them along with marriage reports to the Office of the Commissioner. During the year, Kimball issued more than 1,000 marriage certificates. Nearly half of the couples who received certificates had lived in slavery without any form of marriage ceremony. Kimball also registered couples and forwarded ministers' reports of marriages that were retained by the Assistant Commissioner. In addition to the reports received from Kimball, the Assistant Commissioner also received reports from other officers regarding laws relating to marriage in the District of Columbia, Maryland, and Virginia. A March 22, 1867, act of the Maryland General Assembly validated freedmen marriages in Maryland. In Virginia, two February 27, 1866, acts of the Virginia General Assembly made provisions for issuing marriage licenses and the registration and legalization of marriage relations entered into by former slave couples.<sup>12</sup>

---

<sup>11</sup> Senate Ex. Doc. No. 6, 39th Cong., 2nd Sess., Serial vol. 1276, p. 34; Annual Reports, Assistant Commissioner for the District of Columbia, October 10, 1867, [p. 3], and October 10, 1868, [pp. 5-11].

<sup>12</sup> Annual Reports of the Assistant Commissioners, District of Columbia, October 10, 1867, [pp. 11-13]; *Marriage Records of the Office of the Commissioner, Washington Headquarters of the Bureau of Refugees, Freedmen, and Abandoned Lands, 1861-1869* (National Archives Microfilm Publication M1875, roll 1), RG 105. See also Miscellaneous Reports and Lists, M1055, roll 21.



NATIONAL ARCHIVES AND RECORDS ADMINISTRATION  
MICROFILM PUBLICATIONS

In addition to assisting freedmen in solemnizing slave marriages, the Bureau helped discharged soldiers and their heirs in claims for back pay, bounty payments, and pensions. In accordance with a law passed by Congress on March 29, 1867 (15 Stat. 26), making the Freedmen's Bureau the sole agent for payment of claims of black veterans, Bureau disbursing officers assisted veterans in the preparation and settlement of claims. While many of the subdistricts under the jurisdiction of the District of Columbia field office were involved in veterans claims, most of the activities of the Bureau were centered in Baltimore, MD, where two full-time disbursing officers were assigned to settle and pay veterans claims. In 1868 Bureau agents disbursed more than \$100,000 for military claims.<sup>13</sup>

**RECORDS DESCRIPTION**

The records reproduced in this microfilm publication consist of volumes and inbound records. The volumes were originally arranged by type of record and thereunder by volume number. No numbers were assigned to series consisting of single volumes. Years later, all volumes were arbitrarily assigned numbers by the Adjutant General's Office (AGO) of the War Department after the records came into its custody. In this microfilm publication, AGO numbers are shown in parentheses to aid in identifying the volumes. The National Archives assigned the volume numbers that do not appear in parentheses. In some volumes, particularly in indexes and alphabetical headings of registers, there are a number of blank numbered pages that have not been filmed.

The volumes consist of letters and endorsements sent and received, press copies of letters sent, registers of letters received, letters and orders received, employment registers, registers of contraband camps, marriage records, special orders and circulars issued, and monthly reports forwarded to the Assistant Commissioner. The unbound documents consist of letters and orders received, unregistered letters received, special orders and circulars received, labor contracts, monthly reports, transportation orders, employment rosters, and ministers' reports relating to marriages.

**LIST OF BOOK RECORDS**

The single-volume list of book records of officers in the District of Columbia (no date) is arranged by office, with records of the Assistant Commissioner first. Included in the list of book records are the type of record in each book or volume, the dates of the volume, and the volume number. Throughout this introductory material and in the Table of Contents, the volume number appears in parentheses in the series descriptions of the records.

---

<sup>13</sup> Annual Reports of the Assistant Commissioners, District of Columbia, October 10, 1867, [pp. 10-11], and October 10, 1868, [pp. 13-15].



NATIONAL ARCHIVES AND RECORDS ADMINISTRATION  
MICROFILM PUBLICATIONS

**OFFICES OF STAFF OFFICERS**

**Assistant Inspector General**

The single-volume name index (53½) to the single-volume of letters sent (53), mentioned below, is undated. The numbers in the index refer to the number of the letter.

The single-volume of letters sent, March 1866–September 1868 (53), is arranged and numbered in chronological order, although there are sections of the volume in which the communications were not copied in chronological order. Some of the communications in this volume are also copied in the five volumes of letters sent by the Assistant Commissioner that have been reproduced on Rolls 1 and 2 of Microfilm Publication M1055.

The single-volume name and subject index (52½) to the register of letters received and endorsements sent (52), mentioned below, is undated. The numbers in the index refer to the number of the letter.

The single-volume register of letters received and endorsements sent, March 1866–December 1868 (52), is arranged alphabetically by initial letter of the surname of the correspondent and thereunder arranged in chronological order and numbered.

Unbound letters received, April 1866–August 1868, are arranged according to their entry in the single-volume register of letters received.

Unbound unregistered letters received, March 1866–August 1868, are arranged chronologically.

Unbound inventory and inspection reports of quartermaster stores and medical property, November 1866–October 1868, are arranged chronologically. The reports were submitted on a printed form on which the reporting officer listed the articles; from whom they were received; condition of the articles; and whether the articles should be dropped from returns, repaired, or destroyed.

**Assistant Quartermaster and Disbursing Officer**

The two volumes of registers of letters sent, June 1865–August 1869, 1 (58) and 2 (59), are arranged by time period. The entries are arranged alphabetically by initial letter of surname of addressee, thereunder by press book (five volumes of press copies of letters sent mentioned below), and thereunder chronologically.

The five volumes of press copies of letters sent, 1 (60), 2 (61), 3 (62), 4 (63), and 5 (64), cover the period June 1864–August 1869. Volume 1 (60) is dated June 1864–December 1866; Volume 2 (61), May 1866–October 1867; Volume 3 (62), May 1866–April 1868; Volume 4 (63), January–July 1867; and Volume 5 (64), April 1868–August 1869. There are name indexes for volumes 1 (60), 2 (61), and 3 (62).



NATIONAL ARCHIVES AND RECORDS ADMINISTRATION  
MICROFILM PUBLICATIONS

For a register of these letters, see the two volumes of registers of letters sent mentioned above. Some of the letters in Volume 1 (60) were signed by E. A. Holman, superintendent of Government Farms South of the Potomac and by John A. Elison, chief quartermaster for the Department of Washington.

The four volumes of press copies of letters sent, requisitions, and receipts, September 1864–August 1869, 1 (66), 2 (67), 3 (68), and 4 (69), are arranged chronologically, and there are name indexes for volumes 1 (66) and 2 (67). This series is composed mainly of receipts and requisitions and letters relating to supplies.

The two volumes of registers of letters received, June 1865–August 1869, 1 (55) and 2 (56), are arranged by time period. The entries are arranged alphabetically by initial letter of the surname or office of correspondent and thereunder chronologically. The actual letters received are mentioned below.

Unbound letters received, May 1865–August 1869, are in two numerical sequences. Although these letters are entered in the two volumes of registers of letters received, 1 (55) and 2 (56), it appears as if the letters were first arranged and numbered in chronological order, and then the entry number of the letter was written next to the entry in the register.

Unbound unregistered letters received, September 1866–August 1869, are arranged chronologically.

The single volume of letters received, August 1865–August 1866 (57), is arranged in four subseries and thereunder chronologically. The subseries include letters from the Third Auditor, the Quartermaster, Commissioner O. O. Howard, and from "miscellaneous" sources. The "miscellaneous" include letters from depot quartermasters, private individuals, and other War Department offices.

Unbound contracts for labor and services, March 1865–June 1869, are arranged chronologically. Most of the contracts are for the repair and construction of buildings.

Unbound transportation orders received from Bureau headquarters, June 1867–March 1869, are arranged chronologically. The orders give the name and destination of the person or article.

The single-volume register of disbursements, September 1865–December 1868 (73), is arranged chronologically. The register gives the name of the person to whom the disbursement was made, the date, the voucher number, and the amount and nature of the account.



NATIONAL ARCHIVES AND RECORDS ADMINISTRATION  
MICROFILM PUBLICATIONS

**Superintendent of Marriages**

The single-volume register of marriages, November 1866–July 1867 (30), is arranged by month and thereunder by name of minister issuing the certificate. The register gives the date the certificate was issued, the name of the minister who issued the certificate, the names of the couple, former residences, the date of their marriage, who performed the ceremony, the number of children from previous marriages, and remarks of the minister.

Unbound ministers reports of marriage certificates issued to freedmen, November 1866–January 1867, are arranged chronologically. In their reports, the ministers usually listed the couples who were issued certificates. Included in this series are copies of Superintendent Kimball's reports to the Assistant Commissioner. The last item is a marriage license dated October 1869.

**Surgeon in Chief**

The single volume of letters sent, February 1867–September 1870 (no number), is arranged alphabetically by initial letter of surname of addressee and thereunder chronologically. There are only a few letters dated 1870.

The single volume of endorsements sent and received, February 1867–March 1870 (no number), is arranged chronologically.

The single-volume register of letters received, February 1867–May 1870 (no number), is arranged alphabetically by initial letter of the surname of correspondent and thereunder arranged and numbered in chronological order. The letters in this series have not been located. Most appear to have been forwarded to other officers, and the volume contains many cross-references to endorsements in the single volume of endorsements sent and received mentioned above.

**SUBORDINATE FIELD OFFICES**

**Local Superintendent for Washington and Georgetown**  
*Correspondence*

The single-volume name index (78½) is an index to the two volumes of letters sent, July 1865–September 1868, 1 (77) and 2 (78), mentioned below. The numbers in the index volume refer to the page numbers in the volumes of letters sent.

The two volumes of letters sent, July 1865–September 1868, 1 (77) and 2 (78), are arranged chronologically. See name index above.

The two volumes of endorsements sent and received, July 1865–September 1868, 1 (80) and 2 (81), are arranged chronologically.



NATIONAL ARCHIVES AND RECORDS ADMINISTRATION  
MICROFILM PUBLICATIONS

The single-volume name index is an index to only Volume 3 (76) of the three volumes of registers of letters received that cover the period July 1865–September 1868, mentioned below. The numbers in the volume refer to page numbers.

The three volumes of registers of letters received, July–August 1865 and October 1866–September 1868, 1 (74), 2 (75), and 3 (76), are arranged by time period. The actual letters received are described below. The entries in the volumes are arranged chronologically and numbered in three sequences: July–August 1865; October 1866–April 1868, volumes 1 (74) and 2 (75); and April–September 1868, volume 3 (76).

Unbound letters received, October 1866–August 1868, are arranged according to their entry in the registers of letters received mentioned above. Letters received July–Aug. 1865 and registered in volume 1 (74) appear to be missing from these unbound letters received. The September letters, entered in register volume 3 (76), are also missing.

Unbound unregistered letters received, August 1865 and February 1866–October 1868, are arranged chronologically.

*Reports*

The two volumes of reports forwarded to the Assistant Commissioner, July 1865–October 1868, 1 (95) and 2 (97), are arranged chronologically. Volume 1 (95) consists of reports of tenements occupied by freedmen, reports of funds, rosters of employees of the local superintendent, as well as reports of employment offices. Volume 1 (95) also contains a register of employees, July 1865–June 1867 (pages 266–69), and a register of accounts, December 1866–June 1867 (page 336). Volume 2 (97) consists of reports of the business of the employment office. It also contains circulars issued by the local superintendent, December 1866–August 1867; a list of employees under the direction of the local superintendent who are entitled to rations, June–October 1868; and miscellaneous receipts and memorandums, February–June 1868.

Unbound monthly rosters, reports of persons and articles hired, and time reports, June 1866–August 1868, are arranged chronologically.

Unbound monthly reports from superintendents of industrial schools of materials and clothing received, expended, and on hand, April 1867–April 1868, are arranged chronologically.

*Records Relating to Employment of Freedmen*

Unbound letters received by employment agents, January 1866–November 1867, arranged by agent and thereunder chronologically. These letters were received by the following agents: J. L. Roberts, Miss W. F. Harris, O.S.B. Wall, and D. R. Disbrow.



NATIONAL ARCHIVES AND RECORDS ADMINISTRATION  
MICROFILM PUBLICATIONS

The single-volume "employment" register, July 1867–October 1868 (88), is arranged chronologically. The register gives the names and addresses of applicants for servants, the kind of help desired, and the wages offered. The register usually gives the names, ages, and addresses of servants sent to the applicant. The volume also contains names of men sent to work on an arsenal and to work for General Michler repairing the streets.

The two volumes of "employment" registers from the Wisewell Barracks cover the period August 1866–August 1868 1 (91) and 2 (96). Volume 1 (91) is a register of employers provided servants, and Volume 2 (96) is a register of servants. Both are arranged chronologically. In addition to giving the name of the employer, Volume 1 (91) gives the address of the employer, the number and class of servants sent, and the pay per month. Volume 2 (96) gives the names and ages of servants.

The two volumes of "employment" registers from East Capitol Street Barracks cover the period December 1866–February 1868, 1 (90) and 2 (94). Volume 1 (90) is a register of employers, and Volume 2 (94) is a register of servants. Both volumes are arranged chronologically. Volume 1 (90) gives the name and address of employer, the number and class of servants sent, and the rate of pay per month. Volume 2 (94) gives the name and age of the servant.

Unbound labor contracts, August 1865–March 1867, are arranged numerically, with unnumbered contracts at the end of the series. Contracts between freedmen and employers were witnessed by the local superintendent. Most are printed forms, and they usually indicate the period of service, the rate of wages, and the type of work to be performed.

Unbound monthly rosters from employment agents and superintendents of barracks, November 1866–August 1868, are arranged chronologically.

The single volume of cash accounts of the employment office, July 1865–February 1867 (93), is arranged chronologically. The volume appears to be the accounts of the employment office operated by the local superintendent J.V.W. Vandenburg.

*Other Records*

Unbound consolidated weekly reports of sick and wounded freedmen, February 1867–July 1868, are arranged chronologically. The reports are printed forms on which the surgeons showed the number of men, women, and children under their care; the number at the last weekly report; the number admitted since last report; the number discharged, transferred, or died; and the number of medical attendants on duty.

The single-volume register of freedmen departing from Mason's Island, VA, May 1864–July 1865 (92) is arranged chronologically. The register gives the names, sex, and ages of freedmen and the places where they were sent. The volume also contains



NATIONAL ARCHIVES AND RECORDS ADMINISTRATION  
MICROFILM PUBLICATIONS

a register of applicants for employment dated June 1865, which was probably compiled by an employment agent in the District of Columbia. For other records relating to Mason's Island, see the single volume of accounts of materials used in industrial schools and miscellaneous lists (98) mentioned below.

The single-volume register of patients in the female ward of Lincoln Hospital, July 1866–March 1867 (no number), is arranged chronologically. Another list or register of patients, July–October 1866, appears at the end of the book. The register gives the name, age, and type of illness of the patient, and the dates of admission and discharge from the hospital.

Unbound agents' and superintendents' monthly lists of articles received, expended, or on hand, March 1867–August 1868, are arranged chronologically.

The single volume of accounts of materials used in industrial schools and miscellaneous lists, 1863–68 (98), is arranged by type of record. The volume includes the following: lists of contrabands and articles debted or credited, June 1863; list of articles received by D. B. Nichols, superintendent of contrabands for the Department of Washington, June–April 1863; register of deaths at Mason's Island, VA, February–June 1865; register of freedmen seeking employment, August 1866–August 1867; and accounts of materials used in industrial schools, February–March 1868.

The single volume of accounts, August 1865–July 1867 (82), is arranged chronologically. For a register of accounts for December 1866–July 1867, see volume 2 (95) of reports forwarded to the Assistant Commissioner mentioned above.

The single volume of miscellaneous records of the East Capitol Street Barracks, 1866–68 (79), is arranged by type of record. The volume includes a register of payments received from tenants of the East Capitol Street Barracks, May 1866–August 1867; letters and circulars received and a few copies of letters sent, November 1866–January 1868; and miscellaneous contracts, 1866–67.

The single-volume name index to tenement book is not dated (38). The volume that this book indexes has not been found.

**Subassistant Commissioner (Subdistrict 1)**

*This subdistrict consisted of Washington and Georgetown, and in 1868 it also included the surrounding Maryland counties of Montgomery and Prince Georges.*

The single volume of letters sent, October 1867–June 1868 (86), is arranged chronologically.

The single volume of endorsements sent, October 1867–September 1868 (87), is arranged chronologically.



NATIONAL ARCHIVES AND RECORDS ADMINISTRATION  
MICROFILM PUBLICATIONS

The single-volume register of letters received, October 1867–September 1868 (85), is arranged alphabetically by initial letter of the surname of the correspondent and thereunder arranged in chronological order and numbered.

Unbound letters received, October 1867, consists of four letters.

**Barry Farm**

*The Barry Farm project was an attempt by the Bureau to enable freedmen to purchase land. The farm was located south of the Anacostia River and was purchased by trustees from funds supplied by the Bureau. The trustees were to sell the land in 1-acre lots to freedmen, who were to pay for it within 2 years.*

The single volume of press copies of letters sent and received by the superintendent of Barry Farm, September 1867–March 1869 (100), is arranged chronologically and has a name index.

**Freedmen's Village**

*Freedmen's Village was located across the Potomac River from Washington, DC, on the estate formerly owned by Robert E. Lee. It originated in 1863 as a "model community" for the freedmen in the Washington area and was continued by the Bureau of Refugees, Freedmen, and Abandoned Lands largely as a place for destitute freedmen.*

The single volume of letters sent by the superintendent, July 1867–November 1868 (111), is arranged chronologically. Most of the letters are addressed to the Assistant Commissioner and his staff, and they relate to the general operations of the Freedmen's Village. The volume was originally listed as a Virginia record.

Unbound letters received, December 1864–December 1868, are arranged chronologically. Most of the letters were either sent or returned by the Assistant Commissioner and his staff, but a few are reports from teachers and letters from freedmen.

The single volume of letters and orders received, October 1865–February 1868 (99), is arranged chronologically. From October 1865 to July 1867 the letters and orders copied in the volume were addressed to the assistant surgeon at Abbott Hospital, which was located within Freedmen's Village. Also included for the period are some letters sent by the surgeon. After July 1867, the letters are addressed to the superintendent of Freedmen's Village. Almost all of the letters and orders are from the Assistant Commissioner and his staff.

Unbound special orders and circular letters received, February 1866–October 1868, are arranged by type of order and thereunder chronologically. The orders are primarily issuances from the Assistant Commissioner.



NATIONAL ARCHIVES AND RECORDS ADMINISTRATION  
MICROFILM PUBLICATIONS

Unbound reports, 1865-68, are arranged by type of report. The series includes reports of persons and articles hired, operations reports, rosters, quarterly statements of quartermaster property, estimates of rations, returns of animals, and reports of forage drawn.

Unbound labor contracts, 1864, consist of three items. They are labor contracts witnessed by the chief quartermaster for the Department of Washington.

The single-volume register of people arriving at Freedmen's Village, January 1867-June 1868 (84), is arranged chronologically. The register gives the name and age of the person, the date of arrival, condition or state of health, and name of agent who recommended him for Freedmen's Village. The volume also contains registers of freedmen arriving at Camps Springdale, Wadsworth, Rucker, and Beckwith, 1863-65, and also a register of departures from Camp Springdale. These registers give the name, age, marital status, and former residence of the freedman.

Unbound reports of sick and wounded, returns of medical and hospital property, and statements of receipts and expenditures at Abbott Hospital, 1866-68, are arranged by type of record. For other records relating to Abbott Hospital, see the single volume of letters received (99) mentioned above.

Unbound receipts for materials received by superintendents of workshops and receipts for rent received from the superintendent of Freedmen's Village, December 1864-April 1867, are arranged chronologically. The receipts for materials are also arranged numerically.

**RELATED RECORDS**

In the same record group, RG 105, and related to records of the field offices for the District of Columbia, are those of the Bureau headquarters in Washington, DC, and previously microfilmed records of the Assistant Commissioner and the superintendent of education for Washington, DC. These record series are available in the following National Archives microfilm publications:

***M742, Selected Series of Records Issued by the Commissioner of the Bureau of Refugees, Freedmen, and Abandoned Lands, 1865-1872***

***M752, Registers and Letters Received by the Commissioner of the Bureau of Refugees, Freedmen, and Abandoned Lands, 1865-1872***

***M803, Records of the Education Division of the Bureau of Refugees, Freedmen, and Abandoned Lands, 1865-1871***



NATIONAL ARCHIVES AND RECORDS ADMINISTRATION  
MICROFILM PUBLICATIONS

**M1055, *Records of the Assistant Commissioner for the District of Columbia, Bureau of Refugees, Freedmen, and Abandoned Lands, 1865-1869***

**M1056, *Records of the Superintendent of Education for the District of Columbia, Bureau of Refugees, Freedmen, and Abandoned Lands, 1865-1872***

**M1875, *Marriage Records of the Office of the Commissioner, Washington Headquarters of the Bureau of Refugees, Freedmen, and Abandoned Lands, 1865-1869***

Records in other record groups supplement those of the Assistant Commissioner and subordinate field offices. In Records of United States Army Continental Commands, 1821-1920, RG 393, are records of the military district that included the District of Columbia. Records relating to employment and welfare of freedmen and abandoned property before the establishment of the Bureau are among Records of Civil War Special Agencies of the Treasury Department, RG 366. The records of the Freedman's Savings and Trust Company, 1865-1874, in Records of the Office of the Comptroller of the Currency, RG 101, contain information relating to former slaves who maintained accounts with the bank branches at the District of Columbia.

There have been numerous books, articles, and dissertations published about the Freedmen's Bureau and its operations. For general background, see Paul S. Pierce, *The Freedmen's Bureau, A Chapter in the History of Reconstruction* (Iowa City, IA: 1904), and George R. Bentley, *A History of the Freedmen's Bureau* (Philadelphia, PA: 1955).

Several books written about Commissioner Oliver Otis Howard include *Autobiography of Oliver Otis Howard* (New York, NY: 1907); John Alcott Carpenter, *Sword and Olive Branch: Oliver Otis Howard* (Pittsburgh, PA: 1964); and William S. McFeely, *Yankee Stepfather: O. O. Howard and the Freedmen* (New Haven, CT: 1968).



NATIONAL ARCHIVES AND RECORDS ADMINISTRATION  
MICROFILM PUBLICATIONS

CONTENTS

ROLL	DESCRIPTION	DATES
1	<b>List of Book Records</b> District of Columbia Volume (no number)	
	<b>OFFICES OF STAFF OFFICERS</b>	
	<b>Assistant Inspector General</b>	
	Name Index to Letters Sent in Volume 53 Volume (53½)*	
	Letters Sent Volume (53)	Mar. 21, 1866–Sept. 7, 1868
	Name and Subject Index to Volume 52 Volume (52½)	
	Letters Received and Endorsements Sent Volume (52)	Mar. 1866–Dec. 1868
	Letters Received	Apr. 1866–Aug. 1868
	Unregistered Letters Received	Mar. 26, 1866–Aug. 26, 1868
	Inventory and Inspection Reports of Quartermaster Stores and Medical Property	Nov. 1866–Oct. 1868
2	<b>Assistant Quartermaster and Disbursing Officer</b>	
	Registers of Letters Sent	
	Volume 1 (58)	June 1, 1865–Oct. 31, 1867
	Volume 2 (59)	Nov. 1, 1867–Aug. 31, 1869
	Press Copies of Letters Sent	
	Volume 1 (60)	June 17, 1864–Dec. 15, 1866
	Volume 2 (61)	May 27, 1866–Oct. 31, 1867
3	Volume 3 (62)	May 2, 1866–Apr. 4, 1868
	Volume 4 (63)	Jan. 3, 1867–July 1, 1867
	Volume 5 (64)	Apr. 8, 1868–Aug. 31, 1869
4	Press Copies of Letters Sent, Requisitions, and Receipts	
	Volume 1 (66)	Sept. 26, 1864–Apr. 28, 1866
	Volume 2 (67)	Apr. 27, 1866–Feb. 19, 1867
5	Volume 3 (68)	Feb. 26, 1867–Aug. 18, 1868
	Volume 4 (69)	Aug. 22, 1868–Aug. 13, 1869

\* Volume numbers assigned by the Adjutant General's Office (AGO) are shown in parentheses to assist in identifying the volumes.



NATIONAL ARCHIVES AND RECORDS ADMINISTRATION  
MICROFILM PUBLICATIONS

ROLL	DESCRIPTION	DATES
5 (cont.)	Registers of Letters Received Volume 1 (55)	June 1, 1865–Oct. 31, 1867
6	Volume 2 (56) Letters Received Entered in volume 1	Nov. 1, 1867–Aug. 26, 1869 May 16, 1865–Jan. 8, 1866
7	Letters Received Entered in volume 1	Jan. 9, 1866–Nov. 17, 1866
8	Letters Received Entered in volumes 1 and 2	Nov. 20, 1866–Dec. 6, 1867
9	Letters Received Entered in volume 2	Jan. 4, 1868–Sept. 21, 1868
10	Letters Received Entered in volume 2	Sept. 23, 1868–Aug. 26, 1869
11	Unregistered Letters Received Letters Received Volume (57) Contracts for Labor and Services	Sept. 4, 1866–Aug. 27, 1869 Aug. 31, 1865–Aug. 18, 1866 Mar. 1865–June 1869
12	Transportation Orders Received from Headquarters Registers of Disbursements Volume (73)	June 18, 1867–Mar. 20, 1869 Sept. 21, 1865–Dec. 3, 1868
	<b>Superintendent of Marriages</b> Register of Marriages Volume (30)	Nov. 1866–July 1867
13	Ministers Reports of Marriage Certificates Issued to Freedmen	Nov. 1866–Jan. 1867 and Oct. 7, 1869
	<b>Surgeon in Chief</b> Letters Sent Volume (no number) Endorsements Sent and Received Volume (no number) Register of Letters Received Volume (no number)	Feb. 1867–Sept. 1870 Feb. 15, 1867–Mar. 26, 1870 Feb. 1867–May 1870



NATIONAL ARCHIVES AND RECORDS ADMINISTRATION  
MICROFILM PUBLICATIONS

- 13    **SUBORDINATE FIELD OFFICES**  
(cont.) **Local Superintendent for Washington and Georgetown**  
    **Correspondence**  
    Name Index to Volumes 77 and 78  
        Volume (78½)  
    Letters Sent  
        Volume 1 (77)                             July 15, 1865–Sept. 10, 1867  
        Volume 2 (78)                             Sept. 9, 1867–Sept. 12, 1868
- 14    Endorsements Sent and Received  
        Volume 1 (80)                             July 22, 1865–June 27, 1867  
        Volume 2 (81)                             June 6, 1867–Sept. 16, 1868  
    Name Index to Letters Received in Vol. 76  
        Volume (no number)  
    Registers of Letters Received  
        Volume 1 (74)                             July 14, 1865–Aug. 17, 1865  
   Oct. 18, 1866–May 22, 1867  
        Volume 2 (75)                             May 14, 1867–Apr. 6, 1868  
        Volume 3 (76)                             Apr. 13, 1868–Sept. 11, 1868
- 15    Letters Received                             Oct. 8, 1866–Feb. 4, 1867  
        Entered in volume 1
- 16    Letters Received                             Apr. 17, 1867–Aug. 20, 1868  
        Entered in volumes 1, 2, and 3
- 17    Unregistered Letters Received             Aug. 1865, Feb. 24, 1866–  
   Oct. 3, 1868
- Reports**  
    Reports Forwarded to the Assistant Commissioner  
        Volume 1 (95)                             July 1865–Oct. 1867  
        Volume 2 (97)                             Dec. 1866–Oct. 1868  
    Monthly Rosters, Reports of Persons and  
        Articles Hired, and Time Reports             June 1866–Aug. 1868  
    Monthly Reports from Superintendents  
        of the Industrial Schools of Materials and  
        Clothing                                     Apr. 1867–Apr. 1868
- 18    **Records Relating to Employment of Freedmen**  
    Letters Received by Employment Agents     Jan. 19, 1866–Nov. 7, 1867  
    Employment Register  
        Volume (88)                             July 3, 1867–Oct. 9, 1868  
    Employment Registers from Wisewell Barracks  
        Volume 1 (91)                             Aug. 2, 1866–Aug. 10, 1868  
        Volume 2 (96)                             Aug. 2, 1866–Aug. 6, 1868



NATIONAL ARCHIVES AND RECORDS ADMINISTRATION  
MICROFILM PUBLICATIONS

- |         |   |                             |
|---------|---|-----------------------------|
| 18      | Employment Registers from East Capitol Street   |                             |
| (cont.) | Barracks  |                             |
|         | Volume 1 (90)   | Dec. 10, 1866–Feb. 26, 1868 |
|         | Volume 2 (94)   | Dec. 4, 1866–Feb. 26, 1868  |
|         | Labor Contracts   | Aug. 1865–Mar. 1867         |
| 19      | Monthly Rosters from Employment Agents<br>and Superintendents of Barracks                   | Nov. 1866–Aug. 1868         |
|         | Cash Accounts of Employment Office  |                             |
|         | Volume (93)   | July 31, 1865–Feb. 1, 1867  |
|         | <b><i>Other Records</i></b>   |                             |
|         | Consolidated Weekly Reports of<br>Sick and Wounded Freedmen                                 | Feb. 9, 1867–July 11, 1868  |
|         | Register of Freedmen Departing<br>Mason's Island, VA  |                             |
|         | Volume (92)   | May 18, 1864–July 18, 1865  |
|         | Register of Patients in Female Ward<br>of Lincoln Hospital                                  |                             |
|         | Volume (no number)  | July 1, 1866–Mar. 22, 1867  |
|         | Agents' and Superintendents' Monthly<br>Lists of Articles Received, Expended,<br>or On Hand | Mar. 1867–Aug. 1868         |
|         | Accounts of Materials Used in Industrial<br>Schools and Miscellaneous Lists                 |                             |
|         | Volume (98)   | June 10, 1863–Mar. 31, 1868 |
|         | Accounts  |                             |
|         | Volume (82)   | Aug. 31, 1865–July 31, 1867 |
|         | Miscellaneous Records of East Capitol<br>Street Barracks                                    |                             |
|         | Volume (79)   | May 1, 1866–Jan. 24, 1868   |
|         | Name Index to Tenement Book   |                             |
|         | Volume (38)   |                             |
|         | <b>Subassistant Commissioner (Sub District 1)</b>   |                             |
|         | Letters Sent  |                             |
|         | Volume (86)   | Oct. 4, 1867–June 13, 1868  |
|         | Endorsements Sent   |                             |
|         | Volume (87)   | Oct. 3, 1867–Sept. 7, 1868  |
| 20      | Register of Letters Received  |                             |
|         | Volume (85)   | Oct. 5, 1867–Sept. 3, 1868  |
|         | Letters Received  | Oct. 5, 1867–Oct. 23, 1867  |



NATIONAL ARCHIVES AND RECORDS ADMINISTRATION  
MICROFILM PUBLICATIONS

- |         |  |                             |
|---------|--|-----------------------------|
| 20      | <b>Barry Farm</b>  |                             |
| (cont.) | Press copies of Letters Sent and Received<br>by the Superintendent<br>Volume (100)             | Sept. 18, 1867–Mar. 9, 1869 |
|         | <b>Freedmen's Village</b>  |                             |
|         | Letters Sent by the Superintendent<br>Volume (111)   | July 18, 1867–Nov. 1868     |
|         | Letters Received   | Dec. 26, 1864–Dec. 9, 1868  |
|         | Letters and Orders Received<br>Volume (99)   | Oct. 14, 1865–Feb. 24, 1868 |
|         | Special Orders and Circular Letters<br>Received  | Feb. 21, 1866–Oct. 29, 1868 |
| 21      | Reports  | 1865–68                     |
|         | Labor contracts  | June 8, 1864–Oct. 12, 1864  |
|         | Register of People Arriving at<br>Freedmen's Village<br>Volume (84)                            | Jan. 1, 1867–June 27, 1868  |
|         | Reports of Sick and Wounded  | Jan. 1867–Aug. 1868         |
|         | Receipts and Expenditures at<br>Abbott Hospital  | 1866–68                     |
|         | Receipts for Materials Received,<br>Rent Received from Superintendent<br>of Freedmen's Village | Dec. 1864–Apr. 1867         |



NATIONAL ARCHIVES AND RECORDS ADMINISTRATION  
MICROFILM PUBLICATIONS

**APPENDIX**

This list provides the names and dates of service of known Freedmen's Bureau personnel at selected staff offices and subordinate field offices in the District of Columbia. Additional information regarding persons assigned to various field offices might be found among the Bureau's Washington headquarters station books and rosters of military officers and civilians on duty in the states and other appointment-related records.

LOCATION	DATES
<b>OFFICE OF STAFF OFFICERS</b>	
<b>Assistant Quartermaster Disbursing Officer</b> Joseph M. Brown	June 1864–Aug. 1869
<b>Superintendent of Marriages</b> John Kimball	Nov. 1866–July 1867
J. L. Roberts (Assistant Superintendent)	Nov. 1866–Mar. 1867
M. V. Wright (Assistant Superintendent)	Mar.–July 1867
<b>Surgeon in Chief</b>	
Robert Reyburn	Feb. 1867–Apr. 1869
Patrick Gennan (Freedmen's Hospital)	Apr. 1869–Mar. 1870
Patrick Gennan (Chief Medical Officer)	Mar.–Aug. 1870
<b>SUBORDINATE FIELD OFFICES</b>	
<b>Washington and Georgetown</b>	
<b>Local Superintendents</b>	
W. F. Spurgin	July 1865–Oct. 1866
J.V.W. Vandenburg	Oct.–Nov. 1866
W. B. Beebe	Nov. 1866–July 1867
J.V.W. Vandenburg	July 1867–Sept. 1868
<b>Subdistrict 1 (Washington Georgetown, and Counties of Montgomery and Prince Georges Maryland, 1868)</b>	
William A. Coulter	Sept. 1867–Feb. 1868
J.V.W. Vandenburg	Feb.–Sept. 1868
<b>Freedmen's Village</b>	
George B. Carse	May–Dec. 1865
A. U. Lomas	Dec. 1865–June 1866
A. A. Lawrence	June 1866–Jan. 1867
E. B. Gates	Jan.–July 1867
H. N. Howard	July 1867–Dec. 1868



NATIONAL ARCHIVES AND RECORDS ADMINISTRATION  
MICROFILM PUBLICATIONS

Microfilm Publication M1902

RECORDS OF THE FIELD OFFICES FOR THE DISTRICT OF COLUMBIA,  
BUREAU OF REFUGEES, FREEDMEN, AND ABANDONED LANDS,  
1865-1870

ROLL 15

**SUBORDINATE FIELD OFFICES**

**Local Superintendent for Washington and Georgetown**

*Correspondence*

Letters Received

Oct. 8, 1866-Feb. 4, 1867

Entered in volume 1



1866



W<sup>o</sup> C. S. Oct 16<sup>th</sup> 1866

Dear R. J. <sup>md</sup> Esq.

H<sup>o</sup> Geo. A. C. D. C.

Washington Oct 16<sup>th</sup> 1866.

M. B. Vol 1, No 11, P. 13 - No 1

Rogers W. W.

A. A. Genl. etc.

Direct that the act L. S.  
report at H<sup>o</sup> G<sup>o</sup> immediately

1866



Bureau Refugees, Freedmen & Abandoned Lands,  
Head-Quarters Ass't Commissioner, D. C.,

WASHINGTON, *October 16* 1866.

*Major.* The West Court requests  
you will call here as soon  
as you can this morning.

Very Respectfully  
Yours &c  
*H. H. Rogers*  
A. A. S.

*Major G. H. Vandenberg,*  
West Local Sup't S. C.



K939 (R. F. & A. L., Vol. E) 1866.

1 1/2  
Lanaville near Balto

No. October 16<sup>th</sup>, 1866

Gen John R

Desired two colored servants  
to be sent him from this  
city

md:

Wrapper---( \_\_\_ Enclosures.)

WAR DEPARTMENT,  
BUREAU REFUGEES, FREEDMEN AND ABANDONED LANDS,

Washington... Oct 15 1866.

Respectfully referred to Col  
A. P. Ketchum  
Commissioner, District of  
Columbia

By order of  
Maj. Genl Howard Comr

A. P. Ketchum

Assistant

Ad. Qu. Ac. D.C.

Oct. 19. 1866

Respectfully referred to the  
Local Supt. D.C.

By order of the ac.

Thos. Rogers  
Asst. Dir. of B. & A. L.

O.L.S. & Co. P. 43 Oct 20 1866 No 4

Please state what you  
will pay per month  
for the servants you  
desire. - we can send  
them to you - at any  
time, send direction  
at what station they are  
to stop. and also state  
if you have any one  
in town who  
can make a contract  
in your name

JM

M 98 Vol 1 P 13 1866.



537

N. 232. P. F. H. L. Vol 8, 1866





Lauraville near Palt. M<sup>o</sup> Oct. 1666

Sir,

Will you have the Courtesy to inform me  
per return mail (if convenient) whether or not  
you can furnish me with a well grown col'd boy  
say from 10 to 15 yrs of age & on what terms per  
year; My family is quite small, & the duties & pleasures  
far from onerous - I wish to take care of a horse & make  
himself useful about the farm - If you have  
not one so young perhaps you have one from 15 to 18 or 20 -  
I also want a plain Cook, Wash<sup>er</sup> & C<sup>+</sup> for  
my <sup>(a farmer)</sup> tenant - Mr John Slade - where she would have  
an excellent time of

Yours

By P. Kelly Jr

J. H. Reese

say from 18 to 35 yrs  
of age. Mr Slade also  
wants a wagoner, a  
steady trusty man - all  
of good moral principles &c



Q R 147 C S. Alex. 1866.

Vol. 1. No. 2402. U. C. D. C. 1866.

2 Bureau A. A. & A. G.  
Office of Supr. civi  
Culpeper & Orange  
Culpeper C. H. Oct-17th 1866.

Mr. Tully M. A.  
Bvt. Capt. & Supr

Requests that the whereabouts  
of Henry Harris (col'd) may  
be ascertained, that he may  
provide for his child who  
is now with Mr Slaughter  
Bradford at Culpeper Va.

Harris recently moved  
from Alexandria to Wash-  
ington, where he now resides

10757-1-13-1866

Recd C. S. Alex. Oct-20-1866.

Bureau A. A. & A. G.  
Office of Supr  
Alexa Va Oct-20-1866

Respectfully forwarded  
to Bvt. Lt. Col. W. W. Rogers  
for his information.

V. P. Lee  
Bvt. Col. & Supr

Bureau Refugees, Freedmen & Abandoned Lands

HEAD QUARTERS ASSISTANT COMMISSIONER, D. C.

Washington, Oct 22<sup>d</sup> 1866.

Respectfully refers to this Local  
Supr D. C. who will endeavor  
to find Henry Harris and  
see that he makes provision  
for his children.  
This paper will be returned  
with report.

By order of Bvt. Brig. Gen. HOWARD.

W. W. Rogers  
A. A. General.

E. B. Vol. 2. No. 651. U. C. D. C. 1866



O. L. Supt. S. D. L. A. P. H. L. 3/10.15/66

Caulpiper C. 14 & a  
Oct 18" 1866

W. Mully W. A.  
Brookfield & C

Requests information of  
the whereabouts of Col. James  
Harris -

See  
Harris  
Harris  
Harris



I am very  
Respyly your Oct sent  
"Mr. Angelo here met  
But capt & asst Supt  
B. P. F. et al

These are the  
Supt & asst Supt  
Reg. with information of  
the return amounts of Oct 1864  
Harris

W. M. Kelley N. C.  
But Capt & Supt

San Francisco Cal  
Oct 18<sup>th</sup> 1864

O. P. S. U. S. A. 9/11/11 1864



Bureau of P. O. & A. S.  
Office of the Asst. Supt. Counties of  
Culpeper + Orange Va  
Levee Ctt Oct 18/66

Local Supt  
B. R. H. et al. D. C.  
Washington D. C.

Sir

I have learned that Henry Harris  
Culpeper is now living in Washington D. C.

Said Harris has a little son named  
Turner Harris now living about 2 1/2  
miles from Culpeper Ctt upon the premises of  
a Mr. Sloughly Brashear.

Mr. Bradford wishes the boy  
taken away - by the father as he does not  
require his services. Said boy being a  
very mischievous boy & needs the  
management of his father -

I have notified Harris  
once of the necessity of coming after his  
son, but as yet he has failed to report  
- though he promised Cal Lee to do so  
- the Cal since informs me he is of the  
opinion he is indifferent as to the  
disposition of his boy -

I wish to notify him that  
it will be necessary to apprentice his boy  
unless he comes for him very soon -

I would respectfully request that  
steps be taken to ascertain the whereabouts  
of Henry Harris - when found that he  
be required, come or send for his boy the Com-  
-missioner will bring him if funds are sent for transportation  
over



W. 257 A. F. S. Oct 1866

2 1/2 Manchester, N. H.  
Oct. 17<sup>th</sup> 1866.

Wood, Dr. Chas. P.

Desires to obtain a colored  
servant.

War Dept. Bu. R. F. & A. L.  
Washington Oct. 19<sup>th</sup> 1866.

Respectfully referred to  
Col. Brig Genl G. H. Howard,  
Asst. Commr. &c. Dist. Columbia.

By order of  
Maj. Genl Howard, Comr.  
A. P. Ketchum  
A. A. A. Genl.



Bureau Refugees, Freedmen & Abandoned Lands

HEAD QUARTERS ASSISTANT COMMISSIONER, D. C.,  
Washington, Oct 28<sup>th</sup> 1866.

Respectfully referred to the  
Local Supt. D. C.

By order of Bvt. Brig. Gen. HOWARD.

A. A. A. General.

Recd Oct 28<sup>th</sup> 1866

N.H. 1866  
Manchester, Oct 17

I take this  
to inform you  
I would like a  
in my family  
16 to 20 years old  
that can be relied  
and is healthy  
is willing to be lea-  
will take into  
my family and educate  
& care for like unto my  
own children. By conferring  
with me in regard to the  
above you will greatly  
oblige I am Sir,  
as I have the honor to be  
yours truly  
Chas. P. Wood  
(P. O. Box 101)



W 257 A. F. A. L. Oct 1866

2 1/2 Manchester, N. H.  
Oct. 17<sup>th</sup> 1866.

Wood, Dr. Chas. P.

Desires to obtain a colored  
servant.

War Dept. Bu. R. F. & A. L.  
Washington Oct. 19<sup>th</sup> 1866.

Respectfully referred to  
Col. Brig Genl G. H. Howard,  
Asst. Commr. &c. Dist. Columbia.

By order of  
Maj. Genl Howard, Comr.  
A. P. Ketchum  
A. A. A. Genl.



R R R R R R R R R R

N. H. 1866  
Manchester, Oct 17

Resps. I take this  
method to inform you  
that I would like a  
Negress in my family  
from 16 to 20 years old  
one that can be relied  
upon and is healthy  
and is willing to be lea-  
-ned I will take into  
my family and educate  
& care for like unto my  
own children. By conferring  
with me in regard to the  
above you will greatly  
oblige I am Sir,  
as I have the Honor to be  
yours truly  
Chas. P. Wood  
(P. O. Box 101)



O.E.S. No. L.P.P. 52, No. 19 Oct 29<sup>th</sup> 1866.

Ames Oct. 1866

Y<sup>r</sup> <sup>sup</sup> ~~sup~~

Dear friend as you  
desire can be secured  
through this office -  
but you must state  
kind of pay per mo  
ye

Wages here for girls  
14 to 16 ye<sup>s</sup> is 6 to 8 - ~~10~~  
dollars per mo.

J.M.W.

MS 9.11 - 11. 1866



O. S. No. 7115 Vol 1 111 - 1866 -

---

Bureau R. F. Gen. L.  
H. & Geo. alt. Comm. O. C.  
Oct 17<sup>th</sup> 1866

No. 3

---

Howard C. K.

Prof. Brig. Gen.  
alt. Comm.

---

Request that Local Sup.  
Consult was suffering in  
reference to sending Freed-  
People to Phil<sup>a</sup>.

---

W. C. G. S. ad. 17<sup>th</sup> Nov.



Bureau Refugees, Freedmen and Abandoned Lands,  
Headquarters Ass't Commissioner, District Columbia,

Washington, Oct. 14 1866.

Maj. J. W. V. Vandenberg

Sir

Please counsel with  
Mrs. Griffing about the freed women  
to go to Philadelphia - If you get  
a wagon by tomorrow they <sup>should</sup> better be  
sent - send a letter to Col. Rob<sup>t</sup>  
R. Carson Sec P. F. R OMC. 424  
Walnut St. at any rate so that he  
may know what to expect.

You may receive my requests  
for freedmen from Mrs. Griffing when  
ever she has more on hand than she  
can attend to.

Respectfully,  
L. H. Howard  
Prot. Brig. Gen.

P. S. Apply for the transportation ass<sup>t</sup> - Com<sup>r</sup>  
for the 22 women in two papers today - if Maj. Hun-  
gin has not already done so. L. H. H.



Treasury Dept.  
Oct 16<sup>th</sup> 1866

Eddy, C. F. 3 1/2  
Treasury Dept.

Requests information about  
obtaining Co<sup>l</sup> servants =

O. L. S. & Co. L. B. P. 41. Oct 18<sup>th</sup> 1866

WMS Vol 1 - 15 - 1866 No 1 -

Fredman an Agent  
from this office N-  
We under all assistance  
in our power to  
parties desiring their  
transportation is  
provided in all  
cases when work  
is provided & the  
parties are unable  
to pay their own way  
don't know the  
Manual out of office  
Harris -  
Office Hours 9 to 4



Treasury of the United States,

Redemption Division,

Washington, Oct 16<sup>th</sup>, 1866.

Sir:

I respectfully solicit information on the following points. viz:

Can colored girls be obtained, through your office, for service in families worth? or can you render any assistance towards procuring them?

Does you't, under any circumstances, provide transportation for such persons?

Can you inform me where a lady named, Harris, from Providence, R.I. a sort of State Ag't, is to be found? She has some connection, I understand, with the Freedmen's Bureau.

Between what hours is your office open to the public?

An early reply will greatly oblige, Address as above

Capt Spurgeon:  
Intelligence Office }

Yours Respectfully

C. Z. Eddy



O. P. S. 71273 Vol 1 15. 1864

Bureau R. F. (M) Q

Hedgs All Comd D.C.

Oct 20<sup>th</sup> 1864

No. 5

Regus Wm. W. W.

Bot Lt Col a. a. a. Col.

Regus Cencus report  
of Freed people D.C.



Bureau Refugees, Freedmen and Abandoned Lands,  
Headquarters Ass't Commissioner, District Columbia,

Washington, Oct. 20<sup>th</sup> 1866.

Major Vandenberg,

Major:

The Asst. Comm. desires  
that you furnish immediately a sum-  
mary of the census of the Col. & popula-  
tion of the Dist. of Columbia.

You will also return the reports, &c  
of Maj. Spurgin, to record by him from  
this office to complete his records.

Very Respectfully,

Your Obedt. Servant

H. H. Rogers

Prot. St. Cl. Secy.



262 R. F. & A. L. Vol 8. 1866

South Hadley Mass.

Oct. 22<sup>nd</sup> 1866.

Taylor, Fredk

Desires to obtain a colored  
servant.

War Dept. Bu. R. F. & A. L.,  
Washington, Oct. 25<sup>th</sup> 1866.

Respectfully referred to  
Bot. Brig. Genl. C. H. Howard,  
Apt. Comdr for D. Co.

By order of  
Maj. Genl. Howard, Comd.

*[Signature]*  
A. A. A. Genl.



South Hadley Mass.

Oct 22/66

Gentlemen of the Freedmen  
Bureau

Could you provide  
me with a servant girl  
I w<sup>d</sup> like one from 14 to 17  
yrs old - Next a tidy, & one  
who is fond of little children  
Please write me giving terms  
etc -

Yours &c  
Fredk Taylor

I have been refered to you  
by an employe in the War  
Department -



O. S. L. B. P. 51. No. 18. Oct 29/66

7172 Vol 1 - 1866 -

51/2

Amst Oct 29/66

Please state pay

for the Col

As to the 7

pay & c

here is ~~the~~ etc

10% for

6 to 8% for

chamber

manus

M/V

Head Quarters  
Oct 25th 1866

Respectfully refers to  
the local Super. D. C.  
for reply.

By order of  
Act. Brig. Gen. A. M. ...  
H. H. Rogers  
Prof. A. H. ...



W. D. C. L. S. 28 Oct. 1866

---

Bureau of Gen. A.  
H. A. G. Asst. Comd. D. C.  
Washington Oct 27 1866

---

Nov 1 - 16 - 1866  
A. G.

---

Regiment R. R.  
Surgeon U. S. A.

---

Appointments - C. R. Randall  
Resident of " Dist. Lynchburg  
3rd & 15th St. Canal & Parade.

---



Bureau Refugees, Freedmen and Abandoned Lands,  
Special Relief Commission.  
Headquarters Ass't Commissioner, District Columbia,

Washington, October 27<sup>th</sup> 1866.

Major J. V. M. Vandenberg

Superintendent.

Sir

You are

hereby notified that Mr C. P. Ramsdell is assigned for duty as Visiting Agent in Washington D. C. taking charge of the District lying bet<sup>h</sup> 3<sup>d</sup> & 15<sup>th</sup> St<sup>s</sup> and Canal & Pennsylvania Avenue, and you will please receive Orders for Relief of the Destitute signed by the same.

By order of Brig. Genl C. M. Howard  
Robert Kenburn

Col. Lt. Col. and Surg. U.S.A.  
President, Special Relief Commission.



O. L. S. No. 230251-70:17. Oct 29 1866-

Mr Fry - 6 3/4

Thomastown Conn

MSB Vol 1-17-1866-

Sir we have a man  
& wife smart light  
Colored - and who  
desire to go north  
they have no family  
shall I send them to  
you?

J. M. W.



Recd of J. & J. 1/2

Mr Jmy  
Thomas

Wm

and then  
no family  
to go north  
and the  
Smart - light  
had a man

Wm  
6-1-17-1866

6/14

Wm 1866



Thomaston Conn Oct 30 1866

Dear Sir

I am of opinion only U.S.

I could not think of  
having the child + of course that precludes  
their coming.

Yours truly  
J. H. Terry.



C. S. L. M. B. Vol 1-17-1866

Bureau R. F. Q. L.

H. G. J. W. All Court. D. C.

Oct 24<sup>th</sup> 1866

5-

107

Rayburn Robert

Surg. U. S. A.

Call meeting of the  
writing apt. Dec.

24

H. G. J. W. Oct 25<sup>th</sup> 1866



Bureau Refugees, Freedmen and Abandoned Lands,  
Headquarters Ass't Commissioner, District Columbia,

Washington, October 24<sup>th</sup> 1866 .

Col Maj. J. V. M. Vandenberg

Superintendent.

Sir

Yours are  
hereby requested to notify the visiting Agents in your District,  
that the Monthly Meeting of the Visiting Agents & Superin-  
tendants of the Special Relief Commission will be held  
at the Room of the Hon. Taylor J. Bowen, Postoffice, Wash.  
D.C. on Friday Evening Oct 26<sup>th</sup> 1866 at 7 1/2 o'clock. P. M.

By order of Col Brig. Genl. G. M. Howard

Robert Taylor

Col Lt Col. Genl. Perry M. Wood.

President Special Relief Commission



O.S. Co. 7073 Vol 1-15-1868

Bureau R.F. Para AF  
H<sup>d</sup>. G<sup>o</sup>. West Conn<sup>t</sup>. D.C.  
Oct 25<sup>th</sup> 1864

25  
~~73~~ 14

Rogers W.W.  
a a a Genl.

Request that the Team  
report at H<sup>d</sup>. G<sup>o</sup>. this  
P.M.

The Co. (S) Oct 25<sup>th</sup> 1864



Bureau Refugees, Freedmen and Abandoned Lands,  
Headquarters Ass't Commissioner, District Columbia,

Washington,

Oct 23<sup>rd</sup> 1866.

Maj. J. V. Vanduburg,  
Local Supt. D.C.,

Sir:

The Asst. Com.,

directs that you send the team under  
your charge, to the St. O. D., this  
A.M. to report to me.

Very Respectfully,

Your Obedt Servt.

Wm. Rogers

Asst. Supt. D.C.



Oct 26 7173 101-15-149

Bureau of Land Office

Head Quarters, Wash. D.C.

Oct 26<sup>th</sup> 1866

Keyburg Robert  
Supt. U.S.

Requests that the 2 Horse  
Team report to him at  
Head Quarters

Recd. by Keyburg Robert  
26<sup>th</sup> Oct 1866



Bureau Refugees, Freedmen and Abandoned Lands,

Headquarters Ass't Commissioner, District Columbia,

Washington, Oct. 26<sup>th</sup> 186 .

Major Vandenberg,  
Local Supt. N.C.,  
Major:

Will you please send  
your wagon to these N.C. Co. today - if possi-  
ble - to report to me.

Very Respectfully  
Your Obedt Servt.

Walter Hayburn

Brig. Gen. Col. & Surgeon U. S. A.



Transcript - 27/6/66  
Oct. - as per this order

2/6/66



O.L.S. No. 7173 Vol. 1-19-11-11  
Hedger Art Comd. B. Co.  
Bureau R.F. Co. of  
Washington Oct 27<sup>th</sup> 64

---

Rogers W.W.  
B.L. led & a a a a a

---

Requests that the 2 Horse  
Wagon report immediately

---

L2

S

No. O.L.S. Oct 27<sup>th</sup> 1866



Bureau Refugees, Freedmen and Abandoned Lands,  
Headquarters Ass't Commissioner, District Columbia,

Washington, October 27 1866.

Major J. V. W. Vandenberg.  
Local Supt. D.C.

Major:

The Assistant  
Commissioner directs that you send <sup>at 2 hours</sup> ~~send~~  
wagon to report at these Head Quarters,  
immediately.

Very respectfully  
Your obedient servant  
A. P. Rogers  
A. A. H.



O.L.S. 7173. Vol. 1-17-1864

Washington D.C.  
October 28<sup>th</sup> 1864

Oliphant. E.R.  
Lutiner ~~Sept~~

Requests to be furnished  
with two to three boys  
for his Brothers in Va.

Head Quarters A.C. D.C.  
October 27, 1864.

Respectfully referred to  
Major J. N. H. Vandenberg  
Local Supt D.C. who  
will please procure  
the boys as within re-  
quested, and communicate  
with the writer of this  
application when they  
can be sent.

By order of

Brigadier Genl C. N. Howard

Thos. Rogers  
a. a. a. q.

Recd O.L.S. Oct 28 1864



Interior Department Room 49  
Washington D.C.

October 28<sup>th</sup> 1866

Br. Lt. Col. W. W. Rogers

A. A. A. Genl Bureau R. F. & A. C.

Dist of Columbia

Colonel

I would respectfully request to be furnished with two good honest and industrious colored boys about 15 or 16 yrs old to take care of horses and drive carriage for my Brother F. H. Oliphant and my nephew Genl. S. D. Oliphant late 14<sup>th</sup> Regt. V. R. C. at Uniontown Fayette Co. Pa. Their wages not to exceed \$8.00 per month each with board and lodging, if the boys suit and conduct themselves well they will have good homes as long as they want to stay

I am Sir

Very Respectfully

E. J. Oliphant

(or F. H. and S. D. Oliphant)



O. L. S. Co. W.B. Vol 1-19-29, 13

Washington D.C.  
Oct 29 1864

---

Robert - John L.  
Supt. Co.

Requests; Rations for (6)  
Men one week (4 2) days Rations

Rec<sup>d</sup> O. L. S. Oct 29 1864



Genl Capt. Barracks

Washington D.C.

Oct. 29<sup>th</sup> 1864

Sir -

Please issue to the bearer Rations  
for six men for one week - (42) for use  
at the barracks.

Respectfully, Your Obedt. Servant  
John L. Roberts  
Supt - 42



Rec<sup>d</sup> O.L.S. D.C. War 17866

9

O.L.S. D.C. MB Vol 1-20-14

War Dept  
Bureau of Land  
Oct 29 1866

Stewart Bridge  
a a a Genl.

Gives instructions in  
regard to transportation  
for Refugees & Freedmen

Official copy-



War Department,

Bureau of Refugees, Freedmen, and Abandoned Lands,

Washington, October 29<sup>th</sup>, 1866.

Circular Letter.

As many applications for transportation are received at these Head Quarters without sufficiently detailed statements of the facts in each case I am directed by the Commissioner to request that Assistant Commissioners and other officers of the Bureau will endeavor to have all papers of this class, passing through their office, conform as nearly as possible to the following suggestions.

1<sup>st</sup> The names and number of persons to be transported or the name of the head-man of each family or party, with the number of the latter, and the sex, and class (Refugees or Freed-people) to which they belong will be stated.

2<sup>d</sup> Transportation will only be requested from and to the nearest Railway Station, or Steamboat Landing to the starting point and place of destination.

3<sup>d</sup> When children are to be transported, the age and sex of those of twelve years and over, should be stated, as full fare is charged; and the age only of those from four to eleven, (inclusive) for whom half fare is charged. Children under



four years will not be mentioned, no charge being made for them.

4<sup>th</sup> The particular necessity for the transportation should be stated, and information furnished as to whether the parties will not be a charge to the Government after reaching their destination

Very Respectfully  
Your Obedient Servant  
(Signed) Stuart Eldridge  
Act. Asst. Adjt. General.

Col. Brig. Gen. C. Howard  
Asst. Com. S. C.

Official:  
H. H. Rogers  
Asst. Com.



G. R. Vol. 2. No. 14. W. C. G. C. 1864.

East Capitol ~~Washington~~

Washington Oct 30

O. L. S. Dec. 7 1863 Vol 1-20-

No. 15

Clark Appleton, P.

Requests Nations. How many  
suffering for 62 Freed people  
some north.

Hd. Qu. West Gen. A. S.  
October 30 1864

Respectfully referred to  
Major Vandenberg  
who will ascertain if  
the number herein sta-  
ted are actually going,  
visum rationis only  
to those who are  
ready to go north.

By order of  
Robt. B. Cant. Howard

A. S. Rogers  
A. S. Rogers

Rec<sup>d</sup> O. L. S. Oct 30 1864



394 North Capitol Street  
Washington Oct 30. 1866

St. Col W. W. Rogers A.S.G.  
Bureau C. P. and A.S.

Sir

Ms Giffing desires me to request  
Rations for the following Freed-people going north.

Thomas Hill & 25 others	26	Providence R.I.
Sarah Lamb " 2 "	3	Farmansburg N.Y.
Nancy Burroughs	1	Colchester Ct
George Perry " 1 "	2	Georgetown "
Carly Towle " 1 "	2	Cayuga N.Y.
Annada Greene " 1 "	2	Troy N.Y.
Hannah Washington "	1	Elyria "
Fonessa Warren	1	Derby Ct
Matthew Elliot	1	Trenton N.J.
Armstead Jones " 1 "	2	Harrisburg Pa
Nancy Carter " 2 "	3	Colinsville Ct
Jane Crosby " 1 "	2	Winstead "
James Smallwood " 1 "	2	Avon N.Y.
Julia Thomas " 2 "	3	Dover N.H.
Chas Polk " 1 "	2	Pittsburg Pa
Mary Rice	1	Windilla N.Y.
Sarah Wood " 2 "	3	Middletown Ct



L. R. Vol. 2. No. 14. A. D. 1864.

East Capital

Washington Oct 30

O. L. & Co. '1863 Vol 1-20-

1864

Clark Appleton, P.

Reques-Nations. How me  
Guffin's for 6000  
some more.

Vol. 2. O. L. & Co. Oct 30 1864

Ad. Dr. Easton, DC  
October 30/64

Respectfully referring to  
Major Sandringham  
who will ascertain if  
the number herein sta-  
ted are actually going,  
& return returns only  
to those who are

would go with,  
By order of  
William Sandringham

Wm. Sandringham  
Major

Phillip Johnson	8	2	others	3	
Sarah Davis	"	1	"	2	
			Total	62	

Cincinnati Ohio  
Pittsburg Pa

I have the honor to be  
Very Respectfully Your Obedt Servt  
Appleton P. Clark



C. L. S. No. 11732-1-21-1864

Bureau R. F. & L.

No. 2<sup>nd</sup> West Court St. D. C.

Washington Oct 31<sup>st</sup> 1864

Ray. H. A.

Requests a List of the names  
of employees including those  
on duty at my office who  
are found on rolls of this office

No. 2<sup>nd</sup> West Court St. D. C. Oct 31<sup>st</sup> 1864



Bureau Refugees, Freedmen and Abandoned Lands,  
Headquarters Ass't Commissioner, District Columbia,

Washington, *OCT 31<sup>st</sup>* 1866.

May' Vandenberg.

Dear Major:

Will you send me a list  
of your employees including on it those  
in Mrs. Griffing's Office who are paid on  
your rolls, giving the compensation  
of each.

Yours in Substitution  
W. H. Ray



Rec<sup>d</sup> for O.S. Nov 1<sup>st</sup> 1864

---

Washington D.C.  
Nov. 1<sup>st</sup> 1864

---

O.S. No. 1013 vol 121-17

Rogue Imp.  
At level & a. a. a. 9-

---

Direct that the Two  
Horse team report to  
Kimball 2" & 3" with

---



Bureau Refugees, Freedmen and Abandoned Lands,  
Headquarters Ass't Commissioner, District Columbia,

Washington, Nov. 1<sup>st</sup> 1866.

Maj. Vandenberg,  
Local Supt. D.C.

Sir:

The Asst. Comr.  
directs that you let Mr. Kimball have  
the use of the team in your charge,  
tomorrow & next day - the 2<sup>d</sup> & 3<sup>d</sup> of  
the present mo.

Respectfully,

Your Obedt Servant

H. M. Rogers

A. A. G.



Re<sup>o</sup> of L.S. D.C. Nov 4<sup>th</sup> 1866

---

Washington D.C.

Nov 2<sup>d</sup> 1866

L.S. MSS vol 1-21-11<sup>o</sup> 18

Rogues Wm

aa Guh pa

---

Requests that Nations be  
furnished with Havis for  
(7) seven Freed people going on

---



Bureau Refugees, Freedmen and Abandoned Lands,

Headquarters Ass't Commissioner, District Columbia,

Washington,

Apr. 23 1866.

Major J. W. Vandenberg,  
Local Supt. D. C.

Major:

The Asst. Comr.  
directs that you furnish Miss Harris  
two days rations for seven (7) freed people  
going north.

Very Respectfully,

Your Obedt Servt.

W. H. Rogers

Asst. Comr.



No. O.L.S. Nov 5<sup>th</sup> 1864.

---

Washington D.C.,  
November 5<sup>th</sup> 1864.

---

O.L.S. No. 1-22-19

---

Roberts Geo. C.  
Supt. etc

---

---

Request - Nations for  
& persons. French people  
going north.

---

---



Capt. S. B. Bunnell

Washington D.C.

Oct. 5<sup>th</sup> 1866

My dear General

I have a party of eight (8) persons (4 men & 4 women) who leave here for the north this evening -

Will you please send me tickets for the party for two ~~days~~ (2) days -

Respectfully  
Yours

Wm. S. Roberts

Wm. S. Roberts



20  
No 217 (R. F. & A. L. Vol. 8) 1866.

Vol. 2 No. 100 H. B. D. C. / Feb  
Danby Four Corners, Vt.

November 6th, 1866.

Herrick - Henry D.,

Wants a colored girl not  
less than 14 years old. Will  
board and clothe her.

Wrapper---( / Enclosures.)

WAR DEPARTMENT,  
BUREAU REFUGEES, FREEDMEN AND ABANDONED LANDS,

Washington Nov: 9... 1866.

Respectfully Referred to the  
Assistant Commissioner for the  
District of Columbia.

By order of

Maj. Genl Howard

Commissioner

A. P. Ketchum

act. Asst. Adjt. Genl

Rec'd L. S. D. C. Nov 12 1866

Bureau Refugees, Freedmen & Abandoned Lands

HEAD QUARTERS ASSISTANT COMMISSIONER, D. C.,

Washington, Nov 12 1866.

Respectfully referred to Maj.  
Vandenberg Local  
Supt. D. C. for proper  
action

By order of Bvt. Brig. Gen. HOWARD.

McClintock

A. A. General.

E. O. Vol. 2. No. 723 A. C. D. C. 1866



O. S. G. C. M. B. Vol. 22 - 1890

REV. F. & A. L. NO. 1890

REV. F. & A. L. NO. 1890



Henry R. F. A. L. Vol 8/66



793

Danby 4 Corners, Nov 6. 1866

Breadman's Beard

I want you to send me a  
mexico girl to work for me that is in your  
care for I understand they is many a  
mexico girl that is without a home in  
the south. if they were near I could  
get work I want a active willy good natured  
and good healthy and Careater about the  
age 14 is as young as I should want I will  
do well by a girl and if I take a girl  
at young as 14 years I want to had her stay  
with me until she becomes of age 18 years  
I will ~~board~~ <sup>and board</sup> and clothe a girl and send  
money. Please send me a girl right  
off

Residence Danby Stubbs County Tenn  
Railroad runs through my town from  
Troy <sup>line</sup> 60 miles North of my house

Henry B. Herrick



Rec<sup>d</sup> O. L. S. H. Nov 6 1866

East Cap Bureau,  
Washington Nov 6

O. L. S. MB Vol 1-22. No 27

---

Roberts J. L.

Supt. &c

Requests Nations for 61 Lit  
Free people for one week  
(1400) for use of Bureau.

East Capt. St. Barnetts  
Washington D.C. -  
Nov 6<sup>th</sup> 1866

Maj. Vandenberg -  
Wash D.C. -

Sir

Please send by the bearer  
Rations for use at these barracks  
for Sep men one week (42) rations

Respectfully

Henry Oct sent  
J. Roberts  
Sept 40



Rec<sup>d</sup> O.L.S. Nov 7<sup>th</sup> 1864.

---

Washington. D.C. ~~22~~

November 7<sup>th</sup> 1864

O.L.S. W.B. Vol 1-22-1864

---

Request Wm W.  
a a a Genl

---

Request that the flag be  
turned over to Mr Kelley for  
a short to day.

---

Bureau Refugees, Freedmen and Abandoned Lands,

Headquarters Ass't Commissioner, District Columbia,

Washington,

Mr. 7th

1866.

J. W. Vandenberg  
Local Supt. &c  
Major.

The Assistant Com.

direct that you loan the bearer, Mr. Kelly,  
the flags at your Head Quarters. They  
will be returned to you tomorrow.

Respectfully

Wm. Rogers  
Act. Secy.



Wm. C. L. S. Nov. 7<sup>th</sup> 1866

Phila Pa  
Nov 6<sup>th</sup> 1866

Rev Raymond J.

Statement relative to  
May S. Johnson, (w<sup>rd</sup>)

O. I. S. D. C. M<sup>rs</sup> Vol 1-23-1823

Office Local Supt  
Washington Nov 7<sup>th</sup> 1866

Respy forwarded  
To  
Prot Lt Col. W. M. Rogers  
A A A Genl. D. C.  
Bureau R. F. G.

(pg) J. W. Vandenberg  
Local Supt. D. C.

Philadelphia Pa.  
Nov. 6<sup>th</sup> 1866.

Dear Raymond J. States that Mary E. Johnson  
Freedwoman, desires to return to Washington D.C.  
States that she was promised a School, and induced  
to leave Washington by Mrs. Guffney. With the promise  
that she should have a Teachers situation.  
Asks that transportation be granted her to  
return.



Vol. 2, No. 83 A.C.D.C. 1866

Washington, Nov. 8<sup>th</sup> 1866

24

Clark, A. P.

Agent &c.

States that Mrs. Griffing desires him to request that rations be furnished 36 freed persons, going north.

Rec. A.C.D.C. 14/11/66

Head Quarters A.C.D.C.

November 8. 1866.

Respectfully referred to, Major Vandenberg S.S. D.C. who will furnish Mrs. Griffing with 3 days rations for the number of freed people actually ready to go north.

By order of

Brk Brig Genl C. H. Howard

A. H. Rogers

a.a.g.

E. O. Vol. 2, No. 713. A. C. D. C. 1866.

Re C.O.L.S. Nov 8<sup>th</sup> 1866

O.L.S. D.C. M.B. Vol - 23. A-24



394 North Capitol Street  
Washington Nov 8. 1866

7  
Lt Col W. W. Rogers A.A.S.  
Bureau R. F. and A. S.

Sir

Mrs Griffing desires me to request  
Rations for the following freed-people going north  
Charles Child & 26 others 27 Battle Creek Mich.  
Lucy Smallwood & 4 " 5 (Transportation requested Nov. 8th  
Mary Bolden " 3 " 4 " " " "  
Total 36

I have the honor to be  
Very Respectfully Yours  
Appleton F. Clark



O. L. & D. C. W. B. Vol 1 - 23. No 25

Washington D. C.  
Nov. 8<sup>th</sup> 1866 -

Brown J. M.  
Bot Maj. A. G. M.

Requests thro the A. C. D. C.  
that the necessary papers be  
furnished with matter -

~~Received of the Secretary of War~~

Rec<sup>d</sup>: O. L. & D. C. Nov 8<sup>th</sup> 1866 -

War Department,  
Bureau of Refugees, Freedmen, and Abandoned Lands,

Washington, *M. 8<sup>th</sup>* 1866

Major,

The Dist. Commissary desires  
that the necessary pipes be furnished for  
Ship Walker and informs me  
a 9" Elbow is wanted. I enclose  
order for the same on Sibley & Gay.

With your please see that  
the proper Elbow is put up.

Respectfully

*O. M. Brown*

Dist. Com. S. G. O.

Major Funderburgh

Lead Dept.



O.L.S. Reg. MB Vol 1-24. No 26.

Ermer R F<sup>ca</sup> J  
No<sup>d</sup> for allt Corv  
Nov 9<sup>th</sup> 1866

Regus W<sup>m</sup>  
a a a Gab.

Request to the L.S. De. to call  
No<sup>d</sup> for this morning—

No<sup>d</sup> O.L.S. De. Nov 9<sup>th</sup> 1866

Bureau Refugees, Freedmen, & Abandoned Lands,

Head-Quarters Ass't Commissioner D. C.,

WASHINGTON,

Nov 9<sup>th</sup> 1866.

Major. Please call at  
the office this morning.  
Gen Howard wishes to see  
you.

Very Respectfully  
A. H. Rogers  
Assistant Commissioner



O.S. Soc. M.B. Vol 1-24 No 2

Patterson, A. J.  
Nov 9<sup>th</sup> 1866.

Harrison J. W.

Desires to obtain two  
Cold Sents. one Male & one  
Female. will pay latter  
\$10 per month

Recd O.S. Nov 12<sup>th</sup> 1866,



prime Satisfactory I will  
pay ten dollars per month  
I also should like a  
bright intelligent boy say  
from 14 to 16 years of age  
good size for age. I want  
one to put in the store to  
go of errands & the like. I  
want him bright & good looking  
I will give such an one a  
good home. Take him in  
my family & clothe him well  
if he should prove worth  
more to me than his keeping  
I will give it to him.

The nearest rail way station  
is the one here Paterson on the  
One Rail Road. If it is necessary  
I will meet them at the  
New Jersey Rail Road office or depo  
Jersey City: by which road I  
presume you send. I have  
now



prime Satisfactory I will  
pay ten dollars per month  
I also should like a  
bright intelligent boy say  
from 14 to 16 years of age  
good size for age. I want  
one to put in the store to  
go of errands & the like. I  
want him bright & good looking  
I will give such an one a  
good home. Take him in  
my family & clothe him well  
if he should prove worth  
more to me than his keeping  
I will give it to him.

The nearest rail way station  
is the one here Paterson on the  
One Rail Road. If it is necessary  
I will meet them at the  
New Jersey Rail Road office or depo  
Jersey City by which road I  
presume you send. I have  
now



endeavour to give you  
an idea of about what  
I want. & if I can  
be ascertained I shall  
feel under obligations  
to you & your benevolence  
Please answer this if  
at all convenient &  
inform me when  
& where I can expect  
the servants & oblige

Yours very truly

J. P. Hudson

Ms. A. 9. 2. 8. No. 12. 1866.



Tulsa Nov 9<sup>th</sup> 1866.

Mr Candergh Local Supt  
Agriculture Bureau & I

My Dear Sir  
I am obligations to you for  
your favor of Oct 29<sup>th</sup> in  
reply to my letter in reference  
to obtaining servants from your  
bureau. I will state as near  
as I can the kind of a  
servant I want. I want one  
of about 18 to 20 years of age  
fair sized, good teeth & not  
upulaine in appearance of willing  
disposition, & that can wash & run  
the laundry work I am more  
particular about that the cooking  
as my wife will oversee that.  
althoug if I can get one that  
is capable of doing both I should  
like it. Is a girl that will

O.L.S. Vol. MB. 25-1866. No 28.

Washington D.C.  
Nov 13<sup>th</sup> 1864

Robert J. L.  
Supt. ~~of~~

Request rations for 161 men  
for use at E.C. Banks

No. O.L.S. Nov 13<sup>th</sup> 1864.



Earl Capt. A. Barwick

Washington D.C.

Nov 13<sup>th</sup> 1866

My dear Sir

Sir

Please send by the bearer  
retained for Earl Capt. Barwick for six weeks  
one week (42) retained

Respectfully  
Yours truly

J. Roberts

R. Turner  
Exchange

P.S.

I am much pleased to hear of  
your new appointment.

J.P.



Earl Capt. A. Barreter

Washington D.C.

Nov 13<sup>th</sup> 1866

My Vandybush

Sir -

Please send by the bearer  
notices for Earl Capt. Barreter for six weeks  
one week (42) notices

Respectfully  
Yours Obediently

J. Roberts

R. Turner  
J. Farrey  
In Charge

P.S.

I am much pleased to hear of  
your new appointment.

J.P.



O.L.S. NOV 1 Vol - 25 - 1864 No. 29

---

Washington D.C.  
Nov. 14<sup>th</sup> 1866

---

Clark Appleton P.

---

Reports that forty  
freed people have been  
furnished with rations since  
receipt of rations for thirty  
six persons.

---

Rec<sup>d</sup> O.L.S. Nov 14<sup>th</sup> 1866.

394 North Capitol Street  
Washington Nov 14. 1866

Major J. V. W. Vandenberg  
Local Supt of Freedmen W. D. C.  
Bureau of R. F. and A. L.  
Sir

I have the honor to report  
that forty freed people going north have been furnished with  
three days Rations since the receipt of the Rations for thirty  
Six Persons

Very Respectfully  
Your Obedt Servant  
Appleton D. Clark



O.E.S. 71173 1 Vol. 26 1864 No. 30

Craigville N.Y.  
Nov 6<sup>th</sup> 1864.

Thompson Jas. G.

Desires to obtain a colored  
sergeant

He C. L. S. Dec. Nov. 10<sup>th</sup> 1864.



S. 273 R.F. & A.L. Vol 876  
M/pt. 2. No 940 A. B. D. C. 1866  
Craigville, N. Y.  
Nov. 6<sup>th</sup> 1866.

Thompson, James G.

Desires to obtain a  
colored servant.

War Dept. Bu. R. F. & A. L.  
Washington, Nov. 9<sup>th</sup> 1866.

Respectfully referred to  
Bvt. Brig. Gen. C. H. Howard,  
Apt. Court, re. for D. C.

By order of  
Maj. Genl O. O. Howard,  
A. P. Ketchum  
A. A. A. Genl.



Received  
Nov 15 1866

Bureau Refugees, Freedmen & Abandoned Lands  
HEAD QUARTERS ASSISTANT COMMISSIONER, D. C.,  
Washington, Nov. 10<sup>th</sup> 1866.

Respectfully referred to  
Supt. D. C.

By order of Bvt. Brig. Gen. HOWARD.

A. A. A. General.

Craigville Nov 6 - 1866

C. H. Howard  
Freedmen

Dear Sir

I write to let you  
I can now give employment  
and if you send me one  
of good moral character  
be trusty and faithful the  
five Dollars per month and  
board until the first of April the  
nearest Rail Road Station will be  
Craigville on the Newburgh <sup>of the Erie Road</sup> branch  
and then he can inquire for James  
G. Thompson and <sup>any</sup> one in the place  
can direct him please answer and  
let me know if you will send one  
answer on the receipt of this as I want  
to know immediately  
Truly yours James G. Thompson

Received  
Nov 15 1866



S. 273 R.S. & A.L. Vol 8/66  
M. 2. No 944 A. 6. D. B. 1866

Craigville, N. Y.  
Nov. 6<sup>th</sup> 1866.

Thompson, James G.

Desires to obtain a  
colored servant.

War Dept. Bu. R. F. & A. L.  
Washington, Nov. 9<sup>th</sup> 1866.

Respectfully referred to  
Bvt. Brig. Genl. C. H. Howard,  
Apt. Court, re. for D. C.

By order of  
Maj. Genl. O. O. Howard,

A. P. Ketchum  
A. A. A. Genl.



Craigville Nov 6 - 1866

Maj. Gen. O. O. Howard  
Bureau of Freedmen  
Dear Sir

I write to let you  
know that I can now give employment  
to a servant and if you send me one  
send a man of good moral character  
one that will be trusty and faithful the  
wages will be five Dollars per month and  
board until the first of April the  
nearest Rail Road Station will be  
Craigville on the Newburgh <sup>of the Erie Road</sup> branch  
and then he can inquire for James  
G. Thompson and <sup>any</sup> one in the place  
can direct him please answer and  
let me know if you will send one  
answer on the receipt of this as I want  
to know immediately

Truly yours James G. Thompson

Received  
Nov 11 1866



No. 10<sup>th</sup> O.L.S. Co. Nov 10<sup>th</sup> 1866

Vol. 2. No. 93 A. C. D. Co.

Washington, Nov. 10. 1866.

31

Lewis, David.

States, that Mrs Thomas J. Monnett, residing at Bucyrus, Ohio. desires a good Cook or a Nurse, from ten to fourteen years of age. Also a man, who understands general labor on a Farm.

O.L.S. Co. No. 10<sup>th</sup> Nov 10-1866  
12 31

Bureau Refugees, Freedmen & Abandoned Lands

HEAD QUARTERS ASSISTANT COMMISSIONER, D. C.,

Washington, Nov 10<sup>th</sup> 1866.

Respectfully referred to Maj'  
J. V. W. Vandenberg, Supt.  
Supt. S. B.

By order of Bvt. Brig. Gen. HOWARD.

W. P. Rogers  
A. A. General.



Washington D.C

Nov 10 1866

Col W W Rogers,  
A. A. G.

Sir,

Mrs Thomas J  
Monnett residing at Bucyrus, Ohio,  
desires a good Cook and a nurse from  
Ten to fourteen years of age. Also a man  
who understands general labor on a Farm

Very Respectfully  
David Lewis

Capt David Lewis. Can be addressed at office Asst.  
Comm. D.C.



32

Wm R. F. A. L. Vol 8 1866  
No. 1 Washington Nov 1866

Penfield L. W.

Desires to know if the  
colored servants, which he req-  
uested to be sent to New Britain.  
Conn. have been supplied.

O. L. S. M. B. Vol 26-1866-1232.

Wpd to L. S. DC.  
Sept. 25<sup>th</sup> 66



War Department.

Bureau Refugee Fundamentals  
Washington Nov 7<sup>th</sup> 1866

Referred to Pt. Brig Genl  
C. H. Howard, Asst. Commr. for

D.C. to return the previous  
papers now referred Sept 24<sup>th</sup>.  
He will please answer this  
letter.

Quartermaster  
Major Genl. Howard.

A. P. Ketchum  
Asst. Adj. Genl.

1866

James R. F. & A. L.,  
Wd. Qu. A. C. D. C.

Nov. 9, 1866

Respectfully refers to the  
Local Supt. D. C., who  
will reply to this letter,  
in connection with pa-  
pers referred to him on  
the 25<sup>th</sup> Sept. 1866, on the  
same subject,  
By order of

Pt. Brig. Genl. Howard

Wm. Rogers  
Asst.

E. O. Vol. 2. No. 721. A. C. D. C. 1866.

W. O. L. S. Nov. 10<sup>th</sup> 1866



Surg. Genl's Office  
Washington D.C.  
Nov. 6<sup>th</sup> 1866

Genl. Maj Genl. O. A. Howard  
Com. F. B. R. & A. S.  
Genl.

I have the honor  
to enquire if those colored girls  
which I made application for, Sept  
14<sup>th</sup> 1866, were ever sent north, to Norman  
Eddy & Mrs. Ann Simons, New Britain Conn?  
nothing has been heard of them, and  
my friends are very anxious to have  
the girls at once.

I am Genl. Yrs. Respectfully  
Yours obedt. servt.

Luther M. Benfield  
Surg. Genl's Office



S. P. P. A. L. Vol 5, 1866  
Vol. 1 No. 2263 A. C. D. C. 1866  
Washington, Sept. 21<sup>st</sup> 1866.

Penfield, L. Mo.

Application for two colored  
servants, to be sent to New  
Britain Conn.

264



War Department Bu of R. & L. Lands.  
Washington D. C.

September 24<sup>th</sup> 1866.

Respectfully referred to the Assistant  
Commissioner for the District of Colum.  
bia.

By order of  
Major General Howard  
Commissioner.

A. P. Ketchum  
Adj. Supt. Genl.

Head Quarters A. C. D. C.  
Sept 25. 1866.

Respectfully referred to. Bvt  
Maj. Spurgeon Local Supt  
D. C.

By order of the A. C.  
W. H. Rogers  
A. A. G.

Recd D. L. S. Sept 25 1866



Surgeon General's Office

Washington City, Sept 21<sup>st</sup> 1866.

Brig-Maj General. O. O. Howard  
Com. of R. F. and A. L.  
General.

In accordance with instructions received from your office dated Sept. 14<sup>th</sup> 1866. I have the honor to request that you send two Mulatto girls, ages 18 and 20 years, to New Britain Com. Preference given to those of light complexion.

I have the honor to be  
Very respectfully  
Your Obedient servant  
L. M. Penfield  
Clerk S. G. O.

Address.

Norman Eddy Esqr. }  
New Britain Com. }  
Mrs. Wm. Simons }  
New Britain }  
Com. }



O.S. H. M.B. Vol 27. 1866. No 34

Washington D.C.  
Nov. 10<sup>th</sup> 1866

Clark Appleton P.

Requests rations thro  
Mrs Griffing for 29 / Twenty  
Nine Freed people going  
North.

Nov. 12, 1866

Mrs. Griffing

Requests rations for  
twenty nine persons  
going north.

Head Quar A.C. S.C.  
November 14. 1866.

Respectfully referred to  
Maj Vandenberg, who  
will please furnish  
in accordance with  
previous instructions

By order of  
Act Brig Gen Howard

H. H. Rogers  
Adj. Gen.



394 North Capitol Street  
 Washington Nov 12. 1866

Col W. W. Rogers Comd.  
 Bureau of P. O. and A. S.  
 Sir

Mrs Griffing desires me to request Returns

for the following Freed people going north

Jacob Jones	of 14 others	15	Providence	R. I.
James Carroll	" 3 "	4	Newtown	Conn
Harriet Grey		1	Steubenville	Ohio
Alfred Alexander		1	Lincoln	Ills
Alfred Grant		1	Cincinnati	Ohio
James Gilston	" 2 "	3	West Grove	Pa
Sarah Minor	" 3 "	4	Balston Spa	N.Y.
	total	<u>29</u>		

I have the honor to be  
 Very Respectfully Yours  
 Wm. S. Clark



Office of Solicitor  
476 - 7th St.  
Washington D.C. Oct 30/84

Respectfully referred to Prot.  
Priy. Gen. Chas H. Howard Asst.  
Comm. Bureau R. F. & A. S. Judge  
Fisher recommends Mr. Lewis  
as a worthy gentleman he  
is also personally known to  
The Solicitor as such.

Judge Carter desires  
a colored man & woman  
to send to his farm in  
Ohio. We have frequent  
applications of this kind

Very Respectfully  
Yours etc etc

H. S. Brown  
Solicitor etc

Beckwith, Oct

C. S. 711 151 Ave. 7th St. Wash. D.C.

307

1000 1/2 St. N. W. Wash. D.C.

Hon. Gen. A. S. Brown, St.

Oct. 31, 1884

Respectfully referring to  
Mr. Beckwith, who  
will communicate  
with Mr. Lewis, giving  
him such information  
as he may require.

Yours etc  
H. S. Brown

H. S. Brown  
Solicitor



307

C.S.S. 71131700-25.1866.1037

Rec<sup>d</sup> C.S.S. No. 11500

Sept 26, 66

Office of Solicitor  
476 - 7th St.  
Washington D.C. Oct. 30/66

Respectfully referred to Brok.  
Brig. Gen. Charles Howard Abbott.  
Colo. Bureau R. F. S. A. Judge  
fisher recommends Mr. Lewis  
as a worthy gentleman he  
is also personally known to  
Mr. Sullivan as such.  
Judge Carter desires  
a colored man & woman  
to send to his farm in  
Ohio. He has frequent  
applications of this kind

Very Respectfully  
I am Sir  
S. J. Moore  
Solicitor

Hon. Sec. Ashmun, D.C.  
Oct. 31, 1866

Respectfully refers to  
Maj. Vandenberg, who  
will communicate  
with Mr. Lewis, giving  
him such information  
as he may require,

Yours  
The Asst. Com.

H. H. Rogers  
A. A. G.



Near Chesapeake City Md  
Oct. 26<sup>th</sup> 1866

My Dear Sir

As Farm hands are very scarce here I would be glad to know if there would be any probability of getting three or four men from Washington as I hear there are a great many of the Freedmen out of employment there, and we find almost impossible to get men enough to gather our Corn Crops. Many of the Farmers cannot get hands to carry on their work I would therefore be glad if you would hand this, or make my application to some of the agents of the Freedmen and request they would supply me with some men.

We are paying from twelve to fifteen dollars per month or from seventy five cents to dollar per day, as to quality of the hand. I would be under obligations to you if you can send me the men. I have the thanks of

Yours Very Truly & S

James. C. Lewis

Wm Geo P Fisher }  
Washington }  
D.C. }

Please write to me - direct to  
Chesapeake City Md.



39

Wilmington <sup>Pa</sup>  
Apr. 15. 1866

Geno Rev R. S.

Requests information  
relative to getting employees  
for colored <sup>quarry</sup> to go north

W. L. S. Ple. M. B. Vol. 28. No. 39.



Arlington Va

Nov 15<sup>th</sup> 1866

Maj Vandenburg I have the honour of saying to  
you that I am implazed in the burean services  
getting up people for to go to north to work  
I am making a effort of getting them up and  
I do hope you will write me any information  
you think I need in matters I will sure do  
it I will get men or women either that  
want as many as I can get and as fast as I  
can beey Respectful Recy R. S. Lawes agent of for



N 271. R. F. & A. L. Vol 116  
147-4<sup>th</sup> St.  
Troy, N. Y., 41

Nov. 13<sup>th</sup> 1866.  
Vol. 2. No. 167 A. C. D. C. 1866

Nickes, Townsend

Desires to obtain a colored  
servant.  
C. L. S. D. C. 3031 Vol 29. 11/11

War Dept. Bu. R. F. & A. L.,  
Washington, Nov. 16<sup>th</sup> 1866.

Respectfully referred to Bot.  
Maj. Genl. G. H. Howard, Asst.  
Comr. for D. C.

By order of  
Maj. Genl. O. O. Howard, Comr.

James Thomas  
A. A. A. Genl.



For 11

*Received  
Nov 17 1866  
C. L. S. D. C.*

Genl. B. F. & A. L.,  
Ad. Div., A. C. D. C.,  
Nov. 17, 1866

Respectfully referred to  
Maj. Vandenberg, Local  
Supt. D. C.

By order of the  
Asst. Comr.  
H. H. Rogers  
A. A. A. Genl.

76<sup>th</sup> C. S. D. C. 11/17 1866.



July 11<sup>th</sup>, Nov 13<sup>th</sup> /66

I understand, the Government will  
send at its own expense Freedmen  
who have situations offered them,  
I therefore write for a female house-  
hold servant between 18 & 30 years of  
age, send me as soon as possible,

Please answer,

Townsend Wickes  
142 Fourth St



Vol. 2. No. 136 A.C.A.C. 1866

42  
Hockanum, Conn  
Nov. 14<sup>th</sup> 1866

Wadsworth, S. A.

C. S. D. G. No. 136 1866

Requests that the men  
that are on hand be  
forwarded immediately  
We desire to hear from  
the aget. Commis. as soon  
as convenient.

Rec. A.C.D.C. 11/15/66

Bureau Refugees, Freedmen & Abandoned Lands

HEAD QUARTERS ASSISTANT COMMISSIONER, D. C.,  
Washington, Nov 16<sup>th</sup> 1866.

Respectfully referred to Major  
Vanderburgh, Local Supt,  
D.C.

By order of Bvt. Brig. Gen. HOWARD.  
H. P. Rogers  
A. A. General.

11/17/66

Hockanum Nov 14 1866  
H. Howard  
Sir

Will you have  
kindness to forward as  
many as you have at  
the remainder at  
this time, I should like  
from you: at your  
convenience  
Yours Most Respectfully  
J. A. Wadsworth



Vol. 2. No. 136 A.C.B. 1866

42

Hockanum, Conn

Nov. 14<sup>th</sup> 1866

Wadsworth, S. A.

C. L. S. D. C. No. 136 11442

Requests that the men that are on hand be forwarded immediately as desired to hear from the A. S. Commr. as soon as convenient.

Rec. A. S. D. C. 11/15/1866

No. C. L. S. D. C. 11/17/1866

Hockanum Nov 14/1866

Gen. G. H. Howard

Sir

Will you have the goodness to forward as many men as you have at hand, the remainder at another time, I should like to hear from you at your earliest convenience

Yours Most Respectfully  
J. A. Wadsworth



Washington D.C.  
Nov 7. 1866

Sir:

The bearers of this, Elsie  
and Cilla, two Emancipated  
Slaves, are well  
known to me as honest  
and industrious women.

They have heretofore,  
since they obtained their  
freedom, always been  
able to support them-  
selves by their labor;  
but they are very old and  
infirm and in bad health  
now, and are I think,  
worthy



worthy objects of Charity,  
and well deserving of  
the Assistance of the  
Freedman's Bureau.

I therefore, recommend  
them to the favorable  
Consideration of the  
Bureau, and request, that,  
if it be in accordance  
with its regulations,  
permits for fuel and such  
other things as are usually  
distributed to freedmen may  
be given them.

I Am, Sir,

Your Obedt. Servt.

R. Sulick

Commander U. S. A.

Major Genl. Howard  
Chief of Freedmen's Dep't.  
Washington  
D. C.

These persons live on 17<sup>th</sup> Street,  
below the War Department, opposite  
the Barracks,



A 311 P. F. A. L. Vol 866



Head Quarters A.C. S.C.<sup>2</sup>

November 21. 1866.

Respectfully referred to  
Geny R. Keyburn Pres:  
Special Relief Commission

By order of  
Bvt Brig Gen C. Howard

Wm. Rogers  
A.A.G.

E. B. Vol. 2. No. 759. A. C. S. C. 1866.

Head Qrs Dist. of Col.  
Bureau R. S. & S. L. Adams  
Nov. 21. 1866

Respectfully returned. with the  
request that May. Vandenberg be  
instructed to purchase with the  
amount mentioned here out of funds of Relief Comm

Robert Keyburn

Brvt Lieut. Col. & Pres. Sp. Rel. Comm

O. L. S. C. W. B. 1055-9. 1866 -



45  
A311 (R. F. & A. L. Vol. 8) 1866.

Vol. 2. No. 131 A.C.D.C. 1866

Washington D.C.

November 7, 1866.

Articles - R

Commander U.S.A.

Q.L.S. No. 70310d. 3d 1865

Recommends two colored wo-  
men to the favorable consid-  
eration of the Bureau, as  
objects of charity

Wrapper---( / Enclosures.)

WAR DEPARTMENT,  
BUREAU REFUGEES, FREEDMEN AND ABANDONED LANDS,

Washington November 13 1866.

Respectfully referred to

Brig. Genl. C. W. Howard

Asst. Commissioner for Dist

Columbia.

By order of

Brig. Genl. C. W. Howard

Jamil Thomas  
Actg. Asst. Brig. Genl.

U.S.A. 11/17 1866

Bureau Refugees, Freedmen, & Abandoned Lands,

HEAD QUARTERS ASSISTANT COMMISSIONER, D. C.,

Washington, Nov. 14 1866.

Respectfully referred to

Wandenburg Local

Supt D.C. who will

investigate the case

of the persons within

named, and if proper

subjects, for Freedmen's

Village, will so rec-

ommend, ~~there~~.

By order of the

Asst. Commr

W. H. Rogers

aaay.

C. D. Vol. 2. No. 737. A.C.D.C. 1866.



45  
A311 (R. F. & A. L., Vol. 8) 1866.

Off. Col. 2. No. 131 A. C. D. C. 1866

Washington. D. C.

November 7, 1866.

Aulick - R

Commander U.S.A.

O.L.S. No. 311 Vol. 3. 11/11/66

Recommends two colored wo-  
men to the favorable consid-  
eration of the Bureau, as  
objects of charity

Wrapper---( / Enclosures.)

WAR DEPARTMENT,  
BUREAU REFUGEES, FREEDMEN AND ABANDONED LANDS,

Washington. November 13<sup>th</sup> 1866.

Respectfully referred to

Brig. Genl C. N. Howard

Asst. Commissioner for Dist

Columbia.

By order of

Adj. Genl C. C. Howard

Sam'l Howard  
Actg. Asst. Adj. Genl

Rec. O.L.S. 11/17/1866

Office Local Supt D.C.  
November 20<sup>th</sup> 1866

Respectfully forwarded to Colonel  
Rogers A.A. a Genl D.C. I  
called on the within named Col<sup>d</sup>  
women and found one of them  
sick with chills. I offered to  
send them to Freedman's Village. But  
they said Commander Aulick  
U.S.A. told them not to think  
of such a thing. All they ask  
is to be assisted to some fuel.  
They are able and willing to  
work. I think they are  
worthy of some assistance  
and recommend that (14) one  
quarter doz of local be provided  
them by the Special Relief Com-  
-missioning.

J. Waudenburgh  
Local Supt D.C.  
O.L.S. No. 311 Vol 34. 1866



Dear B. F. A. S.

Hq. Qu. A. C. D. C.

Nov. 19, 1863

Respectfully refers to the  
Local Supt. A. C.

By order of the

Aut. Com.

Thos. Rogers

A. C. D. C.

Answered —

Nov 21, 1863

J. A. W. —

Nov. 21, 1863



499. R. F. & A. L. Col. 1866  
No. 2. No. 150. H. C. D. C. 1866  
Pawtucket R. I. 47  
Nov. 12<sup>th</sup> 1866

Manning G. E.

O. L. S. Dec. 21. 1866. No. 117.

Wishes to know terms on which a Contra-  
band boy will be sent - on application  
for him

War Department

Bureau R. F. & A. L.,

Washington Nov 17. 1866

Respectfully referred to Port. Brig.  
Genl G. H. Howard, Assistant  
Commissioner of the District of  
Columbia. By order:

Saml Thomas  
a. a. a. g.

Recd Nov, 15 1866

Pawtucket Nov 12<sup>th</sup>  
1866.

Maj. Gen. Howard

Dear Sir,

On what terms  
do you send out "contraband"  
boys upon application for a home.  
Please inform me in all the  
particulars by return mail and  
office

Yours respectfully  
G. E. Manning  
Pawtucket  
R. I.  
Payles Bleachery



O.L.S. Doc. No. 32, No. 48

Springfield, Mass  
Nov. 19<sup>th</sup> 1866.

Field. Maj. Wm D.

Desires to obtain a colored  
woman for servant, requests  
a reply immediately.

No. O.L.S. Doc. 11/20 1866.

P.R. vol. 2. No. 201 A.C.S.G. 1866

Springfield Mass  
Nov 19<sup>th</sup> 1866

Agt Ferdinandus Bursau  
Washington D.C

Can you furnish me with  
a Col'd woman to do plain  
Cooking, washing &c for my  
family. I live one mile  
out of the city.

1866

For a capable honest  
woman I will pay good  
wages. If reference is  
required. I can refer  
you to Col. S W Osse, and  
Mr Chadwick (willards) of your  
city or to Hon Geo Ashmun  
of this city and others. An  
Early reply will oblige

Major Wm D Field



O.L.S. De. WPB. Vol. 32, No. 48

Springfield, Mass  
Nov. 19<sup>th</sup> 1866.

Field. Maj. Wm D.

Desires to obtain a colored  
woman for servant, requests  
a reply immediately-

Re. O.L.S. De. 11/20 1866.

Bureau Refugees, Freedmen & Abandoned Lands

HEAD QUARTERS ASSISTANT COMMISSIONER, D. C.,

Washington, Nov. 20 1866.

Respectfully referred to Maj.  
Vanderburg, Local Super  
D.C.

By order of Bvt. Brig. Gen. HOWARD.

Am. R. G. A. A. Gen.

1866

For a capable honest  
woman I will pay good  
wages. If reference is  
required. I can refer  
you to Col. S W Owsen, and  
Mr Chadwick (willards) of your  
city or to Hon Geo Ashmun  
of this city and others. An  
Early reply will oblige  
Major Wm D Field

P.R. vol. 2. DC. 201 A.B.D.C. 1866

Springfield Mass  
Nov 19<sup>th</sup> 1866

Bureau  
Washington D.C.

furnish me with  
woman to do plain  
washing &c for my  
I live one mile  
the city -



C. S. No. 710312d 32. N<sup>o</sup> 49.

---

East Capt<sup>y</sup> Benckly

Nov 19<sup>th</sup> 1866.

---

Robert J. L.

Sup<sup>t</sup> &c

---

Request rations for  
Me at Benckly.

---

Rec<sup>d</sup> C. S. 11/20 1866



East Capitol St. Barracks.

Washington, D. C.

November 19<sup>th</sup> 1866.

Sir

I have the honor to request that forty-two  
(42.) rations be sent by the bearer, to this camp—

Respectfully —

Your Obedt Servant —

J. H. Porter, Captain

Major Ganderburg.



East Capitol St. Barracks.

Washington, D. C.

November 19<sup>th</sup> 1866.

Sir

I have the honor to request that forty-two  
(42.) rations be sent in the evening, to the camp—  
Respectfully—

Your Obedt Servant  
J. P. Roberts, Captain

Major Vandenberg.



O.L. S. Doc. M.B. 20(33) 19 51.

Washington, D.C.  
Nov. 20 1866

Clark, A. P.  
Agent &c.

Requests that rations  
be furnished twenty  
nine (29) freed persons,  
who are going north.

Rec. O.L. S. Doc. "1/21, 1866.

General R. F. A. S.,  
Ad. Qu. A. C. D. C.  
Nov 20 1866

Respectfully referred  
to Major Vandenberg,  
Local Supt. D.C. who  
will please furnish in  
accordance with pre-  
vious instructions.

By order of the  
Asst. Comm.  
H. P. Rogers  
A. C. D. C.



394 North Capitol Street  
Washington Nov 20. 1866

At Col W. W. Rogers A.A.S.  
Bureau R. & A. S.

Sir

Mrs Griffing desires me to request  
Rations for the following persons going north

James Washington & 5 others	6	Hartford Ct
Ann McDevie " 9 "	10	New York
Lydia Nelson " 4 "	5	Battle Creek Mich
Henry Mason " 1 "	2	Worcester Mass
Harvey Butler " 2 "	4	Middlebury Vt
Thomas Bailey " 2 "	3	New Castle Pa
total	<hr/> 29	

I have the honor to be  
Very Respectfully Yours  
Appleton P. Clark



Philadelphia Pa

Nov 19<sup>th</sup> 1866

52

Rev Raymond J.  
Sect Pa. S. R. Assn

Acknowledges Receipt of  
letters Relative to the case  
of Mary E. Johnson etc  
vs Mrs J. Griffing -

O.L.S. No. 711312633 1866.  
1852.

Recd O.L.S. D.C. Nov 21/66

Pennsylvania Branch

AMERICAN FREEDMAN'S UNION COMMISSION,

No. 424 WALNUT ST., PHILADELPHIA.

Nov. 19<sup>th</sup> 1866.

Brevet Maj. W. F. Spurgin, Local Supt.  
Washington, D. C.

Dear Sir:

Yours of  
the 16<sup>th</sup> inst. relating to Mary E. Johnson  
and covering a note from Mrs Griffin  
concerning her, and my own asking  
for transportation for her, was duly  
received this morning.

As the girl insisted in refusing  
such employment as we were able to  
furnish her, and from the fact  
appeared <sup>to be</sup> dissatisfied, and sent her  
under some misapprehension, I deemed  
it proper to ask for transportation to  
send her back, and on the 10<sup>th</sup>  
sent her to Washington.

Thanking you kindly for the interest you  
have taken in the matter, I remain  
Yours truly,

Raymond Burr.

711 Sanson St.



W. L. ...

Don't ...

Nov 19<sup>th</sup> 1866

Wadsworth St.

Desires information about  
Coldmen, as to when they will  
start for home.



Head Quarters Art Corps D.C.  
November 27<sup>th</sup> 1866

Respectfully referred to  
Maj Vandenberg Sout Subt  
D.C., who will please fur-  
nish Mr Wadsworth with  
the desired information,

By order of

Art Brig Gen Howard

H. H. Rogers

a.d.g.

Narragansett Nov. 19<sup>th</sup> 1866  
Gen C. H. Howard

Sir

I wish you  
would, inform me when those  
men will be likely to start,  
it is fine weather now  
and I feel anxious to  
get settled, and at work  
likewise it will be  
likely to be cold soon  
The Comm River will close  
and the boats stop running  
which will make it very  
uncomfortable.

Will you have the goodness  
write by the return mail  
and much oblige

Your <sup>very</sup> humble servant

J. A. Wadsworth

Hockanum Ct



Head Quarters Art Corps D.C.  
November 27<sup>th</sup> 1866.

Respectfully referred to  
Maj Vandenberg Sout Subt  
D.C., who will please fur-  
nish Mr Wadsworth with  
the desired information,

By order of  
Bvt Brig Gen Howard  
J  
H. H. Rogers  
a.d.c.

Narragansett Nov. 19<sup>th</sup> 1866  
Gen C. F. Howard

Sir

I wish you  
would, inform me when those  
men will be likely to start,  
it is fine weather now  
and I feel anxious to  
get settled, and at work  
likewise it will be  
likely to be cold soon  
The Comm River will close  
and the boats stop running  
which will make it very  
uncomfortable.

Will you have the goodness  
write by the return mail  
and much oblige

Your <sup>very</sup> humble servant

J. A. Wadsworth

Hockanum Ct



1248 R. F. A. L. Vol. 111

1116.2.712.2 (1116.2.712.2) 54

Waterloo, N.Y.

Nov. 17<sup>th</sup> 1866.

Bacon, Francis

C. S. D. Co. 1116.2.712.2

Desires to obtain a colored  
servant.

War Dept. Bu. R. F. & A. L.

Washington, Nov. 21<sup>st</sup> 1866.

Respectfully referred to B. O. H.

Brig. Genl C. H. Howard, Adj. Comr.

&c. D. C.

By order of

Maj. Genl C. H. Howard, Comr.

A. P. Ketchum

Adj. Comr.

Bureau R. F. & A. L.

Head Quarters A. C. D. C.

Nov. 22, 1866

Respectfully refers to the  
Local Supt. D. C. who will  
please answer this letter.

By order of the

Asst. Comr.

W. H. Rogers

Adj. Comr.

REC'D Nov. 22 1866



Watertown, Seneca Co., N.Y.  
Saturday, Nov. 17<sup>th</sup> 1866.

Ag. Freedmen's Bureau  
Washington D.C.

I find in  
different parts of the country. Persons in  
want of servants and field hands have  
been supplied by sending to the Freed-  
men's Bureau in Washington. I want  
a farm servant accustomed to all  
kinds of house work. Would rather  
have a middle-aged woman. Can  
such a one be sent me? and can  
a number of men be sent for my-  
self and neighbors next March - if we  
should want them?

By answering these questions  
you will

Grately Oblige

Francis Bacon

Watertown,

Seneca Co.,

N.Y.

P.S. If the woman can be sent  
immediately, send her to the  
above address. F. B.



C. S. C. No. 34. 1855.

Hockanum Comm.  
Nov. 21<sup>st</sup> 1866.

Wadsworth S. A.

Requests that the  
Colored men be forwarded  
immediately, also states  
from the Boatmen of  
city.

P. O. S. C. 11/23 1866.

Hockanum Nov. 21<sup>st</sup> 1866  
J. W. W. Vandeburgh Esq.

Sir,  
Yours of the 17<sup>th</sup> is at hand  
in Reply will say. Men that  
are at work on one lot of  
Wood (which I was oblige to  
give up) are making \$2.00  
per Day at \$5.00 per cord, our  
Chestnut Wood is much easier  
to cut, than the wood about you,  
than I furnish House Rent and  
Fuel. I want 24 Men which I will  
pay \$10.00 per Month and Board.  
I should like them about 20 years  
old - I cant pay any more for the  
jobs I have on hand. Any Boy 18 years  
old can earn \$1.50<sup>00</sup> per Day, than  
I can give the Women & Smaller Boys  
some work if they wish.  
I wish you would send as many as



You can immediately. The Family  
are waiting very impatiently for  
them. I will do the best  
I can by all of those that come  
I can not tell what I can do  
until I see what they can do  
I have 600 Cord to cut in one  
lot near the House. The best Chopin  
I ever saw.

The Boat Starts from New  
at the South Side of Peck  
Slip. Comes up the Sound to  
Connecticut River, and will  
let the Company off at  
South Glensbury. I trust  
I shall get a letter on  
Monday Night, when to meet them  
in York.

Yours Most Respectfully

J. A. Wadsworth



56

*P.O. R. F. & A. L. Vol. 2*  
Vol. 2. No 214 A. C. D. C. 1866  
Springfield, Mass.,

November 19. 1866

Tift - L. A.

Agent F. N. Agency.  
*N.B. Vol. 34. O. L. D. C. 1866*

Encloses application of G. Keith  
of Springfield, for a servant,  
& requests information on  
various points connected with  
the supplying of colored ser-  
vants to persons in the North  
desirous of their services.  
Stamp Date



War Department

Bureau R. F. & A. L.

Washington Nov 21. 1866

Respectfully referred

to the Assistant Commissioner  
for the District of Columbia,  
for the information requested  
in this letter.

By order of

Major General Howard,

**A. P. Ketchum**

A. A. A. General.

1 Bureau R. F. & A. L.

No. 20. A. C. D. C.

Nov. 22. 1866

Respectfully referred to Maj.  
Randolph, Local Supt. D.C.  
who will please furnish the  
information desired.

By order of the

Asst. Commissioner

**A. H. Rogers**  
A. A. A. Gen.

E. O. Vol. 2. No. 764. A. C. D. C. 1866.

*R. F. O. L. D. C. 11/23 1866.*



Springfield, Mass, Nov 19. 1866.

Major Genl O. O. Howard  
Freedmen's Bureau  
Washington, D.C.  
General:

I enclose herewith  
a single application for help and take this  
opportunity to ask a few questions for infor-  
mation in anticipation of my necessities.  
How large is the supply of laborers or servants,  
and what classes can be easiest supplied?  
How soon after you receive the orders will  
or can the parties be delivered here? What  
condition will they be in as to clothing and  
what assurance will applicants have that  
they will get the class of laborers they  
apply for? Please give me any and all  
information that will be of service to the  
Dept myself and applicants and  
oblige

Very Resp'y.

Yours Obedt Servt.  
L. A. Piff

Ag't F. H. Agency.

A. B. Please send all parties for  
this Agency via Hartford.



Springfield, Mass. Nov 19. 1866.

Maj Genl O. O. Howard  
Freedmen's Bureau  
Washington D.C.  
General:

I enclose herewith  
a single application for help and take this  
opportunity to ask a few questions for infor-  
mation in anticipation of my necessities.  
How large is the supply of laborers or servants  
and what classes can be easiest supplied?  
How soon after you receive the orders will  
or can the parties be delivered here? What  
condition will they be in as to clothing and  
what assurance will applicants have that  
they will get the class of laborers they  
apply for? Please give me any and all  
information that will be of service to the  
Dept myself and applicants and  
oblige

Very Resp'y.

Yours Obt Servt.

L. A. Tift

Ag't F. H. Agency.

A. B. Please send all parties for  
this Agency via Hartford.



Gershom Keith, Springfield, Mass  
(Boarding House Keeper)

Wants - A woman as cook & housekeeper  
& general help - If she has two children  
a boy & girl or two girls from 10 to 14  
she will take all three - if healthy. Or  
if she has but one child 3 or 4 years  
old will take her.

L. A. Tift  
Agent.



*Handwritten scribble or signature*

*R. O. L. H. 11/23/1866*



M.B. Vol 36. O.L.S. No 62.

---

Washington D.C.

Nov 26<sup>th</sup> 1866.

---

Chamberlain S.E.  
Clerk.

---

Desires to obtain 131 colored  
serants for a "Sound Union  
Man." in Loudon. Co. Va.

---

Rec<sup>d</sup>. O.L.S. 11/27 1866.



N.B. Vol 36. O.S. No 62.

---

Washington D.C.  
Nov 26<sup>th</sup> 1866.

---

Chamberlain S.E.  
Clerk.

---

Desires to obtain 131 Colonel  
arrants for a "Sound Union  
Man." in Loudon. Co. Va.

---

No. O.S. 11/27 1866.



War Department,  
Bureau of Refugees, Freedmen, and Abandoned Lands,  
Washington, Nov. 26<sup>th</sup> 1866.

Captain

I am desirous of obtaining the  
services of

one Freedman. who understands farming well,  
whose wages will be \$40 per month for one year;

one Woman. who understands housework, thoroughly  
whose wages will be \$4.00 per week for one year

one Boy. about 15 yrs of age. acquainted with taking  
care of horses, and who will make himself  
generally useful.

These people to go to Waterford  
Louisa Co. Va. in the family of a sound Union  
man & Quaker. The freedmen have a school at  
this place, and are building a church;

I am Capt. Very Respectfully

Captain Vanderburgh.

Supt. of Freedmen &c  
Washington D.C.

Young 04 Servt  
J. O. Chamberlain,  
Clerk



NB Vol 37. O.L.S. No 65

---

Head Quarters U.C.

Nov 27<sup>th</sup> 1866.

---

Rogers. Wm. W. Capt Lt  
Col. a wa Genl.

---

Direct thro the Act Com:  
that the Hall over employ-  
ment office be turned over  
to Rev John Kimball for  
Sabbath School &c.

---

Rec. O.L.S. 11/27/1866.



Bureau Refugees, Freedmen and Abandoned Lands,  
Headquarters Ass't Commissioner, District Columbia,

Washington, November 27<sup>th</sup> 1866.

Major J. W. W. Vandenberg  
Local Supt. D. C.

Major:

The Assistant Commissioner directs  
that the "Hall over the employment of-  
fices at Miswell Barracks be turned over  
to the Rev. John Kimball, Supt. of Colored  
Schools, D. C. for use of Sabbath Schools,<sup>nd</sup>  
like purposes.

Very respectfully

Your obedient servant

Wm. Rogers

A. A. Genl.



W.P. 1 Vol 38. O.L.S. A. 67.

Washington D.C.  
J. 331. N. 7. A. 1. 4 Vol. 1866  
For 26 1866.  
Vol. 2. N. 254. A. 6. D. C. 1866

C. B. R. 7. 1. A. L. 18. 66  
Jones Julia [Cold]

Makes statement in reference  
to her 2 children who are  
bound out to Miss Owen  
(w) Paris at King George C. H.  
Va. Also that they be returned  
to her.

Office, Local Supt D.C.  
Washington Nov. 28/66

Respectfully forwarded to Bot  
Lieut Col. ~~Wm. H. Rogers~~ A. A. A.  
Genl. D.C. Bureau, R. F. and A. L.  
the (Cold) woman Julia Jones  
the writer of this communication  
appears to be an honest woman  
I would respectfully recommend  
that her statement be forwarded  
to the Officer in Charge at  
King George Court House, for  
investigation and report.

J. Waudenburgh  
Local Supt D.C.

O. L. S. 218. 1 Vol 58. 1866

Bureau R. F. and A. L.  
Hon. Genl. Asst. Commr. B  
Washington, Nov. 30/66

Respectfully forwarded to  
the Commissioner, Bu-  
reau R. F. and A. L. with  
the request that the  
case within referred to,  
may be investigated, and  
if the statement con-  
tained herein, be true,  
that measures be taken to  
have the children re-  
turned to their parents.

C. H. Howard  
Bot. Brig. Genl.

Asst. Commr.  
E. B. Vol. 2. No. 790. A. C. D. C. 1866.



War Dept. Aw. R. F. M. S.

Washington Dec. 3 1866

Respectfully referred to Bot  
Maj. Genl. J. M. Schofield U.S.A.  
Asst. Coms. for Virginia, for  
investigation and report.

These papers to be returned  
with report.

By order of  
Major Genl. Howard Combs

**A. P. Kerchner**

W. A. A. General.

Bureau R. F. M. S.  
Asst. Dir. Asst. Comin. Dept.  
Richmond Va Dec 5 1866

Respectfully referred  
to Maj James Johnson  
Supt. for investigation  
and report. This paper  
to be returned.

By order of  
Bot Maj Genl Schofield  
Asst Comin  
O. F. W. W.  
A. A. G.

W. A. A. General.



Children aged respectfully 9<sup>and</sup> 11 years be returned to me. As I am satisfied by observation that they are not properly treated.

I am a resident of Washington Dist of Columbia, have a Husband who with myself can support and educate our Children.

Very Respy  
Yours Obedt Servt  
Julia <sup>her</sup> ~~Wash~~ Jones

Witness  
John C. Abel  
Clerk, C. S. D. C.

New Sept. An. R. F. 1866  
Washington Dec. 3<sup>d</sup> 1866  
Respectfully referred to  
Maj. Genl. J. M. Schofield U.S.A.  
Asst. Com. for Virginia, for  
investigation and report.  
These papers to be returned  
with report.  
By order of  
Major Genl. Howard Comd

A. F. Ketchum  
w. a. a. General.  
Bureau R. Road  
Asst Comd Comd Dept.  
Richmond Va Dec 5<sup>th</sup> 1866

Respectfully referred  
to Maj James Johnson  
Supt of for investigation  
and report. These papers  
to be returned.  
By order of  
Maj Genl Schofield  
Asst Comd  
O. J. Moran  
a. a. a. g.



Bureau of R. F. and A. L.  
Office Sup't. 6<sup>th</sup> District, Va.  
Fredericksburg, Va. Dec 17, 66

---

Respectfully referred to Lieut  
Nector Sears, Asst Sup't, of  
the Sub Dist of Stafford  
and King George Counties,  
for investigation and report.  
This paper to be returned.

James Johnson

Erwin }  
P. 281. }

Major T. R. C. Sup't





Bureau of R. F. and A. L.  
Office Sup't. 6<sup>th</sup> District, Va.  
Fredericksburg, Va. Dec 14<sup>th</sup>

---

Respectfully referred to Lieut  
Nector Sears, Asst Sup't. of  
the Sub Dist of Stafford  
and King George Counties,  
for investigation and report.  
This paper to be returned.

James Johnson  
Erw } Major V. R. L. Sup't  
P. 281. }

---





Washington, D.C.

Nov 26<sup>th</sup> 1866.

Maj. J. W. Vandenburg

Local Supt. D.C.

Bureau R. F. Co. G.

Major

I have the honor to submit the following statement. Previous to the rebellion my two children named Caroline and Maria Jones, were sold by my Master and carried South.

I recently ascertained that they were at or near King George Court House Va. Some two weeks ago I went to the Court House and found my children. Caroline with Mr Wm Owen and Maria with Mr John Paine, they refused to give me my children. Claiming that they had been bound to them until they become 18 years of age, by Lieut Robinson, formerly Supt. of Freedman's affairs at King George Ct. H. Va.

I most respectfully ask the interposition of the Freedman's Bureau to the effect that my

Yours



Bureau of Refugees & Freedmen  
Office of Sup't. Sub Dist. Stafford & King Cos  
Fredericksburg Va Dec. 14, 1866

EB 1 Vol 80. O.L. 5 Dec 1866.  
Respectfully returned to Major James Johnson Sup't. 6<sup>th</sup> Va District, with the information that I have investigated the case referred to within, and find that at the time Caroline was bound to Mr Owens [May 12, 1866] she was entirely destitute, that Lieut Roberts made an endeavor to ascertain whether or not the child's parents were living but was unsuccessful. she is well cared for, kindly treated, contented and happy, and wishes to remain with Mr Owens.

Caroline is not bound to Mr James but wishes to remain with him, she is also kindly treated happy and contented.

Hector Sears  
2<sup>nd</sup> Lieut U.R.C &  
Asst. Superintendent

6.18.66  
990

One enclosure

1866

J. 331. R. F. & A. S. of P. A. V. 66  
Bureau of R. F. and A. Land.  
Office Sup't. 6<sup>th</sup> District Va,  
Fredericksburg, Va, Dec 15, 1866

Respectfully returned to Brig Genl O. Brown, Adj. G., inviting attention to endorsement of Lieut Hector Sears Asst Sup't

James Johnson  
Capt U.S. Army  
P. 287.3 Major U.R.C. Sup't.

Bureau R. F. & A.  
Adj. Genl Asst Comd Dept  
Richmond Va Dec 18/66

Respectfully returned to Major Genl O. Howard Comd inviting attention to endorsement of Lieut Hector Sears Asst Sup't.

Major Genl O. Howard  
Adj. Genl  
REC'D  
DEC 19 1866

EB 152. R. F. & A. S. of P. A. V. 66

War Department  
Bureau of R. F. and A. Land.  
Washington Dec 19 66

through Asst Comd D.C.  
Respectfully returned to Julia Jones inviting her attention to the endorsement of Lieut Hector Sears Asst Sup't hereon

By order of  
Major Genl O. Howard,  
A. P. Ketchum  
Acting Asst Adj. Genl.



E. B. Vol. 2. No. 275. A. C. D. C. 1866.

Baron R. P. A. L.

H. G. A. C. D. C.

Dec. 30. 1866.

Respectfully returned  
to the Local Supt. A. C.  
attention invited to  
endorsement heron,  
of Lieut. Sears, Asst  
Supt. Frederickburg Va.

By order of

Robt. B. C. A. C. D. C.

H. P. Rogers  
A. C. D. C.

E. B. Vol. 2. No. 275. A. C. D. C. 1866.



N.P. Vol 39, O.S. 1869

---

Washington D.C.

Nov. 27<sup>th</sup> 1866

---

Keyburn Robert  
Surg U.S. Vols.

---

Gives notice of a meeting  
of the members of the Spirit  
Relief Commission at Room  
of Hon S. Bowen, at City  
Pat Office

---

P.O.S. No. 1128. 1866



Bureau Refugees, Freedmen and Abandoned Lands,  
Special Relief Commission  
Headquarters ~~Asst~~ Commissioner, District Columbia,

Washington, November 27<sup>th</sup> 1866.

Col. Maj. J. V. M. Vandenberg

Superintendent.

Sir

You  
are hereby requested to notify the Visiting Agents in your  
District, that the Monthly Meeting of the Visiting Agents  
& Superintendants of the Special Relief Commission will  
be held at the room of the Hon. Fayler J. Brown, Post  
office Washington D. C. on Friday evening November 30<sup>th</sup>  
1866 at 7 1/2 o'clock P. M.

By order of Col. Brig. Genl. G. M. Howard  
Robert Kenburn

Col. Lt. Col. Sarg. W. M. S. S. S.  
President Special Relief Comm.



No 223 <sup>70</sup> (R. F. & A. L., Vol. 8) 1866.

Vol. 2, No 238 A.C. D.C. 1866  
North East, Cecil Co., Md.

November 22, 1866.

Holmes - Jas D.

Wants a colored woman for  
a housewarrant; is northern &  
radical.

If he can be supplied, will  
send funds for expenses.

M.P. Vol 39, O.L.S. No 711

Wrapper---( / Enclosures.)

WAR DEPARTMENT,  
BUREAU REFUGEES, FREEDMEN AND ABANDONED LANDS,

Washington... Nov 26... 1866.

Respectfully referred to Col  
Brig. Genl C. H. Howard,  
Assistant Commissioner for the  
District of Columbia.

By order of  
Major Genl Howard

A. C. Ketchum  
Adj. Genl.

Genl B. F. A. L.,  
Std. 20, A.C. D.C.,  
Nov. 27, 1866

Respectfully referred to the  
Local Supt. D.C.,

By order of  
Brig. Genl Howard  
Thos. J. [unclear]  
Adj. Genl.

R.F. O.L.S. D.C. 11/28/1866



North East N. C. Nov 22/66  
To the Freedman Bureau Agency

Gent

Can you send me a Freed  
woman Capable of doing  
general housework - Milking  
washing &c on a Farm, Clean  
Sidy & honest. to such a  
one will find a good home  
and pay  
we are Jersey People and  
Radical

Please answer whether you  
can send one or not. if  
you can I will send funds  
to pay the Transp.

Yours Respy  
Jas B Holmes



Vol. 2, No. 250 A.C.S. Co. 1866  
Carter, Paul C.

November 23, 1866

71

Carter, Paul C.

Desires to have a "negro girl,  
orphan preferred; will pay  
for her transportation, com-  
fortably, clothe & educate her &  
pay her good wages.

M.P. Vol 39, O.L.S. No. 11



70 94 O.L.S. No. 11/30/1866

New Dept. Civ. R. Frade  
Washington Nov 28, 1866  
Respectfully referred to the  
Assistant Commissioner, Dist-  
rict of Columbia,  
By order of  
Major Genl. O. S. Howard Comr

James Thomas  
Capt. Dist. Adjt. Genl.

Samuel B. F. A. L.  
Hd. Qu. A. C. S.  
Nov. 30, 1866

Respectfully referred to  
the Local Supt. D. C.  
By order of  
Wm. H. Howard

Wm. H. Howard  
Assistant



"Quincy Mass."  
Nov 23<sup>d</sup> 1866.

Gen O. J. Howard

Gen<sup>l</sup>.

Can I be furnished  
with a "negro girl" Orphan preferred  
by paying all expenses from point  
of embarkation here:

I guarantee that said  
charge shall be comfortably clothed  
Educated and paid reasonable wages.

If not too much trouble  
please advise me in the premises.

If I remain Gen<sup>l</sup>  
Your very Obedient Servant

Gen O. J. Howard

Quelbaster.



72

Elktonville N. C.  
Nov. 24. 1866

C. H. A. F. A. L. Vol. 11  
Vol. 2 P. 252 C. C. D. C. 1866  
Craig James

Desires a servant, (Colored)  
and information as to the  
wages paid to colored  
servants

M. D. Vol. 40, C. C. D. C. 1866

W. C. D. C. D. C. 11/30 1866

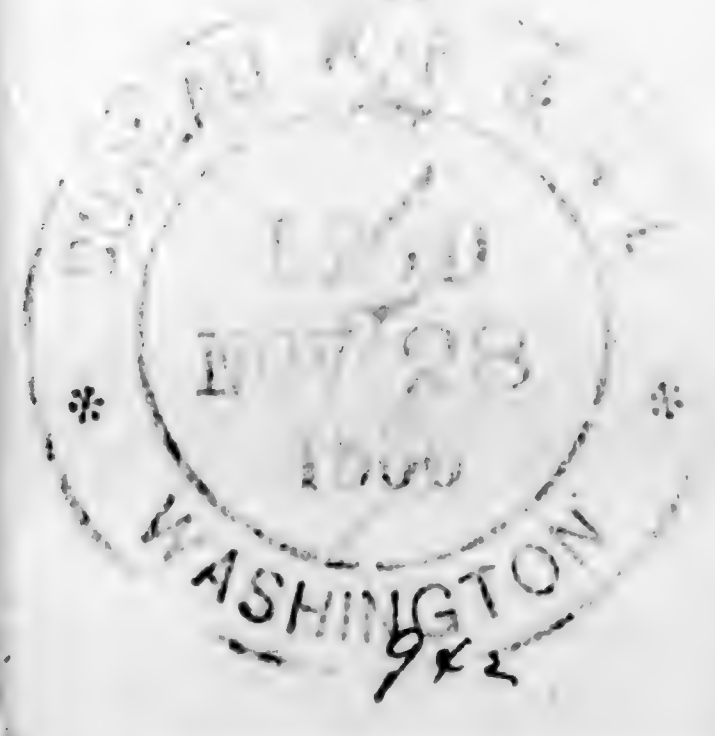

Received by A. F. ...  
Washington Nov 20/66  
Respectfully referred to the  
Assistant Commissioner  
District of Columbia.  
By order of  
Maj. Gen. Thomas Coan.

James Thomas  
Adj. Gen. Adj. Gen.

James A. F. ...  
Adj. Gen. Adj. Gen.  
Nov. 20, 1866

Respectfully referred to  
the Local Sup. D. C.,  
By order of  
Maj. Gen. Thomas Coan  
Adj. Gen.



72

Elktonville N. C.  
Nov. 24. 1866

C. H. A. F. A. L. Wilder  
Vol. 2 of No. 252 A. C. D. C. 1866  
Craig James

Desires a servant, (Colored),  
and information as to the  
wages paid to colored  
servants.

M. J. Pollock, D. C. S. A. 72

Rec'd. D. C. D. C. 11/30 1866.

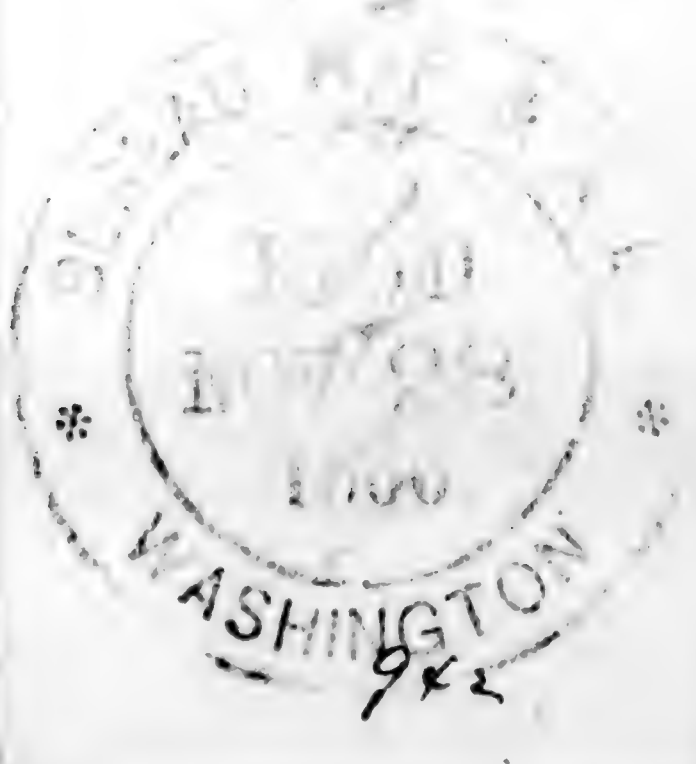

Received by the Act of  
Washington Nov 20/66  
Respectfully referred to the  
Assistant Commissioner  
District of Columbia.  
By order of  
Maj. Genl. Thomas Logan.

Saml Thomas  
Detg. Detg. Adj. Genl

Simon B. F. &c  
H. D. D. H. C. D. C.  
Nov. 30, 1866

Respectfully referred to  
the Local Sup. D. C.,  
By order of  
Robt. M. G. Luskwood  
H. D. D. Rogers  
Adj. Genl.



Ellicottville Nov. <sup>th</sup> 24, 1866

Gen. S. B. Howard Jr. Sir

I frequently see notices in the public papers of how sending the freed-people north when suitable places can be secured for them — I would engage a woman of 45 years of age or a girl of from 10 to 15 — either by the month or year according to the rules of the Bureau — If you would write letting me know if you have any under your care about that age that would be disposed to come north — Also stating the wages usually paid to that description of people with good habits — reference how require ~~the~~ you will much oblige

Yours truly

James Craig

If you reply the address is

James Craig  
Ellicottville  
Catt. Co.

New York



Vol. 2. No. 24 / A.C.D.C. 1866

73

Mr. Ryersons Station, Tenn.  
November 26<sup>th</sup> 1866

Brooker,

Rebecca J.

A.C.D.C. 11473

Desires to obtain a  
colored roomman.

Rec'd C.S.O.C. 11/20/1866

Ryersons Sta. Tenn

Capt. Fredman, Breau

I wish to get a Colored  
Woman for a Kitchen  
maid one that will be  
competent to do most  
any kind of house work  
if one out of employment  
please let me know soon with  
what her salary would be  
either by week month or year  
I will if a good one give  
her a permanent home  
with me

Hoping that I  
may succeed in getting one soon

26<sup>th</sup> Nov 1866

I am Sir

Respectfully

Rebecca J. Brooker

Ryersons Station, Tenn



Vol. 2. No. 24 of A.C.D.C. 1866

73

Myersons Station, Tenn  
November 20<sup>th</sup> 1866

Brooker,

Rebecca J.

A.C.D.C. 1197

Desires to obtain a  
colored room man.

Rec'd. S.O.C. 11/20/66

Bureau Refugees, Freedmen & Abandoned Lands

HEAD QUARTERS ASSISTANT COMMISSIONER, D. C.,

Washington, *Nov 20th* 1866.

Respectfully informs to the  
W. W. Subd Jr. Local  
Supt. D.C.

By order of Bvt. Brig. Gen. HOWARD.

*H. H. Rogers*  
A. A. General.

*Myersons Sta Tenn*

*Freedman Bureau  
I wish  
get a Colard  
or a Witches  
are that will be  
want to do most  
of house work  
out of employment  
I know soon with  
Salary would be  
either by week month or year  
I will if a good one give  
her a permitant - to come  
with me*

*I hope that I  
may succeed in getting one soon*

*26<sup>th</sup> Nov 1866*

*I am Sir  
Respectfully*

*Rebecca J. Brooker  
Myersons Station, Tenn*



N.B. No. 41, O.L.S. No. 75.

H. G. W. C. D. C.  
Dec. 1<sup>st</sup> 1866

Howard C. H.  
Post. Brig. Genl.

Direct that the name  
of Madison Gaskins (Colored)  
be put on De. Roll for pay  
also that he report to me  
duffing

N.B. O.L.S. 12/3/1866.

Bureau Refugees, Freedmen, & Abandoned Lands,  
Head-Quarters Ass't Commissioner, D. C.,  
WASHINGTON, Dec. 1<sup>st</sup> 1866.

St. Col. Wm. M. Beebe  
Local Supt. &c.

Colonel

Please place the  
name of the bearer Rev.  
Madison Gaskins (Colored)  
upon your roll for December  
as an Employment Agent  
at twenty dollars per  
month. He may cooperate  
more directly with Mrs. Guf-  
fing's office if you prefer  
and probably this would be  
better in case Mr. Beckley  
returns to Mr. Vandenberg's  
Office from Alexandria.

Respy  
C. H. Howard  
Post. Brig. Genl.



77  
C 349 (R. F. & A. L., Vol. L) 1866.

Vol. 2. No. 270 N.C.D.C. 1866

New Haven Conn

Dec 1st, 1866

Colton Crasbus

Capt. Am. F. Inf. Comm

Forwarded letter of B. Edwin Hall

of Guilford, Conn, who desired

a female house servant (colored)

N.C.D.C. 1866. No. 77

N.C.D.C. 12/4 1866

Wrapper--- ( / Enclosures.)

WAR DEPARTMENT,  
BUREAU REFUGEES, FREEDMEN AND ABANDONED LANDS,

Washington, Dec. 3<sup>d</sup> 1866.

Respectfully referred to Acting  
Genl. C. H. Howard act. Comm  
District of Columbia

By order of  
Major Genl. Howard Commissioner

A. P. Ketchum

acty act adjt. genl.

General B. A. & A. B.

Head Quarters, D.C.

Dec. 4. 1866

Respectfully referred to Lt.  
Col. Beebe Jr. Local Supt.  
D.C.

By order of  
Acting Genl. Howard  
W. H. Rogers  
A. A. Brown

Received  
Dec 5 1866



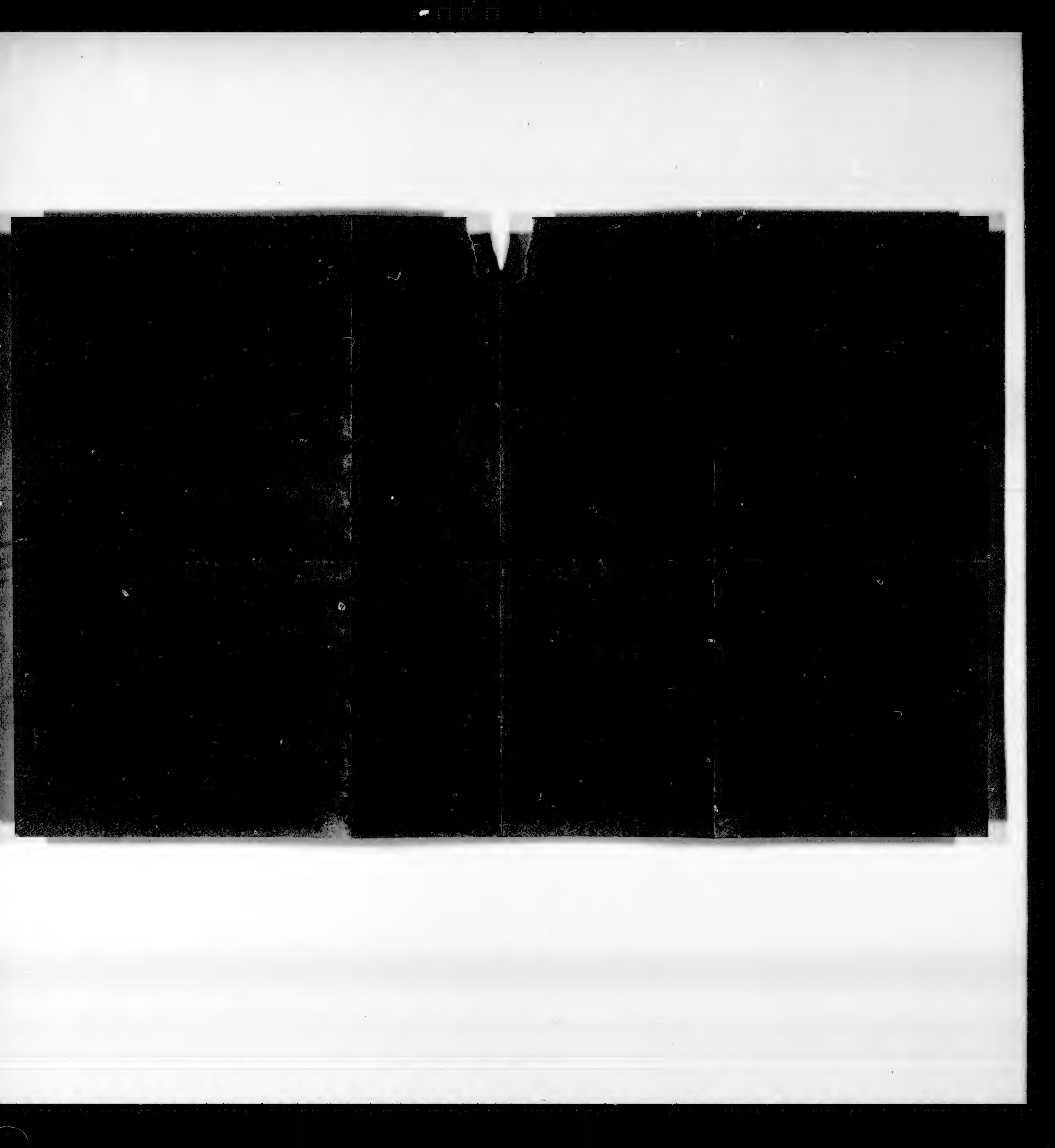



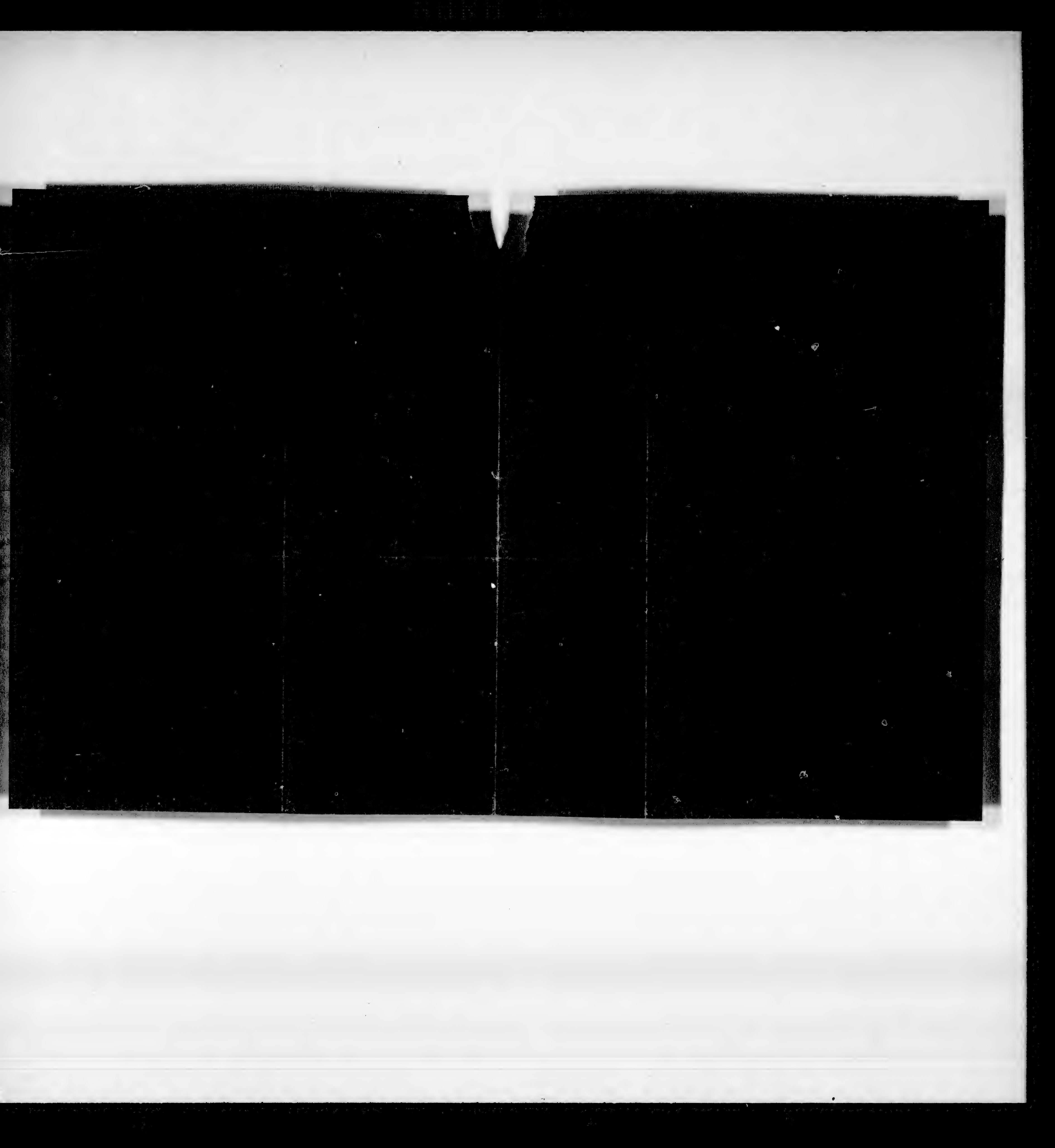



H. 225 R. F. A. L. Vol. 8, 66



To Freedman's Bureau agent

Dear Sir

Can you send me  
a Freed woman capable of doing  
general housework on a Farm  
milking washing &c

If you can I will pay trans-  
portation to our place and give  
a good home and good pay  
to one

We are Jersey people and  
radical

Respy Yours  
A. B. Holmes  
North East  
M. D.



MS. Vol. 42. P. 178.

East Hasting, Conn  
Nov 29<sup>th</sup> 1864.

Wadsworth S. C.

Reports arrival of 114  
Colored men wood choppers  
also want 257 more.  
and 41 Colored girls for  
house servants.

P. O. S. 12/3 1864.

all three that have been  
blacked to fish them

over &



all those that have axes &  
Blankets. fetch them

1864  
J. D. S. H.

House Remov:

Amel H. Colored Birds for

also March 1857 more.

Colored men need clothes

Reports received of 1141

Wadsworth J. D.

Carl Wadsworth  
for 29<sup>th</sup> 1864

1864  
J. D. S. H.



South Hackensack Nov 29 /66  
J. V. M. Vandenburg  
Pis.

We arrived  
safely in time. The Men Request  
to say They like very much so far  
those Trunks that expected Lists  
were at the Boat, and much  
disappointed. Will You Please to  
forward 25 more Men to Choptank  
one List for Mr Hazins one for  
Mr Hall and Three others. I took  
one into the Clan from York  
which maid fourteen (14) I need  
I want four (4) more by the month  
on the Farms. for which I will  
oblige Ten (10) Dollars per Month  
and Board.

Yours Most Respectfully  
J. A. Wadsworth

East Hackensack Eastbury  
Ct Care of Wm. Holsten



South Hackensack Nov 29 /66  
J. V. W. Vandenberg  
Sir

We arrived  
safely in time. The Men Request  
to say They like very much so far  
those Trainers that expected Girls  
were at the Boat, and much  
disappointed. Will You Please to  
forward 25 more Men to Choptank  
one List for Mr Hazins one for  
Mr Hall and Three others. I took  
one into the Clan from York  
which maid fourteen (14) I need  
I want four (4) more by the month  
on the Farms for which I will  
oblige Ten (10) Dollars per month  
and Board.

Yours Most Respectfully  
J. A. Wadsworth

East Hackensack Eastbury  
Care of Head-Holister



1122 Rt. 1 A.L. Vol 8.  
D.C.

Shore



Springville Nov 12th 1844

Mr President

Washington  
D.C.

Sir, will you please  
give me what information you can  
in regard to freedmen that can be  
sent north by you as I would like  
2 or three men and one woman what terms  
they are sent on and if you can send  
those that are capable of chopping, milking,  
taking care of horses and working the  
same also all kinds of work on a  
farm if this should reach you would  
like to hear from you constantly

Yours truly

Frank Hygert  
Springville  
N.Y.



Vol. 2 No 276 A.C.P.C. 1866

79

Sodus Wayne Co. N.Y.  
Nov. 30 1866

Rice

Lewis B.

Desires to obtain  
a colored man <sup>and wife</sup>  
(farm hands) has no objec-  
tions to children if large  
enough to work.

M.P. Vol 42, O.L.S. No 77

Re: O.L.S. 12/5 1866

Sodus Wayne Co  
N.Y.  
Nov 30<sup>th</sup> 1866

Sir

I have the honor  
to request that a farm  
laborer of the following dis-  
cription may be sent to  
me.

I have only seen notice that  
such persons are being sent  
but nothing saying who to  
advice.

I want a good man for  
working on a rough farm  
plowing picking stone chop-  
ing wood &c he must be  
reliable & honest with a  
wife that can take in wash-  
ing & ironing. Children will  
be no objection if they can  
not mind. Better if large  
enough to work.



Vol. 2 No 276 A.C.P.C. 1866

79  
Sodus, Wayne Co. N.Y.  
Nov. 30 1866

Rice

Lewis B.

Desires to obtain  
a colored man <sup>and wife</sup>  
(farm hands) has no objec-  
tion to children if large  
enough to work.

M.P. Vol 42, O.L.S. No 94

Re: O.L.S. 12/5 1866

Bureau Refugees, Freedmen & Abandoned Lands

HEAD QUARTERS ASSISTANT COMMISSIONER, D. C.

Washington, Dec. 4<sup>th</sup> 1866

Respectfully

Yours to the  
Reverend J. Local Supt. D.C.

By order of Bvt. Brig. Gen. HOWARD.

*W. H. Rogers*  
A. A. General.

Sodus Wayne Co  
N.Y.  
Nov 30<sup>th</sup> 1866

I have the honor  
to state that a farm  
of the following dis-  
cription may be sent to

you by special notice that  
sons are being sent  
to you saying who to  
address.

I want a good man for  
working on a rough farm  
plowing picking stone chop-  
ping wood &c he must be  
reliable & honest with a  
wife that can take in wash-  
ing & ironing. Children will  
be no objection if they can  
not mind. Better if large  
enough to work.



Schools convenient where  
children will be expected  
to attend also suitable school.  
If small families two men  
with their wives might be  
sent as the house has two  
large rooms & a summer  
kitchen, - stone, furniture,  
cow, pig, fowls &c will be  
furnished as soon as he be-  
gins to work & needs them  
(stone & provisions furnished as  
soon as he comes & charges) -  
Wages are from \$12 to \$25 per  
month in summer, dont want  
a man who cannot earn \$20  
per month, but will pay  
according to what he does.  
Many laborers might find  
employment here & if you wish  
after these come for me I  
will recommend others to send  
for help.

Route to this place.  
Come to Rochester then  
east on the N.Y. Central  
RR to Newark Station,  
thence 12 miles north  
to Soches Stage leaves  
every afternoon at 4 o'clock  
or the man can walk &  
we will let him have horses  
to go for his family  
I can give references to  
persons in Washington &  
Georgetown if required  
I Please let me know  
before they start.

I Am being  
Respectfully &c  
Lewis Baker  
Soches Wayne Co  
Ct.



1871

1871  
1872  
1873  
1874  
1875  
1876  
1877  
1878  
1879  
1880  
1881  
1882  
1883  
1884  
1885  
1886  
1887  
1888  
1889  
1890  
1891  
1892  
1893  
1894  
1895  
1896  
1897  
1898  
1899  
1900

1901

1902  
1903  
1904  
1905  
1906  
1907  
1908  
1909  
1910  
1911  
1912  
1913  
1914  
1915  
1916  
1917  
1918  
1919  
1920  
1921  
1922  
1923  
1924  
1925  
1926  
1927  
1928  
1929  
1930  
1931  
1932  
1933  
1934  
1935  
1936  
1937  
1938  
1939  
1940  
1941  
1942  
1943  
1944  
1945  
1946  
1947  
1948  
1949  
1950  
1951  
1952  
1953  
1954  
1955  
1956  
1957  
1958  
1959  
1960  
1961  
1962  
1963  
1964  
1965  
1966  
1967  
1968  
1969  
1970  
1971  
1972  
1973  
1974  
1975  
1976  
1977  
1978  
1979  
1980  
1981  
1982  
1983  
1984  
1985  
1986  
1987  
1988  
1989  
1990  
1991  
1992  
1993  
1994  
1995  
1996  
1997  
1998  
1999  
2000



Springfield Mass  
Dec. 1<sup>st</sup> 1866

80

---

Genl. L. A

Agent F. H. A

---

Request to know how soon  
the enclosed order for Orwant  
can be filled. — that the  
Applicants for Orwant  
cannot wait more than  
one week &c

---

W.B. 1 Vol 42. O.L.S. No 80

---

Recd O.L.S. D.G. Dec 3/66



Springfield, Mass.

December 1<sup>st</sup> 1866.

Sir:

I enclose herewith four applications for servants. I also forwarded one with my letter to Genl Howard but have heard nothing from it. I find that parties applicants dont want to wait until I can send you in 20 or 30 applications. Most would like their orders filled on the spot and but a few want to wait longer than a week. Please notify me on the receipt of these orders about how soon they can be filled and oblige

Very Resp'y.

Your Obt Servt.

L. A. Duff

Agent F. H. A.

J. W. Vandorenugh Esq.

Local Supt F. H. A.

Washington D. C.



Gershom Keith - Springfield

Wants a woman 25 to 40 for  
Gentle Housework - if she has a child 4 or  
5 years old or two children, a boy or girl,  
10 to 14 years old will take them.

(This order was sent several days ago.)

J. C. Newcomb.

Barnardston

Wants a woman 20 to 40  
for Gentle Housework.

C. Farney

East Plainfield

Wants a woman 18 to 40 for  
Gentle Housework.

Mrs. A. D. Sawyer

Springfield

Wants a woman for Gentle  
Housework 30 to 40 and a girl from  
10 to 12.

Wm D Field

West Springfield

Wants a woman for Gentle  
Housework 30 to 40 with a girl 12 to  
14.

"Gentle Housework" means Cook washer  
& Ironer &c.



St.  
Washington  
Dec. 4, 1866,

Chas. A. P.  
H. B. 1 Vol. 43. O. L. S. No. 81.

By request of Mrs. Kiffin  
Kiffin. applies for rations  
for 48 food people going  
north.

Rec'd O. L. S. 12/5/1866.

James B. F. & A. S.  
Hq. Cos. A. C. D. C.  
Dec. 4, 1866

Respectfully refers to  
Col. Burt, Local Supt.  
D. C. who will please  
furnish Mrs. Kiffin  
with three (3) days rations  
for the number of food-  
people actually ready to  
go north.

By order of  
Capt. J. C. Howard  
H. B. Rogers  
A. A. C. S.



394 North Capitol Street  
Washington Dec 4, 1866

Lt Col W. W. Rogers U.S.A.  
Bureau P. P. and A. S.  
Sir

Ms Griffing directs me to  
request Patrons for the following Freed-people going north;

Condace Jones & 9 others	10	New York City
Cornelius Wood " 5 "	6	Battle Creek Mich
John Douglas " 1 "	2	Boston Mass
Wm Springfield " 7 "	8	Grand Haven Mich
Maria Lewis " 1 "	2	Hudson N.Y.
Mark Mitchell " 1 "	2	Ponice Ill
John Jackson " 2 "	3	Geneva N.Y.
Austin Nick " 5 "	6	Fall River Mass
Wm Pitts " 2 "	3	Medina N.Y.
Wm Wright " 2 "	3	R. Edwards "
Eliza Davis " 2 "	3	Cincinnati Ohio
total	48	

I have the honor to be  
Very Respectfully Your Obedt Servt  
Appleton T. Clark



82

H 225 (R. F. & A. L., Vol. I) 1866.

Vol. 2, No 29, A. C. D. C. 1866  
North East, Md.

, 1866.

Holmes - James B.

Desires to procure a colored female servant.

A. B. W. H. S. O. L. S. No 82.

Wrapper---(Enclosures.)

H. O. L. S. 12/6 1866.

WAR DEPARTMENT,  
BUREAU REFUGEES, FREEDMEN AND ABANDONED LANDS,

Washington Dec. 5. 1866.

Respectfully referred to Brig  
Genl. C. H. Howard, Assistant  
Commissioner D. C.

By order of  
Major General Howard,

A. P. Ketchum  
a. a. a. General.

James B. F. & A. L.,  
Ad. Div. A. C. D. C.,  
Dec. 6 1866

Respectfully referred to Col.  
Bull, Local Supt. D. C.

By order of the  
Asst Commr  
H. P. Rogers  
a. a. a. General



R 135 83  
(B. F. & A. L., Vol. 8) 1866.

Vol. 2. No. 2 of A.C. D.C. 1866  
Sunderland Mass.

December 1st, 1866.

Root - E. W.

Desires to procure a house on ant.

W.B. Vol 43. C.L.S. No. 83



Wrapper---(Enclosures.)

W.B. C.L.S. D.C. 12/6/1866.

WAR DEPARTMENT,  
BUREAU REFUGEES, FREEDMEN AND ABANDONED LANDS,

Washington December 5th 1866.

Respectfully referred to Brevet  
Brig Genl. C.H. Howard. Assistant  
Commissioner for District Columbia.

By order of  
Maj Genl. O.O. Howard:  
A. P. Ketchum  
Acting Post Adjutant General.

General B. F. & A. L.  
Ad. Qu. A.C. D.C.  
Dec. 6, 1866

Respectfully referred to  
the Local Supt. D.C.

By order of the  
Asst. Commr.  
H. Rogers  
Asst. Commr.



Sunderland Mass.  
Dec. 1. 1866

Gen. O. O. Howard

Dear Sir

I see by the papers that you are making efforts to find employment in this country for colored people. I am very much in want of "help" in my family, & not knowing whom to address in relation to it thought I would write direct to you. My family consists of my self & Mrs. Hook one boy 13 yrs old & one 20 months old. I am the pastor of a country church. We want a woman capable of doing ordinary house work. would like one that can cook - & wash & iron. the first the most important. We would at least like one who can easily learn to do these things. If we could get one that ~~would~~<sup>would</sup> suit us we would like to keep her permanently. I presume I might find places for others. I am sorry to trouble you since you have so many other things to attend to. but you never



be able to put me in the way of getting  
a good help. Can you not send me  
instructions?

Yours sincerely  
E. W. Root.

P. 113  
E. W. Root

Received  
of  
E. W. Root



be able to put me in the way of getting  
good help. Can you not send me  
instructions?

Yours sincerely  
E. W. Root.

Ms. A. 9. 2. 179



116, 2, 1829, 1835, 25, 1837

84

Newark, New Jersey  
December 3<sup>rd</sup> 1866

Grandell,

John H.

Desires to obtain a  
colored servant (freed  
girl).

Sumner B. F. & A. L.,  
Hd. Qu. H. C. S. C.,  
Dec. 6, 1866.

Respectfully referred  
to Col. Bush, Local  
Supt. D. C. for answer.

By order of the  
Asst Commr,

Wm. Rogers  
Asst Commr.

John H. Grandell



Worcester Dispensary No 27 St. John St.

Miss Annina

Worcester Dispensary No 27 St. John St. Worcester

I should like to see you in the prospect of being a good person & family help. If not please find the proper Department.

We wish to engage a strong, capable, good girl to do house work. She must be honest, a good washer & ironer and plain cook & willing to do general house work, and to work for me willing to pay board & 40 dollars per month. Our family consists of 4 persons. Tell Miss daughter & child how we are. Please inform me the expenses in surrounding work and I will remit the sum. Also please inform me how soon you may expect your & supply the required articles.

Respectfully Yours &c

Wm. G. Simons

Would like you to  
Wm. G. Simons  
you will find her at  
No 10 N. Main  
No 10 N. Main



L 122 (R. F. & A. L. Vol. 1) 1866.

W. H. L. No. 101 A B C D

Springville N. Y.

December 86, 1866.

Supt. Frank

Enclosed to you are  
one woman (Lester's  
and to know the terms on  
which they are sent

W. H. L. No. 101 A B C D

W. H. L. No. 101 A B C D

Wrapper---( / Enclosures.)

Recd Dec 8 1866

WAR DEPARTMENT,  
BUREAU REFUGEES, FREEDMEN AND ABANDONED LANDS,

Washington Dec 3 1866.

Respectfully referred to  
Brig. Gen. Edward  
Commissioner, District of  
Columbia  
Command  
Brig. Gen. Edward

A. P. Kelchner

Edward B. F. & A. L.  
Ad. As. H. B. C.  
Dec. 7 1866.

Respectfully referred to the Local  
Supt. D. C.

By order of  
Wm. H. Rogers  
A. A. A. Gen.



MAR 1864

M.B. Hayes O.S.C. Major  
Hd. Qrs. West Command  
Washington D.C. 7/18/64

Reyburn Robert.  
Surg U.S. Vols.

Appoints Mr Joseph  
Reynolds, writing agent

M.B. Hayes O.S.C. Major



NARA 183

Bureau Refugees, Freedmen and Abandoned Lands,  
*Special Relief Commission*  
Headquarters ~~Asst~~ Commissioner, District Columbia,

Washington, December 7<sup>th</sup> 1866.

Genl A. C. Gales, U.S. Army, U.S. Army

Sir

I have the honor  
to inform you, that Mr. Joseph Reynolds, No 300, 9<sup>th</sup> St.  
is assigned for duty as Acting Agent in your District,  
you will please receive orders from the same.

By order of Genl G. M. Howard  
Richard M. Keenan

Genl A. C. Gales, U.S. Army  
President, Special Relief Commission.



Washington D. C. <sup>90</sup>  
Dec. 10<sup>th</sup> 1866.

Dear Mrs. J. S.

Asks for special order  
transportation for Wm.  
W. P. Clark Agent from  
Washington D. C. to Muskegon  
Mich. to accompany ~~the~~ <sup>the</sup> ~~agent~~ <sup>agent</sup>

Bureau R. F. A. S.  
Office Local Supt. D. C.  
Dec. 10<sup>th</sup> 1866.

Respectfully forwarded,  
W. M. Pule  
Sr. Col. 25<sup>th</sup> Regt.  
Local Supt. D. C.

~~Wm. P. Clark~~  
~~Agent~~



Washington Dec, 10<sup>th</sup> 1866.

Brig. Genl C. W. Howard  
Asst. Comd J. C. Bureau Reg. &c.

Sir

I would respectfully submit, that the company of freed people, going to Grand Haven, Muskegon, and Battle Creek (Mich.) Cleveland - Toledo, & Detroit to secure homes and compensating labor are ready to start at four o'clock this afternoon.

I would respectfully ask that A. P. Clark may special order for transportation from this city to Muskegon Mich. (where families of women & children are to go) and return.

Very Respectfully  
J. S. Crisping

Capt - &c.



91  
2191 (R. F. & A. L. Vol. 5) 1866.

Washington D.C.  
December 5, 1866.

Nallach Richard  
Mayor.

Forwards letter of M. A. Jones  
Kabletown W. Va. in reference  
to terms on which Institute  
Freedmen can be hired.

A. P. Ketchum

W. L. C. C.

Wrapper---( Enclosures.)

Recd Dec 6 1866

WAR DEPARTMENT,  
BUREAU REFUGEES, FREEDMEN AND ABANDONED LANDS,

Washington..... 1866.

Respectfully referred to Genl.  
G. H. Howard,  
Actg. Commissioner for D.C.,  
the information furnished the  
information requested.

By order of Genl. Howard.  
A. P. Ketchum  
Actg. Asst. Adjutant Genl.

Ad. Div. A. C. D. C.  
Dec. 8<sup>th</sup> 1866

Respectfully refers to  
Col. Beebe, Local Supt. D.C.,  
for compliance with foregoing  
endorsement of Maj. Gen. O. O.  
Howard, Commissioner.

By order of the Actg. Commr.,  
W. L. C. C.  
A. A. S. Genl.



Mayors Office  
Dec. 5 1866

Respectfully returned  
to Mr. W. O. Leonard  
chief of Freedmen,  
Bureau

Richard Belluch  
Mayor

1500 1/2 St. N.W.

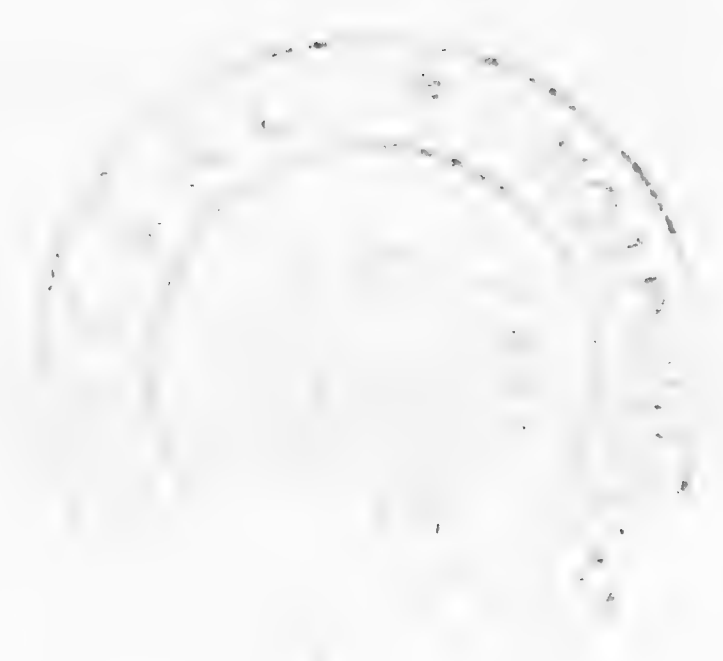

108

8

9





1050

1790 St. Andrew

Remear  
Henry  
Richard H. Wood  
Chief of Freedmen  
to Major G. O. Howard  
Washington D.C.

Henry Spive  
Dec. 5 1866



May 20 1891  
No. 5-1891

Washington

May 20 1891

Chief of Forest Service,

Bureau

Richard B. Wood

Manager

1290 N. J. St. Wash. D. C.

108





NARA 199

Tabletown Jefferson Co. N. Va.

Dec 18. 1866

Gov. Major of Washington D. C.

Sir,

I notice  
in the papers statements concerning  
the great number of freedmen  
now about your city out of  
employment, & being much  
in need of hands, have concluded  
to write to you for information as  
to the terms on which they  
could be hired or whether they  
can be hired for liberal wages  
to labor as farm hands.

Hoping to hear from you at  
your earliest convenience

Yours

Respectfully

Yours, Wm. Scott

Mr. House



99

Washinton Co

Dec 5, 1886

U.S. 325 P.F. A. F. T. 11

Martin Archer N.

late Capt road

sent thousands of

...

Since information in regard to furnishing ration transportation to destitute freedmen about Washington

The Honorable

James A. ...

Washington D.C.

Representing ...  
Surg Genl ...  
Commissioner ...

Order of  
I have the honor to ...  
A. P. Ketchum

...

James A. ...  
Dec. 8, 1886

Respectfully refers to  
S. ... Local Supt.  
D.C. for reply

By order of the  
Act Comm  
...

1072

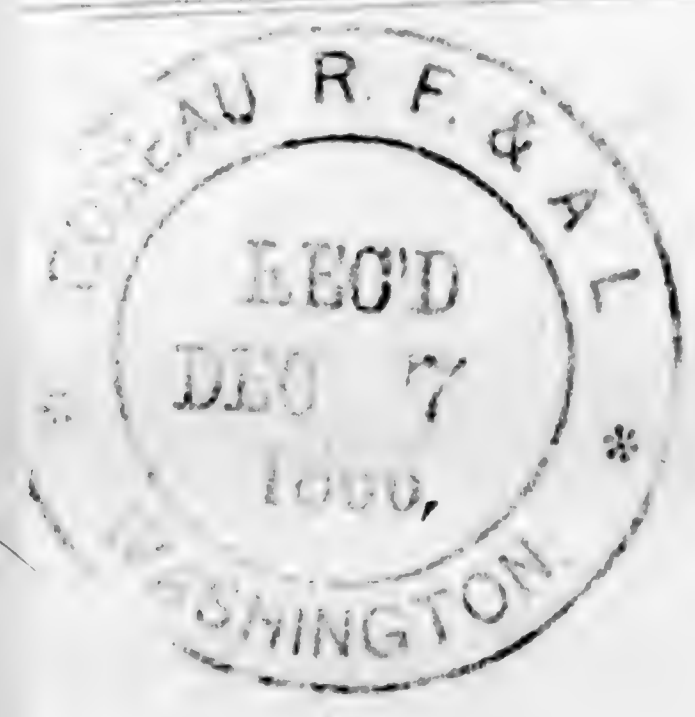

...



ASSESSOR'S OFFICE,  
United States Internal Revenue,  
7th Collection District, State of Pennsylvania.

Westchester, December 5<sup>th</sup> 1866

Maj-Genl O. O. Howard

Sir

Genl Finn Gregg whose  
staff I was formerly on & who at one time was  
Colonel of my Regt. while on a visit to me a  
short time since mentioned that there were  
in the vicinity of Washington a large number  
of Freedmen who were in destitute conditions  
& that the Govt would give them transportation  
& furnish them with rations to & at the place where  
they can be employed - As I think it likely  
that I can give employments to some of them  
I thought it desirable to address you on the sub-  
ject & your prompt reply will greatly oblige

Your Obedient Servant

ARCHER S. HATCHER

late Capt & ADC Genl Sheridan's Staff  
Brevet Maj. U. S. Vols -



Col Beecher  
Reads from Dec 11<sup>th</sup>

Col I forwarded the  
within to you. The long is very  
much. His attention has been  
away. I left him without  
food or home. I have others  
in a similar condition.

Please send blankets  
if they have come or have  
an order for a doz.

Very respectfully  
E. P. Howard  
Supt

P.S. Please send by the  
bearer, also the remainder of  
forage for the month of Dec  
E. P. H.

Washington D.C.  
December 11<sup>th</sup> 1866

Howard Maj  
Supt

Requests the issue of 11 per  
thous to Cold Boy and  
that 12 Blankets be sent  
to him for issue.



NARR 194  
National Freedman's Relief Society, &c.

Washington, D.C. Dec 11 1866

Capt Cowser

Supt Kendall Green Barnwell  
Barnwell Refuge.

Sir

The child of Robert  
Jackson has come to us this  
morning for a pair of shoes -  
The dear little needs them badly, we  
have not a pair at our Office  
and can only send him back  
without any -

If possible hope you can  
relieve him -

Very Truly

J. S. Griffing

per J. E. G.



Leapt Townsend  
Kauai from Honolulu  
Sept 16.



ABSTRACT OF DEEDS

Revenue of the A. S.

Office of the Supt. Counties

County of Orange Va

Dec 17 1866.

McNulty, Nancy

Bookkeeper Supt.

Formal Statement of  
Rebecca Mitchell (Colored) States  
that her husband has left  
her, & that she wishes to  
get his trunk.

Requests that Miss Melton  
as may be deemed proper in  
the case.

Rebecca Mitchell



Bureau of R.A. & A.S.  
Office of the Asst. Supt. Counties of  
Culpeper and Orange Va.  
Culpeper Co. Va.  
December 7<sup>th</sup> 1866 -

Local Supt Bureau R.A. & A.S.  
Washington D.C.

Sir

Rebecca Mitchell (widow) wife of  
M.J. Mitchell states that her husband  
has left her & that he was at ~~the~~  
No 120 3<sup>rd</sup> St Washington at Mrs Baden's  
Boarding House. & further states that her  
husband left <sup>for Ohio</sup> there & and left his trunk and  
considerable wearing apparel & that  
having now waited nearly two months  
for the return of her husband who  
is now somewhere in the State of  
Ohio she has come to the conclusion  
he has deserted her & now wants  
the trunk and other articles that  
may have belonged to Mitchell  
returned to her at this place -

I have the honor to request that  
such steps as you may deem proper  
be taken in the case the woman is needy

I have been making every effort to  
get at the whereabouts of Mitchell but  
have failed to find him very Respectfully  
Yours  
Wm. M. Macmillan Post Capt & Asst



Bureau of R.A. + A.S.  
Office of the Asst. Supt. Counties of  
Culpeper and Orange Va  
Culpeper C.H. Va  
December 7<sup>th</sup> 1866 -

Local Supt Bureau Refut. Supt  
Washington D.C.

Sir

Rebecca Mitchell (widow) wife of  
M.J. Mitchell states that her husband  
has left her & that he was at ~~the~~  
No 120 3<sup>rd</sup> St Washington at Mrs Baden's  
Boarding House & further states that her  
husband left <sup>for Ohio</sup> there & and left his trunk and  
considerable wearing apparel & that  
having now waited nearly two months  
for the return of her husband who  
is now somewhere in the State of  
Ohio she has come to the conclusion  
he has deserted her & now wants  
the trunk and other articles that  
may have belonged to Mitchell  
returned to her at this place -

I have the honor to request that  
such steps as you may deem proper  
be taken in the case the woman is needy

I have been making every effort to  
get at the whereabouts of Mitchell but  
have failed to find him Very Respy  
Yours Obedt  
Wm. Mag. Mearns Capt + Asst



Washington D.C. Dec 12/1866

Washington D.C.

Dec 13<sup>th</sup> 1866

Robert J. L.  
Sup.

States that Patrick  
Conroy, assaulted and  
beat (old) Roy Thomas  
Stewart. Request that  
he be punished.

Refer to  
Miss Emma Smith  
City of New  
York

W.C. C. 1866



1858

Refers to  
Messrs Brown & Smith  
Attys at Law  
7th Street

State of Ohio  
County of Hamilton  
Hamilton, November 1st  
1858

John Smith  
Washington Co. Va.  
1858



Very faint handwritten text at the top of the page, possibly a header or title.

Handwritten text in the upper middle section, including what appears to be a date or reference number.

Main body of very faint handwritten text, consisting of several lines of cursive script that are difficult to decipher.



S. R. Vol. 2 11-218 1866

106

War Department  
Insp. Gen's Office  
Washington Dec 3 1866

Schuyler C.  
Insp. Genl

Suggest that Capt Schuyler  
Genl Ludington, that the  
Number, Sex and age of both  
Male & Female, adult and  
Children, at Mill, Small  
Creek & Capt. Hill, be kept  
NOV 21 1866

NOV 21 1866

War Department  
Bureau R. F. & A. S.  
Washington 5 1866

Respectfully referred to Bt. Brig  
General C. H. Howard, Assistant  
Commissioner for the District of  
Columbia, who will take measures  
to comply with the requirements  
of the Secretary of War.

By order of  
Major General Howard  
Signed A. P. Ketchum  
A. A. General

By order of  
A. P. Ketchum  
A. A. General

Bureau R. F. & A. S.  
Head Quarters, Louis. D. C.  
Washington, Dec. 8. 1866.

Respectfully referred to Lt.  
Col. W. H. Beebe, Local Supt.  
D. C. for compliance with the  
resolution contained herein,  
and endorsement of Maj. Genl  
Howard, Commissioner.

By Order of  
Bt. Brig. Genl Howard  
A. A. General

Washington Dec 8 1866



WAR DEPT  
NA 200

War Department.  
Inspector General's Office  
Washington City. Dec 30. 1866

To

The Commissioners  
of the Freedmen's Bureau.

Sir,

In a Report by Ass' Insp Gen' Ludington to the Secretary of War, respecting Wisewell, Capitol Hill & Kendall Green Barracks, the following suggestions are made

1. That each Superintendent be required to keep a record, showing at all times the number of families in barracks, the number of male and female adults, the number of children male and female and the age of each as nearly as can be ascertained.

2. That in renting rooms care shall be taken by each Superintendent under supervision of the Surgeon to prevent more persons lodging in one room than is consistent with a proper regard to health.

The suggestions are approved by the Secretary of War and he directs that you take measures for carrying them into effect

Very Respectfully General

Yours etc. General

E. Semmes

Inspector General

(Signed)



Bureau Refugees Freedmen and Abandoned Lands  
Head Quarters, Asst Commissioner District Columbia  
Washington December 7<sup>th</sup> 1866

Office

*Wm. D. ...*

A. S. ...



Mr. W. H. C. L. S. C. 147.

Washington, D.C.

Dec 13<sup>th</sup> 1866.

Bureau R. F. A. S.  
Office Local Dept. D. O.  
Washington Dec 18<sup>th</sup> 1866

Clark, M.

Bot Capt. U. S. Inf. Genl.

Respectfully refer me  
to Miss Giffing. Sgt. &  
Mr Roberts. Sub. E. C. Dancks  
for their information.

Reports that Col. people  
have been furnished transportation  
north & return & a<sup>o</sup> if the dead  
were on same or assumed name

The paper to be returned.  
M. O. Duke  
Sr. Col. Local Dept.  
D.C.

The A. C. directs that steps  
be taken to prevent any  
further proceedings of that  
kind.

E. B. [unclear]

Rev. O. L. S. C. 147.



BUREAU 286

Bureau Refugees, Freedmen and Abandoned Lands,

Headquarters Ass't Commissioner, District Columbia,

Washington,

Dec 12<sup>th</sup> 1866.

Sir: Col. W<sup>m</sup> M. Beebe

Local Superintendent G. C.

Colonel:-

It has been found that several colored persons have been furnished transportation north to places of employment, have refused the situations offered them, returned to this city and again received transportation north under the same or a different name.

The Assistant Commissioner directs that you take every precaution to prevent a repetition of such funds. No person will receive transportation twice; and no aid will be extended by this Bureau to any person that, having been furnished transporta-



tion to a place of employment shall  
return to this District.

Respectfully

Your obedient servant,

M. Clark,

Second Capt., Acty Asst Insp. - Genl.



Mr. J. M. C. S. [unclear]  
Washington D.C.  
Dec 12<sup>th</sup> 1866.

Townsend, E. G.  
Maj & Sup<sup>ts</sup>

Request that Shoes and  
Blankets be issued to destitute  
freedmen.

Mr. Deitz

Please issue  
the articles called  
for within taking  
receipt upon  
you.

Mr. Chamberlain  
is absent

W. L. [unclear]



Kendall Green Dec 12<sup>th</sup> 66

Col Wm M. Beebe

Col

I have the honor to

acknowledge the favor of yesterday.

Please issue to Milton Colwell (colored) one pair of shoes, or boots, & also a blanket.

Milton became disabled in Govt. service, & has been in "Hospital" most of the past year. Since then, has been in my employ with various work. Now I give him small compensation.

Also, if assistent, please issue to Daniel Henry, a discharged soldier, just ordered on duty home by Capt. Connor one blanket, & if proper I will charge it on your bill.

Also, one blanket to Leanne Tyler

One also to " Abby Tyler

Very Respectfully

Your Obedt. Servt

P. G. Townsend

Supt



W. B. May 22, 1866, C. 1866.  
H. G. Genl. A. C. D. C.  
Washington D. C. 12/1866.

Robert Genl. B. B. Col  
A. A. A. Genl. D. C.

Direct thro Asst Comdr  
that a Roster of all offices  
& Civilian employees be  
forwarded to H. G. Genl. for month  
of November, 1866.

W. B. May 22, 1866, C. 1866.



NARA 211  
Bureau Refugees, Freedmen and Abandoned Lands,  
Headquarters Ass't Commissioner, District Columbia,

Washington, Dec. 11<sup>th</sup>, 186

Lieut. Col. W. M. S. S. S.  
Local Supt. D. C.  
Colonel:

I am directed by the  
Ass't Commr. to request that you for-  
ward your "List of Officers on duty,  
and "Civilians employed" for the month  
of November, as soon as practicable.

Very Respectfully,

Your obt. Servant,

W. M. S. S. S.

W. M. S. S. S.



N.B. 1706-53. C. L. S. No. 113

Washington, D.C.  
Dec. 12<sup>th</sup> 1866.

Roger W. W.

Brot Lt Col. A. A. A.

State that the order for  
recusation by Mrs. Gifford  
for Mr. Lawson, to Meneatis  
my was by directions of the  
A.C. delivered in person.

W. C. L. S. C. No. 113



NARA 213  
Bureau Refugees, Freedmen and Abandoned Lands,  
Headquarters Ass't Commissioner, District Columbia,

Washington, Dec, 13<sup>th</sup>, 1864.

L. A. W. M. Leach,  
Local Supt. D.C.

Colonel:

The application  
of Mrs. J. S. Giffing of the 11<sup>th</sup> Dist, for  
an order for Mr. Lawson to accompany  
some freed people to Shamoklas Junc. Md,  
has been made, & the order, by direction of the  
Asst Commissioner, issued, & given to  
Mrs. Giffing in person.

Very Respectfully,

Your Obedt. Servt

W. H. Rogers

A. A. A. Gen.



U.S. Army, (I.S. No. 116)  
Washington D.C.  
Dec 8<sup>th</sup> 1864.

Rogers. J. M. W.  
A. A. A. Genl.

Direct thro. Asst Comd.  
that employment be  
provided. William S. Smith.  
giving as a compensation  
Quarters & Rations, with  
the necessary situation.

Recd. O.S. No. 116 1864.



Bureau Refugees, Freedmen and Abandoned Lands,  
Headquarters Ass't Commissioner, District Columbia,

Washington, December 5<sup>th</sup>, 1866.

Dear Col. W. M. Beebe Jr.

Dear Capt. G. C.

Comrades

In Assistant Com-  
missioner's order, we you furnish the bearer  
William J. Smith, employment, and provide  
subsistence & quarters for him until such time as he  
can procure a situation elsewhere.

The subsistence & quarters provided for him  
by you, will be the compensation he is to receive  
for such duty as you may require of him, and he  
will be allowed time & opportunity to search for em-  
ployment, wherever he may desire.

Very respectfully

Your obedient servant

W. H. Rogers

Asst. Comm.



Washington D.C.

117  
December 14<sup>th</sup> 1866

---

Forward E. G.

Supt Sennedall Gunn -

---

Roster of Employees. At Sennedall  
Gunn Barracks for Month of  
November, 1866. -

A. B. Wood 55. C. F. S. 43. 17

---

Recd E. G. Supt 14<sup>th</sup> 1866



Roster of Civilian Employees  
 at Kendall Green Kansas for the  
 month of November 1885

E. G. Townsend Supt

Name of Employee	Pay per mo. \$ cts	Remarks
E. G. Townsend	100 00	Superintendent &c
Robt. J. Jony	18 00	Carpenter
Henry Hall	12 00	Wagoner & Laborer
Byron Harrison	7 00	" "
Milton Colwell	10 00	Teamster & Laborer
Henry Lewis	7 00	Polishing Miterworking &c

I certify that the above is correct  
 for the month of Nov' 1885

E. G. Townsend  
 Supt



Friday Evening Dec 14<sup>th</sup> 1866

To Col. L. C. Hooper  
Frederick Douglass  
Wm. L. Chapin  
Sic.

I received a letter  
from the colored woman whose I  
presented to you yesterday. (The Justice  
of Peace's office) and which was  
sent to me a few days ago for the Col. People's  
Review at New Haven Bridge. I  
do not know how to order it through  
any newspaper. The friends of the family  
have decided that, as she  
is fairly doing, and they think  
wholesome to give the children & etc  
they will keep her at home -  
this winter - So I can do nothing  
further in the case - and you will  
be relieved from any further trouble

118  
Washington D.C.  
Dec 14<sup>th</sup> 1866

Dear Mrs Maria B.

I state that the friends  
of Bettie Bell (colored) who  
was recommended for Freedmen's  
Home, have decided to take  
care of her this winter

Wm. L. Chapin



You will remember that you were  
to send an introduction to  
me to Mr. [unclear] - I therefore  
thought proper to have you  
send [unclear] -

Very Respectfully  
Yours  
[unclear]

54 - 1655  
[unclear]



120

Washington D.C.  
Dec. 11<sup>th</sup> 1866.

Circular Letter  
relating to  
Transportation

Regus Wm. W.  
A. A. A. Genl. G.

Formed Circular Letter  
relating to Applications for  
Transportation. States that  
no orders will be signed, unless  
the parties are destitute  
of...

Wm. W. Wm. W.



NARA 931  
Bureau Refugees, Freedmen and Abandoned Lands,  
Headquarters Ass't Commissioner, District Columbia,

Washington, December 11<sup>th</sup>, 1866.

Circular Letter.

In all applications to these Head Quarters for transportation by Officers, Agents and others, for freed people from this District, it must appear that the Freedmen to be transported are those who are now dependent upon the Government for support, and are liable to remain for some time to come so dependent, or who are located at points where there is great destitution and are liable soon to become for any considerable time dependent upon the Government for support and that employment has been provided for them, whereby the Government will be relieved from further expense on their account.

No orders for transportation will hereafter be signed, until the number of people transported has been stated in the certificate and the printed instructions on the face of the order in this particular, will be strictly complied with.

By order of

Brevet Brigadier General C. H. Howard

Wm. H. Rogers

Brig. Genl Col & A. S. S. G.

Lieut. Col. W. M. Beck  
Local Supt. etc.



Wm. A. R. ...  
H. C. A. C. ...  
Washington D. C. 1/16/64

Roger A. ...  
A. A. ...

States that information  
having been rec<sup>d</sup> in reference  
to one Mr. Johnson of this city had  
been connected with some Freed people  
to go to ... that he had ... his  
contract and left them to shift  
for themselves. Directs that ...  
that the case be placed in Maj  
Fandenberg's hands for investigation  
and to make him return their  
goods to their former places.

W. A. R. ...



NARA 923  
Bureau Refugees, Freedmen and Abandoned Lands.

Headquarters Ass't Commissioner, District Columbia,

Washington, December 13<sup>th</sup> 1866.

Lieut Col H. M. Beebe

Local Superintendent v. C.

Colonel.

Information has reached these  
Head Quarters, that one Mr Johnson  
buddher South side Penn<sup>d</sup>. Avenue between  
5<sup>th</sup> and 6<sup>th</sup> streets, this city had contract  
-ed with, and taken to Virginia, a  
number of freedpeople, and had afterward  
broken his contract with them, and left  
them to shift for themselves, without  
making any provision for them, whatever.

These people having taken their  
effects with them, are now unable  
to get them brought back.

The Assistant Commissioner directs  
that you place the matter in the hands  
of Major Vandenberg, with directions to



Compel Mr Johnson to have their goods returned to them, from whence taken, and to pay to the people the full value thereof.

A List of the goods referred to, is herewith enclosed.

I am Colonel

Very Respectfully  
Your obt Servt.

Wm Rogers

Aug 9.

- 1 Chest.
- 1 Table
- 3 Chairs
- 2 Beds
- 1 Bedstead
- Bed clothes
- 1 Trunk.



1 chest  
 1 table  
 9 chairs  
 2 Benches  
 1 Bedstead  
 Bedstead

1 chest

Wm. L. ...  
 ...

FRIDAY 31

FRIDAY 30

THURSDAY DECEMBER 25, 1841



MONDAY, DECEMBER 26, 1864.

TUESDAY 27

WEDNESDAY 28

✓	1	...
✓	2	...
✓	3	...
✓	4	...
✓	5	...
✓	6	...
✓	7	...
✓	8	...
✓	9	...
✓	10	...



124 Springfield Mass  
Dec 13. 1866

Wm L. A.

Request that if  
orders already forwarded  
for freedmen cannot be  
filled by Saturday Dec  
22. to consider them  
annulled. as parties can  
wait no longer.

Recd at 124/13/66

124 Springfield Mass  
Dec 13. 1866

Miss L.A.

Request that if  
orders already forwarded  
for freedmen cannot be  
filled by Saturday Dec  
22. to consider them  
annulled. as parties can  
wait no longer.

Recd at S. 13/13/66



Springfield, Mass  
December 13. 1866.

Sir:  
If the orders for Freedmen which  
I have already forwarded you  
cannot be filled by Saturday Dec  
22<sup>d</sup> please consider them annulled.

The parties can't wait longer.

Respy  
Your obt servt,  
L. A. Tiff

J. W. Vanderburgh  
Supt Freedmen Bureau  
Washington D. C.

NARA 230  
Springfield, Mass

December 13. 1866.

Sir:

If the orders for Freedmen which  
I have already forwarded you  
cannot be filled by Saturday Dec  
22<sup>d</sup> please consider them annulled.

The parties cont will longer.

Respy  
Joubert sent,  
L. A. Tiff

J. W. Tankersburg

Supt Freedmen Bureau

Washington D.C.



126 Washington D.C.  
Dec 15<sup>th</sup> 1866

Rogers Wm W.

A A A Gent.

States that  
complaints ~~have~~ reached  
Office Aes Comr of the ill  
treatment of a girl 7 yrs old  
living with a woman named  
Julia Janber in a Shanty  
near the Northrop Home for the  
Friendless on 17<sup>th</sup> St between  
L & M. further information  
may be obtained of Miss Mann  
teaching school corner 17 & N Sts.  
The Apt Comr directs that the  
case be investigated, and if  
the facts are as stated and  
the parents of the child are not  
to be found, she will be taken  
to the Colored Orphans Home.  
W. B. 1866. C. L. S. H. 49, 126.

Rec. C. L. S. H. 12/15 1866.

Office Local Supt.  
Washington Dec 15<sup>th</sup> 1866

The within request complied  
with, the child sent to  
Colored Orphans Home.

Bureau Refugees, Freedmen and Abandoned Lands,  
Headquarters Ass't Commissioner, District Columbia,

Washington, December 15<sup>th</sup>, 1866

Treat Col. W. M. Beebe Jr.

General Supt. D. C.

Colonel:

Complaint from a reliable source has reached this Office, of the ill treatment of a girl about 7 years old, living with a woman, named Julia Jenter, in a shanty near the Northrop's "Home for the friendless" on 17<sup>th</sup> St. between L<sup>th</sup> & M.

Further information may be obtained of Miss Mann, teaching school, corner 17<sup>th</sup> & K St.

The 1<sup>st</sup> Comm'ry Genl. directs that you investigate the case and if the facts are as stated, and the parents of the child are not to be found, she will be taken to the Colored Orphan's Home.

Very respectfully

Your obedient servant

H. W. Rogers

A. A. Seal



Julia or Lucy  
Burrny, has a  
child named Ellen,  
Lee - Parker - Weeden

Washington D.C.

Dec 17<sup>th</sup> 1866

Quitting temporary  
Agent

Asks for Spec. Trav.  
provision in the form of  
City to New York  
via New River Boat &  
return in charge  
of business going to different  
places

Bureau R. J. A. G.  
Office Local Supr. D.C.  
Washington Dec 17<sup>th</sup> 1866

copy forwarded  
approved. W.M. Cook

St Col 12<sup>th</sup> W.C. B  
Great Smith etc

*[Faint handwritten notes]*



NARA 235

The Transportation asked last week  
to ship and return not being received  
in time for use, the person in charge  
proceeded to S.M. without Transportation  
making arrangements with the conductors  
on the different roads, to forward said  
Trans<sup>n</sup> having knowledge of it being granted  
Trans<sup>n</sup> was accordingly forwarded  
to the said Roads.

Very Respectfully

Washington Dec. 17<sup>th</sup> /66.

W. W. Rogers

Brig. Genl., Col., & A. A. Genl.

Bureau of Refugees & Abandoned Lands.

Sir

I would

respectfully ask for special order of transportation  
from this city, to Hartford Ct. (by way of Pitts-  
burgh & Hartford & N. H. R.R.) and return in  
change dependent freed people (Women and  
children & some men), going to New York, N. York.  
Newport, Newburg, Providence Anderson & New  
(interior of Ct.) & Hartford.

Very respectfully

J. Emma Chiffins

Appl



Washington Dec. 17<sup>th</sup> / 66.

W. M. Rogers

Bot. Lieut. Col. & U. S. A. Genl.

Bureau Refugee & abandoned Lands.

Sir

I would  
respectfully ask for special order of transportation  
from this city, to Hartford Ct. (by way of Mattam  
Boat & Hartford & N. H. R.R.) and return in  
exchange dependent freed people (Women and  
children & some men) going to New R, Mass.  
Newport, Scitubury, Providence Andover & Hemen  
(interior of Ct.) & Hartford.

Very Respectfully

J. Emma Griffing

Asst Bureau Ref &c

(over)

W.B. 17th 1864  
Albany Penna  
Dec 14 1864

Wells S. C.

Acknowledges receipt  
of 131 Free Colored Women.

W.B. 17th 1864

W. B. 17th  
Dec 14 1864

7 a.m. to 10 p.m.  
Searched.

It is to be hoped that  
3. he is arrived at night and is  
to be contented. We are much  
obliged for the trouble and will  
probably not bother you again  
till spring. With many thanks  
& remain

Yours Respectfully  
A. S. Wells,  
W. B. S. Wells.

Albany  
Bradley Co  
1864



134  
Reverend Station Pa.  
Oct. 12 1856

Booker T. Wash

Wishes Two Colored Servts.  
and is willing to stand to contract  
wants a col<sup>d</sup> woman who  
understands house work gen<sup>lly</sup>  
will pay \$100 for half year  
and do ~~such~~ better each  
coming year.

Booker T. Wash

Booker T. Wash

134  
Ryerswood Station Pa.  
Oct 15 1866

Booker T. Wash

Wishes Two Colored Servts.  
and is willing to stand to contract  
wants a col<sup>d</sup> woman who  
understands house work gen<sup>lly</sup>  
will pay \$100 for full year  
and do ~~such~~ better each  
year

B. T. Wash



Revenue Station, etc

J. M. Vandenberg  
Chief Constable, Dept  
Washington, D.C.

17th Nov 1891

I have read the circular  
in reference to the contract  
for the purchase of  
land for the  
purpose of  
building  
the  
road  
and  
the  
land  
is  
not  
to  
be  
sold  
at  
a  
price  
less  
than  
the  
value  
of  
the  
land  
as  
shown  
on  
the  
map  
of  
the  
land  
and  
the  
land  
is  
to  
be  
sold  
at  
a  
price  
not  
less  
than  
the  
value  
of  
the  
land  
as  
shown  
on  
the  
map  
of  
the  
land

I have read the circular  
in reference to the contract  
for the purchase of  
land for the  
purpose of  
building  
the  
road  
and  
the  
land  
is  
not  
to  
be  
sold  
at  
a  
price  
less  
than  
the  
value  
of  
the  
land  
as  
shown  
on  
the  
map  
of  
the  
land

Very truly yours

J. M. Vandenberg

Chief Constable, Dept  
Washington, D.C.

~~Mr. [unclear]~~

Washington D.C.

Dec 14 1866

Rogers Wm M.

A. A. A. Genl. D.C.

Direct thro West Court  
 that a record be kept showing  
 that all Freedpeople who  
 are sent away, that employ-  
 ment is provided, and that  
 the name of the Employer  
 and Residence, appear on  
 the records

Wm M. Rogers 12/14/66



Washington D.C.  
Dec 14 1866

Rogers Wm W.  
A. A. A. Genl. D.C.

Direct thro West Coast  
that a record be kept showing  
that all Freedpeople who  
are sent array, that employ-  
ment is forbidden, and that  
the name of the Employer  
and Residence, appear on  
the Book

R. C. L. S. H. 19/11/66

Bureau Refugees, Freedmen and Abandoned Lands,  
Headquarters Ass't Commissioner, District Columbia,

Washington, Dec. 14<sup>th</sup>, 1866.

Sr. Col. W. M. Beck, Jr.  
Local Sup't, D. C.  
Colonel:

The Asst Comm'r directs me to inform you that it is important that a record should be kept in your office showing indubitable evidence either in writing, or by the testimony of disinterested parties, that Situations and employment has been provided for all freed people for whom transportation is recommended by you.

He suggests that this record should also give the name and residence, (town or County,) of the employer, rate of wages paid, and such other additional facts, as may be necessary in making a complete report of the operations in this matter when required.

Very Respectfully,

Your Obedt Servant,

J. M. Rogers

a. a. a. s. w.

C. P. B. "D." 111.



Circular.

In addition to the instructions already issued from this office your attention is called to following copy of a letter from the Asst. Comr.

A strict compliance with the requirements ~~of this letter~~ <sup>of which</sup> is essential to the making of proper reports.

~~Copy.~~  
 (True copy attn) W. M. Dula  
 Secy.

Circular.

In addition to the instructions already issued from this office your attention is called to following copy of a letter from the Asst. Comr.

A strict compliance with the requirements <sup>of this letter</sup> of which is essential to the making of proper reports.

~~Copy.~~  
(True copy attno) W. M. Duke  
Asst. Comr.



Washington D.C.  
Dec 12 1866

Duncan W.C.  
802.6 "I bet M.M. In <sup>at</sup> School

Wishes to procure transportation & Clothing for 181  
Destitute - Freed people, from  
Washington D.C. to Providence  
R.I.

Free a. s. m. 9000





W.B. Vol 62, O.L.S. No. 135  
Washington D.C.  
Dec. 18<sup>th</sup> 1864

Robert Jno L.  
Supt. D.C.

States that the case of  
Mary Butler, Col's, has been  
referred to him. She lives  
in No. 4<sup>th</sup> Local Supt. D.C.  
<sup>State</sup> and that the case should  
be investigated.

Bu R. R. W. C. G.  
Office Local Supt. D.C.  
E.B. Vol 73, O.L.S. No. 190  
Respy returned to Mr  
Roberts who will please  
return to this office. The  
original paper in this case  
J.M. D. R. L.  
Supt. D.C.  
Dec. 18<sup>th</sup> 1864

Office Supt. D.C. No. 135  
Washington D.C.  
Dec. 19<sup>th</sup> 1864

Col. M. W. Beane  
Colonel -

I have the  
honor to inform you  
that the case of  
Mary Butler, reported verbally by a  
stranger, representing that  
she was employed in one of  
government departments -  
we did not locate her  
in name, but your  
name & residence of the  
party, representing her case  
in a day that I judged  
it in interest to you.

Very Respectfully  
J. Roberts  
Supt. D.C.

Office Supr East Capt. St. Bernard  
Ruman R. H. & A. L. - J. L. -  
Washington Dec 18<sup>th</sup> 1866

To Col. Pope  
Local Supr M.

Sir -

The case of Mrs  
Mary Foster - residing at 273 St. -  
with H. & G. - with a Mr. Simmons  
has been reported to me -

It is not known, on my list,  
but near you find it - the case is pointed  
by a gentleman from the department and  
I think should be investigated -

Respectfully

Your Obedt Servt

H. Roberts  
Capt East Capt St. Bernard



W. B. 12th 62, O. S. 1866

Sodius Wayne Co. Pa.  
Dec 12<sup>th</sup> 1866

Rice Lewis D.

Acknowledges receipt of letter. States that the prices are satisfactory. But that house rent is extra unless specified in contract, asks that letter be sent immediately.

Rice Lewis D.

W. B. 12th 62, O. S. 1866

Sodius Wayne Co. Pa.  
Dec 12<sup>th</sup> 1866

Gen. Geo. W. Beebe Esq.  
Lieut Col. 128<sup>th</sup> Ill. Inf.  
Supt. Quartermaster

Sir

I have the honor to acknowledge the receipt of your letter of the 2<sup>nd</sup> inst relating to wages of men.

The price stated <sup>17 to 25</sup> is the price paid here now in summer for the very poorest to the very best of laborers & they are boarded but house rent is extra unless special bargain including it. house rent is usually 30 cents per week. prices of labor in winter are not so high as in summer.



and coming  
woman's wages at mashing, are  
10 cents per hour and board  
If she worked on the farm as  
some women do in planting  
hoeing &c. her wages would  
be the same as his if she could  
do as much work.

Woman's wages in the kitchen  
& about the house are \$8 per  
month & board

If more than one man should  
come, I will find a place  
for him to work in the  
course of a few days

Please write again before  
he starts and let me know  
when to expect him.

It will be necessary that he  
be well provided with warm  
under clothing as it will  
be very cold here, the  
thermometer often going 10 below  
zero. I am Dr. Lewis B. Rice



Ms. A. 9. 2. 100

Washington - D.C.  
A.S. 1856.

Quinn Miss M. A.  
512. 6th Street N.W.

Also for transportation  
of clothing for  
freedom going north.

Ms. A. 9. 2. 100

Gen. G. H. Howard.

Sir,

I wish to procure  
transportation, salaries & Clothing for  
the following persons who are  
in employment & will be subject  
to the rules of the organization,  
they are to go to P. T. Co. Co.,  
and they can obtain employment  
Polly Bowen, Sarah Jones,

M. S. Howard, G. H. J.



# AMERICAN TRACT SOCIETY,

28 Cornhill, Boston.

[Instituted at Boston, in 1814.]

13 Bible House, New York.



WILLIAM A. BOOTH, ESQ., *President.*

REV. ISRAEL P. WARREN, *Secretary of the Publication Department, and Editor.*

REV. WILLIAM C. CHILD, D. D., *Secretary of the Charitable Department.*

REV. JOHN W. ALVORD, *Secretary at New York, (13 Bible House, Astor Place.)*

HENRY HILL, ESQ., *Treasurer.*

NICHOLSON BROUGHTON, JR., *Depositary.*

Tract House, 28 Cornhill,

Boston, Dec 27 1860

*[Faint handwritten text, likely a letter or report, mostly illegible due to fading.]*

**AMERICAN TRACT SOCIETY,**

28 Cornhill, Boston. [Instituted at Boston, in 1814.] 13 Bible House, New York.

WILLIAM A. BOOTH, ESQ., President.

REV. ISRAEL P. WARREN, Secretary of the Publication Department, and Editor.

REV. WILLIAM C. CHILD, D. D., Secretary of the Charitable Department.

REV. JOHN W. ALVORD, Secretary at New York, (13 Bible House, Astor Place.)

HENRY HILL, ESQ., Treasurer. NICHOLSON BROUGHTON, JR., Depository.

Tract House, 28 Cornhill,

186

Boston,

*[Faint, mostly illegible handwritten text, possibly a letter or report.]*

War Department,

Bureau of Refugees, Freedmen and Abandoned Lands,

Washington, ----- 186



I have just received your letter of the 10th  
 and am glad to hear of your recovery.  
 I have been thinking of you very much  
 and hope you are now well and happy.  
 I have been thinking of you very much  
 and hope you are now well and happy.  
 I have been thinking of you very much  
 and hope you are now well and happy.

I have just received your letter of the 10th  
 and am glad to hear of your recovery.  
 I have been thinking of you very much  
 and hope you are now well and happy.  
 I have been thinking of you very much  
 and hope you are now well and happy.  
 I have been thinking of you very much  
 and hope you are now well and happy.  
 I have been thinking of you very much  
 and hope you are now well and happy.

141  
WB 1063. O.L. S. 141  
Vol 2. No 3. 1866  
Wolfford, A. H.  
Dec. 6" 1866

Wood, John.

Requests that he may be  
aided in securing a colored  
girl, to assist his wife as  
maid of all work. Prefers  
one whose habits are formed.

Washington, D.C.  
Dec. 17" 1866.

Respectfully referred to Col.  
Rogers, A. A. G. for action.

J. W. Alvord  
Insp. Schools & Buildings.

Head Quarters A. C. & C.  
December 17, 1866.

Respectfully referred to.  
Supt Col Beebe Local  
Supt D.C.

By order of  
Capt Brig Gen C. H. Howard  
A. A. Rogers  
A. A. G.



Wolfeboro, N.H., Concord County  
Lieut Col. Wm. Beebe about Sept  
Bremen refuses treatment  
Hillsborough N.H.

Dear Sir I have  
not written in reply to your favor of  
18th because I thought the accounts  
might be too late to come in in time  
before that when the season is  
over now I can write for you  
- Moses Vassery of this village who  
desires a good General Household  
Bookkeeping increasing stock is  
a lumber party who can by trade  
enough to suit himself & to do one  
who would be glad to give  
we are willing to pay 2000 for  
for a good old goat, the nearest  
road near Station is at the  
the Boston Maine R.R. Please  
write Mr Vassery when he comes  
report a good old goat that  
he may be of use.

I am about fourteen years  
the time therefore think it  
best that you should write directly  
to the Messrs Messrs. Pitt.  
Respectfully yours  
John Wood

John Wood  
Messrs Pitt

I have to inform you  
for your house work -  
I'll pay \$2. per week

Wood John  
for Messrs Pitt

Messrs Pitt.  
March 1867



Waltham N.H.

March 1867

Wood John  
for Moses Parney

Wishes to obtain woman  
for Genl House work -  
Will pay \$2. per ~~the~~ week

March 4<sup>th</sup> 1867

From Robert Lee. From Mrs. ...  
The house ...  
not that you ...  
for the ...  
very ...

W. H. ...

...

...

...



Richmond Va

197 December 19<sup>th</sup> 1866

Stearns Franklin

115 Madison St. Richmond

States that Peter Smith  
is in his employ. is well  
and forwards (\$4) five  
dollars to his (Peter's)  
mother.

Recd. A. G. S. Co. 13/20

Washington D.C.

December 26<sup>th</sup> 1866

Rec<sup>d</sup> of J. M. Waudenburgh, Ass<sup>t</sup> Supt<sup>t</sup> D.C. Bureau  
B. G. and A. L. Five (5) dollars forwarded by Peter  
Smith to his Mother, Lucy Smith through the  
Office of Local Supt<sup>t</sup> D.C. by Franklin Stearns  
pr B. H. Smith <sup>by letter</sup> of date 19<sup>th</sup> December 1866

Witness

Chas. C. Walden.

Lucy <sup>per</sup> Smith  
mark

all the said in his power.

I am not in want of female  
servants, but if she is a good  
woman & able to work she can  
obtain employment here & be near  
her son.

Respectfully

Franklin Stearns  
pr B. H. Smith



Richmond 19<sup>th</sup> Dec. 1862

St. Col. Wm. Beebe  
Lieut. Supt. S. C.

Care of Q. S. S. Washington  
Sir,

Your letter in regard  
to the Mother of John Smith (col.)  
is recd.

She is in my employment <sup>(and</sup>  
has requested me to advance to <sup>(his mother)</sup> her  
five dollars, which you will find  
within. He is disposed to give her  
all the aid in his power.

I am not in want of female  
servants, but if she is a good  
woman & able to work she can  
obtain employment here & be near  
her son.

Respectfully,  
Franklin Harris  
for B. Smith



M. B. Hill U. S. S. No. 1244  
Washington D. C.  
Dec 20<sup>th</sup> 1866

Roberts Jas L.  
Supt. &c

Desires to know if trans-  
portation has been furnished  
Harry Scott. On one other  
Warner known to W. J. City  
within past 10 days

Office Local Supt. D.C.  
Washington Dec 20<sup>th</sup> 1866

Respy. returned.  
No transportation for the  
mentioned parties has been  
sent to this office.  
M. B. Hill Jr.  
S. Col. Local Supt.  
D.C.  
Dec 20<sup>th</sup> 1866

Bureau B. J. & A. L.  
H. B. Des. ac, D. C.  
Dec. 22, 1866  
Respectfully returned to  
Mr. J. L. Roberts, with  
the information that  
transportation has not  
been furnished from the  
H. B. Des. for the parties written  
named.

By order &c  
H. N. Day,  
cc

Copy of report of the  
H. B. Des. ac, D. C.  
Washington Dec 22, 1866  
Mr. J. L. Roberts  
Supt. &c  
D. C.  
will you be  
kind enough to inform  
me if the parties named  
above have been through  
the office transportation  
department  
Very truly  
yours  
M. B. Hill Jr.  
S. Col. Local Supt.  
D. C.



John Jay - 1790  
Secretary of State  
Washington D.C.

Mr. John Jay  
Secretary of State  
Washington

Dear Sir

I have the honor to acknowledge the receipt of your letter of the 10th inst. in relation to the proposed purchase of the land for the purpose of building a new city for the residence of the President of the United States. I have the pleasure to inform you that the same has been referred to the proper authorities for their consideration.

Yours truly

John Jay

Secretary of State

Washington D.C.

MB/1066. O.L.S. 11/19/86  
Washington D.C.  
Dec. 19<sup>th</sup> 1866.

---

Keacock, Eliza  
Supt. Diet Kitchen

---

Request that some wood  
be sent to Diet Kitchen, C.  
Hill, before Saturday

---

Wood sent per enclosed  
Request, Dec. 20<sup>th</sup> 1866  
J.M.W.  
Asst. Supt.  
D.C.

Recd O.L.S. Dec. 12/19<sup>th</sup> 1866



Recd U.S.S. No. 12/19 # 1866

Shred sent for analyzed  
Regent, Dec. 20<sup>th</sup> 1866  
J.M.M.  
sent dupl  
2/26

Regent that remitted  
for sent to Dr. Williams, Co.  
N.Y. for analysis

Wm. C. C. C. C.  
Dupl. sent to Dr. Williams

Washington D.C.  
Dec. 19<sup>th</sup> 1866  
J.M.M.

MB/ Vol 66. O.S. 11249  
Washington D.C.  
Dec. 19<sup>th</sup> 1866

Heacock, Eliza  
Supt. Diet Kitchen

Request that some wood  
be sent to Diet Kitchen, C.  
Hill, before Saturday

Wood sent per enclosed  
Request, Dec. 20<sup>th</sup> 1866

J.W.  
Asst. Supt.  
D.C.

Rec'd O.S. No. 12/19<sup>th</sup> 1866



Washington Dec 17 1864

Colonel Wm. H. French

iii

Dear Sir,

I have the honor to acknowledge the receipt of your letter of the 14th inst. and in reply to inform you that the same has been forwarded to the proper authorities for their consideration.

Very respectfully,  
Wm. C. ...

Wm. C. ...

U.S. M. 66. C. L. S. No. 150

Capital Hill Barracks  
Washington Dec. 25<sup>th</sup> 1866

~~U.S. M. 66. C. L. S. No. 150~~

Rebels J. L. Supt  
Capital Hill Barracks -  
Applics for Stationery

Forward from  
Office a/c  
Dec. 25 1866

Officer Local Supt D.C.  
Washington Dec. 25<sup>th</sup>  
1866

Respy. forwarded  
Approved.

M. Parker  
Lt. Col. 108<sup>th</sup> N.Y. Inf.  
Local Supt D.C.

~~U.S. M. 66. C. L. S. No. 150~~

Rec'd U.S. S. 1<sup>st</sup> Div. 1866



Office Dept. of the Interior  
Bureau of Land Management  
Washington, D.C.

Dear Sir:

Reference is made to your letter of the 10th inst.

concerning the proposed lease of the

land described in the attached copy of the

lease application and the proposed lease

and the proposed lease application.

The proposed lease application is

being reviewed and will be

returned to you as soon as possible.

Very truly yours,

2 2

Very truly yours,

Director

Enclosure

Very truly yours,

Director

Enclosure

Office Dept. Coast Geog. & Surveys  
Bureau of Hydrography  
Washington D.C. 20540

(1) Cal. 1000 fathoms

1000 fathoms

1000 fathoms

1000 fathoms

1000 fathoms

1000 fathoms

1000 fathoms

1000 fathoms

1000 fathoms

1000 fathoms

1000 fathoms

1000 fathoms

1000 fathoms

1000 fathoms

1000 fathoms

1000 fathoms

1000 fathoms

1000 fathoms



Wm. L. ...

Washington D.C.  
Dec. 20<sup>th</sup> 1846

General ...  
Washington

Copy  
Mr

Decide that the letter  
from South Westbury  
Conn. also transportation  
of 257 men to ...  
returned to ...

17

...

Col. Beebe on  
 the manuscript of  
 the ...  
 leave the letter  
 from ...  
 also the ... 25 ...  
 The ... will be returned

Wm. M. Howard

H. C. ...



Col. Beebe is  
 in the manuscript  
 from the letter  
 from Sent [unclear]  
 to [unclear] for [unclear]  
 also the [unclear] [unclear] [unclear]  
 The [unclear] will be returned

signed by B. H. Howard

B. H. Howard

1873  
1214 1/2  
C. L. S. 10 1/2  
K. G. W. C. S.  
Washington D. C.

Rogus W. W.  
Act of Govt.

Order the Act Com.  
that rooms be fitted up  
for accommodation of  
Refugees and Freed men who  
may apply for shelter at various places.  
And if necessary to set apart  
a room for a kitchen, and  
employ a person as cook

R. C. S. C.



NARA 277

Bureau Refugees, Freedmen and Abandoned Lands.

Headquarters Ass't Commissioner, District Columbia,

Washington, December 20<sup>th</sup> 1866.

Lieut Colonel W. M. Beebe.

Local Supt: D.C.

Colonel.

I am directed by the Assistant Commissioner to say, that in view of the necessities of a large number of persons both Refugees and Freedmen who will apply at these Head Quarters for temporary quarters and subsistence, he desires that you at once take measures to fit up rooms at Hillwell Barracks suitable for the occupation of such of these classes of persons as may be sent to you for shelter, the apartments for white and colored to be separate.

Should you find it necessary, the Act Comr directs that you set apart, and fit up one room as a kitchen, and that you employ one person as cook, to prepare the food necessary for them, while remaining at the barracks. You will determine the

number of rooms you may think necessary to  
be prepared, for the purpose above stated,

I am Colonel.

Very Respectfully

Your Obedt Servt.

W. H. Rogers

cc. cc.



A B 1117035

Osage, Mo.  
Dec. 18<sup>th</sup> 1866

Carter Bud. Co.

Desires a Colored  
Girl for a Gentleman by  
the name of Mr R. P. Budbaker.  
will pay \$2.00 per month &  
4 months schooling each  
year.

Red. B. Co. B. Co.

Ossipee N.H.

December 15<sup>th</sup> 1866.

J. W. Audubon  
Asst. Local Superintendent  
Washington Co.

Sir,

Your letter of December 11<sup>th</sup> 1866 is received. I answer in reply that the gentleman who wishes the servant will pay \$3.00 for month board and clothes he give her 12 months boarding a year in a first class boarding house. He will be a good person 14 to 20 years or about that age and he would be preferred and one of ordinary intelligence. I can be recommended. The family Mr. A. P. J. Parks is a family of the highest respectability. The family is not large consisting of a young wife and a few children I believe. I believe it to be a first class place for a servant.

The business of having colored servants is not new to me I having been for 12 years Superintendent of the Board



in Virginia.

The Girl should be sent to  
Royal P. Postbank by Eppingham  
Centre N.H. The nearest Railroad  
Station is New Village N.H.

Send the Girl via Sudbury and  
Boston and on Boston & Maine R.R.  
& Great Falls & Conway N.H. to New  
Village then by Eppingham Stage to  
Eppingham.

Please advise me when  
the Girl is sent.

Mendocino  
Superior Falls

I remain  
Yours respectfully  
Ruel Carter

511 1/2 11th St  
San Francisco

Carrie M. J. K.  
Dec 21 1866

Walter Reed Esq

Devised a correct  
Bill for a Postman by  
the name of Mr R. P. Postbank  
will pay \$200 for month &  
4 months following each  
year

For a Bill see 1866

M. B. W. C. S. Co. 1865

Washington D. C.

Dec. 20<sup>th</sup> 1866.

Rogers W. W.

A. A. G. Genl.

Formed appointment  
of Mrs S. D. Burtell. as Em-  
ployment Agent. D. C. to date  
from Jan 1<sup>st</sup> 1867.

W. C. S. Co. 1867





Vol. 2 - No. 416 G.P.O. 1866

Searsport, Maine  
December 18<sup>th</sup> 1866

Adams,  
J. E.

Vol. 2 - No. 416 G.P.O. 1866

Desires to obtain 3 freed-  
girls between the age of  
16<sup>th</sup> & 20 years.

(Wrapper)  
12 Enclosures

Vol. 2 - No. 416 G.P.O. 1866

Bureau P. O. A. S.  
A. S. D. A. H. D. C.

Dec. 21, 1866

Respectfully referred to  
St. C. B. L. Local  
Supt. R. & F. D. J. C.

By order of the  
Asst Commr  
H. H. Rogers  
a. a. a. m.



W  
Hamington Dec. 14, 1866

Dear Brother Adams

If you will address  
my brother Port. Brig. Gen. Chas. H. Howard  
at Washington. he will give you the  
requisite information about "colored  
help". He has charge of the whole  
matter & is to send a colony North-  
west to Leavenworth about Jan. 6, 1867 =

You can tell him I directed you  
to write to him & name the route by  
which the girls could come from  
Boston and to whose care they are  
to be consigned.

We were sorry to have Miss Gilmore  
leave this term. Give my love to her  
when you see her - Glad to hear such  
good accounts of your baby and  
passage - You beat us in the letter  
but we won't yield the palm as  
to the former - My stay is now in  
Father Rogers parlour & my wife can't  
join me, as she would like to, in  
a message of love to you & yours

Yours ever  
P. B. Howard

1942

1943

1944

1945

1946

1947

1948

1949

1950



Searspott Me.

Decr. 18. 1866.

Gen. Howard.

Dear Sir.

Yr. brother refers me to you in regard to Colored help. He saw in the Congregationalist that it would be forwarded at Govt. expence North or West. Mrs. Adams' Mother would like to have three girls sent to her. one for herself. the others for her children. They will have good places. She would like them from sixteen to twenty. healthy & intelligent as may be. When they are capable they shall have wages -

NARA 888  
If the Katakadin (steamer)  
runs to the Penobscot at the  
time you send, they can all  
go in the care of Dea. Jam<sup>s</sup>.  
H. Adams. Camden Me -  
If she does not, they must  
leave the cars at Bath, & take  
the stage to Camden.

Will you write me at once,  
& I can know the conditions  
better, & act more understand-  
ingly for Mother. Perhaps  
you will think that younger  
help will be more manage-  
able & tractable - please say.  
I send with this your brother's  
note.

Yrs. very truly  
J. E. Adams.



713 1/2 Col 128th U.S.C. 7/5/139

Washington D.C. 139  
Dec 20 1866

Harris Mrs. M. S. M.

Request that Mrs Annie  
Carrington & 2 children, be  
sent to Freedman Village

Office Local Supt. D.C.  
Borrow R.F. & A.L. #  
December 22 1866

Respectfully forwarded approved

M. M. Rube L  
Lt. Col. 128th U.S.C.  
Local Supt. D.C.

East Windsor, N.J.

Sept 10, 1850

Dear Mr. [Name]

Dear Sir,

I have the honor to

acknowledge the receipt of

your kind letter of the 7th inst. in relation to the purchase of a lot of land in the township of [Name] and county of [Name] State of [Name] and in reply to inform you that the same has been purchased and the deed is now in the hands of the [Name] and will be delivered to you as soon as the same is ready for delivery. I am, Sir, very respectfully,  
Dear Sir,  
Your obedient servant,  
[Name]

[Signature]

[Name]

[Address]



11/21/66

Washington D.C.  
Dec 22<sup>nd</sup> 1866

Robert Jay L.  
Supt. etc

Requests that an Ambulance  
be ordered to report to C. H.  
Bancroft to transport James  
Davis Col. to "Home of aged  
& infirm."

Office Local Supt D.C.  
Barrow R. F. and A.L.  
December 22/66

Respectfully forwarded approved -  
M. B. Baker  
Lt. Col. and Local Supt D.C.

John W. ...  
Washington ...

John W. ...  
Washington ...

...

...

...

...

...



6374 (R. F. & A. L., Vol. 1) 1866.

Vol 2-11-12-13-14-15-16-17-18-19-20-21-22-23-24-25-26-27-28-29-30-31-32-33-34-35-36-37-38-39-40-41-42-43-44-45-46-47-48-49-50-51-52-53-54-55-56-57-58-59-60-61-62-63-64-65-66-67-68-69-70-71-72-73-74-75-76-77-78-79-80-81-82-83-84-85-86-87-88-89-90-91-92-93-94-95-96-97-98-99-100  
Oakland P.O., Livingston Co.,

N. Y., December, 1866.

Carrick - Robert,  
1273

Desires female servants  
for himself & his neighbors;  
enquiries about terms, &c.

MB 12071 4-2-3-4-5-6-7-8-9-10-11-12-13-14-15-16-17-18-19-20-21-22-23-24-25-26-27-28-29-30-31-32-33-34-35-36-37-38-39-40-41-42-43-44-45-46-47-48-49-50-51-52-53-54-55-56-57-58-59-60-61-62-63-64-65-66-67-68-69-70-71-72-73-74-75-76-77-78-79-80-81-82-83-84-85-86-87-88-89-90-91-92-93-94-95-96-97-98-99-100

Wrapper---( 1 Enclosures.)

MB 12071 4-2-3-4-5-6-7-8-9-10-11-12-13-14-15-16-17-18-19-20-21-22-23-24-25-26-27-28-29-30-31-32-33-34-35-36-37-38-39-40-41-42-43-44-45-46-47-48-49-50-51-52-53-54-55-56-57-58-59-60-61-62-63-64-65-66-67-68-69-70-71-72-73-74-75-76-77-78-79-80-81-82-83-84-85-86-87-88-89-90-91-92-93-94-95-96-97-98-99-100

WAR DEPARTMENT,  
BUREAU REFUGEES, FREEDMEN AND ABANDONED LANDS,

Washington Dec 21<sup>st</sup> 1866.

Respectfully referred to  
Brig Genl C. H. Howard, Act  
Commissioner for D. C.

By order of  
Brig Genl C. H. Howard  
A. P. Ketchum  
Acting Secy.

Bureau R. F. & A. L.,  
Hq. Div. H. C. D. C.,  
Dec. 22/66.

Respectfully referred to  
Lt. Col. Beck. Local Supr.  
D. C.

By order of the  
Act Commr.  
Thos. Rogers  
Secy.

(1374. R.A. A.S., Vol. 86)

1273



Major Gen Howard

Dear Sir

We are very scarce of Wemens help  
for house work in general and hearing  
that there is a surplus with you ~~who~~  
connected with the Freedmens Bureau  
we would take it kind in you to inform  
us of your way and Manner of hiring  
the Coloured girls and the price per  
week or any other terms connected with  
your arrangements.

I think I can get a few  
of my neighbours to join me. & it  
would be more pleasant for them to  
have some company of their own kind  
Please answer this as soon as convenient  
Direct to Robert Cullish

Yours truly

Oakland Post office  
Swingston County  
New York

Robert Cullish

7113170711 C. S. S. Co. 1864.

Washington D.C.

Oct 20 1864.

Rogers J. W.

A. A. A. Genl. D.C.

Circular letter relative  
to Requisitions. States that  
none will be signed only on  
15" x 30" of each, any varying  
from the above a letter stating  
reason must accompany the  
same.

U. S. C. S. S. Co. 1864.



NARA 297  
Bureau Refugees, Freedmen and Abandoned Lands,  
Headquarters Ass't Commissioner, District Columbia,

Washington, December 20<sup>th</sup>, 1866

Circular Letter:

Requisitions for Supplies in this District will hereafter be forwarded to these Head Quarters for approval only on the fifteenth and thirtieth days of each month, except in urgent cases, when a letter stating the reason for departure from this rule will accompany the requisition.

Requisitions for fuel, forage, straw and stationery will be made on the usual forms, and all other supplies excepting Subsistence Stores will be made on form 31. Office Manual Bureau R. F. and A. L., or form No 40. Quartermasters regulations

Blank forms will be furnished for all supplies needed, upon application to the Chief Quartermaster of this District for the same.

By order of Provost Brigadier General. C. W. Howard.

*W. H. Rogers*  
A. A. G.

*L. C. W. M. Beck Jr.*  
Local Sup't. D. C.

168

Washington D.C.  
Dec 21<sup>st</sup> 1866

Person J. B.

Desires to know if the  
servants for Mr Abbott  
can be obtained

A. B. M. 1725 T. S. 1866

Dec 21 1866



JOHNSON, BROWN & CO.,  
Solicitors of Army and Navy Claims,

B. B. JOHNSON, )  
J. B. BROWN. )

OFFICE, 4 INTELLIGENCER BUILDING,  
Corner of 7th and D Streets.

Washington, D. C., Dec. 24<sup>th</sup> 1866.

Maj. J. M. Vanderburgh  
Freedman's Bureau  
Cor. 7<sup>th</sup> & O Sts

Major: Will you be so  
kind as to inform me  
whether there is any prospect  
of your being able to  
furnish the servants for  
J. B. Abbott which I  
applied to you for some  
time since.

If not, I should regard  
it as a favor for you to  
so state in order that I may  
look elsewhere.

Very respectfully, &c.

J. B. Brown

Washington D.C.

Dec 26 1866.

Reyburn Robert

Surg. US A.

States that there will be  
a Monthly Meeting of the  
members of the S. R. Comm.  
Friday eve Dec 28 at noons  
of Hon S. P. Bowen. City D.C.

Dec 26 1866.



BUREAU 391

Bureau Refugees, Freedmen and Abandoned Lands,  
<sup>Special Relief Commission</sup>  
Headquarters Ass't Commissioner, District Columbia,

Washington, December 26<sup>th</sup>, 1866.

St Col. Wm. M. Archer.

Superintendent

Sir

You are

hereby requested to notify the visiting Agents in your District, that the monthly meeting of the visiting Agents, Superintendents of the Special Relief Commission, will be held at the room of the Messrs. Hughes & Messers, Post office, Wash. D. C. on Friday evening, December 28<sup>th</sup> 1866 at 7 1/2 o'clock P. M.

By order of Brig. Genl. G. M. Stewart

Richard W. Taylor

Act. St. Col. Wm. M. Archer.

President Special Relief Commission

N.B. No. 73. C. S. No. 1. 1862  
Washington D.C.  
December 27<sup>th</sup> 1866

Rogers. Wm. W.

A. A. A. Grub.

Directs the Act Comr.  
that an estimate be forwarded  
to Hd. Qrs as soon as practicable  
for the number of rations req-  
sired for month of Jan 1867.

Directs further that an  
estimate be forwarded on 25<sup>th</sup> of  
each month.

Re. C. S. No. 1. 27<sup>th</sup> 1866



Bureau Refugees, Freedmen and Abandoned Lands,  
Headquarters Ass't Commissioner, District Columbia,

Washington, Dec. 27<sup>th</sup>, 1866.

S. C. G. M. Dub Jr.  
Local Supt. D.C.

Comd:

I am directed by the  
Asst Commr to request that you forward, as  
soon as practicable, to their Hd. Qrs. an  
estimate of the number of rations required  
by you for the month ending Jan'y 31/67,  
as per form enclosed.

He also directs that in future, an  
estimate be forwarded by the 25<sup>th</sup> of each month,  
for the month succeeding.

Very Respectfully,

Yours Obedt Servant

Wm. Rogers

Asst. Commr.

War Department,  
Bureau of Refugees, Freedmen, and Abandoned Lands,

Washington, Dec 26 1866.

Colonel

Mrs Kerran living  
the West Side of 11<sup>th</sup> Street  
between N and O. in a  
Shanty, is an applicant for  
Special relief.

Please have her case  
investigated and attended to  
properly.

By order  
McClure

Bot Capt. A. S. G.

S. Col. W. M. Butler



Mr. [unclear] [unclear] [unclear]

Washington D.C.  
Dec 26 1864

Clark S.W.  
Bot Capt & U. and Genl

Desires that the case  
of Mr. Kerran on 11<sup>th</sup> Street  
be investigated and Relief  
given,

Relief Period No 57

R. C. [unclear] [unclear]

MB 199 747 C. T. S. S. C. No. 116  
Washington D.C.  
Decem<sup>r</sup> 28 1866.

Ray. H. H.  
Clerk.

Forward Roster of  
West Sup<sup>r</sup> for Dist of  
Columbia.

R. C. G. S. C. No. 116  
Dec. 28 1866.





Non official

Bureau Refugees, Freedmen and Abandoned Lands,  
Headquarters Ass't Commissioner, District Columbia,

Washington, Dec. 28<sup>th</sup>, 1866.

Col. W. M. Burt.

Colonel:

Capt. Clark informed me  
yesterday that you desired a list of the  
Asst Supts. in this Dist. - I had one  
made out - I have the honor to en-  
close it herewith.

Very Respectfully.

Your Obedt Servant

H. H. Gray,  
Chief Clerk



Roller of (Capt.) Superintendants) P. R. F. & A. S.  
for Dist. of Columbia.

Name	Supt. of.	Station
G. P. Lee, Capt. U. S. A.	Alex. & Fairfax Co's	Alexandria, Va.
R. G. Rutherford, Pt. Lt. Col (Vols)	Montgomery Co. Md.	Rockville, Md.
Geo. E. Henry, Pt. Major "	Prince George " "	Bladensburg, Md.
W. L. Van Derlip, " " "	Ann Arundel " "	Annapolis, Md.
E. B. Galois, Capt) "	St Marys " "	Leonardtown, Md.
Lawrence, A. A. Capt. (Vols)	Freeman's Village Va	Freeman's Village, Va.
J. A. Brubaker, Pt: " "	Charles Co. Md.	Port Tobacco, Md.
J. E. Hines, (Civilian)	Fairfax Co. Va.	Sienna, Va.

Bureau Refugees, Freedmen & Abandoned Lands

HEAD QUARTERS ASSISTANT COMMISSIONER, D. C.,

Washington, *Dec 27<sup>th</sup>* 1866.

Respectfully *Yours* *W. M. Burt, Jr.*  
*Local*  
*Sup. D. C.*

By order of Bvt. Brig. Gen. HOWARD,

*W. M. Rogers*  
A. A. General.



Bureau Refugees, Freedmen & Abandoned Lands

HEAD QUARTERS ASSISTANT COMMISSIONER, D. C.,

Washington, D. C., Dec. 27<sup>th</sup> 1866.

Respectfully  
Yours,  
W. M. Beck, Jr. Local  
Sup. D. C.

By order of Bvt. Brig. Gen. HOWARD,

W. M. Rogers  
A. A. General.

Vol. 2. No. 445. C. B. D. G. 1866

1717  
East Glastenbury Conn.  
December 24<sup>th</sup> 1866

Windsor, S. A.

W. B. (Vol. 75) C. B. D. G. 1866

Desires to obtain 25 men  
& 10 girls (free people)  
for servants.

C. B. D. G. 1866

1866

Read A. B. C. 12/27/1866

East Glastenbury Conn. 24<sup>th</sup> Dec  
1866  
Capt. [Name] [Name]

[Faint, mostly illegible handwritten text, possibly a list or account]









Hartford Dec 22 1866

Mr C H Hornum Esq  
 To his

We this day rec'd notice from New York that you would have some 25 men arrive at Hartford about Tuesday night next - we shall be ready to receive them, but was disappointed in you not sending some 3 to 6 women capable of doing house work as I requested in a former letter Can you send them I have good places selected for them in good families please reply at your earliest convenience

Yours

A A Wadsworth  
 for Misses

6385 R. F. A. L. W. S. M. S. M.

Pittsburg Pa, 178

December 26. 1866

Vol. 2. No. 259. 16. 1866

Collins - Wm

Requests to be furnished with colored house servants. Lewis at Edgeworth Station.

1101st Mt. B. Co. 11th Regt.

Respectfully referred to Brig. Genl C. Howard, Asst. Comdr District of Columbia.

A. P. Ketchum

Adj. General.

Bureau of F. & A. S.

Washington Dec 27. 66

Bureau B. F. & A. S.

Ad. Qu. H. C. S. C.

Dec. 28. 1866.

Respectfully referred to Lt. Col. Bubb, Local Supt. S. C. for action.

By order of the  
Acty Asst Comr.  
J. H. Rogers  
Adj. Genl.







## THE EVENING CHRONICLE,

Established 1841.

JOS. G. SIEBENECK

WM. A. COLLINS.

SIEBENECK &amp; COLLINS.

EDITORS AND PROPRIETORS.

The Largest Circulation in Western Pa.

Office Evening Chronicle.

Pittsburgh, Dec 26. 1866.

Dear Sir,

I desire to get a negro woman with daughter for house help & will give them a good home & good wages. My family is small. I live at Edgeworth Station about 13 miles from this city in a very pretty valley. Other persons in my neighborhood are desirous of colored help. I understand the Bureau will send the people on free of charge. For reference to my own responsibility I refer to our representative Hen G. H. Morehead. Would you be kind enough to give this matter your attention

I oblige

Yours Respectfully,  
Wm A Collins.

Office Local Sup, D.C.  
Washington Dec. 29<sup>th</sup> 1864

Copy of [unclear] [unclear]  
Respy. referred to  
Maj. C. G. Johnson  
Supt. Kendall Green Barracks  
& Rev. J. L. Roberts  
Supt. Capitol Hill Barracks  
for their instruction  
and guidance.

Wm. D. Duke  
S. C. Local Sup.  
This paper to be returned.



W. H. Murray

L.H. vol. 2 No. 465, A.C. DC, 1866

War Dept.

Washington Dec 22<sup>nd</sup> 1866

Rogers W. H.

W. W. Gault, C.

Perman's Circular letter  
of Ed. Salinger, Insp. Genl  
directing that necessary  
steps be taken to prevent damage  
by fire about Gov<sup>t</sup> Building

MS 177, U.S. No. 113

Re. C. S. No. 149

Bureau O. P. & A. S.

Ad. Insp. A. C. DC,

Dec. 28. 1866,

Respectfully referred to Lt.  
Col. W. M. Beub, Jr. Local  
Supt. D.C. for strict com-  
pliance with the written  
instructions from the  
Secy. of War.

By order of the  
Acty Asst Com,

W. H. Rogers  
ad. Insp.

E. 20 vol. 2 No. 900. A. C. D. C. 1866.



WAR 321  
War Department  
Washington City  
Decr 22. 1866

Circular:

Sir

The Secretary of War, directs that you immediately give instructions to all the Officers and Agents of your Bureau, who have public property under their charge, to take the necessary precaution for preventing its destruction or damage by accidental fire; and also to see by personal inspection, that the apparatus for extinguishing fires, of which they have control, is in proper condition for effective use.

Very Respectfully  
Your Obedt Servt.

(Signed)

Ed Schriver

Inspector General

Official Copy respectfully furnished for the information and guidance of  
Brig. Gen. C. H. Howard. No. 1000. 98

(Signed)

A. P. Ketchum

Official

Wm. Rogers  
S. C. H. S.

1874  
Washington D.C.

December 28<sup>th</sup> 1874

---

Roberts, J. L.  
Agent &c

---

Reports business of the Employment  
Office No. 2 East Capitol Street  
Barracks for 10 two days from  
18<sup>th</sup> to 28<sup>th</sup> inst.

Wm. H. Pollock, C. L. S. D. C.

---

Report No. 2 - 1874

Recd. C. L. S. D. C. 12/28/74

---



Bureau Refugees, Freedmen and Abandoned Lands,

EMPLOYMENT AGENCY.

East Capt St. Barracks,

Washington, Dec 28<sup>th</sup>, 1866.

Col. W. M. Beebe for  
Local Superintendent, D. C.

Colonel

I have the honor to submit the following report of the employment  
office, under my charge, for ten (10) days, from Dec 18<sup>th</sup>  
to Dec 28<sup>th</sup>

Number of Applications for Servants.

For Males, 2

Females, 10 Total, 12

Number of Applicants for Employment.

Males, 2

Females, Total, 2

Number provided with Employment.

Males, \_\_\_\_\_

Females, Total, \_\_\_\_\_

The Number provided with Employment was distributed among the States  
as follows:

Very Respectfully,

Your Obedient Servant,

John Roberts

Agent.

Wm. M. W. O. S. W. W.

Washington D.C.

Dec 18/86

Whittier, Conn. W.

Dr. B. & C. G. W.

States that letter of 19<sup>th</sup> inst  
has been favorably considered &  
transportation will be furnished  
as soon as the name of the nearest  
R.R. Sta. to Calville Va is  
forwarded.

R. O. S. W. W.



Wm. H. S. O. S. J. W. W.

Washington D.C.

Dec 28/86

Whittier, Henry M.

Dr. Dryden & C. G. W.

States that letter of 19<sup>th</sup> inst  
has been favorably considered &  
transportation will be furnished  
as soon as the route of the new  
R.R. Sta. to Calverton Va is  
forwarded.

W. H. S. O. S. J. W. W.

War Department

Bureau of Refugees, Freedmen, and Abandoned Lands.

OFFICE CHIEF QUARTER-MASTER.

Washington, Dec. 21<sup>st</sup> 1866.

Lt. Col. H. M. Beebe, Jr.

Local Supt. 13th R. & N. F.

Washington, D. C.

Sir:

Referring to your letter of the 19<sup>th</sup> inst., requesting transportation for Mary Haddy, & others, freedpeople, to Carlisle, Pa., forwarded to this office approved by Genl. S. H. Howard, you are respectfully informed that the application has been favorably considered, and transportation will be granted, so soon as this office is informed as to the Rail Road Station nearest to Carlisle, Pa., which place does not appear upon any map or R. R. Guide, accessible to this office.

Very Respectfully

Your Obedient Servant

Henry M. Whittier

13th, 13th, Genl & Chief Q. M.  
Bu. R. & N. F.



MBM 98. C. S. No. 187

Washington D.C.

Decem<sup>r</sup>. 29<sup>th</sup> 1866.

Townsend, E. C.

May & Sep<sup>r</sup>. 7<sup>th</sup>

Roster of employees  
at Kendall Green Barracks  
for month of Dec<sup>r</sup>. 1866.

L. K. Wood, Jr. 9. 2. 1866

Unsubscribed fund for  
the maintenance of  
the barracks

Dec<sup>r</sup>. 29<sup>th</sup> 1866

Roster of Employees of Kendall Green  
Barracks, for the month of December, 1866.

E. J. Townsend Sup't.

Names of Employees.	Pay per month.		Amt. paid during the month.		Remarks.
	\$	cts.	\$	cts.	
Townsend, E. J.	100	00	100	00	Superintendent.
Terry, Robert	18	00	16	00	Carpenter.
Wall, Henry	12	00	12	00	Carpenter and Laborer.
Emis, Henry	12	00	6	00	Whitewashing and General Policing.
Wells, Milton	10	00	10	00	Teamster.
Haines, Chas.	20	00	20	00	Watchman and Police.
Seiler, Jno. A.	30	00	5	00	Blacksmith - repairs to cart, etc.

I certify that the above is correct.

E. J. Townsend  
Superintendent.



Roster of Employees at Kendall Green  
 Barracks, for the month of December, 1866.

E. J. Townsend Sup't.

Names of Employees.	Pay per month.		Amt. paid during the month.		Remarks.
	₹	cts.	₹	cts.	
Townsend, E. J.	100	00	100	00	Superintendent.
Terry, Robert	18	00	16	00	Carpenter.
Wall Henry	12	00	12	00	Carpenter and Laborer.
Emis Henry	12	00	6	00	Whitewashing and General Policing.
Wells, Milton	10	00	10	00	Teamster.
Haines, Chas.	20	00	20	00	Watchman and Police.
Seiler, Jno. A.	30	00	5	00	Blacksmith - repairs to cart, etc.

certify that the above is correct.

E. J. Townsend  
 Superintendent.



7113/1079 C. S. S. No. 1112

Washington D.C.  
Dec 29 1866

Brown Maj. J. M.  
W. M.

Direct that a 2 Horse  
Wagon report to Dr J. A. Sladen  
at No 9<sup>th</sup> Cor 19<sup>th</sup> & D. as soon  
as possible.

R. C. S. S. No. 1112

War Department,  
Bureau of Refugees, Freedmen, and Abandoned Lands.

Washington, Dec 29 1866

Colonel,

Will you please  
direct a 2 Horse  
Wagon to report to Dr  
J. A. Sladen A.D.C.  
at Bureau Corner 19<sup>th</sup>  
St as early as possible

Very Respectfully

J. M. Brown

Det. Chy. a. G. W.

Col. W. M. Beebe Jr

Prosewell Parmer



7103/1079 C.S. No. 1112

Washington D.C.  
D.C. 39" 1866

Brown Maj. J. M.  
W. M.

Direct that a 2 Horse  
Wagon report to Sr J. A. Sladen  
at No. 9th Cor 19th St. as soon  
as possible.

970 C.S. No. 1112

War Department,  
Bureau of Refugees, Freedmen, and Abandoned Lands.

Washington, Dec 29 1866

Colonel,

Will you please  
direct a 2 Horse  
Wagon to report to Sr  
J. A. Sladen A.D.C.  
at Bureau Corner 19th  
St as early as possible

Very Respectfully

J. M. Brown

Det. Chy. A.D.C.

Col. W. M. Beebe Jr

Prosewell Parson

190

Washington D.C.  
Dec 26 1866

Boyd Wm

1123 7<sup>th</sup> Ave

States that New Jones  
has been Redwiden, and is entirely  
destitute, and in a starving  
condition. Requests that relief  
is recommended.

Wm Boyd 79. 4. 2. No. 190

No. 1123 7<sup>th</sup> Ave

Office Local Sup<sup>t</sup> D.C.  
December 31 1866

Respectfully referred to  
Rev. J. L. Roberts for  
investigation -

By order of  
Col B. S. Roberts L. S. D.C.

J. W. Mandubryk  
Asst Sup<sup>t</sup>



Sarah Day

14, Oct 1837 C—

— Islemail —

711379 C. P. S. 115. 191  
Washington D.C.  
D. C. 31 1866

Proven Maj. J. M.  
W. G. G. M.

Requests that 11 2<sup>d</sup> Horse  
team be sent to take the  
14 1<sup>st</sup> Horse regiments to Lincoln  
Depot.

R. A. L. 115



1866

711979 A. P. S. No. 191  
Washington D.C.  
D. C. 31 1866

Colonel Maj. J. M.  
W. G. P. M.

Requests that 11 Horse  
teams be sent to take the  
14 Horse wagons to Lincoln  
Depot.

R. C. L. S. 191

Bureau Refugees, Freedmen, and Abandoned Lands,

Quartermaster's Office, No. 132 Pennsylvania Avenue,

Washington, D. C.,

Dec 31 1866

Colonel,

Will you please find  
the names of the 21st  
and 22nd Regts of Col  
Wagon (Co), to which Depot

Very Respectfully

C. M. Brown  
Asst. Surg.

Col. W. M. Butler  
Assistant Adjutant.



213

Washington D.C.  
Dec. 26<sup>th</sup> 1864

W. H. Wittersey, Esq., W.  
Post Office Bldg.  
C. G. M.

Transmits copy of Office  
Manual, Bureau of A. S. G.,  
also, copy Circular of  
Chief, G. M.

MS. 1<sup>st</sup> vol. 88. C. G. S. 213

Re. C. G. S. 1<sup>st</sup> vol. 88.

War Department,  
Bureau Refugees, Freedmen, and Abandoned Lands,  
OFFICE CHIEF QUARTERMASTER,

Washington, Dec. 26<sup>th</sup>, 1866.

Sir:

I have the honor to transmit herewith all copies  
each of General Orders, Nos.

Bureau Officers Manual

Also, 1 copies each of Circulars, Chief Q. M. O.,  
Bureau R. F. and A. L., Nos. 4, 5, and 6

the receipt of which you will promptly acknowledge, by signing and  
returning the accompanying letter.

~~You will be held responsible for the distribution of Orders to officers  
serving under your direction.~~

Very Respectfully,

Your Obedient Servant,

By order of Maj. Genl. O. O. Howard, Commr.

*Henry M. Whittaker*  
Brig. Genl., and Chief Q. M.,  
Bureau R. F. & A. L.

To J. V. W. Vandenburg

Local Sup't

Washington D.C.



71113170188 O.L.S. 267024

Washington D.C.  
Dec. 31 1864.

Davis Levi  
Sec Board of Comm.

States that letter of Col  
Becker, Local Sup. making  
application for admission  
to the "Soldier's Home" for  
Company, formally of the  
U.S. Army, has been referred  
to his office. States that he  
is instructed to state that it  
does not appear that he  
served 20 years. Therefore  
he is not entitled to its ben-  
efits

State

Re O.L.S. 74 2862

MAR 24

711131 M 88 O.L.S. 26 M 24

Washington D.C.  
Dec. 31 1866.

Davis Levi  
Sec Board of Comm<sup>rs</sup>

States that letter of Col  
Becker, Local Supt. Making  
application for admission  
to the Soldiers Home for  
Company, formerly of the  
U.S. Army, has been referred  
to his office. States that he  
is instructed to state that it  
does not appear that he  
served 20 years. Therefore  
he is not entitled to its ben-  
efit

Blak

Re O.L.S. 40 1867.



Office of the Board of Commissioners  
of the Soldiers Home  
Room No. 13 Kinder's Building

Washington D.C. Dec. 31 1866.

Sub. Brigadier General Samuel Thomas

U.S. Army

Assistant Commissioner Bureau R.F. & S.L.

Washington, D.C.

General:

The letter of Lieutenant, Decker, 128<sup>th</sup> Reg-  
iment U.S. Artillery, Superintendent, R.F. &  
S.L., for the District of Columbia, of the  
22<sup>nd</sup> instant, making application for the  
admission of James Conway, formerly a sol-  
dier of the U.S. Army, to the benefits of the  
Soldiers Home, is forwarded with your applica-  
tion on the 26<sup>th</sup>, having been referred to this  
office. I am instructed respectfully to  
inform you, that it does not appear that  
the soldier was served twenty years in the  
Army, or been discharged for disability.

"incurred in the line of duty," conditions  
required by the law establishing the In-  
stitution, to entitle him to its benefits,  
he is therefore not entitled to admission.

I have the honor to be General

Very respectfully

Your Obedt Servt.

(Sgt) Levi Davis

Dir. to Dir of Commission

W. Soldiers Home

Dec 24 1891

Washington D.C.

Washington, D.C.

Copy

W. H. Rogers

Advt



WPA 343

C. Local Supt (A.C.)  
Letters Received

31-491

1867

E. B. No. 616. A. C. D. C. 1867.

Alexandria Va. Jan'y 8. 1867.

Recd. J. P.  
Captn & Suplt.

Requested transportation from  
Alexandria Va. to Jacksonport  
Jackson Co. Arkansas for  
William Brooks, 11 men & 3  
women, dependent freed people,  
by which transfer the Gov't  
will be relieved of their support.

Letter No 31 (A. C. D. C.) 1867  
Dunbar A. C. D. C.

Ad. Qu. A. C. D. C.

Jan'y 9, 1867.

Respectfully returned to Capt  
J. P. Sec. Suplt. for compli-  
ance with Par. 3<sup>d</sup> & 4<sup>th</sup>, Sec.  
2<sup>d</sup> of regulations of trans-  
portation under General  
Orders 138. Also, series of

1865, as set forth in the  
"Officers Manual" of 1866.

In this case security giv-  
en against transfer of  
transportation order may  
be given the Asst Commr of  
this District, instead of  
the Asst Commr. of Ark.

By order of  
Wm. H. Stewart  
McClain  
Capt

E. B. Vol. 3. No. 15. A. C. D. C. 1867.

Recd. A. C. D. C. 1/10/67



MARR 245  
Office Supt. Dist 4,  
Alexandria Va.

Jan'y. 8. 1862

Gen. C. H. Howard  
Asst. Comr. D.C.

General:

I have the honor to request  
transportation from Alex<sup>a</sup> Va. to Jacksonport  
Jackson Co. Ark. for ~~the~~ <sup>specie</sup> ~~the~~ <sup>John D. Lee</sup> & Sherrill (11)  
other freedmen and eight (8) freed women (in all  
20 persons) who are now dependent upon the Govt  
for support.

They have engaged a laborer for Mr.  
J. D. Adams of Jacksonport, and the transfer  
will relieve the Govt of their support.

Very Respectfully,

Your Obedt Servant,

D. P. Lee

Capt. of Co

Supt. Dist 4

W.P. O.S. Dec 12 1867  
Washington D.C.  
Jan 2 1867

make  
order

Quiffing Mrs J.S.  
Agent.

Request transportation  
in Hartford Conn, and  
return in charge of  
freed people, going north.

Office Local Supt L.C.  
Washington Jan 2 1867  
E.B. 1906  
Respy forwarded  
decommended

M. (Rubin)  
Lt. Col. 128<sup>th</sup> U.S.  
Local Supt.

W.P. O.S. Dec 12 1867



Washington Jan 2<sup>d</sup> 1866

Lieut. Col. H. M. Beebe Jr.

Local Supt. St. Bureau Ref. &c.

Sir

I would respectfully ask transportation and return from this city to ~~Head~~ <sup>Head</sup> of in charge of twenty five or more freed-people going to Home and employment in that vicinity. as soon as possible.

Very Respectfully

J. O. Griffing

Capt. &c.

Wm 820 L. d. 3. 1867  
Washington D.C.  
1977 Jan 2<sup>nd</sup> 1867.

Robert Ins L.  
Supt.

States that James  
Arthur (Co. 1) represents  
himself, as being homeless  
& friendless. Recommends  
that he be sent to Freed-  
mans Village

Office Local Supt D.C.  
Washington Jan 2 1867

Respectfully forwarded  
recommending that  
James Arthur be admitted  
to Freedmans Village

Wm Ruler Jr  
Lic. No. 128<sup>th</sup> use of  
Local Supt D.C.

He 820 L. d. 3. 1867

Surran R. J. & A. L.  
No. 20. A. B. D. C.  
Jan 3. 1867.

Respectfully returned to St.  
Ch. W. M. B. B. Local  
Supt. D. C., who will send  
the within named man  
to Freedmans Village, for-  
sating this paper as an  
order for his admission  
to the "Home."

By order of  
Prot. Supt. Gen. Thomas  
H. Rogers  
a. a. d.



Office Supt. Genl H. Barrecks  
 Bureau R.H. & A.L. - D.C. -  
 Washington Aug. 2 - 1866

Lt. Col. Wm. M. Beebe Jr.

Local Supt. D.C. -

Colonel

James Arthur Stevenson reports  
 himself as homeless & friendless and  
 unable to procure work, or do but a  
 little work, if he could get it -

I think him a proper subject  
 for Freedmen's Village -

Respectfully

Your Obedt servt

J. L. Roberts

Supt

Office Supt. Eng. & Barracks  
 Bureau R. & A. S. - D. C. -  
 Washington Aug. 2<sup>d</sup> 1866

Lt. Col. Wm. M. Becke Jr.

Local Supt. D. C. -

Colonel

James Arthur has been reported  
 being as honest & friendly and  
 unable to procure work, or do but  
 little work, if he could get it -

I think him a proper subject  
 for Freedmen's Village -

Respectfully

Your Obedt Supt

J. L. Roberts

supt



205  
Washington D.C.  
Jan. 30 1864

Sampson H. A.

Request that Oliver Felton  
Col. late a Soldier U.S.A.  
be put to Freedmans Village  
1131 1/2 S. C. St. N. 205

Office Local Supt D.C.  
Barnes R. F. & L.  
January 30 1864

Respectfully forwarded, recom-  
-mended that the man be  
sent to Freedmans Village  
M. M. Rucker  
Lt Col. & Local Supt D.C.

Jerman R. F. & L.  
H. S. D. Co. ac. D.C.  
Jan. 30 1864

Respectfully returned to  
S. T. Col. Dub. Local  
Supt D.C. who will  
send the within named  
Oliver Felton, to Freedmans  
Village by presenting this  
paper as an order for  
his admission to the  
"Home."

By order of the  
Asst Commr.  
J. P. Rogers  
A. G.

RECORDED 1864

Rec'd of L. S. No. 43/100



Wal Deben

The bearer

Oliver Felton a Freedman from  
N.C. & lately a soldier, has been  
sick & is now unable to work  
& wishes to go to Freedmen's  
belleys.

Respectfully

(Mud<sup>th</sup> 1867)

W. H. Simpson

208  
Washington D.C.  
Jan 3<sup>rd</sup> 1867

Holman, E. A.  
Supt.

States that he will  
pay the employees at  
O.L.S. Jan 4<sup>th</sup> at 10 1/2 U.M.  
H.P.M. 56. 13. 30. 30. 30.

R. O. S. 13 30 30



Bureau Refugees, Freedmen, and Abandoned Lands,

Quartermaster's Office, No. 132 Pennsylvania Avenue,

Washington, D. C., Jan 2<sup>d</sup> 1862

Col. W. M. Beebe,

Colonel:

I will be at your office tomorrow morning at 10 1/2 o'clock, to pay your employees for the month of December.

Respectfully

By order Major Brown

C. F. Solomon

Capt.

212  
Washington D.C.  
Jan 5<sup>th</sup> 1867.

Brown Maj. J. M.  
A. G. M.

Direct that James  
Warrison, Carpenter, be  
supplied with a team to  
take tables to John Brooks  
School R. 9 S. 10.

W. B. W. S. 7. C. L. S. 20212

R. E. O. L. S. 20212



Bureau Refugees, Freedmen, and Abandoned Lands,

Quartermaster's Office, No. 132 Pennsylvania Avenue,

Washington, D. C.

Jan 25<sup>th</sup> 1867

General,

Will you please let  
James Morrison Carpenter have  
a team to take School tables to  
John Brooks School R. V. S. St.

Respectfully

J. M. Brown  
Act. Asst. Q. M.

Col. W. M. Baber Jr.  
Local Supr.

711312089.045 2/23

215 Washington D.C.

Jan 5<sup>th</sup> 1864

Brown Maj J. M.  
Adj. M.

Request thro Genl.  
Whitney, that an Over  
Coat be furnished his orderly  
also Coat if there is a surplus

Surplus -  
No, coat to Issue

J. M. Wadsworth  
(11)



Bureau Refugees, Freedmen, and Abandoned Lands,

Quartermaster's Office, No. 132 Pennsylvania Avenue,

Washington, D. C.

1867

Colonel,

Gen Whittier requests  
to obtain for the military in Great  
Columbia to supply the place of one Slater  
from Gen. if it is possible to  
obtain one from any surplus coat  
on hand at your office it will  
be a great favor to a good man.

Very Respectfully

A. M. Brown  
Bvt. Major Gen.

Chas. H. Peck Sr.



Com. 124, 125, 126

Bureau Refugee, Freedmen &  
Hd. Qu. Aft. Commissioner  
Complaint Division  
Baltimore, Md. Jan. 17, 1867.

Respectfully forwarded  
to Capt. E. C. Knower, a. a. a.  
Genl. with the remarks that  
this man has been removed  
to the Bay View Asylum  
for proper attention.

The vessel on which this  
man was, is not here,  
nor can the Captain thereof  
be found.

It is likely that the  
Captain, fearing punishment,  
has changed the route of  
his vessel.

*[Signature]*  
Bvt. Col. A. A. S.  
Chief Inspector

K. B. 1/21/1867

Bureau Refugee, Freedmen &  
Hd. Qu. Aft. Commissioner  
Baltimore, Md. Jan. 17, 1867.

Respectfully returned to  
Bvt. Brig. Genl. C. H. Howard,  
Aft. Comm. D. C. (through  
Hd. Qu. Comm. Bu. R. F. & A. S.)  
with attention invited to  
preceding endorsement of

Bvt. Col. W. H. Meigs, Chf. Inspector

*[Signature]*  
Bvt. Brig. Genl. Dols,  
Aft. Commissioner

Head Quarters a. e. o. b.

January 19, 1867

Respectfully referred to  
the Local Supt. o. b. and  
attention invited to endorse-  
ment of Bvt. Col. Meigs heron.

By order of  
Bvt. Brig. Genl. C. H. Howard

*[Signature]*  
a. a. a.



Vol. 5, no. 577, U.S. 1/27

U.S. 1/27

Washington Jan 8 1867

Wm. Beane,

Sir, my dog is on  
the Cape Cod Bay, with no wind  
and frost hard enough to work  
open which is just to get his  
home if it is possible. The Captain  
of the vessel will see it done  
Come, his name is Capt. Samuel  
Curtis. And his address is  
Shatt's Alley, City of Baltimore  
Baltimore, his Agent is Capt. Getty

William Garrison

to my Son's name  
James Garrison



Washington D.C.  
Army 8<sup>th</sup> Regt  
Wm. H. Duff as Capt

Harrison William (Col)

Wm. H. Duff as Capt

It is that his son William Harrison  
is confined in an Oyster  
Boat in Baltimore. It is that  
his son is confined in an Oyster  
Boat in Baltimore.

Bureau R. I. and A. L.  
Office Local Dist. D.C.  
Washington D.C. 7-1867

Respectfully forwarded.  
Mr. Harrison. who makes  
in his Statement that  
yesterday he Baltimore to  
ascertain the truth in the  
matter and was unable  
to obtain the release of his  
son. I respectfully suggest  
that the Officer of the Bureau  
on duty in Baltimore (over)

Should be instructed  
to investigate the  
case & procure the  
release of Dennis  
Hammond.

W. M. B. Tucker  
Lt. Col. 128<sup>th</sup> Regt. I.  
Local Dept. 50  
1867

Bureau A. F. & A.  
Headquarters West Com. S. C.  
Washington Jan 10. 1867.

Respectfully referred to Col  
Mat General E. M. Gregory  
Asst Com. Missouri State of  
Maryland through Head  
Quarters Bureau A. F. & A.

Col Howard

Col Brig Genl U. S. V.

West Com. S. C.

E. B. Vol. 3. 15. 24. v. C. 2. 6. 1867.



Vol. 2, No. 1, 1877

223

Washington, D.C.  
January 12, 1877

Becke Jr. W. W.  
Lieut. Colonel  
Local Supt. (B)

Requests the admission  
of the following named  
free people into the  
Home at Freedmen's  
Village, viz:

Thomas & Sophia Webb

aged 95 infirm

Susan Towle 40 four

(4) children having no  
means of support.

Dear Sir, please

General R. G. A. S.  
Std. Ins. H. D. C.  
Jan'y. 14, 1877.

Respectfully returned to  
St. Col. Beck, Local Supt.  
D.C. who will send the  
within named persons  
to Freedmen's Village,  
presenting this paper  
as an order for their  
admission to the "Home".

By order of  
Wm. H. Howard  
McLure  
a. a. a.

Wash<sup>g</sup> D.C. Jan<sup>y</sup> 11/67

Rev. S. Robert  
Sup. Freedmen  
Sir

Juan Fone  
has four Children, one an  
infant, and has no means  
of support — has no husband  
I ask for her a home  
at Freedmen's Village

Very Respect<sup>ly</sup>  
Res. M. side of } Maec Green  
5th St. bet. L & M }



Office Super East Camp Hill  
Rum R 47 A -  
Washington  
Jan 10<sup>th</sup> 1867

Respectfully recommended  
to Lt. Col. W. M. Becke

Local Supt. etc.

With recommendation  
that the request be granted

W. M. Becke

Superintendent

W. M. Becke

Office Local Supt. etc.  
Washington Jan. 12/67

Respectfully forwarded  
recommended.

W. M. Becke  
Lt. Col. and Local Supt. etc.

W. M. Becke

Bureau Refugees, Freedmen and Abandoned Lands,

Office Local Superintendent, D. C., Corner 7th and O Streets,

Washington, Jan 12<sup>th</sup> 1865

Captain. I have the honor to request  
an order for admission to Freedman  
Village for Thomas and Sophia Webb, colored  
are very old and not able to support themselves.

Very Resp<sup>ly</sup>  
Your obt<sup>l</sup> Serv<sup>t</sup>  
W. M. Duke Jr  
14 Col 128<sup>th</sup> Regt  
Local Sup<sup>t</sup> D. C.

But Capt. S. N. Clark }  
U. S. A. Gen.



Washington, D.C.  
Jan 12<sup>th</sup> 1861

Griffing Messrs.

Ugh

States that Mr. B. Jefferson is very anxious to devote himself to the relief and work for the interests of the freed people of this Dist.

Respy asks that his services may be secured at a reasonable compensation.

Respy forwarded.

Recommending that the within named person be employed - reporting in person to me.

M. Rube

Loc. 128<sup>th</sup> - U.S. T.

Local Supt.

D.C.

Bureau B. D. A. L.  
H. S. H. B. D. C.

Jan 15<sup>th</sup> 1861  
Respectfully returned to Col Rube who is authorized to employ Mr. B. Jefferson at a salary of fifteen dollars per month.

By order of  
Ber Brig Gen Howard  
M. C. C.



Washington Jan. 11<sup>th</sup> 1867.

Lieut. Col. W. M. Beebe Jr  
 Local Supt. D.C. Bureau Ref. &c.

As I would respectfully  
 submit that the Beaman W. B. Jefferson, seems very anxious  
 to devote himself to the work of relief and elevation of  
 the Freed people in this Dist. - and having known him  
 for some time past, to be engaged in voluntary service  
 for their physical and spiritual welfare - and to be  
 himself extremely destitute (for want of employment).  
 It would respectfully wish that his services at a reason-  
 able compensation, may be secured, for such a length  
 of time, as he shall prove efficient in persuading destitute  
 Freed people, to leave this District, and accept homes and  
 self-sustaining positions, in the North East and West,  
 and at the same time shall continue to instruct them  
 in evening & Sabbath schools, when he is not doing.

Hoping for favorable action in his case.

Very Respectfully  
 Your Obedt. Servt.  
 J. H. Griffing.

Sept. 4<sup>th</sup>



727  
Washington, D.C.  
Jan 10<sup>th</sup> 1864

Clark S. A.  
Capt & A. A. Genl

Forward order directing  
that C. C. Walden, an employe  
in Bureau R. R. A., to proceed  
to So Gastonburg construction  
in charge of freed people,  
M. B. W. 43, C. S. W. 25.

W. A. C. S. 26, 40, 26, 1

NARA 979

Bureau Refugees, Freedmen and Abandoned Lands

Headquarters As't Commissioner, District Columbia,

Washington, *July 10<sup>th</sup>*, 1867

Special Orders,

No. 3

(EXTRACT.)

1. C. C. Waldon, an employee of the Bureau of R F & A L for this District, is hereby directed to proceed to South Glasterbury, Conn in charge of Freed people, having performed which duty he will return to this city.

The Quartermasters Department will furnish the necessary transportation.

By order of Brevet Brigadier Genl. C. H. HOWARD,

*A. A. A. General*

A. A. A. General.

*St. Col. W. M. Butler, Jr.*  
*Local Agent, etc.*



MS. A. 9. 2. 235

235

Washington D.C.  
Jan 16<sup>th</sup> 1864

Kindred Father,  
Supt. of Schools

State, that the want  
of the Lumber at School  
House on E. 11<sup>th</sup> near 9<sup>th</sup> ordered  
two days ago, being a ton of  
Coal in yard to be taken,  
also request that 4 book  
cases & 1 Book case may  
sent with same Lumber  
to the School - (Miss Chase's)

Wm. S. 1704 95. C. 2. 235

W. S. 1704 95. C. 2. 235

Washington D.C.  
Jan 16<sup>th</sup> 1867

Col Wm Duke,  
Col

I have the honor to  
inform that the amount of that lumber at  
the school house on E St near 9<sup>th</sup> N.E.  
on the Island ordered two days  
ago, is leaving a ton of coal out  
in the yard to be stolen. We  
have no place to put it until you  
send the lumber.

Will you send by the same team  
to the same address (Miss Leary)  
a Black Board... and a Book  
Case from the Free Library Cor 5<sup>th</sup> & E St.  
(for which I send an order)

Also a Black Board to Kendall Green  
Care of Maj Townsend.



Washington D.C.  
Jan 16<sup>th</sup> 1867

Col Wm Duke.

Col

I have the honor to  
inform you that the amount of that lumber at  
the school house on E St near 9<sup>th</sup> N.W.  
on the Grand ordered two days  
ago, is leaving a ton of coal out  
in the yard to be stolen. We  
have no place to put it until you  
send the lumber.

Will you send by the same team  
to the same place (Miss [unclear])  
Black Guard.

Enclosed find [unclear]  
for which I am

Also a [unclear]  
Care of Maj [unclear]

Also 8 Black Boards to the  
East End of East St in  
Georgetown D.C. for the School  
House for Colored Children.  
lately built.

17 April 1862  
By order of the General

John Kimball  
Supt of School.



Washington D.C. Jan 7<sup>th</sup> 1869

Genl S. W.

Capt. A. A. Spaul

States that the U.S. Army  
Comd has ordered a  
quantity of wood to be  
delivered to Rev. J. Roberts,  
& Maj Townsend for  
judicious distribution  
during the extreme cold  
weather. Also to other points  
that may be deemed proper  
Wm. H. ...

Wm. H. ...

NARA 979

Bureau Refugees, Freedmen, and Abandoned Lands,

Headquarters Ass't Commissioner, District Columbia.

Washington, January 17. 1867.

Sir: Col W. M. Beebe Jr.

Local Sup't D. O.

Colonel: The Assistant Commissioner has ordered a quantity of wood to be placed at the disposal of Mr. Townsend and Mr. Roberts for issue. He directs that you instruct them to issue whatever may be necessary to prevent suffering during the cold weather, and that they will be held responsible for its judicious distribution.

Should you deem it necessary the Assistant Commissioner desires that you specify other points where wood should be kept for issue.

Respectfully

Your obedient servant

M. Clark

a. a. S. G. W.



Vol. 2. No. 824 A.C.D.C. 1887

Washington D.C. Jan 15 1867

Quiffing & Co. 238  
Agents

file

What is a date for purchase  
for use of Mrs. Quincy. Add in  
last office.

Washington D.C. 1867

Office Local Dept

Washington Jan 14 1867

Washington D.C. 1867

Reply forwarded

Approved

W.M. Duke Jr  
Sr. Cal. Local Dept  
DC

(Duplicate)

Washington D.C. 1867  
1867

NARA 388  
Employment Office  
394 North Cap St  
Washington D.C. Jan 15<sup>th</sup> 1867

Lt Col Wm M. Beebe Sr  
Local Supt D.C. Bureau Refuge  
Sir

I would respectfully ask that  
a desk, may be furnished for the use of Mrs Daily,  
Assistant in this Office -

Very Respectfully  
J. E. Griffing, Asst.



Bureau B. I. & A. S.  
H. D. Des. H. C., D. C.  
Jan'y. 19, 1867.

Respectfully returned to  
St. Col. B. C., Local Sect.,  
D. C. (through S. M. R.,  
Regiment). Such cases  
must be investigated  
when referred. If the vis-  
iting Agent is unrelia-  
ble or inefficient, you  
will recommend his  
or her removal and  
nominate some one  
to take the place.

Meanwhile send some  
person from your office  
if the case is a press-  
ing one.

There is no limit  
to your supply, and

(over)  
# 137, O. L. S. 1867

you are not confined  
to orders from visiting  
Agents.

By order of  
W. B. S. M., Howard

A. J. Rogers  
Adapt.

Jan'y 19, 1867



L. R. Vol. 2 No. 333 A. C. D. C., 1867

Washington Jan 9. 1867

Griffing Mrs J. V.

(Wrapper One enclosure)

Requests information as to  
shall be done with those and  
suffering in Mr Parson's  
District, who on announcing to  
him, are told that he can do  
nothing for them.

Bureau Refugees, Freedmen, & Abandoned Lands

Head-Quarters Asst. Commr., D. C.,

WASHINGTON, Jan 10 1867.

Respectfully referred to Surg  
R. Reyburn U.S. V. President  
Special Relief Commission  
for immediate investigation  
and report.

By order of  
Capt Geo Howard  
McCluck  
aaaguel.

Jan 10 1867

Respectfully referred to  
Capt Geo Howard  
President Special Relief

Richard Reynolds  
Capt H. Coker Surg. Dept.  
President Special Relief

Recd. O. S. D. 11<sup>th</sup> 1867

217th St. 10th 1867

Office Local Dist D.C.  
Washington Jan 19<sup>th</sup> 1867

Respectfully returned  
to Post Lt. Col. Reynolds.  
It is not practicable  
for me to investigate  
in person the cases of  
distillation referred  
to me, owing to my  
numerous regular  
official duties, and  
it would greatly assist  
me, if the Pres of the  
Relief Com. would  
give me definite in-  
structions as to what  
will be done where  
visiting agents decline  
to investigate cases on  
the grounds of their  
means of relief being  
exhausted.

J. M. Sullivan  
Lt. Col. Local Dist D.C.

71717M 96 C S 11 2 2 2

Received A. C. D. C. Jan 9. 1867.



1  
Wash, Jan. 9, '67.

Brig. Genl. C. A. Howard

Asst. Comd. D. C. Bureau Ref. &c

I would, <sup>respectfully ask</sup> for information

as to what shall be done with the old and suffering on  
Mr Parsons' dist - who on appealing to him, are told that  
he can do nothing for them?

The woman Albert Mitchell living on  
S. 4th St. was in distress & having been referred  
to Mr Parsons returns again for help.

An old Col. woman 97 yrs. on 3<sup>d</sup> St. 3<sup>d</sup> door below  
Trinity Ch., appeal for help at our Office on Sunday night.  
She was so poorly clothed, that I sent a Freeman to Mr  
Parsons, instead of herself, with a note, stating facts of  
her age & penance & that she was alone & out of fuel & bread.  
— No one came to see her, she came again yesterday & I gave  
her his No. and sent a man with her to his house. She was  
told that she could not see him in Office hours - he did not  
get home till four. - Came back and went at four - He  
told her he had nothing for her - & that I should not  
refer such cases to him.

I know the old woman's condition - that she had no

food or fire - no wood at all. I respectfully ask that her case may receive attention, if possible, as I have seen this morning, that she has no wood or food.

Many old people are at this Office, from other Districts where the winters are now, as they <sup>the old people</sup> are told, without means to help them, at this moment, waiting for assistance in wood and food.

If consistent with regulations I would ask that two cords of wood may be left in charge of this Office, to relieve the extreme cases of distress, that we cannot otherwise supply, giving only to persons whom we know to be absolutely needy.

Very Respectfully  
J. S. Whittington

Asst. Secy



MAILED

711 1/2 17th St. N.W. Wash D.C.

Washington D.C. Jan 18/869

Rogers J<sup>nr</sup> W.

A. A. A. Grad. D.C.

By direction of Asst Commr.  
refers to accompanying Ac-  
count roll as a list of clothing  
required by the orphans at  
the Nat. Home School  
under direction of Mr. De.  
Mair. Also that he will  
be notified to send them to  
Office L.S. in order  
that their signatures may  
be obtained on issues.

711 1/2 17th St. N.W. Wash D.C.

Bureau Refugees, Freedmen and Abandoned Lands,  
Headquarters Ass't Commissioner, District Columbia,

Washington, January 15<sup>th</sup>, 1867.

Dear Genl. H. M. Smith:

I have just received from you a list of clothing required by the officers at Ft. M. and's National Home school, near Castle Point Park, and to say that upon the application of the officers thereof you will issue to them in accordance with the same.

It is not my intention to issue to you the certificate of issue that these supplies may be obtained at the time of issue.

Very respectfully

Your obedient servant,

Wm. Rogers

Act. Secy.



246

2025 02 25 2021

Chapfield, P. San. S. G.

Smith, Alfred, M.

referred to  
Hon. S. W. Schofield.

Suggests that Mr. James  
Forrest may procure from  
the Bureau a middle aged  
German, raised in the country  
for a domestic.

1871 11 11 111. C. S. 11 11 11

1871 11 11 111. C. S. 11 11 11

War Department  
Bureau of Refugee Affairs  
Washington January 12. 1871

Respectfully referred to Brig.  
Gen. John C. H. Moore,  
Asst. Com' for D. C., who will  
please comply with the request  
within, if possible.

By Order of  
Major General C. C. Foster  
A. P. Ketchum  
U. S. Army

Done

H. D. D. H. D. C.

January 15 1871

Respectfully referred  
to Lieut Col Beebe  
for attention and  
action.

By order of  
Brigadier General Howard  
M. Clark  
Major General

NARA 388  
Clearfield Pa January 5<sup>th</sup> 1862

Hon. G. W. Schofield,

Dear Sir,

Mr James Forrest of this place requests me to ask you if he could procure a Woman from the Freedmen's Bureau for a domestic and if so, how? He wants a middle aged Woman who has been raised in the country, he is willing to pay her liberal wages and also to comply with the regulations of the Bureau whatever they may be.

Mr. Forrest is "as has been always a sound Union man, in good circumstances & of good character," and can give satisfactory references if desired. If they will send him such a person as described, it can be done by Express directed to care of G. W. Schofield, Philadelphia Pa. Expenses to be paid on delivery. Hoping to hear from you, I remain your truly

Wm. Alfred M. Smith

Dear Sir,

It kind enough to give me the inform.

over



ation asked not return this letter

Yours truly

Henry S. W. Schofield

May Genl Howard

Official:

H. S. W. S.

Clinton, N. Y. 247

Jan 7<sup>th</sup> 1867  
Vol. 2, No. 549, A. D. C. 1867

Soldier, Albert  
Paris Presb. Church.

Asks that a good house servant  
may be sent him, - one who  
can do fine ironing, and is a  
good cook. One child, boy or  
girl, would be no objection.

Recd from ...

... M. C. ...

WAR DEPARTMENT,  
Bureau of Refugees, Freedmen, and Abandoned Lands,

Washington, D. C.  
Jan 9<sup>th</sup> 1867

Washington, ..... 186

Respectfully referred to, Brig.  
Gen. G. H. Howard Dist.  
Com. Dist. Columbia, for his  
action.

I. Milvord Saxon,  
In the absence of  
Rev. J. W. Howard, Insp. de.

Bureau of F. & A. L.  
Head Quarters Act Com<sup>ty</sup> D. C.  
Washington Jan 9. 1867.

Respectfully referred to  
S. Col. W. M. Beale Jr. Insul  
Supt who will take  
necessary action

By order of  
Col. Brig Gen G. H. Howard  
M. Clark  
a. a. Guil

E. B. Vol. 3. No. 17. A. D. C. 1867.

47



Clinton N.Y.

Jan - 7. 1867.

Rev. J. W. Alvord

Dear Bro. we have been informed thro. a friend from Conn. that you have been somewhat engaged in finding houses for the freedmen & women in Washington. Presuming that we are correctly informed, I make application to you.

My wife is very much in need of a good house servant, one who is a good cook, & is able to do fine ironing. We



w'd prefer a woman of  
sufficient years to be reliable  
as a housekeeper.

Our family is small, consisting  
of wife myself & Baby about  
6 months old.

If we c'd secure a woman  
with a child of 12 or 14, we  
c'd ~~take~~ take them, either ourselves  
keeping the child to take care  
of baby, or else Mrs. Erdman's  
mother who lives in the same  
village. w'd be glad to take  
such an one, either girl or  
boy. I presume it is  
not necessary to mention Protestantism

As a qualification, as you  
probably have but few, if  
any Catholic negroes.

~~We desire~~ One objection in desiring  
a freedwoman is to get a  
servant of our own religion,  
with whom my wife c'd

alternate in attending church.

We pay \$2.00 <sup>per week</sup> to a servant  
who does all the work of  
the <sup>(house)</sup> family, but if strength sh'd  
not be sufficient to do it all,  
we will pay \$1.50, & hire a  
washerwoman weekly.

Not knowing on what  
terms you furnish servants,



MAR 29 1893

nor indeed being sure that  
 you have anything to do  
 with the matter, I simply make  
 application, & if you can  
 accommodate us & send such  
 an one as we want right  
 along, & let me know <sup>what</sup> I  
 owe you, I shall be  
 greatly obliged to you.

Yrs truly,

Albert Erdman,  
 Pastor of Soc. Church.

No 11

(R. F. & A. L., Vol. 9) 1867.

New Alexandria Pa.

June 11

, 1867.

Vol. 2, No. 555, Reg. St. Pa.

M<sup>rs</sup> Sida Henry

Desiring information in regard  
to the above named -

William H. ...

WRAPPER ..... Enclosures,

ccdc

Received through R. F. & A. L., ..... 1867.

WAR DEPARTMENT,

Bureau Refugees, Freedmen, and Abandoned Lands,

WASHINGTON, June 10 1867.

Respectfully referred to Asst.  
Commissioner, District of  
Columbia

By order of

Major Genl. G. O. Howard Com.

A. P. Ketchum

ccadgeneral

General R. F. & A. L.

Head Quarters Asst Com DC

Washington June 11 1867

Respectfully referred to  
Lieut Col Rufus Slocum Capt.  
for action.

By order of

Col Brig General Howard

M. Clark  
ccadgeneral



Wm. R. F. A. L. Oct 9 '87

Gen. O. Howard,  
Sir

I would  
stand through the paper  
that you are sending food  
more work, as you, a woman  
suitable. I would like to proceed  
in them, I wish to see a man  
to work on a farm, and a  
woman to do kitchen and general  
house work.

I wish to be informed how I  
can get them, are they sent  
by the Government, or must  
I go to Washington, or some  
other point to get them?

In Reference I refer you to  
Gen. John Corvett, and  
Jm. A. Cook, Treasurers

Alles Gute am Tag,  
an dem ich mich sehr freuen  
wird.

Sehr Respektvoll  
Herrn H. Bieder  
von Altona

Verantwortlich

Hand  
Stempel



Vol 2, - No 6, 15 - 18 - 1867

257

Washington D. C.  
January 16<sup>th</sup> 1867

Chamberlain, J. C.

Wm. W. C. L. S. 1867

Desires to obtain  
3 freed persons to  
work on the farm  
of E. Matthews,  
living in Loudon  
Co. Va.

Know that he made  
a similar applica-  
tion some 6 weeks  
since of which he has  
heard nothing.

Head Quarters A. C. S. C.  
January 17. 1867

Respectfully referred to  
the Local Supt S. C.,  
for action, and atten-  
tion called to endorse-  
ment on application  
of the same tenor

By order of  
Butting Gen. C. H. Hough  
H. H. Rogers  
A. C. S. C.

E. B. W. S. 10. 60. A. C. S. C. 1867

War Department,

Bureau of Refugees, Freedmen, and Abandoned Lands,

Washington, January 16<sup>th</sup>, 1867.

Dear Colonel W. W. Rodgers

Acting Assistant Adjutant General.

Office Assistant Commissioner D. C. Washington, D. C.

Colonel.

I have the honor to state that I forwarded to your office a communication some six weeks ago asking your assistance to enable me to secure the services of three Freedpeople. viz

One Man for farm hand (used to such labor) pay \$10 per Mo for 1 Yr

" Woman " House servant " 9 " " "

" Boy about 16. Yrs of age to take care of Horses.

All to go on the Farm of E. Matthews, (relative of mine)

a strong Union man living in Loudon Co Va. near School and Church for Freedmen.

I am, Colonel,

Very Respectfully



4444 200

Your Obedt. Servant.

X

J. E. Chamberlain

Clerk Bureau R. I., and N. S.

MS. A. 9. 2. 6. 2. 5. 7. 2. 5. 7

Washington D.C.

Jan. 19<sup>th</sup> 1867

Ferrisden J. C.

Judge.

Desires to obtain a  
coll. from you.

MS. A. 9. 2. 6. 2. 5. 7. 2. 5. 7

1867



Handwritten notes at the top of the page, including the word "Rooms" and other illegible cursive text.

Stanford Corner  
Board & linen - for  
1 woman -

Ingr. P. - Rooms  
437. 3th pt etc. -

711 1/2 10 1/2 St. N.W.

Washington D.C.

Jan 11 1867

Clark S. M.

U.S. Genl.

Requests acknowledgment  
of Circulars No. 1. 2. 3. 4. 5 & 6  
C. S. & 1 copy Cir No. 1  
C. D. M. Bureau N. 139

2018. 11. 2. 1. 11. 11. 11



Bureau Refugees, Freedmen and Abandoned Lands,  
Headquarters Ass't Commissioner, District Columbia,

Washington, Jan<sup>y</sup>. 14<sup>th</sup>, 1867.

St. Col. W. M. Dub. Jr.

Local Supt. D.C.

Columb:

I am directed by the Asst  
Commr to enclose herewith one (1) copy each, of  
Circulars No. 1, 2, 3, 4, 5 & 6 - Series of 1844 - and Circu-  
lar No. 1, C. S. Office Chief Dr. M. Burnham R.  
F. & A. L.

Also - five (5) copies of Circular No. 1,  
Current Series, from these 118. Dcs., the receipt  
of which you will please acknowledge.

Very Respectfully,

Your Obedt Servt,

McClure

u. u. u.

17th 1867

Washington, D.C.  
Jan 21<sup>st</sup> 1867

Clark, Geo. W.

200 200 104 000 000 1557

Makes application for  
position as Clerk under  
Rev. L. Roberts. Supt. East  
Coast St. Bernard's Sta. which  
he has lost a leg. while in  
Service for his Country.  
and has a family depend-  
ent upon him for  
support for which his pa-  
rents have no means.

Office Local Supt. D.C.  
Jan 20<sup>th</sup> 1867.

Respy forwarded. recom-  
mending that Mr Clark be ap-  
pointed a Clerk when a vacancy  
shall occur. Mr Roberts already  
has a man in view for that  
(over)

No. 102, S. 26, 12, 1867

position at his office.

Wm. Duke J.  
St. Co. 138<sup>th</sup> N. J. S.  
Local Supt. D.C.

17th 1867

400



BUREAU REFUGEES, FREEDMEN AND ABANDONED LANDS,

Office: Local Superintendent, B. C., Corner 7th and O Streets,

Washington, Jan'y 21<sup>st</sup> 1867.

Sir,

I have the honor to solicit your recommendation to Genl. C. Howard, for promotion to a Clerkship under Mr. Roberts. At the time Genl. Howard placed me here as a Watchman, I was given to understand (at least so I inferred from my conversation with him) that should a vacancy, or opportunity occur, for a Clerkship, I would be remembered. At that time a Watchman's situation was the best he could do for me, and I needing immediate employment, most cheerfully accepted the position, at the same time looking forward for a time when I would be promoted.

I have a Wife & Child needing assistance from me, and with my present pay, I am unable to do but little for them. I believe myself capable of earning more for the Department, and myself too. I have done my Country some service I am sure. I Enlisted early in her cause, (May 22<sup>d</sup> 61) and have lost a leg in Battle. Altogether I feel that I have some claims on the generosity of those

in authority. I earnestly solicit your kind  
consideration of my Case, My Claims, & Necessities,  
that I may be enabled at no very distant date  
to have my family with me, and be able to give  
them support as I did previous to the War and  
the Misfortunes I thereby Met with  
Feeling assured of your kind Hearts towards  
wounded, and disabled Soldiers. (and thinking  
that perhaps, you know something of my Circumsta-  
nces at the time of the breaking out of the war, and  
the sacrifices I then made of position & ( ) I have  
implicit Confidence in submitting my case to your  
generous Consideration

Most Respectfully Yours

Sicut & Col. N. M. Bebe Jr  
Local Supt. D. C.

Sis. N. Clarke



Vol. 25, No. 66, A.C. D.C., 1867  
Washington D.C.  
June 23<sup>rd</sup> 1867

Robert J. L. 258  
Supt. &c.

Makes application  
for admission to Freed-  
man's Home, for David  
Reed, an aged Freedman  
Residence A St. of So Capt.  
& N. J. Ave. Island  
7113 1/2 St. N. E. D. C.

Office Local Supt. D.C.  
Jan 23<sup>rd</sup> 1867  
Exp. 23<sup>rd</sup> 1867  
Respy forwarded.  
Recommended.

Mrs. C. L. L.  
Lt-Col 128<sup>th</sup> U.S.I.  
Local Supt. D.C.  
No. O. E. S. No. 123 1/2 St.

Bureau of F. & A. S.  
H. S. Mrs. Asst. Commr. D. C.  
Washington, Jan'y 24<sup>th</sup> 1867

Respectfully returned to  
the Local Supt. D.C. who  
will send the within nam-  
ed freedman to the "Home"  
at Freedmen's Village,  
presenting this paper as  
an order for his admis-  
sion there to.

By order of  
Col. Brig. Gen. Howard  
A. H. Rogers  
A. S. D. C.

Office Supt East Coast Ariz  
Bureau R. & A. S.

Washington D. C.  
January 22. 1867

St. Col. W. M. Perry

Local Supt. D. C.

Colonel

I have the honor  
to recommend for admission to Freedman  
Home Daniel Reed Freedman residing on  
H. St. bet South Capt. & N. J. Ave. Island  
Mr. Reed is about 75 or 80 years of age  
feeble & dependent and very infirm  
If an ambulance can be sent for  
him today it will relieve us of  
much anxiety

Respectfully,

Wm. H. S. Supt.

J. Roberts  
Supt.



71170101 O.L.S. No. 259

Washington D.C.  
Jan 24 1867

Clark S. A.  
Capt. & Cavalry

Direct through  
USM Comdr that all  
letters and Telegrams  
from Mr. S. A. Madson  
& Mr. Gray - be sent  
to H. D. ...

No. 111 124 1867 O.L.S.

NARA 410

Bureau Refugees, Freedmen and Abandoned Lands,

Headquarters Ass't Commissioner, District Columbia,

Washington, January 24 ..... 1867.

Sicut Col W. M. Beebe Jr  
Local Supt - D.C.

Col: - The Asst Com<sup>r</sup> requests  
and telegrams  
that you return by bearer all letters, or  
file in your office from S. A. Wadsworth  
of Conn written since Oct-1 1866. Also  
any letters and telegrams from a Mr. Glazier  
of Hartford Conn

Respectfully

Your obed<sup>t</sup> servant

W. M. Beebe

a. a. G. C.



260  
Washington, D.C.  
Jan 23<sup>rd</sup> 1867.

Reyburn Robert  
Surge U.S. Army.

States there will be a  
meeting of the members  
of the S.B. Commission  
Friday ev. Jan 25<sup>th</sup> 1867.

Wm. W. Miller. C. S. & 240.

Rev. C. S. 23<sup>rd</sup> 1867.

Bureau Refugees, Freedmen and Abandoned Lands,  
*Special Relief Commission*  
Headquarters Ass't Commissioner, District Columbia,

Washington, January 23<sup>rd</sup>, 1867.

W. Col. W. M. Ricketts

Sir,

You are hereby requested to notify the visiting Agents in your District, that the Monthly Meeting of the visiting Agents & Superintendants of the Special Relief Commission will be held at the room of the Messrs. Taylor & Bowen, Post office, Wash. D. C. on Friday evening January 25<sup>th</sup> 1867 at 7 1/2 o'clock P.M.

By order of Genl. Brig. Genl. G. M. Howard

Robert Kenner

Act. Lt. Col. Genl. Supt.

President Special Relief Commission



281

Washington, D.C.

Jan 21<sup>st</sup> 1864,

Reverend W. W. H.

U. S. Army, Genl. Hq.

Dear Sir through Col. [unclear]  
I would that the winter  
wounded & destitute freed-  
people, be furnished with  
wood according to their  
necessities.

W. W. H. 105. O. S. 709246.

W. W. H. 105. O. S. 709246.

Bureau Refugees, Freedmen and Abandoned Lands,  
Headquarters Ass't Commissioner, District Columbia,

Washington, January 21<sup>st</sup> 1867.

Genl. Col. W. M. Beebe jr.

Super Supt F. C.

Colonel.

The following names are directed that you will without delay supply the following named destitute people with such quantities of <sup>meat</sup> as their necessities actually require.

- Louisa Hunter, 13<sup>th</sup> St bet R & S.
- Lucinda Browne, 13<sup>th</sup> St bet R & S.
- Robert Johnson, 14<sup>th</sup> St bet R & S.
- John Brown, 14<sup>th</sup> St bet R & S.
- Robert Washington, 11<sup>th</sup> St bet R & S.
- Louisa Johnson, " " " " " "
- Eliza Johnson, 11<sup>th</sup> St bet R & S.
- Maria Johnson, " " " " " "
- Jane Johnson, " " " " " "
- Esther Johnson, " " " " " "
- Mary Johnson, " " " " " "
- John G. Davis, 10<sup>th</sup> St bet R & S.



Nancy Fitz Hugh,	12 <sup>th</sup> St bet. S <sup>th</sup> & J.
Louisa Jackson	" " " " "
Kelly Simons,	" " W <sup>th</sup> Island Ave.
Eliza Wells	11 <sup>th</sup> " " " "
Geo. Forbes	" " " " "

I am respectfully

Yours medical servant

W. H. Rogers  
 A. M. D.

MAR 24 1864

1105 U.S. Dist. Ct.

Washington D.C.

Jan 23<sup>rd</sup> 1864

Davidson J. P.

Desires to obtain 25 Two  
Colored Serps for Mrs  
Margaret Kapp, of North  
Carolina, Pa.

25 Colored Serps



Ms. A. 1. 1. 1. 1. 1. 1.

Ms. A. 1. 1. 1. 1. 1. 1.

Washington D. C.

Jan 23<sup>rd</sup> 1864.

Davidson J. P.

Desires to obtain 250  
Colored Serps for Mrs  
Margaret Kapp, of North-  
umberland Co., Pa.

Ms. A. 1. 1. 1. 1. 1. 1.

Washington D.C.  
May 22, 66

Col. W. D. Keane  
9000 Dept. H. A. S.  
Washington D.C.

I have been very much of the same kind of  
Nordmanskland. There is no application for two (2),  
and girls, so is all right of, enjoying general  
some work. If two good girls can be found they  
can have a comfortable home and good  
family to live with and may give a  
long time. Please inform us soon as convenient  
and you are thanked immediately.

Very truly  
Yours,  
W. D. Keane

Gen. G. M. Williams, Office  
Cor. 14th & F St.  
Washington D.C.



711 B / 17th / 156 / 1864

Washington D.C.  
Jan 25<sup>th</sup> 1864

Rogers Inst<sup>n</sup>  
A. A. A. Grad.

Direct that 121<sup>st</sup> Street  
operations be furnished  
Mrs Lydia J. Steel. for  
freed people going to  
Boston. Mass.

Wm. C. C. C. C. C.

NARA 420  
Bureau Refugees, Freedmen, and Abandoned Lands,

Headquarters Ass't Commissioner, District Columbia.

Washington, January 25 1867.

Sir: Col H M Beebe

Local Dept. C

Colonel: Please send  
27 twenty one rations to Mrs Lydia J. Still  
No. 59. Montgomery Street Georgetown  
26 and for issue to seven destitute poor  
people going to Boston Mass

By order of

Det Brig Gen C H Hayward

H. H. Hayes

Assistant



Washington D.C.

267

Jan 25<sup>th</sup> 1867

Rogers G. M.

1<sup>st</sup> Lt. A. A. A. Genl. D.C.

Desires to know if the  
application for three des-  
titute freed people for  
Chicago is a part of the  
families ordered for that  
place, if so the A. A. A. Com<sup>d</sup>  
directs that they be kept  
together

Wm. H. C. S. 11<sup>th</sup> 1867

Recd. D. C. 11<sup>th</sup> 1867

Bureau Refugees, Freedmen and Abandoned Lands,  
Headquarters Ass't Commissioner, District Columbia,

Washington, January 25<sup>th</sup>, 1867.

Lieut Colonel H. M. Beebe Jr.

Local Supt. D.C.

Colonel,

The Assistant Commissioner noticed an application by you this morning for transportation for three persons (freedpeople) to Chicago, and directed me to enquire if they are a part of the lot of eleven, applied for to go to that place, and if so, to say that he wishes them kept together, and you to report when all are ready to go, as an agent will be sent here, to conduct them to their destination.

Very Respectfully,

Your Obedt Servt.

Wm. H. Rogers

1<sup>st</sup> Lieut 45<sup>th</sup> Infy.

A. A. G.



NARA 423  
Bureau Refugees, Freedmen and Abandoned Lands,  
Headquarters Ass't Commissioner, District Columbia,

Washington, January 25<sup>th</sup>, 1867.

Lieut Colonel H. M. Beebe Jr.  
Local Supt. D.C.

Colonel,

The Assistant Commissioner  
noticed an application by you this  
morning for transportation for three  
persons (freedpeople) to Chicago, and  
directed me to enquire if they are a  
part of the lot of eleven, applied for  
to go to that place, and if so, to say  
that he wishes them kept together, and  
you to report when all are ready to  
go, as an agent will be sent here  
to conduct them to their destination.

Very Respectfully,

Your Obedt Servt.

Wm. P. Rogers

1<sup>st</sup> Lieut 45<sup>th</sup> Infy.

A. A. G.

Washington D.C.

Jan 25<sup>th</sup> 1864

265

Comd Miss W. F.

Agent

20 5 10 100 100

Request transportation from this city to West Bloomfield, N.Y. and return in charge of a party of freed people.

Very respectfully

20 5 10 100 100

Office Local Supt. D.C.

Jan 26<sup>th</sup> 1864

Copy forwarded

Approved

W.M. Duke Jr

Lt Col. 128<sup>th</sup> Regt.

Local Supt. D.C.

Office of the Supt. and Capt. Wiles  
Bureau R.H. D.C.

Washington D.C.

January 25<sup>th</sup> 1864

25. Col. Wm. Beck for  
Local Supt. D.C.  
Colonel.

I have the honor to forward the enclosed applications with recommendation that transportation be furnished.

Respectfully

Your Obedt Servt

J. L. Roberts -  
Supt

20 5 10 100 100



Can you please...

W. G. L. and S.  
F. H. H. H. H.

I have the honor  
to acknowledge the receipt of your letter  
of the 14th inst. regarding the  
matter of the...  
I am sorry to hear that you  
are unable to attend to the  
matter at this time. I will  
be glad to represent you.

Very truly yours,  
W. G. L. H. H. H.

783170115.0.2.8.7.227

J. J. R. Fr. L. V. 1117  
Washington D. C.  
January 22. 1867

Gompkins - Chas N.

Bvt Brig. Genl &  
Act. C. D. G. M.

Forwards copy of communication from Wm Dickson Chief Engineer of the U. S. Steam Fire Brigade, reporting the fire in one of the Seventh St Barracks; and directs attention to the cause of same - the condition of the stove pipes in said barracks.

Hon. Secy. Bureau A. A. A.  
Washington Jan 24/67  
Respectfully referred to Genl C. H. Howard Dist. Com. District of Columbia with attention invited to various reports and directions to provide a series of drawings of an arrangement of this kind through similar means  
Howard  
Bvt Brig. Genl

913 }  
291 }  
702 }  
A. P. Ketchum  
in approval

Bureau Refugees, Freedmen & Abandoned Lands  
HEAD QUARTERS ASSISTANT COMMISSIONER, D. C.,  
Washington Jan 26<sup>th</sup> 1867  
E. B. Vol 3, No. 116, U. S. G. O. 1867  
Respectfully referred to Lieut Col Wm M. Beebe Jr. Local Supt D. C. calling attention to the above endorsement and compliance therewith directed  
Col. Beebe will make requisitions for such material as may be needed to carry out the instructions  
By order of Bvt. Brig. Gen. HOWARD.  
Wm M. Rogers  
A. A. A. General.  
E. B. Vol 3, No. 116, U. S. G. O. 1867

Per C. E. S. etc. 726767



Ms. S. Steam Fire Brigade,  
Chief Engineer's Office,  
Pennsylvania Avenue, Below 19th Street,  
Washington, D. C. January 22, 1867.

Col. Maj. Gen. W. H. Tucker,  
Assistant Quarter Master General,

Ms. S. Army,  
Washington, D. C.

General:

I have the honor to report the occurrence of a fire this morning, about eight o'clock, in one of the frame barracks, situated on South Street between N. and O. streets, occupied by the Freedmen's Bureau.

The Engines were quickly upon the ground, extinguishing the flames before much damage was done. The cause of the fire is attributed to the careless construction of a stove-pipe.

I am, General,

Very Respectfully,

Your Obedt. Servant,

/ over /

NARA 499

Signed) William Dickson  
Chief Eng'r.

Chief Quartermaster's Office  
Washington Depot  
January 22<sup>nd</sup> 1877.

True copy respectfully referred to Major  
General W. T. Howard, Commissioner  
Bureau of Refugees, Freedmen & Sick, for  
his information, and his attention invited  
to the <sup>reported</sup> cause of the fire.

Charles W. Conner  
Brevet Brigadier  
Acting Chief of Depot



271

Washington Dist Columbia  
Jan 28<sup>th</sup> 1867

Rogers Wm  
Lt. & W. A. W. Genl

States that the compensation  
of S. S. Chamberlain, an employee  
is fixed at \$60 per month  
from Feb 1<sup>st</sup> 1867, without a  
ration

Wm Rogers Lt. & W. A. W. Genl

R. F. O. L. S. G. 1128 1867

Bureau Refugees, Freedmen, and Abandoned Lands.

Headquarters Ass't Commissioner, District Columbia,

Washington, January 28<sup>th</sup> 1867.

Special Orders,

No. 13.

(EXTRACT.)

4. The compensation of S. S. Chamberlain, an employee at Wisevell Barracks, is hereby fixed at sixty dollars (\$60) per month (without a ration) from February 1<sup>st</sup> 1867.

By order of Brevet Brigadier-Gen. C. H. HOWARD.

*A. A. Rogers*

A. A. Adj.-General.

*Received by [unclear] [unclear]*



Bureau Refugees, Freedmen, and Abandoned Lands.

Headquarters Ass't Commissioner, District Columbia,

Washington, January 28<sup>th</sup> 1867.

Special Orders,

No. 13

(EXTRACT.)

4. The compensation of S. S. Chamberlain, an employee at Wisevell Barracks, is hereby fixed at sixty dollars (\$60) per month (without a ration) from February 1<sup>st</sup> 1867.

By order of Brevet Brigadier-Gen. C. H. HOWARD.

*A. A. Rogers*

A. A. Adj. General.

*Check to Mr. Chamberlain  
for \$60.00*

27  
Washington D.C.

Jan 28<sup>th</sup> 1869

Roberts people

Sup<sup>ts</sup> &c

Requests that 4000 four  
cords of wood be furnished him  
for issue to destitute freed-  
people

W.B. 170109, C.S. 11 2 270

Re<sup>ce</sup> C.S. 11 2 270



27-

Washington D.C.  
Jan 28<sup>th</sup> 1869

---

Roberts Prop<sup>r</sup>.  
Sup<sup>r</sup> D.C.

---

Requests that 44 four  
Cords of wood be furnished him  
for issue to destitute freed-  
people

W.B. 170109, C.S. 100, 272

Re: O.S. 100, 272

Office Supy. East Capt. A. Bks.,  
General R. A. & A. L.,  
Washington D. C.  
January 28<sup>th</sup> 1867.

St. Louis, Mo. W. J. Beebe Esq.  
Local Supy. D. C.  
Colonel.

I have the honor to request that your (4) cords of wood be measured off, and placed at my disposal, for distribution among destitute widows, &

By complying with the above request, immediate suffering may be greatly relieved.

Many upon my district, have used this kind of wood for fuel, and I found, the other day, a poor woman pulling the sticks from her bed, and using them for fuel.

The wood sent us on Saturday was given out only one or two sticks per family and was all used up in less than two hours - we need while this cold winter lasts, to take per day, beside the four cords asked for above.

Respectfully  
J. B. Roberts,  
Supt.



Washington D.C.  
Jan 28<sup>th</sup> 1867

Rogers D. M. N.  
1<sup>st</sup> Lt. U.S.A., Genl.

Formally appointment  
of Jerome A. Johnson as  
Clerk, to report to J. L. Hobbs  
Supt. &c

MSB 100.109. C.S. 273

R. P. O. S. D. C. 1155701

BUREAU REFUGEES, FREEDMEN, AND ABANDONED LANDS.

Headquarters Ass't Commissioner, District Columbia,

Washington, January 28<sup>th</sup> 1867.

Special Orders,

No. 13

(EXTRACT.)

3. Jerome A. Johnson is hereby appointed a clerk, at a compensation of fifty dollars per month, from January 25<sup>th</sup> 1867, and will report for duty to Rev. J. L. Roberts, Supt. at East Capitol Barracks

By order of Brevet Brigadier-Gen. C. H. HOWARD.

*Wm. H. Page*  
A. A. Adj. General.



274

Washington D. C.  
Jan 18 1869

Rogers A. M. W.  
A. A. A. Genl. D. C.

Forwards appointment  
of Capt. O. S. P. Wall, as  
Employment, <sup>agent</sup> D. C.

W. S. M. W. O. S. 274

Bureau Refugees, Freedmen and Abandoned Lands

Headquarters Asst Commissioner, District Columbia,

Washington, *Jan'y 18<sup>th</sup>*, 1867.

Special Orders,

No. 1

(EXTRACT.)

x x x x  
6 Capt C. S. B. Wall is hereby appointed an Employment Agent of this Bureau and will take charge of an Employment Office, corner 17<sup>th</sup> and I Streets in this City.

He will report to Lieut Col. William M. Beebe, Local Superintendent, 9 E. 7<sup>th</sup> & O Streets

By order of Brevet Brigadier Genl. C. H. HOWARD,

*T. C. W. M. Dubois*  
L. S. DC

*W. H. Rogers*  
A. A. General



Washington D.C.

275

Jan 29 1869.

Howard C. Ke.

Dr Big Gen's ac.

Direct that a good  
quantity of wood be  
left on hand at East  
Capt. Keil Barracks for  
distribution during this  
cold weather.

W. B. Wood 275.

Bureau Refugees, Freedmen, and Abandoned Lands,

Headquarters Ass't Commissioner, District Columbia,

Washington, Jan. 29 1867.

St. Col. Wm. M. Beebe  
Sweat Supt.

Sir

I have a supply of wood constantly on hand at East Capitol Barracks, during the cold weather - also at the place selected upon the Island - to be given out freely on the recommendation of the Visiting Agents or the Supt. of the District Mr. Roberts - I am informed that the supply sent to those places has all been given out -

Respectfully

C. A. Howard  
Chas. B. Jones, Secy.  
C. A. Howard



276

Washington D.C.  
Jan 26<sup>th</sup> 1849

---

Brown J. M.  
Bot May & Co. M.

States that ~~by her~~ the  
articles of Stationary office  
by Genl. Howard for Mrs  
Griffing's office are found  
States that Paper weights  
Waste Baskets & Telling  
Pens are not allowed.  
W.B. M. Co. L.S. 276.

Bureau Refugees, Freedmen, and Abandoned Lands,

Quartermaster's Office, No. 132 Pennsylvania Avenue,

Washington, D. C.,

Jan<sup>r</sup> 26<sup>th</sup> 1867

Colonel,

I send you the articles  
of Stationery on your requisition as  
approved by Gen. C. H. Howard. For  
the Gripping office

Paper Mights, Wash Baskets  
& Rubbing Pens not being allowed by  
Regulations of Bureau (page 28) were  
stricken out by Gen Howard.

Very respectfully  
A. M. Brown

But. Maj. off. the

Col. W. M. Beebe Jr

Local Dep't



277  
Washington D.C.  
Jan 29<sup>th</sup> 1869.

Rogers Wm W.  
A. A. A. Genl

Direct through  
Asst Com<sup>r</sup> that a  
report relative to the  
Case of John Bank  
Co<sup>rd</sup> be forwarded im-  
mediately

Wm W. W. 277

NARA 111

Bureau Refugees, Freedmen, and Abandoned Lands,  
Headquarters Ass't Commissioner, District Columbia,

Washington, January 29<sup>th</sup> 1867.

Lieut. Col. W. M. Beebe Jr.

Local Supt. D. C.

Colonel:

The Asst. Commissioner directs that you report immediately, to these H. Q. D. C. what action has been taken in the case of John Banks and his communication relating to whom, was referred to you with his endorsement, Jan'y. 24<sup>th</sup> 1867

Very respectfully

Your obedient servant

W. H. Rogers

W. H. Rogers



278

Washington D.C.  
Jan 29<sup>th</sup> 1869.

Reyes, W<sup>m</sup> V<sup>r</sup>  
C. C. A. Genl. etc

Direct through  
Civil Com<sup>rs</sup> that a quantity of wood be furnished Mr. Butler for distribution to destitute poor people.

Wm. V. 29<sup>th</sup>

Rev. C. C. A. Genl.

Bureau Refugees, Freedmen, and Abandoned Lands,

Headquarters Ass't Commissioner, District Columbia,

Washington, Jan'y 29<sup>th</sup> 1867.

Lieut Col. W. M. Beebe Jr

Local Supt D.C.

Colonel:

The Asst. Commissioner  
directs that you send to Mr. Batty at the  
Friends Mission, 13<sup>th</sup> St. bet. R<sup>th</sup> & S. a quan-  
tity of wood for distribution to dependent  
free people, the supply furnished him  
having been all distributed.

Very respectfully

Your obedient servant

H. H. Rogers

U. S. Agent.



219

Washington D.C.  
Jan 28<sup>th</sup> 1867

Howard C. Ho  
121 1/2 St. Geo. Ave.

States that Mr. Don  
referred to is a teacher  
his school is in vacating  
of Navy Yard. Residence  
not known.

777 1/2 St. Geo. Ave.

Asst. Secy. of War

Bureau Refugees, Freedmen, and Abandoned Lands,

Headquarters Ass't Commissioner, District Columbia,

Washington, January 28<sup>th</sup> 1867.

Lieut Col. W. M. B. B. B.  
"Local Supt. &c."  
Col.

Mr. Doe, is the  
teacher referred to in the matter for investigation  
regarding the sale of liquor to freedpeople. His  
school is at Goodhope Hill, <sup>in vicinity of</sup> near <sup>of</sup> <sup>ing</sup> <sup>yard</sup> <sup>land</sup> <sup>of</sup> <sup>the</sup> <sup>church</sup>, do  
not know residence but know it is not far  
distant from the church.

Respectfully

G. H. S. S. S.  
B. B. B.  
by M. M. M.



Bureau Refugees, Freedmen, and Abandoned Lands,  
Headquarters Ass't Commissioner, District Columbia,

Washington, Jany, 28<sup>th</sup> 1867.

Lieut Col. W. M. Buba  
"Local Supt. &c." Col.

Mr. Doe, is the teacher referred to in the matter for investigation regarding the sale of liquor to freedpeople. His school is at Goodhope Hill, <sup>in vicinity of Navy Yard,</sup> or Beth Church, we not know residence but know it is not far distant, from the church.

Respectfully

G. H. Sigurd  
B. B. L.  
by M. W. B.

W.B. 112, C. S. 119, 289

Washington D.C.

Jan 26<sup>th</sup> 1869

Rogers W. H.

U. S. A., Gen. D.C.

States that it has received the notice of the C. S. Court that orders for transportation had been made by parties to whom it was entrusted, and directs that in the future it will be given only to the Agent in charge of the party, also that the U. S. inform himself if the transportation is actually used by the parties for whom it was procured.

R. O. S. D. C. 11/2/69



Bureau Refugees, Freedmen and Abandoned Lands,  
Headquarters Ass't Commissioner, District Columbia,

Washington, January 26, 1867.

Colonel.

As there is reason to suspect that orders for transportation have sometimes been sold by parties to whom they have been entrusted, the Assistant Commissioner directs that you will exercise extreme caution in giving out the same taking care to place such orders, in the hands, only, of the Agent who is personally to accompany the freed people, and not until they are ready to start.

He also directs that you take measures to inform yourself, afterwards whether transportation has been actually used by the persons for whom it may be issued.

I have the honor to be

To Lieut Col Beebe.  
Local Dept D.C.

Very Respectfully  
Your obt Servt

W. H. Rogers  
11.11.67

283

A 35 (R. F. & A. L. Vol. ) 1866.

Vol. 2. M. 400000 200 107

Crownsville, Maryland

January 26th, 1866.

Anderson - M. F.

Requests to be furnished with a negro man and woman as servants - farm hand and cook

W. H. M. 113.0. 5 70. 2 13

1866

Wrapper---( Enclosures.)

Rec'd Jan 29. R. F. & A. L. 5. 1866.

WAR DEPARTMENT,  
BUREAU REFUGEES, FREEDMEN AND ABANDONED LANDS,

Washington, Jan. 30. 1866.

Respectfully referred to Col. B. Howard,  
Asst. Comm. Dist. of Columbia  
By order of  
Maj. Gen. Howard

A. P. Ketchum  
a a a general

Head Quarters  
January 30. 1866

Respectfully referred to  
Lieut. Col. N. M. Peite Local  
Supt. D. C.

By order of  
12th Regt Gen C. Howard  
H. H. Rogers  
a. a. a.

12th Regt Gen C. Howard



January 26<sup>th</sup> 1867

Crowsville

Dear Sir

please let  
me know if you got a  
man and woman or man  
and his wife would suit  
me best if I could <sup>them</sup> get  
if not I ~~would~~ <sup>will</sup> take them  
either way the woman  
I want as cook and  
the man to work on  
the farm. let me hear  
from you directly and  
it will come up or you  
can send them down to  
to Crosses Yellubo

by so doing you  
will greatly oblige.

William Henderson  
turn over

MS. A. 9. 2. 1. 1. 1.

direct your letter to  
William F. Anderson  
Leavenworthville Kan  
ty if send you a stamp  
to answer my letter with

Wm. F. Anderson  
Leavenworth Kan





L.R. Vol. 2, No. 668 A.C.D.C. 1867

234

War Dept. Adj. Genl. Office  
Washington Jan 25/67

Mr. J. M. [unclear]

Yours truly  
E. D.

Adj. Genl.

Directs that a report  
be forwarded to that Dept.  
immediately, whether any  
& what violations of the 4<sup>th</sup> & 5<sup>th</sup>  
Sections of the Act of Congress  
entitled, "An act to protect all  
persons in the U.S. in their  
Civil rights & have occurred,  
& what action has been taken  
by the officers & Agents  
of the Bureau."

Bureau R. I. [unclear]

Hon. Sec. of War, Commr. D.C.

Washington, January 25/1867

Respectfully referred to  
Lt. Col. W. M. Beebe Jr. Local  
Supt. D.C.

By order of

Bot. Brig. Genl. Howard

[Signature]  
A. A. S.



War Department  
Adjutant General's Office  
Washington, January 23<sup>rd</sup> 1867

General.

You will please report to this Department without delay, whether, any, and what violations of the 4<sup>th</sup>, 8<sup>th</sup> and 9<sup>th</sup> sections of the Act of Congress, entitled "An Act to protect all persons in the United States in their civil rights" &c have occurred, and what action has been taken by the Officers and Agents of the Freedmens Bureau, in respect to such violations.

By order of the Secretary of War.

(Signed)

E. D. Townsend  
Assistant Adjutant General

Official copy respectfully furnished to Col Aug General C. H. Howard, Assistant Commissioner District Columbia, with directions to forward a report in compliance with the requirements of the above, to this office, at the earliest practicable moment.

By order of Major General Howard Commissioner

(Signed)

A. P. Ketchum

Act. Asst. Adj. General

Bureau of F. B. & A. G.

Washington, January 23<sup>rd</sup> 1867

"over"



Head Quarters 4th Comm. Lt

January 25<sup>th</sup> 1864.

Official

Wm. Rogers  
A. S. S. G.

Vol. 205 1/2 A.C. D.C. 187

287

Washington, Jan 30 1867

Bureau Refugees, Freedmen & Abandoned Lands

HEAD QUARTERS ASSISTANT COMMISSIONER, D. C.,

Washington, January 31 1867.

Respectfully referred to Lieut. Col. Wm M. Beebe Jr. Local Supt. D.C.

Dear Lett. S. G.

MB / W 1/14 C.L.S. 25%

Reports that there is no wood at the East Capitol St. Barracks for use to the destitute.

By order of Bvt. Brig. Gen. HOWARD.

Handwritten signature of A. A. General.

Large handwritten note on the right side of the page, containing several paragraphs of text, including the phrase 'I found a number of families without a particle of wood...' and 'I am respectfully, S. G. Bartlett'.

Rec 506 D.C. 7/31/1867



Dear Mother,  
I have just received  
your letter of the 10th, and  
am glad to hear from you.

I am well at present, and  
hope these few lines will find  
you the same. I have not  
much news to write at present.

I have just received a letter  
from your father, and he  
wishes to hear from you  
very much.

I have not yet received  
a parcel of goods as you  
said in your letter.

I shall send you a parcel  
as soon as possible.

Yours affectionately,  
J. B. [Signature]

W.P.A. 469  
Mrs. Bartlett has submitted  
the following -

I will say, Col. Beebe  
has given me an order for  
four (4) cords of wood at  
the yard. This I asked for  
to be distributed in special  
cases, I made much provision  
for a place to store wood  
here, & on the Island, to  
be issued on the tickets  
of Visiting Agts.

If Col. Beebe's terms are  
kept the wood there will  
be left but little cause  
for complaint in this regard.  
Respectfully,

Wm. H. S. and  
J. L. Roberts  
Supt.



St. B.

Mrs. Bartlett has submitted the foregoing -

I will say, Col. Beebe has given me an order for paper (4) cords of wood at the yard. This I asked for to be distributed in special cases, I had made provision for a place to store wood here, & on the Island, to be issued on the tickets of visiting Apts.

If Col. Beebe's terms are hard the wood there will be left but little cause for complaint in this regard.

Respectfully,

Wm. H. Hunt  
J. H. Roberts  
Supt.

- Mapper -

Office Local Dep't D.C.

Feb. 1<sup>st</sup> 1867

Respectfully referred  
to Mr. D. L. Roberts Inf't.  
& Capitol Barracks. For  
his information, and  
that he may instruct his  
agents to make their  
complaints through the  
proper channel. There  
need be no fear that  
such complaints will  
not be forwarded for  
the information of the  
Asst. Comr.

J. M. [Signature]  
Lt. Col. Local Dep't -  
D.C.

231 708 135. O. O. S. 1867.



7003201 11111. D. S. 287.

New Dept. B. R. & A. L.  
Washington Jan 24 1867.

Howard C. C.  
Maj Genl Comd

States that hereafter no  
fees will be exacted by  
Officers or Agents of the  
Bureau in receiving sit-  
uations for Treaties or  
for Registry of contracts.  
I think that no verbal  
agreement should be made  
as it occasions a great  
deal of trouble.

7003201 11111. D. S. 287.

Bureau Refugees, Freedmen & Abandoned Lands

HEAD QUARTERS ASSISTANT COMMISSIONER, D. C.,

Washington, January 23 1867.

Respectfully referred to Lieut. Col.  
W. M. Beebe, Jr. Local Supt.  
D. C. for compliance with the  
within instructions.

He will also furnish Official  
Copies to all his Agents in his  
District.

By order of Bvt. Brig. Gen. HOWARD.

*Wm. Rogers*  
A. A. A. General.



War Department  
Bureau Refugees, Freedmen & A Lands  
Washington January 24<sup>th</sup> 1867

General.

Hereafter and until further orders, no fees or charges will be exacted by Officers or Agents of this Bureau for services they may render in connection with contracts between freed people and their employers, either in the examination, approval, witnessing or registry of such contracts or otherwise. Please instruct your subordinates to comply with this requirement. Labor contracts should be in writing. If possible, persuade laborers and employers not to rely upon mere verbal agreements. They occasion much confusion. Bureau agents are required to do all in their power to secure fair contracts for the freed people, and in offering their services for that purpose, they should let it be understood that they will be rendered without charge to the parties concerned.

Very Respectfully  
(Signed) O. O. Howard  
Major General Com.

By Gen. E. M. Howard

Wm. C. ...

(over)



Bureau N. F. and A. S.

Head Quarters 1st Comm. DC

Washington January 28<sup>th</sup> 1837

Copy

*W. H. Rogers*

et al.

2

Bureau of Land Office

Head Quarters West Point D.C.

Washington January 28<sup>th</sup> 1857

Copy

W. H. Rogers

W. H. Rogers



259

Washington, D. C.  
Jan 24 1869

Keyburn Robert.  
Surgeon Major

Messrs R. M. Lorenie  
& A. A. Slater. Visiting  
Agents in Dist D. C.

"113170115" C. L. S. 289

R. C. & S. D. Co. 131 1869

Bureau Refugees, Freedmen and Abandoned Lands,  
Headquarters Ass't Commissioner, District Columbia,

Washington, January 29<sup>th</sup>, 1867.

Rev. R. W. Louie & Mr. R. S. Slater are  
here appointed visiting Agents of the Special  
Relief Commission for that portion of Washington  
lying between 3<sup>rd</sup> & 14<sup>th</sup> Sts and S. & C. Sts.

By order of Genl. C. P. Howard A. C.

Robert Wenthur

Br. Lt. Col. Inspector of Police  
& President Special Relief Com.



Bureau Refugees, Freedmen and Abandoned Lands,  
Headquarters Ass't Commissioner, District Columbia,

Washington, January 29<sup>th</sup>, 1867.

Rev. R. W. Loring & M. R. S. Slater are  
hereby appointed visiting Agents of the Special  
Relief Commission for that portion of Washington  
lying between 3<sup>rd</sup> & 14<sup>th</sup> Sts and S. & C. Sts.

By order of Genl. C. P. Howard A. C.

Robert Ventura

Acting Secy. In Charge of this  
District Special Relief Com.

MSB 178 (2) 295

Washington, D. C.  
July 1<sup>st</sup> 1867.

Holman, C. A.  
Sup.

States that he will  
pay the employees at  
Office L. S. and at Keating  
Crews East. Cal. Banc. &  
Dried that they be notified.

MSB 178 (2) 295



War Department,  
Bureau of Refugees, Freedmen, and Abandoned Lands,

Washington, Feb. 1<sup>st</sup> 1867

Col. W. M. Becker,

Colonel,

I will be at your office tomorrow morning at 11 o'clock to pay your employees for the month of January. Please notify Capt Lawrence and Mr Roberts that their employees will also be paid tomorrow morning.

Respectfully

By order Major Brown

J. H. Sherman

Staff.

MAR 4 79

296

Washington, D.C.  
January 9<sup>th</sup> 1867

Trowbridge, Hon. R. E.  
Kelso, Hon. Geo. R.

Recommends Jerome  
H. Johnson, a ~~young~~  
<sup>Col.</sup> young man, for a position  
in the Freedman's Bureau.

Residence  
Corner 23<sup>rd</sup> + L St.  
Washington D.C.

Bureau Refugees, Freedmen & Abandoned Lands

HEAD QUARTERS ASSISTANT COMMISSIONER, D. C.

Jan 15<sup>th</sup> 1867

Respectfully request that  
Mr. Beebe, Jr. Local Supt.  
D.C. for remark as to whether  
or he can find a suitable  
situation for the person  
named within.  
To be returned.

By order of Bvt. Brig. Gen. HOWARD.

Thos. Rogers  
A. A. A. General



Washington DC  
January 8<sup>th</sup> / 67

Hon. John W. Foster  
Hon. Sir

After due consideration, I have come to the conclusion to read this letter to you. I sincerely hope your Honor will excuse this liberty, but as you are so ungenerous in your manner with your committee. I know you will overlook this.

My object in writing this letter to you is a petition on the subject of your application for me, to my Hon. friends for a position in the Department. As you are aware that I am not a young man, I came from a poor, but a very experienced, and a very efficient house in the country, and as a gentleman I would be very glad to have the opportunity of doing so, as an agent for the other side of the globe, as you are aware that I have a very good knowledge of the American literature, the history, and many other subjects, and a very extensive knowledge of the world.

It is unnecessary for me to state to any elaborate manner <sup>in reference to</sup> the subject of my application, as I have had the advantage of a very extensive knowledge of the American literature, and a very extensive knowledge of the world, and a very extensive knowledge of the world.

Believe me, Sir, to be, your very obedient servant, and your very sincere friend, and your very sincere friend. I will be respectable to you in any manner, and your very obedient servant, and your very sincere friend. I will be respectable to you in any manner, and your very obedient servant, and your very sincere friend.

Your humble and obedient servant  
James W. Foster

I should be exceedingly gratified to see the young & worthy colored man who enters the foregoing secure a situation in which, while he secures a support for himself, his example & attainments will furnish a stimulus to his race -

Washington D.C. Jan 9th, 1841  
R. E. Knowledge M.C.  
J. M. McKim

John R. Helas  
Mrs



Ms. A. 9. 2. 17.

Washington D.C.  
Jan 31<sup>st</sup> 1869

Rogers West  
a a a Genl.

Instruct this Offr Com<sup>d</sup>.  
that 131 days rations be  
furnished Mrs Stull  
59. Montgomery St. Georgetown  
for feed of a going north

W. E. O. S. 16 25 1869

Bureau Refugees, Freedmen and Abandoned Lands,  
Headquarters Ass't Commissioner, District Columbia,

Washington, January 31<sup>st</sup> 1867.

Genl Col. William M. Beebe  
Capt. S. S. D. D.  
Colonel.

The Assistant Commissioner directs  
you to send to Mr. Hull, 39 Montgomery Street, Georgetown  
on Saturday three (3) day rations for six (6) freed people  
going North.

Very Respectfully  
Your obedient servant  
H. H. Rogers  
A. A. S.



Vol. 2. No. 578 at 6 D.C. 1864  
29/8  
War Department  
Washington Dec 31 1864.

Schuyler E. C.  
Insp Genl.

Direct thro the Secy  
of War that 30 fire  
buckets be distributed  
at Minut. Co Capitol  
Hill Barracks, and that  
the com<sup>d</sup>g officer be held  
responsible for their being  
kept full of water.  
Wm. 1701 117 02 28 24

1864

War Department  
Bureau R. J. W. A. L.  
Washington Jan 2 1864

Respectfully referred to  
Col. Brig. Genl. C. H. Howard,  
Asst. Commr. D. C. who will at  
once initiate the necessary  
measures to carry out the  
instructions of the Hon. Secre-  
tary of War.

By order of  
Maj. Genl. Howard  
(Sgt) A. Ketchum  
Actg. Asst. Adj. General  
Official  
Wm. Rogers  
Act. S. S.

Bureau R. J. W. A. L.  
Asst. Commr. D. C.  
Washington, Jan 4 1864

Respectfully referred  
to Lieut Col Debe for Local  
Supt. D. C. for immediate  
compliance with the  
within instructions of the  
Hon. Secy of War.

By order of  
Col. Brig. Genl. Thomas  
A. Rogers  
Act. S. S.

Wm. 1701 117 02 28 24

War Department  
 Washington City  
 December 31<sup>st</sup> 1866.

General:

The Secretary of War directs that the following recommendations made by a Board of officers appointed to examine into the subject of protection against damage from accidental fires, be put into effect.

Warrant to the Chief Capital Servants.

Recommended that 30 buckets be distributed at each, and that the commanding officer be held responsible for their being kept properly filled. Also that stores of pipes be removed.

There being great danger of the freezing of plugs, hydrants & water kept in buckets, you will see that the greatest vigilance be practiced by those in charge of buildings, to remedy this as far as possible during the cold weather.

Very respectfully



Your obedient servant,  
(Sgd) E. C. Schriener  
Inspector General

To the Commissioner of the Bureau of Refuges,  
Indian <sup>and</sup> Wounded Lands  
Washington D.C.

Letter No. 5  
C. D. Schriener  
Washington D.C. January 3, 1861

Respectfully,  
W. H. Rogers  
A. S. S. S.

300



~~Reports o~~

301  
Washington D.C.  
Feb 1<sup>st</sup> 1864

Rogers W. W.  
W. A. A. Grant

Appoints N. G. Cassin  
Employment Agent at  
a salary of \$20<sup>00</sup> per mo.  
& one dollar,

W. B. No. 118. O. G. S. 301.

No. O. G. S. No. 24/2 100/1



Bureau Refugees, Freedmen, and Abandoned Lands.

Headquarters Ass't Commissioner, District Columbia,

Washington, February 1<sup>st</sup> 1867.

<sup>10</sup>  
Special Orders,

No. 15

(EXTRACT.)

H. Rev. A. G. Gaskins is hereby appointed an Employment Agent for Bureau, Refugees, Freedmen and Abandoned Lands, for District of Columbia, at a compensation of Twenty (20) Dollars per month and one (1) Ration.

By order of Brevet Brigadier-Gen. C. H. HOWARD.

*A. A. Rogers*

A. A. Adj. General.

*John C. Smith*

*John C. Smith*

302  
Washington D.C.  
Feb 1<sup>st</sup> 1864

---

Keyburn Robert,  
Surg. U.S.A.  
Tus. H. Com<sup>rs</sup>

---

Appoint Richard  
Batty, Military Agent, under  
direction of the Special Relief  
Com<sup>rs</sup>

7115 (S. S. D. Com. 34)

---

7115 (S. S. D. Com. 34)



Bureau Refugees, Freedmen and Abandoned Lands,

Headquarters Ass't Commissioner, District Columbia,

Washington, February 1<sup>st</sup> 1867.

Mr. Richard Patton is hereby appointed  
visiting Agent of the Special Relief Comm.  
mission for that portion of Washington  
lying between 8th and 14th St's & Canal & Broadway

By order of Genl. C. J. Donard M.C.  
Robert Kenburn  
Col. S. C. S. Surgeon U.S. Army  
President Special Relief Comm.

—  
C. M. M. M.  
Feb 1st 1867  
M. M. M.  
M. M. M.

Bureau Refugees, Freedmen and Abandoned Lands,

Headquarters Ass't Commissioner, District Columbia,

Washington, February 1st 1867.

M. Richard Patton is hereby appointed  
visiting Agent of the Special Relief Com.  
mission for that portion of Washington  
lying between 8th and 14th St's & Canal Swandy

By order of Genl. C. P. Howard M.C.  
Robert Kenton  
Supt. of the Special Relief Com.

*[Faint handwritten text, possibly a signature or address]*



303

Washington D.C.  
Feb 9<sup>th</sup> 1867

Parsons J. H.

Forwards his resignation  
as Visiting Agent,

W.P.O.S. 303

W.P.O.S. 303

Washington Feb'y 2<sup>nd</sup> 1867

Dr Robt. Keyburn  
Bot. Lt. Col

President Special Relief Commission

Sir

Herewith I tender  
& beg you to accept my resignation as a  
Visitor for District No 2.

Returning my sincere thanks for  
the courtesies always extended to me

I am very respectfully  
your obt. servt.

H. Parsons

Ed. Mr. M. Becke

I have just received the above

Yours H  
Robert Keyburn  
Lang. N. D. C.

2-4-1867



L. R. Vol. 2 No. 153 A. C. D. C., 1867.

439 D. St.

305

Washington D.C.

February 4 1867

Feb 4/67

Leavey, J. W.

(Wrapper ..... One ..... enclosures)

Reports destitution  
of the family of one  
Mrs. Beals, (freedwoman)  
and requests that they ob-  
tain relief from the Bu-  
reau.

*Faint handwritten notes*

Ms 120. 120. 305

Received A. C. D. C. 1867.

Bureau Refugees, Freedmen, & Abandoned Lands

Head-Quarters Asst. Commr., D. C.,

WASHINGTON, Feb 4 1867.

Respectfully referred to Lieut  
Col. Beebe Jr. Local Supt  
D.C. for his immediate  
attention

By order of

Col. Brig. Genl. Howard

*[Signature]*  
A. A. General

Ms. Beals, husband (an old  
man,) and three daughters, (one  
married with two children,  
sold from her husband and  
has never heard from him  
since) were sold in the  
year and carried to Richmond,  
where they were thought  
insecure property and  
were sent to South Carolina.  
After freedom was proclaimed  
to the slaves, they came  
north by transportation free,  
with no earthly possessions  
except the few ragged clothes  
they wore. Having a brother  
free in this City, they came  
here; he having sent them  
money to come from  
some place below Baltimore  
where the transport left



them. One daughter went into service the day after her arrival here where she has remained ever since. The Father does any work he can get to do, is anxious to do all he can but is old and not very strong. The Mother has taken in washing assisted by the daughter who has the two small children. They are industrious, and willing to do anything to support themselves. The youngest daughter fourteen years old is industrious and willing to do all she can. Their utter destitution when they first came to the city, their energy and determination to help

themselves, their suffering want and privations with a dignity worthy of those who have been highly educated and moving in refined society, their endurance of their hard fate without a murmur, or ever in any way begging for aid, feeling that they ought to support themselves, their desire to improve & learn had strongly enlisted sympathy in their behalf and on examining into the case I find the youngest girl had not even an approach to comfortable clothing. I appeal to the Freedman's Bureau for relief for these most deserving people and particularly for



clothing for the youngest  
girl that she may be able  
to go to school. They are  
all bright & intelligent  
and I have no doubt  
she would improve any  
opportunity afforded her  
to learn.

J. McLeaver  
439 1/2 Street

July 21st



Vol. 2, p. 140, A.C. 2, 6, 1867

Chicago, Illinois  
February 2<sup>nd</sup> 1867

Holmes, G. B.

States that he desires  
to obtain 3 more fami-  
lies of freed people.

That Mr. Sutterlin  
will not be able to leave  
that city for Washing-  
ton D.C. before Feby. 8<sup>th</sup> 67.

Recd A.C. 2, p. 140

Head Quarters A.C. D.C.  
February 5. 1867

Copy referred  
to St. Col. Beebe  
for a list for his  
information with  
statement also that  
Mrs. Doolittle, widow  
agent of Georgetown  
has ready three ad-  
ditional families  
who would like to  
go to Chicago & she  
will apply for their  
transportation

By order of  
Burt B. Hewitt  
Chas. Howard  
J. H. Rogers

E. O. Vol. 2, p. 140, A.C. 2, 6, 1867, A.C. 2, 6, 1867



Northwestern Freedmen's Union Commission,

Rooms, 26 Lombard Block.

(P. O. BOX 2747.)

Rev. R. W. Patterson, D.D., - President.  
Rev. H. B. Holmes, - - - - Cor. Sec'y.  
R. B. Mason, Esq., - - - - Treasurer.

Chicago, Feb 2<sup>d</sup> 1867

Gen C. A. Howard.

Dear Sir -

Your despatch of yesterday is recd -  
we are to have a large public in behalf of this Commission  
on Thursday eve Feb. 7<sup>th</sup> public speakers are to be here  
from abroad. We want to make the most of the meet-  
ing possible - In this account I cannot spare Mr.  
Sutherland until Friday Feb 8<sup>th</sup> He will leave for  
Washington on that day without fail if all is well -  
In the mean time three (3) more families have  
been positively ordered & I trust you will be able to  
have these reach also by the time Mr S. reaches  
you - I had hoped that you would have been able  
to send for him so that he might have returned  
in time to prepare for our meeting - It is not  
certain it will not subject you to some business  
inconvenience -

Yrs very sincerely  
H. B. Holmes



(R. F. & A. L., Vol. 3, ) 1867.

*Miss*  
*Pittsboro Miss*

January 9<sup>th</sup>, 1867.

Ryan J. S.

315

States that a colored servant by the  
name of *Hyacinth* information of her children  
Mary, John, & William - with  
Lewis Carby - near St. Mary's College  
Georgetown D.C.

*WR 315*

WRAPPER ..... (..... Enclosures.)

Received Bureau R. F. & A. L., *Jan 10*, 1867.

WAR DEPARTMENT,

Bureau Refugees, Freedmen, and Abandoned Lands,

WASHINGTON, *July 17* 1867.

Respectfully referred to Asst Commis-  
sioned District of Columbia, who  
will, if possible please obtain and  
furnish to the writer of this letter  
the information requested

By order of

Maj Genl. O. O. Howard:

*A. P. Ketchum*

*Act. Sec. General.*

*New York a.c.s.c.*

*January 18. 1867*

Respectfully referred to  
the Local Supt D.C. for  
compliance with the  
above endorsement of the  
Commissioner.

By order of

*Robt By New St Howard*

*E. O. Vol. 2. No. 62. 3 4 2 9. 1867*

William Calver County, Oregon  
July 1 1867

Dear Mother

I received your letter

of the 26th

and was glad to hear from you  
and to hear that you were all well

I am well at present and hope these few lines

will find you all the same

I have not much news to write at present

but I will write you again when I hear from you

I am your affectionate son

Wm. Calver

I have not much news to write at present

but I will write you again when I hear from you

I am your affectionate son

Wm. Calver

I have not much news to write at present

but I will write you again when I hear from you

I am your affectionate son

Wm. Calver

I have not much news to write at present

but I will write you again when I hear from you

I am your affectionate son

Wm. Calver



1969

I have been thinking about you  
 and wondering how you are getting on.  
 I hope you are well and happy.  
 I have been busy with work lately,  
 but I will try to get some time  
 to write to you more often.  
 I love you very much.  
 Your affectionate son,  
 Fred L. Wynn

I hope you are well and happy.  
 I will try to get some time  
 to write to you more often.

Fred L. Wynn

P. 5 P. G. + A. L. Vol. 474



Washington Feb 8<sup>th</sup> 1867  
Townsend E. G. 323  
Supt. &c.

Requests Material for  
Manufacture of P. D. fabric.  
The work to be done in the  
Camp, by freedmen at  
w/ fair compensation.

Office Local Supt. D.C.  
Washington Feb 9<sup>th</sup> 1867  
Respy forwarded.  
Approved  
M. P. Butler  
Lt Col 128<sup>th</sup> Regt  
Local Supt. D.C.  
Feb 9<sup>th</sup> 1867

Recd A. C. 24 Feb 11/67.  
Bureau Refugees, Freedmen & Abandoned Lands  
HEAD QUARTERS ASSISTANT COMMISSIONER, D. C.,  
Washington February 11<sup>th</sup> 1867.

Respectfully returned to Lt. Col. W. M.  
Beabe, Jr. Local Supt. D. C. for  
information, what disposition  
will be made of this clothing and  
whether it is needed for issue to  
freedpeople at Kencall Green  
Barracks.

By order of Bvt. Brig. Gen. HOWARD.  
A. A. A. General.  
Office Local Supt. D.C.  
Feb. 12<sup>th</sup> 1867

Respy returned to  
Maj Townsend - for the  
information required by  
above endorsement.  
M. P. Butler Jr  
Lt. Col. Local Supt  
D.C.

Hendall Green Feb 13<sup>th</sup>  
Respectfully forwarded  
again with the information  
that this clothing is greatly  
needed in the Camp, &  
among children in school.  
but will be disposed of  
under direction of Local  
Supt. W. M. Beabe, if  
obtained. E. G. Townsend  
Supt.

Office Local Supt. D.C.  
Washington Feb 15<sup>th</sup> 1867  
Respy forwarded  
inviting attention  
is above endorsement.  
There seems to be no  
necessity for the within  
application as clothing is  
now being manufactured  
for distribution by the  
Local Supt. D.C.  
M. P. Butler Jr  
Lt. Col. Local Supt  
D.C.



ESTATE 119. 2. 4. 8. 1867,  
Bureau R. F. 45 A. L.

Head. Dirs. Asst. Commr DC.

Washington, Feby. 16<sup>th</sup> 67

Respectfully returned  
to Lieut. Col. W. M. Beebe Jr.  
Local Supt. DC., who may  
hereafter at his discretion  
place a portion of material  
into the hands of E. H. Towns  
and Supt. &c.

By order of

Rob. Brig Genl. Howard

W. M. Rogers  
U. S. A.

E. B. 600 2. No. 208. A. C. D. C. 1867.



Kendall Green Feb 15th 1867

Col. Wm. Beebe  
Col.

I have the honor to ask for material for the manufacture of fifty pairs of pantaloons in my camp, by freed women, at fair compensation.

cloth $2\frac{3}{4}$ yds per pair	140 yds
Buttons 1 doz per pair	50 doz
Thread	$\frac{1}{2}$ pound

Very Respectfully  
Your Obedt Servt  
E. G. Howard  
Sept

Bureau R. F. W. A. L.  
W. D. Lms. 17th St. Co. 1867  
Washington, D.C. Feb. 16th 1867

Respectfully returned  
to Lieut. Col. C. M. Woodruff  
Local Sup't. D.C. who may  
be called at his discretion  
to place a portion of material  
into the hands of E. G. Howard  
and Super. &c.

By order of  
Col. (Ing) Genl. Howard  
J. H. Rogers  
S. O. 1867. No. 208. A. C. D. & 1867.

Ms. A. 9. 2. 125, O. C. S. 9244,

Washington, D. C.

Feb 8<sup>th</sup> 1864

Rogers W. W.

A. A. A. Genl.

For transportation  
for John Beasley Col.  
Request receipt for the  
same.

file

Ms. A. 9. 2. 125, O. C. S. 9244,



Bureau Refugees, Freedmen and Abandoned Lands.

Headquarters Ass't Commissioner, District Columbia,

Washington, February 8<sup>th</sup> 1867.

Lieut Col. William M Beebe Jr.  
Local Superintendent  
D.C.

Colonel.

I have the honor to transmit herewith  
transportation from this City, to Guineas Station, Va, for  
John Beasley, a dependent freedman.

Please acknowledge the receipt of the same

Very Respectfully

Your obedient Servant

Wm. Rogers

A. A. S.

W.B. 126. 135. O.L.S. No. 225

Washington, D.C. Feb 9<sup>th</sup> 1869

Regent W<sup>m</sup> W.

A. A. A. Genl.

Forward appointment  
of Geo. M. Arnold, as Clerk  
at a compensation of \$50,000

The O.L.S. D.C. 9/9/1869



Bureau Refugees, Freedmen and Abandoned Lands

Headquarters Ass't Commissioner, District Columbia,

Washington, February 9<sup>th</sup>, 1867

Special Orders,

No. 19.

(EXTRACT.)

2. George M. Arnold is hereby appointed an Employment Agent in this District, at a compensation of Fifty (50) dollars per month, and will report to O. J. B. Wall Agent, 17<sup>th</sup> and J. Streets, for duty.

By order of Brevet Brigadier Genl. C. H. HOWARD,

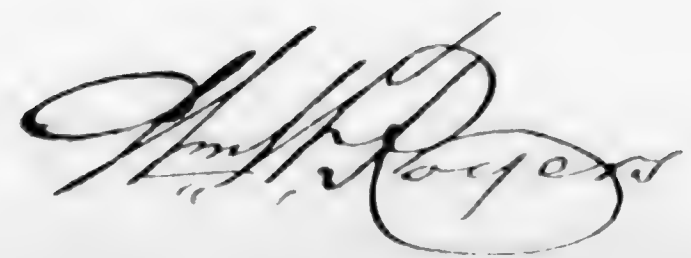

Lieut Col Wm M. B. B.

Local Agent

A. A. A. General.

W.B.W. 126. O. 1326.  
Washington. Dist of Columbia  
Feb 8<sup>th</sup> 1864.

Rogers Hunt  
U. S. A. Genl

States that the report requ-  
ired by Genl Circular No 9.  
Series 1866. has not been rec<sup>d</sup>.

The Adjt Com<sup>d</sup> directs  
that a report be forwarded  
with the least possible  
delay.



Bureau Refugees, Freedmen, and Abandoned Lands,

Headquarters Ass't Commissioner, District Columbia,

Washington, December 24 1867.

Dear Sir,

I have the honor to acknowledge the receipt of your letter of the 17th inst.

in relation to the matter mentioned therein.

I have given the matter my attention and will endeavor to give you the information you desire as soon as possible.

I am very respectfully,  
Dear Sir,  
Yours very respectfully,  
Wm. M. McKim

Very Respectfully,  
Wm. M. McKim

330

Washington D.C. Feb 11<sup>th</sup> 1864

Guffing Miss J. E  
Agent &c

Acknowledges receipt  
of transportation for  
destitute freed people  
going north.

Wm. C. L. ...

Wm. C. L. ...



394 North Capitol

Washington D.C. Feb 11' 1867

Col W. W. Rogers

A. A. C. Genl. Bureau Refse

Sir

I have the honor to acknowledge  
the receipt of transportation for the following expenditure  
fuel people.

Enoch Laman and one man to Boston Mass  
Jackson Gordon and one man & one woman to Smiths Basin D.C.  
Rachel Johnson to Battle Creek Michigan  
Henry Jones to Tonica Ills  
William Jacobs to New Market Ohio  
James Marow to Burlington Vt  
Helen King to Cheucago Yorks N.Y.  
James Clark to Goshen N.Y.  
Henry Dailey to Hatesentown Pa  
James Caswell and three women to Portland, Maine  
James Price one man and three women to Philad<sup>a</sup> Pa.

I am Sir, Very Respectfully

Your Obedient Servant

J. Emanuel King Capt.

7113176.128. O.S.S. No. 332,  
Washington D.C.  
Feb 14 1864

Rayburn Robert  
Surgeon U.S.A.  
Pres S.R. Lewis

States that the appropriation  
of the S.R. Lewis is exhausted  
& that no more issue  
will be made until further  
order

Re: O.S.S. No. 7113176

Appleton H. Clark  
Geo Rogers  
Joseph Reynolds  
Cyrus Bamsdell



Bureau Refugees, Freedmen and Abandoned Lands,

Special Relief Commission  
Headquarters ~~Asst Commissioner~~, District Columbia,

Washington, February 14<sup>th</sup> 1867.

Col. W. M. Beebe  
Supt. of Dist No. 2, S. C.

Sir

The appropriation of the Special Relief Commission for your District having been exhausted, you will issue no more applications for Relief until further notice.

By Order of Genl. C. D. Howard

Robert Kenner  
Vice Pres. & President  
Special Relief Com.

NARA 512  
Bureau Refugees, Freedmen and Abandoned Lands,

Special Relief Commission  
Headquarters ~~Asst Commissioner~~, District Columbia,

Washington, February 14<sup>th</sup> 1867.

Col. W. M. Beebe  
Supt. of Dist No. 2, S. F. C.

Sir

The appropriation of the Special Relief Commission for your District having been exhausted, you will issue no more applications for relief until further notice.

Your order of Genl. C. D. Howard 16

Robert Kenner  
Supt. of Dist No. 2, President  
Special Relief Com.



338

Washington D.C.  
Feb 15<sup>th</sup> 1869.

Roger W. W. W.  
A. A. A. Genl.

Desires a list of clothing directed to be provided for the Boys at the Model School.  
From.

MS. A. 1. 1. 338

MS. A. 1. 1. 338

Bureau Refugees, Freedmen, and Abandoned Lands,  
Headquarters Ass't Commissioner, District Columbia.

Washington, Febry. 15<sup>th</sup> 1867.

Lieut. Col. W. M. Beebe for  
Local Supt. D. C.  
Colonel:

Please send me  
the list of clothing which you were direct-  
ed to furnish for the boys at the Orphan  
Farm School, referred to you Janry. 17<sup>th</sup> 1867

Very respectfully

Your obedient servant

Wm. Rogers

A. A. General



7113170131, O. S. S. No. 342

Washington Feb 15<sup>th</sup> 1869.

Rogers, Wm<sup>th</sup> W.

A. A. A. Genl.

Towards Appointment  
of H. L. Smith 18. Seaver  
Place, Boston, as Employment  
Agent, at a compensation  
of \$1001 per month, to report  
to the Asst Com<sup>r</sup> H. J. Ordway.

No. O. S. S. No. 3/15<sup>th</sup> 1869.

Bureau Refugees, Freedmen and Abandoned Lands

Headquarters Asst Commissioner, District Columbia,

Washington, February 15<sup>th</sup>, 1867.

Special Orders.

No. 22.

EXTRACT.

1 W. L. Smith, No 18. Sears Place Boston, is hereby appointed, an Employment Agent. Bureau R. F. & A. L., in this District, at a compensation of One Hundred (100) dollars, per month, and will report in person to the Assistant Commissioners at Washington D. C. for duty.

By order of Brevet Brigadier Genl. C. H. HOWARD,

Leut Col. Wm. M. Burt,

Leut Col. G. W. D.

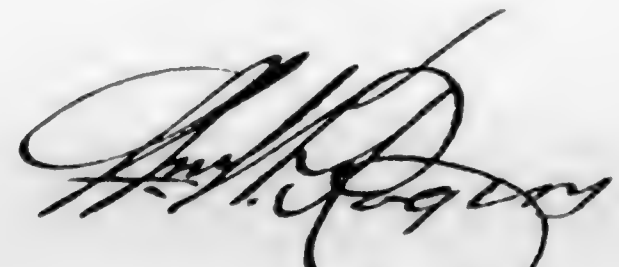

A. A. A. General.



Bureau Refugees, Freedmen and Abandoned Lands

Headquarters Asst Commissioner, District Columbia,

Washington, February 15<sup>th</sup>, 1867.

Special Orders,

No. 22.

(EXTRACT.)

1 W L Smith, No 18. Sears Place Boston, is hereby appointed, an Employment Agent. Bureau R F & A L, in this District, at a compensation of One Hundred (100) dollars, per month, and will report in person to the Assistant Commissioners at Washington D C, for duty.

By order of Brevet Brigadier Genl. C. H. HOWARD,

Secy

Secy

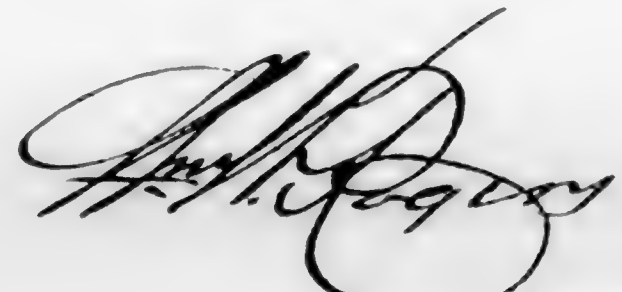

A. A. A. General.

Washington, Feb 15<sup>th</sup> 1864,

Clark S. W.

348

A A S. G.

Direct through the Civil  
Comm<sup>rs</sup>. that the shirts be  
made up for the boys  
at the Farm School, im-  
mediately, as they are  
very destitute.

Witnessed 133, O.S. 348.

Rec<sup>d</sup>. O. S. S. G. Feb 15<sup>th</sup> 1864



Bureau Refugees, Freedmen, and Abandoned Lands,

Headquarters Ass't Commissioner, District Columbia,

Washington, Feb 15 1867.

Serent Col W. M. Beebe

Serent Supt. S. C.

Col: The Assistant

Commissioner desires that you take measures  
to have the shirts made for the boys at the  
Farm School <sup>immediately</sup> as they are very destitute.

I called at the Friends' Industrial  
School yesterday and the lady in charge  
said she had received no directions to make  
shirts for the Farm School, though she has an  
order to make shirts and drawers for boys  
and men. If the articles are to be  
made ~~these~~ notice should be given  
the Supt of the school immediately so that  
she can put her whole force at work on  
them and thirty five sent as soon as  
possible.

Respectfully

McCluck

an Agent.

W.B. Wood. O. S. No. 351.  
Washington Jan 17<sup>th</sup> 1869.

Rogers. W<sup>m</sup>. W.  
A. A. A. Grub.

Upon this M. V. Wright  
an Employment Agent and  
Assistant to Supt. East  
Capt. Parake, at a com-  
pensation of \$30<sup>00</sup> per mo.

W. S. O. S. No. 110254



Bureau Refugees, Freedmen and Abandoned Lands,  
Headquarters Ass't Commissioner, District Columbia,

Washington, January 11<sup>th</sup> 1867

Special Orders,

No. C

(EXTRACT.)

5. Mr. M. V. Wright is hereby appointed an employment agent and assistant to the Superintendent at East Capitol Barracks, at a compensation of thirty dollars (\$30) per month, and will report for duty to Gen. J. S. Roberts, Superintendent at East Capitol Barracks.

By order of Brevet Brigadier Gen'l C. H. HOWARD.

*A. A. A. General*

A. A. A. General.

*Recd. at East Capitol Barracks  
Jan 11 1867*

Bureau Refugees, Freedmen and Abandoned Lands,  
Headquarters Ass't Commissioner, District Columbia,

Washington, January 17<sup>th</sup> 1867

Special Orders,

No. 6

(EXTRACT.)

3. Mr. M. V. Wright is hereby appointed an employment agent and assistant to the Superintendent at East Capital Barracks, at a compensation of thirty dollars (\$30) per month, and will report for duty to Gen. J. S. Roberts, Superintendent at East Capital Barracks.

By order of Brevet Brigadier Gen'l C. H. HOWARD,

*A. A. Rogers*

A. A. A. General.

*I will order Mr. Wright to report to Gen. Roberts*



W B 17d 1311. O. S. No. 352.

Washington Jan 19 1869.

Rogers W<sup>m</sup> W.

A. A. A. Genl.

Appoints W. B. Jefferson,  
Employment Agent, at a  
compensation of \$15.00 per  
month.

Re: O. S. A. No. 415 1869.

Bureau Refugees, Freedmen and Abandoned Lands

Headquarters As't Commissioner, District Columbia,

Washington, January 10<sup>th</sup>, 1864

Special Orders,

No. 6

(EXTRACT.)

Dr. W. S. Jefferson is hereby appointed an Employment Agent in this District, at a salary of fifteen dollars (\$15<sup>00</sup>) per month, to date from the 15<sup>th</sup> inst. and will report to Genl. Colonel W. M. Drake. Fiscal Agent for duty.

By order of Brevet Brigadier Genl. C. H. HOWARD,

*W. M. Rogers*

A. A. A. General.

Genl. Colonel W. M. Drake

Genl. Supt. J. C.



27032

354

Washington, D. C.  
February 11<sup>th</sup> 1867

Columbia, Dist. of

S. W. Clark

A. A. I. General.

Report of Tour of Inspe-  
ction made in accordance  
with Par. 2. S. O. No. 13. A. G.  
D. C. 1867.

Bureau R. F. & A. L.

Headquarters, 1st. Command. A. G.

Washington, Feby. 15<sup>th</sup> 1867

Respectfully referred to Lieut  
Col. W. M. Beebe, Local Supt.  
D. C., who will carry out the  
recommendations contained  
herein.

By order of

Col. Brig. Genl. Howard

W. H. Rogers  
U. S. A. Genl.

E. B. Vol. 3. No. 198. A. G. D. C. 1867.

O. F. D. 262-110107

...

NARA 526

Bureau Refugees, Freedmen and Abandoned Lands,  
Headquarters Ass't Commissioner, District Columbia,

Washington, Feb'y 11<sup>th</sup> 1867.

But 1219. Sent to St. M. and

to the Commissioner S. C.

Dear Sir,

I have the honor to submit the following report in accordance with Special Order No. 2, Par. 2, from these Headquarters, dated January 25<sup>th</sup> 1867.

I would respectfully call your attention to the fact that many of the cases that are sent north remain there a short time and return to apply for a copy of the report and the same process is repeated.

These are not exceptional cases, but so many occur that agents of the Bureau attend with expectations of becoming speak of them as discouraging to the employers and friends of the freed people. Unless some means are adopted to check this irregularity it will prove



a serious drawback on our efforts to relieve this District of its surplus labor; cultivate unsettled habits among the freed people <sup>to</sup> injure their prospects materially among their friends at the North.

To remedy this evil I would earnestly recommend that the names <sup>and</sup> a brief description of every person from this city transported, be kept in an alphabetical register, by the Local Superintendent; that the whole matter both of transporting <sup>and</sup> furnishing servants be placed in his charge; so that every application for servants to whom <sup>ever</sup> adressed shall be filed in his office; that no person shall be sent, until the Superintendent knows the name of the party to which he is going and his address; that any person furnished transportation <sup>to</sup> employment, at the North <sup>on</sup> returning to the District shall not be aided in any way by the Bureau hereafter.

Very respectfully,  
(over)

Your obedient servant  
(Sgt) S. H. Clarke  
A. A. S. G.

Dear Sir

I have the honor to acknowledge the receipt of your letter of the 11th inst.

in relation to the above mentioned matter.

I am, Sir, very respectfully,  
Yours truly,  
S. H. Clarke

*S. H. Clarke*

S. H. Clarke



71121710135. O. L. S. No. 336.

Washington Feb 18<sup>th</sup> 1867.

Clark S. W.  
U. S. General.

Returns letters of S. A.  
Wadsworth,

Rec. O. L. S. Dec 2-18-1867.

Bureau Refugees, Freedmen, and Abandoned Lands.

Headquarters Ass't Commissioner, District Columbia,

Washington, February 11<sup>th</sup>, 1867.

Genl (A. H.) Buba

Local Supt

of

I have the honor  
to return herewith letters of J. A. Madson  
withdrawn from your files

Very respectfully

Yours truly

W. A. R. G.

A. A. L. G.



MB 17d 136. O.L.S. No. 3

Washington Feb 18 1869

Roger W. M. M.

357

A.A.A. Genl.

Appoints John H. Cook,  
an Employment Agent  
Bureau H. F. Genl.

No. 2 O.L.S. No. 2-19-1869

Bureau Refugees, Freedmen, and Abandoned Lands.

Headquarters Ass't Commissioner, District Columbia,

Washington, February 18<sup>th</sup> 1867.

Special Orders,

No. 20

(EXTRACT.)

1. John H. Cook (Oberlin Ohio) is hereby appointed an Employment Agent, Bureau R. F. and A. L. in this District, and will report in person to the Assistant Commissioner at Washington D. C. for duty.

By order of Brevet Brigadier-Gen. C. H. HOWARD.

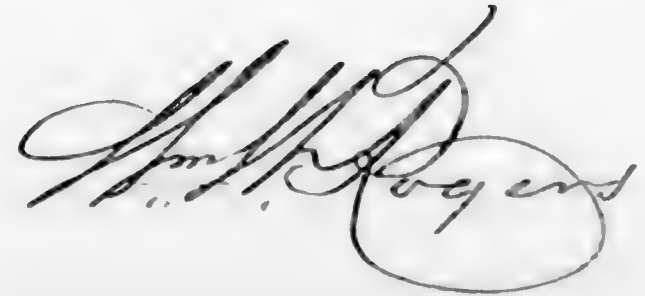

A. A. Adj.-General.

Recd Col William M. Lusk  
Genl Supt D. C.



7211317A136, O.S. 359,

Washington Feb 18<sup>th</sup> 1869,

Gripping Miss J. E.

Desires to know if the  
transformation for Battle  
Creek, Mich. asked for on  
the 11<sup>th</sup> mist can be obtained  
states that the parties wish  
to start the 17<sup>th</sup> inst.

M.C.O.S. No. 2-18-1869.

NOV 24

394 of Cap St

Washington D.C. Feb 18<sup>th</sup> 69

Dr Rev Mr Wm Rube Sr

Local Dept D.C. Bureau of

Sir.

I have the honor to submit  
that transportation was ask on the 11<sup>th</sup> inst  
for Ellen Burke from this City to Canastota N.Y.  
She is to be employed by how Mr Holmes, who  
wishes to send the girl tomorrow morning  
with a lady friend - It is possible  
to get the transportation today.

At am my respect

Yours truly

A. Emma Giffney

Aty



394 of Capt St

Washington D.C. Feb 18 '69

It has been the honor to submit

Local Dept. H. Bureau &c

for.

that transportation was asked on the 11<sup>th</sup> inst  
for Miss Burke from this City to Canastota N.Y.  
She is to be employed by Hon Mr Hobbes, who  
wishes to send the girl tomorrow morning  
with a lady friend - Will it be possible  
to get the transportation today.

Yours truly

Yours truly

A. Emma Giffney

AG

7113110 137 251 360

Washington. Feb 15<sup>th</sup> 1867

Clark S. W.

U. A. U. Genl.

States that Mr. A. J. Wil-  
liams, of Lawrence Conn.  
is no longer connected  
with this Bureau.

Bureau R. F. & A. S.

Headquarters a. e. o. c.

February 18. 1867

Respectfully referred to  
Sp Col Beebe Jr. for his  
information

The persons named  
within are not recognized  
as agents of this Bureau  
and transportation will  
not be furnished for  
friends people to be sent to  
them, except such as  
they may themselves  
employ.

By order of

Robt Birney Howard

*H. H. Rogers*

a. e. o. c.

Rec<sup>d</sup> O. L. S. 251 13-1867



BUREAU 537

Bureau Refugees, Freedmen and Abandoned Lands,  
Headquarters Ass't Commissioner, District Columbia,

Washington, February 15<sup>th</sup> 1867.

Sir:

You are hereby notified that Mr A. F. Williams of Farmington Conn is no longer connected with this Bureau and that freed people will not be sent under the regulations of his circular, erroneously published as approved by the Commissioner

Respectfully  
Your Obedt Servant  
S. W. Clark.  
A. A. S. G.

Official

*W. H. Rogers*  
A. A. S. G.

(Signed)

S. W. Clark.  
A. A. S. G.

Copies sent to:

David Hawley Hartford Conn

Robt G. Cromwell New Haven Conn.

Jas. H. Dunham Pittsfield Mass.

E. A. Newell Springfield "

James Hearn Northampton "

Stephen C. Earle Worcester "

Joshua Merrill, Lowell Mass.  
 Nathaniel White Concord N.H.  
 Benjamin Cheever Portsmouth "  
 Reuben Ruby Portland Me  
 E. D. Godfrey Bangor "  
 Charles C. Frost Bristolboro Vt  
 Rev. D. W. Dayton Rutland "  
 Andrew J. Howard Burlington "  
 Henry Y. Barnes Montpelier "  
 Marshall Mason St Albans "  
 Rev. H. G. Stewart, Providence R. I.  
 Stephen Meyers Albany N. Y.  
 Job. Parker Utica "  
 Dr. M. D. Benedict Syracuse "  
 George W. French Geneva "  
 James O. Bliss, Rochester "  
 A. C. Howard Buffalo "

Official

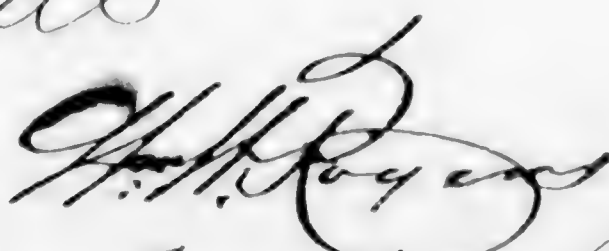
  
 H. H. Rogers  
 A. C. G.



Bureau Refugees, Freedmen and Abandoned Lands,  
Headquarters Ass't Commissioner, District Columbia

Washington, February 15<sup>th</sup> 1867.

Sir:

You are hereby notified that Mr A. F. Williams of Farmington Conn is no longer connected with this Bureau and that freed people will not be sent under the regulations of his circular, erroneously published as approved by the Commissioner

Respectfully  
Your Obedt Servant

(Signed) S. W. Clark.

A. A. S. G.

Official

W. H. Rogers  
A. A. S. G.

Copies sent to:

David Hawley Hartford Conn

Robt G. Cromwell New Haven Conn.

Jas. H. Dunham Pittsfield Mass.

E. A. Newell Springfield "

James Starsh Northampton "

Stephen C. Earle Worcester "

Joshua Merrill,	Lowell Mass.
Nathaniel White	Concord N.H.
Benjamin Cheever	Portsmouth "
Reuben Ruby	Portland Me
E. D. Godfrey	Bangor "
Charles C. Frost	Bristol Vt
Rev. D. W. Dayton	Rutland "
Andrew J. Howard	Wilmington "
Henry Y. Barnes	Montpelier "
Marshall Mason	St Albans "
Rev. H. G. Stewart,	Providence R. I.
Stephen Meyers	Albany N. Y.
Job. Parker	Utica "
Dr. M. D. Benedict	Syracuse "
George M. French	Geneva "
James O. Bliss.	Rochester "
A. C. Howard	Buffalo "

Official

W. H. Rogers  
A. A. G.



MS. B. 1. 2. 138. O. L. S. No. 363

Washington, Feb 19<sup>th</sup> 1864

Rogers Wm. W.

A. A. A. Genl.

Direct thro the Asst  
Comm<sup>r</sup> D. C. that in future  
all applications for freed persons  
who go to States where there  
is a com<sup>r</sup> will be made  
separate from those where  
there are none.

MS. B. 1. 2. 138. O. L. S. No. 363

Bureau Refugees, Freedmen, and Abandoned Lands,  
Headquarters Ass't Commissioner, District Columbia.

Washington, February 19<sup>th</sup> 1867.

Lieut. Col. W. M. Beebe Jr  
Local Superintendent, D. C.

Colonel

The Asst. Commissioner  
directs that in the future, the applications for  
the transportation of freed persons to those States  
in which there are Asst. Commissioners, shall be made  
separate from those to States in which there are none

Very respectfully

Your obedient servant

A. A. General

A. A. General



MSB 139, O.L.S. 70-210  
Washington. Feb 20<sup>th</sup> 1864.

Roger W. W.  
A. A. A. Gen. De.

States that Messrs. W. H.  
W. Chapline, Cyrus R. Johnson,  
and John H. Saunders, have pre-  
sented the proper credentials at  
H. Q. A. C., all necessary as-  
sistance will be rendered them  
in procuring laborers to go  
to Arkansas, & that if they  
have secured their help, the  
application for transportation  
will be forwarded with proper  
papers governing such transpo-  
sition of freed people from one State  
to another.

Re O.L.S. De. 2-21-1864

Bureau Refugees, Freedmen, and Abandoned Lands,

Headquarters Ass't Commissioner, District Columbia,

Washington, January 20<sup>th</sup> 1867.

Dear Sir,  
I have the honor to acknowledge the receipt of your letter of the 17<sup>th</sup> inst. in relation to the matter of the land in Chic County, Georgia.

The land in Chic County, Georgia, is now being surveyed by the U.S. Army, and the results of the survey will be reported to the War Department. It is the policy of the Government to sell the land to the freedmen and to the poor of the South, and it is the intention of the Government to sell the land in Chic County, Georgia, to the freedmen and to the poor of the South.

I have the honor to acknowledge the receipt of your letter of the 17<sup>th</sup> inst. in relation to the matter of the land in Chic County, Georgia. I have the honor to acknowledge the receipt of your letter of the 17<sup>th</sup> inst. in relation to the matter of the land in Chic County, Georgia.

Very respectfully,  
A. H. Rogers  
S. S. S. S.



MBM 144 O.L.S. 37

Washington Feb 21<sup>st</sup> 1864

Rogers, W<sup>m</sup> W

A. A. A. Genl.

Directs that a roster of Officers and Civilian employees be made out in accordance with accompanying form and forward the last day of each month.

Ref. O.L.S. No 2-22-1864

BUREAU 546  
Bureau Refugees, Freedmen and Abandoned Lands,  
Headquarters Ass't Commissioner, District Columbia,

Washington, *February 21<sup>st</sup>* 1867

Lieut Col. William M. Beebe  
Local Sup' DC  
Colonel.

The Assistant Commissioner directs  
that hereafter the report of Officers and Civilian Employees  
will be made on the accompanying form and forwarded promptly  
on the last day of every month

Very Respectfully

Your obedient servant

*Wm. Rogers*

AASG



715131 1411 ( ) 25 25 372

Washington, D.C. Feb 7 '86

Townsend, E. G.  
Supt. &c

States that he has issued  
133 1/2 cords wood on orders  
from the L.S. from Jan 17'  
to date also 3 cords on Mr  
Pursons order. vis y<sup>l</sup>

715131 1411 ( ) 25 25 372

Rendall Green Feb 7<sup>th</sup> 84

Col. Wm. M. Beebe  
Col.

In compliance with your order I have the honor to report. I find your order for wood, since Jan 17<sup>th</sup> Jan to be thirty three & one half (33 1/2) cords. Besides this I have your authority for the distribution in this Camp to destitute families two (2) cords. Also one order of the Parsons Visiting Agent for three cords, to fourteen different families I have distributed two cords more. And to the destitute of my own Camp since the expiration of the order, 1 1/2 cords. Besides the above, by your order, that of Maj. Vandenberg previous to Jan 17, & subsequent to Maj. Spurgens leaving fifteen (15) cords. Also four or six cords of your wood without orders, say three (3) cords.

And since Jan 17<sup>th</sup> thirty nine (39) cords. Previously to Jan 14<sup>th</sup> eighteen (18) cords. Also for my office Quartermaster's school for the month of Jan four (4) cords.

Very Respectfully  
E. J. Lawrence  
Supt.



7113 1700 1111, O. L. S. 16 573  
Washington, D. C. Feb 16 1867.

Charles S. W.  
U. S. A. Genl.

Directs that all applications for transportation for freed people living in Alexandria County & City, and Fairfax Co. Va. be referred to Capt. S. P. Lee, Sup<sup>t</sup>. at Alexandria & that Capt. be notified to inform themselves of the above facts;

!

O. L. S. 16 2 11 1867

Bureau Refugees, Freedmen, and Abandoned Lands,  
Headquarters Ass't Commissioner, District Columbia,

Washington, Feb 16 1867.

Lieut Col H. M. Beebe Jr  
Local Supt DC

Col: The Asst Com<sup>r</sup>  
directs that hereafter the applications  
for transportation for freed people living  
in Alexandria, County and City, and  
Tangier Co Va be referred to Capt S. P.  
Lee Supt. You will therefore notify  
all agents in your jurisdiction to inform  
themselves of the present residence  
of each applicant and refer all residing  
in Capt Lee's jurisdiction as directed  
above.

Respectfully

Your obedient servant

McClun

a. a. a. g. b.



Bureau Refugees, Freedmen, and Abandoned Lands,

Headquarters Ass't Commissioner, District Columbia,

Washington, Feb 16 1867.

Lieut Col H. M. Beebe jr  
Local Supt DC

Col: The Asst Com<sup>r</sup>  
directs that hereafter the applications  
for transportation for freed people living  
in Alexandria, County and City, and  
Tampas Co Va be referred to Capt S. P.  
Lee Supt. You will therefore notify  
all agents in your jurisdiction to forward  
themselves of the present residence  
of each applicant and refer all residing  
in Capt Lee's jurisdiction as directed  
above.

Respectfully  
Your obedient servant,  
McClure  
a. a. agent

Washington, Feb 21 1869,

Roger W. W.

374

U. A. A. Genl. Sec.

Direct that Ed Beebe  
confer with Miss Walker,  
<sup>Chap. of students</sup>  
in reference to making the  
50 part of Pamb. for which  
he made application for the  
Buss at the same school.

W. A. A. Genl. Sec. No 374

W. A. A. Genl. Sec. No 374



Bureau Refugees, Freedmen and Abandoned Lands,  
Headquarters Ass't Commissioner, District Columbia,

Washington, January 21<sup>st</sup>, 1867.

Lieut. Colonel W. M. Beebe, Jr.

General Dept. G. C.

Sir,

The Assistant Commissioner directs that you confer with Miss Susan Halber, in charge of the Industrial School at Wisconsin Turnpike, and ascertain whether she can manufacture the fifty 30 pairs of pantaloons mentioned in your requisition for clothing for the Orphans at Dr. Mearns's Farm School, if the material is furnished by this Bureau. You are going to pay her a reasonable price per pair for making the same.

You will please report the result and what time she will require to furnish the same.

Very respectfully

Your obedient servant

W. M. Rogers

W. M. Rogers

717212  
Washington, D.C. No. 277

Washington. Sept 23<sup>rd</sup> 1867.

Rogers Wm W.

U.S.A. Genl. D.C.

Directs that a "Monthly  
Report of Rations received and  
Issued to" for the month of  
January, 1867, be forwarded  
immediately to H. D. D. C.

No. 277



Bureau Refugees, Freedmen, and Abandoned Lands,

Headquarters Ass't Commissioner, District Columbia,

Washington, July 29<sup>th</sup> 1867.

Dear Sir,

I have the honor to acknowledge the receipt of your letter of the 27th inst.

relative to

the application of the Freedmen's Bureau for the purchase of land for the purpose of settling the freedmen.

I have the honor to inform you that the Bureau has no objection to the purchase of land for the purpose of settling the freedmen, provided that the land is not already owned by any other person, and that the purchase is made in accordance with the provisions of the Act of March 3rd, 1867.

I have the honor to inform you that the Bureau has no objection to the purchase of land for the purpose of settling the freedmen, provided that the land is not already owned by any other person, and that the purchase is made in accordance with the provisions of the Act of March 3rd, 1867.

Very respectfully,

Your obedient servant,

W. H. Boyer

U. S. A.

Bureau Refugees, Freedmen, and Abandoned Lands,

Headquarters Ass't Commissioner, District Columbia,

Washington, July 25<sup>th</sup> 1867.

Dear Sir,

I have the honor to acknowledge the receipt of your letter of the 21<sup>st</sup> inst.

in relation to the

land of the late Mrs. [Name] in the District of Columbia.

The land in question is now being held by the Government and is being sold to the highest bidder. It is situated in the [Location] and is of the size of [Size]. The proceeds of the sale will be used for the benefit of the Freedmen's Bureau.

Very respectfully,

Your obedient servant,

W. H. [Signature]

U. S. A.



117012, 013, 014, 015  
Washington Feb 23<sup>rd</sup> 1867

Regus Wm W.  
A. A. A. Genl.

Directs that Rev Mr. Roberts, investigate the case of Benj Thomas, living on Del. Ave. back of "C" St north, and supply the required relief, and also to send a Medical Officer to attend a woman in Thomas' family who is reported to be very sick. Should the within address be not explicit enough, the agent will call on Miss M. A. Johnson, 318, North B. St. who will give the desired information.

Office Local Supt D.C.,  
Feb 25<sup>th</sup> 1867

Respy referred to  
Rev. J. L. Roberts  
with instructions to  
investigate the within  
case -

Wm. C. Baker  
Local Supt  
D.C.

Washington D.C.  
Feb 25<sup>th</sup> 1867

H. Cal. Beebe Jr.  
Local Supt D.C.

Calend -  
I have investigated the within  
referred case, and make  
the following report.

Benj Thomas has a  
wife & one child (a daughter).  
He has been at work  
for \$8, per week for the last  
two years he informs me.

His wife was confined  
about 8 days since, but is  
doing well, says she needs  
no Dr. or medicine.

When she is well, she  
works for Mrs. Johnson 318  
North B. St. Mr. Thomas  
is out of employment, but  
expects to be employed soon.

They have two rooms  
for which they pay \$6, per mo.  
& have very comfortable.

I would recommend  
that they be furnished with  
wood for a few days.

Respectfully,  
J. L. Roberts  
Supt

117012, 013, 014, 015



Bureau Refugees, Freedmen, and Abandoned Lands,

Headquarters Ass't Commissioner, District Columbia.

Washington, July 23<sup>d</sup> 1867.

Lieut. Col W. M. Beebe Jr  
Local Supt D. C.  
Columbia.

The Asst Comm  
directs that you instruct Wm. H. Roberts  
to investigate the case of Benjamin Thomas  
living on Delaware Avenue back of  
C<sup>o</sup> street north and supply the required  
relief and also have Wm Roberts send a  
Medical Officer to attend a woman of  
Thomas' family who is reported as very  
ill.

Should the above address be not ex-  
plicit enough the agent can call on  
Mrs. J. J. Jones 318 North B<sup>o</sup> street  
who will if necessary accompany the  
visitor to the house.

Very Respectfully  
Your Obedt Servt  
W. M. Rogers  
Asst. Comm.



Ms. A. 1. 143 (25) 374

Washington Feb 19<sup>th</sup> 1864.

Rogers, W<sup>m</sup> W.

A. A. A. Genl

Direct that provisions  
be made to supply such  
clothing as may be neces-  
sary for freed people going  
north from East Capt St  
Baracks, and that the  
same be manufactured at  
Miss Keever's Industrial  
School.

Ms. A. 1. 143 (25) 374

Bureau Refugees, Freedmen, and Abandoned Lands.

Headquarters Ass't Commissioner, District Columbia.

Washington, February 19<sup>th</sup> 1867.

Lieut. Col. M. C. Beebe, Jr.  
Local Superintendent, D. C.  
Colonel.

The Assistant Commissioner  
wishes that you would provide a supply  
of long fur coats for the people we are going  
north from East Capitol Terrace and vicinity,  
and suggests that the same be manufactured at  
the Industrial School at East Capitol Terrace  
under the charge of Miss Eliza Hancock.

and the time parties are secured for the  
month of clothing, should be entered so that  
it can be made up in time to issue to them  
when they go north for the winter.

Very respectfully  
Your Obedt Servant

W. H. Rogers  
A. S. C.



MS. 114. C. 2. 5. 16. 383

Washington Feb 25<sup>th</sup> 1864

General C. C.

Brig Genl. ac.

Direct that C. P.  
Clarke, be put on the  
roll at \$75<sup>00</sup> per month  
to date from 1<sup>st</sup> Feb'y.

MS. 114. C. 2. 5. 16. 383

Bureau Refugees, Freedmen, and Abandoned Lands,

Headquarters Ass't Commissioner, District Columbia,

Washington, Feb. 25 1867.

H. Col. Wm. M. Huber  
Socul Supt  
Col

Please put A.  
P. Clark upon your rolls at  
Seventy five (87 5-) per month  
beginning Feb. 1<sup>st</sup> 1867

Respectfully  
C. W. Howard  
Post. Brig. Gen.  
C. C.



House of Reps, Feb 1st 1867  
L. P. ...

Lawrence W.  
M. L.

Dever's colored  
servant.

7110312011410028, 236

1909

Recd - Feb 1st 1867

WAR DEPARTMENT,

Bureau Refugees, Freedmen, and Abandoned Lands,

WASHINGTON, February 4<sup>th</sup> 1867

Respectfully referred to Brig  
Genl C. W. Howard Assistant  
Commissioner for D. C.

By order of Maj. Genl. Howard

A. P. Ketchum  
A. A. G.

Head Quarters A.C.S.L.  
February 5. 1867

Respectfully referred to  
Lieut Col R. W. ...  
Supt: S.C. ...

By order of  
Brig Genl Howard  
A. P. Ketchum  
A. A. G.

Will Col ...  
Mass to Maj Genl Howard  
and return to ... to the  
Office ...  
Recd U.S. ...



House Rep.

Washington City

1 July 1867

Major Genl D. O. Howard

I want to employ  
a colored man who is  
industrious & a carpenter  
a man with family & who  
can set one laboring man  
to go with him. I can  
give him a place to  
live on a farm where  
another colored family  
lives. I can let him  
have cow pasture, garden  
truck patch & can  
give constant employment  
I of course want him  
to go to Ohio with me  
Can you send me



323 (R. F. & A. L., Vol. 9,) 1867.

East Fairfield Ohio 358

February 22d, 1867.

Raley - Kersey

Articles to be furnished  
with a colored farm servant.

M. M. (149 O. L.) 355

Rec'd L. S. H. 24-1867

WRAPPER ..... (Enclosures.)

Received Bureau R. F. & A. L., Feb. 25, 1867.

**WAR DEPARTMENT,**

Bureau Refugees, Freedmen, and Abandoned Lands,

WASHINGTON, February 25<sup>th</sup> 1867.

Respectfully referred to Brig  
Genl C. H. Howard, Asst  
Commissioner of D. C.

By order of  
Major Genl O. O. Howard

A. P. Ketchum

Act. Asst. Asst. General

Bureau Refugees, Freedmen & Abandoned Lands

HEAD QUARTERS ASSISTANT COMMISSIONER, D. C.,

Washington February 26, 1867.

Respectfully referred to Lt. Col.  
W. M. Beebe, Jr. Local  
Supt. D. C.

By order of Bvt. Brig. Gen. HOWARD.

A. A. General.

East Fairfield  
Columbiana Co. Ohio  
March 18. 1869

Henry Raley

States that he has supplied  
himself with laborer, and  
therefore does not require  
the one for which he  
applied —



West Springfield, Mass. Dec 18<sup>th</sup> 1851  
Columbian Co. (C.)

Dear Sir,  
I write to you in answer to yours of 2<sup>nd</sup> No. 13<sup>th</sup> regarding you to furnish me a farm hand - and having no objection in regard to its procuring none would be sent - I have enjoyed the report of your. Therefore you will please not send as was desired

Very Respectfully  
Wm. K. Kelsey

East Fairfield Columbiana  
County Ohio

Dec<sup>r</sup> 29<sup>th</sup> 1857

Bureau "Repuges, Freedmen &c"

I have

received your communication of  
2<sup>nd</sup> No. 15<sup>th</sup> relative to a Farm hand -

I think the average wages paid to good  
farm hands in this section is probably  
about twenty dollars per mo. - but of  
course varies according to the proficiency  
of the hand

If you can send me a good able hand  
one who has had experience in plowing  
and working and the care of Horses  
I can give him wages according  
to his efficiency as a hand - provide a  
home for him, and afford facilities for  
obtaining if he desires it -

My nearest N. A. Station is Waterford  
on the Pittsburg & Chicago N. A.

3231





Please send me with a water supply  
with a <sup>small</sup> ~~small~~ <sup>one</sup> ~~one~~ who would likely be able to  
apply himself to the various kinds of work  
incident to farm labor in this section.

Please drop me a line concerning action as  
soon as possible. I am in Washington D.C. by

Yours Respectfully

J. H. Brown

as  
Hansen, Rules

P. O. Box 1000, near S. W. of N. H.  
Station & two miles S. of village of C.  
Fairfield

Bureau R. F. W. A. S.

Head Quarters A. S. C.

February 25. 1867

Respectfully referred  
to Genl Col Beebe local  
sup't who will reply this  
letter at once and  
inform Mr Hoskins  
that if children will  
be taken with the

women, they can  
be forwarded at any  
time, an agent,  
accompanying them,

By order of

Robt Angus Howard

W. H. Rogers  
A. S. C.

E. B. Vol. 3. No. 245. A. S. C. 1867.

7/15/1867

Ms. A. 9. 2. 26



Ms. A. 9. 2. 1. 1. 1.

114.

Auburn Feb'y 22. 1867

Breth' Brig' Gen' G. W. Howard

My Wife Mrs R. A.

(Hoskins wrote you some days ago for  
 some freed Women, 9 Women & 1 Boy  
 if they have not been shipped, she wishes  
 you to send <sup>(11)</sup> Elven Woman & the Boy  
 some of these are for farmers in the  
 Country & they are very anxious to have  
 them come as soon as they can be sent,  
 please inform her how soon she can  
 expect them if they have not already  
 been shipped

Yours &c  
 H. Hoskins

Wash

Sir: I have the

that the following  
Colored Girl  
to Paris, etc.  
Named Thomas  
resides at Pitt  
North of Paris.  
A girl that  
and understand

generally. Very Res  
to

Feb 1867

Col. Ruler -

The written com-  
munication is from  
Capt. D. Lewis - an old  
friend of mine - still you  
have the kindness to try  
& send the "Help" as re-  
quested.

Very truly -

H. H. [Signature]

2003126 146. U.S. 13796

2003126

Nov 21 1867



Wash

Sir,

I have the  
 honor the following  
 Colonel Bird,  
 to Paris. Mr.  
 Mansel Thomas  
 resides at <sup>St. Denis</sup>  
 North of Paris.  
 A girl that  
 and understand  
 generally.

Yours

870

My dear Mr. [unclear] 5<sup>th</sup> 1861

I have just received your kind letter of the 2<sup>nd</sup> inst. and am glad to hear that you are all well. I am well at present and hope these few lines will find you all the same. I have not much news to write at present. I am still in the same place and doing the same work. I have not seen any of our friends lately. I have not seen any of our friends lately. I have not seen any of our friends lately.



Wash D.C.

Nov 18<sup>th</sup> 1862

Sir,

I have the honor to receive  
that the following described  
Colored Girl may be found  
to Paris. She is a girl  
named Thomas Bishop who  
resides on Ridge Farm 20 miles  
North of Paris.

A girl that is a good Cook  
and understands house work  
generally.

Very Respectfully

David Lewis

To

Wash D.C.

Feb 18<sup>th</sup> 1862

Sir,

I have the honor to inform  
that the following described,  
Colored Girl, may be sent  
to Paris. I have a gentleman  
named Thomas Gillespie who  
resides at Ridge Farm 30 miles  
North of Paris.

A Girl that is a good Cook  
and understands house work  
generally.

Very Respectfully,

Quinn Lewis

To



394 A Corp St  
Washington D.C. Feb 26 '69

Col W. W. Royce  
A. A. Genl, Bureau Ref &c  
Sir

I have the honor to ac-  
knowledge receipt of transportation for  
Harrison Johnson & four others, from this  
City to Hartford Conn.

Very Respectfully,  
Yours Obedt Serv

J. Eliffing  
Comptroller

NARA 578

7713174 (146) No. 343

Washington Feb 26<sup>th</sup> 1867

Giffing. Miss J. Emma,  
Agent

Acknowledged receipt of  
Transportation from the  
City to Hartford Ct for  
Huntton Johnson & others

Rec'd. L.S. 6-27-1867



70001 VOL 146, O. S. D. C. 375

Washington, Feb 26<sup>th</sup> 1867

Roger W. H.

A. A. A. Gen. H.

Appoint Quartermaster C. H. H. at  
 all employment U. S. A. at  
 compensation of \$75<sup>00</sup> per  
 month, to report to Col. Beebe  
 Local Insp. for duty.

Recd O. S. D. C. 2 26 1867

NARA 580  
Bureau Refugees, Freedmen, and Abandoned Lands.

Headquarters Ass't Commissioner, District Columbia,

Washington, February 26<sup>th</sup> 1867.

Special Orders,

No 218

(EXTRACT.)

H. Chas C Harris is hereby appointed  
an Employment Agent Bureau R.F. & A.L. for  
this District, at a compensation of seventy five  
dollars \$75.00 per month

He will report to Lieut Col Peck. Local  
Supt D.C. Corner 7<sup>th</sup> & O. Streets for duty

By order of Brevet Brigadier-Gen. C. H. HOWARD.

A. A. Rogers

A. A. Adj.-General.

Lieut Col Peck  
Local Supt



MR 170 147, O. L. S. No. 396,

Washington. Feb 23<sup>d</sup> 1869.

Roger M. M.

A. A. A. G. C. D. C.

States that the compensation  
of George M. Amiel is fixed  
at \$50<sup>00</sup> per month to date from  
Feb 1<sup>st</sup> 1869.

R. F. O. L. S. No. 2-23-1869

MS 170 147, O. L. S. No. 596,

Washington, Feb 23<sup>rd</sup> 1867.

Roger M. Wall

A. A. A. G. C. No. 2

States that the compensation  
of George M. Amitt, is fixed  
at \$500<sup>00</sup> per month to date from  
Feb 1<sup>st</sup> 1867.

Re O. L. S. No. 2-23-1867.



Bureau Refugees, Freedmen, and Abandoned Lands.

Headquarters Ass't Commissioner, District Columbia,

Washington, February 23<sup>rd</sup> 1867.

Special Orders,

No 27

(EXTRACT.)

1. The compensation of George McArnold  
Employment Agent Bureau R.F. & A.L. for  
District of Columbia, is hereby fixed, at fifty  
dollars \$50. per month to date from Feby 1<sup>st</sup>  
1867

By order of Brevet Brigadier-Gen. C. H. HOWARD.



A.A. Adj. General.

Special Order

Feb 23 1867

7751701 1117, C. S. L. Co. 394,  
Washington, Feb 23<sup>d</sup> 1864

Royce W. H.

A. A. A. Church & Co.

States that John Reaburn,  
Clerk at Alexandria, 7<sup>th</sup> under  
Capt. J. P. Lee, is waived from  
Duty, and will report to Capt  
Becke, Local Dep<sup>t</sup>. Co. for duty  
at a compensation of \$75<sup>00</sup> per mo-

Rec<sup>d</sup>. C. S. L. Co. 394 23 Feb 1864



Bureau Refugees, Freedmen, and Abandoned Lands.

Headquarters Ass't Commissioner, District Columbia,

Washington, February 23<sup>rd</sup> 1867.

Special Orders,

No 27

(EXTRACT.)

\* \* \*  
2 John Raeburn clerk at office  
of Capt S. P. Lee Alexandria, is hereby  
relieved from that duty, and will report  
in person, without delay to Lieut. Col.  
Beebe Local Supt D. C., for duty in his  
office

The compensation of John Raeburn  
is hereby increased to seventy five dollars  
(\$75) per month, to take effect March 1<sup>st</sup> 1867

By order of Brevet Brigadier-Gen. C. H. HOWARD.

A. A. Rogers

A. A. Adj. General.

Lieut Col Beebe  
Local Supt D. C.

NARA 896

Jr (R. F. & A. L., Vol. 9,) 1867

Westford Vermont

February 18, 1867

Jackson S. S.,

Desires to procure  
farm servants.

WRAPPER ..... (..... Enclosures.)

Rec'd by D. H. D. R. F. & A. L., Feb 23, 1867  
Ref. C. L. S. No. 2-27-1867

WAR DEPARTMENT,

Bureau Refugees, Freedmen, and Abandoned Lands,

WASHINGTON, February 25<sup>th</sup> 1867.

Respectfully referred to Brig  
Genl. C. W. Howard Assistant  
Commissioner of D. C.

By order of  
Major Genl. O. O. Howard.

A. P. Ketchum  
Acty Asst. Ady. Genl

Bureau R. F. & A. L.

Wm. D. S. Asst. Commr D. C.

Washington, Feb 27<sup>th</sup> 1867

Respectfully referred to Lieut  
Col. Wm. Beebe Jr. Local  
Asst. D. C.

By order of

Brig Genl. O. O. Howard  
A. P. Ketchum  
Acty Asst. Ady. Genl



C.B.

1917 - 1918 - 1919 - 1920 - 1921

1917  
1918  
1919  
1920  
1921

1921

1921  
1922  
1923  
1924  
1925  
1926  
1927  
1928  
1929  
1930  
1931  
1932  
1933  
1934  
1935  
1936  
1937  
1938  
1939  
1940  
1941  
1942  
1943  
1944  
1945  
1946  
1947  
1948  
1949  
1950  
1951  
1952  
1953  
1954  
1955  
1956  
1957  
1958  
1959  
1960  
1961  
1962  
1963  
1964  
1965  
1966  
1967  
1968  
1969  
1970  
1971  
1972  
1973  
1974  
1975  
1976  
1977  
1978  
1979  
1980  
1981  
1982  
1983  
1984  
1985  
1986  
1987  
1988  
1989  
1990  
1991  
1992  
1993  
1994  
1995  
1996  
1997  
1998  
1999  
2000  
2001  
2002  
2003  
2004  
2005  
2006  
2007  
2008  
2009  
2010  
2011  
2012  
2013  
2014  
2015  
2016  
2017  
2018  
2019  
2020  
2021

10  
 11  
 12  
 13  
 14  
 15  
 16  
 17  
 18  
 19  
 20  
 21  
 22  
 23  
 24  
 25  
 26  
 27  
 28  
 29  
 30  
 31  
 32  
 33  
 34  
 35  
 36  
 37  
 38  
 39  
 40  
 41  
 42  
 43  
 44  
 45  
 46  
 47  
 48  
 49  
 50  
 51  
 52  
 53  
 54  
 55  
 56  
 57  
 58  
 59  
 60  
 61  
 62  
 63  
 64  
 65  
 66  
 67  
 68  
 69  
 70  
 71  
 72  
 73  
 74  
 75  
 76  
 77  
 78  
 79  
 80  
 81  
 82  
 83  
 84  
 85  
 86  
 87  
 88  
 89  
 90  
 91  
 92  
 93  
 94  
 95  
 96  
 97  
 98  
 99  
 100

L

10-7 10-10-107



209. 2. No. 222 45. 3. 11  
(R. F. & A. L., Vol. 9,) 1867.

Palmyra N.Y., 441

February 23, 1867.

Chappell - Wm H.

Discs to be furnished  
with a colored farm hand.

WRAPPER ..... (..... Enclosures.)

Received Bureau R. F. & A. L., Feb 26, 1867.

RCOL No. 2-27, 1867.

WAR DEPARTMENT,

Bureau Refugees, Freedmen, and Abandoned Lands,

WASHINGTON, Feb. 26, 1867.

Respectfully referred to Brig  
Genl Charles H Howard,  
Assistant Commissioner D.C.

By order of  
Major General Howard,

A. P. Ketchum  
Bot Lieut Col., A.A.A.

Bureau R. F. & A. L.

Ad. Ins. Asst. Commr DC

Washington, Feb 27 1867

Respectfully referred to  
Genl Wm W Beebe Jr  
Supt. D.C.

By order of

Brig Genl Howard

W. Rogers  
A.A.A.



Ms. A. 9. 2. 11

Palmyra N.Y. 6/23/01

General Howard

Sir having  
 been advised to write to you  
 I take this opportunity in regard  
 to help for the coming season  
 as it's very scarce here and wages  
 very high I am compelled to write  
 you for help will you please  
 send me a good man of 20 or  
 25 years of age that understands  
 working on a farm & doing all  
 kinds of farm work in general  
 & I will employ him at good  
 wages with board & lodging  
 please write me by return mail  
 whether you will send me  
 one or not (a quadroon is prefer-

-ble) Very Truly yours  
 Wm. H. Chappell

N.B. I. & Palmyra  
 write conditions re Wayne Co  
 N.Y.



1942-1943

1942-1943

1942-1943

3246

WM 149, O.S. 56, 402

Washington, Feb 27 1867

W.C.C.

Brown, Maj. J. M.

A. G. M.

States that he has a number of  
for one horse in use at East  
Camp Hancock, and in further  
it will be drawn with Col.  
Pickens at Winnetts Hancock.

WM 174, O.S. 56, 1067

Chief Local Inspector

Washington, Feb 27 1867

Respectfully transmitted,

W. M. Gulev Jr

Sted. 128 71/2 St.

Local Inspector



Bureau Refugees, Freedmen, and Abandoned Lands,

Quartermaster's Office, No. 132 Pennsylvania Avenue,

Washington, D. C.,

February 27 1867

Mr. J. L. Roberts

Supt. E. Capitol St. Barracks.

Thos. Col. W. de. Beck Jr.

Fort Supt.

Sir,

I shall draw forage for  
the horses now in your charge, in  
a cart for <sup>and harness</sup> March, with  
forage drawn for horses at Col. Beck's  
Military Barracks.

The horse cart & harness has  
been turned over to me by Supt. Freedmen  
Village.

Very respectfully  
J. M. Brown  
Prof. Surg. U.S.A.

MB 144, O.L.S. No. 403,

Washington D.C. Feb 21 1867

Genl. S. N.

A. A. A. Genl.

I enclose herewith the Act  
 Court that H. Clark an  
 Employment Agent be directed  
 to be at the Pa. & C. and N.  
 Depot, and issue on each order in  
 with a signal, the number of  
 seals of going on the order,  
 and in each case to be  
 furnished; and that you  
 execute.

Re. O. L. S. No. 2 - 26 - 1867



War Department,

Bureau of Refugees, Freedmen and Abandoned Lands,

Washington, February 21<sup>st</sup>, 1867.

Supt. Col. W. M. Rube

Local Supt. D.C.

Col. General Howard suggests that as A. P. Clark is now an employment agent of this Bureau and is conveniently located, he be directed by you to be at the Balt. & Ohio RR depot whenever freed people are sent away, and enter on each transportation order, with in writing and figures, the number actually starting on each order of transportation - which is often smaller than the number specified in the order.

Very Respectfully

A. A. Sprule

N 113 (R. F. & A. L., Vol. 4) 1867.

Recd. by [unclear] of  
Genl. Alexander  
W. C.  
February 20, 1867.

North A. M. 413

Desires to obtain a colored  
servant.

71163170 152. (L. S. 1113)

WRAPPER ..... (..... Enclosures.)

Received Bureau R. F. & A. L., Feb 27, 1867.

**WAR DEPARTMENT,**

Bureau Refugees, Freedmen, and Abandoned Lands,

WASHINGTON, February 21, 1867.

Respectfully referred to Bvt. Brig  
Genl. C. H. Howard, Act Commr.  
District of Columbia.

By order of  
Major General Howard:

A. P. Ketchum  
Adj. General

Bureau Refugees, Freedmen & Abandoned Lands

HEAD QUARTERS ASSISTANT COMMISSIONER, D. C.,

Washington, February 28<sup>th</sup> 1867.

Respectfully referred to Lt. Col.  
W. M. Beebe, Jr. Local  
Supt. D. C.

26.10  
[unclear]

By order of Bvt. Brig. Gen. HOWARD

A. A. General.

Recd. U.S. D.C. 2/28, 1867



Coventry 12/21/67  
Dear Sir I have

just now the amount of  
your share of the  
will of the late John to share  
with the late  
in what is the

case if you have not  
yet received it I will  
write you again I saw I had  
been home if there is  
any thing I will let you  
know in a few days  
I am from where  
I am at present I am  
not at home but I  
will be home in a few  
days I will let you  
know when I can  
see you and I shall  
be as long as I can  
get if I can get  
any more of the

N 43 R. J. A. S. Vol 9 07

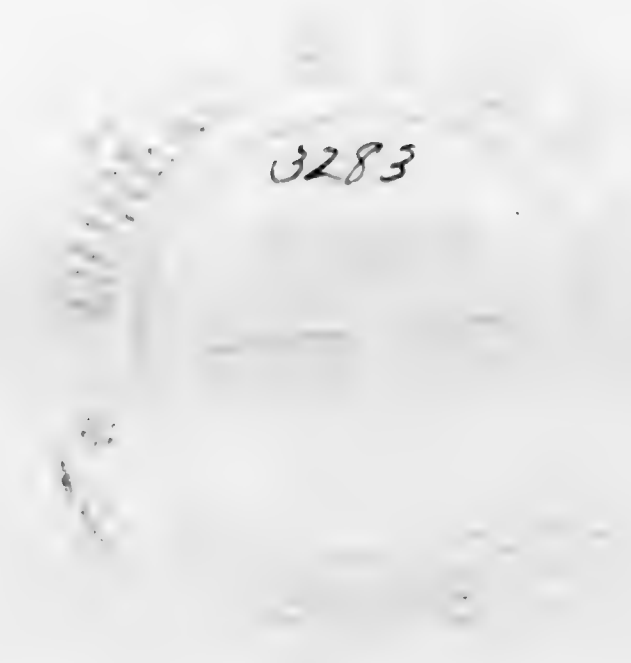

of the South Sea and  
 the East India Company  
 they had built a very  
 fine ship of 1000 tons and I  
 should like to see her  
 built in the same way  
 as the ship of 1000 tons  
 built in the same way

Yours truly

Genl. Pitt Rivers

Colchester in the West  
 County of Essex  
 Essex

The name of the ship is  
 the name of the ship  
 from the name of the ship  
 the name of the ship  
 the name of the ship



5119 (R. F. & A. L., Vol. 9,) 1867.

South Lyon Mich., 4111

Feb 20th, 1867.

P. A. Sayre,

Requests to be furnished with colored farm servants

WAR DEPARTMENT,

Bureau Refugees, Freedmen, and Abandoned Lands,

WASHINGTON, Feb. 27 1867.

Respectfully referred to the Asst Commr for D.C.

By order of

Maj. Genl Howard,

A. P. Ketchum

Bot Lieut Col, aadg.

Bureau Refugees, Freedmen & Abandoned Lands

HEAD QUARTERS ASSISTANT COMMISSIONER, D. C.

Washington March 1st 1867.

Respectfully referred to Lieut Col Wm. M. Beecher Local Supt. D.C.

1731 M 153. C 15 20 1111

WRAPPER ..... Enclosures.

R. F. & A. L. Co. 371 1867

Received Bureau R. F. & A. L., Feb 27, 1867.

By order of Bvt. Brig. Gen. HOWARD.

W. H. Rogers  
A. A. A. General.

1/11/71

Dear [unclear]

[unclear]

[unclear]

[unclear]

[unclear]



As it is the case in the  
 ... which ...  
 To the ... if you  
 ... the ...  
 ... with ...  
 ... to ...  
 ...  
 ...  
 ...  
 ...  
 ...  
 ...  
 ...  
 ...  
 ...

Yours respectfully  
 S. A. Hayes  
 South Lyden  
 Oakland Co  
 Mich.

*Received from  
 March 2nd 1861  
 ...*

21st 1887

Dear Sir

I have the pleasure to inform you that the same has been done as directed by the Board of Directors of the Bank of Montreal in relation to the purchase of the property situated in the City of Montreal and the same has been sold to the highest bidder for the sum of \$100,000.00 and the proceeds of the sale have been paid to the Bank of Montreal.

I am, Sir, very respectfully,  
 Yours truly,  
 J. H. [Name]

The Board of Directors of the Bank of Montreal has also decided to purchase the property situated in the City of Montreal and the same has been sold to the highest bidder for the sum of \$100,000.00 and the proceeds of the sale have been paid to the Bank of Montreal.



of the will was for the  
 his other ... all  
 ...  
 ...  
 ...  
 ...  
 ...  
 where I could not them ... not  
 ... they would be ...  
 ... the entry of ...



32911

I have will make a sketch  
 of the other side of the hill  
 and then meet you  
 at the house where we will  
 all be in the morning at 10 o'clock  
 to take the road to  
 the other side of the hill  
 where I would meet them if I was not  
 in they would be sure to find me  
 near the city at a place called

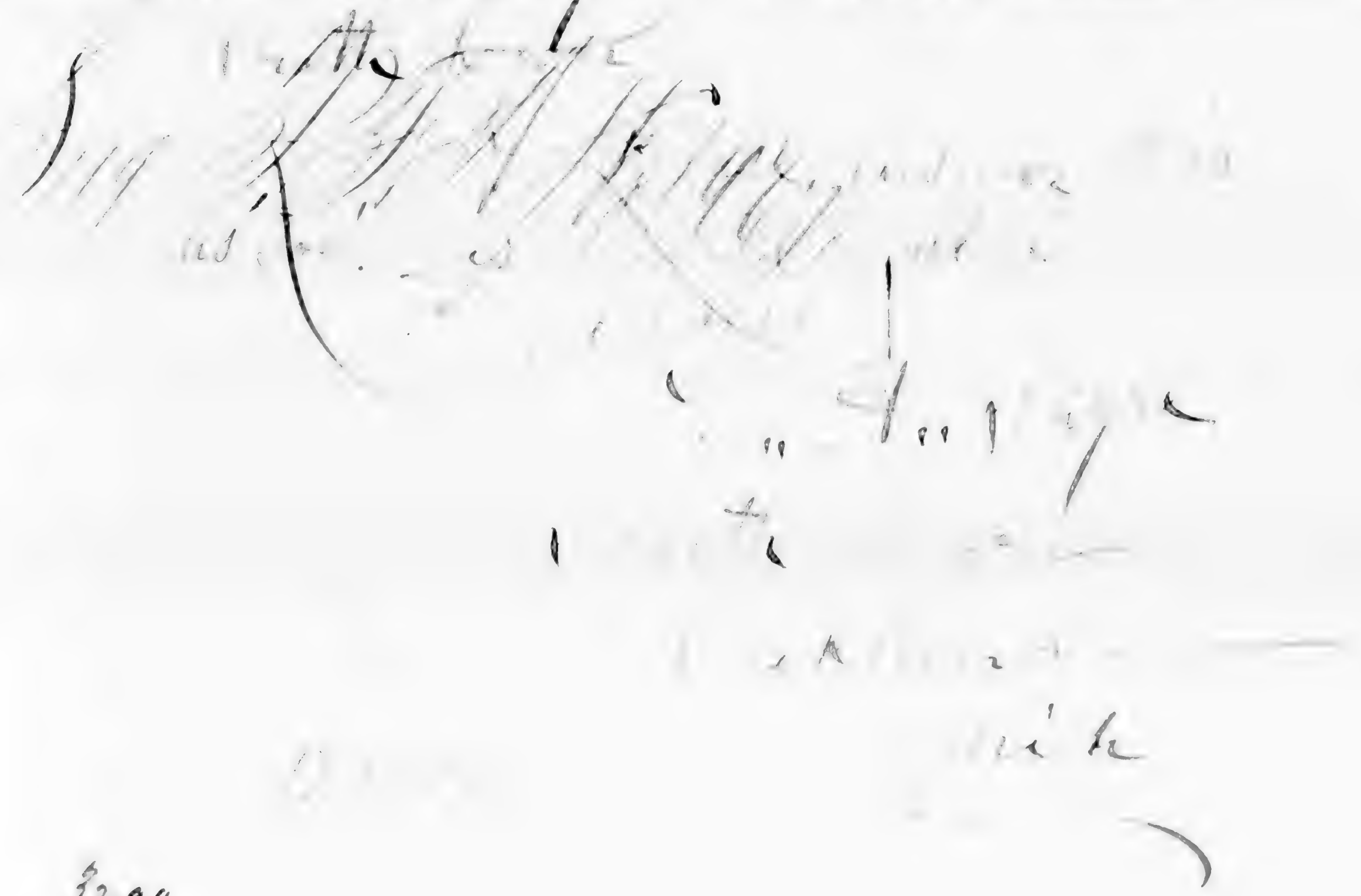

32911



W 53 (R. F. & A. L., Vol. 9,) 1867.

New Alexandria Penn. 420  
Vol 2, No 1052  
February 25<sup>th</sup>, 1867.

Mr. Bride - Henry

WR 155 OLS No 420

Repeats former re-  
quest for two colored  
servants.

WR 155 OLS No 420  
(3312) WRAPPER ..... (..... Enclosures.)

Received Bureau R. F. & A. L., Feb 28, 1867.

WR 155 OLS DC, 2-2-1867.

WAR DEPARTMENT,  
Bureau Refugees, Freedmen, and Abandoned Lands,  
WASHINGTON, March 1<sup>st</sup> 1867.

Respectfully referred to Brig. Genl.  
O. O. Howard, Act. Commissioner of District of  
Columbia, in connection with previous  
papers.

By order of  
Maj. Genl. O. O. Howard.

A. P. Ketchum  
Brig. Genl. Col. + a. a. a. Genl.

Bureau R. F. & A. L.

Head Quarters, District of Columbia  
Washington, March 2<sup>nd</sup> 1867  
Respectfully referred to  
Lt. Col. Wm. M. Beebe for  
Local Supt. D. C. for his  
attention

By order of  
Brig. Genl. O. O. Howard

Wm. M. Beebe  
Act. Supt.

2073  
WR 155 OLS DC

Mr. Bishop



M153 P. J. A. Vol 9 17

50.75  
185-187-188-189-190-191-192-193-194-195-196-197-198-199-200

3312

92

Dear Genl. Howard,

Sir

I wrote

to the Prussian Bureau Office  
Washington some time ago, to secure  
some Prussians, and rec'd a reply  
of which the following is a copy, and  
as they have not arrived, we rec'd  
nothing concerning them, I thought  
perhaps you mistook my letter,  
I do not know what usage Prussians  
consume, but say I will give the  
man \$20. a year, and the woman  
\$15. a year, including  
boarding and washing, and will  
increase their wages, if they prove to  
be good, trusty and capable,  
I want paper yellow ones, & red  
Black ones, as I think they are more  
naturally intelligent, and readily  
at taking up anything, and especially



Mr Garrison, I would treat them  
kindly, they shall be well cared for,  
I am the Freedman's friend.

The Country is healthy, we agree,  
my family is small, it consists of  
myself & wife two boys & one girl grown  
up. If they are truly, industrious  
and worthy I will keep them as long  
as they want to stay, I want the  
man to work on the farm, and  
the woman to do General house  
work, and particularly I want her  
to be a good cook, or if not just  
one that ~~will~~ is capable, and willing  
to be taught, would think she  
should be from 18 to 20 years of age.  
I would have them sent to Fallsburg  
Indiana County Penna, which  
is five miles from my house, and  
if you can not inform me what  
day to meet them there, send  
them to William McHarris Sr,  
and he will take charge of them,

I have written to Henry  
John Lovell, to call at  
this office, perhaps he can give  
you some further information  
as to what I wish them to be,  
Yours Respectfully  
Henry McNeill

Geo. W. Buchanan  
Westmoreland Co  
Penn  
Feb 25<sup>th</sup> 1867

Ms. A. 1. 1. 155. C. 1. 1. 710, 421.

Washington. March 9<sup>th</sup> 1867.

Reverend W. H. H.

A. A. A. York

I state that information  
has been received from the  
Anti-Slavery Society of  
London, that several colored  
people have made arrangements  
with colored people in Baltimore  
and perhaps elsewhere, and  
sought to get out and have  
applied for transportation.  
I wish that the U. S. Consuls  
should be notified of the applications for  
transportation, & forward news  
for persons outside this City.

W. H. H. 1867



Bureau Refugees, Freedmen and Abandoned Lands,  
Headquarters Ass't Commissioner, District Columbia,

Washington, March 27<sup>th</sup>, 1867.

Colonel:

The information has reached the Asst  
Comm that parties engaged in buying  
warranted articles in this District were  
convinced to see me by parties in Baltimore,  
and perhaps elsewhere and are bringing  
colored people from there to this District,  
making contracts with them before an officer  
of this Bureau and applying for transpor-  
tation for them to various points.

The Asst Commissioner deems that  
you are carefully scrutinizing all applications  
for transportation and forwarding same for  
action as that has been obtained outside  
your jurisdiction.

Very respectfully,

Your Obedt Servt

W. H. Rogers  
Asst. Comm.

W. H. Rogers Jr  
Local Asst D. C.  
Washington D. C.



B 31 (R. F. & A. L., Vol. 9,) 1867.

Vol. 2, 1867, C.F.B. D.C. 1867  
Rochester N. Y. 4/24

February 26, 1867.

Bloss - J. O.

W.B. 156, O.L.S. 719, 4/24

Has acted as Agent under  
Mrs J. D. Griffing, and be-  
lieves that 1000 freed people  
could find remunerative  
employment in and near  
Rochester.

For

Rec'd H.C. 3/2/1867  
WRAPPER ..... (..... Enclosures.)  
3313

Received Bureau R. F. & A. L., Feb 28, 1867.

Rec'd O.L.S. D.C. 3-4-1867

WAR DEPARTMENT,

Bureau Refugees, Freedmen, and Abandoned Lands,

WASHINGTON, March 1st 1867.

Respectfully referred to Bvt. Brig. Genl.  
C. H. Howard, Asst. Commissioner of  
District of Columbia, for his information  
and action.

By order of

Maj. Genl. O. C. Howard,

A. P. Ketchum

Bvt. Lieut. Col. + a. a. a. Genl.

Bureau Refugees, Freedmen & Abandoned Lands

HEAD QUARTERS ASSISTANT COMMISSIONER, D. C.,

Washington, March 4<sup>th</sup> 1867.

Respectfully referred to Lieut.  
Col. W. M. Beebe Jr.  
Local Supt. D. C.

By order of Bvt. Brig. Gen. HOWARD,

J. H. Rogers  
A. A. A. General.



NARRATIVE

Rochester Feb 26/67

Genl O. O. Howard

Dear Sir

I have acted  
here in the capacity of  
agt of the ~~Board~~ Freedmen  
Refugees Assoc to pro-  
cure situations and  
places for them to  
live and labour.

I have sent a number  
of orders to Mrs J S Griffing  
she has forwarded over  
to me eight persons who  
are all in good situations  
you'll please.

The people are so well  
satisfied with them that  
the neighbors are all  
wanting to get them for  
domestics and farm hands  
I am called on daily to



proceeds Fund mine, made  
of female for them from  
Washington.

Mrs Griffing has a  
day or more orders for  
new women & children  
to be sent on to fill plac-  
es that are kept open for  
them. I cannot hear  
from her. I rec<sup>d</sup>  
some two weeks since a  
letter signed I presume off-  
icially by Mr Clark  
saying that "No women  
persons would be sent  
to me under Mr Williams  
regulations" Now we of  
the North can nothing for  
Mr Williams regulations  
on anybody's regulations.  
Nor how we get them if  
we only get them. We  
want their service and



and are prepared to pay  
them well for it and pro-  
vide them a living, and  
a condition of living such  
as they have never known  
or that of far comfort

They are starving  
naked & destitute. and are  
in herds of thousands  
living on Gov<sup>t</sup> rations -  
ridle them and benevolent  
persons are writing and besu-  
ching us ~~of~~ the North to send  
food and clothing for them  
to keep them from perishing

We want a thousand  
Men, Women, and Children  
in this City that can labour  
Now we want to know  
whether you will send  
them to us - to us -  
on a prison with them -  
so that these ~~can~~ get

those few laborers -  
we want those laborers  
we want to hire those  
Can we get them  
even by examining after  
them.

I wish to know for  
the benefit of those  
who have applied and  
are waiting - to know  
the result of their appli-  
-cation

Yours obt serv  
R. J. [unclear] [unclear]  
[unclear] [unclear] [unclear]

3313 [unclear]



WB 170 157, O.L.S. 1428

Washington, Feb 23<sup>rd</sup> 1867

Genl. Miss J. E.  
Emp. Agt.

Requests to be furnished  
with 1 Ton of Coal & 1 Cord  
of wood for use of Emp.  
Office 394, North Capitol St.

Rec'd O.L.S. Dec 2-23-1867

Employment Office 394 North Cap, St.  
Washington Feb, 23, 187

Sent Col. Fr. M. Beebe jr.

Local Supt. D.C. Bureau Ref. &c

I would respectfully  
submit that no wood or coal remains from the  
last supply of fuel for this Office

I would therefore  
respectfully ask that a cord of wood and a ton  
of coal may be furnished for the Employment  
Office when these fires are necessarily required.

Very Respectfully

Your Obedt. Servt

A. C. Siffing

Emp. Off.



Vol 2 No 1085 A.C.D.G. 1867

430

Providence R.I.  
March 1<sup>st</sup> 1867

Stewart H. G.  
Employment Agt

Requests that twenty  
eight freed people be  
sent him, by 14<sup>th</sup> inst  
states that he will want  
families soon, and requests  
to know who he shall address  
in future

W. 17d 155, No 1136,

Recd A.C.D.G. March 4 1867

Bureau of A. S.  
And 2<sup>nd</sup> A.C.D.G.  
Washington March 5 1867.

Respectfully referred  
to Lieut Col W. M.  
Baker Jr. Local Supt.  
who will procure  
the laborers within  
required as soon  
as possible and  
send them to

Providence

By order  
Bob Bingham Howard

McClatchy  
a. a. a. quit.

E. O. Vol. 3. No. 279. A.C.D.G. 1867.

2118  
A.C.D.G.



Providence Nov 15<sup>th</sup> 1869

Post By Gen C. N. Howard -  
Asst Com. B. R. I. & A. S.

Sir

Please send me  
the following classes of freed people  
so that they shall reach Providence  
March 14<sup>th</sup>.

- 8 Farm Hands. 3/4
  - 2 Man & Wife without children 3/10
  - 8 Men to work in Brick Yard. 3/20
  - 2 To take care Home & Garden 2/10
  - 6 Single Girls from 18 to 30 years old.
- 
- 28 86602

Shall we not have families too.  
To whom shall I address orders  
in the future?

Very Respectfully

W. G. Stewart  
Asst. B. R. I. & A. S.



Providence Nov 15<sup>th</sup> 1869

Post By Gen C. N. Howard -  
Asst Com. B. R. I. & A. S.

Sir

Please send me  
the following classes of freed people  
so that they shall reach Providence  
March 14<sup>th</sup>.

8 Farm Hands. 3/4

2 Men & Wife without children. 3/4

8 Men to work in Brick Yard. 3/4

2 To take care Home & Garden. 3/4

6 Single Girls from 18 to 30 years old.

28

86 1/2

Shall we not have families too.  
To whom shall I address orders  
in the future?

Very Respectfully

W. G. Stewart

Asst. B. R. I. & A. S.

Providence R.I.  
March 30 1867

---

Stewart, J. G.

Request that Farm hands  
with some servants be sent  
to him.

---



Prudence R. I. March 30<sup>th</sup> 1867

Col. Beebe  
W. G.

Please fo-  
ward to me at your earliest  
convenience.

- 15. Farm Hands.
- 5. Single Women.
- 2. Men & Wives without children.
- 2. Men & Wives with 2 or 3 children

I have the honor to be  
Respectfully

W. G. Stevens  
Sgt. B. R. F. & A  
for Rhode Island

Providence R.I.

March 1<sup>st</sup> 1864

Stewart & F. G.

Employment 198.

Furnish information regarding

names of persons who are employed in

the above named



Providence R.I. March 11<sup>th</sup> 1867.

W. M. Beebe Jr.  
Lt Col. Local Supr D.C.

Sr.

Your communication of  
March 6<sup>th</sup> to Capt Clark has been forwarded  
to me, with orders "in favor of you" of the prob-  
able amount of wages that will be paid for  
different classes of laborers forwarded to me.

The wages paid for Farm hands will be  
\$12 for the first month - after that from  
\$12. to 18 according to their ability & Rations.

For lumber yard, coal yard men & dock  
hands from \$16 to 24 dollars per month  
& Rations. For Brick yard men & house-  
servants from 12 to 18 dollars per month  
& Rations. For female servants from  
Six to twelve dollars per month ac-  
cording to their ability & rations.

I am very respectfully yours

H. G. Stewart

By B. R. Fox for R. Island



433  
No. 24 (R. F. & A. L., Vol. 1, No. 24,) 1867.

Saratoga Springs, N.Y.

February 27th, 1867.

Robles, - Hamilton

W. C. Rogers

Requests to be furnished  
with 2 colored servants, &c.

M 120159 W<sup>n</sup> 433

Rec'd O. L. S. D. C. 3-6-1867

WRAPPER ..... (..... 1/3 Enclosures.)

Received Bureau R. F. & A. L., March 1st, 1867.

WAR DEPARTMENT,

Bureau Refugees, Freedmen, and Abandoned Lands,

WASHINGTON, March 5, 1867.

Respectfully referred to Brig. Genl. C. H. Howard, Assistant Commissioner D. C.

By order of  
Major General Howard,

A. P. Ketchum

Brig. Genl. A. A. G.

Bureau R. F. & A. L.  
Head Quarters, Com. D. C.  
Washington, March 5, 1867.  
Respectfully referred to Lieut. Col. W. M. Beebe, Jr. Local Supt. D. C.

By Order of  
Brig. Genl. Howard  
A. A. Rogers  
A. A. G.



1847

Hamilton

Rev. Mr. A. S. 1847

1847

U

1847





434

Ms. A. 9. 2. 7. 56. 113

C. S. A. L. Vol 9  
Blooming grove N. Y.

March 1. 1867

Owen - S. R.

Requests to be furnished  
with colored farm servants.

Ms. A. 9. 2. 7. 56. 113

3259

Ms. A. 9. 2. 7. 56. 113

Ms. A. 9. 2. 7. 56. 113

War Department  
Bureau of Freedmen  
Washington March 11 1867

Respectfully referred to Bvt. Brig  
Gen. C. A. Howard Sect Comm. for D. C.

By order of  
Major Gen. C. A. Howard  
A. P. Ketchum  
Acty Sect Adjt. General

Bureau Refugees, Freedmen & Abandoned Lands

HEAD QUARTERS ASSISTANT COMMISSIONER, D. C.,

Washington March 5 1867

Respectfully referred to Lt. Col.  
W. M. Beebe, Local Supt.,  
D. C.

By order of Bvt. Brig. Gen. HOWARD.

A. A. Rogers  
A. A. General.

434

message 172276. 1867

C. J. A. L. Vol 9  
Blooming grove N.Y.

March 1. 1867

Owen - S.R.

Requests to be furnished  
with colored farm servants.

701 W 159. No 434.

3259

Rec. O.L.S. D.C. 3-6-67

Rec. O.L.S. D.C. 3-4-67

War Department  
Bureau of Freed A.L.  
Washington March 4<sup>th</sup> 1867

Respectfully referred to Bvt. Brig  
Gen. C. A. Howard Sect Comm. for D. C.

By order of  
Major Genl C. C. Howard  
A. P. Ketchum  
Acty Sect Ady. General.

Bureau Refugees, Freedmen & Abandoned Lands

HEAD QUARTERS ASSISTANT COMMISSIONER, D. C.,

Washington March 5<sup>th</sup> 1867.

Respectfully referred to Lt. Col.  
W. M. Beebe, Local Supt.,  
D. C.

By order of Bvt. Brig. Gen. HOWARD.

A. A. General.



1864

1864

1864

1864

Faint handwritten text, possibly a list or account, with several lines of illegible script.

Second section of faint handwritten text, appearing as a separate entry or paragraph.

Third section of faint handwritten text, continuing the list or account.

1864

1864

A 30 (R. F. & A. L., Vol. 9,) 1867.

Vol. 2, No. 1082 A.C. 56 1587

Alexander H. J.

435  
February 27, 1867.

Will James C.

Wishes to have a colored  
boy sent to him

W. M. 159, No. 435

12013  
12014  
12015  
12016  
12017  
12018  
12019  
12020

Rec'd O. L. S. D. C. 3-6-1867

WRAPPER ..... (..... Enclosures.)

Rec'd O. L. S. D. C. 3-6-1867  
Received Bureau R. F. & A. L., ..... 1867.

WAR DEPARTMENT,

Bureau Refugees, Freedmen, and Abandoned Lands,

WASHINGTON, March 4 1867.

Respectfully referred to Bvt  
Brig. Gen. M. Howard, Asst Com  
District of Columbia  
By order of  
Major General Howard.

A. P. Ketchum

As General

Bureau Refugees, Freedmen & Abandoned Lands

HEAD QUARTERS ASSISTANT COMMISSIONER, D. C.,

Washington, March 5<sup>th</sup> 1867.

Respectfully referred to Lt. Col.  
W. M. Beebe, Local Supt.  
D. C.

By order of Bvt. Brig. Gen. HOWARD.

J. M. Rogers  
A. A. A. General.



Alexander Seneca Co., N.Y.  
Feb. 27<sup>th</sup>, 1867

Gen. Howard;

Sir,

I learn through the Tribune that there are numbers of Freedmen who have neither homes nor employment. If you will send me a colored lad 17 or 18 years of age, of temperate and industrious habits and good disposition, I will pay him eighty four dollars the first year (board & washing included), to work on my farm. If he proves faithful and trustworthy I will increase his wages after the first year in proportion to his improvement, and capacity for performing farm labor. If he

over

A30 R. J. A. L. Vol 967

5019  
120-38807

3574



does not prove trustworthy I will  
 not bind myself to keep him  
 at any price, In your conclusion  
 if you think the school boys  
 under your charge please send  
 him as soon as convenient  
 and oblige

Yours to report  
 Wm. C. Hull

If you require reference as to my  
 responsibility & standing in society  
 I will refer you to Hon. Abel  
 Brown, Hon. Warren Stodgett  
 and Hon. C. G. Whittier through  
 Hon. Paul Burdett who is well  
 acquainted with the parties named  
 W. C. H.



437

Wm. L. A. L. 104. 1047

Canaan Conn.,

March 4. 1867

No. 1112 (40. D.C. 1867

Cummings - R. C.

Requests to be furnished with colored servants.

WM 166. O. L. S. 20. 437

War Department,

Bureau of Refugees, Freedmen &

Washington March 5. 67

Respectfully referred to Bot Brig. Genl

C. N. Howard, Asst Commr D. C.

By order of

Major General Howard,

A. P. Ketchum

Bot Lieut Col., A. A. A. G.



Canaan March 11<sup>th</sup> 67

Fredman's Bureau

Dear Sir

Yours

I want

two freedmen one from 18 to 25 years old, & one from 16 to 20 years old & one freed woman about 18, those that we want to have a good share of in their talent, I want them to go on to a farm & they will have good places where they can stay for a year, if they like I will like, I was an officer in the 11<sup>th</sup> Conn Vol & I brought home with me one freedman & he lives, his doing well, he has been to New York, there



quarters, & the beams well  
I seem to receive that we  
is so well situated

If you wish to receive  
about me I will refer  
you to Hon. Genl. Sherman

Very respectfully  
Yours  
R. W. Sherman  
General  
Carr

Bureau R. F. & A. G.  
Head Quarters, Army, D. C.  
Washington, March 5, 1867.

Respectfully referred to Lt.  
Col. W. M. Beebe, Local Supt.  
D. C.

By Order of  
Bt. Brig. Genl. Howard  
*[Signature]*  
A. A. A. Genl

*[Faint circular stamp]*

Rec'd O. L. S. D. C. 3-6-1867



Canaan, Conn.  
March 19 1867.

Cummings, R. C.

Desires to employ two  
Men (or Man & Boy) and one  
Woman —

Canaan, Conn. 19<sup>th</sup> / 67  
Dear Sir

I have your letter of the 14<sup>th</sup> inst. and  
in regard to the amount of wages to be  
paid per month I will say  
I would like two young men  
say from 16 to 20 years old,  
I expect to pay them from  
\$10.00 per month to \$15.00 per  
month, just according as they  
are for usefulness, I bought  
a boy from Suffolk Va. the fall  
of 1866 the boy was 12 years  
old & last season we paid  
him \$10.00 per month, I want  
to pay him \$12.00 per month  
this season, he goes to school  
winter, I want the woman

In House work I would like  
to have an age from 15 to  
20 years of age. To say  
that from \$4.00 for months to  
\$6.00 for months just as we  
will be worth.

These persons come have  
an opportunity to go to  
school during the winter  
if they wish to. The first  
of April is the time we will  
commence our business for  
the season. Therefore I  
hope to hear from you  
by that time or before.

Very Respectfully  
Yours  
P. C. Cummings



Bureau Refugees, Freedmen & Abandoned Lands

HEAD QUARTERS ASSISTANT COMMISSIONER, D. C.

Washington, March 5th 1867.

Respectfully referred to Lt. Col.  
W. M. Beebe Jr. Local Supt.  
D.C.

By order of Bvt. Brig. Gen. HOWARD.

*John Rogers*  
A. A. General.

*4107 R. I. of L. Vol 96  
Chester Pa March 1st 67*

*Penn. Iron Works.*

*Archbold, Pa.*

*433*

*Wants a colored boy of from 16 to 18 years of age  
to assist in general house work; to whom  
a good home & fair remuneration will be given*

*W. M. Beebe Jr. Local Supt.*

*War Department.*

*Bureau of Refugees, Freedmen and A. Lands.*

*Washington March 2nd 1867.*

*Respectfully referred to Bvt. Brig. General,  
C. H. Howard, Asst. Commissioner, District of  
Columbia*

*By order of*

*Major Genl. C. C. Howard.*

*A. P. Kerlin*

*Bvt. Lieut. Col. a. a. a. a. a.*

*2000  
No. 36 1867*

Thomas Reaney,  
Wm. B. Reaney,  
Samuel Archbold,  
P. S. Rambo.

PENNSYLVANIA IRON WORKS,

ON THE  
DELAWARE RIVER,  
AND ON THE LINE OF THE PHILADELPHIA AND BALTIMORE  
RAILROAD, 14 MILES BELOW PHILADELPHIA.

**REANEY, SON & ARCHBOLD,**  
ENGINEERS AND IRON SHIP BUILDERS.

Chester, Pa. March 1<sup>st</sup> 1867

Major General Howard  
Chief of <sup>the</sup> Ordnance Bureau  
Washington

Sir

I am in want of the services  
of a Colored boy, of from 16 to 18 years of  
age, duties required, to attend to a  
horse and cow and assist in house  
work, to one properly qualified I  
will furnish a good home and  
proper remuneration, and will feel  
obliged if you can forward me one  
at once

Very respectfully  
Saml Archbold



Paul Paul Wick,  
Major, 20th Regt. Col. 1867

M<sup>rs</sup> Entwistle S. B.

Wishes to be informed  
if Colored Laborers  
are sent to any place  
required, by the Govt.  
Asks that a servant  
be sent to him.

1161 1/2 St. N. W. Wash. D. C.

3352

Recd. such as by

War Department,  
Bureau of R. & A. S.  
Washington, March 2, 1867.  
Respectfully referred to the Asst. Comd.  
District of Columbia.  
By order of  
Maj. Genl. Howard.  
**A. P. Kerburn**  
Bt. Lt. Col. & a. a. Genl.

Bureau Refugees, Freedmen & Abandoned Lands  
HEAD QUARTERS ASSISTANT COMMISSIONER, D. C.,  
March 5<sup>th</sup> 1867.  
Respectfully referred to Lt. Col.  
W. M. Beebe, Local Supt.,  
D. C.

I have replied - enquiring  
quit. of wages. Await ans.  
WMB

By order of Bvt. Brig. Gen. HOWARD,  
**Wm. Rogers**  
A. A. General.

NARA 639  
Paw Paw Feb 26<sup>th</sup> /67

Gen. Howard

Sir noticing an advertise-  
ment in the New York Tribune,  
Headed Colored Labores, and that  
they were under your direction I  
take the liberty to ask if the  
Government sends them where they  
are wanted if so I would like to  
have a good farm hand sent me  
A good strong able boddyed man  
a bout twenty five years of age

Direct Lawton VanBuren Co  
Mich

Post Office Paw Paw

Mich

Respectfully yours

J. C. McEntee

Gen. Howard }



Paw Paw  
Van Buren Co.  
Mich.  
March 14 1867.

McEntee, S. C.

Replies to letter of Col Beebe.  
States that he will give a  
farm hand (Col<sup>d</sup>) from \$6 to \$10.  
the first year and from \$10 to  
\$15 the second year.

Paw Paw March 14<sup>th</sup> 1867

Col. Beebe

Sir yours of March 7<sup>th</sup> is  
received in which you request  
me to state the wages that such  
a man as I spoke of would  
receive. They get from six to ten  
Dollars pr month the first year  
& from ten to fifteen the next  
according to their work, there  
is but few of them in this sex  
- was there would be more if people  
knew how to get them White labours  
get from fifteen to twenty Dollars  
for the season that is six or eight  
months of the year. ~~But~~  
Wonder stand me if you send  
me a hand I want a good trusty  
one & a good worker & I will pay  
him accordingly. As there is  
no Rail Road to Paw Paw he will

leave the cars at Lawton that  
is three miles from my place  
& if he will enquire at the  
Express Office for S. C. McIntee  
he will receive the necessary  
- Directions

Very Resp<sup>ly</sup> &c

S. C. McIntee

Paw Paw

Van Buren Co  
Mich

Please inform when sent



Bureau Refugees, Freedmen & Abandoned Lands

HEAD QUARTERS ASSISTANT COMMISSIONER, D. C.,

Washington, March 5<sup>th</sup> 1867.

Respectfully referred to Lt. Col.

W. M. Beebe Jr. Local

Supt. D.C.

By order of Bvt. Brig. Gen. HOWARD.

*[Signature]*

A. A. General.

I should be well  
an effort to in  
families into  
make an effort  
employment. I  
now in my fam  
female I think  
would soon at  
to colored people.  
large number con  
ratio employment

New  
By  
I w  
good  
with  
new  
able.  
A w Ho

City  
1867  
Chas S.  
S. No 440,  
(female)  
Says he  
duce cold  
Village of  
is, and  
ryment  
munity  
over their  
d people  
ember could  
t but they  
introduced  
3-6-1867

*[Faint handwritten notes]*

Leave the cars at Lawton that  
is three miles from my place  
& if he will enquire at the  
Express Office for S. C. Minter  
he will receive the necessary ~~and~~

Directions

Very Resp<sup>ly</sup> &c

S. C. Minter

Paw Paw

Waubesaun Co  
Mich

Please inform when sent



Bureau Refugees, Freedmen & Abandoned Lands

HEAD QUARTERS ASSISTANT COMMISSIONER, D. C.,

Washington, March 5<sup>th</sup> 1867.

Respectfully referred to S. Col.

W. M. Beebe Jr. Local

Supt. D.C.

By order of Bvt. Brig. Gen. HOWARD.

*[Signature]*  
A. A. General.

200  
100-0910

New York  
July 27 1867

By suggestion of Mrs  
I write to say that  
a good house servant  
with a child female  
now old, would not  
be able. My business is  
a Woolen Factory, and  
I should be willing to make  
an effort to introduce colored  
families into our Village, and  
make an effort to find them  
employment. I have a colored  
man in my family & having a  
female I think our Community  
would soon get over their  
prejudice to colored people, and quite a  
large number could find remun-  
erative employment. But they will

New York City  
February 27<sup>th</sup> 1867

Whitehouse Cha S.

M. M. 161. C. L. S. No. 440

Desires a good (female)  
house servant, Says he  
is willing to introduce cold  
families in the Village of  
New Hampshire, and  
find them employment  
thinks the community  
would soon get over their  
prejudice to cold people  
and quite a number could  
find employment but they  
will have to be introduced  
gradually

Recd at D.C.



New York City  
February 27<sup>th</sup> 1867

Whitehouse Cha S.

M/M 161. Q.L.S. 219440

Desires a good (female) house servant, Says he is willing to introduce cold families in the Village of New Hampshire, and find them employment thinks the community would soon get over their prejudice to cold people and quite a number could find employment but they will have to be introduced gradually

Recd at D.C. 2/27/67

New York  
July 27<sup>th</sup> 1867

Gen Howard

By suggestion of Mrs Tilman. I write to say that I want a good house servant and one with a child female 10 to 12 years old, would not be objectionable. My business is manager of a Rodin Factory, and I should be willing to make an effort to introduce colored families into our Village, and make an effort to find them employment. I have a colored man in my family & having a female I think our Community would soon get over their prejudice to colored people, and quite a large number could find remunerative employment. But they will

150-899



have to be introduced gradually -

I can refer to Genl Gilman  
Marston - Hon E A Rollins Mc  
+ Hon C A Rollins Comptroller  
of Internal Revenue or Hon C  
Candler Asst Secy of Treasury  
all of whom are personal  
friends of mine -

Very Respectfully  
Yours

Chas. M. Nichols  
of New Hamp.  
Genie Craft Co -

~~Washington D.C. 20540~~

Annapolis, Md. 441

March 4<sup>th</sup> 1867

Husbands,

Wm. A. H.

Wm. A. H. C. 20540

Dear Sir, when the first  
company of freedmen arrived  
to get, well started, <sup>and</sup> that a woman  
about 12 or 14 yrs. <sup>and</sup> a girl about  
10 or 12 yrs. be sent with this company

From the ...

Remains R. F. & A. S.

Head Quarters A. S. C.

March 6. 1867

Respectfully referred  
to Lt Col Beebe, who  
will answer this  
letter at once, and  
arrange for the  
people to go with the  
first lot.

Yours truly  
Wm. A. H. C. 20540  
Wm. A. H. C. 20540

20540 3-10-67



8  
10  
12  
14  
16  
18  
20  
22  
24  
26  
28  
30

32  
34  
36  
38  
40  
42  
44  
46  
48  
50

52  
54  
56  
58  
60  
62  
64  
66  
68  
70

72  
74  
76  
78  
80  
82  
84  
86  
88  
90

92  
94  
96  
98  
100  
102  
104  
106  
108  
110

112  
114  
116  
118  
120  
122  
124  
126  
128  
130

132  
134  
136  
138  
140  
142  
144  
146  
148  
150

Washington. March 7<sup>th</sup> 1867.

Townsend, E. G.  
Supt.

States that a Col<sup>d</sup> Boy  
by the name of Harold  
Keathman, aged 18 or 20 yrs  
living in his Camp. Sub-  
ject to spasms in one  
of them he fell in the fire  
became badly scalded & disfig-  
ured about the face, & that  
he is unable to support him-  
self.

Recommends that he  
be sent to Freedman's Village  
or somewhere, as the Dept. may  
deem expedient

Office Local Supt. D.C.  
Washington. March 9<sup>th</sup> 1867.

Respectfully forwarded  
recommending that the  
within named person  
be sent to Freedman's Village

Wm. S. L. L.

S. Col. 128<sup>th</sup> Regt.  
Local Supt. D.C.

Asst. Commr., D.C.  
WASHINGTON, MAR 11 1867

Respectfully returned to  
Col Beale who will send  
this person to Freedman's  
Village to be cared for.

By order of  
Arch. B. Jew Howard  
H. Rogers  
a.s.g.



2A  
Crandall Green Martha  
67

Col<sup>d</sup> Wm Rogers  
Col<sup>d</sup>

I have the honor to state  
there is in this camp, a young man, 18 or 20 yrs of  
age, subject to spasms. In one of these, some years  
since, he fell into the fire, & became badly burned  
& disfigured about the face. He is incompetent to  
take care of himself, or labor for support. He  
has no father, & his mother is in extreme poverty  
with several small children, wholly unable to  
provide for him. Doct Howard sent him to  
Freedmans Hospital, but he was discharge-  
d some time since & I have rendered the  
family such assistance as I could.

The name is Darwin Heathman, the  
mother Maria Dayton, & as it is a permanent case  
of decrepitude and almost blindness I would  
respectfully request that provision be made for  
him at Freedmans Village, or else where it  
may be thought most expedient by the Com<sup>d</sup>

Very respectfully  
Your Obedt Servt  
E G Townsend

Sho Local Supt }  
Col Wm M Beebe }

Supt

W. J. W. 164, O. L. S. 449,  
Stillwater, N. Y. Feb 6<sup>th</sup> 1867.

Wm. E. W.

Desires information  
about obtaining colored  
laborers.

W. J. W. 164, O. L. S. 449, 1867.



Albany N.Y. March 6. 1867

J. V. W. Vandenberg Esq

Dip.

Washington

Some information with regard to  
obtaining "freedmen" for labourers  
this Spring I have thought best to  
write you for that purpose.

Will you inform me at your  
earliest convenience what are the  
chances for obtaining good &  
reliable hands to come into this  
region to do farm labor. Quite  
a number are desirous of trying  
the experiment if they could be  
assured that they might be depen-  
-ded upon when here.

I wish to know on what terms  
they can be obtained, either male  
or female, good steady hands

that are inclined to work. — also  
 — Boys of about 15 years, or girls  
 that are old enough to help do  
 the work in a small family  
 or older ones (females) that are  
 able to do housework generally, such  
 as is required by farmers, &  
 much else  
 Yours etc.

E. A. Hart

West Hill, N. York



Ms. A. 9. 2. 164. C. 2. 8. 450

Washington. March 1867

Clark S. M.

A. A. S. Genl.

States that the Genl.  
desires to be informed how  
soon the people can be  
for rounded in Mr. Ste-  
cut of Providence

Received by 5-9-1867

NARA 654  
Bureau Refugees, Freedmen and Abandoned Lands,  
Headquarters Ass't Commissioner, District Columbia,

Washington, March 5, 1867.

Colonel:

The Ass't Com<sup>r</sup> desires to be informed how soon the people can be procured for Mr Stewart of Providence, as he may be able to take charge of them on the journey.

He desires to be informed at once, and that the people be procured as early as practicable.

Respectfully

McClain

a. a. General.

Lieut Col Wm. B. Duke Jr

Soc. Supt. D. C.



200 1100 1600 457 111

711 1100 1600 457 111  
Mar 8, 67

Mr Brokaw  
desires (2) good  
colored female  
house servants  
for general  
housework in  
small families.  
Mr Brokaw's  
address is New  
Brunswick N.J.  
No 57 Baird St.  
near Court House  
M. Clark  
advt.

ED 1100 191 025 110 457 111  
Chief-Quarters Asst. Commr., D.C.  
WASHINGTON, MAR 9 1867

Respectfully referred to  
Lieut Col Beebe Social  
Supp S.C. who will corres-  
pond with Mr Brokaw  
and give his report if  
possible.

By order of

Brig Genl C. Howard  
A. Rogers  
advt.

...

120-8  
...

3-8-1 111

711 1100 1600 457 111

Quartermaster General's Office,

Washington, D. C. Mar 8<sup>th</sup> 1867

Brig Gen. Charles H. Howard  
Freedman's Bureau  
General

Allow me to  
introduce to you the bearer Mr  
G. C. Forkan of New Jersey.

Please attend to him what aid  
and information he requires & oblige

Very respectfully  
Yours &c  
C. H. Howard

Brig Gen. G. M. S.



NARA 657  
Quartermaster General's Office,

Washington, D. C.

Mar 8<sup>th</sup> 1867

Bot Brig Gen. Chas. H. Howard  
Freedmans Bureau  
General

Allow me to  
introduce to you the bearer Mr  
G. C. Hooker of New Jersey.

Please attend to him what aid  
and information he requires & oblige

Very respectfully

Yours &c



Bot Brig Gen. G. M. B.

NARA 658  
Quartermaster General's Office,

Washington, D. C. Mar 8<sup>th</sup> 1867

Bot Brig Gen. Chas. H. Howard  
Friedman's Bureau  
General

Allow me to  
introduce to you the bearer Mr  
G. G. Forkan of New Jersey.

Please attend to him what aid  
and information he requires & oblige

Very respectfully

J. Young & Co



Bot Brig Gen. G. M. D



*B. B.* (R. F. & A. L., Vol. *9*,) 1867.

*Vol. 2, C. G. 100 - 101, G. 106, 107*  
Middletown N. Y.

March 5<sup>th</sup>, 1867.

Willie S. Messing

111 17th St. O. L. S. No. 400

Desires information regard  
ing furnishing servants

WAR DEPARTMENT,  
Bureau Refugees, Freedmen, and Abandoned Lands,

WASHINGTON, *March 7* 1867.

Respectfully referred to *But.*  
*Brig Genl. N. Howard Asst.*  
*Comr. S. C.*

By order of  
*Major General Howard*

*A. P. Ketchum*

*Asst. General*

*By order of Major General Howard*  
*Asst. Comr. S. C.*

INSTRUCTIONS *Mar. 7 1867*

Respectfully referred to  
*Secy. Genl. Duke Social*  
*Supt S. C.*

By order of *Brig Genl. Howard*  
*F. J. Rogers*  
*Asst. Genl.*

5427

WRAPPER ..... (..... Enclosures.)

Received Bureau R. F. & A. L. *Mar. 22*, 1867.

*O. L. S. No. 37-110*





Middletown, N. Y. Mar. 5, 1867.

To the officer in charge  
of Freedmen etc.

Will you be kind  
enough to send me all the information  
necessary to understand the kind of  
help you can furnish - the terms  
on which it can be had, the expense  
of getting it to New York city and  
how that will have to be met?

This place is about 70 miles from  
N. Y. city via Erie R. R. My friends  
and I want servants to do general  
housework. An early answer will  
much oblige yours most truly  
A. H. Bull

712 17th 165 C. S. 1. 11 24 23

St. Johns, Feb 14 1867.

Williamson Fred.

Forwards Draft for \$10.00  
to be paid to John Parker  
Cash

Receipt received.

W. S. C. S. No. 2-18 1867



St Johns Feb 14<sup>th</sup> 1867

Wm Beebe

Dear Sir

Please find  
enclosed ten Dollars for John  
Parker (Colonel) I was away  
from home some time as I shall  
have attended to it before. In  
receipt of this John is there please  
let me know the balance shall  
follow soon

Yours truly  
Fred Wilkins

212, 52, 11, 143, 15, 26, 1867

Washington D. C.  
February 26<sup>th</sup> 1867  
454

Stewart Edridge,  
Art. Maj and A. M. S. N.  
711 1/2 St. ...  
Indishes partial list  
of medical stores in  
his possession.

J. R. F and A. L.

Adj Dir Asst Comr D. C.  
Feb 28<sup>th</sup> 1867

Respectfully referred to  
St Col. M. H. Beebe Jr Local  
Dupt D. C. who will forward  
an application for such  
articles mentioned on the  
within list as may be  
required for use and issue  
in this District

By order of Brig Genl C. H. Howard

H. P. Rogers  
A. C. S.

8. 2. 20. 21. 22. 23. 24. 25. 26. 27. 28. 29. 30. 31.

No. C. S. ...  
Recd at G. C. Feb 26<sup>th</sup> 1867



Office of the Medical Storekeeper  
D. V. Spangler, S.  
Washington D. C. Feb 26/67

Col. H. M. Rogers  
A. S. S.

Col:

Your note of yesterday, requesting list of medical stores wanted, was recd this morning. The Medical Purveyor having as yet furnished no invoices I can not give you a list of articles without quantities, promising however that the amounts are large

- |                         |                           |
|-------------------------|---------------------------|
| Blankets                | Bed sheets                |
| Wool Blankets           | Comfortables              |
| Crockery                | Chairs                    |
| Dresses                 | Working Mensils           |
| Linens & Towels         | Dressing Gowns            |
| Mosquito Nets           | Mattresses                |
| Pillows Cases and Ticks | Shirts (Towels & Handker) |
| Spreads (Bed)           | Shoals                    |
| Towels                  | Towels                    |
| Towels                  |                           |

Shirts.

Tables.

Washstands

This comprises all the main articles.  
I will transmit a copy of invoices when  
rec'd

I am, Col.

Very Respectfully,

(Signed)

Edward L. Adridge

W. Maj. U. S. A.

A. H. Rogers



Shirts.

Tables.

Washstands

This camp uses all the main articles.  
I will transmit a copy of invoices when  
rec'd

Dear Col.

Very Respectfully,

(Signed)

Stuart L. Adridge

Wt. Maj. U. S. A.

A. H. Rogers

711 1706 169. C. L. 2. 119 45. 2

Washington July 26<sup>th</sup> 1867,

Howard C. Ho.

Asst Comm<sup>r</sup> H.

Direct that if any  
Employment agent is dis-  
engaged that he assist  
Mr Brock of Miss. in  
procuring col<sup>rs</sup> help.

45021-102 20 207



Bureau Refugees, Freedmen, and Abandoned Lands,  
Headquarters Ass't Commissioner, District Columbia,

Washington, February 21<sup>st</sup> 1867.

St. Col. W<sup>m</sup> M. Buba,

Local Supt D.C.

Colonel

If any one of your employ-  
ment agents is disengaged sufficiently to  
assist Mr. Buck, of Mississippi, he thinks  
that he might procure his (25) work, fire  
hands, without hindrance to the other parties  
getting hands for Arkansas who were on  
the ground before him.

He makes no complaint your dealing  
in his case, but deprecates waiting here  
idly until all the rest are served. I  
would suggest that he employ several agents  
of his own and perhaps with your advice  
to the best place and method of operating he  
may obtain some hands without delay.

Respectfully

C. A. Howard

Prin. Gen. A.C.

Address me at this  
Office—

Portsmouth  
New Hampshire  
M. J. Perry

Ms. A. 9. 2. 78



By R. J. A. L.

William Lee 1770  
Office —  
Dial Monument  
Museum  
M. Lee

NARA 672  
Port Monmouth N.J.  
Mon 7-67

General Howard

Chief of " Freedmen Bureau "

Dear Sir,

Mr Elias

Marford one of the Deacons of the  
Church I desire wish to procure col-  
-red help - two men and one woman -  
the woman the wife of one of the men  
The men to serve as Field Hands on  
his Farm and the woman to help  
in his House when needed - But  
to live in a separate house near  
by on his Farm - Said house is now  
vacant, and ready for me -

Please inform me if you can send  
free help - and when, and how,  
whether their expenses for forwarding  
will need to be paid in advance or  
after they arrive - Mr Marford is a  
responsible man and will do well  
by the Freedmen - Please reply as soon  
as possible -

Yours most obedtly

H. D. Wilson  
Wash. Dist. Ct. N. M.



Port Tobacco, Md. Feb 19 1867

Benjamin S. Co.  
Genl. Capt. & Surg.  
No 100 100. 025 200 100

States that there are many  
persons in this Dist. owing  
and treatment of said laborers  
are unable to procure them when  
they are wanted, but have been  
unable to do so by the  
policy in Alexandria District

Recommend that no contracts  
be made with any in that  
Dist without being exam-  
ined by the Surg.

Bureau Refugees, Freedmen & Abandoned Lands

HEAD QUARTERS ASSISTANT COMMISSIONER, D. C.,

Washington February 25 1867

Respectfully referred to Lt. Col.  
W. M. Beebe, Local Supt.  
D. C. for his information.  
No contracts will be made  
for freedpeople to go to Counties  
in Maryland, except (orders  
from these Head Quarters)

By order of Bvt. Brig. Gen. HOWARD.

*Amos Rogers*  
A. A. A. General.

*W. M. Beebe*  
Local Supt. D. C.

100 100 100 100

WAR 674  
Bureau R. D and A. L.  
Office Supt. Charles Co. Md  
Port Tobacco Feby 19<sup>th</sup> 1867

Lieut Col. W. W. Rogers.  
A. A. S. G.

Colonel.

There are many persons in this District who, on account of their bad treatment of colored persons, are unable to obtain labor where they are known. These men have been enabled to secure the services of colored persons through the employment Offices, at Washington and Alexandria. I respectfully recommend that no contracts be executed for persons to come to this District, except to parties recommended by the Supt of this Bureau.

I am Colonel

Respectfully

Your obt. Servant

(Signed)

A. C. Brubaker

Port Capt & Supt



Bureau of Indian Affairs  
Headquarters, Wash. D.C.  
Washington, February 22, 1875.

Special

S.S.S.S.

M. W. 166. O. L. S. No. 408.

Washington. March 6<sup>th</sup> 1864.

Howard. C. H.

I Brig Genl. & A. C.

Directs that a requisition  
be made for cloth to make  
Three doz. pair pants for Boys  
from 10 to 15 years old, & to be  
put in the hands of Miss  
Keacock, who will make  
them up free of charge.

M. W. 166. O. L. S. No. 408.



Bureau Refugees, Freedmen, and Abandoned Lands,

Headquarters Ass't Commissioner, District Columbia,

Washington, March 6 1867.

St. Coly W. M. Beebe  
Local Supt D. C.

Dear

Please make requisition  
for cloth for three dozen suits  
of boys' clothing (from 10 to 15 years  
of age). When obtained arrange  
with Maj. Brown A. Q. M. to put  
it in the hands of Miss Hancock  
Capt & Co. East (Capt. Bonds,  
to be made up without charge  
and returned to yourself for  
issue - And retain it for such  
boys as shall be sent for by Miss  
Hancock to whom you will  
issue according to your regulation  
in all issues of clothing to the  
detachment.

R. D. This is not intended to take away  
your discretionary power - but a mere  
suggestion.



Bureau of Refugees, Freedmen, and Abandoned Lands,  
Headquarters Ass't Commissioner, District Columbia,

Washington, March 6 1867.

St. Louis Mo. Mr. Burke  
Dear Sir: D. C.

Dear

Dear Sir: I have received your letter

P. S. This is not intended to take away  
your discretionary power - and to meet a  
specific want as ~~represented~~ a ~~particular~~ ~~case~~  
The cost for these long coats  
of boys' clothing (from 10 to 15 years  
of age) I should estimate average  
about \$1.50 per c. 2. m. As put  
it is the kind of cloth I have  
sent you a ~~list~~ ~~of~~ ~~the~~ ~~goods~~  
I do make up without charge  
and returned to you for  
issue - and retain it for such  
boys as may be sent you by other  
branches to whom you will  
refer according to your reports  
in case of any ~~of~~ ~~the~~ ~~goods~~  
sent.



Ms. Vol 164, O. L. S. No. 457,  
Washington. Mar 4<sup>th</sup> 1867,

Expects. Merrill  
A. A. A. Good

States that Mr. M. J. Fitzg.  
has filed the necessary  
recommendations, at the  
D<sup>o</sup> A. C.

The A. C. directs  
that all necessary work  
be completed soon  
in procuring trip.

Ms. O. L. S. No. 3-11-1867.

Bureau Refugees, Freedmen and Abandoned Lands,

Headquarters Ass't Commissioner, District Columbia,

Washington, *March 4<sup>th</sup>* 1867.

*Dear Sir*

I have the honor to acknowledge the receipt of your letter of the 27th inst. in relation to the application of *Twenty Five* *...* for the purchase of land in the District of Columbia. The same has been referred to the proper authorities for their consideration.

I am, Sir, very respectfully,  
 Yours truly,  
 A. R. Ragsdale

*...*

16.





Bureau Refugees, Freedmen and Abandoned Lands,  
Headquarters Ass't Commissioner, District Columbia,

Washington, February 25<sup>th</sup> 1867

Lieut Col. William M. Beebe Junr  
Local Superintendent. D. C.  
Colonel.

The Assistant Commissioner directs  
that you forward to these Head Quarters, without delay, the  
report of the investigation directed to be made by Major  
Vanderburgh, by endorsement from these Head Quarters  
dated April 21<sup>st</sup> 1866 or communication of Smith Norris,  
relating to the Church at Over Hill, Prince George County,  
Maryland, with the original papers in the  
case,

Very Respectfully

Your obedient Servant

W. H. Rogers  
A. S. C.



45

Charles B. ...  
...

Bureau Refugees, Freedmen & Abandoned Lands

HEAD QUARTERS ASSISTANT COMMISSIONER, D. C.,

Washington, Ch. 9 1866.

Respectfully referred to ...  
Genl ...  
Secy ...

It is ...  
...

77170167025460

...

A. P. Ketchum

...

By order of Bvt. Brig. Gen. HOWARD.

*A. A. A. General*  
A. A. A. General.

...

Thomas Reaney,  
Wm. B. Reaney,  
Samuel Archbold,  
P. G. Rambo.

**PENNSYLVANIA IRON WORKS,**  
ON THE  
DELAWARE RIVER,

And on the line of the Philadelphia and Baltimore  
Railroad, 14 miles below Philadelphia.

**REANEY, SON & ARCHBOLD,**  
ENGINEERS AND IRON SHIP BUILDERS.

Chester, Pa. *March 4<sup>th</sup> 1867*

*Major General Howard*  
*Chief of Ordnance Bureau*  
*Washington*

*Sir*

*Having, written you last  
week in relation to a boy and  
receiving no answer, I have  
engaged one to day and  
consequently am fully  
supplied*

*Very respectfully*  
*Sam<sup>l</sup> Archbold*



Thomas Reaney,  
Wm. B. Reaney,  
Samuel Archbold,  
P. G. Rambo.

**PENNSYLVANIA IRON WORKS,**  
ON THE  
DELAWARE RIVER,

And on the line of the Philadelphia and Baltimore  
Railroad, 14 miles below Philadelphia.

**REANEY, SON & ARCHBOLD,**  
ENGINEERS AND IRON SHIP BUILDERS.

Chester, Pa. *March 4<sup>th</sup> 1867*

*Major General Howard*  
*Chief of Ordnance Bureau*  
*Washington*

*Sir*

*Having, written you last  
week in relation to a boy and  
receiving no answer, I have  
engaged one to day and  
consequently am fully  
supplied*

*Very respectfully*  
*Samuel Archbold*

462  
R. E. ... 1867.  
Fort Monmouth N.J.  
March 9th, 1867.

Wilson Geo W. Jr.  
Requests to be furnished  
with 2 males & 1 female (colored  
servants)

M. H. C. L. 17546

WRAPPED  
Mar 9  
C. C. L. B. - Co. 3-11-1867

WAR DEPARTMENT.

Bureau Refugees, Freedmen, and Abandoned Lands,  
WASHINGTON, March 9th 1867.

Reference is referred to Post Brig  
Genl G. H. Howard Asst Commr for D.C.

Major Genl O. C. Howard  
A. P. Ketchum  
Acty Asst Adjt General

Bureau Refugees, Freedmen, & Abandoned Lands,  
Head-Quarters Asst. Commr., D.C.,  
WASHINGTON, MAR 11 1867

Respectfully referred to. Lt.  
Col Beebe Local Subd DC

By order of  
Post Brig Genl O. C. Howard  
Thos. Rogers  
ad. g.



Washington, March 7. 1867

Washington) March 7. 1867  
415

Nichols, J. B.

Mr. [unclear] [unclear]

Encloses letter of John C.  
Horsbrock, of Rome, N. Y. in  
which he requested to be furnished  
with a colored servant.

Commissioner, Freedmen, & Abandoned Lands,  
Head-Quarters Asst. Commr., D.C.,  
WASHINGTON, MAR 9 1867

Respectfully referred to  
Supt Col Beebe Jacob  
Supt S.C. for answer  
and attention

By order of  
Bvt Brig Gen Howard  
A. H. Rogers  
a. a. a.

rec'd O. L. S. Dec 3-11-1867

Treasury Department,

Bureau of Statistics,

March 7<sup>th</sup>, 1867.

Bro. Alford

I send you  
the letter - I received last night  
from Bro. Holbrook please hand  
it to the proper - officer - to reply to it

Yours Respectfully  
T. B. Nichols



Wormer, N. H.  
 March 5 1849

Rev. D. B. Nichols

Dear Sir: I wrote you  
 some time since on a fortnight  
 ago requesting you to do  
 me the favour to enquire  
 & see if you could find  
 me a colored girl for  
 my family. We do not  
 care so much for her  
 knowledge as her char-  
 acter, & her all round  
 activity. She must be honest,  
 & we are out a great deal  
 & she would often be left  
 entirely alone in the house  
 for half or a whole day.  
 If some good old lady  
 could be found who un-  
 derstands work & is kind  
 & trusting we should like  
 her. We want one not



left them 17 or 18 years of age.

I could also find good places for a dozen or twenty good girls in the villages & among our farmers & perhaps a few more. This is a dairy region & much help is needed & we have many good farms. One told me the other day he would take a man & wife & furnish them a small house on his place.

"We want a plain woman & all such would be better, but if steady & honest they would do.

Perhaps by speaking to Gen. Howard or Mr. Howard you may help us & help some of the colored

people. We want our girl within 4 or 5 weeks, any time.

Excuse me for troubling you but I know your kindness of heart & desire to benefit the colored people. If a dozen, more or less, were to come here, it would open the way for many more.

With best regards,  
I am

Wm. D. T. T. T.  
Wm. C. T. T. T.

P.S. I write again fearing from misdirection or other cause my former letter was carried. What is your address?



thanks you to send this  
to Mr. Howard & ask his  
aid.

(R. F. & A. L., Vol. <sup>464</sup> ) 1867.

1137  
New City O. Hancock Co. Va

March 1st, 1867.

Thomas A. Ho  
of Petersburg Va.

States that when in Washington  
the Col. in charge informed him  
that he would send out 20 guardsmen  
to near Petersburg Va.

States that they will want them  
within two weeks - asks if they  
can get transportation at any time

M. 1701 108, C. L. S. W. 1867

WRAPPER ..... Enclosures.)

Received Bureau R. F. & A. L. <sup>March 4th</sup> 1867.

He O L. S. H. 3-11-1867

WAR DEPARTMENT,

Bureau Refugees, Freedmen, and Abandoned Lands,

WASHINGTON, <sup>March 6th</sup> 1867.

Respectfully referred to Brig  
Genl Howard Best Comm'r

Respectfully referred to  
Major Genl O. O. Howard  
A. P. Ketchum  
Acty Asst Adjt. General

Bureau R. F. & A. L.  
Head Quarters, Genl. D. C.  
Washington, March 8. 1867.

Respectfully referred to  
Lt. Col. W. M. Beebe, Jr.  
Local Supt. D. C.

By Order of  
Bt. Brig. Genl Howard  
J. P. Rogers  
W. W. Gen.



Orange & Alex<sup>a</sup> R.R.  
April 9<sup>th</sup> 1867.

Thomas, W.  
for W. Thomas & C.  
of Parkersburg W. Va.

Wants to employ fifty men  
to cut & split timber for staves  
Also wants 3 or 4 women to  
cook for the men —

Wages to men \$15 per Mo.  
" " women \$7 to \$8 " "

273  
162-4-10-67  
ag<sup>e</sup> 12-18-17

02-01-1964

Faint, illegible text spanning the top half of the page.

Main body of faint, illegible text covering the lower two-thirds of the page.



NO. 2 29

Orange & Ayley R.R.  
April 9<sup>th</sup> 1867.

Shouse, Jr.  
for W. Shouse & Co.  
of Parkersburg W. Va.

Wants to employ fifty men  
to cut & split timber for staves  
Also wants 3 or 4 horses to  
work for the men —

Wages to men \$15 per Mo.  
" " horse \$7.50 " "

Wm. Shouse  
101  
Parkersburg

Orange & Alley's R.R.  
April 9<sup>th</sup> 1867.

Shouse, W.  
for W. Shouse & Co.  
of Parkersburg W. Va.

Wants to supply fifty men  
to cut & split timber for slaves  
Also wants 3 or 4 women to  
cook for the men —  
Wages to men \$15 per Mo.  
" " women 975 \$8 " "

W. Shouse & Co.  
Parkersburg W. Va.  
April 9<sup>th</sup> 1867



John R. A. L. Holgate

20. 13.  
12. 8. 11/65

| Date       | Description     |
|------------|-----------------|
| 1968-01-01 | Initial deposit |
| 1968-01-15 | Withdrawal      |
| 1968-02-01 | Deposit         |
| 1968-02-15 | Withdrawal      |
| 1968-03-01 | Deposit         |
| 1968-03-15 | Withdrawal      |
| 1968-04-01 | Deposit         |
| 1968-04-15 | Withdrawal      |
| 1968-05-01 | Deposit         |
| 1968-05-15 | Withdrawal      |
| 1968-06-01 | Deposit         |
| 1968-06-15 | Withdrawal      |
| 1968-07-01 | Deposit         |
| 1968-07-15 | Withdrawal      |
| 1968-08-01 | Deposit         |
| 1968-08-15 | Withdrawal      |



449 (R. F. & A. L., Vol. 9) 1867.

Cuba N. Y.

July 3<sup>rd</sup>, 1867.

Chief of Bureau

Enclosure of the ...  
with the understanding that ...  
if she does not ...  
with her back to the Bureau.

716, 1711 105, C. L. S. 1145

5023

WRAPPER ..... Enclosures,  
Received Bureau R. F. & A. L. July 7, 1867.

WAR DEPARTMENT,  
Bureau Refugees, Freedmen, and Abandoned Lands,  
WASHINGTON, March 7, 1867.

Respectfully referred to ...  
of Columbia.

A. P. Ketchum

Bureau Refugees, Freedmen & Abandoned Lands  
HEAD QUARTERS ASSISTANT COMMISSIONER, D. C.,  
Washington, March 9, 1867.

Respectfully referred to ...  
Superintendent

By order of Bvt. Brig. Gen. HOWARD,  
A. A. A. General.

WASHINGTON, MAR 7

Respectfully referred to Lieut  
Colonel Rube who will  
please reply to this com-  
munication return the  
enclosed money (\$509) and  
inform Mr. Guilford that  
no charges are made for  
procuring freedpeople to  
go to homes provided  
for them in the north.

By order of  
Bvt. Brig. Gen. C. Howard  
A. A. A. General  
10 St. 115<sup>th</sup> July  
1867

1850

Office

transp-

union free

149 of P. A. L. City  
1867

2nd 2. 1867 1100 26. 1867

3478

66



*[Faint, illegible handwritten text, likely bleed-through from the reverse side of the page.]*

J. C. Adams Lamba N. 3  
New York  
C. B. Adams  
E. A. ...  
S. V. ...  
C. B. Adams

Vol 2. of 162015-75

Medina, N. Y. March 9/67.

466

Barnes, Geo. M.

Requests to be furnished with b. or s. colored men, to work on farms.

M. 1 Vol 168. O.S. No. 466

Adm. & Abandoned Lands  
Asst. Commr., D.C.  
WASHINGTON, MAR 11 1867

Respectfully referred to  
Lt. Col. Beule Ins.  
Local Supt. etc. for  
answer and attention  
By order of.

Chas Howard  
Thos Rogers  
a. a. y.

Answered.

File

Vol 2. of 162015-75

Medina N. Y. Mar 9th 1867

Ward's Brig. Gen. C. M. Howard  
Freedmen's Bureau  
Washington D. C.

The farmers in this vicinity wish six or eight colored men to labor on their farms. We understand that you are forwarding laborers North from time to time for that purpose. We wish to know if there are any on hand at present connected with the Bureau who could be sent to us without delay. We would give them a home good wages, and employment from year to year - if they are faithful, and both parties are suited. We would like those who are accustomed to the management of horses, and who understand farm work, or who are sufficiently over



tractable to readily learn it.

Will you have the goodness to  
write me by return mail, and  
let me know who pays their trans-  
portation &c. and any other  
matters necessary for us to know  
in this connection.

And also if you  
please whether it would be better  
to send a person ~~over~~ to Washing-  
ton to assist in the selection.

Very Respectfully,  
Yours

Geo. M. Edwards

Metalia Ordnance Co  
N.Y.

Box 377

unable to readily learn it.

Will you have the goodness to  
write me by return mail, and  
let me know who pays their trans-  
portation &c. and any other  
matters necessary for us to know  
in this connection.

Perhaps also if you  
please whether it would be better  
to send a person ~~soon~~ to Washington  
to assist in the selection.

Very Respectfully,  
Yours

Geo. M. Barnes

Centralia Orleans Co

N.Y.

Box 377



M 120169, C. G. S. 469,  
Washington, March 1<sup>st</sup> 1864

Wittlesson, Lewis, M.  
Bot. Div. "Gen."  
C. G. M. B. R. 1864

States that referring to  
account 2 M. L. L. &  
C. G. & G. E. D. M. Dept.  
for Feb. 1864 that with  
final copy should be for-  
warded without delay.

Ms. A. 9. 2. 1. 1. 1.

War Department.  
BUREAU REFUGEES, FREEDMEN, AND ABANDONED LANDS,  
OFFICE CHIEF QUARTERMASTER,

Washington, D.C., March 6<sup>th</sup> 1867.

Dear Sir,  
I have the honor to acknowledge the receipt of your letter of the 28<sup>th</sup> ult. in relation to the matter mentioned therein.

The Bureau has no objection to your proposed method of proceeding, and you are requested to proceed without delay in the manner suggested. It is requested that you will keep the Bureau advised of the progress of the work, and that you will forward to the Bureau a copy of the report when completed.

I am, Sir, very respectfully,  
Your obedient servant,

Henry Mitchell



M 170. O. L. S. No. 470

Washington. Feb 19<sup>th</sup> 1869.

Rogers. W<sup>m</sup> W

A. A. A. Genl.

States that the com-  
pensation of W. C. Wright  
is fixed at \$600 per month.  
Date from 1<sup>st</sup> Feb. 1869.

MS. A. 9. 2. 7. 17

Bureau Refugees, Freedmen, and Abandoned Lands.

Headquarters Ass't Commissioner, District Columbia,

Washington, February 19<sup>th</sup> 1867.

Special Orders,  
No 24

(EXTRACT.)

1. The compensation of M. V. Wright  
Employment Agent is hereby fixed at sixty  
dollars \$60<sup>00</sup> per month to take effect February 1<sup>st</sup>  
1867

By order of Brevet Brigadier-Gen. C. H. HOWARD.

Official

*[Handwritten signature]*

(S)

*Wm. N. Rogers*

A.A. Adj.-General.



M 170170. O. G. S. 20<sup>o</sup> 471  
Washington. Feb 28<sup>th</sup> 1867,

Revere. Wm. W.

A. A. H. Genl.

States that applications  
made for Stores can be  
issued the same as other  
supplies when acquainted  
with the parties,

Opines that if Mr C. B.  
Ramsdell recommends  
parties that supplies be  
issued -

W. C. S. 20<sup>o</sup> 471

Memoranda.

Colonel Beebe.

The Asst Comm.  
directs me to say, that Application  
made for stores can be  
issued the same as other  
supplies when you are  
acquainted with the parties  
making the application

Should Mr C. B. Ramsdell  
send any parties to you  
for supplies you can  
furnish them.

Very Respectfully  
H. Rogers

am. y.

H. Mac G.  
July 28. 1864.



Washington, D.C.

Washington, D.C.

March 11<sup>th</sup> 1867

Columbia Dist of

John Kimball

Supt of Schools

Washington, D.C.

States that no reports in

compliance with Circular No

of the 2<sup>d</sup> of Sept Comm. D.C.

of the 15<sup>th</sup> 1866 have not been re-

ceived from the Dist of Col.

Request that necessary meas-

ures be taken to have them for-

warded

Washington, D.C.

Head-Quarter Asst. Commr., D.C.

WASHINGTON, MAR 13 1867

Respectfully referred to.

Lieut Colonel Beebe

Local Supt D.C. and

Compliance with par:

1. Circular no 9. S. 1866.

from these Head Quarter.

directed.

By order of,

Brig Gen Whittetey.

*[Signature]*

*[Signature]*

BUREAU REFUGEES, FREEDMEN, AND ABANDONED LANDS.

Headquarters Ass't Commissioner, District Columbia,

Washington, March 11<sup>th</sup>, 1867.

Col. W. W. Rogers:

A. A. A. General.

Sir:

I have the honor to inform you that no reports have been received in this office from the District of Columbia, such as are called for by Par. 2<sup>d</sup> of Circular No. 9 dated Oct. 12<sup>th</sup> 1866, requiring that "a report be made on the 30<sup>th</sup> of November 1866, by all officers and agents of the Bureau &c."

I respectfully ask that necessary steps be taken to insure the forwarding of said reports

Very Respectfully

Your Obedient Servant,

John Kimball

Lieut. Marriage.



L. R. Vol. 2 No. 11 A. C. D. C., 1867.

Washington D.C.

March 9<sup>th</sup> 1867.

Frisco, D.C.

M 171 (L.S. 171)

(Wrapper ..... One ..... enclosure)

States, that Mr. R. Wood Esq.  
of New Lebanon, Columbia  
County, N.Y. desires to have  
2 boys sent to him, aged from  
15 to 20 years.

Bureau Refugees, Freedmen, & Abandoned Lands

Head-Quarters Asst. Commr., D.C.,

WASHINGTON, March 12<sup>th</sup> 1867.

Respectfully referred to  
Lieut Col Beale Supt  
Supt D.C.

By order of

Brig Gen Whittelsey.

*[Signature]*  
A. A. G.

Received A. C. D. C. 5/11 1867.

Washington D.C.  
March 9. 1867

Prisistal D.C.

Mr. W. Wood.

Requests that two Boys ag<sup>d</sup>  
15 to 20 yrs. be sent to Mr.  
W. Wood of New Lebanon Colum-  
bia Co. N.Y.

Washington March 9/67

Gen. C. M. Howard

Sir

Application  
is hereby made for two Boys  
from 15 to 20 years of age  
to be sent to W. R. Wood Esq.  
of New Lebanon Columbia  
County N.Y.

The nearest R. R. Station  
to his residence is Canaan  
on the Boston & Albany R. R.  
30 miles from the latter place

Mr. Bennett will take  
charge of the boys.

Please select good active  
healthy boys suitable to



Advised on a ~~few~~ <sup>few</sup>

Mr. Conner will, <sup>will</sup> be ready in  
a week or ten days & will  
call on you a day or two  
before he leaves

The ~~most~~ most direct route  
from New York is by Madison  
R.R. to Chattanooga & from  
Chattanooga to Birmingham by  
the B & A R.R.

Respectfully Yours  
B. G. Bristol

494  
S 145 H. F. H. L. T. 1867

Westfield, N.Y. March 8<sup>th</sup> 67.

Treasury Department  
Smith, Austin.

Desires to procure a neat & cleanly Colored woman for house-keeper & Cook, to whom he would give a permanent home and the same pay as to a white woman. Would like to have her on or before the 1<sup>st</sup> April; and if necessary, her fare will be paid in advance.

Wm. H. C. L. 1867

Rec'd C. L. S. to 3-12-67

War Department  
Bureau of Refuges, Freedmen & A. S.  
Washington, March 11<sup>th</sup> 1867.

Respectfully referred to Brig. Genl. C. H. Howard, Act. Commissioner of District of Columbia.

By order of  
Maj. Genl. C. H. Howard.

A. P. Ketchum  
Lt. Col. & A. A. Genl.

at the Office of the Surgeon, in Adjutant's Office  
and-Quarters: Asst. Commr., D.C.,  
WASHINGTON, MAR 12 1867

Respectfully referred to Lieut. Colonel Beule Local Supt.  
for action

By order of  
Brig. Genl. Geo. Whittetery  
J. H. Rogers  
1<sup>st</sup> Lt. 45<sup>th</sup> Infy  
a. a. g.



TREASURY DEPARTMENT.

(Westfield) March 8<sup>th</sup>  
N.Y. }

1867

Gen. C. Howard

Comr. of Freedmen's Bureau,

Sir,

I desire to procure a  
colored woman for a Mrs. Repe Hook

My family consists of myself & wife and one  
daughter 16 years old. If I can get one who  
is competent & faithful, it would give me a  
permanent home, as pay her the same wages  
that we pay a white woman, and I'll assure you  
that she shall be well treated.

I would refer you to Hon. H. C. Wiley, Com. Sec. of  
the Treasury, or Hon. H. C. Cannon of House of Reps.  
Hon. Ira H. Harris of the Senate, or Hon. S. C. Sumner 34, 4<sup>th</sup>  
St. I would be glad to have you send me such  
a woman. I will pay for you if necessary. in

advance

Of course we should begin that it should  
be made as clearly in the matter of form, as  
could possibly be in a church matter.

If you can send me back a document  
I would be glad to have the same as soon as  
possible. I have been for several years  
partly absent from home, as have not kept house,

and in fact a number of my letters have been in  
the post office, as I have been to home my house  
keeping here in a better than time.

The route will be to Baltimore then to  
Philadelphia, then to Erie Pa. and thence  
by the Lake Shore R.R. to Detroit, N. Y.,  
or from Baltimore to Chicago, thence by the  
Old-Fish Lake R.R. to Detroit, or thence  
by the Lake Shore R.R. to Detroit, N. Y.

An Early answer will oblige me,

Very respectfully,  
Yours,

Justin Smith



Conway Mass.  
March 4<sup>th</sup> 1867

Swan, Samuel  
Cashier Conway Natl Bank.

States that four families  
at Conway, desire each  
a female house servant.

M/M/1/1, C. L. N. 1/15,

Rec'd C. L. N. 3-14-67

Conway Massachusetts  
March 4 1867

Dear Sir

I am referred to you by  
Mr. E. A. Jewell of Springfield Mass.  
to whom I applied for colored help,  
but who was not able to procure any,  
his appointment having been revoked.

There are four families  
here at present (and will be many more)  
who want good colored girls to do  
general housework, those preferred  
who are not field hands, but have  
been brought up around the house.  
Also one village butcher wants a  
likely boy from 12 to 15 years old, to  
bring up in his business. The places  
are all good ones & the servants  
will be kindly & liberally treated.  
Can you inform me as to the  
method of obtaining such, how

long it takes, how much it costs  
&c. An early reply will  
greatly oblige

Yours Very Resp  
Saml Swan

Cashier Conway tra Bank  
Conway Mass.

St. Louis H. Mr. Beebe  
Washington  
D. C.



2/22  
East 1 Steamfield N.Y.

March 6th, 1867.

Adams - My son

In answer to the  
possibility of procuring  
colored uniforms for

W.M.C. C. L. S. 1867.

WRAPPED

Rec'd C. L. S. No. 3-13-1867.

WAR DEPARTMENT,

Bureau Refugees, Freedmen, and Abandoned Lands,

WASHINGTON, March 11th 1867.

Respectfully referred to Post Surg  
Genl G. H. Howard - Asst Commr. D.C.

By order of Major Genl O. O. Howard

A. P. Ketchum

Acty Asst Surg. Genl

Asst. Commr., D.C.

Asst. Commr., D.C.

PTON, MAR 12 1867

Respectfully referred to  
Supt Col Beale Dr.  
Socul Supt D.C.

By order of  
Post Surg Genl Whittlesey.

Answered ✓  
M.B.

Wm Rogers  
Asst. Surg.

U.S.

Cast Bloomfield Mar. 6<sup>th</sup> 1867

Gen. Howard

Dear Sir There are many people in this vicinity inquiring for colored laborers, and a few have been procured from Washington. The great trouble is in their being so much delay in receiving the help sent for. I began to write for laborers last Aug. to Mrs. D. Griffith Washington but have not yet recd. the help sent for. The few that have come on here are liked very well and are doing well. People are inquiring daily can you get me a colored girl?

I think if the Freedman Bureau had an agent here, good homes and fair wages could be obtained for a great many colored families. I think they would be treated kindly, fed plentifully, be furnished dwellings, and supplied



1889 733

and to pay good wages after  
having learned our method of  
work, and the quick steps which  
yankers enterprise inspires.

Can you not suggest some method  
by which laborers can be procured  
in 10 or 20 days after application is  
made?

Hoping to hear from you soon  
I remain

Very Respectfully  
A. J. [unclear] [unclear]  
Myron Adams

East Blenheim Cal. 2 N. Y.

and to pay good wages after  
having learned our method of  
work, and the quick steps which  
Yankee enterprise inspires.

Can you not suggest some method  
by which laborers can be procured  
in 10 or 20 days after application is  
made?

Hoping to hear from you soon  
I remain

Very Respectfully  
Yours  
Myron Adams

East Blenheim Cal. 63 N. Y.



1867

Rockaway N.Y. 430

March 11, 1867.

Jones - Geo N.

Requests to be furnished  
with a colored paper for  
envelopes

1161 11173, O.S. 116150

REC'D 3-14-1867

WRAPPED (Enclosures)

Rec'd 16 + 6 5/10  
R. W. & A. L. 1867.

WAR DEPARTMENT,

Bureau Refugees, Freedmen, and Abandoned Lands,

WASHINGTON, Mar 12. 1867.

Respectfully referred to  
the Assistant Commissioner  
for the District of Columbia.

Major General Howard,

Headquarters  
Chief Clerk, U.S.A.

Freedmen, & Abandoned Lands  
Head-Quarters Asst. Commr., D.C.,  
WASHINGTON, MAR 13 1867

Respectfully referred to  
Supt Genl Beale, Local  
Supt D.C.

By order of

Bot Bry Genl E. Whittier

H. Rogers  
C. A. G.

Rockaway N.J. March 11<sup>th</sup> 67  
Maj Gen. O. O. Howard

Dear Sir

I would like to get a boy to attend to my horses and drive for me when occasion requires. The boys who have been with me for the past two years soon become acquainted with other boys white, in the neighborhood and think more of play than work. I have ~~thought~~ that a colored boy would be different - I ~~was~~ have been used to the colored people of the South, having lived in the South and of a slave holding family, but never approved of the system of Slavery - I think I can do well by a likely boy, and understand how to make him attached to me. I am a clergyman of the Methodist



E. Church, but now engaged in the  
practice of Medicine. My wife is  
willing also to do all she can  
for such a boy. I would like to have  
one about 15 or 16 years old.

Please ans. as soon as convenient  
and oblige

Yours Maternally

Geo. F. Jones

I'd like more important than age - a boy  
12 years old if he is large will ans. my pur-  
pose;

with the best of  
the country

S. 148 R. P. A. L. Vol 9 1867

Washington D.C. 454  
March 13 1867

Vol. 2 1865 F. S. & Co.

Soldiers Home  
Fort Paris  
Secretary of Board of Commissioners

Acknowledges the receipt of a recommendation for the admission of James Conway, a refugee discharged soldier, to the Home, and states that the matter will be submitted to the Board at their next meeting.

A. J. [Signature]

The Department  
Bureau of Refugee Provisions  
Washington Mar 14 '67

Respectfully referred to Lt. Col. W. M. Beebe, Local Supt., (through Ad. Gen. Asst. Comm. D.C.)

By order of  
Major General O. C. Howard,

F. D. Sewall

A. A. A.

Washington, D.C.  
March 14 1867

Respectfully transmitted

By order of

Det. Brig. Genl. V. H. Halsey

[Signature]  
A. A. A. General

2-10-67



Office of the Board of Commissioners of the Soldiers' Home,  
ROOM No. 13 WINDER'S BUILDING,

Washington, D. C., March 12, 1867.

Major General O. O. Howard,  
U. S. Army,  
Commissioner R. F. & S. L.  
Washington, D. C.

General:

I have the honor to acknowledge the receipt, (by reference from the Adjutant-General's Office), of the letter forwarded with your recommendation for the admission of James Conroy, a refugee and discharged soldier of the U. S. Army, to the benefits of the Soldiers' Home, and to say, that I will submit the same to the Board of Commissioners, at a meeting to be held on the 21<sup>st</sup> instant.

I have the honor to be,  
General,

Very Respectfully,  
Your obt. Servt.

Levi Davis.

Sec. to the Bd. of Comm.

W. H. C. S. Mass,

68 S. 2nd St. Vol 9, 1867.

Washington Tenn.

March 11, 1867

Urbine - Boyd.

... how people in his neighbor  
hood can obtain colored servants

War Department  
Bureau of Refugee Instruments  
Washington Mar 11, 1867

Respectfully referred to  
Brig. Genl. C. H. Howard Asst.  
Comm. Dist. Col.

In order of  
Major General C. H. Howard,

F. D. Sewall

A. A. S.

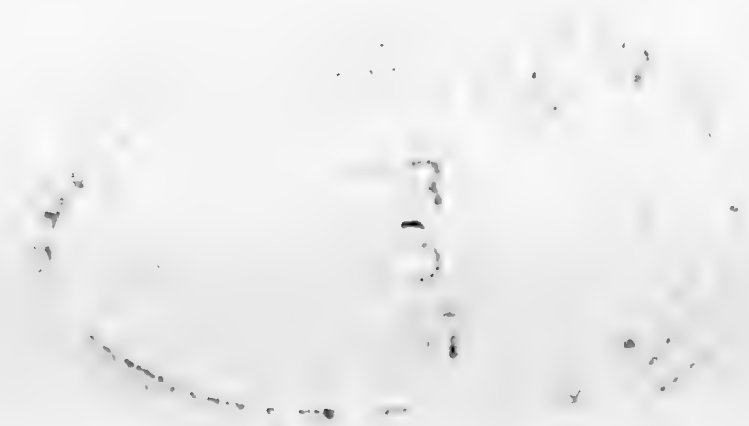

W. H. C. S. Mass, 3rd 1867

... & Abandonment

... Asst. Comm., D.C.

... 1867

Respectfully referred to  
Brig. Genl. W. M. Brooks  
Asst. Sup. G. C.

In order of

Brig. Genl. Whittier

A. A. S.

A. A. S.



BOYD CRUMRINE,  
ATTORNEY AT LAW,

WASHINGTON, PA.  
Office—Opposite the Court House.

Washington, Penn'a.,

To Mar 11 1867

Commissioner of Freedmen's Bureau  
Washington, D. C.

Sir, Frequent appli-  
cations are made to me for information as  
to the manner of obtaining freedmen for  
labor here. You would confer a great  
favor upon a community needy of la-  
borers by sending information upon this  
point.

Very Respectfully  
Boyd Crumrine

Both farm laborers and  
house servants are very  
scarce.



Ms. A. 9. 2. 6. 5. 6. 1867  
Queenstown Md. 406  
March 12<sup>th</sup> 1867

De Courcy - Dr. Wm Henry  
G. A. S. A. L. 9. 107

Wishes to know upon what terms  
as to wages and allowances, how  
labors can be procured through the  
Bureau. - Wishes to employ four  
or five good hands.

Ms. A. 9. 2. 6. 5. 6. 1867

Wm. H. Bureau D. C. & Co.  
Washington March 14<sup>th</sup> 1867

Respectfully referred to the  
Asst. Commr. for Dist. of Columbia  
by order of Maj. Genl. C. C. Hinckley

F. O. Powell

U. S. A. General

Ms. A. 9. 2. 6. 5. 6. 1867

Washington, D. C. 14<sup>th</sup> 1867

Respectfully referred to Lieut  
Col. Wm. Beck for Local Super

D. C.  
By order of  
Brig. Genl. Wm. H. C. Lee  
Wm. H. C. Lee  
Acting Genl.

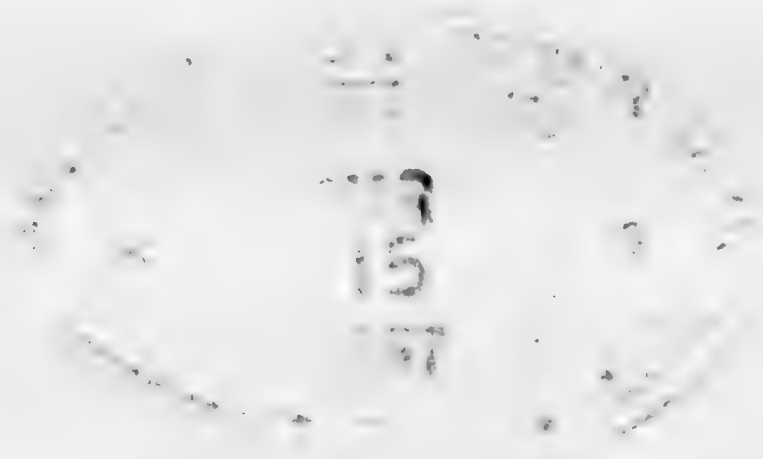

Queenstown  
Queen Ann's Co. Md.  
March 12<sup>th</sup> 1867

Superintendent of  
Freedom's Bureau  
Washington D. C.

I wish respectfully  
to inquire, whether on  
application, Farm labor-  
ers can be readily  
obtained, and at  
what rate of wages  
per month or year?



Accommodations  
could be provided  
for families if the  
expense of maintenance  
and would be al-  
lowed in the contract.

I want four or five  
good farm laborers,  
and if the prospect  
of obtaining them  
is good would  
apply personally

at your office.  
Any information  
given on the subject  
will be appreciated.  
Respectfully  
Address

Dr. Wm. H. DeLooney  
Quincy, Iowa

Ms. A. C. S. J. D. C. W. 1188

Washington. March 15<sup>th</sup> 1867.

Rogers W. W.

A. A. A. Genl.

States that Judge Stephen  
Mason of Newburyport,  
Mass. will furnish homes  
for freed women & girls as  
domestic servants.

and directs a correspondence  
with Judge Mason on  
the subject

Correspondence opened  
March 19<sup>th</sup> 1867

Ms. A. C. S. J. - 1188 - 10 - 1867



Bureau Refugees, Freedmen, and Abandoned Lands.

Headquarters Ass't Commissioner, District Columbia,

Washington, March 15<sup>th</sup>, 1867.

Dear Col. H. M. ...

I have ...

I have ...

I have ...

The ... the ... that ... Judge ...

Yours ...

A. S. ...

M 120 176. O. L. S. W. 49.

Washington. Feb 26 "1864.

Clark S. W.

A. A. G.

Gives information to  
J. O. Blos. of Rochester, N.Y.  
relative to procuring cold  
servants.

States that Col. W.  
M. Beebe, Jr. Local Supt.  
D.C. has the control of Em-  
ployment & Transportation



Bureau Refugees, Freedmen, and Abandoned Lands,  
Headquarters Ass't Commissioner, District Columbia.

Washington, February 21<sup>st</sup> 1867.

J. O. Blyss, Esq  
Rochester, N.Y.

Sir

Your letter to Major General O. O. Howard, asking  
on what conditions freed people will be sent North by the Bureau  
has been referred to me for reply. Before a person starts, the Officer  
sending him must know the name and address of his employer.  
If persons wishing to employ twelve (12) or more freed people, in the  
same town or city, make application together, the servants will be sent  
them, if procured, with an agent in charge. The transportation is  
furnished by the Government. No agent of this Bureau is authorized to  
charge a fee for servants furnished and no employer is expected to  
deduct any incidental expenses he may incur in getting colored  
servants through this Bureau from their wages. As it is found to render  
them discontented and less efficient and so less valuable to employers.  
Lieut Col Wm M Beebe Local Sup' in this City is the proper person to apply  
to for servants and he has direct control of their employment and transportation.

Respectfully  
(Signed) J. M. Clark

A. A. G.

11  
J. M. Clark

1867



NARA 738  
Bureau Refugees, Freedmen, and Abandoned Lands,

Headquarters Ass't Commissioner, District Columbia,

Washington, February 21<sup>st</sup> 1867.

J. O. Bloys, Esq  
Rochester, N.Y.

Sir

Your letter to Major General O. O. Howard, asking on what conditions freed people will be sent North by this Bureau has been referred to me for reply. Before a person starts, the Officer sending him must know the name and address of his employer. If persons wishing to employ twelve (12) or more freed people, in the same town or city, make application together, the servants will be sent them, if procured, with an agent in charge. The transportation is furnished by the Government. No agent of this Bureau is authorized to charge a fee for servants furnished and no employer is expected to deduct any incidental expenses he may incur in getting colored servants through this Bureau from their wages. As it is found to render them discontented and less efficient and so less valuable to employers. Lieut Col Wm M Beebe Local Sup' in this City is the proper person to apply to for servants and he has direct control of their employment and transportation.

Respectfully  
(Signed) J. H. Clark

A. A. S.

12  
11  
H. H. Rogers  
1867



NO 739

S 153 (R. F. & A. L., Vol. 7) 1867.

Akron, Ohio 491

March 12th, 1867.

Sherman - U.S.

Asks how he can get released from labor.

M. M. M. C. 11th

WRAPPER ..... Enclosures.)

Post Paid Bureau R. F. & A. L. 1867.

Recd L. S. C. 310 1867

WAR DEPARTMENT,

Bureau Refugees, Freedmen, and Abandoned Lands,

WASHINGTON, March 15 1867.

Respectfully referred to the Assistant Commissioner L. C.

By order of Major General Howard,

F. D. Sewall

Act. Asst. Adjt. Genl.

Refugees, Freedmen, & Abandoned Lands

Dept. of War

Respectfully referred to Lieut Col Beule Local Sect D.C. for reply

By order of

Brig Gen E. Muttusen

H. H. Rogers

187 (R. F. & A. L., Vol. 7) 1867.

Akron, Ohio

March 12th, 1867.

Sherman - U.S.

Asks how he can get released from labor.

M. W. G. C. 111.

WRAPPER ..... (..... Enclosures.)

Received Bureau R. F. & A. L., ..... 1867.

R. F. & A. L. C. 316-1867.

WAR DEPARTMENT,

Bureau Refugees, Freedmen, and Abandoned Lands,

WASHINGTON, March 15 1867.

Respectfully referred to the Assistant Commissioner I. C.

By order of Major General Howard,

F. D. Russell

Act. Asst. Adjt. Gen.

Refugees, Freedmen, and Abandoned Lands,

WASHINGTON, D. C.

Respectfully referred to Lieut Col Beule Local Supt D.C. for reply.

By order of

Brig Gen E. M. Stanton,

Adj. Gen.



Alfred Mook 12/18/19

Dear Sir

some 3000

... a ... in the ...  
I believe a ...

... you ...  
to ...  
... planning ...

... such might find  
work in this station without  
doubt ...

What terms do you engage  
them I do not cease to them to be  
as good help as can be had  
labourers but if they should prove  
good next season would you mind  
better wages, how would they  
come, through government Expe-  
-nce to be paid back out of  
them wages; or how simple  
person would be best from  
18 to 40 years of age would  
likely be more steady, from 25 to 40

please inform me by return of  
mail I would enclose stamp  
but suppose U.S.A. paid expenses  
A.S. Sherman

P.S. Direct A.S. Sherman  
A.R. von

~~What~~  
What wages } Summit Co  
are usual } Ohio

The Post Office  
is not open



please inform me by return of  
mail I would enclose stamps  
but suppose U.S.A. paid expenses

A.S. Sherman

P.S. Direct A.S. Sherman

A.R. Kim

~~What~~

What wages }  
are usual }

Summit Co  
Ohio

*[Faint, illegible handwriting]*

493

*J. R. [unclear]*

Post Weymouth Wf  
March 13. 1867

Wilson - Rec W. C. x

Requests to be furnished  
with colored farm servants  
W. C. 177. O. S. W. 413

*[Faint handwritten notes and signatures]*  
F. D. [unclear]

United States, Freedmen, & Abandoned Land  
Head-Quarters, Army Department, D.C.

1867

Respectfully referred to Lieut  
Col Beale Local Supt  
D.C. In reply.

By order

Brig Gen E. Whittier

*[Signature]*  
J. Rogers

W. C. 177. O. S. W. 413



Port Monmouth n. j.  
Nov 13/64

Committee of Distribution  
of Freedmen Laborers,  
Gentlemen;

For want of a  
letter or the true name I have ventured  
thus to address you -

Some little time  
since I wrote to Gen. Arnold, but  
have received no reply. Perhaps I did  
not send it to the right source -  
At any rate, I will try again -  
A neighbor of mine and Deacon of  
the Church I serve Wm. Colored help.  
Two men (field hands) one woman, to  
be the wife of one of the men - one  
to help occasionally in house work -  
A good dwelling on the Farm will be  
provided for them - one good pay &  
care. My friend is my very responsible  
and will do well by good help -  
Please inform me at once, if possible,

whether you have the supply on hand  
When you can send them - Whether any  
funds are required beforehand &c &c.

The House is empty now - and  
the work ready immediately -

Very  
Yours

W. V. Wilson

Pastor Baptist Ch.  
Portsmouth

M. J.



whether you have the supply on hand  
When you can sell them - whether any  
funds are required before hand &c &c.

The House is empty now - and  
the work nearly empty -

from

(R. F. & A. L., Vol. 1867)

2491  
Elwood N. J.

March 1867

Parcel No. 87

March 1867

Desires to procure a  
good volume of field hands.

March 1867, O. L. H. 1867

March 1867

WRAPPER ..... Enclosures

WAR DEPARTMENT,

Bureau Refugees, Freedmen, and Abandoned Lands,

WASHINGTON, March 16 1867.

Respectfully referred to  
the Assistant Commissioner  
District of Columbia,

By order of  
Major General Howard  
F. D. Sewall  
Adjutant

Respectfully referred to Lieut.  
Col. Beale doene Subh D.C.,

By order of  
Major General E. Whittier  
J. P. Rogers  
Adjutant





I have been thinking of you  
 and wondering how you are getting on  
 I hope you are well and happy  
 I have not much news to write  
 at present

I am  
 Yours truly  
 J. S. [Name]

I have been thinking of you  
 and wondering how you are getting on  
 I hope you are well and happy  
 I have not much news to write  
 at present



Washington, Nov 10, 1867.

Wright, E. R.  
M. C.

Desires to obtain a servant,  
about 45 years of age, to act  
as house servant.  
Wages \$10.00 per month.

Respectfully referred  
to Lieut Col Beebe  
who with pleasure took  
measures to secure for  
Mr Wright a good  
reliable colored  
man to work about  
the Quaker & claim  
a carriage, and  
have him sent to  
Hudson City N.C.

By order of  
Port Master E. Whittier  
H. Rogers  
Agent

1867 Nov 10

Washington, D.C. 1867

To the chief of the Freedmen  
Bureau

Sir

I desire a servant  
about 45 years of age to act  
as a house servant

The wage \$10 per month,  
My address is E. P. Wright  
"Faith Home" Hudson City N. J.

Respectfully

E. P. Wright

m.c.

March 18. 1864.



To the chief of the Freedmen  
Bureau

Sir

I desire a servant  
about 45 years of age to act  
as a house servant

The wage \$20 per month,  
My address is E. P. Wright  
"Faith Home" Hudson City N. J.

Respectfully

E. P. Wright

m.c.

March 18. 1864.

M. W. 199, C. S. 502.  
Washington. Feb 8 "1867.

Receiv<sup>d</sup> W. W.  
A. A. A. Genl.

Call attention to  
Circ No 8. Series 1866. State  
ment of accounts require  
by said circ will be for-  
warded immediately,  
for Jan 1867.

Recd O. S. 502 - 9 - 1867



Bureau Refugees, Freedmen, and Abandoned Lands,

Headquarters Ass't Commissioner, District Columbia,

Washington, *February 1st* 1867.

Commodore Sells,

I am directed by the Chief Clerk  
to send you a copy of Circular No. 10  
from the Department dated the 1st  
of January last, in relation to  
the State military records required  
of the States, with no particular to these  
States, for the month of January 1867  
with a view to the early completion  
of the list of the military records.

*J. P. [Signature]*

BUREAU REFUGEES, FREEDMEN & ABANDONED LANDS.

Headquarters Assistant Commissioner, District of Columbia.

Washington, July 17, 1866.

CIRCULAR }  
No. 8. }

In addition to turning over all public funds to the regular Disbursing Officer of the Bureau for this District, in accordance with Par. 3, Circular No. 17, War Department, Bureau Refugees, Freedmen and Abandoned Lands, 1865, every officer and agent of this Bureau on duty by an order from these Head Quarters, will render a statement of accounts, at the close of each month, to the Assistant Commissioner, which will embrace all funds received and the sources thereof.

Attention is called to Par. IV, Circular No. 17, War Department, Bureau Refugees, Freedmen and Abandoned Lands, 1865, the terms of which will be strictly complied with. No disbursements, whatever, will be made except upon authority from these Headquarters.

By order of Bvt. Brig. Gen. C. H. HOWARD.

W. W. ROGERS,

*Bvt. Lieut. Col and A. A. G.*

OFFICIAL:

*Assistant Adjutant General.*



M 170150. C. L. S. No. 503.

Washington. March 18/1867.

Respected Robert  
Smyth Esq.

Reappointed Lt. Col.  
Receives <sup>order</sup> Sup<sup>ts</sup> W. Z. S.  
H. Com<sup>rs</sup>.

No. 2040. C. L. S. No. 503.

M 170182. O. L. S. 719. 503.

Washington. Md. 18/1867.

Captain Robert  
Smyth U.S.A.

Reappointed Lt. Col.  
Becher <sup>1867</sup> Sup<sup>t</sup>. W. Z. S.  
R. Com<sup>d</sup>.

Re: O. L. S. 719. 503.



Bureau Refugees, Freedmen and Abandoned Lands,

Headquarters Ass't Commissioner, District Columbia,

Washington, March 10<sup>th</sup> 1867.

Col. M. M. Beebe is hereby reappointed  
Superintendent of the Special Relief Commission for District of Columbia  
W.C.

By order of Gen. McKee

Robert Kenner

Gen'l. Col. President of the  
S. C.

MAR 7 1867

Mc 170130. C. L. S. No. 504  
Washington, March 18<sup>th</sup> 1867,

Cyberus Robert  
Surg. U. S. A.

States it is not the intention of Genl. Howard to appoint visiting Agt. but that cases of distress may be relieved.

Mc 5045 Ag. 3-18-67



WAR 761

Bureau Refugees, Freedmen and Abandoned Lands,

Headquarters Ass't Commissioner, District Columbia,

Washington, March 1<sup>st</sup> 1867

Col. L. M. Keeble  
Supt. Dist. of S. C.

Col. I have the honor to inform you  
that it is not the intention of Genl. Howard  
to appoint visiting agents; if there are any cases  
of distress, they may be referred to the care of  
the Superintendent of the District.

Very Respectfully  
Yours,  
Robert Kenton  
Asst. Secy. President  
S. C.

211701. C. L. S. No. 505,  
Washington. Mel 187867,

Clark S. S.  
A. A. J. Gaud.

Transmits Inventory  
& Inspection report of  
property pertaining to  
the Bureau. App. Wash  
11<sup>th</sup> 1867.

No. C. L. S. No. 3-18-1867



NARA 753

Bureau Refugees, Freedmen, and Abandoned Lands.

Headquarters Ass't Commissioner, District Columbia,

Washington, March 18, 1867.

Sicut Col W. M. Beebe Jr

Local Sect D. C.

Colonel: I have the  
honor to transmit herewith inventory  
and inspection Reports of property  
pertaining to this Bureau, approved  
March 11, 1867.

Respectfully

Your obedt servant

McLain

Acty Asst Insp - General

741 100 150. O.L.S. 70° 506.

Washington. Mich 18<sup>th</sup> 1867,

Rogers. Wm W.  
A.A.A. Genl.

Gives the compensation  
of Mrs D. Daily Emp. Agt.  
B. R. L. and A. L. at \$75.00  
per month. date from Mar  
1<sup>st</sup> 1867.

Ms. C. 2. 1. 6. 3-181-100



Bureau Refugees, Freedmen, and Abandoned Lands.

Headquarters Ass't Commissioner, District Columbia,

Washington, *March 15*, 1867.

Special Orders,

No. *413*

(EXTRACT.)

*3. The compensation of Mrs  
D. Daily, Employment Agent Bureau  
No. 490 St. L. District of Columbia,  
is hereby fixed at twenty five dollars  
(\$25.00) per month to date from  
March 1<sup>st</sup> 1867.*

By order of Brevet Brigadier-Gen. ~~C. H. HOWARD~~

*E. Whittsey  
Asst. Comm. D.C.*

*Wm. Rogers*  
A. A. Adj.-Gen.

*Local Sub.*

*Local Sub.*

No. 120181, O. L. S. No. 74507.

Washington, March 18/867.

Rogers, Wm. W.

A. A. A. Genl.

Fixed the Compensation  
of Miss Emma Griffing  
Emp. Agt. at \$40.00 per  
month, date from March  
1<sup>st</sup> 1867.

No. O. L. S. No. 3-18-1867



Ms. A. 9. 2. 7. 2. 7.

Ms. A. 9. 2. 7. 2. 7.

Found the Confession  
of Mrs. Emma Buffing  
Conf. Sept. 21<sup>st</sup> 1867  
Ms. A. 9. 2. 7. 2. 7.

Ms. A. 9. 2. 7. 2. 7.  
Ms. A. 9. 2. 7. 2. 7.  
Ms. A. 9. 2. 7. 2. 7.

NARA 769

Bureau Refugees, Freedmen, and Abandoned Lands.

Headquarters Ass't Commissioner, District Columbia,

Washington, *March 15*, 1867.

Special Orders,

No. *43*

(EXTRACT.)

The compensation of Miss  
Emma Britting, Employment Agent Bureau  
of the District of Columbia is hereby  
fixed at ninety dollars (\$90.00) per month  
to date from *March 12* 1867.

By order of Brevet Brigadier-Gen. ~~C. H. HOWARD~~.

*John P. Rogers*  
to us

*John P. Rogers*  
A. A. Adj.-Gen.

*John P. Rogers*  
to us



711/70 181. C. S. Co. No. 508.

Washington. Feb 18<sup>th</sup> 1867.

Payee. W. W.

A. A. A. Genl.

Times the Compensation  
of Mrs Louisa Davis  
Asst Emp. Agt. at \$25<sup>00</sup>  
per month. date from March  
1<sup>st</sup> 1867.

No. C. S. Co. 3-180-1307

Bureau Refugees, Freedmen, and Abandoned Lands.

Headquarters Ass't Commissioner, District Columbia,

Washington, March 15, 1867.

Special Orders,  
No. 113

(EXTRACT.)

4. The compensation of Mrs  
Fenisa Davis as Employment Agent  
Bureau of Freedmen, District of Columbia  
is hereby fixed at twenty five dollars  
(\$25.00) per month. To date from Nov  
1-1-66

By order of Brevet Brigadier-Gen. ~~C. H. HOWARD.~~

E. H. ...  
Asst. Commissioner

W. H. Rogers

A. A. Adj.-Gen.

Dear Sir

Yours truly



Troy, N.Y.  
March 14<sup>th</sup> 1867  
J. F. A. L. Vol. 167  
Rogers, John D.  
2<sup>nd</sup> Precinct Station House

asks if two good farm hands  
(freedmen) can be sent to him  
within three or four weeks  
711 1700 1st. C. L. S. H. 715 577

1-30-67  
Asst Commr., D.  
1867

W. C. Department  
Bureau of Prisons  
Washington  
1867  
referred to  
the  
Commissioner  
of the  
Prisons

F. D. Sewall

Respectfully referred to.  
Supt Col Rebe Lovett  
Supt D. C.

By order of  
Portingua C. Williams  
John D. Rogers  
1867

120

Ms. A. 9. 2. 72

Troy New York  
March 14<sup>th</sup> 1864

Genl. Howard, Commandant  
Friedman's Barracks

Can you send me  
two good firemen, those accustomed  
to working on farms preferred.  
I should like to know immediately, if  
you can send them within three or four  
weeks, as it is necessary for me to know  
soon if they can be sent.  
I presume I might find places  
for a dozen good men.

Very Respectfully,  
Your Obedt Servt

John D. Rogers

P.O. Address  
2<sup>d</sup> Precinct Station House Troy N.Y.



(R. F. & A. L., Vol. 4,) 1867.

Medina, N.Y.

March 18<sup>th</sup>, 1867.

Sargent, Geo. W.

Per 34

In receipt of Lt. Col. Beebe's letter of 12<sup>th</sup> inst., in answer to his asking for colored labourers. Thanks he will be able to find places for several families and for 20 or 30 persons. The best wages will be paid.

W. M. Beebe, Jr.

WAR DEPARTMENT,

Bureau Refugees, Freedmen, and Abandoned Lands,

WASHINGTON, March 10, 1867.

Respectfully referred to Lt. Brig. Genl. C. H. Howard, Asst. Commissioner for District of Columbia,

By order of

Malcolm Howard.

F. D. Swann

Act. Secy.

Colon, D. C.

Asst. Secy., D. C.

WASHINGTON, 10<sup>th</sup> MARCH 1867

Respectfully referred to Lieut. Col. W. M. Beebe, Jr. Local Agent, D. C.

By Order of

Lt. Brig. Genl. Whittlesey

John Rogers

Act. Secy.

W. M. Beebe, Jr. 3-20-1867

WRAPPER (Enclosures.)

Received Bureau R. F. & A. L., March 10, 1867.

Medena N. Y. March, 18 1869

<sup>3</sup>  
Maj Gen O. O. Howard

Sir

The letter of  
Lt Col. Beebe of the 12<sup>th</sup> mil-  
in answer to yours asking for  
colored laborers has been received

I think we shall be able  
to find places for several  
families and for twenty or  
thirty persons in this vicinity

The best class of farmers  
desire the Freedmen. We  
will pay them good wages -  
all they will earn -

An agent will leave  
here on the 20<sup>th</sup> instant  
to assist in selecting the  
Freedmen. Several girls  
over



are wanted.

Very Respectfully

Yours

Geo. M. Barnes

Medford

N. H.

1304 347-

Wys. R. F. A. L. Holyday

Ada Iowa 511  
February 1867

Vol 2. No. 1305 at 6.25. 1867

McCarteac J. H.

Wish to employ a family of  
quadruple - the man to make  
quicker use of stock etc, the woman  
and daughter to do housework,  
Should be willing to pay thirty  
dollars per month a year to such  
a family, Report Hon. M. Hillard  
to M. A. Riasson, M.C.

M. A. Riasson, M.C. 511.

M. A. Riasson, M.C. 511.

Dear Sir  
I have the honor to  
acknowledge the receipt of  
your letter of the 14th inst.

and in reply to inform you  
that the same has been  
forwarded to the proper  
authorities for their  
consideration.

I am, Sir, very respectfully,  
Your obedient servant

F. D. Sewall

Commissioner of Freedmen, & Abandoned Lands  
Washington, D.C.  
19th Feb 1867

Respectfully referred to Mr Col  
W. M. Beebe Jr. Local Supt.  
D. C.

By Order of  
Bt. Brig Genl Whittlesby  
A. W. Rogers  
A. W. Rogers



MARA 777  
Dear John August 24. 1864

Dear Howard

I am by the way in case  
that many medicines under your charge  
are seeking employment - I would  
be glad to get a family - the  
man to assist in the house, can  
not - make your own - can you stock  
the stove & bring in to cook  
meat & an assistant, usually -  
To a more, you will find  
I would say thirty  
Dollars per month

I would like you to come to St.  
Augustine or New York & Kaffron  
Yours truly  
J. H. Mendenhall



572  
N. H. J. A. L. Vol 9 1867  
Saline County, Ind  
March 17. 1867  
Vol. 2 No. 355 Oct 6. 56. 507  
Hyland - Ind

Requests to be furnished  
in a colored serowals.

M. W. C. L. S. No. 512  
War Department  
Bureau of Refugees, Freedmen &  
Washington Mar 18. 67

Respectfully referred by  
the Assistant Commissioner  
for the District of Columbia,  
By order of  
Maj. Gen. Howard,  
F. D. Sewell  
Brig. Gen. A. A. General.

3653  
W. C. L. S. C. 3-20. 1867

Bureau Refugees, Freedmen & Abandoned Lands  
HEAD QUARTERS ASSISTANT COMMISSIONER, D. C.,  
Washington, March 20 1867

Respectfully referred to Lieut  
Col. Wm. M. Beebe Jr  
Local Supt. D.C.

By order of Bvt. Brig. Gen. HOWARD  
A. A. General.

... you looking  
... it is better  
... and New York  
... are military  
... if you would  
... take a little  
... more and  
... be preferred  
... secured  
... and have  
... it  
... it  
... give them  
... provide  
... This is a  
... a pity that any person should  
... want employment, what labor  
... is so much needed here,  
... would you to see number  
... in Congress, but not



572

Vol. 9 1867

Sabine County, Tex

March 17. 1867

Vol. 2 No. 365 Oct 6. 26. 807

Hyland - Tex

Requests to be furnished  
in a closed account.

W. H. C. S. 70 5-12

War Department

Bureau of Refugee Provisions &  
Washington Mar 18. 67

Respectfully referred to  
the Assistant Commissioner  
for the District of Columbia.

By order of

Major Genl Howard,

F. D. Sewell

Brigadier Genl. A. A. M.

365

1867

W. H. C. S. C. 5-20. 1867

March 17. 1867 Sabine County  
Tex

Mr Howard, Sir, In looking  
over the monthly returns of 1867  
I see that it appears that  
in Washington and New York  
collected. These are the returns  
submitted, if you would  
send me I will be obliged  
to you, please and will  
obtain, should be paid  
and are furnished, required  
with looking out to see  
yourself, I hope would be  
prepared at first but  
one letter, I would give them  
fair wages and provide  
them good work. It is a  
pity that any person should  
want employment, if laborers  
is so much needed here,  
I would like to see number  
in Congress, I am not



your weekly reports to which  
 I have the honor to have been  
 through. I was there in order  
 to see how things are going  
 and to see if the character and  
 the quality of the work is  
 to the satisfaction of the  
 Board of Directors. I am  
 glad to hear that the  
 work is going on well. I  
 hope to see you soon.

If you should think best  
 to send me a report  
 whenever you are in  
 at home, or the other way  
 with the soldiers there at  
 the barracks, the more I  
 shall be pleased to hear  
 of it. I am, Sir,  
 your obedient servant,  
 J. H.



I have very much to say  
 about the late court you were to  
 attend. It was there in such a  
 manner that I believe I shall  
 not be able to say much  
 about it. I have not yet  
 been able to get any news  
 from the court, and I am  
 sure that you will be  
 disappointed by your  
 expectations.

I have not yet been able  
 to get any news from the  
 court, and I am sure that  
 you will be disappointed  
 by your expectations. I  
 have not yet been able to  
 get any news from the  
 court, and I am sure that  
 you will be disappointed  
 by your expectations.

L. R. Vol. 2 No. 127 A. C. D. C., 186

Bureau Refugees, Freedmen, & Abandoned Lands

Head-Quarters Asst. Commr., D. C.,

Franklinville N. Y. March 15/67.

WASHINGTON, March 20 1867.

Respectfully referred to Lt. Col. W. M. Beebe, Jr. Local Supt.

Lawlor John H.

D. C.

By Order of Bt. Brig Genl Whittlesey

A. A. W. Genl

(Wrapper One enclosures)

Desires to obtain some colored servants, and to know, when they can be sent to him.

Mr Gibson

1100 26 20 1867

Received A. C. D. C. March 1867.



52 Dec 2. 1871  
52 Dec 1871

At a m of the Comm. S. C.,  
Washington, Dec 20. 71

Respectfully referred  
to Lt. Col. W. M. Beebe  
for Local Supt. D. C.

By order of  
Brig. Genl. Whittlesy

A. A. Seal

24th Dec 1871  
main document  
1871 - 25th Dec 1871

5  
1871

Received of *[illegible]*  
to G. H. Co. 24. 11. 18. 18. 18.  
30. Local Supp. 1. 18. 18.

*[illegible]*

By: *[illegible]*

*[illegible]*

11-18-18  
30-1



Franklinville

March 15 1867

Hon W. Van Buren

How are you getting  
along about my birds? I  
wish you would answer  
this so I can know what  
to do about buying a man  
& girl even as it is time to  
be looking around for them  
if you do not answer, I  
would like to have you let  
them go as if you could  
as I am pretty in favour  
of them.

Respectfully

John H. Parker

452 (R. F. & A. L., Vol. ) 1867.

Kenasha, Wis 515

March 2, 1867.

Rev. Mr. [unclear]  
Kenosha, Wis.

Has a boy about 13 years old,  
(colored)  
Cares around him wishes  
servants.

No 1411 133. O. L. S. [unclear]

WRAPPER ..... (Enclosures.)  
R. F. & A. L., Co., 3-21-1867  
Received Bureau R. F. & A. L., ..... 1867.

**WAR DEPARTMENT,**

Bureau Refugees, Freedmen, and Abandoned Lands,

WASHINGTON, March 15 1867.

Submitted by [unclear] to [unclear] Genl  
Chas H. Howard, Act Com, [unclear]  
District of Columbia.

Order of [unclear]  
[unclear] Genl Howard.

F. D. Sewell

A. C. V. General

ASST. COM. [unclear]  
WASHINGTON, [unclear] 1867

Respectfully referred to Lieut  
Col. W. M. Beebe, Jr. Local  
Supt. D. C.

By Order of  
Bt. Brig. Genl Whittlesey  
[Signature]  
A. A. Gen.

Me Distro



452 (R. F. & A. L., Vol. ) 1867.

Kenasha, Wis 515

March 12, 1867.

Rev. Mr. J. ...

Thanks a boy about 13 years old  
(colored)  
I have around him wishes  
servants

W. H. A. 183, O. L. S. ...

WRAPPER ..... Enclosures.)  
R. F. & A. L. Co., 3-21-16  
Received Date R. F. & A. L., ..... 1867.

**WAR DEPARTMENT,**  
Bureau Refugees, Freedmen, and Abandoned Lands,  
WASHINGTON, March 15 1867.

Respectfully referred to Lt. Gen. G. L.  
Chas. H. Howard, Act. Commissioner  
District of Columbia.

By order of  
Lt. Gen. Howard  
F. D. Sewell  
A. A. A. Gen.

Respectfully referred to Lieut  
Col. W. M. Beebe, Jr. Local  
Supt. D. C.

By Order of  
Bvt. Brig. Gen. Whittlesey  
W. H. Rogers  
A. A. A. Gen.

Mc Distm

The first part of the document discusses the importance of maintaining accurate records of all transactions. It emphasizes that every entry should be clearly documented and verified. The text continues to describe the various methods used to collect and analyze data, highlighting the need for consistency and precision in the reporting process.

The second section details the specific procedures for data collection and analysis. It outlines the steps involved in gathering information from different sources and how this data is then processed and presented. The document also addresses the challenges of data management and offers solutions to ensure that the information remains reliable and accessible.



unasha His.  
Mch 12. 67.

Newell J.

wants a boy 13  
or 14 years of  
age, states that  
others around here  
wish servants -

(R. F. & A. L., Vol. 1, ) 1867.

Uniontown Pa 576

March 11<sup>th</sup>, 1867.

Minor, David W.

Wants two stout able bodied unmarried  
colored men to work in a brick yard

Ends

M. W. H. O. S. 576,

WRAPPER (..... Enclosures.)

Received Bureau R. F. & A. L., March 20, 1867.

WAR DEPARTMENT,

Bureau Refugees, Freedmen, and Abandoned Lands,

WASHINGTON, March 20<sup>th</sup> 1867.

Respectfully referred to W. Brig. Genl.  
Chas. H. Howard, Asst. Commissioner  
District of Columbia

By order of  
Maj. Genl. Howard.

F. D. Sewall  
A. A. Howard

Bureau Refugees, Freedmen, & Abandoned Lands,  
Head Quarters Asst. Commr., D.C.,  
WASHINGTON, 21 1867

Respectfully referred to  
Supt Col Beule Local  
Supt & Co.

By order of  
Prof Amos Lewis Whittney  
Amos Rogers  
20.0.9.



Washington, D.C. 11th Pa  
March 11th 1877

Dear Sir

Being desirous of having  
hands as well as to get

your kind regards

I would write

you if you

would send me some

information about

the same

and I would be

very glad to

hear from you

at any time

and I would

be glad to

hear from you

at any time

so that when they  
 go into the field if ever  
 we can meet  
 of those copper head  
 insurrectionists that  
 are known in  
 as well as elsewhere upon  
 the terms of the  
 Fayette, I command  
 a company of black  
 while in service  
 I found them  
 soldiers, and I let  
 they with be good  
 whenever they are  
 surely treated and  
 paid their labour  
 If this can be done  
 they will be a  
 good man who are  
 engaged in



James Brewster

David D. Stone  
Amherst  
Wayne Co. Penna

Wm. C. F. A. L. G.  
1857

296

James Brewster

David W. Thomas  
Amherst  
Wayne Co. Penna

Wm. C. F. A. L. G.  
1857

1896

1857



Ms. 17 of the C. L. S. No. 217.

Washington. March 21 1867

Rogers, Wm. W.

A. A. S. Genl.

States that transportation  
for Ward Seals, from this  
city to Stamford, Ct. has  
been received & delivered  
to Mr Fessenden

No. (L. S.) No. 3-21. 1867.

Bureau Refugees, Freedmen and Abandoned Lands,  
Headquarters Ass't Commissioner, District Columbia,

Washington, March 21<sup>st</sup>, 1867

Lieut Col. William M. Beebe Junr.

Local Superintendent. D.C.

Colonel.

I have the honor to inform you that  
the transportation for Ward Seals from this City to Stanford  
Conn, made on your application, has been received at these  
Head Quarters and sent to Mr. Fessenden.

Very Respectfully

Your obedient Servant

A. M. Rogers  
A. S. G.



Ms. A. 9. 2. 1. 1. 1.

Ms. A. 9. 2. 1. 1. 1.

Washington, March 27<sup>th</sup> 1867,

Robert J. F. S.  
Super

Request to be furnished  
with order for 141 Cards  
Wood. to distribute  
to destitute freed people.

Order furnished on  
Mar 27 1867  
J. S. [unclear]

Ms. A. 9. 2. 1. 1. 1.

WAR 798  
Office Supy. Genl. Capt. J. Gamache  
Washington D.C.  
March 22<sup>nd</sup> 1867 -

Lt. Col. W<sup>m</sup>. M. Beebe Jr.  
Local Supy. D.C.  
Colonel -

We have no wood  
for distribution among Freed-people -  
Please give the bearer, John Bell an order  
for four (4) cords wood so he may take it  
to Maj. Townsend and get some wood this  
morning -

Respectfully  
Yours Obedt Servt.  
G. Roberts,  
Supdy



No 120 185 C. L. S. No 521

Washington. Mch 22<sup>nd</sup> 1867

Reges Wm<sup>th</sup> W.

A. A. A. Genl

Forwards appointment  
of Mrs Josephine S. Griffing  
as Agent B. R. & P.  
at a compensation of \$100  
per month. Date from  
Mch 22<sup>nd</sup> 1867

Rec'd C. L. S. No 3 22<sup>nd</sup> 1867

Bureau Refugees, Freedmen, and Abandoned Lands.

Headquarters Ass't Commissioner, District Columbia,

Washington, *March 22<sup>d</sup>*, 1867.

Special Orders,  
No. *146*

(EXTRACT.)

1. *John W. Smith* is  
now appointed, on detail to Bureau  
of C. & F. District of Columbia at a  
salary of One hundred Dollars (\$100.)  
per month, and will report to *Genl*  
*John S. ...* per assignment  
to duty.

By order of Brevet Brigadier-Gen.

*E. M. ...*  
**C. H. HOWARD**

*Wm. M. Rogers*

A. A. Adj.-Gen.

*Leut Col ...*  
*Local Supt.*



523

Washington G. C.  
March 21 1867

James H. P.

W. B. O. L. S. 523.

Request special attention to enclosed letter from the Justice in relation to procuring servants.

W. B. O. L. S. C. 5-22, 1867.

Headmen, & Abandoned Lands  
Asst. Commr., D.C.,  
WASHINGTON, MAR 22 1867

Respectfully referred to Lieut.  
Col Bebe Social Dept etc.  
for action.

By order of  
D. B. Fryer Ed Whittier  
H. H. Rogers

Ms. A. 9. 2. 2

Smithsonian Institution  
Washington. Mar 21. 1867.

Dear Sir:

I would respectfully  
ask your special attention to the en-  
closed letter from Mr Fuller, a friend  
of mine, with the hope that you can  
comply with his requests.

I am very truly yours  
J. P. R. Phelps.

Genl. H. Howard. U.S.A.  
Freedmen's Bureau.



Pemberton Square  
Boston Mass.  
March 16 1867.

Fuller, R. F.

Desires to engage a female  
hand —

Boston 16 Mar. /67

Dear Sir,

I reside in Weymouth  
15 miles from Boston, where I have  
a farm, keeping 2 horses and several  
cows. I want to get a good colored  
female hand who has done field work  
and takes care of horses and  
cattle. I am willing to take a  
good one of 18 or 19 and have  
him go to school three or four  
months in the winter on what  
I understand the terms of the  
Bureau to be viz board & clothes  
till twenty one. If you had a  
really reliable girl of the same

50.19  
1867

Pemberton Square  
Boston Mass.  
March 16 1867.

Fuller, R. F.

Desires to engage a farm-  
hand —

Boston 16 Mar. /67

Dear Sir,

I reside in Weymouth  
15 miles from Boston, where I have  
a farm, keeping 2 horses and several  
cows. I want to get a good colored  
<sup>male</sup> hand who has done field work  
and taken care of horses and  
cattle. I am willing to take a  
good one of 18 or 19 and have  
him go to school three or four  
months in the winter on what  
I understand the terms of the  
Bureau to be viz board & clothes  
till twenty one. If you had a  
really reliable girl of the same

E. C. B.  
102. 2. 1. 1. 1. 1.  
March 16 1867



age for housework I might take  
 her on the same terms, a month  
 or two longer.

Or I am willing to  
 take an honest experienced  
 adult field hand and pay  
 him what I understand to  
 be your wages \$12 <sup>1</sup>/<sub>2</sub> a month

and board, or even more if you  
 know a man to be worth it.

I understand the Bureau  
 pays transportation.

Would you do me the  
 favor to address me a line  
 on the subject &

oblige your very truly

H. F. Fuller

Gen Rivk. N.Y. 524

March 17 1867.

D. D. F. A. L. 1867,  
Mrs James Delow,

Would be glad to receive a good female  
servant in her family, and doubts not  
good homes could be procured for both male  
and females in her town.

M 186. O. L. S. 524.

Head of Bureau N. Y. + A. S.

Washington, March 21 1867.

Respectfully referred to Gen. Rivk. N. Y.  
M. Howard, Dist. Commissioner, Dist.  
of Columbia.

Respectfully

Maj. Gen. Howard.

F. D. Sewall

Act. Comm.

Chunkirk Chautauque Co. N.Y. March 17 1867

The N.Y. Tribune gives information that the  
agents of the Freedmen's Bureau are employed  
in procuring homes for the freed people,  
We would be very glad to receive a good  
female servant into our family, and  
doubt not good homes can be found  
for both male and female servants in  
this town and the adjacent ones,

Mrs James Delow



United States, Freedman,  
Head-Quarters Ass

Washington, D.C.

WASHINGTON

22 1867

Respectfully referred to  
Col. Bewhe Social Dept D.C.

By order of

Porter & Whittier  
H. Rogers

1867

A. 10. No 1/64  
 701 17th St. C. 22 701 523  
 Philadelphia  
 March 21 1867  
 L. R. Vol 2 No 1383 4828 No 7  
 Am. F. Union, Com<sup>rs</sup>  
 Pennsylvania Branch  
 Robert A. Cross  
 Care Secy

States that a desirable  
 home for a colored boy  
 about 8 years of age can  
 be provided in Philadelphia  
 and asks to be informed  
 if such a child as is de-  
 sired can be found

*C. H. Howard*  
 War Department,  
 Bureau Refugees, Freedmen, and Abandoned Lands.  
 OFFICE CHIEF QUARTERMASTER,  
 Washington, March 22. 1867.

Respectfully referred to *Brig Genl*  
*C. H. Howard*, Asst. Commr. D.C.  
 for his information and with the  
 request that he will commu-  
 nicate with Mr Cross on the  
 subject matter of the within letter

By command of  
*Major Genl C. Howard*  
 Commissioner -  
*Henry M. Whittlesey*  
 Brig Gen., and Chief Q.M.,  
 Bureau R., F. & A. L.

Head-Quarters, Freedmen, & Abandoned Lands  
 Head-Quarters, Asst. Commr., D.C.  
 DIRECTOR, MAR 22 1867

Respectfully referred to *Lieut*  
*Col Beebe* Secut Supt of C.  
 for compliance with the  
 statement of *Brig Genl*  
*Whittlesey* Chief Quartermaster  
 Bureau R. F. & A. L.

By order of  
*Brig Genl C. Howard*  
*Henry M. Whittlesey*  
*Asst. Commr.*

*Edw. ...*  
*...*

No. C. S. S. Co 3-2-1867



STEPHEN COLWELL, Pres.  
FRANCIS R. COPE, Vice Pres.  
ELLIS YARNALL, Rec. Sec.  
ROBERT R. CORSON, Cor. Sec.  
E. W. CLARK, Treasurer.  
35 South Third Street.

PENNSYLVANIA BRANCH  
American Freedmen's Union Commission,

No. 711 SANSOM STREET.

Philadelphia, March 21<sup>st</sup> 1867.

Bob. Brig. Genl. Henry M. Whittlesey,  
Chief Q. M., U. S. A. S.,  
Washington, D. C.

General:

A gentleman of high standing in this city desires for his wife a nice, gentle colored boy, about 8 yrs. of age, to live and be brought up with the family. If you can find such a child, would you favor us by letting us know? He will find the family a nice one, and will want no better home.

An early reply will much oblige  
Your most Obedt Servt  
Robert R. Corson.  
Cor. Secy.

35  
Catais, Maine, March 18. 67

Records Cha. B.

Vol 25 No 1384 A.C.C. Co. 1867

Asks for information what the expenses would be, and whether an agent could obtain at Washington fifty or more colored servants for a large number of families in his town.

M. W. C. Co. 1867

War Department,  
Bureau of Refugee S. & A. C.  
Washington D. C. March 22. 1867

Respectfully referred to Brig. Gen. C. H. Howard, Ass. Com. for the Dist. of Columbia.

By Order of  
Maj. Gen. D. O. Howard  
F. O. Sewall  
U. S. A. Gen.

Chief Clerk, Freedmen, & Abandoned Land  
Head-Quarters Asst. Commr., D.C.  
WASHINGTON, MAR 22 1867

Respectfully referred to  
Lieut Col Beebe  
Supt. D.C.

By order of  
Brig Gen Effie  
A. H. Rogers  
Adj. Gen.

314

M. W. C. Co. 1867



NARA 811

Calais Maine Mch 1867

Genl O. O. Howard

Chief of the Freed Man's Bureau.

Dear Sir

There are a large number of families  
in this town who would like to obtain colored  
servants but they do not know the best method  
of getting them. They have been thinking of  
sending an agent to Washington to see  
what could be done there. If you would  
please to inform us what the expense would  
be & whether an agent could obtain at  
Washington fifty or more, you would greatly  
oblige us.

Your obedient servant  
Chas B. Rounds.

E Bloomfield 24.  
Mch 21/89.

50  
Adams Noyson

Desires to know whether  
Transportation can be  
furnished. Senior Jays  
& Family & Admission Day

Status that there are  
a great many applications  
for seats. In that vicinity  
will not be able to

W.C.P. No 2 23-508



East Bloomfield Mar 21<sup>st</sup> 1867  
Col Wm Beecher

For transportation  
be furnished to Simon Taylor and  
family and Addison Dow  
Some of their friends here said they would  
come if they could have places provided  
for them. There is a continued call  
for colored labourers. I have many  
families spoken for. I have written  
to Mrs. Griffing, a great many letters  
she has sent me four and they give  
good satisfaction. Mrs. Harris has sent  
some few but we want 20 more we get  
none

Respectfully

Yours

Marion Almon

Wages for girls 10¢ per week  
Men get from \$10. to 15. per mo. and board

Pleasant Valley, N.Y.  
A. S. A. March 29<sup>th</sup> 1867.

Vol 2 No 1391 A. S. A. 1867  
Negeman, W. W.

States that a number of families in the vicinity of Pleasant Valley would like to secure the services of a few freed men & women as farm hands and house servants. Asks for information as to the mode of procuring them

W. W. Negeman

New Dept. Bureau of R. F. + A. S.  
Washington, March 23<sup>rd</sup> 1867.

Respectfully referred to Brig. Genl.  
C. M. Howard, Asst. Commissioner  
District of Columbia.

By order of  
Maj. Genl. Howard

A. P. Ketchum  
B. S. H. & A. S. A.

Respectfully referred to Lt. Col.  
W. M. Goodbe, Jr. Local  
Supt. D. C.

By Order of  
Bt. Brig. Genl. Howage  
A. W. Rogers  
U. S. A. Genl

W. W. Negeman



Pleasant Valley N.Y. March

20 67

My Dear General

A number of families in this  
vicinity (near Pikesville or in Hudson) would like  
to secure the services of a few freedmen & women  
as farm hands & house servants. We are ignorant  
of the terms & conditions &c under which  
the Bureau sends them. Can they be had?  
Is it necessary to pay for them?

It is consistent with your  
regulations be good enough to send us such  
information as you think best.

Yours very truly,

W. W. Hegeman

Pleasant Valley

Dutchess County

New York

Very Gen. Howard.

Pleasant Valley N.Y. March

20 67

My Dear General

A number of families in this  
vicinity (near Pikespeak or in Hudson) would like  
to secure the services of a few freedmen & women  
as farm hands & house servants. We are ignorant  
of the terms & conditions &c under which  
the Bureau sends them. Can they be had?  
Is it necessary to go for them?

It is consistent with your  
regulations be good enough to send us such  
information as you think best.

Yours very truly,

W. W. Hegeman

Pleasant Valley

Dutchess County

New York

My Gen. Howard.



NARA 817

M. W. B. C. L. S. No. 530.  
Washington. Feb 25 1847.

Rogers W. M.  
Act. Secy.

States that transportation  
for Virginia C. Customs, which  
was requested by Capt. S. N.  
Clark, has been re<sup>g</sup> & ad  
to Mrs. Oakes Ames.

No. C. L. S. No. 323. 1847.

Bureau Refugees, Freedmen, and Abandoned Lands,

Headquarters Ass't Commissioner, District Columbia.

Washington, March 23<sup>rd</sup> 1867.

Lieut Col William M Beebe Jr  
Local Supt D.C.  
Colonel

I have the honor  
to inform you that the transportation for  
Virginia to Boston, from Washington D.C.  
to Boston Mass, issued at the request of  
Captain S. A. Clark, has been received at these  
Head Quarters and sent to Mrs Oakes Ames  
by whom she has been employed.

Very Respectfully  
Yours, Obedt Servt  
Wm. Rogers  
A. A. S.

L.P. Vol 3. No 29.



L. R. Vol. 2 No. 1257 A. C. D. C., 186

Bureau Refugees, Freedmen, & Abandoned Lands

Head-Quarters Asst. Commr., D. C.,

WASHINGTON, March 25 1867.

Respectfully referred to Lt. Col. Beebe, Jr. Local Supt. D. C. for file. This letter has been answered.

By Order of  
Bt. Brig. Genl Howard

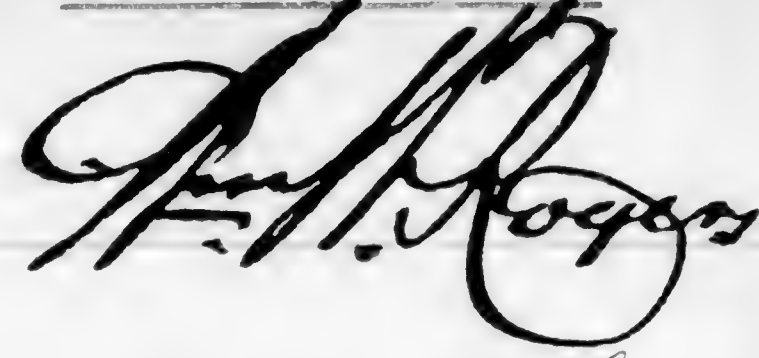

A. A. A. Gent

(Wrapper .....enclosures)

*[Faint handwritten text]*

Received A. C. D. C.

186 .

Vol. 2, No. 359 A. G. D. G. 1867

533

Albany N. Y.  
March 14<sup>th</sup> 1867

Myers Stephen

Ms. A. 1. 1. 34. 0. 4. 5. 7. 5. 33.

States that he has nearly  
~~a hundred applications for~~  
single colored person and  
seventy for families.  
Requests to know if these  
people can be sent.

Ms. A. 1. 1. 34. 0. 4. 5. 7. 5. 33.

Albany, N. Y.  
March 14. 1867.

D. A. Clark Esq  
A. A. J. Gent. &c  
Sir,

I acknowledge the receipt  
of your letter; I would have replied sooner, only  
that other business interfered.

I was using Mr. Williams' circular  
only one week, when I received the circular is-  
sued by your Department, under which latter  
circular I have been working, until I received  
your letter advising me that no more Freed  
people would be sent north under Mr. Williams'  
circular. Mrs Griffith of Washington sent  
me your circular, under which I have been  
ever since operating as above mentioned.

I have now on my list nearly a hundred



applications for single colored persons, and  
seventy from families, for man & wife and  
child <sup>in the county</sup>. The applicants are respectable, and  
the colored people would be well provided for.

Those who know me, and my every antee-  
dent, guarantee that Stephen Myers will do  
everything he takes in hand, in an honorable  
and effective manner. I need only refer, in  
corroboration of this assertion, to Hon. H. W.  
Seward, and to your Treasurer, George E. Baker  
Esq, who personally know me.

My being so generally known, persons  
apply to me for help, & I am compelled to  
disappoint them. I am agent for the State  
Association for sick and wounded soldiers.

Mr Williams insisted upon my accepting the  
Freedman's Agency under him, and I respect-  
fully want to know whether the applicants  
for colored help will be disappointed, by

your not sending the help they seek for.

Respectfully Yours.

Stephen Myers

217 Jefferson St

Albany, N. Y.

The colored persons  
heretofore sent to me, are  
doing well, and are well pleased.

712 1711 1900 C. L. S. 5721

Washington. March 25<sup>th</sup> 1867.

Rogers, Wm. H.

A. A. A. Genl. D. C.

Directs that parties go-  
ing North with freed people  
for N.Y. & other points where  
they have to stay at New Orleans  
know ever right should leave  
that city so as to arrive at  
New York on Tuesdays,  
Wednesdays, Thursdays,  
& Fridays.

Copies forwarded 3-26-1867

H. T.

100 100 100 100 100



Bureau Refugees, Freedmen and Abandoned Lands.

Headquarters Ass't Commissioner, District Columbia,

Washington, March 25<sup>th</sup> 1867

Dear Sir,

I have the honor to acknowledge the receipt of your letter of the 21<sup>st</sup> inst. in relation to the matter of the Freedmen's Bureau. I am sorry to hear that you are unable to attend to the matter at present, but I trust that you will be able to do so in the near future. I have forwarded your letter to the proper authorities for their consideration. I am, Sir, very respectfully,  
Your obedient servant,

A. H. Rogers

L. B. V. 3. 11 2161

336  
Vol 2. No 1416 A.C.D.C. 1867

Rev. J. F. A. L. Tolson  
Montgomery Orange Co. Va.  
March 22. 1867

Ball William

Requests to be furnished  
with colored farm servants.  
No 110190 A.C.D.C. No 29536,

War Department  
Bureau of Refugees, Freedmen &  
Washington Mar 23. 1867

Respectfully referred to  
Brig Genl. C. H. Howard, Assistant  
Commissioner for the District of  
Columbia.

By order of  
Major General Howard,

**A. P. Ketchum**  
Det Lieut Col. Art. U.S.

9790

U.S.C.L.S. Co. 376 1867

Bureau Refugees, Freedmen & Abandoned Lands

HEAD QUARTERS ASSISTANT COMMISSIONER, D. C.,

Washington, March 21. 1867

Respectfully referred to Lieut.  
Col. W. M. Beebe Jr. To-  
cal Dept. U.S.

By order of Bvt. Brig. Gen. HOWARD

**H. A. Rogers**  
A. A. A. General.



N Y

Montgomery Orange Co

March 22<sup>d</sup> 1867

Agent of Freedmans B.

Dr Sir

I have heard that you furnish servants to employers at any depot in the United States. I am entirely ignorant of the way to make application and obtain what I want.

I am a farmer living in the town of Ballkill Temple N Y six miles from the Loshen depot on the Erie Railroad. I want a woman to work in the house ie to cook wash iron bake help with take care of the babies &c generally useful. A woman who can do all these things can get from \$6 to \$10 per month



To a woman able & willing to do these things well I will give \$5; <sup>or more</sup> or help to the cent.

I want also a man to work on the farm wages from \$10. to \$25. per mo I want him to plough mow milk drive team buy stone fence &c. I would not object to a man & his wife a good retired old pair who would be willing to make themselves useful I would not object. Now if you will give me information how to get help of this kind. I am willing to pay for it but I won't pay for ~~more~~ what will do me no good or will cost more than it is worth. Women are very

Scarc in these parts. men not so much so.

Please Address  
William Bull  
Montgomery  
Orange Co  
N.C.

Enclosed find 5 ds for return postage -  
WB.



Washington, Feb 23/86

537  
Erbridge Stewart  
A. M. S. H.

Acknowledges receipt  
of Requisition for 100  
Blankets. States that he  
can only issue on  
requisition from Medic-  
al Officers.

W. D. M. C. S. H. No 537

Re: C. L. S. H. 3-23-1867

Office Adjt. M. S. R. Bu R. S. Ed A. L.  
Washington D. C.

Mar 20d 1867

Lieut-Col. W. M. Beebe

Local Supt.

Colonel.

I have the honor

to acknowledge the receipt of your re-  
quisition of this date, for 100 blankets  
and fifty bed sacks, for distribution.

I regret to inform you that under  
present orders I can issue only to medical  
officers, upon regular requisition, I pur-  
pose calling on Surg Edwards on Mon-  
day to endeavor to effect some arrange-  
ment for supplying such demands as  
yours, and will notify you of the result  
of my effort.

over



Lam, Colonel

Very respectfully

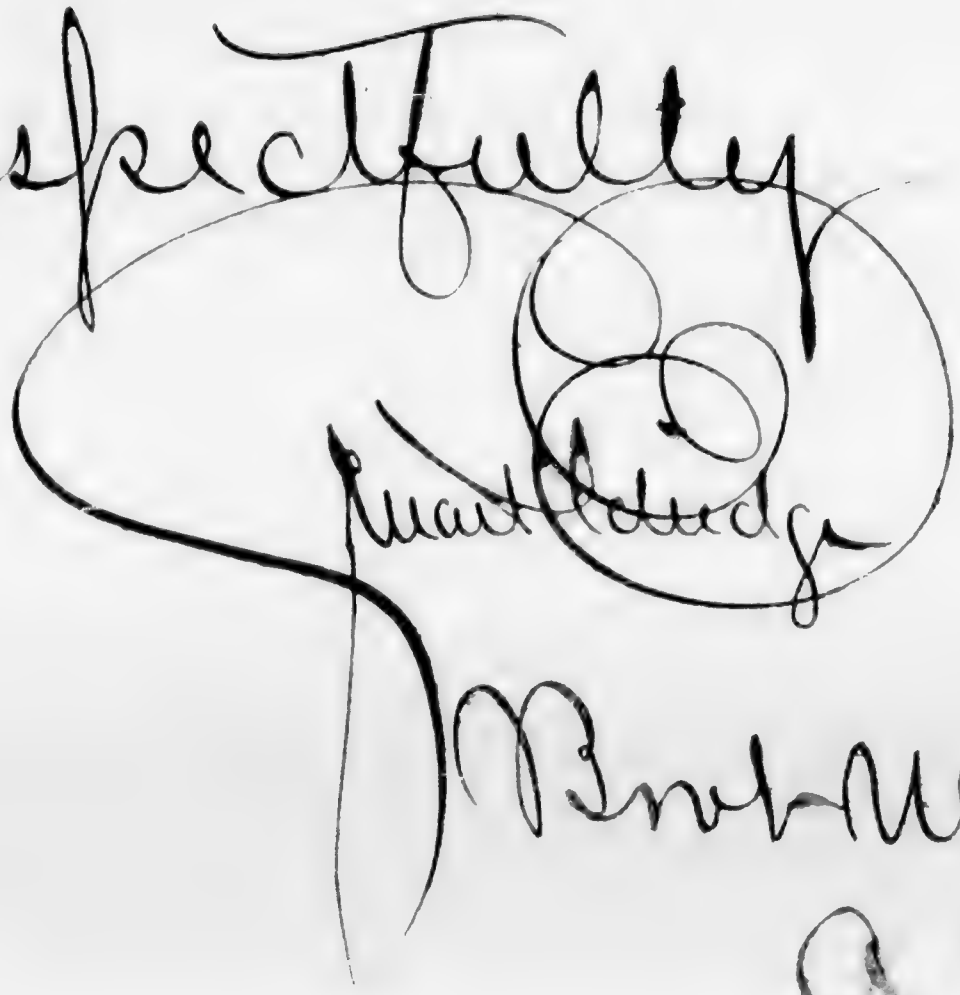
A large, ornate, circular flourish that frames the signature below.

Matthew  
Brookman

A. U. S. R.

Chester Mass.  
March 20<sup>th</sup> 1864.

Elliott, Capt. pro.

Desires to obtain a Woman  
and Boy -

701/207/11, C. L. S. Co. Mass.

Rec<sup>d</sup> C. L. S. Co. Mass.



Chester Mass 20th March 1864  
Lt Col. W. M. Beebe  
Washington D - C

Dear Sir

I made Application  
to E. A. Hewell Esq of Springfield  
Mass about a month ago for  
a colored servant girl - About  
a week since I received a letter  
from Mr. H. - Stating he was no  
longer Agent for the Freedmen's  
bureau and refered me to you at  
Washington D - C -

Will you have the kindness  
to inform me by return - if I  
could obtain a colored servant  
girl from ~~Mass~~ they colored people  
fit to do house work in a small  
family of 6 or 8 persons - There is no  
farm attach - and the work is by no

~~Heavy~~ - means heavy - I require a good  
Smart active Girl not younger than  
14 or 16 years of Age - for which I  
could offer a good Situation -

If you will favour me with  
a report on the matter - and  
if favourable I will remit you  
the required fee of 5 dollars by  
return of mail

Respectfully yours  
Gt Wm Elliott

address  
Chester - Mass



Westfield Mass  
Feb 21 1869

Dear Sir

Your favor of  
6th inst is received.

The person I wrote for  
cannot take the family  
till 1st April as his  
house will not be vacant  
till that day.

I need a man  
immediately <sup>as I wrote you.</sup> as I wrote  
& if he has a wife  
I can give them a  
room. I should of  
course wish for comforta-  
ble folks as they would  
be in the house.

The man I wrote for

NARA 834  
has a separate residence  
for the family he wants.

Our want of them  
is positive but it is  
also imperative - so that  
if we cannot get Freed-  
men's help, we must  
look out for other aid.

If you say we  
can depend on the  
help we will not  
look further - we have  
before sent to New  
York & had emigrants  
sent up. I had  
5 or 6 last year.

I am

Dear

Yours

Wm. W. Adams

Rev. H. B. Holmes,  
Secretary.



Mr. Frances Feb 20  
Westfield N.Y.

Westfield, N.Y.

Feb 21 1867

Dear Sir

I see by your notice  
in the Am Freedman of  
Jan. 1867 that you are  
desirous of obtaining homes  
for Families of Freedmen

One of our Farmers  
has just applied to me  
for help & I suggested a  
colored family - he said he  
should like to get one and  
would furnish a house  
& employ & if the man had  
2 or 3 Sons able to work  
& a daughter he would  
give employment to father  
mother & children. He wants

about 1st April. His  
house is occupied at present  
He wants chopping,  
& the usual work on a  
farm.

If the <sup>freeman</sup> has a son,  
or a friend a middle aged  
man handy with tools  
I would take one myself

Please state terms  
& whether we can depend on  
faithful help as there  
are others who need hands  
especially such as can chop & lumber

Yours  
John Francis,

Rev. W B Holmes,  
26 Lombard Block  
Chicago Illinois.



1171

brief -

11/11/77 4.6

and refer to  
St. Oil Bank for  
answer 7-11-77

*[Faint signature]*

1 Small Family  
for carmen & kitchen

1 Family with 2, 3 or 4 men  
barbers - by April 1st.

Man & wife or single man

3 Girls from 10 - to 15  
about

This application may be  
referred to mess Gripping  
She being personally acquainted  
with Mrs McLeish

For G. W. Bridges

R.R. Station - Monroe, Wis  
P.O. Newcastle, Wis - twelve  
miles from R.R. wants due  
notice that arrangements may be  
made to meet them at Monroe

Care of  
John Frances,  
Westfield N.Y.

For John Frances  
Westfield  
N.Y.

For - Mrs E. E. McLeish  
See 4. and 5. 1914  
Lucas Ill



1 Small Family  
for farm & kitchen

For G. W. Bridges  
R.R. Station - Monroe, Wis  
P.O. Monticello, Wis - twelve  
miles from R.R. wants due  
notice that arrangements may be  
made to meet them at Monticello.

1 Family with 2, 3 or 4 men  
Farmers - by April 1st.

Care of  
John Frances  
Westfield N.Y.

Man & wife or single man

For John Frances  
Westfield  
N.Y.

3 Girls from 10 - to 15  
about

For - Mrs E. E. McLeish  
See 4. and 5. Series  
Lacrosse Ill

This application may be  
referred to Mrs Griffing  
She being personally acquainted  
with Mrs McLeish



540

Chicago, Illinois

March 2<sup>nd</sup> 1867

Holmes, H. B.

Secretary

W. M. G. L. S. 715244

Returns vouchers signed as requested, also encloses applications for 3 families and some children. Encloses the letter with application from N. Y. and desires should not be impossible to fill their order. That Colonel Beebe write to them accordingly.

(2 Enclosures)  
H. B. G. L. S. 307 1867  
Received 7/11/67

Bureau Refugees, Freedmen & Abandoned Lands

HEAD QUARTERS ASSISTANT COMMISSIONER, D. C.,

Washington, March 5<sup>th</sup> 1867

Respectfully referred to Lieut. Col. Beebe Jr. Local Supt. D. C. for answer and attention.

By order of Vyt. Brig. Gen. HOWARD.

J. M. Clark  
A. A. A. General.

~~States Sanitary Commission.~~

North-Western Freedmen's Aid Commission,

son, D. D., - President.  
----- Cor. Sec'y.  
----- Treasurer.

ROOM 26, LOMBARD BLOCK.  
(P. O. BOX 2747.)

Chicago, March 2 1867

To Forward  
Comr B. F. R. & A. S.  
Washington D. C.

Enclosed herewith return vouchers signed as requested. Also find find enclosed applications for 3 families & some children which will perhaps reach you in time to have them sent with Mr Fox. I enclose letters with application from N. Y. that in case their request cannot be filled, they may be written to from Col Beebe's office.

Yours truly  
H. B. Holmes  
Cor Sec



540

Chicago, Illinois

March 2<sup>nd</sup> 1867

Holmes, H. B.

Secretary

117 1/2 S. L. 75044

Returns vouchers, signed as requested, also encloses applications for 3 families and some children. Encloses the letter with application from N. Y. We desires should not be impossible to fill their order. That Colonel Beebe write to them accordingly.

(2 Enclosures)  
P. O. L. 3-7 1867  
Res 117 1/2 S. L. 75044

~~United States Sanitary Commission.~~

North-Western Freedmen's Aid Commission,

Rev. R. W. Patterson, D.D., - President.  
Rev. H. B. Holmes, - - - - - Cor. Sec'y.  
R. B. Mason, Esq., - - - - - Treasurer.

ROOM 26, LOMBARD BLOCK.  
(P. O. BOX 2747.)

Chicago, March 2<sup>nd</sup> 1867

You, C. F. Forward  
Asst Comr B. F. R. & A.  
Washington D.C.

Dear Sir,

I herewith return vouchers signed as requested. Also find enclosed applications for 3 families & some children which will perhaps reach you in time to have them sent with Mr Fox. I enclose letters with application from N.Y. that in case their request cannot be filled, they may be written to from Col Beebe's office.

Yours truly  
H. B. Holmes  
Cor Sec



Vol 2 No 1413 1626  
Mr J. F. A. L. 9. 1867,  
Scottsburg N. Y. 542  
March 21. 1867

Magie, - John D.

Desires to be furnished  
with colored servants.  
704 W. 195. Q. S. N. 42

War Department  
Bureau of Refugees &c  
Washington Mar 25. 67

Respectfully referred to the  
Assistant Commissioner of the  
District of Columbia.

By order of  
Major General Hays,  
**A. P. Ketchum**  
Bot Lieut Col., A. A. G.

3797

Scottsburg N. Y. March 21<sup>st</sup> /67

Agent of the Freedman's Bureau  
Sir:

My family con-  
sists of only myself and wife.  
We are going on a farm this spring  
and need assistance I wish to  
know whether you could send us  
a good man and his wife fit  
for our business.

The man would be required to  
work out-of-doors and I would  
wish him to have some experience  
in the ordinary processes of farm-  
labor. The woman would be needed  
for assisting my wife in the  
house and a kind and teachable  
disposition would be qualification  
enough for her. We would prefer  
persons of middle age though



We would not be lenient on that point I have always been a friend politically and otherwise of the colored race and should any members of the same enter my household while proper subordination would be required I would be disposed to treat them with great humanity and in every way contribute to their progress in intelligence morality and religion I would also be disposed to grant them just pecuniary reward for their services  
 Hoping to hear from you soon  
 I remain

Yours &c  
 John H. Megee

Chief Agents, Freedmen, & Abandoned Land  
 Head-Quarters Asst. Commr., D.C.  
 WASHINGTON, MAR 26 1867

Respectfully referred to  
 the local Supr &c.

By order of  
 Post Brny Genl A. Howard  
 A. H. Rogers  
 Aug 9

5-3-1867  
 2007-2008

721 W 144, C. L. S. 5007

Washington. Feb 25/1867.

Whittlesey, H. M.

547

Brig Genl.

Chief of M. Dept.

Transmits copies of Cir-  
culars of Comd. Bu. R. F.  
and A. L. Nos. 6, 7, 9, & 10.  
Series 1867.

Recd. & forwarded to [unclear]

W. C. S. H. 2-27-67



[Form 9.]

War Department,  
Bureau of Refugees, Freedmen, and Abandoned Lands,  
OFFICE CHIEF QUARTERMASTER,

Washington, *March 25<sup>th</sup>* 1867.

Colonel:

I have the honor to transmit herewith  
copies each of General Orders, Commissioner Bureau R., F., and  
A. L., Nos.

Also, *One* copies each of Circulars, Commissioner Bureau  
R., F., and A. L., Nos. ~~4 to 10 incl 1867~~ (6, 7, 9 & 10. 1867)  
the receipt of which you will  
promptly acknowledge, by signing and returning the accompanying letter.

You will be held responsible for the distribution of Orders to officers  
serving under your direction.

By order of Maj. - Gen. O. O. Howard, Commissioner.

Very respectfully, your obedient servant,

But. Brig. - Gen. and Chief Q. M.,

Bureau R., F., and A. L.

To Lt Col H. M. Butts

Superintendent

Washington D. C.

NARRAGANSETT  
Rec'd O.S.S. No. 92, 1867

---

5118  
Employment Office  
Corner 17<sup>th</sup> and I<sup>st</sup> St

Washington D.C.  
March 28<sup>th</sup> / 67

---

Hall O.S.S.

Agent

No 1711 1744 O.S.S. 348.

Requisition for  
Wood and coal  
for office use

---

Request for wood and coal  
3/28 1867

J.H. Malcomb  
not Supt



Bureau Refugees, Freedmen, and Abandoned Lands.

Headquarters Ass't Commissioner, District Columbia,

Employment Office

Washington, March 28<sup>th</sup>, 1867.

Lieut Colonel W. M. Beebe Jr.

Local Superintendent D.C.

Colonel

I have the honor  
to request that the following supplies  
be provided for use at this office

| No. | Quantity  | Name of Articles |
|-----|---|------------------|
| 1   | 1/4 cord  | Wood             |
| 2   | 1/2 <sup>half</sup> <del>cord</del> <sub>of</sub> <sup>logs</sup> | Coal             |

Very Respectfully,  
Your Att. Servt

O. S. Small  
Employment Office

410195: 20 247  
551  
mch 27 27  
J. P. Robert

Office Local Supt. D.C.  
March 29 1867

Respectfully returned  
to Mr. Roberts with  
the information that  
his application for forage  
should be made to Waj  
J. M. Brown, A. D. M.

W. A. Pulest  
S. Col 128 1/2  
E. 131 1/2  
Local Supt. D.C.

Office Supt. Dist. Asst.  
St. Barnabas  
E. 131 1/2  
March 31 1867

Respectfully referred to Col  
Beck with enclosed  
for information, as the  
Enclosure seems to direct  
that application is to be made to  
him for forage. Respectfully  
J. P. Robert



710195, 24 247  
551  
mch 27 1867  
J. L. Robert

Office Local Supt. D.C.  
March 29<sup>th</sup> 1867

Respectfully returned  
to Mr. Roberts with  
the information that  
his application for forage  
should be made to 'Major'  
J. M. Brown, A.D.M.

W. H. Pulest  
S/Col 128<sup>th</sup> Regt.  
81st Mass  
Local Supt. D.C.

Office Supt. East Dept.  
A. Barnum  
March 31<sup>st</sup> 1867  
803<sup>rd</sup> Mass

Respectfully referred to ~~Col~~  
Col Beebe with enclosed  
for information, as the  
Enclosure seems to direct  
that application is to be made to  
him for forage. Respectfully  
J. L. Robert

NARA 850  
Office Supt. Coast Capt. St. Barnabes  
Bureau No. 21 and A.L.  
Washington Dec. 29<sup>th</sup> 67

Capt. W. M. Webb Jr.  
Local Supt. St.  
Captains.

I have the honor to  
request you to furnish me forage, for the month  
of April owing partially to the new mode  
of drawing supplies &c. I neglected to place my  
request for forage on the regular form.

Respectfully  
Your Obedt. Servt  
(J. L. Roberts)

Supt. Co



226 of the N.L. ...

Handwritten mark or stamp in the bottom left corner.





WAR 950

L. H.

(R. F. & A. L. Vol. 9) 1867.

503

Washington, D. C.

March 27, 1867.

*[Faint handwritten notes, possibly a list or address]*

**WAR DEPARTMENT,**

Bureau Refugees, Freedmen, and Abandoned Lands,

WASHINGTON, March 27 1867.

Respectfully referred to  
Brig. Gen. C. L. Howard, asst.  
Commissioner District of  
Columbia  
By order of  
Major General Howard:

*A. V. Ketchum*

*[Handwritten signature]*



*[Handwritten notes and signatures at the bottom left]*

Bureau R. F. & A. L.  
Head Quarters Com. D. C.  
Washington March 28. 1867.

Respectfully referred, to  
Lt. Col. W. M. Beebe, Jr. Local  
Supt. D. C.

By Order of  
Brig. Gen. Howard

*[Signature]*  
A. A. W. Gen'l

MAR 28 1867

To the Hon. Secy. of War

Rockport Ind,  
March 20 1867

My dear Sir

I have the honor to acknowledge  
the receipt of your letter of the  
19th inst. in relation to the  
application of a man to do farm work  
on the land in office  
of said man a man with  
a family.

Bureau Refugees, Freedmen & Abandoned Lands

HEAD QUARTERS ASSISTANT COMMISSIONER, D. C.,

Washington, March 28<sup>th</sup> 1867.

Respectfully referred to Lt. Col.  
W. M. Beebe, Jr. Local  
Supt. D. C.

By order of Bvt. Brig. Gen. HOWARD

*A. A. Rogers*  
A. A. General.

1867

to C. L. S. N. 3-27-67

MAR

1867



Rockport, Mar 20, 64.

Mrs. J. S. Griffing  
Madam

I desire the services of  
a good Negro man to do farm work  
such as raising tobacco & cutting cord  
wood. I have no objection if you send  
two. I would also lease a piece of land  
to a Negro man with a family.

I expect to pay them a fair price for  
their labor.

Yours truly

Thos. E. Snyder

S. S. Residence Rockport Spencer Coun-  
ty Indiana on the Ohio River,

72120177, Q 18, 114, 538.

Washington, March 29 1867.

Regen. Wm. W.  
A. A. A. Genl.

Appoints Frank. H.  
Smythe, a temporary  
Capt. Agent

No. O. L. S. 3-29-1867.



NARA 957  
Bureau Refugees, Freedmen, and Abandoned Lands,

Headquarters Ass't Commissioner, District Columbia,

Washington, March 29<sup>th</sup> 1867.

Special Orders,

No. 52.

(EXTRACT.)

\* \* \* \* \*  
2. Frank A. Sprague is hereby  
appointed a Temporary Employment Agent  
Bureau R. F. & A. L. in this District.)  
\* \* \* \* \*

By order of Brevet Brigadier-Gen. C. H. HOWARD.

Capt. W. H. ...

Local Agent ...

*Amos Rogers*  
A. J. Adj. Gen.

Vol 4 No 1 of 1867  
March 25 1867

U. S. A. I. 1867

Lancashire N. H.

March 25 1867

Lancashire N. H.

Requests to be fur-  
nished with colored accounts

The Department  
Bureau of Refugees &c  
Washington March 29 67  
Respectfully referred to the  
Assistant Commissioner for  
The District of Columbia  
By order of  
Major Genl Howard,  
A. P. Ketchum  
Act Secy

Head-Quarters Asst. Commr., D.C.,  
WASHINGTON, MAR 30 1867

Respectfully referred to )  
Lieut. Col. W. H. Beebe, Jr  
Local Supt. D. C.

By Order of  
Bt. Brig Genl Howard.

  
A. A. A. Genl.

7.0 U. S. 3.30 P. M. 3.30 P. M.



The first part of the document discusses the importance of maintaining accurate records of all transactions. It emphasizes that every entry should be clearly documented, including the date, amount, and purpose of the transaction. This ensures transparency and allows for easy reconciliation of accounts.

Furthermore, it is noted that regular audits are essential to identify any discrepancies or errors early on. By conducting periodic reviews, one can prevent small mistakes from escalating into larger financial issues. The document also highlights the need for proper categorization of expenses to facilitate budgeting and financial planning.

In addition, the text mentions the significance of keeping receipts and supporting documents for each entry. These documents serve as evidence in case of an audit and help in verifying the accuracy of the recorded information. It is advised to store these documents in a secure and organized manner for easy access.

The second section of the document focuses on the practical aspects of record-keeping. It provides a detailed guide on how to set up a ledger or account book. This includes instructions on how to create columns for dates, descriptions, debits, and credits. The document also offers tips on how to use a calculator or accounting software to streamline the recording process and reduce the risk of human error.

Moreover, it discusses the importance of consistency in recording. Entries should be made promptly after each transaction to ensure that the records are up-to-date and accurate. The document also touches upon the need for a clear and concise description of each transaction, avoiding vague or ambiguous terms.

Finally, the text concludes by reiterating the overall goal of maintaining accurate financial records: to provide a clear and reliable picture of one's financial situation. This information is crucial for making informed decisions about spending, saving, and investing. The document serves as a comprehensive resource for anyone looking to improve their financial management skills.

In summary, the document provides a thorough overview of the principles and practices of accurate record-keeping. It covers everything from the basic rules of accounting to the specific steps involved in setting up and maintaining a ledger. By following the guidelines outlined in this document, individuals can ensure that their financial records are complete, accurate, and easy to understand.

The document is a valuable tool for anyone who wants to take control of their finances and make the most of their money. It is a must-read for anyone who is serious about their financial future.

MAR 29

Vol 2 No 1462 A. G. C. 1867

New Orleans La 25

March 20. 1867

L. J. R. H. 1867.

Dahlgren, V. G.

M. W. 199, C. J. 1867.

Needs 70 to 100 hands  
and wishes to know if he  
can procure them through  
this Bureau

New Dept Bureau A. F. H.  
Washington March 27/67

Respectfully referred to  
the Asst. Commissioner  
District of Columbia -

By order of  
Maj. Gen Howard:

A. P. Ketchum  
a. a. General

Bureau R. F. of A. S.  
Head Dep Asst Com. D. C.  
Washington March 30. 1867.

Respectfully referred to Lt. Col.  
W. M. Beebe, Jr. Local Supt.  
D. C. for his attention, and reply

By Order of  
Bt. Brig Gen Howard

A. A. W. Gen  
A. A. W. Gen

MAR 29

No. C. L. 20, 21, R. 76, 2/30-1867



New Orleans

March 20 1847-

Major General:

C. C. Howard

Adjutant General

General.

I send you to ascertain if I can procure students: either from or through the influence of your Bureau to send my plantation in this State. I need Security a few hundred able hands: to whom I am willing to pay good wages: with provisions and clothing: comfortable houses: garden spots: schools if sufficient number to wear a hat: religious exercises: and diet attractive to

If there may be an appearance to the Government; I presume, you would be glad to have them at work - my brother Admiral Catlyer is not in your city, who would inform you of my ability to perform what I propose -

These inform you as early as possible

and oblige

Yours

C. C. Catlyer

Care of Miller's Guard

No 104 Charles St.



W 1700201. O. L. S. 112569  
Phila Pa. Mar 28 1864  
Vol. 2, No 1495 A.C.D.C. 1864  
Stephens Geo C.  
1122. Locust St.

States that he has estab-  
lished a "Freedman's Help  
Agency" at 1122. Locust St.  
& that the demand for  
farm hands in the interior  
of the State is very pressing  
says he would be willing to  
receive 10 to 20 men & 10 to 20  
women as cooks,  
Chambermaids & as employ-  
ment could be secured for  
them immediately. States  
that he has made arrangements with  
managers of the Home of Industry  
to board them at 40¢ per day  
Desires to know if he can be  
sufficed with the help.

Office Local Supt. D.C.  
Washington Apr 2 1864

Respectfully forwarded  
for the information of the  
Asst. Commr. D.C.  
Wm. Baker &  
Local Supt

E.B. 1700222. O.L.S. 112569

Assumed, April 3<sup>rd</sup>  
Bureau R. F. and St. L.  
E.B. 1700222. O.L.S. 112569  
Hed. Bro. Asst. Commr D.C.

Washington, April 2<sup>nd</sup> 1864  
Respectfully returned to Lt.  
Col. Beebe Local Supt. D.C. who  
will inform Mr. Stephens  
that if he can get the Freedman's  
Aid Society to assume the ex-  
pense of boarding the people and  
other incidental expenses, we can  
continue to send freedmen to him  
as they have been sent heretofore,  
to said Society.

By order of Col. Brig. Gen. Howard  
H. Rogers  
Adj. General



W. 170202, O. F. S. No. 871  
Washington, April 17th 1867

Regus Wm W.

A. A. A. Genl.

States that Complaint  
has reached the USM Comd:  
by one of the Sundry Police  
that the Prisons at E. C. Bar-  
nack, are in a very bad  
condition, & that the residents  
in that neighborhood are  
very much annoyed in  
consequence of the bad smell  
therefrom.

Directs that an  
Agent be ordered to in-  
quire the case & report  
without delay, that means  
shall be taken to abate  
the nuisance.

file - Reported upon  
April 20<sup>th</sup> 1867

Wm W. S. M. W. M. W. M. W. M.

BUREAU OF REFUGEES, FREEDMEN, AND ABANDONED LANDS.

Headquarters Ass't Commissioner, District Columbia,

Washington, April 1<sup>st</sup>, 1867.

Dear Sir,

I have the honor to acknowledge the receipt of your letter of the 27<sup>th</sup> inst.

in relation to

the application of the Freedmen's Bureau for the purchase of land in the District of Columbia.

I have the honor to inform you that the Bureau has no objection to the purchase of land in the District of Columbia for the purpose of settling freedmen and their families.

It is, however, necessary that the land should be purchased in the name of the Freedmen's Bureau, and that the purchase should be made in accordance with the provisions of the Act of March 3<sup>rd</sup>, 1867.

I have the honor to inform you that the Bureau has no objection to the purchase of land in the District of Columbia for the purpose of settling freedmen and their families.

I am, Sir, very respectfully,  
Your obedient servant,

Wm. M. McKim

Assistant Commissioner

Bureau of Refugees, Freedmen, and Abandoned Lands

Washington

Very respectfully,  
Yours obedient servant,

Wm. M. McKim

L. B. O. S. 54.

1. 1. 1. 1.



600

1867 - Vol. 2

600  
Miss J. F. M. T. T. T.  
Philadelphia

April 3. 1867

A. G. U. C.  
R. R. Corson  
Secretary

Requests to be furnished  
with 3 or 4 colored boys  
from 6 to 10 years old,  
for whom good homes  
will be provided

W. M. 212, C. L. 2 W. 111.

War Department  
Bureau of Refugees &c  
Washington Apr 4. '67

Respectfully referred  
to the Assistant Commissioner  
for D. C.

By order of  
Major General Howard

A. P. Ketchum  
Acting Asst. Comr.

Head-Quarters Asst. Commr., D.C.

WASHINGTON, APR 5 1867

Respectfully referred to  
Lieut Col. W. M. Beebe, Jr.  
Local Supt. D. C.

By Order of  
Bt. Brig Gen. Howard

*[Signature]*  
A. G. U. C.

W. M. 212, C. L. 2 W. 111.



PENNSYLVANIA BRANCH

American Freedmen's Union Commission,

No. 711 SANSOM STREET.

STEPHEN COLWELL, Pres.  
FRANCIS R. COPE, Vice Pres.  
ELLIS YARNALL, Rec. Sec.  
ROBERT R. CORSON, Cor. Sec.  
E. W. CLARK, Treasurer.  
35 South Third Street.

Philadelphia, April 3<sup>d</sup> 1867.

Major Genl. O. O. Howard  
Commissioner, Div. of F. & A. S.,  
Washington, D. C.

General: We would be pleased to have you send us, from under your charge, three or four boys between the ages of six and ten, as we have applications for them and can find them comfortable and happy homes.

Please let us know before sending them, and oblige

Yours very truly,  
Robert R. Corson  
Cor. Secy.

WAR 988

*L. C. (R. F. & A. L., Vol. 9.) 1867.*

*Macedon  
Wayne Co NY*

*April 1st, 1867.  
Total \$1530 A.C. 1867*

*Loomis - G. M.  
Smith - G. M.*

*Request to be furnished  
each with colored servant  
for farm work.*

*M. W. L. C. L. 1867*

WRAPPER Enclosures

Received, Bureau R.F. & A.L., 1867.

*A. C. L. S. D. M. 1867*

WAR DEPARTMENT.

Bureau Refugees, Freedmen, and Abandoned Lands.

WASHINGTON, Apr. 4. 1867.

Respectfully referred  
to the Asst Commissioner for  
D. C.

By order of  
Major General Howard,

*A. P. Ketchum*  
Bot Lieut Col., A. A. A. G.

Refugees, Freedmen, & Abandoned Lands,  
WASHINGTON ASST. COMM., D.  
WASHINGTON, APR 5 1867

Respectfully referred to (Lt.)  
Col. W. M. Beebe, Jr. Local  
Agent, D. C.

By Order of  
Maj. Brig. Gen. Howard.

*A. H. Rogers*  
A. A. A. G.



~~War Department~~

~~Bureau of Ordnance~~

~~Washington April 4<sup>th</sup> 1867~~

~~Respectfully referred to you  
by Col. A. Howard Assistant  
Commissioner for G. O.~~

~~By order~~

~~Major Genl. C. A. Howard~~

~~Det. J. P. A. Lloyd 1867  
by det. Capt. ...~~

London 1st 1671

To the Honorable the Secretary of State

Sir I have been  
in a manner a great while that since the  
war of public good I have been  
much industrious. I have a number  
and must needs be a great deal  
of the house of Commons by  
I should like to have a right  
to have it possible to be  
I would Mr. Secretary  
A. H.

I have all the time  
been with the  
and have been  
so full of  
it could be  
in the

Yours  
A. H.



George Washington  
1789

Dear Sir  
I have the honor to acknowledge  
the receipt of your letter of the  
21st inst. in relation to the  
same. I am, Sir, very respectfully,  
Yours, &c.

James Osgood  
George Washington  
Chancellor  
1789

Washington April 4<sup>th</sup> 1867.

602

Public Inc.

Wm. H. C. ...

Enclosed a letter of Mr. Hills of Anona, Livingston Co. N. Y. in which he requests to be furnished with a farm servant

Bar. R. B. ...  
Head Quarters ...

Washington April 5 1867.

Respectfully referred to St. Col  
W. M. ...  
G. A.

By Order of  
Lt. Brig. Gen. ...

*[Signature]*  
A. C. A. G.



...



Anson March 25<sup>th</sup> 1817

Dear Mr. Duffie,

I saw a notice some time ago of a call for employment for colored refugees that have come into Georgetown. Not being able to find the proper address, I take the liberty to write you requesting you to forward this to the proper <sup>authorities</sup> - with

I want a well educated man that is accustomed to all kinds of farm work & knows how to handle a team.

Every other advantage - steady habits - good moral character will be appreciated.

I suppose you have no means of knowing whether an appointment for slavery was desired. Is it certain to be put

The coming month?

My regards to Capt. & the  
two Mrs. Ellis

Yours truly  
Miss Ellis



Paymaster Genl's Office  
Washington D C  
April 4<sup>th</sup> 1867

Genl. G. H. Harward;

Dear Sir

The en-

closed letter from a friend  
of mine will explain itself.

If you have such a man as  
Mr Hills asks for, he can find  
a good home in which he  
will be treated like a man  
and will receive good wages  
for his labor.

Mr Hills lives in the  
town of Nevada, Livingston Co  
N.Y. on the line of the Buffalo  
& Erie R.R.

Truly Yours &c

A. J. Garrison

Genl. G. H. Harward.

132 (R. F. & A. L., Vol. 9.) 1867.

663  
Auburn, N. Y.,

April 3rd, 1867.

Danforth - F.

Ca 9-10-5-15. A.C. 1867

Is engaged in brick & tile making, & wants to employ from 12 to 20 men.

M. W. B. C. L. S. H. 1867

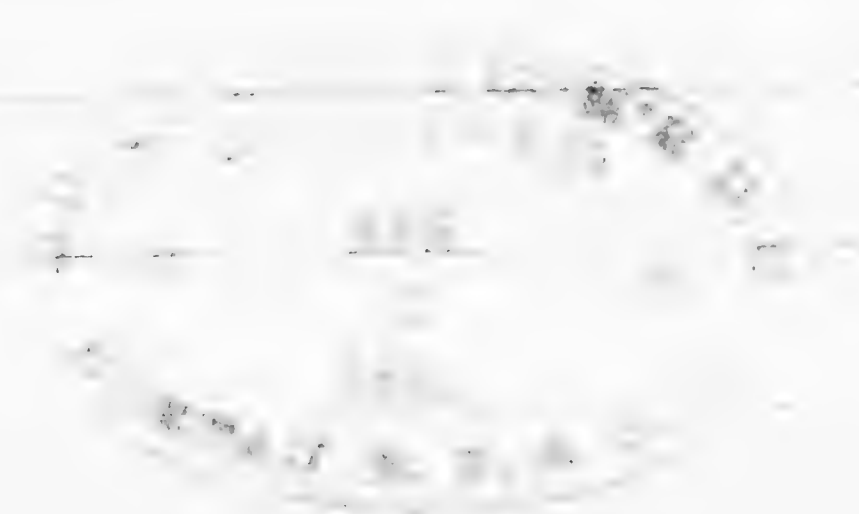

WRAPPER / Enclosures

Received, Bureau R.F. & A.L., Apr 5, 1867.

M. W. B. C. L. S. H. 1867

WAR DEPARTMENT.

Bureau Refugees, Freedmen, and Abandoned Lands,

WASHINGTON, April 5 1867.

Respectfully referred to the Assistant Commissioner for the District of Columbia

By order of  
Major General Howard

A. P. Ketchum  
Bot Lieut Col., & A. A. A. G.

Refugees, Freedmen, & Abandoned Lands,  
Head-Quarters, Asst. Commr., D.C.,  
WASHINGTON, APR 5 1867

Respectfully referred to Lt. Col. W. M. Postle, Jr. Local Supt. D. C.

By order of  
Bt. Brig. Genl Howard.

A. A. W. Genl  
A. A. W. Genl



132 N. P. A. 1704  
1864



Auburn N.H. April 3<sup>rd</sup> 1867

Agent of Freedmans  
Bureau, Washington D.C.

Dear Sir

I am engaged in  
Farming, Brick & Tile making & want  
to employ from 12 to 20 men during the  
season. I have been told that you have  
been sending out parties <sup>of freedmen</sup> into the coun-  
try where places could be secured for them.  
Will you please tell me whether you could  
supply me with good able bodied men  
who would make good hands, for the  
manufacture of Brick. I think you  
make arrangement to take a number of  
married men whose wives would be good  
cooks. Please tell me what wages they will  
expect, with their board &c included, & what  
will <sup>be</sup> the expense attending getting them  
here, & by what terms they could be  
secured. I have thought some of going  
to Washington to make a selection.



Would you think this advisable?  
Please let me hear from you with a  
little delay as convenient to you

Yours truly  
J. Danforth

Ms. A. 9. 2. 29

Ms. A. 9. 2. 29

*Lab* (R. F. & A. L., Vol. *9*) 1867.

*Annawan Henry Co., Ills*

*April 1st.* 1867.

*Lathrop, M. A.*  
*Vol 2 No 15, 19 A.C.C. 1867*

Requests to be furnished  
with colored servants.

*7-11-1867*  
Bureau of Refugees, Freedmen, and Abandoned Lands,  
Asst. Commr., D.C.

WASHINGTON, APR. 6 1867

Respectfully referred to  
Lieut Col. *W. M. Beebe, Jr.*  
Local Supt. D. C.

By Order of  
*Brig. Gen. Howard*

*Frank Rogers*  
A. A. C. G.

WRAPPER (Enclosures)

Received, Bureau R.F. & A.L., *April 5.* 1867.

*Vol 2 No 15, 19 A.C.C. 1867*  
Bureau of Refugees, Freedmen, and Abandoned Lands,  
Asst. Commr., D.C.

WAR DEPARTMENT.

Bureau Refugees, Freedmen, and Abandoned Lands.

WASHINGTON, *April 5.* 1867.

Respectfully referred to  
the Assistant Commissioner for  
the District of Columbia

By order of  
Major General Howard,

*A. P. Ketchum*

Brig. Gen. Col., Army.



Annawan April 1<sup>st</sup> 1867

Gen Howard Dear Sir

I learn from  
the Tribune that you  
have on hand a large  
amount of Contrabands  
If you will send me  
three or four men and  
one two or even three  
women I will get work for  
them all at good wages  
I want to hire 3 men  
and one Girl myself,  
If government will pay  
their fare here send soon  
as you can,

I want young & hands  
quick and honest

Geo C. Alden is, or was  
Quarter master of the  
112<sup>th</sup> Illinois Regt

Wm. H. A. S. May

I will refer you to him  
or to Major J S Gow or  
A V Barker & Co, Annawan  
If you send them to me  
they must come soon  
as my business is pressing  
and spring work is at hand

Yours truly  
M. J. Lathrop

P.S. Address  
Annawan  
Henry Co  
Illinois  
Geo C. Alden is in charge.



Mr. J. F. A. L. Vol 9, 1867

Washington, D.C. 1867  
April 4<sup>th</sup> 1867

Vol 2 No 1546 A.C. 24, 1867

Worcester, Mass., U.S.

U.S. Patent Office.

Requests to be informed if laborers and  
being sent to Mass. + R. Island through  
the Agency of the Freedmen's Bureau, &c.

Vol 170 213. O.L.D. No. 119, 1867



R.I. O.L.D. No. 3. 173. P.M. 11/6 1867

War Department

Bureau of P. & A. L.

Washington April 5<sup>th</sup> 1867

Respectfully referred to Brig  
Genl C. H. Howard Assistant  
Commissioner for D. C.

By Order of

Major Genl Howard

A. P. Ketchum

Actg Asst Asst. General

Adj. Genl. to the Commanding Genl.  
of the District of Columbia, D.C.  
April 20<sup>th</sup> 1867

Respectfully referred to  
Lt. Col. W. M. Beebe Jr.  
Local Supt. D. C.

By Order of

Brig. Genl. Howard

W. M. Beebe

A. A. A. G.

Washington D. C. Apr. 4<sup>th</sup> 1867.

Sir:

That I may answer inquiries from friends at the north, I desire to learn if farm laborers are being sent to Mass or Rhode Island through the agency of the Freedmen's Bureau, and if the wants of particular sections can probably be supplied upon application thereto.

Any information you can furnish will be thankfully received.

Very Respectfully  
Your Obedient

George S. Allen  
U. S. Patent Office

Mr. Geo. Howard  
Comm'r Freedmen's Bureau  
Washington D. C.



To the Hon. Secy of War  
712 17th St. Wash. D.C.  
Started on Apr 4<sup>th</sup> 1867

Paris Temp. Co.

Turnishes names and  
address of persons desiring  
freed people, as follows

Imen, & Almonster, Jr.  
Asst. Commr, Dist  
1701 N. St. W. 1867

Respectfully referred to Lt Col.  
W. M. Redbe, Jr. Local Supt.  
D. C. who will collect the freed-  
people required by the within  
applications, or have them ready  
to be sent during the next  
week.

By Order of  
Ct. Brig. Genl Howard,

A. M. Rogers  
A. A. G.

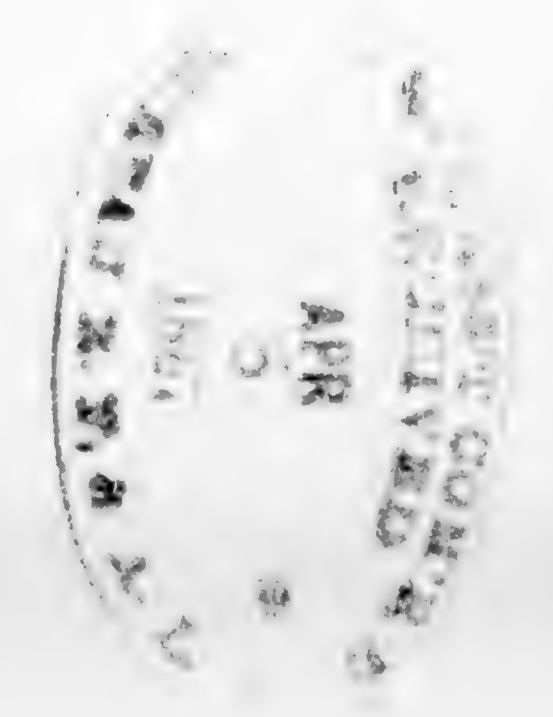

W. M. Redbe (Apr 4<sup>th</sup> 1867)  
Maj. W. B. Clark  
Dear Sir

I have today  
had call upon the following  
persons for laborers, and they  
are very much in want of  
them, they are as follows  
Chas. Keuning, West Point, Md  
want woman and wife Nicholas  
Justus Elmer, West Hill, Md  
& Maria & wife, Nicholas  
Franklin, Essex, Md  
Wife, a good stout man  
L. J. Cochran, West Hill  
a good stout man  
John Webster, Berlin, Md  
a good stout man, all  
the above men are wanted

W. M. Redbe



of farm hands, and thus and by so doing you will  
be wanted in addition much obliged  
to my order of yesterday.

Yours Truly  
J. M. Davis  
J. M. Davis

I do wish if it is possible  
to get any of those that were  
hanging around Fort St. Vrain  
started north you will do so  
as they can find plenty of  
places and good winter -

There men that I have ordered  
help for to day are good  
reliable men and will treat  
that well that work for them  
and will pay good wages.

I am of the married men  
I have written for have children  
that are large enough to put  
out places can be found for  
them so that it will not be  
any objection to them coming  
along. I wish you would  
make an effort to do nothing  
persons along as soon as ~~possible~~  
sent work if not it will be of no use to send them for the persons



M. M. H. C. D. S. 7/4/60  
Washington Apr 6 1860

Request W. M. H.  
w. a. G. H.

States that the manifest  
ation requested for Sarah  
Brown to Harrisville, Pa  
has been <sup>so</sup> delivered  
to Mr Smith of that place.

M. M. H. C. D. S. 7/4/60

NARA 888

Bureau Refugees, Freedmen, and Abandoned Lands.

Headquarters Ass't Commissioner, District Columbia,

Washington, April 6<sup>th</sup>, 1867.

Lieut Col William M Beebe

Local Superintendent D.C.

Colonel.

I have the honor to inform you that  
the Transportation from this City to Henryville Pa. for  
Sarah Brown dependent freedwoman, made on your request  
has been received at this office and delivered to Mr Smith of  
Henryville Pa.

Very Respectfully

Your obedient servant

A. H. G.

A. H. G.

L.B. 7373.



NARA 899

Bureau Refugees, Freedmen, and Abandoned Lands.

Headquarters Ass't Commissioner, District Columbia,

Washington, April 6<sup>th</sup>, 1867.

Lieut Col William M Beebe  
Local Superintendent Gb  
Colonel.

I have the honor to inform you that  
the Transportation from this City to Henryville Pa for  
Sarah Brown dependent freedwoman, made on your request  
has been received at this office and delivered to Mr Smith of  
Henryville Pa

Very Respectfully

Your obedient servant

A. H. B.

A. H. B.

L.B. 73.73.

721 1700 214. C. S. & W. 607.  
Washington. Apr 5 1867.

My dear Mr. W.

A 4 A 600

Appoint Miss M. O.  
Dear, an employment  
Agent, at a commission  
rate of \$50.00 per month.  
Dated from April 5 1867.

W. C. S. & W. 607. No 1 1867.



Ms. A. 9. 1  
Washington. Apr 5<sup>th</sup> 1867.

My dear Mr. W.  
A. A. A. Gent.

Approved Miss M. G.  
Deans, an employment  
Agent, at a commission  
of \$50<sup>00</sup> per month  
paid from Apr 1<sup>st</sup> 1867

Ms. A. 9. 1

Bureau Refugees, Freedmen, and Abandoned Lands.

Headquarters Ass't Commissioner, District Columbia,

Washington, April 5<sup>th</sup>, 1867.

Special Orders,  
No. 57.

(EXTRACT.)

x x x x x

Mrs. Mrs. M. G. Sears, is hereby appointed an Employment Agent, Bureau R. F. & A. L. for District of Columbia, at a Compensation of fifty (\$50) Dollars per Month, to date April 1<sup>st</sup>, 1867.

By order of Brevet Brigadier-Gen. C. H. HOWARD.

A. H. Rogers  
A. A. Adj. Gen.

*For file in the Bureau  
Serial 547, 2 & 3*



700 1 100 214, C. R. B. Vol. 1

Washington. April 5<sup>th</sup> 1867.

Rogers W. W.  
A. A. A. Genl.

Forward official copy  
of Com<sup>rs</sup> from the Com<sup>rs</sup>  
Bureau of C. & A. S. di-  
recting that a list of civilian  
employees who have been  
appointed + whose orders  
was not issued from the  
C. & A. S. in order that they  
may receive ~~the~~ the  
same direct.

Form enclosed.  
C. R. B. C. S. S. C. Pg. 44. 1867 Vol. 1

1867 393

WAR DEPARTMENT  
BUREAU OF REFUGEES, FREEDMEN & ABANDONED LANDS  
WASHINGTON. April 4<sup>th</sup> 1867

Brig Genl. C. C. Howard  
Assistant Commissioner for Dist Col.  
General

I am directed by the Commissioner to request that you will forward to this office a list of the civilian appointees in your District who have been appointed by orders not issued from this office, in order that appointments for them may be made out and sent them from this office.

Hereafter, all such appointments, will, upon the recommendation of the Assistant Commissioner, be made and revoked from this office.

By order of

Major Genl. C. C. Howard

(Signed)

A. P. Kelchum

Brig Genl. Col. and A. S. General

(over)



Bureau of Refugees, Freedmen & Slaves

Head Quarters Wash. Comm. D.C.

Washington April 5<sup>th</sup> 1867

Official

Wm. Rogers

A. S. S. V.

48020 - - -



Bureau Refugees, Freedmen, and Abandoned Lands.

Headquarters Ass't Commissioner, District Columbia,

Washington, April 5<sup>th</sup>, 1867.

Circular Letter.

Superintendents in this District are hereby directed to furnish these Headquarters without delay, a list of all civilian Agents and Clerks, now on duty in their respective Districts, to be made in accordance with the following form in compliance with the enclosed copy of instructions from the Commissioner.

| Name | Date of order of Appointment | in what duty | at what place | Date of pay per month | Remarks |
|------|------------------------------|--------------|---------------|-----------------------|---------|
|      |                              |              |               |                       |         |

By order of

Col. J. M. Howard

*J. M. Howard*

A. A. General

For copy of this

Local Supt &c



Vol 2 No 153 A.B. 2 1867

John S. F. A. L. W. 46  
New York City  
April 5. 1867

Vol 2 No 153 A.B. 2 1867  
Saddler - Rev J.

Requests to be furnished  
with two colored servants  
Vol 2 No 153 A.B. 2 1867

War Department  
Bureau Refugees Freedmen &  
Washington Apr 6. 67  
Respectfully referred to  
Act Brig Genl Chas H Howard  
Act Commr D.C.

By order of  
Major General Howard  
A. P. Ketchum  
a general.



Vol 2 No 153 A.B. 2 1867

Bureau Refugees, Freedmen & Abandoned Lands

HEAD QUARTERS ASSISTANT COMMISSIONER, D. C.  
Washington, April 8<sup>th</sup> 1867

Respectfully reference to St Col  
W. M. Croker, Jr. Local  
Supt. D. C.

By order of Bvt. Brig. Gen. HOWARD

*A. P. Ketchum*  
A. P. Ketchum  
A. General.

Brevet. Rev J. S. Scedder  
156. Chambers St  
New York  
American and Foreign Christian Union,  
156 CHAMBERS STREET

New-York. April 11<sup>th</sup> 1867  
Person appointed by Genl Howard  
with colored servants  
Dr Sir

Will you please in  
me whether you could send  
a colored man & his wife  
& children. The man  
is a good gardener, &  
to take care of horse and  
cow. The woman to do  
general house work, wash  
my ironing, sweeping, cooking  
&c &c. I have a small  
family, wife & one boy only.  
I am willing to pay fair  
wages. Will I have to pay  
their traveling expenses? If so  
I should like to be assured  
if possible that they are good  
servants. I am Secretary



Vol 2 No 1053 A.B. 2 1867

John A. ...  
New York City  
April 5. 1867

Vol 2 No 1053 A.B. 2 1867  
Saddler - Rev J.

Bureau Refugees,  
HEAD QUARTERS  
Washington

Respectfully  
W. M. ...  
Superintendent

Requests to be furnished  
with two colored servants  
Vol 2 No 1053 A.B. 2 1867

War Department  
Bureau Refugees Freedmen &  
Washington Apr 6. 67

Respectfully referred to  
Act Brig Genl Chas H Howard  
Act Commr D.C.

By order of  
Major General Houppard  
A. P. Ketchum  
a general.

By order of Bvt. Brig.  
[Signature]



Vol 2 No 1053 A.B. 2 1867

Brevet. Rev J. S. Saddler  
156 Chambers St  
New York  
American and Foreign Christian Union,  
156 CHAMBERS STREET

New-York April 5th 1867  
To the Person appointed by Genl Howard  
to furnish colored servants  
Dr Sir

Will you please in  
form me whether you could send  
me, a colored man & his wife  
without children. The man  
must be a good gardener, &  
able to take care of horse and  
cow. The woman to do  
general house work, wash  
ing, ironing, sweeping, cooking  
&c &c. I have a small  
family, wife & one boy only.  
I am willing to pay fair  
wages. What I have to pay  
their traveling expenses? If  
I should like to be assured  
if possible that they are good  
servants. I am Secretary



Needmen, & Alameda  
9th Asst. Comm. D.C.  
1861-1867 APR 13 1867

See also 1867-1868

of the American Foreign  
Christian Union I have to  
be away from home ~~two~~ or  
three days in the week he  
sides spending ~~the~~ each day  
in New York. I should  
therefore want a reliable  
man. Two years ago I sent  
to Washington for a lad I  
knew to be proved to be the  
greatest scamp I ever  
knew.

I do hope you can  
assure me as to his character  
& ability. Please answer as  
quickly as possible.

Yours truly  
J. S. Sudder.

Please let me know what  
wages I shall have to pay  
they will have board & room  
furnished by me in the house  
I paid all winter for the man & wife - \$25 per month. - J. S.



Bureau Refugees, Freedmen & Abandoned Lands

HEAD QUARTERS ASSISTANT COMMISSIONER, D. C.,

Washington, April 27<sup>th</sup> 1867

Respectfully referred to St. Col.  
W. M. Beebe Jr Local  
Supt. D. C.

By order of Bvt. Brig. Gen. HOWARD

*A. P. Kitchum*  
A. A. General.

*W. M. Beebe Jr*  
*St. Col.*  
*Freetown Mass*  
*April 3. 1867*

*Payne - Miss H. H.*

Requests to be furnished  
with a female colored servant.  
7117th St. C. L. E. No. 71613.

War Department  
Bureau of Refugees Freedmen &c  
Washington Apr 6. 1867

Respectfully referred to  
Bvt Brig. Genl. A. H. Howard.,  
Asst Commr D. C.

By order of  
Major General Howard  
*A. P. Kitchum*  
Bvt Lieut Col., A. A. G.

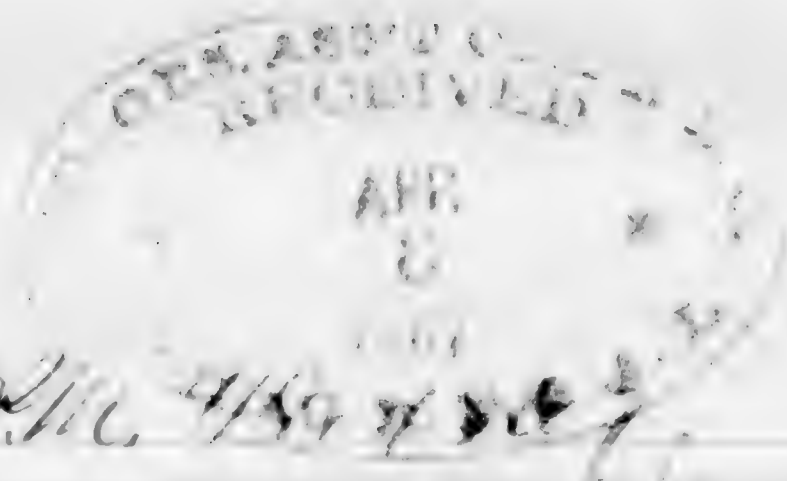

*7117th St. C. L. E. No. 71613*

*Faint handwritten notes on the right side of the page, possibly bleed-through from the reverse side.*



7/2/2010  
To  
P. F. M. L. 1867  
Freetown Mass  
April 3. 1867

Bureau Ref

HEAD Q

Was

Respectfu

W. M

Supt

613  
Payne - Miss H. H.

Requests to be furnish  
ed with a female colored servant.  
711700 215. C. L. E. D. No. 712613.

War Department  
Bureau of Refugees Freedmen &c  
Washington Apr 6. 1867

By order of

2013  
6/1/13

Respectfully referred to  
Bot Brig. Genl C. H. Howard.,  
Asst Commr D. O.

By order of  
Major General Howard  
A. P. Ketchum  
Bot Lieut Col. U. S. A.

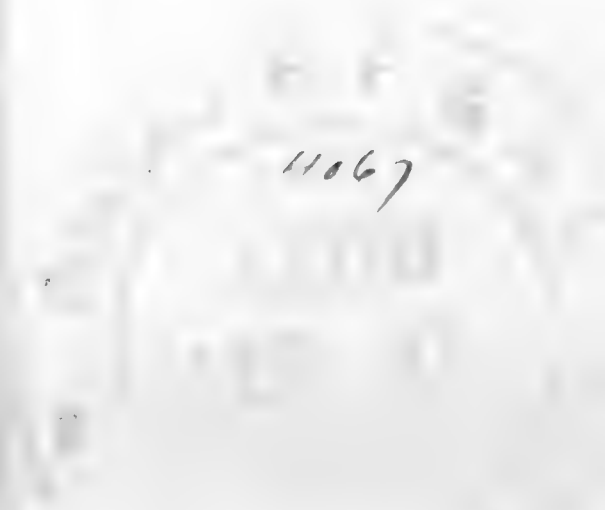

W. C. L. D. 1157 No. 4847 1867

*[Faint, mostly illegible handwritten text, possibly bleed-through from the reverse side of the page.]*



The first thing I noticed  
 when I stepped out of the  
 plane was the humidity. It was  
 sticky and oppressive, clinging  
 to my skin. I had heard that  
 the weather in the South was  
 terrible, but I didn't realize  
 how much it would affect me.  
 The humidity was a constant  
 reminder of the heat and the  
 humidity. It was a constant  
 reminder of the heat and the  
 humidity. It was a constant  
 reminder of the heat and the  
 humidity.

The humidity was a constant  
 reminder of the heat and the  
 humidity.

The humidity was a constant  
 reminder of the heat and the  
 humidity.

Bureau Refugees, Freedmen & Abandoned Lands

HEAD QUARTERS ASSISTANT COMMISSIONER, D. C.,

Washington, April 2<sup>th</sup> 1867

Respectfully referred to Lt. Col. W. M. Beebe, Jr. Local Agent, D. C.

By order of Bvt. Brig. Gen. HOWARD

H. H. Rogers  
A. A. General

1537 A. C. C. 1867  
B. J. F. A. L. Vol. 9, 1867  
Lyme, Ct.  
April 4, 1867

Burr - Res. E. F.

Requests to be furnished  
with 2 colored servants.  
M. W. L. C. L. S. 706/14,  
War Department  
Bureau of Refugees &c.  
Washington Apr. 6, '67

Respectfully referred  
to Bvt. Brig. Gen. C. H. Howard  
Asst. Commr. D. C.

By order of  
Major General Howard  
A. P. Ketchum  
Bvt. Lieut. Col. & Adj. Gen.

RECEIVED  
APR 8 1867  
Ref. O. L. S. 706/14  
4/8/1867



Lyme, New London Co, Ct  
Ap. 4 1867

Dear Sir

I am the pastor of the  
Cong. Church in this place: and  
desire to take into my family a  
colored man & woman (freedman &  
his wife preferred, if without children)  
The man would be employed on a  
farm; the woman in general housework  
and must be a good laundress. One  
of the two should know how to milk.

They are wanted immediately.  
For their services I will pay according  
to the rules of the Department  
for such cases.

Very Truly &amp;c.  
E. F. Burr

1025 1353 N.C. 1127  
Mr. S. F. A. L. Vol 9, 1867  
Half Moon P.O., Pa  
April 3. 1867. 616

Thompson - Homer T.

Requests to be furnished  
with one or two colored accounts  
M. W. L. O. L. S. De. No. 4/4,  
War Department  
Bureau Refugees, Freedmen &c  
Washington Apr 3. 1867

Respectfully referred  
to Brig Genl C. Howard  
Asst Commr D.C.

By order of  
Major General Howard,  
A. P. Kitchum  
Asst Surgt Col 4th Regt.

Bureau Refugees, Freedmen & Abandoned Lands

HEAD QUARTERS ASSISTANT COMMISSIONER, D. C.,

Washington, April 2<sup>th</sup> 1867.

Respectfully referred to  
W. M. Beebe, Jr. Local  
Supt. D. C.

By order of Bvt. Brig. Gen. HOWARD.

*A. A. A. General*  
A. A. A. General.



M. W. L. S. No. 115-116 1/2-1867



Half Moon Apr 3/67

Supt. Freedman's Bureau  
Washington

D. C.

Dear Sir

I am  
desirous of obtaining one or two  
boys to work on a farm,  
Are there any children of the freed  
men under your immediate  
charge? If so what steps are  
necessary to obtain them &  
for what length of time are  
they indentured? Any infor-  
mation you may give me on  
the subject will be thankfully  
received.

Very Respectfully

Horner S. Thompson

Half Moon

Centre County Pa

572  
Wm. L. G. L. G. L.  
Washington, D.C.  
March 29, 1867

Whitaker, E.M.  
Actg Chief Clerk,  
Dept. of Agriculture.

Refers letter of Mr. M. Brown, of Penn Yan asking how freed females can be procured as servants for families in his place, 20 or 30 of whom are wanted.

Wm. L. G. L. G. L. No. 572

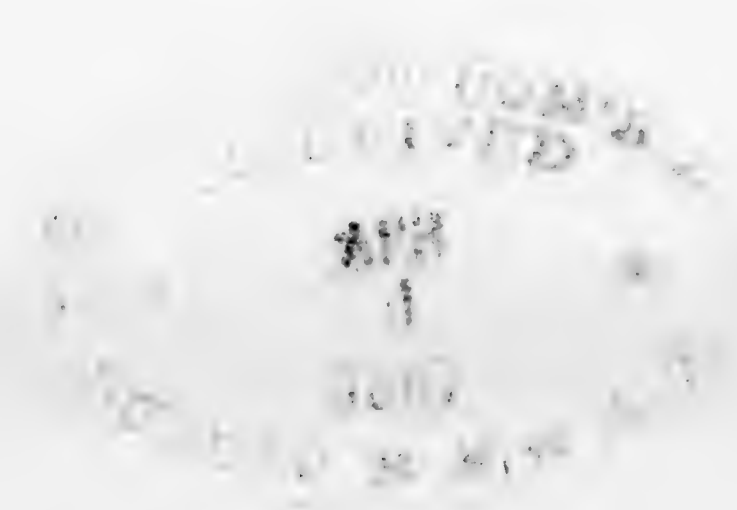

Rec'd O.S. S. 4/1/1867

WAR DEPARTMENT,  
Bureau Refugees, Freedmen, and Abandoned Lands,  
WASHINGTON, March 30, 1867.

Respectfully referred to Col. R. G. ...  
C. H. Howard, Act. Commissioner  
for District of Columbia.

By order of  
Major Howard.

A. P. Ketchum  
Act. Comm.

WASHINGTON, 1867

Respectfully referred to  
Supt. Col. W. M. Beebe for  
Local Supt. D.C.

By order of  
Col. Brig. Gen. Howard  
A. H. Seal

Handwritten notes and scribbles in the left margin of the second page.



Good places among  
 our farmers & /  
 families in the  
 order for 20 or 30  
 of them if we too  
 much trouble  
 will you make  
 some suggestion  
 whether they can  
 be obtained by  
 who is the Modus  
 operandi  
 Yours truly

M. Mason

E. M. Mott

Ms. A. 9. 2. 1. 11. 1867

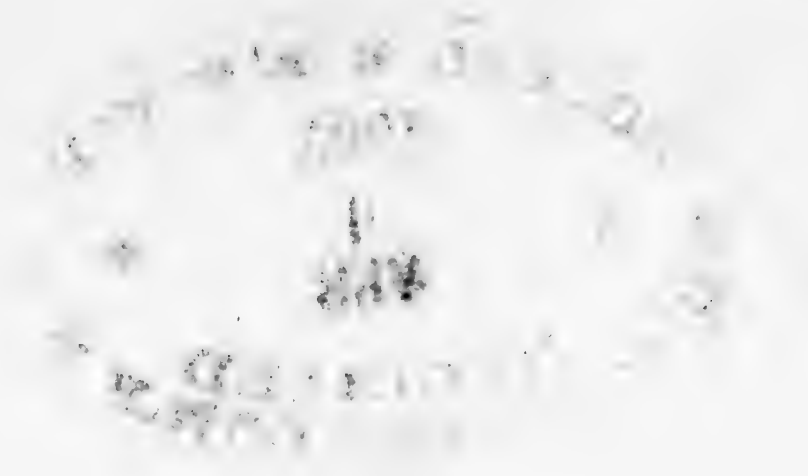

Ms. A. 9. 2. 1. 11. 1867  
 are marked.  
 in his place. on 30 of others  
 presents at dinner for friends  
 asking how food tickets can be  
 Refer letter of Mr. M. Mason of Boston

Very truly  
 Secy of Agriculture  
 Wm. D. Clark  
 Wm. D. Clark, Esq.

March 29, 1867  
 Washington, D.C.  
 Wm. D. Clark



of our Citizens here  
with a recent  
we were like to have  
some work here in  
some hours & are  
lead to suppose from  
the fact that  
could be made  
may be obtained  
at Washington  
from among the  
in charge of the  
Matters of  
on the request of  
Capt. Hester with  
copy to be made

Dept of Agt.  
Washington D.C.  
June 29th 1867

Referred to Maj Genl  
O. O. Howard Comd Bureau  
of Refugee Freedmen  
respectfully requesting  
information upon the  
subject of the inquiry  
made by the writer of  
this letter -

E. W. Whitaker  
acting Chief Clerk



Dear You  
New 21. 67

desire a good many  
of our Citizens here  
whom this society  
would like to procure  
permanence help in  
their houses & are  
led to support from  
the papers that  
could perhaps  
maybe obtained  
at Washington  
from one of them  
in charge of the Treasury  
Bureau I write  
on the request of  
Capt. Penner who  
will be well acquainted

Good flowers, among  
been furnished &  
furniture in the  
order for 2 or 3  
of them if we too  
much trouble  
will you make  
some inquiries  
whether they can  
be obtained by  
wholesale or  
otherwise

Yours truly

W. Brown

G. W. Hutchinson



Ms. A. 9. 2. 8. 26. 1867.

Albany, New York

March 29<sup>th</sup> 1867.

573

Myers Stephen,

217. Jefferson St.

Acknowledges receipt of an official communication in answer to a letter that he wrote. States that in procuring situations for people that he has not charged them anything for his services. nor shall any money be deducted from their wages.

States there is no Benevolent Society in that City, & that he would like to act as Agent & receive a gratuity from the parties to whom he gives the help.

If all is satisfactory, he desires to be <sup>so</sup> informed & would like to have ten women sent from 18 to 35 yrs of age, as cooks &c

Ms. A. 9. 2. 8. 26. 1867.

Albany, N. Y. March 29, 1867

Dear Col. Wm. H. Beck jr.

4c 4c.

I sent a letter some time ago to the Bureau of Refugees &c, and have been officially informed that said letter has been referred to you, for consideration. Permit me to say that in procuring situations for my people, I have charged them nothing for my services - nor has a single cent been withheld directly or indirectly for my use or benefit. Whatever they get, is freely given by those who give the help; and I distinctly stipulate that what I thus get, nor any part thereof, shall at any time be deducted from the servants' wages. The same course has been uniformly observed by me three hundred and six years as agent for the "Underground Railroad", during which time, 2150 refugees have passed through my hands, in their transit to Canada, although for many of them I have procured employment in this vicinity and in adjoining states. From many of these I have received letters expressing gratitude to me for what I had done for them. George Baber Esq. of the Secretary of State's office is cognizant of my course in these matters.

As no "Beneficial Association" exists in this city, whose business it is to co-operate with your Bureau, I cannot of course, be agent. But if my long life course, as at me decided, meet your approbation, I will continue as your agent, on the terms already mentioned, i. e., receiving a gratuity from those to whom I give help, which gratuity shall not at any time, be deducted from my people's wages. Should these terms not meet your approbation, I will of course consider myself no longer agent, for which I would be very sorry, from ~~the~~ motives other than those of a pecuniary nature. If I be so fortunate as to meet your approval, I



1117  
Albany, New York  
March 29 1869

573

Meyer & Steptoe,

217. Jefferson St.

Acknowledges receipt of an of-  
ficial "woman" in and work a  
letter that he made. States that in  
some serious situations for people  
that he has not changed there  
any thing for his services nor  
shall any money be charged for  
his services.

States there is no Department in  
Albany that he is, & that he would  
like to see all Agents & some  
a gathering from the parties  
to whom he gives the help.

Let all of the Agents & factors  
be informed about the  
to have the women and their  
18 to 35 yrs of age, as cooks &c

will report to you as often as you stipulate, the names, residences and  
standing of those to whom I furnish help, and the wages the help  
receive, and how they like their places.

I now want ten women, for house work, ages from 18 to 35;

Two boys, both for general light work about a house  
and garden, out of town; ages from 15 to 25; wages \$150 a year & board.

The general wages for family help is from 5 to 9 dollars a month.

Of course if my terms do not suit, this order need not be filled.

Respectfully Yours  
Stephen H. West.

Office, 217 Jefferson St.  
Albany, N. Y.

217 Jefferson St.

NADA 91A  
N.Y. City 574  
March 21/67.

Remond Y.

Wants to engage a  
boy 17 to 20 years of age  
to take care of 2 drive horses  
Milk Cow, and attend to  
lawn about the house.

716 1/2 (209) 214 574



New York & New Haven Railroad Company,

CORNER 4th AVENUE AND 27th STREET,

Treasurer's Office, March 21<sup>st</sup> 1867

Col. Beebe.

Corner 7<sup>th</sup> St & O Street.

Washington D.C.

Dear Sir

I am in want of a good negro boy from 17 to 20 years of age and I take the liberty of applying to you for information. I wish a smart active fellow who can take care & drive horses - milk a cow and attend to lawn &c around my house.

If you know of such a boy, please write and describe the article - and I will reply or appear in person.

Yours Truly  
W. Demmet



Homer N.Y.  
March 20/67

Woolbrook, John C. 575

Desires to employ a middle-  
aged woman

7111 W. 2. 04. 112. 575.

Homer, N.Y.

Mar. 20 1867

D<sup>r</sup> Mr. Alvord.

I have written  
twice to my friend Rev.  
D.B. Nichol, in reference  
to colored help & can get  
no answer & I venture  
to trouble you. I want  
a good colored girl, who  
is religious if possible,  
but <sup>at</sup> any rate honest. I  
must have trusty help  
for we are necessaril  
out much visiting &  
she will be left alone  
in the house. Some "Auntie"  
who is good & capable  
would suit, tho' we do  
not care so much for  
her knowledge of work

Mr. Woolbrook's wife  
has not been in  
a week or so  
The first one I  
devised that I  
offer to be made  
for a week or so  
in my presence  
by Mr. Howard  
but I have not  
a 2 9/10  
Barnard St. N.Y.  
Homer N.Y.  
Homer N.Y.

Woolbrook 1867

123 11



Dr. M. Howard.

I have  
twice to my  
D.B. Nichol, in  
to colored help  
no answer &  
to trouble you  
a good colored  
is religious if  
but <sup>at</sup> any rate  
must have  
for we are no

aged woman

111 1/2 W. 2nd St. N.E. 544.

What I understand, will  
please assist me  
Howard in procuring  
a statement of cost  
Mr. Holtzworth.

The Asst Commr  
desires that special  
efforts be made to  
find such a statement  
in my name.

Respectfully,  
Robt B. Howard  
M. C. Holtzworth

A. A. S. Spencer  
Bureau of F. & A. S.  
Headquarters, D. C.  
Washington, D. C.

1869 929  
Homer, N.Y.

Mar. 20 1867

D<sup>r</sup> Mr. Alford.

I have written twice to my friend Rev. D. B. Nichol, in reference to colored help & can get no answer & I venture to trouble you. I want a good colored girl, who is religious if possible, but <sup>at</sup> any rate honest. I must have trusty help for we are necessarily out much visiting & she will be left alone in the house. Some "Aunt" who is good & capable would suit, tho' we do not care so much for her knowledge of work



as of her teachableness  
& entire honesty.

This is a dairy region  
& I should think 30 to 50  
females might find  
places among the farmers  
& there are several families  
in the village who want  
such help. Application  
has been made to the  
agency at Syracuse  
without success.

If I knew whom  
to address at Washington  
who has charge of this  
business I would write  
directly to him, but per-  
haps you can put this  
into his hands, telling  
him who I am.

A lady of my congre-  
gation says she wrote to  
the agency in Washington

some little time since  
& enclosed a fee but  
can get no reply.  
I think Gen. Howard  
would do well to take  
some efficient meas-  
ures to supply central  
N.Y. with colored laborers  
as many could get  
good places.

A farmer lately  
told me he would  
take a married wife  
& furnish them a  
dwelling & steady em-  
ployment on his farm.

Perhaps you had better  
show this to Gen. Howard,  
If you will put me in  
the way of accomplishing  
my object or at least drop  
me a line you will greatly  
oblige  
Yours very truly  
Geo. C. Colbrook



to introduce servants  
to places here. This is a  
large & pleasant village  
& they would be well situated  
& have good privileges. The  
region round is occupied  
by thrifty dairy farmers  
who want help.

I should be glad to  
hear from you as soon  
as possible about any  
servants & the prospect  
for others.

Respectfully,  
Jno. C. Holbrook

P.S. I have had one letter  
Mar. 25 from Capt. G. N. Clark  
with whom Mr. Alford conferred.  
I mention this, that there may  
be no misunderstanding.

Recd. C. G. S. L. C. 1/4<sup>th</sup> 1867. —

Mr. Dickson  
Homer, Cortland Co  
N. Y.  
April 2 1867

St. Col. W. M. Ruben,  
Local Supt. do.

Sir: One of the  
29 ult. is recd in reference  
to a colored female servant  
for me, for which I applied  
thru' Rev. Mr. Alford & Rev.  
D. B. Nichols.

Homer is a station  
on the Syracuse & Beijing  
hunters R.R., about  
equidistant from each  
thus connecting us with  
the N. Y. Central & the N. Y.  
& Erie R.R. - or passengers  
from Washington Conn come  
by the Pennsylvania Northern  
route via Harrisburg  
& Elmira N. Y.

Wages of good help  
here are about \$2. per week



where there is considerable work on in small families 1.75. We have <sup>had</sup> an excellent & capable servant for two years at 1.75 as my family is small - wife & two daughters 12 & 14 yrs old. I should not wish to pay more, if the woman is trained. If she has to be taught she ought to have less at first.

I am pastor of a large Congregational Church here & much have an honest & trusty servant as she will be often alone in the house while we are out visiting parsonages, & the children in school. This is a serie qua non with me, I don't care so much for her knowledge of work if she is teachable

& willing. A good girl would find here a permanent & desirable home & I should seek her best good, I am known as a friend of the colored people.

Colored help would be at once taken up here a half a dozen or a dozen could get good places & afterwards more. I will engage to find places at once for six, but would not wish to be responsible for transportation.

Will you inform me what would be the conditions of sending as to transportation, contract as to time &c

If you will write me I will do all I can



West Farms N.Y.  
March 28<sup>th</sup> 1867

Groff, J.B.

Applics for Girl 13 to 15  
Years of age.

7111 Vol 2 04. W. 76

West Farms  
N.Y. March 28<sup>th</sup> 1867

Sir,

I find you are providing  
a list a number of read more to  
the East end. Can you not take  
the opportunity to fill the requisition  
I made some time since for a  
girl from 13 to 15 years of age to  
assist about the house, and ring  
up as a house account. If you will  
do so, and advise me when she  
leaves New York, I will meet  
her at the office at every city  
on the way.

Very respectfully,  
Edw. T. Stewart

Capt. Spurr

March 28<sup>th</sup>

N.Y.



Handwritten notes in the top left corner, including the word "Name" and other illegible characters.

Handwritten notes in the top right corner, including the word "Name" and other illegible characters.

Main body of handwritten notes, including a vertical list of names or terms on the right side and several lines of text below.

Handwritten notes in the bottom left corner, including the word "Name" and other illegible characters.

ROLL # 1867

Andover, Conn.  
March 22, 1867

577

Syman, A. H.

Wants to employ a girl  
about 12 years of age.

W. H. C. L. S. No. 577

W. H. C. L. S.  
No. 577

Andover Ct. March 22/67

Mr. Beebe, Dear Sir:

Having instructed  
a friend of mine (Mr. W. A. Prentice of  
N.Y. who called upon you the other  
day) to make inquiries at the Bureau  
of which you are in charge in  
regard to the procuring of a girl for  
us and having received a note from  
him directing us to address you  
relative to the matter I write.

We want a girl about twelve years of  
age. We specify twelve because we  
think there will be more probability  
of correcting her habits if she happens  
to have some bad ones and a better  
chance to learn her something and  
mould her character than if she  
were older. We are farmers.

Mother wants a girl that can help



she is doing chores about the house and so learn to do house-work. We would should be willing to school and clothe her the same as we would a white girl

We want a girl that is healthy tractable and has a good disposition. What are the conditions on which you put out girls such as I want? If you should send us a girl should we be obliged to keep her if she should not suit? I do not wish to run too much risk for I can get a plenty of white girls here. If it should be thought best to send us a girl she might be sent to the care of Oliver Parish at Hartford Ct. Hartford is twenty miles from here and her fare

from Hartford to Andover would be ninety cents. Please answer this at your earliest convenience and you will oblige

Respectfully Yours

A. H. Lyman

B. Address

A. H. Lyman  
Andover Conn.

211121021110211078  
Office Supt Capt Capt 846  
March 19<sup>th</sup> 1867

Warr Charles C  
Employment Capt.

Refers Edward Thompson  
and Secu (7) others to  
Lt. Col. Becke local  
Supt for employment -

Office Supt Capt Capt Barracks  
Washington D.C.  
March 19<sup>th</sup> 1867

Respectfully transmitted  
J. Roberts  
Supt -



Employment Office  
 East Capitol St Barracks  
 Washington D.C. Feb. 1864

St Ed Wm B. B. B.  
 Local Supt. H.C.  
 Council

I have the honor to report  
 the following named Freedmen wishing employment  
 for whom I have no place

- by -

| Name            | Age | Residence       |
|-----------------|-----|-----------------|
| Edward Thompson | 27  | Camp Grove H.C. |
| James Henderson | 23  | " " " "         |
| Isaac Williams  | 21  | " " " "         |
| James B. B.     | 11  | " " " "         |
| Isaac Cook      | 18  | " " " "         |
| James Reid      | 19  | " " " "         |
| Samuel Chase    | 21  | Harlem Co. D.C. |
| John L. Colburn | 23  | Camp " " "      |

Very respectfully  
 Charles C. Harris,  
 Employment Office

Vol. 2, No. 1, 1867

532

Chicago, Illinois

February 19<sup>th</sup> 1867

Switzerland, J. C.

Mr. Wm. C. ...

Introduces Thos. Tilly Esq. of Chicago <sup>who</sup> states that he (Tilly) expects to return <sup>to Chicago</sup> in 8 or 10 days.

Recommends that transportation be provided for him from Washington D.C. to Chicago. <sup>and</sup> that such families of freed people as are ready, be sent in his charge.

...

Bureau R. & A. B.

Head Quarters A. S. C.

February 25, 1867

Respectfully referred to. Sims and Rich Local Subt. who will endeavor to have the balance of the families intended to be sent by Mr. Switzerland, but who did not go with him, sent by the bearer Mr. Thomas Tilly, and also have filled all orders for freed people to go to Chicago, and make application for their transportation so that they may leave with him by next Monday night.

By command

Robt. H. ... Howard

Wm. Rogers



Washington D C  
Feb'y 19<sup>th</sup> 1864

Gen L. M. Howard  
Asst. Commissioner

Dear Sir:

This will introduce to you  
Thos Gilley Esq of the firm of Gilley <sup>and Armstrong</sup>  
Architects - who occupy rooms adjoining the  
Freedmen's Union Commission in Chicago.  
Mr Gilley has been stopping in the city for  
several weeks & expects to remain 8 or 10  
days longer. I suggested to him that when  
he returned to take in charge a party of  
Freedmen's families, to which he expressed his  
willingness; I would recommend that as  
many of the families might be made ready  
as would go, and put in his charge from  
here. he would ask no remuneration only  
that the Gov. give him transportation, which  
they would give an other agent who could not  
send them to their destination as well perhaps,  
not having the acquaintance in the west -  
Yours truly J. E. Sutterlin



(R. F. & A. L., Vol. ) 1867.

Vol. 207, 1862  
553

1867.

Paper of  
Constant Carter

WM 207 (L) 1867

WRAPPER (Enclosures)

Received, Bureau R.F. & A.L. 1867.

R. O. L. S. L. 12. 11. 4-3-1867

WM 224, OLS 1867

WAR DEPARTMENT.

Bureau Refugees, Freedmen, and Abandoned Lands,

WASHINGTON, April 3<sup>d</sup> 1867.

Respectfully referred to the Assistant Comm. in charge of the District of Columbia who will please cause an investigation into the truth or otherwise of the several statements in his application and act, under the Regulations governing the Bureau, accordingly. Action having been taken by him he will please return these papers to his office for consideration as to the application of the same in his position.

By Order

Wm. L. Howard

A. P. Ketchum

Adj. Gen. S. D. ...

WB 225, OLS 1867

Bureau Refugees, Freedmen, & Abandoned Lands

Head-Quarters Asst. Commr., D.C.,

WASHINGTON, APR 3 1867

Respectfully referred to. to Sent local Dept. Dept. D.C. for compliance with the foregoing endorsement of the Commission.

These papers to be returned, action noted.

By order of

Wm. L. Howard

A. P. Ketchum  
Adj. Gen.

Office Local Dept. D.C.  
Washington April 4<sup>th</sup> 1867

Respectfully returned. A thorough investigation has been made and the statements herein made are found to be correct. His lady corroborates his statement concerning the Sicklers, and



Gives him a character for honesty & sobriety - Owing to his ill health he has been unable to pay his board or in any way provide for himself for several months -

Wm Duke Lt. Col. Local Supt. D.C.

EP 171 228 (C 28 1867)

Refugees, Traders, & Abandoned Property and Quarters Asst. Commr. D.C. WASHINGTON, APR 4 1867

Respectfully forwarded to Commr. Bureau R. F. & A. S. with reference to above endorsement of Lt. Col. Beebe Local Supt. D.C.

C. H. Howard  
Supt. Brig. Genl

EP 228 (C 28 1867) Asst. Commr.

Head Department  
Bureau of R. F. & A. S.  
Washington, April 14 1867

Respectfully returned to Pt. Brig. Genl. C. H. Howard, Asst. Commr. S. Dist. of Columbia who with cause such steps to be taken to give this man temporary assistance as the regulations of the Bureau will allow.

By order of Maj. Genl. Howard

A. P. Ketchum  
Asst. Commr.

EP 171 235 (C 28 1867)

Refugees, Traders, & Abandoned Property and Quarters Asst. Commr. D.C. WASHINGTON, APR 4 1867

Respectfully referred to. Lieut Col Beebe for compliance with above endorsement of the Commissioner -

By order of  
Pt. Brig. Genl C. H. Howard  
H. S. Rogers  
Asst. Commr.

Office Local Supt. D.C.  
Washington Apr 18 67

The Papers mentioned within, were delivered to Constant Banta, in person April 13 1867, to accompany application for position as Watchman.

Wm Duke Lt. Col. Local Supt. D.C.



202  
No 2  
Washington D.C.  
March 29th 1867.

Wilson - Chas J  
(Clk D. M. Gaul's Office)

Introduces Mrs Lilla Johnson (Colored) widow of Stephen Johnson, who was shot about 4 years ago by Mr James Magruder near Rockville Md., leaving her self and children destitute. Recommends that she be assisted by the Freedmen's Bureau.

201 W 209, C. S. W. 209

WRAPPER Enclosures

Received, Bureau R.F. & A.L. March 29, 1867.

WAR DEPARTMENT.  
Bureau Refugees, Freedmen, and Abandoned Lands.  
WASHINGTON, March 29 1867.

Respectfully referred to Order of Brig Gen C. H. Howard, Asst Comm of District of Columbia who will please extend to the destitute freedwoman such assistance as the merits of her case may suggest and the regulations of the Bureau admit of -

By Order of  
Maj Gen C. H. Howard  
A. P. Ketchum  
A. A. A. Gen

2031 W 209, C. S. W. 209  
Freedmen, & Abandoned Lands  
Asst. Commr., D.C.  
WASHINGTON, MAR 29 1867

Respectfully referred to. Supt Col Paul Slocum Supt S.C., who will supply this woman with fuel sufficient for her present necessities and such other aid as may be consistent with regulations of the Bureau.

By order of  
Brig Gen C. H. Howard  
A. P. Ketchum  
a. a. a.

17th & M

File -



Quartermaster General's Office,

Washington, D. C., March 29/ 1867.

Major General O. O. Howard  
Comm. Freedmen's Bureau

Sir:

The Bearer of this is Mrs. Leila Johnson, Colored, the widow of Stephen Johnson who was a slave of Nathan Cook near Rockville, Md. and cruelly shot by a Mr James Magruder in the same neighborhood, leaving the bearer of this unprotected, destitute and unprovided for. Since that event, some four years ago she has been working out, and taking in washing, has been turning her hands towards anything having a look towards earning for her even a few cents to support herself and sickly, suffering children with wavery success. She finds work at this time very scarce, and is now without any pecuniary means.



In this condition she hereby  
applies to you, General, for what  
ever of assistance you may have  
it in your power to give her  
she especially stands in need  
of wood (fuel) and provisioning  
the Essentials to keep them  
warm and to support life.  
While making this application  
for her it is a source of  
gratification for me to be  
able to bear my testimony  
to the applicants good character,  
industrious habits, and unusual  
degree of honesty, sobriety,  
and meritorious demeanor  
She is, Emphatically, a worthy  
and deserving person to enter  
any assistance at your hands  
and in her name, solicit you  
General, to afford all the aid  
and success in your power  
Very respectfully  
Your obt. Servant  
Chas. J. Wallen Clerk



Quartermaster General's Office,

Washington, D. C., March 29 / 1867.

Major General P. A. Howard  
Commr. Freedmen's Bureau

Sir: Her Beares of this is Mrs. Cecilia  
Sabers

Crion Ile.  
March 11 1867

Grego H. S.

Requests that a Young Man  
be sent to him for House-  
work.

M. 1. 18. 18. O. D. 1867

Crion Ile.

*[Faint, illegible handwritten text]*

Recd. C. S. H. 1867



711 1700 08. O.L.S. 1867

171

A  
Ketchum A. P.  
A. A. A. Genl.

28

WAR DEPARTMENT,  
Bureau of Refugees, Freedmen, and Abandoned Lands,

Washington, March 28. 1867

Dear General -

The General desires  
me to refer this lady to you, and  
to request that you will if possible  
put her son in the way of obtain-  
ing employment. His name is  
St. John P. Smith. -

Yours truly  
A. P. Ketchum

St. Col. Wm. Beebe -

Rec'd. E. S. D. C. 4/25/67

Rec'd 3/30/67 - 11-30 a.m.,  
Employment Office  
Very Capt. V. Bannock  
March 30<sup>th</sup> 1867

Office Supt DC  
Wash. Md 130<sup>th</sup> 1867

Respectfully forwarded approved.

Wright Rev M.V.  
Group Capt -

M 190205. Q. S. 1867.  
No. 587.

Request transportation  
for Mrs. Margaret Wright  
from Washington to Boston  
& return -

Sept 38 Regt US Army

Office Supt East Capt. B. W. -  
Washington DC -  
March 30<sup>th</sup> 1867.

Respectfully transmitted  
approved  
H. Roberts  
Supt DC

*[Faint handwritten notes, possibly bleed-through from the reverse side of the page]*



Sept 20  
Wm. Robert  
Sept 20

~~George W. ...~~

Office ...  
March 30 1867

from ...  
for Mrs. ...

Sept 20 ...  
1867

Sept 20 ...  
1867

Sept 20 ...  
1867

Sept 20 ...  
1867

Sept 20 ...  
1867

Sept 20 ...

Sept 20 ...

Sept 20 ...

Payment Office East Capt. St. B. H.  
Inman Co. H. S. L.  
A. Lighter Co.  
March 20/67

Let Mr. H. Legue  
C. S. Jones  
Lieut

Do have the honor to request transportation for Mrs. August Wright, to accompany, Emily Hiltner, fifteen (15) other freed-people from Washington to Boston Mass where employment has been provided for them, and returned.

Respectfully  
Yours Obedt Servt  
O. W. Wright  
Emp. Agt. &c



Employment Office East. Capt. S. B. H.  
Bureau of the Army & Navy  
Washington D. C.  
March 20/67

Dear Sir,  
I have the honor to receive  
your letter of the 17th inst.

I have the honor to request transportation for this August Night, to accompany Company H, 1st Cavalry, to their present location from Washington to Boston Mass, where employment has been provided for them, and return.

Respectfully  
Your Obedt. Servt  
O. W. Wright  
Capt. Regt. Co.

Recd C.L.S.D. 4/30/21 570

James Reynolds, Pine Bridge  
Westchester County wants one  
good woman to general house  
work, good wages to one who  
is competent. This week with  
out fail

Vol 209, C.L.S.D. 590

Daniel D. Stell, New Brunswick  
NJ New Jersey wants one good  
woman for a farm to cook  
and milk, wages \$7. to \$8.  
per month.

Please be kind enough to  
communicate to us immediately  
so that we can let parties  
know when they may  
expect their orders  
filled.

Very Respectfully  
Yours,  
S. D. Simon  
104, East 13<sup>th</sup> Street

New York April 2<sup>d</sup>  
1862

Genl. Col. William Beebe,

Sir I received  
your communication this morn-  
ing, relative to the class of help  
we sent for. We are "very" "very"  
anxious for help of this kind  
as parties who are waiting for  
them are more than anxious our  
Spring orders are overflowing for  
Southern help. George H. Skellock  
James Port Suffolk County, N York  
wants a man and his wife  
one who is a good farm hand  
will take them with one or  
two children wages for the man  
if he is competent hand \$18. per  
month he will furnish them with  
house rent free the woman can



find work enough in the  
Village.

J. V. Johnson Morristown N.Y.  
wants 3. Competent farm hands  
wages from \$12. to 18 per month  
also one good girl for general  
housework. No objection to a  
Married woman.

Elias Sathon Orient Point  
Long Island. 2. Competent  
Farm hands. wages \$12.00 per  
month also one good girl for  
general housework (Single)

Charles Pierce. Tarrytown  
Westchester County N.Y.  
2 good Farm hands perfectly  
competent to work on farm  
wages from \$12. to 18. per  
month. "very" "anxious" this  
week if possible.

Joseph Carpenter New Rochelle  
Manaroneck N.York wants  
two able bodied laborers that  
understands farming perfectly  
they must be sober & industrious  
wages from 18. to \$20. per month  
"very" "very" anxious this  
week.

John S. Wing Colkepsie N.Y.  
wants one good man competent  
to work on the farm take care  
of horses and mill cows.  
and do general farm work  
also one good woman for  
general housework so she can  
cook wash & iron (middle  
aged) satisfactory wages to compe-  
tent persons. this week if  
possible - "very" "anxious".



But Brig Genl Howard

W. A. S. G. G.

W. A. S. G. G.

Lieut Col W. M. Beebe

Local Dept

Memo, O. G. S. 591  
Washington, Feb 7 1867

Clack S. W.  
W. A. S. G. G.

States that Jefferson  
& Thomas also his family will  
go to Ct. to visit Mr.  
Abel has some transpor-  
tion. Direct that instruc-  
tions be given to the  
to use it.

Re: O. G. S. 591, 3-7-1867



No. C. & G. D.C. 3-7-1867

Dear Mr. [Name]

Dear Sir,

I have the honor to acknowledge the receipt of your letter of the 24th inst.

and in reply to inform you that the same has been forwarded to the proper authorities for their consideration.

I am, Sir, very respectfully,  
Your obedient servant,

Wm. [Name]  
[Address]  
[City, State]

Wm. [Name]  
[Address]

Wm. [Name]  
[Address]

Ask to see [Name] -  
for [Name] for [Name]  
[Name]

No one but Jones & his two children need -

Bureau Refugees, Freedmen, and Abandoned Lands.

As at 4 P.M.

Headquarters Ass't Commissioner, District Columbia,

Washington, March 7, 1867.

Colonel :

The bearer-Jefferson - freedman will go to Connecticut tonight with two women. Please have him and George Jones go in company. Capt Hall will meet them at the train tonight and see them off. Mr Abel has Jones' transportation, which please give to him and explain to him how to use it. If he should have started for the depot before this arrives send <sup>his transportation by a</sup> man with Jefferson to see him there. See that these two parties get away tonight certainly.

Send the people to Windsor with Mr Sylaster in charge tomorrow

By order of our



Bot Brig Genl H. Howard  
McLusk,  
a. a. Genl

Lieut Col W. M. Beebe  
Local Supt

1861  
Washington, March 9 1861

Dear Sir

I have had the pleasure  
of receiving your kind letter  
of the 4th inst. in  
reference to the  
above mentioned  
matter. I have  
been thinking about it  
and have no objection  
to your making such  
use of it as you may  
think proper.

Ms. A. 9. 2. 1. 3-5-1861

W. M. Beebe

Post Brig Genl H. Howard  
McClure,  
a. a. 1867

Lieut Col W.M. Beebe  
Local Supt

W. H. R. O. O. O. O. O. O. O.  
Washington, May 9 1867

Lieut Col  
W. H. R. O. O. O. O. O. O.

State that I have  
I have no objection  
to the 1st Regt. in  
that they should have  
been attached to the  
1st Regt. of the 1st  
Division of the Army.

Ms. A. 9. 2. 1. 3. 5. 1. 4. 7



394

Washington D.C.  
Apr 30 1867

Newton D.C.

Supt. Warehouse

Transmit list of  
children in  
District who are in want  
of shoes  
M. W. G. S. D. No. 574

Head Quarters, Traders, & Abandoned  
Asst. Commr.,  
WASHINGTON, APR 30 1867

Respectfully referred to

St. Col. Burt Local Supt.

D. C. who will please

issue shoes for the

free children as with

in request.

By order of

Det. Supt. Howard

*Am. Rogers*  
Asst. General

Office Local Supt D.C.

Washington April 5<sup>th</sup> 1867

Respectfully returned through

Head Qu. Asst. Comr. D.C.  
With request that the sizes  
of the shoes required may  
be furnished.

Wm. Ruler Jr.  
St. Col. Local Supt  
D.C.

Head Quarters, Traders, & Abandoned  
Asst. Commr., I

WASHINGTON, APR 5 1867

Respectfully referred  
to Rev A.C. Newton attend  
called to above endow-  
ment of St. Col. Burt.

By order of

Det. Supt. Howard

*Am. Rogers*  
Asst. General

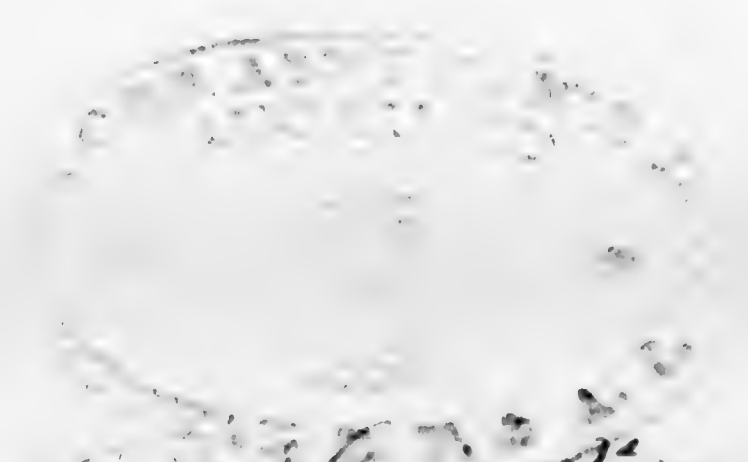

W. C. L. D. No. 47. M. 1867

Washington Sept 3, 07

Genl. G. H. Howard,

Nat. Commr, &c.

Accompanying this is an additional list of scholars in the Georgetown school who are in need of shoes. I hope the application of the teachers will be granted, but trust it will not be necessary to ask for any more for that school the present season.

Very respectfully,

H. E. Keotus,

Sept. 4



Washington, April 10, 1867.

St. Col. Beebe:

By direction of Col. Rogers I return  
to you the enclosed application for shoes,  
with the numbers indicating sizes marked  
against the several names.

Also, by the same direction, I forward  
an application from the teachers of the  
Observatory school, in behalf of some of their  
pupils - the numbers of the shoes wanted being  
indicated as in the list - Col  
Rogers informing me that your general orders  
will cover this case without a specific ap-  
proval.

Very Respectfully,

A. C. Johnson

Supt. Schools, D. C.

207 1878 C.D.C. 1867  
395  
Cyril A. L. [unclear]  
Hollisterville Pa  
March 29. 67.

Cobb. E. S. H.

Is in want of a good farm  
hand, and asks upon what terms  
he can be furnished with one.

W. D. [unclear] C. L. S. [unclear]

W. D. [unclear]  
[unclear] 5/10  
3988



Re: C. L. S. H. M. 4/11/1867.

WAR DEPARTMENT,  
Bureau Refugees, Freedmen, and Abandoned Lands,  
WASHINGTON, April 3<sup>d</sup> 1867.

Respectfully referred to B. B. [unclear]  
[unclear] Asst. Commissioner  
District of Columbia.

Reader of  
Major C. C. Howard

A. P. Ketchum

Done & AD  
APR 20  
1867

Respectfully referred  
to Lt Col. W. M. Beebe Jr  
Local Supt D.C.

By order of  
Pot Brig Gen Howard  
[Signature]  
Acting General



March 29<sup>th</sup> 1867

Hollisterville Wayne County Pa  
Gen E Howard

Send stamp to pay return postage

In the report of the farmers club in Tribune the Reporter states that there are large numbers of colored laborers asking for work

I want a hand if I could have one that would answer my purpose one acquainted <sup>with</sup> the care and management of horses and the work generally done on a farm and would make himself useful to his employer. Can I get such a one and on what terms by the year

Yours Respectfully  
E. J. H. Cobb



576

R. P. A. L. M. 9 1867

Post Station Ohio  
Feb. 19 1867

Scott, S.

I am in want of a good colored girl  
to do general house work to whom  
I will furnish a permanent home

757 1/2 N. 11th St. Phila. Pa.

WAR DEPARTMENT,

Bureau Refugees, Freedmen, and Abandoned Lands,

WASHINGTON, April 3rd 1867.

Respectfully referred to Mr. Brig. Genl.  
Chas. H. Howard, District Commissioner  
District of Columbia.

By order of

Major Genl. C. H. Howard

A. P. Ketchum

Acting Secretary

Refugees, Freedmen, & Abandoned Lands,  
Asst. Commr., D.C.,  
MON. APR 3 1867

Respectfully referred  
to Lieut. Colonel Wm. M.  
Beale Jr. Local Supt. D.C.

By order of

Col. Brig. Genl. Howard

A. A. General

WRAPPED

757 1/2 N. 11th St. Phila. Pa.



Respectfully submitted  
to Maj Gen O. O. Howard  
Jno A. Bishop  
me

Sept 17th 1864  
A. I. W. M. G.

Dear Sir  
I have the honor to acknowledge  
the receipt of your letter of the  
17th inst. in relation to the  
proposed purchase of the  
land on which the new  
cavalry barracks are to be  
erected. I am pleased to  
hear that you are desirous  
of purchasing the same and  
I will be glad to furnish you  
with the necessary information  
in relation to the same.

Respectfully submitted  
 to Major Gen. O. O. Howard  
 for at Brighton  
 MS  
 S. 4000 F. A. L. Vol. 4. 1871

3989

147  
 Dear Sir  
 Hon - Gen. Bingham

I am very much obliged to you for the  
 information that you have given me  
 and all the other information  
 large number of freedmen  
 taking part, under the  
 direction of Gen. Howard  
 address of the Gen -  
 and I am sure a  
 great deal of good will be done  
 female help I will just state  
 of Gen. Howard can send me  
 I could not but know how to do  
 general work, and send to child  
 in I will be very glad to hear from you



her a ~~document~~  
 found, if it is not  
 shown to prove a favor  
 please send into the  
 w. Gen. Howard or an  
 Agent of the ~~Government~~  
 Bureau and please see  
 I am, your obedient  
 servant

address

Gen. Howard  
 Ins. Co.  
 Ill.

Hartford Conn. April 3. 1867.

394

Ferry Davis.

Wishes, that next week, from  
15. to 20. farm hands be sent  
to Hartford Conn. as they are  
very much wanted there.

W. W. 211. C. L. S. H. 112579

Head-Quarters 1st. Commr., D.C.  
WASHINGTON, APR 5 1867

Respectfully referred to)  
Lt. Col W. M. Beebe, Jr.  
Local Supt. D. C.

By Order of  
Pvt. Brig. Genl Howard

W. M. Beebe  
A. A. G.





My dear Mother  
 Dear Mother

I wish that you would send me if possible next week any wheat from 15 to 20 good bushels I would like to buy very much wanted here if you cannot send them next week it will not be of much use to send them at all this Spring as most of our farmers here will have displaced themselves with help for their Spring work -

Yours Truly  
 Henry Green  
 Jackson

Bureau Refugees, Freedmen & Abandoned Lands

HEAD QUARTERS ASSISTANT COMMISSIONER, D. C.

Washington, April 8<sup>th</sup> 1867

Respectfully referred to Lt. Col. W. H. Beebe, Jr. Local Supl. D. C.

By order of Lt. Brig. Gen. HOWARD

*[Signature]*  
A. A. General

*[Faint handwritten text]*  
Norwalk, Conn., 6/19  
April 4. 1867

Christead Samuel E.

Requests for self and neighbors to be furnished with 3 or 4 colored female servants.

W. H. Beebe, Jr. Local Supl. D. C.

War Department  
Bureau of Refugees Freedmen &c

Washington April 6. 67

Respectfully referred to  
Act Brig Genl C. H. Howard,  
Asst Commr D. C.

By order of

Major General Howard,  
A. P. Retchum

Act Lieut. Col. A. A. G.

W. H. Beebe, Jr. Local Supl. D. C.  
APR 15 1867



Dealers in Groceries, Flour, Provisions, &c.

Office of S. E. Olmstead & Co.,

Norwalk, Conn., April 4 1861

Dear Sir,

Yrs

I have just  
some more of the fine  
Gills you have ordered by applying  
through your store - if so be  
you state in what terms you  
for 3 or 4 a number of  
might be with myself or  
could own. We want them  
just but action for it over  
in this case you have  
no more like them at one if they  
can be obtained in any  
you are brought of your country  
with such terms as may appear  
reasonable. Should prefer goods  
of the highest quality.

Mr 1701 21<sup>st</sup> O.L.S. N<sup>o</sup> 620

Washington. Apr 11<sup>th</sup> 1869.

Robert Key J. S.  
Supt.

States that he will <sup>be</sup> absent  
for a day or two under  
Special order N<sup>o</sup> 49. H<sup>o</sup>  
Lt. Comm<sup>r</sup> Genl O.C.  
Harris.

N<sup>o</sup> O.L.S. No. 120 PM. 7/5/86



721 1/2 of 217, O.L.S. No. 120

Washington. Apr 4<sup>th</sup> 1867.

Robert Key J. L. <sup>Ch 20</sup>  
Supt.

States that he will, <sup>be</sup> absent  
for a day or two under  
Special order No. 119. He  
is Command<sup>er</sup> Genl. O.C.  
Alamogordo.

No. O.L.S. No. 120 PM 7/5/67

Office Supt Camp Capt Garrucks  
Washington D.C. -  
April 4<sup>th</sup> 1867 -

Lt. Col. Wm. M. Peck Jr.  
Local Supt D -  
Colonel.

I have the honor  
to inform you that I am to be absent for  
a day or two, under "Special Order No. 49 -  
Gen. C. C. Howard Commission".

Samuel Perry Insp. Capt. will take  
charge of barracks &c until I return.

Respectfully

Wm. C. Roberts

Supt &c



Office Supt Camp Camp Ferris  
Washington D.C. -  
April 4<sup>th</sup> 1867 -

Lt. Col. Wm. M. Peck Jr  
Local Supt D.  
Colorado.

I have the honor  
to inform you that I am to be absent for  
a day or two, - under "Special Order No. 49 -  
Gen. C. C. Howard Commisioner".

Amos Perry Insp<sup>nt</sup> Capt will take  
charge of barracks &c until I return.

Respectfully

Wm. C. Roberts

Supt

April 4

No. 122 (R. F. & A. L., Vol. 9.) 1867.

Vol 2 No 1554 A.C. O.C. 1867-

Washington D.C.

April 3rd 1867.

Carroll A.C.  
Davis Geo.C.

Forwards certificates of the loyalty, devotion and present destitute condition of Clarissa Wilkinson & her 3 small boys, & Philip Anderson & wife & daughter, living in Washington on N st., between 1/2 & 1 st streets, & request that they be assisted by this Bureau.

The parties themselves state that they are in want, & it would appear that Clarissa is very feeble & broken down, &c.

M/M 215. O. L. S. H. W. 22  
WRAPPER 3 Enclosures

Received. Bureau R.F. & A.L. April 6 1867.

M/M 215. O. L. S. H. W. 22

WAR DEPARTMENT.

Bureau Refugees, Freedmen, and Abandoned Lands,

WASHINGTON, April 8th 1867.

Respectfully referred to Bt. Brig. Genl. C. H. Howard, Asst. Commissioner for District of Columbia who will please investigate this case and if necessary, take such measures for the relief of these persons as he may deem proper.

By order of  
Maj. Genl. C. H. Howard

A. P. Ketchum

Adj. Genl. General  
E. B. M. 241. (C. L. S. H. W. 22)  
WASHINGTON, DC 9 1867

Respectfully referred to Lieut. Col. W. M. Beebe, Jr. Local Supt D.C. Attention called to the preceding endorsement from the Commissioner Bureau R. F. & A. L. and compliance therewith directed.

By Order of  
Bt. Brig. Genl. C. H. Howard

A. A. A. Genl.



~~And~~ Phillip Anderson & wife  
 & daughter - living  
 on the island at N. St. Peter. 1st & 1/2 St.

Claudia Wilkinson & 3 small  
 boys living at same place -

These parties allege they are in  
 want, and apply to the Bureau for  
 help. It would seem from rep-  
 resentations made that Claudia  
 is broken down and feeble and  
 unable to support her family -

A. P. Robinson  
 A. A. Atul

W. S. Finney

Decorah Iowa 625  
April 1<sup>st</sup> 1867

W. S. Finney

Finney Isaac S.

W. S. Finney

Tricks a colored girl as  
house servant.

Was sent by A. Frank  
Washington April 6/67

Respectfully referred to  
Lieut. Gen. C. Howard  
Asst Com. District of  
Columbia

By order of  
Major General Howard

A. P. Ketchum

Assistant General

RECEIVED  
APR 11 1867

Respectfully referred to  
Lt. Col. W. H. Beebe, Jr.  
Local Sup't D. C.

By Order of  
Bt Brig. Genl Howard

W. H. Rogers  
A. A. C. Genl



W. S. Finney



[Faint, illegible handwritten text, possibly bleed-through from the reverse side of the page. The text is mostly illegible due to fading and low contrast.]

MAR 9 1867

*F 32* (R. F. & A. L., Vol. 9.) 1867.  
*Vol 2 No 1578 A.C.C. 1867*  
*Otego, N.Y.,*  
*April 6. 1867.*

WAR DEPARTMENT,  
Bureau Refugees, Freedmen, and Abandoned Lands,  
WASHINGTON, April 8. 1867.

Respectfully referred to  
the Asst Commissioner for the  
District of Columbia.

By order of  
Major General Howard,  
*A. P. Ketchum*  
Bot Lieut Col., a. a. g.

*Pilkinton - Rev Geo*

Requests to be informed  
how to obtain colored servants.

*M. W. C. S. No 126*

WASHINGTON, APR 9 1867

Respectfully referred to  
Lt. Col. *W. M. Beebe, Jr.*  
Local Agent, D. C.

By Order of  
Bot. Brig. Gen. Howard

*W. M. Beebe, Jr.*  
A. A. G.



WRAPPER Enclosures

Received, Bureau R.F. & A.L., April 8 1867.

*Re P. O. S. C. 345 M. 7/1/67*



*F 32* (R. F. & A. L., Vol. *9*.) 1867  
No 1578 A. G. C. 1867  
Otego, N. Y., 1867  
April 6. 1867.

*Pilkinton - Geo Jas*

Requests to be informed  
how to obtain colored servants.

*M 170 214 (A. G. C. 1867)*



WRAPPER Enclosures

Received, Bureau R. F. & A. L., April 8 1867.

*A. G. C. 345 M 4772*

WAR DEPARTMENT,  
Bureau Refugees, Freedmen, and Abandoned Lands,

WASHINGTON, April 8. 1867.

Respectfully referred to  
the Asst Commissioner for the  
District of Columbia.

By order of  
Major General Howard,  
*A. P. Ketchum*  
Bot Lieut Col., a. a. g.

WASHINGTON, APR 11 1867

Respectfully referred to )  
Lt. Col. W. M. Beebe, Jr.  
Local Sup't. D. C.

By Order of  
Bot. Brig. Gen. Howard

*W. M. Beebe, Jr.*  
A. A. G.

Albany, Otsego Co  
N. Y.

Gen. Howard.

Dear Sir.

In behalf of a number  
of our most respectable  
Farmers in this commun-  
-ity I write you for direc-  
-tions as to the best  
method of obtaining  
some good, industrious  
freedmen for farm  
labors here.

We can warrant them  
good homes - good  
wages, & kind treatment  
from reliable, trustworthy  
men. There are quite  
a number around here  
now, but more are  
wanted. We want at  
least eight or ten more.



[Faint, illegible text, possibly bleed-through from the reverse side of the page. The text is mostly obscured by a large diagonal shadow and various dark spots.]

We prefer to have  
young men & women  
of the ages of 15 to 22 or  
so.

Will you be kind  
enough to help us, Sir,  
if possible send us  
three men & five  
women, & we will  
warrant them good  
treatment & good  
wages as before stated.

We have already  
sent for quite a colony  
but received only part,  
the rest being taken  
up in New York City.

We would like them  
sooner as possible to com-  
-mence spring work.  
Please help us, & very  
much oblige.

Apr. 6  
1867)

Yours &c.  
John A. Kenton  
Pastor M. E. Church.



MS. A. 9. 77

We prefer to have  
young men & women  
of the ages of 15 to 22 or  
so.

Will you be kind  
enough to help us, Sir,  
if possible send us  
three men & five  
women, & we will  
warrant them good  
treatment & good  
wages as before stated.

We have already  
sent for quite a colony  
but received only part,  
the rest being taken  
up in New York City.

We would like them  
sooner as possible to com-  
-mence spring work.  
Please help us, & very  
much oblige.

Apr. 6  
1867

Yours &c.  
John A. Kenton  
Pastor M. E. Church.

L. R. Vol. 2 No. 155 A. C. D. C., 186

Bureau Refugees, Freedmen, & Abandoned Lands

Head-Quarters Asst. Commr., D. C.,

WASHINGTON, April 9<sup>th</sup> 1867.

Respectfully referred to Lt. Col.  
W. M. Beebe, Jr. Local  
Supt. G. C.

By order of  
1st Brig. Genl. Howard

*A. A. A. Genl.*  
A. A. A. Genl.

*2 1/2 1/2 2 1/2 C. L. 1/2 1/2 1/2*  
(Wrapper *One* enclosure)

*W. M. C. L. 3.45 P.M. 4/9/1867*

Received A. C. D. C. 4/9 1867.



Miss J. F. A. Dwyer

Franklinville, N.C.

April 3rd 1867.

Dear Madam, &c.

States that John H. Lee Capt. of Engineers in the U.S. is still desirous of securing the services of four colored persons - two men + two women, and is willing to pay their fare from Washington to their home etc.

Subj. Bureau of P. O. & A. S.,  
Washington, April 8th 1867.

Respectfully referred to Prof. Brig. Genl.  
C. H. Rowan, West. Comd. District of Columbia.

In order of  
Maj. Genl. C. H. Rowan.

A. P. Kitchum  
Act. Comd.



Enc. sent to B.

that a good home to their number for several years, & pay such wages as is current here among farmers for such services - say from \$10 to \$20 per month for the men & \$6 to \$8 per month for the girls. I have no hesitation in guaranteeing good treatment, and some fragments while they should remain.

Would the men & women be found - for he would not want the one, without the other - please send them to Hinsdale, a station on the New York Erie Railway - served by Penn<sup>a</sup> Northern Central RR to Elmira - then west on Erie Railway to Hinsdale - Writing to him this a three days, before they should have been sent by rail - Address him in my care at this place. Do he could send



at the Station & take to his home some  
14 miles from the Railway.

- If the Government is not furnishing  
transportation for Freedmen now, by  
giving him notice he would pay  
their fare.

Please let me hear from  
you at earliest convenience

I remain Yours

Very respectfully Yours

H. [Signature]

Franklinville N.Y.

April 3. 1867

May Genl C. C. Rowan

Chief "M. Bureau" etc

Genl.

Some days

before leaving Washington D.C.  
my friend John St. Sackett of  
Farmersville Cattaraugus Co. N.Y.  
wrote me about securing the  
services of 40 Negroes - two men  
and two women, for him. I forwarded  
the letter to your Bureau, containing the  
qualifications desired, but when  
I left, your office in charge of the  
Labor Dept, had not been able  
to fill the request - I write now  
to say that Mr Sackett still desires  
the help, and to say that he would  
pursue steady employment on



711, 710, 22, 07, 1867

Hartford, Ct. 629  
Apr. 5 1867

Dan's Reply

States that wages for  
farm hands will be  
from \$12 to \$15 per month  
according to their abilities

Dear Sir  
I received your letter of the 1st  
inst. and in reply to inform you  
that the wages for farm hands  
will be from \$12 to \$15 per month  
according to their abilities. I  
am sorry to hear that you  
are having trouble with your  
farm hands. I am sure that  
if you will be patient and  
kind to them, they will be  
willing to work for you.  
I am, Sir, your obedient  
servant.

711, 710, 22, 07, 1867



they have much to learn and  
they ought to consider the  
education they get by coming  
here to be worth something  
comparable to them

I shall be very glad if the  
order sent to my father  
(which is now safe to you),  
can be filled and the greatest  
number of good faithful men  
be sent forward

Yours truly  
Henry Davis  
Waltham



M 1<sup>st</sup> 220, O.L.S. No 630  
Washington Apr 9<sup>th</sup> 1864.

Brown Maj J. M.  
A. G. M.

I have recd receipt  
for \$80<sup>00</sup>. Rent money  
for tenements occupying  
rooms at Wiscnell Factory

W. O. L. S. No. 417 1864.

Bureau Refugees, Freedmen, and Abandoned Lands,

Received at Washington D.C. this 9<sup>th</sup> day of April  
1867, from Wm. M. Bledsoe  
1000 dollars and  
00 cents, on account of the Refugees' and Freed-  
 men's Fund, for which I am accountable at the Treasury of the  
 United States. Wm. M. Bledsoe  
Wm. M. Bledsoe  
Wm. M. Bledsoe

\$ 80 <sup>13</sup>/<sub>100</sub>



W/M 221, O.L.D. 109, 632

Washington, Apr 11 1867  
Vol 2 No 1619, A.C. G. C. 1867  
District, D.C.

Chief Agent

States that Sarah Ed-  
wards, etc. desires the  
assistance of this Bureau to  
enable her to go to the home  
of Joseph Lawrence near Wilt-  
ingham. Price Geo to Mr.  
+ return, for the purpose  
of getting her child who is  
with Henry Barrett, etc.

The cost of transportation  
there + return with her  
to home. States that transport-  
ation to Providence R.I. is now  
ready for Sarah, + she wishes  
to go as soon as she can get  
her child.

re O.L.D. Dec. 4/11 1867

W/M 243, O.L.D. 109, 1867

Office Local Supt. D.C.  
Washington April 11 67

Respectfully forwarded  
recommending that the  
price of transportation to  
Hollingham + return \$4.00 -  
may be furnished from the  
Special Relief Fund.

W.M. Rube  
S. Coe, Local Supt. D.C.

Receipt for Money  
within -  
1-13-1867

W/M 246, O.L.D. 109, 1867

apt  
Bureau  
Head-Office, Asst. Commr., D.C.,  
WASHINGTON, APR 11 1867

Respectfully returned  
Approved

By order of  
Dr. B. J. Jewett  
A. H. Rogers  
A. A. G.



Bureau R. F. and A. G.  
Employment Office Roosevelt Barracks  
Washington D. C. April 10<sup>th</sup> 1864.

Lieut Col. J. M. ...  
Local Supt. ...  
Bureau R. F. and A. G.

Colonel

Sarah Edwards

... assistance in the Bureau  
to enable her to go to the farm of Mr. Joshua Turner near ...  
... of ...  
...  
Sarah states that the distance to Nottingham  
is about twenty five miles ...  
the stage ...

Sarah's husband went to ...  
...  
... who ...

Very Respectfully  
J. M. ...  
Employment Agent.



*(4100)*

Rec<sup>d</sup> L Washington, Dc April 13<sup>th</sup> 1867, from  
Wm Beebe Jr. Local Supt. Dc. Four  
144<sup>00</sup> Dollars of Special Relief Fund, to  
pay Stage fare from Washington, Dc. to  
Nottingham, Nc. & return.

Sam<sup>l</sup> Edwards

Witness  
J. C. Abach  
Clerk.



Vol 2 No 169 of A. G. O. 1867  
634

WASHINGTON, APR 11 1867

H. Col. Prue will  
please issue the  
messing clothing  
to the within named  
boys on their  
presenting themselves  
to his office for  
that purpose -

W. H. Howard

Major, 3rd

*Vertical handwritten notes on the right margin, including the name "C. H. Howard".*

EX 190240, O. L. S. #4-1867

Ms. O. L. S. No. 330, 4/11/67 749 880 276241 124



Ms. A. 9. 2. 22, O. L. S. 634, 1911/11/17, 1867

Ms. A. 9. 2. 22, O. L. S. 634, 1867

Mr. J. H. Frank  
that for the  
the office for  
according to the  
copy on the  
to the court record  
necessary & things  
Please inform the  
J. H. Frank with

RECEIVED  
APR 11 1867

Ms. A. 9. 2. 22, O. L. S. 634, 1867

Ms. A. 9. 2. 22, O. L. S. 634, 1867



Francis

National Comm. School, etc

Washington, April 1, 1817

Dear Sir

I have the honor to acknowledge your kind letter of the 27th inst. in relation to the National Comm. School, & in answer to inform you that I have the honor to attend me.

The Board of the Comm. are now engaged in the consideration of your petition, and will be happy to hear from you in a few days. I am, Sir, your obedient servant.

Yours truly, J. C. Calhoun

- John C. Calhoun 10000
- William L. Garrison 10000
- Samuel May 10000
- William Lloyd Garrison 10000
- Edward Davis 10000
- Samuel May 10000

Very truly, your obedient servant, J. C. Calhoun



Tennessee

National Farm School, etc

Washington April 1, 1877

Dear Sir

I have in addition your name in connection with the National Farm School, and I am very interested in it.

The land, at the National Farm School, is a very valuable one, and it is a great pity that it is not better cared for. I have a great interest in the National Farm School, and I am very interested in it. I have a great interest in the National Farm School, and I am very interested in it.

One million of dollars is to be given to the National Farm School.

Yours very truly

U. S. President

William D. Boyce - 10 years

George D. Boyce - 1 year

William D. Boyce - 10 years

Edward D. Boyce - 1 year

Samuel D. Boyce - 1 year

Respectfully, for your interest in the National Farm School.

You made me to come out and judge for  
yourself of the propriety of his children  
It is all a matter of course and I suppose it was  
not for her - and I suppose you were  
after them in the first instance.

I have a journal of the proceedings of  
the Committee of the House

of the House of Representatives  
which I have been ordered to  
publish.

Wm. G. Howard

Ms. A. 9. 2. 308/4/17  
Ms. A. 9. 2. 308/4/17  
Ms. A. 9. 2. 308/4/17

Ms. A. 9. 2. 308/4/17

Ms. A. 9. 2. 308/4/17  
WASHINGTON, APR. 11 1867

Mr. Genl. B. B. Wick

Please inform the

Necessary of things

to the within named

bag in the

presenting the money

to his office for

that purpose -

Wm. G. Howard

Ms. A. 9. 2. 308/4/17

Ms. A. 9. 2. 308/4/17



700 1700 225, O. S. N. 65

Washington, April 12 1867

Agenc. Wash.  
Waagen

States that the Town-  
Land is directed to employ  
3 Men. to find all bearings  
at Camp Keopth, R. G. B. B.  
7 1/2 in. and be placed on  
the roll at a cost not  
to exceed \$20. for month  
of one year.

R. O. S. R. M. 4/12/1867

Bureau Refugees, Freedmen, and Abandoned Lands.

Headquarters Ass't Commissioner, District Columbia,

Washington, April 12<sup>th</sup>, 1867.

Dear Col. M. M. Beck jr.

Dear Major G. C.

Dear Sir:

All of your men have been  
discharged except those who are kept up here -  
men at Campbell Hospital. The kind of  
Green Berets of the 38<sup>th</sup> and 39<sup>th</sup> regiments  
should show their names to you on your rolls  
and monthly reports as well as the  
company letter 38<sup>th</sup> and 39<sup>th</sup> regiments.

Very respectfully

Yours at least a man

W. P. Rogers

J. T. J. Sewell

L. B. V. 3. 99.



771742796 L.S. 118691

Philadelphia Penn April 11 '67

Stephens, Geo. E.  
1122 Locust St.

A knowledge recd of  
communication from Col  
Beale, stated that he had per-  
fected the necessary ar-  
rangements with the Union  
of House of Industry, in which  
both men, women, & or-  
phans be sent from by the  
14<sup>th</sup> inst.

Winn, April 11 1867

St. Geo Wm, Beale  
Local Supt. N. F. U. S.

Col. I have the honor to acknow-  
ledge the receipt of your letter of April 3<sup>rd</sup>  
in reply to mine of "Mar. 28" and  
will say, I have perfected arrang-  
ments with Mrs. Harman  
the matron of the "House of In-  
dustry" and she will receive  
any <sup>Freedmen</sup> persons, sent to my order  
who are cleanly, and decently  
clad. And I pledge on my part,  
to procure remunerative and perma-  
nent employment for all healthy  
persons. I have just returned from  
a flying trip through Lancaster and  
Chest. Counties in this State, and the  
demand for labor of this kind

Re C. L. S. 9. (118) 1867.

of the ~~case~~ ~~flow~~ ~~now~~, is very great.  
I therefore most respectfully re-  
quest that

4 Ten (10) men

4 Ten (10) women

4 Ten (10) Boys

4 Ten (10) Girls be sent  
to the <sup>55</sup>House of <sup>59</sup>Industry on the 1<sup>st</sup>  
instant - & <sup>59</sup>Capitulate that I should  
be able to furnish them immediate  
Employment

I remain very respectfully  
Yours Obedt Servt,

Geo. E. Steptoe

1122 Second St.

D. W. C.



7001 W 22nd St. C. S. W. 10401

Washington. Apr 17 '69

Griffing Miss J. E.  
Agent.

Act upon receipt  
of 50 Blank Descriptive  
Lists

W. C. S. 10401-12 1007

394 A Copy 11.

Washington D.C. Oct 12/17

At Col W M Beckler

Local Dept D.C. Bureau Repre

Sir

I have the honor to acknowledge  
the receipt of fifty (50) Blanks of Receipts List  
for Fuel people -

Very Respy.

Your Obedt

J. E. Guffey

Empst agt



647

Washington. Apr 12<sup>th</sup> 69.

Wall O.S.B.  
Emp Agent.

Acknowledgement  
Gift of 50 Blank De-  
scriptive Lists.

7111 Vol 224, O.S.B. No. 1041.

No. O.S.B. No. 11-12-107

Employment Office  
Room 1400 S  
Washington  
April 12<sup>th</sup> 1917

Received this day of Lieutenant  
Col. Wm. W. Beets (3d) Herb  
Rescriptive List, for use  
of this office

O. S. Anwar  
Employment Office



W1102 (R. F. & A. L., Vol. 4) 1867.

710 C. 2. 1131  
Whitehall, Washington C. D.  
Apr 10 1867

Martin A.

Wants two good colored servant girls.  
at from \$6. to \$8. per month

710 C. 2. 1131, O. L. S. 10 9 6 4 2

WRAPPER (.....) Enclosures.

Received Bureau R. F. & A. L., April 12, 1867.

WAR DEPARTMENT,

Bureau Refugees, Freedmen, and Abandoned Lands,

WASHINGTON, April 12, 1867.

Respectfully referred to Brig Genl  
Chas. Howard, Asst. Commissioner  
District of Columbia.

By order of  
Maj Genl. O. O. Howard

A. P. Retchum  
at. at. at. General.

WASHINGTON, APR 11 1867

Respectfully referred to Lt.  
Col. H. L. ... in Local  
Dept. L. Y.

By order of  
Col. Brig. Genl. Howard

Amos Rogers  
at. at. at. General.

NOV 18 1892

Mrs. L. G. S. Wain

NOV 18 1892  
1892



Whitehall  
Huntington County  
of N.Y.

Frederick Beaman

I want two colored servant  
girls that can cook, wash and  
iron, milk & sew & do some  
house work One for myself  
& One for my neighbor who  
live in the Village & have  
small families wages here  
from 6 to 8. , Month  
Please send them all  
One of your care

Respectfully yours,  
F. Martin

No 14 (224, O.L.S. No 643,  
Washington, April 11/67

Raymond W. H.  
A. A. A. Genl.

Orders that (inserted  
above be requested for  
Robert Harris, a Pittsburg  
Pa. & that quantities  
now be furnished twice  
monthly as ordered.

No. O.L.S. DC. 4/11/67



MAR 1897

Rec'd C. L. S. D. C. 4/11<sup>th</sup> 1897

Bureau Refugees, Freedmen, and Abandoned Lands.

Headquarters Ass't Commissioner, District Columbia,

Washington, April 11th, 1867.

Lieut. Col. Wm. M. Beebe  
Local Supt of  
Col.

The Assistant  
Commissioner directs that you make  
application for transportation for Robert  
Harris, from this City to Pittsburg Pa.,  
and that you furnish said Harris quarters  
and subsistence until such transportation  
is received.

Very Respectfully

Wm. Rogers

A. A. A.

L. B. V. 3. 9d.



Bureau Refugees, Freedmen, and Abandoned Lands.

Headquarters Ass't Commissioner, District Columbia,

Washington, April 11th, 1867.

Lieut. Col. Wm. M. Beebe  
Local Supt. of  
Col.

The Assistant  
Commissioner directs that you make  
application for transportation for Robert  
Harris, from this City to Pittsburg Pa.,  
and that you furnish said Harris quarters  
and subsistence until such transportation  
is received.

Very Respectfully

Wm. M. Rogers

A. A. A. 1

L. B. V. 3. 9d.

Office Capt. Cass Garrison

Washington D.C.

April 12<sup>th</sup> 1867

Lt. Col. W. M. Beebe Jr.

Local Supr. D.C.

Colored.

Mr. Harris who claims to be father of the boy, <sup>whom</sup> I took to your office yesterday called on me last evening and produced a note from one Ru Levi Keller by which it appears that Mr. Harris was married to S. Stephenson (the boy's mother) on the 24<sup>th</sup> day of Jan. 1857 - Harris says the boy was born nine months after said marriage which would make the boy 9 years old last Oct.

The boy says he is 14 years of age and all who have seen him are satisfied that he is correct - The boy informed me that his Grandmother's name was Bell, afterwards Robinson by 2 marriages -

In my first conversation with Harris he gave me to understand that the boy was



NARRATIVE  
an illegitimate child, afterwards he made  
the statement as before mentioned and  
also added that his wife's mother had  
been married three times & that her first  
husband's name was "Stephinsen" &c

Miss Allen who has been the boy's teacher  
for several months says, the boy is very  
intelligent, but ~~not always truthful~~, that  
she regarded his untruthfulness as resulting  
from the society with which he was treated  
at home - says she has often been informed  
of Harris' cruel treatment towards the boy &c

Thus came in & stated that Harris  
in their opinion had been ~~connected~~ with the  
boy - they were however dependent upon  
Harris, living in his house & did not  
wish to say much, but had previously consulted  
themselves & Miss Allen & others -

Harris has some papers which  
represent an Ex-party Administration in  
getting the boy from his friends - also  
a note clipped from News-paper which is  
mere gossip & really ~~proves~~ nothing.  
I do not think the man ought

To have charge of the boy - & yet it is my judgment that you will do well to write his friends before sending him to Pillsbury -

Please excuse me for intruding myself in this matter I do it simply from the fact that parties called on me last evening whom I drew out foregoing facts & ~~inferences~~

Very Respectfully  
Yours Obedt Servt  
J. A. Roberts  
Sup<sup>r</sup> -



Washington. Apr. 12<sup>th</sup> 1867.

Robert Rogers L.  
D. D. H. & C.

Acknowledges receipt  
of 50. Blank Descriptive  
Cards.

W. H. C. L. S. H. & C.

W. H. C. L. S. H. & C.

Office Supr. Surg. Capt. Barnard  
Washington D.C.

April 12<sup>th</sup> 1867

Recd. from Office Local Supr. D.C. - 50 copies -  
Description List Bluggs -

J. L. Roberts

Supr. &c



Office Supr. Eng. Capt. Baruch  
Washington D.C.

April 12<sup>th</sup> 1867

Recd. from Office Local Supr. D.C. - 50 gifts -  
Description List Blanks -

J. Roberts  
Supr.

Mr 1 Mr 226. O.L.S. Dec 1861

Washington April 1867.

Royce Wm H.

A. A. A. Genl.

States that Mr E. L. Mahone, of Vicksburg Miss has filed the necessary papers at that office & has deposited his son in power of A.A. & that all necessary assistance be rendered them in procuring help.

1201 P. O. Box 11271  
4. 1867



NARRATIVE  
General Hospital, Freedmen, & Abandoned Lands  
Head-Quarters Asst. Commr., D.C.,  
WASHINGTON, APR 1 1867

Colonel. Am M. Beebe.  
Local Sup't D.C.,  
Colonel.

E. F. Mahone of Vicksburg  
Miss having filed satisfactory papers  
at these Head Quarters, and deputed  
his son W. F. Mahone by power of  
Attorney to act for him in this District  
in procuring 100. freed people as  
laborers on his plantation in Mississippi.  
The Assistant Commissioner direct. Chd.  
you render him assistance in securing  
them and when obtained make applica-  
tion for their transportation, accompanied  
by the necessary papers, regard in such  
Cases.

Very Respectfully  
H. H. Royer

Recd O. L. S. D. L. 4<sup>th</sup> 1867

State that Mr. E. F.  
 Haskins of Boston, Mass.  
 has filed this morning for  
 at that office in and about  
 to be in favor of all  
 that will necessarily be  
 distance he would think  
 no necessary help.

Washington April 1867  
 Roger Smith  
 A. A. A. Grant

Ms. A. 9. 2. 2. 1. 15



Vol 2 No 1410 A.C.D.C. 1867

Washington D.C.

March 20 1867

Pratt

H. D.

I understand that  
Sally Miller's  
deceases to provide  
for a suitable family  
M/W 226, O.L.S. D.C. 1867

Completed with



MAR 26 1867

SP/ M/W 226, O.L.S. 1867  
Beard Key Fund

U.S. D. C. No. 230, 14, 1867

Ms: Vandenberg  
will please give  
order for  
supplies to the  
amount of <sup>ten</sup> ~~five~~  
dollars, with the  
hands of the  
woman Mr. M. H.  
Miller - Will  
also visit the  
family of Wesley  
Conaway (Judman)  
and arrange for  
Mrs. Conaway (paralyzed)  
to go to the Hospital  
and that the children  
be sent to Howard  
St. B.S.

Post Letter

TREASURY DEPARTMENT  
Treasury Department.

March 26 1867

Sir

Permit me to introduce to you Mrs  
Jellie Miller widow of the late S M Miller  
for so many years Secy. of our City Bible Soc.  
She desires aid for a destitute family - She is  
worthy of all confidence -

Very Respectfully

J. Pratt

Jef  
Major Gen. O. Howard  
Washington D C

E  
M



Washington, Feb 4<sup>th</sup> 1877

Dear Mr. M.

A. A. A. Clerk

Under attention of  
letter from Mr. M. in  
reference to A. A. Clerk  
regarding a change  
of membership. It  
is a great trouble and  
the only way of settling  
it is to have a conference  
with the Board of Trustees  
in person.

M 1 vol 227, O. L. S. No. 650

Rec'd O. L. S. L. C. 3-7-1877

Bureau Refugees, Freedmen and Abandoned Lands,  
Headquarters Ass't Commissioner, District Columbia,

Washington,

, 186

had been expected to leave two days  
previously. He desires that you  
will give this matter special at-  
tention, designating some other  
agent, if the present one, is not  
competent and efficient.

Respectfully

Your obedient servant

*P. H. Rogers*

a. a. a. General.

Lieut Col N. M. Bube Jr

Local Superintendent



BUREAU OF REFUGEES, FREEDMEN AND ABANDONED LANDS,  
Headquarters Ass't Commissioner, District Columbia,

Washington, March 7, 1867.

Colonel

The Asst Com<sup>d</sup> directs me to  
invite your attention to letter from  
this office dated Feb. 26. 1867 suggesting  
that A. P. Clark, be directed to superintend  
the matter of departure of parties of  
freed people going north, and filling out  
their transportation orders. He  
suggests further that if Mr Clark has  
charge of this business - or, if any  
other agent has been designated - that  
he be held responsible for the collecting  
of the people in season <sup>arranging</sup> and "other  
necessary preliminaries so that they  
shall leave the city as soon as their  
transportation is secured.

The Assistant Commissioner  
has been particularly annoyed at  
finding parties still in town that

650



17924, O.L.S. 70659

223 J. G. A. L. Vol 9 1867

Vol. 2, 1865, 1866, 1867

Washington

April 8, 1867

Soldiers' Home

Levi Davis, Secretary

Board of Commissioners

Reports that the Commission-  
ers have decided that Mrs.  
James Conway, a discharged  
soldier, is not entitled to enter  
the Home

War Department  
Bureau of R. F. & A. S.

Washington, April 13, 1867.

Respectfully referred (this Asst. Comm-  
District of Columbia) to Col. Beebe  
Local Supt., by whom the application  
in this case was forwarded.

By Order of  
Maj. Gen. O. O. Howard.

A. P. Kitchin

A. C. General.

Head-Quarters Asst. Commr. D.C.

APR 15 1867

Respectfully transmitted to  
Lt. Col. W. M. Beebe, Local  
Supt. D. C.

By Order of  
Maj. Gen. O. O. Howard.

J. H. Rogers  
A. C. General.

W. O. S. D. C. 4 PM. 4/15/1867



Office of the Board of Commissioners of the Soldiers' Home,  
ROOM No. 13 WINDER'S BUILDING,

Washington, D. C., April 8, 1867.

Major General O. O. Howard,  
U. S. Army,  
Commissioner of the Bureau of P. & A. L.  
Washington, D. C.

General.

I have respectfully to inform you, that the Board of Commissioners of the Soldiers' Home, have had under consideration the application forwarded with your approval, for the admission of James Conroy, a refugee and discharged soldier of the U. S. Army, to the benefits of the Home, and decided, that he is not entitled thereto, and consequently cannot be admitted.

I have the honor to be,  
General,

Very Respectfully,  
Your obt. Servt.

Levi Davis.

Sec. to the Board of Commissioners.



MAR 1867

W.M. 229, O.L.S. D.C. No. 656

Washington Feb 1<sup>st</sup> 1867,

Regent W<sup>m</sup> W.

A. A. A. Genl.

Mrs L. M. E. Rich  
Matron. Col<sup>l</sup> Home. Freedom  
upon being relieved by  
Miss Lydia J. Stett will  
report to Col Beebe for  
duty at Camp Agt. D.C.

C.O.S. 2-1-1867

MI W 229, O. L. S. D. No. 656

Washington Feb 1<sup>st</sup> 1867,

Regent W<sup>m</sup> W.

A. A. A. Genl.

Mrs L. M. E. Ricks  
Matron. Col<sup>l</sup> Home. Freedmen  
upon being relieved by  
Miss Lydia J. Stett will  
report to Col Beebe for  
duty as Sup<sup>t</sup> Agt. D. C.

Re O. L. S. 2-1-1867



NARR 1867

Bureau Refugees, Freedmen, and Abandoned Lands.

Headquarters Ass't Commissioner, District Columbia,

Washington, February 1<sup>st</sup> 1867.

Special Orders,

No 15

(EXTRACT.)

2. Mrs L. M. E. Ricks Matron of the Home at Freedmens Village on being relieved by Mrs Lydia J. Stull, will report for duty as an Employment Agent to Lieut Col. William M Beebe Local Superintendent. D.C.

By order of Brevet Brigadier-Gen. C. H. HOWARD.

A. A. Rogers

A. A. Adj. General.

Lieut Col. William M. Beebe

Local Superintendent

D.C.

M. 1302 229. O. L. S. D. C. N. 657

Washington. Feb 4<sup>th</sup> 1867

Rogers D. W.

A. A. A. Genl.

Mr S. M. E. Ricks  
is hereby discharged from  
duty in this D. W. to  
take effect from date.

Re O. L. S. 2-4-1867



Bureau Refugees, Freedmen and Abandoned Lands

Headquarters Ass't Commissioner, District Columbia,

Washington, February 4<sup>th</sup>, 1867

Special Orders,  
No. 16

(EXTRACT.)

1. Mr. L. M. E. Ricks, is hereby discharged and relieved from duty in this District, to take effect this date

By order of Brevet Brigadier Genl. C. H. HOWARD,

*Wm. Rogers*

*Genl. Wm. McRae*

*Genl. Superintendent*

*Mc*

A. A. A. General.

**MICROCOPY**

**1902**

**ROLL**

**15**



# IMAGE EVALUATION TEST TARGET (QA-3)

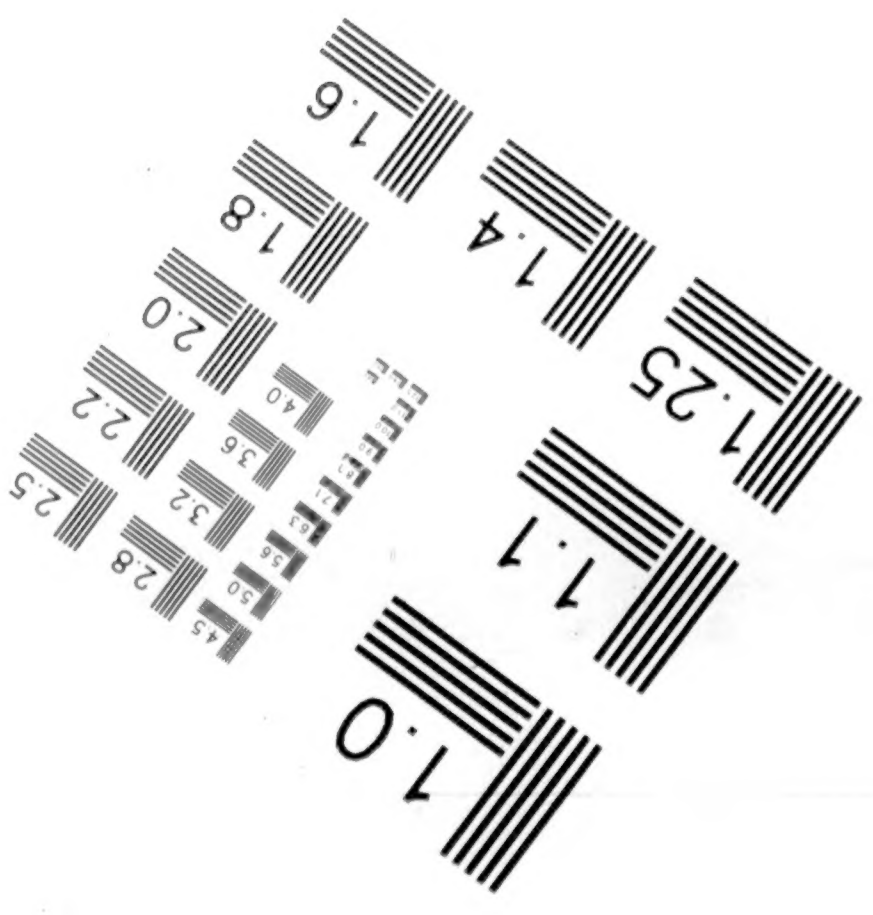
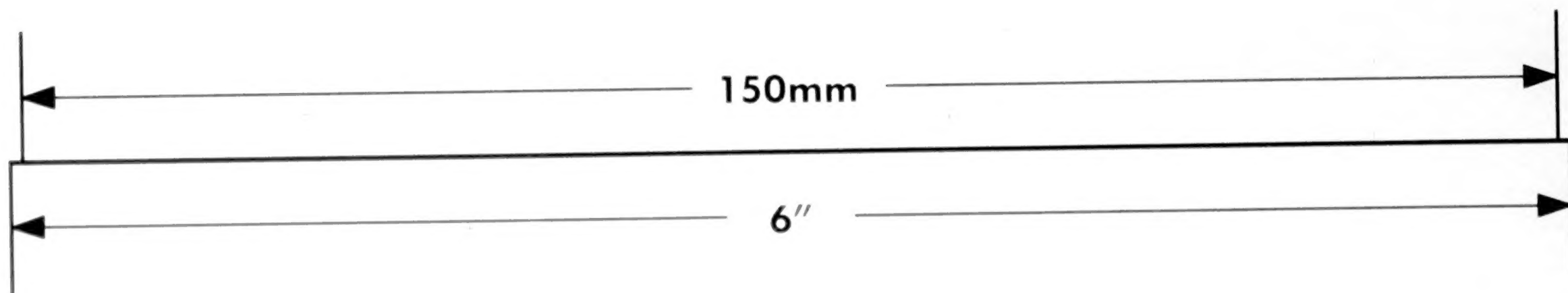
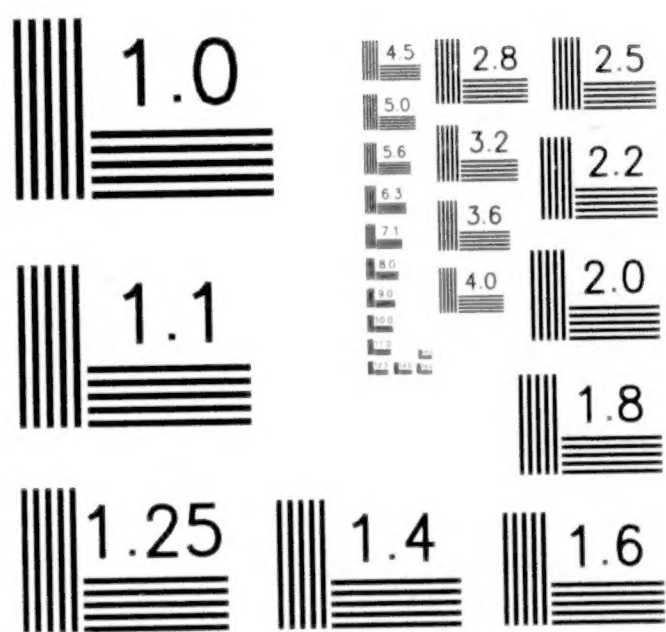
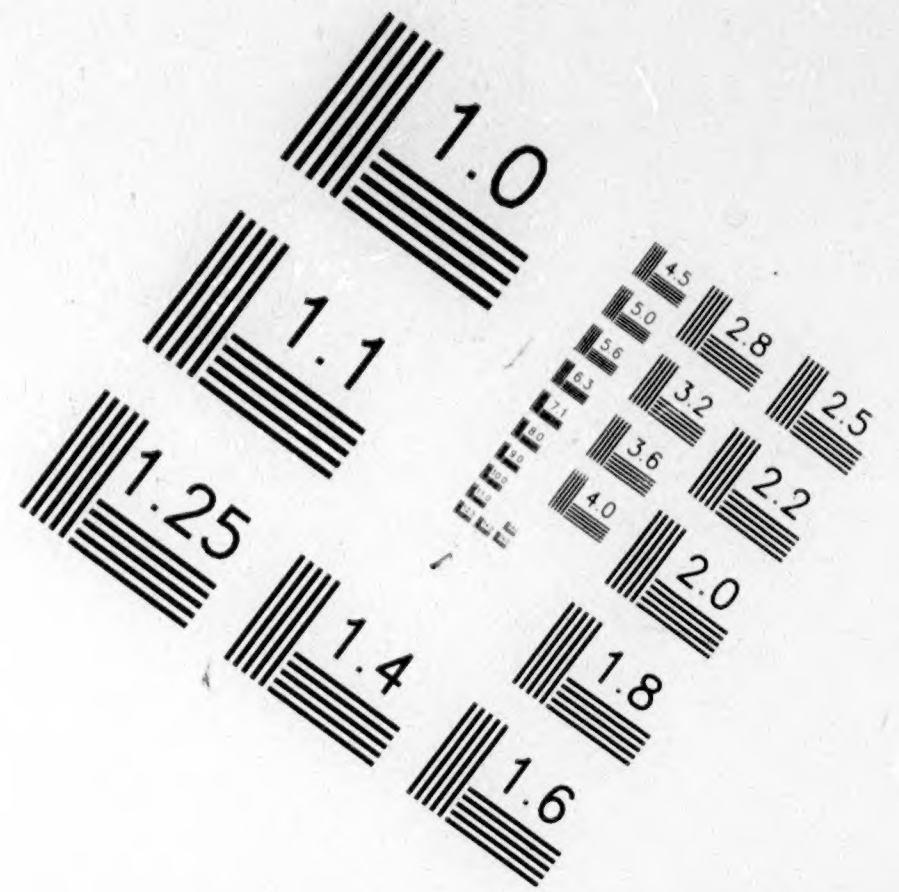
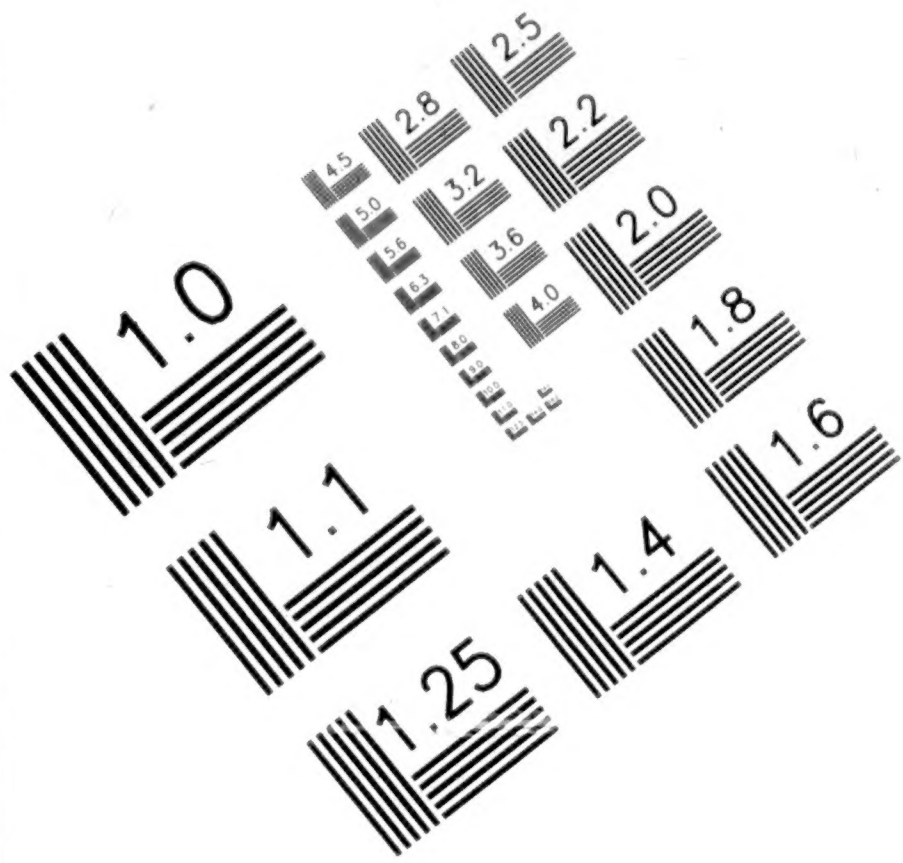

**APPLIED IMAGE, Inc**  
 1653 East Main Street  
 Rochester, NY 14609 USA  
 Phone: 716/482-0300  
 Fax: 716/288-5989

© 1993, Applied Image, Inc., All Rights Reserved

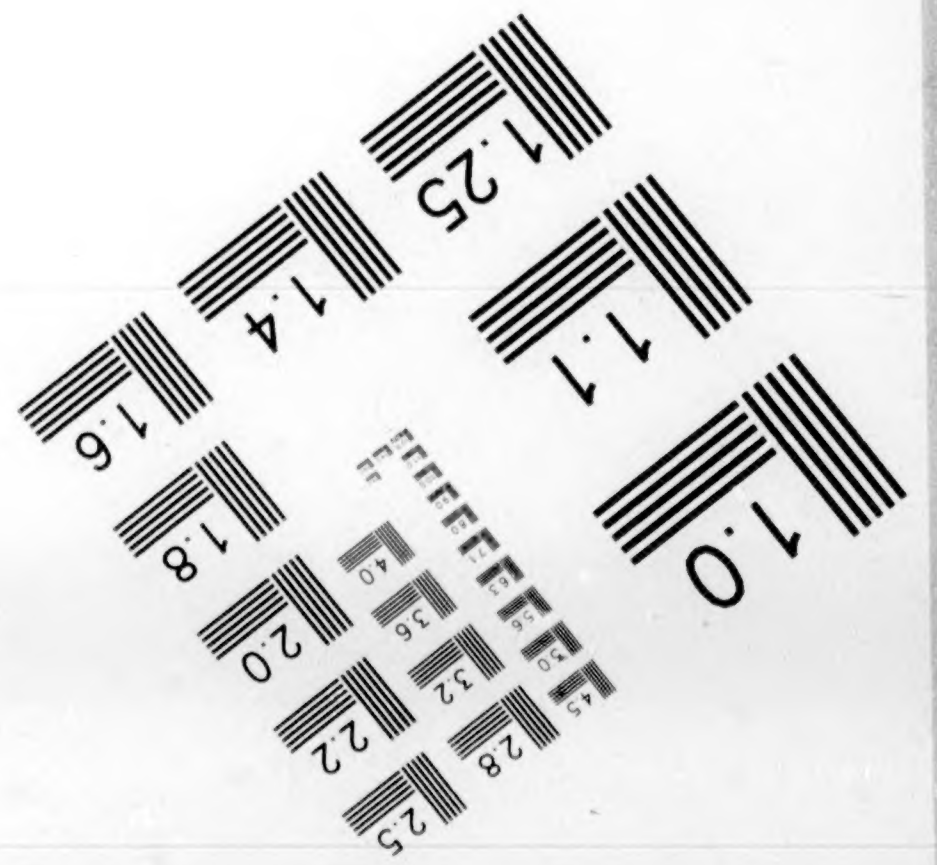



END OF ROLL

PLEASE

REWIND



