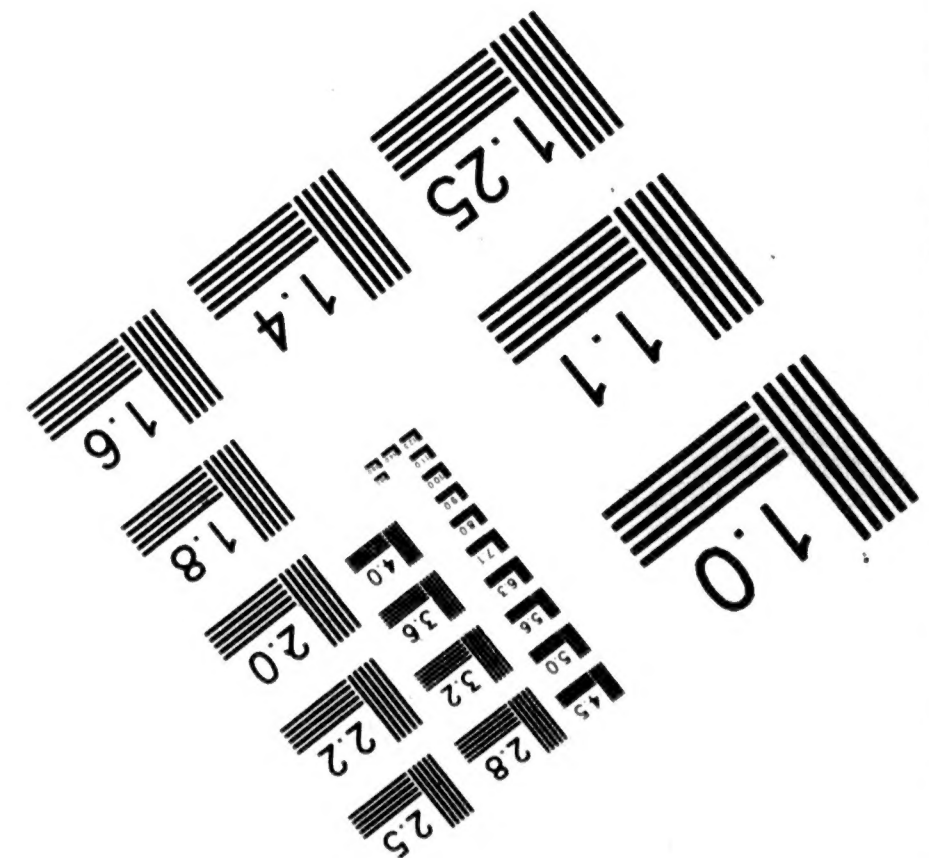
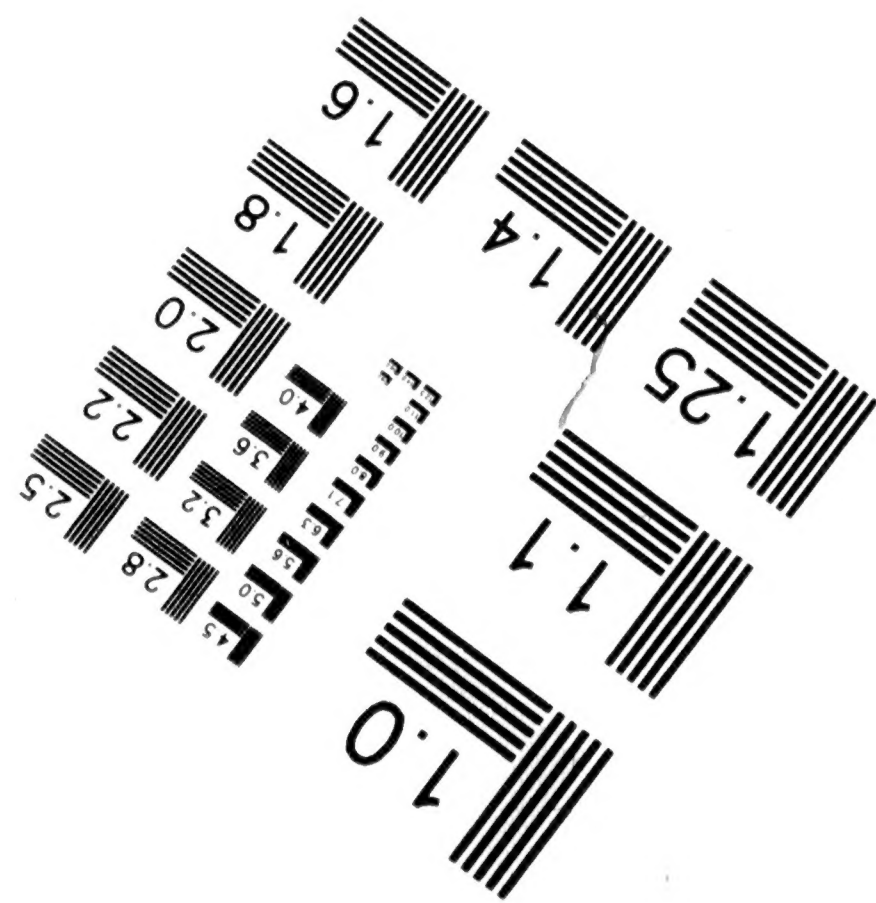
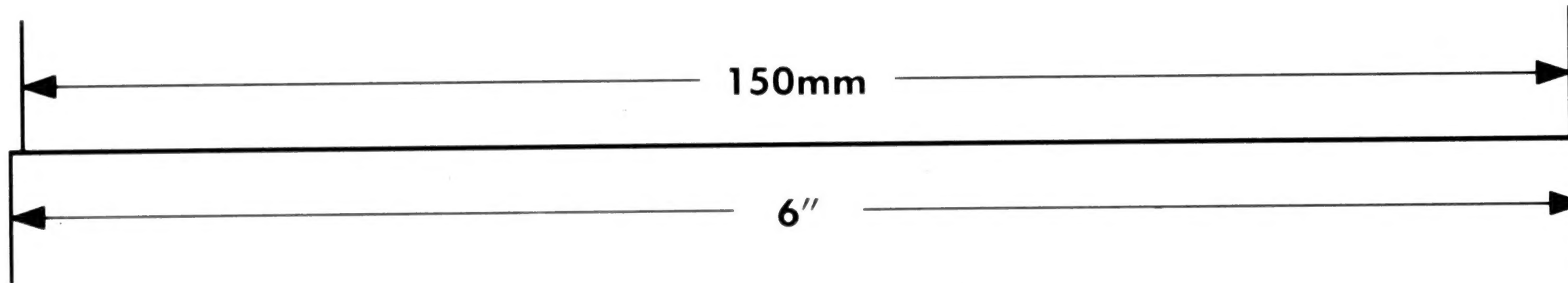
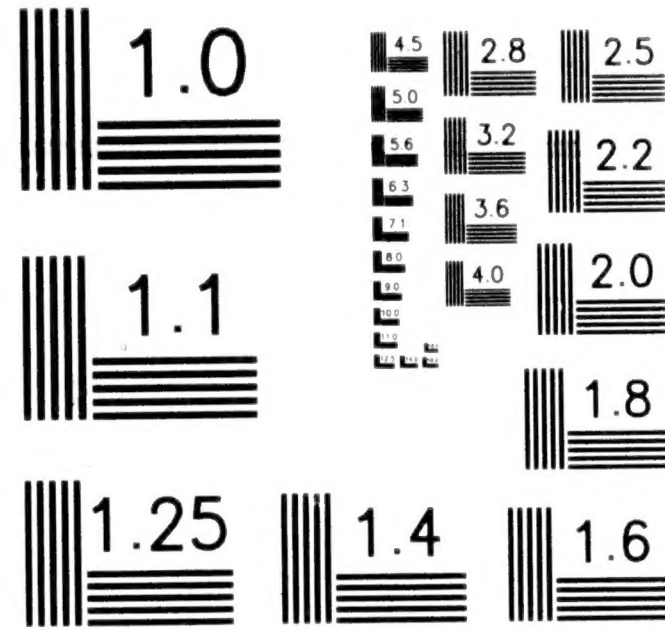
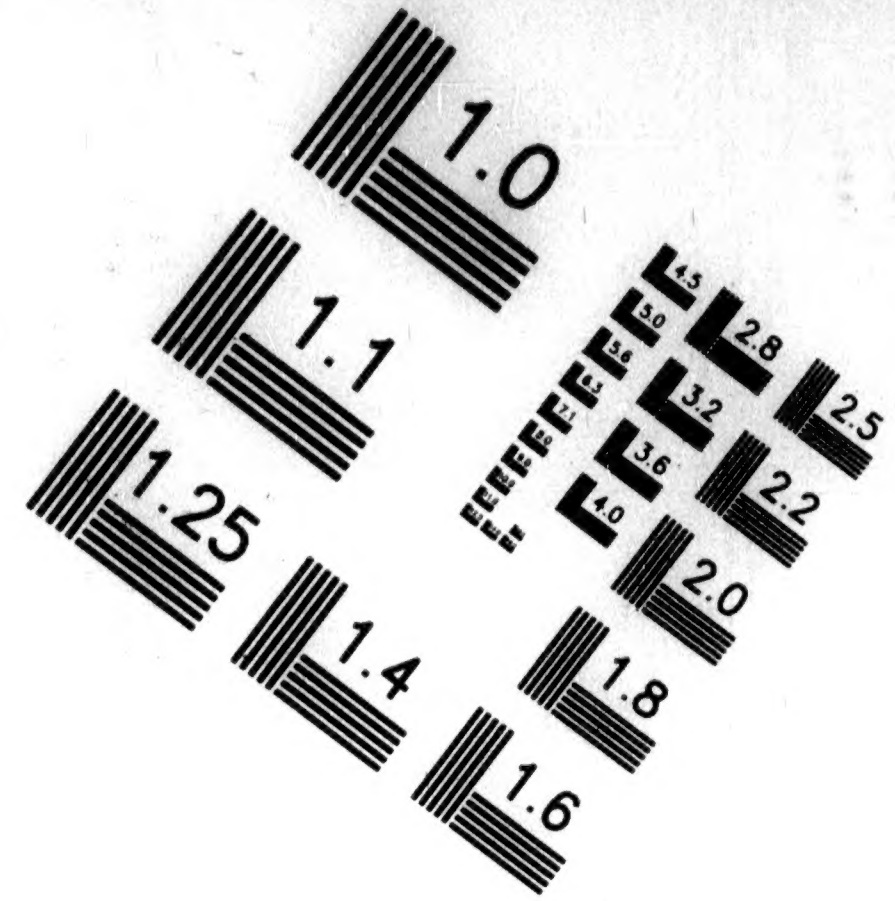
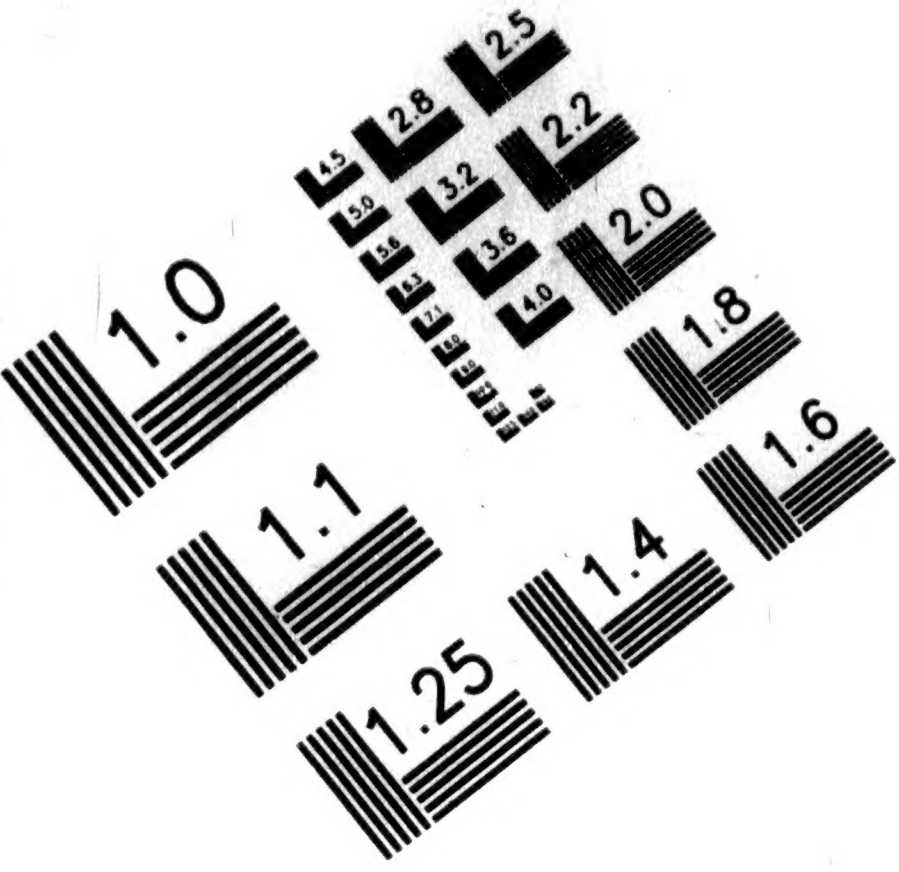

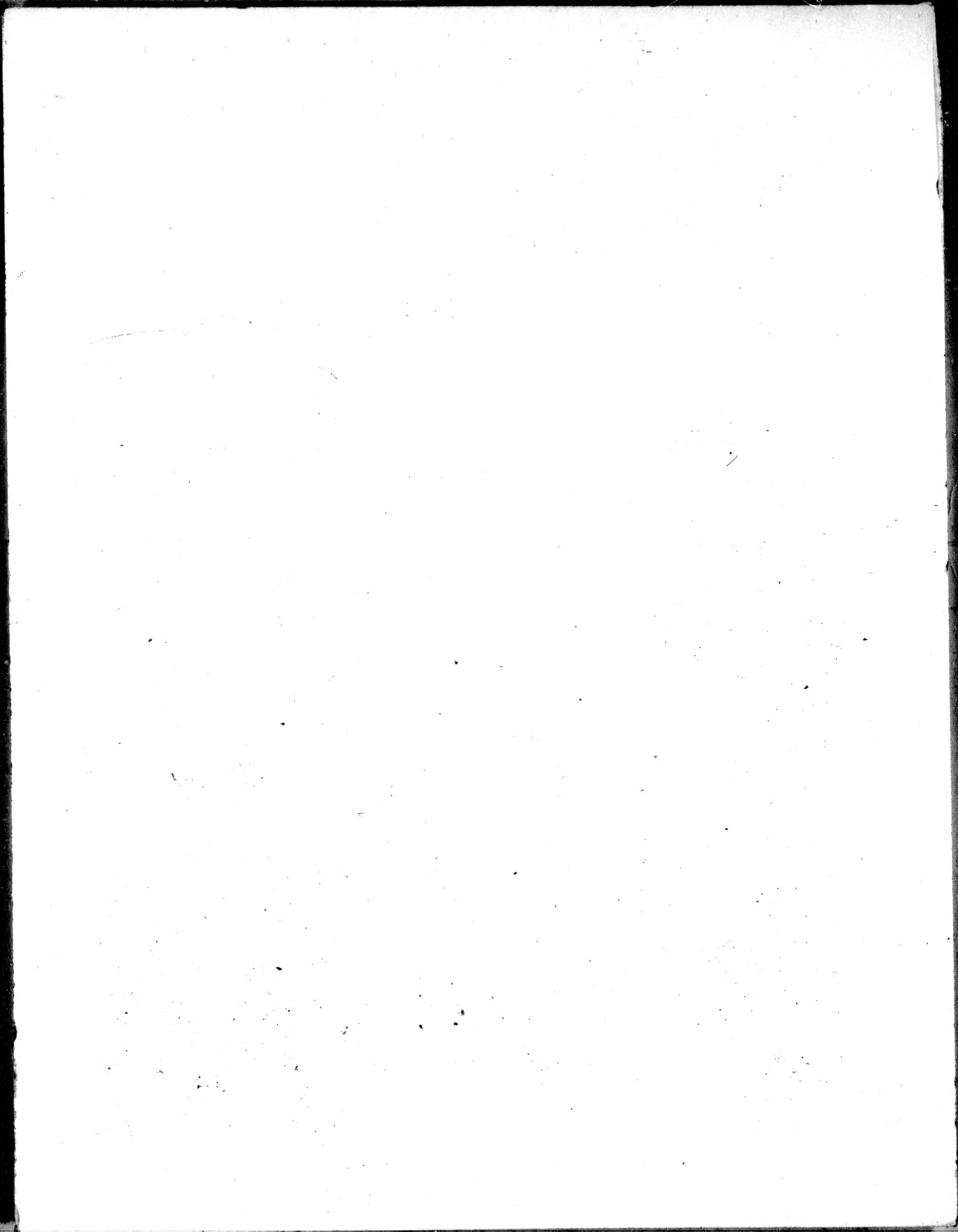

IMAGE EVALUATION TEST TARGET (QA-3)



APPLIED IMAGE, Inc
1653 East Main Street
Rochester, NY 14609 USA
Phone: 716/482-0300
Fax: 716/288-5989

© 1993, Applied Image, Inc., All Rights Reserved





MICROFILMED BY
THE NATIONAL ARCHIVES
8601 ADELPHI ROAD
COLLEGE PARK, MD 20740

Z 2

OPERATOR

M F WISE

DATE FILMED

REDUCTION RATIO

5-29-02 10X

FILM EMULSION NUMBER

2461065101201

PROJECT NUMBER

ROLL NUMBER

M1900 26

19000

ROLL

26

NATIONAL ARCHIVES AND RECORDS ADMINISTRATION
M I C R O F I L M P U B L I C A T I O N S

M1900

RECORDS OF THE FIELD OFFICES FOR THE STATE OF ALABAMA,
BUREAU OF REFUGEES, FREEDMEN, AND ABANDONED LANDS,
1865-1872

United States Congress
and
National Archives and Records Administration
Washington, DC
2002

NATIONAL ARCHIVES AND RECORDS ADMINISTRATION
MICROFILM PUBLICATIONS

NATIONAL ARCHIVES AND RECORD ADMINISTRATION
FREEDMEN'S BUREAU PRESERVATION PROJECT

This National Archives microfilm publication is part of a multiyear project to microfilm the field office records of the Bureau of Refugees, Freedmen, and Abandoned Lands (Freedmen's Bureau). The project was made possible by the United States Congress through The Freedmen's Bureau Records Preservation Act of 2000 (Public Law 106-444). When completed, all of the field records for the States of Alabama, Arkansas, Delaware, Florida, Georgia, Kentucky, Louisiana, Maryland, Mississippi, Missouri, North Carolina, South Carolina, Tennessee, Texas, Virginia, and for the District of Columbia will be available on microfilm. For microfilm availability and description, consult the current edition of the National Archives publication *Microfilm Resources for Research: A Comprehensive Catalog*. You can also view the National Archives microfilm locator on our web site at www.nara.gov.

Acknowledgments

Eric Bechtel	Tashia Jones	Stephanie Richmon
Anne Elam	Brenda Kepley	Loreta Sieh
Thomas Ferrell	Michael F. Knight*	Clarence J. Simmons
Jane Fitzgerald	Denise McAdams	Reginald Washington*
Benjamin Guterman**	Douglas McRae	Richard Whittington
Gail Harriman	Kathy Miller	

Civil War Conservation Corps (CWCC) Volunteers
Directed by Budge Weidman and Russ Weidman

* Reginald Washington and Michael F. Knight wrote the introductory materials.
** Benjamin Guterman edited the introductory materials.

NATIONAL ARCHIVES AND RECORDS ADMINISTRATION
MICROFILM PUBLICATIONS

INTRODUCTION

On the 34 rolls of this microfilm publication, M1900, are reproduced the previously unfiled records of the Alabama office of the Assistant Commissioner, his staff offices, and subordinate field offices of the Bureau of Refugees, Freedmen, and Abandoned Lands, 1865-1872. These records consist of bound volumes and unbound records, containing materials that include letters and endorsements sent and received, monthly reports, applications of freedmen for rations, and other records relating to freedmen's claims and homesteads. These records are part of the Records of the Bureau of Refugees, Freedmen, and Abandoned Lands, Record Group (RG) 105, at the National Archives Building in Washington, DC.

This film series completes the reproduction of all Bureau records created in Alabama between 1865 and 1872. Many of these records were reproduced in 1972 in National Archives Microfilm Publications M809, *Records of the Assistant Commissioner for the State of Alabama, Bureau of Refugees, Freedmen, and Abandoned Lands, 1865-1870*, and M810, *Records of the Superintendent of Education for the State of Alabama, Bureau of Refugees, Freedmen, and Abandoned Lands, 1865-1870*.

HISTORY AND ORGANIZATION

The Bureau of Refugees, Freedmen, and Abandoned Lands, also known as the Freedmen's Bureau, was established in the War Department by an act of Congress on March 3, 1865 (13 Stat. 507). The life of the Bureau was extended twice by acts of July 16, 1866 (14 Stat. 173), and July 6, 1868 (15 Stat. 83). The Bureau was responsible for the supervision and management of all matters relating to refugees and freedmen, and of lands abandoned or seized during the Civil War. In May 1865, President Andrew Johnson appointed Maj. Gen. Oliver Otis Howard as Commissioner of the Bureau, and Howard served in that position until June 30, 1872, when activities of the Bureau were terminated in accordance with an act of June 10, 1872 (17 Stat. 366). While a major part of the Bureau's early activities involved the supervision of abandoned and confiscated property, its mission was to provide relief and help freedmen become self-sufficient. Bureau officials issued rations and clothing, operated hospitals and refugee camps, and supervised labor contracts. In addition, the Bureau managed apprenticeship disputes and complaints, assisted benevolent societies in the establishment of schools, helped freedmen in legalizing marriages entered into during slavery, and provided transportation to refugees and freedmen who were attempting to reunite with their family or relocate to other parts of the country. The Bureau also helped black soldiers, sailors, and their heirs collect bounty claims, pensions, and back pay.

The act of March 3, 1865, authorized the appointment of Assistant Commissioners to aid the Commissioner in supervising the work of the Bureau in the former Confederate states, the border states, and the District of Columbia. In Alabama, operations began in July 1865 when Brig. Gen. Wager Swayne took command as Assistant Commissioner. Bvt. Brig. Julius Hayden succeeded Swayne and served

NATIONAL ARCHIVES AND RECORDS ADMINISTRATION
MICROFILM PUBLICATIONS

from January to March 1868. Col. Oliver L. Shepherd served from March to August 1868, and Col. T. H. Ruger held the position of Assistant Commissioner for only a few days in August before the arrival of Bvt. Lt. Col. Edwin Beecher later in that month. In January 1869, in accordance with an act of July 25, 1868 (15 Stat. 193), Bureau operations in Alabama were terminated except for the educational functions and the collection of claims. Colonel Beecher remained in Alabama as superintendent of education and held that position until the office was closed in July 1870. The majority of Bureau officers and agents in Alabama were active duty military officers, and for the first 2 years of the Bureau's existence in Alabama the agency doubled as the military command for the district. Brig. Gen. Swayne, for example, served as Assistant Commissioner and District Military Commander for Alabama from 1866 to 1868. As a consequence of the wide use of military officers to staff the Bureau, the agency constantly struggled with issues of continuity as well as a lack of personnel to staff the various field offices. At one point at the end of 1866, the Bureau could only staff eight stations in Alabama due to a critical shortage of qualified personnel.

While the work performed by Assistant Commissioners in each state was similar, the organizational structure of staff officers varied from state to state. At various times, the staff could consist of a superintendent of education, an assistant adjutant general, an assistant inspector general, a disbursing officer, a chief medical officer, a chief quartermaster, and a commissary of subsistence. Subordinate to these officers were the assistant superintendents, or subassistant commissioners as they later became known, who commanded the subdistricts. The major subordinate field offices for the Bureau at Alabama included headquarters at Demopolis, Eufaula, Garland, Greenville, Huntsville, Mobile, Montgomery, Opelika, Selma, Talladega, Tuscaloosa, and Tuskegee. Under the direct supervision of the subassistant commissioners were the civilian and military agents. Occasionally, the Bureau retained military officers in a civilian capacity after the termination of their military service. For a list of known Alabama subordinate field office personnel and their dates of service, see the Appendix.

The Assistant Commissioner corresponded extensively with both his superior in the Washington Bureau headquarters and his subordinate officers in the subdistricts. Based upon reports submitted to him by the subassistant commissioners and other subordinate staff officers, he prepared reports that he sent to the Commissioner concerning Bureau activities in areas under his jurisdiction. The Assistant Commissioner also received letters from freedmen, local white citizens, state officials, and other non-Bureau personnel. These letters varied in nature from complaints to applications for jobs in the Bureau. Because the assistant adjutant general handled much of the mail for the Assistant Commissioner's office, it was often addressed to him instead of to the Assistant Commissioner.

In a circular issued by Commissioner Howard in July 1865, the Assistant Commissioners were instructed to designate one officer in each state to serve as "general Superintendents of Schools." These officials were to "take cognizance of all that is being done to educate refugees and freedmen, secure proper protection to schools and teachers, promote method and efficiency, correspond with the benevolent

NATIONAL ARCHIVES AND RECORDS ADMINISTRATION
MICROFILM PUBLICATIONS

agencies which are supplying his field, and aid the Assistant Commissioner in making his required reports." In October 1865, a degree of centralized control was established over Bureau educational activities in the states when Rev. John W. Alvord was appointed Inspector of Finances and Schools. In January 1867, Alvord was divested of his financial responsibilities, and he was appointed General Superintendent of Education.

An act of Congress, approved July 25, 1868 (15 Stat. 193), ordered that the Commissioner of the Bureau "shall, on the first day of January next, cause the said bureau to be withdrawn from the several States within which said bureau has acted and its operation shall be discontinued." Consequently, in early 1869, with the exception of the superintendents of education and the claims agents, the Assistant Commissioners and their subordinate officers were withdrawn from the states.

For the next year and a half the Bureau continued to pursue its education work and to process claims. In the summer of 1870, the superintendents of education were withdrawn from the states, and the headquarters staff was greatly reduced. From that time until the Bureau was abolished by an act of Congress approved June 10, 1872 (17 Stat. 366), effective June 30, 1872, the Bureau's functions related almost exclusively to the disposition of claims. The Bureau's records and remaining functions were then transferred to the Freedmen's Branch in the office of the Adjutant General. The records of this branch are among the Bureau's files.

Constrained by limited resources, Southern opposition, and the politics of Reconstruction, the Bureau faced an enormous challenge in its efforts to assist the freedmen and refugees. Its relief efforts, without question, saved thousands of southerners from starvation. Its attempts to assist freedmen to become self-sufficient, to provide public education, administer justice, and, to a lesser degree, to provide land, all worked with varying degrees of success to lessen the difficulties during the transition from slavery to freedom. One of the Bureau's greatest legacies is the body of records it created and received during the course of its operations. These records are arguably some of the most important documents available for the study of the Federal Government's policies, efforts to reconstruct the South, and Southern social history and genealogy.

THE FREEDMEN'S BUREAU IN ALABAMA

The Freedmen's Bureau major activities in Alabama generally resembled those conducted in other states. The Bureau issued rations to both freedmen and white refugees, supervised labor contracts between planters and freedmen, administered justice, worked with benevolent societies in the establishment of schools, and assisted freedmen in locating land.

Shortly after accepting the position of Assistant Commissioner in Alabama, Brig. Gen. Swayne requested permission from the Freedmen's Bureau headquarters in Washington, DC, to set aside 1,225 acres of land on the Broward Plantation near Montgomery for freedmen. The plantation had been abandoned shortly before the

NATIONAL ARCHIVES AND RECORDS ADMINISTRATION
MICROFILM PUBLICATIONS

end of the war and was confiscated by Federal authorities. Montgomery Home Colony, established on some of this land, became the largest of several "home colonies" set aside to provide services for the freedmen. Home colonies were also established at Talladega, Mobile, Garland, Butler County, Montgomery, Selma, Demopolis, and Huntsville. The colonies were not self-sufficient communities of freedmen like those found in South Carolina or Louisiana. Instead, the colonies were distribution centers where the Bureau disseminated rations, clothes, seeds, and tools; processed claims; provided medical care; and organized services for the infirm, orphans, and the elderly. The central functions of these colonies were organized around a freedmen's hospital. The freedmen's hospital at Montgomery offered services to all races. From November 1866 to August 1867, it treated 168 refugees (whites), 5 of whom died. During the same period the hospital treated 6,058 freedmen, of whom 162 died.

From 1865 to 1867, Alabama suffered repeated and massive crop failures due to drought or frost conditions. During the same period, the state was swept by a series of epidemics, with smallpox proving the most deadly disease affecting the freedmen. In addition to medical care, one of the most important duties for the Bureau in Alabama was the issuance of rations to refugees and freedmen to stave off malnutrition and starvation.

The Alabama Bureau also expended great resources and energy mitigating contract disputes between freedmen and white landowners as well as attempting to overturn draconian "black codes" enacted by the Alabama State Legislature and signed by the Governor. In his 1866 annual report to the Washington, DC, headquarters of the Bureau, Swayne complained that white landowners rampantly defrauded freedmen of benefits spelled out in their labor contracts.¹ However, Swayne complained most extensively in this report about a particular set of "black codes" passed by the Legislature late in 1865 as vagrancy laws. These codes were passed shortly before Christmas after widespread complaints by white landowners that freedmen refused to work during the Christmas week. Apparently, freedmen expected to continue the tradition of time off from work at Christmas dating back to the antebellum years. Brig. Gen. Swayne charged that these laws returned freedmen to a state of slavery. First, he pointed to the authorized use of chain gangs in which freedmen worked with no compensation for even the most minor offenses. Second, the newly established probate courts often worked against freedmen. They were responsible for settling contract disputes between freedmen and white landowners. However, one component of the law passed by the Legislature stipulated that freedmen were not allowed to testify against whites or serve on juries. In cases where the courts found in favor of the white landowners, the presiding judge had the option of forcing freedmen into uncompensated labor for the white landowners or impressing freed-

¹ Annual Report of the Assistant Commissioner, Montgomery, AL, October 31, 1866, *Records of the Assistant Commissioner for the State of Alabama, Bureau of Refugees, Freedmen, and Abandoned Lands, 1865-1870* (National Archives Microfilm Publication M809, roll 2), Records of the Bureau of Refugees, Freedmen, and Abandoned Lands, Record Group (RG) 105, National Archives Building, Washington, DC.

NATIONAL ARCHIVES AND RECORDS ADMINISTRATION
M I C R O F I L M P U B L I C A T I O N S

men's children as free laborers for the litigant. The black codes also authorized county officials to impress orphaned children as laborers on local plantations. Swayne was able to convince the Alabama Legislature to eventually overturn most of these codes. In districts where he could not force the probate courts to fairly enforce the law, he set up special freedmen's courts to hear complaints.

However, Swayne was unable to convince the Legislature to overturn provisions of the vagrancy laws that allowed widespread arrests of freedmen. The code authorized local and state law enforcement officials to summarily arrest those freedmen without contract papers who were allegedly causing "disturbances" in public places and roads. The normal punishment under this penal code was forced labor on nearby plantations. Finally, in March 1867, the Bureau saw this law overturned through the Military Reconstruction Bill for the District of Alabama (14 Stat. 429).

The Freedmen's Bureau in Alabama had a major impact in providing education for freedmen from 1866 to 1869. Due to its limited budget and resources, the Bureau was unable to directly establish and operate the great number of freedmen schools needed. However, the successive Assistant Commissioners proved very adept at finding other means for establishing these schools. They successfully implemented a three-way partnership program in which a wide variety of Northern relief societies flooded the state with resources to build schools, money for books and teachers, or volunteer members who instructed the freedmen for no fee. The freedmen were often responsible for actual maintenance of facilities as well as contributions of money and resources for upkeep of the local schools. Bureau agents oversaw the education program and provided land and protection for the schools. The results of this program were impressive. At the beginning of the school year in October 1866, there were 3,100 freedmen in classes taught by 68 teachers. By June 1867, these figures had grown to just under 10,000 students instructed by 150 teachers.

RECORDS DESCRIPTION

The volumes reproduced in this microfilm publication were originally arranged by type of record and thereunder by volume number. No numbers were assigned to series consisting of single volumes. Years later, all volumes were arbitrarily assigned numbers by the Adjutant General's Office (AGO) of the War Department after the records came into its custody. In this microfilm publication, AGO numbers are shown in parentheses to aid in identifying the volumes. The National Archives assigned the volume numbers that are not in parentheses. In some volumes, particularly in indexes and alphabetical headings of registers, there are a number of blank numbered pages that have not been filmed.

The volumes consist of letters and endorsements sent and received, press copies of letters sent, registers of letters received, fair copies of letters received, letters and orders received, registers of freedmen issued rations, special orders and circulars issued, registers of bounty claimants, reports, registers of contracts, registers of complaints, registers of patients, registers of disbursements, account books, miscellaneous records, and monthly reports forwarded to the Assistant Commis-

NATIONAL ARCHIVES AND RECORDS ADMINISTRATION
MICROFILM PUBLICATIONS

sioner. The unbound documents consist of letters sent and received and endorsements sent, reports, applications for relief, labor contracts, rosters of officers and employees, court records, special and general orders and circulars received, and miscellaneous records. The unbound records also contain monthly reports; oaths of office; applications of freedmen for rations; and records relating to claims, court trials, property restoration, and homesteads.

From June 1866 to January 1868, Assistant Commissioner Swayne also served as the military commander of Alabama. He therefore created and received records in both capacities. The dual function of the Assistant Commissioner resulted in a succession of changes in the official headings used on correspondence and issuances. The title "Office of the Assistant Commissioner" was changed in June 1866 to "headquarters, District of Alabama," and in August 1866 to "Headquarters, Subdistrict of Alabama." The heading "District of Alabama" was used again from March 1867 until superseded by "State of Alabama" in February 1868.

The dual function of the office is also reflected in the recordkeeping practices for that period. Although the Assistant Commissioner generally maintained separate records for each of his capacities, in the case of letters and endorsements sent the records were frequently combined. Wherever they were separable, the records created by the Assistant Commissioner in his military capacity were placed with the Records of United States Army Continental Commands, 1821-1920, RG 393.

List of Book Records of Officers

The single-volume list of book records of officers in the State of Alabama (no date) is arranged by office, with records of the Assistant Commissioner first, and then alphabetically by locations of the subdistrict office. Included in the list of book records are the type of record in each book or volume, the dates of the volume, and the volume number. Throughout this introductory material and in the Table of Contents, the volume number appears in parentheses in the series descriptions of the records

Office of the Assistant Commissioner

The single-volume name index (no date) is an additional index to Volumes 1 (4) and 2 (5) of letters sent (July 27, 1865-June 27, 1866) and Volumes 1 (16) and 2 (17) of special orders issued by the Assistant Commissioner for the State of Alabama. The letters sent and special orders issued have been previously reproduced on National Archives Microfilm Publication M809, *Records of the Assistant Commissioners for the State of Alabama Bureau of Refugees, Freeman, and Abandoned Lands, 1865-1870*, rolls 1 and 17, respectively.

The single-volume miscellaneous name index consists of three unidentified indexes that have no dates and are unnumbered.

NATIONAL ARCHIVES AND RECORDS ADMINISTRATION
MICROFILM PUBLICATIONS

Offices of Staff Officers

COMMISSARY OF SUBSISTENCE

The single volume of letters and endorsements sent and a register of subsistence stores received and issued, 1865-1868 (113)², is arranged by type of record and thereunder chronologically. The letters and endorsements sent, September 1865 to May 1867, are interfiled in the volume, and there is a name index. The register of subsistence stores received cover the period December 1866-May 1868.

The single-volume register of letters received and endorsements sent (37), dated February 1867-May 1868 and February-July 1867, is arranged and numbered in chronological order through August 1867 and thereafter chronologically without numbers. The volume contains an incomplete index.

The single-volume register of letters received and endorsements sent (50), dated February-July 1867, is arranged chronologically and has a name index. Most of the letters that appear in the volume are entered in volume (37). The volume also contains an account of stores purchased by the subdistricts for the period April-May 1867. The accounts are arranged by subdistrict and thereunder chronologically.

Unbound letters received, March-December 1867, consist of registered and unregistered letters and letters and reports received by M. H. Cruikshank, state commissioner for coordinating issuance of supplies to the destitute. The registered letters received, March-December 1867, are arranged according to their entry in volume (37). The unregistered letters, March-October 1867, are arranged chronologically. The Cruikshank letters and reports are arranged by type of record and thereunder chronologically.

Unbound weekly, trimonthly, and monthly reports and returns of rations issued, 1865-66, are arranged by year, thereunder alphabetically by county, and thereunder chronologically. This series provides, in some cases, a list of people who received rations; and in others, the number of rations issued and the number of people who received rations.

Unbound reports of subsistence stores issued and received, July 1867-August 1868, are arranged chronologically by year and thereunder alphabetically by subdistrict. These are reports from subassistant commissioners and agents from local areas.

Unbound list of heads of families who received relief (Certificates of Applicants), covering the years 1867-68 are arranged chronologically. These are printed forms that include the name of the head of the family; the number of men, women, and children in the family; and the amount of corn and bacon received.

² In this microfilm publication, the volume numbers in parentheses are those assigned by the Adjutant General's Office (AGO) of the War Department after the records came into its custody. The volume numbers not in parentheses were assigned by the National Archives and Records Administration.

NATIONAL ARCHIVES AND RECORDS ADMINISTRATION
M I C R O F I L M P U B L I C A T I O N S

Unbound applications for relief, January 1866, May–July 1867, and May 1868, are arranged chronologically. This series consists of sworn statements of applicants indicating why they can't work and information concerning their dependents.

The single volume of accounts of stores issued to agents, November 1866–February 1868 (46), are arranged according to recipient and thereunder chronologically. The entries indicate who received the stores (corn and bacon), whether they were donated, and the amount received and transferred.

INSPECTOR GENERAL AND DISBURSING OFFICER

The single volume of letters received and endorsements sent, March–May 1868 (28), is arranged chronologically. The volume has a name index. The letters concern primarily court cases involving financial settlement, claims, and requests for aid.

QUARTERMASTER AND DISBURSING OFFICER

The single volume of letters received and sent, April–July 1866 (38), consists of two parts. The first part of the volume contains copies of letters received dated April 4 to July 23, 1866. The second part of the volume contains copies of letters sent dated May 10 to July 28, 1866.

The three volumes of press copies of letters sent, 1 (39), 2 (40), and 3 (41), September 1866–July 1870, are arranged chronologically. Each volume has a name index. Edwin Beecher, who was serving as Assistant Commissioner and superintendent of education, signed the letters from February 1869 to July 1870. All of the letters concern the accounting or disbursement of funds.

The single volume of endorsements sent, January–April 1867 (42), are arranged and numbered in chronological order. The volume contains a name index.

The single-volume register of letters received and endorsements sent, January 1867–January 1869 (36), is arranged chronologically and has a name index.

Unbound letters received, January 1868–June 1869, are arranged by year, thereunder by initial letter of surname of correspondent, and thereunder chronologically. The letters from Bureau headquarters are filed after the alphabetical divisions. Although the letters appear to be entered in the volume of letters received and endorsements sent (36), neither the letters nor the entries in the volume are numbered.

Unbound monthly reports of persons and articles hired, September 1865–July 1869, are arranged chronologically. The reports are from Bureau officers and include retained copies of reports of persons and articles hired by the quartermaster.

The single volume of miscellaneous memorandums (45), January 1866–April 1867, is arranged by type of record and thereunder chronologically. The memorandums in the volume concern invoices, accounts, monies, postage, and persons employed and discharged.

NATIONAL ARCHIVES AND RECORDS ADMINISTRATION
M I C R O F I L M P U B L I C A T I O N S

The single-volume account book of stores purchased (48), September 1866–July 1870, is arranged chronologically according to date of purchase. Accounts show articles purchased, the amount spent, and for whom purchased.

The single-volume account book of stores issued in the counties, January 1867–May 1868 (47), is arranged alphabetically by county and thereunder chronologically. The volume contains a partial index, and the accounts show the number of white and black persons issued stores, and the amount of corn, flour, pork, and bacon issued.

The single-volume account book of stores transferred (49), October 1867, is arranged by type of account and thereunder chronologically. The first part of the volume contains an account of stores transferred by the chief quartermaster (May 1 to October 21, 1867); the second part contains accounts transferred to the chief quartermaster (April 23 to October 17, 1867). The volume includes such information as dates, cost, the articles transferred and received, the condition of the articles, and from whom the articles were received or transferred.

SURGEON

The three volumes of letters sent, September 1865–December 1868, 1 (31), 2 (32), and 3 (33), are arranged in chronological order. The indexes include a name and subject index for the first volume and name indexes for the remaining two. They also indicate the content of letters. The volumes also contain the annual reports of the Medical Department, 1866–68, and include reports to the Assistant Commissioner, January and February 1867.

The two volumes of endorsements sent, September 1865–December 1868, 1 (34) and 2 (35), are arranged chronologically and there is a name index for the first volume.

The two volumes of registers of letters received, October 1865–December 1868, 1 (29) and 2 (30), are arranged by time period. The first volume has an index. The entries in the volumes are arranged alphabetically by initial letter of surname of correspondent and thereunder chronologically.

The unbound letters received, December 1865–August 1868, consist of three items that are arranged chronologically.

The single-volume register of invoices of medical supplies received (195), November–December 1865, is arranged according to type of supply.

Subordinate Field Offices

ASHVILLE

The unbound labor contracts, August 1865, are arranged chronologically. The contracts were approved and witnessed by the commander of U.S. Forces at Jacksonville, Alabama, not by a Bureau agent stationed at Ashville.

NATIONAL ARCHIVES AND RECORDS ADMINISTRATION
MICROFILM PUBLICATIONS

BLUFFTON (Opelika Subdistrict)

The records for the subordinate field office at Bluffton include three series: a single volume of letters sent, April–July 1868 (156); a volume of fair copies of letters received and endorsements sent, April–July 1868 (155); and letters received, May 1868. The letters received consist of a single letter reporting the killing of a black youth by a white youth. Both the volume of letters sent and fair copies of letters received and endorsements sent are arranged chronologically and have name indexes.

CAHABA

The single volume of contracts, register of contracts, and registers of transportation and rations issued, 1865–1866 (191), is arranged by type of record and thereunder chronologically. The volume has a name index and a table of contents.

CLAIBORN

The unbound letters received by Lt. A. S. Bennett, the subassistant commissioner at Claiborn, May–July 1868, are arranged chronologically.

DEMOPOLIS

The three volumes of letters sent by the subassistant commissioners at Demopolis, January 1866–December 1868, 1 (138), 2 (139), and 3 (140), are arranged chronologically and have name indexes.

The single-volume register of letters received and endorsements sent (137), April 1867–November 1868, is arranged chronologically. It is primarily a register of letters endorsed or forwarded. The letters received are all unregistered letters. For fair copies of letters received at the post of Demopolis from December 1865 to January 1866, see the single-volume register of complaints (141) mentioned below.

Unbound letters received, August 1865–December 1868, are arranged chronologically and consist of unregistered letters.

The single-volume register of complaints, February 1866–August 1868 (141), is arranged chronologically and, as mentioned above, includes fair copies of letters received at Demopolis for the period December 1865–January 1866. For letters received from April 1867 to November 1868, see the single-volume register of letters received (137).

Unbound miscellaneous records, January 1866–November 1868, are arranged by subject and thereunder chronologically. The series includes an opinion of Clarke and Lyon in *Freedmen v. Ridgway*, leases for a plantation to be used as an asylum, a list of contributors to a black school, and a plan of Bureau buildings. Also included is a list of government buildings at Gainesville, and letters sent, orders issued, reports, and bills of lading.

The single volume of miscellaneous school records of C. L. Drake (a teacher), May 1866–October 1868 (194), is arranged by type of record and thereunder chronologically. The volume contains a roll of students (May 1866–January 1868) that

NATIONAL ARCHIVES AND RECORDS ADMINISTRATION
MICROFILM PUBLICATIONS

includes their names, ages, tuition paid, and days attended. There is also a school property account for the period September 1866–October 1868 that shows the service or item paid for and the amount. In addition, there are records of post and citizen bakeries and accounts (January to August 1864) kept by Capt. C. L. Drake (20th Regiment, Iowa Infantry) while serving at a post in Brownsville, Texas. Drake later served as subassistant commissioner of Demopolis in June 1868.

The single-volume register of patients at the freedmen's hospital at Demopolis (142), June–November 1867, is arranged chronologically according to the date of admission.

ELYTON

The records for the subordinate field office at Elyton include a single volume of letters sent, May–August 1868 (153), a single-volume register of letters received and endorsements sent, May–July 1868 (152), and unbound letters received, May–July 1868. The volume of letters sent is arranged chronologically and includes a name index and monthly reports for June and July. The register of letters received and endorsements sent are arranged and numbered in chronological order and also has a name index. The letters received are arranged chronologically and are entered in the register of letters received.

EUFAULA

The single letter received by H. R. Burton, January 1868, the Bureau agent at Eufaula, concerns payment of a debt claim.

EUTAW

The records for the Bureau agent at Eutaw include an unbound series of letters received, April–June 1868, and unbound labor contracts that consist of two items dated 1866. Both series are arranged chronologically.

GARLAND

The single volume of letters sent by the surgeon, May–October 1868 (145), is arranged and numbered in chronological order and has a name index.

The single volume of letters received and sent and register of prescriptions, 1867–1868 (146), is arranged by type of record and thereunder chronologically.

The two volumes of registers of letters received and endorsements sent (143) and (144) are arranged by time period, thereunder-alphabetically by initial letter of surname of writer, and thereunder chronologically. The first volume (143) has a partial name index.

Unbound letters received, March–August 1867, is arranged chronologically.

The single-volume account book, October 1867–October 1868 (147), is arranged by type of record and thereunder chronologically and consists of three sections. There is a list of commissary supplies received (October 1867–October 1868), accounts of the hospital with the Subsistence Department (October 1867–September 1868), and

NATIONAL ARCHIVES AND RECORDS ADMINISTRATION
M I C R O F I L M P U B L I C A T I O N S

monthly reports of hospital stores remaining, returned, or issued (October 1867–October 1868).

The two series relating to inmates treated at the freedmen's hospital at Garland include two volumes of registers of patients, May 1867–October 1868, 1 (148) and 2 (149), and two volumes of registers of prescriptions, May 1867–October 1868, 1 (150) and 2 (151). The two volumes of registers of patients are arranged by date of admission and several of the entries in the volumes are duplicated. The two volumes of registers of prescriptions are arranged chronologically.

Unbound monthly reports of destitute discharged soldiers, June–November 1867, are arranged chronologically.

Unbound list of expenses incurred for the treatment of freedmen, May 3, 1866, consists of two items.

GIRARD

Unbound letters received by J. B. Healy and a labor contract, 1867–1868, consists of three items. The letters are dated March 1, 1867, and April 1, 1868; the labor contract is dated February 2, 1867.

GREENVILLE

The four volumes of letters sent, September 1865–December 1868, 1 (123), 2 (124), 3 (125), and 4 (126), are arranged chronologically and have name indexes. The first volume contains a register of freedmen; the second volume contains endorsements sent (October 1866 to January 1867).

The two volumes of registers of letters received and endorsements sent, April 1867–November 1868, 1 (121) and 2 (122), are arranged by time period, thereunder alphabetically by initial letter of surname of writer, and thereunder chronologically. Both volumes have name indexes.

Unbound letters received, January 1866–December 1868, are arranged chronologically, and most of the letters from April 1867 to November 1868 appear to be entered in the two-volume series of letters received and endorsements sent, 1 (121) and 2 (122), for that period.

The two volumes of registers of contracts, May–December 1865, 1 (128) and 2 (129), are arranged chronologically. The contracts for the period January–March 1866 appear in the miscellaneous record book series (127) mentioned below.

The single-volume register of complaints, February 1867–December 1868, 1 (130), is arranged chronologically and has a name index.

The single-volume miscellaneous record book, September 1865–August 1867 (127), is arranged by type of record. In addition to containing a register of complaints for September 1865 and copies of contracts for January through March 1866, the

NATIONAL ARCHIVES AND RECORDS ADMINISTRATION
MICROFILM PUBLICATIONS

volume includes an account of subsistence stores issued by both the Bureau and the New York Relief Association for the period from May through August 1867.

Unbound miscellaneous records, June 1866–February 1869, are arranged by type of record and include receipts, returns of commissary property, invoices, reports on current accounts, estimates of funds, affidavits, and incomplete claims applications.

HAYNESVILLE

The single volume of letters sent by W. H. Hunter, August–November 1868 (192), is arranged chronologically and has a name index.

HUNTSVILLE (SUBASSISTANT COMMISSIONER)

The four volumes of letters sent, July 1865–November 1868, 1 (62), 2 (63), 3 (64), and 4 (65), are arranged chronologically and have name indexes.

The two volumes of endorsements sent, September 1865–November 1868, 1 (70) and 2 (71), are arranged chronologically, and only the second volume, 2 (71), has a name index. In this series, cross-references to letters received and sent are designated by a citation of the appropriated file number of the letter.

The single-volume register of letters received, July 1865–March 1866 (57), is arranged chronologically and has a name index. Many of the letters in the series after November 1865 seem to be copied in full, and issuances received by the subassistant commissioner at Huntsville have also been copied in the volume.

The four volumes of letters received, March 1866–December 1868 1 (58), 2 (59), 3 (60), and 4 (61), are arranged chronologically, and each volume has a name index.

Unbound letters received, September 1865–January 1869, are arranged chronologically, and they do not appear to be duplicates of those in the four-volume series of letters received mentioned above.

The single volume of special orders issued, April 1866–April 1868 (72), is arranged chronologically and has a name index.

The single-volume register of rations shipped to agents and issued in the counties, January–October 1866 (80), is arranged by type of record. The volume includes a register of subsistence stores shipped to agents (January–April 1866), a register of rations issued in bulk to freedmen (January–March 1866), and a register of rations issued in the counties (February–October 1866). The subsistence stores shipped are arranged chronologically, rations issued in bulk are arranged chronologically and thereunder alphabetically, and the rations issued in the counties are arranged alphabetically by county. The volume also contains copies and extracts of special orders issued at the contraband camp at Huntsville for the period December 1864–July 1865.

The three volumes of fair copies of contracts, September 1865–January 1868 1 (81), 2 (82), and 3 (83), are arranged chronologically and numbered, and there is a name

NATIONAL ARCHIVES AND RECORDS ADMINISTRATION
M I C R O F I L M P U B L I C A T I O N S

index for the period January 1867–January 1868. The volumes include a copy of each contract and the date on which the contract was made. The contracts involve the rental of property, payments for goods, and obligations of employers to freedmen employees. Some of the entries for 1865 seem to be summaries rather than fair copies. Canceled contracts are generally marked in red ink.

The single-volume docket of trials, January–March 1866 (84), is arranged chronologically by case and includes such information as the title of the case, names of witnesses, the cause of action, the proceedings of the case (including testimony), and the decision of the judge.

Unbound rosters of officers and employees, January–March 1866, are arranged chronologically.

Unbound miscellaneous records, 1865–67, are arranged by subject in accordance with an index list. The records in the series relate to discharges received, affidavits, contracts, accounts, and bills.

HUNTSVILLE AND ATHENS (CLAIMS AGENT)

The two correspondence series for the claims agent at Huntsville and Athens include four volumes of letters sent and unbound letters received. Both series cover the period April 1868–January 1872. The four volumes of letters sent, 1 (66), 2 (67), 3 (68), and 4 (69) are arranged chronologically. Unbound letters received are arranged generally by office of sender. From April 1868 to February 1869 the claims agent was at Athens, and from February 1869 to January 1872 at Huntsville.

Unbound receipts for claims, 1867–72, are arranged alphabetically by initial letter of surname of correspondent and thereunder chronologically by date of claim. The claims also contain information relating to payments.

The single-volume census of black citizens and register of bounty claims received and forwarded, 1865 and June–July 1868 (79½), is arranged by type of record. The first part of the volume is a census of blacks in Athens in 1865. The census includes the person's name, age, sex, and residence; the name of former owner, if applicable; and the person's occupation and current employment. The register of bounty claims received by the agent at Athens is dated June–July 1868. Each entry gives the name of the claimant, the nature of the claim, and the action taken.

The two volumes of registers of claims allowed, April 1868–January 1872, 1 (78) and 2 (79), are arranged chronologically. There is some duplication in the volumes, and they document the claim agent's activities while at Athens and Huntsville.

The two volumes of registers of claims forwarded by the claims agent, May 1866–January 1872, 1 (74) and 2 (75), are numbered and arranged in chronological order. The entries give the date the claim was forwarded, the name of the claimant, and the nature of the claims and the disposition of the claim. These registers were apparently begun by the subassistant commissioner at Huntsville and continued by

NATIONAL ARCHIVES AND RECORDS ADMINISTRATION
M I C R O F I L M P U B L I C A T I O N S

the claims agent at Huntsville. Some of the names in volume 2 (79) of the claims allowed are also in volume 2 (75) of the claims forwarded.

The two volumes of registers of disbursements, January 1868–January 1872, 1 (76) and 2 (77), are arranged and numbered in chronological order. There are cross-references to claims listed in the two volumes of registers of claims forwarded, 1 (74) and 2 (75).

The single-volume register of claimants, June 1868–December 1871 (73), is arranged chronologically by date of receipt of voucher. The entries give the date the voucher was received; the claimant's name, company, and regiment; the amount due the claimant; the date the voucher was returned; the date the money was received; and the date the payment was made. The register was apparently begun by the subassistant commissioner at Huntsville and continued by the claims agent.

Unbound miscellaneous records on claims and copies of school reports, 1865–71, are arranged by type of record. The claims agent also acted as district superintendent of schools.

HUNTSVILLE (FREEDMEN'S HOSPITAL)

The single volume of letters sent by the surgeon, February–March 1866 (87), is arranged chronologically and does not have an index.

The single-volume press copies of letters sent by the surgeon, September 1866–August 1868 (88), is arranged chronologically and consists primarily of letters to the surgeon in chief transmitting reports.

The single-volume register of letters received and endorsements sent February 1867–June 1868 (85), is arranged chronologically and has a name index.

The single volume of special and general orders and circular letters received by the Freedmen's Hospital at Huntsville, May 1865–August 1866 (86), is arranged chronologically and has a name index. Some of the letters received have also been entered in this volume.

The single volume register of sick and wounded, January 1866–July 1868 (89), is arranged chronologically by date of admission and includes each patient's name, sex, nature of illness, date of admission, and date of discharge or death.

Unbound monthly reports of destitute discharged soldiers and families treated, July 1867–June 1868, are arranged chronologically.

JACKSONVILLE

The three-record series for the subassistant and agent at Jacksonville included a single volume of letters sent, May–August 1868; unbound letters received, May–June 1868; and unbound contracts, June–December 1865. All of the series are arranged chronologically. The single volume of letters sent (131) has a name index. The unbound contracts were negotiated at the Post of Jacksonville.

NATIONAL ARCHIVES AND RECORDS ADMINISTRATION
MICROFILM PUBLICATIONS

LIVINGSTON

The single volume of letters sent and fair copies of letters and orders received by agent John L. Stelzig at Livingston, August–December 1868 (157), is arranged chronologically and has a name index. The volume includes monthly reports of operations to the subassistant commissioner for the period from August to November 1868.

The three remaining records for Livingston included a single-volume register of complaints, August–November 1868, unbound court records, 1866–1867, and list of contracts (no dates). The single-volume register of complaints (158) is arranged chronologically; the unbound court records are arranged by case. The undated list of contracts gives the name of the employer and number of contracts.

MOBILE (SUBASSISTANT COMMISSIONER)

The single volume of letters sent, April 1865–April 1868 (108), is arranged chronologically and has a name index for the months after January 1866.

The single volume of press copies of letters sent, April–December 1868 (109), is arranged chronologically and has a name index.

The single volume of press copies of letters of transmittal sent, February 1866–September 1868 (110), is arranged chronologically. Most of the letters in the series relate to reports, invoices, receipts, and bills of lading forwarded. There are also some reports that were copied into the volume.

The two volumes of registers of letters received and endorsements sent, November 1865–December 1868, 1 (106) and 2 (107), are arranged chronologically.

Unbound letters received, September 1865–December 1868, are arranged chronologically by year and thereunder generally according to whether registered or not. The registered letters are generally, but not always, marked with file numbers. These letters are registered in the two volumes of registers of letters received and endorsements sent mentioned above.

The single volume of registers of contracts and complaints, January 1866–August 1868 (114), is arranged by type of register and thereunder chronologically. The first part of the volume contains a register of contracts for the period from January 1866 to January 1868. Until December 1867, there are only brief entries describing the type of labor, period, pay per month, and sex of employee. Thereafter, there are a few entries that give a more detailed copy of the contracts. The register of complaints is for the period from July to August 1868 and contains the name and residence of the complainant, the nature of the complaint, and the action taken.

Unbound transcripts of mayor's docket, August–September 1865, are arranged and numbered in chronological order. The entries consist of brief abstracts of cases tried before the mayor of Mobile. They give the date of the case, the persons involved, the nature of the case, officers and witnesses involved, and the judgment rendered.

NATIONAL ARCHIVES AND RECORDS ADMINISTRATION
MICROFILM PUBLICATIONS

Unbound miscellaneous records, 1865-68, are arranged by type of record. The series includes affidavits, February 1866-December 1867, some of which relate to the riot of May 14, 1867. The records also contain contracts (December 1866-January 1868), authorizations for rations (August 1865), copies of monthly reports of rations issued (January-November 1866), trimonthly reports of destitutes (April-May 1866), and reports of persons and articles hired and returns of quartermaster stores (July 1865-July 1868). In addition, there are such miscellaneous items as a copy of an act dated March 1866 to provide for the erection of schoolhouses in Mobile and proceedings of a board of survey convened to investigate the damage and loss of a shipment of corn.

The single volume "Time Book (112)," Swayne School Construction (1868), is arranged chronologically. A table of wages is pasted on the inside of front cover. An account book of work done provides names of workmen, number of days employed, pay per diem, and amount earned.

MOBILE (FREEDMEN'S HOSPITAL)

The single volume of press copies of letters sent by the surgeon, August 1866-November 1867 (116), is arranged chronologically and has a name index. They are primarily letters transmitting reports. The letters sent from September to November 1865 appear in the single volume miscellaneous record book described below (117). For letters sent from February to July 1866, see the single volume of letters sent and register of letters received (115) listed below.

The single volume of letters sent and register of letters received, January-December 1866 (115), is arranged by type of record and thereunder chronologically, and there is a name index for the letters sent. The letters sent are dated February-July 1866; the letters received are dated January-June 1866; and the register of letters received are dated June-December 1866.

The single-volume miscellaneous record book (117) is arranged by type of record. The volume contains general orders, special orders, circulars, and circular letters received for the period from September 1865 to September 1867. There are also copies of letters sent for the period from September to November 1865 and a list of the required weekly, monthly, quarterly, and semiannual reports that were required by the surgeon in chief for Alabama.

The single-volume monthly abstract of provisions issued, October 1866-October 1867 (118), is arranged chronologically by month. The abstract gives a breakdown of patients (men, women, and children) to whom rations were issued, the types and amounts of rations issued, and the total rations issued.

The two volumes of registers of patients, August 1865-November 1867 (119) and June 1865-November 1867 (no number), are arranged chronologically by date of admission and chronologically, respectively. Some entries in the volumes appear to be duplicates.

NATIONAL ARCHIVES AND RECORDS ADMINISTRATION
MICROFILM PUBLICATIONS

The single volume of morning reports of sick and wounded (120) is dated August 1865–November 1867 and is arranged chronologically.

Unbound monthly reports of treatment of destitute discharged soldiers and their families, dated June–October 1867, are arranged chronologically.

MOBILE (CLAIMS AGENT)

The single-volume register of claimants compiled by the claims agent in Mobile, December 1867–March 1872 (111), is arranged chronologically by date of receipt of voucher. The entries consist of the date the voucher was received, the claimant's name, company, and regiment. It also contains the amount due the claimant, the date the vouchers were returned, the date the money was received from the disbursing officer, the date payment was made to the claimant, and by whom the claimant was identified.

MONTGOMERY (SUBASSISTANT COMMISSIONER)

The three volumes of letters sent, October 1865–December 1868, 1 (92), 2 (93), and 3 (94), are arranged and numbered in chronological order, and volumes 1 (92) and 3 (94) have name indexes.

The two volumes of registers of letters received and endorsements sent, March 1867–December 1868, 1 (90) and 2 (91), are arranged by time period, and each volume has a name index. The entries in the volumes are arranged alphabetically by initial letter of surname of writer and thereunder chronologically. The letters entered in the register were apparently either returned or forwarded

Unbound letters received, May 1865–December 1868, are arranged chronologically. This series consists of letters that were retained, rather than letters entered in the registers of letters received and either returned or forwarded.

Unbound special and general orders and circular letters received, July 1865–May 1868, are arranged chronologically. Most of the issuances were received from the Assistant Commissioner.

The four volumes of fair copies of contracts dated 1865, 1 (196), 2 (197), 3 (198), and 4 (199), are unarranged and consist of copies of contracts made in counties outside the Montgomery subdistrict. Volume 2 (197) contains a list of rooms and tenants at Stonewall Hospital for October 1866 and a record of applicants for unpaid bounties.

The single-volume register of claimants, March 1867–July 1868 (95), is arranged alphabetically by initial letter of surname of claimant and thereunder chronologically by date of receipt of claim. The claims are for bounties and back pay.

Unbound reports sent to the Assistant Commissioner, July 1865–October 1868, are arranged by type of report and thereunder chronologically. Included are narrative reports, including one submitted by an officer subordinate to the subassistant

NATIONAL ARCHIVES AND RECORDS ADMINISTRATION
MICROFILM PUBLICATIONS

commissioner, and form reports of buildings in the possession of the subassistant commissioner.

Unbound miscellaneous records are arranged by type of record. The series includes affidavits (January 1866–September 1867), contracts (January 1866–February 1867), receipts for funds (December 1865–July 1866), receipts for provisions (October 1865–June 1867), authorizations for rations issued (April–July 1866), reports of cases tried (February 1866–May 1868), and miscellaneous papers (July 1865–January 1868).

MONTGOMERY (FREEDMEN'S HOSPITAL)

The single volume of letters sent by the surgeon, January–November 1867 (98), is arranged chronologically and has name index. For other letters sent, see the single-volume surgeon's record book (101) and the single volume of reports of patients (103), listed below.

The single register of letters received and endorsements sent, January–November 1867 (96), is arranged alphabetically by initial letter of writer and thereunder chronologically and has a name index.

The single volume of special orders and circular letters received, January–November 1867 (97), is arranged chronologically and has a name index. Most of the issuances were received from the office of the Chief Medical Officer at Bureau headquarters or from the chief surgeon for Alabama.

The single-volume surgeon's record book, August 1865–January 1867 (101), is arranged chronologically and thereunder by type of record. Included in this volume are copies of letters sent and issuances received; an invoice of hospital stores received; and accounts of the freedmen's hospital and the Home Colony Hospital with the Subsistence Department for the period May–October 1867.

The two volumes of accounts of subsistence stores purchased and issued, January–September 1867, 1 (99) and 2 (100), are arranged chronologically. The second volume 2 (100) contains accounts for the Home Colony Hospital for the period June–August 1867. Other accounts of subsistence stores are filed with the surgeon's record book (101) described above and the register of patients (102) listed below.

The single volume of reports of patients, September 1865–November 1867 (103), is arranged chronologically and thereunder by type of record. There are daily, weekly, and monthly reports, including some for the Home Colony Hospital. The volume also contains copies of special orders received and letters sent by the acting staff surgeon for the period from January to August 1865. There are also invoices of medicines and hospital supplies received for the same period.

The two volumes of registers of patients, August 1865–November 1867, 1 (104) and 2 (105), are arranged chronologically. The second volume 2 (105) also contains a register of patients at Home Colony Hospital for the period January–November 1867.

NATIONAL ARCHIVES AND RECORDS ADMINISTRATION
MICROFILM PUBLICATIONS

Unbound monthly reports of treatment of destitute discharged soldiers and their families (2 items), June–July 1867, are arranged chronologically.

The single-volume miscellaneous registers of food purchased for use at the hospital, 1865–67 (176), is arranged by type of register. The volume was erroneously listed among the book records of Arkansas. It originally was used as a morning report book for an artillery company during the Civil War.

MONTGOMERY (HOME COLONY HOSPITAL)

The single-volume register of patients for the Home Colony Hospital at Montgomery, September 1865–July 1866 (102), is arranged chronologically by date of admission. The volume also contains an account of subsistence stores for January–July 1867. For subsistence accounts for June–August 1867, see volume (100) of the accounts of subsistence stores purchased and issued, and for May–October 1867, see volume (101) of the surgeon's record book. For a register of patients at the Home Colony for January–November 1867, see volume 2 (105) mentioned above.

OPELIKA

The two volumes of letters sent June 1867–December 1868, 1 (133) and 2 (134), are arranged chronologically, and each volume has a name index.

The single register of letters received and endorsements sent, February–December 1868 (132), is arranged chronologically and has a name index. This is primarily a register of letters endorsed or forwarded; therefore, the letters registered in the volume do not appear in the unbound letters received listed below.

Unbound letters received, May 1867–December 1868, are arranged chronologically. Only a few if any, of these letters appear in the register of letters received and endorsements sent.

The single-volume register of complaints, June 1867–January 1868 (330), is arranged chronologically. The register includes copies of endorsements sent or received relating to complaints. This volume was originally "indexed," or listed, as a record of Georgia.

Unbound monthly reports of operations, August–November 1868, are arranged chronologically.

Unbound circular letters issued and orders received cover the period June–October 1868. The circular letters are arranged by circular number and thereunder chronologically. The orders received are arranged by type of order.

SELMA (SUBASSISTANT COMMISSIONER)

The four volumes of letters sent, March 1866–December 1868 [no entries for May 1866], 1 (175), 2 (176), 3 (177), and 4 (178), are arranged chronologically and each volume has a name index. The first volume, 1 (175), also contains records of the proceedings relating to a freedmen's court for the period March–April 1866, which

NATIONAL ARCHIVES AND RECORDS ADMINISTRATION
MICROFILM PUBLICATIONS

states the nature of the cases, testimony, and court decisions. There are a number of cross-references beginning in January 1867 to register file numbers of letters received and endorsements sent.

The single volume of letters sent, July 1867–June 1868 (179), relating to Bureau and quartermaster stores, is arranged chronologically and has a name index.

The two volumes of registers of letters received and endorsements sent, January 1867–December 1868, 1 (173) and 2 (174), are arranged and numbered by time period in chronological order and have name indexes. These volumes are extensively cross-referenced to letters and endorsements sent. Citations are to file numbers.

Unbound letters received, September 1865–December 1868, are arranged chronologically, and most of the letters are for the period January 1867–December 1868 and are entered in the two volumes of registers of letters received, 1 (173) and 2 (174). There is a small number of pre-1867 and several 1868 letters that are unregistered.

Unbound special orders received, November 1865–February 1867, are arranged chronologically.

The single-volume register of complaints, August 1865–April 1868 (180), is arranged chronologically and has a name index.

The single-volume register of employed freedmen dated 1865 (181) is arranged in two parts: the first part of the volume is arranged by sex and thereunder by initial letter of surname of freedman; the second part is arranged according to employer. The register gives the names of the freedmen and indicates the terms of employment.

The single-volume register of rations issued to freedmen and destitute whites, July 1866–September 1867 (182), is arranged chronologically and thereunder by race of recipient.

Unbound morning reports of freedmen in camp and hospital, August–December 1865, are arranged chronologically and include freedmen in the hospital and in the freedmen's camp at Home Colony, which was a leased plantation.

Unbound complaints, June–September 1866, are arranged chronologically. These complaints appear to be entered in the single-volume register of complaints (180) described above.

Unbound miscellaneous records, 1856–69, are arranged by type of record. The series includes labor contracts (January 1866–Mar. 1869), lists of Bureau stores received and transferred (June–September 1865), reports of registration of white and black voters (June–October 1867), and vouchers authorizing pay for services and supplies (August–December 1866). This series also includes memorandums on labor contract settlements (November 1866–February 1868), reports of cases tried (September

NATIONAL ARCHIVES AND RECORDS ADMINISTRATION
MICROFILM PUBLICATIONS

1866–July 1868), miscellaneous records on disbursements (February–November 1866), and certificates of destitution among freedmen (January–June 1867). In addition to the above-mentioned records, there are a copy of the last will of Lewis Tidwell, dated January 22, 1856; lists of confiscated lands; forms used by the Bureau; and specifications for carpentry work on a schoolhouse.

SELMA (FREEDMEN'S HOSPITAL)

The two volumes of letters sent by the surgeon, May 1866–June 1868, 1 (185) and 2 (186), are arranged chronologically. Volume 2 (186) contains the earliest letters sent, dated May–July 1866, by the surgeon at the Talladega hospital. For other records relating to that hospital, see the single volume of letters sent, August–December 1868 (170), listed below for Freedmen's Hospital at Talladega.

The single-volume register of letters received and endorsements sent, July 1867–June 1868 (190), is arranged chronologically and has a name index.

The single-volume register of patients, February 1866–July 1867 (no number), is arranged chronologically. The volume also contains a list of employees for January 1867. Some of the entries appear to duplicate entries in the single-volume register of patients listed below (187).

The single-volume register of patients, October 1866–June 1868 (187), is arranged chronologically by date of admission. Records of patients admitted dating back to February 1866 appear in the unnumbered single-volume register of patients mentioned above.

The single volume accounts of Subsistence Department, August 1867–June 1868 (188), is arranged chronologically and has a name index. Included in the volume is the monthly breakdown of supplies issued and purchased giving quantity, cost per unit, and total cost.

The single-volume register of prescriptions, May 1867–December 1868 (183), is arranged chronologically.

The single volume of morning reports of patients and attendants, August 1867–July 1868 (189), is arranged chronologically.

TALLADEGA (SUBASSISTANT COMMISSIONER)

The four volumes of letters sent by the subassistant commissioner at Talladega, May 1866–December 1868, 1 (164), 2 (165), 3 (166), and 4 (167), are arranged chronologically and have name indexes. The first volume, 1 (164), also contains a receipt roll for pay (April 1867–May 1868); ration returns (May–July 1866); and miscellaneous accounts (April 1867–December 1868).

Unbound copies of letters sent, March–July 1866, are arranged chronologically. Several of these letters are duplicated in the corresponding volume of letters sent, 1(164).

NATIONAL ARCHIVES AND RECORDS ADMINISTRATION
MICROFILM PUBLICATIONS

The three volumes of registers of letters received and endorsements sent, May 1867–December 1868, 1 (161), 2 (162), and 3 (163), are arranged by time period and have name indexes. Many of the letters entered in the registers are in the unbound series of letters received described below. The entries in volumes 1 (161) and 2 (162) are arranged alphabetically by initial letter of surname of writer and thereunder chronologically. Those in volume 3 (163) are arranged chronologically. Volume 3 (163), June–December 1868, includes no endorsements.

The single volume of endorsements sent, June–December 1868 (168), is arranged chronologically and has a name index. Cross-reference citations are to registers of letters received. The endorsements during the period May 1867–June 1868 are filed in the registers of letters received, volumes 1 (161) and 2 (162).

Unbound letters received, December 1865–December 1868, are arranged chronologically. Most of the letters for the period May 1867–December 1868 are marked with file numbers that correspond to entries in the registers of letters received. However, some of the letters for that period appear to be unregistered.

The single volume of special orders issued and received, June 1867–November 1868 (169), are arranged by type of record and thereunder chronologically and has a name index. The orders received were from the Assistant Commissioner's office and related to affairs in the Talladega subdistrict.

The unbound general and special orders and circular letters received, December 1865–November 1867, are arranged chronologically.

The unbound miscellaneous records, 1865–68, are arranged by type of record. The series includes copies of monthly returns of Bureau stores (February–June 1867), reports on indigents (October 1865), reports on rations issued (July 1866), and bills of lading (May 1866–January 1867). The series also includes invoices and receipts of commissary stores (June–October 1866); contracts (May 1865–Mar. 1866); and miscellaneous papers, including some deeds dating from 1859.

TALLADEGA (FREEDMEN'S HOSPITAL)

The single volume of letters sent, August–December 1868 (170), is arranged chronologically and has a name index. For letters sent for the period May–July 1866, see volume 1 (185), mentioned above, of letters sent by the surgeon for the Freedmen's Hospital at Selma.

The single-volume register of patients, February 1867–November 1868 (172), is arranged alphabetically by surname of patient and thereunder chronologically.

The single volume of morning reports of sick and wounded, September 1867–December 1868 (171), is arranged chronologically.

NATIONAL ARCHIVES AND RECORDS ADMINISTRATION
MICROFILM PUBLICATIONS

TUSCALOOSA

The single volume of letters and endorsements sent and letters received, March–October 1866 (135), is arranged chronologically. It has a name index and contains a list of destitute persons issued rations in February 1866.

Unbound letters received, February 1866–May 1868, are arranged chronologically.

The unbound general and special orders and circular letters received, January 1866–May 1867, are arranged chronologically.

Unbound contracts, December 1865–April 1867, are arranged chronologically.

The single-volume register of complaints, January 1866–July 1868 (136), is arranged chronologically and has a name index.

Unbound miscellaneous records, January 1866–May 1867, are arranged by type of record and thereunder chronologically. The records include school reports, ration reports, affidavits, complaints, and statements about threats of personal violence and breaking of contracts.

TUSCUMBIA

The records for the subassistant commissioner at Tuscumbia include a single volume of letters sent, May–August 1868 (159), and a single volume of fair copies of contracts, November 1865–March 1868 (160). Both of these record series are arranged chronologically, and the single volume of letters sent (159) has a name index.

TUSKEGEE

The single volume of letters sent, September 1865–April 1866 (154), by the assistant superintendent at Tuskegee is arranged chronologically and has a name index. Much of the volume consists of weekly reports sent to the office of the Assistant Commissioner for the period September 1865–April 1866. The volume also contains pay receipts for persons serving as election registrars for the period September–October 1867. There is also a breakdown by district on the number of voters registered by each registrar.

The remaining records for the assistant superintendent at Tuskegee include unbound monthly reports of rations issued, February–April 1866, and a single-volume register of patients from an unidentified hospital, 1865–66 (175 Ark.). The monthly reports are arranged chronologically. The single volume register of patients from an unidentified hospital was listed among the Arkansas book records, but the patients are from Alabama.

NATIONAL ARCHIVES AND RECORDS ADMINISTRATION
MICROFILM PUBLICATIONS

tendent of education for Alabama. These record series are available in the following National Archives microfilm publications:

M742, *Selected Series of Records Issued by the Commissioner of the Bureau of Refugees, Freedmen, and Abandoned Lands, 1865-1872*

M752, *Registers and Letters Received by the Commissioner of the Bureau of Refugees, Freedmen, and Abandoned Lands, 1865-1872*

M803, *Records of the Education Division of the Bureau of Refugees, Freedmen, and Abandoned Lands, 1865-1871*

M809, *Records of the Assistant Commissioner for the State of Alabama, Bureau of Refugees, Freedmen, and Abandoned Lands, 1865-1870.*

M810, *Records of the Superintendent of Education for the State of Alabama, Bureau of Refugees, Freedmen, and Abandoned Lands, 1865-1870*

M1875, *Marriage Records of the Office of the Commissioner, Washington Headquarters of the Bureau of Refugees, Freedmen, and Abandoned Lands, 1861-1869*

Records in other record groups supplement those of the Assistant Commissioner. In Records of United States Army Continental Commands, 1821-1920, RG 393, are records of the military district that included Alabama. Records relating to employment and welfare of freedmen and abandoned property before the establishment of the Bureau are among Records of Civil War Special Agencies of the Treasury Department, RG 366. The records of the Freedman's Savings and Trust Company, 1865-1874, in Records of the Office of the Comptroller of the Currency, RG 101, contain information relating to former slaves who maintained accounts with the bank branches at Alabama.

There have been numerous books, articles, and dissertations published about the Freedmen's Bureau and its operations. For general background, see Paul S. Pierce, *The Freedmen's Bureau, A Chapter in the History of Reconstruction* (Iowa City, IA: 1904); George R. Bentley, *A History of the Freedmen's Bureau* (Philadelphia, PA: 1955); and Elizabeth Bethel, "The Freedmen's Bureau in Alabama," *The Journal of Southern History* XIV (February 1948): 49-92.

Several books written about Commissioner Oliver Otis Howard include *Autobiography of Oliver Otis Howard* (New York, NY: 1907); John Alcott Carpenter, *Sword and Olive Branch: Oliver Otis Howard* (Pittsburgh, PA: 1964); and William S. McFeely, *Yankee Stepfather: O. O. Howard and the Freedmen* (New Haven, CT: 1968). For a history of the Freedmen's Bureau and Reconstruction in Alabama, see Peter Kolchin, *First Freedom: The Response of Alabama's Blacks to Emancipation and Reconstruction* (Westport, CT: 1972).

NATIONAL ARCHIVES AND RECORDS ADMINISTRATION
MICROFILM PUBLICATIONS

1968). For a history of the Freedmen's Bureau and Reconstruction in Alabama, see Peter Kolchin, *First Freedom: The Response of Alabama's Blacks to Emancipation and Reconstruction* (Westport, CT: 1972).

NATIONAL ARCHIVES AND RECORDS ADMINISTRATION
M I C R O F I L M P U B L I C A T I O N S

CONTENTS

ROLL	DESCRIPTION	DATES
1	List of Book Records State of Alabama 1 Volume	
	OFFICE OF THE ASSISTANT COMMISSIONER	
	Correspondence	
	Name Indexes	
	Volume (6)*	
	Other Records	
	Miscellaneous Name Index	
	1 Volume	
	OFFICES OF STAFF OFFICERS	
	Commissary of Subsistence	
	Letters and Endorsements Sent and a Register of Subsistence	
	Stores Received and Issued	
	Volume (113)	1865-68
	Register of Letters Received and Endorsements Sent	
	Volume (37)	Feb. 1867-May 1868
	Register of Letters Received and Endorsements Sent	
	Volume (50)	Feb.-July 1867
	Letters Received Pertaining to Subsistence	Mar.-Dec. 1867
	Unregistered Letters Received	Mar.-Oct. 1867
	Letters and Reports Received by M. H. Cruikshank	Jan. 1866-Aug. 1867
	Weekly, Trimonthly and Monthly Reports and Returns of Rations and Provisions Issued	
	Demopolis-Talladega	1865
	Autauga-Conecuh	1866
2	Weekly, Trimonthly and Monthly Reports and Returns of Rations and Provisions Issued	
	Coosa-Randolph	1866
	Benton-Bibb	1866
	Employees-Pest House	1866-67
	Reports of Subsistence Stores Issued and Received	July 1867-Aug. 1868

* Volume numbers assigned by the Adjutant General's Office (AGO) are shown in parentheses to assist in identifying the volumes.

NATIONAL ARCHIVES AND RECORDS ADMINISTRATION
M I C R O F I L M P U B L I C A T I O N S

ROLL	DESCRIPTION	DATES
3	List of Heads of Families Who Have Received Relief ("Certificates of Applicants") Applications for Relief	1867-68 Jan. 1866, May-July 1867, May 1868
4	Accounts of Stores Issued to Agents Volume (46)	Nov. 1866-Feb. 1868
	Inspector General and Disbursing Officer Register of Letters Received and Endorsements Sent Volume (28)	Mar.-May 1868
	Quartermaster and Disbursing Officer Letters Received and Sent Volume (38) Press Copies of Letters Sent Volume 1 (39)	Apr.-July 1866 Sept. 1866-June 1867
5	Press Copies of Letters Sent Volume 2 (40) Volume 3 (41)	June 1867-Aug. 1868 Aug. 1868-July 1870
6	Endorsements Sent Volume (42) Register of Letters Received and Endorsements Sent Volume (36) Letters Received A-G G-K	Jan.-Apr. 1867 Jan. 1867-Jan. 1869 1868 1868
7	Letters Received M-W B-W Monthly Reports of Persons and Articles Hired	1868 1869 Sept. 1865-July 1869
8	Miscellaneous Memorandums Volume (45) Account Book of Stores Purchased Volume (48) Account Book of Stores Issued in the Counties Volume (47) Account Book of Stores Transferred by and to the Chief Quartermaster Volume (49)	Jan. 1866-Apr. 1867 Sept. 1866-July 1870 Jan. 1867-May 1868 Apr.- Oct. 1867

NATIONAL ARCHIVES AND RECORDS ADMINISTRATION
M I C R O F I L M P U B L I C A T I O N S

ROLL	DESCRIPTION	DATES
8	Surgeon	
(cont.)	Letters Sent	
	Volume 1 (31)	Sept. 7, 1865– July 21, 1866
	Volume 2 (32)	July 21, 1866– Mar. 16, 1867
	Volume 3 (33)	Mar. 18, 1867– Dec. 31, 1868
	Endorsements Sent	
	Volume 1 (34)	Sept. 1865– Aug. 1867
	Volume 2 (35)	Aug. 1867– Dec. 1868
	Registers of Letters Received	
	Volume 1 (29)	Oct. 1865–July 1867
	Volume 2 (30)	Aug. 10, 1867– Jan. 1, 1869
9	Letters Received	Dec. 1865–Aug. 1868
	Register of Invoices of Medical Supplies Received	
	Volume (195)	Nov.–Dec. 1865

SUBORDINATE FIELD OFFICES

Ashville

Labor Contracts Aug. 1865

Bluffton

Letters Sent
 Volume (156) Apr.–July 1868
Fair Copies of Letters Received and Endorsements Sent
 Volume (155) Apr.–July 1868
Letters Received May 1868

Cahaba

Contracts, Register of Contracts, and Registers of
Transportation and Rations Issued
 Volume (191) 1865–66

Claiborn

Letters Received May–July 1868

Demopolis

Letters Sent
 Volume 1 (138) 1866
 Volume 2 (139) Jan. 1867– June 1867
 Volume 3 (140) June 1867– Dec. 1868
Register of Letters Received and Endorsements Sent
 Volume (137) Apr. 1867–Nov. 1868
Letters Received Aug. 1865–Apr. 1867

NATIONAL ARCHIVES AND RECORDS ADMINISTRATION
M I C R O F I L M P U B L I C A T I O N S

ROLL	DESCRIPTION	DATES
10	Letters Received	May 1867–Dec. 1868
	Register of Complaints Volume (141)	Feb. 1866–Aug. 1868
	Miscellaneous Records	Jan. 1866–Nov. 1868
	Miscellaneous School Records of C. L. Drake Volume (194)	May 1866–Oct. 1868
11	Register of Patients, Freedmen's Hospital Volume (142)	June–Nov. 1867
	Elyton	
	Letters Sent Volume (153)	May–Aug. 1868
	Register of Letters Received and Endorsements Sent Volume (152)	May–July 1868
	Letters Received	May–July 1868
	Eufaula	
	Letter Received by H. R. Burton	Jan. 1868
	Eutaw	
	Letters Received by J. A. Yordy	Apr.–June 1868
	Labor Contracts	1866
	Garland	
	Letters Sent by the Surgeon Volume (145)	May–Oct. 1868
	Letters Received and Sent and Register of Prescriptions Volume (146)	1867–68
	Registers of Letters Received and Endorsements Sent Volume 1 (143)	Jan. 8–Oct. 15, 1868
	Volume 2 (144)	Oct. 10–Dec. 31, 1868
	Letters Received	Mar.–Aug. 1867
	Account Book Volume (147)	Oct. 1867–Oct. 1868
	Register of Patients Volume 1 (148)	May 1867– Oct. 1868
	Volume 2 (149)	May 1867– Oct. 1868
	Registers of Prescriptions Volume 1 (150)	1867
	Volume 2 (151)	1868
	Monthly Reports of Destitute Discharged Soldiers	June–Nov. 1867
	List of Expenses Incurred for Treatment of Freedmen	May 3, 1866
	Girard	
	Letters Received by J. B. Healy and a Labor Contract	1867–68

NATIONAL ARCHIVES AND RECORDS ADMINISTRATION
M I C R O F I L M P U B L I C A T I O N S

ROLL	DESCRIPTION	DATES
11	Greenville	
(cont.)	Letters Sent	
	Volume 1 (123)	Sept. 1865– Oct. 1866
	Volume 2 (124)	June 1866– Apr. 1867
	Volume 3 (125)	Feb. 1867– July 1868
	Volume 4 (126)	Aug.– Dec. 1868
	Registers of Letters Received and Endorsements Sent	
	Volume 1 (121)	Apr. 1867– Sept. 1868
	Volume 2 (122)	Sept.– Nov. 1868
12	Letters Received	Jan. 1866–Dec. 1868
13	Registers of Contracts	
	Volume 1 (128)	May–Dec. 1865
	Volume 2 (129)	May–Dec. 1865
	Register of Complaints	
	Volume (130)	Feb. 3, 1867–Dec. 1868
	Miscellaneous Record Book	
	Volume (127)	Sept. 1865–Aug. 1867
	Miscellaneous Records	June 1866–Feb. 1869
	Haynesville	
	Letters Sent by W. H. Hunter	
	Volume (192)	Aug.–Nov. 1868
	Huntsville (Subassistant Commissioner)	
	Letters Sent	
	Volume 1 (62)	July 1865– Apr. 1866
	Volume 2 (63)	Apr. 1866– May 1867
	Volume 3 (64)	Apr. 1867– Jan. 1868
	Volume 4 (65)	Feb.–Nov. 1868
14	Endorsements Sent	
	Volume 1 (70)	Sept. 1865– Jan. 1868
	Volume 2 (71)	Feb.–Nov. 1868
	Register of Letters Received	
	Volume (57)	July 1865–Mar. 1866
	Letters Received	
	Volume 1 (58)	Mar.–Oct. 1866
	Volume 2 (59)	Oct. 1866– July 1867
	Volume 3 (60)	July 1867– Jan. 1868
	Volume 4 (61)	Jan.–Dec. 1868
	Letters Received	Sept. 1865–Jan. 1869
15	Special Orders Issued	
	Volume (72)	Apr. 1866–Apr. 1868

NATIONAL ARCHIVES AND RECORDS ADMINISTRATION
M I C R O F I L M P U B L I C A T I O N S

ROLL	DESCRIPTION	DATES	
15 (cont.)	Register of Rations Shipped to Agents and Issued in the Counties Volume (80)	Jan.-Oct. 1866	
	Fair Copies of Contracts Volume 1 (81)	Sept. 1865-Jan. 1866	
	Volume 2 (82)	Jan. 1866-Jan. 1867	
	Volume 3 (83)	Jan. 1867-Jan. 1868	
	Docket of Trials Volume (84)	Jan.-Mar 1866	
	Rosters of Officers and Employees	Jan.-Mar. 1866	
	Miscellaneous Records	1865-67	
	Huntsville and Athens (Claims Agent)		
	Letters Sent Volume 1 (66)	Apr. 1868- July 1869	
	Volume 2 (67)	July 1869- Jan. 1870	
	16	Letters Sent Volume 3 (68)	Feb. 1870- Apr. 1871
		Volume 4 (69)	Apr. 1871- Jan. 1872
		Letters Received	Mar. 1870-Dec. 1871
17	Letters Received	Apr. 1868-Jan. 1869	
	Letters Received	Jan.-Dec. 1869	
18	Letters Received	Jan. 1869-Jan. 1872	
	Receipts for Claims	1867-72	
19	Census of Black Citizens and Register of Bounty Claims Received and Forwarded Volume (79½)	1865 and June-July 1868	
	Registers of Claims Allowed Volume 1 (78)	Apr. 1868- May 1870	
	Volume 2 (79)	Sept. 1868- Jan. 1872	
	Registers of Claims Forwarded Volume 1 (74)	May 1866- July 1870	
	Volume 2 (75)	July 1870- Jan. 1872	
	Registers of Disbursements Volume 1 (76)	Jan. 1868- Apr. 1870	
	Volume 2 (77)	Apr. 1870- Jan. 1872	
	Register of Claimants Volume (73)	June 1868-Dec. 1871	
	Miscellaneous Records on Claims and Copies of School Reports	1865-71	

NATIONAL ARCHIVES AND RECORDS ADMINISTRATION
M I C R O F I L M P U B L I C A T I O N S

ROLL	DESCRIPTION	DATES
19 (cont.)	Huntsville (Freedmen's Hospital) Letters Sent by the Surgeon Volume (87)	Feb.-Mar. 1866
	Press Copies of Letters Sent by the Surgeon Volume (88)	Sept. 1866-Aug. 1868
	Register of Letters Received and Endorsements Sent Volume (85)	Feb. 1867-June 1868
20	Special and General Orders and Circular Letters Received Volume (86)	May 1865-Aug. 1866
	Register of Sick and Wounded Volume (89)	Jan. 1866-July 1868
	Monthly Reports of Destitute Discharged Soldiers and Families Treated	July 1867-June 1868
	Jacksonville Letters Sent Volume (131)	May-Aug. 1868
	Letters Received	May-June 1868
	Contracts	June-Dec. 1865
	Livingston Letters Sent and Fair Copies of Letters and Orders Received by Agent John L. Stelzig Volume (157)	Aug.-Dec. 1868
	Register of Complaints Volume (158)	Aug.-Nov. 1868
	Court Records	1866-67
	List of Contracts	No Dates
21	Mobile (Subassistant Commissioner) Letters Sent Volume (108)	Apr. 1865-Apr. 1868
	Press Copies of Letters Sent Volume (109)	Apr.-Dec. 1868
	Press Copies of Letters of Transmittal Sent Volume (110)	Feb. 1866-Sept. 1868
	Registers of Letters Received and Endorsements Sent Volume 1 (106)	Nov. 1865- Apr. 1868
	Volume 2 (107)	Apr.-Dec. 1868
22	Letters Received	Sept. 1865-Dec. 1868
	Registers of Contracts and Complaints Volume (114)	Jan. 1866-Aug. 1868
	Transcripts of Mayor's Docket	Aug.-Sept. 1865
	Miscellaneous Records	1865-68

NATIONAL ARCHIVES AND RECORDS ADMINISTRATION
M I C R O F I L M P U B L I C A T I O N S

ROLL	DESCRIPTION	DATES
23	"Time Book," Swayne School Construction Volume (112)	1868
	Mobile (Freedmen's Hospital)	
	Press Copies of Letters Sent by the Surgeon Volume (116)	Aug. 1866–Nov. 1867
	Letters Sent and Register of Letters Received Volume (115)	Jan.–Dec. 1866
	Miscellaneous Record Book Volume (117)	Sept. 1865–Sept. 1867
	Monthly Abstract of Provisions Issued Volume (118)	Oct. 1866–Oct. 1867
	Register of Patients Volume (119)	Aug. 1865–Nov. 1867
	Register of Patients Volume (No Number)	June 1865–Nov. 1867
	Morning Reports of Sick and Wounded Volume (120)	Aug. 1865–Nov. 1867
	Monthly Reports on Treatment of Destitute Discharged Soldiers and Their Families	June–Oct. 1867
	Mobile (Claims Agent)	
	Register of Claimants Volume (111)	Dec. 1867–Mar. 1872
	Montgomery (Subassistant Commissioner)	
	Letters Sent	
	Volume 1 (92)	Oct. 1865– Mar. 1867
	Volume 2 (93)	Jan. 1867– Feb. 1868
	Volume 3 (94)	Feb.– Dec. 1868
	Registers of Letters Received and Endorsements Sent	
	Volume 1 (90)	Mar. 1867– May 1868
	Volume 2 (91)	June – Dec. 1868
24	Letters Received	May 1865– Dec. 1867
25	Letters Received	Jan.–Dec. 1868
	Special and General Orders and Circular Letters Received	July 1865–May 1868
	Fair Copies of Contracts	
	Volume 1 (196)	1865
	Volume 2 (197)	1865 (one list, 1866)
	Volume 3 (198)	1865
	Volume 4 (199)	1865

NATIONAL ARCHIVES AND RECORDS ADMINISTRATION
MICROFILM PUBLICATIONS

ROLL	DESCRIPTION	DATES	
26	Register of Claimants		
	Volume (95)	1867-July 1868	
	Reports Sent to the Assistant Commissioner	July 1865-Oct. 1868	
	Miscellaneous Records	1865-68	
	Montgomery (Freedmen's Hospital)		
	Letters Sent by Surgeon		
	Volume (98)	Jan.-Nov. 1867	
	Register of Letters Received and Endorsements Sent		
	Volume (96)	Jan.-Nov. 1867	
	Special Orders and Circular Letters Received		
Volume (97)	Jan.-Nov. 1867		
Surgeon's Record Book			
Volume (101)	Aug. 1865-Jan. 1867		
27	Accounts of Subsistence Stores Purchased and Issued		
	Volume 1 (99)	Jan.-Apr. 1867	
	Volume 2 (100)	May-Sept. 1867	
	Reports of Patients		
	Volume (103)	Sept. 1865-Nov. 1867	
	Registers of Patients		
	Volume 1 (104)	Aug. 1865-May 1866	
	Volume 2 (105)	May 1866-Nov. 1867	
	Monthly Reports on Treatment of Destitute Discharged		
	Soldiers and their Families	June-July 1867	
	Miscellaneous Registers of Food Purchased for use at the		
	Hospital		
	Volume (176 Ark.)	1865-67	
	Montgomery (Home Colony Hospital)		
	Register of Patients		
	Volume (102)	Sept. 1865-July 1866	
	Opelika		
Letters Sent			
Volume 1 (133)	June 1867-Feb. 1868		
Volume 2 (134)	Feb.-Dec. 1868		
Register of Letters Received and Endorsements Sent			
Volume (132)	Feb.-Dec. 1868		
Letters Received	May 1867-Dec. 1868		
28	Register of Complaints		
	Volume (330)	June 1867-Jan. 1868	
	Monthly Reports of Operations	Aug.-Nov. 1868	
	Circular Letters Issued and Orders Received	June-Oct. 1868	

NATIONAL ARCHIVES AND RECORDS ADMINISTRATION
MICROFILM PUBLICATIONS

ROLL	DESCRIPTION	DATES
28	Selma (Subassistant Commissioner)	
(cont.)	Letters Sent	
	Volume 1 (175)	Mar. 1866– Jan. 1867
	Volume 2 (176)	Jan.–Sept. 1867
	Volume 3 (177)	Sept. 1867– Oct. 1868
	Volume 4 (178)	Oct.– Dec. 1868
	Letters Sent Relating to Bureau and Quartermaster Stores	
	Volume (179)	July 1867–June 1868
29	Registers of Letters Received and Endorsements Sent	
	Volume 1 (173)	Jan.– Nov. 1867
	Volume 2 (174)	Nov. 1867–Dec. 1868
	Letters Received	Sept. 6, 1865–Nov. 29, 1867
30	Letters Received	Dec. 10, 1867–Dec. 24, 1868
	Special Orders Received	Nov. 1865–Feb. 1867
	Register of Complaints	
	Volume (180)	Aug. 1865–Apr. 1868
	Register of Employed Freedmen	
	Volume (181)	1865
31	Register of Rations Issued to Freedmen and Destitute Whites	
	Volume (182)	July 1866–Sept. 1867
	Morning Reports of Freedmen in Camp and Hospital	Aug.–Dec. 1865
	Complaints	June–Sept. 1866
	Miscellaneous Records	1856–69
	Selma (Freedmen's Hospital)	
	Letters Sent by the Surgeon	
	Volume 1 (185)	Aug. 1867–June 1868
	Volume 2 (186)	May 1866–July 1867
	Register of Letters Received and Endorsements Sent	
	Volume (190)	July 1867–June 1868
	Register of Patients	
	1 Volume (No Number)	Feb. 1866–July 1867
	Register of Patients	
	Volume (187)	Oct. 1866–June 1868
	Accounts of Subsistence Department	
	Volume (188)	Aug. 1867–June 1868
	Register of Prescriptions	
	Volume (183)	May 1867–Dec. 1868
	Morning Reports of Patients and Attendants	
	Volume (189)	Aug. 1867–July 1868

NATIONAL ARCHIVES AND RECORDS ADMINISTRATION
M I C R O F I L M P U B L I C A T I O N S

ROLL	DESCRIPTION	DATES
31 (cont.)	Talladega (Subassistant Commissioner) Letters Sent Volume 1 (164) Volume 2 (165)	May 1866–Feb. 1867 Feb 1867–Mar. 1868
32	Letters Sent Volume 3 (166) Volume 4 (167) Copies of Letters Sent Registers of Letters Received and Endorsements Sent Volume 1 (161) Volume 2 (162) Volume 3 (163) Endorsements Sent Volume (168) Letters Received	Mar.–Aug. 1868 Aug.–Dec. 1868 Mar.–July 1866 May 1867–Feb. 1868 Feb.–June 1868 June–Dec. 1868 June–Dec. 1868 Dec. 1865–Dec. 1868
33	Special Orders Issued and Received Volume (169) General and Special Orders and Circular Letters Received Miscellaneous Records Talladega (Freedmen's Hospital) Letters Sent Volume (170) Register of Patients Volume (172) Morning Reports of Sick and Wounded Volume (171) Tuscaloosa Letters and Endorsements Sent and Letters Received Volume (135) Letters Received General and Special Orders and Circular Letters Received Contracts	June 1867–Nov. 1868 Dec. 1865–Nov. 1867 1865–68 (some deeds, 1859) Aug.–Dec. 1868 Feb. 1867–Nov. 1868 Sept. 1867–Dec. 1868 Mar.–Oct. 1866 Feb. 1866–May 1868 Jan. 1866–May 1867 Dec. 1865–Apr. 1867
34	Register of Complaints Volume (136) Miscellaneous Records Tuscumbia Letters Sent Volume (159)	Jan. 1866–July 1868 Jan. 1866–May 1867 May–Aug. 1868

NATIONAL ARCHIVES AND RECORDS ADMINISTRATION
MICROFILM PUBLICATIONS

ROLL	DESCRIPTION	DATES
34 (cont.)	Fair Copies of Contracts Volume (160)	Nov. 1865-Mar. 1868
	Tuskegee Letters Sent Volume (154)	Sept. 1865-Apr. 1866
	Monthly Reports of Rations Issued	Feb.-Apr. 1866
	Register of Patients from Unidentified Hospital Volume (175)	1865-66

NATIONAL ARCHIVES AND RECORDS ADMINISTRATION
M I C R O F I L M P U B L I C A T I O N S

APPENDIX

This list provides the names and dates of service of known Freedmen's Bureau personnel at selected subordinate field offices in Alabama. Additional information regarding persons assigned to various field offices might be found among the Bureau's Washington headquarters station books and rosters of military officers and civilians on duty in the states and other appointment-related records.

LOCATION	DATES
Demopolis	
SUBASSISTANT COMMISSIONERS	
Capt. A. C. Haltonstall	Aug.-Dec. 1865
Bvt. Maj. C. W. Pierce	Jan. 1866-Feb. 1868
Lt. A. J. Bennett	Feb.-May 1868
C. L. Drake	June 1868
R. A. Wilson	July-Dec. 1868
Greenville	
SUBASSISTANT COMMISSIONERS	
A. L. Brown	Sept.-Nov. 1865
T. W. Mostyn	Nov. 1865-ca. June 1866
J. F. McGogy	ca. June 1866-Feb. 1867
Samuel Gardner	Feb.-June 1867
William H. Peck	June-Sept. 1867
Samuel Gardner	Sept.-Nov. 1867
J. A. Hart	Nov.-Dec. 1867
Samuel Gardner	Dec. 1867-July 1868
J. F. McGogy	Aug.-Dec. 1868
Huntsville	
SUBASSISTANT COMMISSIONERS	
T. M. Goodfellow	Sept. 1865-Jan. 1866
J. B. Callis	Jan. 1866-Jan. 1868
Robert Harrison	Jan.-Feb. 1868
D. C. Rugg	Mar.-Nov. 1868
Huntsville and Athens	
CLAIMS AGENTS	
J. W. Wilis	Apr.-Sept. 1868
John Wager	Sept. 1868-Jan. 1872
Jacksonville	
SUBASSISTANT COMMISSIONER AND AGENT	
Robert Harrison	May-Aug. 1868
William McKibbin (Agent)	Aug. 1868

NATIONAL ARCHIVES AND RECORDS ADMINISTRATION
MICROFILM PUBLICATIONS

Mobile

SUBASSISTANT COMMISSIONERS

George Harmount	Apr.-Aug. 1865
George Robinson	Oct. 1865-Apr. 1866
G. A. Washburn	Apr.-May 1866
L. J. Whiting	May-Aug 1866
Joseph Logan	Sept.-Oct. 1866
George Tracy	Nov. 1866-Sept. 1867
James Gillette	Sept. 1867-Aug. 1868
John Hyde	Aug.-Sept. 1868
E. H. Weirman	Sept.-Nov. 1868
Frank Towle	Nov.-Dec. 1868

Montgomery

SUBASSISTANT COMMISSIONERS

George A. Harmount	Oct. 1865-Dec. 1866
L. J. Whiting	Dec. 1866-Aug. 1867
J. C. Hendrix	Aug. 1867-Dec. 1868

Opelika

SUBASSISTANT COMMISSIONERS

R. T. Smith	June 1867-June 1868
John Bannister	July-Aug. 1868
D. B. Smith	Aug.-Sept. 1868
G. W. Kingsbury	Sept.-Oct. 1868
D. B. Smith	Oct.-Dec. 1868

Selma

SUBASSISTANT COMMISSIONERS

Samuel S. Gardner	Mar.-June 1866
F. D. Ogilby	June-July 1866
Samuel S. Gardner	July-Aug. 1866
George Shorkley	Aug. 1866-Jan. 1868
Charles C. Bartlett	Jan.-Dec. 1868

Talladega

SUBASSISTANT COMMISSIONERS

D. P. Cilley	Oct.-Nov. 1865
T. Humphrey	Dec. 1865-Apr. 1866
R. Theune	Apr. 1866-Feb. 1867
J. F. McGogy	Feb. 1867-June 1868
George P. Sherwood	June-Dec. 1868

NATIONAL ARCHIVES AND RECORDS ADMINISTRATION
MICROFILM PUBLICATIONS

Tuscaloosa

SUBASSISTANT COMMISSIONERS

Jesse W. Cogswell

W. H. Peck

Robert Blair

Jan.-Apr. 1866

Apr. 1866-Apr. 1867

Apr. 1867-Dec. 1868

Tuscumbia

SUBASSISTANT COMMISSIONERS

Henry Sweeney

W. H. Heilman

John Raines

May-June 1868

June-Aug. 1868

Aug. 1868

Tuskegee

ASSISTANT SUPERINTENDENTS

Andrew Geddes

Spencer Smith

Sept.-Nov. 1865

Nov. 1865-Apr. 1866

NATIONAL ARCHIVES AND RECORDS ADMINISTRATION
MICROFILM PUBLICATIONS

Microfilm Publication M1900

RECORDS OF THE FIELD OFFICES FOR THE STATE OF ALABAMA,
BUREAU OF REFUGEES, FREEDMEN, AND ABANDONED LANDS,
1865-1872

ROLL 26

SUBORDINATE FIELD OFFICES

Montgomery (Subassistant Commissioner)

Register of Claimants

Volume (95)*

1867-July 1868

Reports Sent to the Assistant Commissioner

July 1865-Oct. 1868

Miscellaneous Records

1865-68

Montgomery (Freedmen's Hospital)

Letters Sent by Surgeon

Volume (98)

Jan.-Nov. 1867

Register of Letters Received and Endorsements Sent

Volume (96)

Jan.-Nov. 1867

Special Orders and Circular Letters Received

Volume (97)

Jan.-Nov. 1867

Surgeon's Record Book

Volume (101)

Aug. 1865-Jan. 1867

* Volume numbers assigned by the Adjutant General's Office (AGO) are shown in parentheses to assist in identifying the volumes.

Roll 26

Target 1

SUBORDINATE FIELD OFFICES
Montgomery (Subassistant Commissioner)

Register of Claimants
Volume (95) 1867–July 1868

ALABAMA.

Handwritten notes

Handwritten notes

Handwritten notes

Sub-District of Montgomery,
BUREAU OF REFUGEES, FREEDMEN AND ABANDONED LANDS.

Montgomery, Ala......186

1
2
3
4
5
6
7
8
9
10
11
12
13
14
15
16
17
18
19
20
21
22
23
24
25
26
27
28
29
30
31
32
33
34
35
36
37
38
39
40
41
42
43
44
45
46
47
48
49
50
51
52
53
54
55
56
57
58
59
60
61
62
63
64
65
66
67
68
69
70
71
72
73
74
75
76
77
78
79
80
81
82
83
84
85
86
87
88
89
90
91
92
93
94
95
96
97
98
99
100

Year	Name of Slave	Rank	When Enrolled	When Discharged	Where Discharged	Why Discharged	What Claimed	Amount Claimed	all paid or Disallowed	To whom Forwarded	When Forwarded	When Paid	Remarks
1867	Brown; ^{Anderson Baynes} Gilbert ^{Facts of}						Father appli- cation for bounty	100.00		Genl A P Stone	May 1868		
"	Pick Adolphus												
"	Peter How												
"	Tommy Andrew												
"	Tommy James												
"	Christened. Henry												
"	Tommy Geo												
"	Bayne David												
"	Baldwin Jacob												
"	Pullard. Jacob etc												
"	Blank David												
"	Tommy Geo												
"	Brown. Machine												
"	Burtis Daniel												
"	Bartle. Char												
"	Bibb. Elijah												
"	Bibb. Edward												
"	Bibb. Alexander												
"	Bibb. Judge												
"	Bibb. Joseph												
"	Barcaucus. Tho												
"	Burt. Rodney												
"	Baldwin. John												
"	Brown. Alex												
"	Bury. Thomas												

Debit to balance July 2. 66

When Received	Name	Rank	Company	From	When Entered	When Discharged	Where Discharged
April 1867	Dillehay Paul	Private	A	1866	Apr 15. 66	Macau Gu	
" " "	Dillis, Jacob						
" " "	Davis, Joseph						
" " "	Davis, James						

When Discharged	What Claimed	Amount Claimed	Where or Discharged	Where Forwarded	When Forwarded	When Paid	Remarks
In 100 days of Dec 1866	Bounty	100.	Portland	Wm Fowler	Sept 10. 67	Dec 20. 68	

When Received	Name of Claimant	Rank	County	Age	When Enlisted	When Discharged	Where Discharged	When Discharged	What Claimed	Amount	Where Claimed	To whom Forwarded	When Forwarded	When Received	By whom Received
July 11/88	Samuel Kelley	Private	77	1872	Apr 15. 65	Jan 18. 66	Mass Gen	10th Regt 40th Mass	Bounty	\$100.00	Portland	Wm W Foster	Apr 18. 87		
" "	Gordon Sumner	Sergeant	77	1872	" "	" "	" "	" "	Bounty	\$100.00	Portland	" "	Apr 18. 87		
" "	George Benjamin	Private	77	1872	" "	" "	" "	" "	" "	\$100.00	Portland	" "	Apr 18. 87		
" "	Gordon Ned	Private	76	1876	" "	" "	" "	" "	" "	" "	Portland	" "	Apr 18. 87		
" "	George Shug														
" "	Gordon John														
" "	James Jeffers														
" "	Samuel Edward														
" "	Gay Marshall														
" "	Frank Davis														
" "	James Albert														
" "	William Davis														
" "	Leah Davis														
" "	Jay James														
" "	James Washburn														
" "	James Brew														
" "	Harriet Reed	Private	77	1872	Apr 15. 65	Jan 18. 66	Mass Gen	10th Regt 40th Mass	Bounty	\$100.00	Portland	Wm W Foster	Apr 18. 87		

Ret'd to A. J. Bond
Mar. 26 '87

James
Certificate of Discharge from United States
for the purpose of settling
in *Franklin County*
J. D. Whiting
Superintendent
of Freedmen and Abandoned Lands
J. D. Whiting

April 1847 Long Sawm
August 1847 Brig. Tom
" " " " " Benjamin
" " " " " Lewis Gilas

Points a articles

Map of the land and address

Aug 19. 67	Long. Leonard	Private	A	60000
" " "	Levic, Selas			
" " "	Levic. Washington			
" " "	Leather Smith	Private	T	30000
" " "	Le. Willie			
" " "	Long. Alexander			
" " "	Lawson, Samuel			
" " "	Levic. Henry			
" " "	Long. Abraham			
" " "	Long. Nathan			
" " "	Levic. Ruben			
" " "	Levic, Geo			
" " "	Long. James			

Major Gen. Fowler 1867

Private Co. Genl Howard July 9. 68

Debt to Leonard July 9. 68

Debt to Leonard June 30. 68

" " " 30. 68

When Received	Names of Claimants	Rank	Company	Regiment	When Enlisted	When Discharged	When Discharged	Why Discharged	What Claimed	Amount allowed	or Claimed	To whom Forwarded	When Forwarded	Rec'd Back	Remarks
August 19, 1867	Comdr. Isham														
. . .	Comdr. Smith														
. . .	Offic. Allen														

August 17, 1867
 Roberts, Hil
 Roberts, Wesley
 Ray, P.
 Ray, Samuel
 Ray, Silas
 Rice, Henry
 Rice, Richard
 Ray, Floyd
 Roberts, William
 Rice, Jefferson
 Rainstaff, Joseph
 Beckman, Diction
 Russell, Gibson
 Ray, Peter
 Rice, James
 Roberts, Henry
 Robinson, Samuel
 Rees, Robert
 Robinson, Oliver
 Rees, Henry
 Reid, Sidney
 Reid, Marion
 Rice, Edward
 Reid, Harbord
 Rice, John

New York
 Good return was Sept 24 of Aug 5 68
 Bonwillie N. Y.

June 17, 68

P.H.C. 6th July 1868

Paid to blank July 7 68

Bounty 100 Gul Howard June 22 68

When Received	Name of Claimant	Rank	Company	Regiment	When Enlisted	When Discharged	When Discharged
April 1st 1867	Thompson, Barry	Capt	I	137th Ill.			
August 19, 1867	Turner, Albert						
"	Trink, Wiley						
"	Tracy, Geo						
"	Thompson, Henry						
"	Turner, William						
"	Turner, Kelly						
"	Turner, Henry	Serjt	A	186th	May '65	Jan '66	
"	Tyler, Ferris						
"	Thomas, Jerry						
"	Thomas, James						
"	Taylor, Morris						
"	Tuck, Peter	Private	I	186	May '65	Jan '66	
"	Turner, Jack						

Why Discharged	What Claimed	Amount Claimed	Actual Paid	To Whom Forwarded	When Forwarded	When Received	When Paid	Remarks
	County	\$100.	Quarters	Genl Howard	Mar 68	Aug 28/68		
								Del'd to claimant July 7/68
			Disallowed					Del'd to Genl Dyer
			Disallowed					" " " July 1868

When Received	Name of Claimant	Rank	Company	Regiment	When Enlisted	When Discharged	Where Discharged	Why Discharged	What Claimed	Amount Claimed	Amount Allowed	To Whom Forwarded	When Received	Where Received	Remarks
April 1866	Woodhall Chas	Private	B	137	1865	Jan 18. 66	Macon Ga	Left Regt. Dec 14/65	Bounty	\$100	Quartermaster	Wm Wood	Oct 27/67	July 13. 68	Partly to claimant
"	Wood. Winston	1st Sgt	H	"	"	"	"	"	Bounty	\$100	Quartermaster	Wm Wood	Aug 28/68	July 13. 68	Partly to claimant
"	Wood. Chas W	Private	D	"	"	"	"	"	"	100	Quartermaster	Gen Howard	Mar 6. 68	July 13. 68	Partly to claimant
August 19, 1866	Williams. Sebur														
	Woods, Aaron	Private	H	137	1865	Jan 18. 66	Macon Ga		Bounty	\$100	Quartermaster	Gen Howard	July 9. 68	Nov 3. 68	
	Waton Wm														
	White. Abel														
	Wooden. James														
	Woods. Dickson	Private	D	137		Jan 18. 66	Macon Ga	S.O. 1000 of 1865	Bounty	\$100	Quartermaster	Gen Howard	July 9. 68	Nov 3. 68	
	Woods. Andrew	Serjeant	D	137		"	"	"	"	100	Quartermaster	"	"	Nov 3. 68	
	Woods. Chas W														
	Warrin, Moses														
	Wright. Isaac														
	White. Phillip														
	White. Geo														
	White. Mah														
	White. Madison														
	Williams. Andrew														
	Wright. Charles														
	Williams. Henry														
	Ware. Sampson														
	Wimberly. Adams														
	Wilm. Jackson														
	Washington James														
	Wester. Joseph														
	Williams. James														

2476 Clk Jan 29

When Received	Names of Claimants	Rank	Co	Regt	When made	When Discharged	Where Discharged	Why Discharged	What Claimed	Amount Due	allowed or disallowed	When Forwarded	When Received	Remarks
April 1867 Aug 19, 1867	Young Geo Young, Fred	Private	II	37th Regt	Apr 15, 65	Jan 15, 66	Macon Ga	Sober & soft Dec 1866	Bounty	\$1.00	Disallowed	sent as above May 1867	Sept 1867 July 1868	

Received from the Asst. Commissioner
 State of Ala this 22nd day of February
 1869. my discharge from the 10th U.S.
 Col. Arty. his
George X Coal
 Witness mark.
 Wm. Anderson
 Chas. Jackson

State of Alabama,
 BUREAU REFUGEES, FREEDMEN, AND ABANDONED LANDS.
 Montgomery, Ala., March 15th 1869.

Received of Edwin Beecher West Comisr State
 of Ala on R.F. & L. the sum of Thirty three (\$33⁰⁰)
 and ³⁴/₁₀₀ Dollars. being the amount of bounty re
 due me as Nurse on Steamer Octavia.

Witness
 Wm. Anderson
 John Jacob

RECEIVED
 Service to be forwarded to Washington, D. C., for the purpose of getting

Certificate of Discharge from United States
Wm. Anderson

Feb 21-1869

Assistant SUPERINTENDENT,
 Bureau of Refugees, Freedmen and Abandoned Lands.
W. J. Whiting
W. J. Whiting

RECEIVED
 to be forwarded to Washington, D. C., for the purpose of getting

Certificate of Discharge from United States
Wm. Anderson

Montgomery Ala
 Feb 18th 1869

Assistant SUPERINTENDENT,
 Bureau of Refugees, Freedmen and Abandoned Lands.
W. J. Whiting
W. J. Whiting

Roll 26

Target 2

SUBORDINATE FIELD OFFICES
Montgomery (Subassistant Commissioner)

Reports Sent to the Assistant Commissioner
July 1865–Oct. 1868

11
Bernard R. Fort
Montgomery Ala, July 1st 1865

Asst. Supt. Freedman

To transmit his report for
June 1865 to J. W. Conway
Genl. Supt. Freedman.

Bureau of Free Labor
Montgomery Alabama.
July 1st 1865

J. W. Conway
General Superintendent Freedmen.

Sir:

I have the honor herewith to submit my report for the month ending June 30th 1865.

The past month has been one of great change in many respects. The condition of County Districts, as well as the order and industry of the City, has vastly improved. There is much less ragrancy on the part of Freedmen, and for less abuse and ill-treatment on the part of their late masters since the publication of President Johnson's Amnesty Proclamation, and since his interview with delegations from Southern States have been made public, our Citizens have been more open and frank to acknowledge that Slavery is forever dead.

Few, relinquish their hold reluctantly and are hardly willing to bury the corpse from their sight. A few, the more rebellious, prefer to kill the Negro than to see him free.

But events hasten. Our Victory urges on to new achievements. Show who our vast ago yielded up their slaves to "Freedom" and accept

ted the new order of things with cheerfulness, and
now agitated of mind by fears of Negro Suff.
frage. Thus it is by the will of Heaven, by
Divine right, that the Nations Freedmen are
coming, surely and speedily to occupy their
rightful position - equality with white men
in the eyes of the Law.

Howe Colony

The application for the assignment of lands
to be used temporarily for the colored people,
made by you to the Military Authorities, was refer-
red to me on June 2nd 1845. designating sev-
eral plantations which might be used for our
purpose. I at once examined these plantations
and moved from Camp two hundred and fifty
persons upon one of them in order to raise
the crop, as the season for corn culture was
rapidly passing away, this being the only crop
of any importance raised in this portion
of the State. Two other plantations, as we were
moving on to them, were released and given
back to the owners. Afterwards two more were
released. One other was so near town as
to be inconvenient to us, as straggling into and
out of town would greatly annoy us, and
disturb the industry of the place. This
left us with but two plantations under our
control, and one of them was small having
but few quarters, no house, water source and

poor crop small, and, on the whole, useless
for our purpose. I decided not to use it. We
have therefore held on to the first place, em-
bracing one thousand acres, and sowed about
five hundred acres of corn. But owing to the
fact that the corn entirely neglected in the
early part of the season, when it ought to
have been worked, coupled with a severe
drought, and being unable to draw any
mule. General Smith having given out to Atkins
all his old stock before my arrival here,
our farming operations will not be so suc-
cessful and profitable as I could wish.

Had we commenced our operations on
May 1st instead of June 1st, our results would
have been far more encouraging.

In the mean time, while some have been enga-
ged in agriculture, others have been busy erec-
ting shops and plain houses at the Freedmen
Colony to protect women and helpless chil-
dren against the coming fall and winter storms.
This undertaking has been delayed for the want
of a sufficient number of common tools.

Lately, however, the Post Quarter Master turned over
to me fifty axes, and, before this report shall
have reached you, the last vestige of the Freedmen
Camp across the river, will be broken up, and
they, with the unemployed Negroes in town will
be made comfortable on the plantation eight miles

from the City. I have made extra effort to remove this Camp before, but I saw no object in moving it till I could improve the comfort of the colored people in it. And as we have been unable to draw teams for our own use, I have thought, while dependent upon teams of the Past, for hauling our rations &c it was not practicable to make the change till we could profit by so doing. The time has now come when we can make the change with safety and comfort.

Hospitals

Application for lumber sufficient to build at the Home Colony a plain and commodious Hospital for freed sick as fall upon our hands has been made. We now wait the reply. It is very difficult to procure buildings either in the City or in the adjoining country, for hospital purposes. We greatly need a building where small children can be provided for during the sickness of parents. As we are now situated, it often happens that a Mother is taken sick, having two or three small children who are obliged to go to the hospital with her, for she has no one to care for them in her absence. Had we a place to put such children till the Mother recovers, it would relieve the hospital and be far better for the children.

An Orphan Asylum is also greatly needed. The number of children is very great and among them many Orphans.

I am located in a section where Negroes are regarded as the most popular and profitable mode of investing Capital. They are always saleable. There are hundreds of plantations in this section whose only net profits consisted in the increase and growth of negro children.

This being the case vast numbers of children, helpless and friendless, must be cared for. The demands for an Asylum are urgent and I hope before fall to establish one. If an appeal were made to the benevolence of North I doubt not sufficient aid could be obtained.

The liberal aid I have received from Hon James Yeatman, President Western Sanitary Commission, and Hon Francis G. Shaw, President National Freedmen's Relief Association, New York City, for similar purposes in other sections, renders me confident of material support in this instance.

Marriage Certificates

Feeling the necessity of regulating the conjugal relations of the Freedmen I have inaugurated a system by which an accurate record is kept of all lawful marriages and certificates are issued to the married parties.

The annexed Circular will explain my method.

Resignation!

Captain J. L. Brown, A. A. Q. M. of this Dept
mut. handed in a request to be relieved, assigning
as a reason, that he was not contented with his
situation. I approved and forwarded it, as I am
confident that a man to be useful in this
Dept., must take a deep and abiding interest
in his work, and feel that his toil is not
drudgery. One should be sustained and ani-
mated by the thought that he is giving his ener-
gies to the relief of an oppressed people.
My relations with Captain Brown have been cordial
from the beginning, and I fear it will be difficult to
fill his place.

Conduct of Freedmen.

War naturally quickens the energies of a Nation
and gives a wonderful impetus to National
life. These Southern States give striking evi-
dence of the truthfulness of this statement.
The energy with which the inhabitants met
the emergencies of the rebellion was worthy of
a nobler cause. But the quickening influences
of war have not been felt by the white race
only. The energies of the colored race have
been aroused and called forth. Superadded
to the quickening effects of war, is the inspira-
tion of a newly acquired "Freedom". The future

to them is radiant with new hopes. As the burden
of Slavery is lifted, their purposes rise accord-
ingly. Already two colored schools are in
progress and largely attended. These schools
are self-supporting. Children of color walk
our streets with books under their arms, not-
withstanding it is contrary to the statute law
of the State to teach a colored child to read.
The general conduct of the Freedmen is good.
In many cases they receive nothing more than
a support for their work. The plantations of
many of their former owners have been
desolated by war, and nothing but a sup-
port will be made. Citizens who are wil-
ling to adapt themselves to the new order
of things find but little trouble in contrib-
uting their help. There are a few citizens
in every neighborhood who cause trouble,
but Freedmen are not ill-treated as much as
our mouths are.

Petitions

Petitions through Military channels, constantly
come in for aid to regulate Freedmen-
affairs. The last from ^{the citizens of} Grand Ala. opposite
Columbus. This makes our field of operations very
large, especially for our limited help. We are
looking forward, with hope, to the early arrival
of the Secretariat Commission of the State,
Montgomery, being the Capital of the State, and

the largest city of this portion of the States, it is natural for business to center here, and the manner in which things are done here will give shape to similar transactions in other sections. Realizing this fact I have endeavored to act with caution and deliberation.

My experience thus far, confirms my belief in the ultimate success of our System.

In the contest between slave and free labor, the issue is not doubtful to my mind.

These broad fields, now desolated and neglected, will be made to yield a more beautiful harvest than ever before: the lost millions, accumulated by years of unrequited toil will be replaced, but it will be by the industry of well directed free labor.

I have the honor to be
with much respect

Yr Obedt Servt.

Asst Supt Freedmen

Received
Montgomery Ala, July 10th 1865

Asst Supt Freedmen

For amount here reported for
June 1865 to J. W. Conway
Supt Supt Freedmen

Fredman's Record.
Montg. Ala. Aug. 21. 1815.

Buckley, C. W.
Capt. Fredman's

Report of Prison-
ers confined in Mil-
lery Prison, Montg.
County, Alabama.

Report of Prisoners (Colored) Confined in Military Prison, Montgomery, Alabama

Date of Confinement	Name	By whose Order Confined	Charges	Remarks
June 15 th 1865	Emanuel Myrick	Capt Scott. Pro. Mar.	Stealing Horses	Not yet tried.
22 ^d "	Pompey Lindsay	" " " "	" "	Confined till further orders
" "	Miles McCrary	" " " "	" "	" " " "
" "	Lindsay	" " " "	" "	" " " "
30 th "	Charles Hall	" " " "	" Cotton	" " " "
July 1 st "	Allan	" " " "	" Horses	Time of Confinement not stated.
7 th "	Jacob Peacock	" " " "	" Mules	Confined till further orders
10 th "	D. Holmes	" " " "	" "	Time of Confinement not stated.
" "	Paul Freeman	Maj. Alderman	" "	Confined till further orders
11 th "	Carte McCull	Capt. Jester	" Murder	" " " "
11 th "	Sam Titt	" Scott	" Stealing Mules	" " " "
15 "	Morgan Alfrett	" " " "	" Horses	" " " "
16 th "	Alfred Willis	" " " "	" "	" " " "
17 th "	Henry Forrest	" " " "	" "	" " " "
18 th "	Allan Mullin	" " " "	" Stock	" " " "
21 st "	Sam Little	" " " "	" Cattle	" " " "
" "	Moses Ballads	" " " "	" "	" " " "
" "	Lincy Smith	" " " "	" "	Time of Confinement not given
27 th "	Gilbert	" " " "	" "	" " " "
31 st "	Nathan Lucas	" " " "	" Cotton	" " " "
" "	Jack Hall	" " " "	" "	" " " "
August 2 ^d "	Refus Battle	" " " "	" "	Confined till further orders.
" 5 th "	Jasper Adams	" " " "	" Mules	Time of Confinement not given
" 11 th "	W. Robinson	" " " "	" Stealing	" " " "
" 12 "	Roger Smith	" " " "	" Cotton	Confined till further orders

Date of Confine	Name	By what Officer	Charge	Remarks
August 12 th 1865	Richard Whipple	Capt Scott Prisoner	Stealing	Confined till further orders
17 th "	William Pried	" " " "	" money	" " " "
17 th "	John Taylor	" " " "	Larceny	" " " "
15 th "	Richard Young	" " " "	Theft	" " " "
1 st "	Samuel Edwards	" " " "	" Misd	Time of confinement not stated
July 1 st 1865	Demoy	Capt Scott Prisoner	No charges preferred	Confined till further orders
2 nd "	Geo Edwards	M ^r Nicholas	" " "	" " " "
29 th "	Chas Edwards	Capt Scott	" " "	Time of confinement not given
3 rd "	Tom Calhoun	" " " "	" " "	Confined till further orders
August 7 th "	Jas Mitchell	" " " "	" " "	" " " "
" " "	George	" " " "	" " "	" " " "
" " "	Bill Trout	" " " "	" " "	Time of confinement not stated

Mount-Keys Ala
October 24th 1866.

Brewer R. H.

Agent vs

Reports on the
condition of freedom

Mount Meigs Ala
Oct 24th 1866

Capt L J Whiting
Superintendent B F S
I Montgomery Ala

Dear Sir

Dear Sir. As Agent
of the Bureau of Freedmen & I beg leave to make
the following report of the condition of the
Freedmen & the school at Mt Meigs. The freed-
men are doing very well I have but few compl-
aints of mistreatment except in settlement of
wages due of which much of my time is employ-
ed to get settlements for them I have generally
succeeded in getting settlements without suits, and
where they have had to sue for their wages I have
found the Magistrates disposed to give them
full justice. The Freedmen seem to much better
satisfied and are behaving remarkable well.
From my experience and consulting with the
Planters I believe they are doing about two-thirds
work of what they did when slaves. I believe they

are the best labours that we can get
for our climate & cotton raising and at
the present price of cotton can be made profita-
ble to the farmer. The school under my
charge is doing only moderately well we
have about an average of 35 scholars at school
the children have advanced as fast as
could be expected (and in some cases a very
rapid progress) I have the services of a very
competent teacher as regards her education
and her talent for imparting instruction she
is well qualified but as reliable as she should
be. In consequence of more of my time being
occupied I shall have to respectfully ask
for my pay to be increased from twenty five
dollars per month to forty dollars per month,
all of which is respectfully submitted

To
Capt L G Whiting
Superintendent of B.F.A.L
Meriden, Ala

R H Brewer

Retained Copy
Report of Work done in
this office since the
1st of January 1867,

Montgomery, Alabama

May 31st 1867.

Office Sub-Assistant Commissioner,
BUREAU REFUGEES, FREEDMEN AND ABANDONED LANDS
SUB-DISTRICT OF MONTGOMERY,

Montgomery, Ala., May 31st 1867

O. D. Kinsman
Sub-Assistant Commissioner.

Sir

In compliance with the instructions contained in your letter, dated Head Quarters District of Alabama, Montgomery Ala., May 31st 1867. I have the honor to submit the following report.

Employees.

Since the 1st of January 1867, there has been one Clerk, and one Messenger, employed in this office.

Freedmen's Affairs.

As far as I can learn the freedmen are working very well this year. There are not many complaints of breach of contracts, and in most of these cases the fault is on the side of the employer.

I think the complaints of outrages, and injustice are decreasing, there having been but about thirty (30.) complaints since the first of January and there has been no report of murder of freedmen
1 over 1

since that time,

There have been but a few applications to revoke indentures of apprenticeship under General Orders No. 3, and these, the Judges of Probate, at my request, have always complied with.

There is no provision made by any of the Counties of my District for the support of their poor.

There have been thirty three (33) applications for pay and bounty of discharge colored Soldiers made out at this office and, forwarded to Washington since the 1st of January, 1867.

The corn sent by the Southern Famine Relief Commission for the County of Montgomery was distributed by me for the month of May 1867, to four hundred and twenty (420) white and four hundred and eighty three (483) colored persons.

I am Very Respectfully
Your Obedient Servant
C. J. Whiting,
Lieut 43rd U. S. Infyth
Sub Asst Commr

Retained Copy
Report of Work done in
Office Sub-Test. Com.
B. R. S. & A. L. Sub-Dist
of Montgomery during
the month of June 1867

Office, Sub. Ast. Commr. Div. P. & A. S.
Montgomery, Alabama July 1st 1867.

Col. O. G. Kinsman
Sub. Ast. Commr.

Sir

In compliance with instructions contained in your Letter dated Head Qu. District of Alabama Montgomery Ala May 31st 1867. I have the honor to make the following report:

There is one Clerk and one Ranger employed in this office.

I think the Freedmen have worked very well last month as there have been very few complaints.

There were very few complaints of outrages committed upon Freedmen last month, and no murder reports.

There were twelve ^{applications} (12) for pay and bounty of discharge colored Soldiers made out at this office, and forwarded to Washington last month.

They are now being sent by the Southern Relief Commission for the County of

Montgomery Ala was destroyed ^{by me} for the
month of June 1864 to three hundred and seventy eight (378)
White and two hundred and fifty colored persons

I am Very Respectfully
Your Obedt Servant

Sept 15th Wm. S. D. ^{Genl}
Sub Asst Commr

Retained Copy
Monthly Report
of Labor performed
for the month of
August 1867

Office Sub-Assistant Commissioner
BUREAU R. F. & A. L., SUB-DISTRICT OF MONTGOMERY.

Montgomery, Ala., September 4th 1867.

Col: O. G. Kinsman
Sub Dist Commr
Colonel.

In compliance with instructions contained in your letter dated Head Quarter District of Ala. Montgomery Ala. May 31st 1867. I have the honor to submit the following report.

As there has been very few complaints by Employers against their laborers, it is believed that the Freedmen have worked well during the last month.

There has been but four applications to revoke indentures of apprenticeship, under General Orders No. 3. Head Quarters District of Ala. current series, all of ~~which~~ ^{said cases} have been referred to the Judges of Probate, no report of actions taken has yet been received.

There has been Twenty (20) complaints of violation of contracts, on the part of the Employers, all of said cases have been referred to the Justices of the Peace, in the best where the parties reside.

There has been but

one report of Outrage: committed on freedmen
by their employers in this Suba District."

Several reports
have been made of assaults on freedmen by
white persons, these cases have been referred to
Justices of the Peace.

The Corn and Bacon received
from Lieut Joseph Logan A. S. D. M. at
Mobile Ala has, been issued to Eight Hundred
and Sixtyfour destitute white and Eight Hundred
and Twelve colored people, Making a total of
One Thousand Six Hundred and Seventy six (1,676)
dependent during the month.

I am Very Respectfully
Yours Obedt Servant
Geo. J. Hendrick
Acty Suba Adm Comm

Office Sub Post Commr
Bureau of R. F. Aug 28.
Montgomery Ala Oct. 4th 1867.

Meidriff, Inq. C.
Actg. Sub Post Commr
(Retained Copy)

General Report of Labor
performed during the
month of September.

Office Sub Asst. Commr
Bureau of R. F. and A. S.
Montgomery Ala. Oct. 4th 1867.

Col. C. G. Whisman
Sub Asst. Commissioner
Colonel

In compliance with instructions from Head Quarters District of Alabama I have the honor to make the following General Report of Labor done at this office during the month of September.

~~Since the first of last month there have been~~
Thirtyone (31) Complaints of Laborers having been discharged without pay for the time they had labored, the majority of said Complaints have been made by Freedmen who are interested in the crop, ^{the above} in which cases the parties have returned to the Plantations or been referred to the proper Civil authorities.

~~There have been~~ Three (3) applications ^{made} to revoke indentures of apprenticeship of Minor Children (Colord.) under General Orders No. 3. Head Quarters District of Alabama cannot review, which cases the indentures have been revoked.

Eight (8) cases of Assaults on Freedmen by white persons have been reported, all of which have been referred to the proper Civil authorities and immediate action ^(taken)

Nov (10) Applications for bounty of discharged
(Colored) Soldiers have been made out and forwarded
to Washington D. C. during the month.

Our case of Outrage
Committed on Frederick, has been reported in which case
there was five persons accused (three Colored and two white)
the Colored men were arrested, and bonded over to appear
at the next term of the County Court, two of them
being unable to give the bond required, were confined
in jail. the white men have not been caught,
it is believed they have left the country.

The provisions
furnished by the N. Y. Family Relief Commission, has
been issued to Three Hundred and Thirtysix (336)
white and Two Hundred and Twenty (220) Colored persons
during the month.

I am Very Respectfully
Your Obedient Servant
J. C. Hendrix
Actg. Sub^a Asst. Commr.

Office Sub Treas Comm
Bureau P & L

Montgomery Ala. Feb 11 1867

Head of Div
Sub Treas Comm

General Report of Labor done
at office during month of
October 1867.

Retained Copy

Office Sub Street Commr
Bureau of P. Hand & L
Montgomery Ala Nov 4 1867

Col O J Kneeman
Sub Street Commissioner

Colonel

In compliance with
instructions from Head Quarter District of Alabama, I have
the honor to make the following General Report of
Labor done at this Office during the month of October
1867.

There have been Twenty (20) complaints of
Laborers having been discharged without pay for the
time they had labored, these cases have all been
referred to the proper Civil Authorities.

There have been
Twelve (12) Assaults on Freedmen by white persons reported,
all of which have been referred to the proper Civil
Authorities.

Eight (8) Complaints have been made where parties
have failed to pay laborers for services rendered last year
most of said complaints have been settled.

Seven (7) Complaints
(over)

have been made of Freedmen having been discharged who were entrusted in the Conf. said freedmen have either returned to the plantations or been referred to the proper civil authorities.

Three (3) Applications for bounty of discharged (Colo) Soldiers have been made and forwarded to Washington during the month. Two (2) Complaints have been made of employers having discharged Laborers for being absent at the Election. Letters were written requesting a full statement setting forth their cause for discharging said Laborers also that if said statement was not satisfactory they would be arrested and tried as per Genl Order relative thereto, to which one of the parties has not replied, a Mr Samuel Bradley near Benton London Ms Ala.

The provisions furnished by the U. S. Family Relief Commission, has been issued to Two Hundred and Seventy Nine (279) White and Two Hundred and Twelve (212) Colored Persons during the month.

Very Respectfully
Your Obedt Servant.

Jos. Kendrick
Acty Sub Asst Genl

Office Subst. Comm. B. R. Fr. Co.
Montgomery, Ala. Dec 4th 67

Wendell Smith

Acty Subst. Comm.

General report of Labor
performed at office during
the month of November 1867

"Retained Copy"

Office Sub-Assistant Commissioner,
Bureau R., F. & A. L., Sub-District of Montgomery,

Montgomery, Ala., Dec 4th 1867.

Col. G. D. Kingman
Sub-Assistant Commissioner
Colonel

In compliance
with instructions from Head Dist Dist^{ct} of Ala
I have the honor to submit the following
General Report of Labor performed at this
office during the month of November 1867.

Twenty eight (28) complaints ^{have been} made of Labors
~~of having~~ been discharged without pay for
the time they had labored. These cases have
been settled or referred to the proper civil
Authorities.

Seven (7) cases of Assaults on Freed-
men by white persons reported, all of which
have been referred to the proper civil Authorities.

Thirty (30) complaints have been made
where employers have moved their crops without
making a settlement with their Labors or
without the consent of said Labors. All of
said cases have been referred to the Justices of
the Peace or other officers having jurisdiction
with directions to take action under General
Order No 13. Head Dist Dist^{ct} of Alabama

current series - immediate action has been
taken in all cases heard from

Thurs (3)
Applications to revoke indentures of Apprenticeship
have been made. all have been referred
to the proper Civil Authorities with directions
to take action under General Order No (3)
Head Quarters Dist of Alabama,

Tues (12) Complaints
made when parties failed to pay Laborers
for services rendered last year (1866) most of said
cases have been equitably settled,

Complaints are
being made by Freedmen - also by white persons - that
the Crop and Stock of a great many Planters have
or is being attached to secure payment of advances
made to raise the ^{own} present Crop - in such cases the
Freedmen will receive no pay for their faithful
labor during the year. from the fact that the parties
have nothing that they can get the land bring in
most cases ~~wanted~~ ^{least}

The promissory furnished by the
F. S. Family Relief Commission has been issued to (165)
One hundred and sixty five white persons and one hundred
and forty one (141) colored persons during the month

Very Respectfully
Your old servant

A. J. Suberest Comr

Retained Copy

General Report of
work done at Office Sub
Arch. Census. Sub Dist.
of Ala for month of
December 1848

Office Sub Dist Court D. V. No. 13
Sub Dist of Montgomery
Montgomery Ala. Jan'y 6th 1868

Col O. G. Quismán
Sub. Dist. Commissioner.

Colonel

In compliance with instructions from Head Quarters Dist of Alabama, I have the honor to submit the following General Report of Labor performed at this office during the month of December 1867.

Fourteen (14) Complaints have been made by Freedmen, where they have been discharged without pay for ~~the~~ the time they had labored these cases have been settled at this office or referred to the proper Civil Authorities.

Two (2) Cases of Assaults on Freedmen by white persons reported, both of which have been referred to the Civil Authorities.

(28th)
Twenty (20) ~~Eight~~ Complaints have been made, where Employers have moved their Crops without making settlements, or ^{with their laborers} without their consent, all of ~~the~~ ^{which} cases have been referred to the Justices of the Peace or other officers having jurisdiction, with directions to take action under General Orders No. 13011 Head Quarters Dist.

of Alabama - current series, immediate action has
been taken in all cases heard from.

Nine (9)
Applications to revoke indentures of Apprenticeship
have been made, ~~one~~ ^{all of which} have been referred to
the ^{proper} Civil Authorities - with directions to take action
under General Order No 3. Head Quarters Dist
of Alabama.

Forty ⁴⁴ ~~Twenty~~ (24) Settlements with the Freedmen
have been made at this office, by their Employers
before me ~~and~~ ^{of} all of ~~them~~ ^{which} have been settled
just and equitably.

Complaints are being made
by Freedmen - that their Employers - (^{who} having leased
lands) have nothing that they can attach to
secure pay for their years labor, their crops & stock
having been taken for rent and supplies.

There is
a report among the Freedmen in which they are made to
believe that they are not to employ themselves until after
the 4th of February this report is said to originate from
persons who are making political speeches in different
parts of the Sub District.

Dear Colonel,

Very Respectfully,

Your Obedt Servant

Sub Dist Commr

Office Sub Arch Louis B. B. & L.
Sub Arch of Montomery
Montomery Ala Feb 21st 1868

Henrius J. G.
Sub Arch Commissioner

General Report of labor performed
at Office Sub Arch Louis during
the month of January 1868

Retained Copy

Office Sub-Assistant Commissioner,
Bureau R., F. & A. L., Sub-District of Montgomery,

Montgomery, Ala., February 4th 1868

Major Gen Shunkley
Capt 15th Regt Inf U.S.A.
Adj. Gen. Bureau

Major.

In compliance with instructions from Hd Qrs Dist of Ala. I have the honor to submit the following General Report of Labor performed at this Office during the month of January 1868.

Thirty three (33) Complaints have been made by Freedmen, where they have failed to receive their pay for last years labor, having been discharged without a settlement, these cases have ^{either} been settled at this Office or referred to the several Civil Officers.

Eighty two (82) Complaints have been made, where Employers have disposed of their Crops without the consent of the laborer and without making the proper settlements, all of which have been referred to Magistrate or other Officers having jurisdiction in said cases, with directions to take action under General Order No 13 of Hd Qrs Dist of Ala. ^{series of 1867.} immediate action has been taken

in all cases heard from

Twenty Three (23) Settlements have been made at this Office before me, between Freedmen and their Employers, all of which have been settled just and Equitably and giving satisfaction to both parties.

Three (3) Applications to revoke indentures of Apprenticeship have been made at this Office, all of which have been ^{referred} to the proper Civil Authorities, with directions to take immediate action under Gen. Order No 3. Hd Qu Dist of Ala. series of 1862.

During the month of January 1863 Supplies were issued to 64 white freed Colored persons.

Several cases of Assaults were mediated by White Persons, ^{have been} reported all of which have been referred to the Civil Authorities.

Dear Madam

Very Respectfully
In Obedt Service

Det Arch Crow

Sub Dist. of Montgomery
Bureau P. O. & Co.
Montgomery Ala. Feb 3. 1848

Hendrix. Dur. &

Sub Dist. Commissioners

General Report of Bureau
and Freedmen's Affairs
for the month of February 1848.

Retained Copy
Miscellaneous Reports of
Sub Dist. Commrs. at
Montgomery Ala.

1848-8.

Sub Post of Montgomery
Bureau of F. & A. S.
Montgomery Ala March 2nd 1878

Major George Shookley
Capt 15th Regt, Bohemian Co

A. A. G. Bureau.

Majors:

In compliance
with Circular No 11
to submit the following General Report of ~~the~~ Business Affairs
this Office during the month of February

Disorders (61) Complaints have been made at this Office
where Employees have disposed of their Corps without the con-
sent of the Subors and without making the proper settlement with
them. These cases have all been referred to the General Justice
of the Peace or other officers having jurisdiction in said cases;
with instructions to take immediate action under Genl Order
No 13, 14 Genl Order of the series of 1867. Statements from
these Officers, have been received and are on file in this Office setting
forth the action taken in the cases heard from.

Disputes (25) Settlements have been made at this Office,
before me, between Indians and their Employers, all of which
have been settled just and Equitably, giving satisfaction
to both parties and Employers.

Thirty-four (34) Complaints have been made by the Freedmen
whom they have failed to receive their pay for last years ⁶⁸⁷ labor;
they having been discharged without a settlement. These cases
have been either settled at this Office, or referred to the proper
Civil Authorities.

Two (2) Applications for revocation of Apprenticeships
have been made at this Office. ~~At~~ ^{They were} ~~which~~ have been
referred to the Civil Authorities - with instructions to take
immediate action as per Genl Order No 3 Hd Qu Part
of Alabama series of 1864.

During the month of February Supplies amounted to 578
white and 1216 - Colored Persons.

The Freedmen in this Sub Dist are in many cases out of
employment, the cause is believed to exist on their part from a dis-
position not to enter into Contracts. Applications are made at this Office
daily for laborers in which reasonable compensation is offered.
All means possible are being used to induce them to enter into Con-
tracts.

The Soup Kitchens ^{being} Established in this City under instructions from
Hd Qu State of Ala. will be in operation by the 5th of ~~March~~ ^{July}. Arrangements
are made by which the City Authorities assume the expenses incurred in making
and issuing the supplies furnished in that way.

J. C. Hendrix
Sub Arch Camp

Sub Post of Montgomery
Bureau R. W. A. C.
Montgomery Ala April 1st 1878

Hendrix D. C.

Sub Arch Commr

General Reports of
"Bureau and Business
Affairs" during the month
of March 1878

R. C.

Sub Dist of Montgomery
Bureau B F S
Montgomery Ala April 10th 1868.

Assistant Commissioner
B F S
State of Alabama
Montgomery Ala

General,

I have the honor to submit the following "General Report of Bureau and Freedmen Affairs" in this Sub District during the month of March 1868

1st Non-payment of wages

There has been Thirty Eight (38) Complaints of this character made at this Office by Freedmen. All of which have been referred to the proper Civil Authorities with instructions to attend enough the Contractors to satisfy the claims of the Laborers. A written statement is required from these Authorities setting forth their action taken in said cases.

2nd Violation of Contract (by Contractors Laborers)

Six (6) complaints of this kind has been made by Laborers in which the Contractor has discharged the Laborer. These were settled at this Office or referred to the proper Civil Authorities, directing them to not allow the Laborer to be so discharged, without a legal process at Law. Three (3) complaints have been made by Contractors, where the Laborers have abandoned their Contract. In these cases the Laborers have been induced to return and fulfill the same.

3rd Settlements

Seven (7) Settlements between Laborers and Employers have been made at this

Office during the month. All of which have given entire satisfaction

4th Contracts

One hundred (100) Contracts have been presented at this Office for examination. Strict attention has been given to the same in noting and explaining to the Laborers the obligations contained therein. In many of these written instruments, advantages, are taken of the Laborers. Contracts of this character have ^{been} minutely explained to them, and they have been informed of the result, of continuing to labor under such Contracts.

5th Assault & battery on Freedmen (by white persons)

Two (2) Complaints of this nature have been made at this Office by Freedmen. Both of which have been referred to the proper Civil Authorities, with instructions to take immediate action, which was promptly complied with.

6th Applications for revocation of Abolitionist's

Three (3) Applications of this kind have been made at this Office by Freedmen. The same were referred to the several Judges of Probate, with instructions to take immediate action, as per General Order N^o 3 Head Quarters City of Alabama series of 1867

7th Applications for Bounty

Two (2) of these Applications have been made out and forwarded, from this Office, during the month.

8th Docket of Probate

There has been issued during this month (Supplies) to Four Hundred and (400) Nine White and Eight Hundred & Fifty One (851) Colored Persons, who live in the ^{and adjoining counties} Country, and who do not receive supplies from the South Kitchen of this City.

9th Group Kitchens

No for instructions
from Head Quarters State of Alabama B R F D
A L Two (2) of these Kitchens have been established
and are now dispensing relief to One Hundred and
Thirty persons. (130 daily. (Eighty One (81) White and
Forty Nine (49) Colored). Since the establishing of
said Kitchens (March 13 1868) Fifteen Hundred and
Sixty Nine (1569) persons have been supplied with
relief at a cost (to the Government) of One
Hundred and Seventy two Dollars (107 21), or at
an average ^{cost} of Seven and a half (7 1/2 cts) per day
to each adult person. For the more complete in-
formation of the Assistant Commissioner
Bureau B R F D A L State of Alabama, as
to the mode of conducting and making the
issues of relief above mentioned, attention is
most respectfully invited to the enclosed Cir-
cular and Communication from this Office
relative thereto.

Sam General
Very Respectfully
Your Obedt Servant
J. C. Kendrick
Sub Arch Commissioner

Sub Dirk of Montgomery
B R F. A. L.
Montgomery Ala at 30th 18

Hendrix, C.

Sub Asst. Commissioner

General Report of Bureau
and Treasury Affairs for
the month of April 1848

(Retained Copy)

Sub Dist of Montgomery
Bureau Refugee Freedmen & Abandoned Lands
Montgomery Ala April 30 1868

Assistant Commissioner

State of Alabama

Bureau R. F. & A. L.

Montgomery Ala

General,

I have the honor to submit the following "General Report of Bureau and Freedmen Affairs" in the Sub Dist of Montgomery, during the month of April 1868. viz
1st. Non-payment of wages

There has been Twenty (20) Cases plaints of this character made at this Office by Freedmen. All of which have been referred to the proper Civil Authorities, with instructions to take enough of the Cost of the Employer to satisfy the claims of Labourer. A written statement is required of the Officer or intendant setting forth their actions taken in said cases.

2nd. Violating Contract. by Freedmen

Five (5) Cases

Plaints of this kind have been made by Employers, in which the Labourer has abandoned their contract without any seeming provocation and have in most cases entered into new contract with another party. In all cases heard from, they have been induced to return to their former employer and fulfill the contract made with him.

3^d Settlements

Fifty (15) Settlements (between Seaborn and Employers) have been made at this Office before me; during the month. All of which gave entire satisfaction to both parties.

4th Contracts.

Fifty (50) Contracts have been presented at this Office for Examination. Careful ^{attention} has been given to the obligations contained therein, ~~(the same)~~ ^{and is} ~~planned~~ to the Seaborn. Most of these Contracts were made on the Blank Contract furnished by this Bureau, and had with the approval of both Seaborn and Freedom.

5th Assault & battery or Indignity by white persons. Six (6) Complaints of this nature have been made at this Office by Freedom. All of which have been referred to the proper Civil Officers, with instructions to immediate action; which was in all cases promptly complied with.

6th Applications for revocation of Abolitionist's

one of these applications has been made at this Office by Freedom. She came and referred to the several Judges of Probate, with instructions to take immediate action as per G. O. No 3 of the Dist. of Columbia of 1867.

7th Issues of Rations.

Supplies of Meal and Meat has been issued (during the month) to 505 white and 996 Colored Persons. ~~that live in the country and adjoining Counties~~ ^{consequently} and ~~who do not receive relief from the Soup Kitchens~~ ^{established in this City}.

8th Soup Kitchens

established in this city

8th Soup Kitchens

As will be seen from the ^{relief} ~~the~~ "March ~~report~~" the said Kitchens were ~~issuing~~ ^{relief} daily to One hundred and thirty Persons. The issue now is to ~~it~~ ^{through this morning} Relief is being furnished daily to ~~Two hundred~~ ^{two hundred} ~~Persons~~ ^{Persons} ~~100~~ ¹⁰⁰ ~~white and~~ ^{white and} ~~(91~~ ⁽⁹¹ ~~colored)~~ ^{colored)}. The recipients of "this relief" for the month ending April 30th was Four thousand nine hundred and fifty eight (4958) Persons Three thousand and nineteen (3019) white and one thousand nine hundred and thirty nine (1939) colored Persons at a cost to the Government of Three hundred and ~~thirteen~~ (314.11) and Eighteen ¹⁰⁰ ~~and~~ Dollars or at an average cost of Seven and one half (07 1/2) cents per day to each adult person.

Yours General
 Very Respectfully
 J. H. ~~President~~
 Pub. Work Commission

Sub. Dist. of Montgomery
Bureau of Land & L.

Montgomery Ala May 30th 1848

Hurdin D. C.

Sub. Asst. Commisr

"General Report of
Bureau and Proceedings"
Affairs for May 1848

(Retained Copy)

Sub Dist of Montgomery
Bureau Refugee Freedmen and Abandoned Lands.
Montgomery Ala May 30th 1868

Assistant Commissioner
State of Alabama
Bureau of Land and
Montgomery Ala

General;
I have the honor to submit the following
"General Report Bureau and Freedmen Affairs" in
this Sub Dist during the month of May 1868 -
Non-payment of Wages

First

There has been Thirty (30) Com-
plaints of this kind ^{known in past} reported at this Office by Freedmen
All of which have been referred to the proper Civil
Office with instructions "to attach wages of the ~~last~~
last year- ^{and} of the Employees to satisfy the claims of
said Laborers as per Genl Order No 13 of the 2^d Dist of Ala
of 1867.

Second "Violations of Contracts" By Freedmen Ten (10) Com-
plaints of this kind has been made at this Office by
Employees - in which the Laborers have abandoned
their Contracts without any seeming provocation, and in
some cases entered into new agreements. In these cases
whenever the Freedman could be found - letters of instructions
to them - have been written requiring them to show good
cause why they so abandoned their contracts. In all cases
heard from they have been induced to return and fulfil
their first contract.

Third Assault and Battery on Freedmen by white Persons Three (3) Cases
A number of this kind have been reported at this Office by
Freedmen. The same were referred to the proper
Civil Officers having jurisdiction - with instructions to
to take immediate action: which has been complied
with in all cases heard from.

Fourth Applications for revocation of Apprenticeship - Five (5) of these
applications have been made at this Office by Freedmen
The same were referred to the several Judges of Probate
with instructions to take immediate action as per G.O. No
3 of the Gen. Dir. of Ala. series of 1817

Fifth Applications for Transportation Three (3) Applications for Gov-
ernment Transportation have been made at this Office
by Refugees and Freedmen. The same have been ^{carefully} investigated
by me - and in cases where the parties have been for some
time dependent upon ^{our means} and ^{have} been supported by the Government
their applications have been forwarded to Bureau Head-
Quarters - with recommendations for ^{their transportation}.

Sixth Issue of Rations to Refugees & Freedmen
Supply of Meal, has been issued -
during the month of ¹⁸⁶⁷ Two hundred and nineteen (219)
white and to Four hundred and Eighty Eight (488)
Colored Person

Smith Soup Kitchens.

Through these Kitchens supplies
of Bread and Soup ^{was} ~~is~~ used daily (during the month of
May) to Two hundred and thirty six Persons. One hundred
and fifty five (155) white and Eighty one (81) colored
Persons. The total number of Persons that received this
relief for the month ending May 31st was Six thousand
one hundred and thirty six. (6136) Four thousand and
forty three (4043) white and Two thousand and Ninety
three (2093) colored Persons. at a cost to the Gov-
ernment of Four hundred and nine and two Dollars
(409.27) or at an average cost of some 67 cents per day to
each adult person

Dear General
Very Respectfully
J. H. Smith
J. L. Hendrix
Sub. Cash Commissioner

Sub Dist of Montg, Bu & Pr
Montgomery Ala Dec 30 1865.

Hendrix S. C.
Sub Asst Commissioner

Forward General
Report of Bureau and
Freedmen Affairs, for
the month of June 1865

Sub-District of Montgomery,

BUREAU OF REFUGEES, FREEDMEN AND ABANDONED LANDS.

Montgomery, Ala., June 29, 1868.

Assistant Commissioner
State of Alabama, P. O. Fund N. E.
Montgomery Ala.

General;

I have the honor to submit the following "General Report of Bureau and Freedmen Affairs" in this Sub District during the month of June, 1868.

First. Nonpayment of Wages.

Two (1) Complaints of this kind has been made at this office by Freedmen, all of which have been referred to the proper Civil Authorities, with instructions to take immediate action, as per General Order No 1314 Ad. Com. Dist. of Ala. series of 1867.

Second. Violation of Contract, by Employers and Laborers.

Two (2) of this kind of complaints has been made by the Freedmen, in which they have been discharged without legal process of Law. ^{In} these cases letters of instructions are written to the Employers notifying them, that they will not be allowed to discharge from their place, any person who under the contract is in this a Tenant or a Partner, which instructions have been complied with and the laborer has returned to their employment. Three (3)

of this kind of complaint has been made by Employers
in which it is represented that the Freedmen have abandoned
their contracts without any seeming provocation. These
cases have been amicably settled at this Office. The
laborers having been induced to return and fulfill their con-
tracts.

Third - "Assault and Battery" on Freedmen by White & Colored Persons.

Three (3) Complaints of this nature has been made
at this Office by Freedmen in which they have been as-
saulted by White persons and Two (2) Complaints in
which they (Freedmen) were assaulted by Colored persons.
All of which were referred to the proper Civil Officers
with instructions to take immediate action as for the Laws
of the State in such cases.

Fourth. Applications for Passage.

Two (2) of these
applications have been forwarded to Washington D. C.
(through Office Cook Comr State of Ala) during the
month.

Fifth. Applications for Transportation.

Three (3) applica-
tions of this kind has been made during the month for
One (1) Freedman, and Two (2) Refugees, female. The
situations of the applicants were carefully investigated.

by me, and upon finding that they have been for some time
dependent upon the Government, their applications
were forwarded to Bureau Head Quarters - with recommen-
dation.

Sixth. Doon of Paton's
Supplies of food has
been issued during the month to Thirty (30) White
and to One hundred and thirty one (131) Colored
Persons.

Seventh. Camp Kitchens -

During the month supplies of
Bread and Soap were issued daily to Two hundred and eighty
one persons (281) One hundred and ninety one (191) white and Ninety
(90) Colored. The total number that received this relief for
the month ending June 30 1868 was Two thousand three hundred
and fourteen (2314) Persons (Two thousand nine hundred and
eighty five (2985) white and Two thousand three hundred and
forty nine (2314) Colored.) at a cost to the Government of Two
hundred and eighty seven and ¹⁵/₁₀₀ Dollars (\$287.15) making an average cost
of seven and one half cents ($07\frac{1}{2}^c$) per day to each adult.

Very General

Very Respectfully
J. H. Hendrix
Sub Asst Commr

Sub Dist of Maryland, B. & F. C.
Maryland, Md. Aug 1st 51

Hender C. G.

Sub Dist Commissioner

"General Reports of
Purvey and Freedmen's Affairs
for the Sub Dist of Md.,
during the month of July 1851"

"Retain 1 copy"

Sub-District of Montgomery,

BUREAU OF REFUGEES, FREEDMEN AND ABANDONED LANDS.

Montgomery, Ala., July 31st 1868

Genl C. E. Fisk

Asst Commissioner

State of Ala

Bu R. Fund. A. E.

General;

I have the honor to submit the following
General Report of Refugees and Freedmen Affairs in this
Sub Dist of Montgomery; B. R. F. & E. for the month of
July 1868.

Violations of Contract by Employers.

Trunks (25) Cases
Complaints of this kind have been made at this Office by
Freedmen, in which it is intimated, that the laborers
are discharged without just cause. The laborers in
these cases were 1st 2^d and 3^d Patton in the contract with the
employers and consequently could not be discharged with-
out legal process of law. Letters have been written
to the several magistrates, referring these complaints - and
at the same time informing them; that no one is

allowed to discharge from their place any person, who
is not a member of the Board of Prisoners, Freedmen and Abandoned Lands
under the Act of March 3rd 1867 or Partner - un-
der less legal rights, under the Law of the State in
such cases. These cases - as far as paid from - have been
amicably settled. Seven (7) complaints have been made
by the Employees, in which they reproach the General
as failing to comply with their obligations under
the contract. All of which complaints have been settled
at this Office.

Assault and battery upon Freedmen -

Five (5) complaints
of this nature, has been made at this Office, by
Freedmen, in which they have been assaulted by White
Persons. All of which were referred to the proper Civil
Authorities.

"Applications for Bonds"

None (0) Claims
for "bonds" have been forwarded to the Washing D.C.
through Office Wash. Comm. State of Man - during the
month.

"Soup Kitchens"

During the month, Substis
of Bread and Soup were issued daily to 336
persons 217 White and 119 Colored. The total

numbers that received this relief for the month ending
July 31st was 9074 Quoms; 5865 White and 3209
Colored. At a cost to the Government of 573
29 Dollars, - or at an average cost of 7 cents per
day to each Adult.

Dear General

Very Respectfully

Yours Obedt. Servant

J. C. Hendrix
Subst. Commissioner

Montgomery -

Sept 31 - 1868

Hendrix J B

Bestami Copy

all cases heard from.

Violation of Contract - by Employers -

Twelve (12) Cases.

Complaints of this nature have been made at this Office by Freedmen in which they represent, that they have been discharged from the Employers plantation, without any genuine provocation; Letters have been written to the Civil Officers having jurisdiction - requesting that the Laborers be allowed to return to the said Plantations and thus remain, unmolested, until legally ejected ^{as far as heard from} for the Laws of the State. In all of these cases, satisfactory terms have been agreed upon and the Freedmen have returned to their Labor under the contract.

Assaults & Batteries upon Freedmen by Whites

Two (2) complaints of "assault and battery" have been made by Freedmen, in which they say were perpetrated by White Persons. Both of which were referred to the Proper Civil Authorities with a request that action be taken immediately ^{(upon} the same) as for the Laws of the State. Prompt action has been taken, in all of the cases heard from,

and

During the month Subj. of

Board and Lunch were issued daily to Three hundred
& Eighty four (384) Persons (Two hundred & Thirty (230) White
and One hundred & fifty four (154) Colored)

The total number that received this relief for the
month ending August 31st 1865, was Two thousand and
Eight hundred Ninety Six (2896) White and Three
thousand and^{seventy nine} Colored. At a cost to the Government
of \$6,611.⁴⁵/₁₀₀ Dollars, or at an average cost of two
cents per day to each Adult

Dear General
Very Respectfully
Yours
J. C. Hendrix
Supt. Army Commissioned

Montgomery

(J.A.O.)

Mc

Sept

Sub-District of Montgomery,

BUREAU OF REFUGEES, FREEDMEN AND ABANDONED LANDS.

Montgomery, Ala., September 20, 1868

Assistant Commissioner

State of Alabama

Wm. T. G. C.

Montgomery Ala

Colonel;

I have the honor to submit the following
General Report Bureau and Freedmen's Office
in the Sub-District of Montgomery during the
month of September 1868

Wm. T. G. C.

of this kind have been made at this Office
by Freedmen all as which have been referred
to the proper Civil Authorities with a request
that action be taken upon the same immedi-
ately, as per the Law of the State.

Wm. T. G. C.

Twenty (20) cases have
been made of this nature by the Freedmen

In which they complain that they have been discharged from the ~~service of the~~ ^{service of the} ~~Company~~ ^{Company} without any previous provocation on their part, and without making the necessary just settlements with them. These cases have all been referred to the proper Civil Authorities requesting them to take immediate action as per the Laws of the State in such cases.

Assault and battery

Three ^{Complaints} of Assault and battery have been made at this Office by the Freedmen in which it is represented that they have been persecuted while persons ^{of color} who have been referred to the proper Civil Authorities.

Applications for Transportation

Two ^{Applications} for Transportation have been forwarded from this Office during the month. Particular attention has been paid to the condition of these applicants. In the way of ascertaining 1st their present condition - whether or not they are dependent upon the Government for a support - and 2nd, whether they will be supported - beyond all doubt - at the place of destination &c.

transportation be furnished. I would most respectfully state under this article, that there are a great many of Freedmen and Refugees at present in this Sub Div. who if transportation could be furnished them, would greatly relieve the Government.

Soup Kitchens.

During the month of Supplies of Bread and Soup were issued daily to Three hundred and fifty three 353 Persons. Four hundred and sixteen 416, white and One hundred and thirty seven 137 Colored. The total number that received the relief during the month to the 23rd Inst. was Seven thousand and seventy eight ^{Persons} 7078, of which number Four thousand three hundred and twenty were white and Two thousand seven hundred and fifty eight 2758 Colored. The cost to the Government of Four hundred and forty five 445⁰⁰ Dollars. The rations at the Kitchens have been suspended since the 23rd Inst. The Post Quarter Master having refused to issue - ~~supplies~~ - according to Instructions from War 3rd Oct 1861 -

Dave Clark

J. L. Hendrix
Acting Post Commissioner

och

RC

Sub-District of Montgomery,

BUREAU OF REFUGEES, FREEDMEN AND ABANDONED LANDS.

Montgomery, Ala., October 31st 1865

P. H. Col (during absence)

Asst. Commissioner

State of Alabama

P. P. Fard & Co.

Colored;

I have the honor to inform the following
General Robert of your business letter in this Sub-
Dist for the month of October 1865.

The greatest
trouble among the Freedmen and Employers that has be-
come a source of complaint during the month, is that
the Employers have not made the necessary just and
equitable settlements with the ^{laborers} ~~men~~. In many cases they have
received the Cash and sold the same without their
consent or knowledge ~~of the Freedmen~~ thereby depriving
them of their just portion. I am happy to say that
there is connected with my duties in this Office the
Office of Notary Public and can assure you that when
such cases as the above have come before me, I examine

the functions of the latter, to the best advantage
attainable at Civil Law. Two or three cases of
Employers selling their crop without the knowledge of
the Labourers have been referred to the several Magistrates
previous to my referring the appellations of Wages Public -
requesting them to bring suit for violation of Contract
on the part of the Employers. In all of the cases
heard from the same have been equitably ~~settled~~ ^{adjusted}.

There has been made at this Office during
the month of June 18, settlements between the
Employers & Labourers, careful observation has been
given ~~to the~~ ^{to the} accounts standing against the Labourers
in the way of calling the same over by items to
them. and in this manner of settling a great
many charges have been thrown out and not allowed
to be paid for. Nevertheless in this way the Employers
became satisfied and were willing to abide by my
decision.

There is at present in this Sub. Dist. a
great amount of suffering, from the want of food
and fuel. A great ~~part~~ ^{part} of the supply of clothing
that was at my disposal has I think been very
beneficial in bestowing comfort to them and can
say that the Refugees & Freedmen have been very
well supplied. But in the way of supplying

them with food little has been done save to
those living in and around the City. To these
rations of fresh Beef has been issued to them
from the surplus quantity that was on hand
at the time of suspending the Donp distribution.
Out of this amount of Beef Nine hundred and
forty (940) pounds has been expended to the District
of this City at a cost to the Government of
Sixty five ⁸⁰ Dollars (\$65.80). Nothing as yet can be
done - as yet - to relieve those who live 4 or 5 miles
from the City - as the Beef is the ^{single} ~~only~~ ^{supply} ~~available~~
that the ~~Government~~ ^{Government} now have.

A supply of Cornmeal & Flour has been re-
ceived from the Chf. Q. M. which will be issued, as
worth, to the most needy.

Your Obedient

Very Respectfully

Chas. E. D. Dugan
J. C. Hendry
Sub. Q. M. Commissioned

MONTHLY REPORT OF ~~THE~~

Sub Dist of Montgomery

In the State of

Alabama

For the Month of

February

, 1868

J. W. Hendrix

Sub Assistant Commissioner of the
Bureau of Refugees, Freedmen,
and Abandoned Lands

"Retained Copy"

Forwarded

March

, 1868

Rec'd Bu. R. F. & A. L.

, 1868

Bullden's

MONTHLY REPORT OF ~~REVENUE~~

Subd of Montgomery
In the State of Alabama

For the Month of March, 1868.

Wm H. Hendrix
Sub Assistant Commissioner of the
Bureau of Refugees, Freedmen,
and Abandoned Lands.

Retained Copy

Forwarded _____ 186 .

Rec'd Bu. R. F. & A. L. _____, 186 .

MONTHLY REPORT OF

Quidam

Sub Dist of Montgomery
In the State of Alabama

For the Month of April, 1868.

J. C. Hendrix
Assistant Commissioner of the
Bureau of Refugees, Freedmen,
and Abandoned Lands.

Retained Copy

Forwarded April 30th, 1868

Rec'd Bu. R. F. & A. L. _____, 1868

NAME OF FORMER OWNER.	COURT OR PART.	LOCATION. OTHER BOUNDARIES.	ALTERATIONS SINCE LAST REPORT.				HOW HELD. (ABANDONED OR CONFISCATED.)	DESCRIPTION.			REMARKS.
			GAINED.		LOST.			ACRES UN-CULTIVATED.	TOTAL No. ACRES.	BUILDINGS.	
			Date.	How.	Date.	How.					
The so called "Confederate States"				On hand from last report						The common frame building (two of which are in very bad condition)	There was received, during the month of April 1868 the sum of Thirty (\$30.00) Dollars as rent from the Building.
TOTAL.....											

NOTES—1. In the column of Remarks will be stated the number of Refugees or Freedmen on each farm or tract of land, how they are employed, and whether they are self-supporting; also such other facts in relation to farms as may be of interest.
2. If more than one blank is necessary in making this Report, they will be attached together by proper fasteners on the left-hand margin, as indicated by the " " "
3. The back of the Reports may be used for Remarks, in addition to the proper column on the face.

STATION: Montgomery Ala
DATE: April 30 1868

J. L. Hudniss
Sub Assistant Commissioner.

Building
MONTHLY REPORT OF

Sub Dist of Montgomery
In the State of *Alabama*

For the Month of *May*, 186*8*.

J. C. Hendrix
Sub Assistant Commissioner of the
Bureau of Refugees, Freedmen,
and Abandoned Lands.

May June or July
1868

Forwarded *May 31st*, 186*8*.

Rec'd Bu. R. F. & A. L. , 186 .

MONTHLY REPORT

of Abandoned ~~Land~~ ^{Buildings}

J. C. Hudson
Buildings

Assistant Commissioner of the Bureau of Refugees, Freedmen, and Abandoned Lands, for the State of Alabama, during the month ending May 31st, 1868

Sub Dist. of Montgomery

Alabama

NAME OF FORMER OWNER.	COUNTY OR PARISH.	LOCATION.		ALTERATIONS SINCE LAST REPORT.				HOW HELD, (ABANDONED OR CONFISCATED.)	ACRES UN-CULTIVATED.			TOTAL NO. ACRES.	BUILDINGS.	REMARKS.
		OTHER BOUNDARIES.	Date.	GAINED.		LOST.			CULTIVATED.	Acres wood-land.	Acres cleared.			
				How.	Date.	How.	Date.							
<i>The so-called "Confederate State"</i>	<i>Montgomery</i>	<i>near NW corner Depot</i>		<i>On hand from last report</i>				<i>No property of Bureau track</i>				<i>Six common frame buildings</i>	<i>There was no rent money received</i>	
													<i>Two of which are in very poor condition</i>	

NOTES—1. In the column of Remarks will be stated the number of Refugees or Freedmen on each farm or tract of land, how they are employed, and whether they are self-supporting; also such other facts in relation to farms as may be of interest.
 2. If more than one blank is necessary in making this Report, they will be attached together by proper fasteners on the left-hand margin, as indicated by the *.
 3. The back of the Reports may be used for Remarks, in addition to the proper column on the face.

STATION: Montgomery Ala
 DATE: May 31st 1868

J. C. Hudson
 Assistant Commissioner.

Roll 26

Target 3

**SUBORDINATE FIELD OFFICES
Montgomery (Subassistant Commissioner)**

Miscellaneous Records 1865-68

Receipt for the
Contract of A. J. Brozell
& Paul Meadows

Per Jarrin

Office Sub-Assistant Commissioner,
Bureau R., F. & A. L., Sub-District of Montgomery,

Montgomery, Ala., 1868

I received of John C. Hendricks
the original contract between W. J.
Boasell and David Meadors on the
one part and Bill Formis of the other
part

A. C. Forver J. D.

This case will involve filing a bill in Chancery to settle
up and close the partnership. From all the rights we know
before us, he must owe the old man from \$5000
to \$8000. The advice is to file the Bill

Cum gratia

Cum gratia & gratia

Cum gratia

19. 12. 1871

The State of Ala
Pike Co. Jan 15th 1860

E. J. Williams
J. P.

A contract between
Wm Lawrence and
Joseph Daniel

1860

Received of Mr. J. H. ...
the sum of ...
for ...
J. H. ...

Witness my hand and seal this ...
day of ... 1860

~~...~~

...

Montgomery, Ala.
Jan 22. 1866.

Charles A. Mott's profes-
sals etc —

File

Charles A. Matt of Lansingburgh New York
respectfully proposes as follows:

To give Bond with security upon growing crops
for the payment at govt cost for all Forage,
Rations & Clothing delivered prior to the
1st day of January 1867 upon Requisitions
of said Matt, who shall be Chief in Charge
at said Colony subject to the directions
of Major General Wager Swayne —

Provided State & Local authorities shall contribute &
pay \$2,000 & repair Roadway & Bridges
between City of Montgomery and said
Home Colony & exempt said Plantations
from State & Local taxation while occupied
for Home Colony of Vagrants & Freedmen,

Provided United States will furnish the use of
100 good mules & of 25 good wagons & the
necessary harness for said Mules & provide
medicine & medical attendance and furnish
adequate & competent guards to enforce the
labor of Vagrants & Freedmen and construct
suitable quarters for them to occupy & provide

necessary bedding & utensils for quarters —

The totally helpless and the small children should be fed by Government as compensation for the occupancy of the necessary space upon said Plantations & some allowance should be made for the deprivations ^{— already made} upon timber & fences & for the fuel to be consumed prior to January 1st 1867. —

Montgomery Ala

January 22nd 1866.

I notice there are 70 mules to be sold at Montgomery Jan'y 25th — could not these mules be withdrawn from sale & be delivered to me to be used in giving employment to Vagrants & Freedmen as contemplated in my proposition? —

Very Respectfully
O. M. H.

or pay each seventy five bushels of corn for each
mule or horse he has engaged on the land of
said A. H. Elsbury and also to pay said A. H. Elsbury
or his agent for all Bacon & meal furnished him
during the present year at its market price in
the City of Montgomery at the time it is issued to
him. He further agrees to pay back to the said
A. H. Elsbury or agent all medical expenses incurred
for the freedman Billy Dabney. The said freedman
Billy Dabney also agrees to keep the farming utensils
used by him in good order and return the same to
the said A. H. Elsbury at the expiration of the pres-
ent year. It is further agreed by said freedman Billy
Dabney that he will supply himself with shoes
& clothing. It is also agreed by said freedman Billy
Dabney that if at any time during the present
year, he shall be found idling or idling away his
time, then the said A. H. Elsbury or his agent shall
discharge him ^{with forfeiture of dues & proportion to his offence for} ~~and~~ ~~the~~ ~~same~~ ~~time~~ ~~he~~ ~~may~~ ~~have~~ ~~been~~ ~~in~~ ~~his~~ ~~employment~~ and if
the said freedman Billy Dabney ~~as~~ ~~above~~ ~~said~~ shall at
any time during the present year leave the em-
ployment of A. H. Elsbury voluntarily and ^{without further} ~~of~~ ~~his~~
~~own~~ ~~accord~~, then he shall ~~lose~~ ~~and~~ ~~forfeit~~ all
interest in the crop of the said A. H. Elsbury.

Witness
Emma H. Elsbury

A. H. Elsbury
Billy Dabney

I, J. H. Elsbury, do hereby certify that the above is a true and correct copy of the original as it appears in my possession.

248
1877
1877

1877
1877
1877

Article of agreement made, concluded and agreed upon this the first day of March 1877, between A. H. Osborn of the one part and freedman Bill Dabney of the other. — as follows. The said A. H. Osborn for the consideration hereafter mentioned, doth hereby agree that he will pay to the said freedman Bill Dabney one half of all that is produced and gathered during the present year on 24 acres of land (more or less) belonging to the said A. H. Osborn, and he will also furnish the said freedman Bill Dabney with mules & horses and farming utensils sufficient to cultivate said land. It is also agreed that the said A. H. Osborn shall furnish corn & fodder to feed the mules & horses, while engaged in cultivating, gathering & hauling the crop to market. It is also further agreed that the said A. H. Osborn shall furnish tin for ginning & vacans for hauling said crop, and it is further agreed that the said A. H. Osborn shall furnish Bacon & meal to said freedman Bill Dabney. The said A. H. Osborn further agrees to pay for medical attention for said freedman Bill Dabney. Now in consideration of the above promises the said freedman Bill Dabney agrees that he will labour faithfully & diligently, and cultivate & keep the said land in good order for the present year, obeying strictly all orders given by said A. H. Osborn or his agent. It is further agreed by said freedman Bill Dabney, that at the expiration of the present year, he will return

State of Alabama. Montgomery Co

Praver R. H.

Ag't of R. H. & A. L.

Contract with A. W. M. Lade to erect
School House.

Return to purchase done
with J. C. H.

State of Ala } Contract made & concluded
Montgomery County } on the 24th day of April
between ~~P. W. McAdams~~ P. W. McAdams

on the first part and R. H. Brewer Agent of
the Bureau of Freedmen & Abandoned Lands on the second
part. The party of the first part obligates himself
to build a school house on the land of R. H. Brewer
at the North end of the Black lane near the line
between R. H. Brewer & James H. Jenkins for to be
used as house for the instruction of the Col Children

in the neighborhood said house to be (20) twenty
by (25) twenty five feet (8) eight windows (2) two
floors (10) ^{ten} feet between joints the flooring & window &
door shutters to be dressed and to seat the said house
with as many seats as the the house will allow -
making the necessary room for aisles the seats to
be made of good & substantial lumber with
back boards on the back of each seat the house
to be put up after the stile of the houses at McAdams
Mills out of inch plank and suitable lumber for breaking
the joints the house to be put one and half feet off
of the ground and good and substantial steps -
to be coined with good two and half feet ^{boards} and to have
said house completed according to contract by the
18th day of May 1866. and the said party of the
second part agrees to pay to the said party of
the first part for said building, (\$650.00) six
hundred & fifty dollars to be paid when said
house is finished and turned over to the party
of the second part

Signed on the 24th day of April 1866. J. W. McAdams
R. H. Brewer

Witness

Agent B. F. & A. C.

P. W. McAdams

Montgomery Co. Ark.
Apr. 24 1866

Copy of Contract
H. W. McDade and
R. H. Brown
vs. the Board

for the building
of a School
House

Original Contract
sent to Col. E.
Beecher

Jan 29/68

State of Alabama } Contract made and entered
Montgomery County } into on this the 24th day
of April 1866. between A. W. McDade of the
first part and W. H. Brown Agent for
C. F. and A. L. on the second part.

The party of the first part obligates himself
to build a School House on the land
of W. H. Brown at the north end of the
Clark land near the line between W. H.
Brown and James H. Jenkins. to be used
as a House for the instruction of the
colored children in the neighborhood, said
House to be Twenty (20) by Twenty five (25) feet
and Eight (8) Windows, Two (2) Doors, Ten (10)
feet between joints, the flooring, Window and
door shutters to be dressed, and to seat the
said house with as many seats as the house
will allow, making the necessary room for
each, the seats to be made of good and suitable
lumber, with Back Boards on the back of each
seat, the house to be put up after the style
of the house at McDade's Mill out of such
plans, and suitable lumber for bracing the
joints, the house to be put on & one half feet
from the ground with good and substantial
steps to be covered with good Two and one half
(2 1/2) feet Boards, and to have said house
completed according to Contract by the 18th day
of May 1866.

And the said party of the second
part agree to pay to the party of the first

for said building Six Hundred and Fifty
(\$600.00) Dollars to be paid when said
house finished and turned over to the
parties of the record first.

Signed on this the
24th day of April 1866

Witness
P. H. M. Brown

A. W. M. Dade
R. H. Brown
High B. R. H. H.

Office Notary Public
Ben R. H. H.

Notary Public of Montgomery
Montgomery Ala June 29th 1868

I certify that the above is a true
copy of the original of J. H. H.
Notary Public

Montgomery Ala. Ala.
Apr. 24 1866

Copy of Contract
A. W. M. Dade and
R. H. Brown
High B. R. H. H.
for the building
of a School
House

Original Contract
Sent to C. L. E.
Becher
June 29th 1868

Montgomery Ala

January ^{25th} 1867

Chas S P Doster }
Isiah Franklin } Contract

Contract

This Contract made in the City of Montgomery
State of Alabama, the Twenty Eighth day of January
AD 1867 between Chas. S. G. Doster of Autauga County
Ala. and Isaiah Franklin of Montgomery County
Ala. witnesseth that the said Isaiah Franklin
agrees to do and perform all the customary labor
of a first class field hand, upon the plantation
of the said Doster during the year 1867, to be
obedient to the orders of his employer and his agents
and respectful to all the persons on the plantation
— and the said Doster agrees to pay the said
Franklin Twelve Dollars and a half per month
for his labor, to furnish him good food and
comfortable quarters, and if he brings his
wife to live and labor on the same planta-
— tion to allow him an acre of land to raise
vegetables and to keep poultry and a hog
for his own benefit. Lost time to be deducted.

Witness our hands the day and date above
written

Witness J. C. Keffer

Chas. S. G. Doster ^{Escal}
Isaiiah ^{his} Franklin ^{Seal}
mark

Roads & Co.

July - 1867.

Contract.

T. D. McCall.

&
Frederick.

Sept 4 5-

B.

of the farm in making and gathering
the crop the further more obligate ourselves
to be governed by the rules and regulations
of the farm

J. S. McCall further agrees to let us have
a piece of land out side of the farm
for our own benefit

Witness J. S. McCall

Moses ^{his} Bibb
Amanda Bibb

Simon ^{his} Carpenter
Jack ^{his} Carpenter

Approved
Witness
L. J.
Sept 15th 1869
B. R. S. & S. J.

State of Ala } Contract for labor
Seander County } Between J & M Call
of the first part and the following laborers
of the second part Moses Bibb & wife
Amanda Bibb. Simon Carpenter
Jock Carpenter

See this that all the laborers of the second
part do by their presence obligate themselves
to labor faithfully for the said J & M Call
each day Sunday excepted untill January
1st 1868 working according to the directions of the
said M Call and strictly observing and
obeying all orders made and given by him
for the supervision and government of all
laborers on the farm the said J, & M Call
to furnish the stock and forage for the farm
and all other implements for making the
crop and returns for themselves at the rate of
1 Bushel of meal or Twelve lbs of meat
per month for each hand

All the laborers, are to receive for their services
One half of all ^{the} produce raised by them
and all to pay One half of all the expenses

des to. Ala.
-- July 10. 67. ..

Contract.

B. B. Alexander
&

Friedman

the bales to weigh five hundred
and they on the second part
are to pay back the provisions
consumed on the place and to
return the mules in value with
out hire and to return cows &
hogs in value except such as
the said Alexander may sell
at his discretion also to pay
all the Land rent at the same
price the said Alexander is
to pay. In a few words they of
the second part are to pay the
entire expenses of the place and
to leave the said Alexander in
as good ^{condition} ~~pay~~ as they find him
paying him in addition one
bale to the hand or thirty bales
They of the second part are
to submit to, and be governed
by such rules and regulations
as the said Alexander may
adopt and if any of the Laborers

should loose time it is
to be deducted from his or
hers part of the crop and placed
in favor of the hands generally
They of the second part are
to have houses and fuel without
cost and if any of the laborers
on the second part fail to do
good work or raise a row or
fight or misbehave he, or them
are to be fined or discharged
at the discretion of said Alex
ander. ^{forfeiting their share of crop} He on the first part
is to treat them on the second
part with kindness & humanity
and they on the second part are
to treat the said Alexander with
respect & politeness. The share
of the crop belonging to them
of the second part is to be de-
vided according to their several
capacities and amount of labor
rendered

Mark
 1 Susan x Tyson
 Mark
 1 Rosetta x Lee
 Mark
 1 Caroline x Tyson
 Mark
 1 Alan x Tyson
 Mark
 1 Dan x Tyson
 Mark
 1 Tilman x Tyson
 Mark
 1 Jacob x Tyson
 Mark
 1 Elic x Tyson
 Mark
 1 Monroe x Tyson
 Mark
 1 John x Tyson
 Mark
 1 Sarah x Tyson
 Mark
 1 Virginia x Cheek
 her mark
 1 Sydney x Cheek
 her mark
 1 William x Tyson
 his mark
 1 Rinow x Harrison
 his mark
 1 David x Tyson
 his mark
 1 Jacob x Tyson
 his mark
 1 Daniel x Tyson
 his mark
 1 Geo Griffitt
 his mark
 1 Little x George
 his mark
 1 Henry x Tyson
 his mark
 1 Maria x Gordon
 his mark
 1 Dick x Gordon
 his mark
 1 Emeline x Cheek
 his mark
 1 George x Tyson
 his mark
 1 Caroline x Tyson
 her mark
 1 Amanda x Tyson
 her mark

February 19th 1867

Contract
between

C. S. Foster

and

Friedman

Antanga Co.

This Contract made the Nineteenth day of February 1867 between C. S. G. Doster of Autauga County and Joe Smith and James Gordon freedmen witnesseth that the said Joe Smith and James Gordon each for himself agrees to labor and do and perform all the work of a first class field hand upon the plantation of the said C. S. G. Doster during the year 1867, at the monthly sum of twelve dollars per month; and to be respectful and obedient to the orders of the said Doster and his agents, and well behaved to all the persons on the plantation

And the said Doster agrees to pay the said Joe Smith and James Gordon the said sum of twelve dollars per month, and to give them kind treatment, good rations and comfortable quarters.

This contract may be cancelled or annulled at the pleasure of either party at the end of any month.

In witness whereof the said C. S. G. Doster and Joe Smith and James Gordon have hereunto set their hands and seals this day and date just above written

Chas S. G. Doster (Seal)

Witness

John C. Keffer

his
Joe X Smith (Seal)
mark

his
James X Gordon (Seal)
mark

Four ⁵⁰/₁₀₀ Dollars paid to James Gordon and
Four ⁵⁰/₁₀₀ Dollars paid to J. C. Smith under the
written contract February 19th 1867 in my
presence

John C. Keffer

Montgomery Ala
July 21. 1865.

~~Richard Pemsy,~~
Capt. ~~of the 8th~~
Depot ~~at~~ ~~Montgomery~~

assigning the "Franklin Academy building"
to Capt. C. W. Buckley for a Freedmen's -
hospital, subject to the approval of the Post
Commander. x x

Co. M. T. 49. P. 75 1865

Area Pos. Post. of Montgomery

Montgomery, Ala., July 24/65.

Approved

By order of

Cole S. McWard

Quar. Master

Post Adj't

Assignment

The Building known as The Franklin Academy in the city of Montgomery Ala is hereby assigned to Capt. C. W. Puckley Asst. Surgeon Freedman for a Freedmen Hospital -

This assignment subject to the approval of the Post Commander.

Richard Penney
Capt & Asst
Depot QM

Office Depot Q.M.
Montgomery Ala.
Dec 21st 1865

Warrant to

Arrest Northern white men
suspected as U.S. Soldiers

Murder

October 29. 1865.

State of Alabama
Chickasaw County

To any lawful Officer of the State:

Whereas information & complaint has been made on oath before me, J. E. Norton, Jr. a Justice of the Peace in & for said County, that, on Saturday night, the 28th, inst, at the plantation known as the Bradshaw place, Estate of Henry Lucas, Decd, this County, John, a colored man residing on said plantation was shot at with a gun and killed, and there being just cause to believe that a certain unknown white man, and aided abetted by a certain other unknown white man, both dressed in the uniform of U. S. soldiers did shoot at and kill said John. There are therefore to command you forthwith to apprehend said white men & bring them before me.

This 29th Apr 1865

J. E. Norton Jr
Justice of the Peace

Montgomery Ala
April 21st 1864

William B. W.
Asst Surg. U.S.A.

Invoice of captured
Hospital Stores trans-
ferred to Geo. A. Hammond
Asst Supt B.R. & A.S.

Received

of

10

"Invoice" of Captains Hospital Property transferred
 to Col. Geo. A. Heintzsch, Asst. Supt. Bureau of
 Refugees, Freedmen and Abandoned Lands. April
 21, 1866. by Asst. Surgeon H. E. Williams U.S.A.

Articles	No.	Articles	No.
Bedsteads	50	Chairs	80
Mattresses	120	Stands	50
Quilts	51	Bedsacks	50
Cotton Sheets	160	Cooking Stove & Utensils	1
Pillows (all kinds)	100	Calckins	3
Pillow Cases	100	Boxes Packing	5
Mosquito Bars	17		

I Certify that the above invoice is correct.

Station, Montgomery Ala.
 Date, April 21, 1866.

H. E. Williams,
 Asst. Surg. U.S.A.,
 Asst. At Surg. in Chief.

Invoice of Captured Hospital Property transferred
to Col. Geo. A. Warmount. Asst. Supt. Bureau of
Refuges, Freedmen and Abandoned Lands, by
Act. Asst. Surgeon H. C. Williams U.S.A., April 21. 1866.

Articles	No.	Articles.	No.
Bedsteads	50	Cooking Stove & Utensils	1
Mattresses	120	Caldrons	3
Quilts	51	Bags Packing	5
Cotton Sheets	160		
Pillows (all kinds)	100		
Pillow Cases	100		
Mosquito bars	17		
Chairs	80		
Bedbags	50		
Stands	50		

I hereby Certify that the above Invoice is Correct.

Station, Montgomery Ala.
Date, April 21. 1866.

H. C. Williams
A. S. Surg. U.S.A.
Act. Asst. Surg. in Chief.

Letter Sent.
O. A. J. B. W. J. & Co.

New Orleans, Louisiana
May 25-1866.

Harmonet Geo, A,

Superintendent
to Judge of Probate.

RE

Wishes to know if you
have apprenticed a
Boy by the name of
John

Office Capt. Gulek Curran of R. I. & A. S.
Montgomery, Ala. May 25th 1866.
Judge Grayham
Judge of Probate - Towns Co.

Sir,
I have the honor to request that you will inform me
if you have apprenticed a Boy named "Toby",
formerly the property of Mr. Kelley and being
the son of Frances Col. you saw formerly the
property of the same person if so to whom
he is apprenticed

I am Very Respectfully
Your Obedient Servant
E. E. Hammond.
Capt. Gulek Curran R. I. & A. S.

WAR DEPARTMENT,
BUREAU OF REFUGEES, FREEDMEN, AND
ABANDONED LANDS,

WASHINGTON, D. C.

CLAIM DIVISION.

CLAIM FOR ARREARS OF PAY
AND BOUNTY

Wm. S. ...
Late a *Private* Co. *D*,
137th Reg't *U.S.C.A.* Vols.
Discharged, *Jan 15th*, 186 *6*.

Filed in the _____ Office,
_____, 186 .

FORWARDED BY

DECLARATION FOR ARREARS OF PAY AND BOUNTY.

State of _____ } ss:
County of _____

On this 12th day of March, 1867, personally appeared before me, Wiley Judkins, Clerk U. S. Court, in and for the County and State of _____, Wiley Judkins of _____ in the County of Macon, and State of Alabama

who, being duly sworn, declares that his age is 25 years; that he is the same Wiley Judkins who was a Private in Company D, commanded by Capt Charles Deankins, in the 137th Regiment of United States Colored Troops, who was honorably discharged from the service of the United States at Macon Georgia on or about the

15th day of January, 1866, by reason of S. O. No 100 Dated Dec 14th 1865 Dept of Ga Augusta Ga

And he further states that he has not bestowed, sold, assigned, transferred, loaned, recharged or given away his final Discharge papers, or any interests what ever in the bounty claimed by him

This declaration is made to recover an instalment of bounty \$100 Wiley Judkins from the United States, and the bounty provided by the Section of the Act of Congress, approved July 15th 1866; and he hereby appoints WILLIAM FOWLER, Brevet Major, and A. A. G., Bureau of Refugees, Freedmen, and Abandoned Lands, or his successor in office, of Washington, D. C., as his lawful attorney, and authorizes him to present and prosecute this claim, and to receive and receipt for any orders or moneys that may be issued or paid in satisfaction thereof. My Post Office address is as follows: Montgomery Montgomery County Alabama

Signature of Claimant, Wiley Judkins

Also personally appeared before me, Benjamin Swanson and Lucy Godwin, of the County of Montgomery and State of Alabama, to me well known as credible persons, who, being duly sworn, declare, that they have been for two years acquainted with the above named Wiley Judkins, who was a Private in Company D, of the 137 Regiment of U. S. Colored troops and know that the applicant is the identical person he represents himself to be; that they saw him sign the foregoing declaration; and that they have no interest whatever in this application.

Lucy Godwin
Benjamin Swanson
Signatures of Witnesses.

Sworn to and subscribed before me, this 12th day of March, 1867, and I hereby certify that I have no interest, direct or indirect, in the prosecution of this claim.

Official Signature, E. T. Blake
Clerk U. S. Courts [OVER.]
Middle District of Alabama

State of }
County of } ss:

I,, Clerk of the Court in and for the County and State above named, do hereby certify that, Esq., before whom the foregoing affidavits were made, and who has thereunto signed his name, was, at the time of so doing, a in and for the County and State above named, duly commissioned and sworn; that all his official acts as such are entitled to full faith and credit, and that his signature thereto is genuine.

In witness whereof, I have hereunto signed my name and affixed my official seal, this day of, 186 .
....., Clerk.

WAR DEPARTMENT,
BUREAU OF REFUGEES, FREEDMEN, AND
ABANDONED LANDS,
WASHINGTON, D. C.

CLAIM DIVISION.

CLAIM FOR ARREARS OF PAY
AND BOUNTY

W. S. ...
Late a *Private* Co. *2d*
1374 Regt. *36th* *Inf.* *91* Vols.
Discharged, *Jan* 186 *6*.

Filed in the Office,
....., 186 .

FORWARDED BY

State of Maine
City and County of Washington

Know all men by these presents that the Messrs. Hiram and George A. Marwood of the State and City aforesaid are held and firmly bound unto the Hon. Genl. George D. Downing an officer in the service of the United States and now acting as the Chief Quartermaster of the Bureau P. O. No. 1, 1st State of Maine of the City and County aforesaid in the sum of Three thousand Dollars (\$3000) lawful money of the United States to be paid to the said Hon. Genl. George D. Downing - Of the City and County aforesaid in full and satisfaction of the debt payment to be well and truly made by the said Marwood as hereinafter and hereinafter and each of them severally by their promise.

The condition of this Bond is such that if the above bounden Messrs. Hiram and George A. Marwood shall for themselves their heirs Executors or administrators - build or cause to be built - a certain described Wooden building as per a Contract entered into between the said Hon. Genl. Downing and Messrs. Hiram and George A. Marwood at Washington on the 5th day of July 1867 - (which Contract is on file in

the offer of ^{Gen} Gen G. B. Bunnell and
in which the nature and character of this
building is fully set forth -) as well as
the Thirty first day of July 1867
then the above obligation to be read and
if no effect be obtained then to
remain in full force and effect.

The above articles we have heretofore set
our hands and seals the first day of
July Eighteen hundred and sixty seven

Geo. A. Hammond - [Signature]

^{his} Henry & Duncan [Signature]
merchants

Attest
C. S. Kinsman
J. A. Pope

Memorandum of a Contract entered into
at Montigny Matama. the
Treaty fourth day of June. Eighteen hundred
and fifty seven between the Major Genl
Thomas W. Smith of the Government of
British Columbia and the Matama
for the site of Matama for a post
and a shop. The Matama for the
site of the same post. Guaranteeing the
location at the same place - The Matama
and Montigny the of a Matama
building - as hereafter described -
which Contract is as follows -

That for the sum of Seventeen
hundred and fifty dollars (\$1750.00)
payable in currency - by the said Major
Genl to the Matama - of the said
Major Genl immediately upon the
completion - in a good and substantial manner
of the building hereafter described -
as hereafter described

The said Major Genl - agrees to furnish
the material necessary therefor and to construct
equip and deliver in all respects complete
as before July. thirty first - Eighteen
hundred and fifty seven the following
described - Wooden Building - erected at the
same place - To wit -
Guaranteeing - The Building to measure one hundred

and Eight feet long and Twenty five feet wide
from Outside to Outside and to be fourteen
feet high from floor to Eaves when finished
The Top of floor timber to be Two feet above
the level of the ground

Brickwork - The frame to rest on Brick piers
measuring Three feet on the face in length and
one foot deep and to terminate one foot

under the surface of the ground having
two projecting courses at bottom as per section

Size of Timber - Girders 4 x 8 - Posts 4 x 6

Plates 4 x 6 - Floor joists 2 x 12 - Rafters 2 x 4

Veranda posts 2 x 4 - Floor joists eight inches from

centre to centre and bridged with two rows

of double bridging of 2 x 4 - left nailed at

ends with 10 nails Ceiling joists 2 x 6

Rafters 2 x 6 - placed 2 ft 6 in from centre to centre

and resting on a 2 x 6 plate. Girders 1 x 12

Ridge posts - 1 x 12 Ventilation posts & Rafters 2 x 4

Trusses 1 in thick Veranda posts 4 x 6

Plates 4 x 6 Rafters 2 x 4 Posts 2 x 4

Windows & Doors - Window frames to be made

and for 12 ft. sash of 10 x 15 glass

The end or outside doors to be 4-3" wide

18-1" high and double each side of

which to be 2 1/2 in sheet metal

The Iron rear outside door to be 3 ft wide

and 7-6" high the inside door to be the

and 17.6 - high the inside down to the ch

main size. all to be hung and fastid couple
Siding - Outside Siding of Building. Siding
& roof of Verandah to be of 1 + 12 - stiff
and of and down the joints shiplap with
1 + 3 - stiff & well nailed.

Roofs - all the roof of the verandah
to be made with 1 + 12 planks and the
eave with best pine bungs 3-in to the
weather well nailed.

Ventilator a ventilator no roof to be
formed as shown in section plan.

The roof of main building and ventilator to
be shiplap - at ends as shown in
plan.

Steps - Steps to end doors as shown
in plan.

Floors - The main floor to be laid with
dressed squared & g rounded 1 1/4 in planks
laid with broken joints and well nailed.

Pit - The Pit to be double and fitted with
rats as per plan. The Pit 5 feet deep and
bricked all around with bricks.
A platform to run from each door
to spring to be 5 ft wide - lower than the
floor of the building.

All other work not herein specified
shall to be done in a workmanlike

Wanner
Hoodie gutter

A Hoodie gutter to be attached
to each of the ends of the building
discharging water of the roof through
4. 3" diameter perpendicular Tin Pipes

And for the settlement of the allegations
herein proposed the same be referred
to the Honorable the State of
1847

Signed

Geo. P. Barrington

George P. Barrington
255 Front Street

Mary X Tucker
her mark

Witnessed
J. D. Kinnear

(A Paper)

BUREAU REFUGEES, FREEDMEN AND ABANDONED LANDS

Henry Sumner & Co.
Harmon - to build
Home Colony building
Montgomery Ala Jan 14/65

Official Business,

Contract of Henry Sumner "New Colony"
Building

of Henry Sumner } for erection of a
George A Harmon }

Bill of Exchange
Settlement
Friedman

Receipt of Settlement
Calloway & Burt

In a statement this day before
H. Handolph J.P. it appearing
that we are indebted to B. B. &
Cassidy ^{conductors} over and above our share
in the crop, we hereby express our
selves satisfied at the settlement
and Mr. William A. B. agree
to give ~~we~~ ^{we} ~~our~~ ^{ten} bushels
of grain ~~what~~ ^{we} ~~shall~~ ^{allow} ~~all~~ ^{our} ~~claim~~
to the crop or any portion of the crop.
July 6th 1868

Witness
H. Handolph
J.P.

Wilson ^{his} Bandy
with

Auderman ^{his} Shuckford
with

Janett ^{his} Bell
with

Wash ^{his} ~~Shuckford~~ ^{Louis}
with

Shepherd ^{his} ~~Shuckford~~ ^{Smith}
with

No 62

Robert Adams

vs

Jus Pepe

Sherman of
Dioc Croome

W. W. Johnson is a
Special Constable
To Execute the within
Aug. C. Fox J.P.

Amt. of debt to this
date is $\$10 \frac{60}{100}$ should
further costs accrue
Aug. C. Fox J.P.

The State of Alabama, Montgomery County.

To Any Lawful Constable:

YOU ARE HEREBY required to SUMMON

Gas Pope

personally to attend before me Aug C Rose, a Justice of the Peace in and for the County aforesaid, at my office in Montgomery, on the 3rd day of Oct next, at 10 o'clock on said day, to answer upon oath in an attachment at the instance of

Robert Adams

vs

Diels Crown

what Goods and Chattels of the said Defendant you have in your hands or possession, what sum or sums of Money, or quantity of Merchandise or goods and chattels you owe to the said Defendant, by any existing contract, and what goods and chattels you know to be in the hands of any other person belonging to the said Defendant, and what sum or sums of money, quantity of merchandise, goods and chattels, you may know to be due from any person or persons to the said Defendant.

GIVEN UNDER MY HAND AND SEAL, at office, the 15th day of April 186

Aug. C. Rose J. P. [L. S.]

Affidavits-

Affidavit
of
J. W. Jamison
Co. G. 8th Iowa Inf. U. S.

Febr 3. 1866.

Montgomery

Personally appeared before me Chas. Scott,
Sr. Capt and Provost Marshal Post of
Montgomery Ala. Franklin St. Jamison
Private "Col" & Terra Infidel, who
upon oath deposeth and saith
that about three weeks ago in a
conversation with one Dr Robinson in
the city of Mont. relative to shipping
negroes to Cuba. he Robinson said
that a friend of his (quitting name)
had shipped a cargo of negroes for
Mexico - and that when at sea they
were picked - good from bad and
that the poorer class were sent to
Cuba and the other to Mexico - said
good lands would bring 1500 to 2000
dollars in Cuba and wanted me to
go in with him get negroes and
ship to Cuba. that I could make all
of the money that I wanted he Robinson
said that Slavery would be established
in Mexico inside of two years. that he
Robinson had negroes in Mexico that had
been taken from the State.

That about 3 days ago I met one James
Lulliman at Demopolis Ala. whom I
first overheard in conversation say that
somebody else had accused him of

shipment to Davis Durne Co. or could
put them in charge of any steamboat
Club to be declined by him to Davis
D. Co. he said that they ship
the negro from Mobile boat
for Pensacola. that they were
transferred to vessel out side for
Cuba. that the Turpentine
work was all a sham that
they ship a only a few there and
then only the ignorant one that they
would send all of the smart ones
to Cuba. and that the "guerrilla"
(his party) numbered about three
hundred that the majority of them
were discharged Federal Officers and
Soldiers. that they had other
business - cotton stealing etc
that I think Davis Durne Co. and
are the main parties. and that
the Reeds are equally interested
and have immediate charge of the
Turpentine work. that I am an
Employer of Arthur Post of Montg.
and that I have every reason to believe
that the kidnapping of negroes for
Cuba market is carried on to a
great extent in this State and that.

sending negroes to Cuba. that though
it was the truth no good man son of
a bitch could accuse him of it.
I had further conversation with him
on the subject. left with him he at
first proposed to give me ten dollars
and of towards twenty five dollars
for all negroes I could hire to
go to the Turpentine plantation
in Baldwin Co. Ala. furnished
me a copy of the contract to be
used saying that it was a good
thing also furnished me the address
of the parties in Mobile to ship to.
The Sullivan afterwards told me
that he was engaged in shipping
negroes to Cuba and had been for the
past five months, and that he only
wanted to get one more cargo
off to Cuba and then quit. that it
had got to be too dangerous a business
he then offered to give me twenty five
dollar per head when sent at Mobile
or would give me one half the proceeds
when I went aboard of vessel for
Cuba. gave me the address of Dr Louis H
Reed. Care of Davis Durnan & Co Mobile
to ship to and receive my pay. The Sullivan
also said that I could accompany each.

The parties herein named are the re-
sponsible parties and that the 11th
Yrs of the Kidnappers is at Mobile
Ala. and that discharges Federal
Officers and Soldiers from the rank
of Col down are a terrible and
common in that State. That
one Buoyan late a Lieut Col is
in the Service at Demopolis Ala.
and that the Lane Ship's negroes
to Cuba.

W. of Jamaica
P. M. Co. "G" & Iron Works

Amount subscribed to
before me at Montgomery Ala
this 30th day of Feb'y. 1866.

John P. ...
of Peronka

22 22 22

Hartsump Ala
Jan 28/66

Isaac Spangler

States that W. B. Hall
Did say to him that he
was ordered ^(arrest) to all negroes
whos contracts were not
signed by him

State of Alabama }
Montgomery County - } Isomally appeared before me Isaac
Spangler of Autauga County State of Ala.
and made oath that Mr. B. Hall of Autauga County
State of Alabama did say to him that he was ordered
by the Freedmen Bureau to arrest all negroes whose con-
tracts were not approved by him, and hire them out to
other parties this in the presence of ~~James~~ ~~Allen~~ and
Thomas Calhoun of Autauga County State of Alabama on or
about the 26th of January 1866.

Isaac Spangler

Sown and subscribed to-

Before me at Montgomery Ala. Feb. 8th 1866.

Geo. A. Hammond.

Act. Sup^r Bureau of Ref. Ind. N. C.

April 11th 1866

Affidavit of Madison
H. Simpson of Chambers Co.
Ala. giving an account
distinctance of negroes by
White men, at a private
party, that they (White men) prevented
a colored woman from said
party, threatened the lives
of those there, &c

(one Enclosure)

Case of Madison W. Sipes

Witnesses for Cross.

Mrs. D. Sipes) Residence					
John Li Barte) Covington				
Mrs. John " ") Chambers Co.			
John's wife Sallie " " " " " ") Alabama.		
Lawrence Floyd " ")	
Rich. Fredricks " ")
Henry Phillips " "						
Emanuel Rudd " ")					

1

State of Alabama, Personally appeared before
Montgomery County, and Madison W. Simps of
Schubert's County in said State and made oath
that

on or about ^{Saturday} the third of March that I allowed
certain Freedmen under contract with me to
have a Civil party, and after a small
part of them had assembled there came
six White-men viz) Marias Wallace,
Joseph Summers, James Able, Tix Wilkes and
two others (names unknown) The first three
entered came into my yard and from
the Freedmen off threatening that they would
shoot me and the Freedmen unless we
done as the ordered They also inflicted some
severe punishment on the Freedmen as they
passed out of the House by way of stripping
them with their Pistols which they held
in their hands, I then came to the yard
gate and ordered them to leave my place
which they refused to do threatening to
take my life if I did not go back
to the House they kicked me and fired
one shot from a Pistol and attempted to
take me out of the yard which I prevented
by holding to the railing and the timely
interference of my Mother - They then
proceeded to my ^{dormer} house and took

forced a freed woman² 'Phoebia' from said dwelling
threatening to take her life if she refused to go
They also pulled me out of the door threatening
to shoot me if I made any resistance
pirious to their entering the House they called
out ^{Call on Boop} and three other men 'porties' above mentioned
came to their assistance but did nothing. They
then proceeded to the Cabin yard & severely thrashed
the said Freed woman 'Phoebia' then they told
her & me that they did not want to hear any
thing more of this, and that we had to stop
having parties. They then started off firing
several shots from their pistols as they went

On Monday^{morning} following the said Freed woman
and a "Witness" went to Cipeta to consult a
Magistrate what was best to do, he advised
her to have^{the} said porties arrested and punished
he then issued a Warrant for their arrest but
did not have it executed. On Tuesday night
following the three first named persons of said
porties returned and ~~found~~ ^{finding} that we were
not in the House proceeded to a Boop where
we had concealed ourselves ^{"previous to"} their
coming to the Barn they called at the gate
but on receiving no reply proceeded to one
of the Cabins & forced ~~the~~ a negro man "Lewis"
to accompany them to search for us, firing off
a pistol in the yard at one of my dogs.

on arriving at the Barn they ordered the said
 "Lewis" to go in & ~~bring~~ ^{search for} us ~~out~~ while they stood
 at the front & rear of said Barn with pistols
 in hand ready to shoot us if we attempted
 to escape threatening that if we did not
 come out that they would set fire to the
 Barn & burn it down, on hearing this I thou-
 ght it would be best to show myself & they
 telling the said Lewis "at last" that they would
 compromise it if we would come out &
 then stepped to the Barn door carrying with
 me a double barrel shot gun, for self protection
 As I stepped from the Barn door ^{one} of them stepped
 up to me seizing the gun by the barrel also
 presenting a pistol threatening if I did not
 give up said gun that he would shoot me
~~in the~~ or raised the gun & he stepped off about
 five paces & shot off both barrels stating
 that "now boys we have them" he then set the
 gun down & proceeded to say "Probatia" & struck
 with his fist or pistol & told her if she did
 not walk on in front of him that he would
 shoot her, the other two then took hold of
 me & ordered me to walk along or that
 they would shoot me, they then proceeded
 to the outer part of the barn where they had
 left some Hickory & they they ordered Probatia
 to lay down or that they would shoot her-

they then jerked her on to the ground & whipped
her severely so that she was unable to be up
for several days. They then came on me & bore
me to the ground & inflicted on ~~my~~ person
about twenty five lashes with their sticks or
Hickris, threatening to shoot me if I made
any resistance. They then took the said "Luis"
& flogged him severely, & threatened to shoot
him if he attempted to resist. My Mother
came up during the time with a light for
our assistance. They threatened to take her
life if she did not shut her mouth & keep
still. They then left ordering the said Freedwoman
^{Florida} to stop the manumission or that they would kill
her & me to

In a few days after there came another
party viz' Coy Hugh Wallace, Tip Philips, Acoc
Peter Indrick, ^{and Jackson} James, stating that I would
have to send off the said Freedwoman "Pocbia"
or that they would have her arrested for threats
that she should of made to burn up a Mill
place of Hugh Wallace - which said woman
did not know he owned or did not even
know where it was situated. I insisted that ^{she} ~~they~~
~~would have her arrested~~ but Wallace said that that
would not satisfy the people, that she would
have to leave the place or that ^{scattered} ~~her~~ ^{our} life would be
in danger, they stated before they left that I must
see that she left the place which she did for the
safety of her life. Madison. W. Snipes

Sworn and subscribed to before me at Newberry Alabama
this 11th day of April 1861.

Geo. J. Garrison
Capt. Supr. Bureau of F. S. M. S.

Lauder County, Ala.

February 20th 1867

Jackson Hu

His affidavit as to the
advancement (1100⁰⁰) made
by Messrs Walker and
Barnwell of Mobile
to him in order to raise
his crop.

The State of Alabama, Be it known
Lowndes County } that I, William
Jackson, a citizen of Lowndesboro,
Lowndes County and State of Alabama,
do hereby acknowledge that I have on
this the 20th day of February 1867, received
of Messrs. Walker and Barnwell of Mobile
Alabama the sum of One thousand One
hundred dollars, which said sum of
One thousand One hundred dollars
has this day been advanced to me
by the said Messrs. Walker and Barnwell
to purchase necessary provisions, farming
implements, etc., - and was obtained by
me to enable me to make a crop for
the year 1867, and which said sum
of One thousand One hundred
dollars, I agreed and bind myself
to pay to the said Messrs. Walker and
Barnwell on or before the 1st day of
December next, I the said William
Jackson do hereby declare that the
said advanced of One thousand One
hundred dollars was obtained by
me bona fide for the purpose of
making a crop and that without
said advanced it would not be in
my power to procure the necessary

provisions, implements, &c., to make a crop. For said advance I have this day executed a note to the said Messrs. Walker and Barnwell, payable on the first day of December next, at the Bank of Mobile, Mobile Alabama, - and in consideration of said advance and for the purpose of more effectually securing the payment of the same, in addition to the lien given by the act to give a lien on the crop and stock for advances to assist in making the crop approved January the 15th, 1866, I the said William Jackson do hereby further agree and bind myself to deliver to the said Messrs. Walker and Barnwell, in the city of Mobile on or before the 1st day of December next my entire crop of cotton, ginned and securely packed in bales of the usual size, to be sold by the said Messrs. Walker and Barnwell, and for the selling of which the usual commissions are to be allowed & paid to the said Messrs. Walker and Barnwell, and in case the crop of cotton made by us is insufficient to pay the said commissions for selling the said cotton, then I

further bind myself to deliver the

further bind myself to deliver the
other crop raised on my place during
the year 1867, to Messrs Walker and
Barnwell, in payment of the balance
of said sums then due.

Witness my hand and seal this the 20th
day of February 1867.

Witness —

William Jackson,

Otis Gresham,

The foregoing is a true copy of Original
Mortgage received for record and
recorded this 21st day of February 1867.

James W. Goshaw,
Judge of Probate.

Appendix of

Joshua Shivers

in regard to Mr Peck
not allowing him to
go on his premises &

The State of Alabama }
Montgomery County } Before me G. N. Cushing - a
} Justice of the Peace in & for said County
} Comes Joshua Shires Colored
who on oath says that he has this year employed
by John D. Pitt as a laborer and that he hauled the
corn made on the place, to the residence of W. C. Pitt,
that he has not been paid for his services, & has ob-
tained an attachment under the Military Orders to levy
on said corn, that W. C. Pitt who has the corn in pos-
session, refuses to let affiant go on his place to point out
the same to the Officer, having the attachment & threatens
violence to affiant should he thus come in the enclosure
to secure his legal rights
Sworn to & Subscribed before } Joshua Shires
me this 16th day of Dec. 1867 } his
G. N. Cushing J.P. } mark

Office Probate Judge
Linn Co. County
December 24th 1867

Graham vs Loth
Judge of Probate.

Statement in the case
of Saunders vs Freeman vs
W H Bryan vs

The State of Ala. Probate Court

Louisa County, Ala 24th 1867

Sampson Freeman has this day
filed the following claims against the
Estate of M^r H. Bayan, Trust

a claim of \$150 for himself for
work done in 1866.

a claim of \$150 for Isaac May -

a claim of \$144 for Isaac May for the
work of Jim and Tom,

a claim of 50 Bushels corn & at
least one Bale cotton worth the
market price,

all for work done in 1866.

& sworn to by Sampson Freeman this
the day above written.

JAMES W. GRAHAM
Judge of Probate

There will have to be an administration
on the Estate of Charles May in Louisa County Ala.

State of Alabama }
Montgomery County }

Before me J. H. Nettles
an acting Justice of the Peace in and for
said County & State personally appeared
Nancy Keys, a colored woman, who
being duly sworn says that her mother
Hannah Bryan is an aged woman
living in Newbern N. C. in destitute
circumstances and that she the
said Nancy is unable to pay the
expenses of the said Mother's re-
moval to this County ~~and~~ but that
she is able & willing to maintain her
if brought here.

Sworn to & subscribed

Nancy Keys
Date

This 3 day of Sept. 1828.

J. H. Nettles, J.P.

[Faint handwritten text, possibly bleed-through from the reverse side of the page]

James Handey

[Faint handwritten text, possibly bleed-through from the reverse side of the page]

[Faint handwritten text, possibly bleed-through from the reverse side of the page]

Plantation Fla
Dec 9th / 56

J. C. Allen

In regard to N. B. Hall
ordering contracts that were
made in St. Johns County to be
brought to him for approval

State of Alabama - Personally appeared before me
Montgomery County. Samuel Oliver of Antuagua County
in said State and made oath that Dr. B. Hall
of Antuagua, in said State did write a notice
to the Citizens of his district, to bring to him
their contracts for Justice and approval, and
warning them if they did not do so that the
negroes employed by them would be ~~seized~~
~~and~~ ~~sent~~ ~~out~~ to other parties, who
would comply with his order, or words to that
effect, and that ^{he did} say to him, the said Oliver, that he
the said Hall "would ^{take} ~~seize~~ Dr. Spaulding's negroes
and hire them to other parties," or words to that effect.

All of this on or about the 25th day of January
1861. at Robinson Spring Antuagua County Ala.

Sam. D. Oliver

Sworn and subscribed to before me
at Montgomery Ala. Feb. 9th 1861.

Geo. N. Hammond

Act. Sup. Court of Ala.

~~Mont. 1866~~
Tickets and Returns
for last days of April.
April 25th to April 30, 1866
No of Returns 2990

C. S.,

Issue July 1860 Rations, to Mrs. Woodruff.

By A. Hammond.

Assistant Superintendent.
Bureau of Refugees, Freedmen and Abandoned Lands.

Montgomery, Ala.

July 20th 1860.

C. S.,

Issue *one hundred* ^{Twenty} Rations, to Mrs. *Stover*.

Geo. A. Hammond.

Montgomery, Ala.

Apr 25th 1865.

Assistant Superintendent,
Bureau of Refugees, Freedmen and Abandoned Lands.

C. S.

Issue *Twenty eight* Rations, to *Mrs. Smith.*

Gen. A. Hammond.

Assistant Superintendent,
Bureau of Refugees, Freedmen and Abandoned Lands.

Montgomery, Ala.

Apr 25th 1865.

C. S.,

Issue Twenty eight Bations, to Mrs. Blackwell.

B. A. Hammond.

Assistant Superintendent.
Bureau of Refugees, Freedmen and Abandoned Lands.

Montgomery, Ala.

April 25th/66

C. S.

Issue Twenty eight Rations, to Mrs. Pendleton.

Geo. A. Hammond.

Assistant Superintendent,
Bureau of Refugees, Freedmen and Abandoned Lands.

Montgomery, ~~Feb 21 1866~~ Feb 26

C. S.

Issue Twenty eight Bations, to Mrs. Sizemore.

Geo. A. Hammond.

Assistant Superintendent.
Bureau of Refugees, Freedmen and Abandoned Lands.
April 20th / 86.

C. S.

Issue *Twenty one* Rations, to *Miss Thomas*

G. A. Hammond.

Assistant Superintendent.
Bureau of Refugees, Freedmen and Abandoned Lands.

Montgomery, Ala.

April 20th 1864.

C. S.,

Issue Twenty one Rations, to Mrs. Taylor.

G. A. Hammond.

Montgomery, Ala.

Assistant Superintendent.
Bureau of Refugees, Freedmen and Abandoned Lands.

apl. 27/68

C. S.,

Issue Twenty one Rations, to Mrs. Adams.

Geo. A. Hammond.

Assistant Superintendent,
Bureau of Refugees, Freedmen and Abandoned Lands.

Montgomery, Ala.

April 25th, 1865.

C. S.

Issue *Provisional* Rations, to *Miss Price*

GE. A. Hammond:

Assistant Superintendent.
Bureau of Refugee, Freedmen and Abandoned Lands.

Montgomery

Apr. 20-7/66

C. S.,

Issue Twenty one Rations, to Mrs. Walker

Geo. A. Hammond,

Assistant Superintendent.
Bureau of Refugees, Freedmen and Abandoned Lands.

Montgomery, Ala.

Apr 25 7/66

C. S.

Issue *Monthly* on *Rations*, to *Miss. No. 22.*

G. A. Hammond

Assistant Superintendent,
Bureau of Refugees, Freedmen and Abandoned Lands.

Montgomery, Ala.

Feb 25 7 1865

C. S.,

Issue Twenty one Rations, to Mrs. Adams.

Geo. A. Hammond.

Assistant Superintendent,
Bureau of Refugees, Freedmen and Abandoned Lands.

Montgomery, Ala.

Feb 20 7 / 1865.

G. S.

Issue Priority on Nations, to Mrs. Carver

Geo. A. Hammond.

Assistant Superintendent.
Bureau of Refugee, Freedmen and Abandoned Lands.

Montgomery, Ala.

April 20th 1867

C. S.,

Issue twenty one Bations, to Mrs. Robinson.

Geo. A. Hammond.

Assistant Superintendent,
Bureau of Refugees, Freedmen and Abandoned Lands.

Montgomery, Ala.

Apr. 20th 1866.

C. S.

Issue *Private* rations, to Mrs. Robinson

G. E. N. Hammett.

Assistant Superintendent,
Bureau of Refugees, Freedmen and Abandoned Lands.

Montgomery, Ala.

Apr 25 7 / Feb.

Issue Twenty one Rations, to New York.

Geo. A. Hammond.

Assistant Superintendent.
Bureau of Refugees, Freedmen and Abandoned Lands.

Montgomery, Ala.

Jan. 27 / 1865.

C. S.,

Issue Monthly our Rations, to Mrs. Keith.

Geo. A. Hammond,

Assistant Superintendent,
Bureau of Refugees, Freedmen and Abandoned Lands.

Montgomery, Ala.

ap'd 20th / Feb.

C. S.,

Issue from

Rations, to Miss Stahler

G. A. Hammond.
Assistant Superintendent.
Bureau of Refugees, Freedmen and Abandoned Lands.

Montgomery, Ala.

April 20/64

C. S.,

Issue *Permit*

Rations, to *Mrs. Harris*.

Geo. A. Kennicott

Assistant Superintendent,
Bureau of Refugees, Freedmen and Abandoned Lands.

Montgomery, Ala.

April 20, 1865.

C. S.,

Issue from

Nations, to New Country.

Geo. A. Hammond:

Assistant Superintendent,
Bureau of Refugee, Freedmen and Abandoned Lands.

Montgomery, Ala.

Apr. 25 7/66

C. S.,

Issue 2750

Rations, to Mrs. Wolfe

Ge. A. Hammond:

Assistant Superintendent.
Bureau of Refugees, Freedmen and Abandoned Lands.

Montgomery, Ala.

Apr. 25, 1865.

C. S.,

Issue *207*

Rations, to

Mrs. Johnson.

G. A. Hammond.

Assistant Superintendent.
Bureau of Refugees, Freedmen and Abandoned Lands.

Montgomery, Ala.

April 20-7, 1866.

C. S.,

Issue

from

Rations, to

Miss. Hale

Geo. A. Hammond

Assistant Superintendent,
Bureau of Refugees, Freedmen and Abandoned Lands.

Montgomery, Ala.

Apr 27, 1866

C. S.,

Issue of 2000

Rations, to Mrs. Johnson.

Montgomery, Ala.

April 27/66

Geo. A. Hammond.

Assistant Superintendent.
Bureau of Refugees, Freedmen and Abandoned Lands.

C. S.,

Issue from

Rations, to Mrs. Patten.

Geo. A. Hammond
Assistant Superintendent.
Bureau of Refugees, Freedmen and Abandoned Lands.

Montgomery, Ala.

Apr 26 7. W.

C. S.

Issue from

Rations, to Messrs. Page.

G. A. Hammond.

Assistant Superintendent.
Bureau of Refugees, Freedmen and Abandoned Lands.

Montgomery, Ala.

April 20th 1865.

C. S.,

Issue *27/1866*

Rations, to *Mrs. Porter.*

Gen. A. Hammond.

Montgomery, Ala.

April 27 1866.

Assistant Superintendent.
Bureau of Refugees, Freedmen and Abandoned Lands.

C. S.

Issue drawn

Rations, to Mrs. Payne

Geo. A. Hammond:

Assistant Superintendent,
Bureau of Refugees, Freedmen and Abandoned Lands.

Montgomery, Ala.

April 27 / 1866.

C. S.,

Issue given

Rations, to Miss Collins.

G. A. Hammond.

Montgomery, Ala.

April 25th 1865

Assistant Superintendent,
Bureau of Refugees, Freedmen and Abandoned Lands.

C. S.,

Issue from

Rations, to Mrs. Smith

Geo. A. Hammond.

Assistant Superintendent.
Bureau of Refugees, Freedmen and Abandoned Lands.

Montgomery, Ala.

April 20th 1866.

C. S.,

Issue *fourteen* Rations, to *Mrs. Goff*.

Montgomery, Ala.

Feb. 21-7, 1865.

G. E. A. Hammond.

Assistant Superintendent,
Bureau of Refugees, Freedmen and Abandoned Lands.

C. S.,

Issue

Jambert

Rations, to Mrs. Robertson.

Geo. A. Hammond.

Assistant Superintendent,
Bureau of Refugees, Freedmen and Abandoned Lands.

Montgomery, Ala.

april 28th/66

C. S.,

Issue *fourteen* Rations, to *Miss Moody.*

Geo. A. Hammond.

Assistant Superintendent,
Bureau of Refugees, Freedmen and Abandoned Lands.

Montgomery, Ala.

Apr. 23, 1865

C. S.,

Issue from

Rations, to Mrs. Grip.

Geo. A. Hammond.

Assistant Superintendent,
Bureau of Refugees, Freedmen and Abandoned Lands.

Montgomery, Ala.

April 25th 1865.

C. S.,

~~From~~ *Fountain* Rations, to *Mrs. Lucas.*

Geo. A. Hammond.
Assistant Superintendent.
Bureau of Refugees, Freedmen and Abandoned Lands.

Montgomery, Ala.

Apr. 25-7/66

C. S.,

Issue Fountain

Rations, to Mrs. Allen

Montgomery, Ala.

April 25th 1865.

Geo. A. Hammond.
Assistant Superintendent.
Bureau of Refugees, Freedmen and Abandoned Lands.

C. S.

Issue fontem

Rations, to Mrs. Miller.

Geo. A. Hammond.

Assistant Superintendent.
Bureau of Refugees, Freedmen and Abandoned Lands.

Montgomery, Ala.

April 21st 1865.

C. S.

Issue

fourteen

Rations, to

Mrs. Horton.

Geo. A. Hammond.

Assistant Superintendent.
Bureau of Refugees, Freedmen and Abandoned Lands.

Montgomery, Ala.

April 27, 1865

C. S.,

Issue *fontem*

Rations, to Mrs. Puller.

G. A. Hammond.

Montgomery, Ala.

April 25th 1865.

Assistant Superintendent.
Bureau of Refugees, Freedmen, and Abandoned Lands.

C. S.,

Issue *fourteen*

Rations, to Mrs. M. C. Clark.

Geo. A. Hammond.
Assistant Superintendent,
Bureau of Refugee, Freedmen and Abandoned Lands.

Monrovia, La.

April 27/1866.

C. S.,

Issue fountain : Rations, to Mrs. Bullard.

Montgomery, Ala.

April 27/96.

Geo. A. Hammond.

Assistant Superintendent,
Bureau of Refugees, Freedmen and Abandoned Lands.

C. S.,

Issue *fourteen*

Rations, to *Mrs. Jones.*

G. A. Hammond.

Assistant Superintendent,
Bureau of Refugees, Freedmen and Abandoned Lands.

Washington, D.C.

Apr 20th 1866.

C. S.

Issue *fontem*

Rations, to *Miss. Coleman.*

G. A. Hammond.
Assistant Superintendent.
Bureau of Refugees, Freedmen and Abandoned Lands.

Montgomery, Ala.

Apr. 20th 1866.

C. S.,

Issue *fourteen*

Rations, to *Miss Williams*

E. A. Hammond

Assistant Superintendent,
Bureau of Refugees, Freedmen and Abandoned Lands.

Montgomery, Ala.

April 25th 1865

RECEIVED

C. S.,

Issue Southern Rations, to Mrs. Kaffel

Geo. N. Hammond.

Montgomery, Ala.

April 25th 1865.

Assistant Superintendent.
Bureau of Refugees, Freedmen and Abandoned Lands.

C. S.,

Issue *fourteen*

Rations, to Mrs. *Erving*.

Geo. J. Hammond,

Assistant Superintendent,
Bureau of Refugees, Freedmen and Abandoned Lands.

Montgomery, Ala.

Feb. 25-7 1866.

C. S.,

Issue *fourteen*

Rations, to *Mrs. Duffie*

Montgomery, Ala.

April 25th 1864

Geo. A. Hammond
Assistant Superintendent
Bureau of Refugees, Freedmen and Abandoned Lands.

U. S.,

Issue *fourteen*

Rations, to *Mrs. Matthews*

G. A. Hammond

Assistant Superintendent.
Bureau of Refugees, Freedmen and Abandoned Lands.

Montgomery, Ala.

April 20th 1865.

C. S.

Issue: Fountain

Rations, to Mrs. Cotton.

G. E. A. Hammond.

Assistant Superintendent,
Bureau of Refugees, Freedmen and Abandoned Lands.

Montgomery, Ala.

Apr 25-7/66

C. S.,

Issue from

Rations, to Mrs. S. C.

Gen. A. Hammond:

Assistant Superintendent,
Bureau of Refugees, Freedmen and Abandoned Lands.

Montgomery, Ala.

April 25th/66

C. S.,

Issue *fourteen*

Patrons, to Mrs Sanford.

Geo. A. Harmon;

Assistant Superintendent.
Bureau of Refugee, Freedmen and Abandoned Lands.

Montgomery, Ala.

April 20 71 - H. S.

C. S.

Issue fourteen Nations, to Mrs. Cook

Geo. A. Hammond.

Assistant Superintendent,
Bureau of Refugees, Freedmen and Abandoned Lands.

Montgomery, Ala.

April 22/65

C. S.,

Issue *fourteen* Rations, to *Mrs. Mowry*

Montgomery, Ala.

April 25th 1866.

Geo. A. Hammond.
Assistant Superintendent.
Bureau of Refugee, Freedmen and Abandoned Lands.

C. S. D.

Issue *Journal*

Rations, to Mrs. Johnson.

Geo. T. Hammett.

Assistant Superintendent.
Bureau of Refugees, Freedmen and Abandoned Lands.

Montgomery, Ala.

April 20-7, 1866.

C. S.,

Issue fountain

Patrons, to Mrs. Bradshaw.

Geo. A. Hammond.

Montgomery, Ala.

April 28th/66

Assistant Superintendent,
Bureau of Refugees, Freedmen and Abandoned Lands.

C. S.

Issue

Fonten

Rations, to Mrs. Dinkham.

Geo. A. Hammond.

Assistant Superintendent.
Bureau of Refugees, Freedmen and Abandoned Lands.

Montgomery, Ala.

April 27, 1865.

C. S.,

Issue fountain

Rations, to Mrs. Miller

Geo. A. Hammond.

Assistant Superintendent.
Bureau of Refugees, Freedmen and Abandoned Lands.

Montgomery, Ala.

April 27/86.

C. S.,

Issue Fontem

Rations, to

Mrs. Jones.

GE. A. Harmon.

Montgomery, Ala.

Apr 25 7/1862.

Assistant Superintendent.
Bureau of Refugees, Freedmen and Abandoned Lands.

C. S.,

Issue fountain

Rations, to Mrs. Piper

Geo. A. Hammond.

Montgomery, Ala.

April 25th, 1865.

Assistant Superintendent,
Bureau of Refugees, Freedmen and Abandoned Lands.

C. S.,

Issue fourteen

Rations, to Meip McCool.

Geo. A. Hammond.

Assistant Superintendent,
Bureau of Refugees, Freedmen and Abandoned Lands.

Montgomery, Ala.

April 25 7 1865.

C. S.,

Issue *fourteen*

Rations, to Mrs. Striner.

Geo. A. Hamant.

Montgomery, Ala.

April 20th, 1865.

Assistant Superintendent,
Bureau of Refugees, Freedmen and Abandoned Lands.

C. S.

Issue *Fonten*

Rations, to Mrs. Kaiston.

Geo. N. Hammond

Assistant Superintendent.
Bureau of Refugees, Freedmen and Abandoned Lands.

Montgomery, Ala.

Apr 25th 1865.

C. S.,

Issue *Lantern*

Rations, to *Gen. Mc Lane.*

Geo. A. Hammond.

Assistant Superintendent,
Bureau of Refugees, Freedmen and Abandoned Lands.

Montgomery, Ala.

Apr 20 7 1866.

C. S.,

Issue *fontem*

Rations, to

Mrs. James

Geo. A. Hammond
Assistant Superintendent.
Bureau of Refugees, Freedmen and Abandoned Lands.

Montgomery, Ala.

April 25 7/66

C. S.,

Issue *fourteen*

Rations, to *Mrs. Ratum.*

G. A. Hammond.

Assistant Superintendent,
Bureau of Refugees, Freedmen and Abandoned Lands.

Montgomery, Ala.

Apr. 25th/68

C. S.,

Issue Fifty five Rations, to Mrs. Jordan

Geo. A. Hammond

Assistant Superintendent.
Bureau of Refugees, Freedmen and Abandoned Lands.

Montgomery, Ala.

April 26th / 1866

C. S.,

Issue Fifty

Rations, to Mrs. Bryan.

Geo. A. Hammond

Assistant Superintendent.
Bureau of Refugees, Freedmen and Abandoned Lands.

Montgomery, Ala.

April 26th 1866.

C. S.,

Issue Fifty

Rations, to Mrs. Skipper.

Geo. A. Hammond

Assistant Superintendent.
Bureau of Refugees, Freedmen and Abandoned Lands.

Montgomery, Ala.

April 26th 1866.

C. S.,

Issue Sixty

Rations, to Mrs. Brooks

Geo. A. Hammond

Assistant Superintendent.
Bureau of Refugees, Freedmen and Abandoned Lands.

Montgomery, Ala.

April 26th 1866

C. S.,

Issue one hundred and twenty rations, to Mrs. McD Witt.

Montgomery, Ala.

Geo. A. Hammond -
Assistant Superintendent.
Bureau of Refugees, Freedmen and Abandoned Lands.

April 26th 1866.

C. S.,

Issue twenty eight rations, to Mrs. Cannon.

Montgomery, Ala.

Geo. A. Hammond -
Assistant Superintendent.
Bureau of Refugees, Freedmen and Abandoned Lands.

April 26th 1866.

C. S.,

Issue twenty one rations, to Mrs. Meredith.

Montgomery, Ala.

Geo. A. Hammond -
Assistant Superintendent.
Bureau of Refugees, Freedmen and Abandoned Lands.

April 26th 1866.

C. S.,

Issue twenty one rations, to Mrs. Dennis.

Montgomery, Ala.

Geo. A. Hammond -
Assistant Superintendent.
Bureau of Refugees, Freedmen and Abandoned Lands.

April 26th 1866.

C. S.,

Issue Twenty one Rations, to Mrs. Diland.

Montgomery, Ala.

April 26th 1862.

G. A. Hammond.

Assistant Superintendent.
Bureau of Refugees, Freedmen and Abandoned Lands.

C. S.,

Issue Twenty one Rations, to Mrs. Kent.

Montgomery, Ala.

April 26th 1862.

G. A. Hammond.

Assistant Superintendent.
Bureau of Refugees, Freedmen and Abandoned Lands.

C. S.,

Issue Twenty one Rations, to Mrs. Brooks.

Montgomery, Ala.

April 26th 1862.

G. A. Hammond.

Assistant Superintendent.
Bureau of Refugees, Freedmen and Abandoned Lands.

C. S.,

Issue Twenty one Rations, to Miss Fitzgibbons.

Montgomery, Ala.

April 26th 1862.

G. A. Hammond.

Assistant Superintendent.
Bureau of Refugees, Freedmen and Abandoned Lands.

C. S.,

Issue *Erren*

Rations, to *Mrs. Tomlinson.*

Geo. A. Hammond.

Assistant Superintendent,
Bureau of Refugees, Freedmen and Abandoned Lands.

Montgomery, Ala.

April 26 7 1866.

C. S.,

Issue *Erren*

Rations, to *Mrs. Carter.*

Geo. A. Hammond.

Assistant Superintendent,
Bureau of Refugees, Freedmen and Abandoned Lands.

Montgomery, Ala.

April 26 7 1866.

C. S.,

Issue *Erren*

Rations, to *Miss Mitchell*

Geo. A. Hammond.

Assistant Superintendent,
Bureau of Refugees, Freedmen and Abandoned Lands.

Montgomery, Ala.

April 26 7 1866.

C. S.,

Issue *Erren*

Rations, to *Mrs. Page.*

Geo. A. Hammond.

Assistant Superintendent,
Bureau of Refugees, Freedmen and Abandoned Lands.

Montgomery, Ala.

April 26 7 1866.

C. S.,

Issue given

Rations, to Mrs. McQuay.

Ge. A. Hammond.

Assistant Superintendent.
Bureau of Refugees, Freedmen and Abandoned Lands.

Montgomery, Ala.

April 26 7/66.

C. S.,

Issue given

Rations, to Mrs. Belger.

Ge. A. Hammond.

Assistant Superintendent.
Bureau of Refugees, Freedmen and Abandoned Lands.

Montgomery, Ala.

April 26 7/66

C. S.,

Issue given

Rations, to Mrs. Vickers.

Ge. A. Hammond.

Assistant Superintendent.
Bureau of Refugees, Freedmen and Abandoned Lands.

Montgomery, Ala.

April 26 7/66

C. S.,

Issue given

Rations, to Mrs. Hall.

Ge. A. Hammond.

Assistant Superintendent.
Bureau of Refugees, Freedmen and Abandoned Lands.

Montgomery, Ala.

April 26 7/66

C. S.,

Issue *2000*

Rations, to Mrs. Johnson.

Geo. A. Hammond.

Assistant Superintendent,
Bureau of Refugees, Freedmen and Abandoned Lands.

Montgomery, Ala.

April 26th 1865.

C. S.,

Issue *2000*

Rations, to Mrs. Haynes

Geo. A. Hammond.

Assistant Superintendent,
Bureau of Refugees, Freedmen and Abandoned Lands.

Montgomery, Ala.

April 26th 1865.

C. S.,

Issue *2000*

Rations, to Mrs. Wright.

Geo. A. Hammond.

Assistant Superintendent,
Bureau of Refugees, Freedmen and Abandoned Lands.

Montgomery, Ala.

April 26th 1865.

C. S.,

Issue *2000*

Rations, to Mrs. Offutt.

Geo. A. Hammond.

Assistant Superintendent,
Bureau of Refugees, Freedmen and Abandoned Lands.

Montgomery, Ala.

April 26th 1865.

C. S.,

Issue *Erwin*

Rations, to Mrs. *Thomlin*,

Geo. A. Hammond

Assistant Superintendent,
Bureau of Refugees, Freedmen and Abandoned Lands.

Montgomery, Ala.

April 26⁷ 1866.

C. S.,

Issue *Erwin*

Rations, to Mrs. *Allison*.

Geo. A. Hammond

Assistant Superintendent,
Bureau of Refugees, Freedmen and Abandoned Lands.

Montgomery, Ala.

April 26⁷ 1866.

C. S.,

Issue *Erwin*

Rations, to Mrs. *Piggard*.

Geo. A. Hammond

Assistant Superintendent,
Bureau of Refugees, Freedmen and Abandoned Lands.

Montgomery, Ala.

April 26⁷ 1866.

C. S.,

Issue *Erwin*

Rations, to Mrs. *Ferry*.

Geo. A. Hammond

Assistant Superintendent,
Bureau of Refugees, Freedmen and Abandoned Lands.

Montgomery, Ala.

April 26⁷ 1866.

C. S.,

Issue *Erwin*

Rations, to *Ms. Goodwin*

Montgomery, Ala.

April 26 7 1864

Ge. A. Hammond.
Assistant Superintendent,
Bureau of Refugees, Freedmen and Abandoned Lands.

C. S.,

Issue *Erwin*

Rations, to *Ms. Armstrong.*

Montgomery, Ala.

April 26 7 1864.

Ge. A. Hammond.
Assistant Superintendent,
Bureau of Refugees, Freedmen and Abandoned Lands.

C. S.,

Issue *Fountain*

Rations, to *Ms. Varner.*

Montgomery, Ala.

April 26 7 1864.

Ge. A. Hammond.
Assistant Superintendent,
Bureau of Refugees, Freedmen and Abandoned Lands.

C. S.,

Issue *Fountain*

Rations, to *Ms. Sullivan.*

Montgomery, Ala.

April 26 7 1864.

Ge. A. Hammond.
Assistant Superintendent,
Bureau of Refugees, Freedmen and Abandoned Lands.

C. S.,

Issue *Fountain* Rations, to Mrs. Edwards

Montgomery, Ala.

April 26th 1867.

Geo. A. Hammond.

Assistant Superintendent.
Bureau of Refugees, Freedmen and Abandoned Lands.

C. S.,

Issue *Fountain* Rations, to Mrs. Chatham.

Montgomery, Ala.

April 26th 1867.

Geo. A. Hammond.

Assistant Superintendent.
Bureau of Refugees, Freedmen and Abandoned Lands.

C. S.,

Issue *Fountain* Rations, to Mrs. Hickman.

Montgomery, Ala.

April 26th 1867.

Geo. A. Hammond.

Assistant Superintendent.
Bureau of Refugees, Freedmen and Abandoned Lands.

C. S.,

Issue *Fountain* Rations, to Mrs. Irwell

Montgomery, Ala.

April 26th 1867.

Geo. A. Hammond.

Assistant Superintendent.
Bureau of Refugees, Freedmen and Abandoned Lands.

C. S.,

Issue *fourteen*

Rations, to *Mrs. Cox*

Ge. A. Hammond

Assistant Superintendent,
Bureau of Refugees, Freedmen and Abandoned Lands.

Montgomery, Ala.

April 26th 1866.

C. S.,

Issue *fourteen*

Rations, to *Mrs. Wolfe*

Ge. A. Hammond

Assistant Superintendent,
Bureau of Refugees, Freedmen and Abandoned Lands.

Montgomery, Ala.

April 26th 1866

C. S.,

Issue *fourteen*

Rations, to *Mrs. Shate*

Ge. A. Hammond

Assistant Superintendent,
Bureau of Refugees, Freedmen and Abandoned Lands.

Montgomery, Ala.

April 26th 1866

C. S.,

Issue *fourteen*

Rations, to *Mrs. Dykes*

Ge. A. Hammond

Assistant Superintendent,
Bureau of Refugees, Freedmen and Abandoned Lands.

Montgomery, Ala.

April 26th 1866

C. S.,

Issue fontem Rations, to Mrs. Chase.

Geo. A. Hammond.

Assistant Superintendent,
Bureau of Refugees, Freedmen and Abandoned Lands.

Montgomery, Ala.

April 26th 1867.

C. S.,

Issue fontem Rations, to Mrs. Morgan.

Geo. A. Hammond.

Assistant Superintendent,
Bureau of Refugees, Freedmen and Abandoned Lands.

Montgomery, Ala.

April 26th 1867.

C. S.,

Issue fontem Rations, to Mrs. Cunningham.

Geo. A. Hammond.

Assistant Superintendent,
Bureau of Refugees, Freedmen and Abandoned Lands.

Montgomery, Ala.

April 26th 1867.

C. S.,

Issue fontem Rations, to Mrs. Tisdale.

Geo. A. Hammond.

Assistant Superintendent,
Bureau of Refugees, Freedmen and Abandoned Lands.

Montgomery, Ala.

April 26th 1867.

C. S.,

Issue fourteen Rations, to Mrs. Hoop

Geo. A. Hammond.

Assistant Superintendent.
Bureau of Refugees, Freedmen and Abandoned Lands.

Montgomery, Ala.

April 26th 1866.

C. S.,

Issue fourteen Rations, to Mrs. Aves.

Geo. A. Hammond.

Assistant Superintendent.
Bureau of Refugees, Freedmen and Abandoned Lands.

Montgomery, Ala.

April 26th 1866.

C. S.,

Issue fourteen Rations, to Mrs. Pinkett.

Geo. A. Hammond.

Assistant Superintendent.
Bureau of Refugees, Freedmen and Abandoned Lands.

Montgomery, Ala.

April 26th 1866.

C. S.,

Issue fourteen Rations, to Mrs. Baker.

Geo. A. Hammond.

Assistant Superintendent.
Bureau of Refugees, Freedmen and Abandoned Lands.

Montgomery, Ala.

April 26th 1866.

C. S.,

Issue fourteen Rations, to Mrs. Oatis.

Geo. A. Hammond.

Montgomery, Ala.

April 26th 1862.

Assistant Superintendent.
Bureau of Refugees, Freedmen and Abandoned Lands.

C. S.,

Issue fourteen Rations, to Mrs. Watters.

Geo. A. Hammond.

Montgomery, Ala.

April 26th 1862.

Assistant Superintendent.
Bureau of Refugees, Freedmen and Abandoned Lands.

C. S.,

Issue fourteen Rations, to Mrs. Blunt.

Geo. A. Hammond.

Montgomery, Ala.

April 26th 1862.

Assistant Superintendent.
Bureau of Refugees, Freedmen and Abandoned Lands.

C. S.,

Issue sixty Rations, to Mrs. Ward.

Geo. A. Hammond.

Montgomery, Ala.

April 27th 1862.

Assistant Superintendent.
Bureau of Refugees, Freedmen and Abandoned Lands.

C. S.

Issue *eighty*

Rations, to *Mrs. Funderston.*

Geo. A. Hammond.

Assistant Superintendent.
Bureau of Refugees, Freedmen and Abandoned Lands.

Montgomery, Ala.

April 27, 1866.

C. S.,

Issue *one hundred and twenty* Rations, to *Mrs. Boyd.*

Geo. A. Hammond.

Assistant Superintendent.
Bureau of Refugees, Freedmen and Abandoned Lands.

Montgomery, Ala.

April 27, 1866.

C. S.,

Issue *twenty one* Rations, to *Mrs. Bullard.*

Geo. A. Hammond.

Assistant Superintendent.
Bureau of Refugees, Freedmen and Abandoned Lands.

Montgomery, Ala.

April 27, 1866.

C. S.,

Issue *twenty one* Rations, to *Mrs. Hoate.*

Geo. A. Hammond.

Assistant Superintendent.
Bureau of Refugees, Freedmen and Abandoned Lands.

Montgomery, Ala.

April 27, 1866.

C. S.,

Issue Twenty one Rations, to Mrs. Satrum,

Geo. A. Hammond.

Assistant Superintendent.
Bureau of Refugees, Freedmen and Abandoned Lands.

Montgomery, Ala.

April 27th / 1866

C. S.,

Issue Eleven Rations, to Mrs. Bamarr.

Geo. A. Hammond.

Assistant Superintendent.
Bureau of Refugees, Freedmen and Abandoned Lands.

Montgomery, Ala.

April 27th / 1866.

C. S.,

Issue Eleven Rations, to Mrs. Wpdegraff.

Geo. A. Hammond.

Assistant Superintendent.
Bureau of Refugees, Freedmen and Abandoned Lands.

Montgomery, Ala.

April 27th / 1866

C. S.,

Issue Eleven Rations, to Mrs. Brown.

Geo. A. Hammond.

Assistant Superintendent.
Bureau of Refugees, Freedmen and Abandoned Lands.

Montgomery, Ala.

April 27th / 1866.

C. S.,

Issue *errm*

Rations, to Mrs. Huddleston

Geo. A. Hammond.

Assistant Superintendent,
Bureau of Refugees, Freedmen and Abandoned Lands.

Montgomery, Ala.

April 27th 1866.

C. S.,

Issue *errm*

Rations, to Mrs. McDonald

Geo. A. Hammond.

Assistant Superintendent,
Bureau of Refugees, Freedmen and Abandoned Lands.

Montgomery, Ala.

April 27th 1866.

C. S.,

Issue *errm*

Rations, to Mrs. Hunt

Geo. A. Hammond.

Assistant Superintendent,
Bureau of Refugees, Freedmen and Abandoned Lands.

Montgomery, Ala.

April 27th 1866.

C. S.,

Issue *errm*

Rations, to Mrs. Feltor

Geo. A. Hammond.

Assistant Superintendent,
Bureau of Refugees, Freedmen and Abandoned Lands.

Montgomery, Ala.

April 27th 1866.

C. S.,

Issue *Ervin*

Rations, to *Mr. Low.*

Geo. A. Hammond.

Assistant Superintendent.
Bureau of Refugees, Freedmen and Abandoned Lands.

Montgomery, Ala.

April 27th 1866

C. S.,

Issue *Ervin*

Rations, to *Mr. Willis.*

Geo. A. Hammond.

Assistant Superintendent.
Bureau of Refugees, Freedmen and Abandoned Lands.

Montgomery, Ala.

April 27th 1866.

C. S.,

Issue *Ervin*

Rations, to *Mr. Belger.*

Geo. A. Hammond.

Assistant Superintendent.
Bureau of Refugees, Freedmen and Abandoned Lands.

Montgomery, Ala.

April 27th 1866.

C. S.,

Issue *Ervin*

Rations, to *Mr. Amos.*

Geo. A. Hammond.

Assistant Superintendent.
Bureau of Refugees, Freedmen and Abandoned Lands.

Montgomery, Ala.

April 27th 1866.

C. S.,

Issue *Rivm*

Rations, to *Mrs. Chambers*

Montgomery, Ala.

April 27th 1866.

Geo. A. Hammond
Assistant Superintendent.
Bureau of Refugees, Freedmen and Abandoned Lands.

C. S.,

Issue *Rivm*

Rations, to *Mrs. Porter*

Montgomery, Ala.

April 27th 1866

Geo. A. Hammond
Assistant Superintendent.
Bureau of Refugees, Freedmen and Abandoned Lands.

C. S.,

Issue *Fountain*

Rations, to *Mrs. Keith*

Montgomery, Ala.

April 27th 1866.

Geo. A. Hammond
Assistant Superintendent.
Bureau of Refugees, Freedmen and Abandoned Lands.

C. S.,

Issue *Fountain*

Rations, to *Mrs. Curling*

Montgomery, Ala.

April 27th 1866.

Geo. A. Hammond
Assistant Superintendent.
Bureau of Refugees, Freedmen and Abandoned Lands.

C. S.,

Issue fourteen

Rations, to Mrs. Watts.

Geo. A. Hammond.

Assistant Superintendent,
Bureau of Refugees, Freedmen and Abandoned Lands.

Montgomery, Ala.

April 27, 1866

C. S.,

Issue fourteen

Rations, to Mrs. Sims.

Geo. A. Hammond.

Assistant Superintendent,
Bureau of Refugees, Freedmen and Abandoned Lands.

Montgomery, Ala.

April 27, 1866

C. S.,

Issue fourteen

Rations, to Mrs. Robinson.

Geo. A. Hammond.

Assistant Superintendent,
Bureau of Refugees, Freedmen and Abandoned Lands.

Montgomery, Ala.

April 27, 1866

C. S.,

Issue fourteen

Rations, to Mrs. Lindsey.

Geo. A. Hammond.

Assistant Superintendent,
Bureau of Refugees, Freedmen and Abandoned Lands.

Montgomery, Ala.

April 27, 1866

C. S.,

Issue *fourteen*

Rations, to *Mrs. McCullough*

Geo. A. Hammond.

Assistant Superintendent.
Bureau of Refugees, Freedmen and Abandoned Lands.

Montgomery, Ala.

April 27th 1866.

C. S.,

Issue *fourteen*

Rations, to *Mrs. Black.*

Geo. A. Hammond.

Assistant Superintendent.
Bureau of Refugees, Freedmen and Abandoned Lands.

Montgomery, Ala.

April 27th 1866.

C. S.,

Issue *fourteen*

Rations, to *Mrs. McCullough.*

Geo. A. Hammond.

Assistant Superintendent.
Bureau of Refugees, Freedmen and Abandoned Lands.

Montgomery, Ala.

April 27th 1866.

C. S.,

Issue *fourteen*

Rations, to *Mrs. Cooper.*

Geo. A. Hammond.

Assistant Superintendent.
Bureau of Refugees, Freedmen and Abandoned Lands.

Montgomery, Ala.

April 27th 1866.

C. S.,

Issue Fountain Rations, to Mrs. Kennedy.

Geo. A. Hammond.

Montgomery, Ala.

April 27 7 1866.

Assistant Superintendent,
Bureau of Refugees, Freedmen and Abandoned Lands.

C. S.,

Issue Fountain Rations, to Mrs. Wilson.

Geo. A. Hammond.

Montgomery, Ala.

April 27 7 1866.

Assistant Superintendent,
Bureau of Refugees, Freedmen and Abandoned Lands.

C. S.,

Issue Fountain Rations, to Mrs. Brown.

Geo. A. Hammond.

Montgomery, Ala.

April 27 7 1866.

Assistant Superintendent,
Bureau of Refugees, Freedmen and Abandoned Lands.

C. S.,

Issue Fountain Rations, to Mrs. Lewis.

Geo. A. Hammond.

Montgomery, Ala.

April 27 7 1866.

Assistant Superintendent,
Bureau of Refugees, Freedmen and Abandoned Lands.

C. S.,

Issue fountain

Rations, to Mrs. Hanks

Geo. A. Hammond.

Assistant Superintendent,
Bureau of Refugees, Freedmen and Abandoned Lands.

Montgomery, Ala.

April 27th 1866

C. S.,

Issue fountain

Rations, to Mrs. Gillespie.

Geo. A. Hammond.

Assistant Superintendent,
Bureau of Refugees, Freedmen and Abandoned Lands.

Montgomery, Ala.

April 27th 1866

C. S.,

Issue fountain

Rations, to Mrs. Brown

Geo. A. Hammond.

Assistant Superintendent,
Bureau of Refugees, Freedmen and Abandoned Lands.

Montgomery, Ala.

April 27th 1866

C. S.,

Issue fountain

Rations, to Mrs. Fair.

Geo. A. Hammond.

Assistant Superintendent,
Bureau of Refugees, Freedmen and Abandoned Lands.

Montgomery, Ala.

April 27th 1866

C. S.
Issue fountain

Rations, to Mrs. Grant.

Geo. A. Hammond.

Assistant Superintendent.
Bureau of Refugees, Freedmen and Abandoned Lands.

Montgomery, Ala.

April 27th 1866

C. S.,

Issue milk

Rations, to Mrs. Terry.

Geo. A. Hammond.

Assistant Superintendent.
Bureau of Refugees, Freedmen and Abandoned Lands.

Montgomery, Ala.

April 28th 1866

C. S.,

Issue Lillie

Rations, to Mrs. Larnford.

Geo. A. Hammond.

Assistant Superintendent.
Bureau of Refugees, Freedmen and Abandoned Lands.

Montgomery, Ala.

April 28th 1866

C. S.,

Issue milk

Rations, to Mrs. Terry.

Geo. A. Hammond.

Assistant Superintendent.
Bureau of Refugees, Freedmen and Abandoned Lands.

Montgomery, Ala.

April 28th 1866

C. S.,

Issue milk

Rations, to Betsy Collins

Geo. A. Hammond.

Assistant Superintendent.
Bureau of Refugees, Freedmen and Abandoned Lands.

Montgomery, Ala.

April 30th 1866

Ration Tickets of Rations
issued to Destitutes in the
County of Montgomery from
the 1st to 7 of July 1866.

Issue Fourteen Rations to Mrs Hobson
Geo A. Armstrong
July 7th 1866. Supt. Robt R. J. Jr.
for Wm. M. Smith

Issue Sixty Rations to Becky Pollard
Geo A. Armstrong
July 7th 1866. Supt. Robt R. J. Jr.
for Wm. M. Smith

Issue Seven Rations to Mrs L. Chambers
Geo A. Armstrong
July 6th 1866. Supt. Robt R. J. Jr.
for Wm. M. Smith

Issue Seven Rations to Mrs M. A. Brown
Geo A. Armstrong
July 6th 1866. Supt. Robt R. J. Jr.
for Wm. M. Smith

ca
Issue seven Rations to Mr W Govey
July 14/66
Geo A Hammond
M^r Capt Robt R Jr
Jr W Rumpkin

ca
Issue seven Rations to Mrs Willis
July 14/66
Geo A Hammond
M^r Capt Robt R Jr
Jr W Rumpkin

ca
Issue seven Rations to Mrs Amos
July 14/66
Geo A Hammond
M^r Capt Robt R Jr
Jr W Rumpkin

ca
Issue seven Rations to Mrs Felton
July 14/66
Geo A Hammond
M^r Capt Robt R Jr
Jr W Rumpkin

ca
Issue seven Rations to Mrs Purron
July 14/66
Geo A Hammond
M^r Capt Robt R Jr
Jr W Rumpkin

ca
Issue seven Rations to Mrs E Goodwin
Geo A Hancock
July 6/66
Apr Supt Prof R Jr
Pr Wm Simpson

ca
Issue seven Rations to Mrs Gordon
Geo A Hancock
July 6/66
Apr Supt Prof R Jr
Pr Wm Simpson

ca
Issue seven Rations to Mrs M Smith
Geo A Hancock
July 6/66
Apr Supt Prof R Jr
Pr Wm Simpson

ca
Issue seven Rations to Mrs A Lee
Geo A Hancock
July 6/66
Apr Supt Prof R Jr
Pr Wm Simpson

ca
Issue seven Rations to Mrs Thurston
Geo A Hancock
July 6/66
Apr Supt Prof R Jr
Pr Wm Simpson

^{C^d}
Issue seven Rations to Mrs G Bush
July 6/66
Geo A Hammond
Mfr Supt Bol R F
Fr J W Hampton

^{C^d}
Issue seven Rations to Mrs Updengesaff
July 6/66
Geo A Hammond
Mfr Supt Bol R F
Fr J W Hampton

^{C^d}
Issue seven Rations to Mrs Anna
July 6/66
Geo A Hammond
Mfr Supt Bol R F
Fr J W Hampton

^{C^d}
Issue seven Rations to A Hansen
July 6/66
Geo A Hammond
Mfr Supt Bol R F
Fr J W Hampton

^{C^d}
Issue twenty-eight Rations to Mrs A Watts
July 6/66 X
Geo A Hammond
Mfr Supt Bol R F
Fr J W Hampton

^{c 2}
Issue Fortem Rations to Mrs Hill
July 17/66
Geo A. Hammond
Supt of R. S. n
for W. Hampton

^{c 2}
Issue Fortem Rations to Mrs & Child
July 17/66
Geo A. Hammond
Supt of R. S. n
for W. Hampton

^{c 2}
Issue Fortem Rations to L. Frederick
July 17/66
Geo A. Hammond
Supt of R. S. n
for W. Hampton

^{c 2}
Issue Fortem Rations to Mrs Stone
July 17/66
Geo A. Hammond
Supt of R. S. n
for W. Hampton

^{c 2}
Issue Fortem Rations to Mrs Skinner
July 17/66
Geo A. Hammond
Supt of R. S. n
for W. Hampton

C^d
Issue ^{124 R} Hunter's Rations to Mrs Diddleston
July 6th / 66
Geo A Hammond
M^r Supt B^y R^d
J^r W^m S^r Kin

C^d
Issue ^{124 R} Hunter's Rations to Mrs Gorman
July 6th / 66
Geo A Hammond
M^r Supt B^y R^d
J^r W^m S^r Kin

C^d
Issue ^{124 R} Hunter's Rations to Mrs A Brown
July 6th / 66
Geo A Hammond
M^r Supt B^y R^d
J^r W^m S^r Kin

C^d
Issue ^{124 R} Hunter's Rations to Mrs E Kerr
July 6th / 66
Geo A Hammond
M^r Supt B^y R^d
J^r W^m S^r Kin

C^d
Issue ^{124 R} Hunter's Rations to Mrs Lindsey
July 6th / 66
Geo A Hammond
M^r Supt B^y R^d
J^r W^m S^r Kin

^{c^d}
Issue ^{of} Hunter Rations to Mrs Waller
July 17th 66
Geo A Hammond
M^r Supt Robt R. J.
Pr J. W. Hampton

^{c^d}
Issue ^{of} Hunter Rations to Mrs R Grant
July 17th 66
Geo A Hammond
M^r Supt Robt R. J.
Pr J. W. Hampton

^{c^d}
Issue ^{of} Hunter Rations to Mrs Cooper
July 17th 66
Geo A Hammond
M^r Supt Robt R. J.
Pr J. W. Hampton

^{c^d}
Issue ^{of} Hunter Rations to Mrs Kennedy
July 17th 66
Geo A Hammond
M^r Supt Robt R. J.
Pr J. W. Hampton

^{c^d}
Issue ^{of} Hunter Rations to Mrs Gillespie
July 17th 66
Geo A Hammond
M^r Supt Robt R. J.
Pr J. W. Hampton

^{c^d}
Issue ^{of} Hunter Rations to Mrs Brown
July 17th 66
Geo A Hammond
M^r Supt Robt R. J.
Pr J. W. Hampton

Cd
Issue Fourteen Rations to Mrs H. Fair
July 14/66
Geo A. Hammond
Supt. B. of R. Co.
for J. W. Sampson

Cd
Issue Fourteen Rations to Mrs Pullen
July 14/66
Geo A. Hammond
Supt. B. of R. Co.
for J. W. Sampson

Cd
Issue Fourteen Rations to Mrs Gurling
July 14/66
Geo A. Hammond
Supt. B. of R. Co.
for J. W. Sampson

Cd
Issue Fourteen Rations to Mrs Magee
July 14/66
Geo A. Hammond
Supt. B. of R. Co.
for J. W. Sampson

Cd
Issue Twenty one Rations to Mrs W. Key
July 14/66
Geo A. Hammond
Supt. B. of R. Co.
for J. W. Sampson

Cd
Issue Twenty one Rations to Mrs Griffin
July 14/66
Geo A. Hammond
Supt. B. of R. Co.
for J. W. Sampson

Issue Twenty one Rations to Mrs Kent
July 1766
Geo A Hammond
Mfr Capt Rob R Jr
for Wm Hampton

cd
Issue Twenty one Rations to Mrs Esman
July 1766 X Geo A Hammond
Mfr Capt Rob R Jr
for Wm Hampton

cd
Issue Twenty one Rations to Mrs Irwin
July 1766 X Geo A Hammond
Mfr Capt Rob R Jr
for Wm Hampton

cd
Issue Twenty one Rations to Mrs S. A Hale
July 1766
Geo A Hammond
Mfr Capt Rob R Jr
for Wm Hampton

cd
Issue Twenty one Rations to Mrs L Brooks
July 1766
Geo A Hammond
Mfr Capt Rob R Jr
for Wm Hampton

^{C^d}
Issue Twenty one Rations to Mrs Bullard
July 6/66
Geo A Hammond
M^r Capt Robt R Jr
for J. W. Thompson

^{C^d}
Issue Twenty one Rations to Mrs Bird
July 6/66
Geo A Hammond
M^r Capt Robt R Jr
for J. W. Thompson

^{C^d}
Issue Twenty one Rations to Mrs Dennis
July 6/66
Geo A Hammond
M^r Capt Robt R Jr
for J. W. Thompson

^{C^d}
90 R
Issue Ninety Rations to Mrs S C Elliott
July 6/66
Geo A Hammond
M^r Capt Robt R Jr
for J. W. Thompson

^{C^d}
Issue Forty two Rations to Mrs McCallough
July 6/66
Geo A Hammond
M^r Capt Robt R Jr
for J. W. Thompson

⁵⁶
C^d
Issue Fifty-six ⁵⁶ Patents to Mrs Parly
July 6/66
Geo A Hammond
Mr Supt. Prof R. H.
for W. H. Sampson

C^d
Issue sixty Patents to Mrs S Gray
July 6/66
Geo A Hammond
Mr Supt. Prof R. H.
for W. H. Sampson

C^d
Issue sixty Patents to Mrs Tidwell
July 6/66
Geo A Hammond
Mr Supt. Prof R. H.
for W. H. Sampson

C^d
Issue sixty Patents to Mrs Stevens
July 6/66
Geo A Hammond
Mr Supt. Prof R. H.
for W. H. Sampson

C^d
Issue sixty Patents to Mrs M. E. Kelly
July 6/66
Geo A Hammond
Mr Supt. Prof R. H.
for W. H. Sampson

C^d
Issue seven Rations to Mrs M Thompson
July 31/66
Geo A Harwood
Mr Supt Reg R L
J W Mumfkin

C^d
Issue seven Rations to Mrs L Johnson
July 31/66
Geo A Harwood
Mr Supt Reg R L
J W Mumfkin

C^d
Issue seven Rations to J Gentry Sr
July 31/66
Geo A Harwood
Mr Supt Reg R L
J W Mumfkin

C^d
Issue fourteen Rations to Mr. A Hayes
July 31/66
Geo A Harwood
Mr Supt Reg R L
J W Mumfkin

C^d
Issue fourteen Rations to Mrs Watson
July 31/66
Geo A Harwood
Mr Supt Reg R L
J W Mumfkin

C 2

Issue Hunterton Rations to Mrs W. Cook

Geo. A. Hammond

July 3/66

Apr Supt. B. R. F. H.

for W. M. Hampton

C 2

Issue Hunterton Rations to Mrs C. Lesby

Geo. A. Hammond

July 3/66

Apr Supt. B. R. F. H.

for W. M. Hampton

C 2

Issue Hunterton Rations to Mrs M. Lewis

Geo. A. Hammond

July 3/66

Apr Supt. B. R. F. H.

for W. M. Hampton

C 2

Issue Hunterton Rations to I. Genter Sr.

Geo. A. Hammond

July 3/66

Apr Supt. B. R. F. H.

for W. M. Hampton

C 2

Issue Hunterton Rations to Mrs E. Money

Geo. A. Hammond

July 3/66

Apr Supt. B. R. F. H.

for W. M. Hampton

C. A.

Issue Hunter's Returns to Mrs S Jones

July 31/66

Geo. A. Hammond
Mr Supt. Robt R. J. H.
Per J. W. Hampton

C. A.

Issue Hunter's Returns to Mrs Goss

July 31/66

Geo. A. Hammond
Mr Supt. Robt R. J. H.
Per J. W. Hampton

C. A.

Issue Hunter's Returns to Mrs Tisdale

July 31/66

Geo. A. Hammond
Mr Supt. Robt R. J. H.
Per J. W. Hampton

C. A.

Issue Hunter's Returns to Mrs McIntosh

July 31/66

Geo. A. Hammond
Mr Supt. Robt R. J. H.
Per J. W. Hampton

C. A.

Issue Hunter's Returns to Mrs Milen

July 31/66

Geo. A. Hammond
Mr Supt. Robt R. J. H.
Per J. W. Hampton

Cd

Issue Hunter's Returns to Mrs Gray

July 3rd 1866

Geo A. Starnum
M^r Supt. Prof. R. G. L.
J. W. Starnum

Cd

Issue Hunter's Returns to Mrs & Robinson

July 3rd 1866

Geo A. Starnum
M^r Supt. Prof. R. G. L.
J. W. Starnum

Cd

Issue Hunter's Returns to Mrs. Shorter

July 3rd 1866

Geo A. Starnum
M^r Supt. Prof. R. G. L.
J. W. Starnum

Cd

Issue Hunter's Returns to Mrs P. Thompson

July 3rd 1866

Geo A. Starnum
M^r Supt. Prof. R. G. L.
J. W. Starnum

Cd

Issue Hunter's Returns to Mrs M. James

July 3rd 1866

Geo A. Starnum
M^r Supt. Prof. R. G. L.
J. W. Starnum

C-2
Issue Fifteen Rations to Mrs Mahony
July 31/66
Geo A. Hancock
Mfr Supt B of R. Co
Pr W. Hancock, Va

C-2
Issue Fifteen Rations to Mrs & J. J. Payne
July 31/66
Geo A. Hancock
Mfr Supt B of R. Co
Pr W. Hancock, Va

C-2
Issue Twenty one Rations to Mrs L. Buckner
July 31/66
Geo A. Hancock
Mfr Supt B of R. Co
Pr W. Hancock, Va

C-2
Issue Twenty one Rations to Mrs Redding
July 31/66
Geo A. Hancock
Mfr Supt B of R. Co
Pr W. Hancock, Va

C. 15. Issued to J. Denton Tral (10)
Rations

Work July 5/66

C Cadu
a 1/2

C 2
Issued Thirty Rations to Mrs Longdon
July 3/66
Geo. A. Davenport
Mr Supt. B. R. F. L.
J. W. Wainwright

C 2
Issued Sixty Rations to A. M. Thumason
July 3/66
Geo. A. Davenport
Mr Supt. B. R. F. L.
J. W. Wainwright

C 2
Issued Sixty Rations to Mrs Rollo
July 3/66
Geo. A. Davenport
Mr Supt. B. R. F. L.
J. W. Wainwright

C. 1
Issue ^{of} ~~Forty~~ Returns to Mrs G. Brown
July 20/66
Geo. A. Hammond
M. Supt. Prof. R. D. H.
J. W. Mansfield

C. 2
Issue ninety Returns to Mrs S. C. Chapman
July 20/66
Geo. A. Hammond
M. Supt. Prof. R. D. H.
J. W. Mansfield

C. 2
Issue ¹³⁰ hundred and fifty Returns to Mrs Spencer
July 20/66
Geo. A. Hammond
M. Supt. Prof. R. D. H.
J. W. Mansfield

C. 2
Issue sixty Returns to Miss Corbett
July 27/66
Geo. A. Hammond
M. Supt. Prof. R. D. H.
J. W. Mansfield

C. 2
Issue sixty Returns to Mrs R. Manford
July 27/66
Geo. A. Hammond
M. Supt. Prof. R. D. H.
J. W. Mansfield

C 2

Issue sixty Rations to Mrs E Adams
Geo A Adams
Apr 27 1866
J. W. Thompson

C 2

Issue sixty Rations to Mrs E Adams
Geo A Adams
Apr 27 1866
J. W. Thompson

C 2

Issue sixty Rations to Mrs G Miller
Geo A Adams
Apr 27 1866
J. W. Thompson

C 2

Issue sixty Rations to Mrs M Davis
Geo A Adams
Apr 27 1866
J. W. Thompson

C 2

Issue sixty Rations to Mrs Miller
Geo A Adams
Apr 27 1866
J. W. Thompson

Cd
Issue seven Rations to Mrs Rabun
July 3/16
Geo. A. Hammond
Apr Supt. Robt R. Jr.
for W. W. Hampton

Cd
Issue seven Rations to Mrs M. Offutt
July 3/16
Geo. A. Hammond
Apr Supt. Robt R. Jr.
for W. W. Hampton

Cd
Issue seven Rations to Mrs G. A. Johnson
July 3/16
Geo. A. Hammond
Apr Supt. Robt R. Jr.
for W. W. Hampton

Cd
Issue seven Rations to Mrs A. Dale
July 3/16
Geo. A. Hammond
Apr Supt. Robt R. Jr.
for W. W. Hampton

Cd
Issue seven Rations to Mrs B. Dale
July 3/16
Geo. A. Hammond
Apr Supt. Robt R. Jr.
for W. W. Hampton

¹
Issue seven Returns to Mrs E Dickson
July 5/66
Geo A Sturmont
Supt B. R. D.
for W. D. M. J. H.

²
Issue seven Returns to Mrs. Ellison
July 5/66
Geo. A. Sturmont
Supt B. R. D.
for W. D. M. J. H.

³
Issue seven Returns to Mrs M Jones
July 5/66
Geo. A. Sturmont
Supt B. R. D.
for W. D. M. J. H.

⁴
Issue seven Returns to Mrs G. Hayes
July 5/66
Geo A Sturmont
Supt B. R. D.
for W. D. M. J. H.

⁵
Issue seven Returns to Mrs E. Evans
July 5/66
Geo A Sturmont
Supt B. R. D.
for W. D. M. J. H.

cd
Issued seven Returns to Mrs A Belyer
Geo A Hammond
Mfr Supt Prof R G
for J W Sampson

cd
Issued seven Returns to Mrs S A Brooks
Geo A Hammond
Mfr Supt Prof R G
for J W Sampson

cd
Issued seven Returns to Miss Payer
Geo A Hammond
Mfr Supt Prof R G
for J W Sampson

cd
Issued seven Returns to Mrs S Dale
Geo A Hammond
Mfr Supt Prof R G
for J W Sampson

cd
Issued seven Returns to Mrs A Menis
Geo A Hammond
Mfr Supt Prof R G
for J W Sampson

Issue seven Rations to Miss M. A. Gentry
July 5/66
Geo. A. Hammond
Mr Supt. B. R. H.
P. W. Hampton

Issue seven Rations to Mrs. J. M. Lincoln
July 5/66
Geo. A. Hammond
Mr Supt. B. R. H.
P. W. Hampton

Issue seven Rations to Miss A. Payne
July 5/66
Geo. A. Hammond
Mr Supt. B. R. H.
P. W. Hampton

Issue seven Rations to Miss E. Hooker
July 5/66
Geo. A. Hammond
Mr Supt. B. R. H.
P. W. Hampton

Issue seven Rations to Miss A. Hollis
July 5/66
Geo. A. Hammond
Mr Supt. B. R. H.
P. W. Hampton

^{C. 2}
Issue seven Rations to Mrs S S Paright
X July 3/66
Geo A. Hammond
Mr Supt B. R. J. Jr
for J. D. Hampton

^{C. 2}
Issue seven Rations to Mrs M. P. Belyer
July 3/66
Geo A. Hammond
Mr Supt B. R. J. Jr
for J. D. Hampton

^{C. 2}
Issue seven Rations to Mrs Biggand
July 3/66
Geo A. Hammond
Mr Supt B. R. J. Jr
for J. D. Hampton

^{C. 2}
Issue seven Rations to Mrs S. Allen
July 3/66
Geo. A. Hammond
Mr Supt B. R. J. Jr
for J. D. Hampton

^{C. 2}
Issue seven Rations to Mrs F. Johnson
July 3/66
Geo. A. Hammond
Mr Supt B. R. J. Jr
for J. D. Hampton

C 2
Issued seven Rations to Mrs L Armstrong
July 3rd 1866
Geo H Armstrong
Mfr Supt. Buf R. I. 12
P. W. Sampson

C 2
Issued twenty eight Rations to Mrs Sizer
July 3rd 1866
Geo H Armstrong
Mfr Supt. Buf R. I. 12
P. W. Sampson

C 2
Issued twenty eight Rations to Mrs Gessorn
July 3rd 1866
Geo. H. Armstrong
Mfr Supt. Buf R. I. 12
P. W. Sampson

C 2
Issued twenty eight Rations to Mrs Pendleton
July 3rd 1866
Geo H Armstrong
Mfr Supt. Buf R. I. 12
P. W. Sampson

C 2
28 R
Issued twenty eight Rations to Mrs Edwards
July 3rd 1866
Geo H Armstrong
Mfr Supt. Buf R. I. 12
P. W. Sampson

C 2
Issued twenty eight Rations to Mrs Corvill
July 3rd 1866
Geo H Armstrong
Mfr Supt. Buf R. I. 12
P. W. Sampson

^{c 2}
Issue Hunter's Rations to Mrs S M Lane
July 3rd 1866
Geo A Hancock
Maj Supt Reg R G
for W Mumpkin

^{c 2}
Issue Hunter's Rations to Mrs Dunbar
July 3rd 1866
Geo A Hancock
Maj Supt Reg R G
for W Mumpkin

^{c 2}
Issue Hunter's Rations to Mrs Sullivan
July 3rd 1866
Geo A Hancock
Maj Supt Reg R G
for W Mumpkin

^{c 2}
Issue Hunter's Rations to Mrs P M Lane
July 3rd 1866
Geo A Hancock
Maj Supt Reg R G
for W Mumpkin

^{c 2}
Issue Hunter's Rations to Mrs A Hapbee
July 3rd 1866
Geo A Hancock
Maj Supt Reg R G
for W Mumpkin

Issued Hunter's Rating to Mrs L Wolfe
July 5/66
Geo A Hammond
Mr Supt Prof R. G.
for J. W. Simpson

Issued Hunter's Rating to Mrs S Cotton
July 5/66
Geo A Hammond
Mr Supt Prof R. G.
for J. W. Simpson

Issued Hunter's Rating to Mrs C Turley
July 3/66
Geo A Hammond
Mr Supt Prof R. G.
for J. W. Simpson

Issued Hunter's Rating to Mrs L Watts
July 5/66
Geo A Hammond
Mr Supt Prof R. G.
for J. W. Simpson

Issued Hunter's Rating to Mrs L Morgan
July 5/66
Geo A Hammond
Mr Supt Prof R. G.
for J. W. Simpson

^{c-2}
Issued Fountain Retainers to Mrs E Gile
July 3/66
Geo A. Hammond
Mfr Supt. B. & F.
p. W. D. Smith

^{c-2}
Issued Fountain Retainers to Mrs J. A. Blunt
July 3/66
Geo A. Hammond
Mfr Supt. B. & F.
p. W. D. Smith

^{c-2}
Issued Fountain Retainers to Mrs L Duffie
July 3/66
Geo A. Hammond
Mfr Supt. B. & F.
p. W. D. Smith

^{c-2}
Issued Fountain Retainers to Mrs L Alexander
July 3/66
Geo A. Hammond
Mfr Supt. B. & F.
p. W. D. Smith

^{c-2}
Issued Fountain Retainers to Mrs R. A. Thomas
July 3/66
Geo A. Hammond
Mfr Supt. B. & F.
p. W. D. Smith

Cd
Issued Hunter Rations to Mrs E Langley
July 3/66
Geo A. Armstrong
Supt. Prof. R. J. H.
for J. D. Armstrong

Cd
Issued Hunter Rations to Mrs Gerriss
July 3/66
Geo A. Armstrong
Supt. Prof. R. J. H.
for J. D. Armstrong

Cd
Issued Hunter Rations to Mrs Plunket
July 3/66
Geo A. Armstrong
Supt. Prof. R. J. H.
for J. D. Armstrong

Cd
Issued Hunter Rations to Mrs M Dykes
July 5/66
Geo A. Armstrong
Supt. Prof. R. J. H.
for J. D. Armstrong

Cd
Issued Hunter Rations to Mrs E Morgan
July 5/66
Geo A. Armstrong
Supt. Prof. R. J. H.
for J. D. Armstrong

ca
Issue Fountain Rating to Mrs L Dodge
July 3rd 1866
Geo. A. Hammond
Apr Supt. Prof. R. J. L.
Pr. J. D. Sampson

ca
Issue Fountain Rating to Mrs. Hainston
July 3rd 1866
Geo. A. Hammond
Apr Supt. Prof. R. J. L.
Pr. J. D. Sampson

ca
Issue Fountain Rating to Mrs M. Robertson
July 3rd 1866
Geo. A. Hammond
Apr Supt. Prof. R. J. L.
Pr. J. D. Sampson

ca
Issue Fountain Rating to Mrs M. Gilmer
July 3rd 1866
Geo. A. Hammond
Apr Supt. Prof. R. J. L.
Pr. J. D. Sampson

ca
Issue Fountain Rating to Mrs. Irving
July 3rd 1866
Geo. A. Hammond
Apr Supt. Prof. R. J. L.
Pr. J. D. Sampson

C 2
Issue Fountain Pation to Mrs Girdley
July 3/66
Geo A Hamment
Supt of B. R. Co.
for W. M. Hamment

C 2
Issue Fountain Pation to Mrs St Robinson
July 3/66
Geo A Hamment
Supt of B. R. Co.
for W. M. Hamment

C 2
Issue Fountain Pation to Mrs Barnum
July 3/66
Geo A Hamment
Supt of B. R. Co.
for W. M. Hamment

C 2
Issue Fountain Pation to Mrs Williams
July 3/66
Geo A Hamment
Supt of B. R. Co.
for W. M. Hamment

C 2
Issue Fountain Pation to Mrs Hlood
July 3/66
Geo A Hamment
Supt of B. R. Co.
for W. M. Hamment

C. R.
Issue Hunter + Ration to Mrs Cunningham
July 3/66
Geo. A. Harcourt
Mr Supt Buf R. Co.
for J. W. Sumpter

C. R.
Issue Hunter + Ration to Mr & Chase
July 3/66
Geo. A. Harcourt
Mr Supt Buf R. Co.
for J. W. Sumpter

C. R.
Issue Hunter + Ration to Mrs Ross
July 3/66
Geo. A. Harcourt
Mr Supt Buf R. Co.
for J. W. Sumpter

C. R.
Issue Hunter + Ration to Mrs McPhee
July 3/66
Geo. A. Harcourt
Mr Supt Buf R. Co.
for J. W. Sumpter

C. R.
Issue Hunter + Ration to Mrs L. M. Cool
July 3/66
Geo. A. Harcourt
Mr Supt Buf R. Co.
for J. W. Sumpter

C. A.
Issue Hunterton Rations to Mrs. B. Dalton
July 3rd 1866
Geo. A. Hammond
Supt. Regt. R. I. 12
for W. W. Simpson

C. A.
Issue Hunterton Rations to Mrs. Terry
July 3rd 1866
Geo. A. Hammond
Supt. Regt. R. I. 12
for W. W. Simpson

C. A.
Issue Hunterton Rations to Mrs. Piper
July 3rd 1866
Geo. A. Hammond
Supt. Regt. R. I. 12
for W. W. Simpson

C. A.
Issue Hunterton Rations to Mrs. Smith
July 3rd 1866
Geo. A. Hammond
Supt. Regt. R. I. 12
for W. W. Simpson

C. A.
Issue Hunterton Rations to Mrs. Green
July 3rd 1866
Geo. A. Hammond
Supt. Regt. R. I. 12
for W. W. Simpson

C 2
Issue Fourteen Rations to Mrs C Reynolds
July 3/66
Geo. A. Hammond
Mfr Supt Bof R. I.
Jr W. W. Smith

C 2
Issue Fourteen Rations to Mrs Lewis
July 3/66
Geo. A. Hammond
Mfr Supt Bof R. I.
Jr W. W. Smith

C 2
Issue Fourteen Rations to Mrs Dickson
July 3/66
Geo. A. Hammond
Mfr Supt Bof R. I.
Jr W. W. Smith

C 2
Issue Twenty one Rations to Mrs McKee
July 3/66
Geo. A. Hammond
Mfr Supt Bof R. I.
Jr W. W. Smith

C 2
Issue Twenty one Rations to Mrs M. L. Walker
July 3/66
Geo. A. Hammond
Mfr Supt Bof R. I.
Jr W. W. Smith

C. 2
Issue Twenty one Ratings to Mrs McDonald
July 3/16
Geo A. Hammond
Supt. Bd. P. H.
Pr. W. W. Sampson

C. 2
Issue Twenty one Ratings to Mrs Skida
July 3/16
Geo A. Hammond
Supt. Bd. P. H.
Pr. W. W. Sampson

C. 2
Issue Twenty one Ratings to Mrs Sevier
July 3/16
Geo A. Hammond
Supt. Bd. P. H.
Pr. W. W. Sampson

C. 2
Issue Twenty one Ratings to Mrs Harris
July 3/16
Geo A. Hammond
Supt. Bd. P. H.
Pr. W. W. Sampson

C. 2
Issue Twenty one Ratings to Mrs McKith
July 3/16
Geo A. Hammond
Supt. Bd. P. H.
Pr. W. W. Sampson

^{C²}
Issue Twenty one Rations to Mrs Adams
Geo H. Harwood
Apr Supt. Bof R. Co.
for W. S. Smith

^{C²}
Issue Twenty one Rations to Mrs M. Adams
Geo H. Harwood
Apr Supt. Bof R. Co.
for W. S. Smith

^{C²}
Issue Twenty one Rations to Mrs C. Young
Geo H. Harwood
Apr Supt. Bof R. Co.
for W. S. Smith

^{C²}
Issue Twenty one Rations to M. E. Fitzgibbon
Geo H. Harwood
Apr Supt. Bof R. Co.
for W. S. Smith

^{C²}
Issue Twenty one Rations to Mrs Meredith
Geo H. Harwood
Apr Supt. Bof R. Co.
for W. S. Smith

C 2
Issue Twenty one Returns to Mrs Saffolds
July 3/66
Geo. A. Hammond
Apr Supt Boff R. J. H.
for J. D. Hammond

C 2
Issue Twenty one Returns to Mrs M. Robison
July 3/66
Geo. A. Hammond
Apr Supt Boff R. J. H.
for J. D. Hammond

C 2
Issue Twenty one Returns to Mrs. K. Taylor
July 3/66
Geo. A. Hammond
Apr Supt Boff R. J. H.
for J. D. Hammond

C 2
Issue Twenty one Returns to Mrs. Moore
July 3/66
Geo. A. Hammond
Apr Supt Boff R. J. H.
for J. D. Hammond

C 2
Issue Twenty one Returns to Mrs. Dillard
July 3/66
Geo. A. Hammond
Apr Supt Boff R. J. H.
for J. D. Hammond

C 2
33-12
Issue Thirty three Returns to Mrs. Harris
July 3/66
Geo. A. Hammond
Apr Supt Boff R. J. H.
for J. D. Hammond

C 2
Issue Thirty Five Rations to Mrs M Thompson
July 3/66
Geo A. Hammond
M^r Supt. Robt R. F. H.
J. W. Simpson, Kin

C 2
Issue Thirty Five Rations to Mrs I Miller
July 3/66
Geo A. Hammond
M^r Supt. Robt R. F. H.
J. W. Simpson, Kin

C 2
Issue Forty Nine Rations to Mrs Jordan
July 3/66
Geo. A. Hammond
M^r Supt. Robt R. F. H.
J. W. Simpson, Kin

C 2
9th R
Issue Ninety Rations to Mrs Lippard
July 3/66
Geo. A. Hammond
M^r Supt. Robt R. F. H.
J. W. Simpson, Kin

C 2
9th R
Issue Ninety Rations to Mr I W Hicks
July 3/66
Geo A. Hammond
M^r Supt. Robt R. F. H.
J. W. Simpson, Kin

Issue Thirty Rations to Mrs B Golding
July 31/66
Geo A. Armstrong
Mfr Supt Bof R. F. 11
for W. S. Smith

Issue Forty Two Rations to Mrs Woodruff
July 31/66
Geo A. Armstrong
Mfr Supt Bof R. F. 11
for W. S. Smith

Issue Seventy Rations to Mrs Hoya
July 31/66
Geo A. Armstrong
Mfr Supt Bof R. F. 11
for W. S. Smith

Issue one hundred + two Rations to S. Price
July 31/66
Geo A. Armstrong
Mfr Supt Bof R. F. 11
for W. S. Smith

Issue one hundred + fifty Rations to Mrs Harris
July 31/66
Geo A. Armstrong
Mfr Supt Bof R. F. 11
for W. S. Smith

Issue Sixty Rations to Mrs I. Wood
July 31/66
Geo A. Armstrong
Mfr Supt Bof R. F. 11
for W. S. Smith

Rations tickets of
Rations issued to Sesti-
tutes in the county of
Montgomery from July
8 to July 14. 1866.

Cd
Issue ^{60 R} Sixty Rations to Mrs. Shambles
July 9th /66
Geo. A. Bennett
Supt. B. of R. Co.
J. W. Hampton

Cd
Issue thirty Rations to Si Jackson
July 9th /66
Geo. A. Bennett
Supt. B. of R. Co.
J. W. Hampton

Cd
Issue sixty Rations to Mrs. S. A. Carr
July 9th /66
Geo. A. Bennett
Supt. B. of R. Co.
J. W. Hampton

C 2
120 R
Issue one hundred + twenty Rations to Mr & Mrs
Geo A. Hammond
July 9th 1866
Asst Supt B. R. J. Jr
for W. R. Hammond

C 2
Issue Fifty six Rations to Mrs L. G. G. G.
July 9th 1866
Geo A. Hammond
Asst Supt B. R. J. Jr
for W. R. Hammond

C 2
Issue Fifty two Rations to Mr W. R. G. G.
July 11th 1866
Geo A. Hammond
Asst Supt B. R. J. Jr
for W. R. Hammond

C 2
Issue sixty Rations to Mrs E. G. G.
July 10th 1866
Geo A. Hammond
Asst Supt B. R. J. Jr
for W. R. Hammond

C 2
Issue sixty Rations to Mrs P. G. G.
July 11th 1866
Geo A. Hammond
Asst Supt B. R. J. Jr
for W. R. Hammond

C 2
Issue Fountain Station to Mrs Ewing
Geo A Hammond
July 10/66 X Mr Capt Buf R
for W D Sumpter

C 2
Issue Fountain Station to Mrs R A Thomas
Geo A Hammond
July 10/66 X Mr Capt Buf R
for W D Sumpter

C 2
Issue Fountain Station to Mrs L Watts
Geo A Hammond
July 11/66 X Mr Capt Buf R
for W D Sumpter

C 2
Issue Fountain Station to Mrs M Whiteth
Geo A Hammond
July 10/66 X Mr Capt Buf R
for W D Sumpter

C 2
Issue Fountain Station to Mrs C Robinson
Geo A Hammond
July 11/66 X Mr Capt Buf R
for W D Sumpter

~~C^d
Issued Hunterian Returns to Miss P Thompson
Geo A Davidson
July 11/66
Mr Supt Prof R
to J Davidson~~

~~C^d
Issued Hunterian Returns to Mrs Dobson
Geo A Davidson
July 11/66
Mr Supt Prof R
to J Davidson~~

~~C^d
Issued Hunterian Returns to Mrs E Ross
Geo A Davidson
July 11/66
Mr Supt Prof R
to J Davidson~~

~~C^d
Issued Hunterian Returns to Mrs Reynolds
Geo A Davidson
July 11/66
Mr Supt Prof R
to J Davidson~~

~~C^d
Issued Hunterian Returns to J Gaster Esq.
Geo A Davidson
July 11/66
Mr Supt Prof R
to J Davidson~~

^{C^d}
Issued Hunterton Returns to Mrs Robertson
July 11/66 X Geo A Hammond
Mr Supt B of R. H.
for W. S. M. P. K. in

^{C^d}
Issued Hunterton Returns to Mrs M Williams
July 11/66 X Geo A Hammond
Mr Supt B of R. H.
for W. S. M. P. K. in

^{C^d}
Issued Hunterton Returns to Mrs Skinner
July 11/66 X Geo A Hammond
Mr Supt B of R. H.
for W. S. M. P. K. in

^{C^d}
Issued Hunterton Returns to Mrs McLean
July 11/66 X Geo A Hammond
Mr Supt B of R. H.
for W. S. M. P. K. in

^{C^d}
Issued Hunterton Returns to Mrs Christian
July 11/66 X Geo A Hammond
Mr Supt B of R. H.
for W. S. M. P. K. in

Mr Day of care of

of Campbell
one day

From Hunterton Station to Mrs E. Poye
Geo H. A. ...
July 11/66
Mr Supt. Robt R. Hill
Jr W. W. ...

From Hunterton Station to Mrs E. Longley
Geo H. A. ...
July 11/66
Mr Supt. Robt R. Hill
Jr W. W. ...

From Hunterton Station to Mrs R. Gump
Geo H. A. ...
July 11/66
Mr Supt. Robt R. Hill
Jr W. W. ...

From Hunterton Station to Mrs ...
Geo H. A. ...
July 11/66
Mr Supt. Robt R. Hill
Jr W. W. ...

^{c 1}
Issue Hunter's Rations to Mrs S Cotton
July 11/66
Geo A Hammond
Mfr Supt. Regt R 91
P. W. Sampson

^{c 2}
Issue Hunter's Rations to Mrs Dennis
July 11/66
Geo A Hammond
Mfr Supt. Regt R 91
P. W. Sampson

^{c 2}
Issue Hunter's Rations to Mrs A Goss
July 11/66
Geo A Hammond
Mfr Supt. Regt R 91
P. W. Sampson

^{c 2}
Issue Hunter's Rations to Mrs Hillton
July 11/66
Geo A Hammond
Mfr Supt. Regt R 91
P. W. Sampson

^{c 2}
14 R
Issue Hunter's Rations to Mrs Gorran
July 11/66
Geo A Hammond
Mfr Supt. Regt R 91
P. W. Sampson

C-2
Issue Hunterton Returns to Mrs Meyer
Geo A. Starnum
July 21/66 X Apr Supt Ref R
for Westmumpkin

C-3
Issue Hunterton Returns to Mrs McCool
Geo A. Starnum
July 21/66 X Apr Supt Ref R
for Westmumpkin

C-4
Issue Hunterton Returns to Mrs M Cook
Geo A. Starnum
July 21/66 X Apr Supt Ref R
for Westmumpkin

C-5
Issue Hunterton Returns to Mrs Milin
Geo A. Starnum
July 21/66 X Apr Supt Ref R
for Westmumpkin

C-6
Issue Hunterton Returns to Mrs E Morgan
Geo A. Starnum
July 21/66 X Apr Supt Ref R
for Westmumpkin

C 2
Issue Hunterton Rations to Mrs M Powell
July 11/66 X
Geo A Starnum
Mfr Supt Ref Rm
Pr Wm Smith

C 2
Issue Hunterton Rations to Mrs Mathews
July 11/66
Geo A Starnum
Mfr Supt Ref Rm
Pr Wm Smith

C 2
Issue Hunterton Rations to Mrs M Jones
July 11/66
Geo A Starnum
Mfr Supt Ref Rm
Pr Wm Smith

C 2
Issue Hunterton Rations to Mrs Ruffin
July 11/66
Geo A Starnum
Mfr Supt Ref Rm
Pr Wm Smith

C 2
Issue Hunterton Rations to Mrs Dunham
July 11/66 X
Geo A Starnum
Mfr Supt Ref Rm
Pr Wm Smith

C 2
Issue Twenty eight Rations to Mrs Edwards
July 11/66
Geo A. Hammond
Mr Supt. Prof R. H.
Fr J. W. Hampton

C 2
Issue Twenty eight Rations to Mrs Pendleton
July 11/66
Geo A. Hammond
Mr Supt. Prof R. H.
Fr J. W. Hampton

C 2
Issue Twenty eight Rations to Mrs Nixon
July 11/66 X
Geo A. Hammond
Mr Supt. Prof R. H.
Fr J. W. Hampton

C 2
Issue Twenty eight Rations to Mrs Buckner
July 11/66 X
Geo A. Hammond
Mr Supt. Prof R. H.
Fr J. W. Hampton

C 2
Issue Twenty one Rations to Mrs McDonald
July 11/66 X
Geo A. Hammond
Mr Supt. Prof R. H.
Fr J. W. Hampton

C 2
Issue Twenty one Rations to Mrs McKim
July 11/66 X
Geo A. Hammond
Mr Supt. Prof R. H.
Fr J. W. Hampton

C^d
Issue Twenty one Returns to Mrs Irwin
July 11/46 Geo A. Hammond
Mr Supt. B. R. R.
P. W. Sampson

C^d
Issue Twenty one Returns to Mrs Estlin
July 11/46 Geo A. Hammond
Mr Supt. B. R. R.
P. W. Sampson

C^d
Issue Twenty one Returns to Mrs W. Adams
July 11/46 Geo A. Hammond
Mr Supt. B. R. R.
P. W. Sampson

C^d
Issue Twenty one Returns to Mrs Redding
July 11/46 Geo A. Hammond
Mr Supt. B. R. R.
P. W. Sampson

C^d
Issue Twenty one Returns to Mrs D. Wright
July 11/46 Geo A. Hammond
Mr Supt. B. R. R.
P. W. Sampson

C^d
Issue Twenty one Returns to Mrs Taylor
July 11/46 Geo A. Hammond
Mr Supt. B. R. R.
P. W. Sampson

C^d
Issue Twenty one Returns to Mrs Walker
July 9th 1866
Geo A. Stinson
Mr Supt Prof R. D.
J. H. Stinson

C^d
Issue Twenty one Returns to Mrs Keith
July 11th 1866
Geo A. Stinson
Mr Supt Prof R. D.
J. H. Stinson

C^d
Issue Twenty one Returns to Mrs Morse
July 10th 1866
Geo A. Stinson
Mr Supt Prof R. D.
J. H. Stinson

C^d
Issue Twenty one Returns to Mrs & Young
July 11th 1866
Geo A. Stinson
Mr Supt Prof R. D.
J. H. Stinson

C^d
Issue Twenty one Returns to Mrs N. R. R.
July 11th 1866
Geo A. Stinson
Mr Supt Prof R. D.
J. H. Stinson

Cd
Issue Twenty one Returns to Mrs Adams
July 11/66
Geo A. Adams
Supt. Ref. R. H.
J. W. Adams

Cd
Issue Twenty one Returns to Mrs Price
July 11/66
Geo A. Adams
Supt. Ref. R. H.
J. W. Adams

Cd
Issue Twenty one Returns to Mrs Willard
July 11/66
Geo A. Adams
Supt. Ref. R. H.
J. W. Adams

Cd
Issue Twenty one Returns to Mrs Jones
July 11/66
Geo A. Adams
Supt. Ref. R. H.
J. W. Adams

Cd
Issue Twenty one Returns to Mrs Pless
July 11/66
Geo A. Adams
Supt. Ref. R. H.
J. W. Adams

C. A
Issue seven Rations to Mrs S. Allen
July 11/66
Geo. A. Hammond
Mr Supt. B. P. R. Co.
P. W. Hampton

C. A
Issue seven Rations to Mrs E. Wickham
July 11/66
Geo. A. Hammond
Mr Supt. B. P. R. Co.
P. W. Hampton

C. A
Issue seven Rations to Mrs Belyer
July 11/66
Geo. A. Hammond
Mr Supt. B. P. R. Co.
P. W. Hampton

C. A
Issue seven Rations to Mrs Coffey
July 11/66
Geo. A. Hammond
Mr Supt. B. P. R. Co.
P. W. Hampton

C. A
Issue seven Rations to Mrs Popier
July 11/66
Geo. A. Hammond
Mr Supt. B. P. R. Co.
P. W. Hampton

C. A
Issue seven Rations to Mrs M. Lewis
July 11/66
Geo. A. Hammond
Mr Supt. B. P. R. Co.
P. W. Hampton

C 2

Issued seven Rations to Mrs G. Johnson
+ Geo A. Darnmont

July 11/66

Apr Supt Prof R. G. H.
for West Memphis

Issued seven Rations to Miss Payett

July 11/66

* Geo A. Darnmont
Apr Supt Prof R. G. H.
for West Memphis

C 2

Issued seven Rations to Mrs S. A. Burdick

July 11/66

* Geo A. Darnmont
Apr Supt Prof R. G. H.
for West Memphis

C 2

Issued seven Rations to L. Gentry Jr

July 11/66

Geo A. Darnmont
Apr Supt Prof R. G. H.
for West Memphis

C 2

Issued seven Rations to Mrs Ruben

July 11/66

+ Geo A. Darnmont
Apr Supt Prof R. G. H.
for West Memphis

C. S.
Issue seven Rations to Mrs M Smith
X
July 11/66
Geo A. Bennett
Mfr Capt Buf R
Pr J. W. Smith

C. S.
Issue seven Rations to Miss A. Collins
X
July 11/66
Geo A. Bennett
Mfr Capt Buf R
Pr J. W. Smith

C. S.
Issue seven Rations to Miss E. Stokes
X
July 11/66
Geo A. Bennett
Mfr Capt Buf R
Pr J. W. Smith

C. S.
Issue seven Rations to Mrs R. Hill
X
July 11/66
Geo A. Bennett
Mfr Capt Buf R
Pr J. W. Smith

C. S.
Issue seven Rations to Mrs J. Johnson
X
July 11/66
Geo A. Bennett
Mfr Capt Buf R
Pr J. W. Smith

C.R.
Issue seven Rations for Mrs J. L. Linn
July 11/66
Geo. A. Hammond
Mfr Supt. Prof. R. H.
for W. S. Hammond

C.R.
Issue seven Rations to Mrs A. Payne
July 11/66
Geo. A. Hammond
Mfr Supt. Prof. R. H.
for W. S. Hammond

C.P.
Issue seven Rations to Mrs L. Johnson
July 11/66
Geo. A. Hammond
Mfr Supt. Prof. R. H.
for W. S. Hammond

C.R.
Issue seven Rations to Mrs Brink
July 11/66
Geo. A. Hammond
Mfr Supt. Prof. R. H.
for W. S. Hammond

C.R.
Issue sixty Rations to Mrs Washburn
July 11/66
Geo. A. Hammond
Mfr Supt. Prof. R. H.
for W. S. Hammond

C.P.
Issue sixty Rations to Mrs S. A. Beaman
July 11/66
Geo. A. Hammond
Mfr Supt. Prof. R. H.
for W. S. Hammond

Issue sixty Returns to Mrs N Hyatt
Geo A Adams
July 11/66
Supt. B. M. Co
for J. D. Kimball

United States Sanitary Commission.

July 11th 1866
C. S.
Please issue sixty '60' returns
to beaver from Coosa County
J. D. Kimball
J. D. Kimball

Covara Co

United States Sanitary Commission.

July 11" 1866

C.S. Please issue to bearer
sixty (60) rations

Wm. W. W. W.
W. W. W.

Covara Co

July 11" 1866

C.S. Please issue to bearer
sixty (60) rations

Wm. W. W. W.
W. W. W.

United States Sanitary Commission.

July 11th 1866

C.S.

Please issue to bearer
seventy five (75) rations.

P. S. Winman
A. S.

C. S.
Issue seven Rations to Mrs H Merritt
Geo A. Hammond
July 11/66
Mr Supt Regt
Co 1st Mass. Inf.

C. S.
Issue ninety Rations to Mrs Skene
Geo A. Hammond
July 11/66
Mr Supt Regt
Co 1st Mass. Inf.

C. S.
70 R
Issue seventy Rations to Mrs Lawrence
Geo A. Hammond
July 11/66
Mr Supt Regt
Co 1st Mass. Inf.

C²
Issue Thirty Five Rations to Mrs Osborne
Geo A. Hammond
July 11th 1864
Mr Supt Bof R^{on}
for W^{ashington} Kⁱⁿ

C²
Issue Thirty Five Rations to Mrs Harris
Geo A. Hammond
July 11th 1864
Mr Supt Bof R^{on}
for W^{ashington} Kⁱⁿ

C²
Issue Thirty Five Rations to Mrs M. Thompson
Geo A. Hammond
July 11th 1864
Mr Supt Bof R^{on}
for W^{ashington} Kⁱⁿ

C²
Issue thirty Rations to Mrs L. D. Brown
Geo A. Hammond
July 11th 1864
Mr Supt Bof R^{on}
for W^{ashington} Kⁱⁿ

C²
Issue thirty Rations to Mrs Amos
Geo A. Hammond
July 11th 1864
Mr Supt Bof R^{on}
for W^{ashington} Kⁱⁿ

C²
Issue thirty Rations to Mrs Murphy
Geo A. Hammond
July 11th 1864
Mr Supt Bof R^{on}
for W^{ashington} Kⁱⁿ

C.D.
Issue Hunterdon Returns to Mrs M Cox
July 12/66
Geo A Hammond
Mr Supt Prof R Hon
Pr W Sampson

C.D.
Issue Hunterdon Returns to Mrs Oglesby
July 12/66
Geo A Hammond
Mr Supt Prof R Hon
Pr W Sampson

C.D.
Issue Hunterdon Returns to Mrs Conley
July 12/66
" Geo A Hammond
" Mr Supt Prof R Hon
" Pr W Sampson

C.D.
Issue Hunterdon Returns to Mrs Mahoney
July 12/66
Geo A Hammond
Mr Supt Prof R Hon
Pr W Sampson

C.D.
Issue Hunterdon Returns to Mrs Garrison
July 12/66
Geo A Hammond
Mr Supt Prof R Hon
Pr W Sampson

C 2
Issue ~~Forten~~ Rating to Mrs. Miller
July 12/66 + Geo A. Hammond
Mr Supt. Prof R. R.
for W. W. Smith

C 2
Issue ~~Forten~~ Rating to Mrs. Gilmer
July 12/66 + Geo A. Hammond
Mr Supt. Prof R. R.
for W. W. Smith

C 2
Issue ~~Forten~~ Rating to Mrs. Cunningham
July 12/66 + Geo A. Hammond
Mr Supt. Prof R. R.
for W. W. Smith

C 2
Issue ~~Forten~~ Rating to Mrs. Alexander
July 12/66 + Geo A. Hammond
Mr Supt. Prof R. R.
for W. W. Smith

C 2
Issue ~~Forten~~ Rating to Mrs. Isaacs
July 12/66 + Geo A. Hammond
Mr Supt. Prof R. R.
for W. W. Smith

C 2
Issue ~~Forten~~ Rating to Mrs. Davis
July 12/66 + Geo A. Hammond
Mr Supt. Prof R. R.
for W. W. Smith

C 2
Issue Fortem Rations to Mrs. Perkins
Geo. A. Hammond
July 12/66 } Mr Supt. Regt R Co
for West Virginia

C 2
Issue Fortem Rations to Mrs. Allen
Geo. A. Hammond
July 12/66 } Mr Supt. Regt R Co
for West Virginia

C 2
Issue Fortem Rations to Mr. E. Chase
Geo. A. Hammond
July 12/66 } Mr Supt. Regt R Co
for West Virginia

C 2
Issue Fortem Rations to Mrs. Terry
Geo. A. Hammond
July 12/66 } Mr Supt. Regt R Co
for West Virginia

C 2
Issue Fortem Rations to Mrs. Bunting
Geo. A. Hammond
July 12/66 } Mr Supt. Regt R Co
for West Virginia

C 2

Issue Hunterdon Returns to Mrs McLain
July 12/16 X Geo A. Hammond
Supt. Ref. R. Co.
Pr. W. D. Sampson

C 2

Issue Hunterdon Returns to Mrs E. Gill
July 12/16 X Geo A. Hammond
Supt. Ref. R. Co.
Pr. W. D. Sampson

C 2

Issue Hunterdon Returns to Mrs L. Morgan
July 12/16 X Geo A. Hammond
Supt. Ref. R. Co.
Pr. W. D. Sampson

C 2

Issue Hunterdon Returns to Mrs Dykes
July 12/16 X Geo A. Hammond
Supt. Ref. R. Co.
Pr. W. D. Sampson

C 2

Issue Hunterdon Returns to Mrs J. Wolfe
July 12/16 X Geo A. Hammond
Supt. Ref. R. Co.
Pr. W. D. Sampson

C 2

Issue Hunterdon Returns to Mrs J. J. J. J.
July 12/16 X Geo A. Hammond
Supt. Ref. R. Co.
Pr. W. D. Sampson

C^d
Issued Hunterdon Returns to Mrs. Blunt
Geo. A. Armstrong
July 12/66 X Mr. Supt. Prof. R.
W. W. W. W. W.

C^d
Issued Hunterdon Returns to Mrs. Shorler
Geo. A. Armstrong
July 12/66 X Mr. Supt. Prof. R.
W. W. W. W. W.

C^d
Issued Hunterdon Returns to Mrs. Brown
Geo. A. Armstrong
July 12/66 X Mr. Supt. Prof. R.
W. W. W. W. W.

C^d
Issued Hunterdon Returns to Mrs. Green
Geo. A. Armstrong
July 12/66 X Mr. Supt. Prof. R.
W. W. W. W. W.

C^d
Issued Hunterdon Returns to Mrs. Hodge
Geo. A. Armstrong
July 12/66 X Mr. Supt. Prof. R.
W. W. W. W. W.

cs
Issue Fortem Rations to Mrs M Lewis
Geo A Hammond
July 12/66 X Apr Supt - Prof R R
for W W Sampkin

cs
Issue twenty eight Rations to Mrs Gibson
Geo A Hammond
July 12/66 X Apr Supt - Prof R R
for W W Sampkin

cs
Issue twenty eight Rations to Mrs Carroll
Geo A Hammond
July 12/66 X Apr Supt - Prof R R
for W W Sampkin

cs
Issue twenty eight Rations to Mrs Sizer
Geo A Hammond
July 12/66 X Apr Supt - Prof R R
for W W Sampkin

cs
Issue twenty one Rations to Mrs M Robinson
Geo A Hammond
July 12/66 X Apr Supt - Prof R R
for W W Sampkin

cs
Issue twenty one Rations to Mrs Fitzgibbons
Geo A Hammond
July 12/66 X Apr Supt - Prof R R
for W W Sampkin

^{c 2}
Issue Twenty one Returns to Mrs L Brooks
July 12/66 * Geo A. Hammond
Mr Supt. Prof R.
Jr W. S. Sampson

^{c 2}
Issue Twenty one Returns to Mrs Price
July 12/66 Geo A. Hammond
Mr Supt. Prof R.
Jr W. S. Sampson

^{c 2}
Issue Twenty one Returns to Mrs S. Kinn
July 12/66 * Geo A. Hammond
Mr Supt. Prof R.
Jr W. S. Sampson

^{c 2}
Issue Twenty one Returns to Mrs Mendick
July 12/66 * Geo A. Hammond
Mr Supt. Prof R.
Jr W. S. Sampson

^{c 2}
Issue Twenty one Returns to Mrs Safford
July 12/66 Geo A. Hammond
Mr Supt. Prof R.
Jr W. S. Sampson

^{c 2}
Issue Seven Returns to Mrs A. Beyer
July 12/66 Geo A. Hammond
Mr Supt. Prof R.
Jr W. S. Sampson

C²
Issued seven Rations to Mrs M O'Neal
Geo A. Armstrong
July 12/66
Mr Supt. Regt R
for W.D. Sumpter

C²
Issued seven Rations to Mrs E. Evans
Geo A. Armstrong
July 12/66 X
Mr Supt. Regt R
for W.D. Sumpter

C²
Issued seven Rations to Mrs Goutray
Geo A. Armstrong
July 12/66
Mr Supt. Regt R
for W.D. Sumpter

C²
Issued seven Rations to Mrs M. Wickes
Geo A. Armstrong
July 12/66
Mr Supt. Regt R
for W.D. Sumpter

C²
Issued seven Rations to Mrs S. Hale
Geo A. Armstrong
July 12/66
Mr Supt. Regt R
for W.D. Sumpter

C²
Issued seven Rations to Mrs Gorden
Geo A. Armstrong
July 12/66 X
Mr Supt. Regt R
for W.D. Sumpter

^{c 2}
Issue Seven Returns to Mrs D Baxter
Geo A Hammond
July 12/66 | Mr Supt - Prof R &
Jr W L Sampkin

^{c 2}
Issue Seven Returns to Mrs Biggers
Geo A Hammond
July 12/66 x Mr Supt - Prof R &
Jr W L Sampkin

^{c 2}
Issue Seven Returns to Mrs J Rogers
Geo A Hammond
July 12/66 x Mr Supt - Prof R &
Jr W L Sampkin

^{c 2}
Issue Seven Returns to Mrs L Armstrong
Geo A Hammond
July 12/66 7 Mr Supt - Prof R &
Jr W L Sampkin

^{c 2}
Issue Seven Returns to Mrs Jmlinson
Geo A Hammond
July 12/66 Mr Supt - Prof R &
Jr W L Sampkin

^{c 2}
Issue Seven Returns to Mrs A Hall
Geo A Hammond
July 12/66 Mr Supt - Prof R &
Jr W L Sampkin

C^d
Issued seven Returns to Mrs Thornton
July 12/66 X Geo A Adams
for W^m Sampson

C^d
Issued seven Returns to Mrs S. Porter
July 12/66 X Geo A Adams
for W^m Sampson

C^d
Issued seven Returns to Mrs E. Wolfe
July 12/66 - Geo A Adams
for W^m Sampson

C^d
Issued six Returns to Mrs A. Thayer
July 12/66 X Geo A Adams
for W^m Sampson

C^d
Issued six Returns to Mrs W. S. Jenkins
July 12/66 X Geo A Adams
for W^m Sampson

C^d
Issued six Returns to Mrs E. Adams
July 12/66 X Geo A Adams
for W^m Sampson

C 2
Issued

^{90R}
Thirty Returns to Mrs Whitworth
x
July 12/66
Geo A. Bennett
Mr Supt Prof R
for J. W. Simpson

C 2
Issued

^{36R}
Fifty six Returns to Mrs Ray
Geo A. Bennett
July 12/66
Mr Supt Prof R
for J. W. Simpson

C 2
Issued

Fifty six Returns to Mrs M. L. Dillway
Geo A. Bennett
July 12/66
Mr Supt Prof R
for J. W. Simpson

C 2
Issued

Fifty six Returns to Mrs. M. L. Dillway
Geo A. Bennett
July 12/66
Mr Supt Prof R
for J. W. Simpson

C 2
Issued

Thirty Five Returns to Mrs Louison
Geo A. Bennett
July 12/66
Mr Supt Prof R
for J. W. Simpson

C 2
Issue thirty Rations to Mrs M. M. May
July 9/66
Geo. A. Hammond
Asst Supt Prof R &
J. H. Hammond

C 2
Issue thirty Rations to Mrs. Kibler
July 12/66 *
Geo. A. Hammond
Asst Supt Prof R &
J. H. Hammond

C 2
Issue thirty Rations to Mrs. Spinner
July 12/66 *
Geo. A. Hammond
Asst Supt Prof R &
J. H. Hammond

C 2
Issue Fourteen Rations to Mrs S. Russ
July 13/66 |
Geo. A. Hammond
Asst Supt Prof R &
J. H. Hammond

C 2
Issue Fourteen Rations to Mrs A. M. Gillingham
July 13/66 |
Geo. A. Hammond
Asst Supt Prof R &
J. H. Hammond

Cd
Issue Fourteen Rations to Mrs Proulx
July 13/66 } Geo A Hammond
Mr Supt Prof R
Fr W D Sampson

Cd
Issue Fourteen Rations to Mrs Gurling
July 13/66 } Geo A Hammond
Mr Supt Prof R
Fr W D Sampson

Cd
Issue Fourteen Rations to Mrs Lindsey
July 13/66 } Geo A Hammond
Mr Supt Prof R
Fr W D Sampson

Cd
Issue Fourteen Rations to Mrs Kennedy
July 13/66 } Geo A Hammond
Mr Supt Prof R
Fr W D Sampson

Cd
Issue Fourteen Rations to Mrs Brown
July 13/66 } Geo A Hammond
Mr Supt Prof R
Fr W D Sampson

c 2

Issue Fountain Station to Mrs Kerr

Geo A Hornum

July 13/66

Apr Supt - Prof R G
J W Hampton

c 2

Issue Fountain Station to Mrs M Gulliver

Geo. A Hornum

July 13/66

Apr Supt - Prof R G
J W Hampton

c 2

Issue Fountain Station to Mrs Haller

Geo. A Hornum

July 13/66

Apr Supt - Prof R G
J W Hampton

c 2

Issue Fountain Station to Mrs Garvin

Geo. A Hornum

July 13/66

Apr Supt - Prof R G
J W Hampton

c 2

Issue Fountain Station to Mrs Cooper

Geo. A Hornum

July 13/66

Apr Supt - Prof R G
J W Hampton

Issue Frontier Returns to Mrs & Brown
Geo A. Bennett
July 13/66 Mr Supt Bof RR
for Washington

Issue Frontier Returns to Mrs M Fair
Geo A. Bennett
July 13/66 X Mr Supt Bof RR
for Washington

Issue Frontier Returns to Mrs Frederick
Geo A. Bennett
July 13/66 Mr Supt Bof RR
for Washington

Issue Frontier Returns to Mrs & Reich
Geo A. Bennett
July 13/66 Mr Supt Bof RR
for Washington

Issue Frontier Returns to Mrs Spright
Geo A. Bennett
July 13/66 Mr Supt Bof RR
for Washington

C 2

Issue twenty-eight Rations to Mrs K Wallis

Geo A Bennett

July 13/66

Mrs Supt-Bef R
for W. Bennett

C 2

Issue twenty one Rations to Mrs Beard

Geo A Bennett

July 13/66

Mrs Supt-Bef R
for W. Bennett

C 2

Issue twenty one Rations to Mrs Estbridge

Geo A Bennett

July 13/66

Mrs Supt-Bef R
for W. Bennett

C 2

Issue twenty one Rations to Mrs Bullard

Geo A Bennett

July 13/66

Mrs Supt-Bef R
for W. Bennett

C 2

Issue twenty one Rations to Mrs G Griffin

Geo A Bennett

July 13/66

Mrs Supt-Bef R
for W. Bennett

C 2

Issued Twenty one Rations to Mrs S A Dale
Geo A Bennett
July 13/66
Apr Supt Bof R Y
Pr W Rumpkin

C 2

Issued Seven Rations to Mrs M. Amos
Geo A Bennett
July 13/66
Apr Supt Bof R Y
Pr W Rumpkin

C 2

Issued Seven Rations to Mrs M. A Brown
Geo A Bennett
July 13/66
Apr Supt Bof R Y
Pr W Rumpkin

C 2

Issued Seven Rations to Mrs L Chambers
Geo A Bennett
July 13/66
Apr Supt Bof R Y
Pr W Rumpkin

C 2

Issued Seven Rations to Mrs G. Bush
Geo A Bennett
July 13/66 X
Apr Supt Bof R Y
Pr W Rumpkin

c 2

Issue seven Rations to Mrs W Gony
Geo A Hammond
July 13/66) Apr Supt Ref R 2
Pr W Hampton

c 2

Issue seven Rations to Mrs Goodwin
Geo A Hammond
July 13/66 X Apr Supt Ref R 2
Pr W Hampton

c 2

Issue seven Rations to Mrs Felton
Geo A Hammond
July 13/66 X Apr Supt Ref R 2
Pr W Hampton

c 2

Issue seven Rations to Mrs E Porter
Geo A Hammond
July 13/66 X Apr Supt Ref R 2
Pr W Hampton

c 2

Issue seven Rations to Mrs Updineoff
Geo A Hammond
July 13/66 X Apr Supt Ref R 2
Pr W Hampton

C 2

Issue drawn Returns to Mrs No. [Name]
Geo. A. [Name]
July 13/66 - Mr. Supt. Ref. R.
for [Name]

C 2

Issue drawn Returns to Mrs [Name]
Geo. A. [Name]
July 13/66 - Mr. Supt. Ref. R.
for [Name]

C 2

Issue drawn Returns to Mrs [Name]
Geo. A. [Name]
July 13/66 - Mr. Supt. Ref. R.
for [Name]

C 2

Issue drawn Returns to Mrs M. [Name]
Geo. A. [Name]
July 13/66 - Mr. Supt. Ref. R.
for [Name]

C 2

Issue drawn Returns to Mrs [Name]
Geo. A. [Name]
July 13/66 - Mr. Supt. Ref. R.
for [Name]

C 2

Issue sixty Rations to Mrs Eliza Perry
Geo A. Bennett
July 13th 66 X Apr Supt. Buf R Co
Pr W. W. Sumpter

C 2

Issue sixty Rations to Mrs G. Rushing
Geo A. Bennett
July 13th 66 Q Apr Supt. Buf R Co
Pr W. W. Sumpter

C 2

Issue sixty Rations to Mrs S. Lucia
Geo. A. Bennett
July 13th 66 X Apr Supt. Buf R Co
Pr W. W. Sumpter

C 2

Issue ninety Rations to Mrs. G. McKee
Geo. A. Bennett
July 13th 66 X Apr Supt. Buf R Co
Pr W. W. Sumpter

C 2

Issue ninety Rations to Mrs Lang Moore
Geo. A. Bennett
July 13th 66 X Apr Supt. Buf R Co
Pr W. W. Sumpter

Issue Ninety Ration to Mrs S. Martin
Geo A. Hammond
July 13/66 X Mr Supt B. P. B.
for W. A. Smith

Issue Ninety Ration to Mrs ^W Linn
Geo A. Hammond
July 13/66 X Mr Supt B. P. B.
for W. A. Smith

Issue Ninety Ration to Mrs E. Waller
Geo A. Hammond
July 13/66 X Mr Supt B. P. B.
for W. A. Smith

Issue Thirty Ration to Mrs E. Lane
Geo A. Hammond
July 13/66 X Mr Supt B. P. B.
for W. A. Smith

Issue Quarter Ration to Mrs Plunket
Geo. A. Hammond
July 13/66 X Mr Supt B. P. B.
for W. A. Smith

C 2
Issue Hundred Rations to Mrs S. M. Hough
Geo A. Hammond
July 13/66) Mr Supt. B. R. R.
J. W. Simpson

C 2
Issue Sixty Rations to Mrs E. Martin
Geo A. Hammond
July 14/66) Mr Supt. B. R. R.
J. W. Simpson

C 2
Issue Sixty Rations to Mrs M. Dickey
Geo A. Hammond
July 14/66) Mr Supt. B. R. R.
J. W. Simpson

C 2
Issue Twenty Rations to Mrs Simmons
Geo A. Hammond
July 14/66) Mr Supt. B. R. R.
J. W. Simpson

C 2
120 R
Issue one hundred & twenty Rations to Mrs Smith
Geo A. Hammond
July 14/66) Mr Supt. B. R. R.
J. W. Simpson

C 2
Issue Thirty Rations to Mrs Davidson
Geo A. Hammond
July 14/66) Mr Supt. B. R. R.
J. W. Simpson

Ration Tickets of Rations
 issued to Distresses in the
 County of Montgomery from
 the 1st to the 21st of July 1866
 5390 Rations

C 2 Issue	Monthly Ration July 13 th / 66	to Genl. B. B. Brown Genl. B. B. Brown Capt. B. B. Brown for Ration Tickets
--------------	--	--

C 2 Issue	Monthly Ration July 17 th / 66	to Genl. B. B. Brown Genl. B. B. Brown Capt. B. B. Brown for Ration Tickets
--------------	--	--

C 2 Issue	Monthly Ration July 18 th / 66	to Genl. B. B. Brown Genl. B. B. Brown Capt. B. B. Brown for Ration Tickets
--------------	--	--

C. S.
Issue ~~Frontier~~ Rations to Mrs E Cotton
Geo A Starnum
July 18/66
Asst Supt. Ref. R. G.
for W. D. Hampton

C. S.
Issue ~~Frontier~~ Rations to Mrs E. Page
Geo A Starnum
July 18/66
Asst Supt. Ref. R. G.
for W. D. Hampton

C. S.,

Issue ~~Frontier~~ Rations, to Mrs Alexander

July 18/66

Montgomery, Ala.

Geo. A. Starnum
Assistant Superintendent.
Bureau of Refugees, Freedmen and Abandoned Lands
for W. D. Hampton

C. S.,

Issue ~~Frontier~~ Rations, to Mrs Money

July 18/66

Montgomery, Ala.

Geo. A. Starnum
Assistant Superintendent.
Bureau of Refugees, Freedmen and Abandoned Lands.
for W. D. Hampton

C. S.,

Issue ~~Frontier~~ Rations, to Mrs L. McLeod

July 18/66

Montgomery, Ala.

Geo. A. Starnum
Assistant Superintendent.
Bureau of Refugees, Freedmen and Abandoned Lands.
for W. D. Hampton

C. S.
Issue *Fourteen* Rations, to *Mrs Reynolds*

Montgomery, Ala.

July 18/61

Geo. A. Starnum
Assistant Superintendent,
Bureau of Refugees, Freedmen and Abandoned Lands.

J. H. [unclear]

C. S.

Issue *Fourteen* Rations, to *Mrs G Robinson*

Montgomery, Ala.

July 18/61

Geo. A. Starnum
Assistant Superintendent,
Bureau of Refugees, Freedmen and Abandoned Lands.

J. H. [unclear]

C. S.

Issue *Fourteen* Rations, to *Mrs A Smith*

Montgomery, Ala.

July 18/61

Geo. A. Starnum
Assistant Superintendent,
Bureau of Refugees, Freedmen and Abandoned Lands.

J. H. [unclear]

C. S.

Issue *Fourteen* Rations, to *Mrs D Austin*

Montgomery, Ala.

July 18/61

Geo. A. Starnum
Assistant Superintendent,
Bureau of Refugees, Freedmen and Abandoned Lands.

J. H. [unclear]

c 2

Issue ^{by} Fountain Rations to Mrs L Watts

July 18/66

Geo A Hammond
Asst Supt. Ref. Bn
for W. D. Sampson

c 2

Issue Fountain Rations to Mrs Skinner

July 18/66

Geo A Hammond
Asst Supt. Ref. Bn
for W. D. Sampson

C. S.,

Issue ^{by} Fountain Rations, to Mrs G Wilson

July 18/66

Montgomery, Ala.

Geo A Hammond
Assistant Superintendent,
Bureau of Refugees, Freedmen and Abandoned Lands.
for W. D. Sampson

C. S.,

Issue ^{by} Fountain Rations, to Mrs Evening

July 18/66

Montgomery, Ala.

Geo A Hammond
Assistant Superintendent,
Bureau of Refugees, Freedmen and Abandoned Lands.
for W. D. Sampson

c 2

Issue ^{by} ~~Fountain~~ Rations to Mrs Thompson

July 18/66

Geo A Hammond
Asst Supt. Ref. Bn
for W. D. Sampson

C 2

Issue under Rations

July 18/66

L. Miss Poyett
Geo. A. Hammond
Supt. Ref. R.
to W. W. Humphreys

C 2

Issue under Rations

July 18/66

L. Mrs. S. P. Powell
Geo. A. Hammond
Supt. Ref. R.
to W. W. Humphreys

C 2

Issue under Rations

July 18/66

L. L. G. G. G.
Geo. A. Hammond
Supt. Ref. R.
to W. W. Humphreys

C 2

Issue under Rations

July 18/66

L. Mrs. B. Hale
Geo. A. Hammond
Supt. Ref. R.
to W. W. Humphreys

C 2

Issue under Rations

July 18/66

L. Mrs. M. Jones
Geo. A. Hammond
Supt. Ref. R.
to W. W. Humphreys

C. S.

Issue Ration to Mrs M Belyer

July 18/66
Montgomery, Ala.

Geo A Hammond
Assistant Superintendent.
Bureau of Refugees, Freedmen and Abandoned Lands.

per J. W. Simpson

C. S.

Issue Ration to Mrs E Wolfe

July 18/66
Montgomery, Ala.

Geo A Hammond
Assistant Superintendent.
Bureau of Refugees, Freedmen and Abandoned Lands.

per J. W. Simpson

C
Issue

Frontier Ration to Mrs E Morgan

July 18/66

Geo A Hammond

Asst Supt - Refugees
per J. W. Simpson

C
Issue

Frontier Ration to Mrs Robinson

July 18/66

Geo A Hammond

Asst Supt - Refugees
per J. W. Simpson

C
Issue Frontier Ration to Mrs M Jones

July 18/66

Geo A Hammond

Asst Supt - Refugees
per J. W. Simpson

C.S.
Issue ^{of} ~~Frontier~~ Rations to Mrs Thompson
Geo A. Hammond
July 18/66
Mr Supt - Ref RR
for W. W. Simpson

C.S.
Issue ^{of} ~~Frontier~~ Rations to Mrs Bluffie
Geo A. Hammond
July 18/66
Mr Supt - Ref RR
for W. W. Simpson

C.S.
Issue ^{of} ~~Frontier~~ Rations, to Mrs M. Gray
Geo A. Hammond
July 18/66
Assistant Superintendent.
Bureau of Refugees, Freedmen and Abandoned Lands.
for W. W. Simpson
Montgomery, Ala.

C.S.
Issue ^{of} ~~Frontier~~ Rations to Mrs W. Hayes
Geo A. Hammond
July 18/66
Mr Supt - Ref RR
for W. W. Simpson

C.S.
Issue ^{of} ~~Frontier~~ Rations to Mrs M. Mathews
Geo A. Hammond
July 18/66
Mr Supt - Ref RR
for W. W. Simpson

C 2
Issue ^{of} *Quarterly Rations* to Mrs G. G. G. G.
July 18/66
Geo. A. Harmon
Supt. Ref. B.
pr W. R. M. P. K.

C 2
Issue ^{of} *Quarterly Rations* to Mrs A. G. G.
July 18/66
Geo. A. Harmon
Supt. Ref. B.
pr W. R. M. P. K.

C. S.,
Issue ^{of} *Quarterly Rations* to Mrs *Johnson*
July 18/66
MONTGOMERY, ALA.
Geo. A. Harmon
Assistant Superintendent.
Bureau of Refugees, Freedmen and Abandoned Lands.
pr W. R. M. P. K.

C 2
Issue ^{of} *Quarterly Rations* to Mrs & Ross
July 18/66
Geo. A. Harmon
Supt. Ref. B.
pr W. R. M. P. K.

C. S.,
Issue ^{of} *Quarterly Rations*, to Mrs *McLain*
July 18/66
Montgomery, Ala.
Geo. A. Harmon
Assistant Superintendent.
Bureau of Refugees, Freedmen and Abandoned Lands.
pr W. R. M. P. K.

C-4
Issue *Mountain* Rations, to *L. G. Gester Sr*
July 18/66
Geo. A. Hammond
Supt Dept. Ref. & A.
for W. S. Sampson

C. S.
Issue *Mountain* Rations, to *Mrs. Kaffee*
July 18/66
Montgomery, Ala.
Geo. A. Hammond
Assistant Superintendent.
Bureau of Refugees, Freedmen and Abandoned Lands.
for W. S. Sampson

Issue *in* Rations, to *Mrs. McRae*
July 18/66
MONTGOMERY ALA.
Geo. A. Hammond
Assistant Superintendent.
Bureau of Refugees, Freedmen and Abandoned Lands.
for W. S. Sampson

C. S.
Issue *seven* Rations, to *Mrs. Rabun*
July 18/66
Montgomery, Ala.
Geo. A. Hammond
Assistant Superintendent.
Bureau of Refugees, Freedmen and Abandoned Lands.
for W. S. Sampson

C-2
Issue *seven* Rations to *Mrs. M. Smith*
July 18/66
Geo. A. Hammond
Supt Dept. Ref. & A.
for W. S. Sampson

C2
Issue seven Rations to Mrs Allison
July 18/66
Geo A Hammond
Asst Supt Ref Rtn
Jr W D Sumpter

C2
Issue seven Rations to Mrs Johnson
July 18/66
Geo. A Hammond
Asst Supt Ref Rtn
Jr W D Sumpter

C2
Issue seven Rations to Mrs Rapier
July 18/66
Geo A Hammond
Asst Supt Ref Rtn
Jr W D Sumpter

C2
Issue seven Rations to Mrs Johnson
July 18/66
Geo A Hammond
Asst Supt Ref Rtn
Jr W D Sumpter

C. S.,
Issue ^{28 R} twenty eight Rations, to Mrs Edwards
July 18/66
Montgomery, Ala.
Geo A Hammond
Assistant Superintendent.
Bureau of Refugees, Freedmen and Abandoned Lands.
Jr W D Sumpter

C. S.
Issue ^{of} ~~Quarter~~ Rations to Mrs M McLean
Geo. A. Hammond
Asst Supt. B. of R. & A.
for W. D. Humphreys
July 18/66

C. S.
Issue ^{of} ~~Quarter~~ Rations to Mrs Lewis
Geo. A. Hammond
Asst Supt. B. of R. & A.
for W. D. Humphreys
July 18/66

C. S.
Issue ^{of} ~~Quarter~~ Rations, to Mrs Longley
July 18/66
Montgomery, Ala.
Geo. A. Hammond
Assistant Superintendent.
Bureau of Refugees, Freedmen and Abandoned Lands.
for W. D. Humphreys

C. S.
Issue ^{of} ~~Quarter~~ Rations to Mrs S. Jones
Geo. A. Hammond
Asst Supt. B. of R. & A.
for W. D. Humphreys
July 18/66

C. S.
Issue ^{of} ~~Quarter~~ Rations to Mrs Robertson
Geo. A. Hammond
Asst Supt. B. of R. & A.
for W. D. Humphreys
July 18/66

Issue *Twenty* Rations, to Mrs *Fullmer*

July 18/66

Montgomery, Ala.

Geo A *Stevens*

Assistant Superintendent.
Bureau of Refugees, Freedmen and Abandoned Lands.

W. W. Humphreys

Issue *Twenty* Rations, to Mrs *M. Dykes*

July 18/66

Geo. A. *Stevens*

Asst. Supt. *Ref. & F.*

W. W. Humphreys

C. S.,

Issue *Twenty* Rations, to Mrs *M. Piper*

July 18/66

Montgomery, Ala.

Geo A *Stevens*

Assistant Superintendent.
Bureau of Refugees, Freedmen and Abandoned Lands.

W. W. Humphreys

C. S.,

Issue *Twenty eight* Rations, to Mrs *Meritt*

July 18/66

Montgomery, Ala.

Geo A *Stevens*

Assistant Superintendent.
Bureau of Refugees, Freedmen and Abandoned Lands.

W. W. Humphreys

C.S.
Issue Twenty eight Rations to Mrs. [Name]

July 18/66

Geo A. [Name]
Asst. Sup't B. of R.
J. [Name]

C.S.
Issue Twenty eight Rations to Mrs. [Name]

July 18/66

Geo A. [Name]
Asst. Sup't B. of R.
J. [Name]

C. S.,

Issue Ninety Rations, to Mrs. M. Williams

July 18/66

Montgomery, Ala.

X

Geo. A. [Name]
Assistant Superintendent,
Bureau of Refugees, Freedmen and Abandoned Lands.
J. [Name]

C. S.,

Issue ^{30 R} Thirty Rations, to Mrs. J. Gardner

July 18/66

Montgomery, Ala.

Geo. A. [Name]
Assistant Superintendent,
Bureau of Refugees, Freedmen and Abandoned Lands.
J. [Name]

C. S.,

30 R
Issue Thirty
July 18/66

Rations, to Mr Linsley

Geo A Hammond
Assistant Superintendent,
Bureau of Refugees, Freedmen and Abandoned Lands.

Montgomery, Ala.

J. H. Simpson

C. S.,

Issue Thirty
July 18/66

Rations, to Mrs S Falkner

Geo A Hammond
Assistant Superintendent,
Bureau of Refugees, Freedmen and Abandoned Lands.

Montgomery, Ala.

J. H. Simpson

C. S.,

30 R
Issue Thirty

July 18/66

Rations, to Mrs M Pomeroy

Geo A Hammond
Assistant Superintendent,
Bureau of Refugees, Freedmen and Abandoned Lands.

Montgomery, Ala.

J. H. Simpson

Issue Sixty Rations to Mrs M E Jackson

July 18/66

Geo A Hammond
Asst Supt Ref R R
J. H. Simpson

C. S.,

Issue Sixty Rations, to Mrs Knight

July 18/66

Montgomery, Ala.

Geo. A. Hammond
Assistant Superintendent.
Bureau of Refugees, Freedmen and Abandoned Lands.

W. H. Sampson

C. S.,

Issue Sixty Rations, to Mrs Martha Williams

July 18/66

Montgomery, Ala.

Geo. A. Hammond
Assistant Superintendent.
Bureau of Refugees, Freedmen and Abandoned Lands.

W. H. Sampson

C. S.,

Issue Sixty Rations, to Mrs E. Pritchard

July 18/66

Montgomery, Ala.

Geo. A. Hammond
Assistant Superintendent.
Bureau of Refugees, Freedmen and Abandoned Lands.

W. H. Sampson

C. S.

Issue Sixty Rations to be used

Montgomery, Ala.
July 18/66

Geo. A. Hammond
Asst. Sup. F.

Issue Forty Two Rations to Mrs Irwin

July 18/66

Geo. A. Hammond
Asst. Sup. F.
W. H. Sampson

C. S.,

157 R ^{Gift}
Issue in hundred Nations, to Mrs Osburn

July 18/66

Montgomery, Ala.

Geo. A. Stewart
Assistant Superintendent,
Bureau of Refugees, Freedmen and Abandoned Lands.

per J. W. Thompson

C. S.,

120 R ^{Gift}
Issue in hundred Nations, to Mrs P. J. Abraham

July 18/66

Montgomery, Ala.

Geo. A. Stewart
Assistant Superintendent,
Bureau of Refugees, Freedmen and Abandoned Lands.

per J. W. Thompson

C. S.

Issue Thirty Six Nations to Mrs M. Thompson

July 18/66

Geo. A. Stewart
per J. W. Thompson

C. S.,

33 R
Issue Thirty Six Nations to Mrs Harris

July 18/66

MONTGOMERY, ALA.

Geo. A. Stewart
Assistant Superintendent,
Bureau of Refugees, Freedmen and Abandoned Lands.

per J. W. Thompson

Issue Monthly one Ration, to Mrs McKey
July 18/66
Geo A. Hammond
Assistant Superintendent,
Bureau of Refugees, Freedmen and Abandoned Lands.
Per W. W. Humphreys

C. S.,

Issue Monthly one Ration, to Mrs McKey

July 18/66
Montgomery, Ala.

Geo A. Hammond
Assistant Superintendent,
Bureau of Refugees, Freedmen and Abandoned Lands.
Per W. W. Humphreys

Issue Monthly one Ration, to Mrs Adams
July 18/66
Geo A. Hammond
Assistant Superintendent,
Bureau of Refugees, Freedmen and Abandoned Lands.
Per W. W. Humphreys

C. S.,

Issue Monthly one Ration, to Mrs M. Adams

July 18/66
Montgomery, Ala.

Geo A. Hammond
Assistant Superintendent,
Bureau of Refugees, Freedmen and Abandoned Lands.
Per W. W. Humphreys

C. S.

Issue Twenty one Rations, to Mrs M. Cook

July 18/66

Montgomery, Ala.

Geo A. Harman
Assistant Superintendent,
Bureau of Refugees, Freedmen and Abandoned Lands.
J. W. Sumpter

C 2

Issue Twenty one Rations to Mrs. Ault

July 18/66

Geo A. Harman
Asst Supt Ref & F
J. W. Sumpter

C 3

Issue Twenty one Rations to Mrs. Redding

July 18/66

Geo A. Harman
Asst Supt Ref & F
J. W. Sumpter

C. S.

Issue Twenty one Rations, to Mrs M P Adams

July 18/66

Montgomery, Ala

Geo A. Harman
Assistant Superintendent,
Bureau of Refugees, Freedmen and Abandoned Lands.
J. W. Sumpter

C. S.,

Issue Twenty one Rations, to Mrs Wrough

July 18/66
Montgomery, Ala.

Geo A. Hammond
Assistant Superintendent,
Bureau of Refugees, Freedmen and Abandoned Lands.

J. W. Simpson, Jr.

C. S.,

Issue Twenty one Rations, to Mrs M Keich

July 18/66
Montgomery, Ala.

Geo A. Hammond
Assistant Superintendent,
Bureau of Refugees, Freedmen and Abandoned Lands.

J. W. Simpson, Jr.

C. S.,

Issue Twenty one Rations, to Mrs S Price

July 18/66
Montgomery, Ala.

Geo A. Hammond
Assistant Superintendent,
Bureau of Refugees, Freedmen and Abandoned Lands.

J. W. Simpson, Jr.

C. S.,

Issue Twenty one Rations, to Mrs Jellard

July 18/66
Montgomery, Ala.

Geo A. Hammond
Assistant Superintendent,
Bureau of Refugees, Freedmen and Abandoned Lands.

J. W. Simpson, Jr.

C. S.,

Issue *Twenty* in Rations, to Mrs M Donald

July 18/66

Montgomery, Ala.

Geo A Hammond
Assistant Superintendent.
Bureau of Refugees, Freedmen and Abandoned Lands.

Jr W Sampson

C. S.,

Issue *Twenty* in Rations, to Mrs Moore

July 18/66

Montgomery, Ala.

Geo A Hammond
Assistant Superintendent.
Bureau of Refugees, Freedmen and Abandoned Lands.

Jr W Sampson

C. S.,

Issue *Twenty* in Rations, to Mrs G Young

July 18/66

Montgomery, Ala.

Geo A Hammond
Assistant Superintendent.
Bureau of Refugees, Freedmen and Abandoned Lands.

Jr W Sampson

C. S.,

20 R
Issue *Twenty* in Rations, to Mrs M L Walker

July 18/66

MONTGOMERY, ALA

Geo A Hammond
Assistant Superintendent.
Bureau of Refugees, Freedmen and Abandoned Lands.

Jr W Sampson

C. S.

Issue Twenty one Rations, to Mrs Buckner

July 18/66

Montgomery, Ala.

Geo. A. Hammond

Assistant Superintendent,
Bureau of Refugees, Freedmen and Abandoned Lands.

Wm W. Sumner

C. S.
Issue Twenty one Rations, to Mrs Taylor

July 18/66

Geo. A. Hammond

Asst Supt B. R. F. & A. L.

Wm W. Sumner

C. S. 21 R
Issue Twenty one Rations to Mrs L. T. Brooks

July 18/66

MONTGOMERY, ALA.

Geo. A. Hammond

Assistant Superintendent,
Bureau of Refugees, Freedmen and Abandoned Lands.

Asst Supt B. R. F. & A. L.

Wm W. Sumner

C. S.

Issue Seven Rations, to Mrs E. Allen

July 18/66

Montgomery, Ala.

Geo. A. Hammond

Assistant Superintendent,
Bureau of Refugees, Freedmen and Abandoned Lands.

Wm W. Sumner

^{c 2}
Issue Hunter Returns to Mrs L Dodge
July 19th 66 x
Geo A Hancock
Supt B of R
for W & Sumpkin

^{c 2}
Issue Allen Returns to Mrs & Agnes
July 19th 66
Geo A Hancock
Supt B of R
for W & Sumpkin

^{c 2}
Issue Allen Returns to Mrs & Emma
July 19th 66
Geo A Hancock
Supt B of R
for W & Sumpkin

^{c 2}
Issue Allen Returns to Mrs & Dickson
July 19th 66
Geo A Hancock
Supt B of R
for W & Sumpkin

^{c 2}
Issue Allen Returns to Mrs A Belyer
July 19th 66
Geo A Hancock
Supt B of R
for W & Sumpkin

^{c 2}
Issue Allen Returns to Mrs Menden
July 19th 66
Geo A Hancock
Supt B of R
for W & Sumpkin

^{c 2}
Issued seven Rations to Mrs. Office
July 19/66
Geo A. Hammond
Mr Supt. Ref. Rm
for W. Hampton

^{c 2}
Issued seven Rations to Mrs L. Armstrong
July 19/66
Geo A. Hammond
Mr Supt. Ref. Rm
for W. Hampton

^{c 2}
Issued seven Rations to Mrs. F. Dale
July 19/66
Geo A. Hammond
Mr Supt. Ref. Rm
for W. Hampton

^{c 2}
Issued seven Rations to Mrs S. Dale
July 19/66
Geo A. Hammond
Mr Supt. Ref. Rm
for W. Hampton

^{c 2}
Issued seven Rations to Mrs. Bickers
July 19/66
Geo A. Hammond
Mr Supt. Ref. Rm
for W. Hampton

^{c 2}
Issued seven Rations to Mrs. Sigdale
July 19/66
Geo A. Hammond
Mr Supt. Ref. Rm
for W. Hampton

^{c 2}
Issue Fountain Station to Mrs Burrin
July 19/66
Geo A. Hammond
Mr Supt. Prof R &
J. H. Thompson

^{c 2}
Issue Fountain Station to Mrs Stern
July 19/66
Geo A. Hammond
Mr Supt. Prof R &
J. H. Thompson

^{c 2}
Issue Fountain Station to Mrs E. Gill
July 19/66
Geo A. Hammond
Mr Supt. Prof R &
J. H. Thompson

^{c 2}
Issue Fountain Station to Mrs Gilmer
July 19/66
Geo A. Hammond
Mr Supt. Prof R &
J. H. Thompson

^{c 2}
Issue Fountain Station to Mrs M. L. Lintock
July 19/66
Geo A. Hammond
Mr Supt. Prof R &
J. H. Thompson

C. 2
Issue Fountain Returns to Mrs. Alford
July 19/66
Geo A. Harman
Mr Supt. B. P. R.
P. H. T. Sampson

C. 2
Issue Fountain Returns to Mrs. Parker
July 19/66
Geo A. Harman
Mr Supt. B. P. R.
P. H. T. Sampson

C. 2
Issue Fountain Returns to Mrs. Green
July 19/66
Geo A. Harman
Mr Supt. B. P. R.
P. H. T. Sampson

C. 2
Issue Fountain Returns to Mrs. C. Leiby
July 19/66
Geo A. Harman
Mr Supt. B. P. R.
P. H. T. Sampson

C. 2
Issue Fountain Returns to Mrs. M. Lewis
July 19/66
Geo A. Harman
Mr Supt. B. P. R.
P. H. T. Sampson

C. 2
Issue Fountain Returns to Mrs. Meyer
July 19/66
Geo A. Harman
Mr Supt. B. P. R.
P. H. T. Sampson

^{c 2}
Issue ^{of} Frontier Rations to Mrs Cox
July 19/46
Geo H Sturmont
Supt Bof R
for H Sturmont, Kin

^{c 2}
Issue ^{of} Frontier Rations to Mrs Bosman
July 19/46
Geo H Sturmont
Supt Bof R
for H Sturmont, Kin

^{c 2}
Issue ^{of} Frontier Rations to Mrs Cook
July 19/46
Geo H Sturmont
Supt Bof R
for H Sturmont, Kin

^{c 2}
Issue ^{of} Frontier Rations to Mrs Hickman
July 19/46
Geo H Sturmont
Supt Bof R
for H Sturmont, Kin

^{c 2}
Issue ^{of} Frontier Rations to Mrs Terry
July 19/46
Geo H Sturmont
Supt Bof R
for H Sturmont, Kin

^{C. P.}
Issue Hunterton Returns to Mrs Chase
July 19/66
Geo A. D. [unclear]
Mr Supt - B. P. [unclear]
for [unclear]

^{C. P.}
Issue Hunterton Returns to Mrs Mahoney
July 19/66
Geo A. D. [unclear]
Mr Supt - B. P. [unclear]
for [unclear]

^{C. P.}
Issue Hunterton Returns to Mrs Conley
July 19/66
Geo A. D. [unclear]
Mr Supt - B. P. [unclear]
for [unclear]

^{C. P.}
Issue Hunterton Returns to Mrs Hunt
July 19/66
Geo. A. D. [unclear]
Mr Supt - B. P. [unclear]
for [unclear]

^{C. P.}
Issue Hunterton Returns to Mrs [unclear]
July 19/66
Geo A. D. [unclear]
Mr Supt - B. P. [unclear]
for [unclear]

C²
Issue Fountain Returns to Mrs Wolfe
Geo A. Starnum
July 19/66
Mr Supt. Bof. R.
for W. D. Sampson.

C²
Issue Seven Returns to Mrs Tomlinson
Geo A. Starnum
July 19/66
Mr Supt. Bof. R.
for W. D. Sampson

C²
Issue Twenty eight Returns to Mrs Cecile
Geo A. Starnum
July 19/66
Mr Supt. Bof. R.
for W. D. Sampson

C²
Issue Twenty eight Returns to Mrs Suzie
Geo A. Starnum
July 19/66
Mr Supt. Bof. R.
for W. D. Sampson

C²
Issue Twenty eight Returns to Mrs Gessie
Geo A. Starnum
July 19/66
Mr Supt. Bof. R.
for W. D. Sampson

C²
Issue Ninety Returns to Mrs M. Hayde
Geo A. Starnum
July 19/66
Mr Supt. Bof. R.
for W. D. Sampson

^{cs}
Issue Ninety Returns to Mr & Evans
July 19/66
Geo A. Hammond
Mr Supt. B. P. R.
Pr W. T. Sampson

^{cs}
Issue Ninety Returns to W. S. Austin
July 19/66
Geo A. Hammond
Mr Supt. B. P. R.
Pr W. T. Sampson

^{cs}
Issue Ninety Returns to Mrs M. L. Hall
July 19/66
Geo A. Hammond
Mr Supt. B. P. R.
Pr W. T. Sampson

^{cs}
Issue Ninety Returns to W. Clanton
July 19/66
Geo A. Hammond
Mr Supt. B. P. R.
Pr W. T. Sampson

^{cs}
Issue ^{30 R} Ninety Returns to Mrs J. Brown
July 19/66
Geo A. Hammond
Mr Supt. B. P. R.
Pr W. T. Sampson

^{cs}
Issue ^{30 R} Ninety Returns to Mrs & Mitchell
July 19/66
Geo A. Hammond
Mr Supt. B. P. R.
Pr W. T. Sampson

c 3

3rd R
Issued Thirty Returns to Mrs Wells
July 19/66
Geo A Adams
Mr Supt - B of R
for W. Sampson

Issued Sixty Returns to Mrs J. Booth
July 19/66
Geo A Adams
Mr Supt B of R
for W. Sampson

Issued Sixty Returns to Mrs M. Age
July 19/66
Geo A Adams
Mr Supt - B of R
for W. Sampson

c 2
Issued Sixty Returns to Mrs L. Collins
July 19/66
Geo A Adams
Mr Supt B of R
for W. Sampson

c 2
Issued Thirty-Five Returns to Mrs Louder
July 19/66
Geo A Adams
Mr Supt - B of R
for W. Sampson

^c
Issue Twenty-Ration to Mrs Lawrence
July 19/66
Geo A Hancock
Mr Supt Bof R
Pr W. S. Sumpter

^c
Issue Twenty-one Ration to Mrs James
July 19/66
Geo A Hancock
Mr Supt Bof R
Pr W. S. Sumpter

^c
Issue Twenty-one Ration to Mrs Gentry
July 19/66
Geo A Hancock
Mr Supt Bof R
Pr W. S. Sumpter

^c
Issue Twenty-one Ration to Mrs Harris
July 19/66
Geo A Hancock
Mr Supt Bof R
Pr W. S. Sumpter

^c
Issue Twenty-one Ration to Mrs Saffold
July 19/66
Geo A Hancock
Mr Supt Bof R
Pr W. S. Sumpter

C. 2
Issue twenty one Rations to Mrs Mendick
July 19/66
Geo A Account
Mr Supt Bof R
pr W. S. Smith

C. 2
Issue twenty one Rations to Mrs Robinson
July 19/66
Geo A Account
Mr Supt Bof R
pr W. S. Smith

C. 2
Issue twenty one Rations to Mrs Higginson
July 19/66
Geo. A Account
Mr Supt Bof R
pr W. S. Smith

C. 2
Issue twenty one Rations to Mrs Price
July 19/66
Geo A Account
Mr Supt Bof R
pr W. S. Smith

C. 2
Issue twenty one Rations to Mrs S. Keen
July 19/66
Geo A Account
Mr Supt Bof R
pr W. S. Smith

C. 2
Issue sixty Rations to Mrs M. A. Scott
July 20/66
Geo A Account
Mr Supt Bof R
pr W. S. Smith

C 2
Issued Johnston Rating to Mrs G Keith
July 20/66
Geo A Hammond
Mfr Supt Ref R
for Westman's Kin

C 2
Issued Johnston Rating to Mrs Shuter
July 20/66
Geo A Hammond
Mfr Supt Ref R
for Westman's Kin

C 2
Issued Johnston Rating to Mrs Frederick
July 20/66
Geo A Hammond
Mfr Supt Ref R
for Westman's Kin

C 2
Issued Johnston Rating to Mrs M Stone
July 20/66
Geo A Hammond
Mfr Supt Ref R
for Westman's Kin

C 2
Issued Johnston Rating to Mrs Cooper
July 20/66
Geo A Hammond
Mfr Supt Ref R
for Westman's Kin

C 2
Issue Frontier Rations to Mrs A M McCallough
July 20/66
Geo A Hammond
Mr Supt. Bof R Co
Jr W D Simpson Kin

C 2
Issue Frontier Rations to Mrs S Russ
July 20/66
Geo A Hammond
Mr Supt. Bof R Co
Jr W D Simpson Kin

C 2
Issue Frontier Rations to Mrs S L McCallough
July 20/66
Geo A Hammond
Mr Supt. Bof R Co
Jr W D Simpson Kin

C 2
Issue Frontier Rations to Mrs Gurling
July 20/66
Geo A Hammond
Mr Supt. Bof R Co
Jr W D Simpson Kin

C 2
Issue Frontier Rations to Mrs Fair
July 20/66
Geo A Hammond
Mr Supt. Bof R Co
Jr W D Simpson Kin

C 2
Issue Frontier Rations to Mrs Anderson
July 20/66
Geo A Hammond
Mr Supt. Bof R Co
Jr W D Simpson Kin

^{c 1}
Issue ¹⁴Frontier Returns to Mrs Currier
Geo A Hammond
Apr Supt Prof R G
p W D Sumpter
July 20/66

^{c 2}
Issue ¹⁴Frontier Returns to Mrs Lindsey
Geo A Hammond
Apr Supt Prof R G
p W D Sumpter
July 20/66

^{c 3}
Issue ¹⁴Frontier Returns to Mrs Gillespie
Geo A Hammond
Apr Supt Prof R G
p W D Sumpter
July 20/66

^{c 4}
Issue ¹⁴Frontier Returns to Mrs Kennedy
Geo A Hammond
Apr Supt Prof R G
p W D Sumpter
July 20/66

^{c 5}
Issue ¹⁴Frontier Returns to Mrs S Porter
Geo A Hammond
Apr Supt Prof R G
p W D Sumpter
July 20/66

^{c 6}
Issue ¹⁴Frontier Returns to Mrs Anna
Geo A Hammond
Apr Supt Prof R G
p W D Sumpter
July 20/66

Issue Green Rations to Mrs Willis
Geo. A. Hammond
Mr Supt. By Rn
for W. D. Rumpkin

Issue Green Rations to Mrs W. J. Felton
Geo. A. Hammond
Mr Supt. By Rn
for W. D. Rumpkin

Issue Green Rations to Mrs Hollins
Geo. A. Hammond
Mr Supt. By Rn
for W. D. Rumpkin

Issue Green Rations to Mrs. Gordon
Geo. A. Hammond
Mr Supt. By Rn
for W. D. Rumpkin

Issue Green Rations to Mrs Upderyuff
Geo. A. Hammond
Mr Supt. By Rn
for W. D. Rumpkin

C 2

Issue seven Rations to Mrs Kinn

July 20/66

Geo A. Harman
Mr Supt. Bof Rm
for Westampton

C 2

Issue seven Rations to Mrs Chambers

July 20/66

Geo A. Harman
Mr Supt. Bof Rm
for Westampton

C 2

Issue seven Rations to Mrs M. A. Brown

July 20/66

Geo A. Harman
Mr Supt. Bof Rm
for Westampton

C 2

Issue seven Rations to Mrs E. Cox

July 20/66

Geo A. Harman
Mr Supt. Bof Rm
for Westampton

C 2

Issue seven Rations to W. G. Carey

July 20/66

Geo A. Harman
Mr Supt. Bof Rm
for Westampton

C^d
Issue seven Rations to Mrs Bush
July 20/66
Geo A Hammond
M^r Supt - B of R
for W^m Sampkin

C^d
Issue seven Rations to Mrs Barron
July 20/66
Geo A Hammond
M^r Supt - B of R
for W^m Sampkin

C^d
Issue seven Rations to Mrs Spaight
July 20/66
Geo A Hammond
M^r Supt - B of R
for W^m Sampkin

C^d
Issue twenty eight Rations to Mrs Brown
July 20/66
Geo A Hammond
M^r Supt - B of R
for W^m Sampkin

C^d
Issue twenty eight Rations to Mrs Johnson
July 20/66
Geo A Hammond
M^r Supt - B of R
for W^m Sampkin

C^d
Issue twenty eight Rations to Mrs Hill
July 20/66
Geo A Hammond
M^r Supt - B of R
for W^m Sampkin

^{c.2}
Issue Ninety Rations to Mr Rushing
July 20/66
Geo A. Hammond
Mr Supt Bof Rm
for W. D. Sampson

^{c.2} ^{90 R}
Issue Ninety Rations to Mrs M. Hawks
July 20/66 X
Geo A. Hammond
Mr Supt Bof Rm
for W. D. Sampson

^{c.2} ^{90 R}
Issue Ninety Rations to Mrs L. Butler
July 20/66
Geo A. Hammond
Mr Supt Bof Rm
for W. D. Sampson

^{c.2} ^{90 R}
Issue Ninety Rations to Mrs M. Marshall
July 20/66
Geo A. Hammond
Mr Supt Bof Rm
for W. D. Sampson

^{c.2}
Issue Ninety Rations to Mrs M. Campbell
July 20/66
Geo A. Hammond
Mr Supt Bof Rm
for W. D. Sampson

^{c.2} ^{60 R}
Issue Sixty Rations to Mrs M. Cannon
July 20/66
Geo A. Hammond
Mr Supt Bof Rm
for W. D. Sampson

c 2

60 R

Issue sixty Rations to Mrs. Yorbrough

July 20/66

Geo A. Hammond
M^r Supt. B^o R^o
for Redemptⁿ

c 2

150 R

Issue one hundred & fifty Ration to St James

July 20/66

Geo A. Hammond
M^r Supt. B^o R^o
for Redemptⁿ

~~150~~

c 2

120 R

Issue one hundred & twenty Rations to Mrs Booth

July 20/66

Geo A. Hammond
M^r Supt. B^o R^o
for Redemptⁿ

c 2

120 R

Issue one hundred & twenty Rations to Mrs Booth

July 20/66

Geo A. Hammond
M^r Supt. B^o R^o
for Redemptⁿ

c 2

Issue twenty one Rations to Mrs Bullard

July 20/66

Geo A. Hammond
M^r Supt. B^o R^o
for Redemptⁿ

C 1
Issue Twenty one Returns to Mrs S. A. Hall
July 20/66
Geo. A. Hammond
Apr Capt. Ruf. R. B.
Pr W. S. Humphreys

C 2
Issue Twenty one Returns to Mrs P. Richards
July 20/66
Geo. A. Hammond
Apr Capt. Ruf. R. B.
Pr W. S. Humphreys

C 3
Issue Twenty one Returns to Mrs. Griffin
July 20/66
Geo. A. Hammond
Apr Capt. Ruf. R. B.
Pr W. S. Humphreys

30 R
Issue Thirty Returns to Mrs L. Miller
July 21/66
Geo. A. Hammond
Apr Capt. Ruf. R. B.
Pr W. S. Humphreys

C 12
Issue Thirty Returns to Mrs J. Busby
July 21/66
Geo. A. Hammond
Apr Capt. Ruf. R. B.
Pr W. S. Humphreys

C 2

Issue sixty Ration to Mrs A Rogers
Geo A. Hammond
July 21/66 Mr Supt - Prof R
for West Hampton

C 2

Issue thirty Ration to Mrs M. A. Garter
Geo A. Hammond
July 21/66 Mr Supt - Prof R
for West Hampton

C 2

Issue sixty Ration to Mrs S. Gullens
Geo A. Hammond
July 21/66 Mr Supt - Prof R
for West Hampton

C 2

Issue ^{35 R} thirty Ration to Mrs. ¹⁴ Brink
Geo A. Hammond
July 21/66 Mr Supt - Prof R
for West Hampton

C 2

Issue sixty Ration to Mrs M. Keable
Geo A. Hammond
July 21/66 Mr Supt - Prof R
for West Hampton

Cowls to B
we
Cowls T W.

Col Geo A Hammond
Assistant Supt of
J B & L Montgomery County



Let man George bowls

^{vs}
J W Bowles

Autum. Sworn (George)

was there when the man give him ^x The Mare
George ploughed the mare all the summer
The mare was on the place the last time he saw
her

George was not at the settlement
The settlement was for clothing, shoes & provisions
For provisions they had bought & paid for them
selves. The settlement was made with them by Gov. Shurtan.
Rebin the foreman sent George to Mill the day
the mare was given to George.
The Yankees took George Mules & wagon on
that day, carried him to the corn crib & loaded
his wagon with corn & fodder & carried George
& wagon to Montgony with them. George came
back from Montg. & brought Mules & wagon back
with him, & the Mules were on the plantation
when he left it about the 1st of Janu

George never sold the mare to any one, but al-
ways claimed the mare as his
Mr Chatham (Superintendent) frequently told him
to catch George's mare for him (Chatham)

sworn to & subscribed in my name Feb 9th 1866 Anthony ^{his} Bowles
R H Brewer & J M Chatham, sworn ^{mark}

He attended to business for J W Bowles. Commenced
16th July 1865. There was black & white mare on
the plantation when he went there. Claimed
by Colored Boy George

He Chatham, told George that his mare might
remain on the plantation & work for her feed
& George consented for his mare to remain on
those terms, the provisions on the plantation gave out
about the 8th Sept. & Bowles refused to furnish any
more while he, Chatham, stayed on the plantation
which was about two months

Heard Mr Cowle call her The George Mare and
George owned the Mare up to the time he, Chatham,
left there, and never heard any body doubt the
Mare belonging to George
Sworn to and subscribed } J. M. Chatham
before me this 19th Feb. 1865 }
R H Brewer J P

Flem. Cowles, Colored Man sworn
was living on J W Cowles plantation last year. There
was a black mare, was black when she first came on the
plantation. then she turned nearly white, George
owned the mare, George said the Yankees give
her to him, at Jas Judkins' plantation. George
owned her as long as he Flem. staid on the plan-
tation. George never sold her to any one that he
Flem, knew of; was present when Gov. Shorter made
the settlement with the Negroes. George was not present.
The settlement was made for clothing shoes & provisions
& two months rations of meat, Mr Cowles refused to fur-
nish them meat, clothing & shoes, according to contract
of, and Gov. Shorter settled these matters with the
hands on the place for Cowles, Flemming & Cecels
sworn to and subscribed before me }
this the 19th day of Feb 1866 }
R H Brewer J P

Clark Cowles Col. Man sworn
was present when George demanded the mare of Cowles
Cowles told George he should not have her, and to get
away from there as quick as he could, or he Cowles would
shoot him. George told Cowles he would report to Mr
Brewer and see if he could not get his mare. This was

in the Christmas and George was leaving the plantation with the last load of his things

Sworn to and subscribed)

before me this 19th Feb 1865

R H Brewer J.P.

Clark ^{his} Cowles
Mark

Gen W M Dade Sworn

was present when George demanded the mare of Cowles, Cowles refused to give the mare up and told George to leave there. George has owned the mare from about some time in May and owned her up to the time he George left the plantation and has never given her up his claim

Sworn to and subscribed)

before me this 19th Feb 1866

R H Brewer J.P.

J W M Dade

Col Hammer

Mount Airy Feb 19th 1866

I have decided in the case of which I send you the testimony in that the black mare should be turned over to the Col by George and as I have my doubts in authorizing a State officer to seize and turn over any species of property over the value of fifty dollars and have investigated this case only as an agent of the Freedmen Bureau I request of you to look over the testimony and if you believe the the Col man George should have the mare furnish him with some one to place the mare in his possession and also have the cost of investigation collected which is thirteen dollars & fifty cents (\$13.50)

Respectfully

R H Brewer J.P. ⁷⁷³ Sent

1 Robin Cowles Col. Man, Swore,
The mare was brought on The plantation when Gen.
Piersons Command was returning from Opelousa
Ala. Mr Cowles had lost several Mules at that time,
The boys were out gathering up stock to replace
those taken from the plantation for Mr Cowles,
I think ~~George~~ ^{was brought} The mare there in that way,
I was foreman of # of the plantation, The mare was
very poor when she was brought there, she was fed
altogether on Mr Cowles Corn & fodder, George never
did buy any corn or fodder for her, never heard
of George putting up any claim to her until he
left there, she was always regarded as Mr Cowles
mare, he had been foreman on the plantation about 19-
years, the mare was not worth much when she came on
the place she was there some time before she could be
used, George was in the employ of Mr Cowles, George was
present at the settlement made by Gov. Sherter. Gov. Sherter
~~settled~~ settled all the demands made by the negroes -
he made George make no claims for the mare.

Crossed Cross Examined.

The day that George started to Mill was not the day
that the mare was brought there

Robins -

Testimony

D.

I did not swear that ~~George~~ Gus, brought the
mare on the place, I did not see the mare
when she was brought on the place, I do not know
of my own knowledge who brought the mare there
Gus, Shuler in the settlement did not ask me when
I owned any horses or mules, the settlement was
for money we had paid out ourselves for bacon cloth
ing and shoes,

Sworn to and subscribed } Robin ^{His} Cowles Colored man
before me this 9th day of April }
1866. Jas L. Knapp, J. P., }
Mark

1
Jas. P. Clauahan, sworn,
I was notified at the 2nd Trial. But, ^{could be} not there
in consequence of high water. My subpoena was
verbal, in hearing of this additional testimony
Mr. Brewster was to have the witnesses summoned,
I was at the first Trial, I considered it a fair
Trial, I was at the plantation at the time of
the settlement of Gov. Shuter with the Freedmen
The settlement was made by Gov. Shuter for Mr. Cowles
This settlement was a complete settlement made by
Gov. Shuter with the Freedmen of all claims be-
tween Mr. Cowles and the Freedmen, I understood
it as a final settlement between Mr. Cowles and
the Freedmen, George was present at that set-
tlement, Gov. Shuter said to the Freedmen if
they had any claims against Mr. Cowles to make
it known and he would settle them,
he did settle with each one, one by one (the
heads of families) and settled with this boy
George who was the head of his family,
George set up no claim against Mr. Cowles
for the Ware, George had claims, all of which
were settled, I think ^{the settlement made by Gov. Shuter} was about the last of Novem-
ber, it was the last of Christmas week before

Clanahan —

Testimony

George set up any claim to the mare, that
 I knew of. George was discharged from Mr
 Bowles employ on the 25th December 1865,
 it was the last of Christmas week when George
 made a demand on Mr Bowles for the mare,
 George staid on the plantation some days af-
 ter he received the order to leave, Mr Bowles was
 vexed at their remaining there and they were aware
 of that fact he believed that George demanded the mare
 to provoke Mr Bowles had heard no claims made to Mr
 Bowles for the mare up to that time George had said to
 him Blanchehan, that he would have to see Mr Bowles
 about the mare. This was after he had told the negroes
 to leave the plantation Gov Porter had but one settlement
 with the negroes Mr McCade made a settlement with
 the negroes ~~about~~ the 15th of December, at the request
 of Mr Chatterman & Blanchehan, ^{sanctioned it,} in dividing out the crop
 this was a full settlement with negroes for their part of
 the corn. He divided the fodder with the negroes after
 this some time before Christmas which was the final
 settlement for the year, no claim made for the mare
 when the fodder was divided. Mr Bowles was not on ^{plantation}

Mr Cowles wrote to him to dispossess all the hands
on the plantation 24th December, 1865.

Crosby

Crosby Examined

Gov. Hunter did not ask any of the Freedmen
if they owned any horses or mules at the time
of the settlement, that he made with the Freedmen
Flem, had a mule and carried it off as his
own property, when George was making his ^{last} load
he came up and demanded of Mr Cowles, the
mare, about the last of October he ^{Clanahan when he first} called on the
^{nearby of Mr Cowles plantation} Freedmen on Mr Cowles plantation to point out which
was Mr Cowles stock, and which was theirs in the lot,
and Flem pointed out ^{a mule} as his, and George pointed
out mule as his, the mare was in the lot at the time
with the stock, and they said all the balance
of the stock in the lot belonged to Mr Cowles
and set up no claim to the mare.

Sworn to and subscribed

before me this 9th day of April 1866

James L. Waugh, J. P.

J. P. Clanahan

Lounds Co. Ala

Jury v. S.

Justice of the Peace

Statement of the Trial of
Alex Funderville v. M. Funder
et

Recd March 3^o 1868

James G Mc Dirm
v
Alex Howville
Julius Howville Cold
State of Alabama
Lowndes County
Before A. J. Perry Esq

Case No 2^d day of Dec 1867.

Below will be found a synopsis of the testimony of the witness examined in the above stated case except Cottingham, Wellingham and Jesse McWhorter. Reference is made to their report for the substance of their testimony.

James G Mc Dirm - heard the dogs and rallying of the hogs in the direction of defendants fields, but the balance of his hogs coming from the direction of the field, & near by - saw

Alex Howville & Julius Howville - told Alex that he was killing his hogs. Alex replied no - that it was his Corn that killed. Mc Dirm demanded reparation, as the fence was unlawful, which Alex refused to make.

William Mc Dirm - Was with his father when he met Alex, heard his father ask reparation of Alex, heard Alex say he reasoned - it was his Corn that killed his hogs. Heard Mc Dirm then ask Alex why he wounded the others so severely, which Alex denied.

Further testifies, that the fence is very bad, and stock were in the hole of going in - that Mc Dirms hogs had been in frequently.

Alexander Moncrief - Cold - Was pecking Cotton in same field the Corn was in, saw the hogs, told Alex Howville that "yonder was the hogs in again, Alex then left him, in company with his son Julius

and went off with his gun and dogs in the direction the hogs were, heard, soon after, the hogs rallying and squealing and the dogs baying. It was then 3 o'clock P.M. did not see

Alex Howville any more that evening. Hogs, when he first saw them, were tearing down Alex Corn, near the Cotton house. Hogs mostly black, thought them to be Mc Dirms hogs, though not certain. Hogs - when attacked by Alex and dogs ran in the direction of Mc Dirm, house. Fencer bad, & stack constantly in the field.

Defence
Alex Howville - denies killing the hogs but does not deny the injury to those wounded. Refused reparation at first and pleads that if hogs were injured, his Corn was also injured.

Julius Howville. Parted from his father in the chase after the hogs, met him at the fence where they put the hogs out. Did not see his father kill any of them.

Jack Howville was picking
Cotton across the branch on
the hill side, heard the noise
with the hogs and could
occasionally see Alex and
Julius - thinks he saw
them put the hogs out
and did not see any
injury done to any of
them - was several
hundred yds from the
parties and hogs all the
time.

J. C. Howville, white. The
fuel was not the best, but
might be called a tolerable
fuel. ~~The balance of his~~
~~testimony~~. Had sent Alex
there to put out hogs
before when none were
injured

James G. McCune } at the request of James G. McCune
vs } I issued a summons for thirty
Alex Honvill & } dollars, against Alex Honvill
Julius Honvill. Col. } and Julius Honvill, which
Plaintiff claims for one hog killed
and others injured by defendants
the property of plaintiff about
the 9th or 10th October 1867.
Issued Nov 2^d.
1867.

Nov 23rd 1867. Returned by Constable executed - on this
dated 19th Nov 1867.

" " Case called for trial - defendant asked
and was allowed a continuance until

~~Nov 27th 1867~~ - Trial - Issued a summons for defendant
for J. A. Honvill, Saul Stahely, J. C. Honvill,
Susan Honvill, & Jack Honvill.

Dec 2^d 1867 - Case called for trial - parties appeared -

The plaintiff in support of his demand
examined seven witnesses, viz himself, William
McCune, Alexander Moseley, Sam Hunt
Honvill, J. W. Cottingham, S. B. Willingham
and James Merrhorth - and the defendant
examined in his ~~support~~ defence, himself, Julius
Honvill, Jack Honvill, and J. C. Honvill.
After hearing all the testimony and allegations,
and examining the evidence, I gave judgment
for the plaintiff for Ten dollars and Costs

The above is a transcript from my docket. The
evidence did not shew that Julius Honvill, son of Alex
(a boy of 14 or 15 years), killed the hog or wounded the others,
but there was no doubt left in my mind that as
to Alex Honvill, killing the hog & wounding the others.

J. A. Howille did ^{not} appear, nor did Mr. Stakely -
As the witnesses will likely be called before
you I will make no further remark about
the case -

Very Respectfully
A. J. Perry
Justice of the Peace.

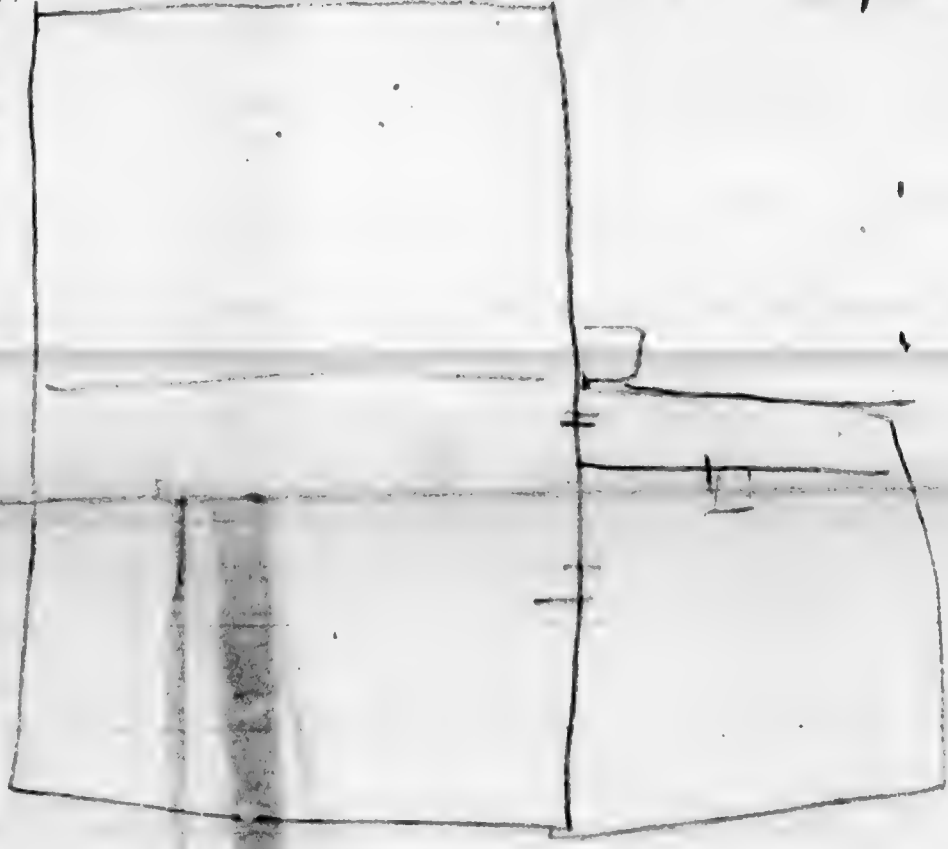

Recd Mar 3rd/68

Sound's Co. Ala

Jury ad

Justice of the Peace

Statement of the Trial of

Alex. Howille vs. M. Perry

et

Recd March 3rd 1868

Seat No. 9000000
Dec 18th 1867

Parnell. A. J.
Justice of the Peace

Statement of the case tried
before him of Frank Toliver
vs. Max Gibson -

Frank Toliver
v. J. J.

Beat a Neg Dec: the 18th 1867
In Justice Court

Maj Gibson

The Plaintiff claims of the Defendant
sixteen Dollars pr. Month for six
months labor for himself and wife on a
Contract entered into on the 14th of Jan 1867
with Wiley J. Gibson

Summons Issued for Defendant on the 16th Dec

The Parties appearing at trial the Defendant
stated to the Court that the Plaintiff
had violated his Contract in various
Respects openly and knowingly proving
the facts by Thos B Green and Henry Gibson
and said that every hand on his
Plantation would swear to the same
and wanted to have them subpoenaed

The Plaintiff having evidence to introduce
I thought it unnecessary the Plaintiff
said there was not a Freedman on the
Place would swear the truth for him
Inasmuch as he could not bring a
witness out of thirty or forty to prove
the Charges false brought against him
I thought him guilty and decided
accordingly making Gibson pay the Cost

I hereby Certify that the above state
ment and investigation of this case
is a true statement of the case and
of my Docket

A L Barnett Pres. Deau

Lauder Co. Alabama

Lauder E. P.

Judge of the Peace

Statement in the Case of
Jenkins Fordholders
J. B. Bradley -

~~Bradley~~
Eggs

State of Ala } Col Geo H. Underhill
Lawrence Co } Attorney at Law

In the matter of Jenkins
Ford (Col) vs L B Brady as referred to
me by you on the 13th Inst

I have this day proceeded to hear the
testimony on both sides and find
that upon accounts that Jenkins Ford
is indebted to L B Brady in the sum
of \$263.41, for provision and expenses
of farm as per contract

The said Jenkins Ford has
raised and has now on hand about
8000 lbs seed cotton one half of
which is Jenkins' subject to
his debt as above stated

Said cotton I have
packed up securely and shall
turn it over to Mr Brady on
the 1st day of July 1868 unless
otherwise ordered by you

I think that I have done my
duty according to evidence brought
before me without favor or
oppression

Respectfully Submitted
G. H. Underhill

Geo H Underhill

P.S. Please let me hear from you
immediately whether the above is satisfact-
ory or not. And if you should wish any
further proceedings on the matter I would
respectfully refer you to Hon W. M. Buckley
as a better person

Delivered at Mount Hatteras Pa
Care of Mr. Lanning

1862
I have the honor to acknowledge the receipt of your letter of the 10th inst. in relation to the above named property. I have the pleasure to inform you that the same has been sold to the satisfaction of the court and the proceeds thereof are being held for your benefit. I have also the pleasure to inform you that the same has been sold to the satisfaction of the court and the proceeds thereof are being held for your benefit.

This case was
sent up a few
days since, and
been settled in full.

A. M. Dwyer.

May 12/68

Mh. May 90 afo
Ca 2

Lyde & R

Wages (a/c)

Statement in the case of
Polodone Lucavo Eding Court London
(a/c) in regards to the swapping
a share for defendant for unpaid
wages. decision in favor of Defth.

Recd March 29/6/18/8

Poladore Lucas Col, } It appears that the
Edenborough ^{was} Lomas Col, } Defendant swapped a
horse that was unsound, to the Plaintiff
for a mule & wagon, & five Dollars boot.

Defendant warranted his horse to be sound
in Every respect, the horse was sick at the
time the swap was made but Defendant,
said that it was owing to his shoes being
two tight. the shoes was pulled off & the
horse still continued to get worse until
he died which was two Days after the
Swap, It was proven in Court, before
the Jury that Defendant warranted the
horse sound, and the Jury rendered,
a verdict in favor of the Plaintiff
that Defendant was to restore to the
Plaintiff his mule & wagon & money

Both Plaintiff & Defendant agreed,
to submit the case to a Jury, & was
both Satisfied with the Jury, I think
that, he had Justice done him
yours J. R. L. P.

Montgomery

Receipts for
Provisions

+
Orders
for
Rations

1865

Receipt of Recital

Of 1200 Bunches of Book

Tomis B.W.

Oct. 28. 1865.

Montgomery -

I
Received this twenty eighth day of Oct.
eighteen hundred and sixty five of
Gen. A. Hammondt Aft. Supt Bureau
of R. T. & A. L. at Montgomery Ala.
twelve hundred pounds of notes
for which I promise to pay the
amount it cost the U. S. Government
on demand

B. W. Arns

"

Receipt for Pork & Beef

Three barrels of Beef
One Barrel of Pork

Amos B. H.

Dec. 1, 1865.

Received this 1st day of December 1865
of Gen. A. Warrornut Capt. Supt. Prison
of Ref. Jan. A. L.; three barrels of Beef
and one barrel of Turkey for which I
promise to pay him their cost to the U. S.
Government - on demand.

B. W. Norris

"

Receipt for Pork

One barrel of Pork
Storris B. H.

Dec 28. 1865.

Received this 28th day of Dec. 1865 at Mont-
gomery Ala. of Gen. N. Hancock Capt. J. S. [?]
Bureau of Dep. of War N. L. and George of [?]
for which I promise to pay the cost to the
U. S. Government on demand.

Montgomery Ala
Dec 28th 1865.

P. G. W. Morris
"

Receipt for Pork

Two Barrels of Pork

~~from~~

Dec. 6. 1865.

[Faint, illegible handwritten notes and signatures, possibly including names like 'J. B. ...' and '...']

[Faint, illegible handwritten notes on the right margin, possibly including '...']

Spec. p. 181
Dec 6 1865
B. W. Harris

This 6th day of Dec. 1865
Gen. N. Vermont, Asst. Sup't Bureau of Inf. S.
Gen. N. L. = two barrels of Pork; for which
I promise to pay the cost to U. S. Govern-
ment - on demand.

B. W. Harris

Receipt for Provisions

Montgomery Co. Ala.
July 20. 66

Captain George S.

Agrees that all
provisions need. from
the U. S. shall consti-
tute a Lien upon his
crop.

State of Alabama & know full well by these presents
Montgomery County that I agree that the value of
all furriens furnished me by the United States
Government during the years 1866 shall constitute
a first lien upon all my interest in all the
products of a certain piece of land situated
about four and one half miles from the City
of Montgomery on the "Narrow Bridge Road"
and being the same leased to me from Bryant
B. Adams bearing date January 20th 1866.
George ^{his} Croom
mark

Witnesses.

Geo. A. Hammond

Actg. Supr. Bureau of Land & C.

J. W. Reynolds

Serj-Company "B" 8th Louisiana (V. C.) Inftry

Jan. 24th 1816.

Cocoa Co. 4 adults & 13 children. = 300 potatoes?

" " 1 " 5 " = 90 "

L

Crossed Hillsbury Bet

July 17 - J. Spiny

A. Spiny + wife + child 12 --

Spiny " " 7 -
Hunters hill " " 1 -

D note " " 9 -
Mrs Long

~~Spiny + wife + child~~
Hillsbury

On account of child
Selling to No

✓

July 18

Cross

Mrs Bradford 3 chil 9-7-5

Prattas N. K. Paschal

Cross Co

Handbook 330 rotation

Handbook 6 children

Murphy 3

Mathis 1 ✓

Hamilton 3 ✓

Sledge —

Cross Co H. Wilson ✓

✓ Mrs Hines 3 chil — 90 rotation

Mrs Martha May 3 chil

✓ Mrs Hope wife 2

Mrs Blackman 3 "

Cross Co 250 rotation to J.P. Purby

Asa

✓ Mr. Jones & wife (Asa)
 - 10 persons
 Mrs. Carter - 2 children
 July 16 " Lewis 1 " "
 Mr. Smith & wife 2 " "
 Mrs. Wright 1 " "
 Mr. Johnson & wife 5 " "
 } 420 persons

Tallahassee

✓ Mrs. Bradshaw 2 children
 " Howard " "
 July 16 " Hancock 2 adults & 4 children
 " Tate 2 children
 ✓ " James 5 "

Florida

✓ July 16 Mrs. Jones 5 chil " - 4
 " " " 4 " 6 - 1
 " " " one woman
 2000 persons
 ✓ 16 Tallahassee Mrs. White
 Mrs. White one child
 " " Palmer one woman
 1200 persons

Montgomery Ala,
Feb. 12, 1866,

George Brown,
Receipt for 100
Freedmen's rations

Received 100 Freedmen's Rations of Sr. F. Garrison
Capt. Supr. Bureau of Ref. F. A. L. at Montgomery
Ala. Feb. 12th 1866. Sr. F. Garrison
Master

Witnessed.
William J. Connor
S. W. Reynolds
Capt. C. F. 8th Louisiana (C. V. Inf'y)

Montgomery Ala. Feb. 21/66
Com. Pub. (30)

Issue to Lucy Adams thirty rotions.

By order of

Miss Gene Swaine
Geo. S. Branning
Jr. & Co., D.C.

Montgomery Ala. Feb. 21, 1866
C.D. Issue to Tom Jackson 20 rotions

By order of Miss Gene Swaine
Geo. S. Branning
Jr. & Co., D.C.

Montgomery Ala.
June 19. 1867

Receipt for 2100
Sacks Corn
16 Casks Bacon from
James Henry Couley

[Faint, illegible handwritten text, likely bleed-through from the reverse side of the page.]

Montgomery, Ala. June 19th 1867
Received from Steamer Mary Conley
2100. Twenty one hundred sacks Corn
16. Fifteen Casks in Bacon (12 in Bad order)
Shuman. Duro
per W. B. Baker

State

Montgomery Al
June 19. 1866.

Receipt for 642
Sacks Corn from
Steamer "Oswego"

[Faint, illegible handwritten text, likely bleed-through from the reverse side of the page.]

Montgomery Ala. June 19th 1864
Received from Steamer Overland
642 Six hundred & forty two sacks Corn
on hand state

Lehman, Durr & Co
per A. R. Baker

Receipt for
Money

1865-1866

Receipt

Receipt for Public Funds.

~~Edwin Wright~~

Paymaster U. S. A.

, 1865 -

To Gen. A. Harman Capt. Sup't.
Bureau of Ref. F. & S. L. amount
rec'd during Oct and Nov. / 65

Received this 11th day of December 1865 at Mont-
gomery Ala. of Geo. A. Nasmorant Asst. Supt.
Bureau of P. & F. N. S.; one hundred and
ninety one dollars and seventy five cents.
as per statement of funds received by
him for rent of buildings at "Stonewall
Hospital", and by charges of twenty five
cents on each laborer employed by con-
tracts approved by him, from Oct. 10th to
Nov. 30th 1865 inclusive.

signed duplicate

Edmond Wright
Rec & Dist Officer

Receipt for money

Decr 11 - 1865

Received this 11th day of December 1865 at Montgomery
Ala. of Geo. A. Harriott Asst Superintendent
Bureau of Ref. F. & A.L. one hundred and
Ninety one dollars and Seventy five cents as per
Statement of funds received by him for rent of
Buildings at Stonewall Hospital, and by charge
of twenty five cents on each laborer employed by
contract approved by him from Oct 10th to Nov 30th
1865 inclusive -

(Signed Triplicates) Edward Wright
Rec & Dist Officer.

Montgomery Ala.

Jan'y. 67. / 1866

Dr. Col. E. Dwyer

Paymaster U. S. A.

1866

Receipts in triplicate to
S. A. H. for funds trans-
ferred. Dec 1865

Received this 6th day of February 1866 of Major
George Allen of Gen. N. Harwood's Regt. 1st
of Reg. Inf. N. L. - Eighty dollars (\$80.00) being
amount of funds received by him in the month of
December 1865. For Rents and Contracts.
The amount for Rents being \$18.00 and the amount
for Contracts \$62.00.

Edward Wright
Rec^y & Disbursing Officer.

Receipt for Public Funds
Bureau of Q. T. and A. S.

Edwin Beecher

Rec. and Dis. Off.

Feb. 1846

Received Mr. Sumner and three dollars and fifty
cents of G. N. Hammond; Asst. Supt. Bureau of Ref.
F. N. S. at Montgomery Ala. Being amount of Public
Funds reported by him as remaining in his possession
March 13th 1866.

Signed & Certified
Montgomery Ala.
March 13th 1866

Edwin Beecher
Acting Dir. Office
Bureau R. F. & A. L.

Received two hundred and three dollars and fifty cents of Geo. A. Hammond Esq. Supr. Bureau of Ref. F. and A. L. at Montgomery Ala. being amount of Public Funds reported by him as remaining in his possession March 1st 1866.

For contract with Larnum \$118.50

.. Rent of building at Newell Hospital, 85.00 \$ 203.50

Signed & Certified.
Montgomery Ala.
March 13th 1866

Edwin Beecher,
Rec. & Dis. Officer,
Bureau F. & A. L.

Revised the contract entered into between
Dr. Guigg and certain free men -
on the 1st July 1866.

J. V. Sayre

Receipt for money

Jan'y 6-1866

Received this 6th day of January 1866 at New York
City at the office of Gen. S. W. Hammondt - Jpt. Supt. Bureau
of Dep. Jan. N. S. - Eighty dollars (\$80.00)
being amount of funds received by him in
the month of December 1865 for "Rents
and Contracts". The amount for Rents being
\$18.00 and the amount for Contracts \$62.00

Edward Wright
Rec^d & Dist Officer

Receipts for Public Funds.

Commissioner, State of Alabama,
BUREAU OF REFUGEES, FREEDMEN AND ABANDONED LANDS.
Office Assistant

1866.

Edwin Beecher

Paymaster U. S. A.

Montgomery,

July 3 - 1866

To Gen. A. Hammon - Capt.
Sub. Bureau of R. F. A. H. J.
Amt. Received by him in Jan'y / 66

Received three hundred and thirty seven dollars
and fifty cents of Geo. N. Hammond. Genl.
Supt. Bureau of Ref. Fund N. S. at Montgomery
Ala. February 3rd 1862. Being amount of funds
reported by him as remaining on hand Feb.
1st 1862.

Edwin Beecher

Rec. & Dis. Officer.

Signed in duplicate.

Received three hundred and thirty seven dollars
and fifty cents of Geo. A. Harncomb Asst.
Supt. Bureau of Inf. Serv. N. L. at Newbury Ann.
February 3rd 1866. Being amount of funds
reported by him as remaining on hand Feb. 1st
1866.

Edwin Beecher.

Signed in triplicate.

Rec. & Dis. Officer, &c.

Montgomery Ala.

April 6th 1866.

✓
Geo. A. Varnum
Asst. Supt. Bureau R. F. A. S.
From
Edwin Bercher
Recd. Dis. Off.

For Public Funds Received
in March 1866.

Received one hundred and forty three dollars
and twenty five cents of G. E. A. Hammond -
Asst. Surg. General of Reg. T. & A. S. of Montgomery
Ala. this 6th day of April 1862. amount of
Public Funds received by him during the Month
of March 1862, as per Report - for that Month.
viz: In contracts with Merchants.

Edwin Beecher
Chf. Disbursing Officer, &c.

Received ~~One~~ hundred and forty three dollars and
twenty five cents of Sec. A. Hammond - Apt.
Supt. Bureau of Ref. Fin. N. S. at Montgomery
Ala. this 6th day of April 1862. amount of
Public Funds received by him during the Month of
March 1862. as per Report for that Month.
viz: On contracts with ~~himself~~.

Edwin Beecher

Chief Disbursing Officer, &c.

Receipt for Money

June 8-1866

Received seventy dollars and twenty five cents of
Geo. A. Harmond Agent. Supr. Bureau of Ref.
Fund A. L. at Montgomery Ala. this 8th day of June
1866.

For Registering Contracts \$20.25
" Rent of Rooms at "Small Hospital" \$50.00

Edwin Becker

Ch. of Dist. Office

B. R. F. & Co. L.

Received twenty dollars and twenty five cents of
Geo. A. Hammond Asst. Supr. Bureau of Ref. Funds
A. L. at Montgomery Ala. this 8th day of June
1866.

For Registering Contracts \$20.25
" Rent of Room at St. Ann's Hospital \$50.00

Edwin Beecher.

Chf. Disg. Officer

B. R. F. & A. L.

Received seventy dollars and twenty five cents
of Gen. A. Harmonist Asst. Supr. Bureau of Ref.
Gen. A. L. at Montgomery Ala. this 8th day of
June 1866.

For Registering Contracts \$25.25

1 Rent of Rooms at Small Hospital \$50.00

Edwin Beecher,

Ch. of Discy Office

S. R. F. A. S.

Receipt for Money
July 1-1866

Received fifty four dollars of Geo. A. Har-
mount Asst. Supr. Bureau of Ref. T. & A. at
Montgomery Ala. this 18th day of July 1866
being balance of Public Funds reported in
his Report July 1st 1866

Hand Rent of Building at Small Hospital.

Edwin Beecher,

Chf. Dirg. office

18. R. F. & A. S.

Received forty four dollars of Geo. J. -
Hammont - Asst. Supr. Bureau of Ref. F.
and A. L. at Montgomery Ala. this 18th day
of July 1868 being amount - balance of Currier
Funds reported in his report July 1st/68.
From Rent of building at Turner Hospital.

Edwin Beecher.

(Signed in triplicate)

Ch. Div. Officer.
B. R. F. & A. L.

Received July four dollars of Geo. A. Hammond.
Act. Supr. Bureau of Ref. Mass. S. at Springfield
Mass. This 18th day of July 1865 being balance
of Public Funds reported in his report on
July 1st 1865.

From Rent of building at Sturrowall Hospital.

Edwin Beecher,

Chief Disg. Officer

B. R. F. & A. S.

Roll 26

Target 4

SUBORDINATE FIELD OFFICES
Montgomery (Freedmen's Hospital)

Letters Sent by Surgeon
Volume (98) Jan.-Nov. 1867

NO 98 FREEDMENT'S HOSP LETTERS SENT JAN-NOV 1867
B OF R.F. AND A.L.
MONTGOMERY, ALABAMA.

Fredericks Hospital
Montgomery Ala January 2nd 1867

Sir

I have the honor to transmit herewith enclosed
Semi Annual Returns ending December 31. 1866
And to state that the over issue of S. O. Rutter
Spe Nit. was made by mistake out of Sanitary
Supplies for which I was not responsible.

I am for very Respectfully
Your Obedt Servt
D. Schatz
W. W. Surgeon of Army
in Charge

Post Maj Genl Joseph K. Barnes
Surgeon General United States Army
Washington D. C.

Fredericks Hospital
Montgomery Ala January 3rd 1867

Sir

I have the honor to transmit herewith enclosed
Duplicate of my Semi Annual Return for the
half year ending December 31st 1866.

The original was forwarded by yesterday's
mail.

I have the honor to be for very Respectfully
Your Obedt Servt
D. Schatz
W. W. Surgeon of Army
in Charge

Post Maj Genl Joseph K. Barnes
Surgeon General United States Army
Washington D. C.

Freedmens Hospital
Montgomery Ala April 13th 1867

Port Lt Col John J. Kipp Lt
Surgeon in Chief Dist of Ala
Montgomery Ala

I have the honor to
Enclose herewith Return of Medical and Hospital
property Form 46. Officers Manual, for the
Quarters ending March 31st 1867.

I Am Sir Very Respectfully
Yours Obedt Servt
D. Schatz
W. W. Surgeon U.S. Army

Freedmens Hospital
Montgomery Ala April 13th 1867

Port Lt Col John J. Kipp Lt
Surgeon in Chief Dist of Ala
Montgomery Ala

I have the honor to
Enclose herewith Report of Sick and Wounded in
Freedmens Hospital for the week ending April 13th 1867

I Am Sir Very Respectfully
Yours Obedt Servt
D. Schatz
W. W. Surgeon U.S. Army

Freedmens Hospital
Montgomery Ala April 13th 1867

Port Maj L B White
Asst Surg U.S. Army
W. W. Med Purveyor
New Orleans La

I have the honor to
transmit herewith enclosed Receipt for Medical
and Hospital Supplies which reached here safe
and in good Condition.

I Am Sir Very Respectfully
Yours Obedt Servt
D. Schatz
W. W. Surgeon U.S. Army

Freedmens Hospital
Montgomery Ala April 15th 1867

Port Lt Col John J. Kipp Lt
Surgeon in Chief Dist Ala
Montgomery Ala

I have the honor to
Enclose herewith reports of Attendants in
Freedmens Hospital for the Month ending April
15th 1867.

I Am Sir Very Respectfully
Yours Obedt Servt
D. Schatz
W. W. Surgeon U.S. Army
in Charge

4.

Freedmen Hospital
Montgomery Ala April 15th 1867

Bot Lt Col Ch. J. Kipp M.D.
Surgeon in Chief. Dist of Ala
Montgomery Ala

I have the honor to
enclose herewith Returns of Articles purchased with
Hospital Fund Freedmen Hospital Montgomery Ala
Corrected, for the Quarter ending March 31st 1867

I am Sir Very Respectfully
Yours Obedt Servt
D. Schatz.
W. W. Surgeon U.S. Army

Freedmen Hospital
Montgomery Ala April 20th 1867

Bot Lt Col Ch. J. Kipp M.D.
Surgeon in Chief. Dist of Ala
Montgomery Ala

I have the honor to
enclose herewith Report of Sick and Wounded
in Freedmen Hospital for the week ending April
20th 1867.

I am Sir Very Respectfully
Yours Obedt Servt
D. Schatz.
W. W. Surgeon U.S. Army
in Charge

5

Freedmen Hospital
Montgomery Ala April 22nd 1867

Bot Lt Col Ch. J. Kipp M.D.
Surgeon in Chief. Dist of Ala
Montgomery Ala

I have the honor to
request that a Board of Survey be ordered to convene
at this place to determine upon the case of one Case
of Spt Vini Gallicci, Injured to me by H. E. Williams
a Surgeon U.S. Army, for which I am responsible and
which I find to be Wated.

I am Sir Very Respectfully
Yours Obedt Servt
D. Schatz.
W. W. Surgeon U.S. Army

Freedmen Hospital
Montgomery Ala Apr 27. 67

Bot Lt Col Ch. J. Kipp M.D.
Surgeon in Chief Dist of Ala
Montgomery Ala

I have the honor to
enclose herewith report of Sick and Wounded in
Freedmen Hospital for the week ending April 27th
1867.

I am Sir Very Respectfully
Yours Obedt Servt
D. Schatz
W. W. Surgeon U.S. Army
in Charge

6.

Freedmens Hospital
Montgomery Ala April 30th 1867

Post Lt Col Chas J. Kipp M.D.
Surgeon in Chief Dist of Ala
- Montgomery Ala

Sir

I have the honor to
enclose herewith personal report for the month
ending April 30th by Ala report of Attendance
at Freedmens Hospital for the month ending
April 30th 1867.

I am Sir Very Respectfully
Your Obedt Servt
D. Schatz

W. W. Surgeon U.S. Army

Freedmens Hospital
Montgomery Ala May 1st 1867

Post Lt Col Chas J. Kipp M.D.
Surgeon in Chief District of Ala
Montgomery Ala

Sir

I have the honor to
enclose herewith Report of Sick and Wounded at
Freedmens Hospital for the month of April 1867 also
Report of "Unfortunates" among the Colored population at
Montgomery County of Montgomery State of Ala.

I am Sir Very Respectfully
Your Obedt Servt
D. Schatz

W. W. Surgeon U.S. Army

7

Freedmens Hospital
Montgomery Ala May 4th 1867

Post Lt Col Chas J. Kipp M.D.
Surgeon in Chief District of Ala
Montgomery Ala

Sir

I have the honor to
enclose herewith report of Sick and Wounded in
Freedmens Hospital for the week ending May 4th 1867

I am Sir Very Respectfully
Your Obedt Servt
D. Schatz

W. W. Surgeon U.S. Army

Freedmens Hospital
Montgomery Ala May 9th 1867

Post Lt Col Chas J. Kipp M.D.
Surgeon in Chief - Dist of Ala
Montgomery Ala

Sir

I have the honor to
enclose herewith Statement of the Hospital Fund
of Freedmens Hospital at Montgomery Ala for the
Month ending April 30th 1867.

I am Sir Very Respectfully
Your Obedt Servt
D. Schatz

W. W. Surgeon U.S. Army

8

Freedmens Hospital
Montgomery Ala May 11th 1867

Brig Lt Col Chas. J. Kipp M.D.
Surgeon in Chief - Dist of Ala
Montgomery Ala

Sir

I have the honor to
enclose herewith Report of Sick and Wounded in
Freedmens Hospital Montgomery Ala for the week
ending May 11th 1867.

I am Sir Very Respectfully
Yours Obedt Servt
D. Schatz

W. W. Surgeon M.D.
in Charge

9

Freedmens Hospital
Montgomery Ala May 15th 1867

Brig Lt Col Chas. J. Kipp M.D.
Surgeon in Chief - Dist of Ala
Montgomery Ala

Sir

I have the honor to
enclose herewith report of attendants at Freedmens
Hospital Montgomery Ala for the month ending May 15th 1867

I am Sir Very Respectfully
Yours Obedt Servt
D. Schatz

W. W. Surgeon M.D.
in Charge

Freedmens Hospital
Montgomery Ala May 14th 1867

Brig Lt Col Chas. J. Kipp M.D.
Surgeon in Chief - Dist of Ala
Montgomery Ala

Sir

I have the honor to
enclose herewith report of destitute discharged
soldiers and their Families who have been treated in
Freedmens Hospital at Montgomery Ala for the
month ending April 30th 1867.

I am Sir Very Respectfully
Yours Obedt Servt
D. Schatz

W. W. Surgeon M.D.
in Charge

Freedmens Hospital
Montgomery Ala May 16th 1867

Brig Lt Col Chas. J. Kipp M.D.
Surgeon in Chief - Dist of Ala
Montgomery Ala

Sir

I have the honor
to enclose herewith - Monthly Statement of Hospital
Fund of Home leading Hospital Near Montgomery
Ala for the month ending April 30th 1867.

I am Sir Very Respectfully
Yours Obedt Servt
D. Schatz

W. W. Surgeon M.D.
in Charge

16.

I Meddons Hospital
Montgomery Ala May 18th 1867

Prot. Maj. G. B. White
Asst Surg. & Acty Asst Med Purveyor
New Orleans La
Sir

I have the honor to acknowledge the receipt of your communication asking for information in regard of a certain box of Spts Vin Gallie's and found to be water - In reply would state that the box of Spts referred to was not invoiced by you to me at all: but was received among other Medical Stores from W. W. Surgeon at E. Williams M.D. in Sept last -

I would also state although I accepted in full for the stores sent to me by you on April 27/67 - there was a deficiency of 3 bottles of Whiskey and 2 Barrels and in the Invoice of the previous Quarter there was also a deficiency of 6 1/2 lbs of Castile Soap and 3 bottles of Brandy. I mention these facts to show you that these supplies are tampered with either in the packing department or during transportation

I have the honor to be for
Your Obedt Servt

Prot. Maj. W. W. Surgeon
of Army

11

Home Colony Hospital
Montgomery Ala May 18th 1867

Prot Lt Col Chas. J. Kipp
Surgeon in Chief - District of Ala
Montgomery Ala
Sir

I have the honor to enclose herewith Special Requisition for your approval for Home Colony Hospital Montgomery Ala

I am Sir Very Respectfully
Your Obedt Servt

W. W. Surgeon of Army
in Charge

Home Colony Hospital
Montgomery Ala May 18th 1867

Prot Lt Col Chas. J. Kipp
Surgeon in Chief - District of Ala
Montgomery Ala
Sir

I have the honor to enclose herewith Report of Sick and Wounded in Freedmens Hospital and Home Colony Hospital for the week ending May 18th 1867.

I am Sir Very Respectfully
Your Obedt Servt

W. W. Surgeon of Army
in Charge

Freedom Hospital
Montgomery Ala May 22nd 1867

18
Port Lt Col L. J. Kipp M.D.
Surgeon in Chief - District of Ala
Montgomery Ala

Sir
I have the honor to
enclose Report of Attendance (Corrected) Employed at Freedom
Hospital and Home Colony Hospital Montgomery Ala
during the month ending May 15th 1867-

I am Sir Very Respectfully
Your obt Servant
D. Schatz
W. A. Surgeon U.S. Army
in Charge

Freedom Hospital
Montgomery Ala May 29th 1867

Port Major C. B. White
Asst. Surgeon U.S.A. & W. M. Puryear
New Orleans La

Sir
I have the honor to
enclose herewith Receipt for Medicine & Hospital Supplies
Invoiced by you to Com. C. Badger U.S.A. Surgeon which reached here
safe and in good Condition. Dr Badger was relieved
from duty on the 15th of this month and the stores were
turned over to me by order of Dr Kipp - Surgeon in Chief -
You will please alter the name on your papers and
send the Invoice to me.

Yrs Obedt Servant
Port Major U.S.A. & W. M. Puryear

Freedom Hospital 13
Montgomery Ala May 30th 1867

Sir
In Compliance with your instructions under date May
14th 1867. I have the honor to enclose herewith Invoice of U.S.A.
Surgeon H. E. Williams U.S.A. of date Sept 1st 1866. also Certified
Copy of Invoice of Asst Surgeon C. B. White U.S.A. & Medical Purveyor
of date June 28th 1866. (The original having been forwarded to
you on the 17th of November 1866. Enclosed please find Copy of
Letter from your Office of date November 23rd 1866.

I am Sir Very Respectfully
Your obt Servant
D. Schatz
Port Major U.S.A. & W. M. Puryear

L. W. Edwards
Surgeon U.S.A. Port Col
Chief Med Officer

"This Surgeon in Chief
District of Alabama
Montgomery Ala.

Freedom Hospital
Montgomery Ala June 1st 1867

Port Lt Col L. J. Kipp M.D.
Surgeon in Chief Dist of Ala
Montgomery Ala

Sir
I have the honor to enclose
herewith Report of Sick and Wounded in Freedom Hospital
and Home Colony Hospital for the week ending June 1st 67
I am Sir Very Respectfully
Your obt Servant
D. Schatz
Port Major U.S.A. & W. M. Puryear

14.

Freedmens Hospital
Montgomery Ala June 3rd 1867

Bot Lt Col Chas J. Kipp upr
Surgeon in Chief - District of Ala
Montgomery Ala
Sir

I have the honor
to enclose herewith Report of Sick & Wounded
in Freedmens Hospital and Home Colony Hospital
Montgomery Ala for the Month of May 1867.

I am Sir Very Respectfully
Yours Obed Servt

Bot Maj Wm T. A. Sney upr

Freedmens Hospital 15
Montgomery Ala June 6th 1867

Bot Lt Col Chas J. Kipp upr
Surgeon in Chief - District of Ala
Montgomery Ala
Sir

I have the honor to transmit
herewith enclosed - Report of deaths to discharged soldiers
and their families who have been treated in Freedmens
Hospital and Home Colony Hospital at Montgomery
District of Alabama for the Month ending May 31st 1867

I am Sir Very Respectfully
Yours Obed Servt

Bot Maj Col T. W. Sney upr

Freedmens Hospital
Montgomery Ala June 6th 1867

Bot Lt Col Chas J. Kipp upr
Surgeon in Chief - District of Ala
Montgomery Ala
Sir

I have the honor to
transmit herewith enclosed Statement of Hospital
Fund of Freedmens Hospital Montgomery Ala
for the Month of May 1867.

I am Sir Very Respectfully
Yours Obed Servt

Bot Maj Wm T. A. Sney upr

Freedmens Hospital
Montgomery Ala June 7th 1867

Bot Lt Col Chas J. Kipp upr
Surgeon in Chief - District of Ala
Montgomery Ala
Sir

I have the honor to trans-
mit herewith enclosed Statement of Hospital Fund
of Home Colony Hospital Montgomery Alabama
for the Month of May 1867.

I am Sir Very Respectfully
Yours Obed Servt

Bot Maj Wm T. A. Sney upr

16.

Home Colony Hospital
Montgomery Ala June 11th 1867.

Lt D. H. Williams
W. W. W. Genl
Sir

I have the honor to call your attention in relation to the Beef now furnished to these Hospitals - that prior to May the beef was of fair average quality - recently I have learned that the Contract calls for Tennessee beef - I presume that as usual with Contracts of this kind calls for an equal proportion of fine & hind quarters - I do not think that I receive such beef & what I do receive is of an inferior quality - particularly since the 1st of May - being of Young Cattle & mostly fine quarters - in this connection I would respectfully ask that the Hospitals were charged 18 1/2 Cents per pound - till the 1st of May - since which time the price increased to 16 Cents per pound - while the Sub Contractor who furnishes the beef - receives only nine Cents per pound - these of itself should show that it is impossible that the Hospitals receive such beef as it should receive when the government pays for the same 10 Cents.

I trust that this matter will receive your early attention.

Yours Very Respectfully
D. Schatz
Port Major W. W. W. Surg. U.S.A.
in Charge.

17
Freedmens Hospital
Montgomery Ala June 15th 1867

Port Lt Col Geo. J. Kipp U.S.A.
Surgeon in Chief - District of Ala
Montgomery Ala
Sir

I have the honor to transmit herewith enclosed. Report of Sick and Wounded Refugees and Freedmen in Freedmens Hospital and Home Colony Hospital for the week ending Saturday June 15th 1867. Also Report of attendants for the month ending June 15th 1867.

I am Sir Very Respectfully
Your Obedt Servt
D. Schatz
Port Major W. W. W. Surg. U.S.A.

Freedmens Hospital
Montgomery Ala June 22nd 1867

Port Lt Col Geo. J. Kipp U.S.A.
Surgeon in Chief - District of Alabama
Montgomery Ala
Sir

I have the honor to enclose herewith. Report of Sick and Wounded Refugees and Freedmen in Freedmens and Home Colony Hospital for the week ending Saturday June 22nd 1867.

I am Sir Very Respectfully
Your Obedt Servt
D. Schatz
W. W. W. Surg. U.S.A.

Freedom Hospital
Montgomery Ala June 24th 1867

Bot Lt Col Ch. J. Kipp M.D.
Surgeon in Chief District of Ala
Montgomery Ala

Sir

I have the honor to state that I am entirely out of rags: at both Hospitals. and have a lot of shirts, drawers and pillow Cases worn and unfit for use and would respectfully ask if I can make use of them. and have them condemned afterwards - if not how can I procure some. as I have a great many Chronic and bed sore Cases on hand.

I am Sir Very Respectfully
Your Obedt Servt
D. Schatz
W. W. Surgeon U.S.A.

Freedom Hospital
Montgomery Ala June 29th 1867

Bot Lt Col Ch. J. Kipp M.D.
Surgeon in Chief District of Ala
Montgomery Ala

Sir

I have the honor to transmit herewith enclosed. Report of Sick and Wounded Refugees and Freedmen in Freedom and Home Colony Hospital. for the week ending Saturday June 29. 1867.

I am Sir Very Respectfully
Your Obedt Servt
D. Schatz
W. W. Surgeon U.S.A.

Freedom Hospital
Montgomery Ala July 1st 1867

Bot Lt Col Ch. J. Kipp M.D.
Surgeon in Chief Dist of Ala
Montgomery Ala

Sir

I have the honor to transmit herewith enclosed. Report of Sick and Wounded Refugees and Freedmen in Freedom and Home Colony Hospital for the month ending June 30th 1867. Report of Discharged Soldiers and their families who have been treated in Freedom and Home Colony Hospital in the month of June 1867. Personal Report for June 1867. Also Return of Articles purchased out of Hospital Funds of Freedom and Home Colony Hospital for the Quarter ending June 30th 1867.

I am Sir Very Respectfully
Your Obedt Servt

W. W. Surgeon U.S.A.

Freedom Hospital
Montgomery Ala July 3rd 1867

Bot Lt Col Ch. J. Kipp M.D.
Surgeon in Chief Dist of Ala
Montgomery Ala

Sir

I have the honor to transmit herewith enclosed Requisition for Medical and Hospital Supplies for your approval for Freedom and Home Colony Hospital for the Quarter ending September 30th 1867.

I am Sir Very Respectfully
Your Obedt Servt

W. W. Surgeon U.S.A.

20

Freedmens Hospital
Montgomery Ala July 6th 1867

Brig Genl Chas J. Kipp Major
Surgeon in Chief District of Ala
Montgomery Ala

Sir
I have the honor to
transmit herewith enclosed Report of Sick and Wounded
in Freedmens and Home Colony Hospitals for the
week ending Saturday July 4th 1867.

I am Sir Very Respectfully
Yours Obedt Servt
D. Schatz.
W. W. Surgeon M.F.A.
in Charge

21

Freedmens Hospital
Montgomery Ala July 9th 1867

Surgeon L. W. Edwards M.F.A.
Brig Genl + Chief Med Officer
B. R. F and W. Lando
Washington D.C

Sir
I have the honor to transmit
you with enclosed duplicate Return of Medical and
Hospital Property Received Issued and Remaining
on hand at Freedmens and Home Colony Hospitals at
Montgomery District of Alabama for the half year ending
June 30th 1867.

I am Sir Very Respectfully
Yours Obedt Servt
D. Schatz.
W. W. Surgeon M.F.A.
in Charge

Freedmens Hospital
Montgomery Ala July 8th 1867

Surgeon L. W. Edwards M.F.A.
Brig Genl + Chief Med Officer
B. R. F and W. Lando - Washington D.C

Sir
I have the honor to transmit
herewith enclosed Return of M. & Hospital Property Received
expended - Issued - and Remaining on hand at Freedmens
and Home Colony Hospitals at Montgomery - District of
Alabama for the half year ending June 30th 1867 also
Vouchers No 1 to 10 for the same - duplicate Return
will be forwarded by tomorrow's Mail

I am Sir Very Respectfully
Yours Obedt Servt
D. Schatz.
W. W. Surgeon M.F.A.
in Charge

Freedmens Hospital
Montgomery Ala July 9th 1867

Brig Genl Chas J. Kipp Major
Surgeon in Chief Dist of Ala
Montgomery Ala

Sir
I have the honor to
transmit herewith enclosed - Statement of the Hospital
Funds of Freedmens and Home Colony Hospitals
at Montgomery Dist of Ala - for the month ending
June 30th 1867.

I am Sir Very Respectfully
Yours Obedt Servt
D. Schatz.
W. W. Surgeon M.F.A.
in Charge

94

Freedom Hospital
Montgomery Ala July 20th 1867.

Bot Lt Col Chas. J. Kipp USV
Surgeon in Chief - District of Ala
Montgomery Ala

Sir
I have the honor to transmit
herewith enclosed Report of Sick and Wounded Refugees
and Freedmen in Freedom and Home Colony Hospitals
for the week ending Saturday July 20th 1867.

I am Sir Very Respectfully
Your Obedt Servt

W. W. Surgeon USV

Freedom Hospital
Montgomery Ala July 20th 1867

Bot Major L. B. White
Asst Surg & Med Purveyor USV
New Orleans La

Sir
I have the honor to transmit
herewith enclosed Receipt for Medical Supplies which
reached here safe and in good Condition

I am Sir Very Respectfully
Your Obedt Servt

W. W. Surgeon USV

Freedom Hospital
Montgomery Ala July 27th 1867

Bot Lt Col Chas. J. Kipp USV
Surgeon in Chief - District of Ala
Montgomery Ala

Sir
I have the honor to
transmit herewith enclosed Report of Attendants
employed at Freedom and Home Colony Hospitals
Montgomery Ala for the month ending July 27th 1867 also
personal report for July 1867.

I am Sir Very Respectfully
Your Obedt Servt

W. W. Surgeon USV

Freedom Hospital
Montgomery Ala July 27th 1867

Bot Lt Col Chas. J. Kipp USV
Surgeon in Chief - District of Ala
Montgomery Ala

Sir
I have the honor to
transmit herewith enclosed Report of Attendants
employed at Freedom and Home Colony Hospitals
Montgomery Ala for the month ending July 27th 1867 also
personal report for July 1867.

I am Sir Very Respectfully
Your Obedt Servt

W. W. Surgeon USV

J. S.

Anderson Hospital
Montgomery Ala Aug 3rd 1867

Port Lt Col Chas. J. Kipp Major
Surgeon in Chief - District of Ala
Montgomery Ala

Sir

I have the honor to
transmit herewith enclosed Report of Sick and
Wounded in Anderson and Home Colony Hospitals
Montgomery Alabama for the month ending July 31st 1867
also Report of Discharge of Soldiers &c who
have been treated during the month of July 1867.

I am Sir Very Respectfully
Yours obt Servt
D. Schatz.
W. W. Surgeon Major
in Charge

Home Colony Hospital
Montgomery Ala Aug 10th 1867

Port Lt Col Chas. J. Kipp Major
Surgeon in Chief - Dist of Ala
Montgomery Ala

Sir

I have the honor
to transmit herewith enclosed Report of Sick & Wounded
in Home Colony Hospital Montgomery Ala for the
week ending Saturday August 10th 1867

I am Sir Very Respectfully
Yours obt Servt
D. Schatz.
W. W. Surgeon Major

J. S.

Home Colony Hospital
Montgomery Ala Aug 15th 1867

Port Lt Col Chas. J. Kipp Major
Surgeon in Chief - Dist of Ala
Montgomery Ala

Sir

I have the honor to transmit
herewith enclosed Report of Attendants Employed at
Home Colony Hospital Montgomery Ala for the month
ending on the 15th of August 1867.

I am Sir Very Respectfully
Yours obt Servt
D. Schatz.
W. W. Surgeon Major

Home Colony Hospital
Montgomery Ala Aug 17th 1867

Port Lt Col Chas. J. Kipp Major
Surgeon in Chief - Dist of Ala
Montgomery Ala

Sir

I have the honor
to transmit herewith enclosed Report of
Sick & Wounded in Home Colony Hospital
Montgomery Ala for the week ending Saturday
August 17th 1867.

I am Sir Very Respectfully
Yours obt Servt
D. Schatz.
W. W. Surgeon Major

28.

Home Colony Hospital
Montgomery Ala Aug 23rd 1867

Bot Lt Col Geo. J. Kipp upr
Surgen in Chief - District of Ala
Montgomery Ala

Sir

I have the honor
to transmit herewith enclosed. Statement of the
Hospital Fund of Freedmens and Home Colony
Hospital Montgomery Alabama for the month
ending Aug July 31st 1867.

I am Sir Very Respectfully
Your obt Servt
D. Schatz
W W Surgen upr
in Charge

Home Colony Hospital
Montgomery Ala Aug 24th 1867

Bot Lt Col Geo. J. Kipp upr
Surgen in Chief - District of Ala
Montgomery Ala

Sir

I have the honor to
transmit herewith enclosed Report of Sick and Wounded
in Home Colony Hospital - Montgomery Alabama
for the week ending August 24th 1867.

I am Sir Very Respectfully
Your obt Servt
D. Schatz
W W Surgen upr
in Charge

29

Home Colony Hospital
Montgomery Ala Aug 25th 1867

Bot Lt Col Geo. J. Kipp upr
Surgen in Chief - Dist of Ala
Montgomery Ala

Sir

In Compliance with your
instructions of the 24th inst. I have the honor to transmit
herewith enclosed Copy of Invoice of Medical and
Hospital property transferred to me by Bot Major S.
Eldridge Acting Medical Store Keeper Washington D.C.

I would also state that the above mentioned
property has not yet been received.

I am Sir Very Respectfully
Your obt Servt
D. Schatz.
W. W. Surgen upr

Home Colony Hospital
Montgomery Ala Aug 27th 1867

Bot Major S. Eldridge
Acty Medical Store Keeper
Washington D. C.

Sir

I have the honor to transmit
herewith enclosed. Receipt for Medical Property received by
you on the 19th of last month. which reached here (yest
-day. Safe and in good Condition

I am Sir Very Respectfully
Your obt Servt
D. Schatz.
W. W. Surgen upr

30

Home Colony Hospital
Montgomery Ala Aug 31st 1867

Bot Lt Col Chas J. Kipp up
Surgeon in Chief District of Ala
Montgomery Ala

Sir

I have the honor
to transmit herewith enclosed Report of Sick and
Wounded Refugees and Prisoners in Home Colony
Hospital Montgomery Ala for the week ending
Saturday August 31st 1867

I am Sir Very Respectfully
Your Obedt Servt

D. Schatz
W. W. Surgeon U.S. Army
in Charge

Home Colony Hospital
Montgomery Ala Sept 1st 1867

Bot Lt Col Chas J. Kipp up
Surgeon in Chief Dist of Ala
Montgomery Ala

Sir

I have the honor to transmit
herewith enclosed Report of Sick and Wounded Refugees &
Prisoners in Home Colony Hospital for the month ending Oct 31st 1867
Personal Report Report of prison hands - also Report of Abolitionists
discharged folden to treatise during the month ending Oct
31. 1867.

I am Sir Very Respectfully
Your Obedt Servt

D. Schatz
W. W. Surgeon U.S. Army
in Charge

31

Home Colony Hospital
Montgomery Ala Sept 4th 1867

Bot Lt Col Chas J. Kipp up
Surgeon in Chief Dist of Alabama
Montgomery Ala

Sir

I have the honor to
transmit herewith enclosed Report of Sick and Wounded
in Home Colony Hospital Montgomery Ala for the week
ending Saturday September 4th 1867.

I am Sir Very Respectfully
Your Obedt Servt

D. Schatz
W. W. Surgeon U.S. Army
in Charge

Home Colony Hospital
Montgomery Ala Sept 10th 1867

Bot Col L. W. Edwards
Surgeon U.S. Army
Chief Medical Officer
Washington D.C.

Sir

In Compliance with
Your instructions of the 5th inst - I have the honor to
transmit herewith enclosed Copy of Receipt of Medical
and Hospital property received by me from Bot Major
S. Eldridge W. M. L. of date July 16th 1867. The Original has
- my been forwarded to S. Eldridge

I am Sir Very Respectfully
Your Obedt Servt

Mrs
Surgeon in Chief
District of Alabama.

D. Schatz
W. W. Surgeon U.S. Army

32

Home Colony
Montgomery Ala Sep 14th 1866

Bot Lt Col Geo J Kipp up
Surgeon in Chief Dist of Alabama
Montgomery Ala

Sir

I have the honor
to transmit herewith enclosed Report of persons
killed in Home Colony - Montgomery Alabama
during the month of September 1866.

I am Sir Very Respectfully
Yours Obed Servant
D. Schatz
W. W. Day M.D.
in Charge

Home Colony Hospital
Montgomery Ala Sep 19th 1867

Bot Lt Col Geo J Kipp up
Surgeon in Chief Dist of Ala
Montgomery Ala

Sir

In Compliance
with your communication of the 17th inst I have the
honor to state that all the Hospital property re-
ceived to me by Bot Maj S. Edridge came in boxes
with the exception of Pillows and Mattresses - The
Boxes were all in good condition when received
The boxes of Mattresses and Pillows were all broken
and lying loose in the Warehouse - but Bot W. W. Day
the Quarters Warden Chief Clerk. Counted out the number
arrived to me from the broken boxes.

I am Sir Very Respectfully
Yours Obed Servant
D. Schatz
W. W. Day M.D.
in Charge

33

Home Colony
Montgomery Ala Sep 21st 1867

Bot Lt Col Geo J Kipp up
Surgeon in Chief Dist of Ala
Montgomery Ala

Sir

I have the honor to
transmit herewith enclosed Report of Sick & Wound
in Home Colony Hospital for the week ending Saturday
Sep 21st 1867.

I am Sir Very Respectfully
Yours Obed Servant
D. Schatz
W. W. Day M.D.
in Charge

Home Colony
Montgomery Ala Sep 23rd 1867

Bot Lt Col Geo J Kipp up
Surgeon in Chief Dist of Ala
Montgomery Ala

Sir

I have the honor to trans-
mit herewith enclosed statement of Fund of Home Colony
Hospital Montgomery Ala for the month of Aug^t 1867.
also Requisition for Medical Supplies for the Quarter
ending Dec 1867 for your approval.

I am Sir Very Respectfully
Yours Obed Servant
D. Schatz
W. W. Day M.D.
in Charge

34

Home Colony Hospital
Montgomery Ala Sep 24th 1867

Bot Lt Col Chas J. Kipp upr
Surgeon in Chief Dist of Ala
Montgomery Ala

Sir

I have the honor to request that an order be issued to Lt J. S. Judd u.c. to transfer the Hospital Fund of Meriden Hospital to Home Colony Hospital -

I am Sir Very Respectfully
Your Obedt Servt
D. Schatz
W. W. Day M.D.
in Charge

Home Colony Hospital
Montgomery Ala Sep 28th 1867

Bot Lt Col Chas J. Kipp upr
Surgeon in Chief Dist of Ala
Montgomery Ala

Sir

I have the honor to transmit herewith enclosed Report of Sick & Wounded in Home Colony Hospital Montgomery Ala for the week ending Saturday Sep 28th 1867

I am Sir Very Respectfully
Your Obedt Servt
D. Schatz
W. W. Day M.D.
in Charge

35

Home Colony Hospital
Montgomery Ala Sep 30th 1867

Bot Lt Col Chas J. Kipp upr
Surgeon in Chief Dist of Ala
Montgomery Ala

Sir

I have the honor to request that the following blanks be furnished this Hospital - for the Quarter ending Dec 31. 1867

- | | |
|---|----------|
| Weekly Reports of Sick & Wounded | 26 |
| Monthly do do do | 18 |
| Report of Attendants | 16 |
| Pay Roll of Attendants | 6 |
| Personal Pay Rolls | 6 |
| Personal Reports | 3 |
| Requisition for Med & Hosp Supplies | Sett - 1 |
| Semi Annual Return of Med & Hosp property | Sett - 1 |
| Report of Person Killed | 16 |

I am Sir Very Respectfully
Your Obedt Servt
D. Schatz
W. W. Day M.D.

Home Colony Hospital
Montgomery Ala Oct 2nd 1867

Bot Lt Col Chas J. Kipp upr
Surgeon in Chief Dist of Ala
Montgomery Ala

Sir

I have the honor to transmit herewith enclosed Report of Sick & Wounded in Home Colony Hospital Ala for the month ending Sep 30/67. Report of Person Killed Report of Attendants. Return of Articles purchased for the Qu ending Sep 30/67. Personal Report also Requisition for blanks for Qu ending Dec 31/67

I am Sir Very Respectfully
Your Obedt Servt
D. Schatz
W. W. Day M.D.

36

Home Colony Hospital
Montgomery Ala Oct 5th 1867

Post Lt Col John J. Kipp upr
Surgeon in Chief District of Ala
Montgomery Ala

Sir

I have the honor
to transmit herewith the enclosed Report of Sick and
Wounded in Home Colony Hospital for the
week ending Saturday Oct 5th 1867.

I am Sir Very Respectfully
Your Obedt Servt
D. Schatz.
W. W. Surg M. A. C.
in Charge

Home Colony Hospital
Montgomery Ala Oct 4th 1867

Majr C. D. Kinoman
Sub Asst Comm in Chief
Montgomery Ala

Sir

I have the honor to request
that the Quartermaster be ordered to furnish clothing
for the destitute Freedmen in this Hospital as follows:
Mens Coats - or Blankets & Pants of each 50
Boys Blankets - Pants & Shoes of each 50
Also Five large stoves to heat the Wards
of this Hospital.

The above are greatly needed, as many of
the patients are almost naked.

I am Sir Very Respectfully
Your Obedt Servt
D. Schatz.
W. W. Surg M. A. C.

37

Home Colony Hospital
Montgomery Ala Oct 12th 1867

Post Lt Col John J. Kipp upr
Surgeon in Chief District of Ala
Montgomery Ala

Sir

I have the honor to transmit
herewith enclosed Report of Sick and Wounded in Home
Colony Hospital for the week ending Saturday Oct 12th 1867

I am Sir Very Respectfully
Your Obedt Servt
D. Schatz.
W. W. Surg M. A. C.

Home Colony Hospital
Montgomery Ala Oct 15th 1867

Post Lt Col John J. Kipp upr
Surgeon in Chief District of Ala
Montgomery Ala

Sir

I have the honor
to transmit herewith enclosed Report of Attendants
Employed at Home Colony Hospital Montgomery
Alabama during the month ending on the 15th
day of October 1867.

I am Sir Very Respectfully
Your Obedt Servt
D. Schatz.
W. W. Surg M. A. C.
in Charge

38

Home Colony Hospital
Montgomery Ala Oct 18th 1867

Bot Lt Col Ch J. Kipp up
Surgeon in Chief Dist of Ala
Montgomery Ala

Sir

In Compliance with your instructions of this date. I have the honor to transmit herewith enclosed - Report of the sick & wounded of the Home Colony Hospital Montgomery Ala

I am Sir Very Respectfully
Your Obedt Servt
D. Schatz.

W. W. King M. J. Army

39

Home Colony Hospital
Montgomery Ala Oct 21st 1865

Bot Lt Col Ch J. Kipp up
Surgeon in Chief - Dist of Ala
Montgomery Ala

Sir

In Compliance with your communication of the 18th inst I have the honor to transmit herewith enclosed - Report of the Number of patients admitted in Freedmens Hospital Montgomery Ala since its organization also date of its organization

I am Sir Very Respectfully
Your Obedt Servt
D. Schatz.

W. W. King M. J. Army
in Charge

Home Colony Hospital
Montgomery Ala Oct 19th 1867

Bot Lt Col Ch J. Kipp up
Surgeon in Chief Dist of Ala
Montgomery Ala

Sir

I have the honor to transmit herewith enclosed Report of sick & wounded in Home Colony Hospital for the week ending Oct 19th 1867

I am Sir Very Respectfully
Your Obedt Servt
D. Schatz.

W. W. King M. J. Army

Home Colony Hospital
Montgomery Ala Nov 2^d 1867

Bot Lt Col Ch J. Kipp up
Surgeon in Chief Dist of Ala
Montgomery Ala

Sir

I have the honor to transmit herewith enclosed Report of sick & wounded for the month ending Oct 31/67 weekly Report for the week ending Nov 2^d 67 Report of discharges fall sick &c personal report for October 1867

I am Sir Very Respectfully
Your Obedt Servt
D. Schatz.

W. W. King M. J. Army
in Charge

48

Home Colony Hospital
Montgomery Ala Nov 9th 1867

Prof Lt Col John J. Kipp M.D.
Surgeon in Chief Dist of Ala
Montgomery Ala

Sir

I have the honor
to transmit herewith enclosed Report of Sick
& Wounded in Home Colony Hospital for the
week ending Saturday Nov 9th 1867

I am Sir Very Respectfully
Your obt Servt
J. S. Schatz
W. W. Surgeon M.D.
in Charge

Home Colony Hospital
Montgomery Ala Nov 15th 1867

Surgeon L. W. Edwards M.D.
Chief Medical Officer
Washington D.C.

Sir

I have the honor
to transmit herewith enclosed original final Return
Survived & Receipt of Home Colony Hospital Montgomery
Ala and respectfully request that a Certificate of
Non indebtedness be forwarded at your earliest
Convenience.

I am Sir Very Respectfully
Your obt Servt
J. S. Schatz
W. W. Surgeon M.D.

49

Home Colony Hospital
Montgomery Ala Nov 15th 1867

Surgeon L. W. Edwards M.D.
Chief Medical Officer
Washington D.C.

Sir

I have the
honor to transmit herewith enclosed Three dupli-
cate Returns of Home Colony Hospital Montg-
omery Ala for week ending Nov 15th 67. Original
Returns were forwarded by yesterday's Mail

I am Sir Very Respectfully
Your obt Servt
J. S. Schatz
W. W. Surgeon M.D.

Home Colony Hospital
Montgomery Ala Nov 15th 67

Col J. Kipp
Surgeon in Chief
Montgomery Ala

Sir

I have the honor
to transmit herewith enclosed final Weekly & Monthly
Reports Home Colony Montgomery Ala. Return of articles
purchased out of Hospital Store also personal
Report ending Nov 15th 67.

I am Sir Very Respectfully
Your obt Servt
J. S. Schatz
W. W. Surgeon M.D.

42

Home Colony Hospital
Montgomery Ala Nov 15th 1867

Chas J. Kipp
Surgeon in Chief
Montgomery Ala
Sir

In compliance
with your instructions of the 11th inst I have the
honor to report that I have transferred to Mr H.
Ogden Esq. Treasurer Montgomery County
Ala the Hospital together with all Medicine
& Hospital property. I have also discharged
all attendants belonging to the Hospital.

I am Sir Very Respectfully
Your Obedt Servt
D. Schutz
W. W. Surgeon of Arms

Home Colony Hospital
Montgomery Ala Nov 16th 67

Surgeon Chas J. Kipp
Surgeon in Chief
Montgomery Ala
Sir

I have the honor
to state that I have forwarded to your Office
One box containing the following books
One Register of patients
One Letter head book
One Letter sent book

I am Sir Very Resp. servt
Your Obedt Servt
D. Schutz
W. W. Surgeon of Arms

Index

A

Barnes J. H.

Badger C. 12

No. 98 Freedmen's Hosp.
Letters Sent Jan - Nov. 1867
B. of R. F. and A. I. L.
Montgomery, Alabama

C

D

Edwards S. A. 13, 20, 21, 31, 40, 41
Elbridge W. S. 29, 31, 32

G

G

N

S

Q

N. J.

1, 2, 3, 4, 5, 6, 7, 8, 9, 10, 11, 12, 13,
14, 17, 18, 19, 20, 21, 22, 23, 24, 25, 26, 27, 28, 29, 30, 31, 32, 33, 34, 35, 36, 37, 38, 39, 40, 41,
42.

Quinn W. S. 29, 30

S

Roll 26

Target 5

SUBORDINATE FIELD OFFICES
Montgomery (Freedmen's Hospital)

Register of Letters Received and Endorsements Sent
Volume (96) Jan.-Nov. 1867

NO 96 FREEDMENTS HOSP LETTERS RECEIVED, JAN NOV 1867.
B. OF R.F. AND A.L.
MONTGOMERY, ALABAMA.

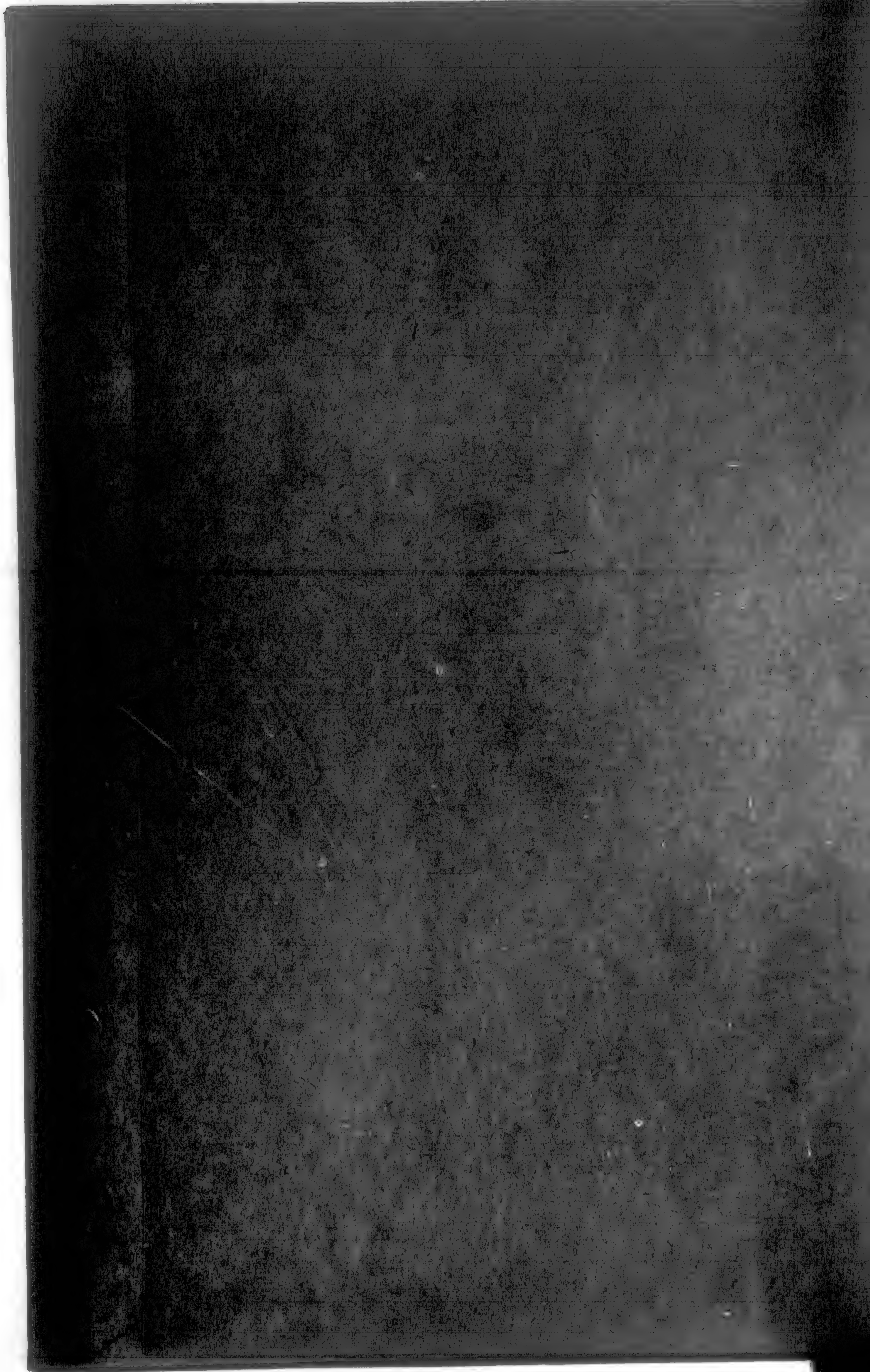

Index Page 3

Freedmen's Hospital
Montgomery
Ala
Letter Book
1867

	Commences on Page	
A		1
B		11
C		21
D		31
E		41
F		51
G		61
H		71
I		81
J		91
K		101
L		121
M		131
N		141
O		151
P		161
Q		171
R		177
S		187
T		197
U		207
V		211
W		217
X		227
Y		231
Z		235

[Faint handwritten text]

Edwards L. A. Chief Med

idge S. Major 41. 113.

Capt. S. O. 110.

Capt James S. A. B. 61.

Surgeon in Charge 197. 201.

R. H. 71. 105.

Chas. J. Surg. 72. 106. 103. 105.

106. 111. 100. 112. 115. 117. 118.

John A. P. 111.

Alfred W. 121. 123. 197. 201.

Henry Stephen 200.

George 200.

Robert Surg. 177.

Wm. W. Surg. Gen. 116.

J. A. A. U. S. A. 157.

157.

Surg. Gen. H. 126. 126. 197. 199.

202.

Williams Eliza betch 101.

H. C. 174.

Wm. B. A. M. D. 217.

Surg. S. J. C. D. M. 217.

Vol. 96

Pages 4-40 are blank—not filmed.

Letters Received

and

No.	Name and Rank of Writer	Date and Subject of Letter
No. 1	Edwards L. A. Chief Medical Officer	Dec. 29. 1866. Circular No. 14. Bureau. R. P. and A. H. Series 1865. is Modified in so far that in paragraph 7. Second line, the words "At the End of Each fiscal Quarter will be withdrawn out, and in lieu thereof, will be inserted the words, "semi-annually". Paragraph 3. Circular No. 5. Surgeon General Office Series 1865. has been cancelled by the Surg. General.
No. 2	Edwards L. A. Surgeon & Dist Col also Chief Medical Officer	Jan. 29. 1867. Paragraph 100. Art. V. of the Officers Manual, as amended, is the established order for Refuges and Penitentiaries in Bureau Hospitals.
No. 3	Edwards L. A. Surgeon & Dist Col. Chief Medical O.	Direct all official papers intended for this office to the "Commissioner of the Bureau" with the name and rank of the Chief Medical Officer written on the lower left hand corner of the envelope. Postage will not be required to be paid on packages thus prepared for the Mail.
No. 4	Edwards L. A. Surgeon & Dist Col. Chief Med. Officer	Feb. 13. 1867. Patients and Attendants in Hospitals, receiving the same Rations, (Army) separate provision Returns are not required.
No. 5	Eldridge S. Brit Majt. A. M. M. C.	July 19. 1867. I have the honor to enclose herewith invoices and receipts for property shipped you on the 18th inst. care of Surg. in Chief. Dist. of Ala.
No. 6	Edward S. A. Surg. with Dist Col. Chief Med. Officer	Sept. 5. 1867. Forward to this office a Receipt relating to the property received by you from Brit Majt. S. Eldridge. A. M. M. C. dated July 16. 1867.

Endowment Books

424

Endowment and Memoranda	
Filed	Filed
Filed	Filed. See Page 46 of Letter B. C.
Filed	Filed.
Filed	Filed. See page 130. L. B. 67
Filed	Filed. See page 107 of L. B. 1st. No. 5. S. P. M. B.

Vol. 96

Pages 43-60 are blank—not filmed.

Letters Received

and

Endorsement Book

Name and Rank of Writer	Date and Purport of Letter
Gillite, James	<p>Oct. 12th 1867. The following is a list of the clothing issued to you yesterday.</p> <p>14 2/4 yards of Cotton cloth</p> <p>9 3 yards of Amberg cloth</p> <p>25 pairs Shoes</p> <p>25 pair Jackets</p> <p>30 pairs Trowsers.</p> <p>30 coats</p> <p>Please issue the above on form 52 (Q.M.M.) the Cotton cloth, and Amberg on separate receipt rolls from the clothing.</p>
Gillite, James	<p>Nov. 1st 1867.</p> <p>Please fill out the enclosed requisitions for 1200</p> <p>124 cords of Wood issued to the hospital lines Oct.</p>

Endorsement & Memorandum	
Filed	Filed
Gillite James Capt 15 th Regt Infy Sub-Asst Comm	<p>Am. 5th</p> <p>Respectfully returned inclosing the requisitions for Fuel as requested</p>

Vol. 96

Pages 63-70 are blank—not filmed.

Letters Received

and

Endorsement Book

Serial	Name & Rank of Writer	Date and Content of Letter
No. 1	Haughton R. B. Lieut. Gen.	April 16 th 1867. Respectfully requests appointment as Druggist or desire a recommendation to Dr. Kipp's position in chief. Dist. of Ala. for an appointment elsewhere.

Serial	Endorsement and Memorandum
No. 1 Dr. Kipp Lieut. Gen.	Mr. Haughton, in my opinion, is worthy of confidence and I would be happy to have him appointed as Dispensary Clerk at this hospital. In any event I cordially recommend him to your favorable consideration. See Page 125. E. W. M. B.

Vol. 96

Pages 73-100 are blank—not filmed.

Settlement Record and

No.	Name and Rank	Date and Subject of Letter
No. 1	Kipp, Chas. J. Surgeon in Chief	Jan. 5. 1867. Forward to this office the contract of Elizabeth Williams as Laundry. Said contract not being on file at this office.
No. 2	Kipp, Chas. J. Surgeon in Chief	Jan. 24. 1867. All Official Communications addressed to this office by Medical Officers serving in this District will be written on letter paper (quarto post) and the letter to be folded in three equal folds, parallel with the writing and endorsed on that fold which corresponds with the top of the sheet - 1st, with the Name of the place where written, and date; 2nd, Name and rank of writer; and 3rd, Analysis of Contents.
No. 3	Kipp, Chas. J. Surgeon in Chief	Jan. 31. 1867. Turn over to the Chief Distancing Officer of the Bureau at Montgomery, the proceeds of the sale of certain articles of Hospital Property. (3 Iron Beds and 1 Stove) which were inspected and condemned and ordered to be sold on the 14 th of April last. The order to add the proceeds of the sale of said articles to the Club Fund is hereby revoked.
No. 4	Kipp, Chas. J. Surgeon in Chief	Feb. 2. 1867. When Medical and Hospital Property is condemned and ordered to be sold after the Inspection Report is approved by the Assistant Commissioner the Surgeon in Chief will direct the Medical Officers responsible for the property to have it disposed of by Auction. When there are but few articles to be sold and the value of the property would not warrant the expense of an auctioneer he will direct the City Hospital Steward or other Employee of the Hospital to act in that capacity. He will then make out a bill for the proceeds to the Chief Distancing Officer and forward it to the Bureau with a copy of said bill to this office.

Endorsement Book

Endorsement and Memorandum.	
Filed.	Filed. See reply on page No. 47. of Letter forwarded.
Filed.	Filed.
Filed.	Filed. See reply on page 57. of Letter Book, 1866-1867.
Filed.	Filed.

Letter Book

and

No.	Name and Rank of Officer	Date and Part of Letter
No. 5	Kipp, Chas. J. Battal. Surg. & Surg. in chief	Feb. 7 th 1867. You are hereby directed to sell at Auction the broad various Medical and Hospital Property unperfected and Condemned April 14 th 1866. viz. 3 Iron Bedstead 1 Cooking Stove with fixtures complete. The Acting Hospital Steward will act as Auctioneer.
No. 6	Kipp, Chas. J. Battal. Surg. & Surg. in chief	Feb. 14 th 1867. The Dispensary Store will be allowed at the Free Hospital Mobile
No. 7	Kipp, Chas. J. Battal. Surg. & Surg. in chief	March 15 th 1867. The attention of Medical Officers and in this District is called to the last clause of paragraph XXXV Article IV. "Officers Manual" and a strict compliance with the same enjoined.
No. 8	Kipp, Chas. J. Battal. Surg. & Surgeon in chief	March 15 th 1867. Your Statement of Hospital Fund for February has not yet been received at this office. You will forward the same without delay.
No. 9	Kipp, Chas. J. Battal. Surg. & Surgeon in chief	March 19 th 1867. In accordance with instructions received from the Chief Medical Officer of the Bureau. You are hereby directed to collect all the Statistics within your reach relating to these classes among the Freed-people specified in the Table herewith enclosed. The inquiries to be entered and accurate; avoid yourself of other reliable agencies Noting the sources from whence the information is derived. The enumeration will include all persons in your locality whether cared for or not. Other cases of defective mental or physical organization of great rarity or unusual interest not stated in the Table may be noted in the blank spaces under an appropriate heading. These reports to be sent to the Surg. in chief for the Chief Med.

Endowment Book

1867

Endowment and Memorandum	
Filed	Filed See page 57. L.B. 67
Filed	Filed See page 57. Letter Book 1867.
Filed	Filed.
Filed	Filed. The Statement was forwarded March 15 th . The delay was occasioned by the Ad. at this post. who failed to send the original to the Bureau.
Filed	Filed. See page 76. L.B. 67

Letters Received

and

Endorsement Book

No.	Name and Rank of Writer	Date and Purport of Letter
No. 10 March 22 1867	Wheeler Chas. J. Battal. Surg. in Chief	March 19, 1867. Forward every Morning to the Sub-Asst Commr of the Sub-District in which your Hospital is located a report of the Number of Patients and Officers under your charge, classifying them as Adult Males and females, and children.
No. 11 April 10 1867	Wheeler Chas. J. Battal. Surg. in Chief	April 8 th 1867. Enclosed find duplicate of approved Inventory and Inspection Report of Med. & Hospital Property for which you are responsible. The bottles will be sold at public Auction, and the Act Hospital Steward will act as Auctioneer.
No. 12 April 13 1867	Wheeler Chas. J. Battal. Surg. in Chief	April 11, 1867. All reports, returns, Statements, &c forwarded to this office must be accompanied by a letter of transmittal enumerating them and referring to the other Subject.
No. 13 April 21 1867	Wheeler Chas. J. Battal. Surg. in Chief	April 20 th 1867. Enclosed please find an order authorizing the repair of buildings at the Colony. The number of the buildings to be repaired is not specified but is left to your discretion. This was done purposely, as the estimate sent me was regarded as too large. You will have no new buildings put in order than are absolutely necessary to accommodate all the inmates of the Colony the Orphan included, and have two (2) of the buildings moved together for kitchen and Mess room for the Asylum. Now but independent necessary repairs and alterations will be allowed. You will from time to time report progress.
No. 14 May 1867	Wheeler Chas. J. Battal. Surg. in Chief	May 1, 1867. You may employ R. H. Haughton as Dr. pensioner at \$25.00 per month and one ration per day.

Endorsement and Memorandum	
Filed	Filed
Filed	Filed See page 60. L.B. 1867
Filed	Filed
Filed	Filed. See page 87. L.B. 67 " " " 65. " "
Filed	Filed. See page 71. L.B. 67 " " 78 L.B. 67 " " 57. " "

No.	Name & Rank of Writer	Date and Purpose of Letter
No. 15 May 2, 1867	Kipps, Chas. J. Bot. Lt. Col. & Surg. Major Surg. in Chief	May 1, 1867. Report of "Unfortunates" required by Circular Letter of March 16 th from this office has not been received from you. Please forward the same as soon as possible.
No. 16 May 21, 1867	Kipps, Chas. J. Bot. Lt. Col. & Surg. Major Surg. in Chief	May 1, 1867. Your Report of Articles not immediately perishable purchased out of the Hospital Fund for the Quarters ending M. L. 31, 1867 has not been received at this office. Please forward the same without delay.
No. 17 May 21, 1867	Kipps, Chas. J. Bot. Lt. Col. & Surg. Major Surg. in Chief	May 1, 1867. Referring to your letter of the 22 ^d inst. in relation to the requisition for fuel at this office of your requisition for fuel. I have been informed that the A. S. M. at Mobile has been authorized to purchase the necessary fuel for your hospital.
No. 18 May 8, 1867	Kipps, Chas. J. Bot. Lt. Col. & Surg. Major Surg. in Chief	May 6, 1867. None but articles used either in the preparation or the serving and means of illumination can be purchased out of the Hospital Fund. Matches should be bought out of such funds. Enclosed, incorrect statement of H. Fund.
No. 19 May 10, 1867	Kipps, Chas. J. Bot. Lt. Col. & Surg. Major Surg. in Chief	May 7, 1867. The attention of Medical Officers on duty in this district is called to Paragraph XXXV. A. Officers Manual. These reports will be made in duplicate and forwarded to this office within five days after the expiration of the month.
No. 20 May 11, 1867	Kipps, Chas. J. Bot. Lt. Col. & Surg. Major Surg. in Chief	May 9, 1867. I enclose herewith list of Hospital property for which receipts are required in the usual manner through this office to Bot. Major S. E. S. Surgeon Med. Storekeeper Washington DC. The bedding and supplies may be issued to sick indigent freed people on rolls according to Form 38. Page 72. Officers Manual - on your recommendation approved by the Surgeon in Chief.

Endorsement & Memorandum	
Filed	Filed See page 76. L. B. 1867
Filed	Filed See page 77. L. B. 1867
Filed	Filed See page 79. L. B. 1867
Kipps, Chas. J. Bot. Lt. Col. & Surg. Major Surg. in Chief	May 11, 1867. Respectfully returned corrected statement enclosed
Filed	Filed
Filed	Filed See page 84. L. B. 1867 41 EX. B. 1867

Letters Received

Endorsement Book

When Received	Name and Rank of Writer	Date and Purport of Letter
May 21 1867	Kipp Chas J Bot Lt Col & Surg Surgeon in Chief	May 22 1867. Your Return of Articles purchased out of Hospital Funds for the Quarter ending M ^o 31 has been lost. Please to forward a duplicate at your earliest convenience
June 21 1867	Kipp Chas J Bot Lt Col & Surg Surgeon in Chief	June 20 1867. You will please forward, without delay to the Acty Asst Gr. M ^r . of the Bureau at Mobile Ala. another Statement of the repairs absolutely required to put in a habitable condition a sufficient number of the buildings at the Camp to accommodate comfortably all the people under your charge. You will at the same time request the A. O. G. M. to make Estimates thereon for Materials and cost of labor and to forward the same through the regular Channel to the Office.
June 27 1867	Kipp Chas J Bot Lt Col & Surg Surgeon in Chief	June 27 1867. The Weekly Report of Sick and Wounded for the Week ending June 22 ^d is respectfully returned for Correction. There is evidently a mistake in the number transferred during the week
July 10 1867	Kipp Chas J Bot Lt Col & Surg Surgeon in Chief	July 8 1867. You will please as soon as practicable forward to this Office a Statement of the Total Money Value of the Medical and Hospital Supplies received by your Medical Purveyors since Nov ^r 1 1866.
July 13 1867	Kipp Chas J Bot Lt Col & Surg Surgeon in Chief	July 11 1867. Your Statements of the Hospital Funds for the Month ending June 30 1867 are respectfully returned for Correction. There is evidently an Error in the Communication of the Return.

Endorsement and Memorandum
Filed See page 89. D.P. 67
Filed See page 116. D.P. Also " 105. " 67
Filed June 29 1867. Respectfully Returned Corrected.
Filed See page 119. D.P. 67
Filed July 13 1867. Respectfully Returned corrected as indicated

110

Letters Received

Endorsement Book

No.	Name & Rank Writer	Date and Purport of Letter
No. 26 Aug 20 1867	Kipp, Chas. J. Bvt. Lt. Col. Surg. U.S.A. Surg. in Chief	July 17, 1867. Surgeons in charge of Hospitals will hereafter forward to this Office Quarterly, an Estimate of the printed Hanks required for their use.
No. 27	Kipp, Chas. J. Bvt. Lt. Col. Surg. U.S.A. Surg. in Chief	Aug. 1, 1867. Respectfully returned. The acct cannot be paid in its present shape. State specifically the articles and the quantity of each purchased. Make the account in the name of the person of whom the articles were purchased. Vouchers for services rendered must be made in Form 11. Officers Manual. (22 G. M. S. U.S.A.)
No. 28 Aug 26 1867	Kipp, Chas. J. Bvt. Lt. Col. Surg. U.S.A. Surg. in Chief	Aug. 24, 1867. You will please without delay forward to this Office a copy of the Service of Medical and Hosp. Property transferred to you by Bvt. Maj. G. E. Worley Act. Med. Store Kuper Washington D.C.
No. 29 Sept 2 1867	Kipp, Chas. J. Bvt. Lt. Col. Surg. U.S.A. Surg. in Chief	Aug. 31, 1867. Accts for services rendered must be made upon Form No. 11. O.M. Accts. for articles purchased, upon Form No. 9. O.M.
No. 31 Sept 6 1867	Ketchum, M. A. A. G. Quartr. Bureau Office	Aug. 28, 1867. The following information having been called for by the Sec. of War for insertion in the Biennial Register, all Commissioners of this Bureau are directed to forward to this Office during the month of September a list of the Civilian Employees in their respective districts under the following heads, viz. Quota Civilian Employees - Laborers giving the amount, the State where born, from what State Employed, and the amount of Annual Compensation. A Hanks is herewith enclosed and it is desired that these lists be made in forms precisely similar.

No.	Name & Rank Writer	Date and Purport of Letter
		Filed
		Filed
		See page 123. Lt. G.
		Aug. 29, 1867.
	Kipp, C. J. Bvt. Lt. Col. Surg. U.S.A. Surg. in Chief	Respectfully returned for instructions. Should the whole account for dues and implements purchased, as well as for services billed be made on form 11. O.M. or are two forms required. See No. 27, this page.
		Filed
		Filed. See page 140. Letter Forwarded.
		Sept 3, 1867.
	Kipp, C. J. Bvt. Lt. Col. Surg. U.S.A. Surg. in Chief	Respectfully returned. Corrected, in accordance with instructions. See No. 27, this page.
		Filed
		See pages 113. and 203. of this book also " " 152 of letter forwarded

Letters Received

and

Endowment Book

No.	Name and Rank of Writer	Date and Purport of Letter
No. 31		Sept. 3, 1867. The Act. Commissioner directs that the witness before made immediately. Such citations only as were on duty on the first of September will be reported and the reading must show this - x x
Sept 6 1867	Subst. Commr Sub Dist Montgomery	A separate report in some form will be made of the civilian Employees of the Hospital in your Sub District.
No. 32		Sept. 17 th 1867. I desire to employ an additional Medical Officer for your Hospital. Please to ascertain if a competent physician who can take the Oath and is willing to serve at a compensation of \$100.00 to \$150.00 per month, can be obtained in Mobile. Answer as soon as possible, giving the Name and Residence of the person recommended.
Sept 18 1867	Surgeon Chief Rifles	
No. 33		Sept. 17, 1867. It having been reported to this office that some of the boxes of Hospital Property transferred to the Maj. S. Eldridge to Medical Officer in this District were broken when they arrived here and that in the repacking of the same, mistakes may have occurred, you will please immediately cause a careful examination to be made of the same to ascertain whether a discrepancy (excess or deficiency) exists between the articles and quantities invoiced and those actually received.
Sept 18 th 1867	Surgeon Chief Rifles	

Endowment & Memorandum
See pages 111 and 203 of this Book also " " 152 of Letters forwarded
Filed
Filed
Filed
Filed
Filed

Letters Received

and

Endowment Book

When Received	Name and Rank of Writer	Date and Purport of Letter
Oct 21st	Surgeon-Chief	Oct. 18th 1867. In compliance with instructions from the Chief Medical Officer of the Bureau, you will with delay report to this Office, the date of the organization of the Hospital under your charge, the whole number of patients since admitted and the length of time each patient has been an inmate, that is, how many have remained in Hospital one month, how many two months
Oct 19th 1867	Surgeon-in-Chief	Oct. 21st 1867. Enclosed please find an official copy of Special Order No. 65, directing the transfer of the Hospital under your charge to the Civil authorities. The transfer will be made without delay. As soon as the transfer is completed you will discharge all Hospital Attendants (Stewards included) and report by letter to this Office. All reports and returns required by existing orders and regulations will be made up to the date of transfer and forwarded to this Office. Final Returns of Property with proper vouchers will be forwarded to this Office as soon as practicable. In case the property is turned to an agent of the Civil authorities, a certified copy of his appointment or order must accompany his receipt for the property. A copy of Special Order No. 65, should also accompany the Property Returns.
Oct 22 1867	Surgeon-in-Chief	

Endowment and Memorandum
Filed
Filed
Copy of Special Order No. 65, to which reference is made on preceding page.
Head Quarters Dist of Ala. B. & F. H. S. Montgomery, Ala. Oct 21, 1867
Special Order No. 65
In accordance with the provisions of Circular Letter from this Office of date of Sept 16th 1867, the County Authorities of the Counties of Madison, Dallas, and Mobile, having signified their acceptance of the proposition contained in said letter, the Bureau Hospital in those Counties with their inmates, Medical and Hospital Stores, will at once be transferred to Civil authorities or duly accredited agents appointed by them. The Officers responsible for the property contained in said Hospitals, will make regular transfers of the same, giving and receiving the proper invoices and receipts therefor.
By Command of Brig. Maj. Gen. O. S. Surayon (Signed) S. C. Greene Capt 24th Regt. Pitt. Maj. 1867 A. A. A. 4.

Letters Received

and

Endorsement Book

When Recd	Name and Rank of Writer	Date and Purport of Letter
No. 36		Nov. 4 th 1867 Your Monthly Report of Sick and Wounded for October is respectfully returned for correction. As all the patients were transferred to the Civil Authorities on the last day of Oct. they should be reported as transferred during the month and not as remaining at date of report. The fact of transfer with date and number of order should be stated under remarks.
Nov. 5 th 1867	Supp. Chf. Surg. in Chief	Nov. 8 th 1867 You will forward to this office through the A. A. G. W. of the Bureau at Wash, all the records of the Hospital, under your charge.

Endorsement and Memorandum
Nov. 5 th 1867. Respectfully returned, corrected in accordance with the directions of the Surgeon-in-Chief, in the foregoing endorsement.
Filed
Filed.

Letters Received

and

Endorsement Book

When Received	Name of Sender	Date and Content of Letter
No. 1	Logan, J. 25th V.R.C.	Apr 25. 1867 Please inform me of the nature and extent of repairs required to accommodate all the Poor people at present under your charge. This is necessary to enable me to make estimates of material required
No. 2	Logan, J. 25th V.R.C.	June 17. 1867 Enclosed please find Memorandum Receipts for property transferred to me by Maj Browning for your personal use. Please sign the receipts and return them to me. The necessary forage can be obtained from the State until I can get the allowance on requisition. On the whole matter is unauthorized by Bureau Regulations I reserve the right to order the property into my possession at any time.
No. 3	Logan, J. 25th V.R.C.	July 11. 1867 Complaint having been made at this office by one of my Employees that you had ordered him to vacate the quarters he now occupies as you no longer required his services to I am directed by Pitt Maj Gen. H. Tracy Sub-Asst Commr. to request you to make an official statement of the facts in the case as soon as practicable. Pending said statement Major Tracy requests that you make no change of quarters among the Employees of the G. M. Dept of the Bureau.

When Received	Name of Sender	Endorsement and Memorandum
	Logan, J. 25th V.R.C.	Filed. See copy on page 81 of Letter Book
	Logan, J. 25th V.R.C.	Filed. See page 63. Ltr. 67
	Logan, J. 25th V.R.C.	July 12. 1867. Respectfully returned with the information that the representation of the Employee in the premises is untrue. I did not order him to leave his present quarters unconditionally and said nothing about his services being no longer required. I did order him to report to his proper Superior Officer and to say that unless he (the Employee) could confine his personal conduct to the limits of propriety, and his attention to his legitimate business I should withdraw from his use any property over which the G. M. Dept. had jurisdiction, his house included. The Employee in question - John Owen - has been insolent to me on several occasions of late without any provocation from me that I am aware of in fact I have never spoken to him for at least four weeks except yesterday. A short time since, after he had been to the Hospital darning every body and every thing my self included, I sent for him to come to my office, but instead of coming as I expected he sent his word by my Steward that "he was busy". I did not push the matter and did not see him. Yesterday my Steward called on me officially to preserve the peace here as "John Owen" had threatened

Letters Received

and

Endowment Books

178

When Received	Name and Rank of Writer	Date and Purport of Letter
Jan 21/67	Bayburn, Robert Surgeon U.S.A. 2d Lt Col Act. Chief Med. Officer	Forwards the original Invoice of H. E. Williams D. A. Surg. U.S.A. dated Dec. 17 th 1866. relating to Property Returns for the period ending June 30 th 1866
Feb 28/67	Bayburn, Robert Surgeon U.S.A. 2d Lt Col Act. Chief Med. Officer	Feb. 12 th 1867. Your Return of Public Property for the period commencing Feb. 17 th 1866 and ending June 30 th 1866. with the vouchers thereto pertaining have been Examined at this office and found to be correct.
Mar 20/67	Bayburn, Robert Surgeon U.S.A. 2d Lt Col Act. Chief Med. Officer	Feb. 15 th 1867. Your Return of Public Property for the period commencing July 1. 1866. and ending Dec. 31 st 1866. with the vouchers thereto pertaining have been Examined in this office and found to be correct. Oct. 11. 1867.
Mar 21/67	Bayburn, Robert Surgeon U.S.A. 2d Lt Col for C. M. O.	Respectfully returned to A. A. Surg. U.S.A. J. G. Gray U.S.A. through Surgeon-in-Chief West of Ala. for compliance with provisions of Circular letter of July 10. 1867. from this office

Endowment and Memorandum
Filed. See reply on Page 50 of Letter Book 1866-7.
Filed. Filed.
Filed. Filed.
See pages 170. of L. B. 1867 " " 187 of Ex. B. 1867

Vol. 96

Pages 179-186 are blank—not filmed.

Letters Received and

Endorsement Book

187

No.	Name & Rank of Recd	Name & Rank of Writer	Date and Purpose of Letter
No. 1	Schatz, J.	Oct-15-1867	Respectfully returned to a. a. Schatz, J. by Capt. W. J. Gray upon and attention called to Endorsement of Det. Col. L. A. Edwards Chief Medical Officer P. R. A. and I. L.

No.	Name & Rank of Recd	Name & Rank of Writer	Date and Purpose of Letter
	Schatz, J.	Oct. 16 th 1867	Respectfully returned corrected according to provision of Circular Letter of July 10/67 from Office of G. M. O. See page 170 of S. P. 1127. also page 177 E. & M. B. 1867.

Vol. 96

Pages 189-196 are blank—not filmed.

Letters Received and

When Received	Name and Rank of Writer	Date and Purport of Letter
No. 1		June 21, 1867. Having been directed by the Asst Comdr on orders from the Commissioner to make out and forward on the 1 st day of July positions a
June 22 1867	Toney, Geo. F. Capt. U.S.A. Sub. Asst. Commr.	report of all Officers, Civilian Agents and Clerks on duty in this Sub-District, with the names, rank Command, duty and Order of Assignment to Station of the Officers. You will please make report to this office giving such information concerning yourself as will enable me to make my report.
No. 2		July 17, 1867. Respectfully returned to Dr. Gray, Surgeon in Charge of Freedmen's Hospital through Dr. Logan Dr. Mr. Insult bearing or language on the part of the Employees of the D. M. Dept. towards any officer or person placed in control will not be tolerated and will cause the summary discharge of the offender. Where offense is
Sept 18 1867	Toney, Geo. F. Capt. U.S.A. Sub. Asst. Commr.	committed by such Employee report must be made to the Gr. Mr. or to the Sub. Asst. Commr. and measures will be taken to have proper punishment administered. The Quarters at Dog River Hospital & Asylum are hired by the Gr. Mr. Dept and Mustered upon the Gr. Mr. Returns and such portions of them as is necessary must be used for Quarters of Employees of the Department. These Quarters should not be considered as coming within the general jurisdiction of the Medical Officer but as within the special jurisdiction and Control of the Gr. Mr. The Gr. Mr. is not in any sense subordinate to or under the directions of the Medical Officer and must be permitted to regulate and Control his own Department subject to orders from his proper superior.

Endowment Book

Endowment and Memorandum	
Filed	Filed
Filed	Filed See page 124-124. E. & M. 137

Letters Received and

When Received	Name and Rank	Date and Purport of Letter
No 3	W. P. Lister	August 23 rd 1867 Enclosed is a document and translation ⁺⁺ thereof respectfully called to your attention. It is the offering of a meeting of persons at the Hospital who appear to be well enough to correct the chief of this description and to have nothing better to do. It was brought here by some worthless colored man living near the Hospital and disciplined with his aid by my clerk Mr. Sargent. I should not have thought the document worthy of attention for a moment had I not considered it as indication of what I have long been inclined to believe, that a class of worthless abandoned paupers were settling at Dog River and living on the Government. This has perhaps to some degree been unavoidable but it should now be stopped immediately. I apprehend that it is desired to have as few patients and certainly as few outside employees as possible at the Hospital. It is a charitable institution, temporary in its character, existing necessarily with the assistance of the Bureau and designed only to supply the lack of arrangement to provide for sick and destitute freedmen on the part of this Community. It is proposed that under a juster political rule and under the influence of bolder sentiment of humanity there have prevailed in the past there will before long be provisions made by State and County authority for the care of their sick and destitute so that aid from the Federal Government will no longer be necessary. In view of this I think very pains should
August 24 1867	Tracy Capt. Ret. Maj. + Capt. USA. Gen. A. C. Comm. Br. R. A. + Ad. Sub. Dist. Mobile	

Endowment Book

Endowment and Memorandum
<p>x Mobile, Alabama near August 22nd 1867 This is to certify that the nurse at Dog River Hospital was brutal to the sick and enjoin them that is dying. George Cross Dues certify by the same in which had been done at the horse stable Steving Montgomery. The morning before whipping her she got her out of the bed with the sheet the next morning she sent her child and got a switch and whipped her and in half of an hour she died and when the others told her that she did she did not care a damn if she killed as many more that the doctor would back her. Eight more will also swear to these things.</p> <p>++ This is to certify that the Nurses of Dog River Hospital are brutal to the sick and cause to the dying. George Cross hereby certifies to the truthfulness of the above. Stephen Montgomery (has the Committee had left out part of their statement which was stated by the Messenger to be to the effect that a girl had been whipped but a short time previous to her death) the morning before she whipped her jerked her out of the bed with the sheet. The next morning she (supposed to be the Nurse) sent her child out to get a switch and whipped the girl. She died in about half an hour afterwards. When the others told her (the Nurse) of it she did not care a damn if she killed as many more that the doctor would back her.</p>

Document

Translation

Letters Received

and

Endorsement Book

When Received	Name & Rank of Writer	Date and Purpose of Letter
---------------	-----------------------	----------------------------

Continued from page 199

to talk to reduce the Hospital to the least possible minimum of patients. Only the extremely aged or the imbecile should be allowed to remain here for Asylums, and other than these classes mentioned all able bodied adults excepting Emptiques should be compelled to leave the place as soon as they are able to work. I think also that places should be found for the large number of children now at Dog River who are able to earn their own living. If this is not done they may be left on the hands of the Government at a time when it may be difficult to provide for them. I trust these views may meet your entire approval.

Sept 3. 1867
Tracy, Gen. H.
Sept 3. 1867
Brig. Maj. U.S.A.
Sub. Act Commr

Sept. 3. 1867.
Respectfully returned to Dr. Gray through Lt Logan a. a. g. M. The change desired will be made subject to future change if it be necessary. The man Williams is of bad report, and it is believed that he has been at the bottom of much of the trouble and mischief among the people at Dog River.

See page 149, L.P.

Tracy, G. H.
Brig. Maj. U.S.A.
Sub. Act Commr

See page 149 of Letters forwarded

Endorsement and Minor comments

Sept. 6. 1867.
Respectfully returned to Brig. Maj. G. H. Tracy U.S.A. Sub. Act Commr through Lt Logan a. a. g. M. Maj. Tracy having stated to me on Saturday the 3rd ult. that the affairs of the G. M. Dept. were under his direction; that he had intended making a clean sweep of the present employees of that department, and that any legitimate Knight Mason would be favorably considered & retained & present the within named persons as suitable substitutes for those who had already retired and above place particularly that of the Watchman, it seemed to me should be filled without any necessary delay. The character of Williams I was prepared to believe for, having known him personally for nearly two years; but as it seems the Trade of his producers are credited in preference to mine I must of course be silent. The names presented, are respectfully withdrawn.

Letters Received and

Endorsement Book

307

Date Recd	Name & Rank of Writer	Date and Part of Letter
1915	Tracy, Geo H.	Sept. 6. 1915. Official Copy respectfully furnished to G. A. Simpson W. J. Gray, in Charge of Audaman Hospital
Sept 6	Port Maj W. A. [unclear]	with the request that he will immediately forward this
1915	Sub. [unclear]	Office a report in accordance with instructions of
		civilians employed at Hospital

	Endorsement & Memorandum
Filed	See page 111. and 112. of this book. also
	" " 152. of Letters forwarded

g
205

216

Vol. 96

Pages 205-216 are blank—not filmed.

Letters Received

and

Endorsement Book

218

When received	Name and Rank of	Date and Purport of Letter
No. 1 Apr 25 1867	White Co. B. Capt. Wm. West Surgeon and A. O. Med. Purveyor U.S.A.	Apr. 20. 1867. I herewith enclose an Invoice of Med ^l Supplies addressed to you On receiving them you will be governed by paragraphs 8. Medical Regulations or par. 1273. Civil Regulations of 1863. Return one of the Receipts after filling up and signing.
No. 22 July 26 1867	White Co. B. Capt. Wm. West Surgeon A. O. Med. Purveyor	July 24. 1867. I herewith enclose an Invoice of Med ^l Supplies addressed to you. On receiving them you will be governed by Paragraph 8. Medical Regulations or by Paragraph 1273 General Regulations of 1863. Return one of the inclosed Receipts after filling up and signing the same.
No. 3 Oct 27 1867	White Co. B. Capt. Wm. West Surgeon and A. O. Med. Purveyor U. S. Army	Oct. 26 th 1867. I herewith enclose an Invoice of Medical Supplies addressed to you and which has been delivered to the Quartermaster at New Orleans for transportation. On receiving them you will be governed by Paragraph 8. Medical Regulations or by Paragraph 1273 General Regulations of 1863. Please return one of the enclosed Receipts to this Dept after filling up and signing the same.
No. 4 Nov 9 th 1867	Whiting L. J. 25 St. Hill St. S. C. C. G. M. Dist. Ala. Br. R. G. M. S.	Nov. 7 th 1867 In compliance with the requirements of Special Orders No. 74. from Hd Qrs. Dist of Ala. Nov 7 1867 I have the honor to enclose herewith Transportation Coupons 27522. / 27523. for yourself from Mobile Ala. to Talladega Ala.

Endorsement and Memorandum

Filed

Filed

Filed

Filed

See page 126. L.B.
1867

Filed

Filed

Filed

Filed

2
219

220

Vol. 96

Pages 219-234 are blank—not filmed.

4
221

222

No. 96. Freedmen's Hosp.
Letters Received. Jan-Nov. 1867
B. F. F. and A. L.
Montgomery, Alabama

2

Roll 26

Target 6

**SUBORDINATE FIELD OFFICES
Montgomery (Freedmen's Hospital)**

Special Orders and Circular Letters Received
Volume (97) Jan.-Nov. 1867

No 97. Freedmen's Hosp.
Special Orders and Circular
Letters Received. Jan-Nov
1867 B. of R, F. and A. L.
Montgomery, Alabama.

NO 97 FREEDMEN'S HOSP SPECIAL ORDERS AND CIRCULAR
LETTERS RECEIVED JAN-NOV 1867 B.OF R,F AND A.L.
MONTGOMERY, ALABAMA.

3

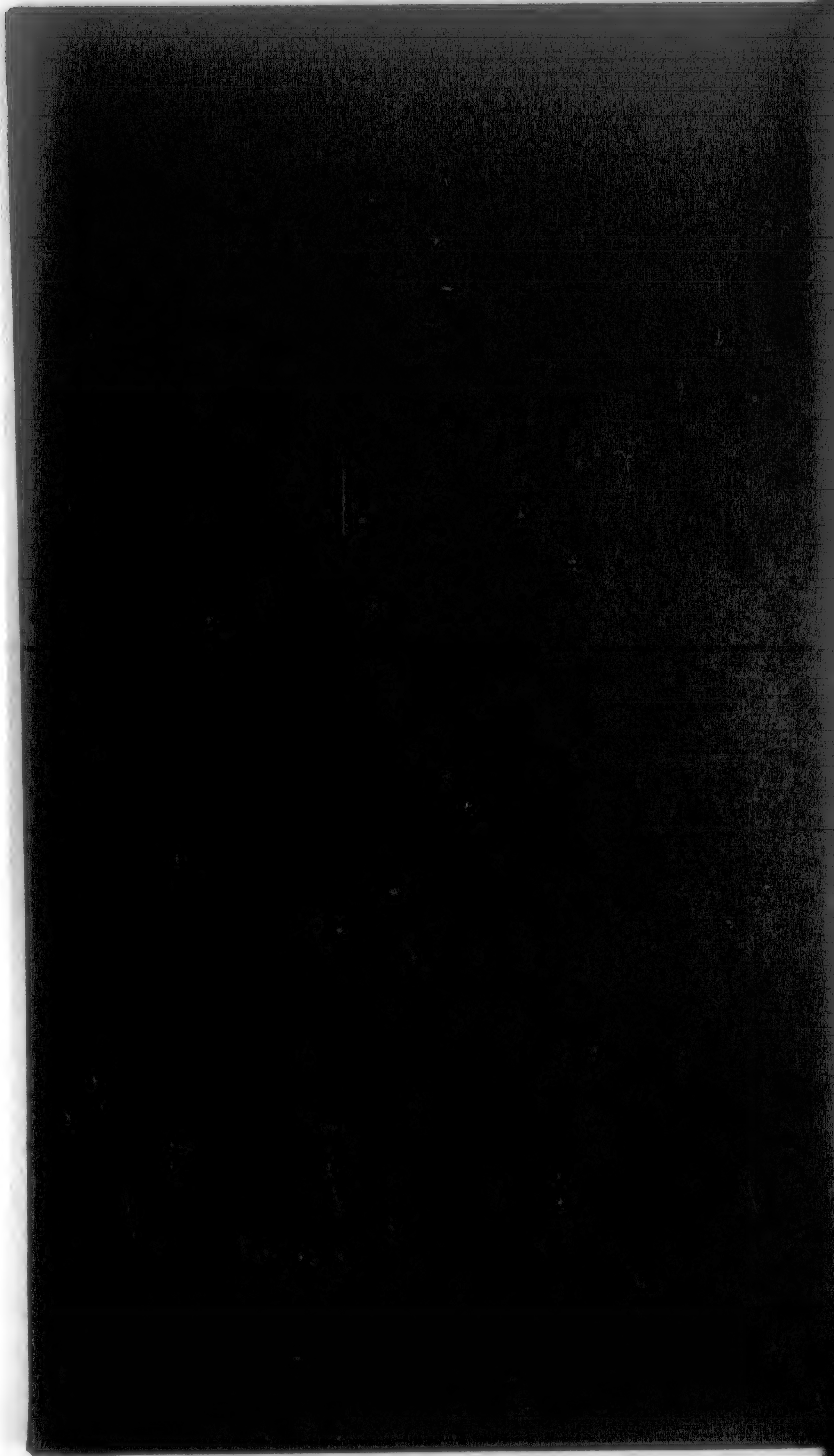

^{ny}
Freedmen's Hospital

Montgomery

Ala

Trusty Circular

from Surg. in Chief

Head Quarters District of Alabama
Office of Surgeon in Chief
Montgomery Ala January 24th 1867

Circular Letter

All official communications addressed to this office by Medical Officers serving in this District will be written on letter paper (Quarto Post) and the letter folded in three equal folds parallel with the writing, and endorsed on that fold which corresponds with the top of the sheet - 1st with the name of the place where written, and date; 2nd Name and rank of writer; and 3rd Analysis of contents.

(Signed) Chas J. Kipp
1st Lt Col & Surgeon in Chief
Surgeon in Chief

W. W. Surgeon J. Schatz, M.D.
Providence Hospital, Montgomery Ala

War Department
Bureau of R. F. and A. Lands
Office of Chief Medl Officer
Washington January 23rd 1867

Sir

You will direct the Medical Officers serving under your Command to direct all official papers intended for this Office, to the Commissioner of the Bureau with the name and rank of the Chief Medical Officer written on the lower left hand corner of the envelope. Postage will not be required to be paid on packages thus prepared for the mail.

Very Respectfully Yrs obt Servt
(Signed) L. W. Edwards

Surg Lt Col & 1st Lt Col. Chief Medl Officer

Respectfully referred to J. Schatz, M.D., for his information and guidance

W. W. Surgeon J. Schatz
Providence Hospital

(Signed) Chas J. Kipp
1st Lt Col & Surg Lt Col Surgeon in Chief Dist Ala

Head Quarters Dist of Alabama
Office of Surgeon in Chief
Montgomery Ala Feb 19th 1867

Circular Letter

The following endorsement on a Communication from this Office to the Chief Medical Officer, requesting information as to whether patients in Hospitals will receive the Contraband ration as stated in paragraph 28 Article IV. or the Army Ration as set forth in paragraph 200 Article V. "Officers Manual" also whether separate provision returns must be used for employed and patients if the same ration is issued to both classes, is published for the information of the Medical Officers on duty in this District.

Respectfully returned to 1st Lt Col Chas J. Kipp up Surgeon in Chief District of Alabama with the information that patients in Hospitals will receive the Army Ration as directed in Paragraph 200 Article V. and that separate provision returns for patients and employes will not be required.

(Signed) L. W. Edwards
Surg Lt Col & 1st Lt Col
Chief Medical Officer

Office C. M. O.
B. R. F. and A. Lands
February 13 1867

Signed Chas J. Kipp
Surg Lt Col & 1st Lt Col
Surgeon in Chief

W. W. Surgeon J. Schatz, M.D.
Providence Hospital
Montgomery Ala

3.

Head Quarter Dist of Alabama
Office of Surgeon in Chief
Montgomery Ala July 22^d 1867.

Sir
You are hereby directed to forward every morning
to the Sub Assist Commissioners of the Sub District of
Montgomery a report of the Number of patients and
attendants under your charge. Classifying them as
adult Males and females and Male and female
Children

Very Respectfully Your Obedt Servt
(Signed) Chas J. Kipp
Brig Lt Col & Surgeon U.S.A.
Surgeon in Chief

W. W. Surgeon I. Schatz U.S.A.
Freedom Hospital
Montgomery Ala

Head Quarter District of Alabama
Office of Surgeon in Chief
Montgomery Ala Mar 15th 1867

Circular Letter

The attention of the Medical Officers,
on duty in this District is called to the last Clause
of paragraph 444 Article IV "Officers Manual" and
a strict Compliance with the same enjoined.

(Signed) Chas J. Kipp
Brig Lt Col & Surgeon U.S.A.
Surgeon in Chief

W. W. Surgeon I. Schatz U.S.A.
Freedom Hospital
Montgomery Ala

Bureau of Refugees, Freedmen, & Abandoned Lands
Headquarters Assistant Commissioner
Office of Surgeon in Chief, District of Alabama
March 16th 1867

Circular Letter

Sir, - In accordance with instructions received from the Chief Medical Officer of the Bureau, you are hereby directed to collect all the statistics within your reach relating to those classes among the freed-people specified in the Table here with enclosed. These inquiries to be as extended and as accurate as possible; and whenever you can avail yourself of other reliable agencies in procuring like data you will please do so, stating the source from whence the information is derived. The enumeration will include all persons coming under the Classification of the Table, among the Colored Race of the locality where your inquiries are instituted, whether they are found cared for in any Charitable institution (Municipal, State, or National), or whether they are still a part of the freed population at large.

Any other Cases of defective physical or Mental organization of great rarity or unusual interest, not stated in the Table, may be noted in the blank spaces, under an appropriate heading.

These reports will all be sent to this Office, to be forwarded to the Chief Medical Officer of the Bureau at Washington.

Very Respectfully, Your obt Servt
(Signed) Chas J. Kipp
Surgeon in Chief
District of Alabama

Dr. Doctor J. Schatz
Acting Asst Surgeon U.S.A.
1st Major

5
Medical Purveying Depot, U.S. Army
New Orleans, La., April 8th 1867.

Sir

I herewith enclose an Invoice of Medical Supplies addressed to you, and which have been delivered to the Quartermaster at New Orleans, for transportation.

On receiving them you will please be governed by paragraph 1200, Medical Regulations, or by paragraph 1273, General Regulations of 1863.

Please return one of the enclosed receipts to this Depot, after filling up and signing the same.

I am, Sir, Very Respectfully, Your obt Servt
(Signed) L. B. White
1st Major Asst Surgeon and
Acty Asst Med Purveyor U.S.A.

Doctor J. Schatz, W.W. Surgeon U.S.A.
or Attending Surgeon
Freedmen Hospital, Montgomery Ala

Headquarters District of Alabama
Office of Surgeon in Chief
Montgomery Ala April 11th 1867

Circular Letter

All reports, returns, statements, &c., forwarded to this Office must be accompanied by a letter of transmittal, enumerating them, and referring to no other subject.

(Signed) Charles J. Kipp
1st Lt Col & Surg U.S.A.
Surgeon in Chief

W.W. Surgeon J. Schatz
Montgomery Ala

6.
Head Quarters Dist of Ala
Montgomery Ala April 22nd 1867

Special Orders
No 5.

A Board of Survey is hereby appointed to convene at the Freedmens Hospital at this place, for the purpose of investigating and reporting upon a discrepancy said to exist between the Service of a certain Case of Negroes transferred by W. W. Surg. St. E. Williams U.S.A. to W. W. Surgeon J. Schatz U.S.A. and the amount therein contained.

Details for the Board

2nd Lt G. W. Ballentine 15th Infantry
2nd Lt J. L. Tull 15th Infantry

By Command of Maj Gen Wagon Swaine
(Sergeant) J. F. Longnehan
1st Lt 24th W. Infantry
W. Asst. Adgt Gen.

W. W. Surgeon J. Schatz

7.
Head Quarters District of Alabama
Office of Surgeon in Chief
Montgomery Ala May 1st 1867

Sir
Report of "Unfortunates" required by Circular Letter of March 16th from this Office, has not yet been received from you - please to furnish the same as soon as possible.

Very Respectfully
Yours Obedt Servt
Sigsbee Chas J. Kipp
Bvt Lt Col Surg USVols
Surgeon in Chief

W W Surgeon J. Schatz U.S.A.
Montgomery Ala

Head Quarters District of Alabama
Office of Surgeon in Chief
Montgomery Ala May 7th 1867

Circular Letter

The attention of Medical Officers on duty in this District is called to paragraph xxxv. A. Office Manual 1857. The Surgeon in Charge of relief establishments will make monthly, to the Chief Medical Officer, a report of any patient, or patients, under their charge who have been Soldiers, or of any relative of a Soldier, or discharged Soldier, giving degree of relationship (Form 59)

These reports will be made in duplicate, and forwarded to this Office within five days after the expiration of the month.

(Signed) Chas J. Kipp
Bvt Lt Col Surgeon USVols
Surgeon in Chief

W W Surgeon J. Schatz
Freedmens Hospital
Montgomery Ala

Head Quarters District of Ala
Montgomery Ala May 13th 1867

Special Orders
No. 10.

W. W. Sungen J. Schatz of a
will in addition to his present duties take charge
of the "Home Colony" Near Montgomery Ala
relieving W. W. Sungen Com. Co. Basque of a

By Command of
Major Genl Wagon Swayne
(Signed) J. F. Cunningham
1st Lt 24th U.S. Inf. W. A. A. S.

Head Quarters District of Ala
Office of Surgeon in Chief
Montgomery Ala May 13th 1867

Sir

Enclosed please find an order assigning you in
addition to your present duties to duty in charge
of the "Home Colony"

You will visit said institution
at least once daily.

If in your opinion the service would
be benefited by the discharge of any of the
present employed at said Colony. You are hereby
authorized to discharge them and fill their respective
places by one competent person.

Very Respectfully Your Obedt Servt
(Signed) Chas J. H. H. H.
Bot Lt Col & Surg U.S.A.
Surgeon in Chief

A. A. Sungen J. Schatz of a
Montgomery Ala

Medical Purveyor Office of Army
New Orleans La May 13th 1867

Sir

Information is respectfully sought as to whether the twelve
bottles of water alleged to have been received by you in lieu
of Spts. Vini Gallicae belonged to the Service sent you for the
Sanat leaving this Port April 21st 1867.

We sent whiskey and
Sarsaparilla Whiskey. Copies of the Report of the board of Survey
or other evidence on the subject is requested; also your own
opinion is asked as to whether this package was tampered
with transit or not.

I wish to know where the blame belongs
and to properly place it.

Your Obedt Servt
(Signed) G. B. White
Port Maj & Asst Surg U.S.A.

W. W. Sungen J. Schatz
Montgomery Ala

Head Quarters District of Alabama
Montgomery Ala May 23rd 1867.

Special Orders
No. 11.

During the temporary absence of the Surgeon
in Chief of the Bureau for this District. A. A. Sungen J. Schatz
W. S. A. will in addition to his other duties perform those
of Surgeon in Chief.

By Command of Maj Genl Wagon Swayne
(Signed) D. H. Williams
1st Lt 41st U.S. Inf. A. A. S.

W. W. Sungen J. Schatz
U.S. Army.

War Department
 Bureau of Refugee, Freedmen, and A Lands
 Office of Chief Medical Officer
 Washington May 21st 1867

Circular Letter

Already some cases of Epidemic Cholera are reported to have occurred at some of the Landings on the Mississippi; and it is not unlikely that this disease may make its appearance at other places. It is therefore necessary to adopt such measures as will best tend to prevent its appearance, or control its extension among Communities.

The first effort of course will be to counteract the tendency to its spontaneous origin, and to avert or prevent its introduction from without, through direct communication with persons or objects believed to be infected.

It will therefore be necessary to observe the utmost care in procuring and preserving the best hygienic condition of every settlement, as relates not only to the localities, but also to personal Cleanliness. Strict attention will be given to the proper Sanitary policing of houses, yards, and streets, using freely disinfectants or absorbents (such as lime, Chlorine, Coal tar, plaster of Paris, Sulphate of Iron - whatever may be most readily obtained.)

Attention should also be given to the use of suitable kinds or quality of food, and its proper preparation by cooking; also the water used for drinking or cooking should be carefully examined, and when pure water cannot be procured in sufficient quantities, and the Spring or River Water contains organic impurities, it should be purified by distillation, or the common method preceptated by Permanganate of Potash. Four half a grain to one grain of the Crystallized Permanganate (or its equivalent in solution) added to one gallon of Water should produce a decided pinkish hue, which disappears within twenty four hours (if the salt has not been used in excess.) The water should then be drawn off, and is ready for use -

"Turbid Water, such as that of the Rio Grande, however

Mississippi and its tributaries, should be filtered, or allowed to settle before using. The deposit of impurities can be hastened by the addition of powdered alum in small quantities, well diffused by stirring."

Whenever a case of Cholera occurs, it will be the duty of the Medical Officer to see that the patient is isolated as far as practicable, and that the strictest attention be given to the Cleanliness of the person, Clothing - bedding - and of all the utensils used - and that disinfectants for the latter be freely employed.

All Cases will be recorded in the form of a special Report, according to the following form:

Name	Nativity	Age	date of Attack	date of Recovery	date of death	Remarks
						Surgeon U.S.A.

The treatment of successful Cases will be given in detail, and also the result of Post Mortem examination.

Every fact relating to the appearance of the disease, either by importation or local Cause, so far as ascertained, will be fully set forth in these Reports, and be sent to this Office through the Surgeon in Chief of the District at the end of each week.

(Signed) L. W. Edwards
 Surgeon U.S.A. and Post level
 Chief Medical Officer

War Department
Bureau of Refuges, Freedmen & Lands
Washington June 3rd 1867.

Sir:
Your Return of Public Property belonging to the Medical and Hospital Department of the Bureau of Refuges, Freedmen and Abandoned Lands for the period commencing October 1st 1866 and ending December 31st 1866, with the vouchers thereto pertaining, have been examined in this office and found to be correct.

Very Respectfully
Your Obedt Servt
(Signed) S. W. Edwards
Surgeon U.S.A. & Bot Col
Chief Medical Officer

S. Schatz
Act Asst Surgeon U.S.A.

Memorandum

Semi-Annual Return of Medical and Hospital property of W. W. Surgeon J. Schatz U.S.A. for periods ending December 31st 1866. Received from the Surgeon General's Office is hereby Cancelled the error in communication from this office of the 14th ultimo occurred in examining said Return.

Head Quarters District of Alabama
Office Surgeon in Chief
Montgomery Ala July 8th 1867

Sir
You will please as soon as practicable forward to this Office a Statement of the total Money Value of the Medical and Hospital Supplies received by you from Medical Purposes since Nov 1st 1866

Very Respectfully
Your Obedt Servant
(Signed) Chas J. Kipp
Bot Col & Surgeon U.S.A.
Surgeon in Chief

W. W. Surgeon J. Schatz
Montgomery Ala

Head Quarters Dist of Alabama
Office of Surgeon in Chief
Montgomery Ala July 17th 1867

Circular Letter
Surgeons in Charge of Hospitals will hereafter forward to this Office, quarterly, an estimate of the printed blanks required for their use.

(Signed) Chas J. Kipp
Bot Col & Surgeon U.S.A.
Surgeon in Chief

W. W. Surgeon J. Schatz
Montgomery Ala

Circular Letter
Regulations as to Requisitions for Medicine and Hospital Supplies

War Department,
Bureau of Refugee, Suffering, and Abandoned Lands -
Office of Chief Medical Officer -
Washington, D.C. July 10th 1867

Hereafter requisitions for Medical and Hospital Supplies will exhibit - in the case of Hospitals, its Clinical Capacity, that is the Number of beds provided for the Sick; - in case of Dispensaries or out door Stations - the estimated (approximately) Number of persons for whom Medicines are required will be stated in full, and its equivalent Number of beds (one tenth) also given; thus in a population of One thousand (1,000) persons where it is estimated ten per cent, would come under treatment the equivalent allowance of Supplies would be indicated for a hospital of One hundred beds.

The requisition must state the estimated total population - and then the estimated percentage of Sick to be treated - which in the above illustration would be One hundred Sick - This percentage will vary according to locality, general condition of the Community as regards habits, pursuits, age (whether a large proportion very old and infirm or the very young - or both) the hygienic condition, etc. - It will range in some places from five to fifteen per cent., or even more, depending upon the Section of the Country - the Season of the Year - Epidemic influences, etc.

When a requisition is for a permanent hospital and out door Sick combined - the Number of beds ^{in the hospital} will be stated - and the estimated Number of persons outside who would be entitled to Medical attendance and Medicines - and the equivalent Number of beds - will also be stated.

Requisitions for "Additional Articles"

will be made on a separate sheet of paper, and the reasons therefor will be distinctly and fully set forth in each case - to be transmitted to this Office through the Surgeon in Chief of the District - who will append such remarks respecting the necessity or non necessity of the issue as he may judge proper for the information of the Chief Medical Officer - No issues for these articles to be made until approved in this Office - Issues for Standard supplies will be made as heretofore -

It must be born in mind that it is not intended to furnish every article of the Materia Medica that may be considered as desirable or even essential for private practice - but the Standard Table as recently amended or slightly enlarged will be rigidly adhered to - as it is believed to contain all the essentials of practice.

The Government does not propose to supply all the instruments or remedies that the refinements of private practice would demand - but such articles as are readily obtained and can be successfully applied for immediate and general relief - and as will abate suffering in a helpless and dependent class - and prevent loss of life or permanent injury to health.

By order of Major-General O. O. Howard, Commissioner,
(Signed) S. W. Edwards
Surgeon U.S.A. and Postal
Chief Medical Officer

Medical Purveyor Dept. U.S. Army
New Orleans La July 15th 1867

Sir
I herewith enclose an Invoice of Medical Supplies
to you and which have been delivered to the Quartermaster
at New Orleans for transportation.

On receiving them you will please be governed by Par.
8. Medical Regulations. or by Par. 1273 Annual Regulation
of 1863.

Please return one of the enclosed receipts to this Depot
after filling up and signing the same.

I am, Sir, Very Respectfully,
Your Obedt Servant
(Signed) G. B. White
Actg Asst Med Purveyor U.S.A.

Doctor J. Schatz, W.W. Surgeon U.S.A.
or attending surgeon
Insular Hospital
Montgomery Alabama

Head Quarters District of Alabama
Office Surgeon in Chief B. R. F. & A. L.
Montgomery Ala Aug 24th 1867

Sir
You will please without delay forward to this Office
a copy of the Invoice of Medical and Hospital property
transferred to you by Post Major S. Eldridge, Acting Medical
Store Keeper Washington D.C.

Very Respectfully, Your Obedt Servant
(Signed) Chas J. Stipp U.S.A.
Surgeon in Chief

J.
W.W. Surgeon J. Schatz
Montgomery Ala

War Department
Bureau of R. F. and A. Supply
Office of Chief Medical Officer
Washington Sept 5th 1867

Sir
In order to effect the settlement of your account of
Medical and Hospital Property to Post Major S. Eldridge M.
S. dated July 16th 1867, you will please forward to this Office
the receipt relating to the property received by you

Very Respectfully,
Your Obedt Servant
(Signed) L. W. Edwards
Surgeon U.S.A. Post to Ad.
Chief Medical Officer

J. Schatz
W.W. Surgeon U.S.A.
Post Surgeon in Chief
Montgomery Ala

Head-Quarters District of Alabama
Office Surgeon in Chief B. R. F. & A. L.
Montgomery Ala Sept 17th 1867

Sir
It having been reported to this office that some of the
bales of Hospital property transferred by Post Major S. Eldridge to Medical
Officers in this District were broken when they arrived here, and
that in the unpacking of the same mistakes have occurred

You will please immediately cause a careful exam-
ination to be made of the same to ascertain whether discrep-
ancy (Excess or Deficiency) exist between the Articles and Quantities
invoiced and those actually received.

Very Respectfully, Your Obedt Servant
(Signed) Chas J. Stipp
Post to Ad. Surg U.S.A.
Surgeon in Chief

J. Schatz
W.W. Surgeon U.S.A.

Head Quarters District of Alabama
Bureau R. I. No. A. Lands
Montgomery Ala Sept 24th 1867

Special Order
No. 59

Dr J. Schatz W. W. Surg of Army
will perform the duties of Surgeon in behalf of
the Bureau in the District during the absence
of Col M. Col. G. J. Kipp Surgeon U.S.A.

By Command of Brig Maj Gen W. Swayne
(Signed) S. C. Green
Capt 24th Regt Brig Maj W. W. G.

Head Quarters District of Alabama
Bureau R. I. No. A. Lands
Montgomery Ala Oct 11th 1867

Special Order
No. 63

Dr J. J. Whiting Chief Quarters in care of
Bureau R. I. No. A. Lands Ala. will issue to Dr J. Schatz
W. W. Surgeon in Charge of Home Colony Hospital at the
following articles for the use of the inmates:

Twenty five Dress Coats
Twenty five Pant Sackets

By Command of Brig Maj Gen W. Swayne
(Signed) S. C. Green
Capt 24th Regt Brig Maj W. W. G.

Head Quarters District of Alabama
Office Chief Q. M. B. R. I. No. A. Lands
Montgomery Ala Oct 17th 1867

Dr J. Schatz
W. W. Surg U.S.A.
in Charge Home Colony Hospital
Montgomery Ala

Doctor

In Compliance with S. O.
No. 63. Part 2. Head Quarters Dist Ala B. R. I. No. A. Lands
Montgomery Ala Oct 11th by S. Green with transfer to you for the
purpose therein named.

Twenty five Dress Coats
Twenty five Pant Sackets
I am very Respectfully
Yours Obedt Servant
(Signed) J. J. Whiting
Capt 45th Regt A. S. M.

Head Quarters District of Alabama
Office Surgeon in Chief B. R. I. No. A. Lands
Montgomery Ala Oct 18th 1867

Sir
You will without delay report to this Office the resp
residence of the inmates of your Hospital before they came
under the charge of this Bureau - that is - how many came
from Montgomery County - how many from Monroe - how
many from Louisiana &c

Very Respectfully
Yours Obedt Servant
(Signed) Chas J. Kipp U.S.A.
Brig Gen Surgeon in Chief

W. W. Surg J. Schatz, U.S.A.
in Charge of Freedmen Hospital
Montgomery Ala

Head Quarters District of Alabama
Office Surgeon in Chief B. R. J. & W. Lewis
Montgomery Ala Oct 18th 1867.

Sir
In Compliance with instructions from the Chief Medical Officer of the Bureau - You will without delay report to this Office the date of the Organization of the Hospital under your Charge the whole number of patients since admitted - and the length of time each patient has been an inmate that is How many have remained in Hospital One month how many two months how many three months &c

Very Respectfully
(Signed) Chas J. Kipp
Surgeon in Chief

Dr J. Schatz
Montgomery Ala

Head Quarters Dist of Alabama
B. R. J. & W. Lewis Montgomery Ala Nov 9 67

Special Order
No 75

In accordance with the provisions of Circular Letter from this Office of date Sep 16th 1867 the Civil authorities of Montgomery County having signified their acceptance of the proposition contained in said letter the Bureau Hospital in that County including the buildings immovable Medical & Hospital stores and fuel stored on the premises will at once be transferred to said authorities or duly accredited agent appointed by them The Officers responsible for said property will make regular transfer of the same giving and receiving the proper invoices & receipts therefor -

By Command of Brig Major Genl W. S. Wainwright
(Signed) S. C. Green
Capt 24th Inf Brig Major W. S. Wainwright
a. n. a. S.

Head Quarters District of Alabama
Office Surgeon in Chief
Montgomery Ala Nov 11 1867

Sir
Enclosed please find in Official ^{copy} of Special Order No 75 directing the transfer of the Hospital under your Charge to the Civil authorities.

The transfer will be made without delay. As soon as the transfer is completed you will discharge all Hospital attendants, Students, included and report by letter to this Office

All reports and returns required by existing orders and regulations will be made up to the date of transfer and forwarded to this Office

Final returns of Property and proper Vouchers will be forwarded to this Office as soon as practicable. In case the property is turned over to an agent of the Civil authorities a Certified Copy of his appointment or order must accompany his receipt for the Property. A Copy of Special Order No 75 should also accompany the Property Return

Very Respectfully
(Signed) Chas J. Kipp
Surgeon in Chief

Dr J. Schatz
W. S. Schatz
Montgomery Ala

Head Quarters District of Ala
Office Surgeon in Chief R. R. F. H. Co
Montgomery Ala No 144 1867

The Contract of Acty Asst Surgeon J. Schatz
upt. is hereby annulled to date November
16th 1867 his services being no longer required

(Signed) Charles J. Kipp
Surgeon in Chief

J.
W. W. Surgeon J. Schatz
Montgomery
Ala.

Index

- B. Ballantine G. W. 6
- B. Badger G. 5.
- E. Eldridge S. 16. 17.
- K. Kipp Chas. J. 15.
- S. Schatz S. 1. 2. 3. 4. 5. 6. 7. 8. 9. 12. 13. 16. 17. 18. 19. 20. 21. 22.
- F. F.
- L. L. 6.
- W. Williams D. E. 6.

Roll 26

Target 7

SUBORDINATE FIELD OFFICES
Montgomery (Freedmen's Hospital)

Surgeon's Record Book
Volume (101) Aug. 1865-Jan. 1867

ALABAMA.

40

[Faded text on two overlapping labels]

Reports & Returns
Required from Freedmen's Hospital

	To
1 Weekly Report of Sick & Wounded every Saturday	Surgeon in Chief
2 Report of Attendants in duplicate 15 th of each mo.	" "
3 Do do do last day of each mo.	" "
4 Do Log Rolls of Attendants do " " " "	" "
5 do of Absentees from 59 do " " " "	" "
6 Monthly Report of Sick & Wounded in duplicate " " " "	" "
7 Monthly Statement of Hospital Fund do " " " "	" "
8 Personal Report " " " "	" "
9 Return of Articles purchased with Hosp. Fund every Quarter in dupl.	" "
10 Requisition for Med. & Hospital Supplies " " in dupl.	" "
11 Semi Annual Return of Med. & Hosp. property in duplicate	Chief Med. Officer

D. M. Garrison
1855

Copies of letters.

No 1.

Head Quarters Department Alabama
Medical Director's office.
August 24th/65.

Sir

You will report in person
without delay to Brig. Genl. Wager
Swayne apt. commissioner of Freedmen
Bureau at Montgomery Ala, for
assignment to duty.

I am Sir
your obed. servant.

To: Satter
Surg. & Bvt Lt Col. ^{USA.} med. Director
Dept. Ala
Actg. Staff Surgeon. D. Schatz USA.

No 2

Head Quarters Dept. of Ala. med. Director's
office. August 24/65.

Sir

The Maj Genl comdg. Directs that all the sick
& wounded now at the Post of Montgomery be
aggregated at the St. Mary's Hospital

The Hospital heretofore known as the Post
Hospital will be turned over immediately to
the apt. Com. Freedman's Bureau, B. Sig. Genl.
W. Swayne or such officer as he may
please to designate, the furniture being
invoiced and receipted for in the prescribed
manner

I am Sir
your obed. servant

official copy
Chas. A. Miller
may 24. 65.

To: Satter
Surg. & Bvt Lt Col. USA. med. Director
Dept. Ala.

Continued.

Spicae pulv.	oz	8
" & Opii	"	4
Lini pulv.	lb	3
Magnes. Sulph.	"	4
Alum Olivae.	bot.	2
" Ricin.	"	8
" Terebenth.	"	3
" Tiglii	oz	1
Opii pulv.	"	8
Linctura	"	12
Pillulae cathart. comp.	oz	6
Plumb. acet.	oz	4
Potass. Iodid.	"	16
Rhin pulv. ^{Summ Sulph}	"	4
Sapo in	lb	2
Seillae pulv.	oz	4
" Symplicis	lb	1
Sodae chlor. Lignor.	"	1
" Bicarb.	oz	24
" & Potass Tart.	"	24

Hospital Stores.

Beef Extract.	lb	24
Nutmegs	"	1/4
Instruments.		
Cupping glasses	no.	2
" tin.	"	2
Probangs	"	5
Scarificators.	"	2
Stethoscope	"	1
Syringe ^{Gold}	"	1
" hard Rubber	"	1
" - Simans	"	1
Drapings.		
Adhesive plaster.	yd	10
Binders board	pic	20

Continued.

Binders boards	pic	20
Stand red.	yd	1
Gutta percha cloth.	"	5
Dehtyol plaster.	"	6
Knapsacks furnished bad condit	No	1
Litters hand.	"	2
Needles case	No	1
Oakum fine	lb	3
Oiled muslin.	yd	5
" Silk.	"	2
Pencils Hair in vial	No	1
Rollers bandages.	Dog	24
Splints sets.	Set	3
Splints apert.	No	15
Suspensary bandage cotton	"	6
Tape cotton.	pic	1
Torr.	lb	2
Towels.	Dog	2

Books & Stationary

Anatomy surgi. Pomors	cop	1
Blank books	No	2
Envelops.	"	25
Ink list.	No	4
Prescript. Ward Books	"	3
Paper wrapping	quires	1

Bedding

Bed sacks	No	6
Blankets white & gray.	"	74
" cases canvas.	"	14
Gutta percha bed covers	"	22
Mosquito bars.	"	14
Pillows hair.	"	12
" cases cotton.	"	12

5

Continued

Furniture & appliances	
Basins tin for Dressing	No 4
Wash hand warm	" 17
Bed pans	" 1
Camp stove	" 1
Buckets leather	" 2
Corks assorted	doz 6
Corkscrews	No 2
Funnel Tin	" 1
graters nut megr	" 1
Hatchet	" 1
Hone	" 1
knives & forks. (used)	" 20
measures graduate	" 2
" minim	" 1
Pots chamber self	" 1
tea tin	" 1
Razor & stop in case	" 1
scales & weights prescrip	" 1
sheep skins repid for meat	" 3
Spatulas	" 2
Spoons table	" 80
" tea	" 17
Urinals glass	" 2
Ladle (used)	" 1
pans sauce (used)	" 1
Pots Mess	" 1
Trays Butlers (used)	" 3
Cups tin (used)	" 80
Plates tin	" 48
Additional articles.	
Bottles	200
Cans	18
jars	4
Boss paper	1
Boss wood tracking	2

Continued

6

Station Montgomery Ala
Date August 25/65

Signed
J. M. Phipps
Staff Surg. U.S.A.
in charge of Hospital Post.

Voucher No 1.

Invoice of Hospital Supplies (Rebel)
Transferred to J. Schatz acting Staff Surgeon U.S.A.
in charge of Friedman's Hospital

Shirts	No	100
Drawers	"	100
Matras	"	60
" Spring	"	7
Sheets	"	140
Pillows	"	100
Comforts	"	103
Wash basins	"	15
Chambers	"	27
Bed pans self	"	5
" Tin	"	4
Cups self	"	33
Spitons	"	9
Coffee pots	"	6
Plates self	"	6
Bread pans bakins	"	25
Iron tea Kettle	"	1
Bread pans	"	11
Pitchers	"	16
Buckets wood	"	1
Dippers Tin	"	4
Candels sticks	"	6
Salt cellars	"	12

7 invoice continued of Rebel supplies

Skillets	No.	2
Bed straws	"	3
Stoves boilers	"	6
Toasting forks	"	2
Ladles	"	1
Spoons Kitchen	"	1
Waiters	"	5
Shovels	"	7
Axe	"	1
Pint cups	"	1
Cooking range	"	1

I certify that the above is a correct invoice
 Signed J. M. Phipps. } Montgomery Ala
 actg. Staff Surg. USA. } August 25th/65
 in charge Post Hospital } Voucher No. 1

Invoice of Medical & Hospital supplies
 transferred to Dr. Schatz actg. Staff Surg. USA
 in charge of Freedman's Hospital Montgomery Ala.
 Materia Medica

acacia pulv.	oz	3
ammon-carb.	"	3
Liq.	"	3
Ciratum Adipis	lb	2
Ext Rhii fluid.	oz	3
Ferri chlor Liq.	"	3
Oyl Glycerina	"	3
Morphia sulph.	"	14
Potas chloras.	"	3
Instruments		
Field case Genl. op. set.	No.	1
Pocket case	"	1
Syring Hard. Rub. oz 4.	"	1
Teeth Ext case	"	1
Adhesive plaster	oz	5
Draining tongue	"	1

Continued

Roller bandage apt.	Doz	8.
Books & stationery		
Anatomy Gray's	copy	1
Dispensary	"	1
Blank Books	No	2
minor surgery	copy	1
Practice Books	"	1
Surgery Erichson's	"	1
Book Stand traveling	No	1
mucilage	bot	1
Bedding		
Bed sacks	No	10
Pillow sacks	"	10
furniture & appliances		
Basins tin wash hand	No	2.
Buckets Leather	"	2.
Hatchet	"	1
Lanterns Glap.	"	3.
Letters hand	"	4
Medicine - panier complet	"	1
Map chest furnished	"	1
Spatulas 3 & 6 inch.	"	2.
Boxes	"	2.
Jars	"	5.
Cans	"	5.
Bottles	"	35

I certify that the above invoice
 is correct.
 J. M. Williamson
 actg. Staff Surg. USA
 Montgomery Ala.
 Aug. 25th/65.
 Voucher No. 2.

Invoice of Medicines & Hospital Supplies
 Transferred to Dr. Schatz, Asst. Staff Surg. Dept.
 in Charge Freedmen Hospital Montgomery Ala

Articles	Quantity
Acidum Sulph. Arom	oz 20
" Tannicum	oz 2
Alcohol	Bot 11
Aether Sertin	oz 8
Argenti Nitras	oz 1
" " Sinc	oz 1
Acidum Tart.	oz 16
Ammonia Carb	oz 16
" Lignum	oz 16
Alumina	oz 10
Camphora	lbs 1/2
Ceratum Adipis	lbs 5
" Cantharides	lbs 1/2
Capsica	oz 26
Cinchona Sulph	oz 8
Capsici	oz 8
Chloroformum	oz 2
Crysolinum	oz 1
Ext Aconiti Radicis Std	oz 8
" Cinchonid Fluid	oz 2
" Colchici Sem Std	oz 8
" Gentian Fluid	oz 16
" Hyoscyamus	oz 2
" Senega Fluid	oz 16
" Spicae "	oz 6
" Colocynth Compes	oz 4
Ferri persulph Liquor	oz 8
" Chlor Liquor	oz 14
Hydrargyri Chloridum unit	oz 20
Hydrargyri Pillula	oz 12

Spicacruaba Et Opi Pul	oz 16
Lini Pulv	lbs 6
Magnesia Sulph	" 12
Oleum Olivae	Bot 9
" Ricini	" 13
" Terbinthinae	" 3
" Tiglii	oz 1
Opi Pulvis	oz 16
" Linctura	oz 2
" " Et Camph	oz 4
Pillula Cathart Compes	lbs 24
Plumbi Acetas	oz 4
Quiniae Sulph	oz 7
Scillae Symplic	oz 16
Sodae Chlorinata Liquor	Bot 18
Sodae Bicarbonas	oz 4
Syrupus Siga Pulv	lbs 2
Spiritus Tinctura	Bot 4
Hospital Store	
Bref Ext of	lbs 50
Gelatin Shred	oz 16
Guttings	oz 8
Cocoa	lbs 12
Sea Blact	" 1
Worpinge	
Adhesiv. Plaster	Can 4
Binders Boards	lbs 12
Flannel Red	lbs 12
Lith Patent	lbs 2
Roller Bandages Apt	lbs 4
Suspensory Bandages	1
Tape	3
Linin	4
Books and Stationary	
envelops apt	No 224
Book	Bot 6
Paper wrapping	Can 3
" Writing apt	" 9 1/2
Portfolio	No 1

J. E. Harvey, Asst. Surg.
 50th Ills Regt

Voucher No. 3

Dr. Schatz
 Asst Staff Surgeon in Charge
 Freedmen Hospital

Chief Surg. Commission Bureau of Hygiene
Frederick & Standard Buildings
Montgomery Ala Sept 27 1865

General Order
Sept 18

Surg. Chas. J. Kipp U.S.
Vol. Surgeon in accordance with order
the Commission of this Bureau reported at the
office of announced as Surg. in chief and
will be relieved and respecting accordinly.

By Order
Brig. Gen. W. Swayne
S. A. G.

Dr. J. Schatz
Act. Staff Surg. U.S.A.
Montgomery
Alabama

Chief Surg. Commission Bureau of Hygiene
Frederick & Standard Buildings
Montgomery Ala Sept 27 1865

Special Order
Sept 18

Medical Officer on duty in con-
nection with Bureau of Hygiene
and Standard Buildings with without delay
report to Surgeon Chas. J. Kipp U.S. Surg.
in Chief, this name rank and Station will
be shown, orders allowed in with same
contracted and date of assignment in full
of contract and compensation allowed.

By Order
Brig. Gen. W. Swayne

Sept 27 1865
S. A. G.

Dr. J. Schatz
Act. Staff Surg. U.S.A.
Montgomery
Ala.

Chief Surgeon Hospital
Montgomery Ala Sept 27 1865

I have the honor to
report that I have been on duty as Surgeon in
charge of the sick District of Montgomery since
the 1st of August inst. I am connected with
Dr. J. Schatz, Staff U.S. Medical Director
Hospital, Fort Lee, Sta. Surg. U.S.A. and
penetration and undoubtedly same as previous
Surgeon.

I am the Surgeon
J. Schatz
Act. Staff Surg.
in charge Fort. Hoopl.

Surg. Schatz J. Kipp U.S. A.
Surg. in Chief
Frederick Bureau
District Ala.

Office Commissary General of Subsistence
Washington

Bureau of Provisions Freedmen & Colored
District of Alabama
Montgomery Sept. 10th 1865

Sir

As the Honorable Secretary of War has granted the authority to commute the rations of horses to Freedmen when these people are in Hospital in the same manner as is done by the Army Regulations for sick soldiers in Hospitals you will hereafter draw only such parts of the rations as are actually required for the support themselves and authorized attendants and in this manner establish a "Hospital Fund" which is expended in the purchase of such articles which are needed by the sick and which are not issued by the Subsistence or Medical Departments.

The accompanying circular from the Commissary General of Subsistence is furnished for your guidance and information.

Very Respectfully

Your Obedt. Servt.

Chas. J. Coffey

Surg. Genl.

Surg. in Charge

Acty. Staff Surg. H. Schatz Capt.
in Charge of Freedmen Hospital
Montgomery Ala.

Circular

Office Commissary Genl. Subsistence
Washington Wash. D. C.

Hospital Fund Now Created

The sick and mending will receive in this manner, only such parts thereof as are required for the support of themselves and authorized attendants. The difference between the number of rations due a Hospital, at each price of the a complete ration of the station and the value of the stock issued, it being the same price and of the same price, available a credit with the Subsistence Department of the Hospital, the "Hospital Fund".

W. H. H.

The Commissary who issues to a Hospital is authorized to purchase for it on the requisition of the Medical Officer in charge, and in the amount not exceeding the Hospital credit at the time, a certain 1st class, solid or fuel to be used in the diet of the sick, and not furnished by the Subsistence Department or Medical Department.

Articles to be used in either the preparation or serving of the food are to be purchased by the Commissary and not furnished by the Quartermaster Department or Medical Department.

Gas, Oil, and other means of illumination to be used instead of candles, which are part of the ration. The Hospital Fund being thus a means of expediting the suffering sick with wants and necessities needed in their health and more comfortable condition, and otherwise to be obtained, its management should be held as a sacred trust and its expenditure controlled strictly to the purpose which this fund is intended to accomplish. Medical and Hospital supplies and

Quarters, medical supplies, and all objects of the expenditure from the appropriations of the different Departments of the military service, are not proper charges against the Hospital credit.

Its Expenditures.

The articles purchased by the Commissary for the sick in Hospital are paid for out of the Subsistence funds in his hands for public disbursement, on a voucher certified to by the Medical Officers in charge; and the balance is diminished in consequence of the amount of the purchases made. An expenditure of money by the Commissary for the subsistence or maintenance of sick in Hospital is accounted for in the manner prescribed for other disbursements of the Subsistence Department. At large Depots or Camp Hospitals, this fund may be partly expended for the benefit of the sick at regimental Posts or in detachments, on requisitions approved by the Medical Director or senior Surgeon of the district.

How Ascertained

A Statement of the Hospital Fund is made out at the end of each calendar month, and appears as a part of the Commissary's Abstract of Issues to Hospital for the month. On this account the balance of credit (if any) to Hospital, at the end of the preceding month, and the number of rations due in the month, at cost price; also the stores which have been issued by the Commissary to the Hospital and articles purchased by him for the sick, during the period, with the cost of each article, are ascertained. The difference between these two amounts credits and debits - leaves an ascertained balance of credit (if the Hospital Fund for the month has not been entirely used up), applicable to authorized expenditures for the subsistence or con-

tinuance of the sick in Hospital during the following month. This Statement may be prepared in the same manner, at any day should there be occasion for ascertaining the exact state of the credit of a Hospital at any particular date. An Abstract of Issues to Hospital and a Statement of the Hospital Fund should be made out monthly for each separate Hospital.

9

Articles	Quantity
Acidum fulvum	28
Acidum Sulphuricum	32
Aether Spiritus	144
Alcohol Fortis	36
Aurum Liquor	38
Argentum Purum	3
Arsenicum Spiritus	12
Banphora	24
Coratrum Acetis	10
Copaiba	96
Cocti Preparata	32
Extract Belladonnae	3
" Gentianae Plurimum	48
" Veratri Viridis Spiritus	6
Ferri Sulfurici Tinctura	32
Ferri Symplicis	24
Glycerina	32
Hydrogyni Chlorid. Com.	2
" Unguentum	3
Specacuantha & Cili. puris	24
Magnesia Sulphur	32
Morphina	24
Olei Scutellae P. P. Tinct.	32
Oleum Ricini	8
" Tridactylae	4
Opii Pulvis	48
" Tinctura	48
Opium Scips	8
Potassae Chlor	16
Quinae Sulphur	60
Sapo	16
Scillae Symplicis	20
Socae Chloromatae Liquor	9
Spiritus Ammoniac	168
Sulphur	32
Sulphur	4

6

Articles	Quantity
Ammonium Sulfur	13
Ammonium Sulfur	20
Ammonium Sulfur	1
<u>Instrumenta</u>	
Syringes, P. S. G. S.	8
Vaccin. V. S. G. S.	21
<u>Dressings etc.</u>	
Lint. P. S. G. S.	5
P. S. G. S.	2
Syringes	10
<u>Socks & S. S. etc.</u>	
Hospital Stewart's Sheet	1
Sheet, S. S. G. S. 16. 14. 14.	1
Compresses, P. S. G. S.	200
Cap. 2 of 100	6
Instrumental S. S. G. S.	1
Triclinic of P. S. G. S.	1
T. S. G. S.	2
P. S. G. S.	16
" " " " " "	16
P. S. G. S.	36
" " " " " "	6
T. S. G. S.	12
P. S. G. S.	12

(Continued)

Packages Articles	Quantity
Bands	2
Baths	390
Boxes, Paper	28
" Wood	32
Cauities	18
Jan & P. S.	6
<u>Hospital Clothings</u>	
Covers, Dressing	200
Slippers	200
Socks, Woolen	300
<u>Furniture & Appliances, P. S. G. S.</u>	
Bins, Tin, Wash, Hand	20
Brooms	12
Buckets, S. S. G. S.	12
Buckets, Wood	12
Caustics	16
Chairs	28
Chairs	2
Chairs	570
Covers, assorted	26
Covers, Glass	12
Pill Cases	2
Pots, S. S. G. S. Delf	20
P. S. G. S. in Case	1
Shells	36
Showerbaths	1
S. S. G. S.	2
S. S. G. S.	24
<u>(Class 1 & 2)</u>	
Various S. S. G. S.	120

(Continued)

Articles	Quantity
P. S. G. S.	6
S. S. G. S.	120
" " "	60
" " "	12
" " "	120
" " "	120

Commodore Letter

Bureau of Refugees, Freedmen and Abandoned Lands
Washington D.C.
Montgomery Ala

Respectfully, some time since passed
within for days from the expiration of such,
month to the Office of the Chief Medical Officer,
Bureau of Refugees, Freedmen and Abandoned Lands,
Washington D.C. a copy of the "Monthly Statement
of Hospital Funds" at the same time forwarding with
copy of the same to this Office.

The names, rank and Station of the Commissioners of
Sustenance by whom the Hospital returns are
issued should be endorsed on the "Statement".
In cases where any outstanding and unpaid bills
that are chargeable against this fund, the same
total of all the indebtedness should be entered on
the "Statement".

Very Respectfully
Your Obedt. Servt.
Charles S. Cook
Surgeon U.S. Army
Surgeon in Chief

Acty Staff Surg. S. Schatz U.S.A.
in Charge of Freedmen's Hospital
Montgomery Ala

War Department.
Bureau of Refugees, Freedmen and Abandoned Lands.
Office of Chief Medical Officer
Washington May 26. 1866

Doctor.

I am engaged in revising the Regulations for the
Medical Department of the Bureau. Please write this Office
direct if existing regulations afford you every facility for
taking care of Sick and Aged in Refugees and Freedmen,
if not, what changes your experience would suggest.

In the Connection your attention is called to
Paragraph 333 Circular No 3000 1866, from
the Bureau. (enclosed) Please state if the Civil
Authorities have adopted the proper measures
for the Care of Sick and Aged in Freedmen,
giving, at the same time, your opinion. And
the facts upon which such opinion is founded,
whether the Medical Department of the Bureau,
should or should not be continued in your District.

Very Respectfully
Your Obedt Servt
(Signed) Capt. W. Storn or
Surgeon U.S. Army
Chief Medical Officer

To
S. Schatz
W. W. Youngren M.F.L.

Freedom Hospital
Montgomery Ala June 1st 1866

Colt W Hornum
Chief Medical Officer
B of R. F. and W. Land.
Washington D.C.

I have the honor to acknowledge the receipt of your communication of the 26th inst and in reply beg to say that it is my opinion that some arrangement should be made for Freedmen who are sick with their Masters while engaged under Contract, that Employers should be compelled to pay so much per day when they send their Servants to the Freedom Hospital for treatment. There are at present a large number of Freedmen in Cities without any visible means of support applying daily for Medical Attendance and while no effort has been made by the City Authorities for providing for the sick, it is also my opinion that Common Humanity requires the continuance of Freedom Hospital

I have the honor to remain
Very Respectfully Yours &c

A. W. Surgeon U. S. A.

Freedom Hospital
Montgomery Ala Nov 17th 1866.

Sir

In Compliance with your instructions in date Nov 10. 1866 I have the honor to forward the enclosed Vouchers pertaining to my Return for periods ending Dec 31st 1865. June 30th 1866. & Sept 30th 1866. respectively viz
Voucher No 1. Invoice of J. W. Phipps W. W. Surg U. S. A.
Voucher No 2. Invoice of J. W. Phipps W. W. Surg U. S. A.
Voucher No 3. Invoice of J. W. Williams W. W. Surg U. S. A.
Voucher No 4. Invoice of J. E. Harvey Surg 58th Ill Regt
Voucher No 5. Invoice of J. E. Harvey Surg 58th Ill Regt
Voucher No 6. Invoice of Robert Fletcher M. D. Surgeon
Receipt of R. H. Beaudry No. of period ending Dec 31st 1865.
Receipt of R. H. Beaudry No. 8. period ending Dec 31st 1865.
Affidavit of Articles Lost or Antiquated Months Augt Sept Oct & Nov 1865.
Voucher No 9. Invoice of C. B. White City M. D. Surgeon U. S. A.
Voucher No 10. Invoice of C. B. White " " " U. S. A.
Voucher No 11. Invoice of Robt Fletcher M. D. Surgeon U. S. A.
Voucher No 12. Invoice of C. B. White W. M. Surgeon U. S. A.
Voucher No 13. Invoice of A. E. Williams W. W. Surg U. S. A.
Voucher No 5 should be revised 47 Knives & Forks in my Return ending Dec 31st 1865. Should be revised 39. I am enabled to aff for the Arseny of Voucher No 8. under the head of bedding

the head Knives and Mattresses on the Invoice are separate and on my Return they are consolidated.

The enclosed Invoice and Receipt were furnished me for my own protection; but as I have no others in my possession I cheerfully send them to facilitate the settling of my account. My Receipts for property I have always forwarded to your Office immediately on Receipt of the Stores. I can not be held responsible for the non Compliance of the Orders of other Officers.

I would also respectfully request

That the Order suspending my pay account
be revoked

I have the honor to remain
Very Respectfully, Your Obedt Servt

Wmly Sent Myself

L. W. Edwards
Surgeon U.S. Post Dept
Chief Med. Officer
Washington D.C.

War Department
D of R F and A Lands
Washington Nov 23rd 1866

Sir
Your Returns of Public Property belonging
to the Medical and Hospital Department of the
Bureau of Refugee Freedmen and Abandoned
Lands for the period commencing August 25th
1865 and ending Dec 31st 1865 with the vouchers
there pertaining have been examined in this
Office and found to be correct

Very Respectfully,
Your Obedt Servt
(Signed) L. W. Edwards
Surgeon U.S. Post Dept
Chief Med. Officer

J. Schatz
W. W. Surgeon
Hon. Surg. in Chief Dept of Ala
Montgomery Ala

War Department
D of R F and A Lands
Washington Nov 23rd 1866

Sir
Your Returns of Public property belonging to the
Medical & Hospital Dept of the D. R. F. & A. Lands
for the period commencing Jan 1st 66 and ending
June 30th 66 with the vouchers there pertaining have been
examined in this office and found to be correct.

Very Respectfully, Your Obedt Servt
(Signed) L. W. Edwards
Surgeon U.S. Post Dept
Chief Med. Officer

J. Schatz
W. W. Surgeon U.S.A.

War Department
D of R F and A Lands
Washington Nov 23rd 1866

Sir
Your Returns of Public property belonging to the
Medical & Hospital Dept of the D. R. F. & A. Lands for the period
commencing July 1st 66 and ending Sept 30th 66 with the vouchers
there pertaining have been examined in this office and
found to be correct

Very Respectfully, Your Obedt Servt
(Signed) L. W. Edwards
Surgeon U.S. Post Dept
Chief Med. Officer

J. Schatz
W. W. Surgeon U.S.A.
Hon. Surg. in Chief Dept of Ala
Montgomery
Alabama

May

1867

Freedmens Hospital at Montgomery Ala in c^o with
Subsistence Department

May 1st

To Authorized attendant and patients
for ten days 200 Army rations at 28 3/4 Cents

66 12 1/2

3 Ckd

May 11th

To 355 Army Rations at 28 1/2 Cents per Ration

73 31 1/4

May 20th

To 247 1/2 Army Rations at 28 3/4 Cents per Ration

71 15 1/2

Freedmens Hospital at Montgomery Ala in c^o with
Subsistence Department

By Supplies drawn from Subsistence Department on previous
Returns from May 1st to 10th

May 1

250 lb Fresh Beef at 16 Cents per lb 40 00

225 lb Flour at 8 " " " 18 00

15 " Beans " 3 1/2 " " " 52 1/2

8 " Coffee " 32 1/2 " " " 2 60

1 1/2 " Tea " 1 36 " " " 2 04

30 " Sugar " 9 1/4 " " " 2 77 1/2

1 Gall Vanilla " 34 " " " 34

8 1/2 lb Salt " 1 3/5 " " " 12 1/2

2 Cans Tomatoes 1 1/2 54 1/2 Cans 1 28 1/4

6 lb Mix Vegetables 22 " " " 1 32

May 11

By 196 pounds Flour at 8 1/2 Cents per lb 15 68

15 " Beans " 3 1/2 " " " 50 1/2

10 " Rice " 10 1/2 " " " 1 05

1 1/2 " Tea " 1 36 " " " 2 04

30 " Sugar " 9 1/4 " " " 2 77 1/2

2 1/2 " Can do. 22 1/2 " " " 57 1/2

10 " Soap " 10 " " " 1 00

9 " Salt " 1 3/5 " " " 12 1/2

May 21

By 75 pounds Pork at 10 1/2 Cents per lb 7 87 1/2

277 1/2 " Flour " 8 " " " 22 31 1/2

15 " Beans " 3 1/2 " " " 50 1/2

10 " Rice " 10 1/2 " " " 1 05

8 " Coffee " 32 1/2 " " " 2 60

1 1/2 " Tea " 1 36 " " " 2 04

33 3/4 " Sugar " 9 1/4 " " " 3 12 1/4

9 " Soap " 10 " " " 90

8 " Salt " 1 3/5 " " " 12 1/2

1/2 " Peppin " 55 " " " 27 1/2

Proceedings Hospital Montgomery Ala in Apr with Subsistence Department

1867
June 1 To 260 Ration w 28 3/4 74 75

June 4 To 42 Ration w 28 1/4 12 07 1/2

June 7 To 260 Ration w 28 3/4 74 75

1867
June 1 By 125 pounds Fresh Beef w 16 cent per lb 20 -
 " 29 3/4 " Flour 8 " " 23 4/4
 " 15 " Beans 3 1/2 " " 5 1/2
 " 10 " Rice 10 1/2 " " 1 05
 " 8 " Coffee 32 1/2 " " 2 60
 " 1/2 " Sugar \$1 36 " " 2 04
 " 30 " Sugar 9 1/4 " " 3 7 1/4
 " 2 Gall Vinegar 3 1/4 " " 68
 " 8 Pounds Soap 10 " " 80
 " 1 Gall Molasses 75 " " 75
 " 1 1/2 Pkts Pork 200 1/4 lb @ 8 cent \$21. 1/2 21 2 1/2

June 11 By 329 lb Flour w 8 cent per lb 27 12
 200 lb Beans w 3 1/2 " " 1 05
 10 lb Rice w 10 1/2 " " 1 05
 16 lbs Coffee w 32 1/2 " " 5 20
 45 lb Sugar w 9 1/4 " " 4 16 1/4
 3 3/4 lb Corn Meal w 22 3/4 " " 85 1/4
 12 lb Soap w 10 " " 1 20
 1 1/4 lb Salt w 1 1/2 " " 1 1/4
 3/4 lb Pepper w 50 " " 41 1/4
 1 Gall Molasses w 75 " " 75
 3 lb Misc Vegetable w 32 " " 1 10

1867 *Fundamental Hospital Montgomery Ala*

June 21 *S. 290 Rations* *w* *28 1/2* *83* *37 1/2*

in acc with Subsistence Department

June 21	To	125	lb	Frank Beef	w	16	✓	30	
		196	lb	Flour	w	8	✓	15	68
		10	lb	Rice	w	10 1/2	✓	1	05-
		1 1/2	lb	Tea	w	\$136	✓	2	04
		30	lb	Sugar	w	9 1/2	✓	2	77 1/2
		1	Gal	Wine	w	30	✓		34
		8	lb	Soap	w	10	✓		80
		1	Gal	Molasses	w	75	✓		75-
		2	lb	corn	w	25			50
		5	lb	White Sugar	w	22		1	10

Home Colony Montgomery Alabama

1867
 June 1 491 Rations at 28 3/4 Cents 1440 57 1/2

June 11 495 Rations at 28 3/4 Cents 136 56 1/2

in ac with Subsistence Department

18 3/4 lb	Salt	w	10 1/2	✓	19	37 1/2
55 1/4 lb	Flour	w	5	✓	44 1/2	18
36 lb	Beans	w	3 1/2	✓	1	26
2 1/2 lb	Rice	w	10 1/2	✓	2	52
39 3/4 lb	Coffee	w	5 1/2	✓	12	73 1/2
7 3/4 lb	Sugar	w	9 1/2	✓	6	80 1/2
4 1/4 lb	Wingard	w	3 1/2	✓	1	65 1/2
16 1/9 lb	Can. corn	w	22 3/4	✓	1	89 1/4
19 1/2 lb	Lard	w	10	✓	1	95 1/2
18 lb	Salt	w	17 1/2	✓	25	
1 1/2 lb	Pepper	w	55	✓		66 1/4
3	Graham Flour	w	70	✓	1	50
5 lb	Mix. Crystals	w	22	✓	1	10
3	Can. Jelly	w	5 1/2	✓	1	87 1/2
1	Can. Meal 196 lb	w	2 3/8	✓		65 1/4
306 1/4	purchase of J. Beef	w	16	✓		49
						150 08

31 2 1/2 lb	l. Fresh Beef	w	16 Cents	✓	50	
5 1/4 lb	l. Flour	w	8	✓	42	72
37 1/2 lb	l. Beans	w	3 1/2	✓	1	51 1/2
22 1/2 lb	l. Rice	w	22 1/2	✓	2	46 1/2
30 1/2 lb	l. Coffee	w	5 1/2	✓	6	50
30 lb	l. Sugar	w	9 1/2	✓	3	77 1/2
1 lb	l. all Wingard	w	3 1/2	✓		32 1/2
2 1/2 lb	l. lard	w	22 3/4	✓		57
19 lb	l. Soap	w	10	✓	1	90
17 3/4 lb	l. Salt	w	17 1/2	✓		26 1/4
1	Can. Meal	w		✓		75
						109 49

Home Colony Montgomery Alabama

1867
 June 21 515 Rations at 28 3/4 Cents 1448 06 1/2

in ac with Subsistence Department

268 1/2 lb	l. Pork	200 1/2 lb	at 10 1/2	✓	21	02 1/2
46 1/4 lb	l. Beef	200 lb	at 16	✓	32	56
349 lb	l. Flour	392 lb	at 8	✓	31	36
25 0 1/2 lb	l. Beans	34 1/2 lb	at 10 1/2	✓	1	28 1/2
25 1/2 lb	l. Rice	25 lb	at 10 1/2	✓	2	67 1/4
250 lb	l. Coffee	lb	at 5 1/2	✓		
200 lb	l. Sugar	20 lb	at 9 1/2	✓	2	77 1/2
100 lb	l. Wingard	1 Gall	at 34	✓		32 1/2
200 lb	l. Soap	8 lb	at 10	✓		50
1	Gall. Molasses		at 75	✓		75
2	Can. Tomatoes		at 25	✓		50
3	Can. Jelly		at 54 1/2	✓	1	62 1/2
1	Can. Jam		at	✓		54 1/2
306 1/4	purchase of J. Beef		at 16	✓		49
						95 70

1864 *Pro domo Hospitalis in Gen. vish*

11. 16. 7
 July 31 *Q. 335 1/2 Rationes ad 29/38 3/4 Punt \$ 98 97*

1864 *Substantivo Dep. artibus in V*

July 31	By	309	Pound of Flour	w	✓	8 1/2	26	26 1/2
		75	Pound of Pork	w	✓	11 1/4	8	45 1/4
		30	Pound of Rice	w	✓	10 1/2	3	15
		20	Pound of Hamony	w	✓	1 1/2		32
		45	Pound of Sugar	w	✓	11 1/2	5	17 1/2
		24	Pound of Coffee	w	✓	3 1/2	7	80
		12	Pound of Soap	w	✓	10	1	20
		1 1/4	Pound of Candies	w	✓	21 1/4		27 1/4
		1	Gallon Molasses	w	✓	75		75
		1	Gallon Vinegar	w	✓	20		20
		1/2	Pound of Pepper	w	✓	55		27 1/2
		1	Can Tomatoes	w	✓	25		25
		100	Pound of Meal	w	✓	3 1/2	8	62 1/2
							57	74 1/4

Home Column 14 on put in in of with

Substance Dept

1867					
July 1	19.20.6	520 Ration	w 29 1/2	with Cent	153 4/10
July 11	19.28.3	Lo 490 Ration	w 29 1/2	with Cent	144 5-5 87 1/2

1867					
July 10	By	585 lb Flour	- 8 1/2	49	72 1/2
		650 lb Beef	- 16	104	
		45 lb Beans	- 6 1/4	2	81 1/4
		20 lb Rice	- 10 1/2	2	10
		40 lb Coffee	- 32 1/2	13	
		75 lb Sugar	- 11 1/2	8	62 1/2
		1 Gall Vinegar	- 23		23
		6 1/2 lb Candles	- 21 1/4	1	33
		20 lb Soap	- 10	2	
		19 lb Salt	- 1 1/4		33 1/2
		1 1/2 lb Pepper	- 55		68 1/4
		3 Can Tomatoes	- 25		75
		2 Gall Molasses	- 75	1	50
		1 Box 200 lb C. Molasses	- 5 1/2	7	25
				194	394 1/2
July 11	By	20 lb Flour	- 11 1/4	22	61 1/4
		392 lb Flour	- 8 1/2	33	32
		30 lb Beans	- 6 1/4	1	87 1/2
		20 lb Rice	- 10 1/2	2	10
		8 lb Coffee	- 32 1/2	2	60
		15 lb Sugar	- 11 1/2	1	72 1/2
		1 Gall Vinegar			
		1 1/4 lb Candles	- 21 1/4		26 1/2
		16 lb Soap	- 10	1	60
		15 lb Salt	- 1 1/4		26 1/4
		1 1/4 lb Pepper	- 55		10 1/4
		1 Gall Molasses	- 75		75
				67	244 1/4

1867 Home Colony Hospital in @c with

July 21 To 5 1/2 Rations at 29 3/4 Cents @ 168 1/4

1867 Subsistence Department

July 21	By 250 pounds Beef	w	- 16	250
	589	" Flour	w	- 9 1/2
	15	" Beans	w	- 6 1/4
	20	" Rice	w	- 10 1/2
	20	" Coffee	w	- 22 1/2
	45	" Sugar	w	- 11 1/2
	1	" Green Wing	w	- 22
	5	" lbs Canned	w	- 21 1/4
	10	" lbs Soap	w	- 10
	4	" lbs Salt	w	- 17 1/4
	1/2	" lb Pepper	w	- 5 1/2
	2	" Gallons Molasses	w	- 7 1/2
	6	" lbs Tomatoes	w	- 25
	5	" lbs Mince	w	-
				109 3/4

1867

Home Colony Hospital Worcester

Aug 7th 28-41-12
750 Rations w 29th Cents per Ration 224 26

Aug 11th Do 750 Rations w 29th Cents per Ration 221 25

1867

Wm in the with Subsistence Department

Aug 7 th	By	20 th pounds Pork	w	✓	11/4	22	61/4
		375 pounds F. Beef	w		16	60	•
		4 Pounds Flour	w	✓	8 1/2	66	64
		60 pounds Beans	w	✓	6/4	3	75
		20 pounds Rice	w	✓	10 1/2	2	10
		20 ³⁰ pounds Coffee Green	w	✓	30 7/8	97	26 1/2
		4 1/2 pounds Tea	w	✓	11 1/2	6	77
		75 pounds Sugar	w		11 1/2	8	62 1/2
		1 Gall Vinegar	w	✓	25		23
		3 3/4 pounds Candles	w	✓	21/4		79
		28 pounds Soap	w	✓	10	2	80
		26 pounds Salt	w	✓	1 1/4		45 1/2
		1 pound Pepper	w	✓	55		55
		1 1/2 pounds Hamming	w	✓	1 1/2	3	13 3/4
		196 pounds Corn Meal	w	✓	5 7/8	7	10 1/2
		2 Gall Molasses	w	✓	75	1	50
						195	67

Aug 11 th	By	750 pounds F. Beef	w	✓	16	120	
		784 pounds Flour	w	✓	8 1/2	66	64
		40 pounds Rice	w	✓	10 1/2	4	20
		20 ³⁰ pounds Coffee Green	w	✓	30 7/8	97	26 1/2
		75 pounds Sugar	w	✓	11 1/2	8	77
		1 Gall Vinegar	w	✓	25		23
		6 1/4 pounds Candles	w		21/4	1	33
		24 pounds Soap	w	✓	10	2	40
		31 3/4 pounds Salt	w	✓	1 1/4		55 1/2
		30 pounds Beans	w	✓	6/4	1	87 1/2
		2 Gall Molasses	w	✓	75	1	50
		35 Cans Tomatoes	w	✓	25	1	25
						217	87

1867

Honorable Colony Hospital Montserrat

37-38-18

Aug 21

Dr 924 Rations w 292 Cuts & Pkts of 242 58

1867

in the month Subsistence Department

2 1/4	lb	Port	w	✓	11 1/4	22	6 1/4
7 1/2	lb	Blow	w	✓	8 1/2	67	0 5 1/2
20	lb	Beans	w	✓	6 1/4	1	87 1/2
10	lb	Rice	w	✓	10 1/2	1	0 5
16 20	lb	Coffee Br	w	✓	2 7/8	6	7 1/4
3	lb	Tea	w	✓	4 1/2	4	7 1/2
45	lb	Sugar	w	✓	11 1/2	5	17 1/2
1	Can	Tomato	w	✓	23		23
8 1/4	lb	Lo m dls	w	✓	21 1/4	1	86 1/2
28	lb	Soap	w	✓	10	2	80
2	Papua	Pepper	w	✓	85	4	102 1/2
2	Gal	Molaner	w	✓	75	1	50
2	Can	Tomatoes	w	✓	25		50
						115	18

Home Colony Hospital Montgomery Ala

1867
Sept 1 1867 30 35 8 2
To Yes Return ✓

Sept 11. 67 34 38 8 4
To 710 Return ✓

in the with Subsistence Department

1867
Sept 1st By 875 pounds Fresh Beef ✓
784 pounds Flour w ✓
45 pounds Beans w ✓
70 pounds Rice w ✓
244 pounds Coffee w ✓
75 pounds Sugar w ✓
2 Gallons Vinegar w ✓
5 pounds Candles w ✓
28 pounds Soap w ✓
15 pounds Salt w ✓
7 papers Pepper w ✓
2 Gallons Molasses w ✓
12 Cans Tomatoes w ✓
20 pounds Milk Vegetable
1 Bol Hominy 196 lbs w ✓

Sept 11. 67 200 1/4 pounds Pork w ✓
588 pounds Flour w ✓
445 pounds Beans w ✓
16 pounds Coffee w ✓
90 pounds Hominy w ✓
4 1/2 pounds Tea w ✓
60 pounds Sugar w ✓
1 Gall Vinegar w ✓
2 1/2 pounds Candles w ✓
12 pounds Soap w ✓
22 1/2 pounds Salt w ✓
2 Gallons Molasses w ✓
2 Cans Jelly w ✓

Sep 21 920 Rations 29 1/2

Oct 1st 67 30 41 12
 No. 770 Rations 2

Sep 21	By	500	lb	F. Beef	✓
		588	lb	Flour	✓
		60	lb	Beans	✓
		30	lb	Rice	✓
		196	lb	C. Meal	✓
		60	lb	Coffee	✓
		80	lb	Sugar	✓
		7 1/2	lb	Candles	✓
		21	lb	Salt	✓
		1 1/2	lb	Pepper	✓
		2	Gall	Wol. Vinegar	✓
		2	Cans	Tomatoes	✓

Oct 1 67		200 1/4	lb	Pork	d
		375	lb	F. Beef	d
		784	lb	Flour	d
		90	lb	Beans	d
		60	lb	Rice	d
		48	lb	Coffee	d
		6	lb	Fat	d
		114	lb	Sugar	d
		1	Gall	Vinegar	d
		8 1/4	lb	Candles	d
		28	lb	Lard	d
		1	Bar	to C. Meal	d
		3	Gallon	Wol. Vinegar	d
		12	Cans	Tomatoes	d

Home Bakery Hospital Montgomery Ala

1867 Oct 11 94-38-12 750 Rations
 Oct 11 980 Rations a Cont for R

Oct 21 913 Rations a Cont for Rats

in the sick Substantive Department

Oct 11 Buy 500 lb Suck Beef
 100 lb Flour
 40 lb Beans
 30 lb Rice
 20 lb Green Coffee
 6 lb Tea
 60 lb Sugar
 7 1/2 lb Candies
 2 1/2 lb Soap
 1 1/2 lb Pepper
 2 Gallons Molasses
 2 1/2 lb Salt
 5 lb White Sugar

2
 21 2000 Pounds Pork
 375 Pounds S. Beef
 578 Pounds Flour
 40 Pounds Beans
 30 Pounds Rice
 32 Pounds Coffee
 105 Pounds Sugar
 2 Gallons Vinegar
 10 lb Candies
 32 lb Soap
 2 lb Pepper
 3 Gallons Molasses

Home Bakery Hospital Montgomery Ala

Nov 1 28-40-12
 Oct 11 1350 Rations a for Rations

Nov 11 1350 Rations a for Rations

in the sick Substantive Department

Nov 1 67 Buy 625 lb S. Beef
 40 lb Flour
 45 lb Beans
 30 lb Rice
 40 lb Coffee
 6 lb Tea
 111 lb Sugar
 1 Gallon Vinegar
 30 lb Soap
 1 lb Pepper
 2 Gallons Molasses
 6 Cans Tomatoes
 6 Cans Jelly
 5 lb W. Sugar

Nov 11 Buy 1 Bar Pork
 625 lb S. Beef
 50 lb Flour
 90 lb Beans
 80 lb Rice
 150 lb Coffee
 12 lb Tea
 150 lb Sugar
 7 1/2 lb Candies
 40 lb Soap
 45 lb Salt
 3 lb Pepper
 5 Gallons Molasses

29. 40- 12 740 R

R.		
500	J. Beef	625 lbs
697	Flour	4 bush
300	Beans	45 lbs
300	Rice	30 lbs
600	Coffee	48 lbs
400	Tea	6 lbs
740	Sugar	111 lbs
100	Trig	1 bush
740	Chickens	9 lbs
740	Soap	30 lbs
400	Pepper	1 lb
2	Gals Molasses	
4	Cans Smoked	
6	Cans Jelly	
5	lb W. Sugar	

25-37- 11- 675 Rations

267 1/2	R. Pork	1 Bar ✓
200	R. J. Beef	250 lbs 625
523	R. Flour	3 Bush 5 lbs
300	R. Beans	45 lbs 90
400	R. Rice	40 lbs 80
500	R. Coffee	45 lbs 150
400	R. Tea	6 lbs 12
500	R. Sugar	45 lbs 150
600	R. Can Tea	4 1/2 lbs 15
600	R. Soap	24 lbs 48
600	R. Salt	22 1/2 lbs 45
600	R. Pepper	1 1/2 lbs 3 lbs
3	Gals Molasses	5 Gals

675
 1350
 675

1

9

0

0

ROLL

2

6

IMAGE EVALUATION TEST TARGET (QA-3)

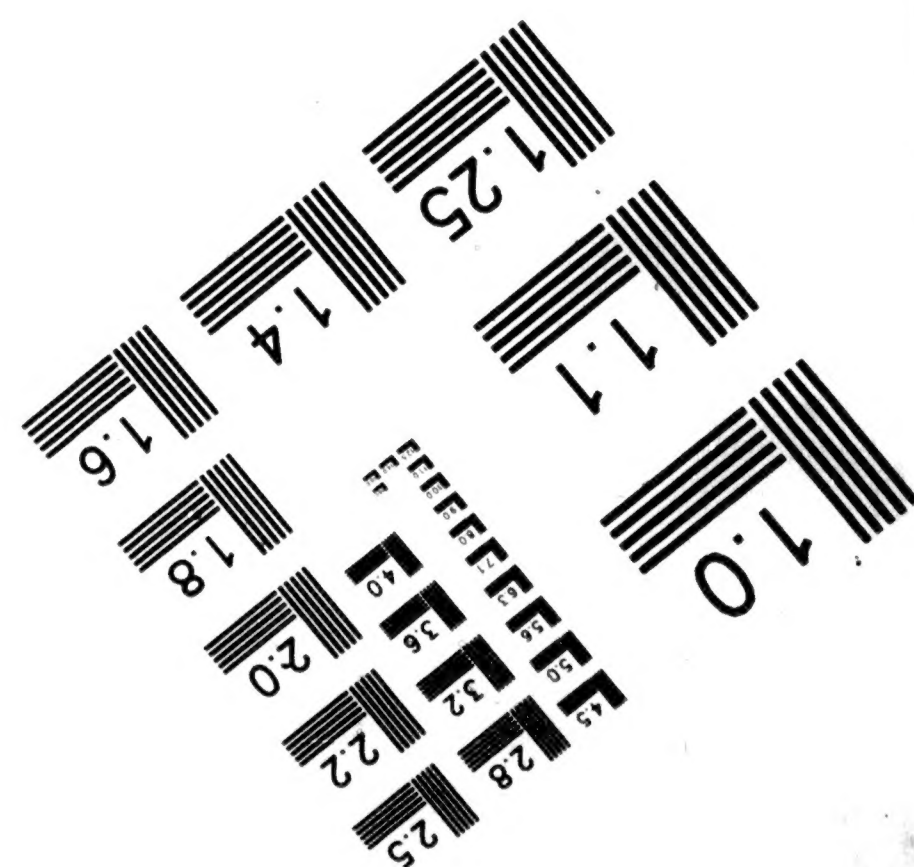
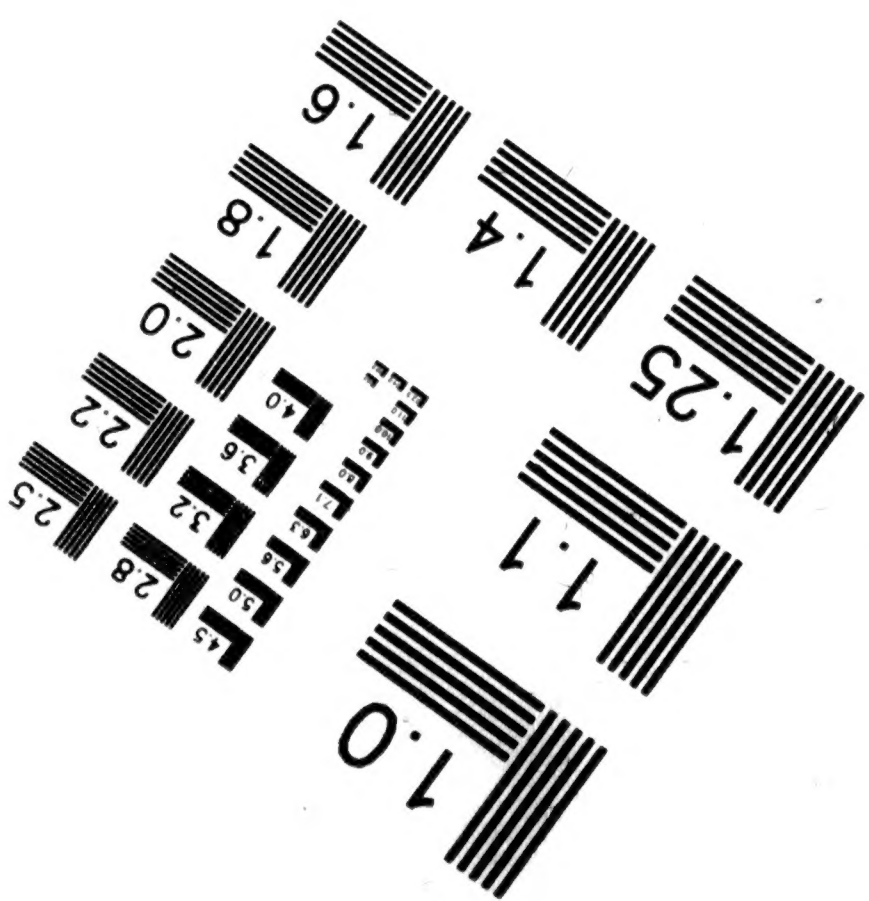
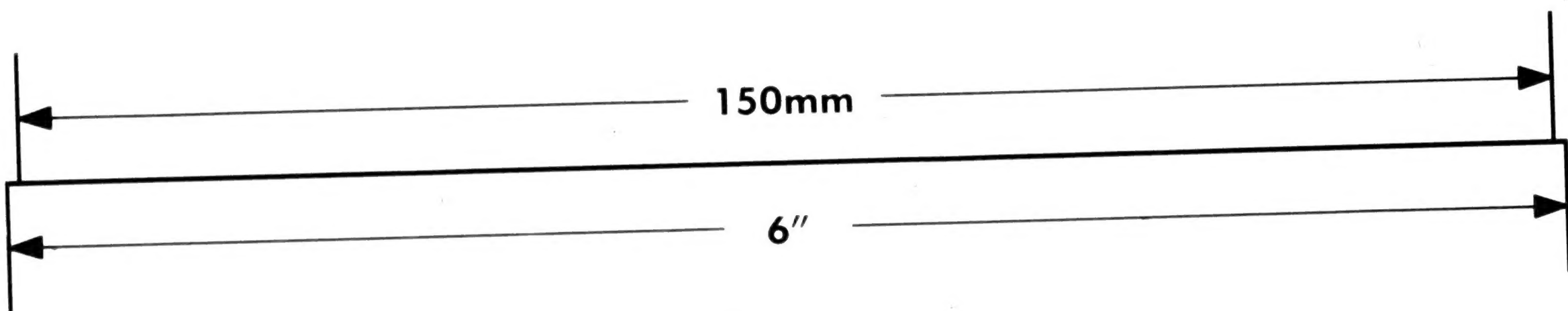
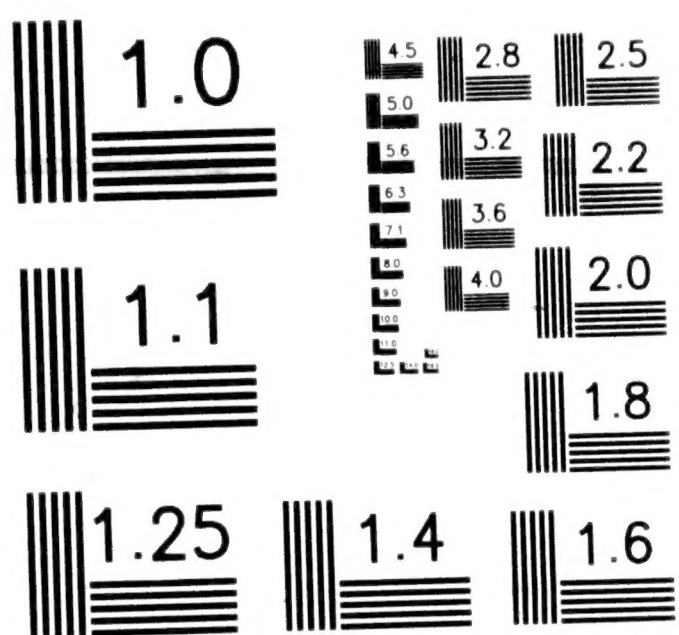
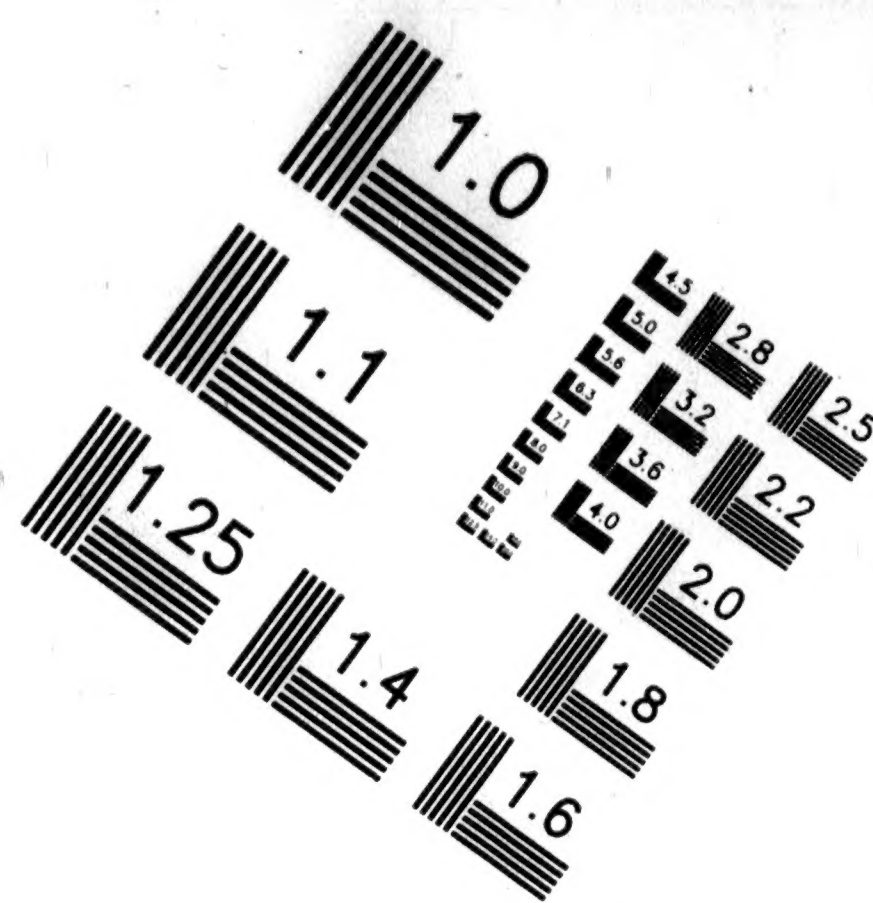
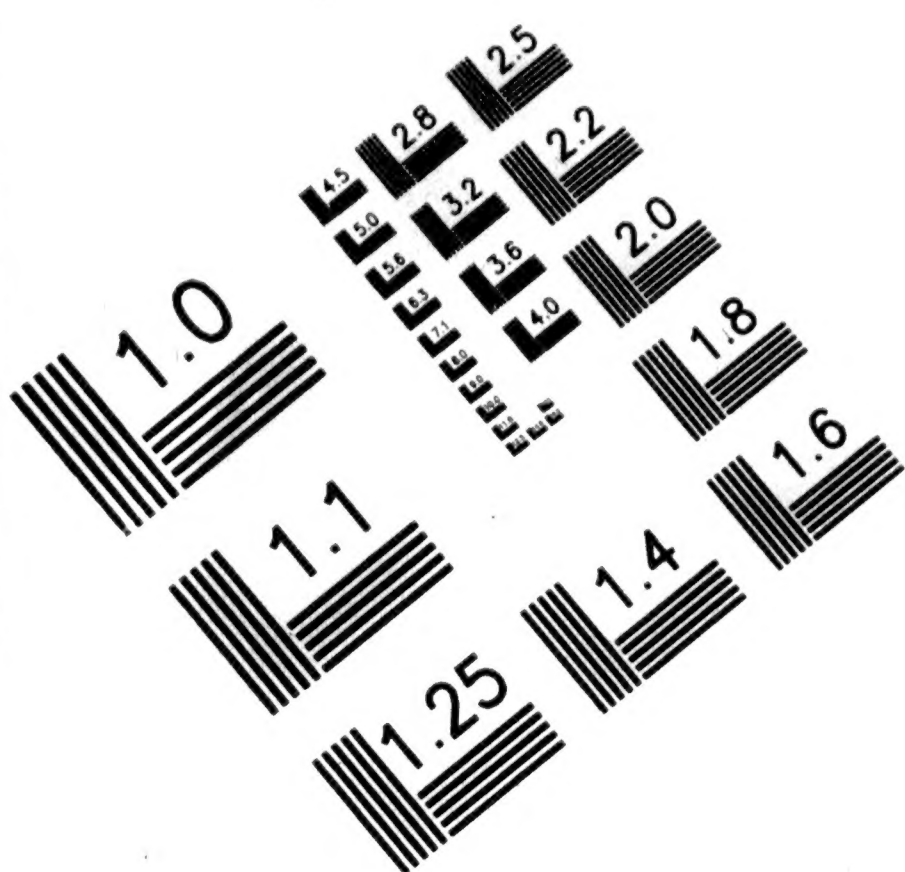

APPLIED IMAGE, Inc
 1653 East Main Street
 Rochester, NY 14609 USA
 Phone: 716/482-0300
 Fax: 716/288-5989

© 1993, Applied Image, Inc., All Rights Reserved

THE END

PLEASE

REWIND

