





**A MICROFILM PUBLICATION**

**[WWW.NARA.GOV](http://WWW.NARA.GOV)**

# IMAGE EVALUATION TEST TARGET (QA-3)

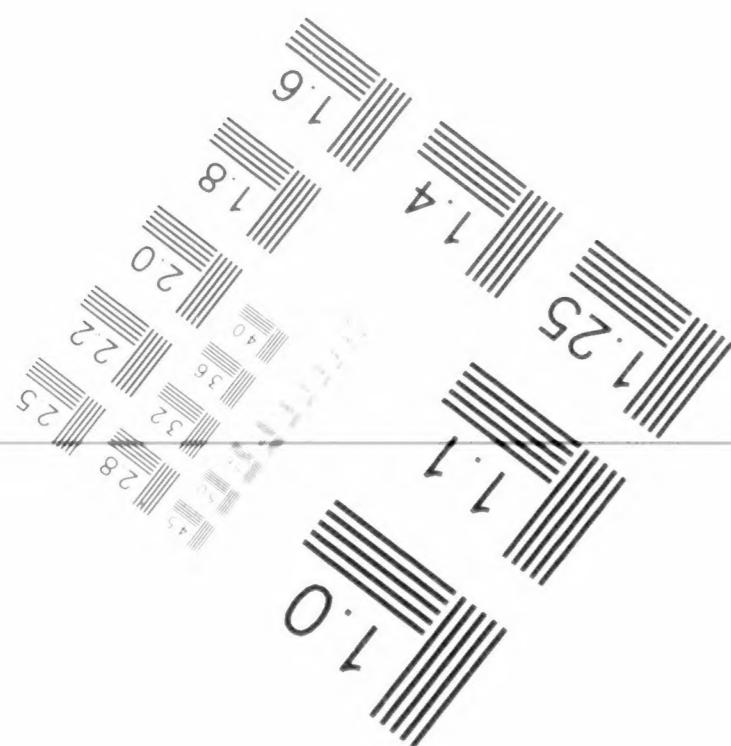
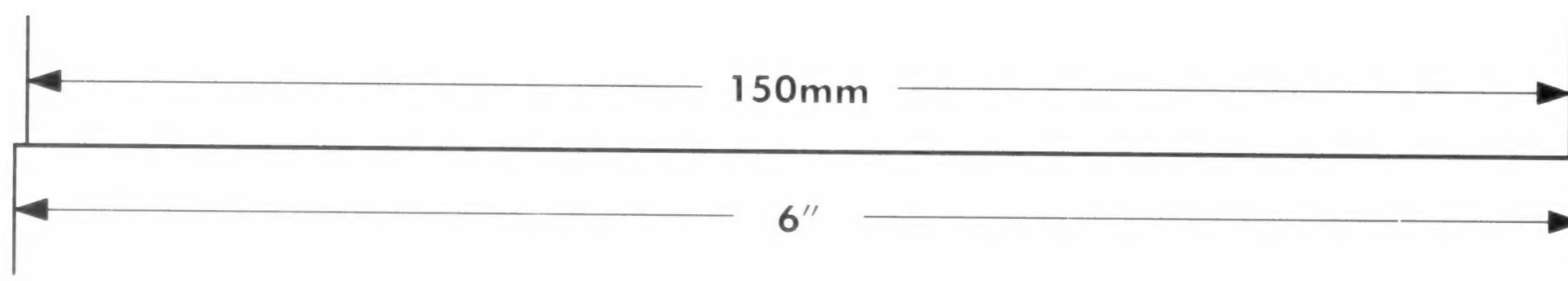
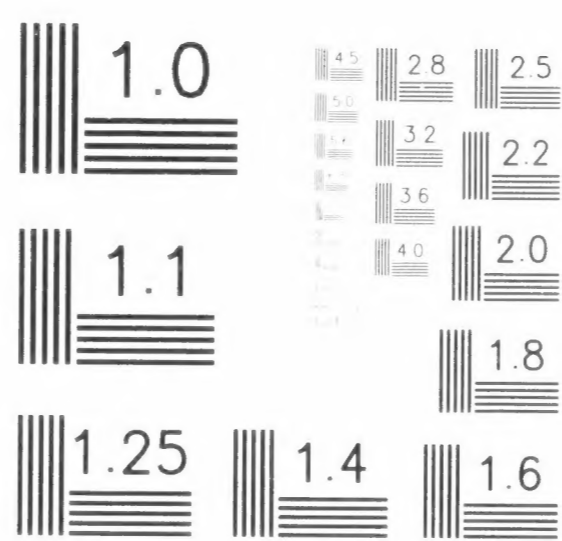
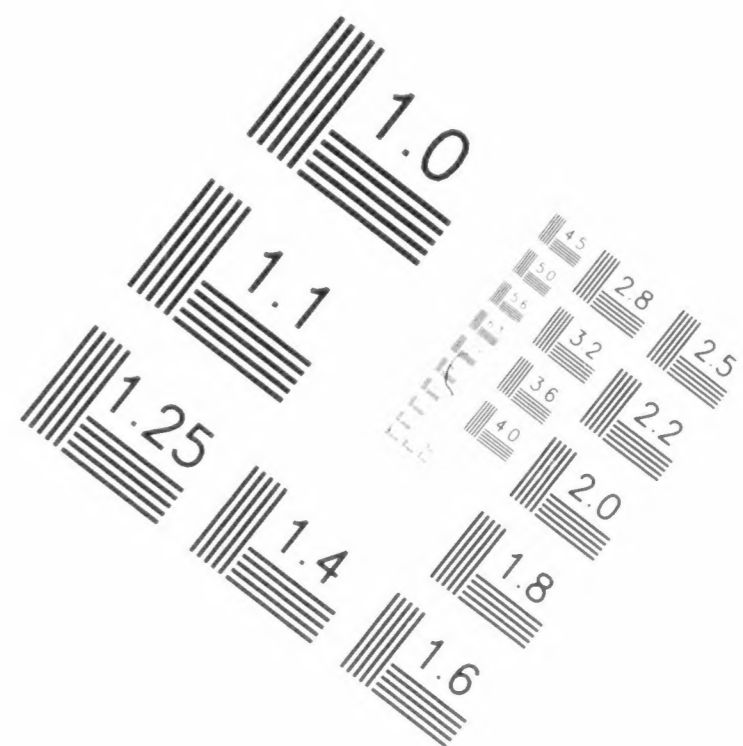
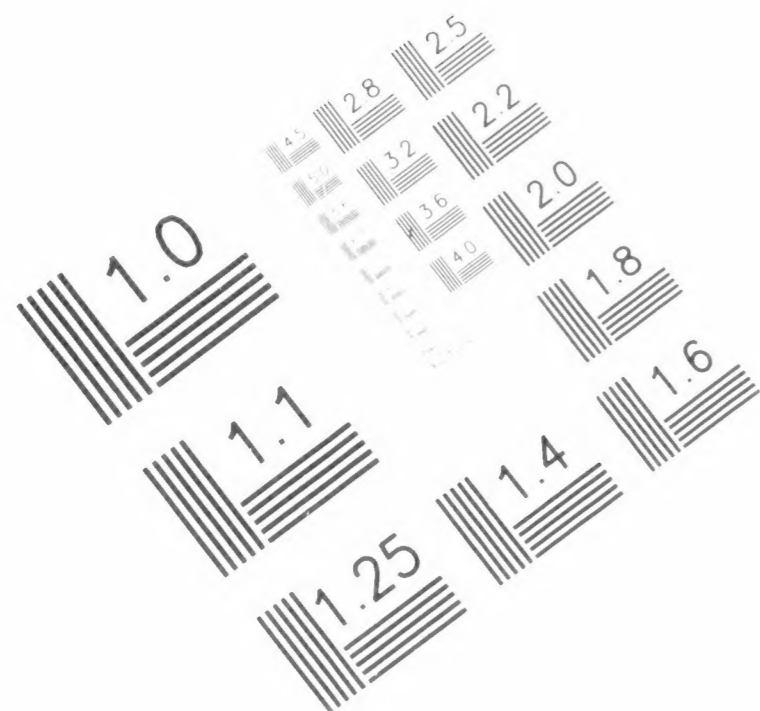

**APPLIED IMAGE, Inc**  
1653 East Main Street  
Rochester, NY 14609 USA  
Phone: 716/482-0300  
Fax: 716/288-5989

© 1993, Applied Image, Inc., All Rights Reserved

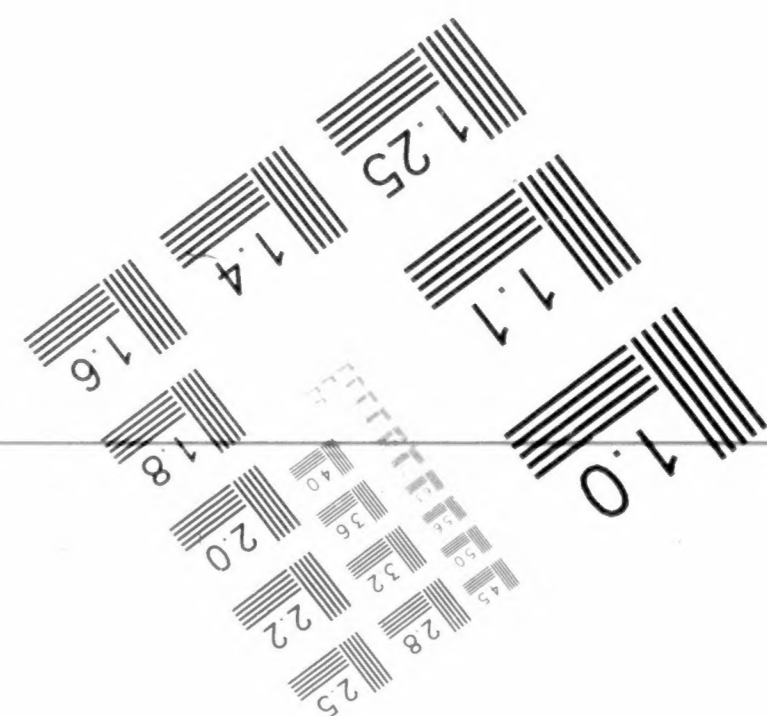

✓



MICROFILMED BY  
THE NATIONAL ARCHIVES  
8601 ADELPHI ROAD  
COLLEGE PARK, MD 20740

OPERATOR

Camera

DATE FILMED

REDUCTION RATIO

11-1-03

10X-15A

FILM EMULSION NUMBER

DAK LOW CONTRAST

436 13-012-01-15-02

PROJECT NUMBER

ROLL NUMBER

1903

40

---

**MICROCOPY**

**19003**

**ROLL**

**40**

---

NATIONAL ARCHIVES AND RECORDS ADMINISTRATION  
MICROFILM PUBLICATIONS

M1903

RECORDS OF THE FIELD OFFICES FOR THE STATE OF GEORGIA,  
BUREAU OF REFUGEES, FREEDMEN, AND ABANDONED LANDS,  
1865-1872

United States Congress  
and  
National Archives and Records Administration  
Washington, DC  
2003

---

NATIONAL ARCHIVES AND RECORDS ADMINISTRATION  
MICROFILM PUBLICATIONS

NATIONAL ARCHIVES AND RECORD ADMINISTRATION  
FREEDMEN'S BUREAU PRESERVATION PROJECT

This National Archives microfilm publication is part of a multiyear project to microfilm the field office records of the Bureau of Refugees, Freedmen, and Abandoned Lands (Freedmen's Bureau). The project was made possible by the United States Congress through The Freedmen's Bureau Records Preservation Act of 2000 (Public Law 106-444). When completed, all of the field records for the States of Alabama, Arkansas, Delaware, Florida, Georgia, Kentucky, Louisiana, Maryland, Mississippi, Missouri, North Carolina, South Carolina, Tennessee, Texas, Virginia, and for the District of Columbia will be available on microfilm. For microfilm availability and description, consult the current edition of the National Archives publication *Microfilm Resources for Research: A Comprehensive Catalog*. You can also view the National Archives microfilm locator on our web site at [www.archives.gov](http://www.archives.gov).

**Acknowledgments**

Lucile Allen	Gail Harriman	Clarence J. Simmons
Tynetta Dempsey	Paul Harrison	Claudia V. Sorto
Anne Elam	Brenda Kepley	Michael Tucker
Thomas Ferrell	Michael F. Knight	Tarenthia F. Turpin
Jane Fitzgerald	M. Marie Maxwell	Reginald Washington*
James H. Gross	Kathy Miller	Richard Whittington
Benjamin Guterman**	Stephanie Richmon	Marlon Wise

Civil War Conservation Corps (CWCC) Volunteers  
Directed by Budge Weidman and Russ Weidman

\* Reginald Washington wrote the introductory materials.

\*\* Benjamin Guterman edited the introductory materials.



NATIONAL ARCHIVES AND RECORDS ADMINISTRATION  
MICROFILM PUBLICATIONS

**INTRODUCTION**

On the 90 rolls of this microfilm publication, M1903, are reproduced the previously unfiled records of the Georgia staff offices and subordinate field offices of the Bureau of Refugees, Freedmen, and Abandoned Lands, 1865-1872. These records consist of bound volumes and unbound records, containing materials that include letters and endorsements sent and received, monthly reports, registers of patients, orders and circulars issued and received, and other records relating to freedmen's complaints and contracts. These records are part of the Records of the Bureau of Refugees, Freedmen, and Abandoned Lands, Record Group (RG) 105.

This film series completes the reproduction of all Bureau records created in Georgia between 1865 and 1872. Many of these records were reproduced in 1969 in National Archives Microfilm Publications M798, *Records of the Assistant Commissioner for the State of Georgia, Bureau of Refugees, Freedmen, and Abandoned Lands, 1865-1869*, and M799, *Records of the Superintendent of Education for the State of Georgia, Bureau of Refugees, Freedmen, and Abandoned Lands, 1865-1870*.

**HISTORY AND ORGANIZATION**

The Bureau of Refugees, Freedmen, and Abandoned Lands, also known as the Freedmen's Bureau, was established in the War Department by an act of Congress on March 3, 1865 (13 Stat. 507). The life of the Bureau was extended twice by acts of July 16, 1866 (14 Stat. 173), and July 6, 1868 (15 Stat. 83). The Bureau was responsible for the supervision and management of all matters relating to refugees and freedmen, and of lands abandoned or seized during the Civil War. In May 1865, President Andrew Johnson appointed Maj. Gen. Oliver Otis Howard as Commissioner of the Bureau, and Howard served in that position until June 30, 1872, when activities of the Bureau were terminated in accordance with an act of June 10, 1872 (17 Stat. 366). While a major part of the Bureau's early activities involved the supervision of abandoned and confiscated property, its mission was to provide relief and help freedmen become self-sufficient. Bureau officials issued rations and clothing, operated hospitals and refugee camps, and supervised labor contracts. In addition, the Bureau managed apprenticeship disputes and complaints, assisted benevolent societies in the establishment of schools, helped freedmen in legalizing marriages entered into during slavery, and provided transportation to refugees and freedmen who were attempting to reunite with their families or relocate to other parts of the country. The Bureau also helped black soldiers, sailors, and their heirs collect bounty claims, pensions, and back pay.

The act of March 3, 1865, authorized the appointment of Assistant Commissioners to aid the Commissioner in supervising the work of the Bureau in the former Confederate states, the border states, and the District of Columbia. While the work performed by Assistant Commissioners in each state was similar, the organizational

NATIONAL ARCHIVES AND RECORDS ADMINISTRATION  
MICROFILM PUBLICATIONS

structure of staff officers varied from state to state. At various times, the staff could consist of a superintendent of education, an assistant adjutant general, an assistant inspector general, a disbursing officer, a chief medical officer, a chief quartermaster, and a commissary of subsistence. Subordinate to these officers were the assistant superintendents, or subassistant commissioners as they later became known, who commanded the subdistricts.

The Assistant Commissioner corresponded extensively with both his superior in the Washington Bureau headquarters and his subordinate officers in the subdistricts. He prepared reports that he sent to the Commissioner concerning Bureau activities in areas under his jurisdiction, based upon reports submitted to him by the subassistant commissioners and other subordinate staff officers. He also received letters from freedmen, local white citizens, state officials, and other non-Bureau personnel. These letters varied in nature from complaints to applications for jobs in the Bureau. Because the assistant adjutant general handled much of the mail for the Assistant Commissioner's office, letters were often addressed to him instead of to the Assistant Commissioner.

In a circular issued by Commissioner Howard in July 1865, the Assistant Commissioners were instructed to designate one officer in each state to serve as "general Superintendents of Schools." These officials were to "take cognizance of all that is being done to educate refugees and freedmen, secure proper protection to schools and teachers, promote method and efficiency, correspond with the benevolent agencies which are supplying his field, and aid the Assistant Commissioner in making his required reports." In October 1865, a degree of centralized control was established over Bureau educational activities in the states when Rev. John W. Alvord was appointed Inspector of Finances and Schools. In January 1867, Alvord was divested of his financial responsibilities, and he was appointed General Superintendent of Education.

An act of Congress, approved July 25, 1868 (15 Stat. 193), ordered that the Commissioner of the Bureau "shall, on the first day of January next, cause the said bureau to be withdrawn from the several States within which said bureau has acted and its operation shall be discontinued." Consequently, in early 1869, with the exception of the superintendents of education and the claims agents, the Assistant Commissioners and their subordinate officers were withdrawn from the states.

For the next year and a half the Bureau continued to pursue its education work and to process claims. In the summer of 1870, the superintendents of education were withdrawn from the states, and the headquarters staff was greatly reduced. From that time until the Bureau was abolished by an act of Congress approved June 10, 1872 (17 Stat. 366), effective June 30, 1872, the Bureau's functions related almost exclusively to the disposition of claims. The Bureau's records and remaining functions were then transferred to the Freedmen's Branch in the office of the Adjutant General. The records of this branch are among the Bureau's files.

NATIONAL ARCHIVES AND RECORDS ADMINISTRATION  
MICROFILM PUBLICATIONS

Constrained by limited resources, Southern opposition, and the politics of Reconstruction, the Bureau faced an enormous challenge in its efforts to assist the freedmen and refugees. Its relief efforts, without question, saved thousands of southerners from starvation. Its attempts to assist freedmen to become self-sufficient, to provide public education, administer justice, and, to a lesser degree, to provide land, all worked with varying degrees of success to lessen the difficulties during the transition from slavery to freedom. One of the Bureau's greatest legacies is the body of records it created and received during the course of its operations. These records are arguably some of the most important documents available for the study of the Federal Government's policies, efforts to reconstruct the South, and Southern social history and genealogy.

**THE FREEDMEN'S BUREAU IN GEORGIA**

**Organization**

Bvt. Maj. Gen. Rufus Saxton, who had directed the "Port Royal Experiment," was appointed Assistant Commissioner for South Carolina, Georgia, and Florida. Saxton established his headquarters at Beaufort, SC, in June 1865, and assigned Gen. Edward A. Wild the responsibility for Bureau affairs in part of Georgia. In September 1865, after Wild was relieved from duty, the office of Assistant Commissioner for Georgia was established, and Brig. Gen. Davis Tillson was appointed as Acting Assistant Commissioner, with exclusive control of all matters concerning the Bureau in Georgia. Tillson reported to General Saxton in South Carolina until December 1865, when he was ordered to report thereafter directly to Commissioner Howard at Washington. Generally, the records pertaining to Georgia and Florida that were created during this early period are included among those of the Assistant Commissioner of South Carolina.

The organization of the Bureau in Georgia was similar to that of the Bureau headquarters in Washington. The Assistant Commissioner's staff included an assistant adjutant general, an assistant inspector general, a chief quartermaster and disbursing officer, and a superintendent of education. Three officers served as Assistant Commissioner in Georgia between 1865 and 1869 and located the Bureau offices in four different cities during that period. General Tillson first established his headquarters at Augusta in September 1865 but moved it to Savannah in October 1866. Col. Caleb C. Sibley succeeded Tillson as Assistant Commissioner in January 1867, and 2 months later he moved the headquarters from Savannah to Macon. It remained there until July 1867, when the office was transferred to Atlanta. In October 1868, Maj. John R. Lewis replaced Sibley as Assistant Commissioner. Lewis served until the office was discontinued in May 1869. From January to May 1869, Major Lewis combined the duties of Assistant Commissioner, with those of superintendent of education. After the office of the Assistant Commissioner was discontinued, Lewis continued to serve as superintendent of education until May 1870.

NATIONAL ARCHIVES AND RECORDS ADMINISTRATION  
MICROFILM PUBLICATIONS

The major subordinate field offices for the Bureau in Georgia, for example, included those with headquarters at Albany, Americus, Athens, Atlanta, Augusta, Columbus, Macon, and Savannah. Under the direct supervision of the subassistant commissioners were the civilian and military agents. Occasionally, the Bureau retained military officers in a civilian capacity after the termination of their military service. For a list of selected Georgia subordinate field office personnel and their dates of service, see the Appendix.

**Activities**

The major activities of the Freedmen's Bureau in Georgia generally resembled those conducted in other states. The Bureau issued rations and provided medical relief to both freedmen and white refugees, supervised labor contracts between planters and freedmen, administered justice, and worked with benevolent societies in the establishment of schools.

When General Davis Tillson took over as Assistant Commissioner for the Freedmen's Bureau in Georgia in September 1865, many of the major cities and towns in the state were troubled with overcrowding, disease, and poverty. In the cities of Macon, Atlanta, Augusta, and Savannah, freedmen and refugees were living in some of the most crowded and deplorable conditions, and many were in dire need of food and clothing, shelter, and medical attention.<sup>1</sup> Convinced, however, that Federal Government relief should be temporary and solely for the needy, General Tillson issued an order on October 3, 1865, prohibiting the distribution of rations to freedmen and refugees who were able-bodied but refused work. To discourage idleness and dependency, Tillson further ordered that only those persons who were able to provide for themselves would be allowed to remain in the towns and cities. Those who desired to stay, said Tillson, "must be compelled, if necessary, to go to the country and accept places of labor found by themselves, or for them, by officers or agents of the Bureau."<sup>2</sup>

Tillson's orders were strictly enforced. One month after his pronouncement, rations issued in Savannah had been reduced from 120,000 to 60,000 per month. For the month of June of 1866, the number of rations issued for the entire State of Georgia totaled less than 20,000. However, in spite of the Bureau's "self-help" policy, limited resources, and the belief that local governments should play a greater role in providing relief for the destitute, the Georgia Bureau issued some 847,669 rations from June 1865 to September 1866. Although the Bureau's actions prevented wholesale starvation and untold suffering, the agency's rations-relief efforts were far less extensive than what Bureau officials had done during the same period in Alabama, North Carolina, South Carolina, and Virginia. Tillson's successors, Assistant Commissioners Caleb C. Sibley (January 1867–October 1868) and John R. Lewis

---

<sup>1</sup> Mildred Thompson, "The Freedmen's Bureau in Georgia in 1865–66: An Instrument of Reconstruction," *The Georgia Historical Quarterly* V, no. 1 (March 1921): 42–43.

<sup>2</sup> House Ex. Doc. 70, 39th Cong., 1st Sess., Serial vol. 1256, p. 58.

NATIONAL ARCHIVES AND RECORDS ADMINISTRATION  
MICROFILM PUBLICATIONS

(October 1868–May 1869) continued to follow the policy of providing limited rations relief. During their tenures, rations were issued only in emergencies and for the most part to hospitals and asylums.<sup>3</sup>

The Georgia Bureau's policy of temporary relief for the needy also guided its approach in providing medical care and assistance for the destitute. Like its ration program, the Bureau viewed its responsibility as one of providing temporary medical relief, primarily in cases of extreme emergencies. The Bureau believed that the ultimate responsibility for providing medical care to those in need lay with Georgia civil authorities. J. W. Lawton, who served as surgeon-in-chief under General Tillson, saw the use of dispensaries as the best means of administering medical relief and the most effective approach to encourage civil officials to take on some of the cost for operating them. Lawton and his successor at various times maintained dispensaries at Albany, Americus, Brunswick, Columbus, Darien, Newton, St. Catherine's Island, St. Marys, and Stone Mountain. The Bureau's medical department also opened hospitals with the idea of eventually turning them over to state and local authorities. The Bureau maintained hospitals at Atlanta, Augusta, Columbus, Macon, and Savannah. At the height of its medical operations (1866–67), however, the agency employed just 13 physicians. Nonetheless, with its limited and overburdened medical staff, the Bureau treated more than 5,000 freedmen for various ailments and vaccinated some 20,000 freedmen and refugees against smallpox from September 1, 1865, through September 20, 1866. By September 1867, the number of freedmen treated by Bureau nearly tripled. At the end of June 1868, close to 17,000 freed men, women, and children received treatment. Despite the Bureau's efforts to treat the weak, the sick, and infirm, the mortality rate among freedmen remained high. By late 1868, most of the Bureau's medical activities ceased, and care for the destitute was turned over to local authorities.<sup>4</sup>

In Georgia, as in other states under the Bureau's jurisdiction, the regulation of written labor contracts between planters and freedmen was of paramount concern. General Tillson's order of October 3, 1865 (Circular Number 2), which restricted the issuing of rations only to those in need, also instructed his subordinates to "make immediate and vigorous efforts" to secure work for unemployed freedmen "where fair compensation and kind treatment will be secured to them." Upon arrival at his

---

<sup>3</sup> House Ex. Doc. 6, 39th Cong., 2nd Sess., Serial vol. 1276, p. 57; Thompson, "The Freedmen's Bureau in Georgia in 1865–66: An Instrument of Reconstruction," pp. 42–43. For a detailed discussion of the Georgia Freedmen's Bureau's efforts in regards to relief, see Paul A. Cimbala, *Under the Guardianship of the Nation: The Freedmen's Bureau and the Reconstruction of Georgia, 1865–1870* (Georgia: The University of Georgia Press, 1997), especially pp. 80–98.

<sup>4</sup> Paul Cimbala, *Under the Guardianship of the Nation: The Freedmen's Bureau and the Reconstruction of Georgia, 1865–1870*, pp. 98–104; See also Todd L. Savitt, "Politics in Medicine: The Georgia Freedmen's Bureau and the Organization of Health Care, 1865–1866," *Civil War History* XXVIII, no. 1 (March 1982): pp. 45–64.

NATIONAL ARCHIVES AND RECORDS ADMINISTRATION  
MICROFILM PUBLICATIONS

post in early September 1865, Tillson found the labor system in Georgia in disarray. Able-bodied freedmen were being paid from \$2 to \$7 per month. Many were of the notion that the Federal Government was planning to distribute land to them at Christmas or New Year's, and thus large numbers of freedmen were refusing to sign labor contracts. Planters, on the other hand, were convinced that the Bureau was the "champion" of the freedmen and totally insensitive to their concerns about freedmen and their unwillingness to labor, and were thus making little effort to prepare for the planting season.<sup>5</sup>

On December 22, 1865, in an effort to remove "false and mistaken impressions" held by the both planters and freedmen, Tillson issued wage guidelines that both parties were expected to follow. Under the new rules, freedmen had the right to choose their own employers, but those freedmen who refused to sign contracts after January 10, 1866, "where employers offer good wages and kind treatment," had to accept contracts that the Bureau made for them. In upper and middle Georgia, where the land was poor and unsuited for raising large quantities of crops, Tillson instructed his officers to secure contracts paying men \$12-\$13 per month, and \$8-\$10 dollars per month for women. Freedmen were to provide for their own clothing and medicines. In other parts of the state and along the coast and southwestern Georgia, where "good crops" could be raised, men were to be paid \$15 per month, including board and lodging, and women \$10 per month. In areas where planters preferred to pay a share of the crop, the order required payment of "from one-third the gross to one half the net proceeds."<sup>6</sup>

Realizing that not all planters would comply with his new wage guidelines, Tillson instructed his subordinates to call on the military to enforce his orders whenever necessary. He was aware in spite of his orders, many of the contracts being signed, even some approved by his own agents, were substandard and not in compliance with his wage schedule. He made clear to both his agents and the planters that such contracts would not be recognized. To emphasize the importance of and his commitment to fair contracts and compensation for freedmen, Tillson offered transportation to freedmen to such areas as southwest Georgia and the Mississippi Valley where wages were higher. In a November 1866 report to Commissioner Howard, Tillson indicated that he had issued 381 orders for transportation for some 2,947 men and 1,013 children.<sup>7</sup>

---

<sup>5</sup> "Statement in brief, of the operations of the Freedmen's Bureau in Georgia, since September last, the date of his assignment to duty," Davis Tillson, Bvt. Maj. Gen., Annual Reports of the Assistant Commissioners, GA, August 7, 1866, Records of the Office of the Commissioner, 1866-69, Records of the Bureau of Refugees, Freedmen, and Abandoned Lands, Record Group (RG) 105, National Archives Building, Washington, DC.

<sup>6</sup> Paul A. Cimbala, "The 'Talisman Power': Davis Tillson, The Freedmen's Bureau, and Free Labor in Reconstruction Georgia, 1865-68," *Civil War History* XXVIII, no. 2 (June 1982): 160.

<sup>7</sup> *Ibid.*, 160-64.

NATIONAL ARCHIVES AND RECORDS ADMINISTRATION  
MICROFILM PUBLICATIONS

Safeguarding rights and securing justice for freedmen was a major area of concern for the Freedmen's Bureau. Following the Civil War, several Southern states enacted a series of laws commonly known as "black codes," which restricted the rights and legal status of freedmen. Freedmen were often given harsh sentences for petty crimes and in some instances were unable to get their cases heard in state courts. In a circular issued by Commissioner Howard on May 30, 1865 (Circular Number 5), Assistant Commissioners were directed to "adjudicate, either themselves or through officers of their appointment, all difficulties arising between negroes themselves, or between negroes and whites or Indians." In response to Howard's circular, General Tillson issued an order on November 15, 1865 (Circular Number 4), instructing his officers to hear and make determinations in cases involving freedmen in which the disputed sum did not exceed \$50, or the punishment did not exceed \$50 or 30 days' imprisonment. Agents were also told that they could "try offences committed by or against freedmen, provided the sentence imposed does not exceed one hundred and fifty dollars or imprisonment for at hard labor for sixty days." Tillson further ordered that "It is preferred that all cases of any importance . . . whenever under the laws there of [the State of Georgia], or by agreement of the parties . . . [where] the testimony of Freedmen can be admitted . . . the Agent will turn them over to the civil authorities for trial." To carry out Tillson's orders, agents were to establish three-member tribunals (known as freedmen's courts) consisting of a Bureau official and two citizens, one chosen by each party involved in the case.<sup>8</sup>

However, when the Georgia State Legislature passed an act conferring civil rights on "persons of color," approved March 17, 1866, Tillson advised his officers on April 6 (Circular Number 4) that they were no longer required to comply with Commissioner Howard's orders of May 30, 1865. While Tillson told his agents that they were to continue to follow instructions issued by him on November 6, 1865 (Circular Number 4), "all cases exceeding their jurisdiction, unless otherwise specially directed by the Department Commander, [were to] be turned over to the civil authorities of the State for adjudication." Despite the Bureau's efforts to secure justice and civil rights for freedmen in Georgia, blacks continued to complain to the agency about some of the "most fiendish and diabolical outrages" suffered by them at the hands of gangs known as "Regulators," "Jayhawkers," and the "Black-horse cavalry." Perpetrators of crimes against freedmen were often not apprehended or prosecuted by civil authorities. At various times, because of increased hostilities toward freedmen and the failure of civil authorities to take action in their cases, Bureau officials in Georgia were compelled to reassert their authority.<sup>9</sup>

Bureau educational activity began in Georgia in October 1865, when G. L. Eberhart was appointed as superintendent of schools (later education). In August 1867, Edward A. Ware succeeded Eberhart. In January 1869, Assistant Commissioner Maj. John R. Lewis assumed the duties of superintendent of education. Lewis served

---

<sup>8</sup> House Ex. Doc. 70, 39th Cong., 1st Sess. Serial Vol. 1256, pp. 61-62.

<sup>9</sup> Senate Ex. Doc. 6, 39th Cong., 2nd Sess., Serial vol. 1276, pp. 54-56.

NATIONAL ARCHIVES AND RECORDS ADMINISTRATION  
MICROFILM PUBLICATIONS

in both capacities until May 1869, when the office of Assistant Commissioner was discontinued, and remained as superintendent education until May 1870. The records of the two offices were not combined. Ware, who had been acting as assistant superintendent, remained in Georgia as acting superintendent until August 1870, when all Bureau officers except the claims agents were withdrawn from the state.

Congress's failure to provide an appropriation for the Freedmen's Bureau during its first year of operation, impacted significantly on the agency's ability to provide adequate assistance for freedmen education. With limited financial resources, the Bureau provided help when it could, and worked vigorously to encourage freedmen and Northern benevolent societies to take on the primary responsibility for providing support for black schools. G. L. Eberhart and his successors were of the opinion that "colored people who are unwilling to help educate their children do not deserve to have schools." To encourage freedmen to participate in this self-support effort, Eberhart urged them to establish educational associations. With assistance from local Bureau agents, educational associations were established in the subdistricts of Thomasville, Bainbridge, Albany, Georgetown, Cuthbert, and Americus. In early 1866, the "pay your own way" policy led to the founding of the Georgia Educational Association (initially organized as the Georgia Equal Rights Association). The Educational Association worked closely with the Bureau and Northern aid societies and became the model "to encourage the people [freedmen] to organized effort in supporting their own schools & managing their own affairs." By the end of 1866, freedmen owned 57 schoolhouses and provided support for 96 of the 127 schools in the state. By the spring of 1867, freedmen contributions sustained some 104 schools and teachers and more than 3,000 students. During the same period, the Bureau maintained some 44 schools and 50 teachers and close to 3,100 pupils. Northern aid societies provided support for 84 schools, 78 teachers, and over 7,000 students. Freedmen also defrayed the expenses for 45 schools under the control of the Bureau and the aid societies.<sup>10</sup>

With the passage of the Army Appropriations Act on July 13, 1866 (14 Stat. 90), the Bureau received its first appropriation and was able to provide greater assistance in its effort to support freedmen education. In addition to providing some \$21,000 for state superintendents' salaries, the Act made available \$500,000 more for the rent and repair of school buildings. In the same month, Congress overrode President Andrew Johnson's veto and extended the life of the Bureau for 2 years. In this new legislation (14 Stat. 173), the Bureau was allowed to "seize, hold, use, lease, or sell" Confederate property for the purpose of educating freedmen. The act also required the Bureau to work closely with benevolent groups and to lease buildings to those associations that supplied teachers. By early July 1869, the Bureau had expended nearly \$105,000 for the construction and repair of school buildings that provided accommodations for 4,690 students. The Bureau spent an additional \$10,471 for the

---

<sup>10</sup> Paul A. Cimbala, *Under the Guardianship of the Nation: The Freedmen's Bureau and the Reconstruction of Georgia, 1865-1870*, pp. 105-110.



NATIONAL ARCHIVES AND RECORDS ADMINISTRATION  
MICROFILM PUBLICATIONS

repair of buildings that provided part-time space for more than 3,500 pupils. By the time the Bureau withdrew from Georgia in 1870, the agency had contributed funds for the building of some 50 schools in the state.<sup>11</sup>

**RECORDS DESCRIPTION**

These records consist of volumes and unbound records. The volumes reproduced in this microfilm publication were originally arranged by type of record and thereunder by volume number. No numbers were assigned to series consisting of single volumes. Years later, all volumes were arbitrarily assigned numbers by the Adjutant General's Office (AGO) of the War Department after the records came into its custody. In this microfilm publication, AGO numbers are shown in parentheses to aid in identifying the volumes. The National Archives assigned the volume numbers that are not in parentheses. In some volumes, particularly in indexes and alphabetical headings of registers, there are blank numbered pages that have not been filmed.

The volumes consist of letters and endorsements sent and received, press copies of letters sent, registers of letters received, letters and orders received, special orders and circulars issued, registers of complaints, and monthly reports forwarded to the Assistant Commissioner. The unbound documents consist of letters and orders received, unregistered letters and narrative reports received, special orders and circulars issued, general orders and circulars received, monthly reports, and records relating to complaints, labor contracts, patents, and court papers.

**LIST OF BOOK RECORDS OF OFFICERS**

The single-volume list of book records of officers in Georgia (no date) is arranged by office, with records of the Assistant Commissioner first, followed alphabetically by locations of the subdistrict offices. Included in the list of book records are the type of record in each book or volume, the dates of the volume, and the volume number. Throughout this introductory material and in the Table of Contents, the AGO volume number appears in parentheses in the series descriptions of the records.

**OFFICES OF STAFF OFFICERS**

**Chief Quartermaster and Disbursing Officer**

The nine volumes of press copies of letters sent, October 1865–May 1869, 1 (62), 2 (63), 3 (64), 4 (65), 5 (66), 6 (67), 7 (68), 8 (69), and 9 (70), are arranged chronologically and have name indexes.

---

<sup>11</sup> Ibid., pp. 116–118.

NATIONAL ARCHIVES AND RECORDS ADMINISTRATION  
MICROFILM PUBLICATIONS

The two volumes of endorsements sent and received, August 1867–May 1869, 1 (71) and 2 (72), are arranged chronologically, and there is a name index in volume 1 (71). For letters and reports received by endorsement and entered in volume 2 (72), see letters and reports received by endorsement (July 1868–April 1869) listed below.

Unbound letters and reports received by endorsement, June 1868–May 1869, are arranged chronologically. These letters and reports are entered in volume 2 (72). **NOTE: Endorsements entered in volume 1 (71) are interspersed with the unbound letters received, mentioned below.**

The three volumes of registers of letters received, January 1867–May 1869, 1 (59), 2 (60), and 3 (61), are arranged by time period. The first two registers also include endorsements sent and received. The series of endorsements was thereafter continued in the two-volume series of endorsements sent and received mentioned above. For letters received, see the series of letters received (January 1867–April 1869) mentioned below. The entries in the registers are arranged alphabetically by initial letter of the surname of the correspondent and thereunder chronologically by date of receipt of the communication.

Unbound letters received, January 1867–May 1869, are arranged according to their entry in the registers of letters received mentioned above.

Unbound unregistered letters received October 1865–April 1869, are arranged by month and thereunder alphabetically by initial letter of the surname of the correspondent.

The two volumes of monthly reports of persons and articles hired that were sent to Bureau headquarters, October 1865–August 1870, 1 (81) and 2 (82), are arranged chronologically, and there is a list of contents in volume 1 (81).

Unbound monthly reports of persons and articles hired that were received from staff and subordinate officers, June 1866–December 1868, are arranged chronologically.

Unbound accounts current, August 1866–March 1867, are arranged chronologically.

Unbound special orders received relating to the issuance of transportation, May 1867–December 1868, are arranged chronologically.

The single-volume register of freight received and forwarded, April 1867–March 1869 (86), is arranged chronologically.

**Surgeon in Chief**

The single volume of letters sent and a register of letters received, September 1865–July 1867 (52), is arranged by type of record and thereunder chronologically. The letters sent are dated September–October 1865 and October 1866–July 1867.

NATIONAL ARCHIVES AND RECORDS ADMINISTRATION  
MICROFILM PUBLICATIONS

Those letters for October 1866–July 1867 also include orders issued and a few copies of letters received. The register of letters received and endorsements sent are dated September 1865–February 1866 and February–July 1867.

The two volumes of press copies of letters sent, July 1867–January 1869, 1 (53) and 2 (54), are arranged chronologically and have name indexes.

The undated single-volume name index (51) is an index to volume 2 (50) of the registers of letters received and endorsements sent and received (July 1868–January 1869) mentioned below.

The two volumes of registers of letters received and endorsements sent and received, July 1867–January 1869, 1 (49) and 2 (50), are arranged by time period. For a name index to volume 2 (50), see volume (51) mentioned above. For entries relating to letters received, see the series of letters received mentioned below. The entries in the first register are arranged alphabetically by initial letter of the surname of the correspondent and thereunder arranged and numbered in chronological order. The entries in the second register are arranged and numbered in chronological order.

Unbound letters received, July 1867–December 1868, are arranged according to their entry in the registers of letters received and endorsements sent and received mentioned above.

Unbound unregistered letters received, September 1865–August 1867, are arranged chronologically.

The single volume of circulars and circular letters issued, August 1867–November 1868 (55), is arranged chronologically.

The single volume of monthly and weekly reports of sick and wounded refugees and freedmen that were forwarded to Bureau headquarters, October 1865–December 1868 (57), is arranged chronologically. The volume also contains a roster of medical officers (1865–67) and copies of inventory and inspection reports (1866–67).

Unbound weekly and monthly reports of sick and wounded refugees and freedmen, October 1865–December 1868, are arranged chronologically.

Unbound weekly reports of sick and wounded refugees and freedmen from assistant surgeons, October 1865–December 1868, are arranged by month, thereunder alphabetically by the name of the hospital, and thereunder chronologically.

Unbound monthly reports of medical attendants that were forwarded to Bureau headquarters, February 1866–December 1868, are arranged chronologically.

Unbound returns of commissioned medical officers that were forwarded to Bureau

NATIONAL ARCHIVES AND RECORDS ADMINISTRATION  
MICROFILM PUBLICATIONS

headquarters, December 1865–December 1868, are arranged chronologically. The reports give the name, rank, and station of each officer, and the nature of service and the date of commission.

Unbound contracts with hospital attendants and surgeons, October 1865–September 1868, are arranged by year. Afterwards, the records are arranged alphabetically by the initial letter of the surname of the employee.

The single-volume of registers of reports and returns received from assistant surgeons and forwarded to Bureau headquarters in Washington, 1867–68 (56), is arranged by type of register. There is a list of contents at the beginning of the volume. The volume also includes a station book of assistant surgeons on duty in Georgia.

The single volume of miscellaneous accounting records, 1865–68 (58), is arranged by type of record. The volume includes cash accounts (September–December 1865), register of contracts with assistant surgeons (October 1865–February 1868, and a register of requisitions from surgeons (1865–67). Also included is a summary of hospital funds (1865–68) and a register of blanks received and issued (1865–67).

**SUBORDINATE FIELD OFFICES**

**Albany (Subassistant Commissioner)**

The four volumes of letters sent, February 1866–December 1868, 1 (234), 2 (120), 3 (123), and 4 (125), are arranged chronologically, and volumes 3 (123) and 4 (125) have name indexes.

The single volume of endorsements sent and received, April–December 1868 (126), is arranged chronologically. Endorsements from January to April 1868 are entered in volume 4 (119) of the registers of letters received mentioned below.

The four volumes of registers of letters received, 1 (114), 2 (117), 3 (118), and 4 (119), are dated February 1866–December 1868. Letters entered in volume 1 (114) for the period February 1866–April 1867 are arranged chronologically. Beginning in April 1867, the letters were entered in volume 3 (118) alphabetically by initial letter of the surname of the correspondent and thereunder chronologically with alphabetical divisions that were continued into volumes 1 (114) and 2 (117). The entries in Volume 4 (119), which are dated January–December 1868, are also arranged alphabetically by initial letter of the surname of the correspondent and thereunder chronologically. There is a name index in volume 3 (118). The letters received entered in the register are mentioned below.

Unbound letters received, April 1867–December 1868, are arranged according to their entry in the registers of letters received mentioned above.

NATIONAL ARCHIVES AND RECORDS ADMINISTRATION  
MICROFILM PUBLICATIONS

Unbound unregistered letters received, March 1866–December 1868 are arranged by year and thereunder alphabetically by initial letter of the surname or office of correspondent, with those from the Assistant Commissioner first, and thereunder chronologically.

The single volume of affidavits of freedmen and charges and specifications against citizens and military personnel, June 1866–September 1867 and January–July 1868 (237), is arranged chronologically.

The single-volume register of contracts, 1866–67 (240), is arranged alphabetically by name of the county and thereunder alphabetically by the initial letter of the surname of the employer.

**Albany (Agent)**

The three volumes of letters sent, March 1867–December 1868, 1 (121), 2 (122), and 3 (124), are arranged chronologically and have name indexes.

The single volume of endorsements sent and received, May–December 1868 (127), is arranged chronologically and has a name index. For letters received by endorsement, see the series of letters received (1867–68) mentioned below. Endorsements for June 1867–July 1868 are in volume 2 (115) of the registers of letters received (August 1867–December 1868) mentioned below.

The two volumes of registers of letters received, February 1867–December 1868, 1 (116), and 2 (115), are arranged by time period and have name indexes. For letters received entered in the registers, see the series of letters received mentioned below. The entries in volume 1 (116) dated February–December 1867 are arranged alphabetically by initial letter of the surname of the correspondent and thereunder chronologically. The entries for letters dated 1867 are mainly from the quartermaster, and this register may be a supplement for 1867. The entries in 2 (115) dated 1868 are also numbered. Volume 2 (115) also contains copies of endorsements sent and received for the period June 1867–July 1868.

Unbound letters received 1867–68 are arranged according to their entry in the registers of letters received or the endorsement sent and received. There are a few unregistered letters at the end of the series.

Unbound orders received, affidavits, and miscellaneous papers, 1867–68 are arranged by type of record and thereunder chronologically.

**Albany (Dispensary)**

The single volume of letters and orders received and letters sent, November 1866–May 1867 and November 1867–December 1868 (130), is arranged chronologically. The first part of the volume contains copies of letters and orders received; the second part is almost exclusively letters sent.

NATIONAL ARCHIVES AND RECORDS ADMINISTRATION  
MICROFILM PUBLICATIONS

The single-volume register of letters received and endorsements sent and received, February–December 1868 (128), is arranged by type of record and thereunder chronologically. For letters entered in the volume, see letters received mentioned below.

Unbound letters received, January–December 1868, are arranged according to their entry in the register of letters received and endorsements sent and received mentioned above.

Unbound monthly reports of attendants and of sick and wounded refugees and freedmen, 1867–68, are arranged by type of report and thereunder chronologically.

The three volumes of registers of patients, January 1867–December 1868, 1 (131), 2 (132), and 3 (133), are arranged chronologically. Volume 2 (132) also contains a register of patients at Americus (January–May 1868).

The single-volume register of letters sent by the surgeon at the dispensary at the military station at Albany, June–July 1868 (129), is arranged chronologically. The volume also contains letters sent and letters and orders received by the surgeon detailed to Station Number 11, 3rd Military District (January–May 1868).

**Americus (Agent)**

The single volume of letters sent, July 1866–November 1868 (136), is arranged chronologically and has a name index. Letters sent, June 1866, are in volume 1 (138) of the registers of contracts mentioned below.

The two volumes of registers of letters received, May 1866–December 1868, 1 (134) and 2 (135), are arranged by time period, and volume 2 (135) has a name index. For the letters entered in the volumes, see the series of letters received mentioned below. The entries in volume 1 (134) are arranged alphabetically by initial letter of the surname of the correspondent and thereunder chronologically. The entries in volume 2 (135) are arranged chronologically. Volume 2 (135) also contains endorsements sent and received from February to December 1868.

Unbound letters received, May 1867–November 1868, are arranged chronologically. Some of these letters are entered in the registers of letters received mentioned above and some are not.

The two volumes of registers of contracts, January–March 1866 and January 1867–June 1868, 1 (138) and 2 (137), are arranged chronologically and have name indexes. Volume 1 (138) also contains letters sent, June 1866, and an inventory stock.

The single-volume register of complaints, August 1867–November 1868 (139), is arranged chronologically, and there is a name index for complaints dating from April to November 1868.

NATIONAL ARCHIVES AND RECORDS ADMINISTRATION  
MICROFILM PUBLICATIONS

Unbound miscellaneous records, 1865-68, is arranged by type of record. The records include monthly returns of stores (April 1867-March 1868), school reports (November-December 1867), reports of persons and articles hired (June 1867-March 1868), leases, affidavits, and reports of murders.

**Americus (Dispensary)**

The single volume of letters sent, August-November 1868 (140), is arranged chronologically.

Unbound letters received, August-December 1868, are arranged chronologically.

Unbound monthly reports of sick and wounded, August-November 1868, are arranged chronologically.

The single-volume register of patients, August-November 1868 (141), is arranged chronologically. There is also a register of patients (January-May 1867) for a dispensary at Americus in volume 2 (132) of the registers of patients (January 1867-December 1868) mentioned above.

**Athens (Subassistant Commissioner)**

The two volumes of letters sent, February 1867-December 1868, 1 (169) and 2 (170) are arranged chronologically and have name indexes. Volume 1 (169) has two indexes: one to the addressee of the letter, and the other to persons mentioned within the letter.

The two volumes of registers of letters received and endorsements sent and received, February 1867-December 1868, 1 (165) and 2 (166), are arranged by time period and have name indexes. For letters entered in the volumes, see the series of letters received mentioned below. The entries are arranged alphabetically by initial letter of the surname of the correspondent and thereunder arranged chronologically and numbered.

Unbound letters received, February 1867-December 1868, are arranged according to their entry in the registers of letters received and endorsements sent and received mentioned above.

Unbound unregistered letters received, March 1867-November 1868, are arranged alphabetically by initial letter of the surname of the correspondent and thereunder chronologically.

Unbound reports sent to the Assistant Commissioner, 1867-68, are arranged by type of report and thereunder chronologically.

The single-volume register of complaints, February 1867-October 1868 (174), is arranged chronologically and has a name index.

NATIONAL ARCHIVES AND RECORDS ADMINISTRATION  
MICROFILM PUBLICATIONS

The single-volume register of freedmen receiving rations, March–April 1867 (177), is arranged chronologically. The last notation in the register is a report of transportation orders issued for May 1867.

**Athens (Agent)**

The three volumes of letters sent, May 1867–November 1868, 1 (171), 2 (172), and 3 (173), are arranged chronologically, and volumes 2 (172) and 3 (173) have name indexes. There are two indexes in volume 3 (173): one is to the addressee of the letter, and the other is to the persons mentioned in the letter.

The two volumes of registers of letters received and endorsements sent and received, May 1867–November 1868, 1 (167) and 2 (168), are arranged by time period and have name indexes. For letters entered in these volumes, see the series of letters received mentioned below. The entries are arranged and numbered in chronological order.

Unbound letters received, May 1867–November 1868, are arranged according to their entry in the registers of letters received and endorsements sent and received mentioned above.

The two volumes of registers of complaints, April 1867–November 1868, 1 (175) and 2 (176), are arranged chronologically and have name indexes.

**Atlanta (Subassistant Commissioner)**

The two volumes of letters sent, October 1865–December 1866 and March 1867–December 1868, 1 (98) and 2 (99), are arranged chronologically and have name indexes. Most of the letters were sent by the subassistant commissioner, however, volume 1 (98) also contains a few letters sent by the agent at Atlanta, a few endorsements sent, and a letter received.

The single volume of endorsements sent and received, January–June 1866 and May 1867–June 1868 (100), is arranged chronologically and has a name index. The first section of the volume (January–June 1866) is basically a register of letters received and endorsements sent. The second section (1867–68) consists of copies of endorsements sent and received that are cross-referenced in volumes 1 (96) and 2 (97) of the registers of letters received (January 1867–December 1868) mentioned below.

The two volumes of registers of letters received, February 1867–December 1868, 1 (96) and 2 (97), are arranged by time period, and volume 1 (96) has a name index. The entries are arranged alphabetically by initial letter of the surname of the correspondent and thereunder chronologically.

Unbound letters received, November 1865–October 1868, are arranged chronologically. Some of these letters are entered in the registers of letters received



NATIONAL ARCHIVES AND RECORDS ADMINISTRATION  
MICROFILM PUBLICATIONS

mentioned above and others are not. There are also some letters received by the agent stationed at Atlanta.

The single volume of special orders and circulars issued, January–October 1866 and May 1867–January 1868 (101), is arranged by type of order and thereunder chronologically. The special orders are dated January–October 1866, and the circulars and circulars letters are dated May 1867–January 1868.

Unbound reports from agents of cases tried in courts, July 1867–July 1868 are arranged chronologically.

Unbound reports from agents of destitute whites and freedmen dated March 1867 are arranged chronologically.

Unbound miscellaneous court papers and reports sent to the Assistant Commissioner, 1865–68, are arranged by type of record.

Unbound charges and specifications against freedmen and white citizens, September 1865–March 1866, are arranged chronologically.

The single volume of orders sent to local citizens and a register of complaints, October 1865–December 1866 and May 1867–November 1868 (103), is arranged by type of record and thereunder chronologically. The orders are dated October 1865–December 1866, and the complaints are dated May 1867–November 1868.

The single-volume register of contracts, December 1867–June 1868 (102), is arranged by county and thereunder chronologically. The volume also contains a register of orders received, November 1865–February 1868.

The single volume of accounts, May 1867–December 1868 (104), is arranged chronologically.

**Atlanta (Assistant Superintendent of Education)**

The single volume of press copies of letters sent, January–May 1869 (45½), is arranged chronologically and has a name index.

**Atlanta (Freedmen's Hospital)**

The single volume of orders and letters received and letters sent, October 1865–August 1868 (105), is arranged chronologically.

Unbound letters received October 1865–August 1868 are arranged chronologically.

Unbound reports of the surgeon in charge, 1865–68, are arranged by type of report and thereunder chronologically. The records include monthly statements of funds (January 1866–August 1868), monthly reports of sick and wounded (November

NATIONAL ARCHIVES AND RECORDS ADMINISTRATION  
MICROFILM PUBLICATIONS

1865–August 1868), monthly reports of hospital attendants (January 1866–October 1868), requisitions for medical stores (April–December 1867), and reports of destitute soldiers treated (August 1867–February 1868).

The two volumes of registers of patients, October 1865–August 1868, 1 (110) and 2 (108), is arranged chronologically by date of admission. The entries give the name, age, and sex of the patient; the date of admission and date of discharge; and the type of disease. Volume 1 (110) also contains a register of subsistence accounts dated March 1867–August 1868.

The single-volume register of patients at the dispensary of Atlanta Medical College, August 1867–August 1868 (107), is arranged chronologically. The entries give the name, age, and sex of the patient; the date of admission and date of discharge; and the type of disease.

The single-volume register of employees under contract, January 1866–March 1867, March 1865–April 1865, December 1865–January 1866, and May 1867–August 1868 (106), is arranged chronologically by date of contract. The volume also contains a prescription book dated December 1865–January 1866, morning reports dated May 1867–August 1868, and copies of letters sent by the 2nd Brigade, 6th Division, Cavalry Corps, Military Division of Mississippi in March 1865. Also included are weekly reports of sick and wounded of the Medical Department of the Cavalry Corps dated March–April 1865.

The single-volume register of subsistence stores issued, February–September 1868 (113), is arranged chronologically.

The single-volume register of commissary and subsistence stores received, February–August 1868 (111), is arranged chronologically.

The single-volume register of furniture, cooking utensils, and bedding in use, February–July 1868 (109), is arranged by month.

The single-volume register of commissary supplies expended, lost, or stolen, March–September 1868 (112), is arranged chronologically.

**Augusta (Subassistant Commissioner)**

The three volumes of letters sent, July 1865–December 1868, 1 (150), 2 (151), and 3 (152), are arranged chronologically and have name indexes. Volume 1 (150) also contains registers of civil agents in the subdistrict dated 1865–66.

The single volume of endorsements sent and received, October 1866–April 1867 (155), is arranged chronologically. Some of the letters are in the series of letters received (March 1867–December 1868) mentioned below.

NATIONAL ARCHIVES AND RECORDS ADMINISTRATION  
MICROFILM PUBLICATIONS

The two undated volumes of name indexes are indexes to volumes 1 (146) and 4 (145) for the periods August 1865–February 1867 and April–December 1868.

The four volumes of registers of letters received, August 1865–December 1868, 1 (146), 2 (143), 3 (144), and 4 (145), are arranged by time period, and there are undated name indexes to volumes 1 (146) and 4 (145), mentioned above. For letters entered in the volumes, see the series of letters received mentioned below. The entries in volume 1 (146) are dated August 1865–February 1867 and are arranged chronologically. For the period August–November 1865, each letter is fully copied in the volume. The entries in volumes 2 (143) and 3 (144), for the period March–December 1867, are arranged alphabetically by initial letter of the surname of the correspondent and thereunder arranged chronologically and numbered. The numbers within each alphabetical division are continued from volume 2 (143) to volume 3 (144). The last entries in volume 3 (144), December 1867–April 1868, and the entries in volume 4 (145), April–December 1868, are arranged chronologically and numbered. There is a new series of numbers for May 1868.

The single volume of letters received, February–May 1867 (142), is arranged chronologically and has a name index. The original letters are in the series of letters received dated March 1867–December 1868 mentioned below.

Unbound letters received, March 1867–December 1868, are arranged according to their entry in the register of letters received (August 1865–December 1868), the volume of letters received (142), and the volume of endorsements sent and received (155) mentioned above.

Unbound unregistered letters received, August 1865–October 1868, are arranged chronologically.

Unbound orders and circulars received, 1865–68, are arranged chronologically.

The single volume of orders received, February–May 1867 (160), are arranged chronologically. The volume also contains a register of rations issued dated April–September 1866.

Unbound reports forwarded to the Assistant Commissioner, August 1865–October 1868, are arranged by type of report and thereunder chronologically.

The two volumes of registers of complaints, June 1865–April 1867, 1 (158) and 2 (157), are arranged chronologically.

Unbound affidavits and other papers relating to freedmen's complaints, 1865–68, are arranged alphabetically by initial letter of surname of the freedman.

NATIONAL ARCHIVES AND RECORDS ADMINISTRATION  
MICROFILM PUBLICATIONS

**Augusta (Agent)**

The single volume of letters sent, July–December 1867 and April–December 1868 (153), is arranged chronologically.

The single-volume register of letters received and endorsements sent and received, May 1867–October 1868 (147), is arranged chronologically and numbered and has a name index. For letters entered in the volume, see letters received (June 1867–March 1868) mentioned below.

Unbound letters received, June 1867–March 1868 are arranged according to their entry in the register of letters received and endorsements sent and received mentioned above.

Unbound unregistered letters received, January 1866–August 1867, are arranged chronologically.

The single volume of contracts, August 1865–February 1866 (159), is arranged chronologically.

The undated volume name index is an index to the register of complaints (156), April–July 1868, mentioned below.

The single-volume register of complaints, April–July 1868 (156), is arranged chronologically. For a name index to the register, see the undated volume name index mentioned above.

**Augusta (Assistant Superintendent of Education)**

The single volume of letters sent, January–May 1869 (154), is arranged chronologically and has a name index.

The single-volume register of letters received and endorsements sent and received, January–May 1869 (149), is arranged chronologically and numbered.

**Augusta (Freedmen's Hospital)**

The single volume of letters sent and orders received, October–December 1865 (161), is arranged chronologically.

Unbound letters received, October 1865–May 1868, are arranged chronologically.

Unbound monthly reports of sick and wounded, October 1865–May 1868, are arranged chronologically.

The single-volume register of patients, September 1865–April 1868 (164), is arranged chronologically.

NATIONAL ARCHIVES AND RECORDS ADMINISTRATION  
MICROFILM PUBLICATIONS

The single volume of monthly statements of hospital funds and ration returns, October 1865–May 1868 (162), is arranged chronologically.

The single-volume register of patients at the smallpox hospital and weekly reports of sick and wounded at smallpox hospital, October 1865–July 1866 (163), is arranged by type of record and thereunder chronologically.

**Bainbridge (Agent)**

The two volumes of letters sent, June 1867–December 1868, 1 (182) and 2 (183), are arranged chronologically and have name indexes.

The three volumes of registers of letters received and endorsements sent and received are dated June 1867–December 1868. Volumes 1 (178), 2 (179), and 3 (180) are arranged by time period. Volume 2 (179) appears to be a supplementary volume for the same time period as in volume 1 (178). There are name indexes in volumes 1 (178) and 3 (180). For letters entered in the volumes, see the letters received (August 1867–December 1868) mentioned below. The entries are arranged alphabetically by initial letter of the surname of the correspondent and thereunder chronologically by date of receipt of the communication.

Unbound letters received, June 1867–December 1868, are arranged according to their entry in the registers of letters received and endorsements sent and received mentioned above.

Unbound unregistered letters received, February–July 1867, are arranged chronologically.

Unbound reports sent to the Assistant Commissioner and contracts, 1865–68, are arranged by type of record or report and thereunder chronologically.

The two volumes of registers of complaints, June 1867–December 1868, 1 (185) and 2 (186), are arranged chronologically and have name indexes.

**Bainbridge (Assistant Superintendent of Education)**

The single volume of letters sent, January–May 1869 (184), is arranged chronologically and has a name index.

The single-volume register of letters received, January–May 1869 (181), is arranged chronologically and has a name index.

**Bairdstown (Agent)**

The single-volume register of letters received and endorsements sent and received, August 1867–September 1868 (190), is arranged chronologically and has a name index.

NATIONAL ARCHIVES AND RECORDS ADMINISTRATION  
MICROFILM PUBLICATIONS

Unbound letters received, July 1866–April 1868, are arranged chronologically, and some of the letters are entered in the register of letters received and endorsements sent and received mentioned above.

Unbound reports sent to the Assistant Commissioner and court papers, 1866–67, are arranged by type of record and thereunder chronologically.

The single-volume register of complaints, August 1867–September 1868 (191), is arranged chronologically and has a name index.

**Barton (Agent)**

The single volume of letters sent, October 1867–August 1868 (188), is arranged chronologically and has a name index.

The single-volume register of letters received and endorsements sent and received, October 1867–July 1868 (187), is arranged alphabetically by initial letter of the surname of the correspondent and thereunder chronologically and has a name index. For letters entered in the volume, see the series of letters received (November 1867–July 1868) mentioned below.

Unbound letters received, November 1867–July 1868, are arranged chronologically, and some of the letters are entered in the register of letters received and endorsements sent and received mentioned above.

Unbound reports sent to the Assistant Commissioner and affidavits, 1867–68, are arranged by type of record.

The single-volume register of complaints and orders sent to local citizens, May–July 1868 (189), is arranged chronologically.

**Blakely (See Fort Gaines)**

**Brunswick (Subassistant Commissioner)**

The single volume of letters sent, March 1867–June 1868 (201), is arranged chronologically and has a name index.

The two volumes of press copies of letters sent, June 1868–May 1869, 1 (202) and 2 (203), are arranged chronologically and have name indexes.

The three volumes of registers of letters received and endorsements sent and received, March 1867–May 1869, 1 (197), 2 (198), and 3 (199), are arranged by time period, and volume 2 (198) has a name index. For letters entered in the volumes, see the series of letters received (May 1867–December 1868) mentioned below. The entries in the first two registers are arranged alphabetically by the initial letter of the surname of the correspondent and thereunder chronologically by the

NATIONAL ARCHIVES AND RECORDS ADMINISTRATION  
MICROFILM PUBLICATIONS

date of receipt of the communication. The entries in the last register are arranged and numbered in chronological order.

Unbound letters received, 1867-1868, are arranged according to their entry in the registers of letters received and endorsements sent and received mentioned above.

Unbound unregistered letters received, July 1866-April 1868, are arranged chronologically.

Unbound reports sent to the Assistant Commissioner and miscellaneous papers, 1866-68, are arranged by type of record and thereunder chronologically.

**Brunswick (Agent)**

The single volume of letters sent, June 1867-December 1868 (204), is arranged chronologically and has a name index.

The single-volume register of letters received and endorsements sent and received, May 1867-December 1868 (200), is arranged alphabetically by the initial letter of the surname of the correspondent and thereunder chronologically by the date of the receipt of the communication. It has a name index. For letters entered in the register, see the letters received (July 1867-December 1868) mentioned below.

Unbound letters received, July 1867-December 1868, are arranged according to their entry in the registers of letters received and endorsements sent and received mentioned above. There are a few unregistered letters at the end of the series.

Unbound school reports and quarterly statements of stores, 1867-68, are arranged by type of report and thereunder chronologically.

**Brunswick (Dispensary)**

The single volume of letters sent, May 1867-December 1868 (206), is arranged chronologically and has a name index.

The single-volume register of letters received and endorsements sent and received, May 1867-December 1868 (205), is arranged and numbered in chronological order and has a name index. For letters entered in volume, see the series of letters received (May 1867-December 1868) mentioned below.

Unbound letters received, January 1867 and May 1867-December 1868, are arranged according to their entry in the register of letters received and endorsements sent and received mentioned above. There are a few unregistered letters at the end of the series.

Unbound monthly reports of sick and wounded, April 1867-November 1868, are arranged chronologically.

NATIONAL ARCHIVES AND RECORDS ADMINISTRATION  
MICROFILM PUBLICATIONS

The single volume of weekly reports of number of patients at the dispensary, June 8, 1867–November 30, 1868 (207), is arranged chronologically. The volume also contains lists of patients (September–November 1866) and lists of refugees visited (October 1867).

The single-volume register of patients, November 1866–November 1868 (208), is arranged numerically.

**Butler (Agent)**

The single volume of letters sent, May–October 1868 (195), is arranged chronologically and has a name index.

The single-volume register of letters received and endorsements sent and received, May–August 1868 (194), is arranged by type of record and thereunder chronologically.

Unbound letters received, April–November 1868, are arranged chronologically.

**Campbellton (Agent)**

Unbound letters received, March 1866–April 1867, are arranged chronologically

The single-volume register of complaints, February 1866–May 1867 (209), is arranged chronologically.

**Carnesville ((Agent)**

The single volume of letters sent, June 1867–August 1868 (211), is arranged chronologically.

The single-volume register of letters received and endorsements received and sent, September 1867–August 1868 (210), is arranged in chronological order and numbered. For letters entered in the volume, see the series of letters received (September 1867–June 1868) mentioned below.

Unbound letters received, September 1867–June 1868), are arranged according to their entry in the register of letters received and endorsements received and sent mentioned above.

Unbound unregistered letters received, May–September 1867, are arranged chronologically.

Unbound contracts and monthly reports of contracts, 1867–68, are arranged by type of record and thereunder chronologically.

The single-volume register of complaints, November 1867–August 1868 (212), is arranged chronologically.



NATIONAL ARCHIVES AND RECORDS ADMINISTRATION  
MICROFILM PUBLICATIONS

**Carrollton (See Agent at Dawson)**

**Cartersville (Agent)**

The two volumes of letters sent, August 1867–December 1868, 1 (214) and 2 (215), are arranged chronologically and have name indexes.

The single-volume register of letters received and endorsements sent and received, April 1867–December 1868 (213), is arranged chronologically. For letters entered in the volume, see the series of letters received (April 1867–November 1868) mentioned below.

Unbound letters received, April 1867–November 1868, are arranged according to their entry in the register of letters received and endorsements sent and received mentioned above.

The single-volume register of complaints, August 1867–December 1868 (216), is arranged chronologically.

**Clarksville (Agent)**

The single volume of letters sent, June–October 1867 (218), is arranged chronologically and has a name index.

The single-volume register of letters received, June–November 1867 (217), is arranged chronologically and has a name index. For letters entered in the volume, see the series of letters received (June–November 1867) mentioned below.

Unbound letters received, June–November 1867, are arranged chronologically. Almost all of the letters appear to be entered in the register of letters received mentioned above.

Unbound monthly returns of Bureau stores, June–October 1867, are arranged chronologically.

**Columbus (Subassistant Commissioner)**

The two volumes of letters sent and endorsements sent and received, April 1866–January 1869, 1 (222) and 2 (223), are arranged by type of record and thereunder chronologically and have name indexes. The letters sent are dated April 1866–January 1869 and the endorsements are dated March 1867–November 1868.

The single-volume register of letters received and endorsements sent and received, March 1867–December 1868 (219), is arranged alphabetically by initial letter of the surname of the correspondent and thereunder chronologically and has a name index. For letters entered in the volume, see the series of letters received (February 1867–December 1868) mentioned below.

NATIONAL ARCHIVES AND RECORDS ADMINISTRATION  
MICROFILM PUBLICATIONS

Unbound letters received, February 1867–December 1868 are arranged according to their entry in the register of letters received and endorsements sent and received mentioned above.

Unbound unregistered letters received, January 1867–February 1868, are arranged chronologically.

Unbound orders received and reports sent to the Assistant Commissioner, 1867–68, are arranged by type of record or report and thereunder chronologically. Included are school reports, reports of contracts, reports of murders, rosters, and reports of persons and articles hired.

**Columbus (Agent)**

The single volume of letters sent, June–November 1868 (225), is arranged chronologically.

The single-volume register of letters received and endorsements sent and received, July 1867–December 1868 (221), is arranged alphabetically by initial letter of the surname of the correspondent and thereunder chronologically. It has a name index. For letters entered in the volume, see the series of letters received, April 1867–June 1868, mentioned below.

Unbound letters received, April 1867–June 1868, are arranged according to their entry in the register of letters received and endorsements sent and received mentioned above.

The single-volume journal, May 1867–November 1868 (226), is arranged chronologically and has a name index. Recorded in the journal are the complaints of freedmen and the actions taken by the agent, the agent's opinions of conditions in the area, and notices of letters sent by the agent.

**Columbus (Assistant Superintendent of Education)**

The single volume of letters, sent January–March 1869 (224), is arranged chronologically and has a name index.

The single-volume register of letters received, January–March 1869 (220), is arranged chronologically and has a name index.

**Columbus (Dispensary)**

The single-volume register of patients, November 1865–December 1867 (228), is arranged by sex and thereunder chronologically.

The single volume of rations returns, register of outdoor patients, and receipts, 1865, 1867–68 (227), is arranged by type of record and thereunder chronologically.

NATIONAL ARCHIVES AND RECORDS ADMINISTRATION  
MICROFILM PUBLICATIONS

**Crawfordsville (Agent)**

The single volume of letters sent, April 1867–November 1868 (262), is arranged generally in chronological order and has a name index. The volume also contains some miscellaneous records such as ration receipts and a register of contracts.

The single-volume register of letters received and endorsements sent and received, June 1867–November 1868 (261), is arranged chronologically and has a name index.

Unbound letters received, April 1867–December 1868, are arranged chronologically. Most of the letters do not appear to be entered in the register of letters received and endorsements sent and received mentioned above.

Unbound school reports, contracts, receipts, and affidavits, 1866–68, are arranged by type of record.

The two volumes of registers of complaints cover the periods November 1867–January 1868 and June–November 1868, 1 (263) and 2 (264). Volume 1 (263) appears to have no precise arrangement. Volume 2 (264) is arranged chronologically and has a name index.

**Cumming (Agent)**

The single volume of letters sent, May 1867–December 1868 (230), is arranged chronologically and has a name index.

The single-volume register of letters received and endorsements sent, April 1867–December 1868 (229), is arranged chronologically and has a name index. For letters entered in the volume, see the series of letters received (April 1867–December 1868) mentioned below.

Unbound letters received, April 1867–December 1868, are arranged chronologically. Most of the letters seem to be entered in the register of letters received and endorsements sent mentioned above.

The single-volume register of complaints, July 1867–October 1868 (231), is arranged chronologically.

**Cuthbert (See Subassistant Commissioner Albany)**

**Cuthbert (Agent)**

The two volumes of letters sent, June 1867–December 1868, 1 (235) and 2 (236), are arranged chronologically and have name indexes.

The two volumes of registers of letters received, June 1867–December 1868, 1 (232) and 2 (233), are arranged by time period and have name indexes. For letters entered in the volumes, see the series of letters received, June 1867–December 1868,

NATIONAL ARCHIVES AND RECORDS ADMINISTRATION  
MICROFILM PUBLICATIONS

mentioned below. The entries in volume 1 (232) are arranged alphabetically by initial letter of the surname of the correspondent and thereunder chronologically. Those in volume 2 (233) are arranged and numbered in chronological order.

Unbound letters received, June 1867–December 1868, are arranged according to their entry in the registers of letters received mentioned above. There are a few unregistered letters at the end of the series.

Unbound orders received, contracts, and miscellaneous court papers, 1865–68, are arranged by type of record.

The single volume of affidavits of freedmen, September 1867 and March–November 1868 (239), is arranged chronologically and has a name index.

The single-volume register of complaints, June 1867–December 1868 (238), is arranged chronologically and has a name index.

**Dahlonega (Agent)**

The single volume of letters sent, January–December 1868 (242), is arranged alphabetically by initial letter of the surname of the addressee and thereunder chronologically with some, but not all, letters to Commissioner Howard and the Governor of Georgia first. The volume has an incomplete name index.

The single-volume register of letters received and endorsements sent and received, 1868 (241), is arranged alphabetically by initial letter of the surname of the correspondent and thereunder chronologically. The first entries do not follow this arrangement. The volume has a name index.

Unbound letters received, December 1867–November 1868, are arranged chronologically. Some of the letters are entered in the register of letters received and endorsements sent and received mentioned above. There are a few school reports at the end of the series.

The single-volume register of complaints, 1868 (243), is arranged alphabetically by initial letter of the surname of the person making the complaint and thereunder chronologically and has a name index.

**Dalton (Agent)**

The two volumes of letters sent, June 1867–November 1868, 1 (246) and 2 (247), are both arranged numerically. In volume 1 (246), it appears as if the letters were grouped according to the name or position of the addressee. In volume 2 (247), the letters are nearly in chronological order. Both volumes have name indexes.

The two volumes of registers of letters received and endorsements sent and received cover the period June 1867–October 1868, 1 (244) and 2 (245). There appears to be

NATIONAL ARCHIVES AND RECORDS ADMINISTRATION  
MICROFILM PUBLICATIONS

no consistent arrangement to the entries in volume 1 (244). Volume 2 (245) is arranged in chronological order and numbered with two series of numbers. Both volumes have name indexes. For letters entered in the volumes, see the series of letters received, July 1867–October 1868, mentioned below.

Unbound letters received, July 1867–October 1868, are arranged by the way they were entered in the registers of letters received and endorsements sent and received (page of the registers). There are a few reports and unregistered letters at the end of the series.

The two volumes of registers of complaints, June 1867–October 1868, 1 (248) and 2 (249), are arranged generally in chronological order and have name indexes.

**Darien (Agent)**

Unbound letters received and contracts, 1866–68, are arranged by type of record and thereunder chronologically.

**Darien (Dispensary)**

The single volume of letters received by the assistant surgeon, March–September 1867 (255), is arranged chronologically. The volume also contains a register of orders and letters of transmittal received by the assistant surgeon.

The single volume of weekly reports of numbers of patients at the dispensary, March 1867–September 1868 (256), is arranged chronologically. The reports were copied into a volume that had been the letter book of B. M. Bryan, assistant surgeon and medical purveyor at Saltillo, Mexico, and it contains three letters dated January–April 1848.

The single-volume register of patients, April 1867–September 1868 (254), is arranged chronologically.

The single-volume "prescription book," April 1867–July 1868 (253), is arranged numerically and contains copies of prescriptions.

**Dawson (Agent)**

The two volumes of letters sent, July 1867–December 1868, 1 (367) and 2 (251), are arranged chronologically and have name indexes. The last letters (September–October 1868) in volume 1 (367) are duplicated in volume 2 (251).

The single volume of endorsements sent and received, September–December 1868 (252), is arranged chronologically and has a name index.

The two volumes of letters received, July 1867–March 1868 and June–December 1868, 1 (366) and 2 (250), are arranged by time period, and volume 2 (250) has a name index. The entries in volume 1 (366) are arranged chronologically, and this

NATIONAL ARCHIVES AND RECORDS ADMINISTRATION  
MICROFILM PUBLICATIONS

volume also includes copies of endorsements sent and received. The entries in volume 2 (250) are arranged alphabetically by initial letter of the surname of the correspondent and thereunder arranged in chronological order and numbered.

Unbound letters received, March 1867–December 1868, are arranged chronologically. Some of the letters are entered in the registers of letters received mentioned above. Most of them are dated 1868.

The single-volume register of complaints, December 1867–August 1868 (368), is arranged and numbered in chronological order and has a name index. For papers relating to complaints entered in the register, see the series of papers regarding complaints, 1867–68, mentioned below. For a register of complaints, September–December 1868, see the register of complaints, July–August 1868 (324), for the agent at Newton described later in this publication.

Unbound papers regarding complaints, 1867–68 are arranged chronologically. The complaints are entered in the register of complaints mentioned above.

**Dorchester (See Agent at Hinesville)**

**Eatonton (See Agent at Milledgeville)**

**Elijay (Agent)**

Unbound letters received, September–November 1867, are arranged chronologically.

**Forsyth (See Agent at Dawson)**

**Fort Gaines (Agent)**

The single-volume name index (260) is an index to volume 2 (259) of the series of letters sent January–June 1868 mentioned below.

The two volumes of letters sent, June 1867–June 1868, 1 (258) and 2 (259), are arranged chronologically and have name indexes. The index in volume 2 (259) is to the page on which the letter is copied. For the name index to the number of the letter, see the name index (260) mentioned above. Some of the letters (January–March 1868 in volume 1 (258) appear to be duplicated in volume 2 (259).

The two volumes of registers of letters received, July 1867–June 1868, 1 (192) and 2 (257) are arranged by time period. The entries are arranged alphabetically by initial letter of the surname of the correspondent and thereunder chronologically. Some of the entries (January–February 1868 in volume 1 (192) are duplicated in volume 2 (257). Volume 2 (257) also contains endorsements sent and received, January–May 1868, which are arranged and numbered in chronological order.

NATIONAL ARCHIVES AND RECORDS ADMINISTRATION  
MICROFILM PUBLICATIONS

Unbound letters received and miscellaneous papers relating to complaints, 1867-68, are arranged by type of record and thereunder chronologically. Some of the letters received are entered in the registers of letters received mentioned above.

The single-volume register of complaints, June 1867-May 1868 (193), is arranged chronologically. For a register of the trials of many of the complaints listed in this volume, see the register of cases tried in freedmen's court, July 1867-April 1868 (260½) mentioned below.

The single-volume register of cases tried in freedmen's court, July 1867-April 1868 (260½) is arranged chronologically.

**Fort Valley (See Agent at Perry)**

**Greensboro (Agent)**

Unbound letters received and contracts are dated 1866-67. There are only two letters received, and they are dated March 1866 and May 1867.

**Greensboro (See Also Agent at Crawfordsville)**

**Griffin (Subassistant Commissioner)**

The two volumes of letters sent, July 1866-February 1867 and July 1867-November 1868, 1 (267) and 2 (268), are arranged chronologically and have name indexes.

The two volumes of registers of letters received covering the periods July 1866-February 1867, August 1867-November 1868, 1 (269) and 2 (266), are arranged by time period and there is a name index in volume 2 (266). For letters received, see the series of letters received, June 1866-February 1867 (265) mentioned below. In volume 1 (269), the entries are arranged chronologically, and they include endorsements sent and received. In volume 2 (266), the entries for 1867 are arranged chronologically, and those for 1868, alphabetically by initial letter of the surname of the correspondent and thereunder chronologically.

The single volume of letters received, June 1866-February 1867 (265), is arranged chronologically and has a name index.

Unbound letters received, August 1867-November 1868, are arranged according to their entry in register number 2 (266) in the registers of letters received mentioned above.

Unbound unregistered letters received, February 1867-July 1868, are arranged chronologically.

NATIONAL ARCHIVES AND RECORDS ADMINISTRATION  
MICROFILM PUBLICATIONS

Unbound contracts, settlements between freedmen and employers, affidavits, and monthly reports sent to the Assistant Commissioner, 1865-58, are arranged by type of record.

The single-volume register of complaints, February 1866-November 1868 (270), is arranged chronologically. The agent at Griffin started this volume.

The single-volume register of contracts dated November 1865-July 1868 (271) is arranged chronologically.

The single volume of accounts, January-November 1868 (272) is arranged chronologically. The volume also includes lists of stores.

**Griffin (Agent)**

Unbound letters received, January 1866-April 1867, are arranged chronologically.

**Halcyondale (Agent)**

The single volume of letters sent, July 1867-December 1868 (274), is arranged chronologically and has a name index.

The single-volume register of letters received and endorsements sent and received, July 1867-December 1868 (273), is arranged alphabetically by initial letter of the surname of the correspondent and thereunder arranged in chronological order and numbered. For letters entered in the volume, see the series of letters received, July 1867-December 1868, mentioned below.

Unbound letters received, July 1867-December 1868, are arranged according to their entry in their register of letters received and endorsements sent and received mentioned above.

Unbound unregistered letters received, June-December 1867, are arranged chronologically.

The single-volume register of complaints, July-November 1867 and June-August 1868 (275), is arranged chronologically, and there is a name index for entries in 1867.

Unbound miscellaneous papers regarding complaints, 1867-68, are arranged chronologically.

**Hawkinsville (Agent)**

The single volume of letters sent, March-September 1868 (277), is arranged chronologically and has a name index.



NATIONAL ARCHIVES AND RECORDS ADMINISTRATION  
MICROFILM PUBLICATIONS

The single-volume register of letters received, March–August 1868 (276), is arranged alphabetically by initial letter of the surname of the correspondent and thereunder chronologically and has a name index. For letters entered in the volume, see the series of letters received, February–August 1868, mentioned below.

Unbound letters received, February–August 1868, are arranged according to their entry in the register of letters received mentioned above.

Unbound unregistered letters received, April 1867–September 1868, are arranged chronologically.

Unbound contracts and reports cover the period 1867–68.

The single-volume register of complaints, March–July 1868 (278), is arranged chronologically and has a name index.

**Hinesville (Agent)**

Unbound letters received, January 1867–November 1868, are arranged chronologically.

Unbound contracts and reports, 1867–68, are arranged by type of record.

**Irvinton (Agent)**

Unbound letters received, August–December 1868, are arranged chronologically. At the beginning of the series are two documents that note all the letters sent and received by the agent.

**Isabella (Agent)**

Unbound letters received, dated April–August 1867, are arranged chronologically.

Unbound returns of stores and reports of persons and articles hired are dated 1867.

**Jackson (Agent)**

Unbound letters received, September 1865–April 1867, are arranged chronologically.

**Jonesboro (Agent)**

The single volume of letters sent, June 1867–November 1868 (280), is arranged chronologically. This series consists mainly of abstracts of letters sent or forwarded, and the volume has a name index.

The single-volume register of letters received and endorsements sent, June 1867–November 1868 (279), is arranged in chronological order and numbered. It has a name index. For letters received, see the series of letters received, June–December 1867, mentioned below.

NATIONAL ARCHIVES AND RECORDS ADMINISTRATION  
MICROFILM PUBLICATIONS

Unbound letters received, June 1867–November 1868, are arranged according to their entry in the register of letters received and endorsements sent mentioned above.

The single-volume register of complaints, June 1867–August 1868 (281), is arranged chronologically and has a name index.

**Lafayette (Agent)**

Unbound letters sent, June 1867–March 1868 (284), are arranged chronologically and have a name index.

The single-volume register of letters received and endorsements sent, May 1867–February 1868 (283), is arranged alphabetically by initial letter of the surname of the correspondent and thereunder arranged in chronological order and numbered. It has a name index. Frequently, the entire letter is copied rather than an abstract of its contents.

The single volume of letters received and register of complaints, 1867–68 (285), is arranged by type of record and thereunder chronologically. The letters received are dated May–June 1867, and the register of complaints, June 1867–February 1868. There is a name index for the entire volume.

**Lagrange (Agent)**

The two volumes of letters sent, May 1867–December 1868, 1 (288) and 2 (289), are arranged chronologically and have name indexes.

The two volumes of registers of letters received and endorsements sent and received, May 1867–December 1868, 1 (286) and 2 (287), are arranged by time period and have name indexes. For letters entered in the volumes, see the series of letters received, May 1867–December 1868, mentioned below. The entries are arranged numerically.

Unbound letters received, May 1867–December 1868, are arranged according to their entry in the registers of letters received and endorsements sent and received mentioned above.

Unbound unregistered letters received, September 1866–May 1868, are arranged chronologically.

Unbound monthly school reports and receipts for notes in trust for freedmen, 1868, are arranged by type of record and thereunder chronologically.

The single-volume register of complaints, June 1867–November 1868 (290), is arranged chronologically and has a name index. The volume also contains a register of provisions received and issued, May–July 1867. (See pages 34 and 35 in the volume.)

NATIONAL ARCHIVES AND RECORDS ADMINISTRATION  
MICROFILM PUBLICATIONS

**Lexington (Agent)**

The volume of letters sent, August 1867–September 1868 (282), is arranged chronologically and has a name index. The series consists of mainly abstracts of letters sent.

Unbound letters received, October 1867–October 1868, are arranged chronologically.

Unbound reports, contracts, and miscellaneous records relating to complaints, 1867–68, are arranged by type of record and thereunder chronologically.

**Macon (Subassistant Commissioner)**

The two volumes of letters sent, December 1865–December 1868, 1 (296) and 2 (297), are arranged chronologically. Volume 1 (296), December 1865–March 1867, is partially duplicated in volume 2 (297), January 1867–December 1868. There is a name index for volume 2 (297).

The four volumes of registers of letters received and endorsements sent, December 1865–December 1868, 1 (291), 2 (292), 3 (293), and 4 (294), are arranged by time period. There are name indexes for every volume except 1 (291). For letters entered in the volumes, see the series of letters received, April–October 1866 and January 1867–December 1868, mentioned below. The entries in volume 1 (291) April–October 1866, are arranged and numbered in chronological order. The entries in volume 2 (292) and 3 (293), January–December 1867 and October 1867–August 1868, are arranged alphabetically by initial letter of the surname of the correspondent and thereunder chronologically. The entries within each alphabetical division are numbered, and in volume 2 (293) there is a separate numerical sequence for each year. The entries in volume 4 (294), August–December 1868, are arranged in chronological order and numbered. The entries in all four volumes include endorsements.

Unbound letters received, April–October 1866 and January 1867–December 1868 are arranged according to their entry in the registers of letters received and endorsements sent mentioned above.

Unbound unregistered letters received, December 1865–October 1868, are arranged chronologically.

The two volumes of registers of complaints, January–May 1866 and March 1867–December 1868, 1 (299) and 2 (300), are arranged chronologically and have name indexes. Volume 1 (299) also contains orders sent to local citizens relating to complaints, January–April 1866.

Unbound orders received, reports sent to the Assistant Commissioner, contracts, and miscellaneous court papers, 1865–68, are arranged by type of record and thereunder

NATIONAL ARCHIVES AND RECORDS ADMINISTRATION  
MICROFILM PUBLICATIONS

chronologically. Included in this series are school reports, land reports, ration reports, reports of persons and articles hired, and accounts current.

**Macon (Assistant Superintendent of Education)**

The single volume of press copies of letters sent, February–May 1869 (298), is arranged chronologically and has a name index.

The single-volume register of letters received and endorsements sent, January–May 1869 (295), is arranged in chronological order and numbered and has a name index.

Unbound letters received consists of three letters dated January–March 1869.

**Macon (Freedmen's Hospital)**

The two volumes of letters sent and letters and orders received, October 1865–September 1868, 1 (301) and 2 (302), have no precise arrangement. Volume 1 (301) includes letters sent and received October 1865–January 1866, printed orders and letters received 1867–68, and orders issued November 1865. Volume 2 (302) includes letters sent February–September 1868 and letters received and sent September and December 1866 and February 1867.

The two volumes of registers of patients treated at the hospital cover the period November 1865–June 1868, 1 (303) and 2 (308). Volume 2 (308), November 1865–April 1868, is duplicated in volume 1 (303), November 1865–June 1868. The entries within each are arranged chronologically by date of admission of patient. Both volumes also contain registers of patients treated outside of the hospital (April 1867–March 1868). Volume 1 (303) also contains a register of the sick and wounded.

The single-volume register of patients, 1866–68 (310), is arranged in four groups (adult males, adult females, male children, and female children) and thereunder chronologically by the date of admission.

Unbound monthly and weekly reports of sick and wounded and monthly reports of attendants, 1865–68 are arranged by type of report and thereunder chronologically.

The two volumes of weekly reports of sick and wounded, May 1866–October 1867 and June–December 1868, 1 (304) and 2 (307), are arranged chronologically

The single-volume register of medications administered to patients, 1866–67 (309), is arranged chronologically.

The single volume of trimonthly ration returns, June–October 1867 (305), is arranged chronologically. Beginning in September 1867, returns were made monthly.

NATIONAL ARCHIVES AND RECORDS ADMINISTRATION  
MICROFILM PUBLICATIONS

Unbound monthly statements of hospital funds, June–November 1868 (306), are arranged chronologically.

**McDonough (Agent)**

The single volume of letters sent, October 1867–August 1868 (315) are arranged chronologically and has a name index.

The single-volume register of letters received and endorsements sent and received, January 1867–September 1868 (314), is arranged chronologically and has a name index. For letters entered in the volume, see the series of letters received, January 1867–June 1868, mentioned below.

Unbound letters received, January 1867–September 1868, are arranged according to their entry in the register of letters received and endorsements sent and received.

The single-volume register of complaints, October 1867–August 1868 (316), is arranged chronologically.

Unbound miscellaneous records relating to complaints and contracts, 1865–66, are arranged by type of record.

**Marietta (Subassistant Commissioner)**

The single volume of letters sent, December 1866–December 1867 (312), is arranged chronologically and has a name index.

The single-volume register of letters received and endorsements sent and received, December 1866–January 1868 (311), is arranged alphabetically by initial letter of the surname of the correspondent and thereunder chronologically and has a name index.

Unbound letters received, May 1866–January 1868, are arranged chronologically, and some of the letters are entered in the register of letters received and endorsements sent and received mentioned above.

Unbound contracts and records relating to complaints, 1865–67 are arranged by type of record.

The single-volume register of complaints and orders sent to local citizens, January–December 1867 (313), is arranged chronologically. The volume also contains receipts for rations and public property, June 1867.

**Marietta (See Agent at Cumming)**

**Marion (Agent)**

Unbound letters received, January 1866–August 1868, are arranged chronologically.

NATIONAL ARCHIVES AND RECORDS ADMINISTRATION  
MICROFILM PUBLICATIONS

Unbound contracts and miscellaneous records relating to complaints, 1867-68, are arranged by type of record.

**Milledgeville (Agent)**

The single volume of letters sent, June 1867-December 1868 (318), is arranged chronologically and has a name index.

The single-volume register of letters received and endorsements sent and received, June 1867-November 1868 (317), is arranged in chronological order and numbered. It has a name index. For letters entered in the volume, see the series of letters received, February-June 1868, mentioned below.

Unbound letters received consist of three letters dated February-June 1868 and are entered in the register of letters received and endorsements sent and received mentioned above.

Unbound unregistered letters received, December 1865-November 1868, are arranged chronologically.

Unbound reports, contracts, and affidavits, May 1866-November 1868, are arranged by type of record and thereunder chronologically. The records include school reports, and reports of persons and articles hired. Also included are returns of Bureau stores.

The single-volume register of complaints and orders sent to local citizens, June 1867-August 1868 (319), is arranged chronologically and has a name index.

**Monroe (Agent)**

Unbound letters received, January 1866-April 1867, are arranged chronologically.

**Newman (Agent)**

The single volume of letters sent, May 1867-September 1868 (328), is arranged chronologically and has a name index.

The single-volume register of letters received and endorsements sent and received, May 1867-September 1868 (327), is arranged chronologically and has a name index.

Unbound letters received, January 1867-August 1868, are arranged chronologically, and some of the letters are entered in the register of letters received and endorsements sent and received mentioned above.

The single-volume register of complaints, May 1867-July 1868 (329), is arranged chronologically and has a name index.

NATIONAL ARCHIVES AND RECORDS ADMINISTRATION  
MICROFILM PUBLICATIONS

**Newton (Agent)**

The two volumes of letters sent, May 1867–August 1868, 1 (322) and 2 (323), are arranged chronologically and have name indexes.

The two volumes of registers of letters received, April 1867–July 1868, 1 (320) and 2 (321), are arranged by time period and have name indexes. For letters entered in the volumes, see the series of letters received, May 1867–July 1868, mentioned below. The entries are generally arranged alphabetically by initial letter of the surname of the correspondent and thereunder chronologically. The registers also include endorsements sent and received, which are arranged and numbered in chronological order.

Unbound letters received, May 1867–July 1868, are arranged according to their entry in the registers of letters received mentioned above.

Unbound monthly reports of contracts, September 1867–July 1868, are arranged chronologically.

The single-volume register of complaints, July–August 1868 (324) is arranged chronologically and has a name index. The volume also contains a register of complaints made at Dawson, GA, September–December 1868.

**Newton (Dispensary)**

The single volume of letters sent, December 1867–September 1868 (325), is arranged chronologically and has a name index.

The single-volume register of letters received and endorsements sent and received, December 1867–December 1868 (326), is arranged chronologically and has a name index.

Unbound letters received, November 1867–December 1868, are arranged chronologically, and some of the letters are entered in the register of letters received and endorsements sent and received mentioned above.

Unbound monthly reports of sick and wounded, December 1867–November 1868, are arranged chronologically.

**Perry (Agent)**

The single volume of letters sent, September 1867–December 1868 (332), is arranged chronologically and has a name index. The volume also contains a register of letters received, which is duplicated in the register of letters received and endorsements sent, September 1867–December 1868 (331), mentioned below.

The single-volume register of letters received and endorsements sent, September 1867–December 1868 (331), is arranged chronologically. For letters entered in the

NATIONAL ARCHIVES AND RECORDS ADMINISTRATION  
MICROFILM PUBLICATIONS

volume, see the series of letters received, September 1867–December 1868, mentioned below.

Unbound letters received, September 1867–December 1868, are arranged according to their entry in the register of letters received and endorsements sent mentioned above.

Unbound unregistered letters received, May 1867 and September 1867–July 1868, are arranged chronologically.

Unbound records, 1867–68, are arranged by type of report and thereunder chronologically. Included are “personal” reports, reports of persons and articles hired, school reports, reports of contracts, and returns of Bureau stores.

Unbound labor contracts and miscellaneous court papers, 1866–68, are arranged by type of record.

**Quitman (Agent)**

The single volume of letters sent, April 1867–July 1868 (334), is arranged chronologically and has a name index.

The single-volume register of letters received and endorsements sent and received, April 1867–June 1868 (333), has no consistent arrangement to the entries.

Unbound letters received, April 1867–August 1868, are arranged chronologically. Some of the letters are entered in the register of letters received and endorsements sent and received mentioned above.

Unbound monthly reports of contracts, April 1867–September 1868, are arranged chronologically.

The single-volume register of complaints, October 1867–June 1868 (335), is arranged chronologically and has name index.

**Riceboro (See Agent at Hinesville)**

**Rome (Agent)**

The three volumes of letters sent, June 1866–December 1868, 1 (340), 2 (341), and 3 (342), are arranged chronologically and have name indexes.

The four volumes of letters received, February 1867–December 1868, 1 (336), 2 (337), 3 (338), and 4 (339), are arranged by time period. There are name indexes for every volume except 1 (336). For letters entered in the volumes, see the series of letters received, February 1867–December 1868, mentioned below. The entries in volume 1 (336) are arranged alphabetically by initial letter of the surname of the



NATIONAL ARCHIVES AND RECORDS ADMINISTRATION  
MICROFILM PUBLICATIONS

correspondent and thereunder chronologically. The entries in volumes 2 (337), 3 (338), and 4 (339) are arranged in chronological order and numbered.

Unbound letters received, February 1867–December 1868, are arranged according to their entry in the registers of letters received mentioned above.

Unbound unregistered letters received, June 1866–December 1868, are arranged chronologically.

The single volume of orders and letters sent relating to complaints, June 1866–March 1867 (343), is arranged chronologically and has a name index.

The single-volume register of complaints, June 1866–November 1868 (344), is arranged chronologically.

Unbound miscellaneous records relating to complaints, 1866, are arranged by type of record.

The single-volume register of contracts, 1866–68 (345), is arranged by month or year and thereunder numerically.

**St. Marys (Agent)**

The two volumes of letters sent are dated September 1867–December 1868, 1 (373) and 2 (374). Volume 1 (373), September 1867–July 1868, is arranged by initial letter of the surname of the person to whom the letter is written and thereunder arranged and numbered in chronological order. Volume 2 (374), August–December 1868, is arranged and numbered in chronological order. Both volumes have name indexes.

The two volumes of registers of letters received, June 1867–December 1868, 1 (371) and 2 (372), are arranged by time period and have name indexes. The entries in both registers are generally arranged alphabetically by the initial letter of the surname of the correspondent and thereunder chronologically. However, in volume 1 (371) the entries for June–August 1867 at the beginning of the register are arranged chronologically.

Unbound registered letters received, May 1867–November 1868, are arranged chronologically.

Unbound unregistered letters received, May 1867–December 1868, are arranged chronologically.

**St. Simons Island (Agent)**

Unbound land report and report of planters who had sent their freedmen away unpaid is dated August–September 1865 and consists of two items.

NATIONAL ARCHIVES AND RECORDS ADMINISTRATION  
MICROFILM PUBLICATIONS

**Sandersville (Agent)**

The single volume of letters sent, May–November 1868 (364), is arranged chronologically and has a name index.

The single-volume register of letters received, April 1867–November 1868 (363), is arranged chronologically by date received and has a name index.

The single-volume register of complaints, May 1867–July 1868 (365), is arranged chronologically. The volume also includes a list of persons who were destitute.

Unbound school report and affidavits cover the period June 1867 and April–May 1868. The school report is dated June 1867 and the affidavits, April–May 1868.

**Savannah (Subassistant Commissioner)**

The two volumes of letters sent, February–December 1866 and February–March 1869, 1 (347) and 2 (397) are arranged chronologically. The last letters in volume 1 (347) are not in chronological order, but the volume has a name index.

The single volume of press copies of letters sent, March 1869–July 1872 (398), is arranged chronologically and has a name index.

The single volume of endorsements sent, March 1866–January 1867 (349), is arranged in chronological order and numbered. Agent Sawyer signed the last endorsements rather than the subassistant commissioner.

The three volumes of registers of letters received and endorsements sent and received, March 1867–August 1872, 1 (394), 2 (395), and 3 (396), are arranged by time period. There is a name index in volume 3 (396). For letters entered in the volumes, see the series of letters of letters received, March 1867–August 1872, mentioned below. The entries in registers 1 (394) and 2 (395) are arranged alphabetically by initial letter of the surname of the correspondent and thereunder chronologically. The entries in volume 3 (396) are arranged and numbered in chronological order.

Unbound letters received, March 1867–August 1872, are arranged according to their entry in the registers of letters received and endorsements sent and received mentioned above.

Unbound unregistered letters received, October 1865–July 1869, are arranged chronologically.

The single volume of special orders and circulars issued, February–July 1867 (399), is arranged by type of order and thereunder chronologically. The volume also contains some miscellaneous registers, 1867–70, most of which pertain to claims.

NATIONAL ARCHIVES AND RECORDS ADMINISTRATION  
MICROFILM PUBLICATIONS

Unbound orders and circulars received, July 1865–November 1867, are arranged chronologically.

Unbound reports sent to the Assistant Commissioner, September 1865–June 72, are arranged by type of report and thereunder chronologically. Included are land reports, reports of persons and articles hired, returns of Bureau stores, ration reports, accounts current, school reports (including teachers' school reports), rosters, and reports of contracts.

Unbound affidavits and papers relating to complaints, June 1865–April 1867, are arranged by type of record.

Unbound labor contracts, 1865–68, are arranged alphabetically by name of the county in which the contracts was made.

The three volumes of registers of complaints, February–October 1866 and July 1867–June 1868, 1 (352), 2 (351), and 3 (353), are arranged chronologically, and volume 1 (352) has a name index.

The single-volume register of claimants, December 1867–February 1872 (350), is arranged chronologically by date the voucher was received. The register gives the name, company, and regiment of claimant; the amount due him; the dates the vouchers were returned; the amount of money received and paid; and by whom the claimant was identified.

Unbound miscellaneous records, July 1865–April 1872 are arranged by type or subject of record. Included are bills of lading, records relating to the distribution of corn in 1867, and records relating to the Rice Hope Plantation, the colony at Belleville, St. Catherine's Island, and the Gibbons Estate.

Unbound records of the assistant adjutant general relating to the restoration of property in the Savannah area, January 1865–January 1867, are arranged by type of record. Included are letters sent, letters received, orders restoring property, applications for the restoration of property, and ration reports.

**Savannah (Agent)**

The single volume of letters sent, June 1867–December 1868 (348), is arranged chronologically.

The single-volume register of letters received and endorsements sent and received, December 1866–April 1868 (346), is arranged alphabetically by initial letter of the surname of the correspondent and thereunder chronologically and has a name index.

Unbound letters received, September–October 1865, are arranged chronologically.

NATIONAL ARCHIVES AND RECORDS ADMINISTRATION  
MICROFILM PUBLICATIONS

**Savannah (Lincoln Hospital)**

The two volumes of letters sent, December 1865–September 1868, 1 (354) and 2 (355), are arranged chronologically.

Unbound letters received, November 1865–September 1868, are arranged chronologically.

Unbound reports sent to Bureau headquarters, October 1865–September 1868, are arranged by type of report and thereunder chronologically. Included are reports of discharged soldiers treated at the hospital, statements of hospital funds, reports of the sick and wounded, and reports of hospital attendants.

The four volumes of registers of patients cover the period 1865–68, 1 (359), 2 (356), 3 (357), and 4 (361). The registers overlap in dates, and several of them contain other miscellaneous information such as a register of prescriptions.

The single-volume "register of sick and wounded at Lincoln Hospital," September 1865–April 1867 (362), is arranged in chronological order and numbered. The volume also contains a register of patients, December 1866–May 1867, arranged by sex and thereunder chronologically.

The single-volume "case, diet, and prescription book," January–March 1867 (358), is arranged chronologically.

Unbound morning reports, March–November 1865 (360), are arranged chronologically.

**Smithville (See Agent at Dawson)**

**Stockton (Subassistant Commissioner)**

The single volume of letters sent, June–December 1867 (370), is arranged chronologically and has a name index.

The single-volume register of letters received and endorsements sent and received, July–December 1867 (369), is arranged alphabetically by initial letter of the surname of the correspondent and thereunder chronologically and has a name index.

Unbound letters received, May–August 1867, are arranged chronologically.

**Thomasville (Subassistant Commissioner)**

The three volumes of letters sent cover the period November 1865–December 1868, 1 (379), 2 (380), 3 (381). Volume 1 (379) is arranged in chronological order and numbered. Volumes 2 (380) and 3 (381) are arranged chronologically, and all the volumes have name indexes.

NATIONAL ARCHIVES AND RECORDS ADMINISTRATION  
MICROFILM PUBLICATIONS

The two volumes of endorsements sent and received, November 1865–December 1866 and March–December 1868, 1 (382) and 2 (383), are arranged numerically. There is a name index to volume 1 (382). Volume 1 (382) also contains a register of notices (help wanted, etc.) date March 1867.

Three volumes of registers of letters received and endorsements received and sent, February 1867–December 1868, 1 (376), 2 (377), and 3 (378), are arranged by time period and have name indexes. For letters entered in the volumes, see the series of letters received, November 1865–November 1868, mentioned below. The entries in registers 1 (376) and 2 (377) are arranged alphabetically by initial letter of the surname of the correspondent and thereunder chronologically. The entries in register 3 (378) are arranged in chronological order and numbered.

Letters received, November 1865–December 1866 (375), are arranged chronologically and has a name index.

Unbound letters received, November 1865–December 1868, are arranged according to their entry in the volumes of letters received, mentioned above.

Unbound unregistered letters received, October 1865–September 1868, are arranged chronologically.

The single volume of general and special orders and circulars received, May 1865–August 1868 (384), is unarranged and has a name index.

Unbound reports and miscellaneous papers relating to complaints, 1865–68, are arranged by type of record and thereunder chronologically. Included are land reports, schools reports, ration reports, and reports of contracts.

The single-volume register of complaints, November 1865–October 1866 and March 1867–October 1868 (385), is arranged in chronological order and numbered. The first entries, 1865–66, consist of a transcript of proceedings; entries for the period 1867–68 are merely a register.

**Warrenton (Agent)**

The single volume of letters sent, April 1867–November 1868 (387), is arranged chronologically with letters to Commissioner Howard (April 1867–May 1868) at the beginning. The volume has a name index.

The single-volume register of letters received and endorsements sent and received, June 1867–November 1868 (386), is arranged chronologically and has a name index.

Unbound letters received, April 1867–November 1868, are arranged chronologically, and some of the letters are entered in the register of letters received and endorsements sent and received mentioned above.

NATIONAL ARCHIVES AND RECORDS ADMINISTRATION  
MICROFILM PUBLICATIONS

The single volume of registers of contracts and complaints, June 1867–November 1868 (388), is arranged by type of register. The register of contracts, June–July 1867, is arranged numerically; the register of complaints, June 1867–November 1868, is arranged chronologically.

Unbound miscellaneous records cover the period 1866–68 and consist of three items. This series includes a contract and an estimate for the construction of a black church.

**Washington (Agent)**

The single-volume register of complaints, December 1865–November 1866 (392), is arranged and numbered in chronological order.

**Watkinsville (Agent)**

Unbound letters received, December 1865–March 1867, are arranged chronologically.

**Waynesboro (Agent)**

Unbound letters sent, June 1866–February 1867, are arranged chronologically.

The single volume of letters sent, March–October 1868 (390), is arranged chronologically and has a name index.

The single-volume register of letters received and endorsements received and sent, March–August 1868 (389), is arranged chronologically and has a name index.

Unbound letters received, December 1865–February 1867 and January–November 1868, are arranged chronologically. Most of the letters do not appear to be entered in the register of letters received mentioned above.

The single-volume register of complaints, June–November 1868 (391), is arranged and numbered in chronological order and has a name index.

Unbound miscellaneous papers cover the period January 1867–May 1868 and consist of three items that are mainly testimonies of freedmen.

**Woodville (Agent)**

Unbound letters received, September 1867–August 1868, are arranged chronologically.

Unbound reports of persons and articles hired, contracts, and papers relating to complaints cover the period 1867–68.

The single-volume unidentified name index is not dated.

NATIONAL ARCHIVES AND RECORDS ADMINISTRATION  
MICROFILM PUBLICATIONS

RELATED RECORDS

In the same record group, RG 105, and related to records of the Bureau's field offices for Georgia, are those of the Bureau headquarters in Washington, DC, and previously microfilmed records of the Assistant Commissioner and the superintendent of education for Georgia and South Carolina. These record series are available in the following National Archives microfilm publications:

**M742, *Selected Series of Records Issued by the Commissioner of the Bureau of Refugees, Freedmen, and Abandoned Lands, 1865-1872***

**M752, *Registers and Letters Received by the Commissioner of the Bureau of Refugees, Freedmen, and Abandoned Lands, 1865-1872***

**M803, *Records of the Education Division of the Bureau of Refugees, Freedmen, and Abandoned Lands, 1865-1871***

**M798, *Records of the Assistant Commissioner for the State of Georgia, Bureau of Refugees, Freedmen, and Abandoned Lands, 1865-1869***

**M799, *Records of the Superintendent of Education for the State of Georgia, Bureau of Refugees, Freedmen, and Abandoned Lands, 1865-1870***

**M869, *Records of the Assistant Commissioner for the State of South Carolina, Bureau of Refugees, Freedmen, and Abandoned Lands, 1865-1870***

Records in other record groups supplement those of the Assistant Commissioner. In Records of United States Army Continental Commands, 1821-1920, Record Group (RG) 393, are records of the military district of Georgia. Records relating to employment and welfare of freedmen and abandoned property before the establishment of the Bureau are among Records of Civil War Special Agencies of the Treasury Department, RG 366. The records of the Freedman's Savings and Trust Company, 1865-1874, in Records of the Office of the Comptroller of the Currency, RG 101, contain information relating to former slaves who maintained accounts with the bank branches in Georgia.

There have been numerous books, articles, and dissertations published about the Freedmen's Bureau and its operations. For Georgia, see Paul A. Cimbala, *Under the Guardianship of the Nation: The Freedmen's Bureau and the Reconstruction of Georgia, 1865-1870* (Athens, GA: 1997). For general background, see Paul S. Pierce, *The Freedmen's Bureau, A Chapter in the History of Reconstruction* (Iowa City, IA: 1904); George R. Bentley, *A History of the Freedmen's Bureau* (Philadelphia, PA: 1955); and Paul A. Cimbala and Randall M. Miller, eds., *The Freedmen's Bureau and Reconstruction: Reconsiderations* (New York: 1999), especially pages 93-118.

NATIONAL ARCHIVES AND RECORDS ADMINISTRATION  
MICROFILM PUBLICATIONS

Several books written about Commissioner Oliver Otis Howard include O. O. Howard, *Autobiography of Oliver Otis Howard* (New York, NY: 1907); John Alcott Carpenter, *Sword and Olive Branch: Oliver Otis Howard* (Pittsburgh, PA: 1964); and William S. McFeely, *Yankee Stepfather: O. O. Howard and the Freedmen* (New Haven, CT: 1968).



NATIONAL ARCHIVES AND RECORDS ADMINISTRATION  
MICROFILM PUBLICATIONS

CONTENTS

ROLL	DESCRIPTION	DATES
1	<b>List of Book Records of Officers</b> State of Georgia 1 Volume	
	<b>OFFICES OF STAFF OFFICERS</b> <b>Chief Quartermaster and Disbursing Officer</b> Press Copies of Letters Sent	
	Volume 1 (62)*	Oct. 17, 1865–July 11, 1866
	Volume 2 (63)	July 10, 1866–Nov. 27, 1866
2	Volume 3 (64) Volume 4 (65)	Nov. 27, 1866–Apr. 27, 1867 Apr. 27, 1867–June 21, 1867
3	Volume 5 (66) Volume 6 (67)	June 21, 1867–Aug. 16, 1867 Aug. 16, 1867–Nov. 26, 1867
4	Volume 7 (68)	Nov. 30, 1867–Apr. 10, 1868
5	Volume 8 (69)	Apr. 13, 1868–Oct. 8, 1868
6	Volume 9 (70)	Oct. 9, 1868–May 31, 1869
7	Endorsements Sent and Received Volume 1 (71) Volume 2 (72)	Aug. 4, 1867–July 3, 1868 June 20, 1868–May 24, 1869
	Letters and Reports Received by Endorsement Entered Volume 72	June 1868–July 1868
8	Letters and Reports Received by Endorsement (cont.)	July 1868–Apr. 1869
9	Registers of Letters and Endorsements Received Volume 1 (59) Volume 2 (60) Volume 3 (61)	Jan. 1867–May 1867 May 1867–Oct. 1867 Aug. 1867–May 1869

\* Volume numbers assigned by the Adjutant General's Office (AGO) are shown in parentheses to assist in identifying the volumes.

NATIONAL ARCHIVES AND RECORDS ADMINISTRATION  
MICROFILM PUBLICATIONS

ROLL	DESCRIPTION	DATES
10	Letters Received Entered in Volumes Entered in Volume 1 (59) A-W	1867
11	Entered in Volume 2 (60) A-M	1867
12	Entered in Volume 2 (60) M-W Entered in Volume 3 (61) A-B	1867 1867-69
<b>NOTE: ROLLS 13-18 ALSO CONTAIN ENDORSEMENTS FILED BY PAGE NO., AS ENTERED IN VOL. 1 (71).</b>		
13	Entered in Volume 3 (61) B-E	1867-69
14	Entered in Volume 3 (61) F-H	1867-69
15	Entered in Volume 3 (61) H-M	1867-69
16	Entered in Volume 3(61) M - R	1867-68
17	Entered in Volume 3(61) R - W	1867-69
18	Entered in Volume 3(61) W - Y Unregistered Letters Received	1867-69 Oct. 1865-Apr. 1866
19	Unregistered Letters Received	May 1866-Aug. 1866
20	Unregistered Letters Received	Sept. 1866-Apr. 1869
21	Monthly Reports of Persons and Articles Hired, Sent to Bureau Headquarters Volume 1 (81) Volume 2 (82) Monthly Reports of Persons and Articles Hired, Received from Staff and Subordinate Officers	Oct. 1865-Jan. 1868 Feb. 1868-Aug. 1870 June 1866-Apr. 1867

NATIONAL ARCHIVES AND RECORDS ADMINISTRATION  
MICROFILM PUBLICATIONS

ROLL	DESCRIPTION	DATES
22	Monthly Reports of Persons and Articles Hired, Received from Staff and Subordinate Officers	May-Oct. 1867
23	Monthly Reports of Persons and Articles Hired, Received from Staff and Subordinate Officers	Nov. 1867-May 1868
24	Monthly Reports of Persons and Articles Hired, Received from Staff and Subordinate Officers	June-Dec. 1868
25	Accounts Current Special Orders Received Relating to the Issuance of Transportation Register of Freight Received and Forwarded Volume (86)	Aug. 1866-Mar. 1867 May 1867-Dec. 1868 Apr. 1867-Mar. 1869
26	<b>Surgeon in Chief</b> Letters Sent and Register of Letters Received Volume (52) Press Copies of Letters Sent Volume 1 (53) Volume 2 (54) Name Index Volume (51) Registers of Letters Received and Endorsements Sent and Received Volume 1 (49) Volume 2 (50)	Sept. 1865-July 1867 July 1867-Oct. 1868 Oct. 1868-Jan. 1869     July 1867-July 1868 July 1868-Jan. 1869
27	Letters Received Entered in Volume 1 (49) A-T Entered in Volume 2 (50) 1-342	July 1867-Mar. 1868  July 1868-Oct. 1868
28	Letters Received Entered in Volume 2 (50) 343-518 Unregistered Letters Received	Oct. 1868-Dec. 1868 Sept. 1865-Aug. 1867
29	Circulars and Circular Letters Issued Volume (55)	Aug. 1867-Nov. 1868

NATIONAL ARCHIVES AND RECORDS ADMINISTRATION  
MICROFILM PUBLICATIONS

ROLL	DESCRIPTION	DATES
29 (cont.)	Monthly and Weekly Reports of Sick and Wounded Refugees and Freedmen Forwarded to Bureau Headquarters Volume (57)	Oct. 1865–Dec. 1868
	Weekly and Monthly Reports of Sick and Wounded Refugees and Freedmen	Oct. 1865–Dec. 1868
	Weekly Reports of Sick and Wounded Refugees and Freedmen from Assistant Surgeons	Oct. 1865–Apr. 1866
30	Weekly Reports of Sick and Wounded Refugees and Freedmen from Assistant Surgeons	May 1866–Feb. 1867
31	Weekly Reports of Sick and Wounded Refugees and Freedmen from Assistant Surgeons	Mar.–Dec. 1867
32	Weekly Reports of Sick and Wounded Refugees and Freedmen from Assistant Surgeons	Jan.–Dec. 1868
33	Monthly Reports of Medical Attendants Forwarded to Bureau Headquarters	Feb. 1866–Dec. 1868
	Returns of Commissioned Medical Officers Forwarded to Bureau Headquarters	Dec. 1865–Dec. 1868
	Contracts with Hospital Attendants and Surgeons	Oct. 1865–Sept. 1868
	Register of Reports and Returns Received from Assistant Surgeons and Forwarded to Bureau Headquarters in Washington	
	Volume (56)	1867–68
	Miscellaneous Accounting Records	
	Volume (58)	1865–68
34	<b>SUBORDINATE FIELD OFFICES</b> <b>Albany (Subassistant Commissioner)</b>	
	Letters Sent	
	Volume 1 (234)	Feb. 1866–Jan. 1867
	Volume 2 (120)	Feb.–Nov. 1867
	Volume 3 (123)	Nov. 1867–Nov. 1868
	Volume 4 (125)	Nov.–Dec. 1868
	Endorsements Sent and Received	
	Volume (126)	Apr.–Dec. 1868

NATIONAL ARCHIVES AND RECORDS ADMINISTRATION  
MICROFILM PUBLICATIONS

ROLL	DESCRIPTION	DATES
34	Registers of Letters Received	
(cont.)	Volume 1 (114)	Feb. 1866–Nov. 1867
	Volume 2 (117)	July–Dec. 1867
	Volume 3 (118)	Apr. –July 1867
	Volume 4 (119)	Jan.–Dec. 1868
35	Letters Received	
	Entered in Volumes 1 (114), 2 (117), and 3 (118)	
	A–W	1867
	Entered in Volume 4 (119)	
	A–C	1868
36	Letters Received	
	Entered in Volume 4(119)	
	D–Y	1868
	Unregistered Letters Received	1866
37	Unregistered Letters Received	1867–68
	Affidavits of Freedmen and Charges and Specifications Against Citizens and Military Personnel	
	Volume (237)	June 1866–Sept. 1867 and Jan.–July 1868
	Register of Contracts	
	Volume (240)	1866–67
	<b>Albany (Agent)</b>	
	Letters Sent	
	Volume 1 (121)	Mar.–June 1867
	Volume 2 (122)	June 1867–Feb. 1868
	Volume 3 (124)	Feb.–Dec. 1868
	Endorsements Sent and Received	
	Volume (127)	May–Dec. 1868
	Registers of Letters Received	
	Volume 1 (116)	Feb. 1867–Dec. 1867
	Volume 2 (115)	Aug. 1867–Dec. 1868, and June 1867–July 1868
38	Letters Received	
	Entered in Volume 1 (116)	
	B–W	1867
	Entered in Volume 2 (115)	1867–68

NATIONAL ARCHIVES AND RECORDS ADMINISTRATION  
MICROFILM PUBLICATIONS

ROLL	DESCRIPTION	DATES
39	Orders Received, Affidavits, and Misc. Papers 1867-68	
	<b>Albany (Dispensary)</b>	
	Letters and Orders Received and Letters Sent	
	Volume (130)	Nov. 1866-May 1867 and Nov. 1867-Dec. 1868
	Register of Letters Received and	
	Endorsements Sent and Received	
	Volume (128)	Feb.-Dec. 1868
	Letters Received	Jan.-Dec. 1868
	Monthly Reports of Attendants and of	
	Sick and Wounded Refugees and Freedmen 1867-68	
	Registers of Patients	
	Volume 1 (131)	Jan.-July 1867
	Volume 2 (132)	Feb. 1867- Jan. 1868 and Jan.-May 1867
	Volume 3 (133)	Feb.-Dec. 1868
	Letters Sent by the Surgeon at the Dispensary	
	at the Military Station at Albany	
	Volume (129)	June-July 1868 and Jan.-May 1868
	<b>Americus (Agent)</b>	
	Letters Sent	
	Volume (136)	July 1866-Nov. 1868
	Registers of Letters Received	
	Volume 1 (134)	May 1866 and Nov. 1867
	Volume 2 (135)	Jan.-Dec. 1868
40	Letters Received	May 1867-Nov 1868
	Registers of Contracts	
	Volume 1 (138)	Jan.-Mar. 1866 and June 1866
	Volume 2 (137)	Jan. 1867-June 1868
	Register of Complaints	
	Volume (139)	Aug. 1867-Nov. 1868
	Miscellaneous Records	1865-68
	<b>Americus (Dispensary)</b>	
	Letters Sent	
	Volume (140)	Aug.-Nov. 1868
	Letters Received	Aug.-Dec. 1868
	Monthly Reports of Sick and Wounded	Aug.-Nov. 1868
	Register of Patients	
	Volume (141)	Aug.-Nov. 1868

NATIONAL ARCHIVES AND RECORDS ADMINISTRATION  
MICROFILM PUBLICATIONS

ROLL	DESCRIPTION	DATES
41	<b>Athens (Subassistant Commissioner)</b>	
	Letters Sent	
	Volume 1 (169)	Feb. 12, 1867–Mar. 31, 1868
	Volume 2 (170)	Apr. 1–Dec. 9, 1868
	Registers of Letters Received and Endorsements Sent and Received	
	Volume 1 (165)	Feb.–Dec. 1867
	Volume 2 (166)	Jan.–Dec. 1868
	Letters Received	
	Entered in Volume 1 (165)	
	A–W	Feb.–Dec. 1867
	Entered in Volume 2 (166)	
	A–W	Jan.–Dec. 1868
42	Unregistered Letters Received	Mar. 1867–Nov. 1868
	Reports Sent to the Assistant Commissioner	1867–68
	Register of Complaints	
	Volume (174)	Feb. 1867–Oct. 1868
	Register of Freedmen Receiving Rations and Furnished Transportation	
	Volume (177)	Mar.–Apr. 1867
43	<b>Athens (Agent)</b>	
	Letters Sent	
	Volume 1 (171)	May 1867–Feb. 1868
	Volume 2 (172)	Feb.–Sept. 1868
	Volume 3 (173)	Sept.–Nov. 1868
	Registers of Letters Received and Endorsements Sent and Received	
	Volume 1 (167)	May 1867–July 1868
	Volume 2 (168)	July–Nov. 1868
	Letters Received	May 1867–Nov. 1868
	Registers of Complaints	
	Volume 1 (175)	Apr. 1867–July 1868
	Volume 2 (176)	July–Nov. 1868
	<b>Atlanta (Subassistant Commissioner)</b>	
	Letters Sent	
	Volume 1 (98)	Oct. 1865–Dec. 1866
	Volume 2 (99)	Mar. 1867–Dec. 1868
	Endorsements Sent and Received	
	Volume (100)	Jan.–June 1866 and May 1867–June 1868

NATIONAL ARCHIVES AND RECORDS ADMINISTRATION  
MICROFILM PUBLICATIONS

ROLL	DESCRIPTION	DATES
44	Registers of Letters Received Volume 1 (96) Volume 2 (97) Letters Received	Feb.-Dec. 1867 Jan.-Dec. 1868 Nov. 1865-Dec. 1867
45	Letters Received Special Orders and Circulars Issued Volume (101)  Reports from Agents of Cases Tried in Courts Reports from Agents of Destitute Whites and Freedmen Miscellaneous Court Papers and Reports Sent to the Assistant Commissioner Charges and Specifications against Freedmen and White Citizens Orders Sent to Local Citizens and a Register of Complaints Volume (103)  Register of Contracts Volume (102)  Accounts Volume (104)  <b>Atlanta (Superintendent of Education)</b> Press Copies of Letters Sent Volume (45½)  <b>Atlanta (Freedmen's Hospital)</b> Orders and Letters Received and Letters Sent Volume (105)	Jan.-Oct. 1868  Jan.-Oct. 1866 and May 1867-Jan. 1868  July 1867-July 1868  Mar. 1867  1865-68  Sept. 1865-Mar. 1866  Oct. 1865-Dec. 1866 and May 1867-Nov. 1868  Dec. 1867-June 1868 and Nov. 1865-Feb. 1868  May 1867-Dec. 1868    Jan.-May 1869  Oct. 1865-Aug. 1868
46	Letters Received Reports of the Surgeon in Charge Registers of Patients Volume 1 (110)  Volume 2 (108) Register of Patients at the Dispensary of Atlanta Medical College Volume (107)	Oct. 1865-Aug. 1868 1865-68  Oct. 1865-Jan. 1867 and Mar. 1867-Aug. 1868 Jan. 1867-Aug. 1868  Aug. 1867-Aug. 1868



NATIONAL ARCHIVES AND RECORDS ADMINISTRATION  
MICROFILM PUBLICATIONS

ROLL	DESCRIPTION	DATES
46 (cont.)	Register of Employees under Contract Volume (106)	Jan. 1866-Mar. 1867, Mar. 1865-Apr. 1865, Dec. 1865-Jan. 1866, and May 1867-Aug. 1868
	Register of Subsistence Stores Issued Volume (113)	Feb.-Sept. 1868
	Register of Commissary and Subsistence Stores Received Volume (111)	Feb.-Aug. 1868
	Register of Furniture, Cooking Utensils, and Bedding in Use Volume (109)	Feb.-July 1868
	Register of Commissary Supplies Expended, Lost, or Stolen Volume (112)	Mar.-Sept. 1868
	<b>Augusta (Subassistant Commissioner)</b> Letters Sent Volume 1 (150)	July 1865-Mar. 1866 and 1865-66
	Volume 2 (151)	Apr. 1866-Mar. 1867
	Volume 3 (152)	Mar. 1867-Dec. 1868
	Endorsements Sent and Received Volume (155)	Oct. 1866-Apr. 1867
47	Name Indexes 2 Volumes	
	Registers of Letters Received Volume 1 (146)	Aug. 1865-Feb. 1867
	Volume 2 (143)	Mar.-Nov. 1867
	Volume 3 (144)	Nov. 1867-Apr. 1868
	Volume 4 (145)	Apr.-Dec. 1868
	Letters Received Volume (142)	Feb.-May 1867
	Letters Received Entered in Volumes 3 (144) and 4 (145) A - W	Sept. 1867-May 1868
	Entered in Volume 4 (145)	Jan.-Dec. 1868
	Entered in Volume (142)	Mar.-May 1867
	Entered in Volume (155)	Mar. 1867

NATIONAL ARCHIVES AND RECORDS ADMINISTRATION  
MICROFILM PUBLICATIONS

ROLL	DESCRIPTION	DATES
48	Unregistered Letters Received Orders and Circulars Received Orders Received Volume (160)	Aug. 1865–Oct. 1868 1865–68  Feb.–May 1867 and Apr.–Sept. 1866
	Reports Forwarded to the Assistant Commissioner	Aug. 1865–Oct. 1868
	Register of Complaints Volume 1 (158) Volume 2 (157)	June 1865–Sept. 1865 Oct. 1865–Apr. 1867
	Affidavits and Other Papers Relating to Freedmen's Complaints A–Y	1865–68
49	<b>Augusta (Agent)</b> Letters Sent Volume (153)	July–Dec. 1867 and Apr.–Dec. 1868
	Register of Letters Received and Endorsements Sent and Received Volume (147)	May 1867–Oct. 1868
	Letters Received	June 1867–Mar. 1868
	Unregistered Letters Received	Jan. 1866–Aug. 1867
	Contracts Volume (159)	Aug. 1865–Feb. 1866
	Name Index 1 Volume	
	Register of Complaints Volume (156)	Apr.–July 1868
	<b>Augusta (Asst. Superintendent of Educ.)</b> Letters Sent Volume (154)	Jan.–May 1869
	Register of Letters Received and Endorsements Sent and Received Volume (149)	Jan.–May 1869
	<b>Augusta (Freedmen's Hospital)</b> Letters Sent and Orders Received Volume (161)	Oct.–Dec. 1865
	Letters Received	Oct. 1865–May 1868
	Monthly Reports of Sick and Wounded	Oct. 1865–May 1868
	Register of Patients Volume (164)	Sept. 1865–Apr. 1868

NATIONAL ARCHIVES AND RECORDS ADMINISTRATION  
MICROFILM PUBLICATIONS

ROLL	DESCRIPTION	DATES
49	Monthly Statements of Hospital (cont.) Funds and Ration Returns Volume (162)	Oct. 1865–May 1868
	Register of Patients at Smallpox Hospital and Weekly Reports of Sick and Wounded at Smallpox Hospital Volume (163)	Oct. 1865–July 1866
50	<b>Bainbridge (Agent)</b> Letters Sent Volume 1 (182) Volume 2 (183)	June 1867–May 1868 May–Dec. 1868
	Registers of Letters Received and Endorsements Sent and Received Volume 1 (178) Volume 2 (179) Volume 3 (180)	June 1867–May 1868 Jan.–Mar. 1868 Feb.–Dec. 1868
	Letters Received Entered in Volume 1 (178) B–W Entered in Volume 2 (179) C–W Entered in Volume 3 (180) B–W	June 1867–Mar. 1868 Jan.–Mar. 1868 Jan.–Dec. 1868
	Unregistered Letters Received Reports Sent to the Assistant Commissioner and Contracts	Feb.–July 1867 1865–68
51	Registers of Complaints Volume 1 (185) Volume 2 (186)	June 1867–July 1868 Aug.–Dec. 1868
	<b>Bainbridge (Asst. Superintendent of Educ.)</b> Letters Sent Volume (184)	Jan.–May 1869
	Register of Letters Received Volume (181)	Jan.–May 1869
	<b>Bairdstown (Agent)</b> Register of Letters Received and Endorsements Sent and Received Volume (190)	Aug. 1867–Sept. 1868
	Letters Received Reports Sent to the Assistant Commissioner and Court Papers	July 1866–Apr. 1868 1866–67

NATIONAL ARCHIVES AND RECORDS ADMINISTRATION  
MICROFILM PUBLICATIONS

ROLL	DESCRIPTION	DATES
51	Register of Complaints (cont.) Volume (191)	Aug. 1867–Sept. 1868
	<b>Barton (Agent)</b>	
	Letters Sent Volume (188)	Oct. 1867–Aug. 1868
	Register of Letters Received and Endorsements Sent and Received Volume (187)	Oct. 1867–July 1868
	Letters Received	Nov. 1867–July 1868
	Reports Sent to the Assistant Commissioner and Affidavits	1867–68
	Register of Complaints and Orders Sent to Local Citizens Volume (189)	May–July 1868
52	<b>Blakely (See Fort Gaines)</b>	
	<b>Brunswick (Subassistant Commissioner)</b>	
	Letters Sent 1 Volume (201)	Mar. 1867–June 1868
	Press Copies of Letters Sent Volume 1 (202)	June 1868–Jan. 1869
	Volume 2 (203)	Feb.–May 1869
	Registers of Letters Received and Endorsements Sent and Received Volume 1 (197)	Mar. 1–Dec. 31, 1867
	Volume 2 (198)	Jan. 1–Dec. 31, 1868
	Volume 3 (199)	Jan. 1–May 5, 1869
	Letters Received Entered in Volume 1 (197)	1867
	A–W	
	Entered in Volume 2 (198)	1868
	A–R	
53	Entered in Volume 2 (198) R–W	1868
	Unregistered Letters Received	July 1866–Apr. 1868
	Reports Sent to the Assistant Commissioner and Miscellaneous Papers	1866–68

NATIONAL ARCHIVES AND RECORDS ADMINISTRATION  
MICROFILM PUBLICATIONS

ROLL	DESCRIPTION	DATES
53	<b>Brunswick (Agent)</b>	
(cont.)	Letters Sent	
	Volume (204)	June 1867-Dec. 1868
	Register of Letters Received and Endorsements Sent and Received	
	Volume (200)	May 1867-Dec. 1868
	Letters Received	July 1867-Dec. 1868
	School Reports and Quarterly Statements of Stores	1867-68
54	<b>Brunswick (Dispensary)</b>	
	Letters Sent	
	Volume (206)	May 1867-Dec. 1868
	Register of Letters Received and Endorsements Sent and Received	
	Volume (205)	May 1867-Dec. 1868
	Letters Received	Jan. 1867, May 1867-Dec. 1868
	Monthly Reports of Sick and Wounded	Apr. 1867-Nov. 1868
	Weekly Reports of Number of Patients at Dispensary	
	Volume (207)	Sept.-Nov. 1866 and June 1867-Nov. 1868
	Register of Patients	
	Volume (208)	Nov. 1866-Nov. 1868
	<b>Butler (Agent)</b>	
	Letters Sent	
	Volume (195)	May 22-Oct. 16, 1868
	Register of Letters Received and Endorsements Sent and Received	
	Volume (194)	May-Aug. 1868
	Letters Received	Apr.-Nov. 1868
	<b>Campbellton (Agent)</b>	
	Letters Received	Mar. 1866-Apr. 1867
	Register of Complaints	
	Volume (209)	Feb. 1866-May 1867
	<b>Carnesville (Agent)</b>	
	Letters Sent	
	Volume (211)	June 1867-Aug. 1868
	Register of Letters Received and Endorsements Received and Sent	
	Volume (210)	Sept. 1867-Aug. 1868

NATIONAL ARCHIVES AND RECORDS ADMINISTRATION  
MICROFILM PUBLICATIONS

ROLL	DESCRIPTION	DATES
54 (cont.)	Letters Received	Sept. 1867–June 1868
55	Unregistered Letters Received	May–Sept. 1867
	Contracts and Monthly Reports of Contracts	1867–68
	Register of Complaints Volume (212)	Nov. 1867–Aug. 1868
<b>Carrollton (See Dawson)</b>		
<b>Cartersville (Agent)</b>		
	Letters Sent	
	Volume 1 (214)	Aug. 1867–June 1868
	Volume 2 (215)	June 30–Dec. 1868
	Register of Letters Received and Endorsements Sent and Received	
	Volume (213)	Apr. 1867–Dec. 1868
	Letters Received	Apr. 1867–Nov. 1868
	Register of Complaints Volume (216)	Aug. 1867–Dec. 1868
<b>Clarksville (Agent)</b>		
	Letters Sent	
	Volume (218)	June–Oct. 1867
	Register of Letters Received	
	Volume (217)	June–Nov. 1867
	Letters Received	June–Nov. 1867
	Monthly Returns of Bureau Stores	June–Oct. 1867
<b>Columbus (Subassistant Commissioner)</b>		
	Letters Sent and Endorsements Sent and Received	
	Volume 1 (222)	Apr. 1866–Feb. 1867 and Mar. 1867–Nov. 1868
	Volume 2 (223)	Mar. 1867–Jan. 1869
56	Register of Letters Received and Endorsements Sent and Received Volume (219)	Mar. 1867–Dec. 1868
	Letters Received	Feb. 1867–Dec. 1868
	Unregistered Letters Received	Jan. 1867–Feb. 1868
	Orders Received and Reports Sent to the Assistant Commissioner	1867–68

NATIONAL ARCHIVES AND RECORDS ADMINISTRATION  
MICROFILM PUBLICATIONS

ROLL	DESCRIPTION	DATES
57	<b>Columbus (Agent)</b>	
	Letters Sent	
	Volume (225)	June 1868–Nov. 1868
	Register of Letters Received and Endorsements Sent and Received	
	Volume (221)	July 1867–Dec. 1868
	Letters Received	Apr. 1867–June 1868
	Journal	
	Volume (226)	May 1867–Nov. 1868
	<b>Columbus (Asst. Superintendent of Educ.)</b>	
	Letters Sent	
	Volume (224)	Jan.–Mar. 1869
	Register of Letters Received	
	Volume (220)	Jan.–Mar. 1869
	<b>Columbus (Dispensary)</b>	
Register of Patients		
Volume (228)	Nov. 1865–Dec. 1867	
Ration Returns, Register of Outdoor Patients, and Receipts		
Volume (227)	1865, 1867–68	
<b>Crawfordsville (Agent)</b>		
Letters Sent		
Volume (262)	Apr. 1867–Nov. 1868	
Register of Letters Received and Endorsements Sent and Received		
Volume (261)	June 1867–Nov. 1868	
Letters Received	Apr. 1867–Dec. 1868	
58	School Reports, Contracts, Receipts, and Affidavits	1866–68
	Registers of Complaints	
	Volume 1 (263)	Nov. 1867–Jan. 1868
	Volume 2 (264)	June–Nov. 1868
	<b>Cumming (Agent)</b>	
	Letters Sent	
Volume (230)	May 1867–Dec. 1868	
Register of Letters Received and Endorsements Sent		
Volume (229)	Apr. 1867–Dec. 1868	
Letters Received	Apr. 1867–Dec. 1868	

NATIONAL ARCHIVES AND RECORDS ADMINISTRATION  
MICROFILM PUBLICATIONS

ROLL	DESCRIPTION	DATES
58 (cont.)	Register of Complaints Volume (231)	July 1867–Oct. 1868
<b>Cuthbert (See Subassistant Commissioner, Albany)</b>		
<b>Cuthbert (Agent)</b>		
	Letters Sent	
	Volume 1 (235)	June 1867–Mar. 1868
	Volume 2 (236)	Mar.–Dec. 1868
	Registers of Letters Received	
	Volume (232)	June 1867–Feb. 1868
	Volume (233)	Feb.–Dec. 1868
59	Letters Received	
	Entered in Volume (232)	
	C–W	1867–68
	Entered in Volume (233)	1868
	Orders Received, Contracts, and Miscellaneous Court Papers	1865–68
	Affidavits of Freedmen	
	Volume (239)	Sept. 1867 and Mar.–Nov. 1868
	Register of Complaints	
	Volume (238)	June 1867–Dec. 1868
60	<b>Dahlonga (Agent)</b>	
	Letters Sent	
	Volume (242)	Jan.–Dec. 1868
	Register of Letters Received and Endorsements Sent and Received	
	Volume (241)	Jan.–Nov. 1868
	Letters Received	Dec. 1867–Nov. 1868
	Register of Complaints	
	Volume (243)	1868
	<b>Dalton (Agent)</b>	
	Letters Sent	
	Volume 1 (246)	June–Dec. 1867
	Volume 2 (247)	Jan.–Nov. 1868
	Registers of Letters Received and Endorsements Sent and Received	
	Volume 1 (244)	June 1867–Jan. 1868
	Volume 2 (245)	Jan–Oct. 1868
	Letters Received	July 1867–Oct. 1868



NATIONAL ARCHIVES AND RECORDS ADMINISTRATION  
MICROFILM PUBLICATIONS

ROLL	DESCRIPTION	DATES
60 (cont.)	Registers of Complaints Volume 1 (248) Volume 2 (249)	June 1867-Jan. 1868 Jan.-Oct. 1868
61	<b>Darien (Agent)</b> Letters Received and Contracts	1866-68
	<b>Darien (Dispensary)</b> Letters Sent and Received by the Assistant Surgeon Volume (255)	Mar.-Sept. 1867
	Weekly Reports of Numbers of Patients at Dispensary Volume (256)	Mar. 1867-Sept. 1868
	Register of Patients. Volume (254)	Apr. 1867-Sept. 1868
	"Prescription Book" Volume (253)	Apr. 1867-July 1868
	<b>Dawson (Agent)</b> Letters Sent Volume 1 (367) Volume 2 (251)	July 1867-Oct. 1868 Sept. 1868-Dec. 1868
	Endorsements Sent and Received Volume (252)	Sept.-Dec. 1868
	Registers of Letters Received Volume 1 (366)	July 1867-Mar. 1868 and June-Aug. 1868
	Volume 2 (250)	Sept.-Dec. 1868
	Letters Received	Mar. 1867-Dec. 1868
62	Register of Complaints Volume (368)	Dec. 1867-Aug. 1868
	Papers Regarding Complaints	1867-68
63	<b>Dorchester (Agent, see Hinesville)</b>	
	<b>Eatonton (Agent, see Milledgeville)</b>	
	<b>Elijay (Agent)</b> Letters Received	Sept.-Nov. 1867
	<b>Forsyth (Agent, see Dawson)</b>	

NATIONAL ARCHIVES AND RECORDS ADMINISTRATION  
MICROFILM PUBLICATIONS

ROLL	DESCRIPTION	DATES
63	<b>Fort Gaines (Agent)</b>	
(cont.)	Name Index	
	Volume (260)	
	Letters Sent	
	Volume 1 (258)	June 1867–Mar. 1868
	Volume 2 (259)	Jan.–June 1868
	Registers of Letters Received	
	Volume 1 (192)	
	A–W	July 1867–Feb. 1868
	Volume 2 (257)	Jan.–June 1868
	Letters Received and Miscellaneous Papers Relating to Complaints	1867–68
	Register of Complaints	
	Volume (193)	June 1867–May 1868
	Register of Cases Tried in Freedmen's Court	
	Volume (260½)	July 1867–Apr. 1868
64	<b>Fort Valley (Agent)</b>	
	<b>Greensboro (Agent)</b>	
	Letters Received and Contracts	Mar. 1866 and May 1867
	<b>Greensboro (See Crawfordsville)</b>	
	<b>Griffin (Subassistant Commissioner)</b>	
	Letters Sent	
	Volume 1 (267)	July 1866–Feb. 1867
	Volume 2 (268)	July 1867–Nov. 1868
	Registers of Letters Received	
	Volume 1 (269)	July 1866–Feb. 1867
	Volume 2 (266)	Aug. 1867–Nov. 1868
	Letters Received	
	Volume (265)	June 1866–Feb. 1867
	Letters Received	Aug. 1867–Nov. 1868
	Unregistered Letters Received	Feb. 1867–July 1868
	Contracts, Settlements between Freedmen and Employers, Affidavits, and Monthly Reports Sent to the Assistant Commissioner 1865–68	
	Register of Complaints	
	Volume (270)	Feb. 1866–Nov. 1868
	Register of Contracts	
	Volume (271)	Nov. 1865–July 1868

NATIONAL ARCHIVES AND RECORDS ADMINISTRATION  
MICROFILM PUBLICATIONS

ROLL	DESCRIPTION	DATES
64	Accounts	
(cont.)	Volume (272)	Jan.-Nov. 1868
	<b>Griffin (Agent)</b>	
	Letters Received	Jan. 1866-Apr. 1867
65	<b>Halcyondale (Agent)</b>	
	Letters Sent	
	Volume (274)	July 1867-Dec. 1868
	Register of Letters Received and Endorsements Sent and Received	
	Volume (273)	July 1867-Dec. 1868
	Letters Received	July 1867-Dec. 1868
	Unregistered Letters Received	June-Dec. 1867
	Register of Complaints	
	Volume (275)	July-Nov. 1867 and June-Aug. 1868
	Miscellaneous Papers Regarding Complaints	1867-68
	<b>Hawkinsville (Agent)</b>	
	Letters Sent	
	Volume (277)	Mar.-Sept. 1868
	Register of Letters Received	
	Volume (276)	Mar.-Aug. 1868
	Letters Received	Feb.-Aug. 1868
	Unregistered Letters Received	Apr. 1867-Sept. 1868
	Contracts and Reports	1867-68
	Register of Complaints	
	Volume (278)	Mar.-July 1868
	<b>Hinesville (Agent)</b>	
	Letters Received	Jan. 1867-Nov. 1868
	Contracts and Reports	1867-68
	<b>Irvinton (Agent)</b>	
	Letters Received	Aug.-Dec. 1868
	<b>Isabella (Agent)</b>	
	Letters Received	Apr.-Aug. 1867
	Returns of Stores and Reports of Persons and Articles Hired.	1867
	<b>Jackson (Agent)</b>	
	Letters Received	Sept. 1865-Apr. 1867

NATIONAL ARCHIVES AND RECORDS ADMINISTRATION  
MICROFILM PUBLICATIONS

ROLL	DESCRIPTION	DATES
66	<b>Jonesboro (Agent)</b>	
	Letters Sent	
	Volume (280)	June 1867–Nov. 1868
	Register of Letters Received and Endorsements Sent	
	Volume (279)	June 1867–Nov. 1868
	Letters Received	June 1867–Nov. 1868
	Register of Complaints	
	Volume (281)	June 1867–Aug. 1868
	<b>LaFayette (Agent)</b>	
	Letters Sent	
	Volume (284)	June 1867–Mar. 1868
	Register of Letters Received and Endorsements Sent	
	Volume (283)	May 1867–Feb. 1868
	Letters Received and Register of Complaints	
	Volume (285)	1867–68
<b>LaGrange (Agent)</b>		
Letters Sent		
Volume (288)	May 1867–June 1868	
Volume (289)	July–Dec. 1868	
Registers of Letters Received and Endorsements Sent and Received		
Volume (286)	May 1867–June 1868	
Volume (287)	Apr.–Dec. 1868	
Letters Received	May 1867–Dec. 1868	
Unregistered Letters Received	Sept. 1866–May 1868	
Monthly School Reports and Receipts for Notes in Trust for Freedmen	1868	
Register of Complaints		
Volume (290)	June 1867–Nov. 1868 and May–July 1867	
<b>Lexington (Agent)</b>		
Letters Sent		
Volume (282)	Aug. 1867–Sept. 1868	
Letters Received	Oct. 1867–Oct. 1868	
Reports, Contracts, and Miscellaneous Records Relating to Complaints	1867–68	

NATIONAL ARCHIVES AND RECORDS ADMINISTRATION  
MICROFILM PUBLICATIONS

ROLL	DESCRIPTION	DATES
67	<b>Macon (Subassistant Commissioner)</b> Letters Sent Volume 1 (296) Volume 2 (297) Registers of Letters Received and Endorsements Sent Volume 1 (291)  Volume 2 (292) Volume 3 (293) Volume 4 (294) Letters Received Entered in Volume 1 (291) 1-133	Dec. 1865-Mar. 1867 Jan. 1867-Dec. 1868  Dec. 1865-Mar. 1867 and Apr.-Oct. 1866 Jan.-Oct. 1867 Nov. 1867-Aug. 1868 Aug.-Dec. 1868  Apr.-Oct. 1866
68	Entered in Volume 2 (292) A-W Entered in Volume 3 (293) A-W Entered in Volume 4 (294)	Jan.-Dec. 1867  Oct. 1867-Aug. 1868 Aug.-Dec. 1868
69	Unregistered Letters Received Registers of Complaints Volume 1 (299) Volume 2 (300) Orders Received, Reports Sent to the Assistant Commissioner, Contracts, and Miscellaneous Court Papers	Dec. 1865-Oct. 1868  Jan.-Apr. 1866, Feb.-May 1866 Mar. 1867-Dec. 1868  1865-68
70	<b>Macon (Asst. Superintendent of Educ.)</b> Press Copies of Letters Sent Volume (298) Register of Letters Received and Endorsements Sent Volume (295) Letters Received  <b>Macon (Freedmen's Hospital)</b> Letters Sent and Letters and Orders Received Volume 1 (301)  Volume 2 (302)	Feb.-May 1869  Jan.-May 1869 Jan.-Mar. 1869  Oct. 1865-Jan. 1866, 1867-68, and Nov. 1865 Feb.-Sept. 1868, Sept. and Dec. 1866, and Feb. 1867

NATIONAL ARCHIVES AND RECORDS ADMINISTRATION  
MICROFILM PUBLICATIONS

ROLL	DESCRIPTION	DATES
70	<b>Registers of Patients Treated</b>	
(cont.)	at Hospital	
	Volume 1 (303)	Nov. 1865–Nov. 1867
	Volume 2 (308)	Nov. 1865–June 1868
	Register of Patients	
	Volume (310)	1866–68
	Monthly and Weekly Reports of Sick and Wounded and Monthly Reports of Attendants	1865–68
	Weekly Reports of Sick and Wounded	
	Volume 1 (304)	May 1866–Oct. 1867
	Volume 2 (307)	June–Dec. 1868
	Register of Medications Administered to Patients	
	Volume (309)	1866–67
	Trimonthly Ration Returns	
	Volume (305)	June–Oct. 1867
	Monthly Statements of Hospital Funds	
	Volume (306)	June–Nov. 1868
	<b>McDonough (Agent)</b>	
	Letters Sent	
	Volume (315)	Oct. 1867–Aug. 1868
	Register of Letters Received and Endorsements Sent and Received	
	Volume (314)	Jan. 1867–Sept. 1868
	Letters Received	Jan. 1867–Sept. 1868
	Register of Complaints	
	Volume (316)	Oct. 1867–Aug. 1868
	Miscellaneous Records Relating to Complaints and Contracts	1865–66
71	<b>Marietta (Subassistant Commissioner)</b>	
	Letters Sent	
	Volume (312)	Dec. 1866–Dec. 1867
	Register of Letters Received and Endorsements Sent and Received	
	Volume (311)	Dec. 1866–Jan. 1868
	Letters Received	May 1866–Jan. 1868
	Contracts and Records Relating to Complaints	1865–67
	Register of Complaints and Orders Sent to Local Citizens	
	Volume (313)	Jan.–Dec. 1867

NATIONAL ARCHIVES AND RECORDS ADMINISTRATION  
MICROFILM PUBLICATIONS

ROLL	DESCRIPTION	DATES
71	<b>Marietta (Agent, see Cumming)</b>	
(cont.)	<b>Marion (Agent)</b>	
	Letters Received	Jan. 1866–Aug. 1868
	Contracts and Miscellaneous Records Relating to Complaints	1867–68
	<b>Milledgeville (Agent)</b>	
	Letters Sent	
	Volume (318)	June 1867–Dec. 1868
	Register of Letters Received and Endorsements Sent and Received	
	Volume (317)	June 1867–Nov. 1868
	Letters Received	Feb.–June 1868
	Unregistered Letters Received	Dec. 1865–Nov. 1868
72	Reports, Contracts, and Affidavits	May 1866–Nov. 1868
	Register of Complaints and Orders Sent to Local Citizens	
	Volume (319)	June 1867–Aug. 1868
	<b>Monroe (Agent)</b>	
	Letters Received	Jan. 1866–Apr. 1867
	<b>Newman (Agent)</b>	
	Letters Sent	
	Volume (328)	May 1867–Sept. 1868
	Register of Letters Received and Endorsements Sent and Received	
	Volume (327)	May 1867–Aug. 1868
	Letters Received	Jan. 1867–Aug. 1868
	Register of Complaints	
	Volume (329)	May 1867–July 1868
73	<b>Newton (Agent)</b>	
	Letters Sent	
	Volume 1 (322)	May 1867–Jan. 1868
	Volume 2 (323)	Jan. 1868–Aug. 1868
	Registers of Letters Received	
	Volume 1 (320)	Apr.–Dec. 1867
	Volume 2 (321)	Dec. 1867–July 1868
	Letters Received	
	Entered in Volume 1 (320)	
	A–W	May–Dec. 1867

NATIONAL ARCHIVES AND RECORDS ADMINISTRATION  
MICROFILM PUBLICATIONS

ROLL	DESCRIPTION	DATES
73 (cont.)	Entered in Volume 2 (321) B-W Monthly Reports of Contracts Register of Complaints Volume (324)	Dec. 1867-July 1868 Sept. 1867-July 1868  July-Aug. 1868 and Sept.-Dec. 1868 (Dawson)
	<b>Newton (Dispensary)</b> Letters Sent Volume (325) Register of Letters Received and Endorsements Sent and Received Volume (326) Letters Received Monthly Reports of Sick and Wounded	  Dec. 1867-Sept. 1868  Dec. 1867-Dec. 1868 Nov. 1867-Dec. 1868 Dec. 1867-Nov. 1868
74	<b>Perry (Agent)</b> Letters Sent Volume (332) Register of Letters Received and Endorsements Sent Volume (331) Letters Received Unregistered Letters Received  Reports Labor Contracts and Miscellaneous Court Papers	  Sept. 1867-Dec. 1868  Sept. 1867-Dec. 1868 Sept. 1867-Dec. 1868 May 1867 and Sept. 1867- July 1868 1867-68  1866-68
75	<b>Quitman (Agent)</b> Letters Sent Volume (334) Register of Letters Received and Endorsements Sent and Received Volume (333) Letters Received Monthly Reports of Contracts Register of Complaints and Trials Volume (335)  <b>Riceboro Agent (See Hinesville)</b>  <b>Rome (Agent)</b> Letters Sent Volume 1 (340) Volume 2 (341) Volume 3 (342)	  Apr. 1867-July 1868  Apr. 1867-June 1868 Apr. 1867-Aug. 1868 Apr. 1867-Sept. 1868  Oct. 1867-June 1868     June 1866-Mar. 1867 Mar.-Dec. 1867 Jan.-Dec. 1868



NATIONAL ARCHIVES AND RECORDS ADMINISTRATION  
MICROFILM PUBLICATIONS

ROLL	DESCRIPTION	DATES
75	Registers of Letters and Endorsements	
(cont.)	Received	
	Volume 1 (336)	Feb.-Sept. 1867
	Volume 2 (337)	Sept.-Dec. 1867
76	Registers of Letters and Endorsements	
	Received	
	Volume 3 (338)	Jan.-June 1868
	Volume 4 (339)	June-Dec. 1868
	Letters Received	
	Entered in Volume 1 (336)	
	A-W	Feb. 1867-Dec. 1868
	Entered in Volumes 2 (337), 3 (338),	
	4 (339)	Feb. 1867-Dec. 1868
	Unregistered Letters Received	June 1866-Dec. 1868
	Orders and Letters Sent Relating to	
	Complaints	
	Volume (343)	June 1866-Mar. 1867
	Register of Complaints	
	Volume (344)	June 1866-Nov 1868
	Miscellaneous Records Relating to	
	Complaints	1866
	Register of Contracts	
	Volume (345)	1866-68
77	<b>St. Marys (Agent)</b>	
	Letters Sent	
	Volume 1 (373)	Sept. 1867-July 1868
	Volume 2 (374)	Aug.-Dec. 1868
	Registers of Letters Endorsements Received	
	Volume 1 (371)	June 1867-Oct. 1868
	Volume 2 (372)	Sept.-Dec. 1868
	Registered Letters Received	May 1867-Nov. 1868
	Unregistered Letters Received	May 1867-Dec. 1868
	<b>St. Simons Island (Agent)</b>	
	Land Report and Report of Planters Who	
	Had Sent Their Freedmen Away Unpaid	Aug.-Sept. 1865
	<b>Sandersville (Agent)</b>	
	Letters Sent	
	Volume (364)	May-Nov. 1868
	Register of Letters Received	
	Volume (363)	Apr. 1867-Nov. 1868

NATIONAL ARCHIVES AND RECORDS ADMINISTRATION  
MICROFILM PUBLICATIONS

ROLL	DESCRIPTION	DATES
77	Register of Complaints	
(cont.)	Volume (365)	May 1867–July 1868
	School Report Affidavits	June 1867 and Apr.–May 1868
<b>Savannah (Subassistant Commissioner)</b>		
	Letters Sent	
	Volume 1 (347)	Feb.–Dec. 1866
	Volume 2 (397)	Feb.–Mar. 1869
	Press Copies of Letters Sent	
	Volume (398)	Mar. 1869–July 1872
	Endorsements Sent	
	Volume (349)	Mar. 1866–Jan. 1867
78	Register of Letters Received and Endorsements Sent and Received	
	Volume 1 (394)	Mar.–Dec. 1867
	Volume 2 (395)	1867–68
	Volume 3 (396)	Jan. 1869–Aug. 1872
	Letters Received	
	Entered in Volume 1 (394)	
	A–W	Mar.–Dec. 1867
79	Entered in Volume 2 (395)	
	A–W	1867–68
	Entered in Volume 3 (396)	Jan. 1869–Aug. 1872
80	Unregistered Letters Received	Oct. 1865–July 1869
81	Special Orders and Circulars Issued	
	Volume (399)	Feb.–July 1867
	Orders and Circulars Received	July 1865–Nov. 1867
	Reports Sent to the Assistant Commissioner	Sept. 1865–June 1872
82	Affidavits and Papers Relating to Complaints	June 1865–Apr. 1867
	Labor Contracts	
	Brooks–Emmanuel	1865–68
83	Labor Contracts	
	Johnson–Tattnall	1865–68
84	Registers of Complaints	
	Volume 1 (352)	Feb.–Aug. 1866
	Volume 2 (351)	Aug.–Oct. 1866
	Volume 3 (353)	July 1867–June 1868

NATIONAL ARCHIVES AND RECORDS ADMINISTRATION  
MICROFILM PUBLICATIONS

ROLL	DESCRIPTION	DATES
84	Register of Claimants	
(cont.)	Volume (350)	Dec. 1867–Feb. 1872
	Miscellaneous Records	July 1865–Apr. 1872
85	Records of the Assistant Adjutant General Relating to the Restoration of Property in the Savannah Area	Jan. 1865–Jan. 1867
	<b>Savannah (Agent)</b>	
	Letters Sent	
	Volume (348)	June 1867–Dec. 1868
	Register of Letters Received and Endorsements Sent and Received	
	Volume (346)	Dec. 1866–Apr. 1868
	Letters Received	Sept.–Oct. 1865
	<b>Savannah (Lincoln Hospital)</b>	
	Letters Sent	
	Volume 1 (354)	Dec. 1865–Jan. 1868
	Volume 2 (355)	Feb.–Sept. 1868
86	Letters Received	Nov. 1865–Sept. 1868
	Reports Sent to Bureau Headquarters	Oct. 1865–Sept. 1868
	Registers of Patients 1865–68	
	Volume 1 (359)	1865–68
	Volume 2 (356)	1865–68
	Volume 3 (357)	1865–68
	Volume 4 (361)	1865–68
	“Register of Sick and Wounded at Lincoln Hospital”	
	Volume (362)	Sept. 1865–Apr. 1867
	“Case, Diet, And Prescription Book”	
	Volume (358)	Jan.–Mar. 1867
	Morning Reports	
	Volume (360)	Mar.–Nov. 1865
	<b>Smithville (Agent, see Dawson)</b>	
	<b>Stockton (Subassistant Commissioner)</b>	
	Letters Sent	
	Volume (370)	June–Dec. 1867
	Register of Letters Received and Endorsements Sent and Received	
	Volume (369)	July–Dec. 1867
	Letters Received	May–Aug. 1867

NATIONAL ARCHIVES AND RECORDS ADMINISTRATION  
MICROFILM PUBLICATIONS

ROLL	DESCRIPTION	DATES
87	<b>Thomasville (Subassistant Commissioner)</b>	
	Letters Sent	
	Volume 1 (379)	Nov. 1865–June 1866
	Volume 2 (380)	June–Dec. 1866
	Volume 3 (381)	Feb. 1867–Dec. 1868
	Endorsements Sent and Received	
	Volume 1 (382)	Nov. 1865–Dec. 1866 and Mar. 1867
	Volume 2 (383)	Mar.–Dec. 1868
	Registers of Letters Received and Endorsements Received and Sent	
	Volume 1 (376)	Feb.–Oct. 1867
	Volume 2 (377)	Oct. 1867–Mar. 1868
	Volume 3 (378)	Mar.–Dec. 1868
	Letters Received	
	Volume (375)	Nov. 1865–Dec. 1866
88	Letters Received	Nov. 1865–Dec. 1868
89	Unregistered Letters Received General and Special Orders and Circulars Received	Oct. 1865–Sept. 1868
	Volume (384)	May 1865–Aug. 1868
	Reports and Miscellaneous Papers Relating to Complaints	1865–68
	Register of Complaints	
	Volume (385)	Nov. 1865–Oct. 1866 and Mar. 1867–Oct. 1868
	<b>Warrenton (Agent)</b>	
	Letters Sent	
	Volume (387)	Apr. 1867–Nov. 1868
	Register of Letters Received and Endorsements Sent and Received	
	Volume (386)	June 1867–Nov. 1868
	Letters Received	Apr. 1867–Nov. 1868
	Register of Contracts and Complaints	
	Volume (388)	June 1867–Nov. 1868
	Miscellaneous Records	1866, 1867, and 1868
90	<b>Washington (Agent)</b>	
	Register of Complaints	
	Volume (392)	Dec. 1865–Nov. 1866

NATIONAL ARCHIVES AND RECORDS ADMINISTRATION  
MICROFILM PUBLICATIONS

ROLL	DESCRIPTION	DATES
90	<b>Watkinsville (Agent)</b>	
(cont.)	Letters Received	Dec. 1865–Mar. 1867
	<b>Waynesboro (Agent)</b>	
	Letters Sent	June 1866–Feb. 1867
	Letters Sent	
	Volume (390)	Mar.–Oct. 1868
	Register of Letters Received and	
	Endorsements Received and Sent	
	Volume (389)	Mar.–Aug. 1868
	Letters Received	Dec. 1865–Feb. 1867 and
		Jan.–Nov. 1868
	Register of Complaints	
	Volume (391)	June–Nov. 1868
	Miscellaneous Papers	Jan. 1867–May 1868
	<b>Woodville (Agent)</b>	
	Letters Received	Sept. 1867–Aug. 1868
	Reports of Persons and Articles Hired,	
	Contracts, and Papers Relating to Complaints	1867–68
	Unidentified Name Index	
	1 Volume	

NATIONAL ARCHIVES AND RECORDS ADMINISTRATION  
MICROFILM PUBLICATIONS

APPENDIX

This list provides the names and dates of service of known Freedmen's Bureau personnel at selected subordinate field offices in Georgia. Additional information regarding persons assigned to various field offices might be found among the Bureau's Washington headquarters station books and rosters of military officers and civilians on duty in the states and other appointment-related records.

LOCATION	DATES
<b>Albany</b>	
SUBASSISTANT COMMISSIONER	
F.A.H. Gaebel (Headquarters at Cuthbert)	Feb. 1866–Oct. 1867
O. H. Howard (Headquarters at Albany)	Oct. 1867–Dec. 1868
AGENT	
O. H. Howard	Mar.–Oct. 1867
C. C. Hicks	Oct. 1867–Jan. 1868
William Pierce	Dec. 1867
Charles Rauschenberg	Jan.–Nov. 1868
<b>Americus</b>	
ASSIST. SUBASSISTANT COMMISSIONER	
George Wagner	July 1866–Mar. 1867
AGENT	
J. W. Robinson	Apr. 1867–Apr. 1868
A. C. Morrill	Apr.–Nov. 1868
<b>Athens</b>	
SUBASSISTANT COMMISSIONER	
John J. Know	Feb. 1867–Dec. 1868
AGENT	
H. C. Flourney	May 1867–Nov. 1868
<b>Atlanta</b>	
SUBASSISTANT COMMISSIONER	
George Curkendall	Oct.–Dec. 1865
D. C. Poole	Jan.–Feb. 1866
George R. Walbridge	Feb.–June 1866
John Leonard	June 1866–May 1867
Fred Mosebach	May 1867–Dec. 1868

NATIONAL ARCHIVES AND RECORDS ADMINISTRATION  
MICROFILM PUBLICATIONS

**Augusta**

SUBASSISTANT COMMISSIONER

J.F.H. Cooke	July-Aug. 1865
J. E. Bryand	Aug.-Nov. 1865
George R. Campbell	Nov. 1865-Apr. 1866
William shields	Apr.-Sept. 1866
W. L. White	Sept. 1866-Feb. 1867
William F. Martins	Feb.-July 1867
E. S. Ehlers	July 1867-Jan. 1868
H. Catley	Jan.-Dec. 1868

ASSIST. SUPERINTENDENT OF EDUCATION

E. B. Bingham	Jan.-May 1869
---------------	---------------

**Bainbridge**

AGENT

W. L. Clark	June 1867-Dec. 1868
-------------	---------------------

ASSIST. SUPERINTENDENT OF EDUCATION

W. L. Clark	Jan.-May 1869
-------------	---------------

**Bairdstown**

AGENT

Joseph McWhorter	July 1866-Sept. 1868
------------------	----------------------

**Barton**

AGENT

William Moffitt	Oct. 1867-Aug. 1868
-----------------	---------------------

**Blakely**

AGENT

William Genth	June-Nov. 1867
---------------	----------------

**Brunswick (Subdistrict)**

SUBASSISTANT COMMISSIONER

George Crabtree	July 1866-Mar. 1867
E. Ehlers	Mar.-May 1867
Douglas Risley	May 1867-Dec. 1868

ASSIST. SUPERINTENDENT OF EDUCATION

Douglas Risley	Jan.-May 1869
----------------	---------------

AGENT

S. North	May 1867-Dec. 1868
----------	--------------------

NATIONAL ARCHIVES AND RECORDS ADMINISTRATION  
MICROFILM PUBLICATIONS

<b>Butler</b> AGENT A. Pokorny	May-Oct. 1868
<b>Campbellton</b> AGENT E. S. Jackson	Feb. 1866-May 1867
<b>Carnesville</b> AGENT C. W. Beal K. Tyner J. W. Barney	May-June 1867 June-Sept. 1867 Sept. 1867-Aug. 1868
<b>Carrollton</b> AGENT Edward Belcher (also at Dawson)	July 1867
<b>Cartersville</b> AGENT C. B. Blacher	Apr. 1867-Dec. 1868
<b>Clarksville</b> AGENT T. J. Herbert	June-Nov. 1867
<b>Columbus</b> SUBASSISTANT COMMISSIONER Fred Mosebach George Wagner John Leonard Harry Haskell	Apr. 1866-Apr. 1867 May-Dec. 1867 Jan.-Dec. 1868 Dec. 1868
AGENT C. W. Chapman	May 1867-Dec. 1868
ASSIST. SUPERINTENDENT OF EDUCATION. Harry L. Haskell	Jan.-Mar. 1869
<b>Crawfordsville</b> AGENT William B. Moore John H. Sullivan (also at Greensboro)	Apr. 1867-Apr. 1868 May-Nov. 1868



NATIONAL ARCHIVES AND RECORDS ADMINISTRATION  
MICROFILM PUBLICATIONS

**Cumming**

AGENT

W. J. Bryan  
(also at Marietta)

Apr. 1867-Jan. 1868  
Jan.-Dec. 1868

**Cuthbert**

SUBASSISTANT COMMISSIONER

F.A.H. Gaebel

Feb. 1866-Oct. 1867

AGENT

Charles Rauschenberg  
C. C. Hicks  
James A. Shiels  
George Ballou

June 1867-Jan. 1868  
Jan.-Mar. 1868  
Mar.-May 1868  
May-Dec. 1868

**Dahlonga**

AGENT

M. P. Archer

July 1866-Jan. 1867

**Dalton**

AGENT

Ralph L. Finney  
P. I. O'Rourke

June 1867-Apr. 1868  
Apr.-Nov. 1868

**Darien**

AGENT

Thomas Pease

June 1866-Apr. 1867

**Dawson**

AGENT

Charles Rauschenbert  
Edward Belcher (also at Carrollton)  
Edward Belcher (also at Forsyth)  
William Pierce (also at Albany)  
William Pierce (also at Smithville)  
Andrew Clark

Mar.-Apr. 1867  
July 1867  
Aug.-Sept. 1867  
Dec. 1867  
Dec. 1867-Aug. 1868  
Sept.-Oct. 1868

**Dorchester**

AGENT

A. M. McIver

Jan. 1867

**Eatonton**

AGENT

J. D. Rogers (also at Milledgeville)

June-Dec. 1867

NATIONAL ARCHIVES AND RECORDS ADMINISTRATION  
MICROFILM PUBLICATIONS

**Elijay**

AGENT

M. R. Archer

Sept.-Nov. 1867

**Forsyth**

AGENT

Edward Belcher (also at Dawson)

Aug.-Sept. 1867

**Fort Gaines**

AGENT

William Genth (also at Blakely)

June-Nov. 1867

William Genth

Nov. 1867-June 1868

**Fort Valley**

AGENT

Daniel Losey

Sept. 1867-Jan. 1868 and  
Oct.-Dec. 1868

**Greensboro**

AGENT

John H. Sullivan (also at Crawfordsville)

May-Nov. 1868

**Griffin**

SUBASSISTANT COMMISSIONER

E. Ehlers

July 1866-Feb. 1867

John Leonard

July 1867-Jan. 1868

George Wagner

Jan.-Nov. 1868

AGENT

J. Clarke Swayze

Jan.-Sept. 1866

James J. Boynton

Sept. 1866-Mar. 1867

**Halcyondale**

AGENT

Lewis Wheelock

July-Dec. 1867

Chas Sawyer

Mar.-Apr. 1868

A. Leers

June-Dec. 1868

**Hawkinsville**

AGENT

E. A. Polloch

Apr. 1867-Feb. 1868

L. Lieberman

Mar.-Sept. 1868

NATIONAL ARCHIVES AND RECORDS ADMINISTRATION  
MICROFILM PUBLICATIONS

**Hinesville**

AGENT

A. M. McIver (also at Dorchester)	Jan. 1867
A. M. McIver (also at Riceboro)	Feb.-Apr. 1867
Charles Holcombe	May 1867-Nov. 1868

**Irvinton**

AGENT

H. de P. Young	Aug.-Dec. 1868
----------------	----------------

**Isabella**

AGENT

William C. Carson	Apr.-Aug. 1867
-------------------	----------------

**Jackson**

AGENT

Wiley Goodman	1865-67
---------------	---------

**Jonesboro**

AGENT

I. G. A. Waldrop	June 1867-Nov. 1868
------------------	---------------------

**LaFayette**

AGENT

D. J. Curtis	May 1867-Mar. 1868
--------------	--------------------

**LaGarange**

AGENT

B. C. Ferrell	Oct. 1866-Apr. 1867
W. E. Wiggins	May 1867-Jan. 1868
Israel Towns	Jan.-Apr. 1868
Harry Haskell	Apr.-Dec. 1868

**Lexington**

AGENT

T. J. Robinson	Aug. 1867-Jan. 1868
Joseph McWhortor	Nov. 1867-Oct. 1868

**Macon**

SUBASSISTANT COMMISSIONER

Louis Lambert	Dec. 1865-Jan. 1866
E. G. Locke	Jan.-Apr. 1866
N. Sellers Hill	Apr. 1866-Dec. 1868

ASSIST. SUPERINTENDENT OF EDUCATION

John A. Rockwell	Jan.-May 1869
------------------	---------------

NATIONAL ARCHIVES AND RECORDS ADMINISTRATION  
MICROFILM PUBLICATIONS

**McDonough**

AGENT

George M. Nolan

Jan. 1867–Aug. 1868

**Marietta**

SUBASSISTANT COMMISSIONER

O. B. Gray

Dec. 1866–Jan. 1868

AGENT

W. J. Bryan (also at Cumming)

Jan.–Dec. 1868

**Marion**

AGENT

H. M. Layless

H. de Young

Jan. 1866–July 1868

Aug. 1868

**Milledgeville**

AGENT

Thomas White

J. D. Rogers (also at Eatonton)

M. R. Bell

Dec. 1865–May 1867

June–Dec. 1867

Jan.–Dec. 1868

**Monroe**

AGENT

John W. Arnold

Jan. 1866–Apr. 1867

**Newman**

AGENT

William F. Martin

Jan. 1867–Sept. 1868

**Newton**

AGENT

Andrew B. Clark

Apr. 1867–Aug. 1868

**Perry**

AGENT

Daniel Losey (also at Fort Valley)

Daniel Losey

Daniel Losey (Fort Valley)

Sept. 1867–Jan. 1868

Jan.–Sept. 1868

Oct.–Dec. 1868

**Quitman**

AGENT

Alvin B. Clark

O. N. Lyon

Apr. 1867–June 1868

June–July 1868

NATIONAL ARCHIVES AND RECORDS ADMINISTRATION  
MICROFILM PUBLICATIONS

<b>Riceboro</b> AGENT A. M. McIver	Feb.-Apr. 1867
<b>St. Marys</b> AGENT William Royal	Aug. 1867-Dec. 1868
<b>St. Simons Island</b> AGENT William F. Eaton	1865
<b>Sandersville</b> AGENT Thomas Harris James R. Smith	1867 May-Nov. 1868
<b>Savannah</b> SUBASSISTANT COMMISSIONER Col. H. F. Sickles J. Hall George Crabtree J. Kearny Smith F. J. Foster J. Murray Hoag J. Murray Hoag (Claims Agent) J. W. Brinkerhoff (Claims Agent)	Oct. 1865-Feb. 1866 Feb.-Mar. 1866 Mar.-June 1866 June-Oct. 1866 Oct.-Dec. 1866 Feb. 1867-Dec. 1868 Jan. 1869-Oct. 1870 Oct. 1870-July 1872
<b>Smithville</b> AGENT William Pierce	Dec. 1867-Aug. 1868
<b>Stockton</b> SUBASSISTANT COMMISSIONER AND AGENT H. F. Mills H. F. Mills (Agent)	June-Aug. 1867 Aug.-Dec. 1867
<b>Thomasville</b> SUBASSISTANT COMMISSIONER Capt. C. C. Richardson Capt. Joseph O'Neil Capt. W. F. White	Nov. 1865-Mar. 1866 Apr.-Dec. 1866 Feb. 1867-Dec. 1868

NATIONAL ARCHIVES AND RECORDS ADMINISTRATION  
MICROFILM PUBLICATIONS

**Warrenton**

AGENT

**Thomas Holden**

R. C. Authery

Apr. 1867–June 1868

July–Nov. 1868

**Watkinsville**

AGENT

Calvin Johnson

Dec. 1865–Mar. 1867

**Waynesboro**

AGENT

A. A. Buck

William Martins

Max Marbach

Dec. 1865–May 1866

June 1866–Dec. 1867

Jan.–Dec. 1868

**Woodville**

AGENT

D. A. Newson

Sept. 1867–Aug. 1868

NATIONAL ARCHIVES AND RECORDS ADMINISTRATION  
MICROFILM PUBLICATIONS

Microfilm Publication M1903

RECORDS OF THE FIELD OFFICES FOR THE STATE OF GEORGIA,  
BUREAU OF REFUGEES, FREEDMEN, AND ABANDONED LANDS,  
1865-1872

**ROLL 40**

**SUBORDINATE FIELD OFFICES**

**Americus (Agent)**

Letters Received	May 1867-Nov 1868
Registers of Contracts	
Volume 1 (138)	Jan.-Mar. 1866 and June 1866
Volume 2 (137)	Jan. 1867-June 1868
Register of Complaints	
Volume (139)	Aug. 1867-Nov. 1868
Miscellaneous Records	1865-68

**Americus (Dispensary)**

Letters Sent	
Volume (140)	Aug.-Nov. 1868
Letters Received	Aug.-Dec. 1868
Monthly Reports of Sick and Wounded	Aug.-Nov. 1868
Register of Patients	
Volume (141)	Aug.-Nov. 1868

NATIONAL ARCHIVES AND RECORDS ADMINISTRATION  
MICROFILM PUBLICATIONS

Roll 40

Target 1

**Americus (Agent)**  
Letters Received

May 1867–Nov 1868



George, American  
Sub. Assistant Commissioner  
Letters Received  
May 1867 - May 1868  
3in.

1-110

Office of the Provost Marshal  
Washington D.C. April 17th 1864

Clark A.P. Agent

Calls attention to enclosed  
Statements of Gen. John Robinson  
& requests that steps be taken  
to return his children to him  
and bring the guilty parties to  
justice and states that the  
case has not been referred to  
and that Robinson has permission  
to refer to Armstrong & Bird  
Attorneys at Vienna, Va. Co.

April 1864

Recd 1864  
April 17th

Bureau R. I. & A. Lucas  
M. J. Sub. Dist. Tennessee  
Tennessee Nov. 2nd 1864

Respectfully forwarded to  
Col. C. C. Sibley Asst  
Commissioner

W. S. White  
Capt + Sub. Asst Com

Office A. Com, Regt R. I. & A.  
Macon, Ga., May 17th 1864

Respectfully referred to J. D.  
Davis, Agent Perry, Houston  
Co. Ga. The right Capt. W. S. White  
Tennessee, Ga. who will  
proceed at once to Dooley Co.  
& thoroughly investigate this  
matter - if it is found that the  
children are unlawfully held  
by Broxton & Henry, you will  
return them to their Father -  
all expense of transportation  
to be borne by Broxton & Henry -  
You will decide as to whether  
the children ought to be paid  
for services rendered by them  
while living with these men  
You will go into this

Fredman, Robinson, before  
the Civil Authorities & have  
him make affidavit of  
the facts connected with  
his imprisonment with a  
view of bringing these men  
to justice.

By Order  
Col. C. C. Sibley  
E. M. Cuyler Secy

Bureau R. I. & A. Lucas  
M. J. Sub. Dist. Tennessee  
Tennessee Nov. 2nd 1864

Respectfully referred to  
U. S. Marshal

W. S. White  
Capt + Sub. Asst Com

Bureau of Land & Light  
Supt. Office Surtman Wash DC 1864

Col

I have the honor to call your attention to the enclosed  
Statement of Jeremiah Robinson, freeman, and  
respectfully request that the necessary steps be  
taken to return his children to him and bring the  
guilty parties in the affair to justice, as it  
occurred last Dec you will see that the case  
has not been attended to as it should have been,  
<sup>in the Dept of Justice</sup>  
The man Robinson has permission to refer you  
to Armstrong & Bond, Attys, in Vienna Va City Co Va,  
who are acquainted with the case, asking your  
immediate attention.

Dear Col

Your obt. Servant

Alon B. Clark

Agent B.R.F. & H.

for Brooks, Lindsey & Bennett Co,

W. C. S. City  
S. D. C.

Office of Benjamin B. F. Esq.  
Fork Valley, Va. Oct 23. 1797

Respectfully returned to Mr. J. G.  
R. Lewis, a. a. Comr this paper  
J. S. Skill, with the information  
that I called on the Judge  
Armstrong & kind all the law  
with James Dooly, Comr of this  
with reference to the within  
named case. And C. C. Armstrong  
informed me that the children  
were properly and that the  
Freedom Robinson were  
and attempted to carry off  
said children; that Henry  
of Boy, he ordered him to leave  
and in refusing they arrested  
him and put him in jail  
through the advice of some of  
his friends. Friends Col Armstrong  
has since released from jail  
the name of James Robinson  
no words of an injury  
in the world and there being no  
said a plea as to a action  
shown in the law. He said  
he told Robinson he had  
no business a home in  
Dooly County, and then bring  
charges against said

to recover damages for false  
imprisonment, and that he  
was being covered under the  
his case for him. That he  
said Armstrong procured a  
situation for said Robinson  
in Court, but he only  
remained in it a short time  
before he left it and returned to  
Patrick County. I made enquiry  
of the Clerk regarding the  
Substantive of James that the  
armstrong's statement was  
correct. He also informed me  
that one of the children had  
been collected away since that  
time supposed to be by or  
through the influence of  
Robinson.

Yours truly  
Benjamin B. F. Esq.

Received of  
Benjamin B. F. Esq.  
the sum of \$100.00  
Oct 23. 1797

Handwritten text, possibly a name or address, including a circled initial 'C'.

---

May  
1867

---

Bureau of Refugees, Freedmen, & Abandoned Lands,  
OFFICE CHIEF QUARTERMASTER, STATE OF GEORGIA.

Waco, Ga. May 11th 1867.

Sir,  
Enclosed please find check for \$30. which  
I have charged to your account for May, 1867

Very Respectfully

your Obedt. Servant

C. J. Harrison

St. Maj. Hehuf g. no.

J. M. Robinson  
Agent Bureau A. F. & A. S.  
Americus, Ga.

13

Bureau of Refugees, Freedmen, & Abandoned Lands.

OFFICE CHIEF QUARTERMASTER, STATE OF GEORGIA.

March, Ga. May 13<sup>th</sup> 1867.

Sir.

Enclosed please find Check to order of Smith  
& Glover, for \$20. in payment of their vouchers for rent.

Very Respectfully

Your Obt. Servant.

C. P. Watson

Bt. Maj. & Chief Q. M.

J. M. Robinson, Esq.  
Agent Bureau R. F. & A. L.  
Americus, Ga.



Sub ass1 Am<sup>r</sup>  
Cuthbert Sr

Reynolds, Clotney

Bureau of Refugees, Freedmen and Abandoned Lands  
OFFICE ACTING SUB-ASSISTANT COMMISSIONER

T M Robinson Esq  
Genl Supt Div of Education Esq

Cathbert, Ga., May 14 1867

Sir

Your letter is received in reference to the  
above. I have to say that no can be issued and  
not I have made an application to the Chief,  
Genl Supt of the Div of Education and  
Children, as you suggested several weeks ago.  
The Application has now sent to Washington 2 months  
ago. The Immorality of Slaves and only  
children on hand, an article not wanted at  
last time of the year, and very unprofitable with  
a view of the future.

C. H. Bennett Esq, Agent Division of  
Education has made application for a Clerk  
and received the permission to have a person  
be. If you see the matter -

I have the honor to be  
Dear Sir

Very respectfully,  
J. A. H. Tubel, Sub-Commissioner

C. P. Malcom

May 19 1877

The Honorable  
John A. B. ...

Does the dean this make me by other  
& will it work well?

Bureau of Refugees, Freedmen, & Abandoned Lands,

OFFICE CHIEF QUARTERMASTER, STATE OF GEORGIA.

Macon, Ga., May 18<sup>th</sup> 1867.

Enclosed find Acquisition for Stationery shipped  
you by "Southern Express" 11<sup>th</sup> May which is pleased  
to sign and return at earliest convenience;

Very Respectfully  
Yours Obedt Servt

C. D. Watson

A Major <sup>and</sup> <sup>in G.</sup> <sup>Adj. Gen.</sup>

Capt J. M. Bennett  
Agent Bureau of A. S. J.  
Americus, Ga.

Office Sub. Asst. Comm. Br. & Gen.  
Cuthbert Ga. May 21. 67.

Respectfully forwarded  
to James M. Robinson Asst.  
Dir. of Ordnance, Americus Ga.  
Your attention is called to the  
circ<sup>copy of</sup>ular order and the Requi-  
sition Blanks sent herewith.  
Make as, mentioned for the required Blanks  
see order No 11 direct to Capt. R.  
W. Malheur, Asst.

1st Lt. Geo. H. -  
Lieut. 45 U. S. Inf.  
Sub. Asst. Comm. Br. & Gen.  
Cuthbert Ga.

17 Bureau of Kings St & A Lds.

Office Ass't Comr. State of Georgia

Macon Ga. May 20<sup>th</sup> 1867.

Sir,

By directions of the Asst. Comr you are requested to forward to this Office per government requisition for supplies under act of Congress approved March 31 1867 for the month of May,

Leicester Co. 2800<sup>lbs</sup> corn 400<sup>lb</sup> Bacon & 100<sup>lb</sup> Salt Castles.

Webster	"	2800 <sup>lbs</sup>	"	400 <sup>lb</sup>	"	} To be signed by J. M. Robinson Asst. American Co.
Dealey	"	2800 <sup>lbs</sup>	"	400 <sup>lb</sup>	"	
Dumpler	"	2800 <sup>lbs</sup>	"	400 <sup>lb</sup>	"	

Respectfully,

Lt. Col. A. C. Gabel

U. S. Army, &c

Leicester Co

For a true copy

Your Obedt Servt

Signed: Geo R Wallbridge.

Capt. U. S. A.

1000 23<sup>th</sup> St. N. C.

Asst. Comr. Proc. R. S. & U. S. A.



Office Subst. Commr  
Bureau of Insp. de.  
Cathbert, Ga. August 11. 67

Respectfully forwarded  
to you by Mr. Robinson  
Esq. for action.

Very truly yours,  
J. M. Smith

11. 45. W. F. S.  
Subst. Commr.



Received  
Sub. Asst. Commr.  
Albany, Ga.

1848

**BUREAU OF REFUGEES, FREEDMEN & ABANDONED LANDS,**

Office Sub. Ass't Commissioner,

Columbus, Ga.,

In obedience to your order of the 11th inst. I have the honor to acknowledge the receipt of your letter of the 10th inst. and in reply to inform you that the same has been forwarded to the proper authorities for their consideration. I am, Sir, very respectfully,  
Yours obedient servant,  
[Signature]



Cultured Gu  
May 29/67

~~J. M. Sibley~~  
c. a. e

Wants to know the number  
of deep drums & blind

MS. 112  
116 513. P. 118.

Office Under Asst. Comm. Pr. & P. 2<sup>d</sup> Div.  
Cullbert Ga. May 2<sup>d</sup> 1867.

James H. Robinson Esq.

Americus Ga.

Sir,

I have your enclosed Circular Letter, dated  
Macon Ga. March 18. 1867, which requires that all the statisti-  
cal information in relation to the number of blind, deaf, dumb,  
imbeciles & insane <sup>maimed</sup> persons <sup>of color</sup> should be furnished.

I am called on to make a report on this subject and desire you  
to give me with as little delay as possible all the information  
on this subject that you can obtain quickly for Sumpter and Lee  
county.

I am, very respectfully,

Your obedt servt.

J. C. Quinn

Post 45 St. S. 1866

Sub. Ass. Comm. Pr. & P. 2<sup>d</sup> Div.

P. S. Give age, sex and condition of each one.

Ms. A. 9. 2. 4

Colo. Sub. to the Hon. Sec. of War  
Washington  
Sept. 30. 1864

Respectfully forwarded to  
J. M. Robinson Esq. Capt  
etc. Union Army

J. M. Swaine  
145th Regt. Inf.  
U. S. Army, Fort Lincoln, Pa.  
P. 13 R. F. & A. Edm.

*[Faint handwritten text]*

Bureau of Refugees, Freedmen and Abandoned Lands,  
OFFICE ASSISTANT COMMISSIONER, STATE OF GEORGIA,

Macon, Ga., *May 29<sup>th</sup>* 1867.

*Sir*

The Assistant Commissioner directs me to inform you that supplies have been ordered to be shipped to you for distribution in the following counties :

*Webster Co 2800 Corn 400 Bacon*  
*Schley " 2800 " 400 "*  
*Sumter " 2800 " 400 "*

You will ~~make out and forward to this office, through~~ *St. F. W. H. Guelch, S. M. C.*  
~~Cust. Gen.~~ special requisition, (form No. 3,) for approval, to cover the above amount. The necessary blanks needed in distributing and accounting for these supplies, can be obtained by application to *St. F. W. H. Guelch, S. M. C.*

All expenses incurred in transporting, storing and distributing will be paid by the Chief Quartermaster, upon proper vouchers being forwarded.

You will fill up and sign the enclosed receipts, upon receiving the amount consigned to you, and return two (2) of them to this office.

Very respectfully, your obedient servant,

*J. M. Robinson Esqr*  
*Agent FC*  
*Americus Ga*

*Geo. R. Walbridge*  
Capt. & Acting Commissary Snb., State of Georgia.

*Thos. S. A. Combs, FC*  
*Cuthbert Ga*

*Faint handwritten text, possibly a name or address.*

June  
1867



Bureau of Refugees, Freedmen and Abandoned Lands,  
OFFICE OF THE ASSISTANT COMMISSIONER

Macon, Ga., June 1st. 1867

Captain

Enclosed please find my Check on Merchants  
National Bank of Savannah, for \$50.00, in payment of  
your vouchers for Services, and of Smith & Brown for rent.  
\$25.00 advanced.

Very Respectfully

your Obedt. Servant

E. J. Watson

St. Major Army of Col.

Capt. J. M. Robinson,

Agent Bureau R. F. & A. S.

Americus, Ga.

City of Macon Ga June 7<sup>th</sup> 1867.  
Moore, C. C.  
Transmits bills of Lading

No 1

*E. Moore*

No. 26. U. S. U. C. Vol. 2. by 187

U. S. Asst. Comm. Gen. R. W. Lds.  
Cuthbert, Ga. June 13. 1879

Respectfully forwarded  
to E. M. Robinson Esq. U. S.  
Asst. Comm. Gen.

E. M. Robinson, Esq.  
1879

Box 45 U. S. Post

U. S. Asst. Comm. Gen. R.  
L. W. Lds.

E. M. Robinson

U. S. Asst. Comm. Gen.

Bureau of Refugees, Freedmen and Abandoned Lands,  
OFFICE ASSISTANT COMMISSIONER, STATE OF GEORGIA,

Macon, Ga., *June 14<sup>th</sup>* 1867.

*Sir*

The Assistant Commissioner directs me to inform you that supplies have been ordered to be shipped to you for distribution in the following counties;

<i>Webster County</i>	<i>5600</i>	<i>Corn</i>	<i>800</i>	<i>Bacon</i>	<i>3</i>	<i>Marble</i>
<i>Schley "</i>	<i>5600</i>	<i>"</i>	<i>800</i>	<i>"</i>	<i>3</i>	<i>Ry</i>
<i>Sumter "</i>	<i>5600</i>	<i>"</i>	<i>800</i>	<i>"</i>	<i>3</i>	<i>Americus Ga.</i>

You will make out and forward to this office through *St. F. A. H. Gabel SA*  
*Conn. Cutbert Ga* special requisition, (form No. 3.) for approval, to cover the

above amount. The necessary blanks needed in distributing and accounting for these supplies, can be obtained by application to *St. F. A. H. Gabel SA Comdr*

All expenses incurred in transporting, storing and distributing will be paid by the Chief Quartermaster, upon proper vouchers being forwarded.

You will fill up and sign the enclosed receipts, upon receiving the amount consigned to you, and return two (2) of them to this office.

Very respectfully, your obedient servant,

*Geo. R. Walbridge*

Capt. & Acting Commissary Sub., State of Georgia.

*J. M. Robinson Esqr*

*Agent*

*Americus*

*Wm. S. Allen Esqr*  
*Cuthbert Ga*

3 100

100 2

Capt Robinson  
Auricular

Cum gratia

June 12 1867

Dear Capt

I wrote the day to our friend  
W. Bird and send to him some money  
for his ward who delivers this letter  
to you he was hired to me by Bird  
as the guardian & here he will  
remain his guardian if not he has  
to turn that way over to you -

Please see about the boy that he  
finds B. Bird or that you find a  
place for him till Bird comes <sup>out</sup> -

Tom should not be hired in this  
letter in to the country.

Please inform me also how  
the Lord's Garden Camp goes on  
and write to me if Mr W Bird  
got your my letter with some  
money due to Tom.

Yours faithfully

J. M. Daily

1. H. - - -

No 2

---



Headquarters District of Georgia,

OFFICE ASSISTANT ADJUTANT GENERAL.

Macon, Ga., June 12<sup>th</sup> 1867.

J. M. Robinson

Agent of Bureau R. I. & A. S.

Americus Ga.

Sir

Your telegram of the 11<sup>th</sup> inst. was transmitted to me by Capt. Dittell yesterday. In reply I have the honor to state that instructions have been given to the Co. of officers in charge of your Co. to approach via the route mentioned in your telegram a detachment of troops at Americus Ga. to that place "in your case".

I am very respectfully,

Your obedient servant

J. H. Brown

1<sup>st</sup> Lt. U. S. Army

Adj. A. G. S.

*Faint, illegible handwritten text, possibly a date or name.*

No 3

Office Acting Assistant Quartermaster,

*Warren, Ga.,*

*1867.*

*W. Moore*



L. B. 543.

Office Sub. West. Com. Br. U. S. A. S. S.  
Cullbert, Ga. June 26, 1867.

J. M. Robinson Esq.

Agent,

American Co.

Sir

I send you last Saturday 1867 as per  
Provision Returns for your views and also Blank Return  
I think you should be furnished with. If you have received  
them you will please to get them and return them to  
that we may get answers for your views in time

Very respectfully

Your obedt servt

Wm. H. S. 1867

Sub. West. Com. Br. U. S. A. S. S.  
S. S.

1800  
11 11 1800  
Mason Lane 7 18

Depository, etc.

No. 4

---

Office Acting Assistant Quartermaster,

Macon, Ga.,

June 27<sup>th</sup> 1867.

J. M. Robinson  
Capt. & Co. 1st A. L.  
Hammock

Sir,

In the 7<sup>th</sup> of this month I shipped  
you Rations for the Det<sup>ch</sup> 26<sup>th</sup> W. G. A. Co. on  
duty with you. On the same day I forwarded  
by mail Duplicate <sup>and</sup> I apply Bills of  
Lading for the same. Up to this time you  
have not returned the Duplicate to me as  
directed. I have written you once before on  
this subject and as yet have received no reply.  
If you have the Bill of Lading referred to will  
you forward at once. If you never received  
it will you notify me, at once. This matter  
must be attended to immediately.

Very Respectfully,  
Your Obedient Servant  
W. M. S.

12 + 16<sup>th</sup> Sept 1867. A. U. G. 4th

R. 10. O. S. A. C. Vol 2 of P. 145.

Wm. H. ...  
...

...

...

...

...

...



Office Agent. Bur. & U. S. A. Eds.  
Division of Liberty.

Americus Ga June 2<sup>nd</sup> 1861.

James M. Robinson Esq.

Agent etc

Americus Ga.

Sir

John Gaudy, a free man who is with  
myself employed under a written contract by Messrs Jones  
& Willard Jones of Webster Co. for this year makes com-  
plaint that in consequence of some false statements other  
free men had circulated about him and of some dissatis-  
faction, which had been caused by his not getting back  
soon enough to the house at night to water the horses,  
as he was working 8 miles from the house, he and  
a set of parties had both together collared him, shaken  
him about pretty roughly, cursed him, drawn their knives  
on him & threatened to cut his throat if he opened his  
mouth for his defence.

He thinks he can not go back without a repetition of  
similar or worse occurrences and desires a few lines  
demanding Mr. Jones to let him take away his  
family without <sup>doing</sup> violence to him.

He is living nearly forty miles from Americans and  
did not know that he had to go there to make his  
arrangement. I thought it proper to see him and send  
to you and save him a trip to Americans.

He is a negro of more intelligence and understanding  
than usual and I believe his statements to be true.

Write by return mail if you please whether he shall  
return or not and in the latter case send him the  
lines mentioned on the preceding page, so that he can  
get his family. If you will send Simons your  
card to me I will see to it, that he makes his  
appearance promptly at the appointed time & place.

I have the honor to remain

Very respectfully,

Wm. Rushenbery  
Agent

Done at New York, this 1st day of June 1851.

Wm. Rushenbery

Agent

Moore, G. E.,  
U.S. I.M.

Macon Ga June 30,  
1867

Regarding Bills of  
Lading.

No 5

---

Office Acting Assistant Quartermaster,  
Macon, Ga., June 30<sup>th</sup>, 1867.

J. M. Robinson  
Americus  
Ga.  
Sir

Enclosed please find Duplicate  
Bill of Lading, for Store Shipments to you on  
June 7<sup>th</sup> 1867, as the the Bill forwarded to  
you at the time the Store was shipped but  
not been rec<sup>d</sup> at this office. Please sign  
at once and return to this office.

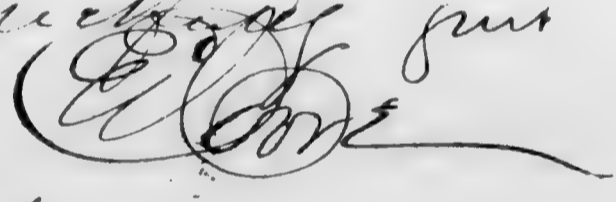
Respectfully yours  
  
1st Lt. 16<sup>th</sup> U.S. Infy,  
A. A. Z. W.

London, 11th Dec. 1894.

Dear Mr. ...  
I have the pleasure to ...  
in the ...

I have the pleasure to ...  
in the ...  
I am, Sir, very ...  
Yours faithfully,  
...

Yours faithfully,  
...

Cher Monsieur le Comte.

Je vous prie de m'excuser

de ne vous avoir

pas écrit plus tôt.

Je suis, Monsieur,

Votre,

très humble serviteur  
Le Comte de Lutzelbourg, Alboing  
Le 15 Mars 1784.  
Je vous prie de m'excuser  
de ne vous avoir pas écrit  
plus tôt. Je suis, Monsieur,  
Votre très humble serviteur  
Le Comte de Lutzelbourg.

Je suis, Monsieur,  
Votre très humble serviteur  
Le Comte de Lutzelbourg.

Je suis, Monsieur,  
Votre très humble serviteur  
Le Comte de Lutzelbourg.

A R Brown No. 12.  
July 2<sup>d</sup> 1854

Friend A. S. S.

Friend Jones

July

1854

Answered Sept 16/7  
Capt. Robinson  
Dear Sir

I have requested one of our  
a certificate in the case of Richard Coley from  
1811 Robert Parker tried by you in Presto Minister to  
as to truthfulness a contradictory of Parkers  
communication ~~is~~ published in the journal  
reputation. I could do so cheaply as Mr. H. &  
I. H. & myself represented the procedure  
& know all the facts connected with the case  
I therefore certify that in the investigation of said  
case that the same was impartially disposed  
by one of the Robinson under the proofs as sub-  
mitted. If either of the parties had the right of  
complaint, it was Richard & not Parker and I  
think he had none because the party was con-  
fessing & think no man would have given more  
available evidence in the case than you did. As  
to the communication of Parkers that is a provision  
of truth from the beginning to the end. It seems  
it unnecessary to point out the many misrep-



... calculations made by ... the ...  
... But will state that the larger part  
thereof is false from the beginning to the end

to or not ...

M. B. ...

Wm. C. C. & M.  
Macor Co. Sub 47/67

Receipt Bill of Lading  
for Signature

No. 6

Office Acting Assistant Quartermaster,  
Macon, Ga., July 4<sup>th</sup> 1867.

Mr. J. M. Robinson  
Americus  
Ga

Sir

Enclosed please Duplicate  
Bill of Lading, returned for your signature,  
sign where the Pinned mark, is and  
return to this office, the one you had  
returned to this office, you had filled a  
up once signed in the wrong place,  
the Blank, at the Top of the Bill, is only  
once you should fill up once sign,

Yours Respectfully  
C. W. E.

18<sup>th</sup> St. 16<sup>th</sup> N. S. Bldg.  
A. A. 2<sup>nd</sup> M.

34.44  
Office, Sub. Dist. Court  
New York City, N.Y.  
October 1, 1891

Respectfully,  
J. H. Robinson, Esq.  
New York City, N.Y.

*J. H. Robinson*  
New York City, N.Y.  
October 1, 1891

Bureau of Refugees, Freedmen and Abandoned Lands,

OFFICE ASSISTANT COMMISSIONER, STATE OF GEORGIA

Macon, Ga., July 5<sup>th</sup> 1867.

*Sir*

The Assistant Commissioner directs me to inform you that supplies have been ordered to be shipped to you for distribution in the following counties:

<i>Wilkes County</i>	<i>4200<sup>l</sup></i>	<i>Com</i>	<i>100<sup>l</sup></i>	<i>Bacon</i>	<i>3</i>	<i>Mar. Vass</i>
<i>Schley</i>	<i>2200<sup>l</sup></i>	<i>Com</i>	<i>100<sup>l</sup></i>	<i>Bacon</i>	<i>1</i>	<i>H.</i>
<i>Sumner</i>	<i>4200<sup>l</sup></i>	<i>Com</i>	<i>100<sup>l</sup></i>	<i>Bacon</i>	<i>3</i>	<i>Ammons</i>

You will make out and forward to this office, through \_\_\_\_\_

\_\_\_\_\_ special requisition, (form No. 3,) for approval, to cover the above amount. The necessary blanks needed in distributing and accounting for these sup-

plies, can be obtained by application to *J. P. A. H. G. H. 500 10*

All expenses incurred in transporting, storing and distributing will be paid by the Chief Quartermaster, upon proper vouchers being forwarded.

You will fill up and sign the enclosed receipts, upon receiving the amount consigned to you, and return two (2) of them to this office.

Very respectfully, your obedient servant,

*Geo. N. Wallbridge*

Capt. & Acting Commissary Sub., State of Georgia.

*J. M. Robinson Com.*

*Agent*

*American Ga.*

*J. P. A. H. G. H. 500 10*

*Com. Sub.*

*Com. Sub.*

B. 20 S. A. C. Vol 2 p. 5143.  
 American Gov, June 25, 1867.

Robinson J. W.  
 Agent do.

States that he has recd information that Sparks Clayton, who shot down a freedman in the streets of this place, is at present in Galveston, Texas. Requests that immediate steps be taken for his arrest and return to this place for trial.

Office of the U.S. Marshal  
 Galveston Tex. June 25, 1867

Copy of your letter of the 23rd inst. is received. The U.S. Marshal at Galveston has been notified of the same and he will endeavor to locate the fugitive and return him to this place for trial. It is requested that you continue to keep me advised of any news relative to the whereabouts of the fugitive.

Very truly,  
 J. H. Smith

Office of the U.S. Marshal  
 Galveston Tex. July 5th 1867.

Respectfully returned to  
 J. H. Smith, U.S. Marshal,  
 Galveston Tex., for an accurate  
 description of the accused  
 parties.

By Order of  
 Col. C. G. Sibley,  
 Eugene T. Sibley,  
 Capt. & Adjt.

Office of the U.S. Marshal  
 Galveston Tex. July 10, 1867

I respectfully returned to  
 J. H. Robinson, Agent do.  
 Galveston Tex., the enclosed  
 copy of the indictment of  
 Capt. E. T. Sibley, et al.  
 Very truly,  
 J. H. Smith

George Brown  
... ..  
... .. 167

George Brown  
George Brown is a young  
man of age 17 or 18 years  
with a fair complexion  
& dark hair with no  
beard; mustache just starting.  
He is about 175 lbs weight  
and writes in his comments  
of progress of speaking.

M. Robinson Aug  
...

Office of Com' General R. F. A. S.  
Atlanta Ga., July 26, 1867.

Respectfully referred to  
Br. Maj. Gen. Chas. Griffin,  
Asst Com' State of Texas,  
Galveston Tex. - with the re-  
quest that the man Clayton  
be arrested and the office  
informed of the same, that  
requisition may be made  
by the Governor of Georgia  
upon the proper authorities  
of Texas, for the purpose  
of bringing the escaped  
criminal to trial in this  
State.

C. C. Silbey

Col. 10th U.S. Inf.

Ex. 205,  
C. 33

West Com'.



Office of the Surgeon R.F. U.S.  
Cavalry

Capt. Eugene Pittell  
U.S. Cavalry

June 26. 1867

Captain,

I have the honor  
to report that I have this morning received  
positive information through S. H. Wilson  
at Marshall that a person (the name  
who committed the assault on the Indian  
in this city to shooting him down in  
public that on Monday) and who succeeded  
in escaping from justice is now in  
Garretts Texas. I would therefore re-  
spectfully request that immediate measures  
be taken to arrest said person (the name)  
and return him to this city for trial.  
The case is a most aggravated one,  
I have also been informed by reliable authority  
that on the day of the shooting, that there  
were 150 armed men posted in buildings  
in the street ready to shoot me and my

press down had no success in making  
the court. The sister and friends of  
this speaker (Clanton) are very defiant  
and insulting, and publicly boast  
that he is beyond the reach of justice,  
and I think it would do them  
a useful lesson, to have him returned  
to this place for trial - or better still  
that he be tried by a Military Commission

I am Capt  
Very Resp<sup>ly</sup> your obed<sup>t</sup> serv<sup>t</sup>  
J. M. Keenan  
Capt

*[Faint, illegible handwriting]*

WARREN 62

LETTER TO MR. ROBINSON, SAVANNAH, GA., JULY 9, 1867.

Dear Sir, July 9 - 1867.

Sir-

Enclosed find my check on Merchants National Bank of Savannah for \$78.46. in payment of your vouchers for Postage and Services less amount advanced you

Very Respectfully  
Your Obedt. Servant

*C. D. Watson*

St. Wof. and A. Q. M.

J. M. Robinson, Esq.  
Agt. Bureau R. F. and A. S.  
Americus, Ga.

Handwritten notes or a signature, possibly including the name "G. ...".

Bureau of Refugees, Freedmen and Abandoned Land.

OFFICE ASSISTANT QUARTERMASTER AND CLERK IN CHARGE. STATE OF GEORGIA.

Marion, Ga. July 12<sup>th</sup> 1867

J.M. Robinson Esq  
Agent Bureau R.F. & A.L.  
Americus Ga

Sir

Enclosed please find Invoices and  
Requisitions for clothing shipped you on 11<sup>th</sup> instant.  
Please sign and return the requisitions at earliest  
possible moment

Very Respectfully  
C.S. Watson

Brigadier Major and A.D.M.

P.S.

This clothing is for issue to destitute Refugees and  
Freedmen on Form #38. (sub voucher) and amounts  
Carried from that, to the voucher (form #33) as ex-  
pended —

Handwritten text on the left margin, possibly a date or page number.

Handwritten text in the upper middle section, possibly a title or main heading.

Main body of handwritten text, consisting of several lines of cursive script.

A single line of handwritten text, possibly a signature or a closing.

Bottom section of the page, containing faint handwritten text or a signature.

Bureau of Refugees, Freedmen and Abandoned Lands,  
OFFICE ASSISTANT QUARTERMASTER AND DISBURSING OFFICER, STATE OF GEORGIA.

Macon, Ga. July 13 - 1867.

Sir -

Enclosed find my check on Merchants National Bank of Savannah for \$38 in payment of your transportation vouchers.

Very Respectfully

Your Obedt. Servant

C. J. Watson

St. Mof. and a. q. m.

J. M. Robinson, Esq.

Agent Bureau R. F. and A. L.

Americus, Ga.



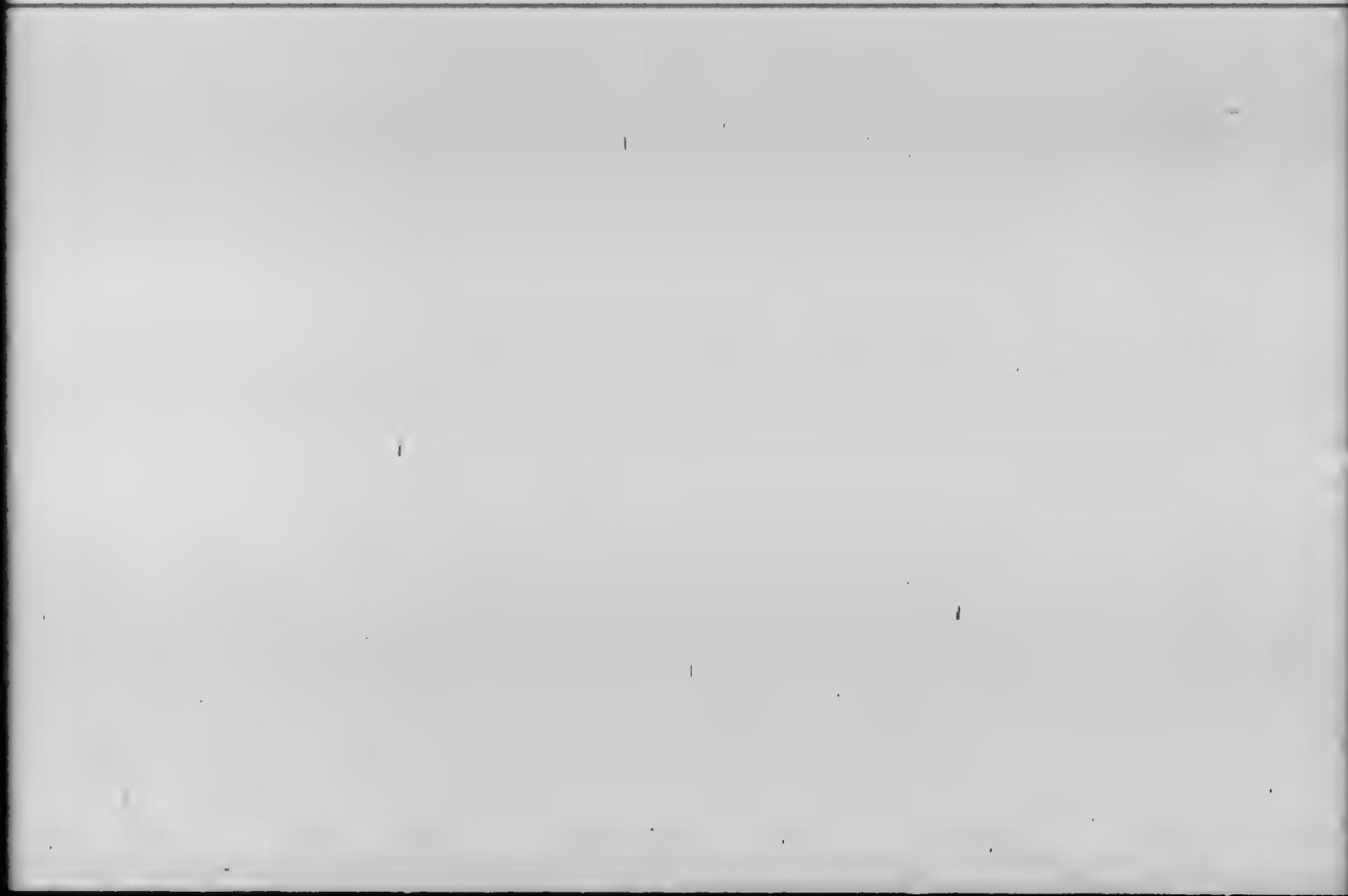

Bureau Refugees, Freedmen, and Abandoned Lands.

Office Agent Division of Albany,

(DOUGHERTY, LEE, AND FERRELL COUNTIES.)

Albany, Ga. July 15 1867.

Capt. Robinson  
Agent B. R. F. & A. L.  
Division of Amurecus.

Captain;

Mr. Sibley's  
Contract is filed in  
this office and approved.  
One of the freedmen on  
the contract named  
Gas Bouca is now  
in Amurecus, having  
left in violation of his  
Contract.

Please have  
him returned to Mr.  
Sibley

Ruby  
Agent

1729, 1731, 1732, 1733, 1734  
Office Agent, Department of  
Americas, Gov. July 11, 67.

J. Robinson, J. H.  
Agent, etc.

Reports the unjust  
arrest of a freed man, and  
request for the removal  
of Judge Ball.

X

Bureau of Reports  
Office of U. S. Com:  
P. T. Americas Sa July 15, 67.

Recently forwarded to Capt. C  
Pickett U. S. with  
the remark that Judge Ball's  
action are unworthy of a  
judge - ignorance or badness  
of character prevents him  
from administering justice.  
In the short time that  
Webster Co. has belonged to the  
S. D. of Culbertson - the  
S. A. C. examined several  
cases and Judge Ball's sentence  
and his indentures were exam-  
ined - his removal is  
recommended. The County  
Jails are mostly horribly  
kept and badly built -  
in Stewart Co. Jail - men  
die by want of  
care and abundance of vermin.

J. M. Sells,  
U. S. A. C. Com.

Office Agent Bureau P. T. Americas  
Atlanta, Ga. July 22, 67.

Respectfully returned to J.  
M. Robinson, Agent, Americas  
thru T. J. H. Smith, S. A. C.  
Culbertson - This office can  
take no action in cases like  
this upon the simple state-  
ment or assertions of Agents  
& Agents - Agent Webster  
will procure copies of the  
testimony upon which the  
indictment Harris was held  
& if possible a report of the case  
from Judge Ball - he will  
obtain all the evidence  
to be found especially that  
of the witnesses for the freed-  
man Harris. Judge Ball  
cannot be recommended  
for removal on any general  
charges - The S. A. C. must  
show evidence of his in-  
competency or shallousness  
in office - or other grounds  
for his removal.  
By order of Col. G. L. Sibley  
Quincy, Neb.  
Capt. C. Pickett

Office Sub. Asst. Comm.  
Burr. of Insp. etc.  
Cullbert. Ga. Aug. 6. 67

I respectfully returned  
to J. M. Robinson Esq.  
Agent. Div. of Territorial Ga  
J. M. Davis

St. 43. 26. P. T.  
Sub. Asst. Comm.



Official Agt Bureau of R. F. & A. L.  
Americus Ga July 11<sup>th</sup> 1869

Lieut Col. F. A. H. Gaebel  
S. A. Com's & C  
Cuthbert Ga

Sir  
When in Preston Webster  
County on Tuesday 9<sup>th</sup> Inst. I found William Harris  
(Colored), confined in the dungeon of the Jail, on complaint  
of attempted murder of Daniels. The jail is a small two  
story building, on the upper floor I found a trap door of  
iron, which being unlocked I descended by means of a  
ladder to the lower portion of the building, where I found the  
jailer Wm Harris. The place was dark and filthy, and  
the only bedding in the place was a very narrow blanket; Having  
two soldiers with me I ordered Harris to be taken out for exercise  
I then examined the evidence on which he was committed, and  
found it very lame and conflicting, on examining the person  
Harris I found he had been stabbed in the back by Daniels. I also  
heard on enquiry that Harris had been working the plantation  
of Daniels on shares, and it looks very much as if Daniels had driven  
Harris off in order to get his share of the crop. Not knowing  
whether I had authority to order his release I employed a lawyer  
to take him out on a writ of "habeas Corpus", should this not  
be successful, I would respectfully request such instructions as  
will enable me to act promptly. I fear there is no justice to  
be had from Judge Bail, so far as I am concerned  
and would respectfully request his removal from Office

Respectfully Your Obedient

J. M. Robinson.  
Agt Bureau R. F. & A. L.

S. S. C. S. C. Vol. 2. 67. P. 203. Supp.  
Office Agent. Div. of American  
Americas. Gov. July 22. 67.

Robinson, J. B.  
Agent. etc.

States in the case of Will  
Harris (breedsman) that Judge  
Ball refuses to take action  
and asks for authority  
to release said breedsman  
now lying in Preston  
 Jail, and that Judge's all  
be removed from office.

3. Office Sub. Asst. Comm.  
Bureau of Rep. etc.  
Cullbert, Ga. July 22. 67.

Respectfully forwarded to  
Capt. E. Fitchell, et al. of  
Attention is respectfully  
invited to letter dated July  
11. 67. from Agent Robinson  
and indorsement of the  
Sub. Asst. Comm. who prays  
for the removal of Judge  
Ball of Webster County  
Court.

C. S. 16. Vol. 2. 67.  
P. 203. Supp.

J. M. Butler

121. 45. 16. P. 1. 4. P. 1. C.  
Bureau of Rep. etc.

Office Agent Bureau R. F. S. A. L.  
Americus Ga July 22<sup>nd</sup> 1867

Lieut. Col. F. A. H. Gabel  
S. A. Comis  
Cuthbert Ga

Col. Capt Smith the lawyer

employed to sue out a writ of "habeas corpus" in the case of  
William Harris, "Freedman" confined in a filthy dungeon, without  
bedding in Preston jail, on (as I firmly believe) a false and  
malicious charge, and whose case I thought to your notice in my  
letter to you of July 11. '67 and informs me that Judge  
Ball refuses to take action on his (Smith's) motion. I most  
respectfully and earnestly ask authority to release the Freedman  
Harris now lying in Preston jail, who was stabbed at the ~~house~~  
into a dungeon and that Judge Ball be reported for removal  
from office. I am

Col

Very Respectfully

Your Obt Servant

Ch Roberson Agt

Bureau R. F. S. A. L.



2.

6. 10. 1911

1. 1. 1912

10 Sept. 5.  
1867

Bureau of Refugees, Freedmen and Abandoned Lands.

Office Sub-Assistant Commissioner.

Cullbert, Ga., July 25<sup>th</sup> 1867

Capt C. Pickett.  
U. S. A. Genl.  
Atlanta, Ga.

Sir:

The charges I have to make against Judge Ball  
of Miller Co. are:

That he bound out Sam Kelly an orphan boy a  
color 14 years old, to Sam Kelly, on the latter's representa-  
tion, that Sam wished to be bound out to him -  
the law prescribes that orphans over 14 years old, shall  
select their own guardians. Sam when hired to Sam  
Kelly had told him, he kidnapped him from an-  
other county and then went to Judge Ball, who  
gave him an indenture of apprenticeship, without  
having seen the boy. Sam run away, is captured  
and I investigated the case and examined the  
records of the county court & his office.

Judge Ball did return Sam Holly to his former owner and cousin a Slave till Sam was 21 years - all this at Webster Co. Ga. in the months of February & March 1837. Attention is respectfully invited to my letter, dated April 3 1837. which I enclose with a copy of indenture. Enclosure 1. & 2. B. & C. The indenture is cancelled.

The second charge is that Judge Ball of Webster Co. sentenced W. Sheppard to pay a fine of \$125<sup>00</sup> and Cost \$40<sup>00</sup> for having deceived an other freedman from a verbal contract; the evidence was circumstantial of a ridiculous weak character - the verbal contract was no contract at all, as when brought into writing was disapproved by the Bev. officer and for this reason the freedman Sheppard left his former Em. owner. Your attention is respectfully called to the letter from my office - dated April 11. '37 and the indorsement of the Statute, which proves that the case was very fact.

Here, this County Judge has sentenced a

predecessor, to two years slavery, to pay \$125,000 -  
with out two years labor, for a not existing crime  
and if existing and the practice against Snodgrass  
would have been excessive, which it was not -  
the fine and cost are exorbitant and show  
Ball's unwillingness to remain longer a Judge.

The second letter from J. L. Robinson Esq.  
Agent Gen. of America, Ga, Enclosure 4 & 5, I  
respectfully recommend to your attention and  
suggest that an officer being to send them  
to prove in this case the true character of  
the Judge, &c. &c, as I have now no time  
to go myself.

Judge Ball is incompetent as a very bad,  
I think both together and so much, as to make  
him a perfect nuisance to the Bureau and  
dangerous to the Community.

I am Capt.

Very respectfully

Your obedient servant

Wm. G. Hall

1245 1/2 St. S. E. corner  
Bureau of Prof. &c.

Office Sub. Post. Cases.  
Bureau, Wash. D.C.  
Admitted, Jan. 27, 1868

Respectfully forwarded  
to Capt. E. Mitchell, et al.  
of Atlanta, Ga. Attention  
is respectfully invited to  
papers and letter dated July  
25, 67, forwarded from this  
Office, referring to the case  
of Judson Ball, of the latter Co,  
and it is respectfully sug-  
gested, that the request of  
J. Robinson, et al., et al.  
will be complied with.

W. H. Scales

121. 45. 1st. 11. 11.  
Sub. Post. Cases.

Office Home Bureau R.R. 12.  
Atlanta, Ga., Aug. 5, 1868.

Respectfully returned to  
C. H. & M. Gabel, S. A. C.,  
Cuthbert, Ga. If you  
will forward sufficient  
evidence under oath to es-  
tablish the facts in this  
case, action can be taken  
but no arrests take the  
within can be complied  
with unless full evidence  
is furnished to warrant  
it.

By order of  
Capt. C. G. Lilly

Chas. C. Curran, Sec'y.  
Capt. W. H. Scales

Americus. Ga. July 25. '47.

W. S. L. M. Gaudin  
Sub. Col. Camp.  
Cuthbert. Ga.

### Extract.

x x x x x x x x

I wish you would send me some instructions in regard to the freedman Will. Harris, who is confined in the vile dungeon at Preston. It is a gross outrage and I only want one word from you in order to release him. Several persons from Preston, have seen me in regard to the matter. Shall I take the responsibility of releasing him? If you say so I will go on Saturday night to Preston and release him & bring him here & hold him until you hear from Atlanta. Something should be done at once, it is a specimen of great cruelty & an outrage.

Very truly  
and respectfully  
Yours,  
J. M. Robinson.

1000

1000

1000

Office Sub. Asst. Comm.  
Bur. of Insp. etc.  
Cuthbert. Ga. Aug 6. 67

I respectfully returned  
to J. M. Robinson Esq.  
Agent Div. of America for  
Attention invited to pre-  
ceding endorsement.

F. M. Wells

St. Asst. U.S.S.  
Sub. Asst. Comm.





Bureau of Refugees, Freedmen and Abandoned Lands,  
OFFICE CHIEF QUARTERMASTER, STATE OF GEORGIA,

Atlanta Ga., July 18 1867.

Sir

Enclosed find my Check on Merchants National  
Bank of Savannah for \$32<sup>24</sup>/<sub>100</sub> in payment of Vouchers of Smith &  
Glover for Rent & Stephen Tonder for hauling

Very respectfully  
Yr. Obedt. Servt.

C. S. Hutson  
Br. Major and A. Q. M.

J. M. Robinson Esq.  
Agent Bureau R. F. & A. L.  
Americus  
Ga.

215-111-41  
1881

1881

Bureau of Refugees, Freedmen and Abandoned Lands,

OFFICE ASSISTANT COMMISSIONER, STATE OF GEORGIA,

*Atlanta*  
*Macon, Ga.,* *July 11th* 1867.

*Dear Sir*

The Assistant Commissioner directs me to inform you that supplies have been ordered to be shipped to you for distribution in the following counties:

*Worth, Spalding, Forsyth, Jones, Wilkes, and*  
*Madison, Ga. The amount in the last*  
*Report under Capt. [unclear] & [unclear]*

You will make out and forward to this office, through

*the [unclear]* special requisition, (form No. 3,) for approval, to cover the above amount. The necessary blanks needed in distributing and accounting for these supplies, can be obtained by application to *Supt. [unclear]*

All expenses incurred in transporting, storing and distributing will be paid by the Chief Quartermaster, upon proper vouchers being forwarded.

You will fill up and sign the enclosed receipts, upon receiving the amount consigned to you, and return two (2) of them to this office.

Very respectfully, your obedient servant,

*G. W. Walbridge*

Capt. & Acting Commissary Sub., State of Georgia.

*J. M. [unclear]*  
*Agent*

*J. A. [unclear]*

Evansville Ga  
July 22<sup>d</sup> 1867

Carver Sarah

Applies for an  
appointment as a  
Teacher of Freedmen.

Respt referred to J. M.  
Robinson, agt. Amey  
through Lt. S. A. C. Cutbert Ga.  
Ga, who will consult with  
Mrs. Custer, and ascertain  
whether a suitable school  
building can be rented or  
built, the aid of the freedmen  
and whether the freedmen  
can pay the board, teacher,  
and anything toward this  
salary, - how many pupils  
can be collected &c. -  
making full report as soon  
as possible, with return of this  
paper.

By order Col. C. C. Silby W. J.

J. R. Lewis  
Major & Adj. Genl  
Act. Supt. Ed.

Office Sub. Asst. Commr  
Bureau of Ref. etc.  
Cuthbert Ga. Aug 8. 67

Bureau of Ref. etc.  
Office Supt. Ed. to J. M. Robinson, Esq.  
Atlanta Ga Aug 6<sup>th</sup> 67 Agent. etc.

A. M. Gack!

P. O. 45. P. O. 9. J. J.  
Sub. Asst. Commr.

Collinsville, Shelby Co. Georgia  
July 22<sup>nd</sup> 1867.

Hon. W. B. Eberhart  
(Supt. Schools for Freedmen)

Sir - This County  
is filled with the freedmen & their children who  
are destitute of a school and too poor at pres-  
ent to support a good one. They are anxious to  
learn and show considerable aptness, as I am witness  
having given some of them lessons at night.  
I have consented to undertake the school, and I  
am decidedly their preference, provided I can get  
assistance from you. In fact they beg me to  
apply to you. My daughter who is now with her  
mother in Baltimore will assist.

We are destitute of a suitable school house; though  
that fact will not deter me from beginning in a  
small room for the present. I am a Philadelphian  
by birth & education & refer you to the Hon. J. H.  
Campbell N. C. St. at. Tenn, Dr. M. McLeod's C. St. at.  
Wiscou - Philada. - & many others.

Hoping to hear from you very soon, I have the honor  
to be

Yours respectfully  
Mrs. Sarah Carter

*Faded handwritten text, possibly a date or name.*

*Faded handwritten text, possibly a signature or name.*

Bureau Refugees, Freedmen, and Abandoned Lands,  
OFFICE ASSISTANT COMMISSIONER, STATE OF GEORGIA.

Atlanta, Ga., July 25<sup>th</sup> 1867.

J. M. Robinson

Agent

Americus

Ga.

Sir,

The Asst Comm directs that you forward at once to this office the receipts and invoice for 1957 lbs of Bacon shipped July 13<sup>th</sup> 1867.

The supplies under Act of Congress approved March 30<sup>th</sup> 1867, for this State, have been exhausted, and it is necessary that the accounts should be closed without delay. If any discrepancies occur from that might be the cause, account for it on Inventory Statement.

Very respectfully

Your Obedt Servt

Geo R Walbridge  
Capt & Col

Thru

S. A. Comr

Americus  
Ga

107  
 108  
 109  
 110  
 111  
 112  
 113  
 114  
 115  
 116  
 117  
 118  
 119  
 120  
 121  
 122  
 123  
 124  
 125  
 126  
 127  
 128  
 129  
 130  
 131  
 132  
 133  
 134  
 135  
 136  
 137  
 138  
 139  
 140  
 141  
 142  
 143  
 144  
 145  
 146  
 147  
 148  
 149  
 150  
 151  
 152  
 153  
 154  
 155  
 156  
 157  
 158  
 159  
 160  
 161  
 162  
 163  
 164  
 165  
 166  
 167  
 168  
 169  
 170  
 171  
 172  
 173  
 174  
 175  
 176  
 177  
 178  
 179  
 180  
 181  
 182  
 183  
 184  
 185  
 186  
 187  
 188  
 189  
 190  
 191  
 192  
 193  
 194  
 195  
 196  
 197  
 198  
 199  
 200



Bureau Refugees, Freedmen, and Abandoned Lands,  
OFFICE ASSISTANT COMMISSIONER, STATE OF GEORGIA.

Atlanta, Ga., July 25<sup>th</sup> 1867.

J. M. Robinson

Account

Merchandise

Due

Sir,

When Ass't Comm. drafts that you forward at once to this Office the receipts sent you for 12000 lbs Corn & 1800 lbs Bacon, signed July 5<sup>th</sup> 1867.

The supplies under Act of Congress approved March 3<sup>rd</sup> 1867 for the State have been accounted for, but it is necessary that the account should be closed without delay. If any discrepancies occur from theft, neglect, or other causes, account for them on your Monthly Statement.

Very respectfully

Yours Obedt Servt

Geo R Walling

Capt U.S.A.

Yours

S. A. Comr

Atlanta Ga

July 31

~~July 31~~  
21

July 31

Bureau of Refugees, Freedmen and Abandoned Lands,  
OFFICE OF ASSISTANT QUARTERMASTER AND DISBURSING OFFICER, STATE OF GEORGIA.

Atlanta July 31 1867.

Sir,

Enclosed find check on Merchants  
National Bank of Savannah for \$146<sup>66</sup>  
Amt. due for services in July 1867.

Very Respectfully

Your Obedt. Servant

W. H. Hession

Adj. Maj. & A. Q. M.

J. M. Robinson Esq

Agent Bureau R. F. M. A.

Americus, Georgia.

Wm. P. C. ...  
Wm. P. C. ...  
...  
...  
...

No 7

---

Office A. A. V. M.  
Newcom Co.

July 30th 1867

J. B. Robinson  
Amicus  
Sr.  
Sir

Enclosed please duplicate  
3 Triplicate Bills of Lading for  
Sub. Stone & Lumber, Clothing, &c. shipped  
to your order this day. The Lumber is  
forwarded as per Requisition of St. Louis.  
The Sub Stone is for the Detach. of 1000  
Stations at Amicus Co.

Please sign the duplicate  
Bills of L. and return to this office  
Respectfully yours



At St. Louis 16th Sept.  
A. A. V. M.

August  
1867

Bureau of Refugees, Freedmen and Abandoned Lands.

Office Sub-Assistant Commissioner,

Cathbert, Ga., August 1<sup>st</sup> 1867.

Genl. H. Robinson, Esq.  
Agent, etc.  
Americus, Ga.

Sir,

You are respectfully requested, to inform me, as soon as possible of the arrival of the tents etc, to enable me, to forward the necessary papers.

Very respectfully  
Your obedient servant

F. A. Gault

121. 43. St. V. St. P.  
Sub. Asst. Commr.  
Bureau of Refugees, Freedmen and Abandoned Lands.

Office Sub. Asst. Co.  
Bureau of Inf. & Rec. M.  
Cuthbert, Ga. Aug  
8. 18 89

Genl. F. A. H.  
St. 48 Regt U. S. I.  
Sub. Asst. Commo.

Aug 2 1889

I request to return  
papers, referring to two  
men, that have gone to  
Texas, and also to state  
the reasons, why these  
papers, have been retain-  
ed so long.

7



Bureau of Refugees, Freedmen and Abandoned Lands.

Office Sub-Assistant Commissioner.

Cuthbert, Ga., August 8, 1867.

J. M. Robinson, Esq.  
Agent, etc.  
Americus, Ga.

Sir,

You are hereby requested to return without delay, the papers <sup>referring</sup> to these two men, that have gone to Texas, as they have been in your office, for more than two weeks, and also state the reason why they have been retained so long in your office.

I respectfully  
Your obedient servant

M. Davis.

126. 43<sup>d</sup> Regt. U. S. A.  
Sub. Asst. Commr.

Sub. Ass't Com<sup>r</sup>  
Quittent Ga

Keypoly noncompliance  
of orders

Bureau of Refugees, Freedmen and Abandoned Lands.

Office Sub-Assistant Commissioner.

Cuthbert, Ga., August 10 1867.

J. M. Robinson Esq

Aquid Dio:

Americus

Sir

Yesterday you did send to me  
instead of the letters demanded and an explanation half  
a letter I enclosed to said papers. When at your  
Office I urged to forward these papers and with  
the completeness as ordered by the act. I found  
parts of this papers and finally you found the  
rest in your office - You forwarded this paper to  
my office with an endorsement of you on an  
enclosure - written by me - I did return this  
papers after 3 weeks you after having cut the  
they leave from my letter you return this letter  
and say that you have forwarded the balance.

As you have no record of your letters and  
I keep a record of every paper passing through  
I know you did not, and if you did it only  
proves that you are very neglectful in retaining  
parts of these papers - with you forward

I have not seen a letter in the last week  
you sent me - I am sure with the  
amount of business you are doing you  
know how to get a letter - I am sure  
with your state of mind and business  
and all your own and various other  
habits - or you better write

I am not coming to visit any longer  
for some letters etc - and will I have no  
more and receive your publications etc.

I saw letters from the late Dr. Wagner  
to Dr. Wagner & wife in your name - I  
remarked to you quite cheap that you  
should forward them to Columbus - the  
little business shows irregularity of  
habits.

In the case of the shooting the report  
and your call for troops - I never thought  
it necessary to report or write a word to  
me - I know that you do it not for the  
sake of showing your superior or myself  
but you never thought of it.

Your action of the Webster County Jail

case I can as a military man not approve  
but can not help to tell you that the  
humanity you show to the rest of your  
position commands my highest respect.  
I say so as I can prove, especially  
that such brutalities have long time  
escaped punishment and were not  
rare in my District - you will see  
by <sup>from</sup> the last encirclement that a declaration  
under oath by somebody is required  
look carefull at those papers and  
act accordingly -

I am Sir

Very respectfully

Your obedient servant

Wm Davis

241 1/2 1st St. N. W.

Headquarters, Bureau B. F., and J. L.

STATE OF TEXAS.

Galveston, Texas, Aug. 14, 1867.

Respectfully returned to

Col. G. C. Sibley, Sp. Com-  
missioner, State of Georgia,  
directing his attention to  
the endorsement of E. M.  
Whitlock, esp. sub. Sp.  
Comm. for the County of  
Galveston, Texas.

Chas. Clifton

Brig. Maj. Gen. U. S. A.,

Sp. Commissioner.

Office Comm. Bureau B. F. & J. L.  
Atlanta, Ga., Aug. 31, 1867.

Respectfully returned to  
P. M. Robinson, Sp. Com-  
missioner, Ga. through  
St. J. H. Sabel, Lt. Col.  
Cavalry, Ga. who will  
furnish to this office any  
reliable information that  
may lead to the arrest  
of this man with return  
of these papers.

By order of

Wm. B. Sibley

Chas. Clifton  
Brig. Maj. Gen. U. S. A.

Wrapper, ( Inclosures.)

Office. Sub. Asst. Com  
Burr: of Ariz. etc.  
Cullbert. You. Sept. 23. 64

---

I respectfully refer you  
to J. M. Robinson, Co. Sgt  
Div: of America.

Com. of Ariz. J. M. Robinson

Lieut: 4.5 the Fort.  
Sub. Asst. Com.

---

*307*

Office Sub-Assistant Commissioner,  
Bureau R., F. and A. L.,  
GALVESTON, TEXAS, Aug 14<sup>th</sup> 1867.

RESPECTFULLY returned to Col.  
Major Genl. Chas Griffin  
Asst. Comd with the  
statement that a thorough  
but unavailing search  
has been made by the  
Police of this City for the  
murderer Clayton - No trace  
of him has been found,  
and it is not probable  
that he is now in  
Galveston.

E. W. Wheelock  
Sub-Assistant Commissioner.

*Cpmo  
(9)*

Headquarters. Bureau R. F., and A. L.  
STATE OF TEXAS.  
Galveston, Texas, Aug 6, 1867.

Respectfully referred to

E. W. Wheelock, esq., Sub-  
Spt. Comd for the County  
of Galveston for his infor-  
mation and action.

These papers to be re-  
turned with report of ac-  
tion taken.

*Chas Griffin*  
Bot. Maj. Gen. U.S.A.,  
Spt. Commissioner.



1  
New York, Aug 18. 1867.  
Agent, etc.  
Southport, Aug 18. 1867.

Office of Col. G. D. Davis of N.Y.  
Southport August 18. 1867.

Travellers, etc.

States that Richard  
Hoyle, col. of Webster Co.  
made a conspiracy against  
his employer W. Garrison  
near Freston and also for  
permission to summon  
the guilty parties and  
witnesses to Southport.

Respectfully referred to Agent  
J. M. Robinson Esq. of New York.  
with the instruction to investi-  
gate the case fully and report  
on it. This paper to be return-  
ed with next report.  
It is understood that people  
are very badly humored in  
the settlement in which Hall  
lives and for this reason  
you will make charges not  
against <sup>Mr. Garrison</sup> the man if you think  
it case important and if it  
could be proved that the employer  
made efforts to revive the  
people here they were and  
the same man of W. H. Allen is  
charged by Hall but he formerly  
bore his freedom of witness  
paying them.  
J. M. Robinson  
Agent, etc. S. S. S. S. S.  
Subject, etc.

Office U.S. Bur. of Fed. Dis.  
Division of Outlets.

Cuthbert, Ga. August 15, 1867

Supt. W. F. H. Grebel.

Sub. App. Comr.

Cuthbert, Ga.

Sir

Richard Hale, a freedman from Webster Co makes complaint that his employer William Yarborough near Toston has whipped <sup>with his fist</sup> and kicked with his foot his son Abraham about 14 years old in mere ill humor and only with the intention of running him off from his really good crop. He is anxious to have the case attended to and if you think it proper to grant me permission to do so I will come on the parties and introduce to this place.

I am, very respectfully

Yours obt. servt.

Ch. Rauschenberg

Agent

Office Sub. Asst. Comm  
Bureau of Insp. etc.  
Cent. Serv. Ga. Aug. 17. '67.  
P.

Gael C. F. A. H.  
Lt. 45 Regt. U. S. I.  
Sub. Asst. Comm.

Orders to answer without  
delay the within questions  
in regard to the Detach  
and duty at Americus—  
and requests to work the  
Office in accordance with  
Officers Manual.

Bureau of Refugees, Freedmen and Abandoned Lands.

Office Sub-Assistant Commissioner,

Cuthbert, Ga., Aug. 17, 1867.

J. M. Robinson  
Agent etc  
Americus Ga.

Sir

You will without delay report  
to this Hd. Q. for how many days  
your Detach of Troops (for this month) has  
rationed. That is to say

Number of men -

Date when one or <sup>2</sup>/<sub>3</sub> men left -

No: of new men

Date from where they need rations

if Capt West came with rations to the end of the  
month - ? if not how many days does he  
need rations.

Send in time the beef bill - for one day  
fresh beef, for the next salt meat and so on.

You do not need 4 Wall tents for 7 men  
quarter them in the Court house if you have  
no room in the tents. I do not know  
exactly how many men you have

but I expect by your indication that  
you have not more than 7.

When a man loses your detachment  
you must report it with care as I have to  
write for information to make my returns out  
correctly I expect from my officers to  
help me work by a like promptness  
but if it is not done very promptly my  
work is only increased.

I see your letter still without book  
marks I have a clerk and will  
now work your office accordingly to the  
manual, so that it can be inspected.

I am Sir

Very respectfully

Your obedient servant

F. F. H. Baker

the 45-103

Calcutta.

Miss D. ...

Macon Ga Aug 20<sup>th</sup> 1863

Dear Mother & ...  
etc.

No 8

---

J. C. 132

...

The 2d Post of Macao  
Macao Coa August 20th 1854

Special Order  
No 135

October 1854  
The following named vessels  
men are hereby relieved from  
duty at Chamorro in accordance  
with the order to Macao Coa and  
will report to the respective Coy Commands  
on duty

Corps August Best Coy, 16th Regt  
Pvt John S. Montgomery, Coy 16th Regt  
Henry Mayatt Coy, 3rd Regt

The 2d Inf. Department will remain  
in operation

By order of the Adjutant General  
James H. H.

Wm. M. Robinson  
Adj. Gen. Bureau N. V. 1854  
Chamorro Ha

1854  
Det. Coy

Wm. M. Robinson  
Adj. Gen. Bureau N. V. 1854  
Chamorro Ha

*Dr. William H. Miller*  
*1840-1880*

*1840-1880*



Bureau of Refugees, Freedmen and Abandoned Lands.

OFFICE ASSISTANT QUARTERMASTER AND DEPUTY COMMISSIONER OF THE BUREAU.

Atlanta Ga., Augt 21<sup>st</sup> 1867.

Sir

I have this day forwarded to your address per Southern Express \$96<sup>74</sup> in payment of the following Vouchers.

W. J. Murray	Boarding	9.00
Smith Glover	Rent	20.00
Freight		4.74
Transportation		63.00

Very Resp<sup>ly</sup>

Your Obedt. Serv<sup>t</sup>

C. Watson

Quar. M<sup>str</sup> and D<sup>ty</sup> Com<sup>r</sup>

J. M. Robinson Esq  
Agent  
Americus  
Ga.

MAILED

144  
1867  
1867  
1867

Copies of Anna's Journal  
Atlanta Ga., Aug. 24, 1867.

Respectfully returned to Geo B.  
Sinakle M.D. Cummins Ga.  
The accounts for medical attend-  
ance on Capt Robinson, clerk &  
servants at Cummins Ga. should  
be certified by Agent Robinson  
& forwarded to this office  
when they will be approved  
& forwarded with payment re-  
commended.

By order of  
J. P. [unclear]  
Agent  
134 State St. Ga.

Division of Refugees, Freedmen and Abandoned Lands,  
Office Agent Division of Americas,

(WEBSTER, SCHLEY AND SUMTER COUNTIES.)

Americus, Ga. August 21<sup>st</sup> 1867.

1  
Capt James Sickett,  
A. A. Guard,  
Sir

Capt J. M. Robinson  
Barnes Coy, at this place is confined to  
his bed with a severe attack of malarial  
fever. Being unable to write you he  
requests me as his attending physician  
to do so. I think it will be several  
days before he will be able to attend  
to the duties of his office. His wife  
and two of the guard are also under  
medical treatment. In former years (continued)  
the latter of malarial fever I do not  
think it is owing to either impure air or  
location as no part of our city is swampy.  
I believe all of the guard have in the  
last two weeks been in malarial, under  
medical treatment by me.

Being requested by

MAR 18

Capt Robinson to attend the Soldiers who  
are and have been sick I have looked  
upon them in the same light as my other  
patients throughout the War. I require the  
commander to refer for medical attention and  
medicines. Please inform me if the Govt  
will pay such bills, and if so, how I am  
to proceed to collect it.

Very respectfully  
Geo W Lusk  
Surgeon

Clinton, R.F.D.

Ms. cor. to Aug 130<sup>th</sup>  
1867.

Deposition in  
reference to the  
Case,

No. 9.

---

5

Wm. C. C. [unclear]  
[unclear]

[Faint handwritten text, possibly a list or notes]

[Faint handwritten text]

Account of  
Aug 30 1867

Account of J. M.  
Agent,

Account of the  
Supply of the  
11th Regt 30th Infy

Account of the  
Supply of the  
11th Regt 30th Infy  
Respectfully returned to J. M.  
Robinson Esq. the  
for the 30th Infy. Co. Capt. G. S. G.  
The return must include the  
issues for the 30th Infy. Co.  
and the 11th Regt. 30th Infy.  
The return must include the  
issues for the 30th Infy. Co.  
and the 11th Regt. 30th Infy.  
The return must include the  
issues for the 30th Infy. Co.  
and the 11th Regt. 30th Infy.

J. M. Lewis  
1st Lt. 45th Infy.

Office Sub. Asst. Commr.  
Bur: of Sup. etc.  
Cuthbert, Ga. Sept 4. 67.

Respectfully returned  
to J. M. Robinson Esq.  
Agent, etc. Attention invi-  
ted to the preceding inder-  
sessment.

J. M. Lewis  
1st Lt. 45th Infy.  
Sub. Asst. Commr.

Bureau of Refugees, Freedmen and Abandoned Lands,  
Office Agent Division of America.

WEBSTER, SCHLEY AND WEBSTER COUNTIES  
Americus, Ga. August 30th 1867.

Capt Geo R Wainwright  
A. S.  
Atlanta Ga.

Capt

Herewith I have the honor  
to forward my Returns of the issues of Provisions to the Soldiers  
for Sumter, Schley and Webster Counties for the month of August.  
I have not forwarded returns for Webster, not having received  
them from the judges of the J. C. but will forward them on  
my Return from Webster, where I shall go next Monday  
I am

Captain

Very Respectfully

Your Obt Servant

J. M. Robinson  
Agent



Americus Ga.  
Aug. 31<sup>st</sup> 1867

Robinson J. M.  
Agent

Forwards List of Stores  
Expended for the month  
of August, 1867, for approval.

Office Asst. Comm. S. R. T. & A. S.  
Atlanta Ga. Oct. 11<sup>th</sup> 1867

Respectfully returned to  
J. M. Robinson agt. thro  
G. Raushenberg, A. S. A, Com  
Cuthbert Ga. approved.

By order of Maj. J. A. Lewis  
act. asst. Com

W. H. Raushenberg  
A. S. A, Com  
Cuthbert Ga.

Office Sub. Asst. Com.  
Bur. of Tr. & A. S.  
Cuthbert Ga. Oct. 11<sup>th</sup> 1867

Respectfully returned  
to J. M. Robinson, Agt.  
Agent, etc.

G. Raushenberg

A. S. A, Com.  
Bur. of Tr. & A. S.

MAHA 129

Macon Ga Sept 4<sup>th</sup>  
1867.

Bills of Lading.

No 10

---

Office Acting Assistant Quartermaster, (S)

Macon, Ga. Sept 4<sup>th</sup> 1867.

J. H. Robinson  
Amnicus  
Ga

Sir

Enclosed find Duplicate  
& Triplicate Bills of Lading for  
Stores shipped to your address by  
Please sign the Duplicate Bill of  
L, and return to this office

Respectfully  
your obedient  
C. J. Moore  
1<sup>st</sup> Lt 16<sup>th</sup> Regt  
A. A. 2<sup>nd</sup> Div  
1<sup>st</sup> Inf  
Transp. Co.

1867

1867

1867

Headquarters District of Georgia,

Adjutant General.

Monticello Va. Sept 12<sup>th</sup> 1867.

J. M. Robinson Esq.  
Agent Bureau A & S  
Americus Ga

Sir

I have the honor to inform you, that the Comd'g officer of the Post of Macon has this day been directed, to order Out Augustus Best  
Lieut. E. W. Chesdry to report to you for duty.

I am very Respectfully  
Your obed<sup>t</sup> Servt  
Edward P. Deady.

1 Lt Chesdry leaves  
am a day.

4.1

1944 12 23

...

Bureau Refugees, Freedmen, and Abandoned Lands,  
OFFICE ASSISTANT COMMISSIONER, STATE OF GEORGIA.

Atlanta, Ga., Sept 12<sup>th</sup> - 1867.

J. M. Robinson, Esq.  
Agent Bureau &c  
Americus, Ga.

Sir:-

I am instructed by  
Major Lewis to say that the Quartermaster  
has been directed to provide seats for the School-  
house at Americus, and that it will be done as  
soon as possible. Very likely the Quartermaster will  
soon be in Americus. You are directed to  
keep possession of the house till it is finished

Very respectfully,

E. A. Ware

Supt Ed. for Ga.

[Faint, illegible text, possibly bleed-through from the reverse side of the page]

[Faint, illegible text, possibly bleed-through from the reverse side of the page]



Bureau of Refugees, Freedmen, & Abandoned Lands.  
OFFICE ACTING ASSISTANT QUARTERMASTER AND DISBURSING OFFICER, STATE OF GEORGIA.

Atlanta, Ga., September 17, 1865.

Captain

Enclosed find my check on Merchant  
National Bank of Savannah for \$146.<sup>00</sup> in  
payment for services for August 1865. I do please  
to fill in date of appointment on, and receipt  
enclosed vouchers.

Very resp.

Yours obt. Servt.

C. G. Watson

A. W. G. M. + C.

Capt. J. M. Atkinson

Agent S. M. A. G. H. S.

Americus Georgia.

100-100000  
100-100000  
100-100000

100-100000

Bureau of Refugees, Freedmen, & Abandoned Lands.

OFFICE ACTING ASSISTANT QUARTERMASTER AND DISBURSING OFFICER, STATE OF GEORGIA.

Atlanta, Ga., Sept. 24<sup>th</sup> 1865

Sir  
Enclosed find my Check on Atlanta National Bank for \$20. in payment of Vouchers of Smith & Glover for rent of Office for August.

Very respectfully  
Your Obedt. Servt.

C. J. Watson

a. a. 2. M. + D. O.

J. M. Robinson Esq  
Agent for  
Americus  
Ga.

W. H. Mason  
1877

Bureau of Refugees, Freedmen, & Abandoned Lands.

OFFICE ACTING ASSISTANT QUARTERMASTER AND DISBURSING OFFICER, STATE OF GEORGIA.

Atlanta, Ga, Septem. 26<sup>th</sup> 1867.

Sir I return herewith one of your Vouchers for transportation. The charge for Cost of Oath for your Vouchers cannot be entered on one for all of them, the item must appear separately on each.

Hereafter please attach a Copy of Affidavit to duplicate Voucher, and do not fill up receipts

Very Respectfully

Your Obedt Servt.

C. G. Watson

a. a. s. m. & D. C.

J. M. Robinson by  
Agent  
Americus  
Ga.

C. P. Hansen

1867

Reporting next rolls  
of the 1st 1867

Bureau of Refugees, Freedmen, & Abandoned Lands.

OFFICE ADJUTANT GENERAL QUARTERSMASON AND DENBIGH ST OFFICE, STATE OF GEORGIA.

Atlanta, Ga., Sept 30 1867

Dear Capt.

I return your Receipt  
rolls of Bureau Property. These  
are used as sub vouchers to  
the Voucher (List of Expenditures  
which require to be approved by the  
Asst Commr) I her filed on  
out for your guidance.

Under late orders the  
receipt rolls of Clothing Camp  
& C. E. of the Q. M. Dept do  
not require to be returned on  
List of Expenditures, but the  
roll itself is to be approved

Yours  
C. J. Watson  
Adjutant Gen.

Capt J. M. Robinson  
Americus Ga

P.S. Dates must be given on receipt rolls, no need  
of certifying about witnesses being a Com or now Com  
officer on receipt rolls of Bureau property

*[Faint, illegible handwriting]*

---

Oct  
1867

---



Bureau of Refugees, Freedmen, and Abandoned Lands.  
OFFICE ACTING ASSISTANT QUARTERMASTER AND DISBURSING OFFICER, STATE OF GEORGIA.

Atlanta, Georgia, ~~October 4~~ 1867.

Sir.

Enclosed find my check on  
Atlanta National Bank for \$42 in  
payment of four Transportation  
accounts. I return others for  
correction. please observe penciled  
memoranda on back of them.

The only way the cost of affidavits  
can be refunded is on the voucher  
that the affidavits appears.

I send you to day a new blank  
for Transportation accounts.

Very Respectfully  
Yours obedt servt

C. J. Watson

Adj. Gen. & D. C.

J. M. Robinson Esq  
Capt & C.

American So

Cuthbert, Ga. October 10. 1867.

W. R. Ransburg, Esq.  
Agent.

States that John Gauding  
of freedom row of Randolph  
& Co, formerly employed by  
Messrs James & Williams of  
Wilkes Co, requests that a  
settlement be made be-  
tween him and his employ-  
ers.

Office A. S. A. Comr. B. R. S. A. S.  
Cuthbert, Ga. Octbr 10. 1867.

Respectfully forwarded to J. M.  
Robinson Esq. Agt. Am. S. A.  
Ga for investigation & report.  
J. M. Robinson, Esq.  
A. S. A. Comr.

25th

Office Agent, Br. R. P. & L.

Division of Cuthbert.

Cuthbert, Ga. Oct 10. 1867

J. M. Robinson Esq.

Agent etc

Americus Ga.

Sir,

John Gauding, a freedman of Randolph Co, formerly in the employment of Messrs James & William Prime of Webster Co and released from his contract with them for this year in consequence of an investigation ordered by Lieut J. D. H. Gaebel S. W. Comr Cuthbert Ga states that James & William Prime owe him for 4<sup>27</sup>/<sub>30</sub> months labor for himself, his daughter and two sons at the rate of \$225.00 per year amounting to \$116.62 - and also the one half of the value of three suits of clothing each, 4 blankets & 4 pair of shoes, having only worked the ~~four~~ one half of the year. He has received 1 pair pants & 1 shirt & 1 pair of shoes, his two sons have received 1 pair pants & 1 shirt each and his daughter has received 4 pair of shoes, the balance of the clothing is yet coming to him. He respectfully asks that a settlement between him & his former employers may be made.

Thos A. S. A Comr of same  
Cuthbert Ga.

Very respectfully

Your Obedt Servt.

Ch. Raushenberg  
Agt.

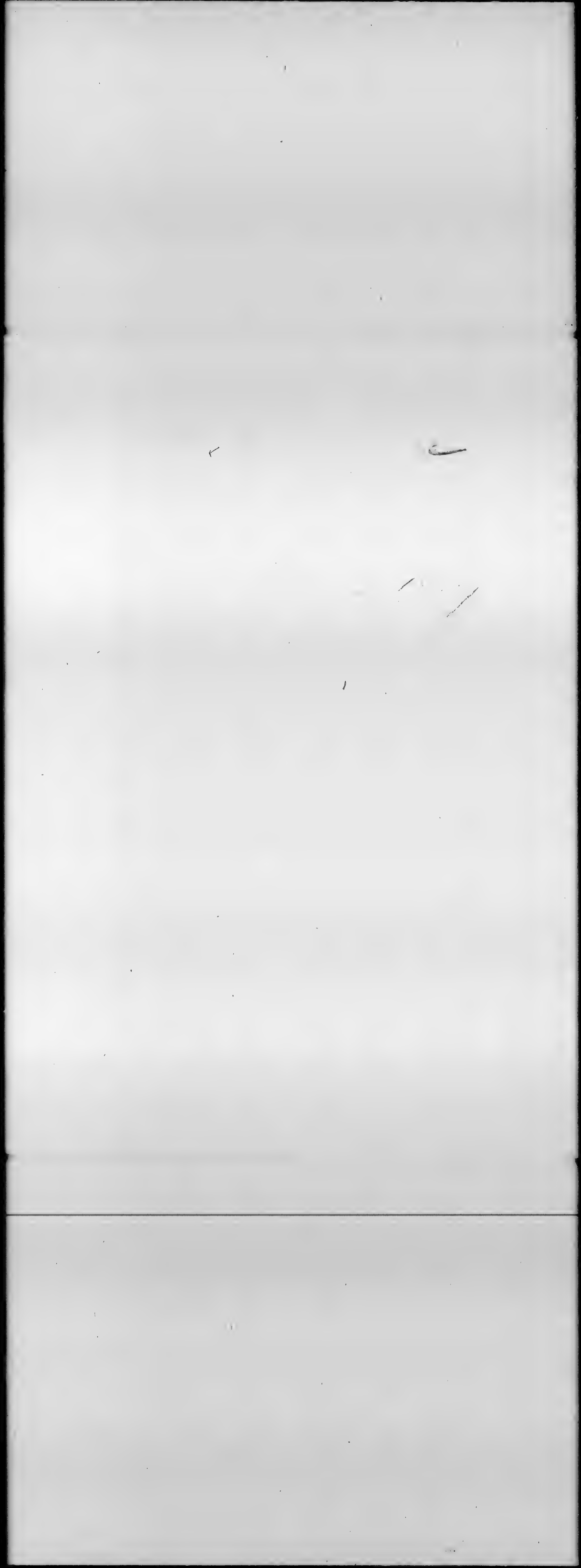

Bureau of Refugees, Freedmen and Abandoned Lands,  
Office Sub-Assistant Commissioner.

Cuthbert, Ga., October 12 1867

James M. Robinson Esq.  
Agent Brs. R. F. & Co  
Americus Ga.

Sir,

You are respectfully requested to furnish  
this Office at once with a copy of the Order by which  
you were assigned to duty at Americus, as copies of  
these Orders have to be furnished by the U. S. Com.  
to the U. S. Com. immediately. The order by which you  
were assigned must have been misplaced as it can  
not be found at this Office.

Very respectfully  
Your obt. servt.  
Ch. R. Kinsler, Surg.  
U. S. A. Comr.

Wm. O. L. L. L.  
Mon. Fa Oct 17<sup>th</sup> 1867  
Hunting Dog & Coy

No 12

---

Office Acting Assistant Quartermaster,

Macon, Ga., Oct 17<sup>th</sup> 1867.

J M. Robinson  
Capt. B.R. U.S.A.,  
Americus Ga.  
Sir

Enclosed find Duplicate Bill  
of Lading for Steer Shipper to your  
order on the 29<sup>th</sup> of Sept 1867.  
As the Bill of Lading forwarded  
at the time of the shipment of the Steer  
was forwarded to O.B. Deambert at  
Americus, and having never received it  
I now forward the Enclosed for your  
signature for the Steer, as I think  
enough to sign and return to this  
office as soon as convenient.

Respectfully yours

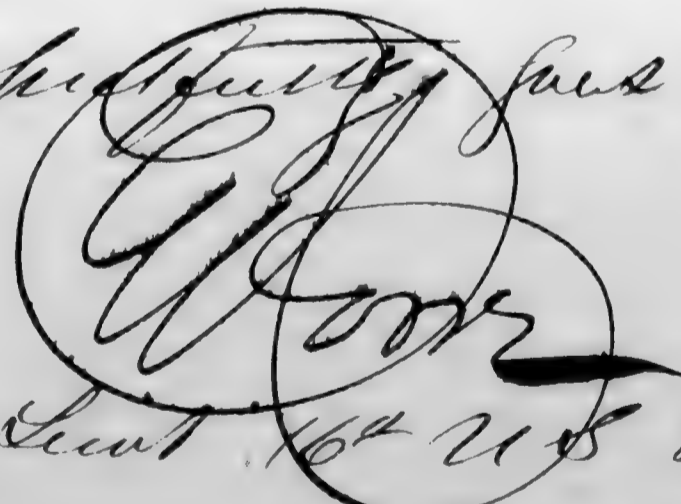
  
W. W. Wood  
1<sup>st</sup> Lieut 16<sup>th</sup> U.S. Inf  
A. C. G. M.





American Express Building & Co. Bonds  
Third Sub-District, South West,  
Albany Ga October 17th, 1857

Mr. Robinson Esqr.

Agent No.

American Gas

I have the honor to transmit herewith, a copy of an  
abstract from the records of the Office of the Com-  
missioner, Bureau of the U.S. State of Georgia & date of  
the 15th of the month of June, in compliance  
with such orders issued by the Chief of this Sub-District.  
The communications intended for this Office, or  
which under existing orders should pass through it will  
be addressed to me at this point.

Very respectfully,

James P. Smith

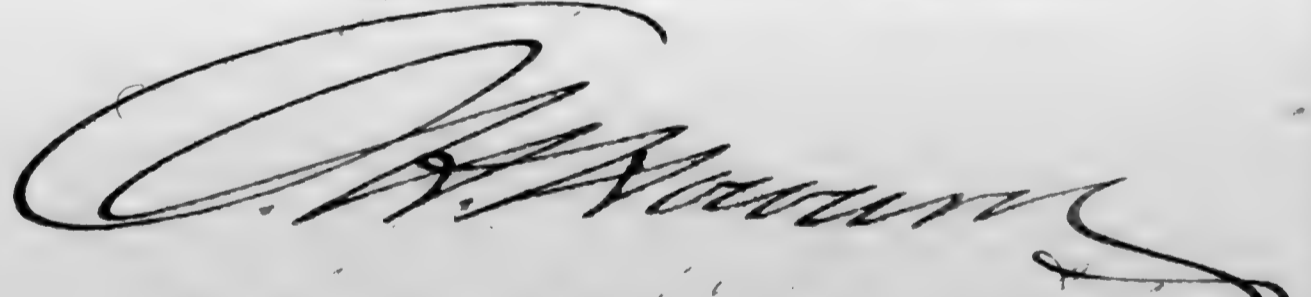
  
Sub. Chief, Sub-District of Albany  
All communications

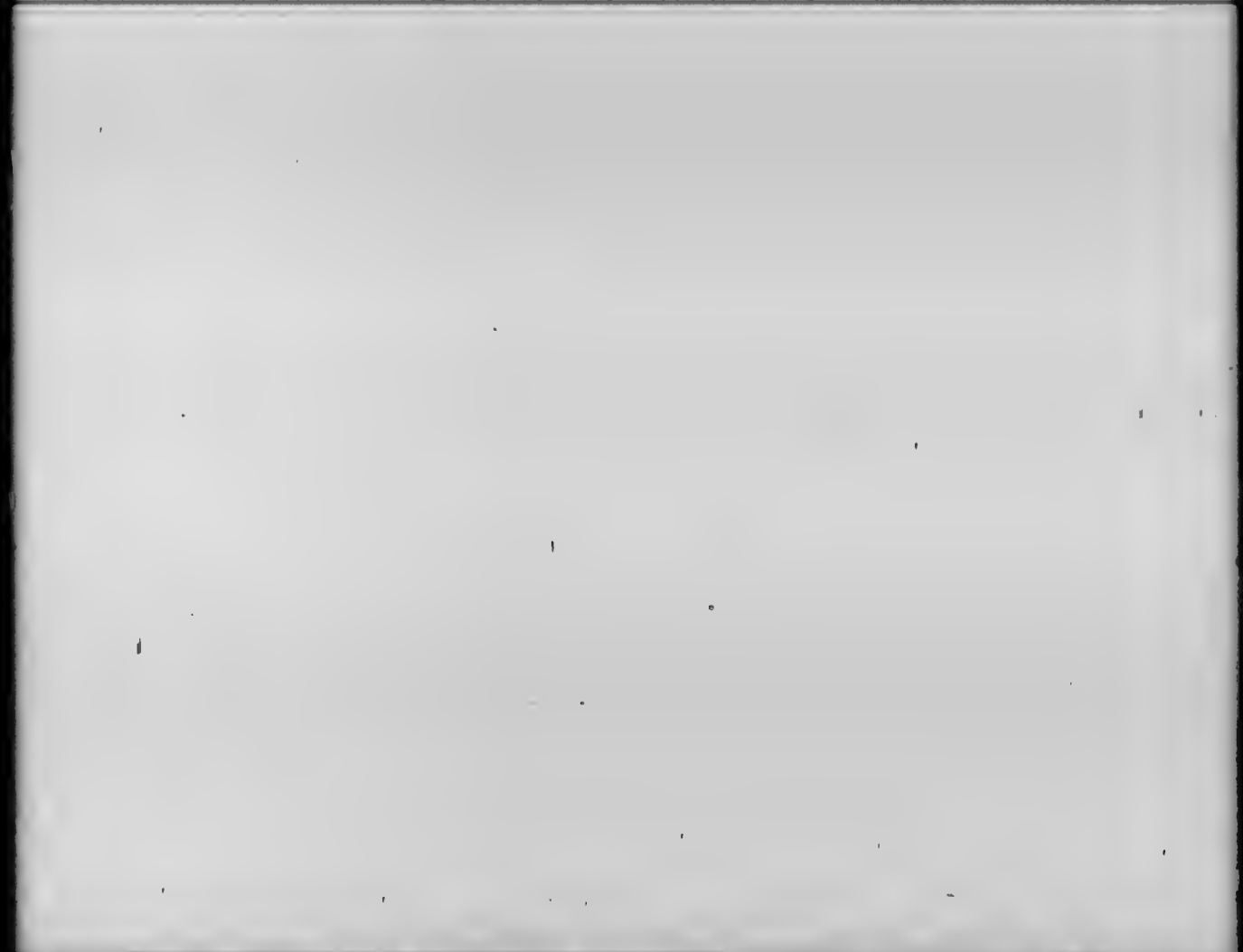

Bureau of Refugees, Freedmen, and Abandoned Lands.

OFFICE ACTING ASSISTANT QUARTERMASTER AND DISBURSING OFFICER, STATE OF GEORGIA.

Atlanta, Georgia, Oct. 21 1864.

Captain

Enclosed find my check  
for \$13 - in payment of your  
transportation account.

Very Respectfully

Your obedient servant

C. J. Watson

Adj. Gen. & D. O.

Capt. J. M. Robinson

Adj. Gen. Bureau R. F. O.

Americus Ga

My Respectful  
Yours &c.

C. A. ...  
L. A. ...

Bureau R. F. & A. G.  
Office Sub. Asst. Comm'r  
Sub. Dist. Columbia  
Albany Ga. Oct. 21. 1867

J. M. Robinson Esq  
Agent. B. R. F. & A. G.  
Americus Ga.  
Sir

If you have not  
already taken steps to  
provide returns for the  
detachment of troops serving  
with you, for the ensuing  
month, by reporting to this  
office the number of returns  
required please do so  
without delay

[Faint, illegible text, possibly bleed-through from the reverse side of the page]

[Faint, illegible text, possibly bleed-through from the reverse side of the page]

Office Sub. Asst. Commr.  
Bur. of Prof. etc.  
Albany, Ga. Octbr 21. 67.

J. M. Robinson Esq.  
Agent. etc.  
Americus, Ga.

Sir,

You are requested, to forward to this  
Office, with as little delay as possible, Requi-  
sitions for fuel, accompanied with Vouchers  
for the purchase of the Same, for Detach-  
ment 16<sup>th</sup> U. S. Inf. on duty at Americus, Ga.  
for month of October. 1867.

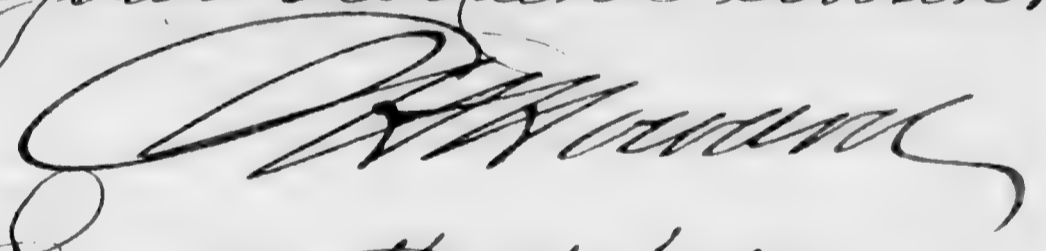
Very respectfully  
Your obedient servant  
  
Lieut 5<sup>th</sup> U. S. Artillery  
Sub. Asst. Commr.

No 13,

Office A. C. Subst.  
Macon Ga Oct-22/67

Moore C. E.  
1<sup>st</sup> Lieut 16<sup>th</sup> Infy F. A. C. S.

Encloses a check for  
Eleven dollars & Sixty  
Cents  $11 \frac{60}{100}$  — — —



Office Acting Commissary of Subsistence,

Waco, Tex. October 22<sup>d</sup> 1867.

P. H. Robinson Esq,  
Agent B.R. F.A.A.  
Americus Ga

iii

Enclosed please find my check  
No. 140. Cash Treasurer's receipt No. 1000. Cash  
in full of \$500<sup>00</sup> payable to the order of Saml Hardy,  
who has furnished Troops at Americus Ga. during the month  
of September 1867.

Please acknowledge receipt of this  
communication. I would inform you that the Detachment  
at Americus, Ga. draw pay but nine days out of the

To Sir

Very respectfully  
Yours  
Waco

1<sup>st</sup> Lieut. H. S. Galt,  
A. C. S.

11

11

Howe's  
Boy

Bureau of Refugees, Freedmen and Abandoned Lands,  
Office Sub-Assistant Commissioner,

Sub. Dist. of Culbert, Ga., Albany, Ga. Nov. 4, 1867.

J. M. Robinson, Esq.  
Agent Bureau of R. F. & A. L. S.  
Americus, Ga.

Sir,

I am required by Lieut. G. E. Moore  
16th. U. S. Inftry. A. A. Co. M. Post of Macon, to  
sign Dupl. Bill of Lading for two barrels of  
Subsistence Stores, shipped to the Detachment  
of troops on duty at your Station, for the  
Month of November '67. You will please in-  
form without delay, if the 2 barrels of Sub.  
Stores, weight 424 lb, have been received in  
good order.

Very respectfully  
Your obedient servant

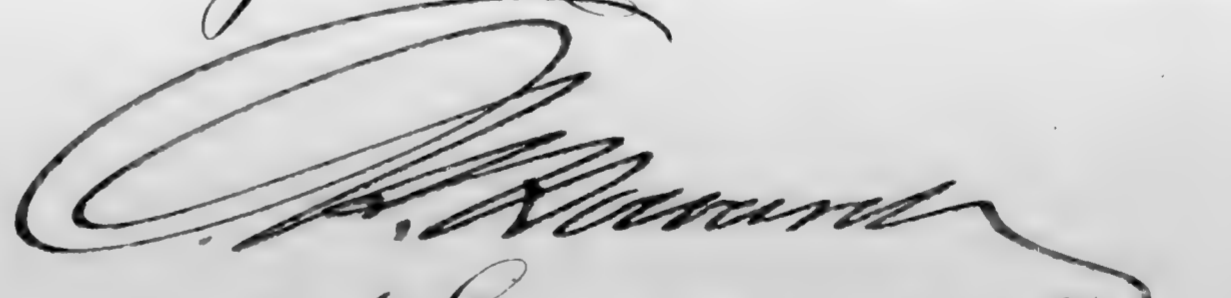
  
2<sup>d</sup> Lieut. 5<sup>th</sup> U. S. Art.  
Sub. Asst. Commr

1

2

3

4

5

I have the honor to acknowledge  
the receipt of your letter of the  
10th inst. in relation to the  
matter of the ...

I have the honor to acknowledge  
the receipt of your letter of the  
10th inst. in relation to the  
matter of the ...

As  
I have the honor to acknowledge  
the receipt of your letter of the  
10th inst. in relation to the  
matter of the ...

I have the honor to acknowledge  
the receipt of your letter of the  
10th inst. in relation to the  
matter of the ...

I have the honor to acknowledge  
the receipt of your letter of the  
10th inst. in relation to the  
matter of the ...

Dear Mr. [unclear]

[Signature]  
[unclear] of [unclear] [unclear]  
[unclear] [unclear]

1

7

1867

Dear Sir,

Mr. Frank [unclear]

Respectfully  
Yours truly,  
[unclear]

Office Sub. Asst. Commr.  
Bur: S. & T. Lds.  
Albany, Gov. Novbr 7. '67.

I respectfully referred to  
J. S. Robinson, Esq. Agent  
who will use every precau-  
tion, to ascertain, if the  
within named Murderer  
is in the limit of his Di-  
vision, and if possible se-  
cure his arrest notifying  
this Office, at once of the fact.

C. H. [unclear]  
Clerk.

In absence of the  
Sub. Asst. Commr.  
And by his Order.



1867

Bureau of Refugees, Freedmen, and Abandoned Lands,  
Office Asst. Commissioner State of Georgia  
Atlanta Georgia Nov. 5<sup>th</sup> 1867.

Lieut. C. H. Howard  
D. A. Comr.  
Albany Ga.

Sir,

The following described man, known by the name of G. J. Gofich,  
is charged with the murder of Tony McCanley, (freedman) at Perry Ga.  
on the night of Nov. 2<sup>nd</sup> 1867, at about 11 O'Clock.

He is described as being Twenty two (22) years of age. Five (5) feet  
six (6) inches high, Sandy hair. Blue eyes, sound shouldered, weighs, one  
hundred and sixty (160) pounds, wore at the time of the murder, a Grey  
Coat, Drab pants and high felt hat.

The Asst. Comr. directs that you use every precaution to ascer-  
tain if he is within the limit of your District, and if possible, secure  
his arrest, notifying this Office at once of the fact.

I am Sir, very respectfully

Your obedient servant,

(sgd.) M. Frank Gallagher.

St. and A. A. A. Genl.

C. H. Howard  
Lieut. C. H. Howard  
In the absence of the  
Sub. Asst. Comr.



[Faint, illegible text, possibly bleed-through from the reverse side of the page. Some faint markings resembling "11" and "10" are visible.]

[Faint, illegible text, possibly bleed-through from the reverse side of the page.]

Bureau of Refugees, Freedmen and Abandoned Lands.

Office Sub-Assistant Commissioner.

{ Sub-Distr. of Northbr. Co., Albany, Ga. Nov. 1867.

J. M. Robinson, Esq.  
Agent, etc.  
Americus, Ga.

Sir,

You will please inform me, as soon as practicable, if you can find in Americus or vicinity, a suitable Clerk for your Office, who can take the required oath, and if so, at what salary you will be able, to secure the services of such Clerk.

Very respectfully,  
Your obedient Servant.

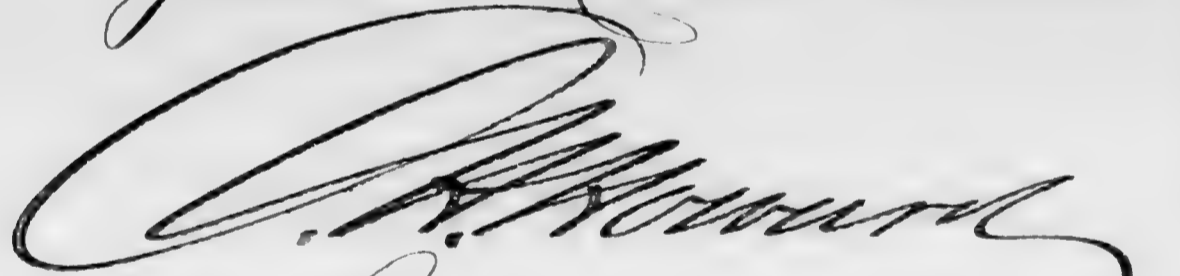
  
2<sup>d</sup> Lieut. 5<sup>th</sup> U. S. Art.  
Sub. Asst. Commr.

James M. Smith  
L. 100  
Bureau of Census

Office Acting Assistant Quartermaster,

Macon, Ga., Nov. 14 1867.

J. M. Robinson Esq  
S. C. Cav. B. R. 7<sup>th</sup> & A. L.  
Americus, Ga.

Sir:

Enclosed please  
find my check No 5 on Asst Treasurer New York  
for \$4<sup>00</sup>/<sub>100</sub> payable to the order of Jesse Hardy, for  
wood furnished to the Detachment of troops at  
Americus for the month of October, 1867.  
Please acknowledge receipt.

Very respectfully  
Your obedt. Servt.  
Jat. M. Ingalls  
1<sup>st</sup> Lt. 16<sup>th</sup> Aft  
A. C. 2. M.

[Faint, illegible text in the upper and middle sections of the page, possibly bleed-through from the reverse side.]

[Faint, illegible text in the lower section of the page, possibly bleed-through from the reverse side.]

Bureau of Refugees, Freedmen and Abandoned Lands,

Office Sub-Assistant Commissioner,

Sub-Dist: of Cuthbert, Ga., Albany Ga. Nov 19 1867.

J. M. Robinson, Esq.  
Agent, etc.  
Americus, Ga.

Sir

I have the honor to inform you, that hereafter the Civil Authorities of the various Counties in this Sub-Dist: must be compelled by the Agents etc of this Bureau, to care & provide for destitute people in their localities, regardless of color.

You will bring to the Notice of the Civil Authorities all cases of destitution, coming under your observation, and in case the local Authorities refuse or neglect to provide for such cases, they will be immediately reported to this Office, in order that steps may be taken for their removal.

Respectfully

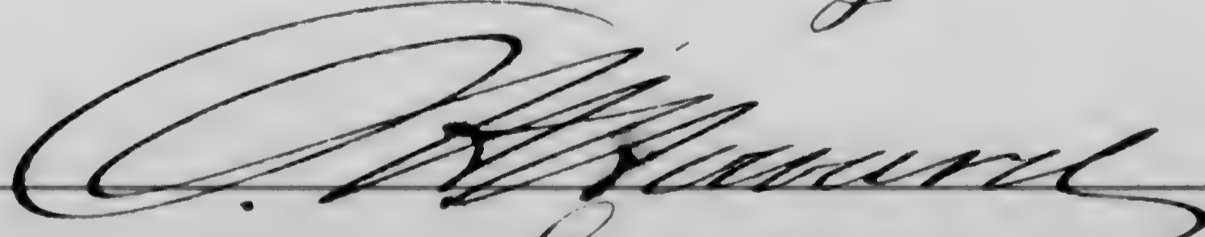

2d Lieut: 5th U.S. Art  
Sub. Dist. Commr.

[Faint, illegible text, possibly bleed-through from the reverse side of the page]

Bureau of Refugees, Freedmen and Abandoned Lands,  
Office Sub-Assistant Commissioner.

Sub-Dist. of Cuthbert, Ga., Albany, Ga. Nov 19 1867.

J. M. Robinson, Esq.  
Agent: Bureau F. R. & A. Lds.  
Americus, Ga.

Sir,

1<sup>st</sup> You will please to make to this Office, on  
" or before the 20<sup>th</sup> inst. a general report of  
" the condition of Affairs in your Division.  
" You will state as clearly as possible  
" the disposition of the white population,  
" the planters, professional men and Civil  
" Authorities towards the freedpeople, and  
" the disposition of the freedpeople towards  
" them.

State how the freedpeople have worked  
during the current year, and how they  
have been treated by their Employers ge-  
nerally, enumerating any cases of cruelty,  
oppression, or injustice, that have come



under your notice.

Report the progress of Education, among the freedpeople, whether they have a desire and disposition to learn or not, and ~~what~~ what measure, if any they have taken to provide themselves with Schools, or other means of obtaining an Education, or if any such provisions has been made for them, by the government or any association

4/10  
State what in your opinion would be the result of entrusting the entire interests of the freedpeople, with their present limited acquirements and knowledge of business, to the Civil Authorities.

Be careful to have your report include as full a Statement with regard to your outlying Counties, as to that in which you are located.

You will make such suggestions as to the future administration of the duties of the Bureau in your Division, as your experiences there may dictate.

Let your report be as full as, in your opinion, the importance of the subject may demand.

Very respectfully  
Your obedient servant

*C. A. Murray*

2<sup>d</sup> Lieut: 5<sup>th</sup> U. S. Art.

Sub. Asst. Commr.

P. S.

You will state at the same time in a Special Report, whether or not in your opinion there is to be in your Division, many cases of extreme want or suffering; amongst the white & blacks, during the approaching winter and spring, for food or clothing & will give your views, as to the best Method of preventing starvation and relieving suffering.

*C. A. Murray*

2<sup>d</sup> Lieut: 5<sup>th</sup> U. S. Art.

Sub. Asst. Commr.

[Faint, illegible text]

[Faint, illegible text]

[Faint, illegible text]

Bureau of Refugees, Freedmen and Abandoned Lands,  
Office, Sub-Assistant Commissioner,

Sub. Dist. of Collect. Co., Albany, Ga. November 18, 1867.

J. M. Robinson, Esq.  
Agent, etc.  
Americus, Ga.

Sir,

I return herewith your requisition for Stationery.

You should make duplicate requisitions on Form No. 38, calling for the quarterly allowance of Stationery, specified in Circular No. 9, O. S. C. April 27, '67, and if in your estimation, that allowance will be insufficient, you will transmit also, at the same time, duplicate Spw. Req. for as much in addition, as may be necessary.

You will make separate duplicate Sp. Req. for the flag you require, designating it, as "One Recruiting Flag."

For fuel for your Office you will make dupl. Req. on Form No. 30, copies of which, I sent you herewith, your purchase vouchers

No 12, should be dated in November. Requisitions for fuel must be forwarded, before the 15<sup>th</sup> of each month, and it is too late now, to make requisition for fuel for month of Oct.

No letter of transmittal for Reports or Returns passing through my Office need be addressed to me, but such letters should accompany all Returns & all Reports (which are not themselves mere letters) & should be addressed to the Officer, for whom such Return or Report is intended.

For your instructions, I enclose Models of such letters of transmittal, in which you will observe, that a letter intended for the Asst. Comr, is marked in red ink "Thro' Lieut. C. St. Howard. 5<sup>th</sup> Artillery. Sub. Asst. Comr". All letters passing thro' my office to higher Authority should be marked, as in the Model.

Your vouchers for travelling Expenses must be accompanied by a letter of transmittal. I return them herewith.

I return your School report for the

same purpose.

To make all plain for you, I have prepared all the papers for your signature. You have only to sign them, copy the letters into your "Book of Letters Sent," and return them to me.

It is earnestly hoped that you will require no further instructions on the points, which I have touched in this letter.

Respectfully

A. M. M. M.

2<sup>d</sup> Lieut. 5<sup>th</sup> U. S. Art.  
Sub. Asst. Comm.

C. J. Waters  
Mar 29/67  
Hempstead

Bureau of Refugees, Freedmen, and Abandoned Lands.  
OFFICE ACTING ASSISTANT QUARTERMASTER AND DISBURSING OFFICER, STATE OF GEORGIA.

Atlanta, Georgia, Nov. 19 1864.

Sir.

Your returns of Stores pertaining  
to Bureau R.F. & A.L. for the months of August  
& September and your returns of Clothing  
Camp and Garrison Equipage for September  
returned for correction, have not been  
received. ~~Neither have your~~  
~~returns for October been received.~~

Your attention is invited to the  
accompanying Circular.

Very Respectfully  
Your obedt servt

C. J. Watson

Adjutant &c.

Capt. J. M. Robinson

Adjutant &c

Amesboro Ga



10/10/10

22/10/10

Bureau of Refugees, Freedmen and Abandoned Lands,

Office Sub-Assistant Commissioner,

Sub-Dist. Albany.

Albany ~~Georgia~~, Ga., November 22<sup>d</sup> 1867.

J. M. Robinson Esq.  
Agent. etc.  
Americus. Ga.

Sir,

You will please inform me, without delay, what number of Rations will be required for the troops at your Station for the Month of December.

Each enlisted man on duty at your Station, is entitled to one sixth ( $\frac{1}{6}$ ) of a Cord of Wood for the present Month of November.

Requisition for this wood will be made by me, meantime you are authorized to purchase the wood, & upon sending me Dupl Forms No 12 C. M. D. receipted in blank, notifying

me, of the amount of Wood purchased  
and the rate pr Cord, you will be re-  
imbursed.

Please do this at once and hereafter  
before the 10th of each Month, for the  
current Month

Very respectfully  
Your obedient Servant

*A. M. Munn*  
2<sup>d</sup> Lieut. 3<sup>th</sup> Regt.  
Sub. Ast. Co. 1<sup>st</sup>

E. J. Watson  
Mar 24/27  
Springfield, Mass

Bureau of Refugees, Freedmen, & Abandoned Lands.

OFFICE ACTING ASSISTANT QUARTERMASTER AND DISBURSING OFFICER, STATE OF GEORGIA.

Atlanta, Ga, Nov 26 1867.

Captain,

I return you copies of  
Returns Bureau Stores & C.C. & G.E. as  
requested.

Your returns of Bureau  
Stores for months of August & Sept  
and C.C. & G.E. for Sept. which were  
returned for correction have not  
yet been received corrected.

Until they are and the October  
returns you cannot be paid.

There will be no delay about  
your pay when the returns and  
reports are rendered promptly.

Very truly

Yours &c

C. S. Watson

Adj. Gen. & Co

Capt. J. M. Robinson

Adj. Gen.

Americus

*L. H. ...*  
*...*

Bureau of Refugees, Freedmen, and Abandoned Lands.  
OFFICE ACTING ASSISTANT QUARTERMASTER AND DISBURSING OFFICER, STATE OF GEORGIA.

Atlanta, Georgia, Nov. 26 1867.

Captain.

Enclosed find my check  
on Atlanta Nat Bank for \$27 -  
in payment of vouchers of Smith  
& Glover for rent \$20 - and Jesse  
Hardy for wood \$7 - forwarded  
by you.

Very Respectfully  
Your obedt servt  
C. J. Watson  
a. a. q. m. & d. o.

Capt. J. M. Robinson  
Agent Bureau of  
Americas Ga

to see it + ...

Cities agt Bureau R. F. A. L.  
Albany Ga. Nov 26<sup>th</sup> 1867

Robinson J. M. agh

Reminds List of times expenses  
in the month of August for  
approval

Bureau R. F. A. L.  
H. & C. A. S. D. of Albany  
Albany Ga. Nov 27<sup>th</sup> 67

Respectfully forwarded  
to Lieut. M. A. Gallagher  
A. A. S. Genl. Bureau R. F. &  
A. L. Albany Ga.

*M. A. Gallagher*

Expressed by 2<sup>d</sup> Lieut. 5<sup>th</sup> Art.  
S. A. Comr.

R. F. A. L.  
H. & C. A. S. D. Albany  
Albany Ga. Dec 5<sup>th</sup> 67

Respectfully  
forwarded

*M. A. Gallagher*

Expressed by 2<sup>d</sup> Lieut. 5<sup>th</sup> Art.  
S. A. Comr.

*J. R. Lewis*

...



Office Agent Bureau R.F.L.P.  
Americus Ga November 26<sup>th</sup> 1867

Lieut W Frank Gallagher  
A.A.S.G.  
Atlanta Ga

Lieut

I have the honor to transmit  
herewith my list of stores expended (from 15. to 33.) for the month of  
August for approval. The originals were forwarded about the 1<sup>st</sup>  
of September, but have never been received. I am

Lieut

Very Respectfully  
Yours obt Servant  
J. W. A. Shindler Capt

Through  
Lieut O H Howard  
J. W. S. Little  
S. S. H. Jones  
Atlanta Ga

A. 101. Oct. 18. 1847. P. 195. 1st

B. F. F. & A. A.  
H. C. Atty. Gen. Albany  
Albany. Co. Oct. 18. 47

Respectfully forwarded  
to J. M. Robinson Esq.  
Agent Div. of Fisheries.



2d Street 5th St. N.Y.  
N.Y. Co.

Wm. L. ...

Bureau Refugees, Freedmen, and Abandoned Lands,  
OFFICE ASSISTANT COMMISSIONER, STATE OF GEORGIA.

Atlanta, Ga., Nov 29<sup>th</sup> 1867.

Mr James M. Ransom  
Agent  
Municipal  
Ga

Sir,  
Your communication of  
re suit for interest under "Regulation of  
Quarterly allowances, Standard for 1867  
" Special Requisition for additional amount  
was received. This office without the ~~the~~ <sup>Special</sup>  
~~Requisition~~ <sup>Requisition</sup> You will please prepare a copy of  
the same mentioned requisition and for  
word the same when it will be filled.

I am Sir

Very respectfully  
Yours At Sent  
J. R. S. S.  
Nov 29<sup>th</sup>

no. 14  
A. S. 195

No 14

---

Office Acting Assistant Quartermaster,

Macon, Ga., Nov 30<sup>th</sup> 1867.

J. M. Robinson  
Adj. B. S. D. A. C.  
Macon, Ga.

A returned Invoice from  
your Duplicate of 1000 lbs of  
beef was assigned to you on Nov 16<sup>th</sup>  
16<sup>th</sup> of Inst. stationed at American Mill  
Please sign Duplicate and return it to  
his office at your earliest convenience.

Very respectfully,

J. M. Robinson

Adj. B. S. D. A. C.

P.S. No Fresh Beef will be purchased  
as full allowance of Pick was sent

J. M. R.

674, vol 1, 18

Bureau R & I A L  
Americus Ga December 2 1867

Robinson J M  
Agent

Transmits List of stores  
expended in approval  
for month of November 1867, re-  
questing that one copy, may be  
returned to him.

1867

B. F. F. & A. L.  
H. d. Ctr. S. D. Albany  
Albany Ga Dec 3. 67

Respectfully forwarded  
to Lieut. M. Frank Gallagher  
A. S. S. Genl. Atlanta. Ga.

*[Signature]*  
2. d. Lieut. 5th. Art  
S. T. Cassir.

J. R. Lewis

B. F. F. & A. L.  
H. d. Ctr. S. D. Albany  
Albany Ga. Dec 4. 67

Respectfully  
forwarded.

*[Signature]*  
2. d. Lieut. 5th. Art  
S. T. Cassir.

S. O. vol.  
No. 12.

Office Bureau R. F. & A. L.  
Americus Ga December 2<sup>nd</sup> 1867

Lieut W. Frank Gallagher  
A. A. S. G.  
Atlanta Ga.

Lieut

I have the honor herewith  
to transmit List of Stores expended. (Form 13)  
pertaining to Bureau R. F. & A. L. for the month of  
November 1867 for approval and am

Lieut

Very Respectfully  
Yours Obs. Servant  
J. M. Robinson Agent

Enough

Lieut C. H. ...  
5<sup>th</sup> U. S. ...  
S. O. ...  
Atlanta

Sub Sis Albany  
C. H. Howard  
H. & C. A. C.

Order that premium have  
first-lien on crop until  
paid



Bureau of Refugees, Freedmen and Abandoned Lands,  
Office Sub-Assistant Commissioner,  
Sub. Dist. Albany,  
Albany ~~City~~, Ga. December 6, 1867.

J. M. Robinson, Esq.  
Agent B. & O. F. & A. L.  
Americus, Ga.

Sir,

I have the honor to inform you, that the Asst. Comr directs, that in all cases where planters have given merchants or factors, mortgages or liens upon crops to secure them for supplies furnished planters or freedmen, and the crop is insufficient to pay the factors or merchants and the freedmen, you are to insist, that the freedmen be paid, and if necessary you will seize sufficient of the crop made by the freedmen, to secure their claims, making immediate and

full report of the case, to the Asst. Comr.  
The freedmen's contracts are lies  
upon the crops they make.

Very respectfully  
Your obedient servant

*J. A. Cassin*  
2<sup>d</sup> Lieut. 5<sup>th</sup> Art.  
J. A. Cassin.

Edw. M. S.

38100. C. S. P. Vol. 3. 1867

Binman R. F. A. L.

St. Francis Ger

Dec 3. 1867

Robinson J. M.

Agent

Transmits "List of  
S. C. Ex. 1867"  
Month of September  
for 1867

*[Faint, mostly illegible handwritten text]*

J. R. Lewis

B. S. P. & A. L.  
600. C. S. P. Albany.  
Albany. Ga. Dec 6. 67.

Respectfully  
forwarded.

*[Signature]*

2<sup>d</sup> Street. 5<sup>th</sup> St.  
St. Louis.

Albany. Ga. Dec 6. 67.

Bureau R.F.O.S.  
American Co  
Dec 3, 1867

Mr. H. Frank Sullivan,  
A. S. T. Genl.,  
Atlanta,

Yr. favor the name  
of "Lauder's" printed "List of States Export"  
in office in the month of September and  
respectfully ask they be returned and  
returned as early as possible. In view  
however the copies previously furnished  
have become missing and Mr. Annual  
has notified me to send other copies  
to him at once. Urgency I have not  
as yet since, but as a matter of  
urgency, are in great need of money,  
which cannot be had in any other  
way than in the sale of

Very respectfully,  
J. H. Sullivan

Bureau R. F. & N. O.,  
HEADQUARTERS SUB-DISTRICT OF ALBANY

*Albany, N. Y. July 17, 1863*

Respectfully forwarded to  
W. MORRILL, ESQ., Agent Bureau Refo-  
red Freedmen and Emancipated Lands Division  
of American - American, Co.

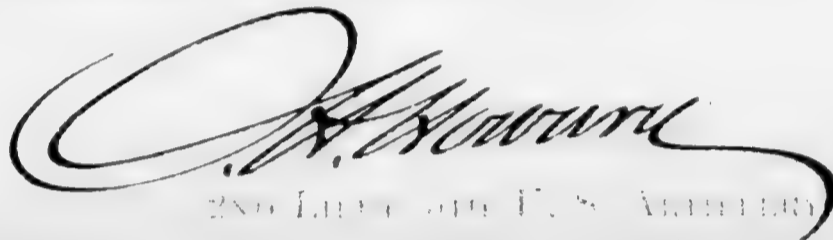

280 LINDEN ST. N. Y. ALBANY  
Sub-Assistant Commissioner.  
See N. Y. L. L. R. Vol. 2, 1863

29. Oct. 1867.

Office Agent Bureau R. F. A. L.  
Columbus Geo. Dec. 7. 1867.

Office Agent Bureau R. F. A. L.  
Columbus Georgia Dec. 7. 1867.

Office Agent, Bureau R. F. A. L.  
Albany Ga., Dec 16, 1867.

Chapman C. W. Agent

Chapman C. W. Agt.

Affidavit of Charles  
Jones stating he has a daughter  
living with Geo. Brown of  
Webster Co. Geo. who has had  
her in his employ for the last  
three years, and refuses to res-  
cuse her to her parents.  
Charles prays that she may  
be returned to him & Brown  
be compelled to make com-  
pensation for her services.

Respectfully forwarded  
through Lieut. George Wagner  
S. A. L. Columbus Georgia

Office Agent Bureau R. F. A. L.  
Columbus Ga. December 7. 1867

Respectfully forwarded to  
Beig Lieut. H. C. Holt, West. Com'r  
S. A. L. of Georgia, for his action.

George Warner  
11th Street S. A. L. of Ga.

Respectfully referred to  
M. Robinson, Agent, West  
Lt. C. H. Howard, S. A. L.  
Albany, Ga. for investiga-  
tion, action & report.

By order of  
J. R. Lee

Major  
Albany Ga. Dec 17. 67

Albany S. A. L. Albany  
Albany Ga. Dec 17. 67

Respectfully  
forwarded.

George Warner  
S. A. L. of Georgia

State of Georgia,  
Muscoy County } Personally appeared before me, C. W. Chapman,  
Agent Bureau P. O. & A. L. Columbus, Georgia, Charles  
Jones, freedman, who being duly sworn says that he is  
the father of Maria Jones, about fifteen years of age, who  
now is & has been for the past three years in the service  
of George Brown in Webster Co. Geo. - That Lovisa,  
the mother of Maria & wife of Charles has endeavored to  
get possession of her daughter, but in consultation with  
George Brown on the subject, he refused to deliver her,  
Maria, to her parents. Charles prays that his  
daughter may be restored to him, and said Brown  
be made to pay for her services while in his  
employ.

subscribed & sworn to  
before me this seventh  
day of December 1867.

C. W. Chapman, Ayt.

Bureau P. O. & A. L.

Columbus Geo.

Charles <sup>his</sup> Jones  
made

Charles Jones has with the name  
Bachman, shall do. Geo.  
P. O. is sufficient.  
Also Bureau's P. O. is sufficient.  
Bureau Co.

Handwritten text, possibly a name or address, including a small circular mark on the left.

Handwritten number:  $15 \frac{50}{100}$

Handwritten text: No 15





Office Acting Assistant Quartermaster,

Macon, Ga., Dec. 9 1867.

J. M. Robinson Esq  
| Agt. B. R. F & Co. L.  
Americus, Ga.

Sir:

Enclosed please  
find my check # 37 on Asst. Treas. New York  
for \$5 <sup>83</sup>/<sub>100</sub> payable to the order of Jesse Hardy in  
payment of wood furnished detachment 16<sup>th</sup> Infy  
at Americus in November, 1867. Please acknowl-  
edge receipt

Very respectfully  
Your obt. Servt.  
Jas. M. Ingalls  
1<sup>st</sup> Lt. 16<sup>th</sup> Infy  
A. G. I. M.

P  
Peter Rankin Hawling Seats 89 - 00  
David Redman 6 Days work 9 - 00  
John Brooking 4 - 00

Mason Ga Dec 11/67  
David Burn,

Enclosed \$22.75 to pay  
certain notes, named  
within.

No 14.

Nov 11<sup>th</sup> 1865

Capt J. M. Williams  
A 24<sup>th</sup> Cavalry  
Ct.

I have the honor to receive your letter of the 11<sup>th</sup> inst. and in reply to inform you that the same has been forwarded to the proper authorities. I am sorry to hear that you are unable to get any more of the kind you want, but it is very likely that the supply of paper of the kind you refer to is exhausted, and you will have to wait until the next supply arrives.

Very respectfully,  
Daniel Kearns

1848

1848

Bureau of Refugees, Freedmen and Abandoned Lands.

Office Sub-Assistant Commissioner,

Sub Dist. Albany Pa. 4

Albany ~~Albany~~ Ga., December 18<sup>th</sup> 1867.

J. W. Robinson  
Agent Bureau R. F. & A. L.  
Americus Ga.

Sir,

You will please make out your requisition for fuel for Month of January 1868, which will be forwarded through this office, and thereafter authority will be given you to purchase the same.

You will do so before the 15<sup>th</sup> of each month, for the fuel required in the next month.

Very respectfully

Your obedient servant

*C. A. Howard*

2<sup>d</sup> Lieut. 5<sup>th</sup> Art.

Sub Ass't Com'r.

Albany Ga.

Dec. 14 1817

Capt. J. M. Robinson

Agent &c.

Dear Sir

I send  
Mr. Geo. Schotzfeldt to  
Americus to lease  
quarters for the detach-  
ment of troops stationed  
there. Please render  
him all necessary as-  
sistance.

He will, while in  
Americus, endeavor to  
make up your property  
returns.

He is instructed  
to bring back to Albany  
if you do not require

his services lawyer at  
Amiricw.

Very truly yours

*W. A. Wood*  
Lieut. & S. A. C.

1864



1. The first part of the report  
 discusses the general situation  
 and the progress made during  
 the year. It also mentions  
 the various projects which  
 have been undertaken and  
 the results obtained. The  
 second part of the report  
 deals with the financial  
 statement and the balance  
 sheet. It also mentions the  
 various items which have  
 been received and the  
 amount of the same. The  
 third part of the report  
 deals with the personnel  
 and the work done by  
 the staff. It also mentions  
 the various projects which  
 have been undertaken and  
 the results obtained. The  
 fourth part of the report  
 deals with the general  
 situation and the progress  
 made during the year. It  
 also mentions the various  
 projects which have been  
 undertaken and the results  
 obtained.

The fifth part of the report  
 deals with the general  
 situation and the progress  
 made during the year. It  
 also mentions the various  
 projects which have been  
 undertaken and the results  
 obtained. The sixth part  
 of the report deals with  
 the general situation and  
 the progress made during  
 the year. It also mentions  
 the various projects which  
 have been undertaken and  
 the results obtained.

Bureau R. F. & A. L.  
Headquarters Sub. Dist Albany  
Albany Co. Dec. 16. 1867

Capt J. M. Robinson  
N.Y. &c.

Dear Capt:

Please enforce  
your decision in the case  
of Alfred Royce (freedman)  
versus W. H. Brewer (white).

I understand that the  
freedman is suffering for  
his money.

Very truly yours

O. H. Adams  
G. & S. O. C.



Bureau of Refugees, Freedmen and Abandoned Lands.

Office Sub-Assistant Commissioner.

Sub. Dist. Albany  
Albany ~~Albany~~ <sup>Albany</sup> ~~Albany~~ <sup>Albany</sup> December 16<sup>th</sup> 1867.

J. W. Robinson  
Agent B. R. F. & A. L.  
Americus Ga.

Sir,

Your attention is again called to my communication of the 22<sup>nd</sup> ult. directing you to forward to this office on or before the 10<sup>th</sup> of each month, vouchers for the purchase of wood for the use of enlisted men for the current month.

You will please, state your reasons for not complying with the directions contained in the letter referred to above.

Very respectfully

Your obedient servant

*A. H. Murray*

2<sup>d</sup> Lieut 5<sup>th</sup> Art.

Sub. Asst. Comm'r.

L. P. Watson  
Dec 16 1891  
Chgo paper & ...

Bureau of Refugees, Freedmen, & Abandoned Lands.

OFFICE ACTING ASSISTANT COMMISSIONER AND RECEIVING OFFICER, STATE OF GEORGIA

Atlanta, Ga., Dec 16 1867.

Sir.

Enclosed find my check on Atlanta Nat. Bank for \$325<sup>00</sup> in payment of your vouchers for Col + A. for pay and postage and of Smith's for rent for Nov.

Your payments have been delayed on account of some of your returns not being received, of which I will write you more fully

Very respectfully

Yours obedt servt

C. J. Watson

Acting Com.

J. M. Robinson Esq

Agent &c

Americus Ga

C. T. Malcom  
Dec 17/57  
Personne & ...

Bureau of Refugees, Freedmen, and Abandoned Lands.

OFFICE ACTING ASSISTANT QUARTERMASTER AND DISBURSING OFFICER, STATE OF GEORGIA.

Atlanta, Georgia, Dec 17 1864.

Friend Robinson,

Your personal of a few days ago was rec'd and I forwarded you the money for your vouchers. although it is contrary to my orders unless all returns have been rendered and found correct.

Your returns for Oct + Nov are in my office but I cannot examine them until the back returns have been received which were returned for correction.

Your returns of Bureau Stores for August was returned Oct. 16 with this endorsement. "Vou 2 not approved. Dates of issue on sub vouchers not given. Vacant spaces not filled"



Your returns of Bureau forms for Sept  
was returned same date. endorsed  
"No vouchers accompany returns  
Returns required in duplicate only"

Your returns of C, C & G. E. for  
Sept. was returned Dec 7. endorsed  
"Returns required in triplicate"

Neither of these returns  
has been returned and is the  
cause of detention of pay.

Your records should show if  
they have been received at your  
office and if you have corrected  
and returned them. and I  
would advise you to hunt them  
up. or if you cannot do that  
to make new returns for those  
months and forward thus  
saving a delay again

Very truly  
Yours &c  
C. J. Watson

1820. 10. 19. Albany, N.Y.  
Dear General, I have  
the honor to acknowledge  
the receipt of your  
letter of the 14th inst.

respecting the  
trial of the  
case of the  
General in the  
case of the  
General, which  
I consider no more  
than a matter of  
the circumstances,  
to come to a  
decision, and  
I have the honor  
to inform you that  
the Court will  
grant a new trial.

In the case  
of the  
General  
Albany, Ga. Dec 19, 1820

Respectfully returned  
to J. M. Robinson, Esq. Sgt  
Div. of America, Ga. who  
will grant a new trial.

*[Signature]*  
J. M. Robinson  
Sgt. & the  
Div. of America

Amherst Dec 18<sup>th</sup> 1867

Capt J M Robinson

Capt Bureau Ft & A S

Sen to Schley & Webster Counties

Captain

in response to the notice calling on me  
to show cause forthwith or pay over the  
money to the amount of a judgment ren-  
dered by you in the case of Alfred Royal prisoner  
for the sum of \$114<sup>00</sup> Respondent respectfully  
sheweth that said judgment is inequitable  
& unjust & should not be enforced as he believes  
and at the trial of said case respondent did  
not know the facts thereof & therefore failed  
to present the same to your honor, Respondent  
further sheweth that said judgment should  
be set aside & a rehearing granted upon  
the following grounds to wit:

1<sup>st</sup> Because Respondent is not nor never was  
liable to pay Alfred Royal any money  
whatsoever, as he respondent never undertook  
or promised to pay him any sum what-  
ever in any way.

2<sup>nd</sup> That the judgment rendered in said case  
is not in accordance with equity, good conscience  
or justice & contrary both to English & American  
law as adjudicated by the courts.

3<sup>rd</sup> That if any person is liable to the said  
Alfred it is John W Jordan & not respondent

The said Jordan assumed & undertook  
of the said Nathan to pay all liabilities that  
said Nathan was responsible for to the said  
Alfred & said Bruce in reference to the  
said lot at the time he purchased from the  
said Nathan & Respondent had nothing  
whatever to do with the leasing of the lot or  
any portion thereof to the said Alfred by  
the said Nathan or the sale by the said  
Nathan to the said Jordan - except that  
he consented to take up the Bond made  
by him to the said Nathan & make one  
to Jordan by the special request of  
said Nathan & Jordan - which he did  
binding himself to make good &  
sufficient title in fee simple upon the  
said lot upon the payment of the  
purchase money - which he is ready  
& willing to do at this time upon con-  
presence on said Jordan's part  
4<sup>th</sup> The doctrine of Landlord & Tenant  
does not arise in this case as  
the said Nathan Bruce was not  
holding under respondent as tenant  
But was holding under a purchase  
& Sale in his own right - Therefore res-  
pondent contends that your Honor com-  
mitted error in holding that it did  
exist & the acts of Nathan constituted

his respondent's agent & therefore  
made him liable for the payment of  
said sum

5<sup>th</sup> Because respondent has discovered  
witnesses who will substantiate & prove  
the facts as set forth & that he was not  
culpable of the same at the time of  
trial. Said witnesses are Dr 13941 and  
others men of high character

6<sup>th</sup> Having stated these several grounds  
of error respondent prays that  
you will take the statement hereto  
annexed of said Nathan corroborated  
by others as part of the case and  
that you discharge respondent from  
said judgment or upon the case  
so that the facts be presented & justice  
be done in the premises in accordance  
with Equity & justice -

And respondent will ever pray  
&c &c

A. C. Brown

Attorney at Law

1874

*William  
H. Fry*

Bureau of Refugees, Freedmen, and Abandoned Lands.

OFFICE ACTING ASSISTANT QUARTERMASTER AND DISBURSING OFFICER, STATE OF GEORGIA.

Atlanta, Georgia, Dec 18 1864.

Captain.

Enclosed find my check on Atlanta Nat. Bank for \$16 in payment of vouchers of Jesse Hardy for wood, and one of yours for transportation.

I return two transportation accounts. The receipts when changed to increase an amount are not allowed.

Very Resply

Your obedt servt

C. J. Watson

Adjut & D.C.

Capt. J. M. Robinson

Adjut &c

Americus Ga



*[Faint, illegible handwritten text]*

Bureau of Refugees, Freedmen and Abandoned Lands,  
OFFICE ACTING ASSISTANT QUARTERMASTER AND DISBURSING OFFICER, STATE OF GEORGIA.

Atlanta, Georgia, Dec 20 1864.

Friend Robinson

Yours of 19<sup>th</sup>

rec'd.

Not having your returns for September, I cannot send you the Sub Vouchers. The returns of Bureau Stores Aug & Sept. which were returned here not since come back. I have the returns for Oct & Nov.

Your returns A. C. & G. E. are all right now except the Nov ones, which have come in in duplicate. Send me another copy.

Yours &c  
O. J. Watson

1874

*Faint handwritten text, possibly a signature or name.*

11

7

Bureau of Refugees, Freedmen and Abandoned Lands.

OFFICE ACTING ASSISTANT QUARTERMASTER AND DISBURSING OFFICER, STATE OF GEORGIA.

Atlanta, Georgia, Dec 24 1864.

Sir.

Enclosed find my check  
on At. Nat. Bank for \$59<sup>50</sup>/<sub>100</sub>  
in payment of your transportation  
mchus.

Very Respcly

Your obed<sup>t</sup> servt

C. J. Watson

Adjut & C.

Capt. J. M. Robinson

Adjut & C.

Americus Ga

# 1516

Mount Vernon Ga (Chief Agent Bureau R. A.)  
Dec 29<sup>th</sup> 67 (Atlanta, Ga. Jan 14<sup>th</sup>)  
Adams & Co

Enquire whether the  
Seward & Bureau  
will pay transportation  
-tion of freed people  
Recommends a  
worthy case.

Respectfully referred  
to M. Robinson Agent  
for H. C. Seward  
S. A. C. Bureau, Ga.  
for investigation  
1340  
21 Aug 1868

Bureau Civil Affairs  
Head Quarters 25 Mt. St.  
January 14<sup>th</sup> 68.

M. Robinson  
2598  
1514-7

Respectfully referred  
to Brigadier General  
C. C. Tilly, Assistant  
Commissioner Bureau R. A.  
of Georgia.

By command of  
Major General  
J. H. Ruffin  
Chief of Bureau

Mount Vernon Georgia  
(December 29th 1867)

General Pope  
Atlanta Georgia

General I have been informed that all matters pertaining to the Freedmen Bureau was transferred to you and, as such I make the following inquiries, Can persons of Color be, or rather will the Freedmen Bureau send persons of Color (when they wish to go back to their people and are not able to pay their own expenses) free of charge, If so there is a woman and three children here on my place who wishes to go to Virginia to her people and she is not able to pay her way, and I am not or else I would as they formerly belonged to me and have been here ever since they were freed, and her good conduct when a slave and since compels me to use every effort I can to get her back to her people in Virginia, and any assistance given her will be thankfully received, If they are allowed to go free of charge please notify me of the facts with particulars how to act in the premises immediately. And Oblige

Very Respectfully  
M. C. Adams

1844

Wm. H. ...  
No 110

Office Acting Assistant Quartermaster,

Macon, Ga.,

1867.



Bureau R. T. & A. S.  
American Co  
July 2, 1868

Cleghorn  
W. C. P.

Make application for  
the position of Clerk  
in the Bureau Office at  
Albany

Bureau R. T. & A. S.  
American Co  
July 3, 1868

Respectfully submitted  
to St. C. Howard U.S.  
Comm. Sub. District of Albany,  
The Office of the Agency  
is very much in need  
of a Clerk & has more  
business than I can properly  
attend to although I

I am often at work  
until midnight, &  
would therefore respectfully  
request that I be allowed  
to employ Mr. Cleghorn  
if only for a brief  
period

J. L. Robinson,  
Agent

St. C. Howard, S. D. Albany  
B. S. F. S. Albany, Ga. Jan 4. '68.

I respectfully forwarded  
to Genl. M. Frank Gallagher  
A. A. S. Genl. Atlanta, Ga.  
It is earnestly recommen-  
ded that Agent Robinson  
be allowed a clerk for a  
few months at least. It  
is impossible for him to  
perform the duties incum-  
bent upon him, without  
assistance

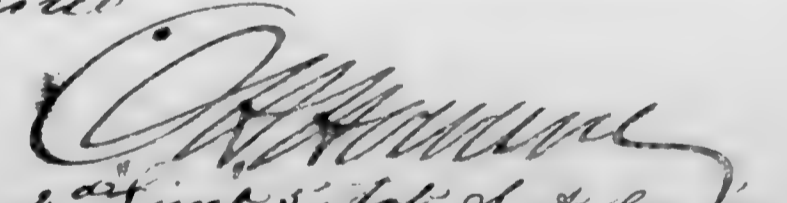
  
St. C. Howard, S. D. Albany

Office of the Bureau  
Atlanta, Ga. Jan 18<sup>th</sup> 1868

Respectfully submitted to  
M. J. Robinson, Agent  
St. C. Howard, S. D.

Atlanta, Ga. in ac-  
cordance with the  
instructions of the Com. to  
assist in the  
management of the  
Bureau Office

By order of  
St. C. Howard, S. D.

St. C. Howard, S. D. Albany

---

Head Qtrs. S. D. Albany  
B. F. F. & A. S.  
Albany. Gov. Jan 20. '68.

Respectfully  
forwarded.

  
2nd Street S. D. State  
S. D. Cass.

---

American Soc Dec 31 1847

J. M. Robinson Esq  
Genl Bureau Water  
Division of Surveys

I have the honor to acknowledge the receipt of your letter of the 24th inst. and to inform you that the same has been forwarded to the proper authorities for their consideration. I am, Sir, very respectfully,  
Your obedient servant,  
J. M. Robinson

J. M. Robinson  
Genl Bureau Water  
Division of Surveys

24  
Knoxville, Tenn Dec 25 '67  
Wilson J L

From unknown daughter  
with M. L. French  
Sumter County Geo  
where she was found  
by B. L. brother in  
law without Benj.  
consent, wish the  
child returned to

Office SAC, RR #1162  
Athens Geo Jan 3/68

Respectfully referred  
to W. Howard 2 trial  
3<sup>d</sup> U.S.C. & S.O.C. &  
Albany Geo, through  
Lieut. W. Frank  
Gallagher U.S.A. &  
B.P. #1162 Atlanta  
Geo

Sub A Com Bk #1162  
City Athens  
Call  
Call

Office Comm Bureau RR #1162  
Athens, Geo Jan 10<sup>th</sup> 1868.

Respectfully referred to  
J. M. Robinson, Agent  
Miss L. C. H. Howard  
S. C. Albany, Ga.  
By order  
B. J. Sibley

3710 2712  
701 4  
2711

Received  
Jan 11  
Respectfully  
Forwarded  
C. H. Howard  
S. C. Albany, Ga.

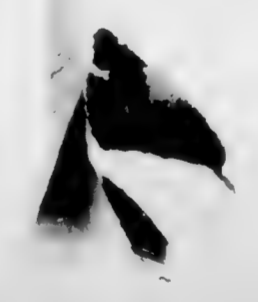

1847  
Dec 25<sup>th</sup> 1847

My Friend  
Beny Dummer's Daughter  
is still with A. S. Fessenden & Co  
in the Town of Ellaville - where she was bound  
to him by Beny S - Brother in law - without  
B's Consent - B - Made application to F. as  
soon as he was Freed - & F. promised him to  
send her up - & went home & bound her  
to him by the Bureau - failing to answer any  
of B's letters applying for her - the child's  
Grand Mother made several applications  
in behalf of B - before she was bound but  
all for nothing - F. knowing B - could not leave  
his business to attend to it - Does the  
act of the Supreme Court give her to  
her Father; Can you do anything for  
him; Can Genl Pope; If your business  
is not too urgent please write me & give  
the particulars - Very Respectfully  
J. S. Milner

Office of the Bureau of the  
Atlanta, Ga. Jan 4<sup>th</sup> 1868

Respectfully returned to  
S. M. Robinson, Agent,  
Midl. U. S. Howard  
S. C. & W. Lang. Ga.  
with authority granted  
to sell.

By order of  
B. B. Sibley  
J. B. Sibley  
Jan 4<sup>th</sup> 1868

Bureau R. F. & D. A.  
Headquarters Sub-District

Atlanta Ga. January 4<sup>th</sup> 1868

Respectfully forwarded  
to S. M. Robinson, Esq.  
Agent to American Ga.

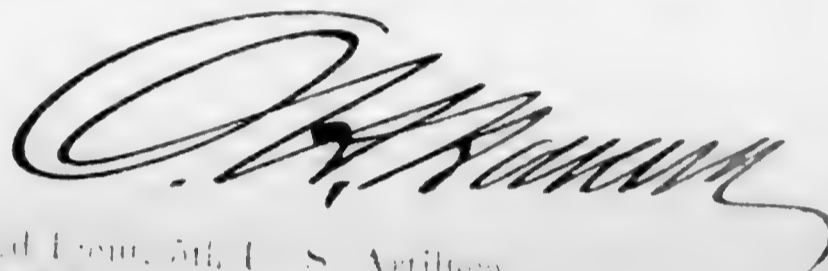

2nd Lt. 5th U. S. Artillery.  
837 1/2 St. Sub-Assistant Quartermaster

*[Faint handwritten notes and signatures on the right side of the page]*

Bureau R.F. & A.S.  
Americus Ga  
December 25, 1867

Respectfully forwarded  
to Lt. O. W. Howard  
S.A. Com. for instruction.  
I believe the within  
Statement to be correct  
I seized the Cotton  
but consider that  
I have no authority  
to order the sale, without  
instructions to do so.  
The Freedmen come  
from a long distance  
and are entirely  
without means of  
support. The Levy  
of the Sheriff is for  
Rent of the Plantation

and my order to  
him alone prevents  
its sale at Auction  
by him. Two thirds  
of the Crop, and  
by far the better part  
was disposed of by  
Cheves & Lee for their  
own benefit, and  
as they have no other  
effects, this Cotton  
alone remains to pay  
the Freedmen - and  
in fact is their property.  
Early instructions  
are respectfully  
requested

J. M. Robinson  
Agent

Bureau R. F. & A. S.  
Adj. Gen. Sub. Dist. Albany  
Albany Ga. Dec 27, 1867

Respectfully for-  
warded to Lieut. M.  
Frank Gallaghan  
U.S.A. Genl. Attache  
with the request that  
Agent Robinson be  
directed to dispose  
of this Cotton to  
pay freedmen.

J. M. Robinson  
Lieut. 5th Artillery  
S.A. Com.

Amurens Dec 25<sup>th</sup> 1867

Capt M. Roberson

at Bureau R. F. & A. S.

offices in Schley & Webster

Counties

On the plantation

of Messrs Chevers & Lee of Sumter Co  
they employed 10 freedmen to labor  
for them during the year 1867 for  
one fourth of the crop. Said Chevers  
& Lee have sold the best of the cotton  
& there are ten Bales of Cotton in  
the ware house of W. Price & Son  
of an inferior quality - It will take  
the entire 10 Bales to pay off the freed  
men & the same has been levied  
on by the sheriff of the county  
who refuses to deliver up said  
cotton to the freedmen though urged  
by you under orders. We wish an  
order that the cotton be turned over  
to said freedmen forthwith & they



allowed to see the same, several  
of said gentlemen are desirous of  
crossing the County, & can't leave  
until they get their ways, Should  
there be any balance left on hand  
we are willing to turn said balance  
over to the sheriff for distribution  
among other creditors But must  
respectfully contend that this cotton  
is the Cotton of the labourers & not  
that of Cheves & Co under contract  
for their ways

Your Obedt Servant  
A R Brewer

Atty for prudemen

L. P. ...  
...  
...

Bureau of Refugees, Freedmen, & Abandoned Lands.

OFFICE ADJUTANT QUARTERMASTER AND DISBURSING OFFICER, STATE OF GEORGIA.

Atlanta, Ga., Jan 6 1868.

Sir,

Your attention is called to the fact that your requisition for fuel for January is but this day received.

It should be forwarded at least fifteen days prior to the month when required, in order that the necessary instructions for purchase may be given.

Very Respectfully

Yours &c  
A. J. Watson  
Adj. Q. M. &c.

Capt. J. M. Robinson  
Adj. &c  
Americus Ga

*[Faint handwritten text, possibly a signature or date]*

Bureau of Refugees, Freedmen and Abandoned Lands.  
OFFICE ACTING ASSISTANT QUARTERMASTER AND DISBURSING OFFICER, STATE OF GEORGIA

Atlanta, Georgia, Jan 7 1868.

Captain.

Enclosed find check on  
At. Nat. Bank for \$216<sup>00</sup> in payment  
of vouchers of Smith & Georv. Am. \$20  
Jesse Hardy wood 7 - and yours  
for services 146<sup>00</sup> and transportation  
\$25 + \$18

Very Resply  
Yours &c

C. S. Watson

Acting Q. M. & D. O.

Capt. J. M. Robinson

Lieut &c

American Sw

No 17

Office Acting Assistant Quartermaster,

Macon, Ga., January 4<sup>th</sup> 1868.

J. M. Robinson  
Apt B R P & A  
Americus Ga

3<sup>rd</sup>

Enclosed please find  
a copy of the statement of B R P & A for the month of  
January 1<sup>st</sup> 1868 in use of Department  
Americus Ga  
January 1<sup>st</sup> 1868 Commissary Stores  
January 3<sup>rd</sup> 1868 " "

Very Respectfully  
J. M. Ingalls  
1<sup>st</sup> Lt. 16<sup>th</sup> Regt. Inf.  
4<sup>th</sup> Mo. A. S. D. Co.

1944

[Faint, illegible text]

[Faint, illegible text]

[Faint, illegible text]



Bureau of Refugees, Freedmen and Abandoned Lands.  
OFFICE ACTING ASSISTANT QUARTERMASTER AND DISBURSING OFFICER, STATE OF GEORGIA

Atlanta, Georgia, JANUARY 13 1865.

Sir

Enclosed find requisitions for Stationery  
shipped you this date, by Express, please sign  
same & return to this office

Very Respectfully  
C. J. [Signature]  
Adjmt & C

J. M. [Signature]

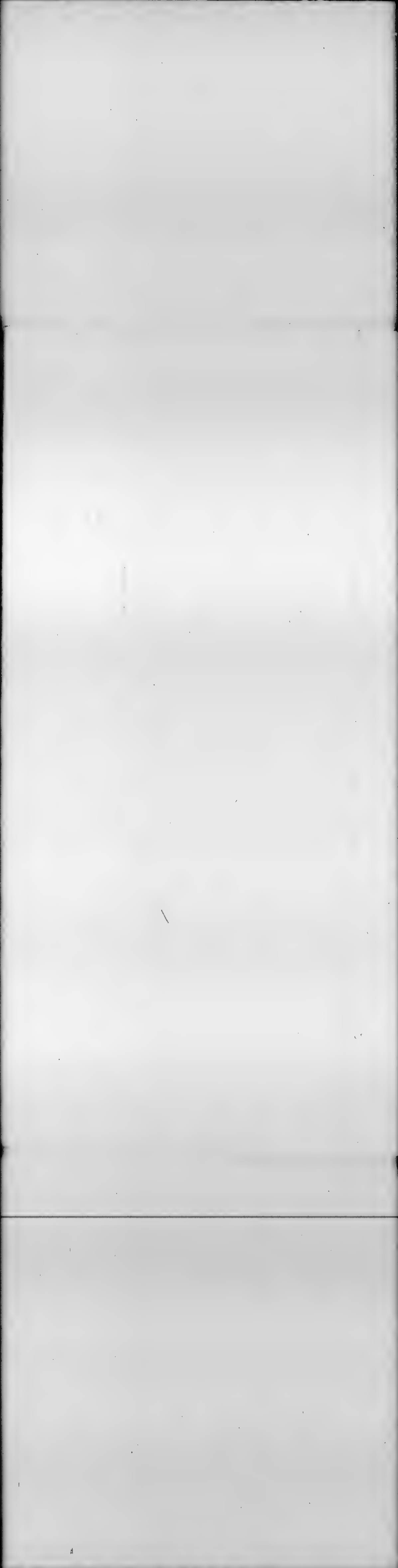

Bureau Refugees, Freedmen and Abandoned Lands,

Headquarters Sub-District of Albany,

Albany, Ga. January 9<sup>th</sup> 1865.

J. M. Robinson Esq.

Agent, Bureau, S. F. & A. L.,  
Americus Ga.

Sir,

I send you to day 50 envelopes with  
my address printed on them. You will please  
send me by mail an equal number of blank  
envelopes. Only postage for printed matter need  
be paid on them.

Very respectfully

Your obedient servant

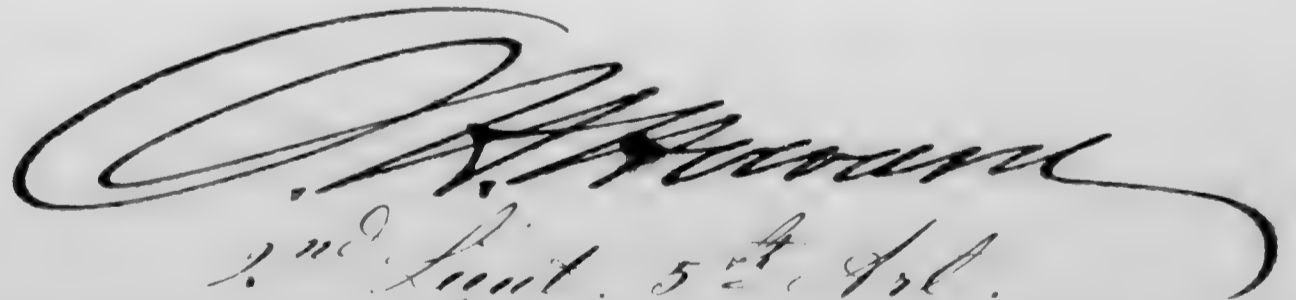

2<sup>nd</sup> Lieut. 5<sup>th</sup> Art.

at O. Comm.



131

Bureau Refugees, Freedmen and Abandoned Lands,

Headquarters Sub-District of Albany,

Albany, Ga. January 15<sup>th</sup> 1865.

J. M. Robinson Esq

Agent Bureau R. & U. S.

Americus Ga.

Sir,

In accepting in making settlements between freedmen & their employers, you will require the employers to pay for the medical attendance for which they are charged in the freedmen's accounts.

If the physicians employed are not satisfied by the employers they & the employers will be required to pay the full value the Government of their bills for medical attendance in which is provided that the freedmen pay the physicians.

It is a matter of the most vital importance to the freed people that accounts of this nature be promptly paid, to the end that they may have proper

medical attendance in future.

It is hoped that physicians will  
use no visitation in attending poor people, being assured  
of the assistance of the Bureau in obtaining their pay.

Very respectfully,  
your obedient servant

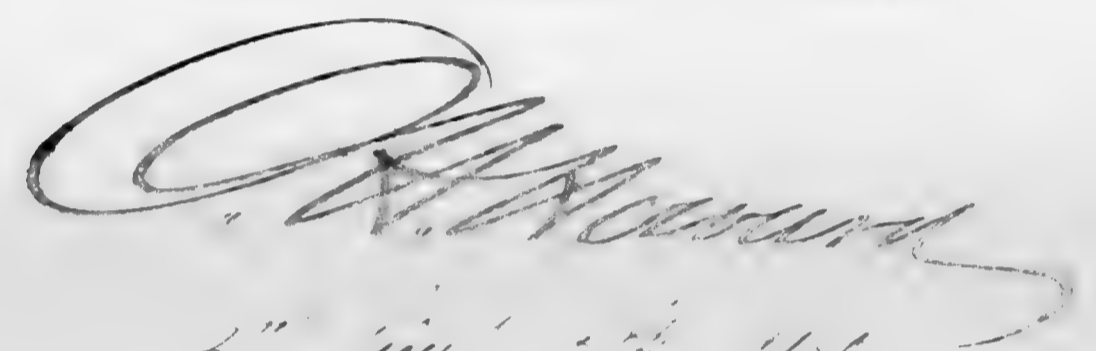

2<sup>nd</sup> Div. of the B. of H.  
1. 11. 1856

C. P. Malen

Jan 14 1901

London, Ontario, Canada

Bureau of Refugees, Freedmen and Abandoned Lands.  
OFFICE ACTING ASSISTANT QUARTERMASTER AND DISBURSING OFFICER, STATE OF GEORGIA

Atlanta, Georgia,

January 14, 1868.

Sir,  
Enclosed you will find invoice  
of Bureau property shipped you, by Express  
Jan'y 13 1868

Very Respectfully  
~~W. M. Ralston~~  
W. M. Ralston

W. M. Ralston Act  
American  
Ga



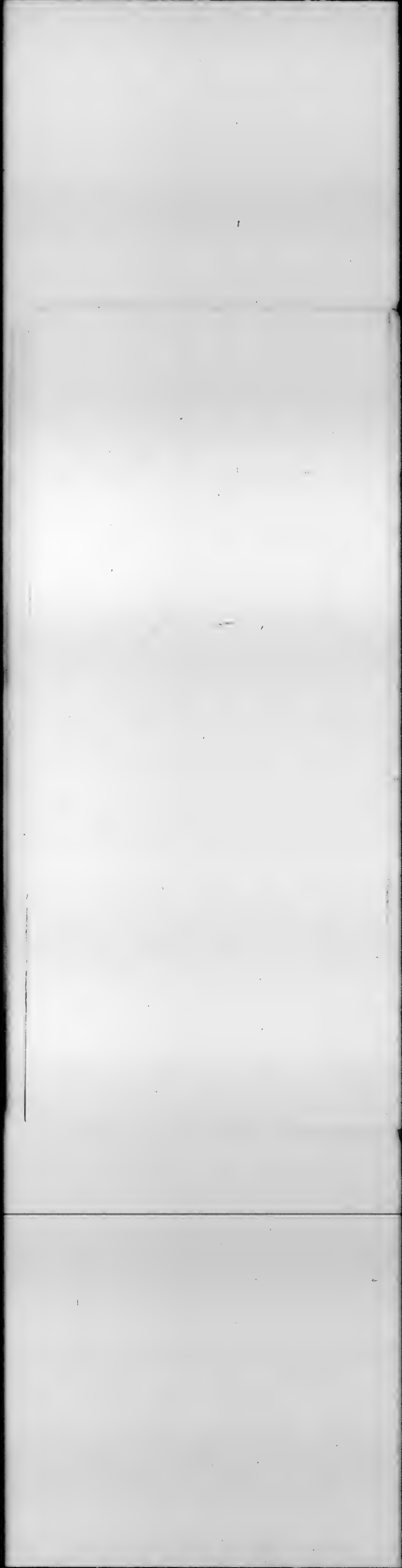

Ms. A. 9. 2. 66

General Delivery, No. 10, New Street, Liverpool.

January 23<sup>rd</sup> 1866

To Mr. Robinson Esq.  
Agent S. B. Co. U. S.  
Liverpool &c.

Sir,

You were long since authorized by me to receive the property of the Liverpool Cotton Co. to pay dividends.

If you can find any of their property, you will seize it, regardless of any claim, and hold it under military guard if necessary, and send an inventory of it to this office.

I am respectfully  
Your obedient servant,

*W. M. M. M.*  
2<sup>nd</sup> Lt. 5<sup>th</sup> U. S. A.  
St. Louis, Mo.

Handwritten text, possibly a signature or name, located in the upper middle section of the page.

Bureau of Refugees, Freedmen and Abandoned Lands.

OFFICE ACTING ASSISTANT QUARTERMASTER AND DISBURSING OFFICER, STATE OF GEORGIA

Atlanta, Georgia, January 28 1868.

Sir  
You are authorized to purchase One Cord of Wood  
to fill your requisition for February  
You will please  
forward Voucher direct to this Office early in Feb  
Very Respectfully  
C. J. Watson  
Asgmt

J. M. Robinson, Aft  
Americus  
Ga

Bureau R. F. & A. T.

HEADQUARTERS SUB-DISTRICT OF ALBANY:

Albany, Ga., *February* 1868.

HOWARD, O. W.

2ND LIEUT. 5TH U. S. ARTILLERY,  
SUB-ASSISTANT COMMISSIONER.

*February*  
*1868*

A. B.  
5474

Bureau Refugees, Freedmen and Abandoned Lands.

Headquarters Sub-District of Albany.

Albany, Ga. February 7<sup>th</sup> 1865

J. M. Robinson Esq.  
Agent Bureau R. F. & A. L.  
Americus Ga.

Sir,

Your attention is called to Par: 9. Art I Page 3. and Art. X Page 7. of the Officers Manual B. R. F. & A. L. which requires you to keep a "Book of Cases" tried.

In accordance with these instructions you will keep an accurate record of all cases coming before you, and in addition to the data enumerated in the Art X above mentioned, the book will contain, as a part of the record of the case, the receipts for all moneys collected & paid by you to freedmen or other parties, signed in the book and properly witnessed.

It is further directed, that you take the greatest care to have all the record books, which you are required to keep, in the most perfect and complete order possible.

The Asst. Commissioner attaches the greatest importance to these records, and insists that they must & shall be made, and that the time necessary to make them shall be devoted to them to the exclusion of any and all other business.

You will immediately acknowledge the receipt of this communication.

Very respectfully  
Your obedient servant

*C. A. Munn*  
2<sup>d</sup> Lieut 5<sup>th</sup> Regt  
S. A. Com'r.

1. 5 50.  
2. 6 50.

Bureau Refugees, Freedmen and Abandoned Lands,

Headquarters Sub-District of Albany,

Albany, Ga. February 10<sup>th</sup> 1865.

J. M. Robinson Esq.  
Agent Bureau R. F. & A. L.  
Americus Ga.

Sir,

Your attention is called to Sec. I Art I Page 3. of  
Officers Manual Bureau R. F. & A. L.

A copy of the instructions mentioned therein as issued  
by the Adjutant General of the Army (is sent you this day). Your  
"Book of Letter Received", "Endorsement & Memorandum Book,"  
& "Letter Sent Book" will hereafter be kept in complete accordance  
with these instructions.

The right hand page of your "Letter Received Book,"  
as now furnished, will be used as an Endorsement & Memorandum  
Book, but will be regarded as a separate and independent  
book, as much as if not within the same covers with the Book  
of Letters Received.

You will thoroughly acquaint yourself with



The instructions given in Articles I & II of the "Instructions"  
(sent you) Page 5. to 24. and in Article V Page 30 to  
35 inclusive.

Your books must be kept in such order  
and completeness that the Inspector General will be able  
without any explanation from you, to understand the entire  
business of your office.

Very respectfully

Your obedient servant

*C. A. Munn*

2<sup>d</sup> Lieut. 5<sup>th</sup> Art.

A. U. Com'r.

C. J. Watson  
1872-1873

Bureau of Refugees, Freedmen, & Abandoned Lands.

OFFICE ACTING ASSISTANT QUARTERMASTER AND DISBURSING OFFICER, STATE OF GEORGIA.

Atlanta, Ga, July 12 1867.

Captain.

Enclosed find check on  
W. Nat. Bank in payment of your  
receipts for services No. 1000  
1800 & 1800 respectively 14. 9. 3 &  
18. of your account No. 1000  
and No. 1000 No. 120

Very Respectfully

A. J. Watson

Adj. Gen. &c.

Capt. J. M. Robinson

Adj. Gen. &c.

Adj. Gen. &c.

P.S. I return account of Dr. J. B. Brown  
which can be paid when amount  
accepted and duplicate copies  
of Amnesty oath with it  
A. J. W.

2

**Bureau R. F. & A. T.**  
HEADQUARTERS SUB-DISTRICT OF ALBANY  
Albany, Ga. 5 1892

**HOWARD, O. W.**  
2ND LIEUT. 5TH U. S. ARTILLERY.  
SUB-ASSISTANT COMMISSIONER

Bureau Refugees, Freedmen and Abandoned Lands,

Headquarters Sub-District of Albany,

Albany, Ga. February 14, 1865.

J. M. Robinson

Agent Bureau R. F. & A. L.

Americus Ga.

Sir

I have the honor to transmit herewith the sum of twenty-three dollars and forty cents in payment of vouchers of Wm. Lerrins Agent for rent of building used as quarters for Troops.

Please acknowledge receipt immediately

Very Respectfully

Your obedient servant

O. H. Howland

Lieut. & S. A. Comm'r

**Bureau R. F. & A. T.**

HEADQUARTERS SUB-DISTRICT OF ALBANY:

Albany, Ga., *June 10* 1868.

**HOWARD, O. W.**

2ND LIEUT. 5TH U. S. ARTILLERY

SUB-ASSISTANT COMMISSIONER

Bureau Refugees, Freedmen and Abandoned Lands,

Headquarters Sub-District of Albany.

Albany, Ga. February 14th. 1868.

J. M. Robinson, Esq.  
Agent Bureau F. & A. L.  
Americus, Ga.

Sir,

I have the honor to request, that you will send me vouchers for  $1\frac{1}{6}$  Cord's wood, purchased for the use of the detachment of troops serving with you, in the month of February, 1868.

With regard to the payment of vouchers for wood purchased for them, for the month of January, I am informed by the Post Quartermaster at Macon, that no more vouchers can be paid, until the Deficiency Bill is passed by Congress, as the Appropriation for the Quartermaster

Department is entirely expended.

Very respectfully  
Your obedient servant

*C. A. Howard*

2nd Lieut. 5th Art.

S. A. Comdr.



Atlanta Ga Feb 28, 68

Hatsen CP

Walterly to purchase  
wood for Morels for

Bureau of Refugees, Freedmen and Abandoned Lands.

OFFICE ACTING ASSISTANT QUARTERMASTER AND DISBURSING OFFICER, STATE OF GEORGIA

Atlanta, Georgia, February 25 1868.

In  
Authority is hereby given you to purchase  
One Cord of Wood to fill your requisition for  
March. You will please forward Vouchers direct  
to this office early in March.

Very Respectfully  
C. J. Watson  
Assistant

J. M. Robinson Adj. Q. M.  
Americus  
Ga

W P Peirce No 4  
Agt.  
Upper Linn  
Linn

---

1854-55

Bureau B<sup>r</sup> & A L  
Office Ugt Lee & Tennell (Co.)  
Smithville Geo Feb 24 1868

J M Robinson  
Ugt B<sup>r</sup> & A L  
Americus - Georgia

Dear Sir

In reply to your favor  
of the 26<sup>th</sup> inst allow me to say  
that the freedwoman "Milley Laramore"  
worked for Jno Laramore  
on his plantation in this county  
and I addressed my communication  
to Mr Laramore at this plantation  
not knowing that he lived at  
Americus.

There are complaints on file  
in this office against Mr Laramore  
for not paying the freedmen in  
his employ 1866. I lived in this

County at the time and have  
some knowledge of his conduct  
towards these freedmen from  
reports then current & generally  
believed. The complainants in  
this case are more convenient  
to Smithville than to Americus;  
they are many, Mr Laramore  
is but one & better able to  
pay RR fare than they, hence  
I enclose a communication  
directing his presence at this  
office on Tuesday, the 10<sup>th</sup> day  
of next month, which I request  
you will have delivered to him.

Very respectfully  
Your obedient servant  
Wm P Pierce  
Agent & S

---

Bureau R. F. & A. L.  
HEADQUARTERS SUB-DISTRICT OF ALBANY:

*Albany, Ga.,* 1868.

---

Howard, O. H.

2ND LIEUT. 5TH U. S. ARTILLERY.  
Sub-Assistant Commissioner.

---

SYNOPSIS.

March  
1868

---

*Received*

1868.

Bureau Refugees, Freedmen and Abandoned Lands,  
Headquarters Sub-District of Albany,

Albany Ga., March 5<sup>th</sup> 1868.

J. M. Robinson Esq.

Agent Bureau R. F. & A. L.

Americus Ga.

Sir,

You will, without further delay, prepare the report called for in the Circular Letter from the Office of the Asst. Commissioner of date February 24<sup>th</sup> 1868. and forward the same as soon as practicable, through this office.

You will exercise great care in making up this report, to the end that the same should be complete and reliable.

Very respectfully

Your obedient servant.

*C. H. Murray*

2<sup>d</sup> Lieut 5<sup>th</sup> Art.

S. O. Com'r.

copy 45  
J M Robinson  
M. Frank Galloway  
secondary escape of certain  
natives

Robinson



BUREAU REFUGEES, FREEDMEN AND ABANDONED LANDS,

(Sumter, Schley and Webster Counties.)

OFFICE AGENT DIVISION OF AMERICUS,

Americus, Ga., *March 10* 1868.

G. M. Frank Gallagher,  
A. A. A. General,  
Atlanta Ga.

Sr

In reply to Circular Letter  
from Office Assistant Commissioner dated Febru-  
ary 24<sup>th</sup> 1868, I have the honor to state, that on  
the 3<sup>rd</sup> of June 1867, Spikes Clayton a young  
white man of this town shot a freedman by  
the name of Samuel Hawkins, and immediately  
made his escape notwithstanding every effort  
to capture him. ~~Since~~ the freedman was not  
killed but recovered entirely, but was subsequently  
killed by lightning. Spikes Clayton is now  
in Havana.

Washington Cole Freedman was shot in same  
month by one Robert Elliott white and badly  
wounded, Elliott also made his escape  
notwithstanding every effort was made  
to capture by Civil & Military Authorities

During the same month, Hally Johnson who  
was murdered by another Highlander by the  
name of David Mitchell, and Mitchell was  
arrested and imprisoned, but the Grand  
jury could find no true bill against  
him, as the evidence which would have  
convicted him was suppressed, - David  
is now at work on the same place where  
he committed the murder,

On Friday night last  
Geo Mc'Cuca, Colored, shot Patrick Stewart  
Colored, <sup>in the back,</sup> on the public square ~~in the back~~ in-  
flicting a dangerous wound, Mc'Cuca is  
now in jail, awaiting the issue.

The foregoing embraces all the  
serious cases that have come to my knowledge  
Many fights and assaults have taken place  
but have generally been settled between the  
parties themselves or have not amounted to  
much -

I am Sir

Very Respectfully

Wm. Robinson

C. P. Watson  
Mich 10<sup>th</sup> 1888

The Service Procession

Bureau of Refugees, Freedmen, and Abandoned Lands.

OFFICE ACTING ASSISTANT QUARTERMASTER AND DISBURSING OFFICER, STATE OF GEORGIA.

Atlanta, Ga., March 10 1868.

Sir.

Enclosed find check on Atlanta  
Nat Bank for \$229<sup>00</sup> in payment  
of vouchers of W. J. Murray 5 -  
J. Hardy 7 - and yours for services  
146<sup>02</sup> postage 4<sup>75</sup> and transportation  
6 - 34. 13 + 13.

I return vouchers of W<sup>m</sup>  
Sims. The certificate on one copy  
not being signed, and further than  
that. When parties sign as agents  
it must be shown what they are  
agents of, and the proper evidence  
accompanying to show that the  
party is duly authorized to receive  
and receipt for money for the Company.

or other organization.

In order to save expense  
but one copy of the affidavits on  
transportation accounts need be sworn  
to a copy on the duplicate will  
answer. and in entering this

item of expense write "Cost of affidavits"

The legal fee of Clerks of Courts is 50c.

Very Respectfully

C. J. Watson

Adj. Gen. &c.

Capt. J. M. Robinson

Adj. Gen.

American Sa

1868

---

Bureau R. F. & A. I.  
HEADQUARTERS SUB-DISTRICT OF ALBANY:  
*Albany, Ga.,*      *1868.*

---

**Howard, O. H.**  
2ND LIEUT. 5TH U. S. ARTILLERY.  
**Sub-Assistant Commissioner.**

---

SYNOPSIS.

---

*Received*      *1868.*

Bureau Refugees, Freedmen and Abandoned Lands,  
Headquarters Sub-District of Albany,

Albany Ga., March 11<sup>th</sup> 1868.

J. M. Robinson Esq. 51  
Agent. B. A. P. & A. L.  
Americus Ga.

Sir,

All monthly reports enumerated in Circular No. 15. -  
(Series 1867. from the office of the Asst. Commissioner,  
State of Georgia) of date Oct. 16<sup>th</sup> 1867. must be sent  
to the office of the Asst. Commissioner, any instructions  
from this office to the contrary notwithstanding.

Very respectfully  
Your obedient servant.

*C. A. Connor*

2<sup>d</sup> Lieut. 5<sup>th</sup> Art.

S. A. Commr.

C. J. Halsen

Mich 14<sup>th</sup> 1868

Chas. West & Co. / St. J.



Bureau of Refugees, Freedmen, and Abandoned Lands.

OFFICE ACTING ASSISTANT QUARTERMASTER AND DISBURSING OFFICER, STATE OF GEORGIA.

Atlanta, Ga., March 14 1868.

Captain.

Enclosed find check  
to order of W<sup>m</sup> Sirrine for  
\$20 - in payment of his  
vouchers for amt. furnished by  
you.

Very Respectfully  
C. J. Watson  
Adjutant Genl.

Capt. J. M. Robinson  
Adjutant  
Americus, Ga

*Wm. L. ...*  
Americus Ga.  
March 23/68.

Robinson. J. M.

Wishes to be transferred to duty in Md. or  
Virginia, so as to be near his parents, as he  
is advanced in years, & his only child. States  
that he has not seen his wife (who will present  
this letter) since April 1867.

Wm. L. ...  
Bureau R. F. & A. Co.  
Washington D. C. March 31/68.  
Respectfully returned. There is no place in  
Maryland or Virginia to which Mr Robinson  
could be transferred.  
By order of  
Maj. Genl. O. O. Howard.  
*Wm. L. ...*  
A. A. Genl.

Americus Ga. March 23<sup>d</sup> 1868

Major Gen. O. C. Howard U.S.A.  
Washington  
D.C.

Sir,

The lady who is present with  
to you, is Mr. Robinson, my wife, and she has been to interview.

I have been on continuous duty since April  
1867, as Agent Bureau N. S. & D. and have seen nothing of my family  
is being low, and scarcely anything since the war broke out, the  
I am anxious of being transferred to the State of Maryland or Virginia  
in order that I may be nearer to my Parents (both now are charge of my  
only child) who are both advanced in years, in infirm health, and  
in need of aid, and who look for a very moment.

In applying for this transfer General Howard  
respectfully state, that there are no complaints to make against my  
Superiors, nor have been, and I wish to see, or the White or Freed people  
whom are almost invariably treated, are respectfully

Mr. Robinson can give you much information  
relative to affairs in this section, with many thanks for your  
previous kindness, and hoping that this application will meet  
your favorable consideration, I have the honor to be

General

With the highest respect

Yours Obedient Servant  
John C. Howard



Bureau Refugees, Freedmen and Abandoned Lands,  
Headquarters Sub-District of Albany.

Albany Ga., March 25<sup>th</sup> 1868.

J. M. Robinson. Esq.  
Agent Bureau R. F. & A. L.  
Americus Ga.

Sir,

Have the enclosed vouchers for one and one sixth  
of a cord of wood for the troops, signed by the party who  
furnished it, and return them to me immediately.

Why have they not been sent before?

You were directed in a letter from this office, of  
date November 22<sup>d</sup> 1867, to send those vouchers to this office  
on the 10<sup>th</sup> of each month.

Your attention is again called to that letter, also to  
a letter from this office of date December 16<sup>th</sup> 1867.

Very respectfully,  
Your obedient servant

*C. Howard*  
2<sup>d</sup> Lieut 5<sup>th</sup> Art. & I. A. Corps.

Letter received

J. M. Ingalls  
2 Mr

Enclaves etc for

Office Acting Assistant Quartermaster,

Marion, Ga., March 31<sup>st</sup> 1868.

J. M. Robinson Esq.  
Capt. B. R. F. & A. S.  
Americus, Ga.

Sir:

I have the honor  
to enclose herewith my check # 24 on Asst Treas.  
of the U. S. for \$12<sup>00</sup> in favor of Jesse Hardy in  
payment of wood during the months of Jan. &  
Feb. 1868. Please acknowledge receipt

Very respectfully,  
Your obedt. servt.  
Jas. M. Ingalls  
1<sup>st</sup> Lt. 16<sup>th</sup> Infy  
C. A. 2<sup>nd</sup> Regt.



Atlanta Ga. April 1868

Wm. L. G.  
A. H. B. m. & D. C.

Transmit direct for payment  
of accounts for services rendered  
at your place account \$

April  
1868

Bureau of Refugees, Freedmen and Abandoned Lands,  
Office Acting Assistant Quartermaster and Debarring Officer, State of Georgia,

Atlanta, Ga. April 10 1864.

Sir.

Enclosed find checks on  
Atlanta Nat. Bank for \$233<sup>92</sup> - in  
payment of your account for services  
146<sup>67</sup> postage 5<sup>25</sup> Travelling expenses  
18<sup>50</sup>. 16 - 17 - & 3<sup>50</sup> of W<sup>m</sup> Surine  
sent 20 - and Jesse Hardy woods  
7 -

I forward requisitions for fuel  
for April for your signature

Very Respectfully

C. J. Watson

Major & S. C.

Capt. J. M. Robinson

Agent &c

Americus Ga



Received by J. M. Robinson  
American Legion  
April 22 1868

Robinson J. M.  
Adj't

67th P. 34, 18

Reports certain facts  
connected with the case  
of Alfred Royal Tindal  
against William H.  
Brewer in order  
for instructions

American

Bureau R. F. & A. L.  
HEADQUARTERS SUB-DISTRICT OF ALBANY:  
Albany, Ga., April 25, 1868.

Respectfully forwarded to  
Lieut. - W. Frank Gallagher - Acting  
Assistant - Adjutant General.

*[Signature]*  
2ND LIEUT. 5TH U. S. ARTILLERY.  
SUB-ASSISTANT COMMISSIONER.

S. M.  
No. 672, Vol. 1, 1868.

Office Home, Bureau R. F. & A. L.  
Atlanta, Ga., May 27, 1868.

Respectfully returned to  
V. M. Polinder - Agent  
 thro' Lt. O. H. Howard.  
S. A. C. Atlanta, Ga.

for copies of all the  
evidence presented in  
this case.

By order of  
Bt. Brig. Genl. Willey  
*[Signature]*  
Lt. Col. G. G. G.

Bureau Refugees, Freedmen & Abandoned Lands,  
Office Assistant Commissioner, State of Georgia.  
Atlanta, Ga., Sept. 17, 1868.

Respectfully returned to  
Messrs. Agent, this 17th  
Maj. C. H. Howard, S. A.  
C. Atlanta, Ga. This case  
must be prosecuted in  
the Civil Court if there  
are just grounds, which  
is doubtful from the  
evidence here adduced.

By order of  
Bt. Brig. Genl. Willey  
*[Signature]*  
Bt. Capt. U. S. A.  
A. A. G.

Memorandum  
April 22 1868

Robinson J. Me  
Ay<sup>r</sup>  
To Mr P. 24 18  
Reports certain facts  
connected with the case  
of Alfred Royal Tomlinson  
against William H. B.  
Broom in respect  
for instructions

American

Bureau R. F. & A. V.  
HEADQUARTERS SUB-DISTRICT OF ALBANY:  
Albany, Ga., April 25, 1868.

Respectfully forwarded to  
Lieut. - W. Frank Gallagher - Acting  
Assistant - Adjutant General.

*[Signature]*  
2ND LIEUT. 5TH U. S. ARTILLERY.  
SUB-ASSISTANT COMMISSIONER.

S. M.  
No. 612, Vol. 1, 1868.

Office Home, Bureau R. F. & A. V.  
Atlanta, Ga., May 22, 1868.

Respectfully returned to  
V. M. Robinson - Agent  
Thro' Lt. O. H. Howard.  
J. A. B. McClary, Ga.

for copies of all the  
evidence present in  
this case  
By order of  
Lt. Brig. Gen. S. H. Silliman  
J. M. Smith  
Lt. A. A. G. 4.

Headquarters 5th District of Albany  
Albany, Ga. May 5th 1868

Respectfully forwarded  
to Mr. Frank Gallagher

*[Signature]*  
2nd Lieut. 5th U. S. Artillery.  
Sub-Assistant Commissioner.

Office Agt - American  
American Co. May 5th  
Respectfully returned  
to Mr. Frank Gallagher  
a a a Lieut Thro'  
Lt. O. H. Howard. S. A. C.  
Albany Ga with  
the information that  
no records of the  
within mentioned <sup>case</sup> nor  
of the within letter  
appears upon the books  
Nor can any evidence

be found in this  
office either "Pro or Con"  
pertaining to the matter  
W. C. Morrill  
Capt B.R. & Co.

attention invited to  
evidence "Pro & Con" here  
- with transmitted -  
W. C. Morrill  
Capt B.R. & Co.

Bureau R. F. & A. L.  
Headquarters Sub-District of Albany

Albany Ga. May 9<sup>th</sup> 1868.

Respectfully returned. Agent Morrill  
will call upon the parties to this  
case, for their evidence.

*W. C. Morrill*  
2nd Lieut. 5th U. S. Artillery,  
Sub-Assistant Commissioner.

Officer Capt. B.R. & Co.  
Announced on July 9<sup>th</sup> 1868  
Respectfully returned to  
Lt. M. Frank Gallagher  
U. S. A. G. Atlanta Ga.  
Thos. H. Howard,  
S. A. C. Albany Ga.  
1868.

Bureau R. F. & A. L.,  
HEADQUARTERS SUB-DISTRICT OF ALBANY.

Albany, Ga. July 14, 1868.

Respectfully forwarded to LIEUT. M. FRANK  
GALLAGHER, Acting Assistant Adjutant General,  
Bureau R. F. & A. L., State of Georgia, Atlanta

*W. C. Morrill*  
2ND LIEUT. 5TH U. S. ARTILLERY;  
Sub-Assistant Commissioner.  
P. O. M. No. 17 Vol. 1868.

Ed. 15. 11. 11

1813 no 701/146

Bureau P. O. & A. S.

America, Geo

April 22<sup>nd</sup> 1868

Genl M. Frank Gallagher

A. A. A. G.

Atlanta Ga.

Sir,

I have the honor to report the following state of facts connected with the case of Alfred Royal Friedman vs William H. Peurr. Alfred commenced before me his action against said William H. in which case I gave judgment in favor of Alfred for one hundred and fourteen dollars, (\$114) -

After the rendition of this judgment said William H. asked for a new trial stating that he had not had a full opportunity to present his evidence, which new trial was granted - On the rehearing no new evidence was adduced and I affirmed the judgment which I had before rendered namely one hundred and fourteen dollars, (\$114) in favor of Alfred.

Said William H. is a man of considerable property but he refuses to pay the judgment rendered in this case against him and says that he will not pay the same until he is compelled to do so.

Owing to orders received from head-quarter,  
I have no power to enforce this judgment  
by seizing the property of said William H. and  
as he refuses to pay the amount I write you  
instructions in regard to this case

Very Respy  
Yours obedt servt  
Wm Robinson

Through  
Lt. W. H. Cowan  
1<sup>st</sup> Lt. H. H. H.

ag



Schley County Ga. 28 April 1868.

No. 10.

Williamson J. B.

States in answer to summons  
to appear he is detained as juror  
but will come as soon as he is  
released from official duties.

filed

Schley County Ga.  
25<sup>th</sup> April 1868.

Capt J. H. Robinson

Sir.

I received your  
Notice this morning and <sup>am</sup> happy to inform  
you - that you have been misinformed  
as to my not complying with my contract -  
I have complied to the letter - and have  
proof to the same - My contract says that  
she shall be entirely subject to to directions  
and control, and that she shall be an  
obedient and respectful servant to me  
and family and when I directed she  
refused - and I consider that as a violation  
of the contract and a forfeiture of wages -  
and I think you have said as much -  
and will agree with me - Uncle Ben told  
me to be sure I was right and go ahead -  
I am confident I am right and can  
not retract - I am a juror and can  
not appear at your office - will be to see  
you as soon as Court breaks. As for paying  
her - I fully intended to pay her for two  
months, had she acted as she ought. She  
was disrespectful and disobedient.

Respectfully

J. H. Robinson

Office Agent -  
Amicus to April 30/88

Morrill W C  
Agent

States he has a large  
number of notes on file  
in office from to  
Friedman - Asks inst-  
-ructions regarding  
their collection.

Bureau R. F. & A. T.  
Headquarters Sub-District of Albany  
Albany Ga. May 12 1888.

Respectfully returned, with the  
request to express more distinctly on  
what points in relation to the collection  
of such notes, he desires instructions.  
Their collection is strictly within  
the scope of his duties, and where pay-  
ment cannot be amicably effected,  
in a reasonable length of time, ade-  
quate to the circumstances of the debtor  
and necessities of the creditor, it becomes  
his duty to ascertain what property  
of the debtor can be made liable for  
the debt, and obtain an order for its  
seizure for the payment of the same,  
by special resort of the case to the  
Assistant Commissioner.

*W. A. Mumford*  
2nd Lt. U. S. Artillery,  
Sub-Assistant Commissioner.

Recd

Bureau R F & A L.  
Office Agent - Sir Americas  
Americus Ga April 30<sup>th</sup> 1868

Lieut-M. Frank Gallagher

A A A Lieut

Atlanta Ga

Lieut:-

I have the honor to state, that I find on file at this office a large number of notes given to Freedmen in payment for labor; and have had several applications from the holders of such notes to collect the same - I would respectfully ask for instructions regarding their collection.

I remain Sir very respectfully  
Your obt. Servant  
W. C. Morrill  
Agent &c

through  
Lieut-D. H. Howards  
5<sup>th</sup> U. S. Art  
Sub

*Infidelity of Robinson's Vouchers*

Bureau R. V. & A. T.  
HEADQUARTERS SUB-DISTRICT OF ALBANY:

*Albany, Ga. May 2<sup>d</sup> 1868.*

*Howard, O. H.*

2ND LIEUT. 5TH U. S. ARTILLERY.  
Sub-Assistant Commissioner.

SYNOPSIS.

*M. C. J.*  
*1868*

*Received May 4<sup>th</sup> 1868*

Bureau Refugees, Freedmen and Abandoned Lands.

Headquarters Sub-District of Albany,

Albany Co., May 2<sup>d</sup> '68 1868.

Capt. J. M. Robinson.  
Amherst Co.

Sir,

Enclosed I return herewith, your property Returns for April, which will have to be made on the new form of Blanks, furnished you by G. S. Watson, A. S. W. & Co., which have to be used, instead of those previously provided. The vouchers are to be entered on the Abstract, and these latter are to be entered on the Returns.

Very respectfully

Your obedient servant

G. S. Watson.

Justified  
for absence of J. S. W. and Co.  
his order

P.S. I also return report of contracts,  
as dupl. contracts, have to accompany it.

1868  
Office Sgt J. W. Ammons  
Ammons Co. Major 4th

Morrill W. C.  
Capt - 4

Asks information regarding  
acquisitions for detachments  
of troops at this place  
& whether same have  
been forwarded thro the  
Sub Asst Comr Office  
to embrace this month.

Bureau R. F. & A. L.  
Headquarters Sub-District of Albany

Albany Ga. May 6th 1868.

Respectfully returned with the  
information that Ration Re-  
ceipts have been forwarded &  
will be there in about 2 days.

*W. H. Moore*  
2nd Lieut. 5th U. S. Artillery,  
Sub-Assistant Commissioner.

*Albany*

Bureau R F & A L  
Office Agent Sw American  
American Co May 4<sup>th</sup> / 65

Lieut. Col Howard  
5th U.S. Art  
Sub Asst-Comr  
Albany Co

Sir:-

I have the honor to inquire whether any requisition for rations for the detachment U.S. troops at this place has been forwarded thro your office to embrace the present month. - Corporal Kite Miller 14 U.S. Infantry informs me that Capt J. M. Robinson late Agent made out the proper requisition & forwarded it in time, but no rations have arrived & I have been obliged to procure rations of Flour & Meat at my own expense - I beg your earliest attention to the matter.

I am Sir very respectfully  
Your obt. Servt  
W. C. Merrill  
Agent &c



P. 2 Kroull  
Apt - Dalton  
regarding note  
E. 16 1 14  
S. 95 1 18

1901  
C. Dalton

700

Office of Bureau N. F. & A. Co  
Boston Mass. May 9<sup>th</sup> 1858

J. M. Robinson Esq  
agt B. N. F. & A. Co  
Americus Ga.

Sir

I would respectfully  
call your attention to a note <sup>\$187.70</sup> One Hundred and eighty seven  
Dollars and seventy cents drawn by John J. Luncheon in favour  
of Sandy Parker Weedman, with interest added from the 1<sup>st</sup> of  
December 1857 to the time of paying said note, the old man is  
in great distress & stands very much in need of the money, and at  
his special request I send you these few lines, hoping that  
you will be successful in collecting the money and relieving  
the Old man's necessities

P.S. It will be necessary for you  
to express the money to Atlantic  
as there is no Express to Spring  
Place & I will notify the Treasurer  
of the Collection

I have the honor to be Sir,  
Respectfully your Obedt Servt  
P. L. O'Rourke,  
a. B. N. F. & A. Co

P. L. O'R  
agt

*Head Office*  

---

**Bureau R. F. & A. T.**

Headquarters Sub-District of Albany

Albany Co. *May 19* 1868.

---

Respectfully

*forwarded.*



2nd Lieut. 5th U. S. Artillery.

*C. W. Smith* Sub-Assistant Commissioner.

---

---

1235  
 Office Agent in America  
 American in May 8<sup>th</sup>  
 Morrill, W. C.  
 Agent

States he summoned  
 one John Horroll of  
 Webster Co to appear  
 at his office, and  
 that he refused.  
 Asks for instructions  
 for this & similar cases

Bureau R. F. & N. T.  
 HEADQUARTERS SUB-DISTRICT OF ALBANY:  
 Albany, Ga. May 9<sup>th</sup> 1868.

Respectfully forwarded to  
 Lieut. - H. Frank Gallagher - Acting  
 Assistant - Adjutant General

*W. C. Morrill*  
 2ND LIEUT. 5TH U. S. ARTILLERY.  
 SUB-ASSISTANT COMMISSIONER.

D. & M.  
 No. Vol. 1868.

Office Agent, Bureau R. F. & N. T.  
 Atlanta, Ga., May 16, 1868.

Respectfully returned  
 to Mr. C. Morrill, Agent  
 in St. C. H. Howard.  
 S. C. H. Albany, Ga. with  
 instructions that in this  
 & similar cases, he will

hear the complaint  
 ex parte, & forward all  
 the evidence elicited,  
 to this office for in-  
 structions & proceed with  
 evidence that defend-  
 ant had been notified,  
 & given every opportu-  
 nity to appear, & had  
 declined or neglected  
 to do so.

By order of  
 B. J. Brigg, Gen'l. S. C. H.  
*W. C. Morrill*  
 Agent  
 Albany, Ga.  
 Will American May 20<sup>th</sup> 1868

1355  
13 10 72

Bureau R & A  
Offia Agt Div America

Americas Co May 8<sup>th</sup> 68

Lieut. M Frank Gallagher  
A A A Gent

Atlanta Ga

Lieut: -

I have the honor to report the following - To wit - That on the 4<sup>th</sup> inst - I summoned John Horroll of Webster Co to appear at this office on Friday the 5<sup>th</sup> inst - to answer to the complaint of Squire Aiken who alleged nonpayment of wages for last years labor - The summons was duly deliv to him & he sent back word he should not come - and has not made his appearance to day - I respectfully ask for instructions for this and similar cases, should such occur -

Very respectfully  
Your obt Servt  
W. C. Morrill  
Agent &c

W. C. Morrill  
U.S. 421

at 11:30 am. Albany Ga

*Faint handwritten text at the top of the page.*

*Smithville Geo  
May 23<sup>rd</sup> 1868*

*Pierce Wm P  
Agent*

*Transmits \$1200 in  
full of A.P. of Ellw  
Flint against Cain  
& Wilbourn*

**Baron R. T. & A. L.**  
HEADQUARTERS SUB-DISTRICT OF ALBANY  
Albany, Ga., May 23<sup>rd</sup> 1868

Respectfully referred to W. B.  
Morris Esq. Agent & Receiver Gen.  
\$1200 enclosed

*[Signature]*  
256 LINDSAY ST. S. ALBANY, GA.  
SUB ASSISTANT COMMISSIONER

**E. & M.**  
No. 100, May 23, 1868

*[Faint handwritten text]*

*[Faint handwritten text]*

W. B. F. & A. L.  
Office Upt Lard Smith (as)  
Southville Geo May 21<sup>st</sup> 1868

(W. Howard)

Trent & S. A. Co

Albany Geo

Trent

I have the honor to enclose  
herewith \$12<sup>00</sup> twelve dollars & ten cents  
in full of amt due Ellen Flint  
co'd (as per a/c)

Ellen Flint - lives in  
America the wife of Abraham  
Flint.

Very respectfully  
Your obt<sup>l</sup> serv<sup>t</sup>  
Wm P. D. Wier  
Agent

U Schley Co  
Mauville Pa May 25<sup>th</sup> 64  
Lumpkin J T

States that he employed  
Sandy Porter (Friedman)  
in 1867 & that in settle-  
ment he gave said  
Sandy a note for  
189  $\frac{75}{100}$  dollars. That  
on or about 1<sup>st</sup> of March  
1868 said note was  
presented to him for  
payment - by L. M.  
Robinson late Agent  
B.R. & A.L. & that  
he paid said Agent  
Robinson 179  $\frac{75}{100}$  Dollars  
& void the note.

Answer





B  
Schley Co  
Elloville Ga May 20<sup>th</sup> 44  
Hudson C B

States that he was  
present when J T  
Lumpkin paid to  
J M Hobbes <sup>late of</sup> the  
amt of a note given  
to Sandy Porter (Friend)  
by said Lumpkin. -  
and that a final settle-  
-ent was made.

J. C. V.

Americus



Office Agt American  
American in May 2<sup>nd</sup>  
Morrell W C  
Agent

States that Ned Walker  
complains of not  
being paid for last  
year's work on plantation  
of Banks Tomkins & Co  
respectfully asks that  
a settlement be made  
for him

Bureau R. F. & A. T.  
Albany, Ga.  
May 26<sup>th</sup> 1868.

Respectfully referred to Dr.  
J. Dougherty, Agent &c.  
Albany, Ga.

*[Signature]*  
2nd Lieut. 5th U. S. Artillery.  
Sub-Assistant Commissioner.

Dr. R. F. & A. T.  
Office Agent Worth & Dougherty Co.  
Albany, Ga. July 28. 1868.

Respectfully returned to Dr. H.  
Howard, S. A. Comr. Dr. R. F. & A. T.  
Albany Ga, with the information  
that Banks Tomkins affirms on  
oath that Ned Walker being quite  
and old man & afflicted with her-  
nia was taken on his place without  
definite contract or understanding  
of any kind, that he received his  
rations & provisions & goods to the

Rec<sup>d</sup> of Lett. May 20<sup>th</sup> 1868.

amount of \$38.00, that the  
case has been before L. E. Hicks, Esq  
Agent. Dr. R. F. & A. T. and that  
it was decided by him, that  
nothing was due to Ned Walker.  
Ch. Ranshberg,  
Agent.

Bureau R. F. & A. T.,  
HEADQUARTERS SUB-DISTRICT OF ALBANY,  
Albany, Ga. July 29<sup>th</sup> 1868.

Respectfully forwarded to  
W. C. MORRELL, ESQ., Agent Bureau Refu-  
red, Freedmen and Abandoned Lands Division  
American - American, Ga.

*[Signature]*  
2nd Lieut. 5th U. S. Artillery.  
Sub-Assistant Commissioner.  
Albany, Ga. July 29<sup>th</sup> 1868.

498 P 139

BUREAU R., FREEDMEN & ABANDONED LANDS;  
OFFICE OF THE AGENT FOR SUMTER, SCHLEY AND WEBSTER COUNTIES.

Americus, Ga., May 23<sup>d</sup> 1863.

Wm H Howard  
Sub Asst Comm

Albany Ga  
Ga

(Mr Watton (call)  
complains that he has had no settlement  
for his last years labor on the place &  
for Ben Lottins. He respectfully  
asks that a settlement be had with Mr  
Lottins. He claims one hundred & eighty  
dollars for his years work.

Very respectfully  
Yours obt Serv  
W C Merrill  
Agent

---

Bureau R. V. & A. T.  
HEADQUARTERS SUB-DISTRICT OF ALBANY:

*Albany, Ga. 1868.*

---

Howard, O. H.

2ND LIEUT. 5TH U. S. ARTILLERY,  
Sub-Assistant Commissioner.

---

SYNOPSIS.

*Letter inquires to be  
made concerning certain  
Soldiers U. S. C Troops*

---

*Received*

*1868.*

LRP 58

Office J. A. Combs Post Bureau R. I. and A. E.

Wilmington, May 29th 1864.

W. C. Merrill Esq

Agent Post Bureau R. I. and A. E.

Wilmington, Del.

Sir

The Adjutant General directs that you make inquiry with a view of ascertaining the whereabouts of the following named colored soldiers

William James late private Co. B. 100th U.S. Col. Troops

Newton Adams late private Co. E. 12th U.S. Col. Troops

Robert Coulter late private Co. A. 12th U.S. Col. Troops

Any information obtained in regard to same will be forwarded to the Assistant Adjutant General without delay.

Very Respectfully, your obedient servant.



2d. Lieut. 5th U.S. Col. Troops and 1st Lieut.

Howard W. H.  
states that school  
reports & reports of  
conduct must be  
sent before a report  
is made

---

9/11/10  
/ 108

---



Office J. A. Conner Bureau R. I. and A. E.

Mary Ga June 1st 1865

W. C. Merrill Esq.

Agent Bureau R. I. and A. E.

American Ga

Sir

Your "School Reports" and your Report of Contracts for the month of May 1865 will be required at this office on the 6th inst.

You will see that both are mailed to this office on, or before that date.

Very Respectfully

Your obedient Servant



2d Lieut. 5th U.S. Art. and J. A. Conner

Received by June 30<sup>th</sup> 1868

Morrill W.  
Agent

Transmits acct against  
J. W. Lumsden, of Dalton Ga.  
for collection.

Bureau R. F. & A. T.  
HEADQUARTERS SUB-DISTRICT OF ALBANY  
Albany, Ga. June 5<sup>th</sup>

Respectfully referred to Sec.  
D. B. Barlow, Esq. Agt. in  
charge.

*[Signature]*  
2ND LIEUT. 5TH U. S. ARTILLERY  
SUB-ASSISTANT COMMISSIONER

E. & M.  
No. 100 Albany, Ga.

*[Faint handwritten notes and signatures]*

Bureau R. F. & A. T.  
HEADQUARTERS SUB-DISTRICT OF ALBANY  
Albany, Ga. June 5<sup>th</sup> 1868

Respectfully forwarded to  
W. A. Morrill, Esq. Agent in  
charge.

*[Signature]*  
2ND LIEUT. 5TH U. S. ARTILLERY  
SUB-ASSISTANT COMMISSIONER

E. & M.  
No. 100 Albany, Ga. 1868

251301113  
02271222126

Office Asst BR F+AT  
Americus Ga June 3 1848

G. O. H. Howard,  
Sub-Asst-Comr

Albany Ga  
Lieut:—

I have the honor  
to transmit herewith A/c's against one  
C. W. Duncan of Calhoun Co presented by  
Friedman for collection. I would respectfully  
ask that you forward them to the proper  
Office for collection & have the amt trans-  
mitted to this Office.

I am Sir

Very respectfully  
Yr obt. Servt  
W. C. Morrill  
Agent &c

Affidavit

C. W. ...

...

... of ...  
... ..

... ..

...

State of Michigan )  
Tuscola County )  
I, Geo. T. Milton, J.P. 1894,  
do hereby certify that C. W. Hanson,  
Custodian of the same, who being duly sworn  
deposes and swears that about the 2<sup>nd</sup> day  
of May 1894, the department made a final  
and final settlement with the said James  
for the services of the same of said James  
and that the settlement was made on  
the common terms of said James, and  
on terms prepared by said James  
James, that James declared himself  
fully satisfied with the settlement and  
one of the day, I, Geo. T. Milton, J.P.,  
Selector in Tuscola County, C. W. Hanson  
of Tuscola Co. was this department, for  
me in 1894, that about Jan'y 1<sup>st</sup> 1894  
C. W. Hanson assumed the entire debt  
and that said C. W. Hanson told Simon  
Oliver in the presence of department  
the Hanson had assumed the debt &  
was the one to look to for pay, that  
Oliver fully understood this at the  
time.

subscribed  
and sworn to this 16<sup>th</sup>  
day of July 1894  
Geo. T. Milton  
J.P.

C. W. Hanson

Recd. at Chambers St  
No 54 Bay of All Saints - 1868  
Fifteen 100 dollar bills within  
from C. W. Hand

Witness payment  
H. C. Morris  
Agree

1868  
I hereby certify that  
I have received from  
C. W. Hand the sum of  
\$1500 in full of the  
debt due to me by  
him on the 1st of  
July 1867  
Wm. F. B. B. B.

State Georgia } Personally  
Sanitor Co } appeared before  
                  } Mr W. C. Morrill  
                  } Capt. B. R. Fisk & at  
                  } one J. J. [unclear] who  
being duly sworn deponeth & saith  
that the within copy is a true  
and correct copy of the original one  
which is lost & that the  
matter has so acknowledged that  
the said within if signed is  
really & truly due his honor  
to his honor's pleasure  
John J. [unclear]

Sworn & Subscribed  
to before me this  
30th day of May 1865

W. C. Morrill  
Capt. B. R. Fisk & L

2011  
5/30/65

C W Bureau

To

Barton Jones

Dr

1867 - To 3 Months work by Judge @ 12<sup>50</sup> \$ 40.50

1867 To 3 Months work by George @ 8<sup>50</sup> 25.50

\$ 66.00



13 P. M. '68  
Office of the  
Smithville Ga  
June 9<sup>th</sup> '68

Respectfully returned to  
Lieut. O. S. Howard  
S. A. C. Albany  
Ga., with the  
information that  
the reports made  
Agent Morrell  
are totally untrue  
and with request  
that Agent Morrell  
furnish this office  
with the names,  
whereabouts, & nature  
of petitions made by  
the "several" applicants  
Wm P. Pice  
Agent

Bureau R. F. & A. C.  
HEADQUARTERS SUB-DISTRICT OF ALBANY  
Albany, Ga. June 11<sup>th</sup> 1868

Respectfully referred to U. C.

Morrell Esq Agent of Bureau  
at Americus Ga

*W. M. Pice*  
2ND LIEUT. 5TH C. ARTILLERY.  
SUB-ASSISTANT COMMISSIONER.

W. & M.  
No. 100

Albany Ga  
June 8<sup>th</sup> 1868

Howard O. S.  
Lieut. S. A. C.

Refers extract from  
a personal letter from  
Agent Morrell at  
Americus for the  
information of  
Pice viz that several  
applications have  
been made to Agent  
Morrell by freedmen  
who claim to have  
been sent by Pice  
from Lee County.  
Agent Morrell  
makes no complaint  
but does not understand  
why Pice should  
do so.

Albany Ga.  
June 5th. 1868.

Extract from a personal  
letter from W. C. Morrill  
Esq. Agent Bureau A. S. & G.  
at Americus Ga. to Lieut  
O. N. Howard S. A. Com'r

x x x x x x x  
" I have had several  
" applications since you were here  
" from freedmen who said  
" they were sent here from by  
" Pierce from Lee Co, and  
" some of them walked twenty-  
" two miles and swore he  
" sent them either here or  
" to Albany". Of course I  
" could do nothing but send  
" them back, but don't under-  
" stand why he should do so.  
" Of course I make no

"complaint, but write you this  
"personally and just to state  
"the facts"

Americus June 4<sup>th</sup> 1865

x x x x x x

A true copy  
for the information of Agent  
Paine

C. H. Norman  
Lieut. & S. A. C.

All

to  
Americus Ga. May 28<sup>th</sup>  
I am A  
Makes statement  
regarding hire of  
teams for Gov. Service  
by Capt J M Hobson  
Late Agt. at this  
place

Office Agt. B. R. & A. L.  
Americus Ga. May 28<sup>th</sup>  
Respectfully forwarded  
to Lt. Frank Gallagher  
a. a. g. Troop A. A. H.  
Houma La. E. Albany  
Ga. with copy of  
Mr Elam's enclosed  
as submitted & shown to  
by him. H. C. Murrell

EDMUND P. A. L. STANTON  
Office Assistant Commissioner  
Americus Ga. May 11<sup>th</sup>, 1868

Respectfully referred to C. J.  
Matson. A. A. G. M.  
& D. O. Atlanta, Ga.  
By order of  
Brig. Genl. Sibley  
Chas. M. ...  
Lt. Col. ...

BUREAU R., F. & A. L.,  
HEADQUARTERS SUB-DISTRICT OF ALBANY:  
Albany, Ga. May 31 1868.

Respectfully forwarded to  
Lieut. Frank Gallagher, Acting  
Assistant Adjutant General.

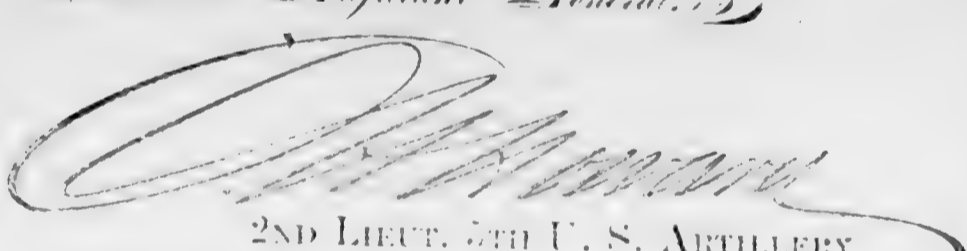
  
2ND LIEUT. 5TH U. S. ARTILLERY.  
Sub-Assistant Commissioner.  
E. & M. No. Vol. 1868.

Americus Georgia May 28<sup>th</sup> /68  
Col W. C. Merrill

at Bureau R. A. & A. L.

Americus Geo

Sir

Enclosed

I forward you an account in  
my favor against the United  
States Government contracted  
by Capt J. H. Roberson former  
of this place which is still due  
& unpaid, said account was for  
transportation on his official  
duties to different points in  
his district - You will please  
assist me in the collection of  
the same & believe me Colonel

Your obt. Servant  
A. Elam

Office A. C. Conie, Bureau N. F. & C.  
Atlanta Ga June 18. 1868

Respectfully returned to Lt. Col. Frank  
Gallagher, A. C. Genl. with the information  
that the enclosed account of Mr. Stam is  
against J. M. Robinson, late Agent, personally  
and not against the United States

Agent Robinson was refunded by the  
Government for expenses incurred by him in  
travelling on official business.

Mr. Stam will have to look to Mr. Robinson  
for his pay, not to the United States, it being a  
private debt.

C. J. Watson

Act. A. C. Genl.

Office A. C. Conie, Bureau N. F. & C.  
Atlanta Ga, June 23. 1868.

Respectfully returned to  
Mr. C. Morrill, Agent, via  
Lt. Col. A. Howard, S. A. C.  
Albany, Ga, attention in  
vited to endorsement  
of Maj. Malson.

By order of,

Bt. Brig. Genl. Sillay.

J. R. Lewis

May 44. "U. S. Infy"  
A. D. Genl

Bureau R. F. & A. L.

HEADQUARTERS SUB-DISTRICT OF ALBANY

Albany, Ga. June 29th

Respectfully forwarded to  
Wm C. Morrill Esq. Agent  
of Bureau R. F. and A. L. Americas

*W. C. Morrill*

SUB-ASSISTANT COMMISSIONER

R. F. & A. L.

No. 111

Wm A. Glau  
for horse hire by  
J. M. Robinson  
Sept. 21 1844



The United States of America

per Capt. W. Robinson of Bureau R.F. & A.S.  
 1868 To Hodge Job Elow - W.D.  
 Feb 14 To hire horse & Buggy 1/2 day \$3.00  
 " 15 " " Horse & Buggy 6.00  
 " 17 " " Horse & Buggy 6.00  
 " " " " Horse & Buggy 1/2 day 3.00  
 " 27 " " Horse & Buggy " " 3.00  
 " 28 " " Horse & Buggy " " 3.00  
 Mch 4 To feed of Horse 1.50  
 " 10 " Hire Horse & Buggy 6.00  
 " 19 " " Horse & Buggy 6.00  
 " 20 " " Horse & Buggy 6.00  
 " 24 " Omnibus Fair 50.  
 " 29 " Hire Horse & Buggy 3.00  
 April " Omnibus Fair 50.  
 " 5 " Hire Horse & Buggy 6.00  
 " 12 " Hire Horse & Buggy 6.00  
 " 23 " Hire Horse & Buggy 6.00  
 \$71.50

Georgia } personally  
 Sumner County } came before  
 me the undersigned Hodge Job  
 Elow who being duly sworn  
 depant & State that the above  
 account is just & true as  
 it stands stated

Sworn to & Subscribed  
 before me this the  
 28<sup>th</sup> day of May 1868

W. C. Morrill  
 Agent B. R. P. & A. S.  
 American Co

Smithwick Geo  
June 12<sup>th</sup> /68

Pierce Wm P  
Agent

124 March 21<sup>st</sup> 1868  
between Elias Mitchell  
and Wm P Pierce  
was made by the  
Jury 1868 & State  
America. The  
accusation therein  
is enclosed: that  
he thinks the agent  
made a mistake  
against Major  
C & P

L. C. ...

Bureau R. F. & N. T.  
HEADQUARTERS SUB-DISTRICT OF ALBANY  
Albany, Ga. June 17<sup>th</sup> 1868.

Respectfully forwarded to 11<sup>m</sup>  
W. Merrill Esq Agent S. Pierce &  
Americus Ga.

  
W. MERRILL  
U. S. ARMY.  
SUB-ASSISTANT COMMISSIONER.

V. S. M.  
No 883 June 2 1868

34 1/2 of T<sup>h</sup>  
Officially Sec'd Smith (Co)  
Smithville Geo June 12<sup>th</sup> 1861

St. Albans  
Smith, J. & Co  
Cherry Geo

Sir

On the 5<sup>th</sup> inst a settlement  
was made between Elias Mitchell and  
Messrs. Smith & Co. by the Agent  
at Union as is explained  
by the enclosed A/c. On my part  
the other party in the employ of  
Messrs. Smith & Co. by a sum of  
one hundred and fifty dollars  
turned over to Elias at 7 o'clock  
on the 5<sup>th</sup>. And he credited the same  
on the enclosed A/c. While through  
you I now refer the case back to the  
Agent at Union with request that he  
collect the balance due. I desire to say  
that the agent was misinformed in  
the settlement; he has charged Cash &  
Smith \$30<sup>00</sup> in the settlement, when  
Elias own sworn statement enclosed

in the contrary and in fact  
judging from their appearance they  
would not make more than a good  
half hand at this time.

Very respectfully  
Your obt. Servant  
Wm. P. Wood  
Capt. &c

Smithville Tenn,

Mitchell Pica

Attest

I state that  
he was to get 75<sup>cts</sup>  
per day for his own  
services as 75<sup>cts</sup> per  
day for the same  
quantity of his  
Whitman Manages Will

June 27, 1864

Personally appeared  
John Mitchell a free being duly sworn  
says that he and his two children  
William & Nancy worked for Oliver & Hall  
from 15<sup>th</sup> June until 17<sup>th</sup> July  
@ 75<sup>cts</sup> per day for himself & 75<sup>cts</sup> per  
day for them (they both considered  
as one hand) but after the work  
was over Mr Oliver the overseer said  
he would allow but 50<sup>cts</sup> per day  
for them both, but to which Mitchell  
did not agree.

John Mitchell

Witness my hand

before me this 15<sup>th</sup> June 1864

Wm J. Jones

(Act. Not. P. A. J.)

[The main body of the document is a long, narrow strip of paper, likely a page from a book or a document, which is mostly blank or contains extremely faint, illegible text. The paper shows signs of wear, including creases and a small dark mark near the center.]

Misses Wilbourn & Cain To

Elias Mitchell

Dr

1867  
Jan

To Six Months & 4 days work Allen @ 50<sup>cs</sup> 31 00

To 50 day work Nancy @ 50<sup>cs</sup> 25 00

To 50 " " Will's @ 50 25 00

To two mos work self @ 75<sup>cs</sup> per day 39 00

\$120.00

Dr

To 32 days last time Allen 4.40

To ofe Ann Book 33.30

To 54<sup>lb</sup> Meat @ 18<sup>cs</sup> 9.72 42.42

Balance due Elias \$70.58

Balance

Jan 12

By 453 lbs seed cotton

received from Wm P. Pines Agent

B. W. S. & L. Smithwick @ 7<sup>cs</sup> 31 71

38 47



1867 Elias Mitchell

To F H Chew Dr

Jan 22	To	1 Bill	Goody	12.75
July 12	"	"	for shoes	3.80
"	"	"	Waters Soap	.25
"	"	"	Hoop	1.50
				<u>18.30</u>

1867 Alben Mitchell  
 To S. H. Olmsted Dr.

Aug. 5	7/2	gas Bleaching	1.57
" "	1	for Stovings	75-
" "	1	" gloves	50
			<hr/> 3.12

Mr Chaves

I was not able  
to make a settlement with  
Elias Mitchell & Co & W and  
have referred the settlement  
to agt Merrill at Amherst,  
and all points of the  
settlement in which you  
are concerned must be  
referred to him

Very Resp<sup>t</sup>

Wm Spence

Andersonville to June 15

Thornburgh A  
and 24 others

make statement that  
large bodies freedmen are  
committing depredations  
that they have no employ-  
ment and refuse to work  
Inclosed names of said  
freedmen. asks for relief.

Office Capt B R F & U S  
Americus Ga June 17 1868

Respectfully forwarded to  
Lt. W. Frank Gallagher U. S.  
A. G. Atlanta Ga. June 21  
C. H. Howard S. A. C. Albany  
Ga. for instructions.

W. C. Morrill  
Agent &c

BUREAU R., F. & A. T.,  
HEADQUARTERS SUB-DISTRICT OF ALBANY:

Albany, Ga., June 18th 1868.

Respectfully forwarded to  
Lieut. W. Frank Gallagher, Acting  
Assistant Adjutant General.

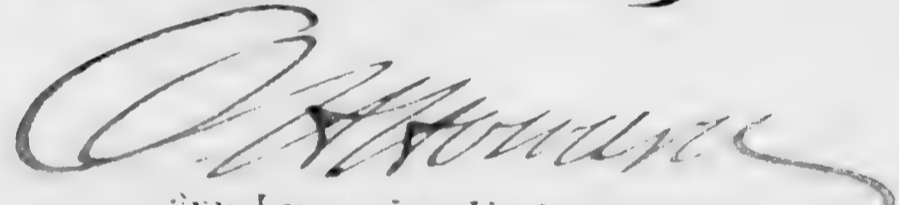

2ND LIEUT. 5TH U. S. ARTILLERY,  
Sub-Assistant Commissioner.

E. & M. No. Vol. 1868.

To The Agent Freedmen  
Bureau Americus Ga.

We The undersigned Citizens  
of Sumter county, living in the  
vicinity of Andersonville, would  
most respectfully call your  
attention to the fact, that there  
is at this time about three hun-  
dred Freedmen including wom-  
en and children living in  
and in the vicinity of this  
place who have no employ-  
ment or visible means of  
support, only as they procure  
it by days work on the plant-  
ations in the country. That  
our Cattle and hogs are  
being killed by them daily.  
That we cannot longer  
bear these depredations,  
and having no wish

to commit a rash act  
 or do any thing to array  
 one class against the  
 other. We therefore call  
 upon you as their lawful  
 agent and advisor to dis-  
 perse them over the coun-  
 try where they may by  
 honest labor procure a  
 support for themselves and  
 families. We would fur-  
 ther state in your informa-  
 tion that farmers have  
 visited the place from all  
 parts of the country and  
 offered them homes and  
 work at fair wages, but  
 they refuse both.

That you may see the  
 impossibility of this country  
 being able to sustain so  
 many vagrants we incl-  
 ose a correct list of

names of men and women  
 with the number of children  
 some of whom will be  
 obliged to starve unless their  
 wants are supplied to work  
 for their support.

A. Thompson M.D.  
 Scott L. Clary  
 J. B. Clark  
 W. W. Clark H. Batton  
 Rice Bass jr. J. Batton  
 James Scott  
 J. H. Briggs J. E. Glover  
 T. M. Youngblood J. W. Glover  
 S. J. Shappery H. Glover  
 J. H. Custer H. Miller  
 E. Smith J. H. Miller  
 James Mathis Robinson  
 B. J. Dyer R. D. Youngblood  
 B. H. Shappery M. P. Huber  
 S. G. Clark J. B. Clark

## List of names of peddlers in order

Amison Lewis	wife & 2 Children	no Employ
Jacob Chapman	wife & 3 Children	no Employ
Wallis Jones	wife & 2 Children	" "
John Jackson	wife	" "
Jacob Birnie	& wife	" "
Elliott Singleton	wife & 4 Children	" "
Henry Flower	" " 4 Children	" "
Thomas Sharp	" " 2 "	" "
Henry Jackson	" " 8 "	" "
Deamon Wilson	" " 3 "	Rail Road
Masey Scott		no Employ
Charity Moore	4 Children	" "
Carter White	wife & nothing	law no Emp
Lumen Hall	wife & 2 Children	" "
Joe West	" " 1 "	" "
Leabel James	own child	" "
Bill Hudson	wife & 1 Child	Rail Road
Edwards		no Employ
Lewis Latour	& wife	no Employ
Henry Davis	& wife	Government
Joe Whitehead		no Employ
Carne Whitman		" "
Disey Marshall		" "
Lemmy Marshall		" "
Dave Stephens		" "
Elijah Lunden	wife & 5 Children	no Employ
Billey Burton		no Employ
Bob Jesso	wife & 5 Children	Rail Road
Mariah Battle	5 Children	no Employ
John Williams	wife & 1 Child	" "
Wmison Brown	& wife	" "
Robert Richards	wife & 2 Children	" "
Jas Emerson	& wife	" "
Butler Johnson	& wife & 9 Children	" "
Albert Williams	wife & 5 "	" "
Lewis Williams	wife & 1 "	" "
Hardy Williams	wife & 1 "	" "

Matilda Jenkins	no Employ
Glasgow & Hubbs & Wife	" "
Hardy Burman & Wife & 3 Children	no Emp
Howell Sugrum Wife & 6	" Shoemaker
Jonas Evans & Wife	no Employ
Isaac Black & Wife & 3 Children	" "
Net Lee & Wife	" "
George Phullops Wife & 1 Child	" "
Wimney Phullops	" "
Frank Lee & Wife & 6 Children	" "
Isaac Morgan Wife & 1 Child	" "
Dysey Johnson 7 Children	" "
Tom Hodges & Wife	" "
Floyd Jackson Wife & 2 Child	Govt
John Burrows Wife & 4	no Employ
Henry Hill Wife & 1 Child	Rail Road
Jessey Burk Wife & 4 Children	no Employ
Isidor Lewis & Wife	" "
Jake Harris & Wife	" "
Adaline Daniel one Child	" "
Bob Scott & Wife	" "
Juley Horne one Child	" "
Tom Charles Wife & 4 Children	Shoe Maker
Spencer Morgan Wife & 3 Children	no Emp
Charles Mullkey Wife & 1	" "
Bob Horton Wife & 3 Children	" "
John Catoe Wife & 1	" "
Arnold Catoe Wife & 2 Children	Black Smith
Sammy <del>Alford</del> <sup>Booth</sup> 2 Children	No Employ
James Haygood	Government
Jeff Green Wife & 2 Children	No Employ
Steve Edge Wife & 9 Children	" "
John Harris Wife & 1 Child	Govt
George Washington & Wife	" "
Betsy Sattle 2 Children	No Emp
George Hot Wife & 1 Child	" "



Nelson Shutter & wife & wife's Daughter  
 and Child by law no Employ  
 Lewis Brown wife & 3 children no Employ  
 Vilot Low " "  
 Easter Reese 3 children no Employ  
 Mark Brown & wife General  
 Nathan Smith & wife "  
 Dennis Williams wife & 1 Child no Employ  
 Moses Leahy wife & 4 " "  
 Madison Williams wife & 5 Child " "

444 364

---

Office of A. Comr, Bureau R. A.  
Atlanta Ga., June 26, '68.

---

Respectfully returned  
to H. C. Merrill, Agent,  
thru Lt. C. H. Howard,  
S. V. C. Albany Ga,  
for investigation.

Agent Merrill will  
in case he finds af-  
fairs as represented,  
advise the freed people  
to go to work & use  
every endeavor to find  
them homes - In the  
event of a refusal, on  
their part, to adopt his  
advice, he will pro-  
ceed against them  
in conformity with  
the Civil laws, in such  
cases provided.

(over)

By order of  
Bt. Brig. Genl. Sibley,  
N. T. Merrison,  
Bt. Major U. S. A.

Bureau R. F. & D. T.  
HEADQUARTERS SUB-DISTRICT OF ALBANY

Albany, Ga. June 27<sup>th</sup> 1864

Respectfully  
forwarded.

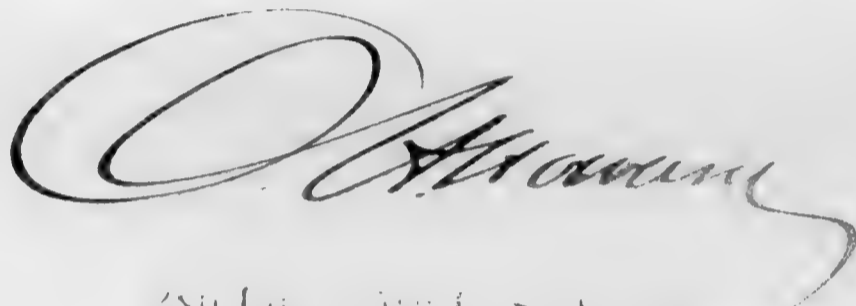

2ND Lt. U. S. A. 1861  
SUB-ASSISTANT COMMISSIONER

E. & M

No. 100 Albany, Ga. 1864

Bureau R. F. & A. L.  
OFFICE AGENT, DIVISION OF AMERICA  
Americus, Ga. July 31 1868

Morrill, Col. C.  
AGENT.

Transmits request Emma  
Wilder that Capt Danson collect  
rent due her from J. W. Rogers

Bureau R. F. & A. L.  
OFFICE AGENT, DIVISION OF AMERICA  
Americus, Ga. August 1 1868

*W. C. Morrill*

Red Danson per J. W. Rogers

Price Apt. J. W. F. A. Z  
Danson per Sept. 1868

Respectfully returned to  
W. C. Morrill Agent. Thru  
Maj. A. Howard, A. C.  
I can not find any such  
man as J. W. Rogers nor  
can I find any person who  
knows Emma Wilder  
*Andrew B. Clark*  
Agent

Bureau R. F. & A. L.,  
HEADQUARTERS SUB-DISTRICT OF ALBANY,  
Albany, Ga. October 20 1868

Respectfully forwarded to  
W. C. MORRILL, ESQ. Agent Bureau R. F.  
& A. L., Division of America, Americus, Ga.

*W. C. Morrill*

2ND LIEUT. 5TH ARTILLERY  
BREVET MAJOR U. S. ARMY.  
Sub-Assistant Commissioner.  
E. & M. No. 1333 Vol. 7 1868.

Bureau Refugees, Freedmen and Abandoned Lands:

Office Agent, Division of Americas,

(Under 'Tobley,' Webster Counties,

Americus, Ga.,

July 31<sup>st</sup> 1868.

Lieut. O. A. Howard  
1st Art. Comd.  
Albany Ga.

Lieut.:

I have the honor to represent the case of Emma Wilder who says she worked for J. W. Ragau<sup>r</sup> of Dawson portion of last year and that she has not rec<sup>d</sup> any thing for such work. She respectfully asks the Capt. at Dawson be requested to investigate the facts and remit the amt; if found due, to this office.

Very respectfully,  
Your obt. servt.  
W. C. Monice  
Capt &c

H<sup>d</sup> Drs Post of Masons  
Masons for July 14<sup>th</sup> 68

Wlio James

Order to deliver up  
Robert Horlan deserter

No 19

Specimen No 92

Comunic Gen  
July 3 1868

Recid the within Robert  
Horlan, deserter, this  
day

Capt Peter [unclear]

July 1868

1868

Head Quarters, Post of Macon  
Macon, Ga. July 1<sup>st</sup> 1868.

Special Orders  
No 92.

Extract

II... Corporal Peter Toole and one Private  
of Company E, 16th Infantry, will proceed to Americus, Ga. and  
receive from Mr. W. C. Morrill, Agent B. R. F. & A. L. Robert  
Harkin, a deserter from Company E, 16th Infantry, and  
conduct him to these Head Quarters.

The Quartermaster's Department will  
furnish transportation each way

2<sup>d</sup> Lieut. 16th Infantry  
Comd'g.

Office of BN & A  
Albany Ga July 6<sup>th</sup> 1868

BUREAU R., F. & A. I.,  
HEADQUARTERS SUB-DISTRICT OF ALBANY;  
Albany, Ga., July 7<sup>th</sup> 1868.

Respectfully forwarded to  
Lieut. M. Frank Gallagher, Acting  
Assistant Adjutant General.

*C. H. Howard*  
2ND LIEUT. 5TH U. S. ARTILLERY.  
Sub-Assistant Commissioner.  
E. & M. No. Vol. 1868.

*Monroe W C*  
*Agent*

States that James Rodgers,  
refuses to appear at this  
office & to settle and pay  
freedman for labor. Asks  
for authority to seize sufficient  
of his property to satisfy the debt.

Office of Comm. Bureau, R. F. & A. I.  
Atlanta, Ga., July 13, 1868.

Respectfully returned  
to Spm C. Monroe - Agent  
thru Lt. C. H. Howard,  
S. G. C. Albany, Ga,  
who is directed to

hear this case, for  
ward to this office  
all evidence elicited,  
substantiating claim  
of freedman; also  
evidence showing  
that Rodgers was re-  
fused to appear at  
settlement, & declined  
to do so.

By order of,  
B. Brig. Genl, Sibbey.  
*M. Frank Gallagher*  
H. H. H. H.



Office Capt B B Hall  
Carrville Ga July 6/68

Lieut. M Frank Gallagher  
A A A Guin  
Cottando Ga

Sir:

I have the honor to state that on July 1<sup>st</sup> I wrote & sent a Summons to one James Rodgers of this County to appear at this office to settle with Zedee Belcher for labor done last year; that the Summons was duly d'd and word was sent back by Mr Rodgers he should not come. The amt due Zedee is 59<sup>00</sup>/<sub>100</sub> dollars and I understand Rodgers is perfectly able to pay and acknowledge the debt. I respectfully ask for authority to require the Sheriff to seize & sell sufficient of his property to settle with Zedee & to pay the costs unless previously settled.

Very respectfully  
Your Obedt Servt  
J. C. Morrill  
Capt B B Hall

200

---

Bureau R. P. & Co. Inc.  
Haverhill, Massachusetts

*May 10, 1910*

Respectfully to you,  
W. P. MORRILL, ESQ., Agent Boston Room  
200 Federal Street, Boston, Mass.  
of American American Co.

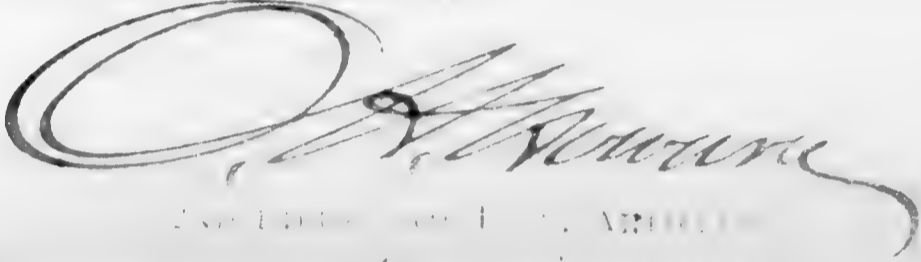

Sub-Assistant Commissioner

May 10, 1910

---

---

Bureau R. F. & A. D.  
OFFICE AGENT, DIVISION OF AMERICANS,  
American, Ga., 1875

---

Morrill, Ed. C.  
AGENT.

Certificate of —  
regarding summons  
to James Rodgers

Bureau Refugees, Freedmen and Abandoned Lands:

Office Agent, Division of Americas,

Quincy, Ark., Webster County,

Americus, Ga., July 18<sup>th</sup> 1868.

I hereby certify that on the 1<sup>st</sup> day of July 1868 I wrote a summons to James Rogers of Sumter Co Ga in the following terms to wit:

Office Agent B. F. & A. R.  
Americus Ga July 1<sup>st</sup> 1868

James Rogers Esq  
Sumter Co Ga  
v. v.

You are hereby required to be and appear at this office on Thursday the 2<sup>d</sup> inst. at 10 o'clock A.M. to settle with Zedre Belcher according to contract. -

Men fail not.

Very respectfully  
W. C. Murrell  
Capt &c

and that I enclosed said summons in a envelope sealed it and gave it to Capt Belcher son of Zedre, directed to James Rogers, Sumter Co. W. C. Murrell  
Capt &c

Applicant  
Zedec Becher

I hereby certify  
that I cannot find  
any contract or  
Memorandum of contract  
between James Rogers &  
Zedec Becher in this  
office for the year 1847  
H. C. Munnell

State of Georgia, Personally appeared before  
County of Sumter } me Zedee Belcher who on  
oath says that on or about  
the 1<sup>st</sup> of January, 1867 he entered into a  
contract with James Rogers of Sumter County  
in the following terms. To wit: ~

That said Rogers was to furnish Land, Stock  
to work said Land & tools sufficient. That  
said Belcher was to cultivate said land  
at his own expense and feed himself and  
in the fall the crop was to be equally  
divided. - That in such division said  
Rogers took 621<sup>lb</sup> Cotton in the said year  
than he gave said Belcher and 14 bushels corn.  
Belcher at that time being sick and that  
Rogers refused to give it up to him claiming  
that Belcher refused to clear some new ground  
tho' the contract never specified anything abt  
it nor was there any understanding to that  
effect, but that some time in Feb<sup>r</sup> 1867 Rogers  
wanted him to clear the new ground but that  
he refused on afe of having all he could do  
in cultivating what the contract specified.

Zedee <sup>his</sup> Belcher  
mark

Sum<sup>r</sup> & subscribed to before

me this 18<sup>th</sup> day of July 1868

W. C. Morrill

Clerk of the Court  
Sumter, Wilk & Webster Counties

Affidavit -  
Cap Belcher.

Sworn to your letter  
to James Rodgers

State of Georgia Personally appeared  
County of Sumter before me Cap Belcher  
who being duly sworn deposed  
& saith that on July 1<sup>st</sup> 1868 he rec'd a  
letter from W. C. Morrill Capt B N F & A L  
and was told by said Capt. to deliver it  
to James Rodgers and that he carried the  
letter and gave <sup>it</sup> to said Rodgers in person.  
Cap. <sup>W. C.</sup> Morrill  
Belcher

Sworn & subscribed to  
before me this <sup>17<sup>th</sup></sup> day of July 1868  
W. C. Morrill  
Capt B N F & A L  
Wm. Schly & Webster Co<sup>s</sup>



Bureau R. F. & A. L.  
HEADQUARTERS SUB-DISTRICT OF ALBANY

July 14, 1865

W. C. MORRILL, Capt. U. S. A.  
Albany, Ga.

*W. C. Morrill*

Albany, Ga. July 14, 1865

Office Capt B.A. Pitt at  
Tenniscoes Ga July 18<sup>th</sup> 65

Respectfully returned to Lt-  
M. Frank Gallagher J.A.G.  
Atlanta Ga via Lt A.A. Howard  
S.A.C. Albany Ga with evidence  
required (Sports) that being  
all could procure owing to fact-  
before stated that Rodgers  
was refused to make  
appearance -

W. C. Morrill  
Capt &c

Bureau R. F. & A. L.,  
HEADQUARTERS SUB-DISTRICT OF ALBANY.

Albany, Ga. July 20, 1865

Respectfully forwarded to LIEUT. M. FRANK  
GALLAGHER, Acting Assistant Adjutant General  
Bureau R. F. & A. L. State of Georgia, Atlanta  
Ga.

*W. C. Morrill*

Second Lt in absence of  
2ND DEPT. 5TH U. S. ARTILLERY

Sub-Assistant Commissioner.

S. A. M. No. 112, Vol. 1, 1865

Bureau R. F. & A. D.  
HEADQUARTERS, SOU. DISTRICT OF TEXAS.

July 14, 1868

W. C. MORRILL, Esq., Agent, Bureau  
of Prisons, State of Georgia,  
Atlanta, Ga.

*W. C. Morrill*

RECEIVED  
JULY 15 1868

Office Capt J. H. F. at  
Cummins Ga July 18 1868

Respectfully returned to Lt  
M. Frank Gallagher J. A. G.  
Atlanta Ga via Lt W. C. Morrill  
J. C. Albany Ga with evidence  
required (4 ports) that being  
all could procure owing to fact  
before stated that Rodgers  
was refused to make  
appearance -

W. C. Morrill  
Capt &c

BUUREAU R. F. & A. D., STATE OF GA.

Office Assistant Commissioner,

Atlanta, Ga. July 29, 1868.

Respectfully returned to J. M.  
C. Morrill Agent State  
Lt C. H. Howard - S.  
J. C. Albany Ga who  
is directed to see in  
Civil Court.

By order of,  
J. B. Bigg, Genl. Sillbey

W. C. Morrill

Bureau R. F. & A. L.  
OFFICE AGENT, DIVISION OF AMERICA  
194 St. L. & G. July 13<sup>th</sup> 1868

Morrill, Col. C.  
AGENT.

states that Miles Aynbush  
refuse to receive a summons  
and brutally assaulted the  
Aynbush who endeavored to  
obtain it. That he has sent  
to arrest him. asks his  
acts so far be approved and  
for further instructions.

Bureau R. F. & A. L.  
HEADQUARTERS SUB-DISTRICT OF ALBANY:  
Albany, Ga. July 14. 1868

Respectfully forwarded:  
Lieut. - W. Frank Colledge - Col. of  
- Cavalry - Adjutant General for the  
instructions of the Assistant  
Commissioner.  
Agent Morrill has  
been directed to hold Wagn-  
er, and await such in-  
structions.

*W. Frank Colledge*  
2ND LIEUT. 5TH U. S. ARTILLERY,  
SUB-ASSISTANT COMMISSIONER.

V. & M.  
No. Vol. 1868.

Office of Com. Bureau R. F. & A.  
Atlanta, Ga., July 10, 1868.

Respectfully returned to  
Mr. C. Morrill - Agent  
1st Lt. C. H. Howard,  
S. & C. Atlanta, Ga.,  
who indicated to turn  
this man Aynbush  
over to the Civil authori-  
ties for trial, imme-  
diately.

By order of,  
St. Brig. Genl, Sillier.  
*W. Frank Colledge*  
1st Lt. U. S. A.

Bureau Refugees, Freedmen and Abandoned Lands;

Office Agent, Division of Americas,

(Sanct. Schley & Webster Counties,

Americus, Ga.,

July 13<sup>th</sup> 1868.

Lieut. O. A. Howard  
Sub Asst Comd.  
Albany, Ga.

Sir:

I have the honor to state that I issued a summons to one Miles Wymbush of Schley Co to appear at this office to settle with one Jacob Edwards whom he had run off from his place. That I gave the summons to said Edwards to deliver and that Wymbush refused to receive it and most brutally assaulted the freemen who only saved his life by flight. I have sent two soldiers to arrest him and respectfully ask my act so far be approved & that I have further instructions in the matter.

Very respectfully,  
Your ob. Servt  
W. C. Mossill,  
Capt.

Bureau R. F. & A. L.  
OFFICE AGENT, DIVISION OF AMERICAN  
Auctions, Cal. July 13<sup>th</sup> 1888

Morrill, Cal. C.  
AGENT.

Enclosure of against  
William Wells Lee Co  
favor Nelson Hill (cont)  
asks that Agt Lee to collect same

Division of American Auctions

July 14

for collection.

*[Signature]*

B. P. F. & L  
Office of Commissioner  
of the State of California

Presented to the Commission  
at the B. P. F. & L. Office  
San Francisco July 14 1888  
Attention  
is invited to the enclo-  
sured affidavits of  
J. M. Wells & Thomson  
and from which it  
appears nothing is  
due Nelson Hill by  
Mr Wells but it may  
be ascertained by

Private Stapply also  
your lines in Simp-  
son County.

Mr Wells & Mr  
Jay are both known  
at this office to be  
creditors of me  
questioned validity

J. M. Wells  
Agent

Division of American Auctions

July 14

*[Signature]*

State of California  
Secretary of State

Bureau Refugees, Freedmen and Abandoned Lands:

Office Agent, Division of Americas,

(Doubt. Tchley. & Webster Counties,

Americus, Ga., July 13<sup>th</sup> 1868.

Lieut. Chas Howard  
Sub Asst Comr  
Attainy Ga

Sir:

I have the honor to represent the case  
of Nelson Hill who claims he has had no  
settlement with William Wells of Lee Co Ga  
for labor done last year. I respectfully ask  
that you forward the enclosed &c and request  
the Capt of Lee Co to make a settlement with  
Mr Wells.

Very respectfully  
Your obt Servt  
W. C. Morrill  
Capt &c

State of Colorado  
County of Do

Personally appeared  
Eliason Jay who being duly  
sworn deposes and says that he  
was familiar with the contract  
between Mr W<sup>m</sup> Wells & Slapley and  
Slapley and the Freedmen.

The contract between Mr Wells  
& Slapley was that Slapley should  
hire the hands & pay the hands &  
deal with them exclusively himself.  
Mr Wells was to be more or less  
responsible to the hands but to Slapley. At  
the end of the year Deposition was  
present where Mr W<sup>m</sup> Wells paid to  
Slapley his (Wells) part of the freedmen  
as per, and was afterward present  
when Nelson Hill told Mr Wells  
that he was perfectly satisfied  
with the settlement made with  
him by Slapley.

Deposition states  
that on the 2<sup>nd</sup> day of July at A. C. C.

together with most all the other  
free owners of the neighborhood  
~~xxxx~~ assembled at the plantation  
of Mr. Stoen to assist Mr. Stoen  
in obtaining his crop, on this  
day Nelson became over-tired  
and was never able to do a good  
days work from that time until  
Christmas, in fact, I suspect, thinks  
Nelson did not go to the field to  
work more than 8 or 10 days after the  
9<sup>th</sup> of July. A servant was in other  
business with Mr. Wells & was on  
the place almost daily.

It is, that  
to his own personal knowledge, according  
to the written contract between Stoen &  
Mr. Nelson Will. Will was to receive  
\$250 for the services of himself & family  
but does not know what Mr. Wells was to receive.

J. L. Jay



\$225<sup>00</sup>

Recd of W. H. Shipley's Accts  
two hundred & twenty five dollars  
which are acknowledged to be a  
settlement in full for all services  
rendered for the year 1867

December 24<sup>th</sup> 1867 . . . . . Volcan<sup>th</sup> Hill  
mark

The above is a true copy of a  
receipt shown me this day by  
Mr W<sup>m</sup> Wells. . . . . Wm<sup>th</sup> P. Pierce

Smithville Va

Wm<sup>th</sup> P. Pierce

July 23<sup>rd</sup> 1868

State of Oregon  
County of Lee

I, \_\_\_\_\_, a duly qualified juror,  
do hereby certify that I have  
been duly sworn and have  
and A. M. Slippy cultivated a crop  
on share crop, as per agreement  
between them. Slippy hired all  
the labor and was himself alone  
responsible for the laborers wages.

It is my duty to certify that  
at the end of the year Slippy  
paid to Slippy his half of the money  
due for labor and told Slippy to  
take the freedom receipt. Slippy  
delivered to the agent the receipt  
of Nelson <sup>will</sup> for the same by Slippy.

The foreman "Wilson Bell" witness  
told the agent in the presence of  
Mr. T. Jay that he was perfectly satisfied  
with the settlement made with him by  
Slippy. The agent states that

Shapiro sent all the affidavits  
against the government and still has  
them. I don't feel confident  
that nothing is due the government  
but if any money is due them it  
is by Shapiro. William Miles

Money submitted  
to you on this  
the 25th day July 68  
Wm Miles  
1101 1/2

William Wells Sec Co Ga  
To Nelson Hill

To years work according to contract	150.00
" " " Son work	120.00
" 3 mos work wife @ 75¢/pr day	57.00
	<u>\$ 327.00</u>

*1151*  
Bureau R. F. & A. L.  
OFFICE AGENT, DIVISION OF AMERICAN  
INDUSTRIES, Ga., July 14 1868.

Morrill, Col. C.  
AGENT.

States that he issued Summons  
to Daniel Washburn to appear  
and settle with Freedwomen for  
labor. That he refuses to come,  
wishes for instructions.

Bureau R. F. & A. L.  
HEADQUARTERS SUB-DISTRICT OF ALBANY  
Albany, Ga., July 18, 1868.

Respectfully forwarded to LIEUT. M. FRANK  
GALLAGHER, Acting Assistant Adjutant General,  
Bureau R. F. & A. L., State of Georgia, Atlanta  
Ga.

*M. Frank Gallagher*  
2ND LIEUT. 5TH U. S. ARTILLERY  
Sub-Assistant Commissioner.  
E. & M. No. Vol. 1868.

Office of Comm. Bureau No. 2  
Atlanta, Ga., July 18, 1868.

Respectfully returned  
to Mr. C. Morrill - Agent  
thru Lt. C. H. Howard.  
S. C. C. Albany, Ga.,  
who is directed to hear  
this case as if defendant  
were present, & show  
on record by evidence,  
that he was duly notified  
to appear & failed.  
By order of,  
B. B. C. Sillay  
Com. of the Bureau

Bureau Refugees, Freedmen and Abandoned Lands;

Office Agent, Division of Americas,

(Doubtless, Del. by, White Counties.)

Americus, Ga., July 14<sup>th</sup> 1868.

Lieut. M. Frank Gallagher  
a a a Genl  
Atlanta Ga

Lieut.

I have the honor to state that on the 9<sup>th</sup> June I issued a summons to Daniel Mashburn of this County to appear at this office & show cause why he did not settle with a freedwoman for last years labor. That the summons was duly delivered but that Mr Mashburn has refused to either make an appearance or send any word to this office why he should not make the settlement. I respectfully ask for instructions regarding the same.

Very respectfully  
Your obt. Servt  
W. C. Merrill  
Capt &c.

Business & Finance  
H. W. ...

July 1894

W. C. ...

*O. A. ...*

...

Office Capt BRF & Co  
Worcester Ga July 1868

Capt BRF to

Monroe W C  
Capt

Reports that James Hill  
complains that Robt Hooper  
tied up & whipped a colored  
girl giving her 450 lashes  
on bare back and that  
he has sent & arrested  
him - asks his action  
be approved & for further  
instructions.

Bureau R. V. & A. I.  
HEADQUARTERS SUB-DISTRICT OF ALBANY:  
Albany, Ga. July 18 1868

Respectfully forwarded to  
Lieut. - Frank Gallagher - Acting  
- Assistant - Adjutant General.

James Hill was seen in  
divided, in case the charges  
are sustained, it would  
be proper to suit, and await  
the instructions of the Assi.  
Commissioner.

END LIEUT. GEN. U. S. ARTILLERY,  
SUB-ASSISTANT COMMISSIONER.

W. & M.  
Vol. 1868.







ATLANTA, GA. ... 1868.

Respectfully  
I have the honor to inform you  
that I have the pleasure  
of acknowledging the receipt  
of your letter of the 15th inst.  
and in reply to inform you  
that the same has been forwarded  
to the proper authorities.

11-21-1868

By order of Brig. General J. G. Sibley, U. S. A.

*J. H. ...*  
First Lieut. 16th U. S. Infantry, and A. A. A. G.  
(E. B. ... 1868)

DEPARTMENT OF STATE OF GA

Office Assistant Commissioner,

Atlanta, Ga., July 21st, 1862

Respectfully returned to Mr.  
C. Merrill Agent  
of C. H. Howard  
S. A. C. Albany Ga, a  
letter invited to an  
depossession from the  
6th W<sup>th</sup> Military Dist.  
& for a full report of  
the action of the Civil  
Authorities (if any was  
taken) in this case.

By order of,

W. B. Ruffin, Secy.  
W. M. G. G. G.  
R. H. G. G. G.

Office Capt B. P. H. & Co  
Cummer Co July 6<sup>th</sup> 1868

Lieut A. H. Wood  
Out Post Com<sup>d</sup>  
Albany Co  
Lieut

I have the  
honor to state that on complaint of  
James Hill & George Weaver that  
Robt. Hodges of this County - did on  
the 5<sup>th</sup> of July take a colored girl &  
tied her up with a rope by her wrists  
and at the time they ~~had~~ left - had  
given her 480 lashes on her bare  
back making ~~other~~ ~~her~~ ~~up~~ her  
clothes and that she was tied when  
they left & begging for water and he  
refusing to allow her any and that  
I have sent two soldiers to arrest  
and bring him to this office and also  
the girl. I respectfully ask my action  
so far be approved and that I have



Office Capt B.R. Foster  
Americus Ga July 6/68

Worrell W. C.  
Agent

Requests Capt Worrell to  
summons Levi Spencer to  
ascertain whether he (Spencer)  
or J.R. Worrell kind a  
freedwoman & to collect of  
said Spencer suit due for  
labor.

Bureau R. V. & A.  
HEADQUARTERS 5th DISTRICT OF ARMY  
Albany, Ga July 7/68

Respectfully referred to W.B.  
Spencer Esq. in his military case,  
who will comply with the request  
of Agent Worrell.

*W. C. Worrell*  
2nd Lieut. 5th U.S. Cavalry  
SUB-ASSISTANT COMMISSIONER

R. & M.  
July 7/68

11-22-68  
Office Capt B.R. Foster  
Americus Ga July 6/68  
Respectfully returned  
to Capt Worrell (thru  
Lt. J. P. Howard) & to  
with request that if  
possible he will give  
information as to  
what part of Tenth Co  
Clinton's Capt. under  
I have made  
diligent inquiry &  
have not been able  
to find him  
W.C. Worrell

Bureau R. V. & A.  
HEADQUARTERS 5th DISTRICT OF ARMY  
Albany, Ga July 11/68

Respectfully referred to  
W.B. Spencer Esq. in his military case,  
who will comply with the request  
of Agent Worrell.

*W. C. Worrell*  
2nd Lieut. 5th U.S. Cavalry  
SUB-ASSISTANT COMMISSIONER

R. & M.  
July 11/68

Office Capt BR & at  
Cincinnati Ga July 6<sup>th</sup> 1865

Lieut O. Howard  
Sub Asst Com<sup>r</sup>  
Albany Ga

Sir:

I have the honor to request the  
Capt of Terrill Co Sumners Levi Spencer  
(Col) now living with Clinton Taylor of said  
County and interrogate him

1<sup>st</sup> whether he or John R. Worrell hired  
a woman by name of Maria Davis  
& if he (Spencer) hired her did he collect  
of Worrell the amt of 16.<sup>00</sup> dollars for  
said work - I and also to collect of  
said Spencer the wages due said Maria  
for work done for him (Spencer) she claims  
60.<sup>00</sup> due from Spencer & 16 - from Worrell  
but Worrell says he paid Spencer the amt.

Very respectfully  
Yours  
W. C. Worrell,  
Capt



---

BRUCE R. F. & W. A. CO.  
HARRISBURG, PA. DISTRICT OF ALBANY  
July 22, 1900

Received in payment of  
W. C. Mordant, Esq. Agent Bureau of  
Public and Commercial Lands, Division  
of Agriculture, Albany, Pa.

*C. A. Hornum*  
ADJUTANT GENERAL'S OFFICE  
Sub-assistant Commissioner  
Albany, Pa. July 22, 1900

---

BUREAU R., F., & W. A.,  
HEADQUARTERS SUB-DISTRICT OF ALBANY  
*Albany, Ga.* 1868

Howard, O. H.,

2ND LIEUT. 5TH U. S. ARTY. B.  
Sub-Assistant Commissioner.

*Received*

1868

Bureau Refugees, Freedmen, and Abandoned Lands

HEADQUARTERS SUB-DISTRICT OF ALBANY.

Albany, Ga. August 20<sup>th</sup> 1865

W. A. Merrill Esq.  
Agent Bureau of F. & A. L.  
Americus Ga.

Sir,

I have the memorandum receipt of your predecessor  
Mr. J. M. Robinson, for

4 Matt Tents  
12 " " Saws  
4 " " Axes  
64 " " Sins  
5 Mosquito Bars.  
5 single Bedsacks.

You will please put these in packages for  
shipment to Be. Road to this point, and send me a list  
showing No. of packages, contents, weight &c. all the data  
necessary to make out Bills of Lading.

Bills of Lading will then be sent you, when  
please ship them to me.

Very respectfully

Your obedient servant



24 West 5th Avenue

Brooklyn, N. Y.

J. A. Gordon

7  
Miss [unclear] [unclear] [unclear] [unclear]  
[unclear] [unclear] [unclear] [unclear]

Respectfully referred to [unclear] [unclear]  
[unclear] [unclear] [unclear] [unclear], who is  
desired to have the investigation reported  
in New Brunswick to [unclear] in his  
District, forwarded at once.

Very truly  
Yours,  
[unclear] [unclear] [unclear]  
[unclear] [unclear] [unclear]  
[unclear] [unclear] [unclear]  
[unclear] [unclear] [unclear]

Miss [unclear] [unclear] [unclear] [unclear]  
[unclear] [unclear] [unclear] [unclear]

respectfully furnished  
to [unclear] [unclear] [unclear] [unclear]  
at [unclear] [unclear] [unclear] [unclear] for his information and  
for compliance with instructions, con-  
tained in foregoing endorsement.

Very truly  
Yours,  
[unclear] [unclear] [unclear]  
[unclear] [unclear] [unclear]

Bureau No. 10, 11, 12  
Office Asst. Genl. State of Georgia  
Atlanta Ga. August 21<sup>st</sup> 1862.

Mr. Frank Gallagher,  
Bot. Capt. U.S.A.  
A. T. A. Dist.  
Atlanta Ga.

Sir,

I have the honor to report that in accordance with S. O. No. 104 of Office Asst. Genl. Bureau No. 10, 11, 12 I visited the offices of the Dist. Asst. Genl. and the Agents of the Bureau at Miami, Amnicus, Dawson and Columbus Ga.

The office of Bot. Maj. Howard, and of Capt. Standen at Miami, was in good order and the books properly kept, except that their own endorsements were entered in red ink.

At Amnicus Books of Letters received & endorsements was not numbered, in many cases there was no record of the date, when a communication was received, some endorsements were copied, where the originals were on file in his office, his own endorsements were copied in red ink, and neither this book nor the journal were indexed.

At the office of Wm. S. Dure at Dawson, neither journal nor Endorsement book indexed, cases of Frank Gallagher,

turned over to the Civil Authorities are not recorded in the journals. Letters received are not numbered in the books, his own endorsements are in red ink, and it is necessary to refer from the record of Letters received, to some other page of the book for the endorsements on them.

Tracy Bahaw at Culbert's, also signs his own endorsements in red ink, and the endorsements are not entered opposite the records of Letters received. Neither his journal nor his note of Letters received is indexed.

In all other respects these offices were found in better condition, than almost any other inspected by me.

I remain, Captain

Very respectfully

Your obedient servant

Wm. H. S. Brownson.

Fort. New, A. S. S. S.

Fanny Garrison  
September 2. 18

Hausenberg, Johns  
Agent. Etc

transmits copy of letter  
from Asst Comm. Delaney  
that suitable persons be  
recommended for appointment  
as agents in Volant, Ind.

J. L. S.



RECEIVED

Wm. H. Hunt  
Director of the  
Office of the Agent  
General of the  
Army, Wash. D. C. Sept 27 1878

Division of  
Agents

52

I have the honor to receive your  
copy of a letter of the Act. Comm. - which is also that the  
members of the Indian Service are to be appointed by the  
President with the consent of the Senate. The Commission  
is to be appointed by the Act. Comm.  
The Act. Comm. being a court it becomes my duty to  
carry out the orders and in compliance with this order  
expressed in a private letter <sup>to me</sup> previous to the receipt of the  
order, I respectfully request you to give to this office  
at an early day as possible the names of one or more persons  
whom you may desire to be appointed to the office of  
agent of the Indian Service for the Territory  
of Wyoming. It is the duty of the Agent to see that the  
law is just and uniform to all without regard to race or color  
and to see that the Indians are treated with respect and  
attention to their rights and to their interests.

Bureau not to replicate exactly with those in the Bureau  
relative to the forest, copies.

It is desired that you would give the same weight  
in the responsibility resting upon you in making these  
statements, you are required to act with as much of any  
disparities as is consistent with the same.

Very Respectfully  
Your Obedt Servt  
Ch. Kraushenberg  
A. P. S.

Received of the  
Office of the  
Atlanta Georgia August 29th 1888

Agent (C. H. Howard)  
Richmond  
Alabama

The last business events that  
have occurred in your line have been  
without delay and unimpeded in the  
this office in an ample manner for the  
-ness of business which in each county of your State  
is, in the selection you will be entitled to  
the interests of the people and unimpeded  
that will be the result of the  
in the course of your official duties

Ch. Rauschenberg  
Agent Etc

Very respectfully  
James M. ...  
Agent of ...  
Atlanta Georgia

Bureau R. F. & A. L.  
OFFICE AGENT, DIVISION OF AMERICUS  
Americus, Ga. Sept 7

Morrill, Ed. C.  
AGENT.

Removal request of Emilia  
Roberts that Agt. See Co  
investigate case of Dr.  
Audus indebted to her for  
Labor 1867

BUREAU R. F. & A. L.  
RECEIVED  
SEPTBR. 8th.  
1868.  
SUB-DIST. ALBANY.

Bureau R. F. & A. L.  
HEADQUARTERS SUB-DISTRICT OF ALBANY  
Albany, Ga. October 9 1868

A. B. Roberts  
W. P. PIERCE, Esq. Agent Bureau R. F. &  
A. L., Division of Division, Dept. of Int.

*[Signature]*  
2ND LIEUT. 5TH ARTILERY  
BREVET MAJOR U. S. ARMY  
Sub-Assistant Commissioner  
E. & M. No. Vol. 1868

Bureau R. F. & A. L.,  
HEADQUARTERS SUB-DISTRICT OF ALBANY,  
Albany, Ga. October 20 1868

Respectfully forwarded to  
W. C. MORRILL, ESQ. Agent Bureau R. F.  
& A. L., Division of Americus, Americus, Ga.

*[Signature]*  
2ND LIEUT. 5TH ARTILERY  
BREVET MAJOR U. S. ARMY  
Sub-Assistant Commissioner  
E. & M. No. Vol. 1868

Com. Roberts  
I have the honor to acknowledge  
the receipt of your letter of the  
7th inst. and in reply to inform  
you that the same has been  
forwarded to the proper  
authorities for their consideration  
and return to me as soon as  
possible.

Bureau Refugees, Freedmen and Abandoned Lands:

Office Agent, Division of Americas,

(Under Treaty of Webster's Convention)

Americus, Ga.

Sept 7<sup>th</sup>

1868.

But ~~Major~~ C. Howard

Sub Asst Comr

Albany Ga

Major

I have the honor to represent the case of Emeline Roberts who claims that Dr Sanders of Lu Co is indebted to her for labor performed by her son John for year 1867. She claims she has rec'd but \$27.00 while the contract was for \$80 <sup>00</sup>/<sub>100</sub>. She respectfully asks the Agt of Lu Co be requested to investigate the matter and if found as stated the balance due her be transmitted to this Office -

Very respectfully  
Your obt. Servt.  
A. C. Merrill  
Agt.

11.

**Bureau R. F. & A. I.,**  
HEADQUARTERS SUB-DISTRICT OF ALBANY.  
*Albany, Ga., October 29<sup>th</sup> 1868.*

Respectfully forwarded to  
W. C. MORRILL, ESQ., Agent Bureau R. F.  
& A. I., Division of Americas, Americus, Ga.

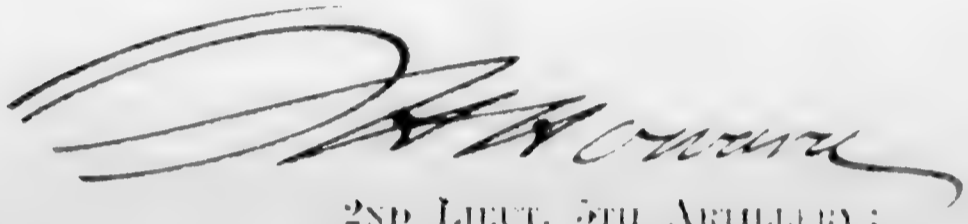

2ND LIEUT. 5TH ARTILLERY;  
BREVET MAJOR U. S. ARMY.  
**Sub-Assistant Commissioner.**  
E. & M. No.                      Vol.                      1868.

*W. C. Morrill  
Albany, N. Y.  
Oct 29 1868*

*Case 2553*

State of Georgia,

OFFICE ASSISTANT COMMISSIONER, BUREAU OF R. F. AND A. L.,

Atlanta, Georgia,

Oct 28<sup>th</sup>

1868.

Mr C. Merrill

Dear Sir

I have the honor

to

ack

acknowledge the receipt of the \$100.00 from the  
State of Georgia, which was paid to me by  
Mr. C. Merrill, Agent of the State of Georgia,  
in the sum of \$100.00, for the purpose of  
the purchase of the land of the State of Georgia,  
which was sold to me by the State of Georgia,  
in the sum of \$100.00, for the purpose of  
the purchase of the land of the State of Georgia,  
which was sold to me by the State of Georgia,  
in the sum of \$100.00, for the purpose of  
the purchase of the land of the State of Georgia,

I have the honor to acknowledge the receipt of the  
\$100.00 from the State of Georgia, which was paid to me  
by Mr. C. Merrill, Agent of the State of Georgia,  
in the sum of \$100.00, for the purpose of  
the purchase of the land of the State of Georgia,  
which was sold to me by the State of Georgia,  
in the sum of \$100.00, for the purpose of  
the purchase of the land of the State of Georgia,

Yours

Very respectfully,  
W. H. C. Merrill

100

Approved by the Com' of  
Accountants Bureau.

The Comptroller is to  
be instructed accordingly  
as directed by the Com'.

By Order  
The Secretary of the  
Internal Revenue  
Bureau  
J. G. C.

Approved by the Com' of  
Accountants Bureau



Mr. Secretary  
Washington

Dear Sir

I have the honor to acknowledge the receipt of your letter of the 10th inst. in relation to the proposed purchase of the building now occupied by the Department of the Interior, and in reply to inform you that the same has been referred to the Board of Commissioners of the General Land Office, and that they are now engaged in a careful examination of the same. I am, Sir, very respectfully,  
Your obedient servant,  
John C. Smith, Secretary

desired to have the Constitution resumed to their former  
place, if the Government makes no claim to the same,  
Article 17, of an Act of Congress passed July 11<sup>th</sup>  
1864, gives to the Commission of the same, and to the  
said Commission, full power, use, force, and authority,  
and said Commissions, and their agents, officers, and  
agents, to do all such things, and to do the same, as  
they may think proper, to do, in and to the United States,  
and in the Territories, and in all places subject to the same,  
to carry into effect the purposes, and to do the same, as  
appropiate the proceeds derived therefrom to the  
education of the freed people &c.

This Commission is still in force, and under it the  
Commissioners have the right to hold, use, and dispose  
of the documents in question. His possession is  
the possession of the United States, and in relation  
thereto within the United States is a part of the public

of the United States have exclusive jurisdiction,  
In this case the United States claim title by  
right of conquest, and whether that title is a valid  
one or not depends upon the law of war and certain  
act of Congress. But it is a title not questioned  
by the Georgia Court. The military service and  
possession of the land vested, and if any pro-  
ceeding should be instituted in any Court of  
the State of Georgia to procure possession of the  
property in question, it would be for violation of  
the service to give to the Government, by virtue of  
the Department of the South.

It appears that a portion of the land in  
question is now used by the Government  
for a military depot, and in consideration of  
the question of title is to be conveyed to the  
Georgia Court, there is no power to prevent  
Mr. Syke from conveying the same to the Court.

It is a beautiful, even more, case.

signed

To Mr. Green

Wm. J. A. Green

Faint, illegible text or markings at the top of the page.

/

—

[Faint, illegible text block]

[Faint, illegible text block]

*Received*

---

BUREAU R., F., & N. L.;  
HEADQUARTERS SUB-DISTRICT OF ALBANY,

*Albany, Ga. 1868*

---

Howard, O. H.,

2ND LIEUT. 5TH U. S. ARTILLERY;  
Sub-Assistant Commissioner.

---

*withdrawing certain notes  
from circulation*

---

*Received*

*1868*

WAR 426

African Refugees, Freedmen, and Abandoned Lands

HEADQUARTERS SUB-DISTRICT OF ALBANY

Albany, Ga. October 24<sup>th</sup> 1865

Wm. C. Norvell Esq.  
Agent Bureau F. D. A. S.  
Americus, Ga.

Sir,

I trust you, before the approaching election  
will be able to give me, in the following words, viz:  
"Go ahead"

You will counsel and advise the freedmen in the  
counties under your supervision, not to participate  
in this election, but to remain away from the polls,  
at home, and to postpone their exercise of the elective  
franchise until more settled times.

You will employ such means as you may  
consider not calculated to enable you to communi-  
cate with the largest number of them, through reliable  
agents in whom you and the freedmen have confidence  
and any expense necessarily incurred in the execution of  
this duty, will be properly provided for.



These instructions will be carried out and this  
duty performed as quickly as may be consistent with  
the thorough accomplishment of the object in view.  
Please acknowledge the receipt of this immediately.

Very respectfully  
Your obedient servant

2nd Lieut 5th Infantry  
St. Mary, U.S.A.  
S. J. G.

Andersonville Ga.  
Mr W C Murrell  
Americus

Mar 5<sup>th</sup> 1868

Sir I send to Mr  
William Smith \$40.00 subject to your  
order which is what we owe Alfred  
Harris which he could of had long  
since if he had of cared on me as you  
directed him - he is due my copartner  
\$115 which he is a ware of & he is due  
me individually 70 which you will please  
will please to send me the ten bill by mail  
to biggers & Co would of course but not able  
to do so  
W C Murrell

Faint, illegible text, possibly bleed-through from the reverse side of the page.

Faint, illegible text, possibly bleed-through from the reverse side of the page.

*Handwritten notes and signatures in the left margin, including the name "C. C. ...".*

**Bureau R. F. & A. L.,**  
HEADQUARTERS SUB-DISTRICT OF ALBANY.

*Albany, Ga., December 15, 1868.*

Respectfully forwarded to  
BREVET CAPTAIN M. FRANK GALLAGHER, Act-  
ing Assistant Adjutant General, Bureau R. F.  
& A. L., State of Georgia, Atlanta Ga.

2ND LIEUT. 5TH ARTILLERY:  
BREVET MAJOR U. S. ARMY.  
Sub-Assistant Commissioner.

E. & M. No. Vol. 1868.

**Bureau R. F. & A. L.,**  
HEADQUARTERS SUB-DISTRICT OF ALBANY.

*Albany, Ga. Dec. 5<sup>th</sup> 1868.*

Respectfully forwarded to  
BREVET CAPTAIN M. FRANK GALLAGHER, Act-  
ing Assistant Adjutant General, Bureau R. F.  
& A. L., State of Georgia, Atlanta Ga.

2ND LIEUT. 5TH ARTILLERY:  
BREVET MAJOR U. S. ARMY.  
Sub-Assistant Commissioner.

E. & M. No. Vol. 1868.

*Office of Comm. Bureau R. F. & A. L.  
Atlanta Ga., Nov 5, 1868.*

*Respectfully returned to  
3rd Maj. C. M. Howard?  
S. A. C. Albany, Ga. for  
signature.*

*By order of  
3rd Lt. H. R. Lewis*

*3rd Maj. W. J. G.  
11. 11. 68*

claim.

By order of,

Bt. Col. J. R. Lewis

Bt. Capt. U.S.A.  
V. V. V. G.

---

Bureau R. F. & A. L.,  
HEADQUARTERS SUB-DISTRICT OF ALBANY.

Albany, Ga., November 12<sup>th</sup> 1868.

Respectfully forwarded to  
W. C. MORRILL, ESQ. Agent Bureau R. F.  
& A. L., Division of Americus, Americus, Ga.



2ND LIEUT. 5TH ARTILLERY;  
BREVET MAJOR U. S. ARMY.  
Sub-Assistant Commissioner.

E. & M. No. Vol. 1868.

---

Bureau R. F. & A. L.,  
HEADQUARTERS SUB-DISTRICT OF ALBANY.

Albany, Ga. Nov. 5<sup>th</sup> 1868.

Respectfully forwarded to  
BREVET CAPTAIN M. FRANK GALLAGHER, Act-  
ing Assistant Adjutant General, Bureau R. F.  
& A. L., State of Georgia, Atlanta Ga.

2ND LIEUT. 5TH ARTILLERY;  
BREVET MAJOR U. S. ARMY  
Sub-Assistant Commissioner.

E. & M. No. Vol. 1868.

---

*Handwritten notes and scribbles in the left margin, including the word "copy" and some illegible text.*

**Bureau R. F. & A. L.,**  
HEADQUARTERS SUB-DISTRICT OF ALBANY,  
*Albany, Ga., December 1868.*

Respectfully forwarded to  
BREVET CAPTAIN M. FRANK GALLAGHER, Act-  
ing Assistant Adjutant General, Bureau R. F.  
& A. L., State of Georgia, Albany Ga.

2ND LIEUT. 5TH ARTILLERY:  
BREVET MAJOR U. S. ARMY.  
Sub-Assistant Commissioner.  
E. A. M. No.                      Vol.                      1868.

*Office of Commr, Bureau R. F. & A. L.,  
Atlanta, Ga., Nov 5, 1868.*

Respectfully returned to  
Br. Maj. C. H. Howard, S.  
S. Albany, Ga, for  
signature.

By order of, D. R. Lewis  
Br. Col.

Br. Maj. U. S. A.  
Albany, Ga.

State of Georgia,  
Bureau of Refugees, Freedmen, and Abandoned Lands:  
Office Assistant Commissioner,  
Atlanta, Ga., *Nov 9<sup>th</sup>* 1868.

Respectfully returned to  
Br. Col. Merrill, Agent, Wash.  
Br. Maj. C. H. Howard, S.  
S. Albany, Ga, with in-  
formation that it is im-  
possible for this office  
to adopt the course re-  
commended by Agent  
Merrill in this case - the  
only remedy applicable  
is the Civil Courts, it is  
recommended they be  
assisted to at once.  
Agent Merrill will render  
all aid in his power  
to forward the freedman

Bureau of Refugees Freedmen and Abandoned Lands,

OFFICE AGENT DIVISION OF AMERICUS,

SEWELL, SULLY AND WEBSTER COUNTIES,

Americus, Ga., Oct 20<sup>th</sup> 1865.

Dear Mr. [unclear]

Atlanta Ga

Dear Sir

I have been informed by Mr. [unclear] with  
the assistance of Mr. [unclear] that an  
order would be issued to seize certain cotton  
from Murray to pay for the [unclear] of  
the [unclear]. I am satisfied that I have  
will not pay unless advised to [unclear] I can  
not get an order to seize from the [unclear]  
the [unclear] is about [unclear] and will not [unclear]  
of the [unclear] [unclear] Mr. Murray  
has [unclear] advised [unclear] to  
to pay [unclear]

Very  
[unclear]  
[unclear]

I am respectfully,  
Yours  
[unclear]

Atlanta Ga

Remission of...

...

1

...



1795

State of Georgia  
Council of Commerce

Whereas the Council of Commerce  
of the State of Georgia  
do hereby certify that  
the same have received  
from the Honorable  
the Secretary of the  
Council of Commerce  
of the State of Georgia  
a copy of the  
Report of the  
Honorable the Secretary  
of the Council of  
Commerce of the  
State of Georgia  
for the year  
1795

Attest  
I, \_\_\_\_\_  
Secretary

Bureau R. F. & A. L.  
OFFICE AGENT DIVISION OF AMERICUS,  
*Americus, Ga., 1868.*

**Morrill, Wm. C.**  
AGENT, ETC.

PURPORT.

Bureau R. F. & A. L.,  
HEADQUARTERS SUB-DISTRICT OF ALBANY,  
*Albany, Ga. November 11, 1868.*

Respectfully forwarded to  
BRIEF CAPTAIN M. FRANK GALLAGHER, A. S. G.  
112 Assistant Adjutant General, Bureau R. F.  
& A. L., State of Georgia, Atlanta Ga.

2ND LIEUT. 5TH ARTILLERY:  
BRIEF MAJOR U. S. ARMY.  
Sub-assistant Commissioner.  
E. & M. No. Vol. 1868.

Bureau R. F. & A. L.,  
HEADQUARTERS SUB-DISTRICT OF ALBANY,  
*Albany, Ga. November 11, 1868.*

Respectfully forwarded to  
W. C. MORRILL, ESQ., Agent Bureau R. F.  
& A. L., Division of Americus, Americus, Ga.

  
2ND LIEUT. 5TH ARTILLERY:  
BRIEF MAJOR U. S. ARMY.  
Sub-assistant Commissioner.  
E. & M. No. Vol. 1868.

*Office of Comy Bureau R.F. & A.  
Milledgeville, Ga. Nov 11, 1868.*

*Respectfully returned, this  
3d. Maj. C. H. Howard, S. G.  
C. Albany, Ga., approved,  
By order of  
3d. Lt. J. R. Lewis.*

*3d. Lt. J. R. Lewis  
3d. Capt. U. S. A.  
A. G. A. G.*

Bureau Refugees, Freedmen, and Abandoned Lands,  
OFFICE AGENT DIVISION OF AMERICUS,  
Sumter, Schley, and Webster Counties,

Americus, Ga., Nov 7<sup>th</sup> 1868.

At Capt M Frank Callahan  
a a a Genl  
Callahan Co

Capt.

I have the honor to forward  
to you a copy of a letter which  
will be sent you a meeting, relative  
to affairs in that County, so you please,  
I have felt necessitated to make some  
effort to stop the almost civil war  
of our colored attacks upon the Freedmen,  
which have I am I am exceedingly  
convinced to be the place I am the  
probable being threatened with death of my  
self & public, I trust it will not  
be of any effect.

Very respectfully,  
Wm. J. S. I  
The Minister

The first part of the  
 report is devoted to  
 a description of the  
 work done during the  
 year. It is divided into  
 several sections, each  
 dealing with a different  
 aspect of the work.

The second part of the  
 report is devoted to  
 a description of the  
 results of the work. It  
 is divided into several  
 sections, each dealing  
 with a different aspect  
 of the results.

The third part of the  
 report is devoted to  
 a description of the  
 conclusions of the work.  
 It is divided into  
 several sections, each  
 dealing with a different  
 aspect of the conclusions.

The fourth part of the  
 report is devoted to  
 a description of the  
 recommendations of the  
 work. It is divided into  
 several sections, each  
 dealing with a different  
 aspect of the recommendations.

Office of the Secretary,  
War Department

Washington, D.C.

Dear Sir:

I have the honor to acknowledge the receipt of your letter of the 10th inst. in relation to the matter of the purchase of the land for the proposed extension of the Washington and Annapolis Railroad. I am sorry to hear that you are unable to furnish the necessary information at this time. It is, however, essential that you should be able to furnish the same as soon as possible, in order that the necessary steps may be taken to complete the purchase of the land. I am, Sir, very respectfully,  
Your obedient servant,  
Secretary of War

Very truly yours,  
Secretary of War

organization to the next year in 1952.  
 The next year in 1953 the first  
 and second years of the first  
 but, I must admit, I am not  
 sure, with a few exceptions, and  
 we did not have the first year of  
 a program. However, all this was  
 being in relation to the first meeting of  
 members to plan for the next year in  
 1951. The first meeting was held on  
 7th Nov and passed resolutions and a  
 determination to set up a committee to  
 plan for the year 1952. The committee  
 was set up and met on 11th Nov. It  
 met at Sacramento and passed  
 - the resolutions and set up a committee  
 of five people to be the first committee  
 of the U.S. The committee was to report to  
 the next meeting in 1952. The committee  
 was to be the first committee of the  
 movement to be set up and to report to  
 the next meeting. The committee of five  
 members was set up and the names of the  
 members are as follows: [illegible]  
 officers are [illegible]  
 I assume you are [illegible]  
 being the [illegible] [illegible]  
 [illegible] [illegible] [illegible] [illegible]  
 [illegible] [illegible] [illegible] [illegible]

I know the discontents of the Government  
and of Congress & I wish that some one  
should be able to collect the  
together the letters under which the  
South complains & then all other causes  
together. I would earnestly request an  
account that you may also let us  
know whether it is to be continued  
or not & protect the correspondence  
from the hands of the public.

Alfred Royal

19

W. A. Bower

Evidence "Pro + Con"



Alfred Royal }  
vs } Action for Damages  
W. A. Brewer }

Witness Examined by Complaining  
Direct Examination

Nathan Bruce on oath Says —

Alfred Royal built house middle of 1865,  
abt July. Built on Land of his. (Nathan)  
Heid land of Mr Brewer under bond for  
title. was to pay 500 dollars. Had made  
no payment. Paid no interest but paid  
rent — the land was to be Brewers until  
paid for — was to pay rent until got title  
Had two years to pay in — Alfred was to  
put good house on Land & to have use of  
it two years. — Saw Brewer and told him  
about Alfred house and he (Brewer) said all  
right the land is yours do as you please.  
Alfred lived in house 5 months. would  
rent for 2, 4 or 5 dollars per month. Gave  
bond back to Brewer. Brewer gave up note  
on return of bond for title. Son of Alfred  
lived in house after bond was given. House  
stood some 3 months after title to land ~~was~~  
was given up — never gave any one any  
title to land after leaving.

Cross Examination

Purchased land of Brewer who gave bond  
for title on payment purchase money — Gave  
note for amt agreed upon — was to pay rent  
quarterly or semi yearly in lieu of interest

was to pay eight or ten dollars per month  
out in lieu of interest on the note. -  
Took possession of land after purchase,  
Leased land to Alfred after taking possession  
for two years. Alfred was to put up frame  
house 18 + 20 feet - ciled overhead with brick  
chimney. House was built with refuse lumber  
Agreement was to build with good lumber.  
House was not ciled. House was weather  
boarded two sides + one side and was placed  
against my house to make or close up the  
side not weather boarded House was  
not removed or torn down before Jordan purchased  
of Mr Brewer. After I moved my shop  
House was not worth anything for rent. House  
was worth 18 or 20 dollars. House would have  
been worth 200 or 300 dollars if agreement  
had been complied with - No chimney to house.  
Went to Mr Brewer to ask <sup>him</sup> abt my right to  
rent land. - I sold the land to Jordan  
abt week before giving up bond -  
Question - Tell what transpired between you +  
Jordan - which was objected to by counsel for  
complacient. - but allowed - Unusual - told  
Jordan abt trade of myself and Alfred. Jordan  
your same as I did. gave information to  
Brewer abt trade The bond was taken back  
to accommodate me and Jordan. -  
Strict Examination

Alfred was not present when trade between me and Jordan was made. Brewer knew of trade between me & Jordan. Brewer made no objection to trade. — There is good deal of trading near there — about 100 yards from Joe Crawford's etc. — Does not know how many feet lumber nor how many lbs nails nor how many shingles was in house —

Cross Et

Lumber was not dressed — different widths joints did not fit. —

H. A. Brewer, Defendant — on oath says — Direct Et —

Sold lot 1<sup>st</sup> August 1846 to Nathaniel Bruce sold it for \$40<sup>00</sup> dollars to be paid within date of sale. Agreement was to be paid in two years from sale. — Gave bond for title to make warranty due to lot in fee simple. Nathaniel was to pay rent in lieu of interest. Nathaniel was in & retained possession. Nathaniel asked if he had right to sub rent any portion of the land I told him I tho't he had under the law.

Question — State what transpired between you Nathaniel & Jordan — which was objected to by complainant — but was allowed —

Answer — Before Jordan traded with Nathaniel or had any talk with him he came to me & I told him (Jordan) had sold to Nathaniel

and Jordan made trade with Nathan  
before I had anything to do with it.  
Was not present when Jordan & Nathan  
made trade. When land was sold to Jordan  
Nathan & myself were present. Never made  
any promises to Royal abt house. Contract  
was made for lease by Nathan & Alfred. Never  
saw house of Alfred until after 1<sup>st</sup> trial.  
only saw it from the street, House was not  
tenable. could not tell whether house was  
made of good lumber or not.

#### Cross E

Nathan paid  $12\frac{56}{100}$  dollars per month for lot  
& shop as rent after he bought.

Told Jordan if he could make any arrangements  
with Nathan so as to give him or get him  
back rent, & the \$40<sup>00</sup> dollars would let  
him (Jordan) have it. — What I wanted  
was the \$40 dollars & back rent.

Took back bond from Nathan & gave him  
(Nathan) the notes & gave similar bond  
to Jordan Sept as to date. —

#### Direct E

Bond given to Nathan was destroyed.

Dwight E.

Alfred Royal - Complainant -

On oath says -

Leased lot of Nathau Brewer for two years - Built a house and was to have rent of same two years for building it. Did not finish house according to contract. Lived in house 5 months. Left son in house and went in the country, on returning was refused admittance to same and could neither get in the house nor have anything to do with it. Mr Jordan telling me he had bought said place and owned the whole. Mr Jordan rented said house for ten dollars per month. Did not consent to being turned out of house.

Cross E.

House was rented for ten dollars per month - Do not know what the value of said house for rent. Do not know of my own knowledge that the house was rented. House was in same condition when son lived in it as I left it. House was not to be ceiled. No specifications about lumber or what kind of house to be built. Mr Jordan refused to allow me to go back. Contract was with Nathau Brewer. Did not know Brewer in contract. Did not know

What title Nathan held to lot. House  
was put up as common grocery. Built  
of plank, not refuse nor rough edge  
Some joints did not fit. Do not know  
Value of house. —

Direct \$4.

It would rent for 9<sup>00</sup> dollars per month  
It was built as a little grocery store  
Was near another store kept by a  
Krudman. Was intending to put up  
chimney according to agreement.

Cross \$4.

Uncle Billy offered me 9<sup>00</sup> dollars per  
month rent. Did not rent as he had  
no ready money. Had horses & cart  
but no other property. — — —

N. A. Smith atty for Alfie admits  
that Nathan Bruce would swear that Alfie  
did know what kind of title he (Nathan)  
had to said lot. — — —

Alfred Royal  
vs  
H. A. Brewer  
Argument for Compliment  
by  
- N. A. Smith  
Atty

Alfred Royal  
Plaintiff  
vs  
William H. Brewer  
Defendant  
Action for damages  
before Col. J. C. Howell  
Agent C. T. A. S. at  
Americus Geo

Argument  
of J. L. Smith, attorney for the plaintiff, who  
has the honor to submit the following views and  
authorities,

1<sup>st</sup> By the bond for better given by the defendant  
the title did not pass but remained in Brewer  
In support of this position I would refer to refer  
to the following cases, Mason vs Bailey & Park 17<sup>th</sup>  
Geo Reports 600. Martin & Butt vs Knight 21<sup>st</sup>  
Geo Reports 504. Moreover Brewer seems unto  
due quantity upon the place in question, then  
Brewer holding the title to the lot and receiving  
rents therefor was according to the definition  
in the Code (Articles) of Georgia Section 2253  
the landlord and Nathan Brewer the tenant.  
Nathan the tenant with the knowledge and  
consent of Brewer the landlord made a con-  
tract with Alfred the plaintiff, that Alfred  
should build on a portion of the lot a house  
and for the building should have the use of the  
house for his years. This according to the same  
Code Section 2258 makes Brewer liable to  
Alfred for this "substantial improvement  
placed upon his lot by his consent"

2<sup>nd</sup> The proof shows that Brewer with full



Knowledge of the arrangement and agreement between Nathan & Alfred took back from Nathan the bond for title which Nathan held and gave up to Nathan the note which he held for the agreed price of the lot in question. The trade between Brewer & Nathan was thus completely rescinded and Brewer is instantly was placed in the relation to the lot in question and all parties interested in said lot as though no bond for title had ever been made. In thus cancelling the trade he sanctioned and became liable for all legal interests which he knew had been conferred by Nathan concerning the lot in question. He knew of the arrangement with Alfred and Nathan's acts thereunder as he had not known of the building before this sanctioning Nathan's contract made Brewer the principal and Nathan only the agent and this makes Brewer liable to Alfred. In support of this position I would refer to the cases of Perry vs Haddon 10<sup>th</sup> Cal. Rep. 362 and Byrum vs Doughty & Bell 13<sup>th</sup> Geo. Rep. 46. In this connection I would suggest that Brewer received the benefit arising from building the house in question for he had the right to sell the property to whom he pleased the moment the trade with Nathan was cancelled and did actually sell it to improve. Then in equity he should pay Alfred for the increase in value given to the lot by Alfred's improvements on the lot.

3<sup>rd</sup> It may be suggested that Nathan is liable to Alfred. This is undoubtedly legally true but not equitably for Brown - assumed all liability by cancelling the trade after full knowledge of all the facts - Moreover if Nathan is liable Brown is also and Alfred can choose against whom he will proceed to enforce his rights - Nor is Jordan liable under the proof to Alfred either legally or equitably - There is no priority between them, that is Alfred and Jordan

4<sup>th</sup> Brown by the sale to Jordan, without reservation deprived Alfred of the enjoyment and use of the house for nineteen months and should be responsible to Alfred for the full amount of the damage sustained by Alfred by means of his Brown's acts. This damage must be measured by the value of nineteen months' rent. The house rented at ten dollars per month for the next two months after Alfred was deprived of the use of it Alfred before leaving it was offered nine dollars per month rent. Nathan states that it was worth three or four dollars per month rent. The whole testimony of Nathan shows that he was biased in favor of Brown and also that he was judging as to what the house would have rented for as a dwelling while the proof shows that it was to be used as a sort of a store house, near another store kept by a Jewman, these two being the only stores owned and kept by Jewman in the town. This would make the house much

more valuable for rent and shows that the estimate  
by Nathan can not be relied upon. But taking  
an average of the rents as stated by Alfred  
and Nathan, to wit, ten, nine, four and three  
dollars per month and it gives six and one half  
dollars per month, for the minimum months one  
hundred and twenty-three and one-half dollars.  
This is the lowest possible amount that can be  
approved and I submit should be increased  
by at least half the difference between this amount  
and one hundred and ninety dollars.

But counsel  
for the defendant contends that Alfred has not  
complied with his part of the contract by putting  
up such a house as he has agreed to put up.  
There is no proof that any time was specified  
as to when the house should be completed  
and Alfred swears that he was going on to  
complete the house according to contract but  
was prevented by the refusal of Jordan whom  
Brewer has sold from taking possession or  
going on the lot - Thus by the act of Brewer  
in selling the lot without reservation, Alfred  
could not comply on his part with the terms  
of the contract - It is a maxim of law  
that "No man shall profit by his own wrong"  
and Brewer by his own act preventing  
Alfred from complying with his part of  
the contract can not set up this ~~his own~~  
the result of his own deed in bar of  
Alfred's right to recover for the damages

the full amount which Mr. Alfus has ac-  
tually sustained - Brown had the house  
been completed it would have been worth more  
for rent - Besides there is absolutely no proof  
as to the amount it would have taken  
to complete the house according to contract  
and so no data as to the amount that  
should be deducted - if any - and it would  
therefore be a mere guess.

Now - all the evidence  
in this case and the foregoing considerations  
Alfus asks for a judgment against said  
Brown for the full amount of the damages  
which he has sustained

All of which is  
respectfully submitted

N. A. Smith  
Atty for Alfus

Alfred Royal  
vs  
H. H. Brewer

Argument for Defendant  
A. R. Brown  
Atty

have transferred the Bond of Brewer  
to Jordan at the time of sale & no  
one would contend for a sum  
that Brewer would have been  
liable in that event. 3<sup>d</sup> That in  
law Nathan is the real party  
that is liable to Alfred & is well  
able to pay for any damage  
that Alfred has sustained if  
any 4<sup>thly</sup> Should not Nathan be  
able then <sup>as it was a private</sup> Jordan is <sup>part of the</sup> liable for any  
time of sale that he would become liable for any  
the purchaser prosee Nathan &  
dispossessed him Alfred from  
the premises & not Brewer  
5<sup>th</sup> That from the Evidence Alfred  
failed to comply with his contract  
with Nathan in every particular  
and is therefore not entitled to  
recover as he put up a different  
house from what he contracted  
& out of different lumber  
Should you see  
proper in your judgment  
to override my views in this  
Case & hold Brewer liable  
I beg leave to state That plaintiff  
is not entitled to recover near  
the amount contended for.

Because Nathan swears that the house was not worth more than 20 or 25 dollars as it then was & it was worth nothing for rent in its then condition or after the shop was taken off & not more than 3 or 4 dollars per month while the shop was there. The statement of Alfred does not show differently while it is true he states that he could have rented it at 9 dollars per month <sup>on lease</sup>. But when he & planned himself he was offered that sum by a party that had no money & would not rent to him on that account. I admit that he could have got the promise from prudent men here in town of \$2000 per month but that does not prove anything whatever as they would rent with a view of not paying. Therefore Dept prove that he be discharged all of which is respectfully submitted

A. C. Brown  
attorney for Brewer

1  
Alfred Royal vs William A. Brewer  
Action for Damages

The plaintiff relies on three grounds for a recovery as furnished me -  
1st ground that Defendant is liable on the Contract on the Law of Landlord & Tenant Code of Georgia par 437 & 2266  
This law is not applicable to the case at bar, as you will see from the definition of said Code of Landlord & Tenant, par 2261 When the owner of lands grants to another simply the right to possess & enjoy the same of such lands either for a fixed time or at the will of the grantor & the tenant accepts the grant the relation of Landlord & tenant exists between them - Will Nathan receive the mere grant to simply possess the Lot in controversy for a fixed time or at the will of Brewer's Most unquestionable he did not - The Evidence shows that Nathan purchased the Lot & gave him Brewer his notes for the purchase money & Brewer gave his Bond to make a *pro simplici titulo* thereby showing that Nathan purchased & did not lease -



2<sup>nd</sup> By looking to the law as it stood prior to the adoption of the Code of Georgia It is very clear that the rules of Landlord & tenant has been changed very materially & this Code has been adopted by legislative enactment since the decisions were made that is relied on by plain tiffs Council, Because all legislative enactments changing the common law rules take precedent over the common law as it stood formerly therefore I contend that the case of Paxon vs Barley & Ford 17<sup>th</sup> Geo page 600 & Martin vs Burt vs Knight 21<sup>st</sup> Geo Reports page 504 does not apply to this case in any particular. Let us look to the question there decided & see whether or I am correct in my conclusions - The 1<sup>st</sup> case decides this question only that Nathan could not set up an adverse <sup>possession</sup> title to the lot as against Brewer's title to the lot until the purchase money was paid. We do not controvert that proposition nor do we seek to set up an adverse possession that question can not be raised from the evidence. &c

there is not a centilla of evidence  
 on that point. But we admit all  
 the way through & in our bond (which  
 has been lost) that Brewer had the  
 legal title & Nathan an Equitable  
 one which would ripen into a  
 perfect Equity & title upon the pay-  
 ment of the purchase money -  
 The last case only decides that a  
 bond for titles is not a legal title  
 This case does not at all conflict  
 with the view we take of the case  
 for we do not contend that the bond  
 from ~~Arthur~~ Brewer to Nathan was  
 a legal title but an equitable one  
 as such an one that upon the  
 payment of the purchase money  
 Nathan could have compelled  
 Brewer to have made him a legal  
 title in a Court of Equity - *Fair v*  
*Harthright* 5<sup>th</sup> Geo Reports page 6 You  
 will also see the question again  
 decided in the case of *Ston-pur v*  
*Greiffin* 12<sup>th</sup> Geo 450 as to the character  
 of the title & none of the decisions  
 referred to by plaintiffs <sup>Council</sup> change  
 the rule as laid down in the two  
 last stated cases. There is another

view of the question that goes for to  
convince my mind that the doctrine  
of Landlord & Tenant under the  
Code of Georgia did not exist. It  
is this could Brewer have dispossessed  
Notham at will certainly not. He  
held a lien paramount on the Lot  
for the purchase money. But in  
order for him to have dispossessed  
Notham he would have been com-  
pelled to have said the notes  
obtained a judgment & then  
to have made a legal deed & had  
the same recorded in the Clerk's  
office of the Superior Court &  
then had the Lot levied on & sold  
to have paid the purchase money  
that was his only remedy at law  
Code of Georgia Paragraph 3581

2<sup>d</sup> Point Taken by plaintiffs Counsel  
That Brewer is liable as principal agent  
on that doctrine - That is as follows  
as the first ground

Let us see who an agent is under the  
definition of the Code of Georgia Par 2157  
The relation of principal & agent arises  
whenever one person expressly or by im-  
plication authorizes another to

act for him or subsequently ratify  
the acts of another in his behalf -  
Now who was the principal in the  
lease of this lot to ~~Nathan~~, Alfred?  
Nathan most unquestionably  
The evidence shows this fact clearly  
It is an absurdity now to say that  
if I ratified or give my consent  
or did not object to a person erecting  
improvements on ~~the~~ another  
man's premises that I should be  
made liable therefor such a thought  
never entered the mind of any  
one before plaintiffs Council  
+ is not law justice or equity  
that it should be so - The evidence  
shows that this lot at the time of the  
lease was Nathan + admitted so  
by Brewer at the time, I do not  
controvert the doctrine as laid  
down in 10<sup>th</sup> Ves R 362 + 13<sup>th</sup> Ves R  
46 as the cases cited only establish  
the fact that where a person performing  
~~the~~ an act for another unauthorized  
the principal may ratify it + make  
it binding on himself, The act of  
Nathan leasing to plff could not be  
objected to by Brewer as Nathan was

the principal & had the right to dis-  
 pose of his property as he thought  
 to his best interest. Now in order  
 for Brewer to have ratified the act  
 of Nathan he must have been  
 the principal & Nathan authority  
 ed to make the loan - The evidence  
 shows clearly to the reverse -  
 3<sup>d</sup> Ground That West is liable to pay  
 for all damages sustained -  
 We contend that the proof shows  
 that we are not liable in any par-  
 ticular - In the 1<sup>st</sup> place it is admitted  
 that Alfred knew the kind of title  
 that Nathan had at the time of loan  
 & leased with full knowledge of  
 the same - 2<sup>d</sup> That Alfred sublet  
 said premises to his son or son or  
 son in law & that he was not  
 dispossessed of the occupation by  
 any act of Brewer, <sup>but</sup> by John W  
 Gordon to whom Nathan sold  
 While it is true that Brewer took up  
 the Bond & gave Nathan his notes  
 to accommodate Nathan ~~Gordon~~  
 fit in Equity Brewer should stand  
 in the same position that he ~~did~~  
 would have done had Nathan

have transferred the Bond of Brewer  
to Jordan at the time of sale & no  
one would contend for a moment  
that Brewer would have been  
liable in that event. 3<sup>d</sup> That in  
law Nathan is the real party  
that is liable to Alfred & is well  
able to pay for any damages  
that Alfred has sustained if  
any 4<sup>th</sup> <sup>Italy</sup> should not Nathan be  
able then <sup>as it was a part of</sup> Jordan's part at the  
time of sale that he would become liable for any  
the purchaser promises Nathan &  
dispassioned him Alfred from  
the promises & not Brewer  
5<sup>th</sup> That from the evidence Alfred  
failed to comply with his contract  
with Nathan in every particular  
and is therefore not entitled to  
recover as he put up a different  
house from what he contracted  
& out of different lumber  
Should you see  
proper in your judgment  
to overrule my views in this  
case & hold Brewer liable  
I beg leave to state that plaintiff  
is not entitled to recover near  
the amount contended for.

Because Nathan swears that the house was not worth more than 20 or 25 dollars as it then was & it was worth nothing for rent in its then condition or after the shop was taken off & not more than 3 or 4 dollars per month while the shop was there. The statement of Alfred does not show differently while it is true he states that he could have rented it at 9 dollars per month <sup>or more</sup>. But when he & planned himself he was offered that sum by a party that had no money & would not rent to him on that account. I admit that he could have got the promise from prudent men here in town of \$2000 per month but that does not prove anything whatever as they would rent with a view of not paying. Therefore Dept prove that he be discharged all of which is respectfully submitted

Attest  
A. L. Brown  
attorney for Brewer

NATIONAL ARCHIVES AND RECORDS ADMINISTRATION  
MICROFILM PUBLICATIONS

Roll 40

Target 2

Registers of Contracts

Volume 1 (138) Jan.-Mar. 1866 and June 1866

Volume pages were filmed sequentially.  
Blank pages were not filmed.



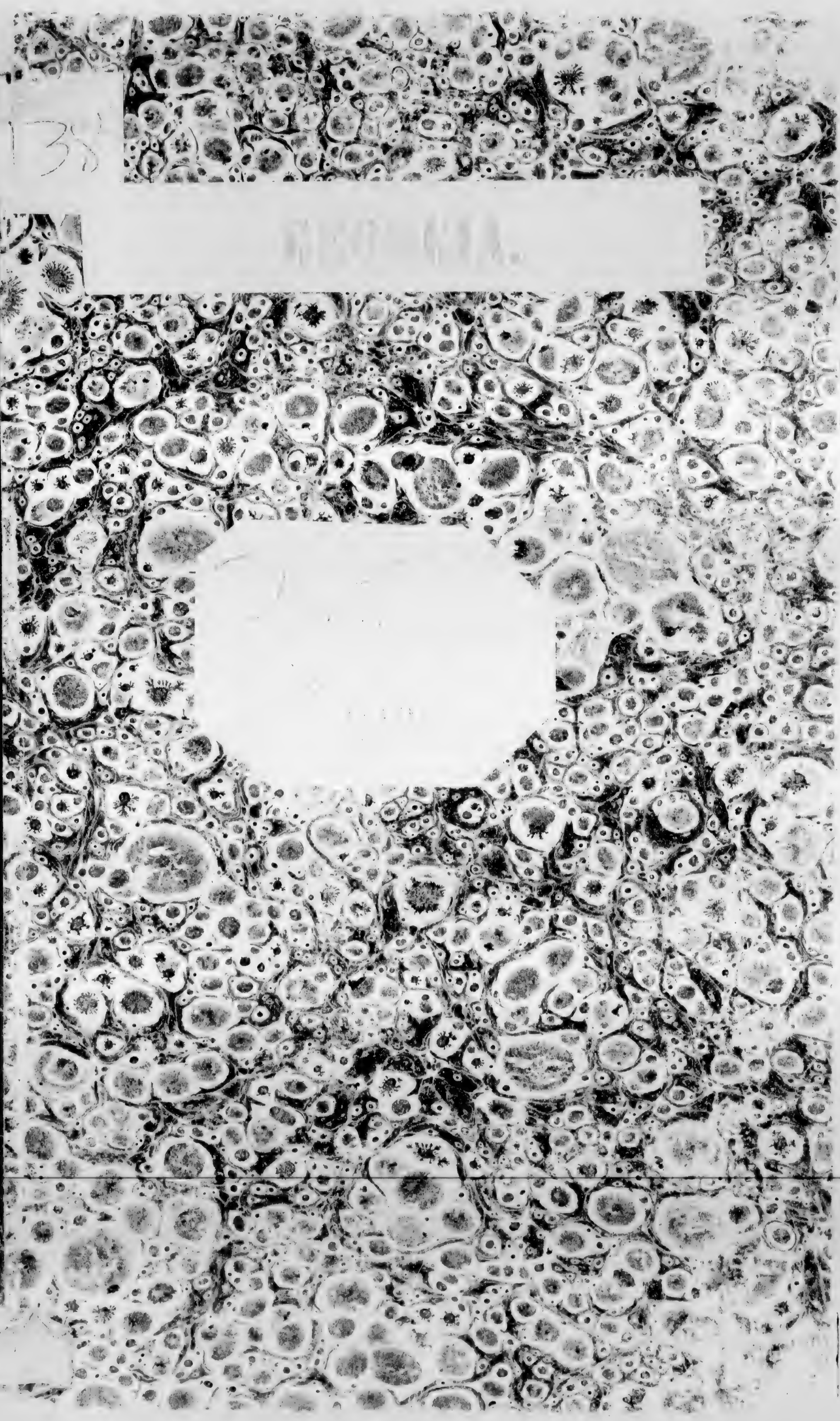

A  
B  
C  
D  
E  
F  
G  
H  
I  
K  
L  
M  
N  
O  
Q  
R  
S  
T  
V  
W  
X  
Y

Handwritten notes at the top left, including a large '1' and some illegible scribbles.

Handwritten notes in the middle section, including a list of items with numbers 1 through 7.

Handwritten notes at the bottom left, including the number '21'.

A B C D E F G H I K L M N O Q R S T U V W Y

1/2

60

100



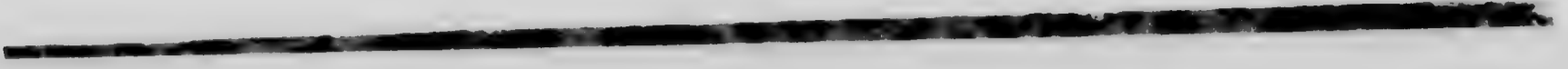

D  
E  
F  
G  
H  
I  
K  
L  
M  
N  
O  
P  
Q  
R  
S  
T  
U  
V  
W  
Y

6. 1000  
1000  
1000

6  
1000  
1000  
1000  
1000  
1000



*f. 10*

G  
H  
I  
K  
L  
M  
N  
O  
P  
Q  
R  
S  
T  
U  
V  
W  
Y

1

Jan. 26	14
Feb. 1	1

Jan 26	2
Mar 7	3
Mar 14	4
Mar 21	13
Mar 28	4
Apr 4	23
Apr 11	23
Apr 18	28
Apr 25	31





v

A.  
Lives 2<sup>nd</sup> 2  
Lives 1<sup>st</sup> 11

J.  
Mars 1<sup>st</sup> 1  
Lives 1<sup>st</sup> 1  
Lives 2<sup>nd</sup> 1  
Lives 3<sup>rd</sup> 1

9  
 9.      6.5      2.5  
 9.      6.      1.10  
 9.      3      1.3

>

1

14

1	Year 1	5
2	Year 2	12
3	Year 3	20
4	Year 4	31
5	Year 5	44
6	Year 6	60
7	Year 7	77

1

1  
 Cypress Mt. S. d. e. Dunes

- 1866 Jan 20. Contract.  
 Between  
 J. S. Jay and G. W. Price.  
 and Freedmen.
- 1 William Thomas. Full Hand
  - 2 Green. Haynes + Brother " "
  - 3 Jobe Bailey " "
  - 4 Abner Bailey " "
  - 5 William Palmer " "
  - 6 Monroe Siro " "
  - 7 George Haynes " "
  - 8 Levy Haynes " "
  - 9 Edward Harris " "
  - 10 Robert Hill " "
  - 11 Simon Caldwell " "
  - 12 Sarah Ware and two children 2 " "
  - 13 Solomon Stoughton " "
  - 14 Rachel Paly for in Ellis " "
  - 15 Ann Harris and two children " "
  - 16 Fred Stoughton " "
  - 17 West Lane " "
  - 18 William Brown and his daughter. 2 1/2 " "

The Freedmen are the property of the Freedmen.

Contract.  
 Between  
 Wade J. Parlow.  
 And

1866  
 Dec 12 1 John Powers Freedman  
 Charles Ford + Dr. Hollen, witnesses.

1  
Cyprian Act. J. d. e. Dur.

Stirling Glover

to L

Charles Spincy

\$15.45

Cyprian A. G. & D. D. D. D.  
 Seelye County, Wis

Mr Sterling Glover

1866	To Charles Spring	50
Jan 28 <sup>th</sup>	To making 4 plows 1000	4,00
" "	" mending 2 Rods	.50
Feb 24 <sup>th</sup>	" making 4 plows 100	4,00
Mar 14 <sup>th</sup>	" laying 2 plows	1,00
" "	" work on covering plow	.25
" "	" mending Traces 50 <sup>th</sup> share's horse 150	2,00
" 24 <sup>th</sup>	" making 4 plows 100	4,00
" "	" making one wedge 100	1,00
" "	" laying 8 plows 50	4,00
" "	" one iron wedge 100	1,00
May 12 <sup>th</sup>	" work on 6 sweeps	2,50
Nov 24 <sup>th</sup>	" work on wagon	1,50

25,75  
 10,00  
\$ 15,75

Cr By Cash

Amt Due



Approved J. C. ...

Approved Feb 10<sup>th</sup> 1866.

Approved Feb 12<sup>th</sup> 1866.



2

1866

Feb

Office Agent Bureau N. J. ...

12 "Contract" Between

C. J. Stewart

and

Jefferson and Eliza ...

Four Children ... \$20 per year

Contract

"

11 Between J. P. Sturgeon

and

Piggie. Freeman ... Five Children

Board and Clothing

12 ...

...

...

...

14 ...

...

...

...

17 Contract

John W. ...

...

...

...

Apr. 10 1864

Apr. 10 1864

Apr. 10 1864

Apr. 10 1864

3

1866

Office Agents Bureau Register

Feb 17

Contract

between D. G. Mayo  
and Trustees  
John Mitchell per Bond \$120.00 per  
John Fair " " \$100.00 "  
Edmund Darnell " " \$100.00 "  
Richard Ticket, Sec Man \$75.00 per  
John Ticket " " \$125.00 per  
For all Clerks

Feb 17

Contract

between J. L. Adair  
and Trustees  
Flora Wood " " \$50.00 per  
Board

Feb 17

Contract

between J. L. Adair  
and Trustees  
Edmund Atarney  
for Mary Murray @ \$1.00  
Board

Sec 1

and Trustees

and Trustees

for all Clerks 10

~~\_\_\_\_\_~~  
Treatise of the Standard of the

of the Standard of the

Standard of the

Standard of the

Standard of the

4  
1866

Office Agent Bureau of Agents

19 Contract

James J. Smith  
Agent Bureau  
of Agents  
of the  
Bureau of Agents  
of the  
Bureau of Agents  
of the  
Bureau of Agents

copy

19 Contract

James J. Smith  
Agent Bureau  
of Agents  
of the  
Bureau of Agents  
of the  
Bureau of Agents

19 Contract

James J. Smith  
Agent Bureau  
of Agents  
of the  
Bureau of Agents  
of the  
Bureau of Agents

19 Contract

James J. Smith  
Agent Bureau  
of Agents  
of the  
Bureau of Agents  
of the  
Bureau of Agents

Freeman's Standard Ledger

411 1941 ab

411 1941 ab

411 1941 ab

411

1866 Office Agent Bureau of Agriculture

Contract  
for  
the  
purchase of  
land

Contract  
for  
the  
purchase of  
land

Contract  
for  
the  
purchase of  
land  
Adeline + 400

Contract		
Bellevue of Graves		
and Meadows		
to	Samuel	115
to	John	60
to	James	100
to	William	26
to	Charles	100
to	Thomas	150
to	George	100

Total

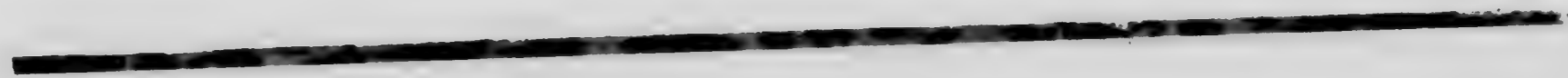

Provisional and Sordened Land

1844

1844

1844

1844



1866<sup>6</sup> Copye Summa. N.G. & Co.

Jan 20 Contract  
between Dr. Kuntzschke  
and  
W. Jones  
Robert L. Jones

1866

Contract  
between Dr. Kuntzschke  
and  
W. Jones  
1866

Contract  
between Dr. Kuntzschke  
and  
W. Jones  
1866

Contract  
between Dr. Kuntzschke  
and  
W. Jones  
1866

Contract  
between Dr. Kuntzschke  
and  
W. Jones  
1866

Contract  
between Dr. Kuntzschke  
and  
W. Jones  
1866

Apr 30 1861

Apr 30 1861

Apr 30 1861

Apr 30 1861

Apr 30 1861

7  
1866 Copy Bureau N. J. A.

28 21 (Contract)  
Bureau of Census  
Washington  
D. C.  
1866

1866

29 Contract  
Bureau of Census  
Washington  
D. C.  
1866

31 Contract  
Bureau of Census  
Washington  
D. C.  
1866

1844



Amos 5: 1-17

Amos 5: 18-27

Amos 5: 28-31

8  
 1866 *Oran Surman N.Y. A.L.*

9 21 'Contract'  
 Debit on *John W. Surman*  
 and *William*  
*Surman and Family*  
 Peter " " 21.00  
 Lewis " " 0.00 *paid*  
 Clark " " 30.00  
 Henry Hill " " 1.25  
 Daniel " " 110.00  
 Moore " " 150.00  
 Sandy " " 10.00  
 Henry Tomlin " " 2.00  
 Allen " " 10.00 *paid*  
 Kuhn " " 10.00  
 George " " 10.00  
 Fred " " 7.00  
 Sam " " 7.00  
 George Ross " " 1.25  
 John Tracy " " 10.00 *paid*

21 'Contract'  
 Debit on *John W. Surman*  
 and *William*  
*Surman*  
*Debit*  
*Surman and Family*

Anna P. Smith

Sept 11 1844

9  
1846 Copy Survey N. 1/2 S. 1. 1.

21. Contract  
Between John Smith  
and Thomas  
James  
John Smith  
Thomas James  
Witnesses  
John Smith, Thomas James  
John Smith, Thomas James

2 Contract  
Between John Smith  
and Thomas  
James  
John Smith  
Thomas James  
Witnesses  
John Smith, Thomas James

22. Contract  
Between John Smith  
and Thomas  
James  
John Smith  
Thomas James  
Witnesses  
John Smith, Thomas James

Approved June 21 1861

Approved Dec 21 1861

Approved Feb 22 1862



10  
1846

Case Dues A. J. & Co.

20 Contract

John S. Smith  
and Thomas

John Thomas	12 50
Edd. Dickson	12 50
Quia Dickos	13 50
Merida Barlow	10 00
Thomas Woods	12 50
Linda Thomas	6 00
Wm. Richards	6 00
Robert Cartwright	12 50
Sara "	6 00
Penny "	10 00
Lu "	5 00
Sarah Whitehead	10 00

Board

22 Contract

John S. Smith	40 00
Thomas Woods	22 50
Quia Dickos	25 00
Com. 50	5 00
John S. Smith	25 00
John S. Smith	8 00
John S. Smith	32 50
John S. Smith	21 00
John S. Smith	15 00
John S. Smith	10 00
John S. Smith	10 00

Board

Approved J. 10. 1846

Approved J. 10. 1846

11  
1866 Copy Bureau R. I. S.

20 Contract

to M. E. R.  
 J. G. S.  
 J. G. S. 12.  
 J. G. S. 3.  
 J. G. S. 15.  
 J. G. S. 10.  
 J. G. S. 12.  
 J. G. S.

21 Contract

to E. R.  
 J. G. S.  
 J. G. S. 18.  
 J. G. S. 17.  
 J. G. S. 18.  
 J. G. S. + Board 26.  
 J. G. S. 6.  
 J. G. S. Board 26.  
 J. G. S.

22 Contract

to E. R. S. S.  
 J. G. S.  
 J. G. S. 8.50  
 J. G. S.

Board 26 for letter and Board 26

23 Contract

to J. G. S.  
 J. G. S. 160.50  
 J. G. S. 20.  
 J. G. S. 12.

U



✓ 9. 2. 1. 1. 1.

Sept 23rd 1846

Sept 23rd 1846

Sept 23rd 1846

12  
1866

Agua Dulce N. 1

Contract  
E. A. ...  
...  
...

Contract  
E. A. ...  
...  
...

Contract  
E. A. ...  
...  
...

Contract  
...  
...  
...  
...  
...  
...  
...

Contract  
...  
...  
...  
...  
...

1/2 ... + 1/2 ...

1. J. 1844

1. J. 1844

1. J. 1844

1. J. 1844

1. J. 1844

Contract

1866

10

11

Contract

John G. Galt

John G. Galt

Joe. 125 0

John 95 0

Emma and J. G. Galt 1 0

Board

11

Contract

J. G. Galt

John G. Galt

Carroll Galt 1 0

Wm. Galt 1 0

John Galt 1 0

Board

12

12

Contract

John G. Galt

J. G. Galt

John G. Galt

Martin Galt

John G. Galt

13

Contract

John G. Galt

John G. Galt 1 0

John G. Galt 261 0

John G. Galt 125 0

George G. Galt 208 0

John G. Galt 1 0

John G. Galt 251 0

John G. Galt 131 0

Board

1844

1844

1844

1844



14

1866

Co. D. 1st Regt. N.Y. + S.I.

Dec 26

Account

Balance B.B. Van Allen  
for Dec 1866

108 00

108 00

108 00

108 00

108 00

108 00

108 00

Dec 26

Account

to the Co. D. 1st Regt. N.Y. + S.I.

for Dec 1866

for Dec 1866

20 00

Dec 26

Account

to the Co. D. 1st Regt. N.Y. + S.I.

for Dec 1866

20 00

18 00

12 00

18 00

12 00

to

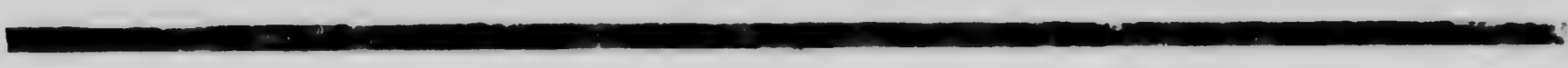

1. 1. 1. 1. 1. 1.

1. 1. 1. 1. 1. 1.

1. 1. 1. 1. 1. 1.

45.

1. Contract A. J. Smith

Contract  
Lumber  
Furniture  
Paint

Contract  
Lumber  
Furniture  
Paint  
Glass

Contract  
Lumber  
Furniture  
Paint  
Glass  
Cabinet  
Kitchen  
Halls  
P. 20

Contract  
Lumber  
Furniture  
Paint  
Glass

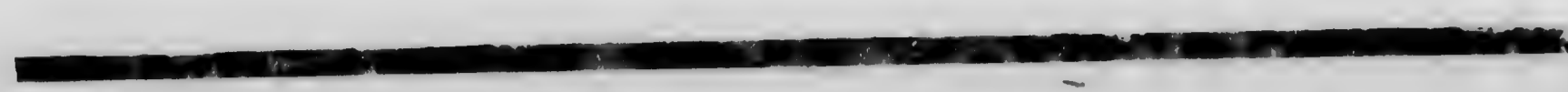

1854

1854

1854

1854

1854

16

1866 (over D. & A. P. S.)

Contract

over Doctor G. W.

J. G. ...	10000
J. G. ...	1000
J. G. ...	60
J. G. ...	150
J. G. ...	10
Frank Parker	15000
Miss ...	20000
John ...	5000
...	...

Contract

over G. W. ...

J. G. ...	110
J. G. ...	100
J. G. ...	1000
J. G. ...	1000
J. G. ...	1000
...	...

Contract

over J. A. G. ...

J. G. ...	10
J. G. ...	10
J. G. ...	10
J. G. ...	10



1 3000 1

1 3000 0

1 3000 0

47  
1866 Office Bureau K. J. L.

Contract

James A. J. Miller  
James Miller  
James Miller  
James Miller  
James Miller  
James Miller

1866

Contract

Be... for...  
James Miller  
James Miller  
James Miller

1866

Contract

James Miller  
James Miller  
James Miller  
James Miller  
James Miller  
James Miller  
James Miller  
James Miller  
James Miller

1866



*[Faint, illegible handwriting]*

*[Faint, illegible handwriting]*

*[Faint, illegible handwriting]*



17  
1866

(Specimen) *Mercurius*

27 *Centras*

*Y. G. 17*  
*Y. G. 17*  
*Y. G. 17*

28

*Centras*

<i>Y. G. 17</i>	
<i>Y. G. 17</i>	
<i>Y. G. 17</i>	
<i>Y. G. 17</i>	10.00
<i>Y. G. 17</i>	15.00
<i>Y. G. 17</i>	10.00
<i>Y. G. 17</i>	1.00
<i>Y. G. 17</i>	0.00
<i>Y. G. 17</i>	

28

*Centras*

<i>Y. G. 17</i>	
<i>Y. G. 17</i>	2.00
<i>Y. G. 17</i>	2.09.00
<i>Y. G. 17</i>	12.00
<i>Y. G. 17</i>	12.00
<i>Y. G. 17</i>	16.00
<i>Y. G. 17</i>	1.00
<i>Y. G. 17</i>	0.00
<i>Y. G. 17</i>	1.00
<i>Y. G. 17</i>	

1 3 16

1 3 16

1 3 16

19 1861 Coffee Auction H. J. ...

20 1861 Contract ...  
...  
...  
... 100 ...  
...  
...

21 1861 Contract ...  
...  
...  
...  
...  
...  
...  
...

1844

149

1844

1844

211

1866 Cyren Duran & K. S. L.

Contract

For	
C. S. J. ...	31
" ...	1400
" ...	125 00
Total	

Contract

own

Ben	17	...
" ...		
" ...		
" ...		
" ...		

Contract

Sell on Dec 9	
" ...	7.50
" ...	111
" ...	1000
" ...	

Contract

Sell on J. 6	
" ...	
" ...	
" ...	10000
" ...	25

Co



21  
1866  
Office Surgeon A. I. S. D.

Contract  
to the Surgeon General  
for  
Cotton 100 1. 60.

Contract  
to the Surgeon General  
for  
Cotton 100 1. 60.

Contract  
to the Surgeon General  
for  
Cotton 100 1. 60.  
Cotton 100 1. 60.  
Cotton 100 1. 60.  
Cotton 100 1. 60.  
Cotton 100 1. 60.  
Cotton 100 1. 60.  
Cotton 100 1. 60.  
Cotton 100 1. 60.

Contract  
to the Surgeon General  
for  
Cotton 100 1. 60.  
Cotton 100 1. 60.  
Cotton 100 1. 60.  
Cotton 100 1. 60.  
Cotton 100 1. 60.

Sept 1 1846

1 1846

1 1846

1 1846



1866

Office Bureau P. F. ...

3

Contract

Belton T. E. ...

and ...

... 68 00

...

...

3

Contract

Belton T. E. ...

and ...

...

...

...

...

3

Contract

Belton T. E. ...

and ...

...

...

...

3

Contract

Belton T. E. ...

and ...

...

...

...

3

Contract

Belton T. E. ...

and ...

...

...

...

...

March 3, 1846.

March 3, 1846

March 3, 1846

March 3, 1846.

11

23

# Cyber Bureau S. S.

1866

7

at  
 7.00  
 10.00  
 15.00

"

Contract  
 Ca - 1  
 P  
 1000  
 1000  
 1000

Contract  
 S. S. S. S.  
 S. S. S. S.  
 S. S. S. S.  
 S. S. S. S.

"

Contract  
 S. S. S. S.  
 P  
 1000  
 1000

"

Contract  
 Re P.  
 S. S. S. S.  
 S. S. S. S.



5 ✓ ... 16

✓ ✓ ✓ 16

✓ ✓ ✓ 16

✓ ✓ ✓ 16

✓ ✓ ✓ 16

2

1866

# Green Swamp N. F. No. 1

June 6

Contract

Between J. M. Lind

and Freeman

for

See also

Wired Swater

Wired Swater

Wired Swater

Wired Swater

Wired Swater

Wired Swater

Wired Swater

Wired Swater

Wired Swater

Wired Swater

Wired Swater

Wired Swater

Wired Swater

Wired Swater

Wired Swater

Wired Swater

Wired Swater

Wired Swater

Wired Swater

Wired Swater

Wired Swater

Wired Swater

Wired Swater

Wired Swater

Wired Swater

Wired Swater

Wired Swater

Wired Swater

Wired Swater

Wired Swater

Part 1 of 2

June 6 1866 235

June 6 1866 130

June 6 1866 380

June 6 1866 130

June 6 1866 5

June 6 1866 4

June 6 1866 100

June 6 1866 100

June 6 1866 150

June 6 1866 75

June 6 1866 120

June 6 1866 40

June 6 1866 5



1/1 1 1 1 1 1



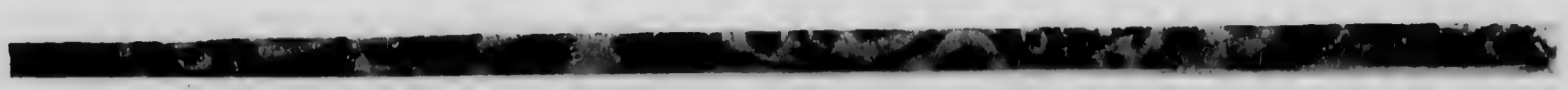

11111111111111111111

11111111111111111111

11111111111111111111



6  
1866

Quebec Bureau N° 11

Jan 6 Contract

to the Board  
of Trade

Jan 1	to 31	1750	100
Feb 1	to 31	1100	200
Mar 1	to 31		100
Total			

Jan 4 Contract

to the Board  
of Trade

Jan 1	to 31	2000	
Feb 1	to 31		
Mar 1	to 31		
Total			

Mar 1

to the Board  
of Trade

Mar 1	to 31	1500	
Apr 1	to 31	1000	
May 1	to 31	1000	
Total			



Amos 1 1-6 14

Amos 1 7-13 14

Amos 1 14-15 14

---

1866

Contract

...	11
...	11
...	6
...	11
...	1
...	6
...	11
...	22
...	6

Contract

...	...
...	9600
...	18000
...	...
...	...
...	...

Contract

Between ... and Medical Alliance



~

*[Faint handwritten text]*

*[Faint handwritten text]*

*[Faint handwritten text]*

28

1864

Contract J. F. ...

11

Contract

Benjamin W. ...

...

...

...

40.00

11

8

Contract

Benjamin Parney Parker

...

50.00

...

8.00

...

8.00

...

8.00

...

50.00

...

50.00

...

25.00

Board

11

8

Contract

Benjamin Parney Parker

...

...

...

...

Part. City

...

11

8

Contract

Benjamin Parney Parker

...

20.00

...

1.40



1, 10, 15, 20, 25, 30, 35, 40, 45, 50, 55, 60, 65, 70, 75, 80, 85, 90, 95, 100

1, 10, 15, 20, 25, 30, 35, 40, 45, 50, 55, 60, 65, 70, 75, 80, 85, 90, 95, 100

1, 10, 15, 20, 25, 30, 35, 40, 45, 50, 55, 60, 65, 70, 75, 80, 85, 90, 95, 100

1, 10, 15, 20, 25, 30, 35, 40, 45, 50, 55, 60, 65, 70, 75, 80, 85, 90, 95, 100

1841 Office Duran A. S. G. 2

1 10 Contract  
 Between J. A. S. & Co  
 12000  
 11500  
 11500  
 11500  
 et

10 Contract  
 Between C. S. Duran  
 Ann. Friedman  
 Dick Morgan  
 Boston & Co.

" 12 Contract  
 Between W. S. Adams  
 J. S. Duran  
 Du  
 aster  
 Caroline  
 Liza  
 George  
 et

" Contract  
 Between J. S. Duran  
 C. S. Duran  
 11000  
 11000  
 et



Apr. 1. 11 1116

Apr. 1. 11 1116

Apr. 1. 11 1116

Apr. 1. 11 1116



1866 (Specimen No. 11)

11 Contract

to the ...

to the ...

to the ...

12 Contract

to the ...

to the ...

to the ...

13 Contract

to the ...

to the ...

to the ...

14 Contract

to the ...

to the ...

to the ...

Contract

to the ...

to the ...

to the ...



1897 11 15 16

1897 11 10 16

1897 11 10 16

1897 11 10 16

1897 11 10 16

Inventory of Stock June 1st 1866.

17 Apr	48	Perch	E	JXU
10 "	48	"	L	CE
"	10	"	E	LY
1 "	12	"	JX	IX
4 "	12	"	E	U
302 "	200	Trucks	JX	U
74 "	200	"	JX	75
108 "	400	"	JJ	JL 00
82 "	600	"	JJ	L 10
24 "	800	"	JJ	L 20
12 "	300	"	JX	J 20
12 "	1500	"	UU	U 20
16 "	1000	"	UU	L 0
10 "	1000	"	LL	L 20
2 "	1000	"	E	L 20
120 "	1000	Trucks, mts, etc	UX	U 20
2 "	1000	"	UX	J 0
7 "	1000	Trucks	JJ	J 0
7 "	1000	"	UX	J 0
7 "	1000	"	JX	J 0
6 "	1000	"	JX	J 0
2 "	1000	Trucks	JX	J 0
2 "	1000	"	JL 2	U 70
2 "	1000	"	J 7 2	U 70
10 "	1000	Trucks	UX	U 70
2 "	1000	"	JDX	U 70
2 "	1000	"	J 7 0	U 70
4 "	1000	Trucks	JX	U 70
1 "	1000	"	JJ	L 20
			U 70	

Inventory of Tools from 1884

Continued

1117.00

1 1/2 in. 7/8 dia. 10" Pipe	11
4 in 3/4 " " " "	70
0 - 1 1/2 " " " "	11
8 in. dia. 10" L. in. 7/8 3/4	100
2 in. dia. " " 1 in	10
2 in " " " 7/8	10
2 in " " " 7/8	10
2 in " " " 3/4	10
2 in dia. 9 in	10
10 in. dia. 10 in. 10 in.	10
1 1/2 in. dia. 10 in. 10 in. 10 in.	10
11 in. dia. 10 in. 10 in.	10
1 in. dia. 10 in.	10
2 in. dia. 10 in.	10

1/2 in. dia. 10 in. 10 in.	10
2 in " " " 7/8	10
7 in " " " 7/8	10
4 in " " " 7/8	10
2 in " " " 1 1/2	10
0 dia. " " " 10 in.	10

10 in. dia. 10 in. 10 in.	10
12 in. dia. 10 in. 10 in. 10 in.	10
10 in. dia. 10 in. 10 in.	10

1 in. dia. 10 in. 10 in.	10
2 in. dia. 10 in. 10 in.	10
0 in. dia. 10 in. 10 in.	10
2 in. dia. 10 in. 10 in. #30	10
2 in. dia. 10 in. 10 in. #4719	10
2 in. dia. 10 in. 10 in. #38	10
2 in. dia. 10 in. 10 in.	10

Director, Fleet June 1<sup>st</sup> 1846.

9 <sup>th</sup> Dec.	1 #11 Service	—
12 <sup>th</sup> "	78 " "	—
" "	78 " 9 "	—
" "	34 " 8 "	—
8 <sup>th</sup> "	78 " 8 "	—
8 <sup>th</sup> "	12 " 8 "	—

21 <sup>st</sup> "	3 <sup>rd</sup> " Bath. 9 <sup>th</sup> " 7 <sup>th</sup>	□
2 <sup>nd</sup> "	" " " 12 <sup>th</sup> "	—
6 <sup>th</sup> "	Commodore Row " "	7
2 <sup>nd</sup> "	Ball " " "	—
1 <sup>st</sup> "	Commodore " "	—
3 <sup>rd</sup> "	" " " "	—
24 <sup>th</sup> "	" " " "	—

1 <sup>st</sup> "	Commodore " "	—
12 <sup>th</sup> "	" " " "	—
6 <sup>th</sup> "	" " " "	—
22 <sup>nd</sup> "	" " " "	—
14 <sup>th</sup> "	" " " "	—
7 <sup>th</sup> "	" " " "	—

30 <sup>th</sup> "	Commodore " "	—
10 <sup>th</sup> "	" " " "	—
Commodore	" " " "	—
24 <sup>th</sup> "	" " " "	—

1 <sup>st</sup> "	Commodore " "	—
12 <sup>th</sup> "	" " " "	—
9 <sup>th</sup> "	" " " "	—
1 <sup>st</sup> "	" " " "	—

Inventory Stock June 1866

What Brought Forward

Sept 18 6 3/4  
" " 1 6  
" 112 Spring  
" 114  
"

Set Pat Wheel

"  
" Hubbs Ruggie  
" " Wagon  
" Spokes  
" " Ruggie  
" 1 1/8 Rims  
" " "  
" 1 1/4 "  
" 1 1/2 "  
" 1 3/4 "  
" 2 "

Shall Rent Singletree  
Buss

Singletree over "  
Buss " "

1 Day Coach Singletree  
Seat Rails

Whole Bent Seat Rails  
Buss.

Inventory Stock June 1866.

And brought forward

Bar 76 1/2

" 1 1/4

" 170 1/2

" 1 1/2

" 70 1/4

" 72 1/2

" 5/16

" 1 1/2

" 74 1/2

" 1/16

" 5/8 Oak

" Sum of 10 3/4

21	pw	Glacier needles	5	511
110	"	Warping "		111
4	doz	1 1/2 in M.H.S. Balls		51
2	"	" " " " "		52
61	Set	Screw Print Bandel		3913
3	"	1/4 in Pin "		120
6	"	2 3/8 " "		121
6	"	2 1/2 " "		120
2	doz	awl blades		617
16	"	awl clips		565
36	"	awl clips		565
2	"	awl clips		565
266.4	doz	awl clips		565



I have the pleasure  
to inform you  
that I have received  
your letter of the 11th

I have the pleasure  
to get your card inside. The same was sent  
me by Mr. [unclear] [unclear] [unclear]  
and I have " " " "

We want good [unclear] and are  
willing to pay a good price for it. Please  
let [unclear] of [unclear] [unclear] if it can be had.  
We are [unclear] to the recommendation of Mr. [unclear]  
[unclear]. If you have not the size let us know  
what you have. What price

Very Respectfully  
Yours Truly  
J. S. [unclear]

110000

London June 25th 1866

Dear Sir

I have the honor to acknowledge the receipt of your letter of the 21st inst.

in relation to the

of

Please let me know by return of post

what date you can send me the money for which I have

received your order against J. Buchanan, with L. J.

deposited with me, for which I have received

dated Oct 4, 1866. It is not before the date of

the London Letter.

I am, Sir, very respectfully,  
Your obedient servant

Wm. Lloyd Garrison

Wm. Lloyd Garrison

London June 28th 1866

Dear Sir

I have the honor to acknowledge the receipt of your letter of the 21st inst.

in relation to the

of 19th inst. I have the honor to acknowledge the receipt of your letter of the 21st inst.

in relation to the

of 19th inst. I have the honor to acknowledge the receipt of your letter of the 21st inst.

in relation to the

Wm. Lloyd Garrison

Wm. Lloyd Garrison

Wm. Lloyd Garrison

Dear Mother  
 I received your letter of the 11th  
 and was glad to hear from you  
 and to hear that you were  
 all well. I am well at present  
 and hope these few lines will  
 find you all the same. I  
 am  
 Yours truly  
 J. D. [Name]

11012

1785

London 1<sup>st</sup> Dec 1785

My dear Sir

I have just received your kind letter of the 28<sup>th</sup> inst. in relation to the account of the late Mr. [Name] which you have been good enough to send me. I am very glad to hear that you have been successful in your endeavours to get the account cleared up. I am sorry that you have not been able to do so before this time, but I am sure you will be able to do so in a few days. I am very glad to hear that you have been successful in your endeavours to get the account cleared up. I am sorry that you have not been able to do so before this time, but I am sure you will be able to do so in a few days.

Yours truly

[Signature]

Received of the above named [Name] the sum of [Amount] in full of the account of the late Mr. [Name] as per [Reference].

Coppy Invoice N. H. Spring Co

New Haven June 29. 1866

Mr Am Simin

Bought of New Haven Spring Co,  
Manufacturers of English Steel Springs of Every Description  
Terms, Cash. #4 Howard St,

12 pr	1 1/2	1/4	Side Springs	@ \$50	102,	
4 "	1 1/2	1/4	" "	" 75	30	
			30 + ing			\$136 00

Amicus High St Bldg.

Mr Wm. L. ...

Dear Sir,

I have enclosed papers  
to identify claims against the Am. M. Ins Co  
(also the original Invoice) which you will please collect  
and forward and to N. H. Spring Co and let  
me know if there was a lot of Springs  
The papers will be sent against the Co  
Yours truly  
Amicus

My Respt  
Wm Simin  
to Geo D Simin

1866 Dec 10 29 1866

John H. ...  
185  
...

" 22 Dr J. S. ...  
...  
...

" 27 ...  
...  
...

Old Guildy. Andrew B. Chapman Capitan  
some more.

and the other side of the street

the other side of the street

1766 Dec 20 A. T. S. S.

D 28

I have the honor to acknowledge the receipt of your letter of the 17th inst. in relation to the above mentioned matter.

I have the honor to acknowledge the receipt of your letter of the 17th inst. in relation to the above mentioned matter.

I have the honor to acknowledge the receipt of your letter of the 17th inst. in relation to the above mentioned matter.





1846

Case of ... R. D. ...

Jan

... ..

...

... ..

NATIONAL ARCHIVES AND RECORDS ADMINISTRATION  
MICROFILM PUBLICATIONS

Roll 40

Target 3

Registers of Contracts  
Volume 2 (137)

Jan. 1867-June 1868

Volume pages were filmed sequentially.  
Blank pages were not filmed.



11-11

11-11

1844

of the

of the

of the

Wm. C. C. 32

*Faint handwritten text, possibly a signature or date.*



1944 55

8	
11	

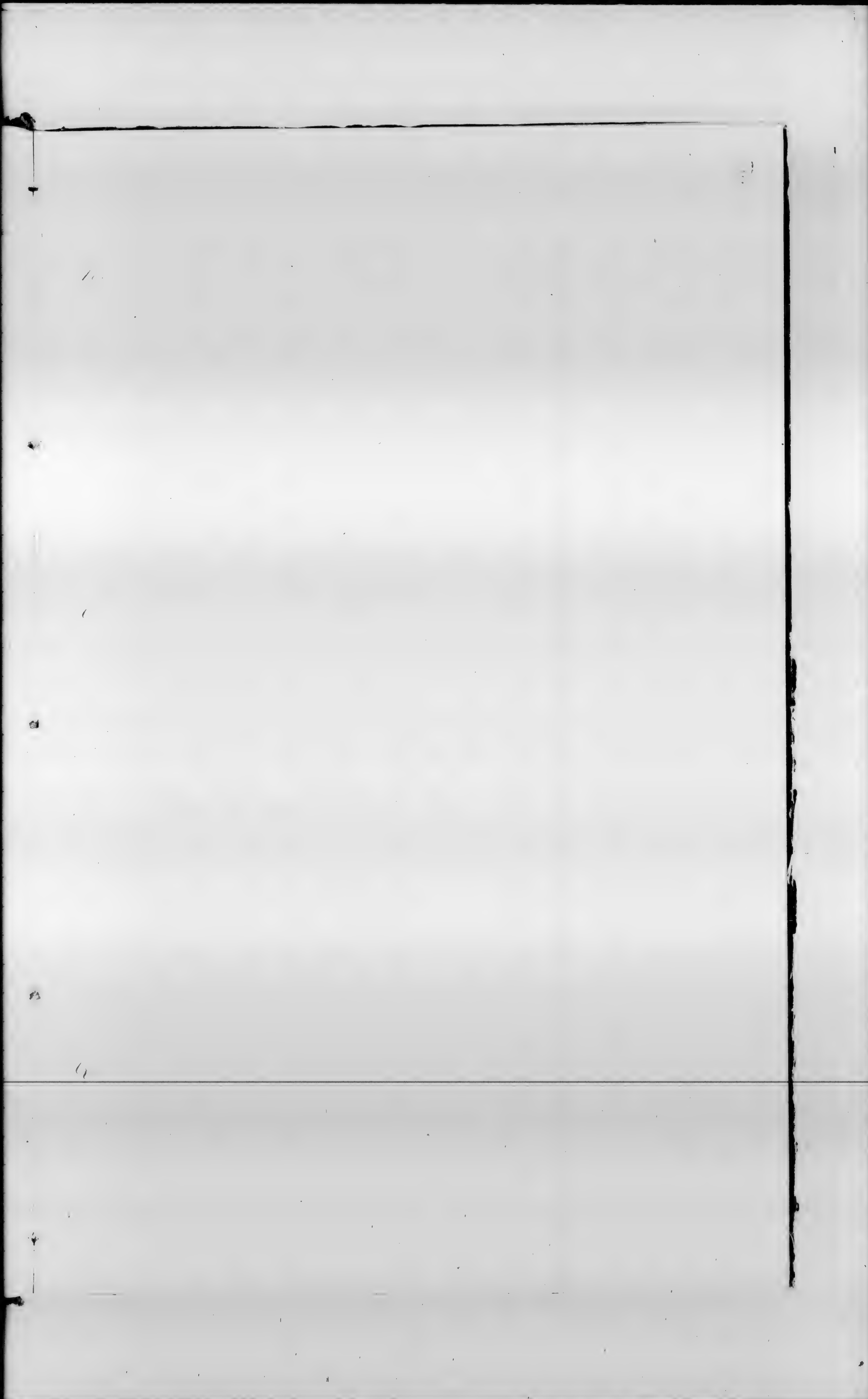

10

1845  
1000 1000

1845  
1000 1000  
1000 1000  
1000 1000

11 12 13 14 15 16 17 18 19 20 21 22 23 24 25 26 27 28 29 30 31 32 33 34 35 36 37 38 39 40 41 42 43 44 45 46 47 48 49 50 51 52 53 54 55 56 57 58 59 60 61 62 63 64 65 66 67 68 69 70 71 72 73 74 75 76 77 78 79 80 81 82 83 84 85 86 87 88 89 90 91 92 93 94 95 96 97 98 99 100



1841	Jan 1	to	Jan 31	1842
1842	Jan 1	to	Jan 31	1843
1843	Jan 1	to	Jan 31	1844
1844	Jan 1	to	Jan 31	1845
1845	Jan 1	to	Jan 31	1846
1846	Jan 1	to	Jan 31	1847
1847	Jan 1	to	Jan 31	1848
1848	Jan 1	to	Jan 31	1849
1849	Jan 1	to	Jan 31	1850
1850	Jan 1	to	Jan 31	1851
1851	Jan 1	to	Jan 31	1852
1852	Jan 1	to	Jan 31	1853
1853	Jan 1	to	Jan 31	1854
1854	Jan 1	to	Jan 31	1855
1855	Jan 1	to	Jan 31	1856
1856	Jan 1	to	Jan 31	1857
1857	Jan 1	to	Jan 31	1858
1858	Jan 1	to	Jan 31	1859
1859	Jan 1	to	Jan 31	1860
1860	Jan 1	to	Jan 31	1861
1861	Jan 1	to	Jan 31	1862
1862	Jan 1	to	Jan 31	1863
1863	Jan 1	to	Jan 31	1864
1864	Jan 1	to	Jan 31	1865
1865	Jan 1	to	Jan 31	1866
1866	Jan 1	to	Jan 31	1867
1867	Jan 1	to	Jan 31	1868
1868	Jan 1	to	Jan 31	1869
1869	Jan 1	to	Jan 31	1870
1870	Jan 1	to	Jan 31	1871
1871	Jan 1	to	Jan 31	1872
1872	Jan 1	to	Jan 31	1873
1873	Jan 1	to	Jan 31	1874
1874	Jan 1	to	Jan 31	1875
1875	Jan 1	to	Jan 31	1876
1876	Jan 1	to	Jan 31	1877
1877	Jan 1	to	Jan 31	1878
1878	Jan 1	to	Jan 31	1879
1879	Jan 1	to	Jan 31	1880
1880	Jan 1	to	Jan 31	1881
1881	Jan 1	to	Jan 31	1882
1882	Jan 1	to	Jan 31	1883
1883	Jan 1	to	Jan 31	1884
1884	Jan 1	to	Jan 31	1885
1885	Jan 1	to	Jan 31	1886
1886	Jan 1	to	Jan 31	1887
1887	Jan 1	to	Jan 31	1888
1888	Jan 1	to	Jan 31	1889
1889	Jan 1	to	Jan 31	1890
1890	Jan 1	to	Jan 31	1891
1891	Jan 1	to	Jan 31	1892
1892	Jan 1	to	Jan 31	1893
1893	Jan 1	to	Jan 31	1894
1894	Jan 1	to	Jan 31	1895
1895	Jan 1	to	Jan 31	1896
1896	Jan 1	to	Jan 31	1897
1897	Jan 1	to	Jan 31	1898
1898	Jan 1	to	Jan 31	1899
1899	Jan 1	to	Jan 31	1900

1841  
1842  
1843  
1844  
1845  
1846  
1847  
1848  
1849  
1850  
1851  
1852  
1853  
1854  
1855  
1856  
1857  
1858  
1859  
1860  
1861  
1862  
1863  
1864  
1865  
1866  
1867  
1868  
1869  
1870  
1871  
1872  
1873  
1874  
1875  
1876  
1877  
1878  
1879  
1880  
1881  
1882  
1883  
1884  
1885  
1886  
1887  
1888  
1889  
1890  
1891  
1892  
1893  
1894  
1895  
1896  
1897  
1898  
1899  
1900

1841  
1842  
1843  
1844  
1845  
1846  
1847  
1848  
1849  
1850  
1851  
1852  
1853  
1854  
1855  
1856  
1857  
1858  
1859  
1860  
1861  
1862  
1863  
1864  
1865  
1866  
1867  
1868  
1869  
1870  
1871  
1872  
1873  
1874  
1875  
1876  
1877  
1878  
1879  
1880  
1881  
1882  
1883  
1884  
1885  
1886  
1887  
1888  
1889  
1890  
1891  
1892  
1893  
1894  
1895  
1896  
1897  
1898  
1899  
1900

1841  
1842  
1843  
1844  
1845  
1846  
1847  
1848  
1849  
1850  
1851  
1852  
1853  
1854  
1855  
1856  
1857  
1858  
1859  
1860  
1861  
1862  
1863  
1864  
1865  
1866  
1867  
1868  
1869  
1870  
1871  
1872  
1873  
1874  
1875  
1876  
1877  
1878  
1879  
1880  
1881  
1882  
1883  
1884  
1885  
1886  
1887  
1888  
1889  
1890  
1891  
1892  
1893  
1894  
1895  
1896  
1897  
1898  
1899  
1900

1. 1000 1000 1000 1000

2. 1000 1000 1000 1000

3. 1000 1000 1000 1000

4. 1000 1000 1000 1000

5. 1000 1000 1000 1000



1. (unclear) (unclear) (unclear) (unclear)

(unclear) / (unclear) / (unclear) / (unclear)

(unclear) (unclear) (unclear) (unclear)

(unclear) / (unclear)

(unclear) (unclear) (unclear) (unclear)



1			
2			
3			
4			
5			
6			
7			
8			
9			
10			
11			
12			
13			
14			
15			
16			
17			
18			
19			
20			

Handwritten text at the top edge, possibly a page number or header, consisting of several rows of small, illegible characters.



<p>1000</p> <p>1000</p>	<p>1000</p>
<p>1000</p>	<p>1000</p>
<p>1000</p>	<p>1000</p>
<p>1000</p>	<p>1000</p>
<p>1000</p>	<p>1000</p>
<p>1000</p>	<p>1000</p>
<p>1000</p>	<p>1000</p>
<p>1000</p>	<p>1000</p>

1. ... ..  
 2. ... ..  
 3. ... ..  
 4. ... ..  
 5. ... ..  
 6. ... ..  
 7. ... ..  
 8. ... ..  
 9. ... ..  
 10. ... ..  
 11. ... ..  
 12. ... ..  
 13. ... ..  
 14. ... ..  
 15. ... ..  
 16. ... ..  
 17. ... ..  
 18. ... ..  
 19. ... ..  
 20. ... ..  
 21. ... ..  
 22. ... ..  
 23. ... ..  
 24. ... ..  
 25. ... ..  
 26. ... ..  
 27. ... ..  
 28. ... ..  
 29. ... ..  
 30. ... ..  
 31. ... ..  
 32. ... ..  
 33. ... ..  
 34. ... ..  
 35. ... ..  
 36. ... ..  
 37. ... ..  
 38. ... ..  
 39. ... ..  
 40. ... ..  
 41. ... ..  
 42. ... ..  
 43. ... ..  
 44. ... ..  
 45. ... ..  
 46. ... ..  
 47. ... ..  
 48. ... ..  
 49. ... ..  
 50. ... ..  
 51. ... ..  
 52. ... ..  
 53. ... ..  
 54. ... ..  
 55. ... ..  
 56. ... ..  
 57. ... ..  
 58. ... ..  
 59. ... ..  
 60. ... ..  
 61. ... ..  
 62. ... ..  
 63. ... ..  
 64. ... ..  
 65. ... ..  
 66. ... ..  
 67. ... ..  
 68. ... ..  
 69. ... ..  
 70. ... ..  
 71. ... ..  
 72. ... ..  
 73. ... ..  
 74. ... ..  
 75. ... ..  
 76. ... ..  
 77. ... ..  
 78. ... ..  
 79. ... ..  
 80. ... ..  
 81. ... ..  
 82. ... ..  
 83. ... ..  
 84. ... ..  
 85. ... ..  
 86. ... ..  
 87. ... ..  
 88. ... ..  
 89. ... ..  
 90. ... ..  
 91. ... ..  
 92. ... ..  
 93. ... ..  
 94. ... ..  
 95. ... ..  
 96. ... ..  
 97. ... ..  
 98. ... ..  
 99. ... ..  
 100. ... ..

(11) / 11 / 11

John Doe	100	100	8/30	100
James Smith	50	50	100	100
William Brown	50	50	100	100
Thomas Jones	50	50	100	100
Isaac Taylor	50	50	100	100
David Wilson	50	50	100	100
John Van	50	50	100	100
Samuel King	50	50	100	100
John Hill	50	50	100	100
Wm. Scott	50	50	100	100
Thos. Green	50	50	100	100

1. ... ..

///

///

...

///

Date	Description	Amount
1/1	Cash	100.00
1/2	Bank	50.00
1/3	Sales	200.00
1/4	Expenses	75.00
1/5	Interest	10.00
1/6	Dividends	30.00
1/7	Transfer	150.00
1/8	Total	565.00

1000 1000 1000

1000 1000 1000

1000

1000

1000





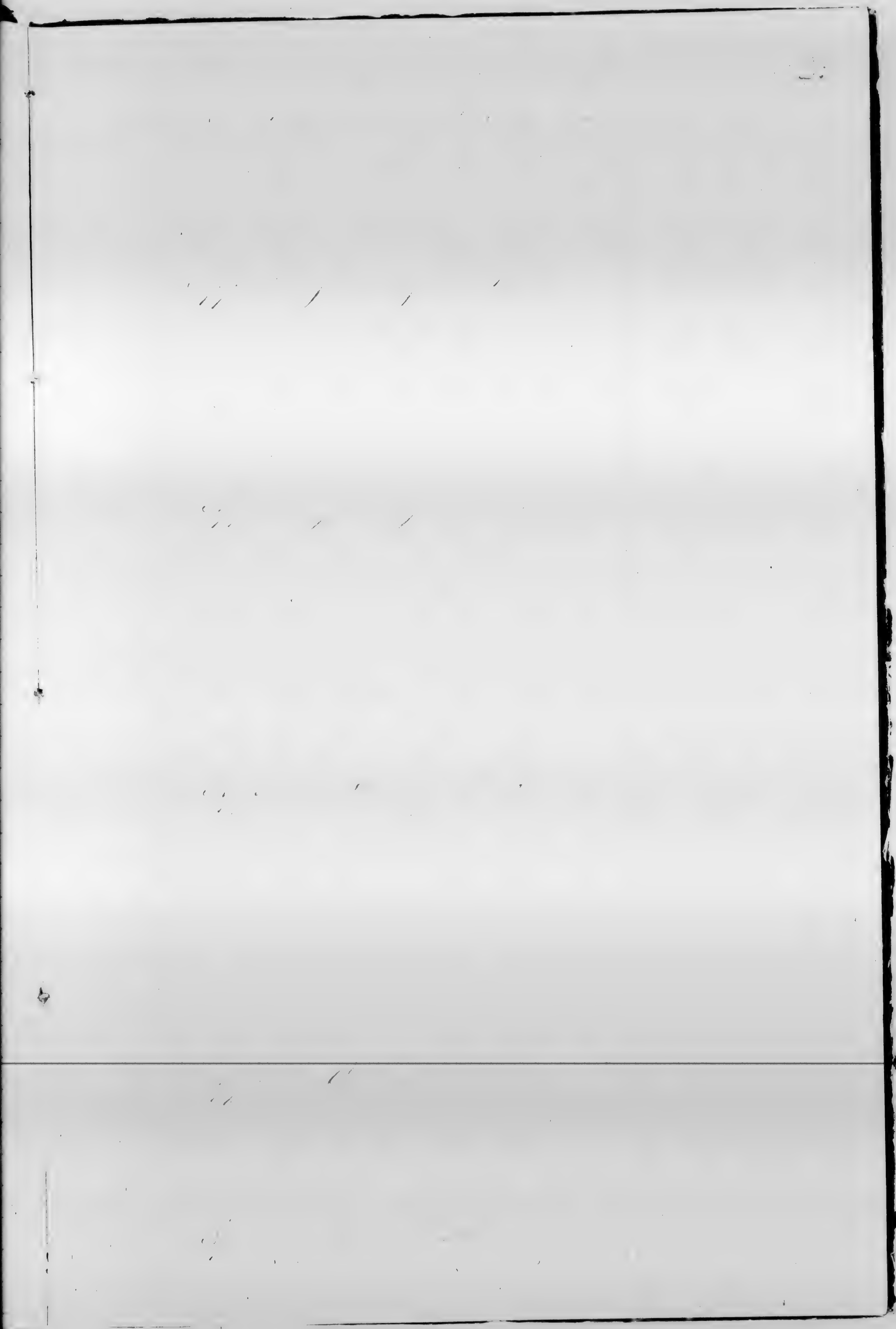

70

<p>1. ...</p> <p>2. ...</p>	<p>...</p>
<p>3. ...</p> <p>4. ...</p>	<p>...</p>
<p>5. ...</p> <p>6. ...</p>	<p>...</p>
<p>7. ...</p> <p>8. ...</p>	<p>...</p>
<p>9. ...</p> <p>10. ...</p>	<p>...</p>
<p>11. ...</p> <p>12. ...</p>	<p>...</p>
<p>13. ...</p> <p>14. ...</p>	<p>...</p>
<p>15. ...</p> <p>16. ...</p>	<p>...</p>
<p>17. ...</p> <p>18. ...</p>	<p>...</p>

2

Jan 1st 1882

11

12

13

14

15

Contract between  
W. W. ...  
...

Contract between  
...

Feb 23 Contract between  
W. W. Roark  
+ Friedman  
Mays Ware

\$103 00

April 6 Contract between  
John S. Greffi  
+ Friedman  
Ulas Hodge

\$7,50

Feb 10 Contract between  
Charles W. Duncan  
+ Friedman  
Henry Black & Children  
Lucy Francis & Henry  
James Brown & Wife Francis  
William ...

\$378 50

201 75

\$112 50

1 - [unclear]

11 - [unclear]

11 - [unclear]

Approved February 23<sup>d</sup> 1867

Approved [unclear]

Approved February 1<sup>st</sup> 1861

Office of Bureau of Refugees

Feb 2

Contract between  
McGuerry  
& Friedman

Birda Gibbing 60 years old \$50 00

Caroline Wilber & Fudko & Schutlin \$60 00

5  
Prudential & Abandoned Lands Summaries

Approved February 12<sup>th</sup> 1867

Included on page 30.



Contracts approved by J. W. Robinson

1862  
1<sup>st</sup> July Contract between John Harrel  
and  
Green Josoy  
Squire Ashin

---

1864  
1<sup>st</sup> July Contract between betw. J. W. Elam  
Supt. County and  
W. Elam  
Thomas Boone } friends.

---

1867  
11<sup>th</sup> July Contract between:  
J. A. J. Vinson  
and  
William Thomas (with  
J. W. Robinson)

---

1867  
15<sup>th</sup> July Contract betw  
Eug. Clark  
and  
J. W. Robinson

---

1867  
15<sup>th</sup> July Contract betw  
J. W. Robinson  
and  
Robert G. Gage and  
John Robinson

---

1870. Bureau of ... ..

1870  
20<sup>th</sup> July

Contract between  
U. S. ... ..

...

1870  
24<sup>th</sup> July

Contract between  
...

...

1870  
5<sup>th</sup> July

Contract between  
...

...

1897  
Aug 25  
1897

Contract with

Contract with  
L. H. Hussey  
" "  
" "

1897  
Sept 10  
1897

Contract with

1897  
Sept 20  
1897

Contract with  
" "  
" "

1898  
Jan 1  
1898

Contract with

70 ... (by ...)

... ..

... ..

... ..

... ..  
... ..  
... ..

... ..

Contract with

1854  
Contract with  
2nd

Contract with

1854

Contract with

1854

Contract with

1854

1944 53



187  
Contract between  
G. H. Thomas Jr  
and Friedman  
Kissam Kelly,

\$ 60.00

" Contract between  
G. H. Thomas Jr  
and Friedman  
Kissam Kelly

\$ 10.00

187  
Contract between  
G. H. Thomas Jr  
and Friedman  
Kissam Kelly

Contract between  
G. H. Thomas Jr  
and Friedman  
Kissam Kelly

July 1 J. H. Caldwell  
and partners  
John Allen

11 2 J. H. Caldwell  
and partners  
Cous. Lord et al

1 25 J. H. Caldwell  
and partners  
John Allen

J. H. Caldwell  
and partners  
John Allen



A. H. Fisher  
and Friedman  
Richard Morgan

E. F. H. Phau  
and Friedman  
Caleb Gavin

E. F. H. Phau  
and Friedman  
Caleb Gavin

E. F. H. Phau  
and Friedman  
Robert Caldwell

Anderson Cott  
and Friedman  
Ken Lewis

Geo. H. H. H.  
and partner  
Geo. Jackson

Sam. S. S.  
and partner  
Geo. H. H.

Geo. H. H.  
and partner  
Geo. H. H.

Geo. H. H.  
and partner  
Geo. H. H.

Geo. H. H.  
and partner  
Geo. H. H.

Wm. T. Tuck  
and partner  
Lewis Tuck

Geo. W. W. W. W.  
and partner  
New York

W. W. W.  
and partner  
Lucy Cunningham

J. W. W.  
and partner  
Hill & Wood

J. W. W.  
and partner  
Samuel Gilliam

S. G. Addy  
and partner  
George Addy

John Taylor  
and partner  
Henry Clement,

110

Thomas P. Cuyler  
and partner  
John Cuyler

~~J. G. Glover  
and partner  
Polly Glover~~

Contracts approved by J. 192

1893  
March 13<sup>th</sup> Contract bet:  
Chas. C. Suggard  
vs  
Elizabeth Purney  
John Purney  
Lillian " "  
Robert " "

---

1893  
March 13<sup>th</sup> Contract between:  
Chas. C. Suggard  
vs  
Frank Carter

---

1893  
March 13<sup>th</sup> Contract bet:  
L. W. Miller  
vs  
Wm. Miller  
Frank Miller

---

1893  
March 20<sup>th</sup> Contract bet:  
E. G. Mitchell  
vs  
Joseph Wynn

---

1893  
March 20<sup>th</sup> Contract bet:  
E. G. Mitchell  
vs  
Joseph Wynn

---

Robinson Agent Bureau B. Va. S. I.

1863

March Contract bet  
20 Wm. W. Henry  
" "  
Charles Smith, Jr.

1863

March Contract bet  
17 William Nelson  
" "  
Henry Smith

1863

April Contract bet  
2 J. G. S. Goodman  
" "  
Yerres Woods, Jr.

1863

April Contract bet  
1 Wm. W. Henry  
" "  
Charles Smith, Jr.

1868

April Contract bet -  
29 James Hatfield  
" "  
(James Chapman from)

Contracts approved by W.C.

April 29

Contract bet -  
B. J. Head  
and

George Lamer (Grand)  
Joe Lamer "  
Gula Lamer "  
Crisly West "  
Leitch West "  
Lynch West "

Contract dated

Jan 1<sup>1868</sup> at for one year -  
on file in office

May 2

Contract bet -  
Das & Harrison  
and

Nelson Hooper + other freemen

May 2

Contract bet -  
W. R. Stewart  
and

Jackson Kauford + others

Monroe Report Bureau R. F. & A. L.



Wm. Dray (Colonel) of Edgefield  
District South Carolina does hereby  
authorize W. R. Dorn of Webster County  
Ga. to get his son Lawrence of the same  
State & keep him under his control  
until the 1<sup>st</sup> day of December  
next. If at any time he shall leave  
him the said W. R. Dorn has per-  
-mission to get him whenever he may  
be found. The said W. R. Dorn agrees  
to give Lawrence rations & clothes  
& twenty dollars as remuneration  
for his services until the above  
specified time at the expiration of  
which he is to send him to the  
said Wm. Dray  
(Signed) Wm. Dray  
W. R. Dorn

Personally appeared before me  
W. C. Merrill Agent B. N. F. & at  
Sanctuary Sch. & Webster Co's W. R.  
Dorn who being duly sworn depone  
& saith that the above induction is  
the true intent & meaning of said  
Wm. Dray & that he rec'd it from  
said Wm. Dray by Mail from Edgefield  
S. C. & that he hereby agrees to  
fulfill his part of said contract in  
proportion of pay however he reserves  
the right to pay Lawrence for rations  
the time he gets him - but to furnish  
him clothes &c.  
Done & subscribed  
before me 24<sup>th</sup> June 1868  
W. C. Merrill  
Agent

W. R. Dorn

NATIONAL ARCHIVES AND RECORDS ADMINISTRATION  
MICROFILM PUBLICATIONS

Roll 40

Target 4

Register of Complaints  
Volume (139)                      Aug. 1867–Nov. 1868

Volume pages were filmed sequentially.  
Blank pages were not filmed.

Case 1000

Emmanuel P. ...



Aug 1867 -  
Nov 1868  
American M

INDEX  
to  
Case Book  
1868



William D. Quinn 111

Andrew Geo 37

Richard R. ...

...

...

...

...

Memorandum

...

Vertical handwritten notes on the right margin, possibly a list or index.

Bleek Moss 53.

Bleeker D 79

Bivins L 95

Birt M 96

Black Tom 101.

Brown Lead 134

Bryant

Brown L. 134

Brunnan C. 134

Brown D. 134

Brown G. 134

Brown H. 134

Brown I. 134

Brown J. 134

Brown K. 134

Brown L. 134



Clark Emma	13	Putterson. Oliver.	118
Cuba Lee	88.59	Putterson. Oliver.	118
Cato Arnold	49.50	Putterson. Oliver.	118
Carter Lillian	69	Putterson. Oliver.	118
Clark Frank	75	Putterson. Oliver.	118
Clark James	85	Putterson. Oliver.	118
Collins Walter	102	Putterson. Oliver.	118

C  
 7  
 2  
 1  
 0  
 1  
 2  
 2  
 5  
 5  
 7  
 11  
 7  
 11  
 2  
 2

...  
 ...  
 ...  
 ...  
 ...

Daniel Cady 21, 29

Dowdell Richd 23

Daniel Cady 21, 29

Dowdell Richd 23

Daniel Cady 21, 29

Dowdell Richd 23

Daniel Cady 21, 29

Dowdell Richd 23

Daniel Cady 21, 29

Dowdell Richd 23

Daniel Cady 21, 29

Dowdell Richd 23

Daniel Cady 21, 29

Dowdell Richd 23

Ellison Simon 66

1840  
1841  
1842  
1843  
1844  
1845  
1846

1847  
1848  
1849  
1850  
1851  
1852  
1853  
1854  
1855  
1856  
1857  
1858  
1859  
1860

Fagin Bob	19
Ford Augusta	46
Fasiler John	43
<del>Ruffin Geo</del>	41
Fudge Thom	47 57
Flin' Ellen	52

Ford Lucinda 48

Foster Tom 77

Fair James 53

Fl... ..

Fl... ..

G  
C  
L  
L  
L  
L  
L  
L  
L  
L  
L

Grubbs John 27

Grubbs Martha

Griffin Jane 54

Griffin David 106

Griffin Elizabeth 106

Griffin John

Griffin Mary 106

Griffin Sarah 156

Griffin Thomas 106

Griffin William

Griffin David 106

Griffin John 106

Griffin Samuel 173

Griffin Thomas 106

Griffin Andrew 106

Grant Barbara 106

Grant John 106

Griffin John 106  
Griffin Elizabeth 106  
Griffin John 106  
Griffin Mary 106  
Griffin Sarah 156  
Griffin Thomas 106  
Griffin William 106  
Griffin David 106  
Griffin John 106  
Griffin Samuel 173  
Griffin Thomas 106  
Griffin Andrew 106  
Grant Barbara 106  
Grant John 106

Holley M	7	W. M. D. C.	
Hodge Colman	11	Wilmington Col.	55
Hoot Adam	17	W. M. D. C.	56
Hauptman Hector	20	W. M. D. C.	
Harrison James	21	W. M. D. C.	57
Hodge Sarah	25	W. M. D. C.	
Israel B J	39	W. M. D. C.	
Hill Bob	74	W. M. D. C.	201
Hammond A	96	W. M. D. C.	208
		W. M. D. C.	209
		W. M. D. C.	210
		W. M. D. C.	220

Richard Richd	138
W. M. D. C.	132
W. M. D. C.	136
W. M. D. C.	138
W. M. D. C.	138
W. M. D. C.	140
W. M. D. C.	140
W. M. D. C.	140
W. M. D. C.	140

Suprohan G 6  
Isaac Green 20  
Isaac Mary 73  
Isaac Saul 97

Isaac Mary 73

2/1  
1/2  
1/3  
1/4  
1/5  
1/6  
1/7  
1/8  
1/9  
1/10  
1/11  
1/12  
1/13  
1/14  
1/15  
1/16  
1/17  
1/18  
1/19  
1/20  
1/21  
1/22  
1/23  
1/24  
1/25  
1/26  
1/27  
1/28  
1/29  
1/30  
1/31  
1/32  
1/33  
1/34  
1/35  
1/36  
1/37  
1/38  
1/39  
1/40  
1/41  
1/42  
1/43  
1/44  
1/45  
1/46  
1/47  
1/48  
1/49  
1/50  
1/51  
1/52  
1/53  
1/54  
1/55  
1/56  
1/57  
1/58  
1/59  
1/60  
1/61  
1/62  
1/63  
1/64  
1/65  
1/66  
1/67  
1/68  
1/69  
1/70  
1/71  
1/72  
1/73  
1/74  
1/75  
1/76  
1/77  
1/78  
1/79  
1/80  
1/81  
1/82  
1/83  
1/84  
1/85  
1/86  
1/87  
1/88  
1/89  
1/90  
1/91  
1/92  
1/93  
1/94  
1/95  
1/96  
1/97  
1/98  
1/99  
1/100

Jackson Thomas 22 88

Jackson Hardy 34

Jackson Joe

Jones Geo' 41

Jenkins B R 62

Jones Burton 47

Jackson Bob 72

Johnson Isaac 83

Johnson James 86

Johnson Henry 90

Jones Jerry 93

Jones John 121

Jones Mary 47

Jones Robt - 111

Jones Wm 10

Johnson Eliza 108

Powers Exch 171

Jones Wm 85

James Arthur 207

James Col 200

Jenkins Robt - 211

Jenkins Wm 22



Kimber Mohave 9

Keuchian 2 78

Kitchins Boas

11

11  
12  
13  
14  
15  
16  
17  
18  
19  
20  
21  
22  
23  
24  
25  
26  
27  
28  
29  
30  
31  
32  
33  
34  
35  
36  
37  
38  
39  
40  
41  
42  
43  
44  
45  
46  
47  
48  
49  
50  
51  
52  
53  
54  
55  
56  
57  
58  
59  
60  
61  
62  
63  
64  
65  
66  
67  
68  
69  
70  
71  
72  
73  
74  
75  
76  
77  
78  
79  
80  
81  
82  
83  
84  
85  
86  
87  
88  
89  
90  
91  
92  
93  
94  
95  
96  
97  
98  
99  
100

Little Region 2  
La Phe 50

East Stearns 128  
Lamar Geo 133  
Lamar 107 33  
Lamar 116  
Lamar 118  
Lamar 118  
Lamar 111  
Lockett, Rich 114  
Lorris, H. C. 107  
Lumkin, C. P. 111  
Lamar, Winston 115  
f



Mrs Mary 31

Mrs. Martha 111

Mrs. Levi 111

Mrs. - Martha 111

Sto. Kanna.

10  
2  
6  
1  
5  
7  
14  
7  
11  
X  
3  
2

Patterson Wm 3  
Pickett Sallu 36

W. Bell John 1  
W. Bell John 91  
Price George 157  
Powers J. V.  
Price Robert 107  
Price John 114  
Pittman Daniel 115  
Pocamore J. 88  
Price Alex 178  
Patten Wm 302  
Powell Wright 111  
Phipps Thomas 115

Robert, Catherine	26	Robinson, John	22
Robinson, Susan	30	Robinson, George	21
Ross, Dicy	32	Robinson, John	20
Russell, Eliza	42	Robinson, John	19
Ruffus, Geo	45		
Rodgers, Jim	55		
Raven, John	51		
Robert, Brauner	87, 88		
Russell, Cornelia	98		
Russell, R R			

Vandell, Martha 131

Wagner, James 154

Ward, Catherine 131

Wasson, Sam 131

Wasson, Luke 71

Wasson, John 71

Wasson, John 71

Wasson, John 71

Wasson, John 71

Wasson, John 71

Wasson, John 71

Wasson, John 71

Townsend L	4,31	Sanders, York	211
Salmon Henry	10	Blanca, Havana	212
Scarbor Andrew	18	Staten, Polun	213
Smith H	44	Sigsbee	214
Sperry Charlotte	100		

Tucker C. 1877  
 Tupper Amanda 27  
 Tupper Richard 31  
 Tupper George 38  
 Tupper William 44  
 Tupper Frederick 49  
 Tupper Henry 56  
 Tupper Betsey 63  
 Tupper William 70  
 Tupper John 77  
 Tupper George 84  
 Tupper Charles 91  
 Tupper Daniel 98  
 Tupper 105

5  
 7  
 11  
 15  
 21  
 27  
 33



Taylor Dianah 15  
 Musley John 33  
 Pools Wm 35  
 Burns L 58  
 Pools Charlotte 94  
 Perry Isaac 99

No. 1  
 ... 18  
 ... 14.5  
 ... 57  
 Taylor Luck 174  
 ...  
 ...  
 Taylor ... 201

London, England, 1914

1914  
52

1771  
1771

Webb Wm 5  
 Ware Wm 45  
 Wilson J Ben 60  
 Wiles Anderson 61  
 Westbrook John 65  
 Williams Milly 89

Wilson J Ben 60  
 Wiles Anderson 61  
 Westbrook John 65  
 Williams Milly 89  
 Wilson J Ben 60  
 Wiles Anderson 61  
 Westbrook John 65  
 Williams Milly 89  
 Wilson J Ben 60  
 Wiles Anderson 61  
 Westbrook John 65  
 Williams Milly 89

Wilson J Ben 60  
 Wiles Anderson 61  
 Westbrook John 65  
 Williams Milly 89  
 Wilson J Ben 60  
 Wiles Anderson 61  
 Westbrook John 65  
 Williams Milly 89

11  
 21  
 3  
 2

\_\_\_\_\_

*11 - 11 - 11*

Handwritten issue by W. W. Robinson  
Agent Bureau of A. S. L.  
on the 13<sup>th</sup> June 1897.

Handwritten issue by W. W. Robinson  
on the 14<sup>th</sup> July 1897.

Letter sent Aug. 15<sup>th</sup> 1897.

Letter sent Aug. 15<sup>th</sup> 1897.

Affidavit, I before me J. M. Robinson  
 Sheriff of Bureau Co. Ia. personally examined  
 the following persons  
 Ben Howe, Edmund Howe, Scott Howe,  
 Richard Howe, George Howe,  
 and on the 18th inst. of 1864, and being duly  
 sworn, they say that the following are the  
 only men in this county who

(signed) J. M. Robinson  
 August 18

Affidavit, I before me J. M. Robinson  
 Sheriff of Bureau Co. Ia. personally examined  
 the following persons and says, that  
 the latter is American born, under no  
 bond or attempt to kill him and I believe  
 that a warrant may issue for his arrest.

(signed) J. M. Robinson  
 August 18

August 19th will report George Hart (white) to ward  
 Anderson (black) (freed).

August 21st, letter to Mr. Harriott with the request  
 to pay in money for the value of work.

August 20th, letter to Mr. Red Taylor to send  
 Henry Woodford.

William Ware (Prisoner) make statement  
against Martin L. Brady, that he  
shot his dog and him and in the fall  
and by order of the Agent at the Bureau to  
appear next Saturday 17<sup>th</sup> at 9 o'clock at  
this office.

Letter sent August 15<sup>th</sup> 1907.

Person. Name

Person. Name



Letter sent to Washers Willis, Hunter Co. to appear  
at this office, next Tuesday 20 August 1867.  
The statement of Freedman Barton is: Threatened his  
wife and kids his children.

Mr. Collins (white) letter received to appear <sup>this Saturday</sup> next Saturday  
or Monday he had an order to appear Saturday 16th. to settle  
with Frank (free).

Wm. Thison (free): appears by order of Capt. Robinson  
and says that Betty (free) will appear at this office.  
Wm. Thison has order to appear Monday next 19 Aug.  
1867.

at hand

Amicus La Roque - 59, 1867

Ella Tupper } Complaint  
that her husband had abandoned  
her and left her destitute

John Lewis } Verdict for divorce of  
his wife by Chaffee  
Chas. Tupper }  
to be a witness

James Henry Carter } Complaint  
Davidson Brown } wages for 1866

ordered to appear  
+ pay some money

John Lewis }  
Chas. Tupper } Verdict in favor of  
Chas. Tupper  
ordered to appear

John Lewis } Complaint  
Davidson Brown } wages for 1866

ordered to appear

J. M. Robinson and Benjamin Smith,

Co. ... ..

Thomas Adams } Complaint - wages  
the complaint } 1866  
Mr. T. Adams }

William Adams } Complaint - wages  
1866  
Mr. T. Adams }

Aug 21

Wm. Adams } Notified to come to court  
and pay wages due by 4 o'clock  
for 1866 wages

James Adams } Complaint - wages  
1866  
Mr. T. Adams }

Wm. Adams to appear on Wednesday 3/24

James Adams } Wages due by 4 o'clock  
1866  
Note & pay to  
Mr. T. Adams }

Wm. Adams } Wages  
1866  
Wages due to James Adams  
1866  
Mr. T. Adams }

Wm Robinson vs Bann 17182  
Judgment for Plaintiff \$35.31  
Attorney Fees ——— 16.50

Inclosure

The money in this case is due James,  
son of Lewis Hutchcock, with, the  
bank having paid said Lewis  
Hutchcock the 1/2 of the crop  
and the interest for his was with  
him for the purpose of

11  
Noah Curtis } Complaint  
vs }  
H. King } Money due for  
digging well

Antony Brown }  
vs }  
Henrietta Brown }  
Said Brown  
whipped his  
wife 25- Lashes  
ordered to appear Saturday by 7

John Dorn }  
vs }  
William Dorn }  
Breaching contract

Isaac Green }  
vs }  
William Dorn }  
wages -

Lizzie Green }  
vs }  
David G. Green }  
Schles County }  
Unlawful detentions  
of two children Green  
ordered to appear and produce child  
G

Richard Hall }  
vs }  
W. D. Green }  
Maltreatment to the

Judgment in Plaintiff  
\$2650

Office August 17<sup>th</sup> 1867  
 Sept 7.  
 Wright Brady & Insurance  
 vs Charles Sumner & Distributor  
 Colver

Patent Manna }  
 Jack L. S. Hook }  
 Lewis Hook }  
 U.S.  
 M. E. Sparks }  
 Ordered for trial 7

Sept 7, 1867  
 Nelson Holly shooting mice at  
 vs John Holly Nelson when he descends  
 of tubular Co ways die him  
 \$10 due John Holly now my debt  
 Nelson is at W. T. Adams plantation

Jack L. S. Hook  
 Lewis Hook  
 M. E. Sparks  
 Nelson  
 John Holly  
 Charles Blacksher  
 Lucy Hamilton  
 Julia Richards  
 Nancy Knight  
 Jackson  
 Jack King  
 Tom Richard  
 Marshall

Ernest Grant ✓	Peter Stubbfield
Charles Lucas ✓	Alex Blacksher
John Sanders ✓	Elyse Grant
Septime Hayward ✓	W. T. Adams
Thomas <del>Hook</del> ✓	
Patrick Holly ✓	
Charles Blacksher ✓	Ordered for
Lucy Hamilton ✓	trial
Julia Richards ✓	
Nancy Knight ✓	
Jackson ✓	Left Wednesday
Jack King ✓	Sept 1867
Tom Richard ✓	Friday Sept 11
Marshall ✓	



J. H. Robertson Agent

1000 ... ..

1000 ... ..

Fancy Harris } signing lease  
vs } \$7.00  
a copy }

ordered to appear Monday Sept 9

Maria Ann Walker } complains of  
vs } a lease drawn  
vs H. J. D. } up & breach of  
contract

Ordered for trial on Wednesday next

Henry Fiddall } complains of  
vs } nothing done to him  
Wright & Mundy } 1/2 copy

Edmund Montgomerie } complains  
vs } that he was turned  
James Baldwin } off without cause  
was making an entry  
Ordered for Monday Sept 15

London Stewart } complains of  
vs } being dismissed  
William Bailey } in buying a mule  
& that said mule to be  
his property without  
proper process of law

Ordered to appear on Saturday

The unit Lucia was paid in full  
and discharged from contract -  
amount due \$12,20

Captain Joseph Dyer was chosen by  
Genl. Tindall to settle the matter in regard  
to the share of the Corp, and a settlement  
was made and all Trade holds  
were receipted in full

English and ...

William Case } Complaints  
D. S. } Deaf and dumb  
Duncan McNamee } visible in ear  
to appear Saturday 11<sup>th</sup>

William Case (father) } complaints that  
D. S. } she is percauctly  
John Robinson } Sanny to him only  
he has to settle September 18<sup>th</sup> to be  
returned to his mother at ...  
(He has not returned Sanny at Christmas  
but remains in Louisa County taking his  
child with him since when his mother has  
no reason and fears that she may be  
returned to her. Sanny is 10 years of age  
(Mabelle)

The mother of this child living with Mr  
Horgan in ...  
at ...

James Woodcomb  
D. S.  
John ... } to appear at this  
George ... } office before me  
Wm ... } 28<sup>th</sup> to answer  
complaints of  
James Woodcomb.

100 - 1000000 12 1 8 1000 10000

Sept.  
23

George Dickerson Long Perkins complaint threatened to  
kill him and that George  
went to the home of Henry  
on business about the  
plantation with the both  
working on the contract  
the difficulty between Long  
and Henry's son was about  
some wife inheritance and  
James H. South  
Wilmington:

and some correspondence with  
George and the home being heard  
conversations between George and  
Henry in regard to the wife's  
cotton. Henry and  
J. D. D. Long visit in an  
threaten to kill his son  
bring a S. Long's wife near  
the garden George left the  
house. Henry's wife not in  
the man Henry shot George.

Simon McKinnin 11<sup>th</sup> Adams St. and digging well

October

1. To take Mrs. Joseph Harris Bialing and not her son  
prop it at one at the  
office.



James Wilson  
James Wilson (Mason) 1781

Sept. 1781 James Wilson 1781

May 27 Alex Hamilton William ten <sup>with me forward</sup> <sup>considered to what</sup> <sup>loges are in</sup> <sup>Simon from</sup> <sup>Hamilton</sup>

May 27 Dr. Yutwick William Hyles. <sup>In this case it appears</sup> <sup>that William Hyles</sup> <sup>received his plantation with</sup> <sup>him last year in the name</sup> <sup>of William not only</sup> <sup>did not make any thing</sup> <sup>but is to claim an amount</sup> <sup>of 1000 and for 8000</sup> <sup>to say that such, said not</sup> <sup>having been claim as we</sup> <sup>will by H for provision</sup> <sup>on other things a warrant</sup> <sup>to William.</sup>  
<sup>William claims that he</sup> <sup>will see myself by</sup> <sup>Simon and I have</sup>

May 27 The Court of Session 1781 <sup>provision has</sup> <sup>been made of</sup>

1781 <sup>complaint of</sup> <sup>James Wilson</sup>



11  
I will by Dickin, on going out  
for the 30th day of December  
1850

I will be a Board of  
Censors, consisting of Mr.  
J. M. Senter, Mayor, Col.  
Holt and A. M. Robin in  
the Bureau of P. & C. who  
made a resolution of \$

and to return to the work

Complaint made of J. M. ...

... ..

... ..

How did I see the answer  
every man which so do.  
is not a man with sons  
I can believe, but how  
will he be in the  
... ..  
... ..  
... ..  
... ..  
... ..  
... ..  
... ..  
... ..  
... ..

First Monday in June

Capt. ...  
S. Richard ...

Complaint ...

... ..

Agrost. Beauveria Se ...

Agrostis

Beauveria

[Faint handwritten notes in the left column]

[Faint handwritten notes in the right column]

[Faint handwritten notes in the middle section]

[Faint handwritten notes in the bottom section]

~~Alfred Probst~~  
Alfred Probst

William H.  
~~Brown~~  
Brewer.

Sue for Damages for  
house on Lanna Street  
for materials has Lumpy  
County

Charles Williams (W)

Wages 1867 -

Colaba Maria Home  
9

William Spear

Threat to Kill &c

Ruan Smith Phil

Complain that Phil  
threatened to kill his  
son and called him  
a liar &c

After hearing the evidence  
 in the said case it is  
 considered and adjudged  
 that the plaintiff Alfred  
 Traylor do recover of  
 William W. Brower  
 defendant the sum of  
 one (140) hundred and  
 forty dollars for his  
 damages and a sum of  
 five dollars for costs.

To be read to be  
 discharged at once  
 & paid of -

Date	Complainant	To
17 <sup>th</sup> Oct. 1857	William James Salove Happe?	Complaints, own him 910 and eighty cents.
15 <sup>th</sup> Oct. 1857	Harriet Laster	<del>Complaints</del> Complaints. (white). refuse to pay. To appear Tuesday 22 <sup>nd</sup> Oct.
18 <sup>th</sup> Oct. 1857	Elisabeth Lewis	Complaints threatened and wife her. Monday a m. 21 <sup>st</sup> October.
18 <sup>th</sup> Oct. 1857	Emma Bala.	Glaustern Gans. Complaints threatened and wife her. Monday a m. 21 <sup>st</sup> October. to appear.
19 <sup>th</sup> Oct. 1857	Willis Johnson	Guston Congleton Complaints: given him off with the 7 <sup>th</sup> promark he work nothing.  To appear Monday 21 <sup>st</sup> Oct. 1857.
	Edm <sup>d</sup> Grant	A. M. Cat Removing Colter without permission Wednesday Oct 23 <sup>rd</sup>

agent Bureau de ... 27

October

November

Case examined  
Permission approved.  
man work up.

Cannot be paid  
until December 25  
about \$774 due him,

Discharged  
Not returned.

## Complaints made to J. M. Robinson

1867	Complainant	Nature of Complaint
Oct 21	W. Styles	Difference in regard to certain acts outside of Contract
(Oct 21)	Vilas Hinkley (S. Bagley) S. O. Lins S. Macken & others	Wages 18 Cts
Oct 23	Angela Joan Pharr Evelyn Evelyn	Complaints: Threatened and whipped with a stick. 24 <sup>th</sup> October to appear 9 O'Clock at this office.
" 25	J. J. Emmett 11 <sup>th</sup> Lopp	No payment & was added to appeal Monday next
" 28	Mrs. F. McCarty John Mason	Complaint Breach of Contract
" 28	Henry Lane (S. O. Lins)	Bad treatment & threatening to shoot.
" 29	Danie Machens William Bryor.	Complaint irregular to Division of Prop. to appear Monday Morning next.



Case of Juan & F. H. & M. M. <sup>31</sup>

Settled.

Settled between Parties.

Settled by note  
of \$17.45

John Mason paid \$3.00

Turned over to Civil Authority

Parties did not appear ~~at court~~

81  
7. 27  
8. 12  
11. 18

November

1. *Wm. More* *Burton* *Albritten*  
to appear Monday 4th

Nov. 1

*John Nilson* *Ed. Marti* & *A. Port* vs *John* *prayerment* *the* *wagon*  
to appear Monday 4th

Nov. 5. *Milly Lewis* *Jane* *Wahouse* *Wages* *66* *v.* *67*

Nov. 7. *Wm. J. Anderson* *Wages* *1567*

Nov. 9. *Wm. Stubb* vs *W. Burden* *complaints* *in* *London*

Nov. 11. *to appear* *Sunday* *12* *Nov* *11*

Nov. 12. *to appear*



32  
Nov. 9. G. B. Amulet George Warner Bridge of Contract.

Nov. 9. G. W. May. Ann Purloo. Contract for child.

Nov. 11. Lucy Washington Jean Harris don payment of wages  
to appear 12 Nov. 1865

Nov. 14. Eliza Mayberry Mc Little Breach of Contract  
Nov. 15, 12 o'clock

Nov. 17. ...  
11<sup>th</sup> ...

Nov. 18. ...

33  
Friedman delorched, said him  
full.

---

The Grandmother take the  
child until further orders.

---

Deposition

---

Judgment in favor  
of Plaintiff of  
~~150.00~~ 120

Carried to Page 194

William Wilkey  
order to pay \$5 per week  
to Catherine

L. U. U.

A. K. Brown

31 (2) ... .. 111 7 1200

1000 ... ..

1000 ... ..

1000 ... ..

1000 ... ..

1000 ... ..

1000 ... ..  
Edge  
Edge  
Edge

1000 20. ... ..  
Hudson ... ..  
Hudson ... ..

1000 21 ... ..  
Hudson ... ..  
Hudson ... ..

1000 ... ..  
Hudson ... ..



38 Complaints made to C. M. Brown

1857	Complainant	Defendant	Particulars
Nov. 21.	Elise Wacker	Amalia Jahn	Refuse to pay 20th Nov.
Nov. 23.	Florise Andersen	John Andersen	Wife of John Andersen to appear 30th Nov 1857
Nov. 23	John Bennett	Thomas Bird	<del>John Bennett</del> To appear 30th Nov 1857
Nov 23	Elmina (George) Mc Cain	George Richardson	Wages Saturday December 14th to appear.
Nov. 23	Michel Edwards	Frank Hall	refuse give daughter 28. Saturday 30th Nov. to the court and not appear but the court to which the woman was taken is not.
Nov. 23	Martha Freise	J. W. Hogan	Payment of 20th 28. Saturday 30th Nov 57
Nov. 25.	Jo Ford	C. Mann	Wife of defendant 30th Nov.
" 25	Charles Braun	Mrs S.A. Peoples	Wages due for 1857 added to appear on Saturday 30. 1857



Copy of ...

Assumed

The gold must not  
be sent back to ...  
in finish. It is ...  
perfect ...  
the gold ...  
of ...

A. R. ...

1867	Complainant	Defendant	Nature of Complaint
Nov. 25	<del>Edith. Moore</del> Carp	Miss Bap.	beating and threatening to hit Saturday 30 to 100.
Nov. 25	Sunday. <del>Hawkins</del> Hawkins	Sam Hendrick	Money. Wages 100. Saturday 30 to 100.
Nov. 25.	Jim Hynan	Mabel Co Mason	being beaten. Saturday 30 to 100.
Nov 26	Jim Janette	Edmund Grant	Refusing to pay money de. for Saturday 30 to 100
Nov. 27.	Arthur Cole Loise People	<del>Lamont Blane</del> Lamont Blane	Refused give ab her ch. 100.  on the 10th and 100 to 100 in on the 10th 2
Nov 27	Com'ty	Ed. Moore	Complaint
Nov. 29.	Robert Robinson	Sam Moore	Beating & threatening to kill him. Saturday 7th Decem 1867
Nov 30	John <del>Robinson</del> Miles	A. Keller	Refusing to pay money for Cox's

Am 11/11/11

AK Brown for expense

C. J. ...  
\$1, ...  
1/1

AK Brown for Plaintiff

Disburse

AK Brown for Plaintiff

For the sick mother  
works into for July

~~xxxxxx~~

No charge for complaint  
Disburse

AK Brown  
for expense

1857			
Dec. 1	Shipping		
Dec 30	Ship Cable.	Low Water	at 2 o'clock at the harbor.
Nov 10	Case in Court		
Dec 1	May 2 <sup>d</sup> Wilder	for damages	Sticking & Kicking
Decemb.			
2.	Phonine Jacob.	Wash Guard.	Require to pay wages. to appear 9 <sup>th</sup> of Decemb. 57.
Dec. 2.	Lewis Waters	Driver	Require to deliver his Dr Clothing. or appear Saturday 3 <sup>rd</sup> Dec.
Dec. 2.	Maria Ann	John Lumphin	Monday 9 <sup>th</sup> Decemb. 1857.
Dec. 3.	Henry Wood	Robert & John John	Require to give up clothing and pay wages. 9 <sup>th</sup> Dec. 1857.
Dec. 3.	Ben King	Charles Cox	Difficulties with Contract, 9 <sup>th</sup> Dec. 1857
Dec. 3.	John Wood Henry King	George Provl.	Difficulties with Contract 9 <sup>th</sup> Dec. 1857.

Champin

Champin

Champin is a word  
to say the be

Champin is a name  
of fine character &  
the mother a champion

Dec. 3.	Whigham & Lewis.	Augustus Patterson.	Loose about the Crisp. 9 <sup>th</sup> of Dec. 1867
Dec. 3.	Thomas Carbin	Saml Mc Mah.	Refuse to pay wages 10 <sup>th</sup> of Dec. 1867
Dec 3	John a Lane	Joseph Sells	Refuse to pay wages. Rins & pay wages. Saturday 14 <sup>th</sup> Dec 1867
Dec. 6	Lavine May	Sam Pross (freeman).	Refusing and threats to appear 9 <sup>th</sup> Dec. 1867.
Dec 6	Liam Monroe	Ysam freed prof. w.	Refuse to pay wages. 10 <sup>th</sup> Dec. 1867
Dec. 7.	James Lovewell.	C. B. Gray.	Refuse to give wages. To appear Saturday 15 <sup>th</sup> 1867. (Thom)
Dec 9.	Liam Ryan	Mill Ryan freed m.	Refuse to pay work. To appear next Monday at 5 o'clock
Dec. 9	Byne Pickett	Dr. Sanders.	Refuse to pay work. To appear next Monday at 10 <sup>th</sup> Dec 1867
Dec 9.	Wm Brown	George	Refuse to pay work. To appear next Monday at 10 <sup>th</sup> Dec 1867

Wm. Byrd for Plaintiff

Dec 19. Betty Ann Brown. Elizabeth Taylor / wages.  
(Brown) Sabers Bay 14<sup>th</sup> Dec.

Dec. 12	John [unclear] [unclear]	[unclear] [unclear] [unclear]
---------	--------------------------	-------------------------------

Dec. 11	Henry Nye, <sup>Highway</sup> [unclear] Harc	[unclear] [unclear] [unclear]
---------	---	-------------------------------

Dec. 10	William Schapp's son Harry. [unclear]	Seized him in [unclear], Monday 10th Dec. [unclear] Metcher County.
---------	--	--

Dec 14	Act. [unclear] [unclear] [unclear]	For wages 1887
--------	---------------------------------------	----------------

Edam [unclear]	David Mayo	Compt. [unclear] [unclear] [unclear] [unclear] [unclear] [unclear] 1887
----------------	------------	---

(Dec 14)	George Hayes [unclear]	George Hayes John [unclear]	Compt. Wages
----------	---------------------------	--------------------------------	--------------

Samuel Tison or Will Bryan	Complaint for damages to waggon
----------------------------------	---------------------------------------



Left Littlefield

After hearing the evidence in the above  
 case it is considered and judged that the  
 plaintiff do recover of the defendant as  
 follows that the Dept put said wagon in the  
 same repair that it was in at the time he received  
 it & pay twenty five dollars for the use of  
 the same or in default thereof that he pay  
 fifty dollars  
 Dec 14<sup>th</sup> 1867

48

Monday

Jane Brady  
vs  
Martin G. Brady

Cash

Complains that  
that M.G. Brady had  
the bond to his  
in the school & the  
the bond to his  
to do, but  
out to the  
\$10.00  
paid by  
to be  
to get  
for

Monday

Eli Kitchens  
vs  
Elias F. Brantam

Complains that  
Contract

Brantam  
returns  
for bond

Eli Kitchens in right  
of wife  
Caroline Kitchens  
vs  
Elias F. Brantam

As done  
vs  
Thompson Peck

Monday  
&  
Hadden

Stephen Cady  
vs  
Richard Swanson

\$51

Case deprimed

See 18

Gene starting was this day arrested  
by Corporal Pitt Miller and returned  
Gene being charged with the murder  
of Gabe Woodard - in Taylor County  
July April or May 1865 -

James Lovett } Complaint non payment  
vs } of wages  
Franklin Mc Gady }

Byrd

George Home } Complaint  
Laura Home } wages and  
Ellen Jackson } non fulfillment  
Kagan Home } of contract in  
Kantel Home } regard to Corn  
Chloe Home } House &c  
vs  
James Manna over Saturdays  
& W.M. Home } Garrison 4.16)

Brown

Thomas Robinson } wages 1864  
and } Cotton at warehouse  
Kwace } of Keanold & Johnson  
vs } seized pending a  
J.M. Gay } settlement  
vs } note, Col Price in

Samuel Taylor } arrest from  
vs } for intercept  
James Murphy } wagon, cow, some  
vs } stock of fodder  
vs } belongs to Taylor



Wm. Albritton vs George Sykes } non payment  
of wages &  
breach of contract  
indicated after  
Saturday 4. Jan

Jeff Brown vs Levi Addy } worked for \$1500

Jane Wiggins vs R F Wiggins } wages

U S Sackett vs Alex Meloy } Complaint on contract  
+ for settlement

Arny Clements vs Brown Samuel McGowan } complaint  
for wages  
of 1867

Account following in the Court on coming forward  
to the Cotton is found the rule to be paid. The balance

paid to J. A. Thornburg	-	\$1.00	
paid to Easton		10.00	
balance due Mink			\$61.82
May 22 paid Mink in full			61.82

Case dismissed

In this case it appears that the The Ganah  
is not the Contracting Party with Army  
but Fred Hankins (Colonel) and that said  
Fred has supported Army & 4 children, and  
has expended more than his share of the  
Army's money to Army work only 4 men  
Case dismissed

Zadock Belcher vs James Rodgers  
Complaint for failure  
of contract.  
ordered to appear twice,

Prinus Hitcher vs Alfred Hawley  
Taking possession of  
Prinus' Property with  
due process of Law  
Monday July 11, 1868

July 3. 1868

Howe Henry Gardner complains  
that his son Dennis has been kept  
by Meredith Stratton since Gardner  
and has not paid him one cent  
that said Dennis has been kept  
in a state of slavery being that  
+ that Dennis is 22 years of age  
John H.

July 4. 1868

Prinus

Allen Armstrong  
George Hawley  
vs  
Peter Finch & Daniel Finch  
John Henry & William White  
for entering and  
searching his house  
without due process  
of Law

Wages paid  
& Cotton seized  
Thursday July 9. 1868  
Continued Saturday 18. 1868



case of illegal liquor dismissed  
\$64.50 admitted by Allen had been paid  
- fine by a bill

Lucy Polbright } Complaint not paid  
vs } of wages - 1807  
F W North }

Henry Adams } Not paid 12 hours  
vs } according to contract  
Hud Lister } 1st day  
Friday May 11 1806

Eliza Cunningham } Not paid 12 hours  
vs } 12 hours  
William Cross } Saturday  
Monday 11 1806

Richard (wife) } ordered to appear  
vs } on Friday - but did  
Edmund Carter } would obey my  
order -

Rebecca Steward } Not paid 12 hours  
vs } Friday 11 1806  
John Gay } Saturday 11 1806  
Not paid till Saturday

James Swell } Not paid 12 hours  
vs } of wages 5  
George Mc Gady } Thursday July 9 1806

Lucie Depinaud - evidence  
that she was paid in full, with  
books of the contents of which she  
acknowledged

B. 3-114  
1-1-1  
7-1-1

John Bray } Constant ill health  
vs } ordered to appear  
Robert Bray } at 2 o'clock this  
P.M.

---

Frank Thomas } wages  
vs } ordered to appear  
Capi Weller } on Saturday  
July 11. 67

---

John Drake }  
vs } ~~Complaint \$100, ordered~~  
George Ruffin } wages 1867  
~~George Ruffin~~ } ordered to appear  
Randall Duckworth } Thursday 9<sup>th</sup> June

---

Joe Croff } wages 1868  
vs } Cottons seized  
George Garrison }  
vs }  
M. O. Shilony }  
W. B. Shilony }

---

Mary ... } Complaint  
vs } non payment of ...  
... } Thursday July 13

---

From No. 103 cont

Judgment \$108 with interest from 18<sup>th</sup> of  
December in favor of Geo. Ruffin  
Judgment for plaintiff \$108<sup>00</sup> in favor of  
John R. Cook

John Spake

Kidnapping of  
child, and disburse  
& contempt of order  
of Bureau

Devin Simpson

John ...  
Saturday ...

James Coleman

...  
...  
... 1866

...  
...  
...

...  
...  
... 1865

Thurston

...  
... 1860 ...

Turned over to Civil Authority  
~~And \$1000.00 + costs + \$1000.00 fine,~~





51  
Paid to Hatty the Balance due  
Sixty five and 5/100 Dollars -

Rec<sup>d</sup> Payment  
by Hatty ~~Hatty~~ Hatty  
Hatty

John Robison

Missy ...  
...  
Golden ...  
Jackson ...  
Alabama ...  
...  
...

Miss ... 1866  
...  
... July 29, 65

Miss ... 1868  
...  
Houston  
Saturday Feb 1, 68

Henry Young } wages ...  
...  
George Black }



Case dismissed. The book has  
receipt in full for wages of Whittier  
for year 1866

was dismissed. The fact was noted  
in the circumstances of the will,  
about \$80.

Case dismissed, the young  
by evidence produced and his  
own admission of guilt

Selden Cooper, Yagers and  
John Kelly, shooting birds at  
Selden's house

Selden's household  
Mar. 21, 1861  
Charles Kinsman, settled  
Taylor's household, 5. 1861

George Thomas, was  
settled in  
Lewis Harris, 1861

Daniel Tomp, settled  
Doc Crawford, settled  
Elijah Langford, x  
Lester Spencer  
Selsam Bright, settled x

Joseph Wood, Mr. Morgan will be in  
in Canada 1868  
Robert W. Morgan, his family sick

Bureau of Land Office

San Antonio County, Tex

Comanche, Tex

February 11, 1868

Simon Waters

C. J. & J. P. Pham, Sr. & Co. came before  
 me Simon Waters a justice of the peace  
 who being duly sworn depose and  
 say that on about the 25<sup>th</sup> day of December  
 1866 he was employed by C. J. & J. P. Pham  
 Planters of San Antonio County to perform labor  
 for their Plantation, then agreeing to pay  
 him wages \$5 per each hand, that in  
 consideration of the payment of the said  
 amount he procured further hands  
 for said Phams, who made a contract  
 with said Phams to labor on said Plantation  
 and commenced work under contract  
 and that said Phams have further  
 entered to comply with their contracts  
 with him Waters

Done to & subscribed at  
 before me this 10<sup>th</sup> day of February  
 1868

J. M. Robinson  
 J. P.

Georgia  
Santa Cruz  
Levi Spencer

117  
Thomas R. & J. S.  
American Co  
February 11 1868

John R. Howell

Personally came before  
you Levi Spencer a person of color who  
being duly sworn deposes and says  
that on about January 1 1867, he  
entered into a contract with John  
R. Howell a white citizen of this county  
to cultivate thirty acres of land  
belonging to said John R. and  
perform the labor customary on a  
plantation, and that he Levi was  
to have one half the lint cotton  
raised on said thirty acres for  
his share of the crop in lieu of wages  
that three bales of lint were raised  
on said land - that in addition to  
the above he worked two days splitting  
logs at \$1 per day - five days work in  
house at \$1 " " " " fifteen days work  
in cotton at \$1.25. Three days work seeding  
corn at \$1 per day fifteen days work  
weeding corn at \$1.25 per day - nine days  
work hauling lime 100. Two days work  
gunning cotton \$1.50 per day and that he  
paid Mr. Bennett thirty dollars in acct  
of J. R. Howell, receiving from same  
\$20.00.

The thirty dollars above mentioned  
paid to Mr. Bennett was the proceeds  
of one of the bales of cotton  
Levi Spencer  
work

Sworn to & subscribed before me  
this 10th day of February 1868

J. M. Robinson  
Agent

Comd to Page  
68 ~~68~~

James Price } Portion of the crop  
 vs } 45 Cans 70 Cans  
 & Daniel & Mully } Saturday 21<sup>st</sup> July

John Sanders }  
 vs }  
 David Evans }  
 2000 for year 1867  
 account to appear Saturday  
 July 21<sup>st</sup> 1867 - 18<sup>th</sup> Cans

Note for James } For Raisin of Crops  
 vs } 1867 -  
 John Mully }

John Williams was taken by the Cotton & Steam  
 Fidda Macke 1,000 196. 329. 4. 529.  
 504'2 - 515, mm - Total 5 (500) 7 76000 kg  
 29674'2 - 2 1000 196. 329. 4. 529. 75 in one month,  
 2000 and 1000 196. 329. 4. 529. 75 in one month,  
 #8.32. - 1000 196. 329. 4. 529. 75 in one month,  
 Total 11,800 — Bagging & Tax 1/4 — 24.20  
 8.100.00

added to volume 75, included case —



James Sumner }  
vs }  
Edward Westwick }  
} Col. of the  
} Corp 1864

John Hunt  
vs  
Edward Westwick

Mairinda H. K.  
vs  
Edward Westwick

Anna Small  
vs  
Edward Westwick

March,

John Anderson	}	and his wife
and his wife		and their children

March 11  
Richard Pittman  
John Jennings

Prince Anderson  
1877  
Kamita  
March 11th  
Monday 11th, 1877

3/31 1800 Cotton  
 10 1/2 6 1/2 hands --- 1 1/3 452.  
 3 13 8  
 2 36 00  
 12  
 48 00

3/29  
 4) 9 2/3 2 1/2 9000 22 7.00  
 2 1/2 1/2 4 2/3 400  
 4 2/3

my	Quinn - 40	360 0	
Henry	Maria 75	260	739
Arthur	Quinn 208	386 6	
Mr. Henry	Patience	8	
John	100	339.28	
John	100	4) 84.82	
Edwin	11	42 24	
		3) 230	
		4) 73	
		1 1/2	

495-16  
 4 1/2 228  
 19 20  
 16 25 13.68  
 18 86  
 16 56  
 16 60  
 26 43  
 28 51  
 47.97 due

Quinn Hamilton (son) - worked on  
 plantation of Hamilton 1879. Knew Maria  
 went on plantation, was driven away by James  
 who worked the place - took her back with  
 \$40, then was no better boy than Howard  
 he worked until he was taken sick  
 1 year with 120. Quinn is evidence of Prince  
Sanders, Quinn has sick two weeks  
 don't know what mother is or father.

Prince Sanders, son  
 Howard worked all year

The mother is in Arkansas.

The Children staid in school last year  
Alvin H. Day - Is this year hired to  
Linn Water Colored in Lee County  
for \$80. - France says he cannot read  
and write and has not educated  
the children -

Ced B. B. Hamilton (Horn)

Guinea Chicken 2 Pea Fowls & some  
hogs stolen - Refused to settle with  
Howard because he heard Howard had  
stolen 5 Bushel Wheat.

There is no evidence that the Bay Head  
stole anything - and as the evidence  
is faithless - He is awarded \$85.34

Office Bureau R & A  
April 4, 1868

Shadrack Fortson vs  
Gerrit Wilkinson } during his abs.  
from his plantation  
by appropriating crops

order to appear on  
Thursday April 8<sup>th</sup> for trial  
at 10 o'clock

Complaints made by J. W. Robinson Agent to R. S. H.

J. W. White had to report at this office } refusing to pay last years wages to one freed laborer }  
Saturday  
17<sup>th</sup> of April  
1858

1868  
Date

April  
27<sup>th</sup>

Complaints made to W. C. Merrill  
Henry Matthews  
vs  
Randall Hart

Nature of Complaint  
Contracted to work for Hart  
for share of crop on certain  
land designated and now  
under cultivation. That having  
refused to work other lands Hart  
drives him off the place  
was summoned to appear Friday  
May 1<sup>st</sup> at 10 o'clock.

April  
28

Keziah Little  
vs  
R. W. Wilkinson

Complains that she was hired  
as house servant & that she has  
been ordered to field and upon  
refusing was ordered from the  
place without pay & threatened with  
whipping - was summoned to  
appear with contract on Friday  
May 1<sup>st</sup> at 12 o'clock.

April  
29

Wm Patterson  
vs  
Wm DeLoach

Complains that he was hired to  
Defendant with the understanding  
that each party was to quit  
whenever agreeable upon axes  
being settled. The plaintiff avers  
that according to that understanding  
he left Defendant & now can not  
get his pay. Was summoned to  
appear at 10 o'clock on Thursday  
30<sup>th</sup> April -

81

Agent Bureau Refugee Freedmen<sup>d</sup> Abandoned Lands  
Disposition of case

Hort agrees to leave Henry  
alone to work his own crop &  
he also agrees to furnish said  
Henry Land outside for potatoes  
& cane & Henry agrees to work  
a 5 acre unit of Land for said  
Henry - Land is furnished him  
for the potatoes &c. -

Williamson was ordered to  
pay Negroes up to time  
of leaving of work April 27  
unless he kept her for  
horse - but - she preferring  
to go away -

Neither Hort, made appearance



Complaints made to W E Morice  
Nature of Complaint-

1868

April

29<sup>th</sup> Louisa Turner complains that she has been turned  
off from Defendant's place & being  
vs  
- Sampson used - was summoned to  
appear this day at 12 o'clock

W<sup>m</sup> Webb complains that he was assaulted &  
struck & had a knife drawn on him  
vs  
29<sup>th</sup> Welch Melgady with intent of serious injury -  
was summoned to appear Friday at 11  
o'clock for investigation.

John Ingalls complains that he has worked  
vs  
Bass Hall for Defendant since 1<sup>st</sup> Feb & now  
has been turned off without pay -  
was summoned to appear on Friday  
May 1<sup>st</sup> at 12 o'clock

83

Agent - Brown R F & A L.  
Disposition of Case

It was mutually agreed between  
the parties that all old matters  
should drop & they would again  
commence work under first  
agreement - both parties being  
some what to blame.

Turned over to civil authorities to  
have a warrant issued against Mr  
McGraw.

Neither party made appearance

81 Com~~plaints~~ plaints made to U. E. Morrill  
 Nature of Complaint

May 1st - Ned Holly vs. Alex. Chappell  
 complains that has not been paid for draughted work for last year - was summoned to appear on Tuesday May 5<sup>th</sup> at 3 o'clock P. M.

May 1st - Eliza Mitchell vs. Wm. Skilton  
 complains that has not been paid for last years work - was summoned to appear on Monday at 12 o'clock

May 20 - Mahena Kimber vs. John Robinson  
 complains that has not been paid for last years work - was summoned to appear Monday 4<sup>th</sup> May at 10 o'clock

Agent Bureau R. F. W. A. L.  
Disposition of Case

25

My complaint  
being sent for & was agreed the  
amount to paid in full by Mr. [Name]

will come on Saturday 9<sup>th</sup> May -  

Wages for self at 60 <sup>cts</sup> per month from 20 <sup>th</sup> Feb to 31 <sup>st</sup> Apr	62.40	
" " Daughter 50 <sup>cts</sup>	52.00	
Pr		114.40
To Scott's fee	45.23	
To lost time & rations	9.89	
	15.50	
To cash paid		80.62
Balance due		\$ 33.88

Full payment in full of  
the above fee this 9<sup>th</sup> day of May 1868  
at Mahala & number  
with  
Witnesses present  
W. C. [Name]

Complaints made to U. C. Merrill  
nature of complaint

May  
2<sup>d</sup>

Harry Salmon  
vs  
Alfred Lushy

complaint of nonpayment of wages  
according to contract. Summons  
to appear Monday 4<sup>th</sup> inst at ten o'clock

May  
2<sup>d</sup>

Colman Hodges  
vs  
Arvid Bayley

complaint nonpayment of wages for  
1886 - was summoned to appear Tuesday 5<sup>th</sup>  
at 2 o'clock Papers on file left by Hodges

Agent Bureau R. F. & A. L.  
Disposition of Cash

87

settled before Capt.  
Robinson

Postponed until Dr Bogley  
returns from Paris -

Colman Hodges Cr  
By work as per contract -

600.00

Dr  
To Book of which is acknowledged 570.67  
Balance due \$29.33

The work done by me since the 1st of Jan. The  
bill is for 240.00 and it is for 240.00 with the  
balance to pay 29.33 to the amount of  
the bill.

Complaints made to W. C. Morrill  
Nature of Complaint

May  
4<sup>th</sup>

George Mumay  
vs  
W L White

complain of nonpayment of wages as  
is evidenced by note produced -  
was summoned to appear on Tuesday 4<sup>th</sup>  
at half past nine - He refused to receive  
the ~~paper~~<sup>summons</sup> or to make his appearance &  
threatened the complainant with serious  
injury - Lives on Widow Armstrong  
Place abt a mile beyond Davidson's mill

May  
4

Mima Clark  
vs  
Nias Clark

complain that she has not been  
paid for last years work - was  
summoned to appear at office on  
Wednesday 6<sup>th</sup> inst -

Agent Bureau R. F. & A. L.  
Disposition

80 paper dollars this may 5<sup>th</sup> & promised  
to pay 25<sup>th</sup> next week -  
May 25<sup>th</sup> Rec'd twenty five  
dollars in this note. The  
balance the holder promises  
to pay next week for  
calling for

Defendant brings in bill of G. A. Gosper	5.00
" " " " L. W. Shropshire	4.50
" " " " Money + orders	9.35
Dr to last term 27 1/2 days	9.17
Income Cr by 70 days worth	25.70
Items and due from Bureau	2.12

Defendant takes oath as to correctness of his  
bill - Complainant could not remember  
all last term - Settled by Mr Clark giving  
and due from



Complaints made to W. C. Morrill  
nature of complaint

4<sup>th</sup> May Squinellen vs John Howell complains that he has not been paid for last years wages - was summoned to appear Friday 5<sup>th</sup> inst at 2 o'clock

5<sup>th</sup> May Sarah Taylor vs Goodman Dickes complains that she worked for defendant in 1866 & was to receive 1/4 acre of Land by deed from defendant for in payment for labor - that in the fall she was turned away & refused the land & was not paid for her work was summoned to appear on Thursday the 5<sup>th</sup> inst.

Agent Bureau R F & A L  
Disposition of case

Refuses to appear - unable to  
Says will be here on Sat-  
17th inst -

Mr Dickson (or oath), says that complainant did  
not want for him stopping doing his working &  
working on Sat night & Sunday - & that he furnished  
a sworn for complainant to live, in payment of same  
& that he never furnished to dead land as asserted  
The complainant - having no proof but that the  
above is true the case was dismissed especially  
as defendant swore it had been previously disposed  
of by St. Vincent former agent -

Complaint made to W. C. Morrill  
nature of complaint-

May 1st Adam Cook complains that he has had no attention  
or labor for last year - Summons  
5th Reuben Slippy to appear at this office on Thursday the  
24th. Herring Hock - # 1121 -

May 5th Caroline Seaber complains of being sick & entirely destitute  
- Patterson & not able to work. asks for something  
to be done for them -

Agent Bureau N<sup>o</sup> 7<sup>th</sup> 43 R L  
 Disposition of Case

Case postponed until Mr. Howell can be heard from  
 Value Crop Cotton 937.46  
 The hands worked - Adam worked 3 hands = 124.98  
 169 bushels corn 169.00  
 1400 lbs cotton picked 7.00  
 Value of extra work 19.00  
 319.98

Dr  
 To exp of Adam 277.15  
 Bal due \$42.83

It appearing from their looks & appearance that their  
 statement was true I made application to the  
 Judges of the Superior Court that they be  
 admitted to the poor farm, & have medical  
 attendance - which application was granted  
 & the order made out for the Supt of said farm  
 accordingly.

complaints made to W. E. Merrill  
Nature of Complaint

May  
6<sup>th</sup>

Bob Frazier  
vs  
F Frazier

Complains of not being properly  
supplied with food & turned off  
without cause. Succeeded to  
trial Thursday 7<sup>th</sup> and at one!

May  
8<sup>th</sup>

Dector Hampton  
vs  
George Chum

Complains nonpayment of wages  
ordered to appear Saturday

Agent Bureau R. F. 45 12 2  
Disposition of Case

The evidence not sustaining the charges the  
case was dismissed & the boy returned to work

The evidence appearing that the boy, Hector  
was hired to drive team to Fort Valley  
& that the 1<sup>st</sup> day out defendant sold team  
& gave Hector privilege of returning team  
or going on to see his brother. He chole  
the latter & went on to Fort Valley & took  
care of two horses for board & feeding  
It is believed justice to both parties would  
defendant pay the boy some money -

Complaints made to W. C. Merrill  
Nature of Complaint

Jan'y Amos  
Mar. James Harrison nonpayment wages - letter filed  
9th do do do do do do do do do do  
Boone Admistrator at 1 mill  
Estate of Jackson  
Accard  
Mrs. Stone }  
Mulligan }  
Linn )

May 9th Johnnie Bell nonpayment of wages as is evidenced  
by note for \$200 - do do do do do do do do do do  
L. L. Murray Munday 4th inst - at 2 o'clock

Agent, Bureau R. F. W. A. L.

Disbursement of case  
 Estate of Jackson  
 Same, Garrison's ac 57.50  
 By one and one half bushels in light good 22.50

Wiley Jackson	all such, but in	9.00
W. C. Merrill	same case and	1.25
Wiley Jackson	Rec'd. Bal	70.40
By	Arms	in Garrison
By Lewis, work		35.00
His part crop		41.60
Wheat pay by Mr. Mulkey		5.00
		<u>51.60</u>
His ac for the year		26.75
Bal due		54.85
Silas Jackson paid to Wiley		30.00
		<u>84.85</u>

Rec'd Eighty four <sup>85</sup>/<sub>100</sub> dollar  
 in full of the above ac  
 Wiley Jackson

Written & sent  
 W. C. Merrill



Complaint made to H. C. Merrill

9th

May Richard Smith

vs

J. G. Collins

complaint of wages as ordered  
by state report - sum of \$100  
to pay at 10 cents

Ben<sup>th</sup> Mansfield

vs

May Ben Cummings

complaint of nonpayment of wages  
\$100 - dollars - sum of \$100  
Wednesday 10th at 10 cents

Agent Bureau R F A L

91

Mr Collins asserts he is utterly unable to pay the note at present but will try and procure Rich's consent which appeared satisfactory to complainant.

Declares he is utterly unable to pay at present but will endeavor to do so. Bortell says he will wait a while longer.



Merrill Agent Bureau R. F. A. L.  
Disposition of case

The def<sup>s</sup> not proving the charges and it appearing  
all were chgd with & at market rates no  
further action was taken in the case.

Agreed to pay 5.<sup>00</sup> dollars per month until  
the debt is settled

Case transferred to Page 194 & 195

Complaints made to W<sup>c</sup>  
Water Complaint

11<sup>th</sup> John Grubb  
May 21  
Mortimer S. Grubb

nonpayment of wages was summoned  
to appear Sat. 16<sup>th</sup> at 2 o'clock

11<sup>th</sup> Isaac Price  
May 21  
George Harris

complaint of being turned off -

Morrill & Gould Bureau N<sup>o</sup> 117 (27)  
Disposition of Case

Matter Satisfactorily arranged.

Complaints Made to W. C. Merrill  
 Nature of Complaint

11<sup>th</sup> May Sandy Grinds vs Stephen Bone  
 administrator  
 Estate Jackson  
 complains of non payment of wages as is evidenced by etc  
 Summons to appear this day at 11 o'clock

18<sup>th</sup> May John Robinson vs R Slippy ex-works  
 H Hooks  
 complains he has not been paid or had any settlement for last year  
 Summons to come at 23<sup>d</sup> at 10 o'clock  
 Paper filed, with return Hook  
 etc.

1115  
Report Bureau R for A L,  
Inspection of case

The evidence appearing that Mr Boone did  
not engage Sandy & was not liable as  
Administrator for his wages. Rich<sup>d</sup> Joubert  
will settle with Sandy for quit-claim



1118

Complaints Made to W.C.  
Nature of Complaint

18th May	Louis Stevenson vs Langkin	complaints that she can not get her things as he forcibly holds them.
-------------	----------------------------------	---

Lucy Ross vs Mell Hart	complaints of having bro't up child & has rec'd no compensation ordered to appear on Sat. 23 <sup>d</sup> inst. at 2 oclock.
------------------------------	---

Morrice vs. B. R. T. & A. G.  
Dispositio<sup>n</sup> of Case

was ordered to deliver them up to complainant

It is sh<sup>o</sup>wn on the evidence that Dickey ought to  
be paid twenty five dollars for taking care of  
the child, & also of the children of defendant  
for three months. — says will pay himself  
(same note)

18  
 May John Tusley complains of being turned off  
 21 without cause - Summed to appear  
 James Holman Wednesday at 11 o'clock am

18 Handy Jackson complains of being turned off  
 May 21 & driven from place with threat.  
 Joe Jackson Summed to appear Wednesday at 2  
 o'clock

191

The evidence from B of the other hand that he was contentious & a general brawler on the place. The care and disposition of the matter is that John do not go back on the place & that in the settlement Mr. Holman keep a/c of amt paid & pay him what in the nature of the case the agt- of this office thinks just this fall

matter satisfactorily arranged parties going back to work.

May Charles Tools  
19<sup>th</sup> vs  
James Weaver

complaints of being refused to  
contract & refuses to pay worth  
done. Summoned to appear Wednesday  
at 12 o'clock.

May Jallie Deckett  
19<sup>th</sup> vs  
Peter Croghan

complaints of being that while  
on the street without care

By 3 1/2 Mos work @ 10 <sup>00</sup>	35.00
By rations 3 1/2 mos 1 1/2 weeks @ 1.07	16.05
By 16 days work @ 6 <sup>00</sup> per month	3.68
By 16 days rations	3.00
	<u>\$57.73</u>

for use.

To amb. rations + sundries furnished self & wife	31.53
Balance due	<u>\$26.20</u>
May 20 <sup>th</sup> Cash recd	10.00
Bal now due	<u>\$16.20</u>

Turned over to civil authorities for use.

117  
May 19<sup>th</sup> Guye Adams <sup>vs</sup> complainer of nonpayment of wages for labor  
George Mathis

May 19<sup>th</sup> Cicuba <sup>vs</sup> Nonpayment of wages as  
evidenced by two notes one  
for \$77.<sup>40</sup> & one for \$71.<sup>50</sup>  
summoned to appear July 2<sup>d</sup>

After hearing the evidence and examining  
 the cases it is the order of the Justice  
 that the defendant pay complainant for the time  
 & work done thirty five dollars & that  
 Andrews be responsible for one half the shop  
 rent between him & Loren Matthews for  
 two weeks at one dollar per day which  
 amounts to Andrews part of six dollars.

recapitulation	Andrews Cr	35.00
"	" Dr	6.00
	Balance due	\$29.00

Read this 26<sup>th</sup> June 8.00 of the above  
 George Andrews

Part paid me was from this 23<sup>rd</sup> day of May  
 Transferred to Page 130 & 131 & settled.



May 19<sup>th</sup> B. J. Heall  
vs  
George Lawer

Complains that George has broken  
contract repeatedly & that he has  
acted in such a manner as to  
endanger his crop, calls in witness  
which is granted, on Wednesday at  
10 o'clock. Case continued  
to pages 116 + 117

Augusta Font  
vs  
Jim. Sawyer

nonpayment wages last year, ordered  
to appear Sat - at 10 o'clock

117

The evidence appearing from the hands on the  
 place & substantiated by respectable white men  
 that George has repeatedly broken his contract  
 in disobeying the orders of Mr Slaff, Agt -  
 & that he had used filthy & profane language  
 to the women on the place repeatedly. That he  
 had nearly finished two mules of Mr Asads.  
 & sworn he would obey no ones orders tho'  
 expressly stated in contract he should obey  
 all just orders from Mr H or agt it is  
 ordered that the contract between Mr Asad &  
 the Freedman George be annulled & also the  
 Contract between said George & the other hands &  
 that Mr Asad hereby ordered to assume the contract  
 between said Freedman & George & faithfully carry said  
 contract out. That said Freedman be in no ways in=  
 -convenienced or injured in their prospects of enjoyment  
 of their portions of the crop. - Said Asad to make a  
 fair & just settlement with George for corn &  
 provisions advanced <sup>by him & party</sup> but to receive no wages  
 for his personal services.

Upon a rehearing the above decision was sus=  
 -tained excepting the item of Georges wages  
 which were allowed. Case continued  
 to pages 116 & 117

Debt Due Doyle	20.00
doe rendered	10.90
Balance	9.10

Paid the 28<sup>th</sup> of May 1850

May 19 Gus Jones  
vs  
Tom Duckworth

assault with a club ordered  
to appear Wednesday 10 o'clock

		B. J. Head		cr
May 22 <sup>d</sup>	B. J. Head	By 191 <sup>lb</sup>	meat @ 20	38.20
	vs	By 172 <sup>1/2</sup>	" meat @ 17 <sup>1/2</sup>	21.12
	George Lamer	By Tobacco furnished		1.60
	continued from	By Team (6 mule) 3 days		18.00
	Page 114.	By Team (2 mule) 2 days		4.00
		By 41 <sup>3/4</sup>	corn @ 1.50	62.62
		By 1908	" fodder @ 1 <sup>1/2</sup>	28.62
				<u>\$ 174.48</u>

The contract between said George &  
Friedman having been annulled and  
Mr Asau having <sup>been</sup> ordered to assume  
the same. The Friedman preferred to deal  
with George & Mr Hood is hereby  
relieved from any damages insofar  
concerning with 1<sup>st</sup> order on Page 105. -

Neither party made an assurance

Ganges Cr

By 4 <sup>26</sup> / <sub>100</sub> months worth Sinsu, Cash & High @ 15.00	\$ 71.00
By 4 <sup>26</sup> / <sub>100</sub> " " " " " " " " @ 10.00	47.70
By 4 <sup>26</sup> / <sub>100</sub> " " " " " " " " @ 8.00	38.10
By 2 weeks worth " " " " " " " " @ 10.00 per month	5.00
By "	2.00
By 4 <sup>26</sup> / <sub>100</sub> months worth George @ 10.00	71.00
By 130 weeks rations @ 1.07	139.10
By 105 bushels corn	157.50
By 2520 <sup>lbs</sup> Fodder @ 1/2¢	37.50
By 100 bushels @ 20¢	20.00
	<u>\$ 589.20</u>

By error in Sur 6<sup>th</sup> of Ganges wages

23.30  
\$ 565.90

R. L. Asad Cr

Balance due George - \$ 174.48  
\$ 391.47

Rec'd payment two hundred dollars of the above in cash and note for one hundred & ninety one <sup>42</sup>/<sub>100</sub> dollars secured by primary lien on crops of R. L. Asad,

Jorge L. Asad  
for W. J. Good,

Att, at Law  
(Carter)

Rec'd payment in full of  
the above acct  
George Lamer  
T. W. Munn

May 23<sup>d</sup> Eliza Adams  
vs  
Samuel Mudgett

Non-payment for last years labor  
claims damages for not being  
supplied with mules, - claims for fuel  
cotton, burning coal & her share  
of the crop. -

May 23<sup>d</sup> John Foster  
vs  
John Roberts

non-payment - of wages for last  
year. claims he lost to own &c  
to sat: Summed to appear Sat  
30<sup>th</sup> May at 10 o'clock am

Eliza Cr by suspension Am Cotton & Fodder	298.83
" " 300 bushel Coal	15.00
" " Cotton picked (1st work)	125.00
" " Damages for nonfurnishing Stock	75.00
	<u>\$ 513.83</u>

Dr -

To cash rec'd, April 1867 -	108.00
To a/c rendered for the year	<u>485.50</u>
	593.50

The above a/c includes the following names  
 Wm. Allan News, Eliza News, Jack News,  
 John News, Jim News, Caroline News,  
 Houston

Cr by Cotton & Crop finally	25.00
a/c rendered	59.60

The a/c was settled satisfactorily

May 23<sup>o</sup> Hiram Smith  
vs  
Thomas Grant

complain of bringing a man  
to theater who pretended to be  
Regt of the 18<sup>th</sup> Mass & threatened to  
shoot complainant if he repeated  
the facts of the affair. Summed to  
appear Wednesday at 10 o'clock

May 23<sup>o</sup> George Buffin  
vs  
R Duellworth  
J. S. 97 1860

Nonpayment of wages as is  
evidenced by note for \$108.00  
Summed to settle Sunday 26<sup>th</sup> at  
9 o'clock a.m.

J. H. Howland  
at the Court

A further party made assurance,

Defendant has filed petition in bankruptcy  
abt 7<sup>th</sup> or 8<sup>th</sup> May 07



121  
May Stephen Marshall Note ~~dated~~ or due bill  
23 vs for labor 1867 for 71.53  
Taylor & Wernice Next from W.A. Hopkins money  
on deposit with Price & Son upon  
order from this office.

23<sup>d</sup> Thomas Fudge Note dated Dec 25 1866 or  
vs \$146<sup>55</sup> - Cr 50<sup>00</sup> 1867 Dec )  
May Charles Taylor Cr by 500 - Bal due 91<sup>55</sup> &  
interest. - Next from W.A.  
Hopkins money on deposit with  
Price & Son upon order from this office.

23<sup>d</sup> Wilbourn Ware Note given to John Cras or bearer  
May vs for 75<sup>00</sup>. Succeeded to appear on  
Alfred Nagel Tuesday at 12 o'clock M. Note with  
W.A. Hopkins.

Notes given back to W. A. Howkins  
& receipt taken back

Note given back to W. A. Howkins  
& receipt taken back

Arnold Cato  
as  
May 26<sup>th</sup>  
Dr. Thombright

complaint of nonpayment of  
labor in black Smith work  
Sund Wednesday 12 o'clock

Arnold Cato  
as  
May 25<sup>th</sup>  
James Clark

non payment of labor done  
in 1867 Sat. 20<sup>th</sup> inst -  
Sund ~~Thursday~~ 12 o'clock

Mary Nit  
as  
Green Pason

sum of a refused pay for work  
done since Christmas  
Sund to appear Wednesday 12  
o'clock

125

Cr By work in 1868 5.00  
 she also should they were in copartnership  
 & the defendant should next on oath, of the  
 other nature.  
 Rec'd the above sum of \$5.00  
 Arnold & Co  
 atty

case postponed & w Smith Sumner  
 defendant vs Plaintiff \$3,000  
 Payment - agreed on satisfactorily  
 Payment - Rec'd in full  
 Arnold & Co atty

Cr By two 1/4 day, \$5.00 \$ 12.50

Dr	ratons	107	
Lo dues		200	
Pro fees		<del>200</del>	
		200	507
	Balanc due		6,93
	Last -		193
			500
	Rec'd Payment - in full		
Witness	Mary Ship		
Wm Sunderland	att'y		

May 25<sup>th</sup> Ellen Flint  
vs  
Cain & Williams

Sumis last year

JR Post a 1850  
Capers Field

May 26 Man Black  
vs  
James Gohm

nonpayment of wages 1847  
work Mill for 3<sup>d</sup> cotton <sup>plus wheat</sup> corn, & 4<sup>th</sup>  
cotton. - Sumis to appear  
Sat 11 o'clock. Man refuses  
to Mr Oliver at Prue's office

May 27 Jane Griffin  
vs  
A H West

Settlement for balance 1846 -  
Sun 5 27<sup>th</sup> May

Ellen B. By labor on farm 41.00

Dr

To Last term <sup>7<sup>th</sup></sup>	Meat + Meal <sup>6<sup>th</sup></sup>	13.90	
To A/c due Betty Crocker		5.00	
" " " Dr Pracock		10.00	28.90
	Balance due		\$17.10

The above a/c was rendered by Wm. H. ...  
apt on Co & transmitted to this office  
with balance due Papers filed

Rec'd payment in full of the above a/c

Witness:  
J. H. ...

Ellen B. ...  
mark

Co By 11 Mo's work 50.00

A/c as rendered & which is acknowledged 64.00  
5.24 69.24

Balance due from Lane

Amicus du May 16<sup>th</sup> 1867  
 One day after date I promise  
 Jim Rodgers to pay Jim Rodgers or bearer  
 vs \$12.00 for value recd.  
 George Mathis (Signed) George Mathis

Stephen Marshall Due Stephen Marshall (fixed on)  
 vs Seventy one dollars & fifty three cts  
 Taylor & Comill for Arrear sundry during year  
 1867  
 (Signed) Taylor & Comill

Thomas Fudge Due Thomas Fudge on twenty fifth  
 vs day of December 1866 for his labor &  
 Chas A Taylor family on hundred & forty six & 54  
 cts. Recd fifty dollars Dec 25 1867  
 Balance due 96 <sup>54</sup>/<sub>100</sub>  
 Signed Chas A Taylor

111

Note returned to W A Hawkins atty  
for compliance - Mr World says this case  
~~was~~ or note was settled before Capt Robinson & the latter  
claimed to have lost the note will send next morning  
settlement.

Note returned to W A Hawkins atty  
for compliance -



December 24<sup>th</sup> 1857

Luluus. Turner By the twenty sixth of December  
vs Next I promise to pay Luluus  
Jos. J. Wilson Turner seventy one and fifty Cents  
(\$71.50) for value received

(Signed) Jos. J. Wilson

Lee Cuba

December 24 1857

vs By the twenty fifth of December  
Jos J. Wilson Next I promised to Lee Cuba  
seventy seven dollars and forty Cents  
(\$77.40) for value received

(Signed) Jos J. Wilson

Ben Wilson

December 2 1857

vs I do Ben Wilson a (Colored)  
Wm. Kees to bearer just nine dollars & 30 Cents  
for balance of services of himself  
his two boys Jordan & Manuel for 1857

(Signed) Wm. Kees

Value of note

\$ 71.50

Value of note

\$ 77.40

Payments sundry on notes  
Bal due

\$ 148.90

82.56

\$ 66.40

Received Payment in full of  
the above notes this 30th day of May

Witness,  
Chas. Smith

his  
J. X. Sullivan  
Mall

Anderson, Wilson

vs

Wm. S. Pitt

December 25<sup>th</sup> 1855  
 Due Anderson, Wilson & (Attord)  
 laborer twenty nine  $\frac{00}{100}$  dol-  
 lars for the balance of his  
 services for 1855

(Signed) Wm. S. Pitt

Perry, Robinson

vs

J. R. Daniels

(Amended. Dec. 25, 1855)  
 One day after I promise to  
 pay to Perry, Robinson or bearer  
 \$100 dollars and 25 Cents per  
 value received.

(Signed) J. R. Daniels

This the 10 January 1855

George Whaley

vs

W. S. White

One day after date I promise  
 to pay George Whaley or bearer  
 seventy five  $\frac{00}{100}$  dollars for value  
 received in labor for 1855

(Signed) W. S. White

George Ruffin  
vs  
R. L. Sucknuth

(Remembered 15<sup>th</sup> 1857)  
I promise to pay George Ruffin or  
bearer one hundred & eight dollars  
per value received  
(Signed) R. L. Sucknuth

John Westbrook  
vs  
Wiles Bass

(April 30<sup>th</sup> 1857)  
By the first of November next  
I promise to pay J. John  
Westbrook or bearer the sum  
of twenty (\$20) feet dollars per  
value received  
(Signed) Wiles Bass

Simon Ellison  
vs  
C. W. Duncan

On or by the twenty-fifth of  
Dec<sup>r</sup> next I promise to pay Simon  
Ellison for the services of his  
son Willie Hunt \$200 dollars  
value rec<sup>d</sup> May 21<sup>st</sup> 1867  
Copy of note to (Sgd) C. W. Duncan  
original in his possession  
Duncan lives in Colchester Co.

30th  
May

Return

30<sup>th</sup> Bunker Jones His children George & John  
 May vs  
 C W Drucum sachs. work to Ballou apt  
 Cuthbert. Drucum lives in  
 Callahan - C.

Returned & filed

May Lucinda Ford complains of child being brutally  
 30<sup>th</sup> vs  
 John Davis whipped & maltreated.  
 Summ'd Sat 6<sup>th</sup> June

May Sallie Carter nonpayment of wages for son  
 20<sup>th</sup> vs  
 Ulrich Collins 1866 - Summ'd Sat  
 6<sup>th</sup> June 10 october

George	Boy 3 months work \$850	25.50
John	" " " " \$1350	40.50
		\$66.00

The case being examined & the evidence appearing the child rec'd only a usual whipping for disobedience of orders the case was ~~settled~~ satisfactorily to both parties & the children returned to work.

Case been settled by Capt Robinson  
on Decr 11<sup>th</sup> 1867

May 1846  
 30<sup>th</sup> vs  
 James Collier & Isaac Cotton  
 Nonpayment of wages for last  
 year claim for drap made

May 1846  
 30<sup>th</sup> vs  
 Saml McGowan  
 Nonpayment wages 1846  
 claim 4 2/3 months wages from  
 4<sup>th</sup> Feb to 27<sup>th</sup> June @ 10 = per m.  
 Saml's Sat 6<sup>th</sup> June at 11 o'clock  
 def lives in Webster Co. Has made  
 no appearance this 10<sup>th</sup> June

Bob Judds  
 vs  
 Mully & Dancer  
 Nonpayment wages 1847  
 Saml to def

Matthew Duce (Furniture in debt)

Cr by Matthew <sup>his wife</sup> <sup>10/11</sup>	60.00
" " " <sup>1/2</sup>	25.00
	<hr/>
	85.00
Dr	
To of as receipt	44.00
" " " "	<hr/>
	\$ 41.00

Rec'd Twenty (20) Dollars of the  
 above this 12<sup>th</sup> June 1868  
 Robt. <sup>and</sup> Jackson  
 Paid the Twenty one dollars the balance on  
 above - Robt. Jackson



June 1<sup>st</sup> Mary Isaac  
vs  
J. A. Wilson

Seven Months after date of  
promise to pay Mary Isaac  
Thirty-two <sup>80</sup> dollars for labor  
performed at my house from  
January 14<sup>th</sup> 67 to May 18<sup>th</sup> 67  
at 80¢ per month -

(Signed) J. A. Wilson  
Summit to appear Wednesday, 3<sup>rd</sup>  
to collect -

June Bob Hill  
vs  
John Jordan

Complains of being turned out  
of doors & from place without  
cause & refused pay. Summ'd  
Wednesday 12 October

June Frank Clark  
vs

Wm Ramsey

Nonpayment of wages 1867

Summ'd Sat 6<sup>th</sup> June 11 October

June 6<sup>th</sup> Has made no appearance nor sent any word

Defendants lives in Lee County

June 3 Jim Morgan vs Mitchell Morgan Nonpayment Wages 1865  
Summons Sat 6<sup>th</sup> inst - 12 o'clock

July 4<sup>th</sup> Tom Foster vs J. D. Collins & Wm. Styles Non Settlement of Wages 1867  
Summons Friday 5<sup>th</sup> inst 10 o'clock  
L 133 P 177

June 4<sup>th</sup> Isaac Hendrick vs Levi Nelson Nonpayment of House rent.  
Summoned to appear this day

Claims for self & 3 boys (round themselves) \$ 650.<sup>00</sup>

Ct Amt due Duun 24,00

So amt paid 13,30  
Balanc due \$ 10,70

order was accepted and amt paid to  
Complainant by Col Hamilton.

June 5  
 Frank Bulcher vs  
 Mrs Hughes  
 Complaints of taking turkey from  
 her & refusing to give it up  
 Summons here Monday 10 o'clock.

151364179

June 5  
 Phil Lee vs  
 Jesse Stanford  
 Complaints of nonpayment of  
 wages for 1866  
 Summons Monday at 10 o'clock

151364179

facto not minus ar. et tunc, cum  
virescent

Phoebe Cr 13y 3/4 Mrs Wm (a 3<sup>00</sup>) 2375

Lo castu vid

Pat cur

12.50  
\$16.25

from John Haven  
 5th by his father, nonpayment of work for  
 Adolphus Gray last year -  
 Wm Stewart Summed Monday 9 Octob

from John Mitchell nonsettled wages in Lu  
 5 do Co He sent here to arrange by  
 James Wilton Mr Pine as porter live here

was still a credit - make appearance

To Six months work Allen @ 50c	31.00
150 days work money @ 50	25.00
To 50 " " " " " " @ 50	25.00
To two mos work self @ 75	39.00
	<u>\$ 120.00</u>

or

To 32 days lost time Allen	640
To acf from book	33.36
To 54 <sup>th</sup> month @ 184	972
But due	<u>49.42</u>
Acf sent to Mr Pierce	<u>70.50</u>



83

June 5<sup>th</sup> Isaac Johnson Nonsettlement wages 1868

vs

Olive Crittenden Summons Tuesday 10 o'clock

11/19/1868

84

June 5<sup>th</sup> J<sup>W</sup> Melroy turned off from Mac & not allowed to work any where else without prosecution. Summons Sat 6<sup>th</sup> 9 o'clock

By one + one half mas work @ 6.00

\$9.00

Postponed until Wednesday 10<sup>th</sup> at 9 o'clock  
The evidence appearing from the other hand that  
Wm has not done his duty + severely done a boys  
work both parties were satisfied to quit +  
give up the contract.

The Wm Cr by 5 months work \$50.00

Robert his boy 5 " " 20.00

Rations for the two Wm whole + boy's ration 35.29  
\$105.29

Dr

327 <sup>1</sup> / <sub>4</sub>	Bacon @ 20	65.40
22 <sup>3</sup> / <sub>4</sub>	Corn @ 150	34.12 <sup>5</sup> / <sub>8</sub>
16 <sup>2</sup> / <sub>4</sub>	gals Syrup @ 100	16.50
63 <sup>1</sup> / <sub>3</sub>	Clotk @ 25 <sup>4</sup> / <sub>8</sub>	15.83
	Tobacco	4.35
	Shoes	11.87 <sup>2</sup> / <sub>8</sub> 141.07

Bal due from Wm 35.78

Cr by over chq on Corn 1.87

Bal due from Wm 33.91-

Complaint - gave note for amt -

15

June 6<sup>th</sup> Jerry Clark  
vs  
Robt Griffin

Nonpayment of Wages in 1867  
Summond Sat 13<sup>th</sup> 1868 at  
11 o'clock

16

June 6<sup>th</sup> John Johnson  
vs  
Arthur Saightory

nonpayment wages for child in  
1867  
Summond Sat 13<sup>th</sup> 10 o'clock

By 2 3/4<sup>th</sup> months work by Charles @ 200 \$6.67<sup>2</sup>  
Porter came but was absent. case postponed.

June Brachus Roberts  
8<sup>th</sup> vs

Saml Duran

Due bill of Sixty one dollars  
Jan 2<sup>d</sup> 1868. Filed in draw  
Case to be carried to Boston when  
Compliment - lines

June Brachus Roberts  
8<sup>th</sup> vs

Eph' Sandus

Due bill for 38 <sup>29</sup>/<sub>100</sub> dollars volen  
with Jan 2<sup>d</sup> 1868  
Compliment lines in Boston,  
Due bill in draw. (Filed)

June Johnnal Jackson  
8<sup>th</sup> vs

Thomas Murray

Nonsettment of Wages 1867

Cr by years work	400.00
for	
The brook age and lost time	164.96
Bal due	\$235.04
As Security on note to Wm Gurry \$100 <sup>00</sup>	
which Murray agrees to pay	
Bal due	\$135.04

Rec'd Payment by note  
for above amt on Osmonds

Shmad & Jackson  
mkr

Witness  
W. C. Merrill

June 8<sup>th</sup> Milly Wms non payment wages of <sup>self</sup> child  
 vs Jane Washington 1866 - Summ'd  
 P. Tomney to appear Wednesday 10<sup>th</sup> inst - at  
 9 o'clock. Milly lives in annex  
 P Tomney 4 miles from town

June 8<sup>th</sup> Henry Johnson non payment of wages in 1867  
 vs Wm Morgan Summ'd Wednesday 10<sup>th</sup> inst 10 o'clock  
 Sumter Co -  
 Has not made appearance. writ  
 to H. D. 2rs

17  
Co 1 1/2 years

After examination I find there is -  
Balance due Mitty \$ 2.02

Rec'd Payment of full  
Mitty's Wages  
by Mr. Con Washburn

Claims 1/4 <sup>th</sup> Cotton made 49 bales - 16 hands	
" 19 bushels corn - 24 gals Syrup - Saw' saw	
was severely whipped <sup>with walking stick</sup> - drew pistol on him	
Value of 49 B/c	2117.20
1/4	529.36
14 hands each share	24.29
Henry being 2 <sup>d</sup> class was allowed on Cotton	25.00
Share of corn 19 bushels @ 1.25	23.75
Share of syrup 4 gals	4.00
Potatoes 5 1/2 bushels @ .50	2.75
	\$ 55.51

Dr  
to book up as acknowledged \$ 55.25  
Bal due Mr Morgan \$ 36.75

Account & battery turned over to civil  
authorities.



June Maria Murray Nonpayment wages 1867  
 9                    vs  
       Saul Washburn Summons Monday 15<sup>th</sup> at 9 o'clock  
       Senter Co  
       Return to make return

June Maria Murray Nonpayment wages 1867 June  
 9<sup>th</sup>                    vs  
       John R Worrell Summons Monday 15<sup>th</sup> at 9 o'clock

June Jerry Jones Nonpayment of wages  
 10                    vs  
       John Pickett Summons to day at 2 o'clock

To labor for year 1867 60.00  
 To 3 Suits clothing he agreed to give 15.00  
\$75.00

To Labor of Lou Davis year 1867. 75.00  
\$150.00

To Moustering 18 days by Special Contract 18.00

Have written to agt L & Co

Repairing 7 windows @ 1.50 10.50  
 " 2 doors @ 1.00 2.00  
\$12.50

Case postponed until further notice

June  
10<sup>th</sup> Charlotte Toder  
vs  
H. J. Harris

Nonpayment of wages due her  
husband 1867.

Summ'd -  
defendant gone to Atlanta. wait until  
he returns.

June  
10<sup>th</sup> Littleton Bivins  
vs  
Homer Deucus  
Wm Mize

Nonpayment of judgment for \$7.<sup>00</sup>  
rendered by Capt Robinson -

Summ'd Monday 14<sup>th</sup> just 11 o'clock  
Summ'd Wednesday 16<sup>th</sup>

June  
10 Alfred Hammons  
vs  
Marshal Birt

Note dated Apr 26 1867 for  
\$33 <sup>48</sup>/<sub>100</sub> dollars due one day after  
date.

J. W. Ironmeyer

Summ'd Monday 16<sup>th</sup> 2 o'clock  
(Wednesday)

Claims work on hour by husband

\$36.82

Cr by years work & loss		75.00
To book exp & cash rec'd	\$27.80	
To 26 days lost time @ 24 <sup>c</sup>	6.24	
To 26 days return @ 20 <sup>c</sup>	5.20	39.24
		<u>\$35.76</u>
By error in lost time		1.76
Balance due		\$37.52

Value of note

33.68

Interest from 26<sup>th</sup> Apr 1867 -

June 11<sup>th</sup> Samuel Inel claims amt due for labor  
vs  
Jacob M Gay Summ'd Sat 13<sup>th</sup> 9 o'clock

June 11<sup>th</sup> Cornelia Bessess Nonpayment of wages in 1866  
vs  
R R Bessess Summ'd Sat 13<sup>th</sup> 10 o'clock  
D 152 & 156

June 11<sup>th</sup> Isaac Terry Nonpayment of wages in 1867  
vs  
John Carter Summ'd Sat 13<sup>th</sup> 10 o'clock  
D 153 & 157

Unit from W. S. Abbott 24.66  
 By Bal on settlement 6.22  
\$40.88

Case of ...  
 ...

To wages in 1866 as per account 30.00  
 To Two suits of clothes 10.00  
 To one pair shoes 2.50  
\$42.50

To amt for Mrs Jones chgs below 1.00  
 To a Mrs Purpus for linen 2.00  
 Bal in 49.50  
\$52.50

To bill of currencies furnished 27.50  
 To over chg on clothes 2.50  
 Bal in 30.00  
\$12.50

By 11 days work in 1866 \$22.00

To amt on purchase 200  
 Withst Bal in 20.00  
\$20.00

R. J. Birnie

Wm Ferry  
 mat

June 12 Charlotte Spicy vs Champmurgency  
 complains of her husband being  
 left + taken children. requests  
 that Capt Pierce be asked to  
 return her the child's lock, name  
 Napoleon - defendant lives in New York,  
 with another woman.

June 12 Tom Black vs R. C. Coarsy  
 due till 21<sup>st</sup> collors Mich 5<sup>th</sup> 43  
 returned to day at 2 o'clock

June 12 Walter Colins vs Sara Tison  
 claims suit for digging well  
 returned to day at 3 o'clock

1164185

Two bills

\$ 21.29

Lo diggi, ude 3th fut a ser

\$ 13.75

Two bills  
at \$ 10.00 each to the  
of -



June 12<sup>th</sup> <sup>103</sup> Sarah Beebe claims and due for money loaned

Feb. Merrill

June 14<sup>th</sup> Joe Price non-suitment wages 1867

Mullhays & Dauid summoned this aft

June 14<sup>th</sup> Lewis Waford assault & battery on his wife

Howkin Mann

Mary, Lewis

\$ 1570

See Farmers ~~in full~~  
 Bal due <sup>to</sup> Mully & Daniels \$5.00 )  
 & other <sup>to</sup> Mully & Daniels

Claims 1/4 Cotton 1/3 d Corn  
 1/2 Potatoes  
 Cr by Share Crop 41.12<sup>2</sup>  
 Cr " 12 Plow Stocks @ 2.00 24.00  
 Cr " well bucket - &c 1.80  
66.92

Dr  
 To A/c for the year 70.10<sup>4</sup>  
 Bal due Mully & Daniels \$3.187

Case turned over to civil authorities

June 14	Henry Packard vs	Nonpayment wages Jan 1848
	George Gooden	Sum'd Tuesday 15 at 9 o'clock
	1847/8	

June 14	George Inwards vs	nonpayment wages 1867
	J. R. Graves	summoned

June 14	Gorgiano vs	non payment wages 1867
	William Brown	

One month wages 5.00

To lost time

1.00

Bal due 4.00

Direct amt - advanced 50

Bal due \$ 3.50

Rec'd Payment

Witness --

Rec'd Payment  
Hamm & Packerel

W. C. Merrill  
Capt B B Co.

Defendant times in Lee Co

Promiss to pay in full 35.00 on 15<sup>th</sup> July.

June  
14<sup>th</sup> Carolina Richard  
vs  
Maria Lane

nonpayment wages 1867

George Stokes of  
Schley Co

Summ'd Wednesday 11 Octobr

June  
14<sup>th</sup> Rhoda Spain  
vs  
Albert Gane

Summ'd off from place without  
pay  
Summ'd this aft at 3 P.M.

June  
14<sup>th</sup> Wesley Ladd  
vs

Note for work 1867

Jas. A. Wilson

Summ'd Wednesday 16<sup>th</sup> 2 o'clock  
Lives in Sumter Co notes in draw

Caroline	claim 1/4 cotton 1/3 <sup>d</sup> corn	109.16
Maria	" 1/4 cotton 1/3 <sup>d</sup> corn	109.16
		<hr/> \$ 218.32

By  
 To of & extra work 200.55  

---

 \$ 17.74

Caroline share	8.36
Maria share	9.38
	Recd Payment in full
	Caroline Richards
	Maria Lane

Claims on mortgage paid, at 3%, 1000 \$3,00

Note \$1 <sup>30</sup> / <sub>100</sub> date 23 <sup>rd</sup> Dec <sup>24</sup> 1847	\$ 81.30
Note Camilla Ladd	6.00
	<hr/> 87.30
To amt pd on first note	35.00
	<hr/> \$ 52.30

Caroline and Maria  
 24<sup>th</sup> Dec 1847  
 Received of  
 the sum of  
 \$ 52.30  
 for the  
 amount of  
 the first note  
 of \$ 87.30

June Joe Price  
16<sup>th</sup> us

Estate Jackson  
S. S. Boon adm<sup>r</sup>

nonsettled work 1867

Papers on file in unfinished business book

June Kate Washington  
16 us

nonsettled wages 1867

Wm Hall

Summed Wednesday 17<sup>th</sup> \$10.00 other  
lines in Sumter Co & miles  
returned & returns to come, under  
10<sup>th</sup> 1867. Late, under in app  
instead in 1867. 1867  
submitted attorney's note under  
line. Sat. was prevented from  
by sickness -

By work on Gin House	15.00
" " " Stable	15.00
By Making 4 Suture Wagon wheels 24"	16.00
" " 2/3 of 2 wheels @ 3 <sup>00</sup>	6.00
" " 6 bellows	6.00
" " 2 Wagon tongues	6.00
	<u>\$64.00</u>

By picking cotton sup. husband + daughter

State of Ga } Personally appeared before me  
 County of Sumter } Wm Hall who on oath says  
 that he settled with husband of  
 complainant less a few dollars + that afterward  
 the daughters of complainant came + he paid  
 them the balance due them for all work  
 done by said family. W. B. Hall

Seen + Subscribed to  
 before me this 4<sup>th</sup> day of August 1868  
 W. C. Monroe  
 J. C. H.



173

June Henry King  
16 vs  
So Reese

nonsettlement wages 1867  
Sum'd this aft -

June J. H. Pharr  
17 vs  
Sam Roberts &  
other Freedmen

Complains of insubordination  
& refusing to allow assistance  
in working out crop -

Claims wages from 21<sup>st</sup> Feb to 24<sup>th</sup> Nov 1880

171  
72.00

Case was settled by Capt Robinson in full upon Dr. Rice's oath to that effect, and proven by other testimony, and was dismissed

Upon a careful & thorough investigation of the condition of the crop & hearing all the testimony of the hands & Mr. Pharr's statement. It appears that Mr. Pharr considered his crop in absolute need of more help in order to save it, in which the Agent concurs, and that on hearing an extra hand ~~was~~ & placing hands in the field Sam Roberts went & in the presence of Mr. Pharr, ordered him to leave & did in reality drive him off by force, & that other hands also threatened him should he attempt to stay. It was therefore ordered that Mr. Pharr have authority to engage help to save his crop & that all the other hands excepting Sam return to work, who is dismissed from the place for violently threatening & attempting to execute threats in Mr. Pharr's presence against one of his hands.

June 17 John Wood vs Mr Waldrip J.P. complains that his property was illegally seized. in that he only had one mill. 3 hay & horse furniture.

June 18 Mary Huckabery vs Capt A.L. French nonpayment wages 1866 With sums when return from A.

June 18 Adelin Wallace vs Anthony Wallon assault & battery & attempted shooting

Cr by work from 4<sup>th</sup> July to Christmas at  
75<sup>rs</sup> per day \$97.50  
~~175~~

Case turned ~~of~~ over to civil authorities

June 19<sup>th</sup> Edmely assault & battery  
vs  
Mr Jones

June 22<sup>nd</sup> Jefferson Phals complains of <sup>self</sup> using pasture  
vs  
S. Crofford that was rented to him  
Sumter Co  
Sund<sup>y</sup> 23<sup>rd</sup> 2 o'clock  
10 miles on road  
to ~~Sumter~~

1877

Turned over to civil authorities

Defendant not making appearance it is  
 ordered that he pay this face the full  
 value of pasture & all other claims compellingly  
 incurs the failure of moving said pasture  
 Proof being here produced that Mr Crawford  
 was detained upon important business & that  
 he did send word that it was impossible to appear  
 and asked the case be postponed one day the  
 above judgment is revoked & the case stand on  
 its original merits

& was upon return of the court at the same place.



171

to the full amt	38.02
to the amt recd to date	
Bal due	34.03

bill in error  
 to  
 to Bessie  
 20th

Recd. [unclear] in full  
 20th X 5

Filed petition in bankruptcy 27th May & John  
 Ope was named as a creditor.



Jan Randall Archer non Settlement wages 1867  
23

<sup>23</sup>  
John Robinson Sent Monday 29<sup>th</sup> 11 o'clock  
Preston on work -  
Summons was sent <sup>to be here</sup> at 8<sup>th</sup>

Jan Sam Wilson  
24

<sup>24</sup>  
Wm J. Ples  
Sumter Co  
10 miles

due bill or order on Catts  
for 70.<sup>00</sup> Jan 25 1867

Sent Monday 29<sup>th</sup> 10 o'clock  
Order on file in draw

W. G. ...

1901

The ...  
 ...  
 ...  
 ...

Has filed petition of bankruptcy 8<sup>th</sup> Jan'y  
 & said Jan<sup>y</sup> was named as one  
 of the creditors.

June Isaac Green Settlement of wages 1867  
 24 us  
 Calvin Carter Summed Monday 29 of October

June Martin Shellow Settlement wages last year  
 26 us  
 John Joiner Sum'd Monday 29<sup>th</sup> 1868 at  
 12 o'clock P

Faint, illegible handwriting at the top of the page, possibly a list or notes.

Upon starting the day Mr Joiner has  
overpaid Martin<sup>for</sup> all of his & wife's work.

June Richard Harsten nonpayment wages 1867

27<sup>th</sup>

vs

Stephen Lusty

Summed Monday 29<sup>th</sup> 1868 at  
9 o'clock AM

June Amanda Statum worked for defendant from July 1<sup>st</sup>  
27 vs 1865 to Christmas same year for  
Merrett Statum 5 bushels Corn & 40<sup>lbs</sup> Bacon as  
Morison Co Wages for the year.

85

This case was settled by agent Robinson  
& Mr Lusty had a receipt in full for  
all demands, which settlement was  
witnessed by Isaac Madaway his  
fellow Settler --- Mr Lusty on oath says  
his contract was to be to the 15<sup>th</sup> July 1847.

Sum & contents to  
before me this 29<sup>th</sup> day June 1847  
W. C. Morley -

1867

Jan 29

John Broadway

Jan 29  
Catherine Cooll  
Martha Randall  
adm of 1st ch  
New Randall

claims 70 dollars lost <sup>year</sup> wages  
& 50. dollars money loaned  
Sund Tuesday 30<sup>th</sup> at 10 o'clock

Just as I was about to go  
a fair girl she has written me  
saying that she is coming to see me on the  
next ship and she will be at the  
end of the week.



June 29 Wm Bell

as  
Geo' Harris  
Lumber Co  
10 miles -

Complains of receiving but 50c  
on a debt of 20, for building  
a Piazza

Amid Wednesday July 1<sup>st</sup> 1868

11/19/47

June 29 Lamin  
Cesely West  
as  
Geo Lamer

Worked out 1000 1868  
+

Promiser to pay this fall

Cash Cr by 4 <sup>24</sup> / <sub>30</sub> months with self	
Loan & Note @ 15%	71.00
Dr	
Lo etc	33.80
	<hr/>
But Dr	37.20

Given order on B. J. Asad for amt.  
 The order on B. J. Asad was not accepted  
 & a new order was given on Col Goode who  
 holds a note of Goode for 192<sup>42</sup>/<sub>100</sub> signed by  
 B. J. Asad & payable this fall. See C B P 116+117

Rec'd payment in full of  
the above amt.

W. C. Merrill  
 Cashier

1867

July 1st Zedec Belcher Nonsettled wages 1867  
vs  
James Rogers Sum'd Thursday 2<sup>d</sup> 10 o'clock

July 1st Horriett Lester Nonsettled wages 1867  
vs  
Oscar Congleton Sum'd Monday 6<sup>th</sup> 10 o'clock  
Sumter Co

14  
 7 - ...  
 ...

41.11  
 5.90  
 16.00  
 7.00  
 23.00  
 6.34  
 2114.00  
 7.33

By  $3\frac{17}{26}$  day work @ 9<sup>00</sup> 32.78  
 Dr  
 To book of a 33.30  
 Due Mr Carpenter .52

July 1<sup>st</sup> Callie Vanus Nonpayment wages for month \$5 dues  
 as work  
 Dr. Hale Sund. & day

July 21<sup>st</sup> Catherine Roberts Continued from page 32  
 as judgment in favor of Plaintiff 20.<sup>00</sup>  
 William Williams

Cr By month 3 days see 11,00  
3

Dr  
A/c from book + last 5.67

Bal \$5.33

Pro's Payment in full  
Sallit Vorur

witness  
L. H. [unclear]

Castro Cr by unit judgment \$20,00  
Dr

To cash rec'd this 4<sup>th</sup> day of July 300  
Bal \$17,00

July James Hill  
6<sup>th</sup> Guye Seams  
vs  
Robert Hodges  
Andersonville

Complainant that defendant tied  
up & most brutally whipped a  
child, <sup>named Martha</sup> giving her 400 lashes,  
when she left, that she was  
tied up by her wrists until she  
was nearly faint & dead  
Was assisted by the military  
at my orders.

R

July Sam Russell  
6<sup>th</sup> Luke Russell  
vs  
Benj Russell  
Baker Co

claims that defendant hid the  
wages due them from the  
S. W. R. R. and has refused to pay  
it over to complainant. The amount  
is \$21.<sup>21</sup>/<sub>100</sub> each, sent to C. A. C. to  
forward. & also clothing of wife  
& three children.

Case postponed until I go to Andersonville.

Says will pay when unit is determined  
from Capt S. W. R.



July 6<sup>th</sup> Lucinda Hathaway  
 vs  
 John F. Effingham  
 Nonsettment of wages 1867.  
 Sum'd Monday 13<sup>th</sup> at 10 o'clock

July 6<sup>th</sup> Absolun Cobb  
 vs  
 R. Wilkinson  
 complains of driving his boys  
 off place. —  
 Sum'd Monday 13<sup>th</sup> 1868

Contract was for

60,00

cash pasthand rent! I go to Ellenville. -

The man <sup>lobb</sup> was proved to be a broker and  
general disturber of the peace on the Plantation  
but on promising to do better Mr Williamson  
was obliged to take his boys back and set  
them to work.

July John Pettitt driving off from Plantation  
 6 vs  
 Sidney Boyden Sumoed Monday 13<sup>th</sup> July 1868

July John Clark Nonpayment of Wages June 1868  
 6 vs  
 Amy Gatewood Summoed Monday 13<sup>th</sup> July at  
 9 o'clock.

By Six months work @ 10.00,	60.00
By rations for 26 weeks	27.80
Dr	87.80
To 10 days lost time & rations	5.75
To meat & meal	10.25
	<u>16.00</u>
	\$ 71.80

Paid by giving Note due 1<sup>st</sup> Oct. 1868 payable at this Office. Note on file in draw. c,

The complainant did not make appearance and defendant took witnesses of his own race that nothing was done & the matter is dismissed.

July 7<sup>th</sup> Nelson Jorvay  
vs  
Umas Slaffy

Nonpayment wages 1867

Sum'd Monday 13<sup>th</sup> at 12 o'clock

W<sup>m</sup> Wells of Lee Co is the  
responsible party. Write to Capt  
Pierce to settle this case.

Case came over & is on file  
from office v. a. c.

July 7<sup>th</sup> Mrs A. L. Cottle  
vs  
Frank Smith

complaints of refusing to obey  
orders & pretends to take charge of man  
Sum'd Thursday 9<sup>th</sup> at 10 o'clock

Claims according agreement for years work	150.00
" " " for dau Wm	120.00
" 3 months work for wife @ 19	57.00
	<del>127.00</del>
	\$327.00

complaints charge not good + the case dismissed

July 9th  
Hera Law vs Ryan Smith  
nonpayment wages 1866  
summoned Monday 13th

July 9th  
Benj Jones vs David Wilkinson  
complains of not allowing him meat to finish his crop  
summoned Monday 13th at 2 o'clock

Claims your wages self + daughter \$100.00

By your uncle Henry wife Milly 200.00

Dr

To book of last term + cash pd. <sup>115.17</sup> <sup>45</sup> 160.17  
160.17  
39.83

Settled by note on demand.

Case was settled satisfactorily + am -  
- Plaintiff went back to work.



Cotton raised on Liverpool Cotton  
 Companies Plantations Janett &  
 McEua Places seized to pay Tidman

Cotton, <sup>rais</sup> on Plantations of Cods Lodge  
 of Lewis seized to pay Tidman

Cotton on plantations of Sanger  
 Hill seized to pay Tidman

Cotton raised on Plantations of  
 John Gay seized to pay Tidman

July John Rusby  
 9 vs  
 B Goodman

See bill 345 see John  
 Summ'd to day at 2 o'clock

July Sabra Hill  
 9 Ann Rogers  
 vs  
 James Hill

of desertion & adultery &  
 abduction of child.  
 Summ'd Monday 13<sup>th</sup> 9

Admitted to jail Oct 11<sup>th</sup> inst.

Never made appearance

July 10<sup>th</sup> W<sup>m</sup> Patterson Nonpayment Wages 1868  
vs  
W<sup>m</sup> DeLoach Summand Monday 10 o'clock

July 10<sup>th</sup> Richard Cullwell Nonsettlement Wages 1867  
vs  
J. J. Pason

By 2<sup>3</sup>/<sub>6</sub> months @ 9.00 \$ 18.67

Dr

To meat & meal 4<sup>th</sup> mo  
Bal due

2.53  
\$ 16.14

Rec'd payment by note made payable  
Dec 25<sup>th</sup> 1868

M<sup>th</sup> J. J. Jattison

Case was settled by Cap<sup>t</sup> Robinson  
& Lewis & Capt French acting as umpires.

July 10<sup>th</sup> Louise Bloek Run off from place without pay  
 as  
 Joel Hall Summons Sat<sup>11<sup>th</sup></sup> 10 o'clock

July 10<sup>th</sup> Jane Turner nonpayment of labor  
 as  
 James Fagin Summons Sat<sup>11<sup>th</sup></sup> 9 o'clock

By 3 months work at 40 - per year  
 - now sent back to work in 1891

This woman refusing to go back as she  
 promised and not making her appearance  
 in several days she is discharged from  
 Mr Hall employ with loss of wages

Claim on month work

\$5.00

Rec'd Payment  
 J. M. Turner

Witness  
 W. C. Merrill

211

July Robt Jackson nonpayment wages 1807  
 10<sup>th</sup> as

J. S. Bonn  
 Adm<sup>r</sup> State pen  
 Jackson

July Betty Stewart by  
 18<sup>th</sup> Squire Hanson for husband, nonpayment wages -  
 as  
 Col Hamilton



117  
settled 12 Months tending stock @ 500 60.00

Claims for spinning plow line Hooks 6.00  
paid himself -

The case was paid settled + Col H  
had Rept - in full of all accounts -

218  
July 13<sup>th</sup> Sam Galt,  
vs  
Jas How

Refused to allow him to work  
his part of crop or harvest  
11<sup>th</sup> met at 10.

July 13<sup>th</sup> Jacob Rowie  
vs  
Miles Wyntush

nonpayment wages

11<sup>th</sup> met at 11 o'clock

The ~~defendant~~ defendant refused to receive  
summons & brutally assaulted complainant  
as complainant believes with intent  
to kill him - A const. two soldiers  
& arrested him & went to C. A. C  
for instructions.

217

The man was allowed to have his  
crop - but was to leave after he had  
gathered it; —

By 3/4 months work 800 26,00

Dr

To ofc Mr Weybuck	342	
To suit clothes from W's brother	800	1342
Bal due		\$12,58

Dr

To 8 days last time	240	240
Dr		10,18

By 1/2 day work		25
Bal due		\$10,43

By iron patch		200
---------------	--	-----

12,43

Settled by note on demand payable at  
this office

Note on file in *Dom*.



Cr by 2 months rent of land	200
to bank	10
	<u>210</u>

Rec'd from bank on 1/1/1919  
 210.00

Cr by 6 months rent	37.50
to bank	18.00
	<u>19.50</u>

Matt O'Hara is the responsible party  
 to pay the above.

July  
13

Hony Jones  
vs  
Mrs J. A. Peoples

nonpayment wages 1861

14<sup>th</sup> 11 Oct 61

July  
13<sup>th</sup>

Mrs Coffey  
vs  
Inland Sulivan

complaints of defendant owing her  
24 $\frac{7}{10}$  dollars for rent of house  
lives in Lawson Co.

July Joe Hart -  
 13<sup>th</sup> vs  
 Andrew Glover

Turned off from place +  
 14<sup>th</sup> at 2 o'clock

July Sue Williams  
 14<sup>th</sup> vs  
~~Abner Harvey~~  
 P. Allen

run off from place without arms  
 15<sup>th</sup> 9 - o'clock

Refused to make appearance & said  
 word would have to send more  
 than one man after him.

29  
The parties promised to take each other's complaints  
& he on his part promised to do his duty  
faithfully. — So the case was amicably settled.

Porter's came in before night  
write to S. Y. Allen tomorrow 18<sup>th</sup>



July 12 Albert Alexander nonpayment wages  
 vs  
 Scott Brown 13<sup>th</sup> at 9 o'clock

July 14 Jefferson Davis nonpayment wages 1867  
 vs  
 Thomas Day 10 day

Neither party made appearance

Still Satisfactorily

July  
16  
Clara Williams  
vs  
Prof Eirdman

Nonpayment of wages 11.65  
17<sup>th</sup> at 9.00 o'clock

July  
16  
Ruben Price  
vs  
James Murphy

Assault & battery

127  
Declares he is utterly unable to pay  
at present but promises to do so as  
soon as possible

Turned over to civil authorities.

July 16 Eliza Johnson Turned off without pay.  
vs  
Oliver Cottonbush 17<sup>th</sup> 10 o'clock

July 16 Emiline Williamson Turned off without pay.  
vs  
Mrs Taylor  
Sibly Co 17<sup>th</sup> 10 o'clock

The case was settled by the girl returning  
to her work & promising to do her duty  
which the evidence disclosed that she had not.

1850

1850

1850

1850

July 17<sup>th</sup> Margaret Moore  
vs  
Charles Moore  
at W.B. Stewart

desertion & leaving child.  
asks for expenses of "chudbirt"  
Says that he has threatened to  
kill her.  
Col Stewart is witness

July 17<sup>th</sup> Ed Robinson  
vs  
John Gatewood

nonpayment wages  
18<sup>th</sup> 9 o'clock

Issued perishes on H. B. account for 20.<sup>00</sup>

Cr By one months work	9.06
Dr	
To cash	
Bal due	<del>5.00</del> 4.06



July John Sparks  
17<sup>th</sup>

vs  
E. J. Murray

nonpayment wages 1867

Summ'd to day

July Charles Limes  
17<sup>th</sup>

vs  
H. M. Loyless

nonpayment wages 1868

Summ'd to day -

Cr by Debit & Tempu years work	216.00
" " pulling 1088 <sup>lb</sup> cotton <sup>in the</sup> seed	5.44
" " 100 bushels cotton seed	20.00
	<u>\$ 241.44</u>

Dr	
To aft. Violat <sup>1812</sup> Aft Tempu <sup>26.80</sup>	44.92
To his personal life	192.76
Bal Due	<u>237.68</u>
	\$ 3.76

Cr by work 13.00  
 Will pay as soon as can - some time this fall

Recd Payment in provisions  
 Christ's Love  
 mill

July 18<sup>th</sup> Zach Taylor nonpayment wages 1868  
 vs  
 John Price sum to pay of 9-

July 18<sup>th</sup> Margaret Chappel nonpayment wages 1868,  
 vs  
 Elias Brauner sum to Monday 27<sup>th</sup> / 68

By work  $1\frac{1}{6}$  weeks work

2.00

Gave note & promised to pay 1<sup>st</sup> Aug<sup>st</sup> 1868

234  
John Cannon  
John Lovel  
July 18<sup>th</sup> Murre Davis nonpayment wages 1868

vs  
Edward Gocham To day at 3 P.M

Postponed until Monday 27<sup>th</sup>  
Send a summons

Complaints live on Place of  
R. L. Brewer (Miller Co)

July 30<sup>th</sup> Lewis Wotter nonsettled wages  
vs  
Jno S. Lanaman

Cr By Six Months work	7.00	42.00
cr by 26 work returns @ 1.07		27.82
		<u>\$ 69.82</u>

Dr		
To bank of a	57.35	
Dr bills	2.00	
lost time	5.67	65.02
		<u>65.02</u>

Balance		4.80
---------	--	------

I Recd Payment  
Lewis + Watts

Witness  
W. C. Morrill

July 30 George Stirling vs non payment wages 1867

Book Settled Summ'd at 1<sup>st</sup> Aug

11

July 31 Jack Jones vs non payment wages 1868

Wm McCoy Summ'd at 1<sup>st</sup> Aug

Note 41<sup>sc</sup> in my this fall



July 31<sup>st</sup> Simon White sent payment wages 1867  
 W<sup>m</sup> Glover Summed this day at 11 o'clock  
 L. 1868  
 The complement written for J. W. Page  
 of Boston with whom contract was  
 made before he left at that place.  
 Was to left at Boston & see all.

July 31<sup>st</sup> John Bryant driven off without pay  
 John Talbot Summed 21<sup>st</sup> 1868 at 11 o'clock

Case was amicably settled.

210  
222  
Aug<sup>21</sup> James Bronson  
1<sup>st</sup> vs  
Mr Bell

Horrible detention of child  
sum'nd to day at 11 o'clock  
not sent until further investigation

Aug<sup>21</sup> John Wright  
1<sup>st</sup> vs  
H<sup>m</sup> Deloache

Unsettled wages 1868

249

Cr by Six Months work	42.50
<i>or</i>	
Lo book of	15.18
Bal due	<u>27.32</u>

Recd payment by note for above amt -  
payable 25<sup>th</sup> December 1868

241  
Aug<sup>r</sup> Peter Borfield  
7<sup>th</sup> vs  
H. J. Culver

Statement of uses  
L

Aug<sup>r</sup> Johann Moser  
7<sup>th</sup> vs  
Col Jones

Statement for Cotton

Cr by 6<sup>20</sup>/<sub>20</sub> months work @ 8<sup>00</sup> 34,00  
 Dr  
 31 days last term 10,00  
 Both a/c 35,05  
 Dr bills for several diseases 25,00 70,05  
 Bal due from Peter 16,05  
 Cr by error is both a/c 400  
 Bal due from Peter 12,05

Cr by lotter as it is in the field \$ 65,00  
 Dr  
 So book a/c 73,62  
 Bal due from Samuel 8,62  
 Cr by 3 1/2 months work @ 5<sup>50</sup> wife 18,25  
 Dr  
 So book a/c 475  
 due wife 13,50  
 Take Samuel indebtedness 8,62  
 due Samuel 4,88  
 Dr So extra work 17 days 8,50  
 rations 3,21  
 11,71  
 4,88

due col yours 6,83  
 10,33

211  
Sept. 1<sup>st</sup> Willis Furr

nonpayment wages 1866

vs  
Saml Patterson

See Bentons Report abt it before  
Auding Commrs

Sept 2<sup>nd</sup> Geo Dushman

driven off without pay

vs  
Mrs Hall

Summ'd - tomorrow at 10  
See Page 170 --

This Case was previously settled by Dexter Pyre  
former Capt -

Cr by amt ————— \$5.00  
To be paid this fall as soon as letter  
is sold —



1818  
1818  
30  
John Adams vs  
John Adams vs  
1818  
1818

1818  
21  
John Wilson vs  
John Wilson  
1818  
1818

2411  
The case was settled satisfactorily. —

Case was settled satisfactorily and complaint  
went back to work,

270  
Aug<sup>st</sup> Peter Nelson      nonpayment wages  
vs  
Tone Beurt      (summarized) at 5<sup>th</sup> of Oct

Aug<sup>st</sup> Martha Nelson      crim off without pay  
vs  
Mr Chamberlain at 11 o'clock

Clovis and - of

201  
850

will pay this fall as soon as Cotton is sold

Send her back to Plantation.

Aug  
6Svi Nelson  
vs  
Dr Bird

Misplacement of logs

Summed at 4 o'clock

Mr Oliver is responsible party  
lives ~~at~~ some 4 miles from hereAug  
6Solomon Green  
vs  
Samuel GreenDriven off & refused to be allowed  
to work his crop & stock taken away  
at 8<sup>th</sup> 11 o'clockSaid letter he had not come on of  
of very old age & infirm. The case  
to be settled by personal examination  
on the place.

Aug 6 Alex Wilder ~~was~~ ~~dismissed~~ ~~was~~ 1867  
 vs  
 Rich Loebell Oct 9 o'clock

Aug 28<sup>th</sup> Charles Smith was turned off without pay  
 vs  
 Moses Bomer Summed 22<sup>d</sup> 10 o'clock

Aug 22 Hannah Pitts for 2 months work looking 24<sup>th</sup> 1867  
 vs  
 Rich Tyler

215  
Settled before Capt Robinson & Settlement  
on back of contract.

Settled Satisfactorily

Aug 24<sup>th</sup> James Robertson driver of without cause, & without  
James Robson pay<sup>d</sup> Punish'd Sunday morning

Sept 7<sup>th</sup> Emanuel Roberts nonpayment wages for Jan 1847  
Dr Sanders write to J. A. C per legat Ler Co to act  
Ler Co

Sept 10<sup>th</sup> Black Price nonpayment wages.  
Mullhays & Davids



Cr by share crop for self	41.12 <sup>2</sup>
" " " " " wife	41.12 <sup>2</sup>
" " " " 2 Girls (one share)	41.10 <sup>2</sup>
	<u>123.37<sup>2</sup></u>

Dr	
To Coal	77.59
Dr Bonous bill	15.50
Dr Jones	24.50
Cash	10.00
	<u>129.59</u>

But one Mully & Davill \$ 6.22

Sept 15<sup>th</sup> Martha Nelson  
vs  
Jesse Chaulies

Complains (on oath) that she was driven off from place without cause without pay & that defendant has broken contract on file in Sumner Co. Circuit summoned 16<sup>th</sup> inst 10 o'clock

Sept 15 Washington Lucas  
vs  
Julius Byrd

States (on oath) on Friday 4<sup>th</sup> inst went to the farm to ask permission to come to see his mother who was sick, that he does not remember that he said yes or no. That he came to town on Sat 6<sup>th</sup> & on Monday returned to work but was told by defendant that he must get off the place in half an hour or he would load his gun & shoot him. Summoned Wednesday 16<sup>th</sup> inst at 12 o'clock.

Compliment was her Aug 5. 1830 & promised  
to return to Plantation to work. Mr Chamisso  
being ready to pay her when she fulfills her  
part of contract. She refusing to do so and coming  
here saying she had returned & they drove her off  
again & it being proved it was false. The  
Agt does not think Mr Chamisso entitled  
to pay her for her work.

This case was satisfactorily settled  
by complainant - going back to work. Mr  
Byrd promising to lose the time Washington  
lost in coming to this Office.

350

Sept 16 York, under  
by  
A Hudson

Complainant (on oath) says that  
defendant drove him from Plaintiff's  
without cause and refused to pay  
him anything for his labor. -  
Summed Thursday Oct 10<sup>th</sup> 1862

Le 299 & 245

Sept 17<sup>th</sup> Jimmy Wilson  
by  
Wm. Patton

Complainant (on oath) <sup>that defendant</sup>  
drove her off to place <sup>without pay</sup> & struck her  
with a large stick & threatened  
to kill her mother.  
Summed Sat 19<sup>th</sup> at 4 o'clock  
Postponed until Wed 23<sup>rd</sup>.

Sept 26 (Elfred James)  
by  
James Murray

States (on oath) that on Friday 27<sup>th</sup>  
while sick he was struck a severe  
blow by defendant & that he threatened  
to shoot him & threaten his life  
So that he was obliged to leave,  
Summed Monday 28<sup>th</sup> 11 o'clock

Did not make appearance

Case Satisfactorily Settled & Complainant  
was bound to complete Contract.

Has made no appearance

Oct 1<sup>st</sup> Mahann & Almon claims 1/2 days work sweeping your  
by labor for last year. -  
A. Knudsen

Oct 2 Patsy Hudson claims wages due for  
us picking cotton. -  
John Statow

Oct 14<sup>th</sup> Mary, complains of turning off without  
as pay. -  
Col Jones

201

Case settled satisfactorily & Mary  
returned to work.

1811 Mary's Law  
 19 no. 1  
 I have kept  
 record in 1811  
 some money  
 and it is  
 all in the  
 name of Mary  
 1811

1811 Mary's Law  
 7 no. 1  
 some West  
 money

1811 Jan West  
 10 no. 1  
 money



2115

The first of the year  
 was a very cold one  
 and the snow lay  
 on the ground for  
 several weeks  
 The weather was  
 very disagreeable  
 and the people  
 were much  
 distressed  
 The crops were  
 all killed  
 and the people  
 were very  
 poor  
 The winter was  
 very long  
 and the people  
 were very  
 poor  
 The spring was  
 very cold  
 and the people  
 were very  
 poor  
 The summer was  
 very hot  
 and the people  
 were very  
 poor  
 The autumn was  
 very cold  
 and the people  
 were very  
 poor

1811

27

W. L. East Massachusetts Map 2. 1811

111  
112  
John East  
1811

Massachusetts Map

1811

111 John Robinson Massachusetts Map 2. 1811

26  
112  
C. G. East

The first part of the report  
 was written by the  
 Department of the Interior  
 and the Department of  
 Agriculture. The second  
 part of the report was  
 written by the  
 Department of the Interior  
 and the Department of  
 Agriculture. The third  
 part of the report was  
 written by the  
 Department of the Interior  
 and the Department of  
 Agriculture.

308

213  
 111 10/20/1911 Attachment of ...  
 11 11/1/1911  
 11 11/1/1911

309

111 11/1/1911  
 11 11/1/1911  
 11 11/1/1911  
 11 11/1/1911  
 11 11/1/1911

111 11/1/1911  
 11 11/1/1911  
 11 11/1/1911

Group 1 by 40 buckets, 1000  
17 2/3 1/2 small water tank

2

1. 1000 in 1000 gal. water tank  
2. 1000 in 1000 gal.

3

Group 2 by 1000 buckets 1000  
17 2/3 1/2 small water tank

1000 in 1000 gal. water tank

Yielda Hancock — Monday

Y. M. Fenton Tuesday

Geo. Combs Wednesday

W. T. Adams & Co. Thursday

Wm. Ingham Friday

E. T. & H. Thayer Saturday

John H. Thayer Monday

Wm. Smith & Co. Tuesday

Wm. Combs } Wednesday

John C. Davis } Thursday

272

1871  
 31  
 1871  
 31  
 1871  
 31  
 1871  
 31  
 1871  
 31

1871  
 31  
 1871  
 31  
 1871  
 31  
 1871  
 31  
 1871  
 31

1871  
 31  
 1871  
 31  
 1871  
 31  
 1871  
 31  
 1871  
 31

Co. by order	14.00
11/21/44 to order -	5.25
	<u>19.25</u>

11/21/44 to order -	10.00
11/21/44 to order -	10.00
11/21/44 to order -	10.00

11/21/44 to order -	10.00
11/21/44 to order -	10.00
11/21/44 to order -	10.00

11/21/44 to order -	10.00
11/21/44 to order -	10.00
11/21/44 to order -	10.00



Mr. J. M. Howe  
 Mr. G. W. ...  
 Mrs. Robinson,  
 or  
 Country Lane

Mr. Thomas Murray  
 or  
 John Henry  
 Cassin  
 Cold Spring

Referring to go with  
 Sewell in New York

Mr. ...  
 or  
 Mrs. ...

... ..  
 ... ..

Received of the Treasurer of the  
Board of Directors of the  
City of New York

the sum of \$1000.00  
for the year 1850

By Cash	1800	1783
To Balance	200	1800
	<u>200</u>	1800

Wm. C. Johnson  
Treasurer

Received  
\$1000.00



1898  
L. L. L.

great work

1

1

2

1

	Count	Check
Walter Swanson	/	/
Gilbert Hale	/	/
Jacob Tracer	/	
Jim Morgan	/	
Samuel Smith Carter	/	/
Jean Kempp	/	
Will Westbrook	/	
David Lord	/	
Henry Freeman		/
John Harris	/	/
Arthur Carter	/	/
Alvin Carl	/	
George Hawken	/	
Charles Carter		/
William Brown	/	
John Glance	/	
Ben Buchanan	/	
Willis Johnson		/
Thomas Cox		/
Mary Smith		
William Freeman		/
Henry Weston	/	/
Richard Estlin		/
John Warde	/	/
Samuel Kemnick	/	
Henry ...		

Andrew Johnson  
George Walker  
Isaac Linnemarth  
Charles Thompson  
Jim Black

Shaw	Schick	Heat	Pecreast.	1875 Stocks
------	--------	------	-----------	----------------

/	/	/	/	
/	/	/	/	2
/			/	2
/			/	2
/			/	2
/	2.	/	/	2
/	2.	/	/	2
/	2.	/	/	2
/	/	/	/	2
/		/	/	2
/		/	/	2
/		/	/	2
/		/	/	2
/		/	/	2
/		/	/	2
/		/	/	2
/		/	/	2
/		/	/	2
/		/	/	2
/		/	/	2

Jackets

Hats

Gloves

Shirts

Shoes

Stockings

Mary Lewis  
 Judith Long  
 Annanda Fielder  
 John Williams  
 Susan M. Math  
 Nathan Andrews  
 Jesse Lyke  
 Matilda Brady  
 Harriet Gardner  
 Minah King  
 William Puck  
 Rachel Couts  
 Thomas Borman  
 Minta Gasking  
 Willy Sawkins  
 Stephen Query  
 Richard Woods  
 Tyra Chambers  
 Martha Maddef  
 June Mann

NATIONAL ARCHIVES AND RECORDS ADMINISTRATION  
M I C R O F I L M P U B L I C A T I O N S

Roll 40

Target 5

Miscellaneous Records

1865-68



Lease

of three rooms, used  
by Detachment 16th  
U. S. Infantry on duty  
at Americas. Co.

E 713

MISC.

LEASE

Americas

Miscella-  
-neous,

Georgia. } This Indenture  
Sumter County. } made this fourteenth  
day of December eighteen hundred and  
sixty seven, between William Serrin, Sgt  
of said County and State of the first part  
and 2<sup>nd</sup> Lieut. O. H. Howard 5<sup>th</sup> U.S. Artil-  
lery, Sub. Asst. Commr. Bureau Sv. F. & A. L. for  
and in behalf of the United States, of  
America of the second part, witnesseth: that  
the said William Serrin doth lease and  
demise, unto the said 2<sup>nd</sup> Lieut. O. H. Howard  
and his successors in office: three certain rooms  
two on the first floor, and one on the second floor  
of a building, situated on East side of  
Public Square in the City of Americus and said  
County, and on a lot, known in the plan of  
said City as lot No: 17. To hold the same  
until the thirty first day of March eighteen  
hundred and sixty eight, the said 2<sup>nd</sup> Lieut.  
O. H. Howard, or his successors in office,  
paying therefor the monthly rent of  
Fifteen - dollars, payable at the expira-  
tion of each and every month, or as soon  
thereafter, as the government shall furnish  
the funds for that purpose.

And the said 2<sup>nd</sup> Lieut. O. H.  
Howard, 5<sup>th</sup> U.S. Artillery, Sub. Asst. Commr.  
Bureau Sv. F. & A. L. for and in behalf of the

United States of America covenants to pay the said rent, in the manner and form so specified above, and deliver up, said three rooms quietly, on the first day of April eighteen hundred and sixty eight, in as good condition, as the same were, when received by him, reasonable wear and tear thereof excepted:

Provided, that if the said rooms be destroyed by fire, during the continuance of this lease, then this lease to utterly cease, and the said William Sirrin shall not claim or receive from the said 2<sup>nd</sup> Lieut. O. H. Howard, or his successors in office, any more of the rent, above herein stipulated as rent, than shall be due on the day of such destruction by fire. And further, that he, the said William Sirrin, his heirs, executors, administrators and assigns, shall and will grant to the said 2<sup>nd</sup> Lieut. O. H. Howard or his successors in office, at his or their costs and charges, if so requested by written request, before the expiration of the lease herein granted, a further lease of said rooms for such term, as may be required by the said 2<sup>nd</sup> Lieut. O. H. Howard or his successors in office, to commence at the expiration of this term, at and under the same monthly

rent, and containing the same covenants  
herein inserted, and also that it shall and  
may be lawful, for the said 2<sup>nd</sup> Lieut: C. H.  
Howard or his successors in office, to keep out  
of every month's rent, herein agreed to be  
paid by him for said rooms, all such  
money as shall be paid, laid out or expen-  
ded by him or such successors for repairs, amend-  
ments and additions by him or them made  
and done in and about said rooms, by  
and with the consent or direction of said  
William Serrin his heirs and assigns.

It is further provided, that if  
during the continuance of this lease, the exi-  
gencies of the public service, should require  
the party of the second part to vacate the  
said rooms, then this lease shall utterly  
cease, and the said William Serrin, his  
heirs or assigns, shall not claim any more  
of the rent, above herein stipulated as  
rent, than shall be due on the day, the  
rooms are vacated.

In witness whereof, we have hereunto  
set our hands and fixed our seals, the day  
and year above written.

Witness J. M. Robinson  
1874 Head of H

Wm Serrin  
Officer  
2<sup>nd</sup> Lieut: 5th U. S. Arty  
Sub. Asst. Commr  
B. S. P. 80 P. 1

W. W. [ED. FORM NO. 1.]  
REPORT OF SCHOOLS,  
STATE SUPERINTENDENT,

Retained Copy November 1867  
No 30

State of Illinois  
American

Annals, 1867.

American

American

Retained copies  
of

School Reports

Received, .....

# STATE SUPERINTENDENT'S

To Bureau R. F. & A. L., for the month of April, 1867,

A School under the distinct control of one Teacher, or a Teacher with one assistant, is to be reported as one School.

No. of Day Schools.	No. of Night Schools.	NAME AND LOCATION OF SCHOOL.	PRESENT SESSION.		SOCIETIES, &c., PATRONS.	No. Schools sustained by Freedmen.	No. Schools sustained in part by Freedmen.	No. Teachers transported by Bureau.	No. School Buildings owned by Freedmen.	No. School Buildings furnished by Bureau.	TEACHERS.		No. of Pupils (Boys and Girls)
			When opened.	When to close.							White.	Col'd.	
1	0	Americus Academy, N.C.			Am. Miss. Assoc.	0	1	0	0	0	3	0	30
1	0	Edwards & Wiley Co (Chs)			None	0	1	0	1	0	2	0	30
1	0	Anderson Co (Chs)			Am. Miss. Assoc.	0	1	2	0	1	2	0	30
1	0	Phillips Co (Chs)			" " "	1	0	0	0	0	1	0	12
<b>TOTALS.</b>						1	3	2	1	1	8	0	110

- To these questions give exact or approximate answers, prefixing to the latter the word "about."
1. How many of above Schools are graded? 3 How many grades? 5
  2. How many Day or Night Schools, within your knowledge, not reported above? 1 Whole No. of Pupils 30
  3. How many Sabbath Schools, within your knowledge, not reported above? 0 Whole No. of Pupils 0
  4. How many Industrial Schools? 0 Whole No. Pupils in all, 0 State the kind of 0
  5. Whole amount of Tuition paid by Freedmen during the month, None
  6. Whole amount of expenses for the above Schools by the Bureau for the month, None
  7. Grand total of expenses for support of above Schools by all parties for the month, None
  8. Whole No. of High or Normal Schools, 0 How many pupils in all? 0
  9. State the public sentiment towards Colored Schools, Favorable
  10. Remarks. None

# S MONTHLY SCHOOL REPORT,

District, State of *Georgia*

To contain one entire calendar month, and to be forwarded as soon as possible after the close of the month.

SCHOOL	No. PUPILS ENROLLED. (Both Day and Night Schools.)		No. Pupils enrolled last Report.	No. left School this Month.	No. New Scholars this Month.	Average Attendance.	No. of Pupils paying Tuition.	No. of White Pupils.	No. always Present.	No. always Punctual.	No. over 16 years of Age.	No. in Alphabet.	No. Spell and Read easy Lessons.	No. advanced Readers.	No. Geography.	No. Arithmetic.	No. Higher Branches.	No. Writing.	No. Needle-work.	No. Free before the War.	No. Sabbath Schools.	No. Teachers in Sabbath Schools.	No. Pupils in Sabbath School.
	Male.	Fem'e.																					
0	34	76	123	11	0	112	0	112	112	3	0	58	54	54	54	0	54	76	0	0	0	0	0
0	35	25	0	10	5	28	28	0	28	28	4	2	10	10	0	10	0	10	8	0	0	0	0
0	30	40																					
0	12	18																					
0	113	159	123	21	5	140	140	140	140				60	64	64	0	114	84	0	0	0	0	
	272																						

No. of Pupils (estimated) in all such Schools, 35  
 No. of Pupils (estimated) in all such Schools, 0  
 The kind of work done, 0

No. Teachers in all, 1 White, 1 Colored 0  
 No. Teachers in all, 0 White, 0 Colored 0

State Report

*[Handwritten signature]*

[FORM 2, ED.]

**REPORT OF SCHOOLS,**  
**(DISTRICT SUPT.)**

*Retained Copy December 1867*  
*No. 2*

State of Georgia

December 1867.

*Almanac*

Forwarded, .....

Received, .....



# DISTRICT SUPERINTENDENT'S REPORT

To Bureau R. F. & A. L., for the month of December, 1867,

A School under the distinct control of one Teacher, or a Teacher with one assistant, is to be reported as one School.

No. of Day Schools.	No. of Night Schools.	NAME AND LOCATION OF SCHOOL.	PRESENT SESSION.		SOCIETIES, &c., PATRONS.	No. Schools sustained by Freedmen.	No. Schools sustained in part by Freedmen.	No. Teachers transported by Bureau.	No. School Buildings owned by Freedmen.	No. School Buildings furnished by Bureau.	TEACHERS.		No. PUPILS ENROLLED (Both Day and Night Schools).	
			When opened.	When to close.							White.	Col'd.	Male.	Female.
											<i>Freedmen's School                      Announcing                      T. S. Anderson                      as Educator                      of the                      Freedmen</i>			<i>all the                      Year</i>
TOTALS.														

This Report is incomplete unless each blank is filled by a number or symbol.

- To these questions give exact or approximate answers, prefixing to the latter the word "about":
1. How many of above Schools are graded? ..... How many grades? .....
  2. How many Day or Night Schools, within your knowledge, not reported above? ..... Whole No. of Pupils .....
  3. How many Sabbath Schools, within your knowledge, not reported above? ..... Whole No. of Pupils .....
  4. How many Industrial Schools? ..... Whole No. Pupils in all, ..... State the kind of work .....
  5. Whole amount of Tuition paid by Freedmen during the month, .....
  6. Whole amount of expenses for the above Schools by the Bureau for the month, .....
  7. Grand total of expenses for support of above Schools by all parties for the month, .....
  8. Whole No. of High or Normal Schools, ..... How many pupils in all? .....
  9. State the public sentiment towards Colored Schools, .....
  10. Remarks. *No Report has been received this Office from on account of the Holidays?*

# MONTHLY SCHOOL REPORT

*Americus* District, State of *Georgia*

To contain one entire calendar month, and to be forwarded as soon as possible after the close of the month.

No. PUPILS ENROLLED. (Both Day and Night Schools.)		No. Pupils enrolled last Report.	No. left School this Month.	No. New Scholars this Month.	Average Attendance.	No. of Pupils paying Tuition.	No. of White Pupils.	No. always Present.	No. always Punctual.	No. over 16 years of Age.	No. in Alphabet.	No. Spell and Read easy Lessons.	No. advanced Readers.	No. Geography.	No. Arithmetic.	No. Higher Branches.	No. Writing.	No. Needle-work.	No. Free before the War.	No. Sabbath Schools.	No. Teachers in Sabbath Schools.	No. Pupils in Sabbath School.
Male.	Fem'e.																					
10	9	0	0	0	16	14	0	16	16	19	4	15	0	0	0	0	0	0	0	0	0	0

Pupils (estimated) in all such Schools, ..... No. Teachers in all, ..... White, ..... Colored, .....

Pupils (estimated) in all such Schools, ..... No. Teachers in all, ..... White, ..... Colored, .....

of work done, .....

*in Schools although blanks are furnished probably*  
*J. M. Robinson Secy*

1864

[FORM 2, ED.]

**REPORT OF SCHOOLS,**  
**(DISTRICT SUPT.)**

State of \_\_\_\_\_

\_\_\_\_\_ 186 .

*Amesbury*

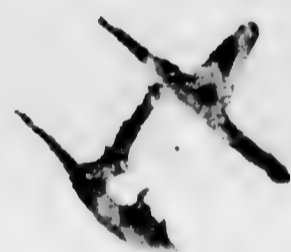
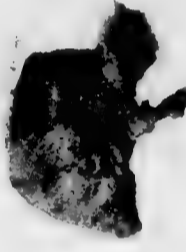

Forwarded, \_\_\_\_\_

Received, \_\_\_\_\_

# DISTRICT SUPERINTENDENT'S MO

To Bureau R. F. & A. L., for the month of December, 1867, *Am*

A School under the distinct control of one Teacher, or a Teacher with one assistant, is to be reported as one School.

This Report is incomplete unless each blank is filled by a number or cypher.	No. of Day Schools.	No. of Night Schools.	NAME AND LOCATION OF SCHOOL.	PRESENT SESSION.		SOCIETIES, &c., PATRONS.	No. Schools sustained by Freedmen.	No. Schools sustained in part by Freedmen.	No. Teachers transported by Bureau.	No. School Buildings owned by Freedmen.	No. School Buildings furnished by Bureau.	TEACHERS.		No. PUPILS ENROLLED.		No. Pupils enrolled last Report.
				When opened.	When to close.							White.	Col'd.	Male.	Fem'e.	
	1	1	<i>Sumner, Freedmen's High Sch.</i>				0	1	0	0	0	3	0	65	70	5
	1	0	<i>Sumner School Andersonville</i>				1	1	0	0	1	3	0	15	37	40
	1		<i>Chatham Sch. Co.</i>				0	1	0	1	0	2	0	25	30	6
TOTALS.	3	1										0	0	105	137	10
	4													257		

- To these questions give exact or approximate answers, prefixing to the latter the word "about."
1. How many of above Schools are graded? 2 How many grades? 2
  2. How many Day or Night Schools, within your knowledge, not reported above? 3 Whole No. of Pupils (estimated) 105
  3. How many Sabbath Schools, within your knowledge, not reported above? 2 Whole No. of Pupils (estimated) 137
  4. How many Industrial Schools? 0 Whole No. Pupils in all, 0 State the kind of work done 0
  5. Whole amount of Tuition paid by Freedmen during the month, None
  6. Whole amount of expenses for the above Schools by the Bureau for the month, Not known
  7. Grand total of expenses for support of above Schools by all parties for the month, Not known
  8. Whole No. of High or Normal Schools, 0 How many pupils in all? 0
  9. State the public sentiment towards Colored Schools, Very good
  10. Remarks. Sumner School is the only one in the district that has a building of its own.

# MONTHLY SCHOOL REPORT

*Ames* District, State of *Georgia*

To contain one entire calendar month, and to be forwarded as soon as possible after the close of the month.

No. Pupils enrolled last Report.	No. left School this Month.	No. New Scholars this Month.	Average Attendance.	No. of Pupils paying Tuition.	No. of White Pupils.	No. always Present.	No. always Punctual.	No. over 15 years of Age.	No. in Alphabet.	No. Spell and Read easy Lessons.	No. advanced Readers.	No. Geography.	No. Arithmetic.	No. Higher Branches.	No. Writing.	No. Needle-work.	No. Rec before the War.	No. Sabbath Schools.	No. Teachers in Sabbath Schools.	No. Pupils in Sabbath School.
5	0	0	129	0	0	129	129	4	0	84	54	54	54	0	54	70	0	0	0	0
40	2	9	44	0	0	18	30	11	6	22	19	19	19	0	22	0	0	1	3	106
60		15																		
105	2	29	173	0	0	147	159	15	6	103	73	73	73	0	76	70	0	1	3	106

(estimated) in all such Schools, 50 No. Teachers in all, 2 White, 1 Colored, 1  
 (estimated) in all such Schools, \_\_\_\_\_ No. Teachers in all, \_\_\_\_\_ White, \_\_\_\_\_ Colored, \_\_\_\_\_  
 work done, \_\_\_\_\_

1865  
James Smith  
at New York

James Smith

1865  
James Smith  
at New York

# Report of Persons Murdered in District

Names of Persons Murdered		Names of Suspected Murderer		Date
White	Colored	White	Colored	

*Note:— The disposition made of the case will be reported in Column of Remarks.*

Act of America, etc.

Date

Locality

Remarks

... ..  
... ..  
... ..



A-45111 -  
Bond  
of  
Dempsey, George

Amesbury

L

United States of America }  
State of Georgia }  
County of Sumter }  
H. Walker, Robert J. Hodges, William Simms,  
Michael H. Stephens, and Charles Darley,  
securities, acknowledge ourselves, heirs and  
jointly bound unto Lieutenant Colonel  
H. W. Snow Parson Marshal General  
of the State of Georgia or any other officer whom  
the commandant of the department may name,  
in the first and full sum of ten thousand  
dollars (\$10,000) good and lawful money of the  
United States for the true payment of which we  
bind ourselves, our heirs, executors, administrators,  
and assigns, jointly and severally, firmly by  
these presents, sealed with our seals, and  
dated this 18<sup>th</sup> day of November 1865.

The  
condition of the above obligation is as follows,  
to wit, Whereas the above bound Drumpsey  
Hooker is charged with the offence of shooting  
a Medican named William  
and whereas there is danger that the  
wound occasioned by the said shooting  
may prove mortal and whereas the said  
Drumpsey desires to give bail to appear before  
Captain J. Entwistle Assistant Provost  
Marshal or any other Military Court having  
jurisdiction.

Now should the said Drumpsey Hooker,  
or he and truly be and appear before the said  
J. Entwistle Assistant Provost Marshal or any

other Military Court having jurisdiction  
on the day of this present month or at  
such other time as may be designated by the  
said Captain J. Entwistle or other Military Court  
having jurisdiction to answer said charge  
according to the laws governing said case  
then this bond shall void else of full force  
and virtue

Deputy and approver?  
James [unclear]  
[unclear]

Jemy, H. Hooks  
Wm. [unclear]  
Robt. [unclear]  
William [unclear]  
Charles J. [unclear]

Georgia - American

1) Miscellaneous Reports  
received 7/4 in

1. Lease of 3 Rooms  
by Detachment on Duty  
Dec. 1867 1 doc.

2. Report received of  
Treason <sup>in</sup> District  
(1866) 1 doc.

3. Case of (Dismal Hooker)  
Nov 1865 2 docs.

4. Affidavits received  
Nov. 1868 3 docs.

5. U. S. Internal Revenue  
Certificate - Jan. 1868  
1 doc.

6. Apprenticeship of Tom Haley  
to John B. Haley  
April 1867

7. Statement exhibiting  
the allowance of Clothing to  
Soldiers (Retained Copy)  
7/4 1 doc.

Georgia, American  
District Records

1. Retained Copies of Monthly  
Returns of Slaves Pertaining  
to the Bureau.

Apr. 1867 - Mar. 1868  
1 in.

2. Retained Copies of Reports  
by Sick and Wounded  
Freedmen.

Aug. - Nov. 1868  
1/4 in.

B. Retained Copies Received  
of District Supt. School  
Reports Nov. - Dec. 1867  
3 doc.

A. Retained Copies Received  
of Monthly Reports of  
Persons and Articles Held

June 1867 - Mar. 1868  
1/2 in.

161  
Mr. Foster (No 1)  
to be in custody, the Court

From information  
received I believe that  
J. J. Walker is the party  
who was at Mr. Foster's  
when Mr. Foster (No 1)  
was shot and I believe  
him to be the man who  
shot Foster

James Eastwick  
Capt 176 1865

District of  
Columbia  
Nov 16<sup>th</sup> 1865

Answer

1845  
Albany, N.Y.

Dear Sir,  
I have the honor to acknowledge the receipt of your letter of the 15th inst. in relation to the purchase of a lot of land in the town of Albany, N.Y. for the purpose of erecting a building for the use of the Court of Sessions. I have the pleasure to inform you that the same has been approved by the Board of Supervisors, and that the necessary steps have been taken to secure the purchase of the same. I have the honor to enclose herewith a copy of the report of the Board of Supervisors, and a copy of the resolution of the Court of Sessions, in relation to the purchase of the same. I have the honor to remain, Sir, your obedient servant,  
J. C. [Signature]

Yours truly,  
J. C. [Signature]

RRR 922

May 11<sup>th</sup> 1868  
Office of the Surgeon General  
Washington D.C.

American



Georgia. } Personally appeared before me  
County of Sumter } Richard Reese, who on oath  
deposeth & saith, that he is  
a resident of Schley Co. Ga. That on Nov 3<sup>rd</sup> 1868  
he went to Ellaville the County Seat of Schley, Co. Ga.  
cast his vote for Presidential Electors. That he so  
deposited his vote. That he was then asked by  
S. J. McCrawry if he had paid his taxes for 1867,  
that he replied that his employer had told him at  
the settlement of his years labor (1867), he (the Employer)  
had paid tax & charged the amount against  
him in settlement. That said employer, then &  
there swore he had not paid said Reese's tax &  
upon after hearing said oath of Employer, Oliver  
Waldrep who as Justice of the Peace, was holding  
the Election took from the ballot box the ticket  
said Reese had deposited & told him it was a  
penitentiary offence to vote unless first paying  
his taxes. That said Reese then paid about \$5.00  
dollars to said McCrawry, of which the  
following is a true copy. Received of  
Richard Reese four dollars & fifty cents for  
taxes, interest & cost; for 1867 & credited the same  
upon fixa issued by H. L. Tison, J.C. for Schley Co.  
Ga. this Nov 2<sup>nd</sup> 1868.

Sworn & Subscribed to before me at Americus Ga. this 7<sup>th</sup> day of Nov. 1868.  
W. C. Morris, Agt. B. R. F. W. A. L.

S. J. McCrawry, Const  
Richard Reese  
Mark.

Office of the  
Secretary of the  
Army  
Washington, D.C.

Approved

Approved  
[Signature]  
[Signature]

George Personall, appellant  
Compl. against? before Mr J. P. Hannan  
who on oath says  
That he was Superintendent  
of the Plantations of H. F. Jones in  
Wilder Co in 1867. That John Harris  
one of the Freedmen on said Plantations  
said to Elias East, one of the Freedmen  
on said place a coat <sup>12<sup>00</sup></sup> and pants  
1 <sup>2<sup>50</sup></sup> worth in all to 14<sup>50</sup> that  
in the settlement of said case  
he retained the coat of \$14<sup>00</sup> being  
in one case said to be paid said  
Harris and that in final settlement  
he paid the value to H. F. Jones with  
H. F. Jones charged to said East to his  
debit.

I have subscribed to  
copy in this of the  
of Memphis  
T. C. [unclear]

2100-21 68  
Lippincott  
Lippincott  
Lippincott

Lippincott

Georgia. } Personally appeared before  
 County of Sumter } me Abram King &  
 Jackson Black who } on oath deposited & said  
 That they are residents of Schley Co. That on  
 Nov 2<sup>nd</sup> 1868 they were arrested by Luther Stewart  
 & John Chaney & confined in jail. That they  
 were kept in jail until about one & a half  
 hours of sunset on Tuesday Nov 3<sup>rd</sup>, That  
 at or about that time said Stewart &  
 Chaney came to the jail & both promised  
 them that if they, the said Abram King &  
 Jackson Black would vote the Democratic  
 ticket at the Election then in progress, they  
 the said Stewart & Chaney would release  
 them from confinement. That said King  
 & Black assented to the proposition proposed  
 by Stewart & Chaney & were immediately  
 released —

Abram <sup>his</sup> King  
 Jackson <sup>his</sup> Black.  
 Mark.

Sworn & Subscribed to  
 before me this Seventh  
 day of Nov 1868  
 W. C. Morrill.  
 Agt B. R. H. & A. L.  
 A True Copy.

U. S. Internal Revenue  
Weyher Certificate

Assessment

(110.)

UNITED STATES INTERNAL REVENUE.  
WEIGHER'S CERTIFICATE.

[To be used in the shipping district, and a copy sent to the Assessor and Collector.]

*2<sup>d</sup>* District, State of *Georgia*  
*American, Jan 21, 1865.*

I HEREBY CERTIFY, that I have weighed the following described Cotton, produced by \_\_\_\_\_, and owned or held by *M. N. Stephens*, in the *2<sup>d</sup>* Collection District of the State of *Ga*, and ascertained the weight to be as given below, and affixed to the bales metallic tags lettered and numbered as herein described, viz:

MARKS.	No. BALES.	LETTER AND NUMBERS.	GROSS WEIGHT.	NET WEIGHT.	AMOUNT OF TAX, AT 2½ CENTS PER POUND.
<i>Y/Z</i>	<i>24</i>	<i>1 tag</i>	<i>10.453</i>	<i>10.035</i>	<i>25087</i>

And that the above entries are true, correct, and complete in every particular.

*R. J. Wilkes*  
Weigher and Marker.

5, 1, 108



(110.)

UNITED STATES INTERNAL REVENUE.  
WEIGHER'S CERTIFICATE.

[To be used in the shipping district, and a copy sent to the Assessor and Collector.]

*2<sup>d</sup> District, State of Georgia*  
*Americus, Jan 21, 1868.*

I HEREBY CERTIFY, that I have weighed the following described Cotton, produced by \_\_\_\_\_, and owned or held by *M. H. Stephens*, in the *2<sup>d</sup>* Collection District of the State of *Ga*, and ascertained the weight to be as given below, and affixed to the bales metallic tags lettered and numbered as herein described, viz:

MARKS.	No. BALES.	LETTER AND NUMBERS.	GROSS WEIGHT.	NET WEIGHT.	AMOUNT OF TAX, AT 2½ CENTS PER POUND.	
<i>YZ</i>	<i>24</i>	<i>Notags</i>	<i>10,453</i>	<i>10,035</i>	<i>250</i>	<i>87</i>

And that the above entries are true, correct, and complete in every particular.

*R. W. Miller*  
Weigher and Marker.

*Faint handwritten text, possibly a date or reference number.*

*a.*

*Apprenticeship of  
Sond Holly to  
John B. Holly.*

*Original*

*Recorded among 18<sup>th</sup>  
1867 of Chappinell*

*A true and correct  
true Minutes of  
Court this 27<sup>th</sup> April  
7<sup>th</sup> 1867*

*Chappinell*

George being made to appear to the  
Probate Court that John Holly a freedman  
aged about one year of light complexion spare  
made is without father or mother in this County  
incapable of maintaining him or any other relative  
capable of maintaining him or who is able to comply  
with the requirements of the law and having no  
estate sufficient for his support and upon the  
Statement of James C Holly that the Boy John  
Holly desires to be apprenticed to John B Holly of  
said County it is hereby ordered by the Court that  
said John aforesaid be and he is hereby apprenticed  
to John B Holly of said County until he arrives  
at the age of Twenty One years to be by him the  
said Holly taught the Occupation of Farming and  
the said Holly binds himself to furnish the said  
John with food and clothing sufficient for his  
comfort and to treat him in a humane manner  
giving only the same degree of force to compel his  
obedience that a Father may use with his Minor  
Child to compel his obedience and see that he has  
proper attention and Medical treatment in time of  
Sickness and learn him to read the English language

Given under my hand and official  
Signature in Office at Preston this 11<sup>th</sup> day of May 1867

Geo. W. Ball J. C.

STATEMENT exhibiting the amount of Clothing to each soldier during his enlistment, and his proportion for each year respectively, as established by the Secretary of War.

CLOTHING	BY YEARS					Total in five years.
	1st.	2d.	3d.	4th.	5th.	
Hat, campaigner	1	1	1	1	1	5
Yankee Cap	1	1	1	1	1	5
Coat, Campaigner	1	1	1	1	1	5
Blue Flannel Sack Coat	2	2	2	2	2	10
Trowsers	3	2	3	2	3	13
Flannel Shirts	3	3	3	3	3	15
Flannel Drawers	3	2	2	2	2	11
Boots, pairs	4	4	4	4	4	20
Stockings, pairs	4	4	4	4	4	20
Leather Stock	1		1			2
Great Coat	1					1
Stable Frock	1		1			2
Cambric Overall	1	1	1	1	1	5
Waistcoat	1		1			2

*Continued*



NOTES.—Erasures and alterations of entries are prohibited.

Regular and Extra Issues will not be blended in the same Receipt Roll

Each signature, whether written by the soldier or acknowledged by mark, must be witnessed

Where no issues have been made, spaces will be filled by a parallel, (thus:       )

Mounted men may, at their option, receive one pair of "boots" and two pairs of "bootees," instead of four pairs of bootees.

As the Metallic Shoulder Scales, Letters, Numbers, Castles, and Flashes, will last for many years, they will be borne on the returns as company property, in the same manner as are canteens and straps, haversacks, canteens and straps, and other articles of camp and garrison equipage, and will be charged to the soldier only when lost or destroyed through neglect.

I certify that the foregoing Receipt Roll  
is correct and that no Commission is  
in duty here with me  
J. H. Robinson  
Agent Bureau Office

Retained Copy  
No. 2.  
American

Retained Copy  
1867 June

J. H. [unclear]  
Quartermaster U. S. Army,

at [unclear]

REPORT OF PERSONS AND ARTICLES HIRED

For [unclear], 1867.

1867





month of

186, by

Quartermaster U. S. Army.

OWNED.	AMOUNT OF RENT OR PAY IN THE MONTH.		REMARKS. <small>Showing by whom the buildings were occupied and for what purpose, and how the vessels and men were employed during the month.</small>	TIME AND THE AMOUNT DUE AND REMAINING UNPAID.			
	Dolls.	Cents.		From—	To—	Dollars.	Cts.
			Transfers and discharges will be noted under this head.				

Total amount due and remaining unpaid . . . . .

month of

186, and that the observations under the head of "Remarks," and the statement

*Wm. Robinson Agt*  
*Quartermaster.*

*Quinn's Copy*  
No. 2.

*Revised copy of 1867*

*John P. Quinn*  
Quartermaster U. S. Army,

at *Springfield*

REPORT OF PERSONS AND ARTICLES HIRED

For *the year*, 186 .

•  
•  
•  
•

REPORT of Persons and Articles employed and hired at Amicus Co. during the month of

Running numbers.	No. of each class.	NAMES OF PERSONS AND ARTICLES.	DESIGNATION AND OCCUPATION.	SERVICE DURING THE MONTH.			RATE OF HIRE OR COMPENSATION.			DATE OF CONTRACT, AGREEMENT, OR ENTRY INTO SERVICE.	BY WHOM OWNED.
				From	To	Days.	Dolls.	Cents.	Days, month, or voyage.		
		17	17						17	17	

Amount of rent and hire during the month . . . . .

I CERTIFY, ON HONOR, that the above is a true report of all the ~~persons and~~ articles employed and hired by me during the month of amounts due and remaining unpaid, are correct. EXAMINED:

Commanding.

month of *August*, 186*6*, by *J. L. ...* ~~Quartermaster~~ *U. S. Army.*

OWNED.	AMOUNT OF RENT OR PAY IN THE MONTH.		REMARKS. <small>Showing by whom the buildings were occupied, and for what purpose, and how the vessels and men were employed during the month.</small>	TIME AND THE AMOUNT DUE AND REMAINING UNPAID.					
	Dolls.	Cents.		Transfers and discharges will be noted under this head.		From—	To—	Dollars.	Cts.
<i>None</i>			<i>1 - J. L. ...</i>						

Total amount due and remaining unpaid . . . . .

month of *August*, 186*6*, and that the observations under the head of "Remarks," and the statement

*J. L. ...* ~~Quartermaster~~

Retained Copy  
No. 2.

Retained Copy, October 1867  
No. 1.

J. N. Robinson  
Quartermaster U. S. Army,  
at Annapolis, Md.

REPORT OF PERSONS AND ARTICLES HIRED

For October, 1867.

REPORT of Persons and Articles employed and hired at *Sumner Co* during the month of

Running numbers.	No. of each class.	NAMES OF PERSONS AND ARTICLES.	DESIGNATION AND OCCUPATION.	SERVICE DURING THE MONTH.			RATE OF HIRE OR COMPENSATION.			DATE OF CONTRACT, AGREEMENT, OR ENTRY INTO SERVICE.	BY WHOM OWNED.
				From	To	Days.	Dolls.	Cents.	Days, month, or voyage.		
		<i>1 Horse</i>	<i>(Coffin)</i>	<i>1/1</i>	<i>2/1</i>	<i>31</i>	<i>20</i>	<i>00</i>	<i>21</i>	<i>1/1</i>	<i>Sumner Co</i>

Amount of rent and hire during the month . . . . .

I CERTIFY, ON HONOR, that the above is a true report of all the persons and articles employed and hired by me during the month of amounts due and remaining unpaid, are correct. EXAMINED :

Commanding.

Month of October, 1867, by J. D. Robinson Quartermaster U. S. Army

ED.	AMOUNT OF RENT OR PAY IN THE MONTH.		REMARKS. <small>Showing by whom the buildings were occupied, and for what purpose, and how the vessels and men were employed during the month.</small>	TIME AND THE AMOUNT DUE AND REMAINING UNPAID.			
	Dolls.	Cents.		From—	To—	Dollars.	Cts.
			<small>Transfers and discharges will be noted under this head.</small>				
	20	00	Went as Officer to 1st Cavalry at Columbus, Ga		31 <sup>st</sup> October	20	00
	20	00				20	00
			Total amount due and remaining unpaid			20	00

Month of October, 1867, and that the observations under the head of "Remarks," and the statement

J. D. Robinson  
Quartermaster.

No. 2.

Retained copy November 1867  
No. 21

Post & Courier Agent  
Bureau R. H. & A. L.  
~~Quartermaster U. S. Army~~

at Amherst Georgia

REPORT OF PERSONS AND ARTICLES HIRED

For November, 1867.



REPORT of Persons and Articles employed and hired at *American Sea* during the month of

Running numbers.	No. of each class.	NAMES OF PERSONS AND ARTICLES.	DESIGNATION AND OCCUPATION.	SERVICE DURING THE MONTH.			RATE OF HIRE OR COMPENSATION.			DATE OF CONTRACT, AGREEMENT, OR ENTRY INTO SERVICE.	BY WHOM OWNED.
				From	To	Days.	Dolls.	Cents.	Days, month, or voyage.		
		<i>1 Person</i>	<i>Used as Officer</i>	<i>Jan 1</i>	<i>Jan 30</i>	<i>30</i>	<i>20</i>	<i>00</i>	<i>month</i>	<i>January 1st 1867</i>	<i>James &amp; Glover</i>

Amount of rent and hire during the month . . . . .

I CERTIFY, ON HONOR, that the above is a true report of all the persons and articles employed and hired by me during the month of amounts due and remaining unpaid, are correct. EXAMINED:

Commanding.

of *November*, 186*6*, by *J. C. Robinson* <sup>*Bureau of P. & S.*</sup> ~~Quartermaster~~ *U. S. Army.*

D.	AMOUNT OF RENT OR PAY IN THE MONTH.		REMARKS. <small>Showing by whom the buildings were occupied, and for what purpose, and how the vessels and men were employed during the month.</small>	TIME AND THE AMOUNT DUE AND REMAINING UNPAID.			
	Dolls.	Cents.		From—	To—	Dollars.	Cts.
			<i>Transfers and discharges will be noted under this head.</i>				
<i>Nov</i>	<i>20</i>	<i>00</i>	<i>Occupied by W. Robinson at Bureau of P. &amp; S.</i>	<i>November 1<sup>st</sup></i>	<i>November 30</i>	<i>20</i>	<i>00</i>

*20 00*

Total amount due and remaining unpaid . . . . . *20 00*

th of *November*

, 186*6*, and that the observations under the head of "Remarks," and the statement

*J. C. Robinson* <sup>*Agent*</sup>  
*Bureau of P. & S.* ~~Quartermaster~~

No. 2.

1867

Retained copy December  
No 35

J. W. Robinson Agt  
Bureau R. F. & L  
Quartermaster U. S. Army,

at Americus Ga

REPORT OF PERSONS AND ARTICLES HIRED

For December, 1867.

Retained

REPORT of Persons and Articles employed and hired at *Americus Ga* during the month of

Running numbers.	No. of each class.	NAMES OF PERSONS AND ARTICLES.	DESIGNATION AND OCCUPATION.	SERVICE DURING THE MONTH.			RATE OF HIRE OR COMPENSATION.			DATE OF CONTRACT, AGREEMENT, OR ENTRY INTO SERVICE.	BY WHOM OWNED.
				From	To	Days.	Dolls.	Cents.	Days, month, or voyage.		
		<i>1 Room</i>	<i>Used as Office</i>	<i>1</i>	<i>30</i>	<i>30</i>	<i>20</i>	<i>00</i>	<i>1</i>	<i>1/18</i>	

Amount of rent and hire during the month . . . . .

I CERTIFY, ON HONOR, that the above is a true report of all the persons and articles employed and hired by me during the month of amounts due and remaining unpaid, are correct. EXAMINED:

Commanding.

2.

Month of *December*, 186*7*, by *J. M. Robinson* *Agent Bureau of Public Buildings*  
*Quartermaster U. S. Army.*

OWNED.	AMOUNT OF RENT OR PAY IN THE MONTH.		REMARKS. <small>Showing by whom the buildings were occupied, and for what purpose, and how the vessels and men were employed during the month.</small>	TIME AND THE AMOUNT DUE AND REMAINING UNPAID.			
	Dolls.	Cents.		From—	To—	Dollars.	Cts.
	<i>20</i>	<i>00</i>	<i>Occupied by J. M. Robinson Agent Bureau of Public Buildings</i>		<i>December 30<sup>th</sup></i>	<i>20</i>	<i>00</i>

*20 00* Total amount due and remaining unpaid . . . . . *20 00*

Month of *December*, 186*7*, and that the observations under the head of "Remarks," and the statement

~~Quartermaster~~

*Return in*  
No. 2.

Quartermaster U. S. Army,  
at *Americus*

REPORT OF PERSONS AND ARTICLES HIRED

For *January*, 186*f*.  
*Return*

1568

REPORT of Persons and Articles employed and hired at *Americus Georgia* during the month

Running numbers.	No. of each class.	NAMES OF PERSONS AND ARTICLES.	DESIGNATION AND OCCUPATION.	SERVICE DURING THE MONTH.			RATE OF HIRE OR COMPENSATION.			DATE OF CONTRACT, AGREEMENT, OR ENTRY INTO SERVICE.	BY WHOM OWNED.
				From	To	Days.	Dolls.	Cents.	Days, month, or voyage.		
		<i>1 Person</i>	<i>U.S. Officer</i>	<i>January 1<sup>st</sup></i>	<i>31<sup>st</sup></i>	<i>20</i>	<i>00</i>	<i>month</i>	<i>January 1<sup>st</sup> 1861</i>	<i>Wm. L. ...</i>	

Amount of rent and hire during the month . . . . .

I CERTIFY, ON HONOR, that the above is a true report of all the persons and articles employed and hired by me during the month of amounts due and remaining unpaid, are correct. EXAMINED:

*Commanding.*

th of *January*, 186*8*, by *J. M. Robinson* *Quartermaster U. S. Army.*

DAYS.	AMOUNT OF RENT OR PAY IN THE MONTH.		REMARKS. <small>Showing by whom the buildings were occupied, and for what purpose, and how the vessels and men were employed during the month.</small>	TIME AND THE AMOUNT DUE AND REMAINING UNPAID.			
	Dolls.	Cents.		From—	To—	Dollars.	Cts.
<i>20</i>			<i>Occupied by the Quartermaster January 1<sup>st</sup> to January 3<sup>rd</sup> '68</i>				

Total amount due and remaining unpaid *20*

th of *January*, 186*8*, and that the observations under the head of "Remarks," and the statement

*J. M. Robinson* *Quartermaster.*



No. 2.

J. M. Robinson  
Bureau of Ordnance & Artillery  
~~Quartermaster U. S. Army,~~  
at *San Antonio, Tex.*

REPORT OF PERSONS AND ARTICLES HIRED

For *February*, 1868.

REPORT of Persons and Articles employed and hired at *Americus Ga* during the month of

Running numbers.	No. of each class.	NAMES OF PERSONS AND ARTICLES.	DESIGNATION AND OCCUPATION.	SERVICE DURING THE MONTH.			RATE OF HIRE OR COMPENSATION.			DATE OF CONTRACT, AGREEMENT, OR ENTRY INTO SERVICE.	BY WHOM OWNED.
				From	To	Days.	Dolls.	Cents.	Days, month, or voyage.		
		<i>Room</i>	<i>Used as Office</i>	<i>1<sup>st</sup> Feb</i>	<i>29<sup>th</sup> Feb</i>	<i>29</i>	<i>20</i>	<i>00</i>	<i>29</i>	<i>1<sup>st</sup> January 1868</i>	<i>Am. Marine Co.</i>
		<i>W. Murray</i>	<i>Handy</i>	<i>1<sup>st</sup> Feb</i>	<i>2<sup>nd</sup> Feb</i>	<i>2</i>	<i>5</i>	<i>00</i>	<i>2</i>	<i>1<sup>st</sup> February 1868</i>	<i>W. Murray</i>

Amount of rent and hire during the month . . . . .

I CERTIFY, ON HONOR, that the above is a true report of all the persons and articles employed and hired by me during the month of  
of amounts due and remaining unpaid, are correct. EXAMINED:

*Commanding.*

Month of *February*, 1868, by *J. W. Robinson, Agent* <sup>Bureau of P. & F.</sup> ~~Department of the Army~~

ED.	AMOUNT OF RENT OR PAY IN THE MONTH.		REMARKS. <small>Showing by whom the buildings were occupied, and for what purpose, and how the vessels and men were employed during the month.</small>	TIME AND THE AMOUNT DUE AND REMAINING UNPAID.			
	Dolls.	Cents.		From—	To—	Dollars.	Cts.
	20	00	Used as Office by Agent <i>J. W. Robinson</i> } <i>1<sup>st</sup> February</i>	<i>29<sup>th</sup> February</i>	20	00	
	5	00	Standing <i>supplies</i> } <i>1<sup>st</sup> February</i>	<i>5 February</i>	5	00	

25 00

Total amount due and remaining unpaid

25 00

Month of *February*

1868, and that the observations under the head of "Remarks," and the statement

*J. W. Robinson*  
Agent

*March 1868*

No. 2

*John Robinson*  
.....  
*Quartermaster U.S.A. at*

*Amesbury Pa*  
.....

Report of Persons and Articles Hired

For *March* ..... 1868

Report Of Persons and Articles Employed and hired at *Murrow In* during *Mo*

No. *1*

Running Nos.	No. each Class	NAMES OF PERSONS AND ARTICLES.	DESIGNATION AND OCCUPATION.	SERVICE DURING THE MONTH.			RATE OF HIRE OR COMPENSATION.		DATE CONTRACT, AGREEMENT, OR ENTRY INTO SERVICE.	BY WHOM OWNED.
				From	To	Days.	Dolls.	Cents.		

		<i>One Person</i>	<i>and at</i>	<i>1</i>	<i>31</i>	<i>31</i>	<i>2000</i>	<i>00</i>	<i>18</i>	<i>1868</i>	
--	--	-------------------	---------------	----------	-----------	-----------	-------------	-----------	-----------	-------------	--

Amount of Hire and *...* during the *...*

I certify on honor, that the above is a true copy of all the persons and articles employed and hired by me *...* during the *...* and the statement of amounts paid and remaining unpaid are correct. EXAMINED:

Months of March 1864, by *M. Robinson Agent Bureau U.S.A.*

BY WHOM

AMOUNT OF  
RENT OR PAY  
IN MONTH.

REMARKS.

TIME AND THE AMOUNT DUE AND  
REMAINING UNPAID.

W N E D.

Dollars. Cents.

Showing by whom the Buildings were occupied, and for what purpose;  
and how the Vessels and Men were employed during the month.  
Transfers and discharges will be noted under this head.

From To Dollars. Cents

*paid at 2000 Co. and by Robinson 1864, 1865  
Page B. P. P. H. March 1 March 20 00*

ing the month,

Total Amount due and Remaining unpaid, *00*

of the month of

*March*

1864, and that the observations under the head of Remarks,

*Agent Bureau U.S.A.*

Retained U.S.

No. 15.

Retained Co. No. 1

1867

No. 1

MONTHLY RETURN

OF

Stores pertaining to Bureau of Refugees,  
Freedmen and Abandoned Lands.

RENDERED BY

*J. M. Robinson Agent*  
*Bureau R.F. & L.*  
*at various places*  
FOR THE

Month of April 1867

J. W. BURKE & CO., Stationers, Printers and Binders.

1867

MONTHLY RETURN OF STORES PERTAINING TO BUREAU

Received, issued and remaining on hand at *Americus Georgia* in the month of

WHEN RECEIVED.	NO. OF INVOICE.	OF WHOM RECEIVED.	<i>Office Table</i>	<i>Office Desk</i>	<i>Office Chairs</i>
ON HAND PER LAST RETURN.					
<i>April 26, 1867</i>		<i>L George Wagner</i>	<i>1</i>	<i>1</i>	<i>2</i>
		<i>V.R.C &amp; Agent Bureau Wash</i>			
		TOTAL TO BE ACCOUNTED FOR.	<i>1</i>	<i>1</i>	<i>2</i>
WHEN ISSUED.		TO WHOM ISSUED.			
		TOTAL ISSUED.			
		ON HAND TO BE ACCOUNTED FOR.	<i>1</i>	<i>1</i>	<i>2</i>

NOTE.—One return with Vouchers and one without to be sent to the Commissioner Bureau R. F. & A. L., through the Office of the Asst. Commissioner of the District, accompanied by letter of advice.



REPORT OF THE BUREAU OF REFUGEES, FREEDMEN AND ABANDONED LANDS,

of *April*

1867

by

*J. M. Robinson Agent Bureau R. F. & A. L.*

I certify that the foregoing return exhibits a true and correct statement of all the property that has come into my hands on account of Bureau R. F. & A. L., during the month ending on the *30*<sup>th</sup> of *April* 1867

*J. M. Robinson*  
*Agent Bureau R. F. & A. L.*

No. 15.

*Return*  
MONTHLY RETURN

OF

Stores pertaining to Bureau of Refugees,  
Freedmen and Abandoned Lands.

*Retained Copy June 1867*

*203*

RENDERED BY

*Amos*

FOR THE

month of *June*

*1867*

# Monthly Return of Stores pertaining to Bureau of Refugees F

WHEN RECEIVED	NO. OF INVOICE.	OF WHOM RECEIVED.								
			<i>Office Table</i>	<i>Office desks</i>	<i>Office Chairs</i>	<i>Blank books</i>	<i>Inkstand</i>	<i>Paper folder</i>	<i>Ruler</i>	<i>Eraser</i>
ON HAND PER LAST RETURN			1	1	2					
<i>June 10th</i>		<i>Mayn C. J. Watson</i> <i>Chief Quarters Master</i>				3	1	1	1	1
		TOTAL TO BE ACCOUNTED FOR.	1	1	2	3	1	1	1	1
WHEN ISSUED.		TO WHOM ISSUED.								
		TOTAL ISSUED	1	1						
		ON HAND TO BE ACCOUNTED FOR.	1	1	2	3	1	1	1	1

NOTE. - One return with Vouchers and one without to be sent to the Commissioner's Bureau R. F. & A. I. through the Office of the ~~Chief~~ *Quarters* master of the District, accompanied by letter of advice.

Freedmen and Abandoned Lands received, issued and remaining

on hand at *Americus.*

in the month of *June* 1867.

by *J. M. Robinson. Agt Bureau R. F. & A. L.*

I certify that the foregoing return exhibits a true and correct statement of all the property that has come into my hands on account of Bureau R. F. & A. L. during the month ending on the *thirtieth* of *June* 186*7*.

NO. *Retained Copy* VOUCHER TO FORM 15.

*June* 1867  
List of Stores pertaining to B. R. F. & A. L.

RECEIVED FROM

.....  
.....

At .....

*Retained  
June*

*June*

*Retained Copy June 1867*

*1867*

LIST OF STORES PERTAINING TO BUREAU R. F. & A. L. delivered by Wm. C. Watson, A.C.W.  
 to W. Robinson Agent Bureau R.F. & A.L. at American Co.  
 on the 10<sup>th</sup> day of June 1867

NUMBER OR QUANTITY.	ARTICLES.	COST WHEN NEW.		CONDITION WHEN DELIVERED.	REMARKS.
		DOLLARS.	CENTS.		
3 Doz 40	Blank Books	1	50	Each	New
1 m	Do. Blank	3	00	Doz	"
1 m	Do. Paper	50		Each	"
1 m	Do. Ruler	20		"	"
1 m	Do. Eraser	25		"	"

I CERTIFY that I have this day delivered to W. Robinson Agent Bureau R.F. & A.L.  
 at American Co. the articles specified in the foregoing list.

(DUPLICATES.)

W. C. Watson  
 Agent, A.C.W. Bureau R.F. & A.L.



*Returns Copy*

No. 51.

*Retained Copy August 1867*

*no 10*

MONTHLY RETURN

OF

CLOTHING, CAMP AND GARRISON EQUIPAGE,

RENDERED BY

Co. \_\_\_\_\_, Reg't \_\_\_\_\_,

FOR THE

Month ending \_\_\_\_\_ day of *August*, 1867

*Approved as*

# Monthly Return of Clothing, Camp and Garrison Equipage,

received and issued at *San Francisco* in

WHEN RECEIVED.	No. of INVOICE.	OF WHOM RECEIVED.	CLOTHING.											
			Hats or caps.	Cap letters, emble, shield, & flame.	Cape hats.	Forage caps.	Cords and tassels.	Outer leathers.	Boots and shoes, or wraps.	Numbers.	Sergeant Majors'.	Quartermaster Sergeants'.		
ON HAND PER LAST RETURN.														
TOTAL TO BE ACCOUNTED FOR.														
WHEN ISSUED.	No. of Roll.	To WHOM ISSUED.												
TOTAL ISSUED.														
ON HAND TO BE ACCOUNTED FOR.														

CLOTHING.																				
UNIFORM COATS.					METALLIC SCAPES, PAIRS.			UNIFORM JACKETS.												
Ordinance Sergeants'.	Chief Musicians'.	First Sergeants'.	Sergeants'.	Corporals'.	Musicians'.	Privates'.	Non-commissioned Staff.	Sergeants'.	Corporals'.	Sashes.	Sergeant Majors'.	Quartermaster Sergeants'.	First Sergeants'.	Sergeants'.	Corporals'.	Privates'.	Trowsers.	Flannel Sack Coats.	Flannel Shirts.	

Note.—A letter of advice and duplicate of the Return, without vouchers, to be enclosed and sent with this to the Quartermaster General, Washington, D. C.  
 All communications to the Quartermaster General relating to "Clothing and Equipage," should be so endorsed on the envelope, under the word "Official," with the signature thereto of the officer writing the communication. Communications thus addressed and endorsed need no postage stamp.

the month of

*August*

, 18 *54*,

by

*J. P. Garrison Agent Boston N. H. 24.*

CLOTHING.

BED SACKS.

Drawers, pairs of.	Boots, Cavalry, pairs of.	Bootes, Infantry, pairs of.	Stockings, pairs of.	Leather Stocks.	Great Coats. <i>Leath.</i>	Water-proof Ponchos.	Water-proof Blankets.	Great Coat Straps, No. of.	Blankets, woolen.	<i>Wool Coats, 1/2 doz.</i>
					20				111	
				20					111	
									11	
									11	111

CAMP AND GARRISON EQUIPAGE.

Spades.	Knapsacks, complete.	Haversacks.	Canteens and Straps.	Axes.	Axe Helves.	Camp Kettles.	Mess Pans.	Camp Hatchets.	Hatchet Handles.	Garrison Flag.	Garrison Flag Hatbands.	Storm Flag.	R. Signal Flag.	R. Signal Flag Hatbands.	Camp Colors.	Guidons.	Trumpets.	Flags, with extremities plumed.	Files.



I certify that the foregoing Return exhibits a true and correct statement of all the Clothing and Camp and Garrison Equipage which has come into my possession, on account of the Quartermaster Department, in the month of *August* 18 *57*.

POST OFFICE OR STATION:

*Superior* *Wm. J. Johnson*  
*Agent* *Commanding Co. L.*

DATE:

*August 31. 1857*

*Retained Copy*

No. 15.

MONTHLY RETURN

OF

Stores pertaining to Bureau of Refugees,  
Freedmen and Abandoned Lands.

RENDERED BY

FOR THE

month of *August* 1867

*Retained Copy August 1867*

*10*



1867 978

on hand at *American Co.* in the month of *August* 1867. by *J. M. Robinson Agent Bureau W. P. & Co.*

I certify that the foregoing return exhibits a true and correct statement of all the property that has come into my hands on account of Bureau R  
F. & A. L. during the month ending on the *thirty first* of *August* 1867

*J. M. Robinson*  
Agent  
*11th - 1867*



*Ret. & Copy. August. 1867.*

*Wm. L. ...*  
No. 15.

MONTHLY RETURN

OF

Stores pertaining to Bureau of Refugees,  
Freedmen and Abandoned Lands.

RENDERED BY

FOR THE

month of *August* 1867.

## Monthly Return of Stores pertaining to Bureau of Refugees

WHEN RECEIVED	NO. OF INVOICE.	OF WHOM RECEIVED.							
			Office Table	1					
			Office Chests	2					
			Office Chairs	2					
			Blank Books	3					
			Ink Stands	1					
			Paper Stacks	1					
			Trunks	1					
			Eraser	1					
ON HAND PER LAST RETURN									
Aug 1. 1897		Waf. C. W. Watson W.M.							
TOTAL TO BE ACCOUNTED FOR.				1	2	4	3	1	1
WHEN ISSUED.									
TO WHOM ISSUED.									
TOTAL ISSUED.									
ON HAND TO BE ACCOUNTED FOR.									

NOTE.—One return with Vouchers and one without to be sent to the Commissioner's Bureau R. F. & A. L. through the Office of the Chief Quarter-master of the District, accompanied by letter of advice.

Freedmen and Abandoned Lands received, issued and remaining

1862	1863	1864	1865	1866	1867	1868	1869	1870	1871	1872	1873	1874	1875
100	100	100	100	100	200	10	10	400	1	1	1	1	1
						10	10	400	1	1	1	1	1

100	100	100	100	100	200	10	10	400	1	1	1	1	1
						3	1	125	1	1			

30	35	19	10	40	10	10	400	1	1	1	1	1	1
						3	1	125	1	1			

29	33	81	54	50	100	10	10	400	1	1	1	1	1
						3	1	125	1	1			

on hand at *Amicus Ga* in the month of *August* 1867.

by *J. M. Robinson Agent Bureau R. F. & A. L.*

I certify that the foregoing return exhibits a true and correct statement of all the property that has come into my hands on account of Bureau R. F. & A. L. during the month ending on the \_\_\_\_\_ of \_\_\_\_\_ 18\_\_

1867 504

*Retained Copy, August 1867.*  
*No 11*

*[Faint handwritten text]*  
[No. 33.]

No..... Form 15. ....186

List of Stores Expended

BY

*J. M. Robinson Agent*  
*Bureau R. F. & L.*  
at *Armenius Ga*  
in the month of *August* 1867

NO. 33.

List of Stores pertaining to Bureau R. F. & A. L., expended in the public service at American Camp, under the direction of J. M. Robinson Agent, in the month of August, 1867.

NO. OR QUANTITY.	ARTICLES.	APPLICATION.
Five (5) Quills	Letter Paper	Expended in Office of Agent
One (1) "	Footscep "	
One hundred twenty (120)	Envelopes	
Two (2) Sheets	Plotting paper	
Ten (10)	Envelopes "	

I certify on honor, that the several articles of Stores pertaining to Bureau R. F. & A. L., above enumerated, have been necessarily expended in the public service at this station, as indicated by the marginal remarks, annexed to them respectively.

(Signed in Duplicate.)

APPROVED.

*G. C. Selby*  
Col. 16<sup>th</sup> U.S. Inf. Post. Brig. Feb. 22, 1867  
and Asst Commissioner.

*J. M. Robinson*  
Bureau R. F. & A. L.

Retained Copy

No. 15.

MONTHLY RETURN

OF

Stores pertaining to Bureau of Refugees,  
Freedmen and Abandoned Lands.

RENDERED BY

*J. M. Robinson Agent  
at Americus Ga*

FOR THE

Month of August 1867

J. W. BURKE & CO., Stationers, Printers and Binders.

*Retained Copy August 1867*

*Mc 5*



MONTHLY RETURN OF STORES PERTAINING TO BUREAU OF REFUGEES, FREEDMEN AND ABANDONED LANDS,

Received, issued and remaining on hand at *Amory* in the month of *August* 186*7* by *J. M. Robinson* Agt Bureau R. F. & A. L.

WHEN RECEIVED.	NO. OF INVOICE.	OF WHOM RECEIVED.	ON HAND PER LAST RETURN.	WHEN ISSUED.	TO WHOM ISSUED.	TOTAL TO BE ACCOUNTED FOR.	TOTAL ISSUED.	ON HAND TO BE ACCOUNTED FOR.
		<i>Office Table</i>	<i>1</i>			<i>1</i>		<i>1</i>
		<i>Office Books</i>	<i>2</i>			<i>2</i>		<i>2</i>
		<i>Office Chairs</i>	<i>2</i>			<i>4</i>		<i>4</i>
		<i>Bureau Benches</i>	<i>3</i>			<i>3</i>		<i>3</i>
		<i>Iron Stands</i>	<i>1</i>			<i>1</i>		<i>1</i>
		<i>Paper Boxes</i>	<i>1</i>			<i>1</i>		<i>1</i>
		<i>Stool</i>	<i>1</i>			<i>1</i>		<i>1</i>
		<i>Crates</i>	<i>1</i>			<i>1</i>		<i>1</i>
		<i>Tables</i>	<i>100</i>			<i>100</i>		<i>63</i>
		<i>Spools</i>	<i>100</i>			<i>100</i>		<i>65</i>
		<i>Chairs</i>	<i>100</i>			<i>100</i>		<i>81</i>
		<i>Tables</i>	<i>100</i>			<i>100</i>		<i>84</i>
		<i>Tables</i>	<i>100</i>			<i>100</i>		<i>56</i>
		<i>Tables</i>	<i>200</i>			<i>200</i>		<i>182</i>
		<i>Tables</i>	<i>10</i>			<i>10</i>		<i>7</i>
		<i>Tables</i>	<i>10</i>			<i>10</i>		<i>9</i>
		<i>Tables</i>	<i>400</i>			<i>400</i>		<i>278</i>
		<i>Tables</i>	<i>1</i>			<i>1</i>		<i>1</i>
		<i>Tables</i>	<i>6</i>			<i>6</i>		<i>4</i>
		<i>Tables</i>	<i>6</i>			<i>6</i>		<i>4</i>
		<i>Tables</i>	<i>1</i>			<i>1</i>		<i>1</i>

NOTE.—One return with Vouchers and one without to be sent to the Commissioner Bureau R. F. & A. L., through the Office of the Asst. Commissioner of the District, accompanied by letter of advice.

I certify that the foregoing return exhibits a true and correct statement of all the property that has come into my hands on account of Bureau R. F. & A. L., during the month ending on the *31<sup>st</sup> day* of *August* 186*7*

*J. M. Robinson*  
Bureau R. F. & A. L.

FORM 15

*Attended by J. M. ... t. 1867.*  
*W.C.S.*

*[Signature]*  
[No. 33.]

No. .... Form 15. .... 186

List of Stores Expended

BY

.....  
.....  
at .....  
in the month of ..... 186

**NO. 33.**

List of Stores pertaining to Bureau R. F. & A. L., expended in the public service at \_\_\_\_\_, under the direction of \_\_\_\_\_, in the month of August, 186/ .

NO. OR QUANTITY.	ARTICLES.	APPLICATION.
10	Shirts	for use of the station
15	Shirts	for use of the station
20	Shirts	for use of the station
25	Shirts	for use of the station
30	Shirts	for use of the station
35	Shirts	for use of the station
40	Shirts	for use of the station
45	Shirts	for use of the station
50	Shirts	for use of the station
55	Shirts	for use of the station
60	Shirts	for use of the station
65	Shirts	for use of the station
70	Shirts	for use of the station
75	Shirts	for use of the station
80	Shirts	for use of the station
85	Shirts	for use of the station
90	Shirts	for use of the station
95	Shirts	for use of the station
100	Shirts	for use of the station

I certify on honor, that the several articles of Stores pertaining to Bureau R. F. & A. L., above enumerated, have been necessarily expended in the public service at this station, as indicated by the marginal remarks, annexed to them respectively.

(Signed in Duplicate.)

APPROVED .

Bureau R. F. & A. L.

and Ass't Commissioner.

Retained Copy, Sept 1867  
No 17.

*[Faint handwritten text]*  
[No. 33.]  
No. .... Form 15. .... 186

List of Stores Expended

BY

*[Handwritten signature]*  
at *[Handwritten location]*  
in the month of *September* 1867

*[Faint handwritten text]*

NO. 33.

List of Stores pertaining to Bureau R. F. & A. L., expended in the public service at St. Michael's Ga., under the direction of J. M. Robinson, Agt., in the month of September, 1867.

NO. OR QUANTITY.	ARTICLES.	APPLICATION.
Five (15)	Jackets	Issued to destitute poor people as per W.oucher
Three (13)	Hats	
Twenty one (21)	Trowsers	
Fourteen (14)	Suits	
Twenty one (21)	Shoes	
Sixteen (16)	Stockings	

I certify on honor, that the several articles of Stores pertaining to Bureau R. F. & A. L., above enumerated, have been necessarily expended in the public service at this station, as indicated by the marginal remarks, annexed to them respectively.

(Signed in Duplicate.)

APPROVED.

and Ass't Commissioner.

*J. M. Robinson*  
Bureau R. F. & A. L.

Retained Copy, September, 1867.  
10012

*Retained Copy*

No. 15.

MONTHLY RETURN

OF

Stores pertaining to Bureau of Refugees,  
Freedmen and Abandoned Lands,

RENDERED BY

*J. M. Robinson Agent  
Bureau R.F.S.L.*

FOR THE

Month of *September* 1867

NEW ERA JOB OFFICE, Atlanta, Georgia.

*Retained*

**MONTHLY RETURN OF STORES PERTAINING TO BUREAU OF REFUGEES, FREEDMEN AND ABANDONED LANDS,**

Received, issued and remaining on hand at *Amoy as before* in the month of *September* 186*7*, by *J. W. Robinson Agent*

WHEN RECEIVED.

NO. OF VOUCHER.

OF WHOM RECEIVED.

*11th Regt*  
*64th Regt*  
*Cyprus Company*  
*Marine's Co*  
*1st Island*  
*Pay Dept*  
*Prov*  
*Quar*  
*2d Regt*  
*3d Regt*  
*4th Regt*  
*5th Regt*  
*6th Regt*  
*7th Regt*  
*8th Regt*  
*9th Regt*  
*10th Regt*  
*11th Regt*  
*12th Regt*  
*13th Regt*  
*14th Regt*  
*15th Regt*  
*16th Regt*  
*17th Regt*  
*18th Regt*  
*19th Regt*  
*20th Regt*  
*21st Regt*  
*22nd Regt*  
*23rd Regt*  
*24th Regt*  
*25th Regt*  
*26th Regt*  
*27th Regt*  
*28th Regt*  
*29th Regt*  
*30th Regt*

ON HAND PER LAST REPORT.

*1 1 2 3 1 1 1 1 15 65 81 84 56 182 7 9 28 1 4 4 1*

WHEN ISSUED.

TOTAL TO BE ACCOUNTED FOR.

TO WHOM ISSUED.

*Expended in Office*  
*Issued to destitute Freedmen*

*1 2 4 3 1 1 1 1 15 65 81 84 56 182 7 9 28 1 4 4 1*  
*4 3 150 1/2 2 2 1/2*  
*15 13 21 14 5 16*

TOTAL ISSUED.

ON HAND TO BE ACCOUNTED FOR.

~~*1 1 2 3 1 1 1 1 15 65 81 84 56 182 7 9 28 1 4 4 1*~~  
*1 2 4 3 1 1 1 1 48 52 66 70 55 166 3 6 15 1/2 2 2 1/2*

NOTE.—One return with Vouchers and one without to be sent to the Commissioner Bureau R. F. & A. L. through the Office of the Assistant Commissioner of the District, accompanied by letter of advice.

I certify that the foregoing return exhibits a true and correct statement of all the property that has come into my hands on account of Bureau R. F. & A. L. during the month ending on the \_\_\_\_\_ of \_\_\_\_\_ 1867.

*Union*

[No. 33.]

*Retired 17 Sept 1867*

No. .... Form 15. .... 186

List of Stores Expended

BY

*J. M. Robinson*  
*Capt. Bureau P. P. Co.*  
*at Annapolis Pa.*

in the month of *September* 1867



NO. 33.

List of Stores pertaining to Bureau R. F. & A. L., expended in the public service at Americus, under the direction of A. M. Robinson Esq. in the month of September, 1862.

NO. OR QUANTITY.	ARTICLES.	APPLICATION.	
Forms (4)	Quire Letter Paper	Expended in Office of Agent Bureau R. F. & A. L.	
Three (3)	Three Pools Cap		
One hundred & fifty (150)	Envelopes		
One half (1/2)	Bottle Mad Put.		
Two (2)	Sheets Blotting Paper		
Two (2)	" Envelope Paper		
One half (1/2)	Bottle Mucilage		
Fifteen (15)	Jackets		Issued to Destitute Freedpeople
Thirteen (13)	Hats		
Twenty one (21)	Trousers		
Fourteen (14)	Shirts		
Twenty one (21)	Shoes		
Sixteen (16)	Stockings		

I certify on honor, that the several articles of Stores pertaining to Bureau R. F. & A. L., above enumerated, have been necessarily expended in the public service at this station, as indicated by the marginal remarks, annexed to them respectively.

(Signed in Duplicate)  
 APPROVED. C. C. Sibley  
Bot. Brig. Genl. U.S.A.  
 and Asst. Commissioner.

A. M. Robinson Esq.  
 Bureau R. F. & A. L.

Retained Copy  
2010

Retained Copy

[No. 33.]

No. .... Form 15. .... 186

List of Stores Expended

BY

J. K. Robinson  
Agent Bureau of Fish

at American Gu

in the month of September 1867

NO. 33.

List of Stores pertaining to Bureau R. F. & A. L., expended in the public service at Amnicus Ga., under the direction of J. M. Anderson, in the month of September, 1867.

NO. OR QUANTITY.	ARTICLES.	APPLICATION.
Fifteen (15)	Jackets	Issued to destitute freepeople as per Sub Voucher.
Thirteen (13)	Hats	
Twenty one (21)	Trowsers	
Fourteen (14)	Shirts	
Twenty one (21) p.	Shoes	
Sixteen p. (16)	Stockings	

I certify on honor, that the several articles of stores pertaining to Bureau R. F. & A. L. mentioned herein, have been necessarily expended in the public service at this station, as indicated by the several remarks, annexed to them respectively.

(Signed in Duplicate.)

APPROVED.

*J. M. Anderson*  
Bureau R. F. & A. L.

and Ass't Commissioner.

Retained Copy, Sept. 1867.  
No 13

Retained Copy  
No. 51.

MONTHLY RETURN  
OF  
CLOTHING, CAMP AND GARRISON EQUIPAGE,  
RENDERED BY

Co. \_\_\_\_\_, Reg't \_\_\_\_\_

FOR THE

Month ending 15 day of Sept 1867.

*Provision*

# Monthly Return of Clothing, Camp and Garrison Equipage,

WHEN RECEIVED.	No. of INVOICE.	OF WHOM RECEIVED.	CLOTHING.													
			Hats or caps.	Cap letters, emble, shell, & fringe.	Cap covers.	Forage caps.	Cords and tassels.	Ostrich feathers.	Eagles and rings, or emblems.	Numbers.	Sergeant Majors.	Quartermaster Sergeants.				
		ON HAND PER LAST RETURN.														
TOTAL TO BE ACCOUNTED FOR,																
WHEN ISSUED.	No. of Roll.	To WHOM ISSUED.														
		<i>Issued to the Garrison Regiment.</i>														
TOTAL ISSUED,																
ON HAND TO BE ACCOUNTED FOR,																

NOTE.—A letter of advice and duplicate of the Return, without vouchers, to be enclosed and sent with this to the Quartermaster General, Washington, D. C.  
 All communications to the Quartermaster General relating to "Clothing and Equipage," should be so endorsed on the envelope, under the word "Official," with the signature thereto of the officer writing the communication. Communications thus addressed and endorsed need no postage stamp.

received and issued at

*Amesbury, Va.*

in

CLOTHING.																				
UNIFORM COATS.				METALLIC SCAPES, PAIRS.		UNIFORM JACKETS.														
Ordinary Sergeants.	Chief Musicians.	First Sergeants.	Sergeants.	Corporals.	Musicians.	Privates.	Non-commissioned Staff.	Sergeants.	Corporals.	Sashes.	Sergeant Majors.	Quartermaster Sergeants.	First Sergeants.	Sergeants.	Corporals.	Privates.	Trowsers.	Flannel Sack Coats.	Flannel Shirts.	

the month of

*September*

, 18 *62*

by

*A. B. Robinson Capt. Bureau A. S. G. S.*

CLOTHING.

BED SACKS.

Drawers, pairs of.	Boots, Cavalry, pairs of.	Boots, Infantry, pairs of.	Stockings, pairs of.	Leather Stockings.	Great Coats.	Water-proof Ponchos.	Water-proof Blankets.	Great Coat Straps, No. of.	Blankets, woolen.							Single.	Double.
					<i>90</i>					<i>120</i>							
					<i>70</i>					<i>120</i>							
									<i>24</i>								
					<i>70</i>				<i>24</i>	<i>90</i>							

*Great Coat Straps*

CAMP AND GARRISON EQUIPAGE.

Spades.	Knapsacks, complete.	Haversacks.	Canteens and Straps.	Axes.	Axe Helves.	Camp Kettles.	Mess Pans.	Camp Hatchets.	Hatchet Handles.	Garrison Flag.	Garrison Flag Haulbars.	Storm Flag.	Revolving Flag.	Revolving Flag Haulbars.	Camp Colors.	Guidons.	Trumpets.	Bagges, with extra mouthpieces.	Fifes.	

CAMP AND GARRISON EQUIPAGE.

DRUMS.

Complete.	Tent's, leather.	Leads, snare.	Skins.	Sticks, pairs.	Drum Stick Carriages.	Cords.	Snare, set.	Wall Tents.	Wall Tent Poles.	Wall Tent Poles and Pins, sets.	Common Tents.	Common Tent Poles & Pins, sets.	Shelter Tents.	Shelter Tent Pins.	Iron Pots.	Pickaxes.	Pickaxe Handles.

CAMP AND GARRISON EQUIPAGE.

BOOKS AND BLANKS.

Complete.	Blank.	Blank.	Blank.	Blank.	Blank.	Blank.	Blank.	Blank.	Blank.	Blank.	Blank.	Blank.	Blank.	Blank.	Blank.	Blank.	Blank.	Blank.	Blank.	Blank.

I CERTIFY that the foregoing Return exhibits a true and correct statement of all the Clothing and Camp and Garrison Equipage which has come into my possession, on account of the Quartermaster Department, in the month of \_\_\_\_\_ 18 \_\_\_\_\_

POST OFFICE OR STATION: \_\_\_\_\_

\_\_\_\_\_  
*Commanding Co.*

DATE: \_\_\_\_\_



No. 51.

MONTHLY RETURN  
OF  
CLOTHING, CAMP AND GARRISON EQUIPAGE,  
RENDERED BY

*Wm. Robinson*  
Co. *1st* *Regt* *9th* *Inf* *U.S.*

FOR THE

Month ending *22* day of *September* 1867.

*Retained Copy, Co. 1st Regt, 9th Inf, U.S.*  
*No. 14*

# Monthly Return of Clothing, Camp and Garrison Equipage,

WHEN RECEIVED.	No. OF INVOICE.	OF WHOM RECEIVED.	CLOTHING.													
			Hats or caps.	Cap letters, castle, shell, & flame.	Cap covers.	Forage caps.	Cords and tassels.	Ostrich feathers.	Eagles and rings, or eagles.	Numbers.	Sergeant Majors'.	Quartermaster Sergeants'.				
		ON HAND PER LAST RETURN.														
TOTAL TO BE ACCOUNTED FOR.																
WHEN ISSUED.	No. of Roll.	To WHOM ISSUED.														
September 1847		To destitute freeman														
TOTAL ISSUED.																
ON HAND TO BE ACCOUNTED FOR.																

NOTE.—A letter of advice and duplicate of the Return, without vouchers, to be enclosed and sent with this to the Quartermaster General, Washington, D. C.  
 All communications to the Quartermaster General relating to "Clothing and Equipage," should be so endorsed on the envelope, under the word "Official," with the signature thereto of the officer writing the communication. Communications thus addressed and endorsed need no postage stamp.

received and issued at

*W. ...*

CLOTHING.																				
UNIFORM COATS.						METALLIC SCALES, PAIRS.		UNIFORM JACKETS.												
Ordnance Sergeants'.	Chief Musicians'.	First Sergeants'.	Sergeants'.	Corporals'.	Musicians'.	Privates'.	Non-commissioned Staff.	Sergeants'.	Corporals'.	Sashes.	Sergeant Majors'.	Quartermaster Sergeants'.	First Sergeants'.	Sergeants'.	Corporals'.	Privates'.	Trowsers.	Flannel Sack Coats.	Flannel Shirts.	

the month of *September*, 186*1*, by

*Wm Robinson* *Act. Bureau R.I. & C.*

CLOTHING.

DED SACKS.

CAMP AND GARRISON EQUIPAGE.

Boots, Cavalry, pairs of.	Boots, Infantry, pairs of.	Stockings, pairs of.	Leather Stocks.	Great Coats.	Waterproof Ponches.	Waterproof Blankets.	Great Coat Straps, No. of.	Blankets, woollen.	Single.	Double.
								70	126	
								16	120	
								27		
								21		
								70	98	

Spades.	Knapsacks, complete.	Haversacks.	Canteens and Straps.	Axes.	Axe Handles.	Camp Kettles.	Mess Pans.	Camp Hatchets.	Hatchet Handles.	Garrison Flag.	Garrison Flag Haulbands.	Storm Flag.	Recruiting Flag.	Recruiting Flag Haulbands.	Camp Colors.	Guidons.	Trumpets.	Bugles, with extra mouth-pieces.	Fibs.



I CERTIFY that the foregoing Return exhibits a true and correct statement of all the Clothing and Camp and Garrison Equipage which has come into my possession, on account of the Quartermaster Department, in the month of *September* 1867

POST OFFICE OR STATION: *Americus Ga* *J. H. Robinson Capt*  
*Comdr R. J. A. C. Commanding Co.*

DATE: *September*

*Retained Copy*

No. 15.

MONTHLY RETURN

OF

Stores pertaining to Bureau of Refugees,  
Freedmen and Abandoned Lands.

RENDERED BY

\_\_\_\_\_

FOR THE

Month of *October* 186*7*

J. W. BURKE & CO., Stationers, Printers and Binders.

*Retained Copy, October 1867*  
*no 22*



Retained Copy, October 1867  
No. 20.

[No. 33.]

No. .... Form 15. .... 186

List of Stores Expended

BY

*[Signature]*  
at *[Signature]*  
in the month of *October* 186



NO. 33.

List of Stores pertaining to Bureau R. F. & A. L., expended in the public service at  
....., under the direction of....., in the  
month of....., 186

NO. OR QUANTITY.	ARTICLES.	APPLICATION.
<i>1</i>	<i>1</i>	<i>1</i>
<i>2</i>	<i>2</i>	<i>2</i>
<i>3</i>	<i>3</i>	<i>3</i>
<i>4</i>	<i>4</i>	<i>4</i>
<i>5</i>	<i>5</i>	<i>5</i>
<i>6</i>	<i>6</i>	<i>6</i>
<i>7</i>	<i>7</i>	<i>7</i>
<i>8</i>	<i>8</i>	<i>8</i>
<i>9</i>	<i>9</i>	<i>9</i>
<i>10</i>	<i>10</i>	<i>10</i>
<i>11</i>	<i>11</i>	<i>11</i>
<i>12</i>	<i>12</i>	<i>12</i>
<i>13</i>	<i>13</i>	<i>13</i>
<i>14</i>	<i>14</i>	<i>14</i>
<i>15</i>	<i>15</i>	<i>15</i>
<i>16</i>	<i>16</i>	<i>16</i>
<i>17</i>	<i>17</i>	<i>17</i>
<i>18</i>	<i>18</i>	<i>18</i>
<i>19</i>	<i>19</i>	<i>19</i>
<i>20</i>	<i>20</i>	<i>20</i>
<i>21</i>	<i>21</i>	<i>21</i>
<i>22</i>	<i>22</i>	<i>22</i>
<i>23</i>	<i>23</i>	<i>23</i>
<i>24</i>	<i>24</i>	<i>24</i>
<i>25</i>	<i>25</i>	<i>25</i>
<i>26</i>	<i>26</i>	<i>26</i>
<i>27</i>	<i>27</i>	<i>27</i>
<i>28</i>	<i>28</i>	<i>28</i>
<i>29</i>	<i>29</i>	<i>29</i>
<i>30</i>	<i>30</i>	<i>30</i>
<i>31</i>	<i>31</i>	<i>31</i>

I certify on honor, that the several articles of Stores pertaining to Bureau R. F. & A. L., above enumerated, have been necessarily expended in the public service at this station, as indicated by the marginal remarks, annexed to them respectively.

(Signed in Duplicate.)

APPROVED.

*C. C. Schley*

Bureau R. F. & A. L.

and Ass't Commissioner.

Retained Copy. October, 1867  
No 15

Retained Copy  
No. 51.

MONTHLY RETURN  
OF  
CLOTHING, CAMP AND GARRISON EQUIPAGE,  
RENDERED BY

Co. \_\_\_\_\_, Reg't \_\_\_\_\_,

FOR THE

Month ending \_\_\_\_\_ day of \_\_\_\_\_, 1867.

*Retained Copy*

*Approved*

# Monthly Return of Clothing, Camp and Garrison Equipage,

WHEN RECEIVED.		CLOTHING.									
No. of INVOICE.	OF WHOM RECEIVED.	Hats or caps.	Cap letters, casel., shell, & blank.	Cap covers.	Forge caps.	Cords and tassels.	Ostrich feathers.	Flags and rings, or enghes.	Numbers.	Sergeant's Majors.	Quartermaster Sergeants.
	ON HAND PER LAST RETURN.										
TOTAL TO BE ACCOUNTED FOR,											
WHEN ISSUED.	No. of Roll.	To WHOM ISSUED.									
		<i>To substitute Freedmen</i>									
TOTAL ISSUED,											
ON HAND TO BE ACCOUNTED FOR,											

NOTE.—A letter of advice and duplicate of the Return, without vouchers, to be enclosed and sent with this to the Quartermaster General, Washington, D. C.  
 All communications to the Quartermaster General relating to "Clothing and Equipage," should be so endorsed on the envelope, under the word "Official," with the signature thereto of the officer writing the communication. Communications thus addressed and endorsed need no postage stamp.

received and issued at *San Antonio, Texas* in

CLOTHING.																				
Quartermaster Sergeants.	UNIFORM COATS.					METALLIC BUCKLES, PAIRS.		UNIFORM JACKETS.												
	Chief Musicians.	First Sergeants.	Sergeants.	Corporals.	Musicians.	Privates.	Non-commissioned Staff.	Sergeants.	Corporals.	Sashes.	Sergeant Majors.	Quartermaster Sergeants.	First Sergeants.	Sergeants.	Corporals.	Privates.	Trowsers.	Flannel Sack Coats.	Flannel Shirts.	

the month of

*October*

, 18*67*,

by

CLOTHING.

BED SACKS.

Drawers, pairs of.	Boots, Cavalry, pairs of.	Bootees, Infantry, pairs of.	Stockings, pairs of.	Leather Stocks.	Great Coats.	Waterproof Ponchos.	Waterproof Blankets.	Great Coat Straps, No. of.	Blankets, woolen.	Blankets, woolen.	Single.	Double.
					70				95			
					70				93			
					2				111			
					2				41			
					68				32			

4

CAMP AND GARRISON EQUIPAGE.

Spades.	Knapsacks, complete.	Haversacks.	Canteens and Straps.	Axes.	Axe Helves.	Camp Kettles.	Mess Pans.	Camp Hatchets.	Hatchet Handles.	Garrison Flag.	Garrison Flag Halliards.	Storm Flag.	Recruiting Flag.	Recruiting Flag Halliards.	Camp Colors.	Gudrons.	Trumpets.	Bugles, with extra mouth pieces.	Fifes.	

5



I CERTIFY that the foregoing Return exhibits a true and correct statement of all the Clothing and Camp and Garrison Equipage which has come into my possession, on account of the Quartermaster Department, in the month of *October* 186*7*.

POST OFFICE OR STATION:

*American Falls*

*J. M. [Signature]*

Commanding Co.

DATE: *31<sup>st</sup> October*

RECEIVED

Received  
No. 51.

Retained Copy. October 1867.  
No 12

MONTHLY RETURN  
OF  
CLOTHING, CAMP AND GARRISON EQUIPAGE,

RENDERED BY

*J. M. Robinson*  
Co. Bureau Regt *R. T. S. C.*

FOR THE

Month ending *31* day of *October*, 1867.

*Robinson*

*J. C.*

# Monthly Return of Clothing, Camp and Garrison Equipage,

received and issued at

*Fort Stevens, Virginia*

in

WHEN RECEIVED.	No. of INVOICE.	OF WHOM RECEIVED.	CLOTHING.														
			Hats or caps.	Cap letters, cusps, shell, & flame.	Cap covers.	Forage caps.	Cords and tassels.	Ostrich feathers.	Eagles and rings, or eagles.	Numerals.	Sergeant Majors.	Quartermasters or Sergeants.					
		ON HAND PER LAST RETURN.															
TOTAL TO BE ACCOUNTED FOR.																	
WHEN ISSUED.	No. of Roll.	To WHOM ISSUED.															
		<i>W. A. ...</i>															
TOTAL ISSUED.																	
ON HAND TO BE ACCOUNTED FOR.																	

WHEN RECEIVED.	No. of INVOICE.	OF WHOM RECEIVED.	CLOTHING.																				
			UNIFORM COATS.					METALLIC SCALES, PAIRS.			UNIFORM JACKETS.					Trowsers.		Flannel Sack Coats.		Flannel Shirts.			
			Colonel Sergeants.	Chief Musicians.	First Sergeants.	Sergeants.	Corporals.	Musicians.	Privates.	Non-commissioned Staff.	Sergeants.	Corporals.	Sashes.	Sergeant Majors.	Quartermaster Sergeants.	First Sergeants.	Sergeants.	Corporals.	Privates.	Trowsers.	Flannel Sack Coats.	Flannel Shirts.	

NOTE.—A letter of advice and duplicate of the Return, without vouchers, to be enclosed and sent with this to the Quartermaster General, Washington, D. C.  
All communications to the Quartermaster General relating to "Clothing and Equipage," should be so endorsed on the envelope, under the word "Official," with the signature thereto of the officer writing the communication. Communications thus addressed and endorsed need no postage stamp.



the month of *October*, 18*65*, by

*J. M. Robinson* Agent Bureau R. V. A. C.

CLOTHING.

BED SACKS.

Drawers, pairs of.	Boots, Cavalry, pairs of.	Boots, Infantry, pairs of.	Stockings, pairs of.	Leather Stocks.	Great Coats.	Waterproof Ponchos.	Waterproof Blankets.	Great Coat Straps, No. of.	Blankets, woolen.	Blankets, <i>Great Coats' Blankets</i> .	Single.	Double.
					70					93		
					70					93		
					2					41		
					2					41		
					60					80		

CAMP AND GARRISON EQUIPAGE.

Spades.	Knapsacks, complete.	Haversacks.	Canteens and Straps.	Axes.	Axe Helms.	Camp Kettles.	Mess Pans.	Camp Hatchets.	Hatchet Handles.	Garrison Flag.	Garrison Flag Hauliards.	Storm Flag.	Recruiting Flag.	Recruiting Flag Hauliards.	Camp Colors.	Guidons.	Trumpets.	Bags, with extra monthly issues.	Fifes.



I CERTIFY that the foregoing Return exhibits a true and correct statement of all the Clothing and Camp and Garrison Equipage which has come into my possession, on account of the Quartermaster Department, in the month of *October* 1867.

POST OFFICE OR STATION:

*Americus Ga.*

DATE:

*29<sup>th</sup> October 1867.*

*J. H. [Signature]*  
*10<sup>th</sup> [Signature]* Commanding Co.

Retained Copy, November 1867  
No. 1

No. 1 [No. 33.]  
Form 15. November 1867

List of Stores Expended

BY

J. M. Robinson Agent  
Bureau R.F.S. & L.  
at Americus Ga  
in the month of November 1867

(Signature)

NO. 33.

List of Stores pertaining to Bureau R. F. & A. L., expended in the public service at  
*Americus Ga.*, under the direction of *J. M. Robinson Agent.*, in the  
 month of *November*, 186*7*.

NO. OR QUANTITY.	ARTICLES.	APPLICATION.
<i>Seventeen (17)</i>	<i>Jackets</i>	<i>Issued to</i> <i>Freed People as per</i> <i>sub voucher</i> <i>No 1</i>
<i>Twelve (12)</i>	<i>Hats</i>	
<i>Eight (8)</i>	<i>Trowsers</i>	
<i>Three (3)</i>	<i>Shirts</i>	
<i>Three (3)</i>	<i>Shoes</i>	
<i>Thirty two (32)</i>	<i>Stockings</i>	
<i>Nineteen (19)</i>	<i>Jackets</i>	<i>Issued to</i> <i>Freed People as per</i> <i>sub Voucher</i> <i>No 2</i>
<i>Ten (10)</i>	<i>Hats</i>	
<i>Five pairs (5)</i>	<i>Trowsers</i>	
<i>Seven (7)</i>	<i>Shirts</i>	
<i>Three pairs (3)</i>	<i>Shoes</i>	
<i>Twenty six pairs (26)</i>	<i>Stockings</i>	

I certify on honor, that the above article of Stores pertaining to Bureau R. F. & A. L. enumerated, have been necessarily expended in the public service at this station, and that the following are the original remarks, annexed to the same, respectively.

(Sign in Duplicate)

APPROVED.

*C. C. Sibley*  
 and R. F. & A. L. Commissioner.

*J. M. Robinson*  
 Bureau R. F. & A. L.

Retained Copy, No. 32  
 Members

Retained Copy, November  
 No. 3

STATEMENT exhibiting the allowance of clothing to each soldier during his enlistment, and his proportion for each year respectively, as established by the Secretary of War.

CLOTHING	FOR FIVE YEARS.					Total in the five years.
	1st.	2d.	3d.	4th.	5th.	
Hat, trimmed.....	1	1	1	1	1	5
Forage Cap.....	1	1	1	1	1	5
Uniform Coat or Jacket.....	1	1	1	1	1	5
Blue Flannel Sack Coat.....	2	2	2	2	2	10
Trousers.....	3	3	3	3	3	15
Flannel Shirts.....	3	3	3	3	3	15
Flannel Drawers.....	3	2	2	2	2	14
Bootees, pairs.....	4	1	1	1	1	20
Stockings, pairs.....	1	3	1	1	4	20
Leather Stock.....			1			2
Great Coat.....	1					1
Stable Frock.....	1		1			2
Faigue Overall.....	1	1	1	1	1	5
Blanket.....	1		1			2

Receipts for clothing  
 recd. from ~~J. W. Robinson~~  
 J. W. Robinson



**NOTES.—Erasures and alterations of entries are prohibited.**

Regular and Extra Issues will not be blended in the same Record Roll.

Each signature, whether written by the soldier or acknowledged by him, must be witnessed.

Where no issues have been made, spaces will be filled by a parole, etc., as usual.

Mounted men may, at their option, receive *one* pair of "boots" and *one* pair of "gaiters" instead of *four* pairs of "boots".

As the Metallic Shoulder Seals, Letters, Numbers, Castles, and Stars and Devices of the Army are now being issued to the company property, in the same manner as are cashes, lanterns and signals, these seals, letters and stars and devices are now being issued to the company property and will be charged to the soldier or to the company as the case may be.



MAR 1867

Retained Copy. November, 1867  
No 25

Received Copy  
No. 51.

MONTHLY RETURN

OF

CLOTHING, CAMP AND GARRISON EQUIPAGE,

RENDERED BY

J. W. Robinson  
Co. B. Reg't 1st U.S. Col.

FOR THE

Month ending 26 day of November, 1867.

Robinson

Monthly Return of Clothing, Camp and Garrison Equipage,

received and issued at *American Legion* in

WHEN RECEIVED.	No. of INVOICE.	OF WHOM RECEIVED.	CLOTHING.																		
			Hats or caps.	Cap letters, emble, shield, & flame.	Cap covers.	Forage caps.	Cords and tassels.	Ostrich feathers.	Eagles and rings, or eagles.	Numbers.	Sergeant Majors.	Quartermaster Sergeants.									
		ON HAND PER LAST RETURN.																			
TOTAL TO BE ACCOUNTED FOR, . . . . .																					
WHEN ISSUED.	No. of Roll.	To WHOM ISSUED.																			
<i>November 1861</i>		<i>To Destitute Freedmen</i>																			
TOTAL ISSUED, . . . . .																					
ON HAND TO BE ACCOUNTED FOR, . . . . .																					

CLOTHING.																				
UNIFORM COATS.					METALLIC SCALDS, PAIRS.		UNIFORM JACKETS.													
Ordinary Sergeants.	Chief Musicians.	First Sergeants.	Sergeants.	Corporals.	Musicians.	Privates.	Non-commissioned Staff.	Sergeants.	Corporals.	Sashes.	Sergeant Majors.	Quartermaster Sergeants.	First Sergeants.	Sergeants.	Corporals.	Privates.	Trowsers.	Flannel Sack Coats.	Flannel Shirts.	

NOTE.—A letter of advice and duplicate of the Return, without vouchers, to be enclosed and sent with this to the Quartermaster General, Washington, D. C.  
 All communications to the Quartermaster General relating to "Clothing and Equipage," should be so endorsed on the envelope, under the word "Official," with the signature thereto of the officer writing the communication. Communications thus addressed and endorsed need no postage stamp.

NOV 1867

the month of *November*, 18*67*, by *J. M. Robinson Agent for H. P. S.*

CLOTHING.

BED SACKS.

Drawers, pairs of.	Boots, Cavalry, pairs of.	Bootees, Infantry, pairs of.	Stockings, pairs of.	Leather Stocks.	Great Coats.	Waterproof Ponchos.	Waterproof Blankets.	Great Coat Straps, No. of.	Blankets, woolen.	Blankets, cotton.	Single.	Double.
					68				32			
					68				62			
					25				12			
					25				12			
					43				40			

CAMP AND GARRISON EQUIPAGE.

Spades.	Knapsacks, complete.	Haversacks.	Canteens and Straps.	Axes.	Axe Blades.	Camp Kettles.	Mess Pans.	Camp Hatchets.	Hatchet Handles.	Garrison Flag.	Garrison Flag Haulbars.	Storm Flag.	Recruiting Flag.	Recruiting Flag Haulbars.	Camp Colors.	Guidons.	Trumpets.	Bugles, with extra mouth pieces.	Files.	

CAMP AND GARRISON EQUIPAGE.

DRUMS.	
Complete.	
Men's, leather.	
Men's, snare.	
Slings.	
Sticks, pairs.	
Drum Sock Carriages.	
Cords.	
Snare, set.	
Wall Tents.	
Wall Tent Flies.	
Wall Tent Poles and Pins, sets.	
Common Tents.	
Common Tent Poles & Pins, sets.	
Shelter Tents.	
Shelter Tent Pins.	
Iron Poles.	
Pickaxes.	
Pickaxe Handles.	

CAMP AND GARRISON EQUIPAGE.

BOOKS AND BLANKS.

Clothing Account Book.	
Descriptive Book.	
Order Book.	
Clothing Returns.	
Receipt Rolls.	
Final Statements.	

I certify that the foregoing Return exhibits a true and correct statement of all the Clothing and Camp and Garrison Equipage which has come into my possession, on account of the Quartermaster Department, in the month of *November* 186*7*.

POST OFFICE OR STATION: *Annville Pa* *J. B. Smith* *Annville Pa*  
*Wm. R. S. S. Commanding Co.*

DATE: *November 30<sup>th</sup> 1867*

Returned by  
No. 15.

Retained by J. November 1867  
No. 26

MONTHLY RETURN

OF  
Stores pertaining to Bureau of Refugees,  
Freedmen and Abandoned Lands,

RENDERED BY  
*J. M. ...*  
*Bureau R.F. & A.L.*

FOR THE  
Month of *November* 1867

1867

MONTHLY RETURN OF STORES PERTAINING TO BUREAU OF REFUGEES, FREEDMEN AND ABANDONED LANDS,

Received, issued and remaining on hand at *Anniston Ala* in the month of *August* 1867, by *J. H. Robinson*

WHEN RECEIVED.	NO. OF VOUCHER.	OF WHOM RECEIVED.	ON HAND PER LAST REPORT.	TOTAL TO BE ACCOUNTED FOR.	WHEN ISSUED.	TO WHOM ISSUED.	TOTAL ISSUED.	ON HAND TO BE ACCOUNTED FOR.
		<i>John A. ...</i>	<i>1</i>	<i>1</i>	<i>November 1867</i>	<i>To Institute Freedmen</i>	<i>1</i>	<i>1</i>
		<i>...</i>	<i>2</i>	<i>2</i>			<i>2</i>	<i>2</i>
		<i>...</i>	<i>4</i>	<i>4</i>			<i>4</i>	<i>4</i>
		<i>...</i>	<i>3</i>	<i>3</i>			<i>3</i>	<i>3</i>
		<i>...</i>	<i>1</i>	<i>1</i>			<i>1</i>	<i>1</i>
		<i>...</i>	<i>1</i>	<i>1</i>			<i>1</i>	<i>1</i>
		<i>...</i>	<i>1</i>	<i>1</i>			<i>1</i>	<i>1</i>
		<i>...</i>	<i>36</i>	<i>36</i>			<i>36</i>	<i>36</i>
		<i>...</i>	<i>22</i>	<i>22</i>			<i>22</i>	<i>22</i>
		<i>...</i>	<i>13</i>	<i>13</i>			<i>13</i>	<i>13</i>
		<i>...</i>	<i>10</i>	<i>10</i>			<i>10</i>	<i>10</i>
		<i>...</i>	<i>6</i>	<i>6</i>			<i>6</i>	<i>6</i>
		<i>...</i>	<i>70</i>	<i>70</i>			<i>58</i>	<i>12</i>

NOTE.—One return with Vouchers and one without to be sent to the Commissioner Bureau R. F. & A. L., through the Office of the Assistant Commissioner of the District, accompanied by letter of advice.

I certify that the foregoing return exhibits a true and correct statement of all the property that has come into my hands on account of Bureau R. F. & A. L., during the month ending on the *31st day* of *August* 1867.  
*J. H. Robinson*  
Treasurer R. F. & A. L.

*Returned Copy*

No. 15.

MONTHLY RETURN

OF

Stores pertaining to Bureau of Refugees,  
Freedmen and Abandoned Lands,

RENDERED BY

*Dec 1/67*

FOR THE

Month of \_\_\_\_\_ 186

NEW ERA JOB OFFICE, Atlanta, Georgia.



MONTHLY RETURN OF STORES PERTAINING TO BUREAU OF REFUGEES, FREEDMEN AND ABANDONED LANDS,

Received, issued and remaining on hand at *Americus Ga* in the month of *December* 186*7*, by *J. M. Robinson Agent*

WHEN RECEIVED.	NO. OF VOUCHER.	OF WHOM RECEIVED.	Office Tables	Office Desk	Office Chairs	Blank Books	Ink Stand	Paper-folder	Ruler	Eraser	Shoelaces	Flag
			2	1	4	3	1	1	1	1	12	
		<i>Ch. Watson</i>										1
			2	1	4	3	1	1	1	1	12	1
WHEN ISSUED.		TO WHOM ISSUED.										
			TOTAL ISSUED.									
			ON HAND TO BE ACCOUNTED FOR.									

NOTE.—One return with Vouchers and one without to be sent to the Commissioner Bureau R., F. & A. L., through the Office of the Assistant Commissioner of the District, accompanied by letter of advice.

I certify that the foregoing return exhibits a true and correct statement of all the property that has come into my hands on account of Bureau R., F. & A. L., during the month ending on the *31<sup>st</sup>* day of *December* 186*7*  
*J. M. Robinson Agent*  
 Bureau R. & A. L.

Retained Copy December 1867  
No 53

Retained Copy  
No. 51.

MONTHLY RETURN

OF

CLOTHING, CAMP AND GARRISON EQUIPAGE,

RENDERED BY

J. M. Robinson  
Co Agent Bureau R. F. & A. L.

FOR THE

Month ending 31<sup>st</sup> day of December, 1867.

Comptroller

# Monthly Return of Clothing, Camp and Garrison Equipage.

received and issued at *Americus Georgia* in

WHEN RECEIVED.		CLOTHING.									
No. of INVOICE.	OF WHOM RECEIVED.	Hats or caps	Cap letters, castle, shell, & flame	Cap covers.	Forage caps.	Cords and tassels.	Ostrich feathers.	Eagles and rings, or eagles.	Numbers.	Sergeant's Medals.	Quartermaster's Sergeants.
		ON HAND PER LAST RETURN.									
TOTAL TO BE ACCOUNTED FOR.											
WHEN ISSUED.	No. of Roll.	To WHOM ISSUED.									
<i>December 1867</i>		<i>To Destitute Freedmen</i>									
TOTAL ISSUED.											
ON HAND TO BE ACCOUNTED FOR.											

CLOTHING.																				
Ordnance Sergeants.	UNIFORM COATS.					METALLIC SCALES, PAIRS.		UNIFORM JACKETS.												
	Major Musicians.	First Sergeants.	Sergeants.	Corporals.	Musicians.	Privates.	Non-commissioned Staff.	Sergeants.	Corporals.	Sashes.	Sergeant Majors.	Quartermaster Sergeants.	First Sergeants.	Sergeants.	Corporals.	Privates.	Trowsers.	Flannel Sack Coats.	Flannel Shirts.	

NOTE.—A letter of advice and duplicate of the Return, without vouchers, to be enclosed and sent with this to the Quartermaster General, Washington, D. C.  
 All communications to the Quartermaster General relating to "Clothing and Equipage," should be so endorsed on the envelope, under the word "Official," with the signature thereto of the officer writing the communication. Communications thus addressed and endorsed need no postage stamp.

the month of *December*, 186*7*,

by

*J. M. V. ... Agent Bureau R. F. & A. L.*

CLOTHING.

BED SACKS.

CAMP AND GARRISON EQUIPAGE.

Drawers, pairs of.	Boots, Cavalry, pairs of.	Bootees, Infantry, pairs of.	Stockings, pairs of.	Leather Stocks.	Great Coats. <i>Foot</i>	Water-proof Ponchos.	Water-proof Blankets.	Great Coat Straps, No. of.	Blankets, woolen.	<i>Great Coat Straps</i>
					43					40
					43					40
					17					40
					26					0

Shades.	Knapsacks, complete.	Haversacks.	Canteens and Straps.	Axes.	Axe Helves.	Camp Kettles.	Mess Pans.	Camp Hatchets.	Hatchet Handles.	Garrison Flag.	Garrison Flag Halliards.	Storm Flag.	Revolving Flag.	Revolving Flag Halliards.	Camp Colors.	Guidons.	Trumpets.	Binoculars, with extra barrels.	Fifes.
											1								

CAMP AND GARRISON EQUIPAGE.

DRUMS.	
Complete.	
Heads, leather.	
Heads, snare.	
Slings.	
Sticks, pairs.	
Drum Stick Carriages.	
Cords.	
Snares, set.	
Wall Tents.	
Wall Tent Flies.	
Wall Tent Poles and Pins, sets.	
Common Tents.	
Common Tent Poles & Pins, sets.	
Shelter Tents.	
Shelter Tent Pins.	
Iron Pots.	
Pickaxes.	
Pickaxe Handles.	

CAMP AND GARRISON EQUIPAGE.

BOOKS AND BLANKS.

Clothing Account Book.	
Descriptive Book.	
Order Book.	
Clothing Returns.	
Receipt Rolls.	
Final Statements.	

I certify that the foregoing Return exhibits a true and correct statement of all the Clothing and Camp and Garrison Equipage which has come into my possession, on account of the Quartermaster Department, in the month of *December* 18*67*.

POST OFFICE OR STATION: *Americus Ga.* ..... *Commending Co.*  
DATE: *December 31<sup>st</sup> 1867*

No. 15.

MONTHLY RETURN

OF

Stores pertaining to Bureau of Refugees,  
Freedmen and Abandoned Lands,

RENDERED BY

*J. M. Robinson*

*Agent*

FOR THE

Month of *January* 1868

NEW ERA JOB OFFICE, Atlanta, Georgia.

*1568*

**MONTHLY RETURN OF STORES PERTAINING TO BUREAU OF REFUGEES, FREEDMEN AND ABANDONED LANDS,**

Received, issued and remaining on hand at *Americus Georgia* in the month of *January* 1868, by *J. W. Robinson, Agent*

WHEN RECEIVED.	NO. OF VOUCHER.	OF WHOM RECEIVED.	WHEN ISSUED.	TO WHOM ISSUED.
		<i>Coffee</i>		
		<i>Wine Tables</i>		
		<i>Dishes</i>		
		<i>Stoves</i>		
		<i>Paper folder</i>		
		<i>Books</i>		
		<i>Crates</i>		
		<i>Shavings</i>		
		<i>Times letter paper</i>		
		<i>Stationery</i>		
		<i>Envelopes</i>		
		<i>Envelopes paper</i>		
		<i>Shirts &amp; Buttons paper</i>		
		<i>Buttons</i>		
		<i>Boots</i>		
		<i>Office tape</i>		
		<i>Wool</i>		
		<i>Flax</i>		
ON HAND PER LAST REPORT.				
		<i>1 2 4 3 1 1 1 1 12 5 2 350 2 1 1 5 36 1</i>		
		<i>1 2 4 3 1 1 1 1 12 5 2 350 2 1 1 5 36 1</i>		
TOTAL TO BE ACCOUNTED FOR.				
		<i>1 2 4 3 1 1 1 1 12 5 2 350 2 1 1 5 36 1</i>		
TOTAL ISSUED.				
		<i>1 2 4 3 1 1 1 1 12 5 2 350 2 1 1 5 36 1</i>		

*12*

NOTE.—One return with Vouchers and one without to be sent to the Commissioner Bureau R. F. & A. L., through the Office of the Assistant Commissioner of the District, accompanied by letter of advice.

I certify that the foregoing return exhibits a true and correct statement of all the property that has come into my hands on account of Bureau R. F. & A. L., during the month ending on the *31st* of *January* 1868 of *J. W. Robinson*



NEW ERA

*W. H. ...*

No. 15.

MONTHLY RETURN

OF

Stores pertaining to Bureau of Refugees,  
Freedmen and Abandoned Lands,

RENDERED BY

*W. H. ...*

FOR THE

Month of *November*, 1868

NEW ERA JOB OFFICE, Atlanta, Georgia.

**MONTHLY RETURN OF STORES PERTAINING TO BUREAU OF REFUGEES, FREEDMEN AND ABANDONED LANDS,**

Received, issued and remaining on hand at *Americus Georgia* in the month of *January* 186*5*, by *W. Robinson. Agent*

WHEN RECEIVED.	NO. OF VOUCHER.	OF WHOM RECEIVED.	ON HAND PER LAST REPORT.	WHEN ISSUED.	TO WHOM ISSUED.	TOTAL ISSUED.
		<i>Upper Bureau</i>	<i>1</i>			<i>1</i>
		<i>Upper Bureau</i>	<i>2</i>			<i>2</i>
		<i>Upper Bureau</i>	<i>4</i>			<i>4</i>
		<i>Blanche B. 183</i>	<i>3</i>			<i>3</i>
		<i>Iron stands</i>	<i>2</i>			<i>2</i>
		<i>Paper folder</i>	<i>1</i>			<i>1</i>
		<i>Ruler</i>	<i>1</i>			<i>1</i>
		<i>Crates</i>	<i>1</i>			<i>1</i>
		<i>clothes</i>	<i>1</i>			<i>1</i>
		<i>Dinner</i>	<i>12</i>			<i>12</i>
		<i>Letter paper</i>				
		<i>Blank paper</i>	<i>5</i>			<i>5</i>
		<i>Blank paper</i>	<i>2</i>			<i>2</i>
		<i>Blank paper</i>	<i>350</i>			<i>350</i>
		<i>Blank paper</i>	<i>2</i>			<i>2</i>
		<i>Blank paper</i>	<i>1</i>			<i>1</i>
		<i>Blank paper</i>	<i>1</i>			<i>1</i>
		<i>Blank paper</i>	<i>5</i>			<i>5</i>
		<i>Blank paper</i>	<i>36</i>			<i>36</i>
		<i>Blank paper</i>	<i>1</i>			<i>1</i>
		<b>TOTAL TO BE ACCOUNTED FOR.</b>	<i>1 2 4 3 2 1 1 1 1 12 5 2 350 2 1 1 5 36 1</i>			<i>1 2 4 3 2 1 1 1 1 12 5 2 350 2 1 1 5 36 1</i>
		<b>WHEN ISSUED.</b>			<i>To destitute people</i>	<i>12</i>
		<b>TOTAL ISSUED.</b>				<i>12</i>
		<b>ON HAND TO BE ACCOUNTED FOR.</b>	<i>1 2 4 3 2 1 1 1 1 0 5 2 350 2 1 1 5 36 1</i>			<i>1 2 4 3 2 1 1 1 1 0 5 2 350 2 1 1 5 36 1</i>

NOTE.—One return with Vouchers and one without to be sent to the Commissioner Bureau R. F. & A. L. through the Office of the Assistant Commissioner of the District, accompanied by letter of advice.

I certify that the foregoing return exhibits a true and correct statement of all the property that has come into my hands on account of Bureau R. F. & A. L., during the month ending on the \_\_\_\_\_ of \_\_\_\_\_ 186\_\_\_\_\_

*Returned Copy*

No. 15.

MONTHLY RETURN

OF

Stores pertaining to Bureau of Refugees,  
Freedmen and Abandoned Lands,

RENDERED BY

*J. W. Robinson*  
*Agent*

FOR THE

Month of *January* 186*8*

NEW ERA JOB OFFICE, Atlanta, Georgia.



No. 15.

MONTHLY RETURN

OF

Stores pertaining to Bureau of Refugees,  
Freedmen and Abandoned Lands,

RENDERED BY

*J. M. Robinson*  
*Agent*

FOR THE

Month of *January* 1868

NEW ERA JOB OFFICE, Atlanta, Georgia.

MONTHLY RETURN OF STORES PERTAINING TO BUREAU OF REFUGEES, FREEDMEN AND ABANDONED LANDS,

Received, issued and remaining on hand at *Americus Georgia* in the month of *January* 186*8*, by *J. W. Robinson*

WHEN RECEIVED.	NO. OF VOUCHER.	OF WHOM RECEIVED.	WHEN ISSUED.	TO WHOM ISSUED.
		<i>Office, etc.</i>		
		<i>Office, etc.</i>		
		<i>Office, etc.</i>		
		<i>Blank Books</i>		
		<i>Smith House</i>		
		<i>Paper, Folders</i>		
		<i>Rubber</i>		
		<i>C. Water</i>		
		<i>Stockings</i>		
		<i>Leaves yellow paper</i>		
		<i>Foot's cap</i>		
		<i>C. no. paper</i>		
		<i>C. no. paper</i>		
		<i>Sheets writing paper</i>		
		<i>Bottle Red. ink</i>		
		<i>Bottle. Ink</i>		
		<i>Office tape</i>		
		<i>Sho. pins</i>		
		<i>String</i>		
ON HAND PER LAST REPORT.				
		<i>1 2 4 3 1 1 1 1 12 5 2 350 2 1 1 5 36 1</i>		
TOTAL TO BE ACCOUNTED FOR.				
		<i>1 2 4 3 1 1 1 1 12 5 2 350 2 1 1 5 36 1</i>		
WHEN ISSUED.				
TOTAL ISSUED.				
ON HAND TO BE ACCOUNTED FOR.				
		<i>1 2 4 3 1 1 1 1 12 5 2 350 2 1 1 5 36 1</i>		

NOTE.—One return with Vouchers and one without to be sent to the Commissioner Bureau R., F. & A. L., through the Office of the Assistant Commissioner of the District, accompanied by letter of advice.

I certify that the foregoing return exhibits a true and correct statement of all the property that has come into my hands on account of Bureau R., F. & A. L., during the month ending on the *31<sup>st</sup>* of *January* 186*8*

[No. 33.]

No. .... Form 15. .... 186

List of Stores Expended

BY

*Full. Robinson*  
*Bureau R. F. & A. L.*

at *Albany Ga*  
in the month of *January* 1868

CHIEF U. S. OFFICE, BUREAU R. F. & A. L., GA.  
ATLANTA, GA., *Feb 5th* 1868

RESPECTFULLY returned, approved.  
By order of Bvt. Brig'r. Gen'l. C. C. SIBLEY.

2d Lieut. 16th U. S. Infantry  
A. A. A. G.

Bureau R. F. & A. L.  
Headquarters Sub-District of Albany  
Albany Ga. *February 10th* 1868.

Respectfully forwarded  
*to J. M. Robinson Esq.*  
*Agt. de. Americus Ga.*

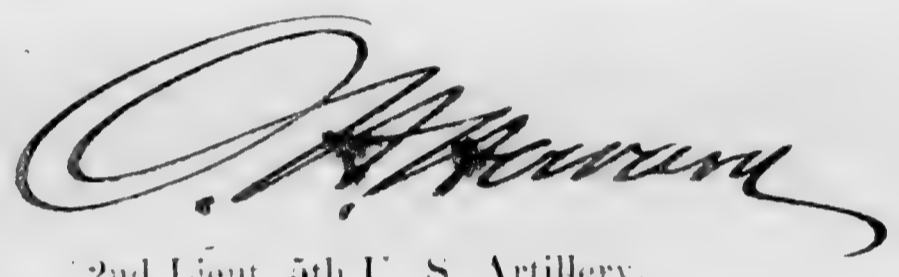

2nd Lieut. 5th U. S. Artillery.  
Sub-Assistant Commissioner.

NO. 33.

List of Stores pertaining to Bureau R. F. & A. L., expended in the public service at Amherst, Va., under the direction of J. M. [unclear], in the month of January, 1868.

NO. OR QUANTITY.	ARTICLE.	APPLICATION.
12.	Twelve pairs Stockings	To destitute poor people as per sub-voucher No 1

I certify on honor, that the several articles of Stores pertaining to Bureau R. F. & A. L., enumerated, have been necessarily expended in the public service at this station, as indicated by the marginal remarks, annexed to them respectively.

(Signed in Duplicate.)

APPROVED.

*B. C. Silbey*  
Bvt Brig Genl and Ass't Commissioner.

*J. M. [unclear]*  
Bureau R. F. & A. L.



Retained Copy  
No. 51.

MONTHLY RETURN

OF

CLOTHING, CAMP AND GARRISON EQUIPAGE,

RENDERED BY

*Retained Copy*

Co. \_\_\_\_\_, Reg't \_\_\_\_\_,

FOR THE

Month ending *31<sup>st</sup>* day of *January*, 186*8*.

Monthly Return of Clothing, Camp and Garrison Equipage,

received and issued at *Monterey* in

WHEN RECEIVED.		CLOTHING.										
No. of INVOICE.	OF WHOM RECEIVED.	Hats or caps.	Cap liners, caps, shawl & flange.	Cap covers.	Forage caps.	Cords and tassels.	Ostrich feathers.	Eagles and rings, or angles.	Numbers.	Sergeant Majors.	Quartermaster Sergeants.	
	ON HAND PER LAST RETURN.											
TOTAL TO BE ACCOUNTED FOR.												
WHEN ISSUED.	No. of Roll.	To Whom ISSUED.										
TOTAL ISSUED.												
ON HAND TO BE ACCOUNTED FOR.												

CLOTHING.										
UNIFORM COATS.						METALLIC SCALDS, PAIRS.			UNIFORM JACKETS.	
Outrance Sergeants.	Chief Musicians.	First Sergeants.	Sergeants.	Corporals.	Musicians.	Privates.	Non-commissioned Staff.	Sergeants.	Corporals.	Sables.
Sergeant Majors.	Quartermaster Sergeants.	First Sergeants.	Sergeants.	Corporals.	Privates.	Trowsers.	Flannel Shod Coats.	Flannel Suits.		

Note.—A letter of advice and duplicate of the return, without vouchers, to be enclosed and sent with this to the Quartermaster General, Washington, D. C.  
 All communications to the Quartermaster General relating to "Clothing and Equipage" should be so endorsed on the envelope, under the word "Official," with the signature thereto of the officer writing the communication. Communications thus addressed and endorsed need no postage stamp.

the month of

, 18 ,

by

CLOTHING.

BED SACS.

Drawers, pairs of.	Boots, Cavalry, pairs of.	Bootees, Infantry, pairs of.	Stockings, pairs of.	Leather Stocks.	Great Coats.	Water-proof Ponchos.	Water-proof Blankets.	Great Coat Straps, No. of.	Blankets, woolen.							Single.	Double.
					26												
					26												
					26												
					26												
					0												

CAMP AND GARRISON EQUIPAGE.

Shades.	Knives, complete.	Haversacks.	Canteens and Straps.	AXES.	Axe Helms.	Camp Kettles.	Mess Pans.	Camp Hatchets.	Handker Handies.	Garrison Flag.	Garrison Flag Haulbands.	Steam Flag.	Revolving Flag.	Revolving Flag Haulbands.	Camp Colors.	Guidons.	Trampers.	Flags, withes, &c.	Flags.

CAMP AND GARRISON EQUIPAGE.

DRUMS.	
Comp. Jere.	
Drumsticks, better.	
Drumsticks, square.	
Sticks, pairs.	
Drum Stick Carriages.	
Cords.	
Snare, set.	
Wall Tents.	
Wall Tent Poles.	
Wall Tent Poles and Pins, sets.	
Common Tents.	
Common Tent Poles & Pins, sets.	
Shelter Tents.	
Shelter Tent Pins.	
Iron Pots.	
Pickaxes.	
Pickaxe Handles.	

CAMP AND GARRISON EQUIPAGE.

BOOKS AND BLANKS.

	Trading Account Book.	
	Descriptive Book.	
	Order Book.	
	Clothing Returns.	
	Receipt Rolls.	
	Final Statements.	

PAR 100

I certify that the foregoing Return exhibits a true and correct statement of all the Clothing and Camp and Garrison Equipage which has come into my possession, on account of the Quartermaster Department, in the month of \_\_\_\_\_ 18\_\_\_\_

POST OFFICE OR STATION: .....

.....  
*Commanding Co.*

DATE:

APR 1868

*Retained Copy*

No. 15.

MONTHLY RETURN

OF

Stores pertaining to Bureau of Refugees,  
Freedmen and Abandoned Lands,

RENDERED BY

FOR THE

*Month of February 1868*

NEW ERA JOB OFFICE, Atlanta, Georgia.

*Retained Copy*

*Retained Copy*



*Returned Copy*  
[No. 33.]  
No..... Form 15. ....186

List of Stores Expended

BY

*J. M. Robinson*  
*Bureau R. F. & A. L.*  
at *Amory Ga* ..  
in the month of *February* 1868 ..

OFFICE ASS'T. COM'R. BUREAU R. F. & A. L., GA.  
ATLANTA, GA. *March 5* 1868

RESPECTFULLY returned, approved.  
By order of Bvt. Brig'r. Gen'l. C. C. SIBLEY.

2d Lieut. 16th U. S. Infantry  
A. A. A. G.



NO. 33.

List of Stores pertaining to Bureau R. F. & A. L., expended in the public service at Americus Ga., under the direction of J. M. Robinson, in the month of February, 1868.

NO. OR QUANTITY.	ARTICLES.	APPLICATION.
Three (3) Quires	Letter Paper	Expended in <sup>Agents</sup> Office
One (1) Quire	foolscap	" " "
One hundred & Seventy five (175)	Envelopes	" " "
One (1) Sheet	Blotting Paper	" " "
One Half Doz	Bottle Red Ink	" " "
One (1) Piece	Office tape	" " "
Twenty (20)	Steel Pens	" " "

I certify on honor, that the several articles of Stores pertaining to Bureau R. F. & A. L., above enumerated, have been necessarily expended in the public service at this station, as indicated by the marginal remarks, annexed to them respectively.

(Signed in Duplicate.)

APPROVED.

*G. C. Sibley*

and Ass't Commissioner.

*J. M. Robinson*  
Bureau R. F. & A. L.

APR 1868

*[Handwritten signature]*

[No. 33.]

No. *1* Form 15. *March* 1868

List of Stores Expended

BY

*[Handwritten signature]*  
*[Handwritten signature]*  
at *[Handwritten signature]*

in the month of *March* 1868

OFFICE ASS'T. COM'R. BUREAU R. F. & A. L., GA.

ATLANTA, GA., *April 9* 1868

RESPECTFULLY returned, approved.

By order of Brig'r. Gen'l. C. C. SIBLEY.

*[Handwritten signature]*  
2d Lieut. 16th U. S. Infantry  
A. A. A. G.

*[Faint handwritten mark]*

NO. 33.

of Stores pertaining to Bureau R. F. & A. L. expended in the public service at Amherst under the direction of J. S. [Signature] in the month of March, 1868.

NO. OR QUANTITY.	ARTICLES.	APPLICATION.
Case (20) Quills	Letter Paper	for [marginal note]
Case (1) Ink	Cap	" " "
Case (1) [unclear]	Envelopes	" " "
Case (1) [unclear]	Stationery	" " "
Case (1) [unclear]	Stationery	" " "
Case (1) [unclear]	Mucilage	" " "
Case (1) [unclear]	Stationery	" " "
Case (1) [unclear]	Stationery	" " "

I certify on honor, that the several articles of Stores pertaining to Bureau R. F. & A. L., above enumerated, have been necessarily expended in the public service at this station, as indicated by the marginal remarks, annexed to them respectively.

(Signed in Duplicate.)

APPROVED.  
[Signature]  
B. B. [unclear] and Ass't Commissioner.

[Signature]  
Bureau R. F. & A. L.

NATIONAL ARCHIVES AND RECORDS ADMINISTRATION  
MICROFILM PUBLICATIONS

Roll 40

Target 6

**Americus (Dispensary)**

Letters Sent

Volume (140)

Aug.-Nov. 1868

Volume pages were filmed sequentially.  
Blank pages were not filmed.

PHOTODUPLICATION

GEORGIA.

*Septimo Seni-*  
*Inde, page*  
*Americano de*  
*Hospital.*

HOSPITAL DEPT  
U. S. ARMY.

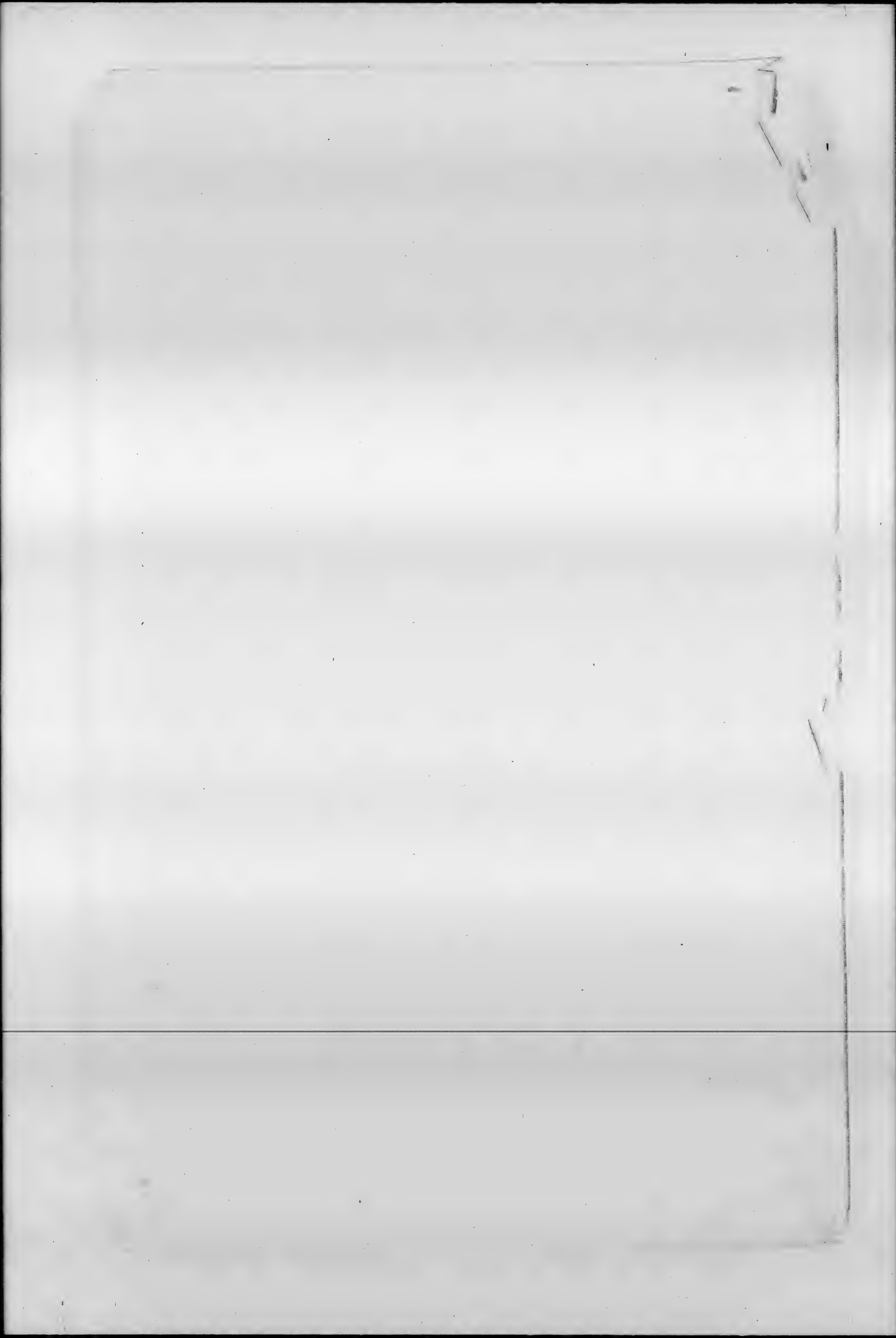

Office Dep. W. R. F. & A. S.  
Americus, Ga. Aug. 31/58

Dr. James M. Quincy  
Surgeon in Chief, Dis. Georgia  
Atlanta, Ga.  
Sir

I have the honor to transmit  
herewith my report of sick and wounded  
freedmen for the month of August 1858

Very respectfully,  
J. H. Carter

West. 11/2/58

Quincy

Dr. James M.  
Surgeon in Chief, Dis. Ga.  
Atlanta, Ga.  
Sir

Office W. R. F. & A. S.  
Americus, Ga. Aug 31/58

I have the honor to trans-  
mit herewith my report of persons  
and articles seized for the month  
of August 1858

Very respectfully,  
J. H. Carter

West. 11/2/58

Quincy

Dr. James M.  
Surgeon in Chief, Dis. Georgia  
Atlanta, Ga.  
Sir

Office Dep. W. R. F. & A. S.  
Americus, Ga. Aug. 31/58

I have the honor to transmit  
herewith my vouchers for services of  
W. R. F. & A. S. from Aug. 5<sup>th</sup> to Aug. 31<sup>st</sup> 1858

Very respectfully  
Yr. Obedt. Servt.  
J. M. Carter  
U.S. A. M.D.

Office Disb. B.R. & A.L.  
Americas, Ga. Aug. 31/58

Sir

Dr. James M.  
Surg. in Chf. Dis. Sec.  
Atlanta, Ga.

I have the honor to transmit herewith  
the vouchers for the rest of the  
month for the use of Disb. money from  
13<sup>th</sup> to 31<sup>st</sup> Aug. 1858

Very respectfully  
Yr. Obedt. Servt.  
J. M. Carter  
U.S. A. M.D.

Office Disb. B.R. & A.L.  
Americas, Ga. Sept 12/58

Sir

Dr. James M.  
Surg. in Chf. Dis. Sec.  
Atlanta, Ga.

I have the honor to transmit to  
you my report of sick &  
wound prisoners for the month  
ending Saturday Sept 5/58.

Very respectfully  
Yr. Obedt. Servt.  
James M. Carter  
U.S. A. M.D.

Office Disb. B.R. & A.L.  
Americas, Ga. Aug 31/58

Sir

James M.  
Surg. in Chf. Dis. Sec.  
Atlanta, Ga.

I have the honor to transmit herewith  
my report for the month of August for  
prisoners and articles kind, with vouchers  
appertaining thereto

Very respectfully  
Yr. Obedt. Servt.  
J. M. Carter  
U.S. A. M.D.

Office Disb. B.R. & A.L.  
Americas, Ga. Sept 12/58

Sir

U.S. A. M.D.  
Atlanta, Ga.

I have the honor  
to transmit herewith duplicate copies  
of the M.D. & Hosp. reports recd. from  
you, and to submit that the articles  
were of good quality and in good  
condition & corresponding with the  
invoice.

Very respectfully  
Yr. Obedt. Servt.  
J. M. Carter  
U.S. A. M.D.



Office Surg. B.R. & A.S.  
Americus, Ga. Sept. 12/58

L. A. Edwards  
Surg. M.C.  
A.M. Office B.R. & A.S.  
Washington, D.C.

Sir

I have the honor to transmit herewith triplicate receipt of med. & Hosp. property from W. A. N. Dillinger M.C. together with a copy of my report of the same.

Very respectfully,  
J. P. Carter  
A.S. M.C.

Office Surg. B.R. & A.S.  
Americus, Ga. Sept. 12/58

L. A. Edwards  
Surg. in Chf. State Ga.  
Atlanta, Ga.

Sir

I have the honor to transmit herewith triplicate receipt of med. & Hosp. property from W. A. N. Dillinger M.C. together with a copy of my report of the same.

Very respectfully,  
J. P. Carter  
A.S. M.C.

Office Surg. B.R. & A.S.  
Americus, Ga. Sept 15 1858

L. A. Edwards  
Surg. in Chf. State Ga.  
Atlanta, Ga.

Sir

I have the honor to state, that the time since my assignment to duty in charge of this Dispensary has been so limited that I have been unable through my uniform engagemt. as to the health of this District. In Shelby County I am well informed and would state, that since the year 1854, I have been actively engaged in the practice of medicine in said County, and have never met with so many cases of disease (Scarlet fever, Measles, Rheumatism, Nervous Venereal, & various other diseases) nor of so much suffering, as well of medical attention as exist there at this time. Many cases (from Congestion of vital organs) are fatal, which I think, might have been prevented by proper and timely treatment. The disease now, from various causes, have been unable to make more than an ordinary report, and in many instances being entirely unmet with in this. The patients are young men in a military sense of their usual condition. The physicians are all of the school of the medical medicine in time.

without a fair prospect of termination.  
In this city and vicinity there is much  
sickness, especially in it true about  
the Plains of Georgia in South Georgia.  
As report from Webster, the same causes,  
however, & sickness, spread throughout the  
District, and produce the same effect.

Very Resp. Thy  
J. P. Carter  
Col. S. G.  
W. A. W. W.

Office Dis. B. R. & A. S.  
Americus, Ga. Sept. 18<sup>th</sup> / 58

Very

Dr. James M.  
Sur. in Chf. Dis. Co.  
Atlanta, Ga.

I have the honor  
to transmit herewith Receipt for 100 yds  
Blankets for recruits, & Co. S.

Very Resp. Thy  
J. P. Carter  
Col. S. G.  
W. A. W. W.

Office Dis. B. R. & A. S.  
Americus, Ga. Sept. 17<sup>th</sup> / 58

Very

Dr. J. M.  
Sur. in Chf. Dis. Co.  
Atlanta, Ga.

I have the honor  
to transmit herewith  
my report of sick and wounded

freedmen for the week ending Saturday  
Sept 19<sup>th</sup> 1858.

Very Resp. Thy  
J. P. Carter  
Col. S. G.

Office Dis. B. R. & A. S.  
Americus, Ga.  
Sept. 25<sup>th</sup> / 58

Very

Dr. James M.  
Sur. in Chf. Dis. Co.  
Atlanta, Ga.

I have the  
honor to transmit herewith my report  
of sick and wounded freedmen for  
the week ending Saturday Sept. 12<sup>th</sup> 1858

Very Respectfully  
J. P. Carter  
Col. S. G.  
W. A. W. W.

Office Dis. B. R. & A. S.  
Americus, Ga. Sept 30<sup>th</sup> / 58

Very

James M.  
Sur. in Chf. Dis. Co.  
Atlanta, Ga.

I have the  
honor to transmit herewith my  
report of sick & wounded  
freedmen for the month of  
Sept 1858

Very Resp. Thy  
J. P. Carter  
Col. S. G.  
W. A. W. W.

18

Office Insp. B. R. & A. L.  
American Co  
Sept. 28<sup>th</sup> 1858

Leaving

James M.  
Surgeon in Chief Dist. Sec.  
Atlanta, Ga.

I have  
the honor to transmit herewith my  
report for the month of  
Office of Surgeon in Chief, B. R. & A. L.  
p. O. Oct. 1<sup>st</sup> 1858  
J. M. Carter  
U.S. A.

Office Insp. B. R. & A. L.  
American Co

Leaving

James M.  
Surgeon in Chief Dist. Sec.  
Atlanta, Ga.

I have the honor to transmit  
herewith my report of persons and  
articles seized for the month  
of September, together with  
vouchers  
Very respectfully  
J. M. Carter  
U.S. A.

Office Insp. B. R. & A. L.  
American Co Oct. 18<sup>th</sup> 1858

Leaving

James M.  
Surgeon in Chief Dist. Sec.  
Atlanta, Ga.

I have the honor to forward  
herewith my reports of sick & wounded  
soldiers for the weeks ending Saturday  
Sept. 19<sup>th</sup> & 25<sup>th</sup> 1858 with descriptions  
Very respectfully  
J. M. Carter  
U.S. A.

Office Insp. B. R. & A. L.  
American Co Oct 25<sup>th</sup> 1858

Notice

Inf. Co.  
W. M. & J. C.  
Atlanta, Ga.

I have the honor to forward  
herewith requisition  
for the month of October 1858 for use  
of Dispensary at this place  
Very respectfully  
J. M. Carter  
U.S. A.

Living

Office Disb. B. R. S. A. S.  
American Govt. Bldg.

James M.  
Surgeon in Chief, U.S. Army  
Atlanta, Ga.

Sir,  
I have the honor to have had  
transmitted by report of Sick and  
Wounded Quartermaster in the month  
ending Saturday Oct. 31, 1858

Very respectfully,  
Yr. Obedt. Servt.  
J. N. Carter  
M.D. U.S.A.

Office Disb. B. R. S. A. S.  
American Govt. Bldg.  
Oct. 13/58

Living

James M.  
Surgeon in Chief, U.S. Army  
Atlanta, Ga.

Sir,  
I have the honor to have had  
transmitted by report of Sick and  
Wounded Quartermaster in the month  
ending Saturday Oct. 31, 1858

Very respectfully,  
Yr. Obedt. Servt.  
J. N. Carter  
M.D. U.S.A.

Edwards

U.S. A.  
Surgeon U.S.A.  
C. M. C. B. R. S. A. S.

Office Disb. B. R. S. A. S.  
American Govt. Bldg. 31, 1858

Washington D.C.

Sir:

I have the honor to have  
received with duplicate receipt  
for Medical and Hospital property  
received from Surgeon in Chief James  
M. Living U.S.A. Together with  
a copy of my report of the same.

Very respectfully,  
Yr. Obedt. Servt.  
J. N. Carter  
M.D. U.S.A.

Yours truly

Office Disb. B. R. S. A. S.  
American Govt. Bldg.  
Sept. 30th 1858

Edwards

U.S. A.  
Surgeon U.S.A.  
Atlanta, Ga.

I have the honor to forward  
to you the enclosed in. Postage for the  
month of September 1858.

Very respectfully,  
Yr. Obedt. Servt.  
J. N. Carter  
M.D. U.S.A.

Office Disp. R.R. & A.L.  
Americus, Geo.  
Sept. 20<sup>th</sup> 1858

Colleges  
P. H. Capt. Wm. Frank  
U.S.A. Gen. Co.  
Florida Geo.

(Capt.)  
I have the honor to forward  
herewith in report of "Services and  
Articles used" for the month of Sep.  
Tember with vouchers pertaining thereto.  
Very Resp. Servt.  
J. M. Carter  
U.S.A.

Office Disp. R.R. & A.L.  
Americus, Geo. Sept. 20<sup>th</sup> 1858

Colleges  
P. H. Capt. Wm. Frank  
U.S.A. Gen. Co.  
Florida Geo.

(Capt.)  
I have the honor to forward herewith  
vouchers for services for the month of September  
1858 & respectfully request the same to be  
approved and paid.  
Very Resp. Servt.  
J. M. Carter  
U.S.A.

Office Disp. R.R. & A.L.  
Americus, Geo.  
Oct 7<sup>th</sup> 1858

U.S.A. (revised)  
L. A.  
Geny. W. A. &  
St. M. Office R.R. & A.L.  
Washington D.C.

Sir - I have the honor to transmit  
herewith Duplicate Receipt for med-  
ical & Hospital property received from  
U.S.A. W. A. Jones W.A. with a copy of  
my report of the same.  
Very Respectfully,  
J. M. Carter  
U.S.A.

Office Disp. R.R. & A.L.  
Americus, Geo.  
Oct. 7<sup>th</sup> 1858

Wm. J.  
U.S.A. W.A.  
U.S.A. Geo.

Sir - I have the  
honor to transmit herewith Du-  
plicate Receipts for medical &  
Hospital property received from you,  
and to report that the articles  
were of good quality, in good con-  
dition & corresponded with the invoice.  
Very Respectfully,  
J. M. Carter  
U.S.A.

Office Insp. B. R. & A. S.  
Annapolis, Geo.  
Oct. 17/58

Friend  
James M.  
Surgeon Chief Dist. Geo.  
Atlanta Geo

Sir,  
I have the honor to trans-  
mit herewith the minutes of the Dispo-  
sition of the Medical & Hospital Establish-  
ment.  
Very respectfully  
Yr. Obedt. Servant  
J. D. Carter  
M.D.

Office Insp. B. R. & A. S.  
Annapolis, Geo.  
Oct. 17/58

Friend  
James M.  
Surgeon Chief Dist. Geo.  
Atlanta Geo

Sir,  
I have the honor to trans-  
mit herewith my report of  
sick and wounded Soldiers for  
the week ending Saturday  
Oct. 17/58  
Very respectfully  
Yr. Obedt. Servant  
J. D. Carter  
M.D.

Office Insp. B. R. & A. S.  
Annapolis, Geo.  
Oct. 21/58

Friend  
W. D. S. M. G.  
Wash. Geo  
C. Carter

I have the  
honor to acknowledge this day the  
receipt of the following articles of  
medicines in good order & of good  
quality: Min. Sulph. 1/2, Hyd. Chlorid.  
1/2, Al. Hyd. 1/2 & Insult. Pot. 1/2.  
Very respectfully,  
Yr. Obedt. Servant  
J. D. Carter  
Wash. Geo.

Office Insp. B. R. & A. S.  
Annapolis Geo.  
Oct. 21/58

Friend  
W. D. S. M. G.  
Wash. Geo

Major - I have  
the honor to forward herewith vouchers  
for fuel for the month of October, ac-  
cording to instructions from your  
Office dated October 17/58.  
Very respectfully,  
Yr. Obedt. Servant  
J. D. Carter  
Wash. Geo.

38

Office Surg. B. H. & A.  
American Co.  
Oct. 21<sup>st</sup> 1858

Dear Sir

James M.  
Surg. in Chief Dist. Div.  
Atlanta Ga.

I have the honor to transmit herewith my report of sick and wounded soldiers for the week ending Saturday October 21<sup>st</sup> 1858.

Very Respectfully  
Wm. H. Carter  
M.D.  
Atlanta, Ga.

Office Surg. B. H. & A.  
American Co.  
Oct. 21<sup>st</sup> 1858

Dear Sir

James M.  
Surg. in Chief Dist. Div.  
Atlanta Ga.

I have the honor to transmit herewith a report of sick and wounded soldiers for the week ending Saturday, Oct. 21<sup>st</sup> 1858.

Very Respectfully  
Wm. H. Carter  
M.D.  
Atlanta, Ga.

Office Surg. B. H. & A.  
American Co.  
Oct. 21<sup>st</sup> 1858

Dear Sir

James M.  
Surg. in Chief Dist. Div.  
Atlanta Ga.

I have the honor to transmit herewith my report of sick and wounded soldiers for the week ending Saturday Oct. 21<sup>st</sup> 1858.

Very Respectfully  
Wm. H. Carter  
M.D.  
Atlanta, Ga.

Office Surg. B. H. & A.  
American Co.  
Oct. 21<sup>st</sup> 1858

Dear Sir

James M.  
Surg. in Chief Dist. Div.  
Atlanta Ga.

I have the honor to transmit herewith my report of sick and wounded soldiers for the week ending Saturday, Oct. 21<sup>st</sup> 1858.

Very Respectfully  
Wm. H. Carter  
M.D.  
Atlanta, Ga.

Office Dep. B. R. J. A. S.  
Assessors Gen.  
Oct. 21<sup>st</sup> 1858

Colleges

B. Capt. M. T. R.  
C. A. S. Gen.

Atlanta Ga.

Sept.

I have the honor to forward  
herewith herewith you herewith for the  
month of Oct. 1858 & respectfully  
trust, the same may be approved  
and paid

Very Respectfully  
yours  
J. J. Carter  
C. A. S. Gen.

Office Dep. B. R. J. A. S.  
Assessors Gen.  
Oct. 21<sup>st</sup> 1858

Colleges

B. Capt. M. T. R.  
C. A. S. Gen.

Atlanta Ga.

Sept.

I have the honor to forward  
herewith you herewith for the  
month of Oct. 1858 & respectfully  
trust, the same may be approved  
and paid

Very Respectfully  
yours  
J. J. Carter  
C. A. S. Gen.

Office Dep. B. R. J. A. S.  
Assessors Gen.  
Nov. 21<sup>st</sup> 58

Major

Major C. S. D.  
C. A. S. Gen.

Atlanta Ga.

Major

I have the  
honor to forward herewith you  
herewith for the month of  
Nov. 1858

Very Respectfully  
yours  
J. J. Carter  
C. A. S. Gen.



103

Office Dep. to the Atty.  
General  
Washington, D.C.  
Nov. 11th 1858

Very

James M.  
Surg. in Chf. Dist. Sec.  
Atlanta, Ga.

Dear Sir

I have the honor to have  
received your Report of sick and  
wounded Soldiers in the week ending  
Nov. 7th 1858

Very Respectfully  
Yrs. Obedt. Servt.  
Wm. G. Carter  
Asst. Surg. U.S.A.

Office Dep. to the Atty.  
General  
Washington, D.C.  
Nov. 11th 1858

Very

James M.  
Surg. in Chf. Dist. Sec.  
Atlanta, Ga.

Dear Sir

In compliance with Circular  
of the Genl. Office dated Nov. 10th 1858  
I have the honor to state that I am  
not furnished with any information  
relative to the loss of the General  
Hospital in the vicinity of the  
City of Washington  
Thereof

Very Respectfully  
Yrs. Obedt. Servt.  
Wm. G. Carter  
Asst. Surg. U.S.A.

11

London, 18th Dec 1847  
Dear Mother

My dear Mother

I have just received your kind letter of the 14th and was glad to hear from you and to hear that you were all well.

I am well at present and hope these few lines will find you all the same. I have not much news to write at present. I am still in the same place and doing the same work. I have not much to write at present. I am still in the same place and doing the same work.

Yours affectionately

John Smith

My dear Mother

I have just received your kind letter of the 14th and was glad to hear from you and to hear that you were all well.

I am well at present and hope these few lines will find you all the same. I have not much news to write at present. I am still in the same place and doing the same work. I have not much to write at present. I am still in the same place and doing the same work.

Office Disp. R. H. A. A.  
Am. Disp. Co.  
Nov. 10, 1878

100 10

Dear Sir,  
I have the honor to  
acknowledge the receipt of  
your letter of the 10th inst.

in relation to the  
purchase of a quantity of  
the same, and in reply to  
advise you that the same  
has been ordered and will  
be ready for shipment  
in a few days.

Office Disp. R. H. A. A.  
Am. Disp. Co.  
Nov. 11, 1878

Dear Sir,

I have the honor to  
acknowledge the receipt of  
your letter of the 10th inst.

in relation to the  
purchase of a quantity of  
the same, and in reply to  
advise you that the same  
has been ordered and will  
be ready for shipment  
in a few days.

Very respectfully,  
R. H. A. A.  
Am. Disp. Co.

Office District of Columbia  
Washington, D.C.  
November 1858

Dear Sir,  
I have the honor to acknowledge  
the receipt of your letter of the  
10th inst.

in relation to the  
proposed amendments to the  
constitution of the District of  
Columbia, and in reply to inform  
you that the same have been  
referred to the committee on  
the subject, and that it will  
be the duty of the committee  
to report thereon at an early  
day.

I am, Sir,  
Very respectfully,  
Your obedient servant,  
John C. Hunter

John C. Hunter,  
Secretary of the  
District of Columbia,  
Nov. 20th 1858

Walter

Major C. F.  
H. M. & Co.

I thank you

for the information you have  
been kind enough to give me  
in relation to the proposed  
amendments to the constitution  
of the District of Columbia,  
and in reply to inform you  
that the same have been  
referred to the committee on  
the subject, and that it will  
be the duty of the committee  
to report thereon at an early  
day.

I am, Sir,  
Very respectfully,  
Your obedient servant,  
John C. Hunter

I have the honor to acknowledge the receipt  
 of your letter of the 15th inst. in relation  
 to the matter of the ...  
 and in reply to inform you that the same  
 has been forwarded to the proper authorities  
 for their consideration. I am, Sir,  
 very respectfully,  
 Yours,  
 J. M. ...

Office of the Asst. Secy.  
Treasury, Wash.  
Nov. 20th 1858

John

Wm. O. J. G.  
Wm. O. J. G.  
Atlanta, Ga.

Prof. I have  
the honor to transmit herewith the  
report of Stephen Jordan for  
fuel furnished the Dispensary for  
the month of Nov. 1858

Very respectfully  
Yr. Obedt. Servt  
Wm. O. J. G.  
Atlanta, Ga.

1

Office of the Asst. Secy.  
Treasury, Wash.  
Nov. 21st 1858

John  
Henry

I enclose herewith  
the report of Stephen Jordan for  
Atlanta, Ga.

Prof. I have  
the honor to transmit herewith the  
report of Stephen Jordan for  
fuel furnished the Dispensary for  
the month ending October 1858.

Very respectfully  
Yr. Obedt. Servt  
Wm. O. J. G.  
Atlanta, Ga.

Office of the  
Commissioner  
of the District of Columbia

Very

Dear Mr.  
Cory in charge  
District of Columbia  
Washington, D.C.

I have the honor to request that  
you will inform me what information  
shall be of the value & character of the  
documents and also of the rights &  
titles, as well as the names & names  
of the parties.

Very Respectfully,  
J. M. [Signature]  
Washington, D.C.

41

Thos. J. [Signature]  
Washington, D.C.

I have the honor to request  
that you will inform me what  
information shall be of the value &  
character of the documents and  
also of the rights & titles, as  
well as the names & names of  
the parties.

Very Respectfully,  
J. M. [Signature]  
Washington, D.C.

Wm. C. Smith.

Atlanta, Ga.

Nov. 25<sup>th</sup> 1868

I have enclosed to you a copy of the  
works & revised copies of the same being  
the records of the Disp. will be trans-  
mitted as directed in Div. XXIV. Page 25  
of the Manual. Enclosures to that effect  
will be sent, when the Court's report  
is received. With respect to the  
so the Court's report is herewith re-  
turned for explanation why they were  
not entered. Letters & papers will be  
prepared of under instructions from  
The A. A. E. M.

(j d)

Nov. 25<sup>th</sup>

Wm. C. Smith,  
Circuit Judge



Off. Exp. R. 7th St.  
Washington, D.C.  
Jan. 11th 1858

Dear Sir

W. J.  
W. J. W. W.  
Munro, Geo.

I have  
the honor to acknowledge the receipt  
of your letter of the 7th inst. &  
thank you for the information  
concerning the same.

Very respectfully,  
W. J. W. W.  
W. J. W. W.

W. J. W. W.  
Munro, Geo.  
Jan. 11th 1858

Very

Yours M.  
W. J. W. W.  
Munro, Geo.  
I have the honor to  
acknowledge the receipt of your  
letter of the 7th inst. &  
thank you for the information  
concerning the same.  
Very respectfully,  
W. J. W. W.  
W. J. W. W.

Office of the Surgeon General  
Washington, D.C.  
Dec 27 1858

Camp

Dear Sir,  
Camps in the West Co.  
Alaska, etc.

Notes

I have the honor to have  
received a copy of report of Mr. W. and  
wondered whether you had intended  
to visit Alaska, with the intention that  
the small number is coming to  
packing up "items" and not entering them  
names on the Register.

Very Respectfully  
Yours,  
W. C. C. G.  
U.S.A.

Office of the Surgeon General  
Washington, D.C.  
Dec 27 1858

Accepter

Bl. Capt. W. S. G. H.  
A. A. G. Genl.  
Alaska, Geo.  
Capt.

I have the honor to forward  
herewith a copy of the report for the  
month of November 1858, and respectfully  
request the same may be approved  
and void.

Very Respectfully,  
Yours Obedt. Servt.  
J. W. C. G.  
U.S.A.

54

Office of the Surgeon General  
Washington, D.C.  
April 20th 1858

Dear Sir,  
I have the honor to acknowledge  
the receipt of your letter of the  
10th inst.

In answer to your letter of the  
10th inst. I beg to inform you  
that the same has been forwarded  
to the proper authorities for  
their consideration.

I am, Sir, very respectfully,  
Your obedient servant,  
Wm. G. Wells  
A. S. M. G.

Office of the Surgeon General  
Washington, D.C.  
April 21st 1858

Gulley

1st Capt. M. S. ...  
1000 ...  
Atlanta Ga.

Capt.

I have  
the honor to acknowledge  
the receipt of your  
Report of "Passes & Articles Used  
for the month of ... 1858, with  
... ..

I am, Sir, very respectfully,  
Your obedient servant,  
Wm. G. Wells  
A. S. M. G.

Office of the U.S. Fish Com.  
Washington, D.C.  
Nov 20th 1858

Camp

James M.  
Camp, to the Chief Secy  
Monticello

Sir,  
I have the honor to have recd  
your kind letter of the 17th inst and  
in reply to inform you that the period  
ending Nov 1st 1858.

Very respectfully  
Yours  
J. D. Carter  
U.S. Fish Com.

W.A.  
Camp, to the Chief Secy  
Monticello, Va.

I have the honor to have recd  
your kind letter of the 17th inst and  
in reply to inform you that the period  
ending Nov 1st 1858.

Very respectfully  
Yours  
J. D. Carter  
U.S. Fish Com.

1847  
1848  
1849

1850  
1851

1852  
1853  
1854

1855  
1856  
1857

1858  
1859  
1860

1861  
1862

1863  
1864  
1865  
1866  
1867  
1868  
1869  
1870

1871  
1872  
1873

NATIONAL ARCHIVES AND RECORDS ADMINISTRATION  
MICROFILM PUBLICATIONS

Roll 40

Target 7

Letters Received

Aug.-Dec. 1868

Americus, Ga.

Letters received by  
Surgeon-in-Chief  
Aug. - Dec. 1868 1/2 in  
Unentered

Bureau of Hygiene, Freed'n & M'ld. I'ids.,  
Office Surgeon-in-Chief, State of Georgia.

ATLANTA, GA. 1868.

*James M. Lamy -*  
*Aug. 11<sup>th</sup> - 1868*

*Appointment*

James M. Lamy,  
Surgeon-in-Chief.

PURPORT

*August*  
*1868*

ATTEST



Bureau of Refugees, Freedmen and Abandoned Lands,  
OFFICE SURGEON-IN-CHIEF, STATE OF GEORGIA.

Atlanta, Georgia, August 11<sup>th</sup> 1868.

Dr James T. Carter  
Americus Ga.

Sir,

By authority granted by the Com<sup>r</sup> B. R. F. and A. S. under date August 6<sup>th</sup> 1868, You are hereby appointed A. A. Surgeon in Charge of Disp, to be established during the sickly season at Americus Ga. I enclose Contracts in triplicate, and Oaths of Office in duplicate which you will have properly executed, and forward to this Office without delay. You will hire a room or small building suitable for the Disp, and for the safe custody of the Medical and Hospital supplies which will be sent to you, and make requisition on the A. A. D. M. and R. O. at these Hd Qrs for such articles of furniture &c as are indispensable.

On receipt of your Contract properly executed, a supply of Medicines, Blanks &c will be forwarded to you.

I enclose a copy of the order by the Asst Com<sup>r</sup> State of Ga assigning you to duty.

Very respectfully

Your Obedt Serv<sup>t</sup>

James M. Smith

Surgeon in Chief  
Dist of Ga

Office of Procurement  
 U.S. Army  
 Washington, D.C.  
 August 14, 1868

Office Surgeon Chief  
 Atlanta Georgia  
 Aug 14. 68

Respectfully forwarded to  
 A. A. Surg J. W. Carter refer.  
 who will return the Receipts  
 filled in and signed to this  
 Office on receipt of the  
 Medical Stores and Com-  
 paning them with the  
 Invoices.

James M. Smith  
 Surgeon in Chief  
 Dist of Ga

*[Faint handwritten text]*

1839  
11

of  
)

Washington Hospital  
Virginia Co.  
August 18 1839

11

Dear Sir  
I have the honor to acknowledge the receipt of your letter of the 11th inst. in relation to the above mentioned matter. I have the pleasure to inform you that the same has been forwarded to the proper authorities for their consideration. I am, Sir, very respectfully,  
Your obedient servant,  
John C. Wainwright

John C. Wainwright  
Washington Hospital  
Virginia Co.

am  
of  
to  
Dear Sir,  
I am very pleased to hear from you.  
Yours truly,  
J. C. Wainwright

1839

UNITED STATES OF GEORGIA,

Office Surgeon-in-Chief.

Atlanta, Georgia, 1868.

*James M. Loring*  
#1  
*Aug. 17/68*

*Blank Reports*  
*& when forwarded*

*James M. Loring,*  
Surgeon-in-Chief.

PURPORT.

BUREAU OF REFUGEES, FREEDMEN, AND ABANDONED LANDS.

Office Surgeon-in-Chief, State of Georgia.

Atlanta, Ga., August 17<sup>th</sup> 1863.

O. A. Surgeon J. W. Carter *refd.*  
Americus Ga.

Sir,

I have the honor to forward to you by this  
days mail a supply of Blanks for the following Reports  
or the receipt of which you will acknowledge on the form  
enclosed therewith and forward to this Office.

Monthly Report sick and convalesced freedmen due on 1<sup>st</sup> of month  
Weekly do do do do due every Saturday  
Pay accounts of Contract Surgeons to be forwarded to this  
Office for approval at the end of the month.

Return of Medical and Hospital Property due at end of  
June and December, or on Closing Disp. Original with Com-  
plete set of vouchers, and duplicate to be forwarded through  
this Office to Chief Medical Officer, and duplicate with Com-  
plete set of vouchers to be retained by you.

Requisitions for Medical and Hospital Supplies, -

Receipts for do do do

Invoices for do do do

(over)

I also forward a copy of the "Officers Manual," and  
file of Circulars re necessary to instruct you how to carry on  
your duties, the receipt of which you will acknowledge.

You will report to this Office the date of opening your  
Diary and acknowledge receipt of this letter.

Very respectfully

Your Obedt Servt

J. M. Smith

Surgeon in Chief

Dist of Co

Office of a. a. upon In chg Dist  
Anno Domini Ga Aug 18<sup>th</sup> 1868.

Darter James W  
A. A. Surgeon

Makes Application for  
permission to hire Senaud  
to keep Dispensary in order

Office Surgeon in Chief  
Atlanta Georgia  
August 21<sup>st</sup> 68.

Respectfully returned to  
Mr J. W. Carter, who is au-  
thorized to employ a man  
at \$10<sup>00</sup> a month.

J. M. Smith  
Surgeon in Chief  
Dist of Ga

Office U.S. In chg Dispensary  
Macon Ga Aug 15 1863

Dr James M Loring  
Sur in chg. of Surgeon  
Atlanta Ga

Sir:

I have the honor to  
make application for permission to hire a  
servant to take care and keep in order the  
Dispensary to which I am assigned.

Very respectfully  
Your obt. Servt  
J. W. Carter  
A. A. Surgeon U.S.A



W. J. Watson

Aug 19<sup>th</sup> 1868

Bill of Lading

Bureau of Refugees, Freedmen and Abandoned Lands.  
OFFICE ACTING ASSISTANT QUARTERMASTER AND DISBURSING OFFICER, STATE OF GEORGIA

Atlanta, Georgia, August 19<sup>th</sup> 1868.

Doctor,

Enclosed find Bills Reading for hospital property shipped you this day. Upon receipt of the property, the same being correct and in good order, please sign & return the duplicate P/O. The triplicate you retain.

Very Respectfully

Thos. M. Swann

C. J. Watson

A. A. G. M. T. O.

Mr. J. W. Carter

A. Asst. Surg. U.S.A.

Americus, Georgia.

C. T. Watson

Aug 20<sup>th</sup> 1868

Relative to Vouchers  
of Hugh Bivins.

Bureau of Refugees, Freedmen and Abandoned Lands,  
Office Acting Assistant Quartermaster and Stating Officer, State of Ga.,

Atlanta, Ga. August 20 1868.

Sir.

I return vouchers of Hugh  
Hivins. forwarded by you with  
others made up to corr. which  
you can certify to have accepted  
and witnessed and return to me  
for payment. The services  
must appear upon your report  
of Persons and articles hired for  
August.

Very Respectfully  
A. J. Watson

August 20.

J. M. Carter  
Major General  
Americus Ga

C. J. Watson

Adm. & L. O.  
Aug. 26<sup>th</sup> 1858

Pays Hugh Bivins

\$12<sup>00</sup>

Bureau of Refugees, Freedmen and Abandoned Lands.  
OFFICE ACTING ASSISTANT QUARTERMASTER AND DISBURSING OFFICER, STATE OF GEORGIA

Atlanta, Georgia, August 26 1865 .

Sir.

Enclosed find check to  
order of Hugh Pivins for \$12  
in payment of his vouchers  
forwarded by you

Very Respectfully  
A. J. Watson  
A. J. Watson & Co.

Dr. J. M. Carter  
A. J. Watson & Co.  
Americus Ga

Bureau Refugees, Freed'n & Ab'd. U.S.,  
Office Surgeon-in-Chief, State of Georgia.

ATLANTA, GA. Aug 27 1858.

*James M. Loring*

*Aug. 27<sup>th</sup> 1858*

*Relates to Books  
sent per Express.*

James M. Loring,  
Surgeon-in-Chief.

PURPORT.

Wrapper..... Enclosures.

Bureau of Refugees, Freedmen and Abandoned Lands,  
OFFICE SURGEON-IN-CHIEF, STATE OF GEORGIA.

Atlanta, Georgia, August 27<sup>th</sup> 1868.

W. W. Lucie, M. D., Eastern Ave.  
Americus Ga.

Sir:

I have the honor to forward to you the following  
Books per Express.

One (1) Copy U. S. Army Regulations Ed 1861.  
One (1) Copy Hospital Stewards Manual.  
One (1) Hospital Register. One (1) Order and Letter Book.  
One (1) Ward Prescription Book. You will also receive  
copies of the same in duplicate, one of which you will retain,  
and attach the other as a receipt to your proposed return, and send  
me duplicate receipts in the enclosed blanks.

Very respectfully

Wm. D. Smith  
Surgeon in Chief  
Dist of Ga



C. J. Watson  
Sep 1. 24/58

Pays (myself Vouchers)

Bureau of Refugees, Freedmen, and Abandoned Lands, State of Georgia:

OFFICE ACTING ASSISTANT QUARTERMASTER AND DISBURSING OFFICER,

Atlanta, Georgia, *Sept 24* 1868.

Sir.

Enclosed find check for  
\$95<sup>96</sup> in payment of your  
vouchers for services \$2<sup>63</sup> of  
Mrs. Sirrine for rent \$10 - and  
of Char. Comer for services \$<sup>33</sup>  
forwarded by you

Very Respectfully  
C. J. Watson

Wagon & Co.

Dr. J. M. Carter

Washington

Americus Ga

STATE OF GEORGIA,  
OFFICE SURGEON-IN-CHIEF, BUREAU R., F. & A. L.,  
Atlanta, Ga., ..... 1868.

*James M. Laing*  
*Sept. 28<sup>th</sup> 1868*

*Relates to Duplicate  
& Triplicate Receipts*

~~~~~  
JAMES M. LAING,  
Surgeon-in-Chief.  
~~~~~

**PURPORT.**

.....  
.....  
.....  
.....  
.....  
.....  
.....  
.....  
.....  
.....

State of Georgia,

OFFICE SURGEON-IN CHIEF, BUREAU OF R., F. AND A. I.,

Atlanta, Georgia, September 28<sup>th</sup> 1868

A. A. Surg. J. W. Carter M.D.  
Americus Ga.

Sir,

Your attention is called to my letter dated Aug. 27<sup>th</sup> '68, in which you were directed to send me Receipts in duplicate for the Goods then forwarded, which have not been received at this Office.

These Receipts should be in triplicate, vide Circular letter dated Nov. Dept. B. R. F. and A. I. March 17<sup>th</sup> '68. to enable you to comply with the provisions of which a blank Receipt is now forwarded.

You will forward to me at once duplicate Receipts with a report of the quality and Condition of the Articles, and the triplicate Receipt with a copy of that report for the Chief Medical Officer.

Very respectfully

Your Obedt Servt

Wm. M. B. B. B.

Surg. in Chief

Dist. of Ga.

STATE OF GEORGIA,  
OFFICE SURGEON-IN-CHIEF, BUREAU R., F. & A. L.,  
Atlanta, Ga., Sept 30 1868.

~~~~~  
JAMES M. LAING,  
Surgeon-in-Chief.  
~~~~~

**PURPORT.**

.....  
.....  
.....  
.....  
.....  
.....  
.....  
.....  
.....  
.....  
.....  
.....  
.....

*James M. Laing  
Sept. 30<sup>th</sup>/68*

*Correct Reports of  
Sept 19<sup>th</sup> & 25<sup>th</sup> required*

State of Georgia,

OFFICE SURGEON-IN-CHIEF, BUREAU OF R., F. AND A. L.,

Atlanta, Georgia, September 30<sup>th</sup> 1865.

A. C. Surr, Jr. Esq. of  
Crawfords Ga.

Referring to the enclosed report on the balance sheet, and the  
balance sheet from Mr. Carter not taken into account the "W. re-  
mainder at last Weekly Report." In neither report does the "W. dis-  
count" amount to the "Total loss during the week," entered by  
Mr. Carter, which seems to have been entered at hap hazard to  
make the Report balance. Mr. Carter will make corrections in his  
next report and enclosing sheet of 10<sup>th</sup> to agree with the "W. entered  
in account in the Report now returned. You will make the same cor-  
rections in the retained copy of that Report. Mr. Carter will  
return with these Reports properly made out to this Office without  
delay.

Very respectfully

Your Obedt Servt

Wm. S. H. H. H.

Surgeon in Chief Ga.

STATE OF GEORGIA,  
OFFICE SURGEON-IN-CHIEF, BUREAU R., F. & A. L.,  
Atlanta, Ga., 1868.

JAMES M. LAING,  
Surgeon-in-Chief.

PURPORT.

Oct.  
1868

James M. Laing  
Oct. 9<sup>th</sup> / 68

Witness to Instrument  
by Dr. M. F. Bowes -

State of Georgia,

OFFICE SURGEON IN CHIEF, BUREAU OF R., F. AND A. L.,

Atlanta, Georgia,

October 2<sup>d</sup>

1868

to a Surg J. W. Carter  
Americus Ga.

Sir:

Dr Bours at Macon has been instructed to forward to you by express a complete set of instruments allowed for Dispensaries, on the arrival of which you will forward to him two Receipts with a report of the quality and Condition of the Articles and forward one Receipt with a Certified Copy of that report to this Office for transmission to the G. M. O. as required by Circular letter from the Commr dated March 17 '68.

Blank Receipts in triplicate as herewith forwarded.

Very respectfully

Your Obedt Servt

Wm. M. Wood

Surg in Chief

(Dist of Ga)



PARALLEL

STATE OF GEORGIA,  
OFFICE SURGEON-IN-CHIEF, BUREAU R. F. & A. L.,  
Atlanta, Ga., ..... 1868.

*James M. Laing*  
*Oct. 27/68*  
*Relates to pay a/c*

~~~~~  
JAMES M. LAING,  
Surgeon-in-Chief.  
~~~~~

**PURPORT.**

.....  
.....  
.....  
.....  
.....  
.....  
.....  
.....  
.....  
.....

State of Georgia,

OFFICE SURGEON IN-CHIEF, BUREAU OF R., F. AND A. L.,

Atlanta, Georgia, October 2<sup>d</sup>

1868

A. A. Surg. J. M. Carter  
Cherokee Co.

Sir,

The enclosed Five Receipts are returned for compliance  
with Circular Letter dated February 19<sup>th</sup> '68 and Circular No. 1  
dated March 5<sup>th</sup> '68 both from this Office.

Very respectfully

Your Obedt. Servt

Wm. M. Spencer

Surgeon Chief

Dist. of Ga

C. J. Watson

-A. G. Mudd.

Oct. 5<sup>th</sup> 1868.

Authority - To buy  
one cord of wood  
for Dispensary

Bureau of Refugees, Freedmen, and Abandoned Lands, State of Georgia:

OFFICE ACTING ASSISTANT QUARTERMASTER AND DISBURSING OFFICER,

Atlanta, Georgia, Oct. 5 1868.

Sir,

You are authorized to purchase  
One (1) cord of Wood to fill your  
requisition for October. You will  
send account for same direct  
to this office at once for settlement

Very Respectfully  
C. J. Watson

ccgm & Co.

J. M. Carter

W. J. Ingram

Americus Ga

M. F. Bowes

Colo. U.S.A.

Oct. 5<sup>th</sup> 1858

---

Transmits - Med. & Apt  
Supplies with Invoices

---

Lebley Hospital,  
Macon Georgia.  
Oct. 30 1868

A. A. Day: J. T. Carter, M.D.  
Americus Ga  
Sir.

I have the honor  
herewith to enclose Invoices of Instruments  
this day ordered (as per Dr: Ex Co:) to you.  
You will please return Receipts to me for  
the same at your earliest convenience.

Very Respect.

Your Obedt Servt.  
W. F. Bowes,  
A. A. Day, M.D.

C. J. Watson

Oct. 19<sup>th</sup> 1858.

Relates to Chas. R. B.

Bureau of Refugees, Freedmen, and Abandoned Lands, State of Georgia:

OFFICE ACTING ASSISTANT QUARTERMASTER AND DISBURSING OFFICER,

Atlanta, Georgia, Oct. 12 1868.

Sir.

Enclosed find check to your  
order for \$110<sup>00</sup> in payment of  
your vouchers for services 99<sup>00</sup>  
postage 1<sup>25</sup> and of Chas. Corner  
for \$10 - also check to order of  
Mr. Sirmine for \$20 - in payment  
of his vouchers furnished by you

Very Respectfully

C. J. Watson

Major & D.C.

Dr. J. M. Carter

Major General

Americus Ga



STATE OF GEORGIA,  
OFFICE SURGEON-IN-CHIEF, BUREAU R. F. & A. L.,  
Atlanta, Ga., Oct 15 1868.

-----  
JAMES M. LAING,  
Surgeon-in-Chief.  
-----

**PURPORT.**

-----  
-----  
-----  
-----  
-----  
-----  
-----  
-----  
-----  
-----

*James M. Laing -  
Oct. 15<sup>th</sup> 1868*

*Notified Dr. M. G. Bowers  
to forward certain medicine*

State of Georgia,

OFFICE SURGEON IN CHIEF, BUREAU OF R., F. AND A. L.,

Atlanta, Georgia, October 16<sup>th</sup>

1868.

A. A. Sugg, M. D.  
Columbus, Ga.

Sir,

I have this day directed Dr W. F. Bond in Charge of  
the Disp' at Macon to forward to you by Express all the con-  
tents of the following articles viz. "Chinino's Tincture", "Hydrargyri  
Chloridum Solut.", "Hydrargyri pilulae" and "Zincis Sulphas" and re-  
ceive you of the date of sending the same. You will acknowledge  
receipt to some be letter.

Very respectfully,

Your Obedt Servt  
James M. Smith  
Surgeon in Chief  
Dist of Ga

M. J. Burns, U.S. Army -  
(Oct. 19<sup>th</sup>/68

Forwards medicines &  
requires Receipt -

Libley Hospital  
Macon Georgia  
Oct: 19-1864.

Ch Surg: J. W. Curtis, ap. r.  
Americus Ga.

Dublin

I have the honor  
to state that I have this day expressed (by  
Doh: Exp: Co:) to your address the following  
articles of (Med: Instr: Instr: 43. Hy: Clo:  
Inst: 83 - Hy: Pill: 83 - Ins: Polop: Lig: 43  
you will please acknowledge the receipt  
of the same.

Very Respect

your obt. svt.

W. H. Jones,

a. a. surg. ap. r.

Capt. George Wright  
Med. & Storekeeper  
W.S.A.,  
Oct. 21<sup>st</sup> 1868.

---

Relates to Invoices of  
Med. Supplies &c -

---

Depot of the Chief Medical Purveyor, U. S. A.

New-York, ( )

186

Sir,

I herewith enclose ~~you~~ Service of Medical Supplies addressed to you, and which have been delivered to the Quarter-Master at New-York, for transportation.

On receiving them, you will please be governed by paragraph 8, Medical Regulations, or 1237 General Regulations of 1861. Please return the enclosed receipt to this depot.

I am, Sir, very respectfully,

Your obedient Servant,

Medical Storekeeper, U. S. A.

Doctor

Or Attending Surgeon.

D. H. Mason  
Cash. M. & Co.,  
Nov. 1<sup>st</sup> 1868

Authorizes the purchase  
of Wood for Exp.  
for Nov. 1868

With Circulation No. 305

Nov 1  
1868

Bureau of Refugees, Freedmen, and Abandoned Lands, State of Georgia:  
OFFICE ACTING ASSISTANT QUARTERMASTER AND DISBURSING OFFICER,

Atlanta, Georgia, *November 11* 1868.

*Sir,*

You are authorized to purchase for  
use of dispensary, one lot each of No. 1 & fill  
your four requisitions for Number 1800 belts therefor  
to be forwarded direct to this office as soon as  
practicable. Your attention is invited to the  
requirements of accompanying circular No 2.

Very Resp. &c.

*C. D. Watson*

*A. C. Quintrell*  
Jr.

*Mr. J. M. Carter*  
U.S.A.  
Americus,

*Ga.*



Angus Pettitt  
St. 12 Infantry  
C.A. 2nd,  
Nov 4<sup>th</sup> - 1858

Relates to Bills of  
Lading, of Med. Supplies

**Depot Quartermaster's Office,**

Savannah, Ga., *MAY 15* 1868.

Abraham S. Ingalls  
Savannah, Ga.

Sir:

I enclose in  
duplicate and triplicate  
Bill of Lading of Medical Stores  
shipped you for Colonel R. P. Co.  
in the arrival of the articles  
please return duplicate to this  
office properly endorsed

Very Respectfully  
Your Obedt Servt  
Eugene M. Pettit  
1st Lt. Infantry  
Adj. Gen.  
P. J.

Alfred  
L. ...  
...

...

Bureau of Refugees, Freedmen, and Abandoned Lands.  
OFFICE ACTING ASSISTANT QUARTERMASTER AND DISBURSING OFFICER, STATE OF GEORGIA.

Atlanta, Georgia, Nov 17 186 .

Sir.

Enclosed find check to  
your order for \$32.50 in  
payment of vouchers of R. B  
Black \$20 - Chas Comer 10 -  
and yourself for postage  
250.

Very Respectfully  
C. J. Watson

Major & Co.

Dr. J. N. Carter

Adjutant U.S.A.

Americus Ga

PARALLEL 15

STATE OF GEORGIA,  
OFFICE SURGEON-IN-CHIEF, BUREAU R., F. & A. L.,  
Atlanta, Ga., \_\_\_\_\_ 1868.

*James M. Laing*  
*Surg. in Chief.*  
*Nov. 19<sup>th</sup> 1868.*

~~~~~  
JAMES M. LAING,  
Surgeon-in-Chief.  
~~~~~

*Relates to Procuring of Med.  
+ Surg. Supplies.*

**PURPORT.**

.....  
.....  
.....  
.....  
.....  
.....  
.....  
.....

State of Georgia,

OFFICE SURGEON-IN-CHIEF, BUREAU OF R., F. AND A. L.,

Atlanta, Georgia, November 19<sup>th</sup> 1868

W. A. Surg, & W. Carter  
Americus Ga.

Sir,

You will pack up all the Medical "as Hospit" Stores remaining on hand at your Disp, for transmission to A. A. Surgeon W. B. Bowers Sibley Hospit Macon Ga. forwarding at the same time one Invoice to this Office for the C. M. O. "as too to Dr Bowers "as obtaining particular Duplicate Receipts.

You will fill in the enclosed "Invoices of Stores" in duplicate and if practicable forward to this Office on receipt of invoice in order that the transportation will be sent.

Very respectfully

Your Obedt Servt

W. A. Stephenson  
Surgeon in Chief  
Dist of Ga.

Office Insp. B. R. Webb

American Co.  
Nov 20 1868

you should be paid for  
the balance of

Carter, J. W.  
Albany, N. Y.

the amount of the bill  
for the balance of the  
month of October 1868

Relates to pay for  
services for October 1868

1868  
1868

Office Disp. B. R. F. & A. Co.  
Americus, Geo.  
Nov. 20<sup>th</sup> 1868.

Maj. C. S. Watson  
C. A. M. & S.  
Atlanta, Geo.

Major: I have the honor to state that I have been anxiously looking for a check for services for the month of October, for several days, & fearing that it may have been overlooked, I take the liberty to remind you

Very Respectfully,  
Yr. Obedt. Servt.  
J. W. Carter  
Americus, Geo.



J. Watson

(C.A.M. & D.)

Jan. 26<sup>th</sup> 1868.

Please to check for  
remittance of C.A.M.

Bureau of Refugees, Freedmen, and Abandoned Lands, State of Georgia.

OFFICE ACTING ASSISTANT QUARTERMASTER AND DISBURSING OFFICER,

Atlanta, Georgia, *Nov 26* 1868.

Sir,

Enclosed find check for  
\$99<sup>10</sup>/<sub>100</sub> in payment of your  
voucher for services in Col. *Watson*  
Very Respectfully  
*C. J. Watson*  
a. a. g. m. & d. c.

Dr. J. H. Carter

a. a. g. m. & d. c.  
Americus Ga



State of Georgia,

OFFICE SURGEON-IN-CHIEF, BUREAU OF R., F. AND A. L.,

Atlanta, Georgia, November 30<sup>th</sup> 1868.

W. A. Long, J. H. Carter,  
Contractors.

Sir,

I enclose herewith S. O. 1574 Par III dated Office  
Asst Comm State of Georgia November 29<sup>th</sup> '68 annulling your  
Contract to date November 30<sup>th</sup> '68. You will send to this Office  
with as little delay as possible your final Returns of Medical and  
Hospital Property, also the two affidavits (herewith forwarded) duly executed.

Very respectfully

Your Obedt Servt

Wm M. Jones

Surgeon in Chief

Dist. of Ga

STATE OF GEORGIA,  
OFFICE SURGEON-IN-CHIEF, BUREAU R. F. & A. L.,  
Atlanta, Ga., ..... 1868.

~~~~~  
JAMES M. LAING,  
Surgeon-in-Chief.  
~~~~~

**PURPORT.**

.....  
.....  
.....  
.....  
.....  
.....  
.....  
.....

State of Georgia,

OFFICE SURGEON-IN-CHIEF, BUREAU OF R., F. AND A. L.,

Atlanta, Georgia, December 1<sup>st</sup>

1868.

A. A. Surg J. N. Carter.  
Ames  
Ga.

Sir,

I enclose herewith your final "Pay Accts"  
properly made out, which you will sign & return to this Office  
without delay.

Very respectfully

Your Obedt Servt

Wm. H. Wood

Surgeon in Chief  
Dist of Ga



State of Georgia,

OFFICE SURGEON IN-CHIEF, BUREAU OF R., F. AND A. L.,

Atlanta, Georgia, December 3<sup>d</sup>

1868.

Dr. J. W. Carter  
Americus  
Georgia,

Sir,

You will forward to this Office with the records of  
your District, the copy of the "Officer's Manual" in your possession,  
on arrival of which your receipt, now on file in this Office, will be  
sent to you.

Very respectfully  
Your obt. Serv<sup>t</sup>  
Wm. H. H. H. H.  
Surgeon in Chief  
Dist of Ga.



1711 -  
5000

Bureau of Refugees, Freedmen, and Abandoned Lands, State of Georgia:

OFFICE ACTING ASSISTANT QUARTERMASTER AND DISBURSING OFFICER,

Atlanta, Georgia, *November 11* 1868.

*Doctor,*

Enclosed find the Bills *lading* necessary  
for the shipment of your hospital & medical property  
to Macon. Directions for the disposition of these  
Bills you will find pencilled thereon.

Very Resp<sup>ly</sup>,

*C. J. Watson*

Major & D. A.

*Dr. J. M. Carter*

*Appling St. W. P.*

*Macon, Ga.*

1873

Bur. R. F. & A. Lds.  
Office Freedmen's Dispensary.  
Albany, Ga. Decr 15. '68

Dr J. W. Carter,  
A. A. Surgeon U.S.A.,  
Americus, Ga.

Sir,

I have the honor to acknowledge your favor from to day with receipt for pill file. As the same would not answer the prescribed invoices and receipts necessary to account for that article in our semiannual Reports of Med. & Hosp. Stores I enclose you Duplicate Invoices and Receipts and respectfully request that you sign the latter and return them to me at your earliest convenience.

Very respectfully  
Your obedt servant,  
Ch. Raushenberg  
A. A. Surg. U.S.A.

6 11 — 11  
242 10

Bureau of Refugees, Freedmen, and Abandoned Lands, State of Georgia:

OFFICE ACTING ASSISTANT QUARTERMASTER AND DISBURSING OFFICER,

Atlanta, Georgia. Dec 15 1868.

Sir.

Enclosed find check to your  
order for \$39 - to pay vouchers  
of Chas. Corner 10 - Robt C. Black  
20 - Stephen Pounce 7 - and give  
for postage 2 - furnished by  
you

Very Respectfully  
C. J. Watson

Adj. Gen. & D. C.

Dr. J. W. Carter

Adj. Gen. (S. G.)

Americus, Ga



State of Georgia,

OFFICE SURGEON-IN-CHIEF, BUREAU OF R., F. AND A. L.,

Atlanta, Georgia, - *December 16* 1868,

*Mr. J. H. White*  
*Cherokee Co.*

*Sir,*

*In compliance with orders of the Surgeon-in-Chief at Cherokee Co., Ga. you will forward to this Office ten or twelve copies of all reports, or official letters and other official papers received by you during the term of your office in Cherokee. This was previously directed by a Circular Order of the Surgeon-in-Chief dated Nov. 25, 1868. You will understand that the Office is an incomplete class.*

*Very respectfully*

*Wm. H. H. H. H.*

*Wm. H. H. H.*

*Surgeon-in-Chief*

*Cherokee Co.*



NATIONAL ARCHIVES AND RECORDS ADMINISTRATION  
MICROFILM PUBLICATIONS

Roll 40

Target 8

Monthly Reports of Sick and Wounded Aug.-Nov. 1868

REPORT OF BIRTHS DURING THE MO

Males

No. of births in Hospital

No. of births elsewhere

Total

REPORT OF VACCINATIONS DURING THE MONTH

No. of Cases

Vaccinated successfully

unsuccessfully

Revaccinated successfully

unsuccessfully

Total

DIRECTIONS TO BE FOLLOWED IN MAKING REPORT OF SICK AND WOUNDED.

I. *Separate* reports of Refugees and of Freedmen will be made, month v. to the Surgeon-in-Chief of the District, who will transmit them, together with the consolidated monthly report, on regular blanks, to the Chief Medical Officer of the Bureau.

II. In making out the tabular list, cases remaining from previous months are to be entered in first column. Under the heading of *new cases*, those only are to be entered which have been taken on sick report or received into hospital during the month represented by the report. *All deaths*, however occurring during the month, are to be entered in the column of deaths, opposite the name of the disease causing death.

III. The "remaining from last monthly report," and the "gain since last monthly report," equal the "total under treatment during the month." The totals of "discharged," "transferred," and "died," give the "total loss during the month." The "total loss during the month," and "total remaining at date of this report," must equal, when added together, the "total number under treatment during the month."

IV. Patients above and including the age of fourteen will be enumerated as adults; below that age, as children.

V. Whenever cases are entered opposite any of the headings printed in *Tables*, or reported under *Class I*, (and the wound or injury has been received at the hands of another person,) the precise nature of the affection or the circumstances of the case so reported must be set forth in detail in column headed "remarks," or in an accompanying letter of transmittal.

REPORT

OF

Sick and Wounded ~~Refugees and~~

Station *Americus*

District of *Georgia*

Month of *August 1868.*

FORWARDED BY

*James M. Leamy*

~~*J. H. Carter*~~

~~*A. N. King, M.D.*~~

*The name of the Surgeon in Chief is to be*

*Surgeon-in-Chief* ~~*is to be*~~ *Entered in above space*

Here specify briefly the names of the Hospitals, Camps, Plantations, &c., the statistics of which are included in the within report.

*Dimensions retained copies of Reports of Sick & Wounded*

REMARKS.

I certify that this Report is correct and true to the best of my knowledge and belief.

*J. M. Carter*  
*as Surgeon M.D.*

In charge of *Dispensary*



ORDER 1. DIATHETIC DISEASES.  
 Gout.....  
 Acute rheumatism.....  
 Chronic rheumatism.....  
 Anæmia.....  
 Cancer.....  
 Tumors.....  
 Dry gangrene.....  
 Other diseases of this order.....

2 2 4

ORDER 2. TUBERCULAR DISEASES.  
 Consumption.....  
 Scrofula.....  
 Other diseases of this order.....

CLASS III.—PARASITIC DISEASES.  
 Itch.....  
 Tape worm.....  
 Other intestinal worms.....  
 Other diseases of this class.....

CLASS IV.—LOCAL DISEASES.  
 ORDER 1. DISEASES OF THE NERVOUS SYSTEM.  
 Apoplexy (cerebral).....  
 Epilepsy.....  
 Headache.....  
 Insanity.....  
 Inflammation of the brain.....  
 " of the membranes of the brain.....  
 " of the spinal cord.....  
 Nostalgia.....  
 Neuralgia.....  
 Paralysis.....  
 Sunstroke.....  
 Tetanus.....  
 Other diseases of the nervous system.....

27 17 16 10 70

Carry forward.....

Pistula in ano.....  
 Femoral hernia.....  
 Inguinal hernia.....  
 Prolapsus ani.....  
 Hemorrhage from the stomach.....  
 Hemorrhage from the bowels.....  
 Inflammation of the tonsils.....  
 Inflammation of the stomach.....  
 Inflammation of the bowels.....  
 Inflammation of the peritoneum.....  
 Acute inflammation of the liver.....  
 Chronic inflammation of the liver.....  
 Jaundice.....  
 Piles.....  
 Other diseases of this order.....

ORDER 7. DISEASES OF URINARY AND GENITAL ORGANS.  
 Calculus.....  
 Diabetes.....  
 Dropsy from renal disease.....  
 Diseases of the prostate.....  
 Diseases of the testis.....  
 Gravel.....  
 Inflammation of the kidneys.....  
 Inflammation of the bladder.....  
 Incontinence of urine.....  
 Hydrocele.....  
 Other diseases of this order.....

ORDER 8. DISEASES OF THE BONES AND JOINTS.  
 Anchylosis.....  
 Caries.....  
 Inflammation of joints.....  
 Inflammation of periosteum.....  
 Necrosis.....  
 Other diseases of this order.....

Carry forward.....

28 18 16 10 70



REPORT OF BIRTHS DURING THE MONTH.

Males, Females, Total

No. of births in Hospital.....

No. of births elsewhere.....

Total.....

REPORT OF VACCINATIONS DURING THE MONTH.

No. of Cases.

Vaccinated successfully.....

    "    unsuccessfully.....

Revaccinated successfully.....

    "    unsuccessfully.....

Total.....

DIRECTIONS TO BE FOLLOWED IN MAKING REPORT OF SICK AND WOUNDED.

I. Separate reports of Refugees and of Freedmen will be made, monthly, to the Surgeon-in-Chief of the District, who will transmit them, together with the consolidated monthly report on regular blanks, to the Chief Medical Officer of the Bureau.

II. In making out the tabular list, cases remaining from previous months are to be entered in first column. Under the heading of *new cases*, those only are to be entered which have been taken on sick report or received into hospital during the month represented by the report. All deaths, however occurring during the month, are to be entered in the column of deaths, opposite the name of the disease causing death.

III. The "remaining from last monthly report," and the "gain since last monthly report," equal the "total under treatment during the month." The totals of "discharged," "transferred," and "died," give the "total loss during the month." The "total loss during the month," and "total remaining at date of this report" must equal, when added together, the "total number under treatment during the month."

IV. Patients above and including the age of fourteen will be enumerated as adults; below that age, as children.

V. Whenever cases are entered opposite any of the headings printed in *italics*, or reported under *Class I*, (and the wound or injury has been received at the hands of another person,) the precise nature of the affection or the circumstances of the case so reported must be set forth in detail in column headed "remarks," or in an accompanying letter of transmittal.

Retained Copy  
REPORT

Sick and Wounded Refugees and Freedmen

Station *Currier*

District of *Ga*

Month of *September 1868*

FORWARDED BY

*Surgeon-in-Chief*

Here specify below the names of the Hospitals, Camps, Plantations, &c., the statistics of which are included in the within report.

REMARKS.

I certify that this Report is correct and true to the best of my knowledge and belief.

*Surgeon*

*In charge of*



**Class II.—CONSTITUTIONAL DISEASES.**

**ORDER 1. DIATHETIC DISEASES.**

Gout.....  
Acute rheumatism.....  
Chronic rheumatism.....  
Anemia.....  
Cancer.....  
Tumors.....  
Dry gangrene.....  
Other diseases of this order.....

17 14 3 32

**ORDER 2. TUBERCULAR DISEASES.**

Consumption.....  
Scrofula.....  
Other diseases of this order.....

**Class III.—PARASITIC DISEASES.**

Itch.....  
Tape worm.....  
Other intestinal worms.....  
Other diseases of this class.....

**Class IV.—LOCAL DISEASES.**

**ORDER 1. DISEASES OF THE NERVOUS SYSTEM.**

Apoplexy (cerebral).....  
Epilepsy.....  
Headache.....  
Insanity.....  
Inflammation of the brain.....  
" of the membranes of the brain.....  
" of the spinal cord.....  
Nostalgia.....  
Neuralgia.....  
Paralysis.....  
Sunstroke.....  
Tetanus.....  
Other diseases of the nervous system.....

2 2 2

1

4 3 7

Carry forward.....

Dyspepsia.....  
Diseases of the pancreas.....  
Diseases of the spleen.....  
Fistula in ano.....  
Femoral hernia.....  
Inguinal hernia.....  
Prolapsus ani.....  
Hemorrhage from the stomach.....  
Hemorrhage from the bowels.....  
Inflammation of the tonsils.....  
Inflammation of the stomach.....  
Inflammation of the bowels.....  
Inflammation of the peritoneum.....  
Acute inflammation of the liver.....  
Chronic inflammation of the liver.....  
Jaundice.....  
Piles.....  
Other diseases of this order.....

2 2  
2 3 9  
1 1

**ORDER 7. DISEASES OF URINARY AND GENITAL ORGANS.**

Calculus.....  
Diabetes.....  
Dropsy from renal disease.....  
Diseases of the prostate.....  
Diseases of the testis.....  
Gravel.....  
Inflammation of the kidneys.....  
Inflammation of the bladder.....  
Incontinence of urine.....  
Hydrocele.....  
Other diseases of this order.....

**ORDER 8. DISEASES OF THE BONES AND JOINTS.**

Anchylolysis.....  
Caries.....  
Inflammation of joints.....  
Inflammation of periosteum.....  
Necrosis.....  
Other diseases of this order.....

1 1

Carry forward.....

2 2

2 2 2 2 2



TABULAR LIST OF DISEASES.	No. remaining at date of last report.	NEW CASES.					TOTAL.	ALL DEATHS.	No. remaining at date of last report.	NEW CASES.					TOTAL.	ALL DEATHS.
		Adult Males.	Adult Females.	Male Children.	Female Children.	TOTAL.				Adult Males.	Adult Females.	Male Children.	Female Children.	TOTAL.		
Brought forward.....	70	2	1	1	1	5	10	1	70	3	1	1	1	6	10	1
<b>ORDER 9. DISEASES OF THE INTEGUMENTARY SYSTEM.</b>																
Abscess.....		1				1										
Boil.....																
Carbuncle.....																
Ulcers.....		2	1			3										
Whitlow.....																
<i>Skin diseases.</i>																
<b>ORDER 10. CONDITIONS AND DISEASES PECULIAR TO FEMALES.</b>																
Pregnancy.....																
Premature labor.....																
Abortion.....																
Prolapsus uteri.....																
Inflammation of the uterus.....																
Puerperal peritonitis.....																
Ovarian dropsy.....																
Leucorrhoea.....																
Dysmenorrhoea.....																
Amenorrhoea.....																
Menorrhagia.....																
<i>Other diseases of this organ.</i>																
<b>Class V.—VIOLENT DISEASES AND DEATHS.</b>																
<b>ORDER 1. WOUNDS, INJURIES, AND ACCIDENTS.</b>																
Burns and Scalds.....																
Brought forward.....	70	2	1	1	1	5	10	1	70	3	1	1	1	6	10	1
<b>TABULAR LIST OF DISEASES.</b>																
Brought forward.....																
Contusions.....																
Concussion of the brain.....																
Drowning.....																
Sprains.....																
Dislocations.....																
Frost-bite.....																
Simple fractures, (not gunshot).....																
Compound fractures, (not gunshot).....																
Gunshot wounds, (of all kinds).....																
Incised wounds.....																
Lacerated wounds.....																
Punctured wounds.....																
Poisoning.....																
<i>Other accidents and injuries.</i>																
<b>ORDER 2. HOMICIDE.</b>																
<b>ORDER 3. SUICIDE.</b>																
<b>ORDER 4. EXECUTION OF SENTENCE:</b>																
Hanging.....																
Shooting.....																
<b>UNCLASSIFIED.</b>																
Old age.....																
Malingering.....																
Convalescents from other hospitals.....																
Total.....	70	2	1	1	1	5	10	1	70	3	1	1	1	6	10	1

**II. GENERAL SUMMARY.**

REMAINING LAST MONTHLY REPORT.		GAIN SINCE LAST MONTHLY REPORT.		Total number under treatment during the Month.	DISCHARGED DURING THE MONTH.				Total.	TRANSFERRED DURING THE MONTH.				DIED DURING THE MONTH.				REMAINING AT DATE OF THIS REPORT.				TOTAL NUMBER UNDER CHARGE OF BUREAU.			
Adult Males.	Adult Females.	Male Children.	Female Children.		Adult Males.	Adult Females.	Male Children.	Female Children.		Adult Males.	Adult Females.	Male Children.	Female Children.	Adult Males.	Adult Females.	Male Children.	Female Children.	Adult Males.	Adult Females.	Male Children.	Female Children.	Adult Males.	Adult Females.	Male Children.	Female Children.
1				1				1																	
20	18	10	10	48	27	28	15	15	87	27	28	15	15	87	27	28	15	15	87	27	28	15	15	87	

REPORT OF BIRTHS DURING THE MONTH.

Males. Females. Total.

No. of births in Hospital.....

No. of births elsewhere.....

Total.....

REPORT OF VACCINATIONS DURING THE MONTH.

No. of Cases.

Vaccinated successfully.....

" unsuccessfully.....

Revaccinated successfully.....

" unsuccessfully.....

Total.....

DIRECTIONS TO BE FOLLOWED IN MAKING REPORT OF SICK AND WOUNDED.

I. Separate reports of Refugees and of Freedmen will be made, monthly, to the Surgeon-in-Chief of the District, who will transmit them, together with the consolidated monthly report on regular blanks, to the Chief Medical Officer of the Bureau.

II. In making out the tabular list, cases remaining from previous months are to be entered in first column. Under the heading of *new cases*, those only are to be entered which have been taken on sick report or received into hospital during the month represented by the report. *All deaths*, however occurring during the month, are to be entered in the column of deaths, opposite the name of the disease causing death.

III. The "remaining from last monthly report," and the "gain since last monthly report," equal the "total under treatment during the month." The totals of "discharged," "transferred," and "died," give the "total loss during the month." The "total loss during the month," and "total remaining at date of this report," must equal, when added together, the "total number under treatment during the month."

IV. Patients above and including the age of fourteen will be enumerated as adults; below that age, as children.

V. Whenever cases are entered opposite any of the headings printed in *italics*, or reported under *Class I*, (and the wound or injury has been received at the hands of another person,) the precise nature of the affection or the circumstances of the case so reported must be set forth in detail in column headed "remarks," or in an accompanying letter of transmittal.

REPORT.

OF

Sick and Wounded Refugees and Freedmen.

Station

District of

Month of *Feb* 1868.

FORWARDED BY

*Surgeon-in-Chief*

Here specify, in full, the names of the Hospitals, Camps, Plantations, &c., the statistics of which are included in the within report.

REMARKS.

*I have to report that the...*

*The number of cases...*

*I have to report...*

I certify that this Report is correct and true to the best of my knowledge and belief.

Surgeon

In charge of



ORDER 2. ENTHETIC DISEASES.

Syphilis	74	4	8	0	5	17
Gonorrhœa	7	11	3	0	0	7
Orchitis (gonorrhœal)						
Stricture of urethra						
Purulent ophthalmia						
Bite of serpents						
Other diseases of this order						

ORDER 3. DIETIC DISEASES.

Scurvy						
Purpura						
Delirium tremens						
Inebriation						
Chronic alcoholism						
Other diseases of this order						

Class II.—CONSTITUTIONAL DISEASES.

ORDER 1. DIATHETIC DISEASES.

Gout						
Acute rheumatism						
Chronic rheumatism	12	24	13	21	0	1 35
Anæmia						
Cancer						
Tumors						
Dry gangrene						
Other diseases of this order						

ORDER 2. TUBERCULAR DISEASES.

Consumption						
Serofula						
Other diseases of this order						

Class III.—PARASITIC DISEASES.

Itch		0	1	1	0	2
Tapeworm						
Other intestinal worms	27	0	21	15	12	23
Other diseases of this class						

Class IV.—LOCAL DISEASES.

ORDER 1. DISEASES OF THE NERVOUS SYSTEM.

Apoplexy (cerebral)						
Epilepsy	1	9	1	0	13	
Headache						
Insanity						
Inflammation of the brain						
of the membranes of the brain	1	2	1	0	0	3
of the spinal cord						
Nostalgia						
Neuralgia	7	3	2	1	1	4
Paralysis	2	1	1	1	1	2
Sunstroke						
Tetanus						
Other diseases of the nervous system						

Carry forward

462-205202 74 83 5 1

ORDER 5. DISEASES OF THE RESPIRATORY SYSTEM.

Asthma	3	6	2	1	6	3
Acute bronchitis	9	1	0	3	1	14
Chronic bronchitis		1	1	1	0	1
Dropsy of the chest						
Epistaxis						
Inflammation of the larynx						
Inflammation of the lungs		2	1	1	0	4
Inflammation of the pleura						
Hemorrhage from the lungs						
Other diseases of this order						

ORDER 6. DISEASES OF THE DIGESTIVE ORGANS.

Colic	3					
Constipation	14	10	10	2	2	24
Cholera morbus						
Cholera infantum	1	1	0	5	0	11
Cirrhosis of the liver						
Dropsy from hepatic disease	1					
Dyspepsia	1					
Diseases of the pancreas						
Diseases of the spleen		2	6			8
Fistula in ano						
Femoral hernia						
Inguinal hernia						3
Prolapsus ani						
Hemorrhage from the stomach						
Hemorrhage from the bowels						
Inflammation of the tonsils	1	5	2	0	0	7
Inflammation of the stomach						
Inflammation of the bowels						
Inflammation of the peritonæum						
Acute inflammation of the liver	3	3	0	6	1	5
Chronic inflammation of the liver						
Jaundice	1	1	1	1	0	1
Piles						
Other diseases of this order						

ORDER 7. DISEASES OF URINARY AND GENITAL ORGANS.

Calculus						
Diabetes						
Dropsy from renal disease						
Diseases of the prostate						
Diseases of the testis						
Gravel		1	0	1		1
Inflammation of the kidneys						
Inflammation of the bladder						
Incontinence of urine						
Hydrocele						
Other diseases of this order						

ORDER 8. DISEASES OF THE BONES AND JOINTS.

Anchylolysis						
Caries						
Inflammation of joints	1	1	1	6	0	6
Inflammation of periosteum		1	1	3	0	1
Necrosis						
Other diseases of this order						

Carry forward

828 232, 222, 94 97 650

659



REPORT OF BIRTHS DURING THE MONTH.	REPORT	REMARKS.
<p>Male. Females. Total.</p>		
<p>No. of Births in Hospital. No. of Births out of Hospital.</p>	<p>Sick and Wounded Refugees and Freedmen.</p>	<p>Plaf. 111 Order 111 - In pain Wishes on account of head &amp; The Surge -</p>
<p>REPORT OF VACCINATIONS DURING THE MONTH.</p>	<p>Station <i>Amnicus</i></p>	<p>Plaf. 111, Order 111, Disease of the neck, typhoid, in the neck.</p>
<p>No. of Males.</p>	<p>State of <i>Georgia</i></p>	<p>Plaf. 111 Order 111, Phthisis Pulmonalis.</p>
<p>No. of Females.</p>	<p>Month of <i>November 1863</i></p>	<p>Plaf. 111, Order 111 Enlargement of the Spleen by malaria.</p>
<p>No. of Children.</p>		<p>Plaf. 111, Order 111 Displacement of diseased Nervous &amp; Displacement of the same.</p>
<p>No. of Deaths.</p>		<p>Plaf. 111, Order 111 - Injured (3) Heart of accident by falling into the river. The case of typhoid (2) &amp; also of typhoid (1) are are also the result of accident.</p>
<p>No. of Burials.</p>		
<p>DIFFERENCES TO BE FOLLOWED IN MAKING REPORTS ON SICK AND WOUNDED.</p>		<p>I certify that this Report is correct and true to the best of my knowledge and belief.</p>
<p>1. Sick and Wounded Reports should be made monthly, at the end of each month, by the Surgeon, who will transmit them, together with the original reports, to the Medical Officer of the Station.</p>		<p><i>J. A. Surgeon</i> In charge of Dispensary</p>
<p>2. If a patient is admitted to the Hospital, the Surgeon should make a report on the admission, and if the patient is discharged, a report on the discharge, should be made, and if the patient dies, a report on the death, should be made, and if the patient is buried, a report on the burial, should be made.</p>		
<p>3. If a patient is admitted to the Hospital, the Surgeon should make a report on the admission, and if the patient is discharged, a report on the discharge, should be made, and if the patient dies, a report on the death, should be made, and if the patient is buried, a report on the burial, should be made.</p>		
<p>4. If a patient is admitted to the Hospital, the Surgeon should make a report on the admission, and if the patient is discharged, a report on the discharge, should be made, and if the patient dies, a report on the death, should be made, and if the patient is buried, a report on the burial, should be made.</p>		
<p>5. If a patient is admitted to the Hospital, the Surgeon should make a report on the admission, and if the patient is discharged, a report on the discharge, should be made, and if the patient dies, a report on the death, should be made, and if the patient is buried, a report on the burial, should be made.</p>		



Inebriation .....  
 Chronic alcoholism .....  
 Other diseases of this order .....

**Class II.—CONSTITUTIONAL DISEASES.**

**ORDER 1. DIATHETIC DISEASES.**

Gout .....  
 Acute rheumatism .....  
 Chronic rheumatism ..... 1 22 30 1 1 54  
 Anæmia .....  
 Cancer .....  
 Tumors .....  
 Dry gangrene .....  
 Other diseases of this order .....

**ORDER 2. TUBERCULAR DISEASES.**

Consumption .....  
 Scrofula .....  
 Other diseases of this order .....

**Class III.—PARASITIC DISEASES.**

Itch .....  
 Tape worm .....  
 Other intestinal worms ..... 23 24 47  
 Other diseases of this class .....

**Class IV.—LOCAL DISEASES.**

**ORDER 1. DISEASES OF THE NERVOUS SYSTEM.**

Apoplexy (cerebral) .....  
 Epilepsy .....  
 Headache ..... 1 3 1 5  
 Insanity .....  
 Inflammation of the brain ..... 1 1  
 " of the membranes of the brain .....  
 " of the spinal cord .....  
 Nostalgia .....  
 Neuralgia ..... 1 1  
 Paralysis .....  
 Sunstroke .....  
 Tetanus .....  
 Other diseases of the nervous system .....

Carry forward ..... 30 137 153 62 64 416

Cholera morbus .....  
 Cholera infantum ..... 3 5 9  
 Cirrhosis of the liver .....  
 Dropsy from hepatic disease ..... 1 1  
 Dyspepsia ..... 1 1  
 Diseases of the pancreas .....  
 Diseases of the spleen ..... 1 1  
 Fistula in ano ..... 1 1  
 Femoral hernia .....  
 Inguinal hernia ..... 1  
 Prolapsus ani .....  
 Hemorrhage from the stomach .....  
 Hemorrhage from the bowels .....  
 Inflammation of the tonsils ..... 2 1 1 1 3  
 Inflammation of the stomach .....  
 Inflammation of the bowels .....  
 Inflammation of the peritoneum .....  
 Acute inflammation of the liver ..... 2 4 1 3  
 Chronic inflammation of the liver ..... 1  
 Jaundice .....  
 Piles ..... 1 1  
 Other diseases of this order .....

**ORDER 7. DISEASES OF URINARY AND GENITAL ORGANS.**

Calculus .....  
 Diabetes .....  
 Dropsy from renal disease .....  
 Diseases of the prostate .....  
 Diseases of the testis .....  
 Gravel ..... 1 1  
 Inflammation of the kidneys .....  
 Inflammation of the bladder .....  
 Incontinence of urine ..... 1 1  
 Hydrocele .....  
 Other diseases of this order .....

**ORDER 8. DISEASES OF THE BONES AND JOINTS.**

Anchylolysis .....  
 Caries .....  
 Inflammation of joints ..... 2 2 1 3  
 Inflammation of periosteum .....  
 Necrosis .....  
 Other diseases of this order .....

Carry forward ..... 37 186 183 75 75 314



TABULAR LIST OF DISEASES.					TABULAR LIST OF DISEASES.								
	No. remaining at date of last report.	NEW CASES.			Total.		No. remaining at date of last report.	NEW CASES.			Total.		
		Adult Males.	Adult Females.	Male Children.				Female Children.	Adult Males.	Adult Females.		Male Children.	Female Children.
Brought forward.....	37	181	153	73	73	314	Brought forward.....	67	188	218	79	75	500
<b>ORDER 9. DISEASES OF THE INTEGUMENTARY SYSTEM.</b>							<b>ORDER 2. HOMICIDE</b>						
Abscess.....		1			1		Contusions.....	3	1			1	2
Boil.....		1		1	2		Concussion of the brain.....						
Cyanoide.....							Drowning.....						
Ulcers.....	10	3	2		7		Sprains.....						
Witchow.....	3						Dislocations.....	1				1	
<b>ORDER 10. CONDITIONS AND DISEASES PECULIAR TO FEMALES.</b>							<b>ORDER 3. SUICIDE</b>						
Pregnancy.....							Frost-bite.....						
Premature labour.....							Simple fractures (not gunshot).....						
Abortion.....			2		2		Compound fractures (not gunshot).....						
Protrusion of the uterus.....	2		2		5		Gunshot wounds (of all kinds).....						
Inflammation of the ovaries.....							Lacerated wounds.....						
Purpura peritonidis.....							Punctured wounds.....						
Ovarian dropsy.....							Poisoning.....						
Leucorrhoea.....			3		3		<i>Other accidents and injuries.</i>						
Dysmenorrhoea.....			11		11		<b>ORDER 4. EXECUTION OF SENTENCE:</b>						
Amennorrhoea.....	5		4		5		Hanging.....						
Menorrhagia.....			1		1		Shooting.....						
<b>OTHER DISEASES OF FEMALES</b>							<b>UNCLASSIFIED.</b>						
.....	8		5		5		Chilblains.....			1		1	
<b>CASES V.—VIOLENT DISEASES AND DEATHS.</b>							<b>ORDER 1. WOUNDS, INJURIES, AND ACCIDENTS.</b>						
<b>ORDER 1. WOUNDS, INJURIES, AND ACCIDENTS.</b>							<b>Burns and Scalds.....</b>						
<b>Burns and Scalds.....</b>					3	3	<b>.....</b>						
Brought forward.....	67	188	218	79	75	500	<b>.....</b>						

## II. GENERAL SUMMARY.

REMAINING LAST MONTHLY REPORT.		GAIN SINCE LAST MONTHLY REPORT.		Total number under treatment during the Month.	DISCHARGED DURING THE MONTH.		TRANSFERRED DURING THE MONTH.		DIED DURING THE MONTH.		REMAINING AT DATE OF THIS REPORT.		TOTAL NUMBER UNDER CHARGE OF BUREAU.		
Adult Males.	Adult Females.	Male Children.	Female Children.		Adult Males.	Adult Females.	Male Children.	Female Children.	Adult Males.	Adult Females.	Male Children.	Female Children.	Adult Males.	Adult Females.	Male Children.
33	25	3	1	63	225	47	82	80	63	4	4	190	219	79	75
190	219	79	75	634	225	47	82	80	63	4	4	190	219	79	75
190	219	79	75	634	225	47	82	80	63	4	4	190	219	79	75
190	219	79	75	634	225	47	82	80	63	4	4	190	219	79	75
190	219	79	75	634	225	47	82	80	63	4	4	190	219	79	75

Retained Copies  
of

WEEKLY REPORT

OF

SICK AND WOUNDED REFUGEES  
AND FREEDMEN.

Station: *Americus*

District of: *Georgia*

FOR THE

Week ending *August 29<sup>th</sup>*, 1863.

*Sept. 3<sup>rd</sup>*  
*" 12<sup>th</sup>*  
*" 19<sup>th</sup>*  
*" 25<sup>th</sup>*  
*Oct 3<sup>rd</sup>*  
*" 10<sup>th</sup>*  
*" 17<sup>th</sup>*  
*" 24<sup>th</sup>*  
*" 31<sup>st</sup>*  
*Nov. 7<sup>th</sup>*  
*" 14<sup>th</sup>*  
*" 21<sup>st</sup>*  
*" 28<sup>th</sup>*  
*" 30<sup>th</sup>*

REMARKS.

DIRECTIONS.

The names of Medical Cadets and Hospital Stewards will be placed below the list of Medical Officers. *Separate Reports of Refugees and of Freedmen* will be made to this Office. If the Report is of *Refugees*, erase the word *Freedmen* in the designation; and if of *Freedmen*, strike out the word *Refugees*. These Reports must be forwarded weekly, on Saturdays, to the Surgeon-in-Chief of the District, who will forward a consolidated Report on the succeeding Monday to the Chief Medical Officer of the Bureau, Washington, D. C.

REPORT of Sick and Wounded Refugees and Freedmen in *Dispensary*, for the week ending Saturday, *August 27<sup>th</sup>*, 1868.  
 STATION: *Americus*, DISTRICT OF *Georgia*, Bureau of Refugees, Freedmen, and Abandoned Lands.

NAME OF WRITER.	STATION.	REMAINING AT LAST WEEKLY REPORT.				GAIN SINCE LAST WEEKLY REPORT.				TOTAL UNDER TREATMENT DURING THE WEEK.	DISCHARGED DURING THE WEEK.				TRANSFERRED DURING THE WEEK.				DIED DURING THE WEEK.				TOTAL LOSS DURING THE WEEK.	REMAINING AT DATE OF THIS REPORT.				NUMBER OF BEDS FOR PATIENTS.		NUMBER OF ATTENDANTS.		TOTAL NUMBER UNDER CHARGE OF BUREAU.					RATIO PER 1,000 OF DEATHS DURING THE WEEK.
		Adult males.	Adult females.	Male children.	Female children.	Adult males.	Adult females.	Male children.	Female children.		Adult males.	Adult females.	Male children.	Female children.	Adult males.	Adult females.	Male children.	Female children.	Adult males.	Adult females.	Male children.	Female children.		Total.	Adult males.	Adult females.	Male children.	Female children.	Occupied.	Vacant.	Male.	Female.	Adult males.	Adult females.	Male children.	Female children.	
<i>J. M. Castle</i>	<i>Americus</i>					<i>18</i>	<i>22</i>	<i>9</i>	<i>3</i>	<i>52</i>														<i>18</i>	<i>22</i>	<i>9</i>	<i>3</i>					<i>18</i>	<i>22</i>	<i>9</i>	<i>3</i>		
<i>(A). W.A.</i>	<i>Sept. 3<sup>rd</sup></i>	<i>15</i>	<i>22</i>	<i>9</i>	<i>3</i>	<i>37</i>	<i>45</i>	<i>11</i>	<i>10</i>	<i>107</i>	<i>15</i>	<i>22</i>	<i>9</i>	<i>3</i>									<i>32</i>	<i>31</i>	<i>13</i>	<i>10</i>	<i>11</i>					<i>31</i>	<i>13</i>	<i>10</i>	<i>11</i>	<i>97</i>	
	<i>" 13<sup>th</sup></i>	<i>31</i>	<i>13</i>	<i>10</i>	<i>11</i>	<i>70</i>	<i>85</i>	<i>33</i>	<i>31</i>	<i>316</i>	<i>93</i>	<i>117</i>	<i>12</i>	<i>12</i>									<i>304</i>	<i>8</i>	<i>3</i>	<i>1</i>	<i>"</i>					<i>8</i>	<i>3</i>	<i>1</i>	<i>"</i>	<i>12</i>	
	<i>" 17<sup>th</sup></i>	<i>8</i>	<i>3</i>	<i>1</i>	<i>"</i>	<i>51</i>	<i>72</i>	<i>31</i>	<i>35</i>	<i>201</i>	<i>11</i>	<i>66</i>	<i>29</i>	<i>32</i>									<i>168</i>	<i>18</i>	<i>9</i>	<i>3</i>	<i>3</i>					<i>18</i>	<i>9</i>	<i>3</i>	<i>3</i>	<i>33</i>	
	<i>" 26<sup>th</sup></i>	<i>18</i>	<i>9</i>	<i>3</i>	<i>3</i>	<i>34</i>	<i>38</i>	<i>12</i>	<i>36</i>	<i>253</i>	<i>1280</i>	<i>38</i>	<i>54</i>									<i>194</i>	<i>30</i>	<i>17</i>	<i>7</i>	<i>5</i>					<i>30</i>	<i>17</i>	<i>7</i>	<i>5</i>	<i>59</i>		
	<i>Oct. 3<sup>rd</sup></i>	<i>30</i>	<i>17</i>	<i>7</i>	<i>5</i>	<i>58</i>	<i>77</i>	<i>32</i>	<i>29</i>	<i>235</i>	<i>663</i>	<i>129</i>	<i>31</i>									<i>177</i>	<i>22</i>	<i>13</i>	<i>10</i>	<i>3</i>					<i>22</i>	<i>13</i>	<i>10</i>	<i>3</i>	<i>78</i>		
	<i>" 10<sup>th</sup></i>	<i>22</i>	<i>13</i>	<i>10</i>	<i>3</i>	<i>36</i>	<i>40</i>	<i>16</i>	<i>20</i>	<i>194</i>	<i>28</i>	<i>31</i>	<i>18</i>									<i>120</i>	<i>21</i>	<i>20</i>	<i>8</i>	<i>5</i>					<i>20</i>	<i>21</i>	<i>20</i>	<i>8</i>	<i>51</i>		
	<i>" 17<sup>th</sup></i>	<i>21</i>	<i>21</i>	<i>11</i>	<i>5</i>	<i>47</i>	<i>57</i>	<i>22</i>	<i>21</i>	<i>288</i>	<i>48</i>	<i>24</i>	<i>25</i>					<i>1</i>				<i>177</i>	<i>12</i>	<i>15</i>	<i>7</i>	<i>2</i>					<i>12</i>	<i>15</i>	<i>7</i>	<i>2</i>	<i>30</i>		
	<i>" 21<sup>st</sup></i>	<i>12</i>	<i>16</i>	<i>5</i>	<i>4</i>	<i>11</i>	<i>18</i>	<i>11</i>	<i>15</i>	<i>163</i>	<i>33</i>	<i>15</i>	<i>13</i>									<i>119</i>	<i>18</i>	<i>17</i>	<i>4</i>	<i>5</i>					<i>18</i>	<i>17</i>	<i>4</i>	<i>5</i>	<i>24</i>		
	<i>" 31<sup>st</sup></i>	<i>18</i>	<i>17</i>	<i>4</i>	<i>5</i>	<i>21</i>	<i>35</i>	<i>15</i>	<i>28</i>	<i>231</i>	<i>59</i>	<i>39</i>	<i>21</i>	<i>27</i>								<i>195</i>	<i>23</i>	<i>24</i>	<i>8</i>	<i>6</i>					<i>23</i>	<i>24</i>	<i>8</i>	<i>6</i>	<i>35</i>		
	<i>Nov. 7<sup>th</sup></i>	<i>23</i>	<i>24</i>	<i>3</i>	<i>6</i>	<i>72</i>	<i>77</i>	<i>32</i>	<i>27</i>	<i>258</i>	<i>63</i>	<i>63</i>	<i>30</i>	<i>27</i>								<i>184</i>	<i>34</i>	<i>20</i>	<i>5</i>	<i>5</i>					<i>34</i>	<i>20</i>	<i>5</i>	<i>5</i>	<i>53</i>		
	<i>" 14<sup>th</sup></i>	<i>34</i>	<i>110</i>	<i>5</i>	<i>5</i>	<i>52</i>	<i>53</i>	<i>19</i>	<i>21</i>	<i>239</i>	<i>41</i>	<i>83</i>	<i>20</i>	<i>20</i>								<i>197</i>	<i>15</i>	<i>20</i>	<i>4</i>	<i>1</i>					<i>15</i>	<i>20</i>	<i>4</i>	<i>1</i>	<i>20</i>		
	<i>Nov. 21<sup>st</sup></i>	<i>15</i>	<i>20</i>	<i>4</i>	<i>1</i>	<i>54</i>	<i>64</i>	<i>22</i>	<i>22</i>	<i>208</i>	<i>63</i>	<i>76</i>	<i>20</i>	<i>27</i>				<i>1</i>	<i>1</i>			<i>189</i>	<i>4</i>	<i>8</i>	<i>6</i>	<i>1</i>					<i>4</i>	<i>8</i>	<i>6</i>	<i>1</i>	<i>19</i>		
	<i>" 27<sup>th</sup></i>	<i>4</i>	<i>8</i>	<i>1</i>	<i>1</i>	<i>4</i>	<i>5</i>	<i>2</i>	<i>1</i>	<i>31</i>	<i>6</i>	<i>8</i>	<i>6</i>	<i>1</i>								<i>21</i>	<i>2</i>	<i>5</i>	<i>1</i>	<i>1</i>					<i>2</i>	<i>5</i>	<i>1</i>	<i>1</i>	<i>10</i>		
	<i>to the period ending Nov. 30<sup>th</sup></i>	<i>2</i>	<i>1</i>	<i>1</i>	<i>1</i>	<i>"</i>	<i>"</i>	<i>"</i>	<i>"</i>	<i>11</i>	<i>2</i>	<i>5</i>	<i>2</i>	<i>1</i>								<i>10</i>	<i>"</i>	<i>"</i>	<i>"</i>	<i>"</i>					<i>"</i>	<i>"</i>	<i>"</i>	<i>"</i>	<i>"</i>		

*J. M. Castle*  
 U.S. Surgeon U. S. A. in charge.  
*Dispensary*

LIST OF MEDICAL OFFICERS.

NAME.	RANK.	STATION.	PRESENT OR ABSENT.	BY WHAT AUTHORITY PLACED ON DUTY.
<i>J. D. Carter</i>	<i>Capt.</i>	<i>Amman Post</i>		<i>Prof. Gen. C. H. Howard</i>

*J. D. Carter*  
*Capt. Surgeon U.S.A.*

In charge of *Dispensary*

NATIONAL ARCHIVES AND RECORDS ADMINISTRATION  
MICROFILM PUBLICATIONS

Roll 40

Target 9

Register of Patients  
Volume (141)

Aug.-Nov. 1868

Volume pages were filmed sequentially.  
Blank pages were not filmed.

NARRATIVE

GEORGIA.

*Spencer*  
*1877*

**U. S. A.**  
**HOSPITAL DEPARTMENT.**  
**REGISTER.**

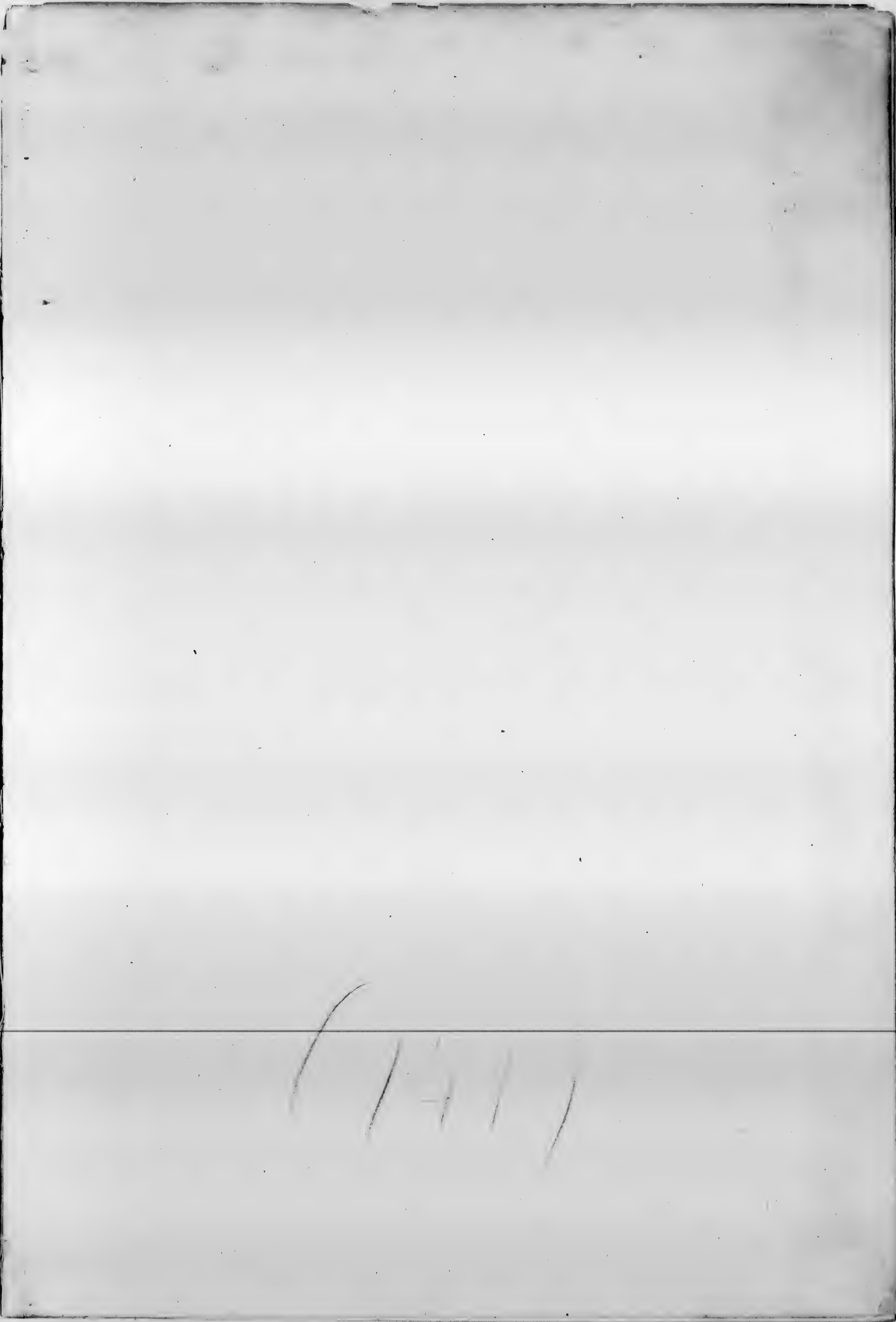

# REGISTER OF THE SICK AND WOUNDED

NAMES	Rank		Admitted	Regiment & Corps	Mole - Children	General	Company	Complaint	Admitted
	Actual	Pract.							
Nehemiah Wheaton								Chronic Ulcer	Aug. 26
John Whitson	2							Sub. Intermitt. Febr.	" "
Wm. Parsons	3							" "	" "
Charlotte Clark			1					Dysentery	" "
Sally Gay			2					Catarrh	" "
Hugh Williams	1							Shilly gut.	" "
Wm. Jones	2							" "	" "
Wm. Jones			3					Rheumatism	" "
Wm. do.			4					Shilly gut.	" "
Wm. do.			5					" "	" "
Wm. do.	6							" "	" 27
Wm. do.	7							Dysentery	" "
Charlotte Clark			8					" "	" "
Maria Davis			9					" "	" "
William Johnson			5					Sub. Interm. Febr.	" "
Anna Donaldson			9					Catarrh	" "
Ed. Wheaton	8							Ch. Ulcer	" 28
Virginia Hunter			10					Sub. Interm.	" 28
Wm. do.	9							Convulsions	" "
Wm. do.			11					Sub. Interm. Febr.	" "
Abraham Brooks	10							" "	" "
Queen Stewart						1		" "	" "
Wm. do.			12			2		" "	" "
Wm. do.					1			" "	" "
Wm. do.					2			" "	" "
Wm. do.			12					Dysentery	" 29
General Ruffin	1				3			" "	" "
Wm. Christian			13					" Stability -	" "
Wm. Allen					4			Sub. Interm.	" 29
Wm. do.					5			Sub. Interm.	" "
John do.	11							Sub. Interm.	" "
Wm. do.					6			" "	" "
Wm. do.			14					Sub. Interm.	" "
Wm. do.			15					" "	" "
Wm. do.			15					" "	" "
Maria Phillips			17					" "	" "
Andrew James					7			" "	" "
Wm. do.	12							" "	" "
Elizabeth do.			18					" "	" "
Wm. do.			19					" "	" "
Wm. do.	13		19		7			Rheumatism	" "



Returned to Duty	Deserted	Discharged from Service	Sent to General Hospital	On Furlough	DIED	REMARKS
------------------	----------	-------------------------	--------------------------	-------------	------	---------

*Oct. 3*

*Aug. 30*

*" "*

*" "*

*" 30*

*" "*

*" "*

*" "*

*" "*

*" "*

*" "*

*Oct 3*

*Sept. 30*

*" "*

*" 15*

*Oct 3*

*Sept. 3*

*" 30*

*" "*

*" "*

*" "*

*" "*

*" "*

*" "*

*" 31*

*" "*

*Oct. 10*

*Sept. 7*

*" 3*

*" "*

*" "*

*" "*

*" "*

*" "*

*" "*

*" "*

*" "*

*" "*

*" 10*

# REGISTER OF THE SICK AND WOUNDED

NAMES	Rank	Regiment or Corps	Company	Complaint	Admitted
Christina Appes	1			Interdian	Aug. 29
Medie Co			1	Interdian	" "
Seneca "			1	"	" "
W. J. Matthews		1		Interdian	" "
Jim Syate	2			"	" "
Martha Cooley		2		"	" "
Caroline Bop		3		"	" "
W. G. Smith		4		Interdian	" "
W. G. Smith	3			"	" "
Jerry Humphreys	4			"	" "
Jenny Evans		5		"	" "
John "			2	"	" "
Lena Brown		4		"	" 31
Jerry Stanton			3	"	" "
Horace Sellaus	5			"	" "
Edmond Edgeworth	5			Interdian	" "
May Ann Edgeworth			2	"	" "
Rachel Wilson		7		"	" "
W. J. Green	7			"	" "
Margaret "		8		"	" "
Frank Thompson	8			"	" "
Lucina "		9		"	" "
Mary "			4	"	" "
Warren Seay	9			Interdian	" "
John "	10			"	" "
Adeline "			5	"	" "
James Jones	11			Interdian	" "
Polly Lewis			6	Interdian	" "
John "			4	"	" "
Louisa Black		10		"	" "
Pearl Boy				"	" "
Lily "				"	" "
Mary Smith		11		"	" "
Florence "		11		"	" "
John Lewis		15		"	" "
Louisa White		14		"	" "
	23	31	12		10

AT

*Amiens, Dec.*

186

Returned to Duty	Deserted	Discharged from Service	Sent to General Hospital	On Furlough	DIED	REMARKS
------------------	----------	-------------------------	--------------------------	-------------	------	---------

*Sept. 2*

*" "*

*" "*

*" 10*

*" 2*

*" "*

*" "*

*" 10*

*" 2*

*" "*

*" "*

*" "*

*" 3*

*" "*

*" "*

*" /*

*" 3*

*" "*

*" "*

*" "*

*" "*

*" "*

*" "*

*" "*

*" /*

*" "*

*" "*

*" 3*

*" /*

*" "*

*" "*

*" "*

*" "*

*" "*

*" 3*

*" "*

*" "*

*" "*

*" "*

# REGISTER OF THE SICK AND WOUNDED

NAMES	Rank	Regiment or Corps	Company	Complaint	Admitted
Richard Wheaton	1			Chronic Mucos	Sept. 1.
Caroline Fisher		1		Feb. Rem.	" "
Liberty Ross	2			16 days. Chron.	" "
York Phillips			1	Wound	" "
Emma Robertson			1	3 <sup>rd</sup> ophthalmia	" "
Sally Cobb		2		Rheumatism	" "
Luca Robertson		3		Supposed Sun	" "
Wm. Ford		4		Feb. Rem.	" "
Thos. Coker	4			" "	" "
Wm. Carter	5			Delirium	" "
Milly Caroline	5			Old age	" "
Pauline Jones	7			Feb. Rem.	" "
Ritter Meadows	4			" "	" "
Sam. Riddle	5			Feb. Sub. Quat.	" "
Henry White			2	Wounds	" "
Mary do			2	" "	" "
Thos. Coker	7			Feb. Rem.	" "
Joe Simmons	5			Rheumatism	" "
Frank Cherry	5			Feb. Sub. Quat.	" "
Eugene Black			3	" "	" "
Sabra "			3	" "	" "
Nelson Early	7			Feb. Rem.	" "
John Robinson			4	" "	" 2
Beluca Walden			5	" "	" 2
" Riddle			6	Delirium	" "
Charlotte George	4			Delirium	" "
Thos. Bury	5			" "	" "
Eliza Maxwell				Delirium	" "
Bartlett do	8			Delirium	" "
H. A. Matthews	7			Constipation	" "
Henry Wood	9			Feb. Rem.	" "
Sam. Payne	8			Rheumatism	" "
Lawrence Gayler	10			Feb. Rem.	" "
Frances Wood	9			Delirium	" "
Ben. Black	11			Feb. Sub. Quat.	" "
Maria Travis	11			Diarrhoea	" "
Frederic Green	11			Pyemiasis	" "
Wm. Howard	12			" "	" "
Lucas Ford	12			Feb. Sub. Quat.	" "
W. J. Griffin	13			Delirium	" "
	12 13		3		6

AT

*Amicus, Geo.*

186

Returned to Duty	Deserted	Discharged from Service	Sent to General Hospital	On Furlough	DIED	REMARKS
------------------	----------	-------------------------	--------------------------	-------------	------	---------

		Oct 3				
		Sept 8				
		" 12				
		" 4				
		" 1				
		Oct 12				
		" 3				
		Sept 8				
		" "				
		" "				
		" "				
		" "				
		" "				
		" 4				
		" "				
		" "				
		" 8				
		" 4				
		" "				
		" "				
		" 8				
		" "				
		" "				
		" 4				
		" 8				
		" "				
		" "				
		" 5				
		" 2				
		" 3				
		Oct 10				
		Sept 8				
		" "				
		" 3				
		" "				
		Oct 10				
		Sept 5				
		" "				
		" 15				

# REGISTER OF THE SICK AND WOUNDED

NAMES	Rank	Regiment or Corps	Company	Complaint	Admitted
W. R. Miller		1		Amnesia	Sept. 2
William Pickard	1				" 3
Mary Ladd			1	Tub. Mem.	" "
Mathias Nelson	2			Influenza	" "
Stagg Smith		1		Tub. Mem.	" "
Katy Smith	2			After Pains	" "
Joe Simmons	3			Rheumatism	" "
W. A. Montgomery			2	Tub. Int. Intest.	" "
W. H. Chase			2	Cholera Intest.	" "
J. R. McDaniel	3			Tub. Int. Intest.	" "
M. J. McCoy	4			3 <sup>d</sup> Syphilis	" "
W. J. Griffin	5			Abortion	" "
Edw. Smith	6			Headache	" "
W. B. Jackson	4			Agripic acid	" "
W. M. McTee	5			Rheumatism	" "
Richard Reed	6			Hemorrhoids	" "
Lena Harris		7		Tub. Int. Intest.	Sept. 4
W. B. Jackson		7		Ulcer, Chronic	" "
W. A. Montgomery			3	Tub. Int. Intest.	" "
William Thompson			4	" " " "	" "
W. H. Chase			3	Cholera Intest.	" "
John Phillips			1	Tub. Mem.	" "
Charlotte George	8				" "
Anna Harris	9			3 <sup>d</sup> Syphilis	" "
Henry Barber	8			Tub. Intest. Intest.	" "
Elmira Roberts			5	" " " "	" "
Randall Reed	9			Rheumatism	" "
William Do	10			Abortion	" "
Minny Morgan	11			" " " "	" "
Catharine Allen	11			Tub. Int. Intest.	" "
John Do	12			" " " "	" "
Adolphus "	13			" " " "	" "
John C. Sargent	14			Gonorrhoea	" "
W. A. Montgomery	11			Abortion	" "
Mary Higgins	12			Tub. Mem.	" "
John Do	13			" Int. Intest.	" "
W. A. Montgomery			6	" " " "	" "
W. A. Montgomery	14			" " " "	" "
Edward Brown	15			" " " "	" "
Ellen Ross			7	Tub. Mem.	" "

Returned to Duty	Deserted	Discharged from Service	Sent to General Hospital	On Furlough	DIED	REMARKS
------------------	----------	-------------------------	--------------------------	-------------	------	---------

*Jan 15*

*Feb 1*

*Sept 10*

*" 6*

*" 10*

*" 4*

*" 18*

*" 5*

*Sept 19*

*" 5*

*" 20*

*" 15*

*" 5*

*" 10*

*" 20*

*Jan 7*

*Sept 7*

*Oct 3*

*Sept 7*

*" 11*

*" 10*

*" 11*

*" "*

*" 25*

*" 7*

*" "*

*" 15*

*" 7*

*Oct 1*

*Sept 7*

*" "*

*" "*

*" 12*

*" 15*

*" 11*

*" 7*

*" "*

*" 8*

*" "*

*" 11*

# REGISTER OF THE SICK AND WOUNDED

NAMES	Rank	Regiment or Corps	Company	Complaint	Admitted
Eli Daniel	16			Sub. Int. gut. Sept. 1	
Charlotte George		15		Debility " 5	
N. Chase			3	Andersa Refect " "	
Thos. Hart	17			Debility " "	
Ben. Lee		11		Sub. Int. gut. " "	
Jakob Rosing		17		Const. Liver " "	
Blanch Rose		18		Debility " "	
John Satta	18			Sub. Int. gut. " "	
Ida "				Debility " "	
Mrs. Rattle				Sub. Int. gut. " "	
Isaac Brewster		14		" " " " " "	
Mary "		20		" " " " " "	
Susan "			11	" " " " " "	
St. J. Stendersen	19			Debility " "	
Henry Jones	20			Sub. Int. gut. " "	
David Wilson		21		" " " " " "	
Henry Rep	21			Chim. Liver " "	
R. Robinson				" " " " " "	
John Allen		22		Sub. Int. gut. " "	
Leah Fortin			4	" " " " " "	
Mary "			11	" " " " " "	
Laura "			7	" " " " " "	
Mary Morgan		23		" " " " " "	
Mar. Lee		24		" " " " " "	
R. Killbuck	25			Debility " "	
Mary Otter	26			Defect. Vision " "	
John Lewis				Sub. Int. gut. " "	
Wm. "			8	Sub. Int. gut. " "	
Ideline "		28		" " " " " "	
Frank Barnes	29			" " " " " "	
Lucinda Cook				Const. Liver " "	
Gregory Jennings	30			Debility " "	
Walter Ward		31		Sub. Int. gut. " "	
Edmond Cook	32			" " " " " "	
Wm. Cook		27		" " " " " "	
John "			9	" " " " " "	
Stephen Castle	33			Const. Liver " "	
Samuel Jones	34			Pain " "	



AT

*Specimens, Sec.*

186

Returned to Duty	Deserted	Discharged from Service	Sent to General Hospital	On Furlough	DIED	REMARKS
------------------	----------	-------------------------	--------------------------	-------------	------	---------

*Sept. 7*

*" 20*

*" 10*

*Sept. 35*

*" 7*

*" "*

*" 12*

*" 8*

*" "*

*" "*

*" "*

*" "*

*" "*

*" 15*

*" 8*

*" 11*

*Oct 8*

*" "*

*" "*

*" "*

*" "*

*" "*

*" "*

*" "*

*" "*

*" "*

*" 11*

*" "*

*" "*

*" 12*

*" 5*

*" "*

*" "*

*" "*

*" "*

*" "*

*From fall from wagon*

# REGISTER OF THE SICK AND WOUNDED

NAMES	Rank	Regiment or Corps	Company	Complaint	Admitted
Willy Bracl		1		Uk. Rem.	Sept. 3
Vinny Warren		2		Uk. Sub. part.	" "
Wm. White	1			Uk. Rem.	" "
Wm. McTi	2			Uk. Sub. part.	" "
Lucius Ford		1		Uk. Sub. part.	" "
Geo. Hancock	3			" " "	" "
W.R. Parker		3		Uk. Rem.	" "
Wm. Boyeman		4		Uk. Rem.	" 4
Wm. Myers		3		" Sub. part.	" "
Albert B.				" " "	" "
Wm. Murphy	1			" Rem.	" "
Wm. Harris		5		Uk. Sub. part.	" "
Wm. Harris	3			Uk. Rem.	" "
Wm. McGowan				Uk. Sub. part.	" "
Jennett Rowson		8		Uk. Sub. part.	" "
Wm. Lewis	6			" Rem.	" "
Wm. " "		9		" " "	" "
Wm. " "		10		" " "	" "
Wm. " "		11		" " "	" "
Wm. " "		12		" " "	" "
Wm. " "			3	" " "	" "
Wm. " "			4	" " "	" "
Wm. " "		13		Uk. Rem.	" "
Wm. " "		14		Uk. Rem.	" "
Wm. " "		15		Uk. Rem.	" "
Wm. " "		16		Uk. Rem.	" "
Wm. " "		17		Uk. Rem.	" "
Wm. " "		18		Uk. Sub. part.	" "
Wm. " "		19		" Rem.	" "
Wm. " "			7	" " "	" "
Wm. " "			5	" Sub. part.	" "
Wm. " "	20			" Rem.	" "
Wm. " "	21			" " "	" "
Wm. " "	22			Uk. Sub. part.	" "
Wm. " "			1	Uk. Sub. part.	" "
Wm. " "		7		" " "	" "

AT

*American, Geo.*

186

Returned to Duty	Deserted	Discharged from Service	Sent to General Hospital	On Furlough	DIED	REMARKS
------------------	----------	-------------------------	--------------------------	-------------	------	---------

*Sept. 12*

*" 8*

*" "*

*" "*

*" "*

*" "*

*" "*

*" 14*

*" 10*

*" "*

*" 14*

*" 25*

*" 14*

*" 14*

*" "*

*" 14*

*" "*

*" "*

*" "*

*" "*

*" "*

*" "*

*" 10*

*" 15*

*" 102*

*" "*

*" 14*

*" 10*

*" "*

*" 14*

*" "*

*" 10*

*" 14*

*" "*

*Oct. 12*

*Sept. 10*

*" "*

## REGISTER OF THE SICK AND WOUNDED

NAMES	Rank	Regiment or Corps	Company	Complaint	Admitted
Wm Burton	1			Feb. Hem	Sept. 7
Ann Keigley		1		Consumption	" "
Mrs. Coates		2		Feb. Sub. gut.	" "
Thos Hodge	2			" " "	" "
Ann Do		3		" " "	" "
Nolan "	3			" " "	" "
Robert Crandall	4			" " "	" "
Lucia Scott		4		" " "	" "
Betty Jory		5		" " "	" "
Anna Collins	5			" " "	" "
Clenny Collins			1	" " "	" "
Caroline "			2	" " "	" "
Louisa Jory			3	Bronchitis	" "
Betty Jory			4	Feb. Hem.	" "
S. P. Coates		1		" Sub. gut.	" "
Adelle Holt		5		Rheumatism	" "
Catherine Coates		7		Consumption	" "
J. Mathews		2		Feb. Sub. gut.	" "
Thos Walker	6			" " "	" "
Rebecca "		8		" " "	" "
Vina "			5	" " "	" "
Lizzie "			6	" " "	" "
John "		3		" " "	" "
Caroline "			7	" " "	" "
Henry "		4		" " "	" "
John "			5	" " "	" "
Neal "			9	" " "	" "
Shade Boyano	7			Consumption	" 8
Ann M. Coates		9		Croup	" "
Joe Mair	8			Croup	" "
Ben. Holmes	9			Rheumatism	" "
Josiah Simmons		3		Feb. Sub. gut.	" "
Anna Foster		10		" " "	" "
Joe Huddle	10			" " "	" "
Major Bush		6		" " "	" "
Ann Coates		7		" " "	" "
Ann Cook		8		" " "	" "
Margaret Cook			10	" " "	" "

Returned to Duty	Deserted	Discharged from Service	Sent to General Hospital	On Furlough	DIED	REMARKS
------------------	----------	-------------------------	--------------------------	-------------	------	---------

*Sept 13*

*" 11*

*" "*

*" "*

*" "*

*" "*

*" "*

*" "*

*" "*

*" "*

*" "*

*" "*

*" 14*

*" "*

*" 10*

*" 30*

*" 10*

*" "*

*" "*

*" "*

*" "*

*" "*

*" "*

*" "*

*" "*

*" "*

*" "*

*" "*

*" "*

*" "*

*" "*

*" 11*

*" 20*

*" 30*

*" 3*

*Sept 11*

*" "*

*" "*

*" "*

*" "*

*" "*

*" "*

*" "*

# REGISTER OF THE SICK AND WOUNDED

NAMES	Rank	Regiment or Corps	Company	Complaint	Admitted
Liza Henderson		1		Feb. Int. gut	Sept. 8
Judith Clark		2		" Rem.	" "
Babel Pica		3		Rheumatism	" "
Edmond Johnson	1			" "	" "
Walt Collins	2			Feb. Int. gut	" "
Chin Clark Sr.	3			" " "	" "
John Banks	4			Rheumatism	" "
Siley Holmes		1		Feb. Int. gut	" "
Margaret Jantti			1	" " "	" "
James "	5			Rheumatism	" "
Philip Pierce	5			Feb. Int. gut	" "
Mary Fish		5		G. S. Wound	" "
Jennet Milica		5		Feb. Int. gut	" "
Patience Jones		7		Feb. Rem.	" "
Edmond Black	7			" Int. gut	" "
Willie Green			1	Chol. Inf.	" "
Miles Brown	8			Feb. Rem.	" "
Charles Payne	9			" "	" "
Stephen Stewart	10			" "	" "
Mary "		8		" "	" "
Harriet Martin Lee		9		" Int. gut	" "
Eliza Gaddy		10		" Rem.	" "
John "	11			" Int. gut	" "
M. S. "	12			" " "	" "
Mary Fields		11		" " "	" "
Simon Ellison	13			Typhid Liver	" "
Daniel West		2		Feb. Int. gut	" "
Bettie Badger			2	Chol. Inf. &c.	" "
Anna White			3	Typhid Liver	" "
Mary Wesson		3		Feb. Int. gut	" "
Mary Wesson			4	" " "	" "
H. P. Chase		5		Feb. Rem.	" "
Hamilton Leitch		6		Typhid Liver	" "
Richard Whalen	14			Chronic Ulcer	" 9
John Simmons		7		Cholera Infant	" "
Frank Bette		12		Feb. Int. Gut	" "
Fitz Oliver	15			" " "	" "
Henry Walker		5		" Int.	" "

Returned to duty	Deserted	Discharged from Service	Sent to General Hospital	On Furlough	DIED	REMARKS
------------------	----------	-------------------------	--------------------------	-------------	------	---------

J  
 Sept 11  
 " 15  
 Oct 10  
 Oct 10  
 Sept 11

" "  
 " 20  
 " 11  
 " "  
 " 20  
 " 11  
 " "  
 " "  
 " 15  
 " 11  
 " 20  
 " 15  
 " "  
 " "  
 " "  
 " 11  
 " 15  
 " 11  
 " 11  
 " 11  
 " 15  
 " 11  
 " 11  
 " 15

*At The hands of her  
 husband who absconded  
 soon after the shooting*

" "  
 " "  
 " 15  
 " "  
 Oct. 8  
 Sept. 30  
 " 14  
 " "  
 " 12

# REGISTER OF THE SICK AND WOUNDED

NAMES	Rank	Regiment or Corps	Company	Complaint	Admitted
Henrietta Waller		1		Feb. Int. gut.	Sept. 7
Joe Vimmens	1			Sp. Meningitis	" "
Jas. Early		1		Brucella's	" "
Harriet "		2		Enlarged Spleen	" "
Wm "		2		Worms	" "
Lemna Jackson			1	Feb. Int.	" "
Daniel Cott	3			Feb. Rem.	" "
Sylvia Fildes	3			" Int. gut.	" "
Green "		3		Dec. Mouth	" "
Mrs. Griffin	4			U. Hemorrhage	" "
Grant Jones		4		Feb. Int. Gut.	" "
Samy Foster	5			" " "	" "
Fanny Anderson	5			" " Int.	" "
Willie Spencer		5		" " "	" "
Jane Cutler			2	Worms	" "
Adolphus Jordan	4			Gonorrhoea	" "
Green Williams	5			do	" "
John Cannon	6			Feb. Int. gut.	" "
Jane "		7		" Rem.	" "
Dick Roberts	7			" "	" "
Charlotte Clark		8		Acidema	" "
Rufus Jones	8			Feb. Rem.	" "
Rachel Brown	9			Const. Liver	" "
Ellen Olive	10			Constipation	" "
Eliza Rice	11			Feb. Rem.	" "
Lucretia Harris	12			" Int. gut.	" "
Mattie Gardner			3	" " "	" "
Geo. Ellison	13			Headache	" "
Isaac Gardner	9			Feb. Int. gut.	" "
Dr. W. Birnie	10			" Rem.	" "
Anna Ronaldson		14		Gonorrhoea	" "
Joe Emerson	11			Feb. Int. Gut.	" "
Edmund Harper	12			" " gut.	" "
Mary Cutler	15			Spasmodic Int.	" 10
Emma Roberts			4	2 <sup>d</sup> Symp. bilis	" "
Bonnie Wilson	16			Feb. Int. gut.	" "
Albey Brown			5	Brucella's	" "
George Spain		6		Feb. Int. gut.	" "



Returned to Duty	Deserted	Discharged from Service	Sent to General Hospital	On Furlough	DIED	REMARKS
------------------	----------	-------------------------	--------------------------	-------------	------	---------

*Sept. 12*

*" 15*

*" 15*

*" "*

*" "*

*Oct. 10*

*Sept. 15*

*" 12*

*" 15*

*" 15*

*" 15*

*" "*

*" 12*

*" "*

*" "*

*" 20*

*" 20*

*" 12*

*" 10*

*" "*

*Oct. 3*

*Sept. 15*

*" "*

*" 12*

*" 15*

*" 12*

*" "*

*" "*

*" "*

*" 15*

*" 15*

*" 10*

*" 12*

*" 15*

*" 15*

*" 15*

*" 15*

# REGISTER OF THE SICK AND WOUNDED

NAMES	Rank	Regiment or Corps	Company	Complaint	Admitted
George Matthews	1			Jaundice	Sept. 10
Miles Brown	2			Feb. Int. gut.	" "
Chantry Cottle		1		" Mem.	" "
Andersen Son	3			" Int. gut.	" "
S. S. Andersen			1	" Mem.	" "
Isabel Orea		2		Generalize	" "
Margarette Jewett			2	J. Int. gut.	" "
James do		1		Int. Liver	" "
M. Liza Anna Brock			3	Feb. Int. gut.	" "
Zach. Moore				Swollen Knee, etc.	" "
J. R. Gulwood		2		Feb. Mem.	" "
Wollie Harris		3		Debility	" "
Edw. Birnie	1			Feb. Mem.	" "
Frank Thomas	5			" "	" "
Wm. Sniffin		1		W. & Liver, etc.	" "
Nancy Wess		5		Bronchitis	" "
Chas. Winn	6			Feb. Int. gut.	" 11
Wm. Nyles	7			" " "	" 11
Nancy Droug		6		" " Int.	" "
Maria Miller		7		" " "	" "
Fred. Hall	8			Redness skin	" "
Rebecca Clark			1	Feb. Int. Int.	" "
B. Mimms	9			" " Int.	" "
Nancy Fields		8		" " "	" "
King "			3	" " "	" "
Elizabeth Roe		9		" " "	" "
Lucinda Winn			5	" " "	" "
John Jackson	10			" " "	" "
Ellie Thomas		10		Feb. Mem.	" "
Queen Collins		11		" Int. gut.	" "
Marian Taylor	11			" " Int.	" "
Mrs. Williams	12			" " "	" "
George Pierce	13			Constipation	" "
Lizbeth Spurgeon		12		Feb. Int. Int.	" "
John "			4	" " "	" "
Amanda "			5	" " "	" "
Henrietta Stewart			7	Debility	" "
Amelia Cheney	13			Feb. Int. Int.	" "

Returned to Duty	Deserted	Discharged from Service	Sent to General Hospital	On Furlough	DIED	REMARKS
------------------	----------	-------------------------	--------------------------	-------------	------	---------

*Sept. 21*

*" 13*

*" 17*

*" 13*

*" 17*

*Oct. 3*

*Sept. 13*

*" 17*

*" 13*

*Oct. 15*

*Sept. 17*

*" 20*

*" 17*

*" "*

*" 13*

*" 18*

*" 14*

*" "*

*" 10*

*" "*

*Oct. 10*

*Sept. 14*

*" "*

*" "*

*" "*

*" "*

*" "*

*" "*

*" 17*

*" 14*

*" 17*

*" "*

*" 14*

*" 17*

*" "*

*" "*

*" 20*

*" 14*

# REGISTER OF THE SICK, AND WOUNDED

NAMES	Rank	Regiment or Corps	Company	Complaint	Admitted
Mourning Stewart			1	Feb. Int. gut	Sept. 11
Linas	1			Feb. " "	" 12
Wm. Fields	2			" " "	" 12
Booker Dudley	3			" " "	" "
Grant Jones	4			" " "	" "
M. S. A. Black			2	" " "	" "
Jack. Moore		1		Rheumatism	" "
Forrest Simmons	5			Feb. Int. gut	" "
Eddie Hamilton				" " "	" "
Julia Idlet			3	" " Int.	" "
William "	6			" " "	" "
Fletcher "				" " "	" "
Robert Jackson				" " "	" "
Arthur Marshall			5	" " gut	" "
Nathan Prince	7			Feb. Rheum.	" 14
Katy Mitchell			4	" Int. Gut.	" 14
Willis Mitchell			6	Bronchitis	" "
Maria Willis		1		Debility	" "
Anna Oliver			5	Feb. Int. gut.	" "
James Fleming			6	" " "	" "
Lucretia Oliver		2		" " "	" "
Mary A. Charlotte		3		" " "	" "
Wiccie Spencer			7	" " "	" "
Bob Jackson	8			Chrom. Ulcer	" "
Emma Wattle			7	Bronchitis	" "
Lusan "		4		Leucorrhoea	" "
Co. K. K. K.		5		Pharyngitis	" "
Isabel Ora				Neuralgia	" "
Grant Jones			8	Feb. Rheum.	" "
Florida Holt		7		" " "	" "
Milton "		7		" " "	" "
Wm. Simmons		10		" " "	" "
Jack. Moore		11		Inf. Mem. Jt. dh.	" "
John "	9			Bronchitis	" "
Henry Williams			8	Feb. Int. gut.	" "
Samuel Curtis		8		" Rheum.	" "
W. Watson	10			Chrom. Ulcer	" "

Returned to Duty	Deserted	Discharged from Service	Sent to General Hospital	On Furlough	DIED	REMARKS
------------------	----------	-------------------------	--------------------------	-------------	------	---------

*Sept 14*

*" 15*

*" "*

*" "*

*" "*

*" "*

*Sept 15*

*" "*

*" 17*

*" "*

*" "*

*" "*

*" 15*

*" 21*

*" 19*

*" 21*

*" "*

*" 17*

*" "*

*" "*

*" "*

*" "*

*" "*

*" 21*

*" 21*

*" 18*

*Oct 3*

*Sept 21*

*" "*

*" "*

*" "*

*Sept 13*

*Sept 21*

*" 17*

*" 31*

*Oct 3*

# REGISTER OF THE SICK AND WOUNDED

NAMES	Rank	Regiment or Corps	Company	Complaint	Admitted
Amos Boyd	1			Feb. Rem.	Sept. 14.
Rich. Gathwood	2			" "	" "
Shelton Everett	3			Contus. & W.?	" "
Emily Patterson		1		Feb. Sub. gut.	" "
" Clark			1	" " "	" "
M. S. Matthews		2		Sw. Breast	" "
Wells and Phillips	4			Wound	" "
John Jones	5			Feb. Sub. gut.	" "
Thomas Burton	6			Swollen head	" "
Henry "	7			Feb. Rem.	" "
Mariah Ralls		3		Rheumatism	" "
Richard Oliver	8			Feb. Sub. gut.	" "
Jordan "			1	" " Int.	" "
Thomas Mitchell			2	" " "	" "
Jack Bell	9			" Rem.	" "
Lucy Lewis			2	" " "	" "
H. C. Washington		3		" " gut.	" "
Seaton Williams		1		" " "	" "
Margaret Woodfield			3	" " Int.	" "
Charlotte Cook		11		Diarrhoea	" "
Joe Mingo	10			Colic & Liver	" "
Annie Hunter		3		Feb. Sub. gut.	" "
Lizzie Smith			11	" " "	" "
Minnie Morgan		6		Engorg. Spleen	" "
Alyria Fildes		7		Feb. Sub. gut.	" "
Mary Cox		8		Phalagium	" "
Emil Clark	9			Feb. Sub. gut.	" "
Elizabeth "			5	" " "	" "
Anna Ayers			6	" " "	" "
Charlotte "		10		Rheumatism	" "
Lilla Comer		11		Feb. Rem.	" "
Lula Daniel			7	" " "	" "
Devonian Williams		12		G. S. Wound	" "
John Jones	11			Feb. Rem.	" "
George Williams	12			" Sub. gut.	" "
M. S. King		13		" Rem.	" "
M. Rose "			8	" " "	" "
Henry W. Scott			15	" " "	" "

AT

*Amicus, Co.*

186

Returned to Duty	Deserted	Discharged from Service	Sent to General Hospital	On Furlough	DIED	REMARKS
------------------	----------	-------------------------	--------------------------	-------------	------	---------

*Sept 17*

*" 21*

*" 11*

*" 17*

*" "*

*" "*

*Oct 3*

*Sept 17*

*Oct 10*

*Sept 22*

*Oct 3*

*Sept 15*

*" 20*

*" "*

*" 23*

*" "*

*" 20*

*" "*

*" "*

*" "*

*" 30*

*" 18*

*" "*

*" 30*

*" 19*

*" "*

*" 18*

*" "*

*" "*

*" 22*

*" "*

*" "*

*" "*

*" "*

*" "*

*" "*

*" 18*

# REGISTER OF THE SICK AND WOUNDED

NAMES	Rank	Regiment or Corps	Company	Complaint	Admitted
Anna Wilson			1	Portuguese	Sept. 13
Jim Long	1			Sub. Fever	" "
Fancy Jones		1		Constipation	" "
Louis Williams	2			Neuralgia	" "
Kenneth (French)		3		Sub. Sub. gut.	" "
Margaret Ireland		3		Opium water	" "
John	3			Sub. Sub. gut.	" "
William Merrill		4		Protop. Muri.	" "
Leroy Hall		5		Sub. Sub. gut.	" "
Ed. Brown			1	Diarrhea	" "
John Head		5		Sub. Sub. gut.	" "
Alfred Shingles	4			" Rem.	" "
Wm. Shingles		7		" Sub. gut.	" "
Charly "	5			" " Gut.	" "
Mary Keister		8		" Rem.	" "
Jessie Harris		9		" Sub. gut.	" "
Henrietta Stewart		10		Const. Intest.	" "
Leroy Hollaway		11		Sub. Sub. gut.	" "
Fanny "			2	" " "	" "
Sam R. Remick	4			" Rem.	" "
Abner "	7			Chrom. Scabid.	" "
Gracie Robertson		12		Sub. Sub. gut.	" "
Ida Jones			3	" " "	" "
John "			3	" " "	" "
Liza Gray		13		Advent. ja.	" "
Ed. Summers	8			Sub. Sub. gut.	" "
Bessie Wilson		14		" " Gut.	" "
H. G. Williams	7			" " gut.	" "
Leah Stewart		15		" " "	" "
Mary Johnson		15		" " "	" "
James Crawford			3	" Rem.	" 16
Wm. Cook			11	" Sub. Gut.	" 16
Sam Bivins	10			" Rem.	" "
Benson Collier			4	Stom.	" "
Anna Ellis	11			Constipation	" "
Henry "	12		5	Diarrhea	" "
Wash - Sheffield	13			Diarrhea	" "
Sub. Davis			5	Sub. Rem.	" "



Returned to Duty	Deserted	Discharged from Service	Sent to General Hospital	On Furlough	DIED	REMARKS
------------------	----------	-------------------------	--------------------------	-------------	------	---------

*Sept 30*

*" 22*

*" 17*

*" "*

*" 17*

*" 15*

*" 17*

*Oct 10*

*Sept 28*

*" 18*

*" "*

*" 22*

*" 18*

*" 20*

*" 22*

*" 17*

*" "*

*" "*

*" "*

*" 22*

*Oct 10*

*Sept 17*

*" "*

*" "*

*" 13*

*" 17*

*" 17*

*" 17*

*" "*

*" 17*

*" 20*

*" 22*

*" "*

*" 23*

*" 20*

*" "*

*" 30*

*" 24*

# REGISTER OF THE SICK AND WOUNDED

NAMES	Rank	Regiment or Corps	Company	Complaint	Admitted
Shuman Davis			1	Feb. Rem.	Sept. 10
Julia Walker		1		" "	" "
Strom Jay	1			" "	" "
Felly "		2		" "	" "
Chloe "		3		" "	" "
Moss "	2			" "	" "
Loce "		2		" "	" "
Quirk "		3		" "	" "
Patry "			1	" "	" "
Charles Kemack		4		" "	" "
Anna "			2	" Subjept.	" "
Joe Byrd	3			" " "	" "
M. B. Byrd		5		" " "	" "
R. J. Byrd			3	" " "	" "
E. H. Wood		5		De lity	" "
Wm. H. Ellis			11	Sub. Subjept.	" "
Harriet Adams		7		" Rem.	" "
Rose "		8		Abundant	" "
Julia Black			11	Sub. Subjept.	" "
R. Reese	4			" Subjept.	" "
Brandy McCreca	5			" " quart.	" "
Bruce Moore		7		Akewind	" "
V. H. Black	5			Quarant.	" "
Jack Black			5	Sub. Subjept.	" "
James Brown	7			Sub. Subjept.	" "
Edmond Ansel	8			Sub. Subjept.	" "
May McFar		10		D. Syphilis	" "
Mrs. Harris		11		Quarant.	" "
Alice Robertson		12		Sub. Rem.	" "
Fizzie Harris			5	Rem.	" "
Eliz. Harris		13		Rem.	" "
Emma Robertson			5	D. Syphilis	" "
Verde Williams			6	Sub. Subjept.	" "
Anna Robertson		14		" " Sub.	" "
Amanda "		15		" " "	" "
James Henderson		15		" " "	" "
Clara Clark			7	" " Sub.	" "
Henry Henderson			8	" " "	" "

Returned to Duty	Deserted	Discharged from Service	Sent to General Hospital	On Furlough	DIED	REMARKS
------------------	----------	-------------------------	--------------------------	-------------	------	---------

*Sept. 24*

*" "*

*" "*

*" "*

*" "*

*" "*

*" "*

*" "*

*" "*

*" 21*

*" "*

*" "*

*" "*

*" 22*

*" 20*

*" 24*

*Oct. 10*

*" 10*

*Sept. 30*

*" 29*

*" 30*

*" 31*

*" "*

*" "*

*" "*

*" 20*

*" "*

*" 21*

*" "*

*" "*

*Sept. 20*

*" 24*

*" "*

*" "*

*" "*

*" "*

# REGISTER OF THE SICK AND WOUNDED

NAMES	Rank	Regiment or Corps	Company	Complaint	Admitted
Maria Wheaton		1		Feb. Rem.	Sept. 17.
Willis Bap	1			Rheumatism	" "
Winn Thompson	3			"	" "
Bertha Simpson	3			Cholera	" "
Caroline G. Wood			1	Feb. Int. gut.	" "
Lizzie Mansfield		2		" " "	" "
Eloise "		3		" " "	" "
Babel Coe		4		Neuralgia	" "
Willis Lott	4			Feb. Rem.	" "
Orange Hawkins	5			Reddena	" "
R. Chambliss	5			Feb. Int. gut.	" "
Harriet Hawkins		3		" " Vert.	" "
Lillie Baker		5		Neuralgia	" "
Anna Baker		7		Syphilis	" "
Jennie Holloway			2	Feb. Rem.	" "
Frances Warner			3	" " "	" "
Selina "			4	" " "	" "
Mary "			5	" " "	" "
Maria Wheaton		8		Int. gut.	" "
R. Clayton	7			Dermat. head	" "
W. Collins	8			Feb. Int. gut.	" "
W. Dyer		9		Odontalgia	" 18
Ann Mill		10		"	" 18
W. A. Rowan		11		Syphilis	" "
Lizzie Davis			6	Headache	" "
Ellen Newson		12		Feb. Int. gut.	" "
Louisa "			7	" " "	" "
Frances Gibson		13		Chrysom. tub.	" "
Jennie Wilson		14		Feb. Int. gut.	" "
Jane Leman		15		" " "	" "
W. A. Warren		16		Rheumatism	" "
Caroline Fish		17		Feb. Int. gut.	" "
Maria "			8	" " gut.	" "
Wesley "			1	" " "	" "
Wm. Simons		9		" " "	" "
Mary Sawyer		18		Feb. Rem.	" "
Ann "			1	" " "	" "
August Hall		19		" " "	" "
Ann Brown			10	" Int. gut.	" "

Returned to Duty	Deserted	Discharged from Service	Sent to General Hospital	On Furlough	DIED	REMARKS
------------------	----------	-------------------------	--------------------------	-------------	------	---------

*Sept. 25*

*Oct. 10*

*" 3*

*Sept. 23*

*" 20*

*" "*

*" "*

*Oct. 3*

*Sept. 23*

*Oct. 3*

*Sept. 20*

*" 23*

*" 17*

*Oct. 13*

*Sept. 23*

*" "*

*" "*

*" "*

*" 20*

*Sept. 20*

*" 18*

*" "*

*Oct. 4*

*Sept. 23*

*" 20*

*" "*

*" 30*

*" "*

*" "*

*Oct. 10*

*Sept. 23*

*" 20*

*" "*

*" "*

*" 25*

*" "*

*" 20*

# REGISTER OF THE SICK AND WOUNDED

NAMES	Rank	Regiment or Corps	Company	Complaint	Admitted
Jim Hogan	1			Rheumatism	Sept. 18
Leona Harris		1		Amnesia	" "
R. H. O. Stevens		1		Feb. Feb. gut.	" "
Rebecca Harris			1	" Rem.	" "
Mary Stewart		2		" "	" 19
Myron "	2			" "	" "
Rebecca King		3		" Feb. Gut.	" "
Sula Jones			2	" " gut.	" "
Patience Smith		4		" " Gut.	" "
Laura Key		5		Constipation	" "
Clarence Fish		6		Feb. Feb. Gut.	" "
Jesse D. Johnson			2	Chol. Int.	" "
Leona Brown	2			Feb. Rem.	" "
Wm. Griffin		7		H. Hemorrhage	" "
Sam. Howell		8		Feb. Feb. Gut.	" "
Sam. Bliss	4			" " "	" "
Simon "		3		Worms	" "
Laura "			3	" "	" "
Sammy "		4		" "	" "
Isabel Cline		9		Neuralgia	" "
Mary Furlow		10		Const. Liver	" "
Louisa Perkins		11		Fever	" "
V. A. Clark		12		Rheumatism	" "
Lacey Ellison		13		Feb. Feb. Gut.	" "
Jacob "	5			" " "	" "
" "	5			" Rem.	" "
Polly Sutton		12		" Feb. Gut.	" "
Laura "			4	" " "	" "
John Reid	7			Dyspepsia	" "
Henry Top	5			Ulcus, Chron.	" "
Wes "	7			Feb. Feb. Gut.	" "
John Hill		15		" " "	" "
Anna Williams		15		" " "	" "
M. Arab Mott		17		Syphilis	" "
Jones & Co.	10			Dyspepsia	" "
John Carter			5	Feb. Feb. Gut.	" "
Wm. "		18		Wound	" "
John Cameron	11			Debility	" "

Returned to Duty	Deserted	Discharged from Service	Sent to General Hospital	On Furlough	DIED	REMARKS
------------------	----------	-------------------------	--------------------------	-------------	------	---------

*Oct. 1*  
*" 3*  
*Sept. 20*  
*Sept. 25*

*" "*  
*" "*  
*" 22*  
*" 21*  
*" 22*  
*" "*  
*" "*  
*" 27*  
*" "*  
*" 20*  
*" "*  
*" "*  
*" 27*  
*" "*  
*" "*

*Oct. 3*  
*Sept 27*  
*Oct. 15*  
*Oct. 10*  
*Sept 23*

*" "*  
*" 27*  
*" 22*  
*" "*  
*" 30*

*" 22*  
*" "*  
*" "*  
*Oct. 17*  
*Sept. "*  
*" 21*  
*" "*  
*" 30*

# REGISTER OF THE SICK AND WOUNDED

NAMES	Rank	Regiment or Corps	Company	Complaint	Admitted
Mary Burne		1		Rheumatism	Sept. 19
Abraham Kemp	1			Feb. Int. gutt.	" "
Henry Barron		1		" " "	" "
Penber "		2		" " "	" "
Mary Jones		2		" " "	" "
Susan "		3		" " "	" "
Caroline Milena		4		" " "	" "
Mattha "		5		" " "	" "
Mary Thomas		5		" " "	" "
Bill "		3		" " "	" "
John "		11		" " "	" "
Henry Andrew			1	" " "	" "
Muriel "			2	" " "	" "
Peterina Ruttle		7		Old Worn	" 21
Robert "	2			Stomach	" 31
Rebecca "		8		"	" "
John "		5		"	" "
Stephen Shilton	3			Feb. Int. Gut.	" "
S. A. Conthous			3	" " "	" "
Emeline "			11	" " "	" "
Anna "			5	" " "	" "
Martin Epps	4			" " "	" "
" "			6	" " "	" "
Charles Snelson	5			" " "	" "
Fanny "		9		" " "	" "
Joe Briggs	4			" " "	" "
Lama "			5	" " "	" "
Henry Payer		11		" " "	" "
Lilly Miles			7	" " "	" "
Andrew Fletcher	7			" " "	" "
Mary Stewart		11		" " "	" "
Conce Williams	8			" " "	" "
Miss Fish			7	Diarrhea	" "
Isaac Tward		12		Feb. Int. gutt.	" "
Lila Allen			8	Suppl. to Worn	" "
Annex Meyer		8		Feb. - Worn	" "
Wm. Barber	7			" " "	" "
Lily "		9		" " "	" "



Returned to Duty	Deserted	Discharged from Service	Sent to General Hospital	On Furlough	DIED	REMARKS
------------------	----------	-------------------------	--------------------------	-------------	------	---------

*Sept 22*

*" "*

*" "*

*" "*

*" "*

*" "*

*" 27*

*" "*

*" "*

*" "*

*" "*

*" "*

*Oct 21*

*Oct 28*

*" "*

*" "*

*" 24*

*" "*

*" "*

*" "*

*" "*

*" "*

*" "*

*" "*

*" 31*

*" 27*

*" "*

*" "*

*" "*

*" "*

*Oct 24*

*Sept 3*

*Oct 5*

*Sept 27*

*" "*

*" "*

*" "*

# REGISTER OF THE SICK AND WOUNDED

NAMES	Rank	Regiment or Corps	Company	Complaint	Admitted
Frank Curry	1			Hb. Rem.	Sept 21
Judy "			1	" "	" "
Frank " Jr		1		" "	" "
Oliver Patterson			2	Sub. gut.	" "
W. Daniel	2			Hb. Rem.	" "
He. Casey				" "	" "
Joshua Summers		2		Chol. Dissect	" "
Caroline		1		Hb. Sub. gut.	" "
Robert Miller		5		Sub. Rem.	" "
Anna Raack		2		St. Syphilis	" "
Wm. Taylor	4			Yemen's head	" "
Anna Daniel		3		Debility	" 22
Alice "		1		Tonsillitis	" "
Mary Johnson		5		Debility	" "
Jack Moore		1		" "	" "
Edwin Crocker		5		Sub. Sub. Test.	" "
Edw. Bell		2		" " "	" "
Mary Cain		7		" " "	" "
Marion Crocker		3		Cephalalgia	" "
Sylvia King		7		Debility	" "
Maria Miller		10		Indigestion	" "
Monkey Carter		11		Sub. gut. gut.	" "
Mimsford "	5			" " "	" "
Katherine Bap		12		" " Sub.	" "
Jack "			3	" " gut.	" "
E. Stevens		13		Asthma	" "
Wm. Taylor		14		Tonsillitis	" "
Marion Harris	4			Sub. gut. gut.	" "
Mary "		15		" " "	" "
W. J. Cook			4	Asthma	" "
James F. "			4	" "	" "
Wm. "			5	" "	" "
J. B. "			7	" "	" "
Lyton Battle	7			Rheumatism	" "
John "		10		" "	" "
James Tucker	8			Odontalgia	" "
Michael Greenwood		17		Sub. Rem.	" "
James "		8		" Sub. gut.	" "
George Staples		4		" " "	" "

Returned to Duty	Deserted	Discharged from Service	Sent to General Hospital	On Furlough	DIED	REMARKS
------------------	----------	-------------------------	--------------------------	-------------	------	---------

*Sept. 29*

*" "*

*" "*

*" 24*

*" 29*

*" "*

*" 30*

*" 24*

*" 29*

*Oct. 15*

*" "*

*" 30*

*" "*

*" "*

*" 35*

*" "*

*" "*

*" "*

*" 30*

*Oct. 10*

*Sept 3*

*" "*

*" 27*

*" 25*

*" 30*

*" 30*

*" 25*

*" "*

*" "*

*" "*

*" "*

*Oct. 10*

*Sept 3*

*" 22*

*" 29*

*" 24*

*" "*

*" "*

# REGISTER OF THE SICK AND WOUNDED

NAMES	Rank	Regiment or Corps	Company	Complaint	Admitted
Maria Rusk		1		Feb. Feb. Feb. Sept. 22	
Ella "		2		" " " " "	
Frank "			1	" " " " "	
Alfred "			2	" " " " "	
Harriet Ladd		3		" " " " "	
Frances Daniels		4		" " " " "	
Mark "			3	" " " " "	
Sam "	1			" " " " "	
Mary Hamilton		5		" " " " "	
Mathew King		6		" " " " "	
Ch. "			4	" " " " "	
Frank Wallace			1	Wounds	
Elma McLean		7		Feb. Feb. Feb. "	
Ed. "	2			" " " " "	
Nancy Pop		8		Rheumatism	
John Coleman	3			Feb. Feb. Feb. "	
W. Idlet	1			" " " " "	
Ho. Matthews	5			" " " " "	
Th. Cook			3	" " " " "	23
Ho. Idlet			6	Wounds	23
Adel. Idlet				" " " " "	
Wm. Nyles	4		2	" " " " "	
Simon Gilbert				Feb. Feb. Feb. "	
Ho. Graize	8			" " " " "	
Lena McPherson		9		" " " " "	
Mary Thomas		10		" " " " "	
Bettie Hyacin		11		" " " " "	
Isabel "				" " " " "	
Green McConnell			3	" " " " "	
Jim Higgins	10			" " " " "	
Calavia Harris			1	" " " " "	
Chas. Harris			7	" " " " "	
Leona "		12		" " " " "	
Cherry Clark	12			Assessment here	
Clara "			3	Feb. Feb. Feb. "	
Paul "			8	" " " " "	
Geo. J. Conway	14			" " " " "	
S. H. "			6	" " " " "	
Amy Hoyle			7	" " " " "	

AT

*Americus, Geo.*

186

Returned to Duty	Deserted	Discharged from Service	Sent to General Hospital	On Furlough	DIED	REMARKS
------------------	----------	-------------------------	--------------------------	-------------	------	---------

*Sept 25*

*" "*

*" "*

*" "*

*" "*

*" "*

*" "*

*" "*

*" "*

*" 25*

*" 25*

*" 27*

*" 25*

*" "*

*" 30*

*" 25*

*" "*

*" 27*

*" "*

*" "*

*" "*

*" 25*

*" 27*

*" "*

*" "*

*" "*

*" 25*

*" 27*

*" 25*

*" "*

*" 30*

*" "*

*Oct 3*

*Sept 27*

*" "*

*" "*

*" 25*

*" "*

*" 27*

# REGISTER OF THE SICK AND WOUNDED

NAMES	Rank	Regiment or Corps	Company	Complaint	Admitted
West Ladd		1		Feb. Sub. York	Sept. 23
Mrs. Fish			1	Sept. 23	" "
J. McCrea		2		Feb. Sub. York	" "
Charlotte Clark		3		Croup	" "
Isaac Williams	1			"	" "
Rena Milner		4		Sept. 23	" "
John W. Holmes		1		Feb. Rem.	Sept. 23
Cornelia Conroy		2		" "	" "
E. Johnson		6		" Sub. York	" "
M. Thomas			2	" Rem.	" "
Aug. "		7		" "	" "
Harriet Perryman			3	" "	" "
Rob. "		2		" "	" "
Bettie "			4	" "	" "
Ada Davis	2			" "	" "
Jno. Frederick R	3			" "	" "
E. Florence			5	Chol. Infants	" "
Rebecca Black		8		Feb. Rem.	" "
Sam. Casey	4			" Sub. York	" "
Susan Allen		9		Chol. Infants	" "
Harriet "		10		Feb. Sub. York	" "
Linda "		11		" " Sub.	" "
James "			3	" " "	" "
Lena "			6	" " "	" "
John "		4		" " "	" "
Ben. Billings		5		" " York	" "
Louisa Stewart		12		" Rem.	" "
Mary Coburn	5			" Sub. York	" "
H. Woodson	6			" Rem.	" "
J. Pridemore		13		" Sub. York	" "
Rose "		14		" " "	" "
Frank Hooks		15		" " York	" "
Willie Hooks		6		" " York	" "
And. Hapley		7		" " "	" "
Nancy "			7	" " "	" "
Mattha Daniel		16		" " "	" "
Martha Simmons		17		" " "	" "
George Hill	7	17		" " "	" "

Returned to Duty	Deserted	Discharged from Service	Sent to General Hospital	On Furlough	DIED	REMARKS
------------------	----------	-------------------------	--------------------------	-------------	------	---------

*Sept 27*  
*Oct 1*

*Sept 25*  
*Oct 3*

*" 21*  
*Oct 10*

*Sept 30*

*" "*

*" "*

*" 27*

*" 30*

*" "*

*" "*

*" "*

*" "*

*" "*

*" "*

*" 30*

*" "*

*" 27*

*Oct 10*

*Sept 27*

*" "*

*" "*

*" "*

*" "*

*" "*

*" 30*

*" 27*

*" 30*

*" 27*

*" "*

*" 30*

*" 27*

*" "*

*" "*

*" "*

*" "*

*" "*

# REGISTER OF THE SICK AND WOUNDED

NAMES	Rank	Regiment or Corps	Company	Complaint	Admitted
Clark Mims	1			Venerboca	Sept 24
John Thomas			1	Sub. Sub. quab.	Sept 25
Dave Taylor			2	" " "	" "
Patsy Jones		1		" " "	" "
Anthony Keigler	3			Whinnabain C.	" "
Sam Salswood	3			Sub. Sub. quab.	" "
Charlotta George		2		" " quab.	" "
Lizzy King			1	Diarrhoea	" "
W. G. B. Howard			2	Sub. Sub. quab.	" "
Frank Moore			2	Inflam. Muc. Mem.	" "
Selina Warner			3	Sub. Mem.	" "
Nancy Moore		3		Diarrhoea	" "
Allen King	4			Sub. Mem.	" "
Emma Freeman		4		" " "	" "
Virginia Johnson		5		" " "	" "
Henry Freeman	5			" " "	" "
Eli Linder	6			" " "	" "
Jeff. Weyman	7			Aberration of vision	" "
Sam " "		6		Sub. Sub. quab.	" "
Allen Weyman			4	" " "	" "
Samuel Thomas	8			Wound, forehead	" "
Henry Allen			5	Sub. Sub. Sub.	" "
Anna Allen			7	Constipation	" "
Arthur Evans	9			Dysentery	" "
Walter Evans	10			" " "	" "
Simon McIlwain			4	Wound	" "
Black " "			4	" " "	" "
Thomas Bennett				Diarrhoea	" "
William Foster		8		Colic. Mem.	" "
Coll. Van		9		Sub. Mem.	" "
Samuel Skatts		10		" " "	" "
Allen Weyman		11		" Sub. quab.	" "
Aranda Muntgen			5	" " "	" "
Patsy Waige		12		" Mem.	" 26
Ben. West	11			" " "	" "
Phar. Postell		13		Diarrhoea	" "
Joseph " "			5	Wound	" "
John Stewart	12			Sub. Sub. quab.	" "



Returned to Duty	Deserted	Discharged from Service	Sent to General Hospital	On Furlough	DIED	REMARKS
------------------	----------	-------------------------	--------------------------	-------------	------	---------

*Sept 18*  
*Sept 28*  
 " "  
 " "  
 " "  
 " 28  
 " "  
 " "  
 " "

*Oct 30*  
*Oct 10*  
*Sept 28*  
 " "  
 " "  
 " "  
 " "  
*Oct 10*  
*Sept 28*  
 " "  
 " "  
 " "  
 " "

*Oct 2*  
 " "  
*Sept 30*  
 " "  
*Oct 10*  
 " "  
 " 30  
 " "  
 " 28  
 " "  
 " 30  
 " "  
*Oct 9*  
*Sept 30*  
 " 28

# REGISTER OF THE SICK AND WOUNDED

NAMES	Rank	Regiment or Corps	Company	Complaint	Admitted
Comelia Stewart			1	Bronchitis	Sept. 26
Emma Ervinge			2	Feb. Sub. quib.	" "
Mellen Hart	1			" " Feb.	" "
Lula Jordan			3	Cholera	" "
Minnie Davis		1		Feb. Sub. quib.	" "
George Davis	3			" " "	" "
Charley Payne	4			Feb. Rheum.	" "
Lelina Lloyd		1		" " "	" "
Caroline Lloyd			4	" " "	" "
Wm. Smith	4			Feb. Sub. Feb.	" "
Alma Oliver			5	Bronchitis	" "
Minnie Pierce		2		Dysentery	" "
Paulina Huston		3		Rheumatism	" "
John Palmer		4		Feb. Rheum.	" "
James Wilson		5		Rheumatism	" "
Abraham Brown	5			Feb. Rheum.	" "
Mrs. Kinsler	5			Rheumatism	" "
Chas. " "		6		Feb. Sub. quib.	" "
Henry Armstrong		7		" " "	" "
Alonzo Pinkard	7			Feb. " "	" "
Blair Black	8			" " Feb.	" "
David Cobb	9			" " quib.	" "
St. John Everett	10			Rheumatism	" "
Sarah Doyler		8		Feb. Sub. Feb.	" "
And. Jackson	11			Feb. Rheum.	" "
William Wipke	12			" Sub. post.	" "
John Roberts	13			" " "	" "
Wm. Lloyd	14			" " "	" "
Mary Francis			6	" " "	" "
Grant Snelson		3		" " "	" "
Charles " "		3		" " "	" "
Robert Tipton		4		" " "	" "
Marshall " "		5		" " "	" "
Ellen " "			7	" " "	" "
Henry Higgins	15			Feb. Rheum.	" "
Leola Henry		9		" " "	" "
Abner Hill	16			Feb. Rheum.	" "
Mrs. Ann Hooper			8	Rheum.	" "
Liberty Jones	17			Chrom. Rheum.	" "

Returned to Duty	Deserted	Discharged from Service	Sent to General Hospital	On Furlough	DIED	REMARKS
------------------	----------	-------------------------	--------------------------	-------------	------	---------

*Oct. 2*

*Sept. 30*

*" "*  
*Oct. 9*

*Sept. 30*

*" "*

*" "*  
*Oct. 2*

*" "*

*" "*

*" 30*

*" "*

*" "*

*Oct. 2*

*" 9*

*" 2*

*Oct. 9*

*Sept. 30*

*" "*

*" "*

*" "*

*" "*

*Oct. 9*

*Sept. 30*

*Oct. 2*

*Sept. 30*

*" "*

*" "*

*" "*

*" "*

*" "*

*" "*

*" "*

*" "*

*Oct. 2*

*Oct. 2*

*" "*

*" "*

# REGISTER OF THE SICK AND WOUNDED

NAMES	Rank	Regiment or Corps	Company	Complaint	Admitted
Solomon Sutton	1			Sub. Dist. Genl.	Sept. 29
Nathan Bond	2			Sub. Dist. Genl.	" 28
P. J. Kell			5	Wounds	" 28
J. G. Kell			1	"	" "
M. L. "			2	"	" "
J. W. "			2	"	" "
Anderson, Wm	3			Sub. Dist. Genl.	" "
Margaret Scan		1		" Wounds	" "
Lolly Bull		2		Sub. Dist. Genl.	" "
Henry "	4			" " "	" "
Angelina "			3	" " "	" "
Billy "		3		" " "	" "
Lucy "			11	" " "	" "
Joi Simmons	5			" " "	" "
Levi Jenkins		4		" " "	" "
Janice Kell		5		" " "	" "
Bessie Jenkins			5	" " "	" "
Mary Williams		6		Wounds	" "
Lucy Lewis			5	Sub. Dist. Genl.	" "
Priscilla Dean		7		Wounds	" "
Martha "		8		Sub. Wm.	" "
Sizzie Davis			3	Wounds	" "
Harriet Peters		9		Sub. Dist. Genl.	" "
Janice Peters		10		" Wounds	" "
Mary Anderson		11		" " "	" "
Theresa Gordon	6			Cramp Cholera	" "
Hereta "		12		Wounds	" "
Amanda "			4	" " "	" "
Ann "			5	" " "	" "
Spencer "			7	Rheumatism	" "
Mary J. Fish			6	Wounds	" "
Wm. Clark		5		Chol. Infants	" "
M. L. Wilson				Wounds	" "
Maudie Wince		13		Rheumatism	" "
Ann Gibson		14		Sub. Dist. Genl.	" "
Lucy "	7			" " "	" "
Agnes "			7	" " "	" "
Lydia Jones		15		" " "	" "

Returned to Duty	Deserted	Discharged from Service	Sent to General Hospital	On Furlough	DIED	REMARKS
------------------	----------	-------------------------	--------------------------	-------------	------	---------

*Sept. 30*

*" "*

*" "*

*" "*

*" "*

*" "*

*" "*

*Oct. 2*

*Sept. 30*

*" "*

*" "*

*" "*

*" "*

*" "*

*" "*

*" "*

*" "*

*Oct. 9*

*Sept. 30*

*" 9*

*Oct. 3*

*" "*

*Sept. 30*

*Oct. 2*

*" "*

*" "*

*" "*

*" "*

*" "*

*Oct. 10*

*Sept. "*

*Oct. 9*

*Oct. 10*

*Sept. 30*

*" "*

*" "*

*" "*

## REGISTER OF THE SICK AND WOUNDED

NAMES	Rank	Regiment or Corps	Company	Complaint	Admitted
Livia Hedges		1		Rheumatism	Sept 28 <sup>th</sup>
Clara "			1	Neuritis	" "
James Hedges	1			Rheumatism	" "
Leta Allen			1	St. Wound	" "
George Hill			2	" Int. part	" "
Mary Johnson		3		" "	" "
George Vime	2			Gonorrhoea	" "

Monthly Report made to the above —

AT

*Urbancus, Geo.*

186

Returned to Duty	Deserted	Discharged from Service	Sent to General Hospital	On Furlough	DIED	REMARKS
------------------	----------	-------------------------	--------------------------	-------------	------	---------

*Oct. 20*  
*Oct. 2*  
*" 9*  
*" 2*  
*Sept. 30*  
*Oct. 2*  
*" 20*  
*Oct. 9*

# REGISTER OF THE SICK AND WOUNDED

NAMES	Rank	Regiment or Corps	Company	Complaint	Admitted
Henry Hampton			1	Feb. sub. gut.	Sept 29 <sup>th</sup>
Fred Jackson			1	" " "	" "
Wm. Hayes			2	" " "	" "
Wm. Wilson			3	" " "	" "
John "	1			" " "	" "
Lucy Bennett			4	Distemper	" "
Carrie Davis			5	Worms	" "
Ed. Bell	2			Feb. sub. gut.	" "
Wm. Kella Smith			1	" " "	" "
Ellen Tophen				Worms	" "
Mathias Thomas			2	Feb. Rem.	" "
Chas. "	3			" " "	" "
Martha Ruffin			7	Respiration	" "
George "	4			Vomica	" "
William Allen			8	Constipation	" "
Isabel Price			9	Constipation	" "
Judy Harrold			10	Feb. sub. gut.	" "
George "			3	" " gut	" "
Maria "				" " gut	" "
Annie Williams	5			Diarrhea	" "
Clara Johnson			11	Feb. sub. gut.	" "
Samuel Chapman				Constipation	" "
Catherine Roberts			12	Whitlow	" "
Anna Sells	7			Feb. sub. gut.	" "
Maria Smith			13	Suppuration	" "
Fanny Williams			14	Debility	" 30
Cecilia "				Feb. Rem.	" "
Martha Jackson			15	" sub. gut.	" "
Robin Holt	8			" " "	" "
Lucinda Holt			16	" " "	" "
Allen Thompson			17	Yersillitis	" "
Elizabeth Clark				Feb. Rem.	" "
May Clay			18	" " "	" "
William M. Thomas			19	Pharyngitis	" "
John H. Kelly			4	Edentia	" "
Jack Moore			5	Suppuration	" "
Clara Singer	9			Feb. sub. gut.	" "
Sophrony "			21	" " "	" "



Returned to Duty	Deserted	Discharged from Service	Sent to General Hospital	On Furlough	DIED	REMARKS
		Sept 30				Tub. Pul. Inct. 4... 7... 2... 1
		" "				" " Tub. 0... 1... 0... 1
		" "				" " " " " " " " " "
		" "				Tub. Rinit. 1... 1... 1... 2
		Oct 9				Asthma 0... 1... 0... 0
		Oct 15				Wheez 0... 2... 0... 0
		Sept 30				Rheumatism 0... 2... 0... 0
		" "				Nausea 1
		Oct 3				Constipation 1 - 1
		Oct 2				Conjunctivitis 1
		" "				Dropsy 1 - 0... 0... 0
		" 9				Gonorrhoea 1 - 0... 0... 0
		Sept 30				Whitlow 0... 1... 0... 0
		Oct 9				Suppur. Catarr. 0... 1... 0... 0
		Sept 29				Debility 0... 1... 0... 0
		Oct 2				Leucorrhoea
		Sept 30				" " " " " " " " " "
		" "				" " " " " " " " " "
		Oct 24				" " " " " " " " " "
		Oct 2				" " " " " " " " " "
		" 16				" " " " " " " " " "
		Sept 30				" " " " " " " " " "
		Oct 15				" " " " " " " " " "
		Oct 2				" " " " " " " " " "
		" "				" " " " " " " " " "
		Sept 30				" " " " " " " " " "
		" "				" " " " " " " " " "
		Oct 2				" " " " " " " " " "
		" "				" " " " " " " " " "
		" "				" " " " " " " " " "
		Sept 30				" " " " " " " " " "
		Oct 10				" " " " " " " " " "
		" 30				" " " " " " " " " "
		" "				" " " " " " " " " "

# REGISTER OF THE SICK AND WOUNDED

NAMES	Rank	Regiment or Corps	Company	Complaint	Admitted
(2) Marian Watson	1			Feb. Int. quet	Skt. 30.
(11) Joel Watson	2			Ulcus Chlor.	" "
Jessy Burt		1		Feb. Int. quet	" "
Margaret Brown		2		" " "	" "
Ving Beyerman		3		" " "	" "
Hettie Berisden			1	Worms	" "
Eliza Co.			2	"	" "
Jennie Williams	3			Inflam. Liver	" "
Isaac Ingram			1	Feb. Int. quet	" "
Harriet Williams		4		Dysmenstrua	" "
Leannah Hill		5		"	" "
Mary Burton	4			Rheumatism	" "
Isaac Brown	5			Feb. Int. quet	" "
Sally Jones			3	Worms	Oct. 1 <sup>st</sup>
Veney "			4	Convulsions	" "
Lira Colgate		6		3 <sup>d</sup> Syphilis	" "
Joe Maize	6			Debility	" "
James Champion	7			Rheumatism	" "
Louisa "		7		Feb. Int. quet.	" "
Jimmie Bernard	8			" " "	" "
Eugene Cottle			2	" " "	" "
Eddward Bell	9			Constipation	" "
Amy Bell		8		Rheumatism	" "
Mary Ellis			3	Bronchitis	" "
William Lynck			4	Worms	" "
Heester Guildford		9		Feb. Int. quet.	" "
Rose Miller co.			5	" " "	" "
Alfred Ford	10			" " "	" "
Kitty Jefferson		10		" " "	" "
John Lee		11		" " "	" "
Abram Wells	11			" " "	" "
Barbara Allen		12		Rheumatism	" "
William Harris		13		Feb. Int. quet.	" "
Sam'l G. Goad	12			Ulcus Chlor.	" "
Mary J. Kemmer		14		3 <sup>d</sup> Syphilis	" "
Isaac Gandy	13			Feb. Int. quet.	" "
Lukey "		15		Debility	" "
Edgelina "		16		Feb. Int. quet	" "

Returned to Duty	Deserted	Discharged from Service	Sent to General Hospital	On Furlough	DIED	REMARKS
------------------	----------	-------------------------	--------------------------	-------------	------	---------

*Oct 2*

*" 13*

*" 2*

*" "*

*" "*

*" "*

*" "*

*" "*

*" "*

*" 1*

*" "*

*" "*

*" 2*

*" 2*

*x*

*Oct 1*

*" 25*

*Oct 9*

*" 2*

*" "*

*" "*

*" "*

*" 1*

*" "*

*" 2*

*" "*

*" "*

*" "*

*" "*

*" "*

*" 1*

*" "*

*" "*

*Oct 1*

*" 2*

*" 1*

*" 2*

# REGISTER OF THE SICK AND WOUNDED

NAMES	Rank	Regiment or Corps	Company	Complaint	Admitted
Lucinda Early		1		Debility	1st
Eugenia Washor			1	Feb. Int. gut.	" "
Adam Gary			1	" " Int.	" "
Jack Hoar	1			" " "	" "
Mary "		2		Diarrhea	" "
Simon Pitman		2		Abcep (Cholera)	" "
Robert Moore		2		Shin	" "
Margaret "			2	Itch	" "
Edwards "		3		" "	" "
Wilson Collins	2			Constipation	" "
Mary Jones		4		Spinal Irritation	" "
Wm. Henderson	3			Cephalalgia	" "
Alford Starke		4		Melancholia	" "
Allen Thompson	4			Scorbutic	" "
Caroline Fish		5		Feb. Int. gut.	" "
Sammy Early				" " "	" "
William Lee Key		7		" " "	" "
Amanda Early			2	" " "	" "
George Staples		8		" " "	" 2
J. A. Williams		8		" " "	" 2
Stephen R. Minny	5			" " "	" "
Edmond Allen	6			Cephalalgia	" "
Andy Hawkins		9		Feb. Int. gut.	" "
J. A. Emerson			4	" " "	" "
Sophia Helm		10		" " "	" "
Caroline Roberts		11		Pharyngitis	" "
Seaborn Nelson	7			Diarrhea	" "
Willie Mitchell			5	Feb. Int. gut.	" "
Patrick Mitchell	8			" " Int.	" "
Belle Early		12		Melancholia	" "
Willie "			7	" " "	" "

Returned to Duty	Deserted	Discharged from Service	Sent to General Hospital	On Furlough	DIED	REMARKS
------------------	----------	-------------------------	--------------------------	-------------	------	---------

*Oct 9*

*Oct 2*

*" "*

*" "*

*" "*

*" 15*

*" "*

*" "*

*" "*

*" 9*

*" "*

*" "*

*" 3*

*" 9*

*" 2*

*" "*

*" "*

*" "*

*" "*

*" 2*

*" "*

*" "*

*" "*

*" "*

*" "*

*" "*

*" 15*

*" "*

*" "*

*" 9*

*" "*

# REGISTER OF THE SICK AND WOUNDED

NAMES	Rank	Regiment or Corps	Company	Complaint	Admitted
Mahala Brown		1		Diarrhoea	Oct. 3
Nancy Jones			1	Constipation	" "
Wm Furlow	1			Inflam. Liver	" "
Mahala Brown		2		Diarrhoea	" "
William Edwards		1		"	" "
Mrs Thomas		2		"	" "
Mary James		3		Menorrhagia	" "
Willis Edwards	2			Feb. Int. gutt.	" "
Sally Donithy		4		Debility	" "
Monday Morning					
Billie Johnson		1		Diarrhoea	Oct. 5 <sup>th</sup>
Jesse "	1			Feb. Typhoid	" "
Alison Beacham	2			" Feb. Int. Gut.	" "
Robert King	3			" Pleurisy	" "
Lizzie "			1	" "	" "
Frank Jackson		2		" Feb. gutt.	" "
Major Callier	4			" " "	" "
Josephine Niema			3	" " "	" "
Willie Lynch		1		" " "	" "
Sam McBrady	5			Ulc. Chron.	" "
Jack More				Inflam. Bone etc.	" "
Billie Perryman			3	Feb. Int. Gut.	" "
Marion York		3		" " "	" "
Victoria Brown		4		Diarrhoea	" "
Caroline Davis		5		Cystitis	" "
Edward King	6			Paralysis	" "
Jella Adams			1	Feb. Pleur.	" "
Iola Roberts			5	Chol. Disent.	" "
James Mackel		6		Phlebotomy	" "
William "		7		" " "	" "
Walter Freeman			2	" " "	" "
Georgia "			"	" " "	" "
Gary Lloyd				Feb. Int. gutt.	" "
Hebron Morgan				" " "	" "

Returned to Duty	Deserted	Discharged from Service	Sent to General Hospital	On Furlough	DIED	REMARKS
------------------	----------	-------------------------	--------------------------	-------------	------	---------

Oct 9

" 9

Oct 9

" 6

" "

" "

" 3-

" 2

Oct. 4

Oct 28

Oct. 7

" 9

" "

" 7

" "

" "

" "

Oct 21

Oct 9

Oct. 5

" "

Oct. 9

" 15

" 9

" 15

" "

" "

" 9

" "

" 7

" "

Oct 15

Oct 16

# REGISTER OF THE SICK AND WOUNDED

NAMES	Rank	Regiment or Corps	Company	Complaint	Admitted
<i>Tuesday</i>					
James Jones	1			Rheumatism	Oct. 5 <sup>th</sup>
Matilda Perkins		1		"	" "
Wm Thomas			1	Feb. Rem.	" "
John "	2			" "	" "
Jelly "			2	" "	" "
Nancy Moore		2		" "	" "
John Newton			1	Worms	" "
Betsy "			3	"	" "
Wm "		3	2	"	" "
John Lewis		4		Debility	" "
John "	3			"	" "
Betsy Manson		5		Worms	" "
Sella Johnson		6		"	" "
Alie Burns			4	Feb. Int. quot.	" "
Janna do.		3		" " "	" "
Lucius Thomas	4			" " "	" "
<i>Wednesday</i>					
Shade Turner	4			Feb. Int. quot.	Oct. 7
John Houser	5			" " "	" "
Lizzie King		7		" " "	" "
Washington Turner	6			Feb. Int. quot.	" "
Chancy do		8		" " "	" "
do do Jr.			4	" " "	" "
Willie Gillum			5	" " Feb.	" "
Mat Gilbert	7			" Rem.	" "
Ben. Lewis Jr.			3	Debility	" "
Edith Wilson		9		Rheumatism	" "
Tom Luster	8			Feb. Int. quot.	" "
Cecilia Lewis		10		" " "	" "
Thmes do			4	Worms	" "
Cover "			5	"	" "
Richmond James	9			"	" "
Susie Batten		11		Feb. Int. quot.	" "
Mary Hunt		12		" " "	" "
Willie do			6	Cyp. manachou	" "
Lucy Victoria Varner			7	Feb. Int. quot.	" "
Mary do			8	" Rem.	" "
Wm do	10	12	4	" Int. quot.	" "



Returned to Duty	Deserted	Discharged from Service	Sent to General Hospital	On Furlough	DIED	REMARKS
------------------	----------	-------------------------	--------------------------	-------------	------	---------

*Oct. 13*

*" "*

*Oct. 9*

*" "*

*" "*

*" "*

*" "*

*" "*

*" "*

*" "*

*" "*

*" "*

*" "*

*" "*

*" "*

*" "*

*" 9*

*" "*

*" "*

*Oct. 7*

*" 9*

*" "*

*" "*

*" "*

*" "*

*" "*

*" "*

*Oct. 7*

*" "*

*" "*

*" "*

*" 7*

*" 24*

*" 9*

*" 9*

*" "*

# REGISTER OF THE SICK AND WOUNDED

NAMES	Rank	Regiment or Corps	Company	Complaint	Admitted
Chadley Varner			1	Feb. Int. Tert.	Oct. 7
Charles Braxton	1			" " "	" "
Nelson & Co.		1		Constipation	" "
Charles Britton	2			"	" "
James Crowder		2		Feb. Int. Tert.	" "
Samuel Martin		3		" " "	" "
Robert Crowder	3			" " "	" "
Frederick Levy	1			" " "	" "
Thursday					
Robert Jackson	5			Mela. Abn.	" 8
Tom. Hlyatt		1		2 <sup>d</sup> Syphilis	" "
John Washington		5		Feb. Int. Tert.	" "
Philp & Co.	6			" " "	" "
Katherine Roberts		4		Whitlow	" "
William Cook			2	Worms	" "
George Ruffin	7			Feb. Int. Tert.	" "
Samuel Pace			3	Feb. Int. Tert.	" "
May Jane Byrd		7		Feb. Int. Tert.	" "
Johnny & Co.			1	" " "	" "
Mary Brown		8		Constipation	" "
M. Thos. Pace		9		Feb. Int. Tert.	" "
Emma Olive			1	Rheumatism	" "
Seaborn Nelson	8			Oedentalgia	" "
Shadrach Dandridge	9			Feb. Int. Tert.	" "
Will, Thomas		10		Rheumatism	" "
Curry Bap		11		Genus Inca	" "
Maria Corvate		12		Constipation	" "
John Green	11			Rheumatism	" "
Anna & Co.		13		Feb. Int. Tert.	" "
Friday					
Alfred Dime	11			Feb. Int. Tert.	" 9
Estine Battle		11		Old Pain	" "
Stephen Jones			3	Feb. Int. Tert.	" "
John N. Winn	12			Spinal Tenderness	" "
Samuel Patterson	13			Enlarged Spleen	" "
J. M. Daniels	14			Oedentalgia	" "
Thomas Franklin			5	Mela. Abn.	" "

Returned to Duty	Deserted	Discharged from Service	Sent to General Hospital	On Furlough	DIED	REMARKS
------------------	----------	-------------------------	--------------------------	-------------	------	---------

*Oct 9*

*" "*

*Oct 7*

*" "*

*" "*

*" "*

*" "*

*" "*

*Oct 9*

*" "*

*Oct 9*

*Oct 9*

*" "*

*" 24*

*" 9*

*" "*

*" 8*

*" 9*

*" 15*

*" 9*

*" "*

*" 15*

*" 15*

*" 9*

*" 15*

*" 9*

*" 12*

*" 15*

*" 15*

*" "*

*Oct 9*

*" "*

*" 24*

# REGISTER OF THE SICK AND WOUNDED

NAMES	Rank	Regiment or Corps	Company	Complaint	Admitted
Robert Bryant	1			Feb. Int. Feb	Oct. 9
Carrie Co.		1		" " gutt.	" "
Catherine "			1	" " "	" "
Lily "			2	Stomach	" "
Pinky Robertson		2		Feb. Int. gutt.	" "
Zach Moore			1	Inflam. Wound	" "
Robert Calaudt	2			Feb. Int. gutt.	" "
Evelind Jones		3		" " "	" "
<i>Saturday</i>					
Willie Gray			1	Feb. Rem.	" 10
Prabella Cleveland			1	" " "	" "
Simon Ellis	1			" Int. gutt.	" "
Julia Co.		1		" " "	" "
Priscilla Walker		2		" " "	" "
Ving Walker			2	" " "	" "
Emma Anderson			3	" " "	" "
Hester Bonetti		3		" " "	" "
John Co.	2			" " Int.	" "
Sarah Cott		4		See nipples	" "
William "		5		Impacted fa	" "
John Mansfield	3			Wound	" "
Lacey Roberts		6		Disinfection	" "
Warren "	4			Feb. Int. Int.	" "
Chas. Judge		7		Wound	" "
Sammy "			4	Chorea Infant	" "
Sarah Armstrong		8		Feb. Int. Int.	" "
Alice "		9		" " "	" "
Mena "			5	" " "	" "
Sophia Rainey		10		Debility	" "
Melinda "		11		Disinfection	" "
Richard Simpkins	5			" " "	" "
Barbara "		12		Feb. Int. Int.	" "
Doek "			2	" " "	" "
Mrs Stewart	6			" " gutt.	" "
Mary Furlow		13		Debility	" "
Susan McLeira		14		Wound	" "
Wesley Trapp			3	Convulsion	" "

Returned to Duty	Deserted	Discharged from Service	Sent to General Hospital	On Furlough	DIED	REMARKS
------------------	----------	-------------------------	--------------------------	-------------	------	---------

*Oct. 14*

*" 12*

*" "*

*" "*

*" "*

*" 13*

*" 12*

*" "*

*Oct 15*

*" "*

*" 12*

*" "*

*" "*

*" "*

*" "*

*" "*

*" 13*

*" 13*

*" 10*

*" 15*

*" 21*

*" 18*

*Oct 16*

*" 15*

*" "*

*" "*

*" "*

*" "*

*" "*

*" "*

*" 13*

*" "*

*" "*

*" 15*

*" "*

*Oct. 19*

# REGISTER OF THE SICK AND WOUNDED

NAMES	Rank	Regiment or Corps	Company	Complaint	Admitted
Amanda Harrison		1		Feb. Int. quot.	Oct. 10
Corey Cummings		2		" " "	" "
Thos. do		1		" " "	" "
Millie "		2		" " "	" "
Calvin "		3		" " "	" "
Alford Maxwell		4		Worms	" "
Thomas D.		5		"	" "
Julia Lamar		6		"	" "
Alford Hendrick	1			Feb. Int. quot.	" "
Sam. Allen	2			" " "	" "
Monday					
Sam. Casey	1			Cent. & Wd.	Oct. 12 <sup>th</sup>
Henry Gunn	2			"	" "
Mabelle Myers		1		Feb. Int. quot.	" "
Stech Hodges			1	Chol. Infest.	" "
Am. Co.		2		Feb. Int. quot.	" "
Urania Ad. Maxwell		3		" " "	" "
Mattha Ann Dykes		4		" " "	" "
Caroline do				Ammoniac	" "
Lelemy "				"	" "
Miller Gilliard	4			Feb. Int. quot.	" "
Jimmie Pace			5	Burrowing	" "
Saa West.		5		Flu.	" "
William do		5		2 <sup>o</sup> Syphilis	" "
Daphne Jones			9	Chol. Infest.	" "
Jerry Wap	6			Ammoniac	" "
John Mansfield	7			Feb. Int. quot.	" "
Carrie Wap		6		Whelp.	" "
A. S. Gilliard		7		Feb. Int. quot.	" "
John Wap		8		Debility	" "
...		8		"	" "

Returned to Duty	Deserted	Discharged from Service	Sent to General Hospital	On Furlough	DIED	REMARKS
------------------	----------	-------------------------	--------------------------	-------------	------	---------

*Oct 12*

*" "*

*" "*

*" "*

*" "*

*" "*

*" "*

*" "*

*" "*

*" "*

*Oct 12*

*" "*

*" 13*

*" "*

*" "*

*" "*

*" "*

*Jan 13*

*" 13*

*" 13*

*" 13*

*" 13*

*" 13*

*" 13*

*" 13*

*" "*

*" "*

# REGISTER OF THE SICK AND WOUNDED

Name	Age	Rank	Company	Regiment	Notes
Alfred Miller		1			at 1st bat 1st 27
John Miller		2			at 1st bat 1st 27
John Miller		3			at 1st bat 1st 27
John Miller		4			at 1st bat 1st 27
John Miller		5			at 1st bat 1st 27
John Miller		6			at 1st bat 1st 27
John Miller		7			at 1st bat 1st 27
John Miller		8			at 1st bat 1st 27
John Miller		9			at 1st bat 1st 27
John Miller		10			at 1st bat 1st 27
John Miller		11			at 1st bat 1st 27
John Miller		12			at 1st bat 1st 27
John Miller		13			at 1st bat 1st 27
John Miller		14			at 1st bat 1st 27
John Miller		15			at 1st bat 1st 27
John Miller		16			at 1st bat 1st 27
John Miller		17			at 1st bat 1st 27
John Miller		18			at 1st bat 1st 27
John Miller		19			at 1st bat 1st 27
John Miller		20			at 1st bat 1st 27
John Miller		21			at 1st bat 1st 27
John Miller		22			at 1st bat 1st 27
John Miller		23			at 1st bat 1st 27
John Miller		24			at 1st bat 1st 27
John Miller		25			at 1st bat 1st 27
John Miller		26			at 1st bat 1st 27
John Miller		27			at 1st bat 1st 27
John Miller		28			at 1st bat 1st 27
John Miller		29			at 1st bat 1st 27
John Miller		30			at 1st bat 1st 27
John Miller		31			at 1st bat 1st 27
John Miller		32			at 1st bat 1st 27
John Miller		33			at 1st bat 1st 27
John Miller		34			at 1st bat 1st 27
John Miller		35			at 1st bat 1st 27
John Miller		36			at 1st bat 1st 27
John Miller		37			at 1st bat 1st 27
John Miller		38			at 1st bat 1st 27
John Miller		39			at 1st bat 1st 27
John Miller		40			at 1st bat 1st 27
John Miller		41			at 1st bat 1st 27
John Miller		42			at 1st bat 1st 27
John Miller		43			at 1st bat 1st 27
John Miller		44			at 1st bat 1st 27
John Miller		45			at 1st bat 1st 27
John Miller		46			at 1st bat 1st 27
John Miller		47			at 1st bat 1st 27
John Miller		48			at 1st bat 1st 27
John Miller		49			at 1st bat 1st 27
John Miller		50			at 1st bat 1st 27



Returned to Duty	Deserted	Discharged from Service	Sent to General Hospital	On Furlough	DIED	REMARKS
------------------	----------	-------------------------	--------------------------	-------------	------	---------

*Oct. 11*

*11*

*Oct 15*

*" "*

*" 21*

*" 1*

*Oct 16*

*" "*

*Oct 15*

*" "*

*" 16*

*Oct 10*

*" "*

*" 21*

*" 10*

*" "*

*" "*

*" "*

*" "*

*" "*

*" "*

*" "*

*Oct 10*

*Oct 10*

*" "*

*" "*

*" "*

*" "*

*" 26*

*Oct 10*

*Oct 10*

# REGISTER OF THE SICK AND WOUNDED

NAMES	Rank	Regiment or Corps	Company	Complaint	Admitted
<i>Wednesday</i>					
Martha Cobb		1		menstruation Ret. 14	
Alicy West		2		Feb. Rem.	" "
Louisa "		3		" "	" "
Warren Bronson	1			Rheumatism	" "
Michael "		"		"	" "
Caroline Perry			1	Feb. Ret. gut.	" "
Palmer Williamson	2			" Rem.	" "
Leoras Spicer		5		Mercure	" "
Ellen Schumpert		6		Colic	" "
Aaron Wright	3			Feb. Rem.	" "
Mary "		7		" "	" "
Phillis "			3	Feb. Ret. Gut.	" "
Chas. Lyons	11			" " gut.	" "
Rob. Jackson	5			Blow, Ch.	" "
Hoyd. Nelson	6			Feb. Ret. gut.	" "
Warwick Jones	7			" Rem.	" "
Linda "			3	" "	" "
Grace "		8		" "	" "
Elsie "		9		" "	" "
Anna "		10		" "	" "
Abraham Thomas	8			" Ret. Gut.	" "
Scabers Nelson	9			" "	" "
Sherman Grant			1	Chol. Defaut.	" "
Maudie Smith		11		Feb. Ret. gut.	" "
Mininda "			4	" Rem.	" "
Arthur Deussen	10			" Ret. gut.	" "
Fred. Hobbs	11			" Ret.	" "
Rich. Gibson	11			" Rem.	" "
Caroline Holt			5	Croup	" "
Candice Sumner			6	Feb. Ret. gut.	" "
Wm. Nutt	12			St. Aphilitis	" "
Edith Nutt		12		"	" "
Katy Jones			7	Worms	" "
Osman Read		2		"	" "
Geo. Wickett		3		Cough	" "
Marion Allen	13			Feb. Ret. Gut.	" "
Thos. "		"	5	"	" "
Marta "			7	"	" "
Mary "				"	" "

Returned to Duty	Deserted	Discharged from Service	Sent to General Hospital	On Furlough	DIED	REMARKS
------------------	----------	-------------------------	--------------------------	-------------	------	---------

*Oct 10*

*" "*

*" "*

*" "*

*" "*

*" "*

*" "*

*" "*

*" "*

*" "*

*" "*

*" "*

*" "*

*" "*

*" "*

*" "*

*" "*

*" "*

*" "*

*" "*

*" "*

*" "*

*" "*

*" "*

*" "*

*" "*

*" "*

*" "*

*" "*

*" "*

*" "*

*" "*

*Oct 16*

*" "*

*" "*

*" "*

*" "*

*" "*

# REGISTER OF THE SICK AND WOUNDED

NAMES	Rank	Regiment or Corps	Company	Complaint	Admitted
Chas. Womack		1		Neuralgia	Oct. 14 <sup>th</sup>
M. Harry	1			Colic	Oct. 15
May Harry		2		Debility	" "
Ed. Gibson	2			Feb. Rem.	" "
Pinky Atkins	3			Feb. Int. gut.	" "
Thomas Day	4			Constipation	" "
Geo. Washington	5			Feb. Int. gut.	" "
Ed. Williams	6			Rheumatism	" "
Assurance Washin <sup>g</sup>			1	Worms	" "
G. A. Washington			2	"	" "
Mollie Williams		3		Diarrhoea	" "
Leonard Widen	7			Rheumatism	" "
Glen Lewis	8			Debility	" "
May Clark		4		Constipation	" "
Ro. Andrews			1	Feb. Int. gut.	" "
Louisa Cobb			3	Worms	" "
Booker Norman	9			Diarrhoea	" "
Friday					
Mollie Tavernport		5		Constipation	" 16
Ed. Wians	10			Diarrhoea	" "
Lucy Washam			4	Colic	" "
John Woods	11			Rheumatism	" "
Harper "		6		Headache	" "
Chloe Wilson				Feb. Rem.	" "
Solomon Walker		7		" "	" "
George Davis		8		" Feb. gut.	" "
Sam. C. Brady	12			Meas. Ch.	" "
Wm. Jones			2	Colic	" "
Carolina James	9			Feb. Int. gut.	" "
Sarah Mendenhall	10			Dysmenorrhoea	" "
Frank "	"			Rheumatism	" "
George Nelson			3	Diarrhoea	" "
Caroline Keys	12			Colic	" "
Mellie Key				Feb. Rem.	" "
Maria Patterson			5	Feb. Int. Rem.	" "
Sam. Jones	12			Diarrhoea	" "

Returned to Duty	Deserted	Discharged from Service	Sent to General Hospital	On Furlough	DIED	REMARKS
------------------	----------	-------------------------	--------------------------	-------------	------	---------

*Oct. 16*

*" 16*  
*" "*  
*" "*  
*" "*  
*" "*  
*" "*  
*" "*  
*" "*  
*" "*  
*" "*  
*" "*  
*" "*  
*" "*  
*" "*  
*" "*  
*" "*  
*" "*

*Oct 16 Oct "*  
*" " " "*  
*" " " "*  
*" " " "*  
*" " " "*  
*" " " "*  
*" " " "*  
*" " " "*

*" 16 Oct. 16*  
*" " " "*  
*" " " "*  
*" " 24*  
*" 16 " 16*  
*" " " "*  
  
*" 26*

# REGISTER OF THE SICK AND WOUNDED

NAMES	Rank	Regiment or Corps	Company	Complaint	Admitted
Caroline Roberts		1		Whitlow	Oct. 17
Louisa Elliot		2		Debility	" "
G. H. "		1		Feb. Int. gut.	" "
William "		3		" " "	" "
Julia "			1	" " "	" "
Priscilla Comen		3		Diarrhea	" "
Isaac "	1			"	" "
Henry Cunningham		3		"	" "
John Stevenson		4		Feb. Int. Gut.	" "
Maria Comen		5		Asthma	" "
Jane Kendrick				Sprain	" "
Ann "	2			Feb. Int. gut.	" "
" "	3			Constipation	" "
Martha Hill		6		Constipation	" "
Alice Nash			2	Feb. Int. gut.	" "
Caroline Lykes		7		Strain	" "
Clenny "		8		" "	" "
Edw. Hodges			"	Chol. Inf. Gut.	" "
John Titell	4			Rheumatism	" "
Ellen "		9		Headache	" "
P. "		5		"	" "
Mary Jackson		10		Feb. Int. gut.	" "
Sally Gary		11		" " "	" "
Thomas Bennett	5			" " "	" "
Levi "		12		Diarrhea	" "
Erice Foster		13		Feb. Int. gut.	" "
Mason W. Cain		14		" " "	" "
Maria Inceport		15		Alpharagia	" "
Allen King	6			Debility	" "
Madison Woods	7			Feb. Int. Gut.	" "
Spencer Crutcher	8			" " Gut.	" "
Martha "		10		Diarrhea	" "
Alice Wiley			3	Feb. Int. gut.	" "
Ella "			4	" " "	" "
Mary Ford		17		Labor, pains	" "
S. E. Brown			5	Diarrhea	" "
Chas. Tomlinson	9			Feb. Int. Gut.	" "

Returned to Duty	Deserted	Discharged from Service	Sent to General Hospital	On Furlough	DIED	REMARKS
------------------	----------	-------------------------	--------------------------	-------------	------	---------

*Oct. 23 Oct. 23*

*" " " "*

*" 21 " 21*

*" " " "*

*" " " "*

*" " " "*

*" " " "*

*" " " "*

*" " " 23*

*Oct. 19*

*" "*

*" 17*

*" 23*

*" 21*

*Nov. 1*

*" "*

*Nov. 23*

*" "*

*" 21*

*" "*

*" 21*

*" "*

*" "*

*" 23*

*" 20*

*" "*

*" 17*

*" 23*

*" "*

*" 21*

*" 23*

*" 19*

*" "*

*" "*

*Nov 15*

*Oct. 21*

# REGISTER OF THE SICK AND WOUNDED

NAMES	Rank	Regiment or Corps	Company	Complaint	Admitted
<i>Monday</i>					
Mary Willis			1	Dysentery	Oct. 19 <sup>th</sup>
Washington Sheffield	1			Gonorrhoea	" "
Lilli Allen	3			Dysentery	" "
Bob Burton	5			Feb. Int. gut.	" "
Phoebe Lewis		1		Neuralgia	" "
Georgia McQua		2		Feb. Int. gut.	" "
Christine "		3		Retrospective diarr.	" "
Mary Henderson		1		Feb. Int. gut.	" "
See - Arriet			1	" " Int.	" "
George Carter	4			Dysentery	" "
Wm. Foster		5		Delirium	" "
Isaac Johnson		5		Rheumatism	" "
Sam. Saunders	5			Spinal Thr.	" "
Harriet Emma Dudley		7		Dissection of Int.	" "
Thomas Grant			2	Chol. Infant.	" "
Sam. Oliver			3	Constipation	" "
Sam. O'Leary	6			Wen. Ch.	" "
James Morris		8		Rheumatism	" "
Catherine Oliver	7			Feb. Int. gut.	" "
Walter Fielder		9		Dysentery	" "
Fanny Bell	8			Feb. Int. gut.	" "
<i>Tuesday</i>					
James Wilson	9			Odontalgia	" 20
Elizabeth Nelson			1	Feb. Int. Gut.	" "
Philip Washington	10			" " gut.	" "
Jane "		10		" " "	" "
George Kelly	11			" " "	" "
Mad. Smith	12			" " "	" "
Altha L. Martin	13			" " "	" "
William Johnson	14			Hæmorrh.	" "
Ephraim Montgomery	15			Constipation	" "
Louisa Washington		11		2 <sup>d</sup> Syphilis	" "
Alvan Holloway	16			Rheumatism	" "
Georgia McQua		12		Feb. Int. gut.	" "
Austin Allen			1	" " "	" "
Robert Andrews			5	" " "	" "
Louisa Taylor	13			" " Int.	" "



Returned to Duty	Deserted	Discharged from Service	Sent to General Hospital	On Furlough	DIED	REMARKS
------------------	----------	-------------------------	--------------------------	-------------	------	---------

*Oct. 23*

*" 26*

*Oct. 19.*

*" 21*

*" 22*

*" 21*

*" 26*

*Oct. 21*

*" 23*

*" "*

*" 23*

*" "*

*" "*

*" 23*

*" "*

*Nov. 1*

*" 20*

*" 19<sup>th</sup>*

*" 23*

*" 18.*

*Oct. 20*

*" 22*

*" "*

*" "*

*" "*

*" 20*

*" 22*

*Oct. 23*

*Oct. 23*

*" 22*

*" "*

*" "*

*" 23*

## REGISTER OF THE SICK AND WOUNDED

NAMES	Rank	Regiment or Corps	Company	Complaint	Admitted
<i>Tuesday (con.)</i>					
John Taylor	1			Feb. Sub. Febr.	Oct. 20
Jane Kendrick		1		Neuralgia	" "
Sophronia McGraw		2		Odontalgia	" "
Delia Ann Ellis		3		Constipation	" "
Burlyson "			1	"	" "
Maria Willis		1		Feb. Sub. Febr.	" "
Susan McGraw		5		"	" "
<i>Wednesday</i>					
Surgey Museley		6		Feb. Rem.	" 21
Wm. Mott	2			2 <sup>d</sup> Syphilis	" "
Edith "		7		" "	" "
Martin Daniel	3			Feb. Sub. Febr.	" "
Phoebe Randall		8		" " "	" "
Melinda Thompson		9		Hematuria	" "
John S. Kelton	4			Feb. Sub. Febr.	" "
Bertha Norman	5			Abscess	" "
Ed. Bray	6			Jaundice	" "
Milly Little		10		Feb. Sub. Febr.	" "
Lizzie Hawkins		11		Neuralgia	" "
Tom O'Grady	7			Wound, Ch.	" "
Josephine Letour			2	Feb. Sub. Febr.	" "
Lewis Adams	8			Neuralgia	" "
Lizzie "		12		Feb. Sub. Febr.	" "
James Jarrett	9			Prurigo	" "
Ellen Patterson			3	Feb. Rem.	" "
<i>Thursday</i>					
Charlotte Wilson		13		Feb. Sub. Febr.	" 22
John Roper	10			" " Febr.	" "
Emma Robertson			4	2 <sup>d</sup> Syphilis	" "
Lucinda Jones		14		Feb. " Febr.	" "
Maria Fletcher		15		" " "	" "
David Bray		16		Constipation	" "
Georgiana McGraw		17		Feb. Sub. Febr.	" "
Henry Rop	"			Wound Ch.	" "
Chas. Reid	12			Feb. Sub. Febr.	" "
Washington "			1	" " Febr.	" "

Returned to Duty	Deserted	Discharged from Service	Sent to General Hospital	On Furlough	DIED	REMARKS
------------------	----------	-------------------------	--------------------------	-------------	------	---------

*Oct. 23*

*" 20*

*Oct. 20.*

*" "*

*" "*

*" "*

*Oct. 23*

*" "*

*" "*

*Nov. 23*

*" "*

*" "*

*" "*

*" "*

*" 27*

*Oct. 23*

*" "*

*" "*

*Oct. 23*

*" "*

*" "*

*" "*

*Oct. 23*

*By Fall from wagon.*

*Oct. 23*

*" "*

*" "*

*Oct. 23*

*" "*

*Oct. 22.*

*" "*

*" "*

*Oct. 23*

*" "*

# REGISTER OF THE SICK AND WOUNDED

NAMES	Rank	Regiment or Corps	Company	Complaint	Admitted
Mary Reid			1	Feb. Int. Sect.	Oct. 22.
Melinda Myers			1	" " "	" "
Florida Scott			3	Cholera	" "
Friday					
Sally Smith			3	Feb. Hem.	Oct. 23
Benj. "			1	" " "	" "
John Kinard			1	Rheumatism	" "
Alford James	1			Feb. Int. Sect.	" "
Henry King			2	Conjunctivitis	" "
John Moore			2	Inf. of feet	" "
Dan. Scott				Contracted W.	" "
Charles Henry			3	Bronchitis	" "
Samuel "	5			Gynermodia	" "
Charlotte Wilson	6			Nausea	" "
Carrie "	7			Abuse	" "
Francis Denton	8			" "	" "
Simon Reppose			3	Feb. Int. Sect.	" "
Silly Lewis	9			" " "	" "
James Buchanan				Diarrhoea	" "
Isther "			4	Feb. Int. Sect.	" "
Maria "			5	Feb. Int. Sect.	" "
Robert Evans	2			" " Sect.	" "
Alice Daughton	10			" " Sect.	" "
John Smith	3			" " "	" "
Betsy Williams	11			" " "	" "
Saturday					
Richard Berryhill	5			Feb. Int. Sect.	" 24
Margaret "	12			" " "	" "
Henry Simpson	"			Feb. Hem.	" "
Julia Annester	13			" Feb. Sect.	" "
Lewis Davis	7			Conjunctivitis	" "
Rebecca Williams	14			Colic	" "
John Reid	8			" Sect.	" "
Florida Myers	15			Inf. Liver	" "
Henrietta Roberts				Gynermodia	" "
George Biscoe			1	Feb. Hem.	" "
Lery Co.			5	" "	" "

Returned to Duty	Deserted	Discharged from Service	Sent to General Hospital	On Furlough	DIED	REMARKS
------------------	----------	-------------------------	--------------------------	-------------	------	---------

*Oct. 23*

*" "*  
*Jan 10*

*Oct. 23*

*" "*

*Oct. 23*

*" 28*

*Oct. 28*

*Oct. 21*

*Oct. 23*

*" "*

*" 26*

*" 23*

*" "*

*" "*

*Oct. 23*

*" "*

*" "*

*Oct. 28*

*" "*

*" "*

*" "*

*" "*

*" 24*

*" "*

*" "*

*Oct. 27*

*Oct. 28*

*" "*

*By Fall from horse*

# REGISTER OF THE SICK AND WOUNDED

NAMES	Rank	Regiment or Corps	Company	Complaint	Admitted
<i>Saturday (cont)</i>					
Rose Harris			1	Febr. Int. gut	Oct. 24
Uellie Owens			2	Phrenitis	" "
Mary Henderson		1		Febr. Int. gut	" "
Ann Hodges		2		" " "	" "
Richard Owens		1		" " "	" "
Charity "			3	Phren.	" "
Eliza Hodges		2		Chancera	" "
Jesse Humphreys	1			"	" "
Georgia Ann Do		3		Phrenitis	" "
Ann Wade		4		Headache	" "
Edmond Waters	2			Constipation	" "
Olivia Foster	3			Febr. Int. gut	" "
Reuben Stephens	4			" " "	" "
Betsy Johnson	5			Debility	" "
Phoebe Crawford	6			Convulsions	" "
Kate Blunsom			4	Febr. Int. gut	" "
Mahala Do	7			" " "	" "
Anna Meady	8			Prodig. Men.	" "
Lucinda Hudson			5	Febr. Men.	" "
Sally Goldwell	9			" Int. gut	" "
May Cox	10			Febr. " Int.	" "
John Harper	5			Febr. Int. gut	" "
Ed Jackson	6			" " "	" "
Pedro "	7			" " "	" "
Chancy Judge	11			Convuls.	" "
Luz Callaway	12			Febr. Int. gut	" "
Peter Boyant.	8			" " "	" "
Joe Hazlet.			4	" " Int.	" "
Mary Comer	13			Phrenitis	" "
Rosa Allen		3		Debility	" "
Maria Miller	14			Febr. Int. gut	" "
Louisa Kull		4		Chancera	" "
Maria Fair	15			Febr. Int. gut	" "
Maria "	17			Phrenitis	" "
Laura Hankins			7	Febr. Int. Int.	" "
Henry Do		5		" " "	" "
Maria "			8	" " "	" "
Francis "	18			" " "	" "
	19		8	" " "	" "

AT

*Amicus, Ser.*

186

Returned to Duty	Deserted	Discharged from Service	Sent to General Hospital	On Furlough	DIED	REMARKS
------------------	----------	-------------------------	--------------------------	-------------	------	---------

*Oct. 28*

*" "*

*" "*

*" "*

*" "*

*" "*

*" "*

*" "*

*" "*

*" "*

*" "*

*" "*

*" "*

*" "*

*" 27*

*Oct. 28*

*" "*

*Oct. 28*

*" "*

*" "*

*" "*

*" "*

*" "*

*Oct. 28*

*" "*

*" "*

*" "*

*" "*

*" "*

*" "*

*" "*

*" "*

*" "*

*" "*

*" "*

*" "*

# REGISTER OF THE SICK AND WOUNDED

NAMES	Rank	Regiment or Corps	Company	Complaint	Admitted
<i>Saturday (con)</i>					
Franklin Curry	1			Feb. Sub. Gut. (Oct. 24)	
Lama Ellis		1		" "	" "
S. E. Brown			1	2 <sup>d</sup> Syphilis	" "
George Elligan		1		Diarrhea	" "
Mary Ann Caldwell			2	Worms	" "
Robert Colwell	2			Feb. Sub. gut.	" "
Thomas Franklin	3			Ab. sp. Ch.	" "
Green Harris	4			Feb. Sub. Gut	" "
Miss King			3	Worms	" "
Ann. Edson	5			Colic	" "
Wm. Thos. Edson	6			Do.	" "
Ann Allen		2		Feb. sub. gut.	" "
Suzanne Gordon	7			" Worms	" "

<i>Sunday</i>					
George Johnson			4	Worms	" 26
Peggy Dudley		3		Subst. Intest.	" "
Mary King			11	Diarrhea	" "
John Patterson	8			Convers. hum.	" "
Suz. Gordon	9			Feb. Sub.	" "
Sam Johnson	10			" Sub. Gut	" "
Miss Jones	11			" " "	" "
Mark King	12			" " "	" "
Henrietta Rose		1		" " Int.	" "
Belva Carter	13			" " "	" "
John Lewis	14			Feb. Worms	" "
Sam. Jones	15			" Sub. gut.	" "
<hr/>					
Alfred Brown			3	Chol. Infact.	" "
Jennie Rogers		5		Feb. Sub. gut.	" "
George Huffer	16			" " Int.	" "
Howard Dixon	17			" " "	" "
Wm. King	18			" " Int.	" "
Adriana McLean		6		" " Int.	" "
Susan McGraw		7		Worms	" "
John Jackson	19			Feb. Sub. Gut	" "





## REGISTER OF THE SICK AND WOUNDED

NAMES	Rank	Regiment or Corps	Company	Complaint	Admitted
	<i>Tuesday</i>				
Charley Payne	1			Feb. Rheum.	Oct. 27
Fanny Jones			1	" Sub. gut	" "
S. G. Jones		1		" " "	" "
W. Buchanan	2			Headache	" "
George Matthews	3			General head	" "
Chas. Kearney	4			Dysentery	" "
Solomon Green	5				
Emma Clayton			2	Rheumatism	" "
Dave Washington Patterson			1	Worms	" "
Bruce Clayton	6				
Jack Merritt			2	Inflam. of feet	" "
Wm. Blaise	7			Feb. Sub. gut.	" "
Wm. Nyles	8			" " "	" "
A. J. Griffin		2		Dysentery	" "
John Rowser	9			" " "	" "
Wm. Anderson		3		Feb. Sub. gut.	" "
" Sheffield		1		Feb. " "	" "
Betsy "			3	" " Sub.	" "
Mary "			1	" " "	" "
Simon "				Rheumatism	" "
Willie Seay		5		Feb. Sub. gut.	" "
Chas. "		6		" " "	" "
Abraham "	10			" " "	" "
Willie Davis			5	" " "	" "
Florida Hunt		7		Feb. Sub. gut.	" "
Wm. Walker		3		Stomach	" "
* Miranda Belcher		8		Feb. Sub. gut.	" "
Dea. Belcher			1	Constipation	" "
James Jarratt	11			Bruise	" "
	<i>Wednesday</i>				
Jennie Wilson		9		Rheumatism	" 28
Emma Willis	12			skin	
Wm. Harvey	13			Dysentery	
John Elat	14			"	
Mary Harvey		10		Feb. Sub. Gut.	
Susan McQueen		11		Worms	
B. Clayton	15			General head	

Returned to Duty      Deserted      Discharged from Service      Sent to General Hospital      On Furlough      DIED      REMARKS

*Oct. 29*  
*Oct. 29*

*" "*  
*" "*  
*" "*

*Oct. 27*  
*" "*  
*" 27*

*Oct. 29*  
*" "*  
*" "*

*" "*  
*" "*  
*" "*  
*" "*  
*" "*  
*" "*  
*" "*

*Oct. 29*  
*" "*  
*" "*  
*" "*

*Have not seen the case*

*Oct. 29*  
*" "*

*By fall from wagon*

*Oct. 29*  
*" "*  
*Oct. 29*

## REGISTER OF THE SICK AND WOUNDED

NAMES	Rank	Regiment or Corps	Company	Complaint	Admitted
Heck Hamilton	1			Ab. Int. gut.	Oct. 28
Jennie Hill				" " " "	" "
Willie Spencer			1	Itch	" "
M. J. Gregg		1		Constipation	" "
Carolina Jones		2		Feb. Int. gut.	" "
Hugh Birns	2			" " " "	" "
Peter Holman	3			" " " "	" "
Warwick Jones	4			Engorged Spleen	" "
Mat. Mann	5			Feb. Int. Test.	" "
Nick Hill	6			Constipation	" "
M. J. Griffin		7		Inflam. Liver	" "
Phob. Crawford		8		" " " "	" "
Annie Midgley		9		Isolab. Testis	" "
Sam. Murdy		10		Suppur. Catarrh	" "
S. G. Davis				2 Hemorrhoids	" "
Sarah Birns		1		Feb. Int. gut.	" "
Grace Jones				3 " " " "	" "
Linda "				4 " " " "	" "
Edmond Dixon	7			" " Test	" "
Rosie "		8		" " " "	" "
Lucy Dixon		9		" " " "	" "
Web. Sumner	8			Debility	" "
Ben Smith	9			Rheumatism	" "
Ella Hoy				5 2. Syphilis	" "
H. G. Dudley		10		" " " "	" "

Thursday

Sam. David			1	Feb. Hemit.	Oct. 29
Mary Spud			1	Neuralgia	" "
Jane Washington			2	Feb. Int. Test.	" "
Jesse Martin				Prostatitis	" "
Green David	2			Engorged Spleen	" "
Emanuel Carter	3			Edentalgia	" "
Mary Adams			3	Sprain	" "
Charles Payne	4			Feb. Mem.	" "
Margaret Little			4	" Int. gut.	" "
Samuel Clayton	5			" " " "	" "
Florida Holt			5	" " " "	" "

Returned to Duty	Deserted	Discharged from Service	Sent to General Hospital	On Furlough	DIED	REMARKS
------------------	----------	-------------------------	--------------------------	-------------	------	---------

*Oct. 29*

*" "*

*" "*

*" "*

*" "*

*" "*

*" "*

*Jan. 13*

*Oct. 29*

*" "*

*Jan. 13*

*Oct. 29*

*Jan. 13*

*Oct. 29*

*Jan. 13*

*Oct. 29*

*" "*

*" "*

*" "*

*" "*

*" "*

*" "*

*Oct. 29*

*" 28*

*" 13*

*Oct. 29*

*" "*

*" "*

*Jan. 13*

*Oct. 29*

*" "*

*" "*

*" "*

*Jan. 13*

*Oct. 29*

*Jan. 13*

## REGISTER OF THE SICK AND WOUNDED

NAMES	Rank	Regiment or Corps	Company	Complaint	Admitted
<i>Thursday (con)</i>					
Charles Tomlinson	1			Rheumatism	Oct. 29
Martha J. Comery		1		Dyspepsia	" "
Simon Martin	2			Feb. Rem.	" "
Isabella "		2		" "	" "
Jane "			1	" "	" "
James Garrett	3			Bruise	" "
Thos. Starnes	4			Diarhoea	" "
Mrs "	5			"	" "
Mary Coleman			2	Worms	" "
Nancy Thomas			3	"	" "
Susan Moor			4	"	" "
John do	6			Constipation	" "
Jane Wilson			1	"	" "
Sallie Jones		3		Feb. Int. gut.	" "
May Manson		4		Hemorrhoids	" "
Julia Mauck		5		"	" "
James Johns	7			Feb. Int. Gut.	" "
John Mansfield	8			" " "	" "
Julian Gregory			2	" " gut.	" "
Tom Jones			3	" " "	" "
Dicky Wilson				Erysipelas	" "
Robert Jackson	9			Wound	" "
Mrs "	10			Bronchitis	" "

*Monthly Report to this date.*



## REGISTER OF THE SICK AND WOUNDED

NAMES	Rank	Regiment or Corps	Company	Complaint	Admitted
<i>Friday</i>					
Jennie Hill			1	Feb. Int. gut.	Oct. 30 <sup>th</sup>
Anna Moss		1		" " " "	" "
Frank S. Binn			1	" " " "	" "
Caroline Smith		1		Dysentery	" "
Wm. Johnson	1			Feb. Int. gut.	" "
Caroline McLean		2		Polyp. Uteri	" "
Jack Hill	2			Feb. Int. gut.	" "
John Lewis	3			" " " "	" "
J. H. Truway		3		Polyp. Uteri	" "
Mary Ann Black		4		Leucorrhoea	" "
Thos. Michael	4			Acidacidity	" "
Charity Womack		5		Rheumatism	" "
Lucy Hillis		7		Polyp. Uteri	" "
Sallie Hoop			2	Constipation	" "

<i>Saturday</i>					
Sister Rowland	1			Feb. Int. gut.	" 31
Catherine "	1			" " " "	" "
Walter Gordon	3			Scapula	" "
Georgia Ann McLean	3			Feb. Int. gut.	" "
Kitty Turner	4			" " " "	" "
Lucy Everett			1	Boil	" "
Thomas Hoop	3			" " " "	" "
Geo. W. Hays			2	Bronchitis	" "
Mary Stewart			1	Feb. Int. gut.	" "
Katy Stewart	5			" " " "	" "
Erny Carter	4			Rheumatism	" "
Wm. Johnson			3	Constipation	" "
Jane Lewis	3			Feb. Int. gut.	" "
Wm. Johnson	7			Rheumatism	" "
Forest Gordon			4	Chills & Int. gut.	" "
Walter McJunkin	5			" " " "	" "
Michael Johnson	2			Boil	" "
Cilla Jones	9			Dysentery	" "
Thos. Tomlinson	4			Feb. Int. gut.	" "
John Beards	5			" " " "	" "
Lucinda Atkins	10			" " " "	" "



Returned to Duty	Deserted	Discharged from Service	Sent to General Hospital	On Furlough	DIED	REMARKS
------------------	----------	-------------------------	--------------------------	-------------	------	---------

*Oct 30*

*" "*

*" "*

*Nov 1*

*Oct 30*

*Nov 1*

*Oct 30*

*" "*

*Nov 1*

*Oct 30*

*Oct 30*

*" "*

*Oct 30*

*Nov 2*

*" "*

*" "*

*" "*

*" "*

*" "*

*" "*

*" 3*

*" 2*

*" "*

*" 4*

*Nov 2*

*" 1*

*" 7*

*Nov 2*

*" "*

*Nov 2*

*Nov 2*

*" "*

*" "*

*" "*

# REGISTER OF THE SICK AND WOUNDED

NAMES	Rank	Regiment or Corps	Company	Complaint	Admitted	
<i>Saturday (cont)</i>						
<i>Mary E. Atkins</i>		1		<i>Dysmenstrua</i>	Oct. 31	
<i>Anson Anthony</i>	1			<i>Inflam. Liver</i>	" "	
<i>Mattie Hawkins</i>		2		<i>Feb. Int. gut.</i>	" "	
<i>Ellie King</i>			1	<i>Hoarse</i>	" "	
<i>Sunday</i>						
<i>Washington Puffinb</i>	1			<i>Enterocolic</i>	Nov. 2	
<i>Cynthia Neal</i>		1		<i>Diarrhoea</i>	" "	
<i>Henry Neal</i>			1	<i>Diarrhoea</i>	" "	
<i>Eliza Wallace</i>		2		<i>Proctopus. Uteri</i>	" "	
<i>Joe Peters</i>	2			<i>Feb. Int. gut.</i>	" "	
<i>James Madison</i>			1	<i>Chol. Infant.</i>	" "	
<i>Lehman William</i>		3		<i>Feb. Int. gut.</i>	" "	
<i>Joe Martin</i>	3			<i>Rheumatism</i>	" "	
<i>Malinda Brown</i>		4		"	" "	
<i>Jack Moore</i>			2	<i>Inflam. M. Th.</i>	" "	
<i>John Weeks</i>	4			<i>Pneumonia</i>	" "	
<i>Anna Willis</i>		5		<i>Prostratitis</i>	" "	
<i>James Williams</i>			3	"	" "	
<i>Susan Lewis</i>				2	<i>Chol. Infant.</i>	" "
<i>Jessie Thomas</i>				3	"	" "
<i>Thos. Quinn</i>		5		<i>Feb. Int. gut.</i>	" "	
<i>Malinda Brown</i>		6		"	" "	
<i>Winnie Fletcher</i>		6		"	" "	
<i>Antoinette Davis</i>				4	<i>Proctopus</i>	" "
<i>Lucinda Davis</i>		7		<i>Old age</i>	" "	
<i>Monday</i>						
<i>Wm. K. Jones</i>		7		<i>Diarrhoea</i>	" 3	
<i>Grace Jones</i>		8		<i>Proctopus</i>	" "	
<i>Ben Smith</i>		8		<i>Rheumatism</i>	" "	
<i>Liberty Jones</i>		9		<i>Uter. Thr.</i>	" "	
<i>Melinda Smith</i>		9		<i>Feb. Int. gut.</i>	" "	
<i>Lucinda</i>				5	"	" "
<i>Sherman</i>			4	"	" "	
<i>John King</i>		11		<i>Colic</i>	" "	

AT

*Amicus, Sea.*

186

Returned to Duty	Deserted	Discharged from Service	Sent to General Hospital	On Furlough	DIED	REMARKS
------------------	----------	-------------------------	--------------------------	-------------	------	---------

*Nov. 9*

*" "*  
*Nov. 3*

*" "*

*Nov. 18*

*Nov. 5*

*" "*

*" 20*

*Nov. 8*

*" 7*

*" 4*

*" 7*

*Nov. 2*     *" 2*

*Nov. 7*

*" "*

*" "*

*" "*

*" 5*

*" "*

*" "*

*" "*

*" 7*

*" "*

*Nov. 5*

*" "*

*" 9*

*Nov. 10*

*Nov. 7*

*" "*

*" "*

*" 7*

# REGISTER OF THE SICK AND WOUNDED

NAMES	Rank	Regiment or Corps	Company	Complaint	Admitted
				<i>Resident (Cas)</i>	
Grace Turner	1			Phthisis Pul.	Nov. 3 <sup>d</sup>
Henry Caldwell	2			Heart	" "
Samuel Bap		1		Rheumatism	" "
Joseph Allen				Feb. Sub. gut.	" "
Henry Bap	3			Incontinence	" "
(Amuel) Clayton	4			Gonorrhoea	" "
W. J. Dudley		2		Mercurial	" "
Charles Lawrence			1	Feb. Sub. gut.	" "
Charles Jordan		3		Conjunctivitis	" "
Malchey Heintz		4		Feb. Sub. gut.	" "
Conner			1	" " "	" "
Louisa Perry		5		Ulcer Ch	" "
Henry "			2	Feb. Sub. gut.	" "
Collis "			2	" " "	" "
Samuel "			3	" " "	" "
John Perry	5			" " "	" "
Edmond Siro	6			" " "	" "
Leroy "		6		" " "	" "
Frank "		7		" " "	" "
Arthur Gordon				" " Feb.	" "
Leroy "			4	" " gut.	" "
Amanda "			3	" " "	" "
John Oliver	8			Feb. Sub. gut.	" "
Sam Gray	9			Gravel	" "
Wm. Turner		8		Diarrhoea	" "
Wm. Dowdle	10			Feb. Sub. gut.	" "
Lucinda Dowdle		9		Proctitis	" "
John Ward	11			Diarrhoea	" "
George "			4	Feb. Sub. gut.	" "
John "			5	" " "	" "
Lidia Ann Vickus		10		Proctitis	" "
Lucinda Webb		11		Feb. Sub. gut.	" "
Anna "		12		Debility	" "
John "			6	Diarrhoea	" "
Samuel Moore	12			Dislocation	" "
John "	13			Rheumatism	" "
Henry Ann Williams		13		Asthma	" "
John Carter	14			Gonorrhoea	" "

AT

*Americus, Geo.*

186

Returned  
to  
Duty

Deserted

Discharged  
from  
Service

Sent to  
General  
Hospital

On Furlough

DIED

REMARKS

*Tuesday (Nov)*

*Nov 4*

*Nov 7*

*" 3*

*" 15*

*Nov 7*

*" 9*

*Nov 5*

*" "*

*Nov 5*

*" "*

*" "*

*" "*

*" "*

*" "*

*" "*

*" "*

*" 7*

*" "*

*" "*

*" "*

*" "*

*Nov 7*

*" "*

*" 15*

*Nov 7*

*" "*

*" "*

*" "*

*Nov 7*

*" 7*

*" 7*

*" "*

*" "*

*" "*

*Bill from Hulse*

## REGISTER OF THE SICK AND WOUNDED

NAMES	Rank	Regiment or Corps	Company	Complaint	Admitted
<i>Tuesday (Cont)</i>					
Thomas Perrot	1			Diarrhea	Nov. 3
Ving Mausew	1			Feb. Int. Gut.	" "
Ann McGoady	2			" " "	" "
Ann Brown			1	Worms	" "
Lucinda "			2	"	" "
Eliza "			3	"	" "
Sam Cannon	2			Rheumatism	" "
Lorissa Banks	3			"	" "
Hettie "			4	Chol. Infant	" "
Esther Saffin	4			Feb. Int. Gut.	" "
Mary Ann "			5	" " "	" "
William Gibson	5			Rheumatism	" "
Varat Harris	5			Headache	" "
Delia Abner	6			Constipation	" "
Dick Brown	4			Feb. Int. Gut.	" "
Eliza Jane (Crosby)			4	Sore Throat	" "
Thomas Boston	5			Feb. Int. Gut.	" "
Willie Brown	6			" " "	" "
Eugene Agnew			2	Worms	" "
Charles "			3	"	" "
William Gollin			6	"	" "
John Williams	7			Feb. Int. Gut.	" "
George Terrell	8			Rheumatism	" "
Sarah "		8		Feb. Int. Gut.	" "
Jan "	9			" " "	" "
Elbert "			4	" " "	" "
Anna "			7	" " "	" "
Abby Fisher	10			" " Feb.	" "
<i>Wednesday</i>					
Alan Johnson	11			Croup	" 11 <sup>th</sup>
John Harper	12			Rhin. in ear	" "
Isaac Stevens	13			Rheumatism	" "
Chas. Croshaw	14			Diarrhea	" "
Emily Bap		9		Rheumatism	" "
Levi Fuller	15			Asthma	" "
Wesley Adams	16			Feb. Int. Gut.	" "
Susan "		10		" " "	" "

Returned to Duty	Deserted	Discharged from Service	Sent to General Hospital	On Furlough	DIED	REMARKS
------------------	----------	-------------------------	--------------------------	-------------	------	---------

*Nov. 3*

*" 7*

*" "*

*" "*

*" "*

*" "*

*" 9*

*" 9*

*Nov. 7*

*" "*

*" "*

*" 9*

*Nov. 7*

*" "*

*" "*

*" 9*

*Nov. 7*

*" "*

*" "*

*" "*

*" "*

*" "*

*" 9*

*Nov. 7*

*" "*

*" "*

*" "*

*" "*

*Nov. 6*

*" 9*

*Nov. 7*

*" 9*

*" "*

*Nov. 7*

*" "*

# REGISTER OF THE SICK AND WOUNDED

NAMES	Rank	Regiment or Corps	Company	Complaint	Admitted
<i>Wednesday (Cont)</i>					
James Adams			1	Tub. Pul. quot.	Nov. 4
John "			2	" " "	" "
Gina "			1	" " "	" "
Willie "			3	" " "	" "
Leoline Wesley			4	Burn	" "
Wesley (White)	1			Engorged spleen	" "
Wm. Morgan		1		Diap. Muri	" "
Edw. Asian		2		Rheumatism	" "
Wm. Birnie	2			"	" "
Wm. Birnie				2 Tub. Pul. quot.	" "
Mirinda Brown				3 Typhoid	" "
Wm. McGrady				Wleg. Chorea	" "
Jeffrey Walker	1			Tub. Pul. quot.	" "
John Case		3		Dysmenstrhea	" "
Wm. Haney		4		Diarrhea	" "
John "			5	Asthma	" "
William Phelps	5			Tub. Pul. quot.	" "
Wm. Davis		5		Murderhaia	" "
Wm. Mc	6			Rheumatism	" "
Wm. "		6		"	" "
John Langley		7		Tub. Pul. quot.	" "
Wm. D. D. D.				Dysmenstrhea	" "
Philip Washington	8			Cutis	" "
Geo. Washington	9			Scarlet fever	" "
Leah Stewart		5		Tub. Pul. quot.	" "
Forest Dumbas			6	" " "	" "
Green Harris	10			" " "	" "
Mary Nixon		9		" " Tub.	" "
George Walker	11			Suppur. Liver	" "
<i>Thursday</i>					
Michael Dingo	10			Tub. Wleg	5
Robert Bodger		7		Dysentery	" "
John Langley	11			Tub. Pul. quot.	" "
John W. Langley		8		" " "	" "
Wm. McGrady	12			" " "	" "
Wm. Green	13			" " "	" "
Mary Ford	14			Rheumatism	" "



Returned to Duty	Deserted	Discharged from Service	Sent to General Hospital	On Furlough	DIED	REMARKS
------------------	----------	-------------------------	--------------------------	-------------	------	---------

*Nov. 7*

*" "*

*" "*

*" "*

*" "*

*Nov. 7*

*Nov. 9*

*" "*

*Nov. 7*

*" "*

*Nov. 7*

*" 12*

*Nov. 7*

*" 12*

*Nov. 7*

*Nov. 4*

*" 12*

*" "*

*Nov. 7*

*Nov. 4*

*Nov. 7*

*" "*

*" "*

*" "*

*" "*

*" 12*

*Nov. 12*

*" "*

*Nov. 7*

*" "*

*" "*

*" "*

*" "*

## REGISTER OF THE SICK AND WOUNDED

NAMES	Rank	Regiment or Corps	Company	Complaint	Admitted
<i>Thursday (over)</i>					
Wm. Ayles	1			Feb. Int. gut.	Nov. 5
Sam. Daniel		1		Gibbity	" 5
John Johnson		2		Feb. Int. gut.	" "
Josephus Corneo			1	Worms	" "
Willie Leach		1		"	" "
James Jones		2		"	" "
William May	2			Diarrhoea	" "
Jane "		3		"	" "
Julia "		"		Brunchitis	" "
Sam. Ryan	4			Constipation	" "
Ho. Stewart	5			"	" "
Mrs. "		5		"	" "
Mary "		6		Diarrhoea	" "
Mary Carter	6			Tussillitis	" "
John "				"	" "
Amos Jones	7			Feb. Int. gut.	" "
<i>Friday</i>					
Chas. Allen		1		Feb. Int. gut.	Nov. 6
Emma Field				" " "	" "
Philip Washington	1			Bubo	" "
Peggy Dutton		2		Inflam. Brain	" "
Lula Funder			2	" Corymbium	" "
Andrew Buchanan	2			Deep sores	" "
Sarah Anderson		3		Feb. Int. gut.	" "
Louisa "		4		Brunchitis	" "
Louisa and D.		5		"	" "
Julia "		6		"	" "
Robert Caldwell			1	Diarrhoea	" "
Lula "				"	" "
Esther Roberts		7		Rheumatism	" "
Ed. Smith		8		Tubula in (no.)	" "
Mary Thomas			4	Rheumatism	" "
James "			2	"	" "
John Morgan	2			Tussillitis	" "
Sam. Cobb	4			Diarrhoea	" "
Miss Morgan	5			Feb. Rem	" "
John Wilson	6			" "	" "
Mark Redding	7			" "	" "

Returned to Duty	Deserted	Discharged from Service	Sent to General Hospital	On Furlough	DIED	REMARKS
------------------	----------	-------------------------	--------------------------	-------------	------	---------

*Nov. 7*

" "

" "

" "

" "

" "

" "

" "

" "

" "

" "

" "

" "

" "

" "

" "

*Nov. 7*

" "

" "

" 12

" "

" "

" 7

" 10

" "

" "

*Nov. 7*

" "

" 12

*" 7*

" "

" "

" "

" "

" "

" "

## REGISTER OF THE SICK AND WOUNDED

NAMES	Rank	Regiment or Corps	Company	Complaint	Admitted
<i>Friday (Cont)</i>					
Kitty Morris				Dysmenstrua	Nov. 5
Swan Adams				Chol. Infant.	" "
John "			1	" "	" "
John Jones	1			Feb. Sub. gut.	" "
Mary "		2		" " "	" "
Jane "		3		" " "	" "
Thomas "			2	" " "	" "
" Sick			3	Worms	" "
Mary "				" "	" "
Amanda Whitten		4		Feb. Sub. gut.	" "
Rebecca Miller	2			Inflam. Liver	" "
Sam. Blinn	3			Feb. Sub. gut.	" "
Nancy "		5		" " "	" "
Will. Jones	1			Headache	" "
<i>Saturday</i>					
Priscilla Adams		1		Feb. Sub. gut.	Nov. 7.
Warren Wilburn	1			Gonorrhoea	" "
James "		2		" "	" "
Wm. Mott	3			2 <sup>d</sup> Syphilis	" "
Will "		3		" "	" "
Emma Robinson			1	" "	" "
Alva "		4		Constipation	" "
Jane Hill		5		Bronchitis	" "
George Cain	3			Whee, Chr.	" "
Wm. Edwards	4			Headache	" "
Wm. Edwards		5		Gonorrhoea	" "
Nathan Adams	5			Gonorrhoea	" "
Paddy Smith		7		Whee, Chr.	" "
Shelby Burnett		8		Bronchitis ch.	" "
Charles Nelson	6			Diarrhoea	" "
Carol Brins			2	Feb. Sub. gut.	" "
Janey Rector		8		Rheumatism	" "
Eliza Brown		9		" "	" "
Letitia Jones		10		Feb. Sub. gut.	" "
Lester Berryhill			1	" " "	" "
	6	"	1		

Returned to Duty	Deserted	Discharged from Service	Sent to General Hospital	On Furlough	DIED	REMARKS
------------------	----------	-------------------------	--------------------------	-------------	------	---------

*Nov. 6*

*" 12*

*" "*

*Nov. 7*

*" "*

*" "*

*" "*

*" "*

*" "*

*" "*

*" 12*

*" "*

*" "*

*" "*

*Nov. 10*

*" 13*

*" 13*

*" 20*

*" "*

*" "*

*Nov. 10*

*Nov. 13*

*" 20*

*Nov. 7*

*" 20*

*" "*

*" "*

*Nov. 10*

*" "*

*" "*

*" "*

*" "*

*" "*

# REGISTER OF THE SICK AND WOUNDED

NAMES	Rank	Regiment or Corps	Company	Complaint	Admitted
<i>Thursday (cont)</i>					
Louisa Crawford		1		Dysmenorrhea	Nov. 7 <sup>th</sup>
Peter Smith		1		Act. Int. Gut.	" "
Charlotte Harris		2		" " gut	" "
Elizabeth Ann		3		Colic	" "
Charles Thomas		2		Act. Int. gut.	" "
John Pope	1			Pneumonia	" "
J. Phillips	2			Diarrhea	" "
Yvonne Wilson		"		Act. Int. gut.	" "
Madison Butler	3			Colic	" "
Thomas Carr	1			"	" "
Harriet Dixon		5		Insult	" "
Esther Brewster		6		Act. Int. gut.	" "
Alice do.			1	" " "	" "
Wm Henry "		3		" " "	" "
Laura Smith			2	Diarrhea	" "
Maria Anderson		7		Diarrhea	" "
<i>Monday</i>					
Abigail George		8		Diarrhea	Nov. 9 <sup>th</sup>
Wm Murphy	5			Colic	" "
Martha Maxwell	6			Act. Int. Gut.	" "
Ann Davis		9		" " gut	" "
Louisa Jones			3	" " "	" "
John Johnson	7			" Int. gut.	" "
Lucy Johnson	8			Diarrhea	" "
Wm McGrady	9			Blue Cholera	" "
Charles Harris		1		Act. Int.	" "
Edmund Harris	10			" " "	" "
Harriet Floyd		10		Pneumonia	" "
Madison Carter	11			Colic	" "
Maria Marshall		11		Act. Int. Gut.	" "
Lucy do.			4	" " "	" "
Mary			5	" " "	" "
John Mene	12			Diarrhea	" "
Louisa Crawford		12		Act. Int.	" "
Frank Payne	13			" " "	" "
Randall Haight	14			" Int. gut.	" "

Returned to Duty	Deserted	Discharged from Service	Sent to General Hospital	On Furlough	DIED	REMARKS
------------------	----------	-------------------------	--------------------------	-------------	------	---------

*Nov. 20*

*Nov. 10*

*" 12*

*" 7*

*" 10*

*" 10*

*" 20*

*Nov. 10*

*" "*

*" "*

*" 13*

*" 10*

*" "*

*" "*

*" "*

*" 13*

*Nov. 20*

*Nov. 10*

*" 12*

*" "*

*" 13*

*" "*

*" 10*

*" 20*

*Nov. 13*

*" "*

*" "*

*" 10*

*" "*

*" "*

*" "*

*" 20*

*Nov. 13*

*" "*

*" 10*

# REGISTER OF THE SICK AND WOUNDED

NAMES	Rank	Regiment or Corps	Company	Complaint	Admitted
<i>Monday (don)</i>					
<i>Joseph Crawford</i>	1			<i>Generalia</i>	<i>Nov. 9.</i>
<i>John Davis</i>	2			<i>Sub. Int. quot.</i>	" "
<i>Sibby Kelly</i>				" "	" "
<i>Martha McCrea</i>				<i>Delap. Int.</i>	" "
<i>Charles Nelson</i>	3			<i>Sub. Rem.</i>	" "
<i>Tuesday</i>					
<i>Richard James</i>				<i>Sub. Int. quot.</i>	<i>Nov. 10</i>
<i>Allen Meadows</i>	4			" "	<i>Nov. 10</i>
<i>Marie Anderson</i>			3	<i>Generalia</i>	" 10
<i>Mary May</i>			1	<i>Generalia</i>	" "
<i>Ellen Cobb</i>			5	" "	" "
<i>Sallie Cobb</i>			4	<i>Inflam. Liver</i>	" "
<i>Sallie Jackson</i>			3	<i>Worms</i>	" "
<i>William Jackson</i>			1	" "	" "
<i>William White</i>			2	<i>Worms</i>	" "
<i>Wm. Cobb</i>	5			<i>Worms</i>	" "
<i>John Birns</i>			3	<i>Worms</i>	" "
<i>Amelia Co.</i>			3	" "	" "
<i>Reuben "</i>			1	" "	" "
<i>Eliza "</i>			1	" "	" "
<i>Neil "</i>			3	" "	" "
<i>Edmund Thomas</i>	6			<i>Sub. Int. Int.</i>	" "
<i>Ving Mason</i>			7	" "	" "
<i>Cabrina Barber</i>			8	<i>Generalia</i>	" "
<i>Martha Hunt</i>			9	<i>Generalia</i>	" "
<i>John Davis</i>			10	<i>Generalia</i>	" "
<i>Palla W. Davis</i>			5	<i>Worms</i>	" "
<i>Thos. Stewart</i>	7			<i>Sub. Int. quot.</i>	" "
<i>Leitha Stewart</i>			11	" "	" "
<i>Oliver Brown</i>			12	<i>Generalia</i>	" "



Returned to Duty	Deserted	Discharged from Service	Sent to General Hospital	On Furlough	DIED	REMARKS
------------------	----------	-------------------------	--------------------------	-------------	------	---------

Nov. 19  
 Nov. 11  
 " "  
 " "  
 Nov. 13

Nov. 12  
 Nov. "  
 " "  
 " 13  
 Nov. 20

" "  
 Nov. "  
 Nov. 12  
 " "  
 " 21

Nov. 17  
 " "  
 " "  
 " "  
 " "  
 " "  
 " "  
 " "  
 " "  
 " 12  
 " "  
 Nov. 20

" "  
 Nov. 12  
 " "  
 " "  
 " "  
 " 13

*Accident from Ken fire*

# REGISTER OF THE SICK AND WOUNDED

NAMES	Rank	Regiment or Corps	Company	Complaint	Admitted
<i>Thursday</i>					
Charlotte George	1			Sub. Int. gut.	Nov. 13 <sup>th</sup>
Thomas Stewart	1			" " "	" "
Charlotte Innes	2			" " "	" "
Kitty Hill	3			Worms	" "
Martin McWilliams	2			Inflam. Liver	" "
Chamny Miller	11			Sub. Int. Gut.	" "
Jesse Martin	2			Bronchitis	" "
John Ingers	3			Sub. Int. gut.	" "
Henry Battle	11			Bronchitis, Ch.	" "
Lucey Hearnes	5			Rheumatism	" "
Jane "			1	Worms	" "
Andrew "		1	"	"	" "
Sarah "			2	"	" "
Martin "		2		"	" "
Spencer Canby	5			Sub. Int. gut.	" "
Sea Walton	6			Rheumatism	" "
Lewis Washington	7			Sub. Int. gut.	" "
Adeline Washington	6			" " "	" "
Martha Canby	7			Asthma	" "
Ann McGrady	8			Sub. Resm.	" "
Lelia "			3	Sub. Int. gut.	" "
John Purser	8			" " "	" "
Maria Pop	9			" " "	" "
William Marshall	10			" " "	" "
Nichol Purcell	9			Sub. Int. gut.	" "
Christine McCarra	11			Rheumatism	" "
Sarah Purcell	12			Sub. Int. gut.	" "
<i>Friday</i>					
Caroline Johnson	13			Stomach	13
Bates Johnson	14			"	" "
Thomas P. Johnson	10			Sub. Int. Gut.	" "
Wm. H. "		3		" " "	" "
May "			4	Worms	" "
Lida "			5	"	" "
Sam "		4		"	" "
Mrs. Thomas		5		Chol. Infant.	" "
Henry "	15			Dysentery	" "

Returned to Duty	Deserted	Discharged from Service	Sent to General Hospital	On Furlough	DIED	REMARKS
------------------	----------	-------------------------	--------------------------	-------------	------	---------

Nov. 12

" "

" "

Nov. 13

" "

Nov. 20

Nov. 13

Nov. 12

" "

" "

" "

" "

" "

" "

" "

" "

" "

" "

" "

" "

Nov. 13

" "

" "

Nov. 13

" "

" "

" "

" "

" "

" "

" "

" "

## REGISTER OF THE SICK AND WOUNDED

NAMES	Rank	Regiment or Corps	Company	Complaint	Admitted
<i>Wednesday</i>					
George Green	1			Tub. Pleur.	Nov 11
Thomas "			1	" "	Nov 11
John Gory	2			" "	" "
Maria "		2		Amenorrhoea	" "
Patience Crosby		3		Rheumatism	" "
Amanda "		4		" "	" "
Sammy White	3			Dysentery	" "
Anthony Kieglu	1			Rheumatism	" "
Thomas Bap		5		Dysenteria	" "
Mary Fisher		6		Tub. Int. gut.	" "
Vinny Manser		7		Tub. Int. gut.	" "
Collins McEgady			1	" " "	" "
Green Payne	5			" " "	" "
James Davis	6			" " "	" "
Wilson Martin	7			Rheumatism	" "

<i>Friday (con)</i>					
Mary Johnson	8			Dysentery	Nov 13
Susan Army	9			" "	" "
Benj Manser	8			Rheumatism	" "
Sarah "	10			" "	" "
Jane Andrews			2	Tub. Int. gut.	" "
James Barrwick	9			Tub. Pleur.	" "
John "			2	" " "	" "
Susan Myrick	11			" " "	" "
Charles Payne	12			Tub. Int. gut.	" "
Maria Martin	13			" " "	" "
John Davis	10			" " "	" "
Ben "	11			" " "	" "
Tom. Cooney	12			Bronchitis	" "
James Bonis	13			" "	" "
Wm. Baule	14			Dysentery	" "
Maria "			3	Dysentery	" "
James Stanton			3	" "	" "
James "			4	" "	" "

Returned to Duty	Deserted	Discharged from Service	Sent to General Hospital	On Furlough	DIED	REMARKS
------------------	----------	-------------------------	--------------------------	-------------	------	---------

*Nov. 13*

*" "*

*" "*

*" 20*

*Nov. 13*

*" "*

*" "*

*" "*

*" 20*

*Nov. 2*

*Nov. 13*

*" "*

*" "*

*" "*

*" "*

*Nov. 13*

*" "*

*" "*

*" "*

*" "*

*" "*

*" "*

*" "*

*" "*

*" "*

*" "*

*" "*

*" "*

*" "*

*" "*

*" "*

*" "*

*" "*

## REGISTER OF THE SICK AND WOUNDED

NAMES	Rank	Regiment or Corps	Company	Complaint	Admitted
		<i>Cavalry</i>			
Nancy Ward		1		Odontalgia	Nov. 14
Anneta Washington		2		Feb. Sub. quot.	" "
Joe Mott	1			Rheumatism	" "
Ansau "		3		Feb. Sub. quot.	" "
Melinda Taylor		4		Dysmenstrua	" "
Larry Washington		5		Flooding	" "
Allen White	2			Feb. Sub. quot.	" "
Harriet Richard			1	Chol. Infant.	" "
James Minner	3			Piles	" "
Leanne Bop		6		Feb. Sub. quot.	" "
James Gibson	4			" " "	" "
M. Gibson			2	Worms	" "
Bettie "			3	"	" "
Jena Washington		7		Syphilis	" "
Winnie Childs		8		Retention Uteri	" "
Winnie Walker		9		Ischuria	" "
Patience Jones		10		Feb. Sub. quot.	" "
Adam Parker		5		" " "	" "
James Jones		6		" " "	" "
Billy Reese		11		Leucorrhoea	" "
John Parks			1	Worms	" "
" Parks Jr.		7		Feb. Sub. quot.	" "
Walter Montgomery		12		" " "	" "
Matilda Sapp		13		" " "	" "
Benjamin Walker		8		Trismus	" "
Emily Turner		14		Rheumatism	" "
Breck McFee		9		Feb. Sub. quot.	" "
Jack Minis		10		Debility	" "
Emma Agins		15		Feb. Sub. quot.	" "
Zury Carr			1	" " "	" "
Ving Carr			3	" " "	" "
Laura Carr			6	" " "	" "
Thomas Carr	11			Headache	" "
Anna "			7	Constipation	" "
" "		11		Feb. Sub. quot.	" "
E. Bogart		12		" " "	" "
Jim Boyer		13		" " "	" "
James Boyer		14		Constipation	" "
James Boyer			2	"	" "

Returned to Duty	Deserted	Discharged from Service	Sent to General Hospital	On Furlough	DIED	REMARKS
------------------	----------	-------------------------	--------------------------	-------------	------	---------

*Nov 14*

*" 15*

*" 20*

*" 15*

*Nov 16*

*" "*

*" 15*

*" 20*

*" "*

*" 15*

*" "*

*" "*

*" "*

*" "*

*Nov 17*

*Nov 21*

*" 15*

*" "*

*" "*

*" "*

*" 20*

*" "*

*" 15*

*" "*

*" "*

*" 20*

*" "*

*" 15*

*" 20*

*" 11*

*" "*

*" "*

*" "*

*" "*

*" 14*

*" "*

*" 15*

*" "*

*" "*

*" "*

*" "*

## REGISTER OF THE SICK AND WOUNDED

NAMES	Rank	Regiment or Corps	Company	Complaint	Admitted
<i>Monday</i>					
Oscar Johnson	1			Rheumatism	Nov. 16
Samuel Salt	2			Feb. Int. gutt	" "
Burwell Highton	1			Syphilis	" "
Winnie Ellis	3			Feb. Int. gutt	" "
William Leland	3			Feb. Int.	" "
Jennette Cooney	10			Palpitation	" "
John Hill	5			Phonitis	" "
Chauncy Newell	1			Feb. Int. gutt	" "
Jack Moore	3			Inflam. St. feet.	" "
Perot Jackson	11			Rheumatism	" "
Charlotte George	7			Feb. Int. gutt	" "
Alfred Lantry	5			Pneumonia	" "
Minerva Lantry	8			Feb. Int. gutt	" "
Kesiah Baldwin	9			" " "	" "
William Perry	10			Ulceration	" "
Charles "	6			Ulcers	" "
Green Harris	1			Feb. Int. gutt	" "
Deliza McInnis	11			Amnesia	" "
John Lee Ford			1	Feb. Int.	" "
John Cato			1	Wounds	" "
G. C. Brown			2	"	" "
J. C. "			2	"	" "
Abraham Cooney	7			Feb. Int. gutt	" "
Robert Jackson	8			Phonitis	" "
A. Castleberg	7			Feb. Int.	" "
India Murray	12			Feb. Int. gutt	" "
<i>Tuesday</i>					
Paul Lander	10			Rheumatism	Nov. 17
William Smith			3	Feb. Int. gutt	" "
Earle "			11	" " "	" "
Frank "			3	" " "	" "
Chloe McCoy	13			" " "	" "
Abby "	14			" " "	" "
John Harris	11			" " "	" "
Mary "			4	Wounds	" "
William "			5	" "	" "
John L. Johnson	12			Ulceration	" "
	13				



Returned to Duty	Deserted	Discharged from Service	Sent to General Hospital	On Furlough	DIED	REMARKS
------------------	----------	-------------------------	--------------------------	-------------	------	---------

		Nov. 20				
		" 15				
		Nov. 20				
		Nov. 15				
		" 20				
		" "				
		" "				
		" "				
		" 28				
		Nov. 20				
		" "				
		" "				
		" "				
		" "				
		" 16				
		" "				
		" "				
		" 20				
		" 20				
		" "				
		" "				
		" "				
		" 15				
		" "				
		" 20				
		" 15				

		Nov. 11				
		" "				
		" "				
		" "				
		" "				
		" "				
		" "				
		" "				
		" "				
		" "				
		" 17				

# REGISTER OF THE SICK AND WOUNDED

NAMES	Rank	Regiment or Corps	Company	Complaint	Admitted
<i>Tuesday (cont)</i>					
Charlotte Williams		1		Debility	Nov. 17
Minerva Arnold		2		Feb. Int. gut.	" "
John "		1		" " "	" "
Jane "			1	" " "	" "
Ryal Thompson	1			Rheumatism	" "
Burton Payne	2			"	" "
Henry Hayes	3			Diarrhoea	" "
Mary Graves		3		Constipation	" "
Amanda Clark		4		Feb. Int. gut.	" "
Sally Davis			2	" " "	" "
<i>Wednesday</i>					
Henry Sims		5		Diarrhoea	Nov. 18
Green Harris	4			Diarrhoea	" "
Walter Parker	5			Feb. Int. Gut.	" "
Lizzie Hayward	6			" " gut.	" "
Tommy Connor			3	" " "	" "
Wm "			4	" " "	" "
Thos. Patterson		2		Scorbut	" "
John "		3		"	" "
Mary "			5	"	" "
Wm. Turner	7			Colic	" "
Fanny May		6		Diarrhoea	" "
John Griffin	8			Rheumatism	" "
Jane Duncan		7		Goitres	" "
Henry Wilson		8		Rheumatism	" "
Sammy White	9			Feb. Int. Gut.	" "
Tracy White		9		" " gut.	" "
Wm. Ford			5	Feb. Mem.	" "
Joe White		4		" Int. gut.	" "
Ed. Williams	10			Constipation	" "
Geo. H. Hill		5		Cyphitis	" "
Anna Ronaldson	10			Constipation	" "
Edmond Johnson	11			Feb. Int. gut.	" "
John Fletcher	11			" " "	" "
William Herbert			7	" " "	" "
Paul Jones	12			Diarrhoea	" "
Wm. Houston	13			Diarrhoea	" "

Returned to Duty	Deserted	Discharged from Service	Sent to General Hospital	On Furlough	DIED	REMARKS
		<i>Nov. 20.</i>				
		" "				
		" "				
		" "				
		" "				
		" "				
		" "				
		" "				
		<i>Nov. 20</i>				
		<i>Nov. 25</i>				
		" "				
		<i>Nov. 20</i>				
		" "				
		" "				
		" "				
		" "				
		" "				
		" "				
		" "				
		" 18				
		" 20				
		<i>Nov. 20</i>				
		" "				
		" "				
		" "				
		<i>Nov. 25</i>				
		<i>Nov. 20</i>				
		" "				
		" "				
		" "				
		" 25				
		" 20				

## REGISTER OF THE SICK AND WOUNDED

NAMES	Rank	Regiment or Corps	Company	Complaint	Admitted
<i>Thursday</i>					
Allen Taylor	1			Conjunctivitis	Nov. 19
George Ruffin	2			Feb. Int. gut.	" "
Annice Bell			1	Diarrhea	" "
Rachel James		1		Feb. Int. gut.	" "
John "	3			" " "	" "
May Gregory		2		Rheumatism	" "
Sam. Jennings	4			Feb. Int. gut.	" "
M. A. Jennings		3		" " "	" "
Simon Callen	5			" " "	" "
Mary W. Winn			2	Diarrhea	" "
Mrs. Suppan			1	Diarrhea	" "
John Simpson			2	"	" "
Jolly Cook		4		Rheumatism	" "
McHenry			3	Feb. Int. gut.	" "
Jesse, Hunter		5		Gonorrhoea	" "
Mary Burton		6		Feb. Int. gut.	" "
Hunsback Davis		7		Rheumatism	" "
M. L. "			3	Feb. Int. gut.	" "
Lewis Davis			4	" Int. gut.	" "
Alice "			1	" " "	" "
Ann "		5		" " "	" "
Pyche "	6			Diarrhea	" "
Thos. H. H. "			5	Feb. Int. gut.	" "
John Ren	7			Rheumatism	" "
H. G. Ren		9		"	" "
C. J. Johnson			6	" Syphilis	" "
<i>Friday</i>					
W. Smith	10			Constipation	Nov. 20
Wm. Davis	"			Diarrhea	" "
Mrs. Wm.	12			Constipation	" "
Frank Mountain	8			"	" "
Isabella "	13			Colic	" "
Henry King	14			Rheumatism	" "
Caroline Beatty	15			"	" "
Francis Gray	16			Feb. Int. gut.	" "
Alonzo Gifford	17			" " "	" "
Fred. Coate	9			" " "	" "

Returned to Duty	Deserted	Discharged from Service	Sent to General Hospital	On Furlough	DIED	REMARKS
------------------	----------	-------------------------	--------------------------	-------------	------	---------

*Apr. 20*

" "

" "

" "

" "

" "

" "

" "

" "

" "

" "

" "

" "

" "

" 25

*Apr. 20*

" "

" "

" "

" "

" "

" "

*Apr. 20*

" "

" "

*Apr. 20*

" "

" "

" "

" "

" "

" "

" "

" "

" "

" "

## REGISTER OF THE SICK AND WOUNDED

NAMES	Rank	Regiment or Corps	Company	Complaint	Admitted
<i>Friday (Con.)</i>					
<i>John Burroughs</i>	1			<i>Feb. Int. gut.</i>	<i>Nov. 20</i>
<i>Priscilla do.</i>		1		" " "	" "
<i>Betsy Martin</i>		2		" " "	" "
<i>Susan Jansen</i>			1	<i>Worms</i>	" "
<i>Thomas "</i>			1	"	" "
<i>Mary Furnworth</i>			2	"	" "
<i>James Jackson</i>	2			<i>Rheumatism</i>	" "
<i>Milly "</i>		3		<i>Diarthrosis</i>	" "
<i>Monroe Payne</i>		4		"	" "
<i>Henry Parker</i>			2	<i>Bronchitis</i>	" "
<i>Mason Parker</i>			3	<i>Pneumonia</i>	" "
<i>Caron Gamlin</i>			4	<i>Feb. Int. gut.</i>	" "
<i>Manson "</i>	3			" " "	" "
<i>Mary "</i>		5		" " "	" "
<i>L. Nora Louder</i>			5	" " "	" "
<i>Fannie Arcus</i>			5	" " "	" "
<i>Geo. W. &amp; E. Wilson</i>	4			" " "	" "
<i>Lora "</i>		6		" " "	" "
<i>Mr. Mott</i>	5			<i>Typhoid</i>	" "
<i>Edith "</i>		5		"	" "
<i>Emma Watson</i>			2	"	" "
<i>Saturday</i>					
<i>Charlotte Coleman</i>			7	<i>Goldty</i>	<i>Nov. 21</i>
<i>Lottie Keigler</i>			8	<i>Rheumatism</i>	" "
<i>Green Suggan</i>	5			"	" "
<i>Wm. J. S. Young</i>			9	<i>Feb. Int. Gut.</i>	" "
<i>Stacie Brown</i>			10	<i>Rheumatism</i>	" "
<i>Joseph John</i>	7			<i>Feb. Int. gut.</i>	" "
<i>Joseph Harrison</i>	8			<i>Worms</i>	" "
<i>Bob Jackson</i>	9			<i>Worms</i>	" "
<i>William White</i>			7	<i>Worms</i>	" "
<i>James Gindley</i>			4	<i>Convulsion</i>	" "
<i>Wm. A. Gindley</i>			8	<i>Worms</i>	" "

Returned to Duty	Deserted	Discharged from Service	Sent to General Hospital	On Furlough	DIED	REMARKS
------------------	----------	-------------------------	--------------------------	-------------	------	---------

*Nov 20*

" "

" "

" "

" "

" "

" "

" "

" "

" 27

" 28

*Nov 20*

" "

" "

" "

" "

" "

" "

" "

" "

" "

*Nov 2*

" "

" "

*Nov 23*

" 28

" 23

" 21

" 30

" "

*Nov 28*

" "

REGISTER OF THE SICK AND WOUNDED

NAMES

Rank

Regiment  
or Corps

Company

Complaint

Admitted

*Emma Henderson*

*Monday*

*1*

*Infantry, 1st, No. 23*



AT

186

Returned  
to  
Duty

Deserted

Discharged  
from  
Service

Sent to  
General  
Hospital

On Furlough

DIED

REMARKS

*Nov. 30*

---

**MICROCOPY**

**19003**

**ROLL**

**40**

---

IMAGE EVALUATION  
TEST TARGET (QA-3)

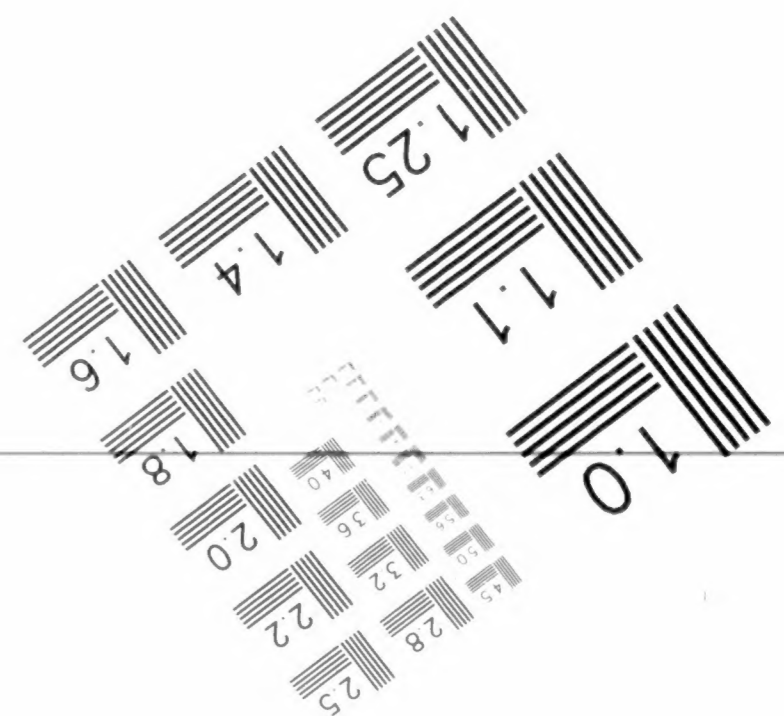
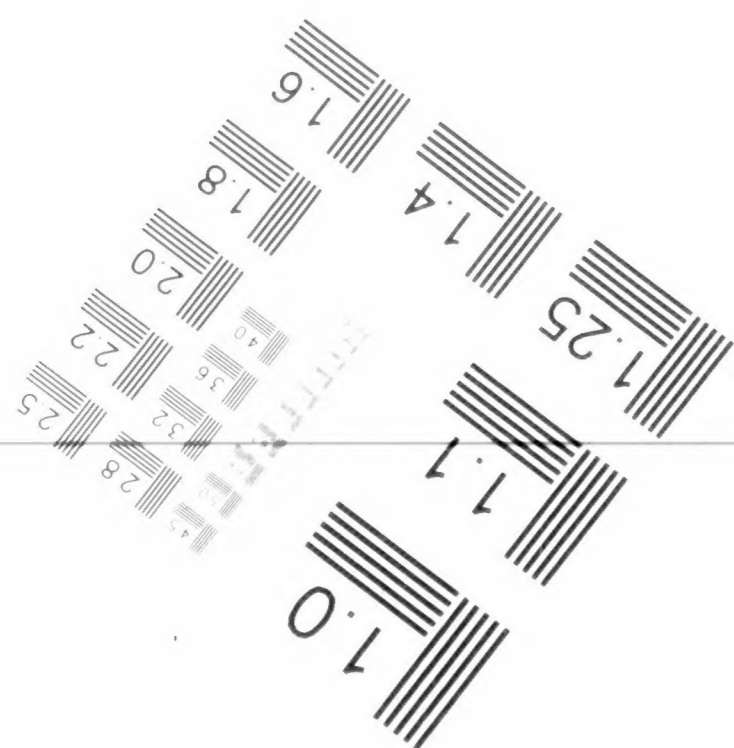
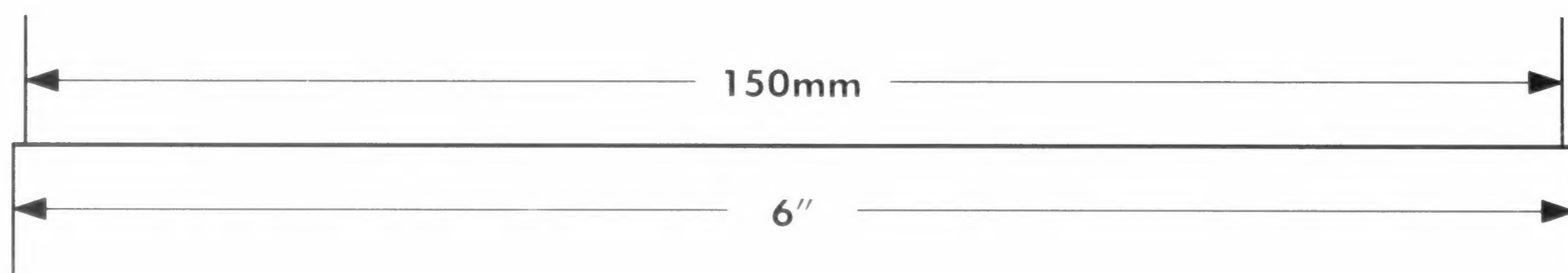
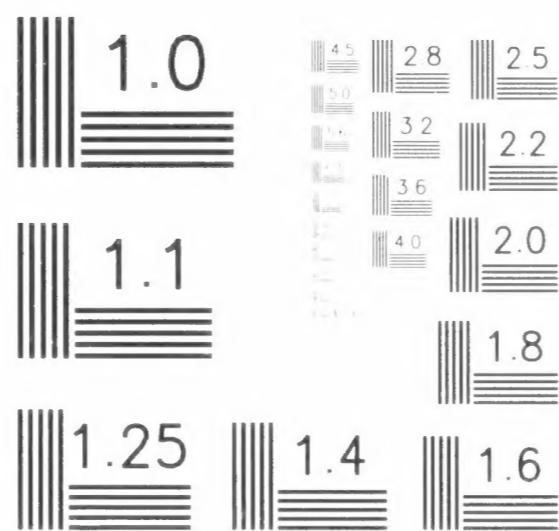
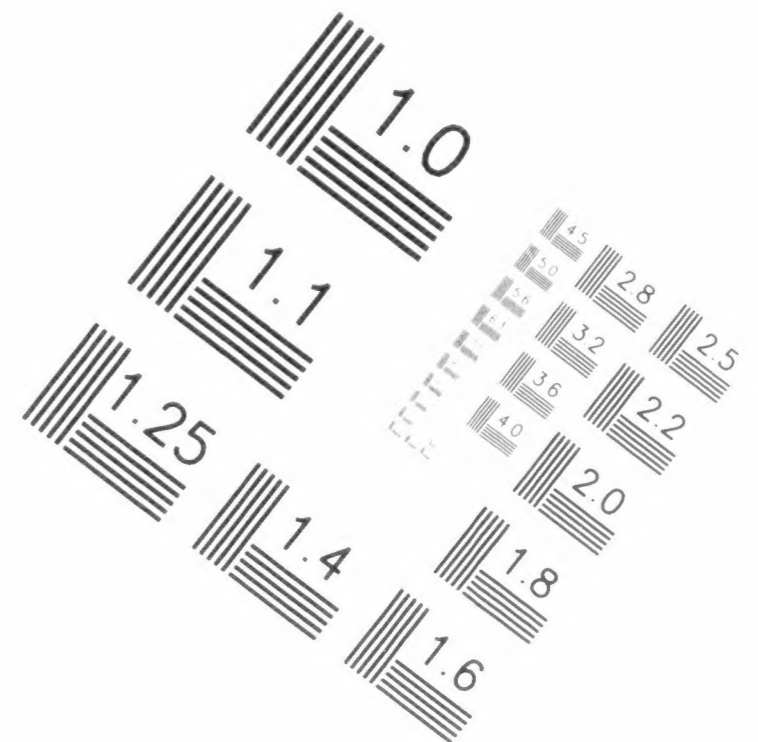
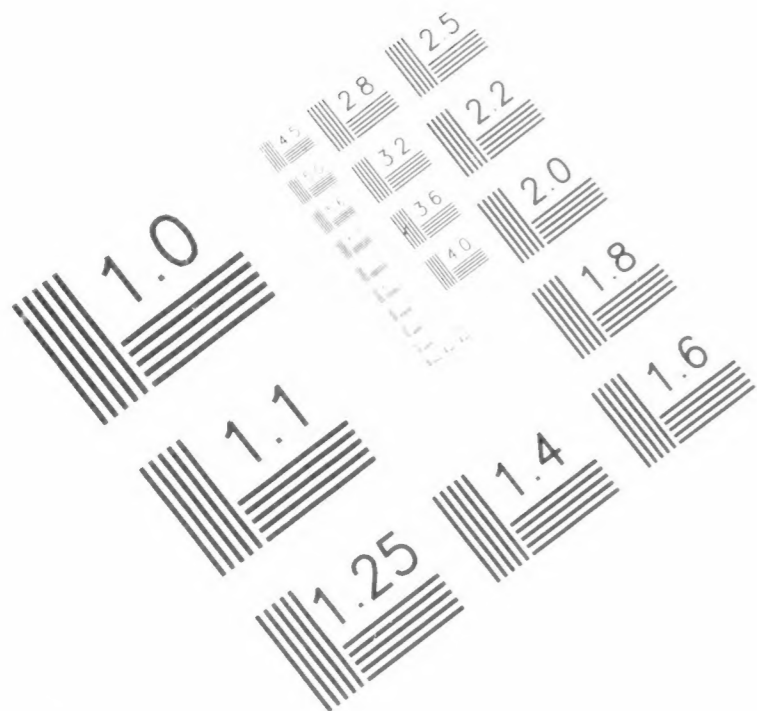

APPLIED IMAGE, Inc  
1653 East Main Street  
Rochester, NY 14609 USA  
Phone: 716/482-0300  
Fax: 716/288-5989

© 1993, Applied Image, Inc., All Rights Reserved

**END OF ROLL**

**PLEASE**

**REWIND**

