









# IMAGE EVALUATION TEST TARGET (QA-3)

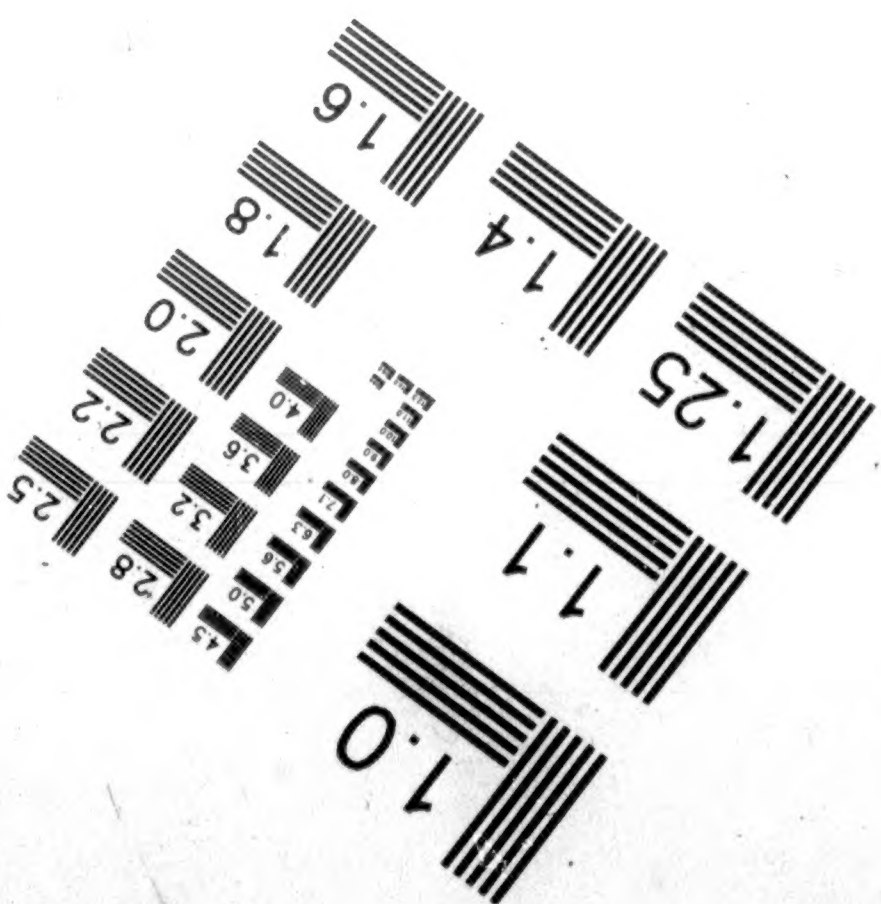
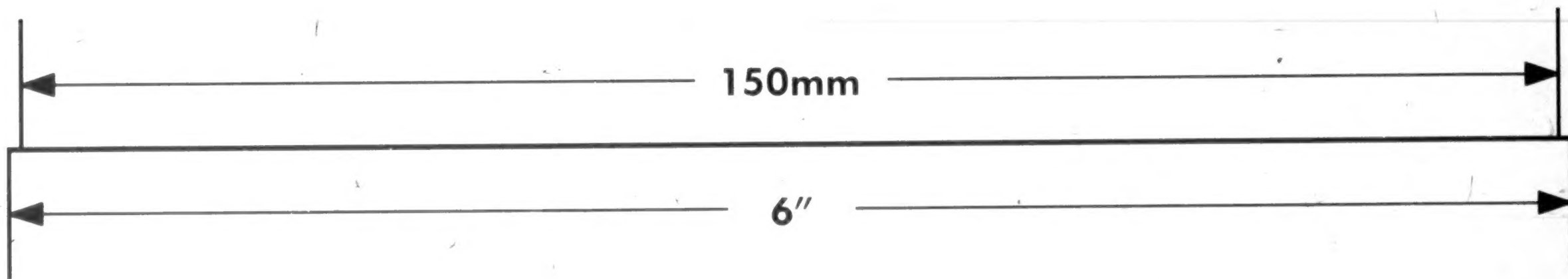
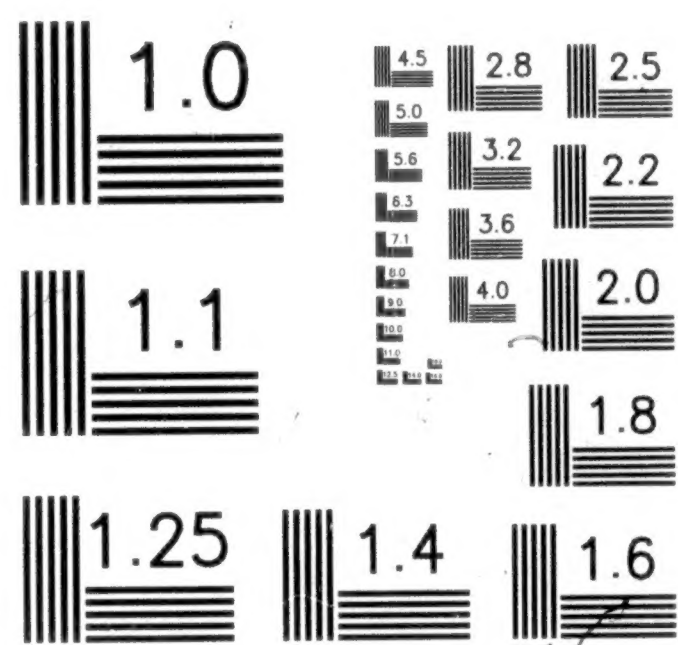
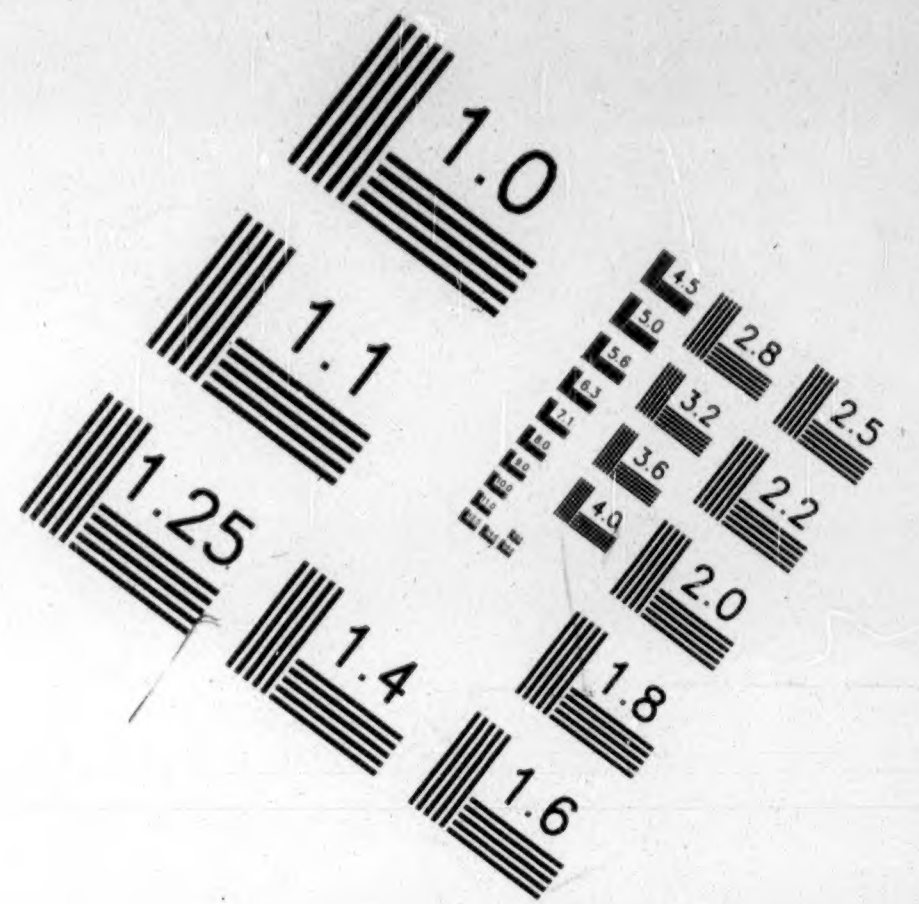
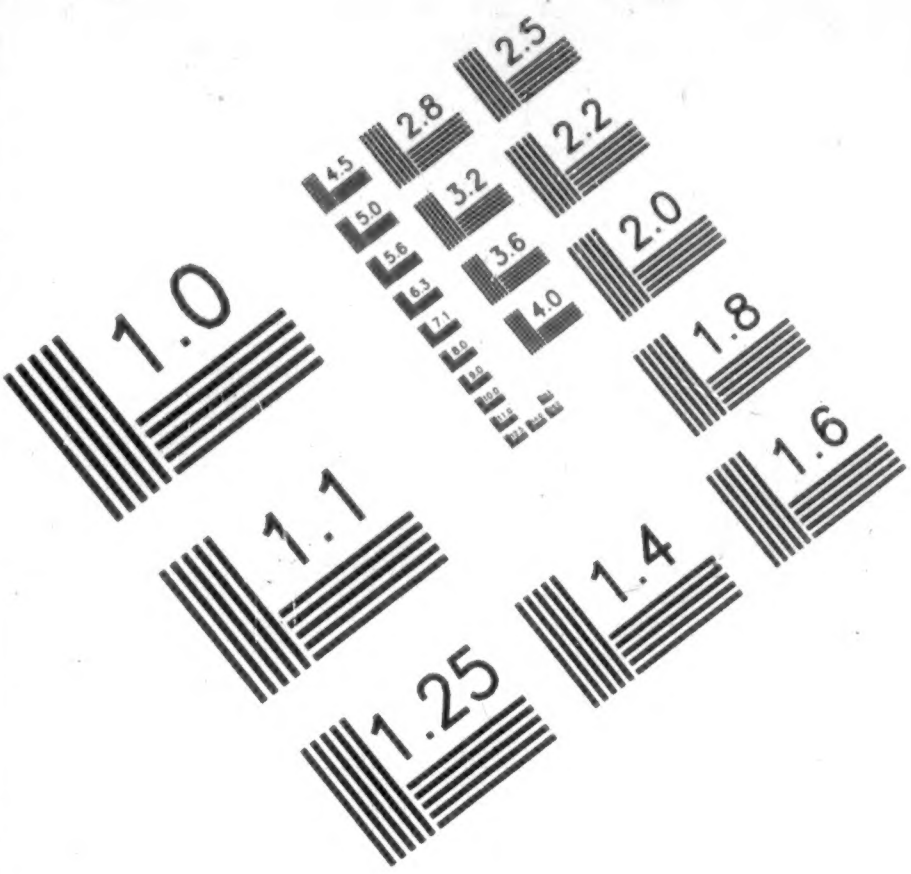

**APPLIED IMAGE, Inc**  
 1653 East Main Street  
 Rochester, NY 14609 USA  
 Phone: 716/482-0300  
 Fax: 716/288-5989

© 1993, Applied Image, Inc., All Rights Reserved

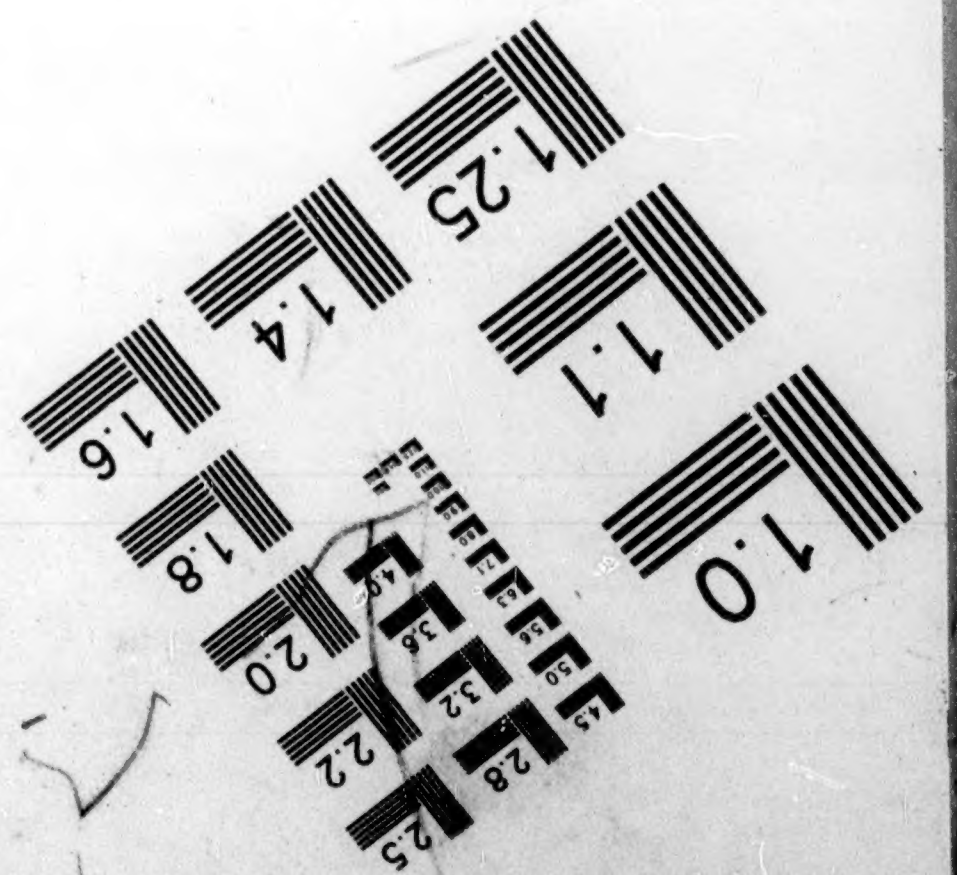



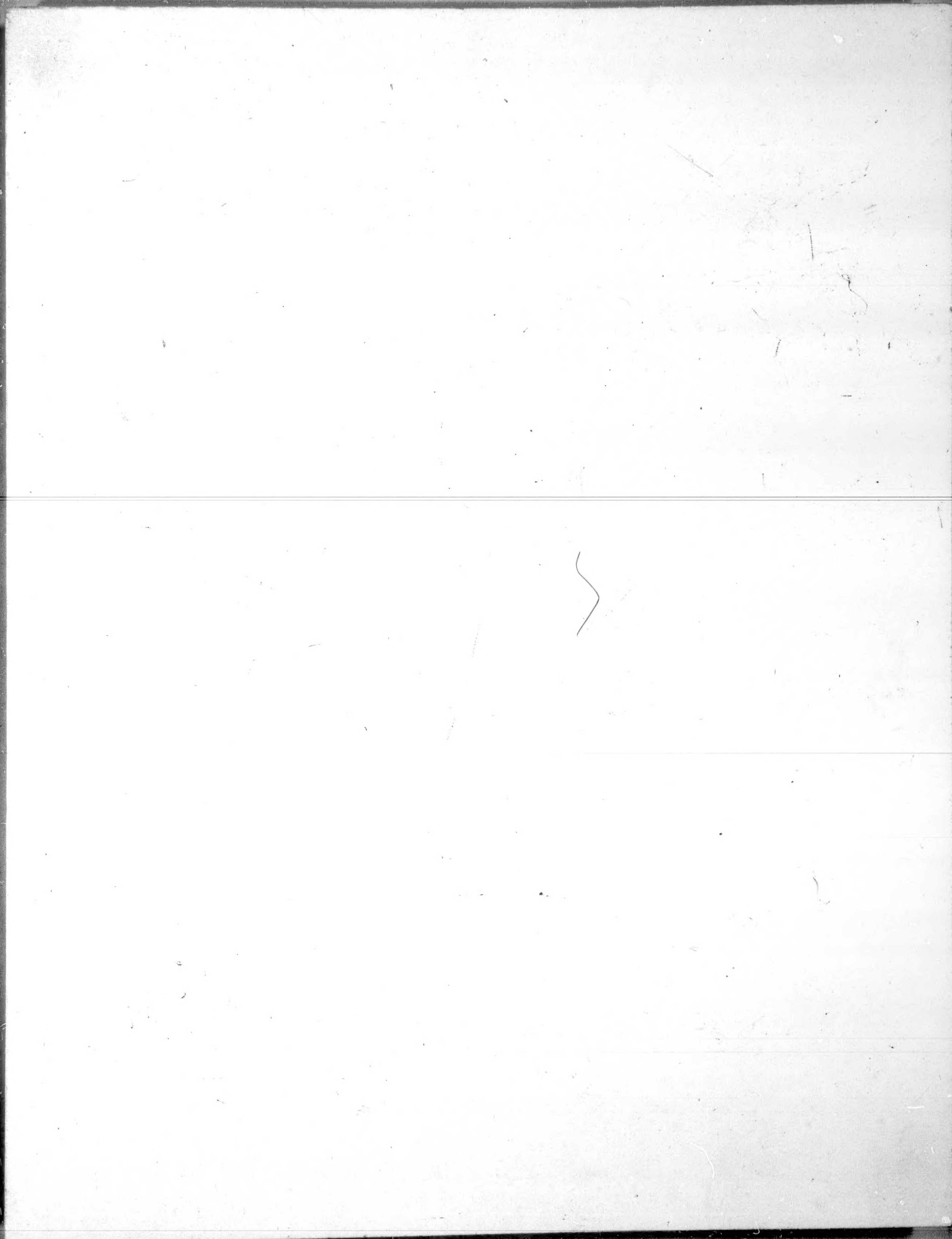





MICROFILMED BY  
THE NATIONAL ARCHIVES  
8601 ADELPHI ROAD  
COLLEGE PARK, MD 20740

Z 11

OPERATOR

M. F. WISE

DATE FILMED

REDUCTION RATIO

3-18-4 / 10X

FILM EMULSION NUMBER

246 0906 014 01

PROJECT NUMBER

ROLL NUMBER

M1905 103



MICROCOPY

M 1 9 0 5

ROLL

1 0 3



NATIONAL ARCHIVES AND RECORDS ADMINISTRATION  
MICROFILM PUBLICATIONS

M1905

RECORDS OF THE FIELD OFFICES FOR THE STATE OF LOUISIANA,  
BUREAU OF REFUGEES, FREEDMEN, AND ABANDONED LANDS,  
1863-1872

United States Congress  
and  
National Archives and Records Administration  
Washington, DC  
2004



NATIONAL ARCHIVES AND RECORDS ADMINISTRATION  
MICROFILM PUBLICATIONS

NATIONAL ARCHIVES AND RECORD ADMINISTRATION  
FREEDMEN'S BUREAU PRESERVATION PROJECT

This National Archives microfilm publication is part of a multiyear project to microfilm the field office records of the Bureau of Refugees, Freedmen, and Abandoned Lands (Freedmen's Bureau). The project was made possible by the United States Congress through The Freedmen's Bureau Records Preservation Act of 2000 (Public Law 106-444). When completed, all of the field records for the States of Alabama, Arkansas, Delaware, Florida, Georgia, Kentucky, Louisiana, Maryland, Mississippi, Missouri, North Carolina, South Carolina, Tennessee, Texas, Virginia, and for the District of Columbia will be available on microfilm. For microfilm availability and description, view both the microfilm catalog *Black Studies: A Select Catalog of National Archives Microfilm Publications* and the National Archives microfilm locator on our web site at [www.archives.gov](http://www.archives.gov).

Acknowledgments

Lucile Allen	Gail Harriman	Kathy Miller
Miranda Booker	Paul Harrison	Allison Olson
Tia Briscoe	Allen Johnson	Elizabeth Rydzewski
Jackie Budell	Hilary Kaplan	Clarence J. Simmons
Carlita Earl	Brenda Kepley	Michael Tucker
Jane Fitzgerald	M. Marie Maxwell	Reginald Washington*
Raymond Glover	Linda McGreevy	Marlon Wise
Benjamin Guterman**	Douglas McRae	

Civil War Conservation Corps (CWCC) Volunteers  
Directed by Budge Weidman and Russ Weidman

\* Reginald Washington wrote the introductory materials.

\*\* Benjamin Guterman edited the introductory materials.



NATIONAL ARCHIVES AND RECORDS ADMINISTRATION  
MICROFILM PUBLICATIONS

**INTRODUCTION**

On the 111 rolls of this microfilm publication, M1905, are reproduced the records of the staff officers of the Assistant Commissioner and the subordinate field offices of the Louisiana headquarters of the Bureau of Refugees, Freedmen, and Abandoned Lands, 1863-1872. These records consist of bound volumes and unbound records containing materials that include letters sent and received, monthly reports, registers of complaints, labor contracts, and other records relating to freedmen's claims and bounty payments. These records are part of the Records of the Bureau of Refugees, Freedmen, and Abandoned Lands, Record Group (RG) 105.

**HISTORY AND ORGANIZATION**

The Bureau of Refugees, Freedmen, and Abandoned Lands, also known as the Freedmen's Bureau, was established in the War Department by an act of Congress on March 3, 1865 (13 Stat. 507). The life of the Bureau was extended twice by acts of July 16, 1866 (14 Stat. 173), and July 6, 1868 (15 Stat. 83). The Bureau was responsible for the supervision and management of all matters relating to refugees and freedmen, and of lands abandoned or seized during the Civil War. In May 1865, President Andrew Johnson appointed Maj. Gen. Oliver Otis Howard as Commissioner of the Bureau, and Howard served in that position until June 30, 1872, when activities of the Bureau were terminated in accordance with an act of June 10, 1872 (17 Stat. 366). While a major part of the Bureau's early activities involved the supervision of abandoned and confiscated property, its mission was to provide relief and help freedmen become self-sufficient. Bureau officials issued rations and clothing, operated hospitals and refugee camps, and supervised labor contracts. In addition, the Bureau managed apprenticeship disputes and complaints, assisted benevolent societies in the establishment of schools, helped freedmen in legalizing marriages entered into during slavery, and provided transportation to refugees and freedmen who were attempting to reunite with their family or relocate to other parts of the country. The Bureau also helped black soldiers, sailors, and their heirs collect bounty claims, pensions, and back pay.

The act of March 3, 1865, authorized the appointment of Assistant Commissioners to aid the Commissioner in supervising the work of the Bureau in the former Confederate states, the border states, and the District of Columbia. While the work performed by Assistant Commissioners in each state was similar, the organizational structure of staff officers varied from state to state. At various times, the staff could consist of a superintendent of education, an assistant adjutant general, an assistant inspector general, a disbursing officer, a chief medical officer, a chief quartermaster, and a commissary of subsistence. Subordinate to these officers were the assistant superintendents, or subassistant commissioners as they later became known, who commanded the subdistricts.



NATIONAL ARCHIVES AND RECORDS ADMINISTRATION  
MICROFILM PUBLICATIONS

The Assistant Commissioner corresponded extensively with both his superior in the Washington Bureau headquarters and his subordinate officers in the subdistricts. Based upon reports submitted to him by the subassistant commissioners and other subordinate staff officers, he prepared reports that he sent to the Commissioner concerning Bureau activities in areas under his jurisdiction. The Assistant Commissioner also received letters from freedmen, local white citizens, state officials, and other non-Bureau personnel. These letters varied in nature from complaints to applications for jobs in the Bureau. Because the assistant adjutant general handled much of the mail for the Assistant Commissioner's office, it was often addressed to him instead of to the Assistant Commissioner.

In a circular issued by Commissioner Howard in July 1865, the Assistant Commissioners were instructed to designate one officer in each state to serve as "general Superintendents of Schools." These officials were to "take cognizance of all that is being done to educate refugees and freedmen, secure proper protection to schools and teachers, promote method and efficiency, correspond with the benevolent agencies which are supplying his field, and aid the Assistant Commissioner in making his required reports." In October 1865, a degree of centralized control was established over Bureau educational activities in the states when Rev. John W. Alvord was appointed Inspector of Finances and Schools. In January 1867, Alvord was divested of his financial responsibilities, and he was appointed General Superintendent of Education.

An act of Congress, approved July 25, 1868 (15 Stat. 193), ordered that the Commissioner of the Bureau "shall, on the first day of January next, cause the said bureau to be withdrawn from the several States within which said bureau has acted and its operation shall be discontinued." Consequently, in early 1869, with the exception of the superintendents of education and the claims agents, the Assistant Commissioners and their subordinate officers were withdrawn from the states.

For the next year and a half the Bureau continued to pursue its education work and to process claims. In the summer of 1870, the superintendents of education were withdrawn from the states, and the headquarters staff was greatly reduced. From that time until the Bureau was abolished by an act of Congress approved June 10, 1872 (17 Stat. 366), effective June 30, 1872, the Bureau's functions related almost exclusively to the disposition of claims. The Bureau's records and remaining functions were then transferred to the Freedmen's Branch in the office of the Adjutant General. The records of this branch are among the Bureau's files.

#### THE FREEDMEN'S BUREAU IN LOUISIANA

##### ORGANIZATION

On June 13, 1865, Commissioner Oliver Otis Howard appointed Chaplain Thomas W. Conway as the Assistant Commissioner for Louisiana. At the time of his appointment, Conway headed the military's Louisiana Bureau of Free Labor, which



NATIONAL ARCHIVES AND RECORDS ADMINISTRATION  
MICROFILM PUBLICATIONS

managed the affairs of freedmen employed on "abandoned" plantations. Conway transferred the Bureau of Free Labor to the newly established Freedmen's Bureau Louisiana headquarters at New Orleans. The parishes of Madison, Carroll, Concordia, and Tenasas in northeastern Louisiana were reassigned in January 1866 from the jurisdiction of the Assistant Commissioner for Mississippi to that of the Assistant Commissioner for Louisiana. The other Assistant Commissioners or Acting Assistant Commissioners in Louisiana and their terms of office were Gen. James S. Fullerton, October 4-18, 1865; Gen. Absalom Baird, October 19, 1865-September 1866; Gen. Philip H. Sheridan, October 5-November 27, 1866; Gen. Joseph A. Mower, November 28, 1866-December 4, 1867; Lt. Col. William H. Wood, December 5, 1867-January 2, 1868; Gen. R. C. Buchanan, January 3-August 24, 1868; and Gen. Edward Hatch, August 25, 1868-January 1, 1869.

When Conway took over as Assistant Commissioner, the state was divided into districts that were composed of one to three parishes and commanded by either an agent or superintendent. In April 1867, the state was reorganized into seven subdistricts headed by subassistant commissioners. Subassistant commissioners were required to file monthly inspection reports of their respective jurisdictions with the Assistant Commissioner. Agents or assistant subassistant commissioners, who were responsible for one to two parishes, received their instructions from and reported to subassistant commissioners. The major subordinate field offices for the Bureau in Louisiana included those with headquarters at Baton Rouge, Franklin, Monroe, Natchitoches, New Orleans, Shreveport, and Vidalia. For a list of known Louisiana subordinate field office personnel and their dates of service, see the appendix.

#### ACTIVITIES

The major activities of the Freedmen's Bureau field office in Louisiana generally resembled those conducted in other states. The Bureau provided various forms of relief to both freedmen and white refugees, supervised labor contracts, assisted freedmen in the establishment of schools, administered justice, helped freedmen locate land, and assisted blacks with military claims for back pay, bounty payments, and pensions.

Between June and September 1865, the Bureau in Louisiana issued some 455,290 rations to destitute freedmen and 157,691 to white refugees. With no appropriated funds from Congress, the Bureau relied on several sources to carry out these activities: income from confiscated property, requisitioned supplies from the army, aid from benevolent societies, and a three-dollar tax on black adult laborers. Despite the Bureau's efforts, however, tens of thousands of freedmen and refugees remained in dire straits throughout the state. The lack of available funds, continuous flooding, crop failures, and disease severely hampered the Bureau's relief programs. On March 30, 1867, Congress appropriated monies for a "special relief fund" (15 Stat. 28). The fund authorized the Secretary of War, through the Freedmen's Bureau, to issue provisions and rations to destitute persons in Southern states, including Louisiana.



NATIONAL ARCHIVES AND RECORDS ADMINISTRATION  
MICROFILM PUBLICATIONS

In response to the act, Commissioner Howard issued a circular on April 3, 1867 (Circular Number 11), that set aside \$500,000 for the purpose.<sup>1</sup>

The agency maintained homes for refugees and orphans. Hundreds of refugees were housed in two hotels in New Orleans (the Commercial and the Western Verandah) and later the Marine Hospital. While most of the residents were from Louisiana, some were from Texas, Florida, Kentucky, Mississippi, Alabama, and Tennessee. Beginning in 1865, the Bureau provided assistance to several privately run orphan asylums in New Orleans and other areas of the state until its work for orphans was discontinued in September 1865. The Bureau also provided medical aid to freedmen and white refugees. In 1866, to help combat such diseases as cholera, yellow fever, and smallpox, seven doctors, on average, served under the Bureau in Louisiana: five at the New Orleans hospital and one at both the Shreveport hospital and the Rost Home Colony. The Bureau also maintained numerous dispensaries throughout the state. In spite of the closure of the Rost Home Colony hospital and most of the Bureau's dispensaries by the end of 1867, the agency in 1868 treated more than 8,500 freedmen for various infectious diseases. At the Rost Home Colony—one of the most successful of the four "home colonies" established in Louisiana—Bureau officials also issued rations and clothing, established a school, provided employment, and compiled a variety of personal data about individuals who arrived and departed from the Colony. Both the New Orleans and the Shreveport hospitals maintained registers of patients and the sick and wounded.<sup>2</sup>

The regulation of written labor agreements between planters and freedmen was a major concern of the Freedmen's Bureau. In a circular issued on December 4, 1865 (Circular Number 29), Bureau officials in Louisiana outlined the rules governing the free labor system in the state. Freedmen could choose their employers, and all contracts were to be approved by a Bureau agent. Wages were not set, but the circular declared that it was the freedmen's "duty" to "obtain the best terms they can for their labor." Freedmen were required to work 26 days per month, consisting of 10-hour days in the summer and 9-hour days in the winter. Any work time exceeding 6 hours beyond the normal workday would constitute an additional day's work. In addition to wages, freedmen were also entitled to receive rations, clothing, "comfortable" living quarters, and medical attention, and each family was to receive a half-acre plot to maintain a garden. Five percent of the freedman's monthly wages was to be retained by the employer for the purpose of sustaining schools for the freedman's children. In cases where freedmen desired to work for a share of the crop, employers were required to have sufficient amounts of provisions available for

<sup>1</sup> Howard A. White, *The Freedmen's Bureau in Louisiana* (Baton Rouge: Louisiana State University Press, 1970), 64–76.

<sup>2</sup> *Ibid.*, 76–85; For a discussion of the establishment and activities at Rost Home Colony, see Michael F. Knight, "The Rost Home Colony: St. Charles Parish, Louisiana," *Prologue* 33, no. 1 (Fall 2001): 214–220; Records relating to the Freedmen's hospital at New Orleans have been reproduced on *Records of the New Orleans Field Offices, Bureau of Refugees, Freedmen, and Abandoned Lands, 1865–1869* (National Archives Microfilm Publication M1483, rolls 1–7); For Shreveport hospital records, see roll 101 in this publication.



NATIONAL ARCHIVES AND RECORDS ADMINISTRATION  
MICROFILM PUBLICATIONS

freedmen and their families each month. Also, employers who entered into share agreements were obligated to pay Bureau agents 1/20 of the amount of the freedmen's share of the crop each month for the benefit of freedmen schools.<sup>3</sup>

In the two years following the April 1862 occupation of New Orleans by Union troops, various civilian and military organizations established schools to educate freedmen in Louisiana. Gen. Nathaniel Banks's order of March 22, 1864 (Department of the Gulf General Order 38), established a board of education to govern the organization of freedmen's schools. B. Rush Plumly was appointed head of the board, and Lt. Edwin M. Wheelock became supervisor. Schools under the board's jurisdiction were supported mainly by a tax on citizens recently disloyal to the Union. On June 29, 1865, Assistant Commissioner Conway took charge of the schools, and on July 5, 1865, replaced Plumly and Wheelock with Capt. H. R. Pease as superintendent of education. Pease's successors included Bvt. Maj. A. G. Studer, Lt. F. R. Chase, J. M. Lee, L. O. Parker, H. H. Pierce, and E. W. Mason.

Pease divided the state into seven school districts, placing military and civilian personnel in charge. Under these officers were school directors responsible for each parish and "canvassers" who collected the school tax for each district. At the time of his arrival, there were some 126 freedmen schools, with 230 teachers and approximately 19,000 students. However, with limited funds and intense opposition to the school tax, Circular Number 34, dated December 27, 1865, directed that all schools be "suspended until such time as it may be found practicable to re-establish them on a permanent and self-supporting basis."<sup>4</sup>

In February 1866, then-Assistant Commissioner Baird sought to make schools self-supporting through a tuition plan. Despite Baird's new plan and congressional appropriations of 1866 and 1867 for freedmen education in the South, the Freedmen's Bureau's educational programs in Louisiana continued to face financial difficulties. In June 1868, Congress authorized the Bureau to sell school buildings to private groups that were willing to maintain freedmen schools, and the Bureau entered into cooperative agreements with such groups as the American Missionary Society, the Methodist Freedmen's Aid Society, and the Free Mission Baptists. Under the agreements, the Bureau provided monies for construction of the school buildings, and the religious organizations maintained the schools. In 1870, the cooperation between the Bureau and religious groups led to significant progress in the establishment of numerous freedmen schools in Louisiana. Despite their efforts however, freedmen schools continued to suffer from the effects of limited resources, lack of competent teachers, and a segregated school system.<sup>5</sup>

<sup>3</sup> House Ex. Doc. 70, 39th Cong., 1st Sess. Serial vol. 1256, pp. 30-33.

<sup>4</sup> White, *The Freedmen's Bureau in Louisiana*, pp. 166-175; See also House Ex. Doc. 70, 39th Cong., 1st Sess., Serial vol. 1256, pp. 35-36.

<sup>5</sup> White, *The Freedmen's Bureau in Louisiana*, 176-200.



NATIONAL ARCHIVES AND RECORDS ADMINISTRATION  
MICROFILM PUBLICATIONS

Safeguarding rights and securing justice for freedmen was of paramount concern to the Freedmen's Bureau. Following the Civil War, several Southern states enacted a series of laws, commonly known as "black codes," that restricted the rights and legal status of freedmen. Freedmen were often given harsh sentences for petty crimes, and in some instances were unable to get their cases heard in state courts. Assistant Commissioners were directed to "adjudicate, either themselves or through officers of their appointment, all difficulties arising between negroes themselves, or between negroes and whites or Indians."<sup>6</sup> Assistant Commissioner Conway issued Circular Number 15 (September 15, 1865), authorizing his subordinates to establish freedmen courts in cases where freedmen were not receiving just treatment. Conway's successors—Fullerton, Baird, and Sheridan—believed that civil officers in most parishes administered justice impartially in freedmen cases, and so abolished the special tribunals as unnecessary. Nevertheless, Bureau officers were still required to represent freedmen in court cases and refer the most extreme cases of injustice to United States courts. In the latter part of 1866, fearing that freedmen's rights were not being adequately protected, Assistant Commissioner Joseph Mower re-instituted some Bureau judicial functions that had been previously suspended by his predecessors. William H. Wood, who succeeded Mower, told Bureau agents during his tenure that only in cases where the evidence clearly showed the civil court's failure to administer justice, were they to become involved. Wood's replacement, Gen. Robert C. Buchanan, like Fullerton, Baird, and Sheridan, continued the policy of leaving matters of justice to civil authorities. By the time Gen. Edward Hatch assumed office as Assistant Commissioner in 1868, Louisiana had restored its constitutional relations with the Federal Government, and matters concerning justice were returned to the state.<sup>7</sup>

The Southern Homestead Act (14 Stat. 66), approved by Congress on June 21, 1866, made available for public settlement 46 million acres of public lands in Alabama, Arkansas, Florida, Louisiana, and Mississippi. Six million acres of this Federal land was located in Louisiana. The act specifically prohibited discrimination against applicants due to race, and thus offered Louisiana freedmen and others an opportunity to become landowners. Only persons who headed households or were former United States soldiers were eligible to apply. A five-dollar application fee was required of all applicants, which allowed them to settle on an 80-acre tract and gain permanent possession after five years of cultivation. Generally, the Freedmen's Bureau, through "locating agents," assisted interested freedmen in finding plots, and provided them with one-month subsistence, free transportation to their prospective tracts of land, and seeds for initial planting. By January 1867, J. J. Saville, as locating agent, found homesteads for 87 freedmen, 73 whites, and 14 soldiers. However, because the New Orleans land office was closed, only 7 were able to file applications. While limited resources and the lack of suitable lands for settlement hindered freedmen in their effort to acquire land, freedmen also faced intense opposition from whites who opposed black land ownership. Freedmen were thus

<sup>6</sup> House Ex. Doc. 11, 39th Cong., 1st Sess., Serial vol. 1255, pp. 45-46.

<sup>7</sup> White, *The Freedmen's Bureau in Louisiana*, 134-165.



NATIONAL ARCHIVES AND RECORDS ADMINISTRATION  
MICROFILM PUBLICATIONS

encouraged by Bureau officials in Louisiana to settle on land in large numbers in order to protect themselves from intense opposition by whites.<sup>8</sup>

An act of Congress on June 14, 1864, authorized the payment of bounties, not to exceed \$100, to black soldiers who had entered the military after June 15, 1864, and who were free on April 19, 1861 (14 Stat. 126). Amendments in 1866 dropped the requirement of freedom at enlistment and offered additional bounties of \$100 for those blacks who had signed on for three years, and \$50 for individuals who enlisted for two years. To assist black soldiers and their heirs in filing bounty and other military claims against the Federal Government, a claims agency was initially established in the United States Sanitary Commission. On July 14, 1865, Commissioner Howard authorized Freedmen's Bureau officials to act as agents of the Commission and to assist it in filing for black military claims. However, freedmen often rejected the free services of the agency and paid fees to private claims agents, believing that they would receive their money quicker. In 1867, concerned about abuse and fraud in the settlement of black military claims, Congress passed a law making the Freedmen's Bureau the sole agent for payment of claims of black veterans (15 Stat. 26). From October 31, 1866, through September 30, 1867, the Bureau in Louisiana settled claims amounting to just \$1,489.73. However, one year later, 240 veterans' claims amounting to \$52,058 were settled, with 484 remaining to be resolved.<sup>9</sup>

**RECORDS DESCRIPTION**

These records consist of volumes and unbound records. The volumes reproduced in this microfilm publication were originally arranged by type of record and thereunder by volume number. All volumes were assigned numbers by the Adjutant General's Office (AGO) of the War Department after the records came into its custody. In this microfilm publication, AGO numbers are shown in parentheses to aid in identifying the volumes. The National Archives assigned the volume numbers that are not in parentheses. No numbers were assigned to series consisting of single volumes. In some volumes, particularly in indexes and alphabetical headings of registers, there are blank numbered pages that have not been filmed.

The volumes consist of letters and endorsements sent and received, press copies of letters sent, registers of letters received, letters and orders received, registers of freedmen court cases, special orders and circulars issued, registers of claimants, registers of complaints, marriage certificates, and monthly reports forwarded to the Assistant Commissioner. The unbound documents consist of letters and orders

---

<sup>8</sup> Ibid., 59-63.

<sup>9</sup> Howard A. White, *The Freedmen's Bureau in Louisiana*, pp. 160-162; See also, Annual Reports of the Assistant Commissioners, Louisiana, October 5, 1868 [pp. 19-20], Records of the Office of the Commissioner, Record Group 105, National Archives Building, Washington, DC.



NATIONAL ARCHIVES AND RECORDS ADMINISTRATION  
MICROFILM PUBLICATIONS

received, unregistered letters and narrative reports received, special orders and circulars issued, and general orders and circulars received. The unbound records also contain monthly reports, labor contracts, marriage certificates, and records relating to claims.

Some of the volumes contain more than one type of record, reflecting a common recording practice of clerks and staff officers of that period. On roll 67, for example, the volume of applications for laborers for Bragg Home Colony also contains a register of complaints. Some other examples of additional series within volumes can be found in records on rolls 72, 78, and others. Researchers should read carefully the records descriptions and arrangements in the table of contents to make full use of these documents.

**RELATED RECORDS**

In the same record group, RG 105, and related to records of the Bureau's field offices for Louisiana, are those of the Bureau headquarters in Washington, DC, and previously microfilmed records of the Assistant Commissioner and the superintendent of education for Louisiana. These record series are available in the following National Archives microfilm publications:

***M742, Selected Series of Records Issued by the Commissioner of the Bureau of Refugees, Freedmen, and Abandoned Lands, 1865-1872***

***M752, Registers and Letters Received by the Commissioner of the Bureau of Refugees, Freedmen, and Abandoned Lands, 1865-1872***

***M1027, Records of the Assistant Commissioner for the State of Louisiana, Bureau of Refugees, Freedmen, and Abandoned Lands, 1865-1869***

***M1026, Records of the Superintendent of Education for the State of Louisiana, Bureau of Refugees, Freedmen, and Abandoned Lands, 1864-1869***

***M1483, Records of the New Orleans Field Offices, Bureau of Refugees, Freedmen, and Abandoned Lands, 1865-1869***

***M826, Records of the Assistant Commissioner for the State of Mississippi, Bureau of Refugees, Freedmen, and Abandoned Lands, 1865-1869***

***M1875, Marriage Records of the Office of the Commissioner, Washington Headquarters of the Bureau of Refugees, Freedmen, and Abandoned Lands, 1861-1869***

NATIONAL ARCHIVES AND RECORDS ADMINISTRATION  
M I C R O F I L M P U B L I C A T I O N S

Records in other National Archives record groups supplement those of the Assistant Commissioner. In Records of United States Army Continental Commands, 1821-1920, RG 393, are records of the military district that included Louisiana. Records relating to employment and welfare of freedmen and abandoned property before the establishment of the Bureau are among Records of Civil War Special Agencies of the Treasury Department, RG 366. The records of the Freedman's Savings and Trust Company, 1865-1874, in Records of the Office of the Comptroller of the Currency, RG 101, contain information relating to former slaves who maintained accounts with bank branches in Louisiana.



NATIONAL ARCHIVES AND RECORDS ADMINISTRATION  
M I C R O F I L M P U B L I C A T I O N S

**APPENDIX**

This list provides the names and dates of service of known Freedmen's Bureau personnel at the Plantation Department and selected subordinate field offices in Louisiana. Where noted, officers served at two locations. Additional information regarding persons assigned to various field offices might be found among the Bureau's Washington headquarters station books and rosters of military officers and civilians on duty in the states and other appointment-related records.

LOCATION	DATES
<b>PLANTATION DEPARTMENT</b>	
<b>Superintendent</b>	
Capt. Frank Bagley	July 1865–May 1866
C. R. Stickney	May–Sept. 1866
<b>Assistant Quartermaster</b>	
W. B. Armstrong	Oct. 1866–June 1867
<b>ABBEVILLE</b>	
<b>Assistant Subassistant Commissioner</b>	
A. N. Murtagh	Apr. 1867–June 1868
<b>ALEXANDRIA</b>	
<b>Assistant Superintendent</b>	
S. G. Williams	June 1866–Apr. 1867
<b>Assistant Subassistant Commissioner</b>	
S. G. Williams	May–Nov. 1867
George Buttrick	Nov. 1867–June 1868
H. P. Hathaway	June–Dec. 1868
<b>ALGIERS</b>	
<b>Provost Marshal of Freedmen</b>	
William E. Dougherty	May 1865–Apr. 1866
<b>Agent</b>	
Richard Folles	May 1866–Apr. 1867
<b>Assistant Subassistant Commissioner</b>	
Richard Folles	Apr. 1867–Oct. 1868
Isaac Stathem	Oct.–Dec. 1868
<b>AMITE</b>	
<b>Assistant Superintendent</b>	
H. H. Rouse	Sept.–Dec. 1865
Edward Ehrlich	Dec. 1865–Feb. 1866
W. K. Tillotson	Feb.–Apr. 1866
James Hough	Apr.–Nov. 1866
<b>Assistant Subassistant Commissioner</b>	
James Hough	Nov. 1866–May 1868
George F. Austin	May–Nov. 1868
Joseph D. Buckley	Nov.–Dec. 1868

NATIONAL ARCHIVES AND RECORDS ADMINISTRATION  
MICROFILM PUBLICATIONS

LOCATION	DATES
<b>BATON ROUGE</b>	
<b>Subassistant Commissioner of the 2nd Subdistrict</b>	
George F. Schager	May-June 1867
William H. Webster	July 1867-Jan. 1868
Frank D. Garretty	Jan.-June 1868
Charles Hill	July-Dec. 1868
<b>BATON ROUGE</b>	
<b>Agent</b>	
M. J. Sheridan	Feb.-Apr. 1866
E. C. Phetteplace	July 1866
Abner Doane	Oct. 1866
William H. Webster	Jan.-May 1867
<b>Assistant Subassistant Commissioner</b>	
William H. Webster	May 1867-Feb. 1868
George Inness	Feb.-June 1868
Charles Hill	June-July 1868
S.H.B. Schoonmaker	July-Nov. 1868
J. Woods Coleman	Nov.-Dec. 1868
<b>BAYOU SARA</b>	
<b>Agent</b>	
C. W. Hawes	Dec. 1865
A. H. Nickerson	Jan. 1865-May 1866
G. M. Ebert	May-Sept. 1866
Richard M. Leake	Sept.-Oct. 1866
Alexander M. Massie	Nov.-Dec. 1866
E. T. Lewis	Jan.-May 1867
<b>Assistant Subassistant Commissioner</b>	
E. T. Lewis	May-June 1867
A. Finch	June-Oct. 1867
A. Finch (also St. Francisville)	Oct. 1867-Mar. 1868
George C. Dunwell (also St. Francisville)	Mar.-May 1868
Robert M. Davis	May-Oct. 1868
F. W. Gibson (also St. Francisville)	Oct.-Dec. 1868
<b>BRASHEAR CITY (See Franklin)</b>	
<b>CARROLLTON</b>	
<b>Agent</b>	
Elijah Guion	Apr.-May 1867
<b>Assistant Subassistant Commissioner</b>	
J. J. Saville	May-Aug. 1867
George Bruning	Sept. 1867-May 1868
William Wright	May-Dec. 1868



**NATIONAL ARCHIVES AND RECORDS ADMINISTRATION**  
**M I C R O F I L M P U B L I C A T I O N S**

LOCATION	DATES
<b>CHOFIELD PLANTATION (See New Orleans)</b>	
<b>CLINTON</b>	
<b>Agent</b>	
A. W. Hayes	Feb. 1866
James DeGrey	May 1866–Apr. 1867
<b>Assistant Subassistant Commissioner</b>	
James DeGrey	Apr. 1867–May 1868
George C. Dunwell	May–July 1868
H. E. Barton	Aug.–Dec. 1868
<b>COLUMBIA</b>	
<b>Agent</b>	
William H. Webster	Feb.–Dec. 1866
William M. Todd	Dec. 1866–Apr. 1867
<b>Assistant Subassistant Commissioner</b>	
William M. Todd	Apr.–July 1867
E. J. Sullivan	Aug. 1867–June 1868
Charles De Lowenstrom	June–Dec. 1868
<b>COVINGTON (See Madisonville)</b>	
<b>DE CROS STATION (See Jesuits Bend)</b>	
<b>DONALDSONVILLE</b>	
<b>Agent</b>	
A. Milliken	Feb. 1866
St. Clair Mandeville	Mar.–June 1866
Henry Krause	June–July 1866
Alexander M. Massie	Aug.–Oct. 1866
<b>DONALDSONVILLE</b>	
<b>Agent</b>	
J. D. Rich (also St. James)	Mar. 1866
John H. Brough (also St. James)	Apr.–Oct. 1866
John H. Brough (also Donaldsonville)	Nov. 1866–Apr. 1867
<b>Assistant Subassistant Commissioner</b>	
John H. Brough	Apr. 1867–Sept. 1868
Victor Benthien	Sept.–Oct. 1868
James H. Dobie	Oct.–Dec. 1868
<b>EVERGREEN (See Marksville)</b>	
<b>FRANKLIN</b>	
<b>Subassistant Commissioner of the 3rd Subdistrict</b>	
S. W. Purchase	June–Dec. 1867
J. W. Keller	Dec. 1867–Jan. 1868
W. F. Lynch	Jan.–Feb. 1868
William H. Webster	Feb.–Nov. 1868
Victor Benthien	Nov.–Dec. 1868

NATIONAL ARCHIVES AND RECORDS ADMINISTRATION  
MICROFILM PUBLICATIONS

LOCATION	DATES
<b>FRANKLIN</b>	
<b>Provost Marshal</b>	
Sidney E. Shepard (also Brashear City)	Dec. 1864–July 1865
Sidney E. Shepard (also Franklin)	July–Sept. 1865
E. P. Bishop	Sept. 1865
Charles E. Merrill	Sept. 1865–Jan 1866
<b>Agent</b>	
Charles E. Merrill	Jan.–Apr. 1866
J. W. Keller	May 1866–Apr. 1867
<b>Assistant Subassistant Commissioner</b>	
J. W. Keller	Apr.–Dec. 1867
George C. Dunwell	Jan.–Feb. 1868
R. W. Mullen	Feb.–Oct. 1868
W. F. Loan	Oct.–Dec. 1868
<b>HAMMOND STATION</b>	
<b>Agent</b>	
James A. Hudson (also Springfield)	May–July 1866
<b>Assistant Subassistant Commissioner</b>	
Francis Garrett (also Hammond Station)	June–Oct. 1867
P. H. Murphy	Nov. 1867–Sept. 1868
<b>HOMER</b>	
<b>Assistant Subassistant Commissioner</b>	
William Stokes	Dec. 1867–Dec. 1868
<b>HOUMA</b>	
<b>Assistant Superintendent</b>	
George H. Harris	Dec. 1865–Jan. 1866
<b>Agent</b>	
Henry S. Wadsworth	Jan.–May 1866
George A. Ludlow	June 1866–Apr. 1867
<b>Assistant Subassistant Commissioner</b>	
George A. Ludlow	Apr.–Nov. 1867
William Woods	Dec. 1867–July 1868
M. W. Morris	July–Dec. 1868
<b>JEFFERSON CITY (See Carrollton)</b>	
<b>JESUITS BEND</b>	
<b>Provost Marshal</b>	
Silas Sawyer (also St. Bernard Parish)	Jan.–Apr. 1863
William Bragg	Aug.–Oct. 1864
Capt. George Breuning	Oct.–Nov. 1864
Lt. Charles Brooks	May 1864–July 1865
Charles W. Gardiner (also De Cros Station)	Sept.–Dec. 1865



NATIONAL ARCHIVES AND RECORDS ADMINISTRATION  
MICROFILM PUBLICATIONS

LOCATION	DATES
<b>JESUITS BEND (cont.)</b>	
<b>Agent</b>	
Charles W. Gardiner	Feb.-June 1866
George F. Schayer (also Aliance Plantation)	June 1866-Mar. 1867
George F. Schayer	Apr. 1867
<b>Assistant Subassistant Commissioner</b>	
Theodore Jaques	May-Oct. 1867
Edward S. Wilson	Dec. 1867-Jan. 1868
E. H. Hosner	Jan.-Aug. 1868
 <b>KENILWORTH PLANTATION (See New Orleans)</b>	
 <b>LABATUTS LANDING (See New Roads)</b>	
 <b>LAKE PROVIDENCE</b>	
<b>Agent</b>	
George W. Rollins	Jan. 1866-May 1867
<b>Assistant Subassistant Commissioner</b>	
George W. Rollins	May-Oct. 1867
Thomas H. Hannon	Oct. 1867-Jan. 1868
E. H. Masters	Jan.-Dec. 1868
 <b>MADISONVILLE</b>	
<b>Agent</b>	
A. J. Rose	Oct. 1866
W.H.R. Hangen	Nov. 1866-May 1867
<b>Assistant Subassistant Commissioner</b>	
W.H.R. Hangen	May 1867-Sept. 1868
W.H.R. Hangen (also Covington)	Sept.-Nov. 1868
Thomas H. Jenks, Jr. (also Covington)	Nov.-Dec. 1868
 <b>MANSFIELD</b>	
<b>Assistant Subassistant Commissioner</b>	
J. J. Walsh	Mar. 1867-May 1868
Michael Cary	May-Aug. 1868
Edward Henderson	Aug.-Dec. 1868
 <b>MARKSVILLE</b>	
<b>Agent</b>	
Amos S. Collins (also Evergreen)	Mar-Aug. 1866
Amos S. Collins (also Marksville)	Aug. 1866-May 1867
<b>Assistant Subassistant Commissioner</b>	
Amos S. Collins	May 1867-May 1868
Cyrus H. Ross	May-Dec. 1868

**NATIONAL ARCHIVES AND RECORDS ADMINISTRATION**  
**M I C R O F I L M P U B L I C A T I O N S**

LOCATION	DATES
<b>MERRITS PLANTATION (See New Orleans)</b>	
<b>MILLIKEN BEND</b>	
<b>Assistant Provost Marshal</b>	
D. McCall	May 1864
<b>Provost Marshal</b>	
Benjamin F. Cheney	Nov.-Dec. 1864
<b>Assistant Subassistant Commissioner</b>	
C. P. Varney	May-Sept. 1867
T. F. Cummins	Sept.-Dec. 1867
A. J. Baby	Jan.-Feb. 1868
John S. Shaw	Feb.-Dec. 1868
<b>MONROE</b>	
<b>Subassistant Commissioner of 5th Subdistrict</b>	
Samuel C. Gold and W. W. Webb	Mar. 1867-Aug. 1868
John H. Bowen	Aug.-Nov. 1868
<b>MONROE</b>	
<b>Assistant Superintendent</b>	
Frank Morey	Sept.-Oct 1865
<b>Agent</b>	
J. H. Wisner	Feb.-Mar. 1866
H. A. Pease	Apr. 1866
Joseph Burns	May 1866-Jan. 1867
Frank Morey	Feb.-June 1867
<b>Assistant Subassistant Commissioner</b>	
Charles C. Swenson	June-Nov. 1867
W. R. Wheyland	Nov. 1867-Apr. 1868
Edward K. Russ	Apr.-Aug. 1868
Edward K. Russ (also Trenton)	Aug.-Oct. 1868
H. L. Irwin (also Trenton)	Oct.-Dec. 1868
<b>MONTGOMERY</b>	
<b>Assistant Subassistant Commissioner</b>	
D. W. White	June 1867-Sept. 1868
<b>MOSSY FARM PLANTATION (See Trinity)</b>	
<b>NAPOLEONVILLE</b>	
<b>Provost Marshal</b>	
J. W. Greene	May-Nov. 1865
<b>Agent</b>	
Francis S. Dodge	Dec. 1865-Feb. 1866
A. C. Ellis	Feb. 1866-May 1867
<b>Assistant Subassistant Commissioner</b>	
O. H. Hempstead, Jr.	May-Oct. 1867
John W. Sword	Nov. 1867-May 1868
Julius Lovell	May-Dec. 1868



NATIONAL ARCHIVES AND RECORDS ADMINISTRATION  
MICROFILM PUBLICATIONS

LOCATION	DATES
<b>NATCHITOCHEs</b>	
<b>Subassistant Commissioner of the 4th Subdistrict</b>	
James Cromie	June 1867–May 1868
Isaac N. Walter	May–July 1868
N. B. McLaughlin	July 1868
G. A. Hewlett	July–Nov. 1868
Theodore W. De Klyne	Nov.–Dec. 1868
<b>NATCHITOCHEs</b>	
<b>Agent</b>	
W. H. Henderson	Feb.–Apr. 1866
James Comie	May 1866–May 1867
<b>Assistant Subassistant Commissioner</b>	
Charles Miller	May 1867–Sept. 1868
E. H. Hosner	Aug.–Dec. 1868
<b>NEW IBERIA</b>	
<b>Agent</b>	
Edmund C. Burt (also St. Martinsville)	Dec. 1865–Jan. 1866
William H. Cornelius (also St. Martinsville)	Jan. 1866–Apr. 1867
<b>Assistant Subassistant Commissioner</b>	
William H. Cornelius (also St. Martinsville)	Apr.–July 1867
I. W. Keller (and A.A.C. Leblanc, clerk, St. Martinsville)	Aug. 1867
L. Jolissaint	Sept.–Oct. 1867
John T. White	Nov. 1867–Dec. 1868
<b>NEW ORLEANS</b>	
<b>Assistant Subassistant Commissioner for Orleans Parish Left Bank</b>	
A. N. Murtagh	May 1867
L. Jolissaint	June–Aug. 1867
W. H. Cornelius	Sept. 1867
John T. White	Oct. 1867
L. Jolissaint	Nov. 1867–Dec. 1868
<b>NEW ORLEANS</b>	
<b>Assistant Subassistant Commissioner for St. Bernard and Plaquemine Parishes</b>	
Ira D. M. McClary (also Kenilworth Plantation)	Apr.–Dec. 1867
Oscare A. Rice (also Chofield Plantation)	Jan. 1868
P. J. Smalley (also Chofield Plantation and P. O. Lock Box 841)	Jan.–June 1868
H. M. Whittmore (also Merritts Plantation)	June–Dec. 1868

NATIONAL ARCHIVES AND RECORDS ADMINISTRATION  
MICROFILM PUBLICATIONS

LOCATION	DATES
<b>NEW ROADS</b>	
<b>Agent</b>	
Thomas H. Hopwood (see Labatuts Landing)	Mar. 1866
Thomas H. Hopwood	Apr.-July 1866
H. F. Wallace	July 1866-Apr. 1867
<b>Assistant Subassistant Commissioner</b>	
H. F. Wallace	Apr.-Nov. 1867
M. Basso (also Point Coupee)	Nov. 1867-Feb. 1868
C. J. Lorigan (also Waterloo)	Feb.-Apr. 1868
C. J. Lorigan (also New Roads and Waterloo)	Apr.-June 1868
Victor Benthien	July-Oct. 1868
<b>PLAQUEMINE</b>	
<b>Provost Marshal</b>	
M. Masicot	Jan. 1865
Nelson Kenyon	Feb.-Oct. 1865
James M. Eddy	Oct. 1865
<b>Agent</b>	
A. R. Houston	Dec. 1865
J. C. Stimmell	Feb.-Apr. 1866
F. A. Osbourn	May 1866-Apr. 1867
<b>Assistant Subassistant Commissioner</b>	
F. A. Osbourn	Apr.-Dec. 1867
E. Charles Merrill	Jan.-Dec. 1868
<b>POINT COUPEE (See New Rhoads)</b>	
<b>PORT HUDSON (See Clinton)</b>	
<b>PRAIRIE LANDING (See Trinity)</b>	
<b>ST. BERNARD (See New Orleans)</b>	
<b>ST. FRANCISVILLE (See Bayou Sara)</b>	
<b>ST. JAMES (See Donaldsonville)</b>	
<b>ST JOSEPH (Subassistant Commissioner for 6th Subdistrict)</b>	
<b>(See Vidalia)</b>	
<b>ST. JOSEPH</b>	
<b>Agent</b>	
David L. Jones	Aug.-Oct. 1865
A. Roberts	Nov. 1865
A. Hemingway	Nov.-Dec. 1865
R. D. Mitchell	Jan.-Feb. 1866
J. H. Hastings	Feb. 1866-Apr. 1867
<b>Assistant Subassistant Commissioner</b>	
J. H. Hastings	Apr.-May 1867
Edward Henderson	May 1867-Aug. 1868



NATIONAL ARCHIVES AND RECORDS ADMINISTRATION  
M I C R O F I L M P U B L I C A T I O N S

LOCATION	DATES
<b>ST. MARTINSVILLE (See New Iberia)</b>	
<b>SHREVEPORT</b>	
<b>Subassistant Commissioner of the 7th Subdistrict</b>	
Martin Flood	May 1867–July 1868
Frank D. Garretty	Aug. 1868
<b>SHREVEPORT</b>	
<b>Assistant Superintendent</b>	
D. H. Reese	Oct.–Dec. 1865
L. Horrigan	Dec. 1865–Apr. 1866
<b>Agent</b>	
E. E. Williams	May–June 1866
William P. Hagardon	June 1866
Martin Flood	June 1866–May 1867
<b>Assistant Subassistant Commissioner</b>	
Thomas F. Monroe	May 1867–Dec. 1868
<b>SHREVEPORT</b>	
<b>Superintendent of Education</b>	
James McCleery	Sept. 1869–Sept. 1870
<b>SPARTA</b>	
<b>Assistant Subassistant Commissioner</b>	
E. W. Dewees	Dec. 1866–Feb. 1868
George Schayer	Feb.–June 1868
Edward Newell Bean	June–Dec. 1868
<b>SPRINGFIELD (See Hammond Station)</b>	
<b>THIBODEAUX</b>	
<b>Agent</b>	
C.P.M. Taggart	Aug. 1866
S. A. Kohly	Feb.–Mar. 1867
J. D. Rich	Mar.–Apr. 1867
<b>Assistant Subassistant Commissioner</b>	
J. D. Rich	May–June 1867
J.A.A. Robinson	June–Nov. 1867
Francis Sternberg	Nov. 1867–Apr. 1868
Nelson Bronson	Apr.–Sept. 1868
I. H. Van Antwerp	Sept.–Oct. 1868
William S. MacKenzie	Oct.–Nov. 1868
William Hollenback	Nov.–Dec. 1868
<b>TRENTON (See Monroe)</b>	

**NATIONAL ARCHIVES AND RECORDS ADMINISTRATION**  
**M I C R O F I L M P U B L I C A T I O N S**

LOCATION	DATES
<b>TRINITY</b>	
<b>Assistant Subassistant Commissioner</b>	
M. Johnson Lemmon (also Prairie Landing)	May 1867–July 1868
J.H.H. Camp (also Mossy Farm Plantation)	Aug. 1868
J.H.H. Camp (also Trinity)	Sept.–Nov. 1868
Van R. K. Hilliard	Nov.–Dec. 1868
<b>VERMILLIONVILLE</b>	
<b>Agent</b>	
S. W. Purchase	Jan. 1866–Apr. 1867
<b>Assistant Subassistant Commissioner</b>	
S. W. Purchase	May 1867
Edward Lindemann	May 1867–Jan. 1868
Oscar A. Rice	Jan.–Dec. 1868
<b>VERNON</b>	
<b>Assistant Subassistant Commissioner</b>	
W. Bishop	May 1867–Sept. 1868
<b>VIDALIA</b>	
<b>Subassistant Commissioner of the 6th Subdistrict</b>	
J. H. Hastings (also St. Joseph)	May–June 1867
J. H. Hastings (also Vidalia)	June–Oct. 1867
George W. Rollins	Nov. 1867–July 1868
Frank D. Garretty	July–Aug 1868
George W. Rollins	Aug.–Dec. 1868
<b>VIDALIA</b>	
<b>Agent</b>	
J. H. West	Aug.–Sept. 1865
B. B. Brown	Feb. 1868–Apr. 1867
<b>Assistant Subassistant Commissioner</b>	
B. B. Brown	Apr.–June 1867
George H. Dunford	June–Oct. 1867
Christian Rush	Sept. 1867–July 1868
Alexander Hamilton	July–Dec. 1868
<b>WATERLOO (See New Roads)</b>	







NATIONAL ARCHIVES AND RECORDS ADMINISTRATION  
MICROFILM PUBLICATIONS

ROLL	DESCRIPTION	DATES
3	<i>Registers of Payments</i>	
(cont.)	The two volumes of registers of payments, 1 (64) and 2 (65), are dated July–October 1867 and January 1868–March 1872, respectively. Volume 1 (64) is arranged chronologically. Volume 2 (65) is arranged in chronological order and numbered by payment number. For a name index to volume 2 (65), see the single-volume name index (66) described above.	
	Volume 1 (64)	July–Oct. 1867
	Volume 2 (65)	Jan. 1868–Mar. 1872
	<i>Register of Payments</i>	
	The single-volume register of payments, ca. 1868 (63), is arranged alphabetically by initial letter of surname of claimant. The register gives the name, company, and regiment, and amount paid to each claimant. The names of these claimants are not duplicated in the two volumes of registers of payments described above.	
	Volume (63)	ca. 1868
4	<b>COMMISSARY OF SUBSISTENCE</b>	
	<i>Press Copies of Letters Sent</i>	
	The single volume of press copies of letters sent (70) is dated September 1868–April 1869. It is arranged chronologically and has a name index.	
	Volume (70)	Sept. 1868–Apr. 1869
	<i>Unregistered Letters Received</i>	
	The unbound unregistered letters received, January 1868–June 1869, are arranged chronologically.	
		Jan. 1868–June 1869
	<i>Record of Supplies Furnished Planters</i>	
	The single-volume “Record of Supplies Furnished Planters for the Subsistence of Employed Freedpeople, Issued under the Provisions of Circular #1 Dated Headquarters, Bureau of Refugees, Freedmen and Abandoned Lands, District of LA. Jan. 23, 1868” (71), is dated March–July 1868 and March–November 1868. The series is arranged in two lists and thereunder chronologically. The names are numbered, and most of them appear on both lists. The lists partially duplicate each other.	
	Volume (71)	Mar.–July 1868; Mar.–Nov. 1868
5	<i>Accounts</i>	
	The single volume of accounts, April–October 1868 (72), is arranged by parish, thereunder by name, and thereunder chronologically.	
	Volume (72)	Apr. –Oct. 1868



NATIONAL ARCHIVES AND RECORDS ADMINISTRATION  
MICROFILM PUBLICATIONS

ROLL	DESCRIPTION	DATES
5	<i>Account Book of Planters for Supplies Furnished</i>	
(cont.)	The single-volume account book of planters for supplies furnished, January 1868–May 1869 (73), is arranged by name of planter.	
	Volume (73)	Jan. 1868–May 1869
	<i>Miscellaneous Reports and Accounting Records</i>	
	Unbound miscellaneous reports and accounting records are dated January 1868–November 1869 and arranged chronologically	
		Jan.–June 1868
6	<i>Miscellaneous Reports (cont.)</i>	July 1868–Nov. 1869

**PROVOST MARSHAL GENERAL OF FREEDMEN**

*Letters and Endorsements Sent*

The single volume of letters and endorsements sent, August 1865–January 1867 (128), is arranged by type of record and thereunder chronologically. The letters sent are dated August–September 1865, and the endorsements are dated September 1865–January 1867.

Volume (128)

Letters Sent

Aug.–Sept. 1865

Endorsements Sent

Sept. 1865–Jan. 1867

*Press Copies of Letters Sent*

The two volumes of press copies of letters sent, June 1865–December 1866, 1 (126) and 2 (127), are arranged chronologically and have name indexes. The dates of the volumes overlap. Some of the letters are duplicated in the single volume of letters and endorsements sent (128) described above.

Volume 1 (126)

June–Oct. 1865

Volume 2 (127)

Aug. 1865–Dec. 1866

7 *Register of Letters Received*

The single-volume register of letters received, January–October 1865 and February 1867 (125), is arranged alphabetically by initial letter of surname of correspondent and thereunder chronologically.

Volume (125)

Jan.–Oct 1865; Feb. 1867

*Register of Letters Received (“Transmittal Book”)*

The single-volume register of letters received titled “Transmittal Book”(21) is dated ca. 1866 and arranged alphabetically by initial letter of surname of correspondent and thereunder chronologically (no dates actually stated). The “EB” numbers given in the left column refer to page numbers in the endorsement section of the single volume of letters and endorsements sent (128) described above.

Volume (21)

ca. 1866



NATIONAL ARCHIVES AND RECORDS ADMINISTRATION  
MICROFILM PUBLICATIONS

ROLL	DESCRIPTION	DATES
7	<i>Letters Received by G. W. Foster</i>	
(cont.)	The single volume of letters received by G. W. Foster, assistant provost marshal general of freedmen, September–November 1865 (98), is arranged chronologically. The volume also contains a <b>register of school taxes</b> dated March–April 1866.	
	Volume (98)	Sept. 1865–Apr. 1866
	<i>Special Orders Received</i>	
	The single volume of special orders received, August 1865–June 1866 (129), is arranged chronologically.	
	Volume (129)	Aug. 1865–June 1866
	<i>Registers of Proceedings in Freedmen's Court</i>	
	The two volumes of registers of proceedings in Freedmen's court are dated November 1864–October 1868 and September 1865–March 1866, 1 (134) and 2 (135), respectively. The entries in each volume are arranged chronologically, but the dates of each volume overlap. Both volumes have name indexes. The entries in the volumes give the name of the accused, nature of charge, the date tried, and the sentence of findings or the court.	
	Volume 1 (134)	Nov. 1864–Oct. 1868
	Volume 2 (135)	Sept. 1865–Mar. 1866
	<i>Registers of Complaints</i>	
	The three volumes of registers of complaints, 1 (136), 2 (137), and 3 (140), cover the period 1865–68. The entries within the registers are arranged chronologically although the dates of the volumes overlap. The entries consist of the freedman's name, residence, and a summary of the complaint.	
	Volume 1 (136)	Jan.–Dec. 1868
	Volume 2 (137)	Aug. 1865–Jan. 1868
		Sept–Oct. 1868
	Volume 3 (140)	Mar. 1865–Jan. 1866
	<i>Complaints</i>	
	The two volumes of complaints, February–March 1863, October–December 1864, and January–December 1865, 1 (138) and 2 (139), are arranged chronologically. Volume 1 (138) also contains a <b>register of passes</b> , March–July 1865, and a few <b>letters sent by the Superintendent of Negro Labor</b> , Department of the Gulf, March 1863.	
	Volume 1 (138)	Feb.–Mar 1863; Oct–Dec. 1864; Jan.–Dec. 1865
	Volume 2 (139)	Aug.–Sept. 1865





NATIONAL ARCHIVES AND RECORDS ADMINISTRATION  
MICROFILM PUBLICATIONS

ROLL	DESCRIPTION	DATES
9	<i>Receipt Book for Money</i>	
(cont.)	The single-volume receipt book for money dated September 1865–January 1866 (141) is arranged chronologically.	
	Volume (141)	Sept. 1865–Jan. 1866
	<i>Accounts</i>	
	The single volume of accounts dated 1859–66 (145) is arranged in general chronological order and has a name index.	
	Volume (145)	1859–66
	<b>QUARTERMASTER</b>	
	<i>Register of Letters Received</i>	
	The single-volume register of letters received, July 1867–January 1868 (57), is arranged by month and thereunder numerically.	
	Volume (57)	July 1867–Jan. 1868
	<i>Register of Vouchers Issued</i>	
	The single-volume register of vouchers issued, July 1865–April 1866 (54), is arranged by month. The entries give the date the voucher was issued, name of person to whom issued, amount, and purpose of expenditure. Most vouchers are for rent of buildings.	
	Volume (54)	July 1865–Apr. 1866
	<i>Accounts Current of Captain W. B. Armstrong</i>	
	Unbound accounts current of Captain W. B. Armstrong dated March–June 1866 are arranged chronologically.	
		Mar.–Apr. 1866
10	<i>Accounts Current</i> (cont.)	Apr.–June 1866
11	<b>SURGEON IN CHIEF</b>	
	<b>Correspondence</b>	
	<i>Letters Sent</i>	
	The two volumes of letters sent dated August 1865–May 1869, 1 (81) and 2 (82), are arranged chronologically. There is a name index in Volume 2 (82).	
	Volume 1 (81)	Aug. 1865–Mar. 1868
	Volume 2 (82)	Apr. 1868–May 1869



NATIONAL ARCHIVES AND RECORDS ADMINISTRATION  
MICROFILM PUBLICATIONS

ROLL	DESCRIPTION	DATES
11 (cont.)	<i>Letters Sent</i> Unbound letters sent, August 1865–June 1867, are arranged chronologically. Most of the letters were copied into volume 1 (81) of the letters sent described above.	Aug. 1865–June 1867
12	<i>Endorsements Sent and Received</i> The single volume of endorsements sent and received, August 1865–May 1869 (83), is arranged chronologically. At the front of the volume are <b>copies of orders received</b> by the chief medical officer.	Aug. 1865–May 1869
	<i>Register of Letters Received</i> The single-volume register of letters received, August 1865–January 1869 (78), is arranged alphabetically by initial letter of surname of correspondent and thereunder arranged in chronological order and numbered. For the actual letters received, see the series of registered letters received described below.	
	Volume (78)	Aug. 1865–Jan. 1869
13	<i>Registered Letters Received</i> Unbound registered letters received, September 1865–Sept 1868, are arranged according to their entry in the single-volume register of letters received described above.	Sept. 1865–Sept. 1868
	<i>Unregistered Letters Received</i> Unbound unregistered letters received, July 1865–May 1869, are arranged chronologically.	July 1865–Dec. 1866
14	<i>Unregistered Letters (cont.)</i>	Jan. 1867–May 1869
15	<i>Scrapbook of Telegrams Received</i> The single-volume scrapbook of telegrams received, August–November 1865 (80), is arranged chronologically.	Aug.–Nov. 1865
	<i>Special Orders and Extracts of Special Orders Received Relating to the Medical Office</i> The single volume of special orders and extracts of special orders received relating to the medical office, August 1865–April 1869 (79), is arranged chronologically and has a name index. A few letters received that relate to personnel are included.	
	Volume (79)	Aug. 1865–Apr. 1869

NATIONAL ARCHIVES AND RECORDS ADMINISTRATION  
MICROFILM PUBLICATIONS

ROLL	DESCRIPTION	DATES
15	<b>Reports</b>	
(cont.)	<i>Chief Medical Officer's Annual and Monthly Reports of Operations</i>	
	Unbound chief medical officer's annual and monthly reports of operations, 1866-69, are arranged by type of report and thereunder chronologically. The annual reports are dated October 1866-September 1868, and the monthly ones, March 1868-March 1869.	
	Annual Reports	Oct. 1866-Sept. 1868
	Monthly Reports	Mar. 1868-Mar. 1869
	<i>Monthly Returns of Medical Officers in Louisiana</i>	
	Unbound monthly returns of medical officers in Louisiana, July 1865-May 1869, are arranged chronologically. The returns list the names of the surgeons, their stations, ranks, the nature of their duties, and the dates of their commission or contract.	
		July 1865-May 1869
	<i>Monthly Reports of Persons and Articles Hired</i>	
	Unbound monthly reports of persons and articles hired, December 1865-May 1869, are arranged chronologically.	
		Dec. 1865-May 1869
16	<i>Weekly and Monthly Reports of Sick and Wounded</i>	
	Unbound weekly and monthly reports of sick and wounded, August 1864-May 1869, are arranged by type of report and thereunder chronologically. Included are both reports from surgeons and copies of the chief medical officer's reports sent to Washington.	
		July 1865-Mar. 1866
17	<i>Reports (cont.)</i>	Apr.-Oct. 1866
18	<i>Reports (cont.)</i>	Nov. 1866-June 1867
19	<i>Reports (cont.)</i>	July-Dec. 1867
20	<i>Reports (cont.)</i>	Jan.-July 1868
21	<i>Reports (cont.)</i>	Aug. 1868-May 1869
22	<i>Reports (cont.)</i>	Aug. 1864-June 1867
23	<i>Reports (cont.)</i>	July 1867-May 1869



NATIONAL ARCHIVES AND RECORDS ADMINISTRATION  
MICROFILM PUBLICATIONS

ROLL	DESCRIPTION	DATES
24	<p><i>Weekly Reports Received from Surgeons Concerning Cholera Cases</i> Unbound weekly reports received from surgeons concerning cholera cases, July 1867–February 1868, are arranged chronologically. The surgeons listed the names and ages of cholera victims and dates of attack, recovery, or death on tabular reports.</p>	July 1867–Feb. 1868
	<p><i>Monthly Reports of Attendants Employed</i> Unbound monthly reports of attendants employed, August 1865–May 1869, are arranged chronologically. Included are reports from subordinates and retained copies of those sent to Bureau headquarters in Washington, DC.</p>	Aug. 1865–May 1869
25	<p><i>Reports of Rations Issued</i> Unbound reports of rations issued, October 1865–May 1869, are arranged chronologically.</p>	Oct. 1865–May 1869
	<p><i>Morning Reports of the Assistant Surgeon at Birney Plantation</i> Unbound morning reports of the assistant surgeon at Birney Plantation, January 1864–February 1865, are arranged chronologically. The reports show the number of freedmen who were sick, the number who died, the number discharged, and the number remaining.</p>	Jan. 1864–Feb. 1865
	<p><i>Miscellaneous Reports</i> Unbound miscellaneous reports dated August 1865–September 1868 are arranged chronologically.</p>	Aug. 1865–Sept. 1868
	<p><b>Other Records</b></p>	
	<p><i>Register of Patients</i> The single-volume register of patients, July 1865–April 1869 (86), is arranged in chronological order by date of admission and numbered.</p>	
	Volume (86)	July 1865–Apr. 1869
26	<p><i>Employee Contracts</i> Unbound employee contracts, October 1865–April 1869, are arranged chronologically. The printed contracts usually give the name, race, station, and salary of the nurse or hospital attendant.</p>	Oct. 1865–Apr. 1869



NATIONAL ARCHIVES AND RECORDS ADMINISTRATION  
MICROFILM PUBLICATIONS

ROLL	DESCRIPTION	DATES
26	<i>Registers of Assessments of Cargoes for Hospital Tax</i>	
(cont.)	The three volumes of registers of assessments of cargoes for hospital tax are dated February–June 1865, 1 (99), 2 (100), and 3 (101). The dates of the volumes overlap: volume 1 (99), February–June 1865; volume 2 (100), February–June 1865; and volume 3 (101), March–June 1865. The entries within the volumes are arranged chronologically. The entries give the name of the boat, its owner, the cargo, and the amount of tax.	
	Volume 1 (99)	Feb.–June 1865
	Volume 2 (100)	Feb.–July 1865
	Volume 3 (101)	Mar.–June 1865
	<i>Requisitions for Medical Supplies</i>	
	The single volume of requisitions for medical supplies, August 1865–June 1869 (85), is arranged chronologically.	
	Volume (85)	Aug. 1865–June 1869
27	<b>SUBORDINATE OFFICE PLANTATION DEPARTMENT</b>	
	<i>A Bureau of Free Labor was established in the Department of the Gulf under a superintendent. The superintendent's office became the Assistant Commissioner's in Louisiana in 1865 when the Bureau of Refugees, Freedmen, and Abandoned Lands was created. In July 1865, a Plantation Department was created under the Assistant Commissioner to supervise black labor and enforce Bureau labor regulations, which had been the primary function of the earlier Bureau of Free Labor. The records of the early Bureau are described with those of the Plantation Department. When the Plantation Department was abolished in 1866, the assistant quartermaster of the district carried out its functions.</i>	
	<i>Press Copies of Letters Sent</i>	
	The single volume of press copies of letters sent, May 1866–June 1867 (89), is arranged chronologically. Most of the letters are addressed to plantation owners but some are to Bureau officers.	
	Volume (89)	May 1866–June 1867
	<i>Register of Letters Received and Endorsements Sent and Received</i>	
	The single-volume register of letters received and endorsements sent and received, July 1864–July 1865 (88), is arranged chronologically.	
	Volume (88)	July 1864–July 1865



NATIONAL ARCHIVES AND RECORDS ADMINISTRATION  
MICROFILM PUBLICATIONS

ROLL	DESCRIPTION	DATES
27	<i>Register of Letters Received</i>	
(cont.)	The single-volume register of letters received, September–October 1865 (74), is arranged alphabetically by initial letter of surname of the correspondent.	
	Volume (74)	Sept.–Oct. 1865
	<i>Inspection Reports</i>	
	The single volume of inspection reports, August–September 1865 (90), is arranged by parish and thereunder by name of plantation. There is a name index to inspectors in the volume.	
	Volume (90)	Aug.–Sept. 1865
	<i>Registers of Black Persons</i>	
	The eleven volumes of registers of black persons are undated and are arranged alphabetically by initial letter of name or surname of the person. The entries give the name, age, sex, class of laborer, and wages of former slave; the name and residence of the former owner; and the name and parish of the present employer.	
	Volume 1 (110)	A–B      Undated
	Volume 2 (111)	C–D      ”
28	<i>Registers (cont.)</i>	
	Volume 3 (112)	E–F      ”
	Volume 4 (113)	G–H      ”
	Volume 5 (114)	I–J      ”
	Volume 6 (115)	K–L      ”
	Volume 7 (116)	M–N      ”
29	<i>Registers (cont.)</i>	
	Volume 8 (117)	O–P      ”
	Volume 9 (118)	Q–R      ”
	Volume 10 (119)	S–T      ”
	Volume 11 (120)	W–Z      ”
	<i>Freedmen's Employment Registers</i>	
	The two volumes of freedmen's employment registers are dated April 1864–April 1865, 1 (91) and 2 (92). The registers overlap in dates: volume 1 (91) is dated April 1864–January 1865 and volume 2 (92), June 1864–April 1865. The entries within the registers are arranged chronologically. Each entry records for the freedman the name, age, and sex; the names of former owners; former residence; and the name and residence of the employer.	
	Volume 1 (91)	Apr. 1864–Jan. 1865
	Volume 2 (92)	June 1864–Apr. 1865



NATIONAL ARCHIVES AND RECORDS ADMINISTRATION  
MICROFILM PUBLICATIONS

ROLL	DESCRIPTION	DATES
30	<i>Registers and Payrolls of Freedmen Employed on Plantations</i> Unbound registers and payrolls of freedmen employed on plantations, 1864-68, are arranged alphabetically by parish. The registers give the names, ages, sex, and class of the laborer; names of former owners; and former residences of freedmen. The payrolls give similar information except that they include the freedmen's monthly wages, the number of days worked, amount of money received, and signatures or "X."	
	Ascension Parish	1864-67
31	Ascension and Assumption	1865-67
32	Assumption	1865-67
33	Assumption and Carroll	1865-67
34	Concordia, East Baton Rouge, Iberville	1865-67
35	Iberville, Jefferson, Lafayette, Madison, Natchitoches	1864-68
36	Point Coupee, Sabine, St. Charles, St. Helena, St. James	1864-68
37	St. James	1864-66
38	St. John de Baptiste, St. Martin, St. Mary, Tensas	1864-68
39	Terre Bonne, West Baton Rouge, West Feliciana	1864-68
	<i>Freedmen's Labor Contracts</i> The single volume of freedmen's labor contracts, September 1863-December 1864 (93), is arranged chronologically. The volume also contains an employment register that was probably compiled in 1864.	
	Volume (93)	Sept. 1863-Dec. 1864
40	<i>Labor Contracts (Agreements with Freedmen)</i> Unbound labor contracts ("agreements with freedmen"), 1864-68, are arranged alphabetically by parish.	
	Ascension and Assumption	1864-68
41	Avoyelles, Bienville, Bossier, Caddo	1866-68
42	Caldwell and Carroll	1866-68







NATIONAL ARCHIVES AND RECORDS ADMINISTRATION  
MICROFILM PUBLICATIONS

ROLL	DESCRIPTION	DATES
52 (cont.)	<i>Cash Account Books</i> The two volumes of cash account books are dated 1864-66, 1 (97) and 2 (122). Each book is arranged by name of planter with whom there was an account and thereunder chronologically.	
	Volume 1 (97)	1864-65
	Volume 2 (122)	1866
	<i>Ledger of Accounts</i> The single-volume ledger of accounts, February-June 1865 (33), is arranged by account and has a name index.	
	Volume (33)	Feb.-June 1865
<hr/> <b>SUBORDINATE FIELD OFFICES</b> <b>ABBEVILLE (ASSISTANT SUBASSISTANT COMMISSIONER)</b>		
	<i>Letters Sent</i> The single volume of letters sent, June 1867-June 1868 (173), is arranged chronologically and has a name index.	
	Volume (173)	June 1867-June 1868
	<i>Register of Letters Received</i> The single-volume register of letters received, May 1867-July 1868 (172), is arranged chronologically and has a name index. For an unduplicated register for the same period, see the single-volume scrapbook of letters received (171) described below.	
	Volume (172)	May 1867-July 1868
	<i>Scrapbook of Letters Received</i> The single-volume scrapbook of letters received, May-October 1867 (171), is arranged chronologically. The volume includes a few circulars and extracts of special orders. The volume also contains a <b>register of letters received</b> (June 1867-July 1868), arranged chronologically with a name index. The letters received are registered in either this register or in the single-volume register of letters received (172) described above.	
	Volume (171)	May-Oct. 1867
	<i>Letters Received</i> Unbound letters received, February-April 1868, are arranged chronologically.	
		Feb.-Apr. 1868



NATIONAL ARCHIVES AND RECORDS ADMINISTRATION  
MICROFILM PUBLICATIONS

ROLL	DESCRIPTION	DATES
52 (cont.)	<i>Narrative Reports</i> The single volume of narrative reports, November 1867–June 1868 (174), is arranged chronologically and has a name index.	
	Volume (174)	Nov. 1867–June 1868
	<i>Reports of Persons and Articles Hired</i> Unbound reports of persons and articles hired, September 1867–June 1868, are arranged chronologically.	
		Sept. 1867–June 1868
	<i>Monthly Returns of Stores</i> Unbound monthly returns of stores, June 1867–June 1868, are arranged chronologically.	
		June 1867–June 1868
	<i>Miscellaneous Records</i> Unbound miscellaneous records, June 1867–June 1868, are arranged by type of record. The records include subvouchers (June 1868); special orders received, (December 1867); bills of lading (June 1867–April 1868); contracts (March 1868); and abstracts (April–June 1868).	
		June 1867–June 1868
	<b>ALEXANDRIA (ASSISTANT SUPERINTENDENT AND ASSISTANT SUBASSISTANT COMMISSIONER)</b>	
	<i>Letters Sent</i> The two volumes of letters sent, March 1866–December 1868, 1 (179) and 2 (180), are arranged chronologically, and each volume has a name index. Volume 2 (180) also contains a <b>register of contracts</b> for Parish Rapides, 1865. Information in the volume includes date, termination, and parties to the contract; class of laborers (men, women, or children); average wages; number at work for support only; number of acres in plantation; how cultivated; and the witnesses to the contract. There is also a <b>register of contracts</b> for Parish Avoyelles, 1865, which includes the same information as for Parish Rapides.	
	Volume 1 (179)	Mar. 1866–Sept. 1868
	Volume 2 (180)	Sept.–Dec. 1868



NATIONAL ARCHIVES AND RECORDS ADMINISTRATION  
MICROFILM PUBLICATIONS

ROLL	DESCRIPTION	DATES
52	<i>Registers of Letters Received</i>	
(cont.)	The three volumes of registers of letters received, January 1867–October 1868, 1 (176), 2 (177), and 3 (178), are arranged by time period. There are name indexes for volumes 2 (177) and 3 (178). The entries in volumes 1 (176) and 2 (177) are arranged alphabetically by initial letter of the surname of correspondent and thereunder arranged in chronological order and numbered. Entries in volume 3 (178) are arranged chronologically and include endorsements.	
	Volume 1 (176)	Jan.–Dec. 1867
	Volume 2 (177)	Jan.–Aug. 1868
	Volume 3 (178)	Sept.–Oct. 1868
53	<i>Registered Letters Received</i>	
	Unbound registered letters received, January 1867–August 1868, are arranged by year, thereunder by initial letter of surname of writer, and thereunder arranged in chronological order by date received and numbered. The letters are registered in three volumes of registers of letters received described above.	
		Jan. 1867–Aug. 1868
	<i>Unregistered Letters Received</i>	
	Unbound unregistered letters received, March 1866–December 1868, are arranged chronologically by date received.	
		Mar. 1866–Dec. 1868
	<i>Letters and Circulars Received</i>	
	The single volume of letters and circulars received, March–November 1866 (175), is arranged chronologically. The volume also contains <b>special orders and circulars received</b> , July 1865–November 1866, arranged chronologically.	
	Volume (175)	Mar–Nov. 1866
	<i>Trimonthly Reports of Operations</i>	
	Unbound trimonthly reports of operations, June 1867–February 1868, are arranged chronologically.	
		June 1867–Feb. 1868
54	<i>School Reports</i>	
	Unbound school reports, January 1867–November 1868, are arranged chronologically.	
		Jan. 1867–Nov. 1868
	<i>Returns of School Property</i>	
	Unbound returns of school property, August 1866–December 1868, are arranged chronologically.	
		Aug. 1866–Dec. 1868



NATIONAL ARCHIVES AND RECORDS ADMINISTRATION  
MICROFILM PUBLICATIONS

ROLL	DESCRIPTION	DATES
54 (cont.)	<i>Monthly Reports of Receipts and Expenditures of Schools</i>  Unbound monthly reports of receipts and expenditures of schools, January 1867–August 1868, are arranged chronologically.	Jan. 1867–Aug. 1868
	<i>Monthly Inspection Reports</i> Unbound monthly inspection reports, February 1866–October 1868, are arranged chronologically.	Feb. 1866–Oct. 1868
	<i>Reports of Indigent and Helpless Freedmen and Whites Applying for Relief</i> The single-volume of reports of indigent and helpless freedmen and whites applying for relief, August 1867–January 1868 (182), is arranged chronologically. The volume also contains <b>complaints</b> dated June 1866–September 1868.	Aug. 1867–Jan. 1868
	<i>Monthly Reports of Persons and Articles Hired</i> Unbound monthly reports of persons and articles hired, July 1866–August 1868, are arranged chronologically.	July 1866–Aug. 1868
	<i>Monthly Returns of Rations Issued and Stores</i> Unbound monthly returns of rations issued and stores, January–June 1868, are arranged chronologically.	Jan.–June 1868
	<i>Reports of Supplies Issued Planters</i> Unbound monthly reports of supplies issued planters, March–September 1868, are arranged chronologically.	Mar.–Sept. 1868
	<i>Indentures</i> Unbound indentures, December 1865–December 1866, are arranged chronologically.	Dec. 1865–Dec. 1866
	<i>Miscellaneous Lists Relating to Bounties</i> The single volume of miscellaneous lists relating to bounties, 1865–67 (181), is arranged by type of list.	1865–67



NATIONAL ARCHIVES AND RECORDS ADMINISTRATION  
MICROFILM PUBLICATIONS

ROLL	DESCRIPTION	DATES
54	<i>Accounts with Planters for Stores Supplied</i>	
(cont.)	The single volume of accounts with planters for stores supplied, March–September 1868 (183), is arranged by name of planter and thereunder chronologically. The volume has a name index.	
	Volume (183)	Mar.–Sept. 1868
	<i>Bills of Lading</i>	
	Unbound bills of lading, April 1867–December 1868, are arranged chronologically.	
		Apr. 1867–Dec. 1868
	<i>Miscellaneous Records</i>	
	Unbound miscellaneous records, August 1865–November 1868, are arranged by type of record.	
		Aug. 1865–Nov. 1868
<b>ALGIERS (AGENT AND ASSISTANT SUBASSISTANT COMMISSIONER)</b>		
	<i>Letters Sent</i>	
	The five volumes of letters sent, May 1866–December 1868, 1 (187), 2 (188), 3 (189), 4 (190), and 5 (191), are arranged chronologically, and each volume has a name index. Volume 1 (187) also contains <b>memorandums</b> , June 1865–April 1866, and volume 4 (190) also contains <b>endorsements</b> , May–June 1867.	
	Volume 1 (187)	May 1866–Sept. 1867
	Volume 2 (188)	Apr. 1867–Feb. 1868
	Volume 3 (189)	Mar.–Sept. 1868
	Volume 4 (190)	Sept.–Nov. 1868
	Volume 5 (191)	Nov.–Dec. 1868
55	<i>Endorsements Sent and Received</i>	
	The single volume of endorsements sent and received, January–December 1868 (194), is arranged chronologically and has a name index.	
	Volume (194)	Jan.–Dec. 1868
	<i>Registers of Letters Received</i>	
	The two volumes of registers of letters received, January 1867–December 1868, 1 (184) and 2 (185), are arranged by initial letter of surname of writer and thereunder arranged in chronological order by date received and numbered. Both volumes have name indexes. The volumes also include <b>endorsements sent and received</b> .	
	Volume 1 (184)	Jan.–Dec. 1867
	Volume 2 (185)	Jan.–Dec. 1868



NATIONAL ARCHIVES AND RECORDS ADMINISTRATION  
MICROFILM PUBLICATIONS

ROLL	DESCRIPTION	DATES
55	<i>Letters, Special Orders, and Circulars Received</i>	
(cont.)	The single volume of letters, special orders, and circulars received, November 1866–August 1868 (186), is arranged chronologically.	
	Volume (186)	Nov. 1866–Aug. 1868
	<i>Registered Letters Received</i>	
	Unbound registered letters received, January 1867–December 1868, are arranged according to their entry in the two volumes of registers of letters received 1 (184) and 2 (185) described above.	
		Jan. 1867–Dec. 1868
	<i>Unregistered Letters Received</i>	
	Unbound unregistered letters received, May 1865–December 1868, are arranged chronologically by date received.	
		May 1865–Dec. 1868
56	<i>Special Orders and Circulars Issued</i>	
	The single volume of special orders and circulars issued, March 1866–December 1867 (195), is arranged chronologically and has a name index. The volume also contains <i>indentures</i> (April 1866), arranged chronologically, and one circular received (March 14, 1866).	
	Volume (195)	Mar. 1866–Dec. 1867
	<i>Trimonthly Reports of Operations</i>	
	The two volumes of trimonthly reports of operations, January 1867–December 1868, 1 (192) and 2 (193), are arranged chronologically. There is a name index to volume 2 (193) dated 1868.	
	Volume 1 (192)	Jan.–Dec. 1867
	Volume 2 (193)	Jan.–Dec. 1868
	<i>Trimonthly Reports of Operations</i>	
	Unbound trimonthly reports of operations, January–December 1866, are arranged chronologically.	
		Jan.–Dec. 1866
	<i>School Reports</i>	
	Unbound school reports, May 1866–December 1867, are arranged chronologically.	
		May 1866–Dec. 1867



NATIONAL ARCHIVES AND RECORDS ADMINISTRATION  
MICROFILM PUBLICATIONS

ROLL	DESCRIPTION	DATES
56 (cont.)	<i>Monthly Returns of School Property</i> Unbound monthly returns of school property, May 1866–November 1868, are arranged chronologically.	May 1866–Nov. 1868
	<i>Reports of Assistant Inspector of Freedmen</i> Unbound reports of the assistant inspector of freedmen, January 1866–November 1868, are arranged chronologically. Included are quarterly consolidated reports.	Jan. 1866–Nov. 1868
	<i>Reports of Persons and Articles Hired</i> Unbound reports of persons and articles hired, November 1866–December 1868, are arranged chronologically.	Nov. 1866–Dec. 1868
	<i>Monthly Returns of Public Animals</i> Unbound monthly returns of public animals, May 1866–December 1867, are arranged chronologically.	May 1866–Dec. 1867
	<i>Returns of Ordnance and Ordnance Stores</i> Unbound returns of ordnance and ordnance stores, May 1866–December 1867, are arranged chronologically. The records also include invoices of stores.	May 1866–Dec. 1867
	<i>Monthly Reports of Numbers Issued Rations, Clothing and Medicines</i> Unbound monthly reports of numbers issued rations, clothing, and medicines, February–April 1866, are arranged chronologically.	Feb.–Apr. 1866
	<i>Monthly Returns of Provisions Issued Destitutes</i> Unbound monthly returns of provisions issued destitutes, January–July 1868, are arranged chronologically.	Jan.–July 1868
57	<i>Monthly Returns of Stores Received and Issued</i> Unbound monthly returns of stores received and issued, May 1866–March 1868, are arranged chronologically.	May 1866–Mar. 1868



NATIONAL ARCHIVES AND RECORDS ADMINISTRATION  
MICROFILM PUBLICATIONS

ROLL	DESCRIPTION	DATES
57 (cont.)	<i>Proceedings Before Provost Court</i> Unbound proceedings before the provost court, August–November 1865 and May–December 1867, are arranged chronologically.	

Aug.–Nov. 1865; May–Dec. 1867

*Register of Court Trials*

The two-volume register of court trials, February 1866–November 1868, 1 (197) and 2 (198), are arranged in chronological order and numbered. Included in the volumes are the testimonies of trials. Volume 2 (198) also contains **affidavits**, December 1867–November 1868, arranged chronologically.

Volume 1 (197)	Feb. 1866–July 1867
Volume 2 (198)	July 1867–Nov. 1868

*Registers of Black Persons*

Unbound registers of black persons are undated and unarranged.

Undated

*Register of Military Tax to Repair  
Levee at McDonoughville*

The single-volume register of military tax to repair the levee at McDonoughville (201) is dated May 15, 1865 and arranged by initial letter of surname of taxed persons and thereunder numerically. Included in the volume is a copy of Circular Number 5, dated November 1, 1865, exempting certain persons from paying the levee tax. The volume also contains letters sent and summonses to appear at the agent's office, August 1866–August 1867, arranged chronologically; a register of summonses to appear at the agent's office, August 1867–November 1868, arranged chronologically; a register of "indigent and destitute freed people applying for relief," January–August 1868, arranged chronologically; a register of "indigent and destitute white people applying for relief," January–July 1868, arranged chronologically; and a "list of persons promising to pay at stated periods," apparently to pay either court costs, fines, or money owed following a court case, August 1867–July 1868, arranged chronologically.

Volume (201)	May 15, 1865
--------------	--------------

*Journal of Business Transacted*

The two-volume journal of business transacted, April 1867–December 1868, 1 (199) and 2 (200), is arranged chronologically. The journal entries cover mainly visitors' complaints, the paperwork performed, and visits made.

Volume 1 (199)	Apr. 1867–June 1868
Volume 2 (200)	June–Dec. 1868



NATIONAL ARCHIVES AND RECORDS ADMINISTRATION  
MICROFILM PUBLICATIONS

ROLL	DESCRIPTION	DATES
57	<i>Reports of Accounts Current</i> (cont.) Unbound reports of accounts current, July 1866–July 1868, are arranged chronologically.	July 1866–July 1868
	<i>Miscellaneous Accounts</i> The single volume of miscellaneous accounts, May 1865–November 1868 (196), is arranged by type of account and thereunder chronologically. Included are accounts concerning freedmen schools, Provost Marshal Department, tuition, and levies.	
	Volume (196)	May 1865–Nov. 1868
	<i>Miscellaneous Records</i> Unbound miscellaneous records dated November 1864–November 1868 are unarranged.	Nov. 1864–Nov. 1868
58	<b>AMITE CITY (ASSISTANT SUPERINTENDENT AND ASSISTANT SUBASSISTANT COMMISSIONER)</b>	
	<i>Letters Sent</i> The single volume of letters sent, August 1865–December 1868 (203), is arranged chronologically. The volume includes some letters received and has a name index.	
	Volume (203)	Aug. 1865–Dec. 1868
	<i>Register of Letters Received</i> The single-volume register of letters received, April 1866–December 1868 (202), includes endorsements and is arranged in chronological order and numbered.	
	Volume (202)	Apr. 1866–Dec. 1868
	<i>Registered Letters Received</i> Unbound registered letters received, May 1866–December 1868, are arranged in chronological order and numbered. The letters are registered in the single-volume register of letters received (202) described above.	
		May 1866–Dec. 1868
	<i>Unregistered Letters Received</i> Unbound unregistered letters received, August 1865–December 1868, are arranged chronologically.	
		Aug. 1865–Dec. 1868
	<i>Monthly Inspection Reports</i> Unbound monthly inspection reports, March 1866–December 1868, are arranged chronologically.	
		Mar. 1866–Dec. 1868



NATIONAL ARCHIVES AND RECORDS ADMINISTRATION  
MICROFILM PUBLICATIONS

ROLL	DESCRIPTION	DATES
58 (cont.)	<i>Reports of Persons and Articles Hired</i> Unbound reports of persons and articles hired, April 1866–December 1868, are arranged chronologically.	Apr. 1866–Dec. 1868
	<i>Register of Complaints</i> The single-volume register of complaints, July 1865–March 1866 (204), is arranged chronologically. The volume also contains <b>complaints and affidavits</b> , August–September 1865, arranged chronologically, and a <b>register of complaints</b> , August–December 1867, arranged chronologically.	July 1865–Mar. 1866
	<i>Register of Contracts</i> The single-volume register of contracts, June 1865–October 1866 (205), is arranged chronologically, and has a name index.	June 1865–Oct. 1866
	<i>Indentures</i> Unbound indentures are dated January 1866–November 1867, and are unarranged.	Jan.–Apr. 1866
59	<i>Indentures</i> (cont.)	May 1866–Nov. 1867
	<i>Bills of Lading</i> Unbound bills of lading are dated February 1866–March 1868 and are arranged chronologically.	Feb. 1866–Mar. 1868
	<i>Receipts for Supplies Issued Planters</i> Unbound receipts for supplies issued planters, March–August 1868, are arranged by initial letter of the surname of the planter.	Mar.–Aug. 1868
	<i>Accounts</i> The single volume of accounts, March–September 1868 (206), is arranged by name of planter and thereunder chronologically. The volume has a name index.	Mar.–Sept. 1868



NATIONAL ARCHIVES AND RECORDS ADMINISTRATION  
MICROFILM PUBLICATIONS

ROLL	DESCRIPTION	DATES
59	<i>Miscellaneous Records</i>	
(cont.)	Unbound miscellaneous records, September 1865–December 1868, are arranged by type of record. Included are accounts current, July–December 1867; monthly reports of supplies issued to planters, March–May 1868; monthly school reports of the district superintendent, November–December 1868; affidavits, June 1866; an appearance bond, September 1865; and records of quartermaster stores, September 1865–March 1867.	Sept. 1865–Dec. 1868
<b>BATON ROUGE (SUBASSISTANT COMMISSIONER OF THE 2ND SUBDISTRICT)</b>		
	<i>Letters Sent</i>	
	The single volume of letters sent, May 1867–December 1868 (216), is arranged in chronological order and numbered.	
	Volume (216)	May 1867–Dec. 1868
	<i>Registers of Letters Received</i>	
	The six volumes of registers of letters received cover the period May 1867–December 1868. All volumes include endorsements sent. Volumes 1 (208), 2 (209), and 3 (210) are arranged in chronological order by date received and numbered. Volumes 4 (211), 5 (212), and 3 (213) are arranged chronologically by date received. There are name indexes in Volumes 2 (209), 3 (210), 4 (211) 5 (212), and 6 (213).	
	Volume 1 (208)	May–July 1867
	Volume 2 (209)	June–Dec. 1867
	Volume 3 (210)	Dec. 1867–Feb. 1868
60	<i>Registers of Letters (cont.)</i>	
	Volume 4 (211)	Feb.–May 1868
	Volume 5 (212)	May–July 1868
	Volume 6 (213)	July–Dec. 1868
	<i>Unregistered Letters Received</i>	
	Unbound unregistered letters received, May 1867–December 1868, are arranged chronologically by date received.	
		May 1867–Dec. 1868
	<i>Reports of Persons and Articles Hired</i>	
	Unbound reports of persons and articles hired, May–June 1867 and February 1868, are arranged chronologically.	
		May–June 1867 and Feb. 1868



NATIONAL ARCHIVES AND RECORDS ADMINISTRATION  
MICROFILM PUBLICATIONS

ROLL	DESCRIPTION	DATES
61	<b>BATON ROUGE (ASSISTANT SUBASSISTANT COMMISSIONER)</b>	
	<i>Letters Sent</i>	
	The four volumes of letters sent, July 1866–December 1868, 1 (217), 2 (218), 3 (219), and 4 (220), are arranged chronologically, and each volume has a name index.	
	Volume 1 (217)	July 1866–July 1867
	Volume 2 (218)	July 1867–May 1868
	Volume 3 (219)	May–Oct. 1868
	Volume 4 (220)	Oct.–Dec. 1868
	<i>Registers of Letters Received</i>	
	The three volumes of registers of letters received, 1 (207), 2 (214) and 3 (215), are dated January–May 1865 and January 1867–December 1868. Volumes 1 (207) and 2 (214) are arranged in chronological order by date received and numbered. Volume 3 (215) is arranged chronologically by date received. Volumes 2 (214) and 3 (215) have name indexes. Volume 1 (207) includes endorsements sent, and volume 3 (215) includes endorsements sent and received, dated June–December 1868. Volume 1 (207) also contains a <b>register of destitute persons</b> (no date) arranged by initial letter of surname and thereunder by race.	
	Volume 1 (207)	Jan.–May 1865
	Volume 2 (214)	Jan. 1867–Apr. 1868
	Volume 3 (215)	May–Dec. 1868
	<i>Letters Received</i>	
	Unbound letters received, October 1865–December 1868, are arranged chronologically by date received. Some of the letters are registered in the three volumes of registers of letters received, 1 (207), 2 (214), 3 (215), described above.	
		Oct. 1865–Apr. 1868
62	<i>Letters Received (cont.)</i>	May–Dec. 1868
	<i>Monthly School Reports</i>	
	Unbound monthly school reports, January 1867–October 1868, are arranged chronologically.	
		Jan. 1867–Oct. 1868
	<i>Monthly Inspection Reports</i>	
	Unbound monthly inspection reports, February 1866–October 1868, are arranged chronologically.	
		Feb. 1866–Oct. 1868
	<i>Monthly Reports of Persons and Articles Hired</i>	
	Unbound monthly reports of persons and articles hired, January 1867–November 1868, are arranged chronologically.	
		Jan. 1867–Nov. 1868



NATIONAL ARCHIVES AND RECORDS ADMINISTRATION  
MICROFILM PUBLICATIONS

ROLL	DESCRIPTION	DATES
62 (cont.)	<i>Monthly Reports of Supplies Issued Freedmen</i> Unbound monthly reports of supplies issued freedmen, February–October 1868, are arranged chronologically.	Feb.–Oct. 1868
	<i>Court Papers</i> Unbound court papers, October 1866 and June 1867, are arranged by name of case. Most of the papers relate to the case of <i>Tousey and Roberts v. Freedmen on the McHatton Plantation</i> .	Oct. 1866 and June 1867
	<i>Affidavits</i> Unbound affidavits, February and June 1867, are arranged chronologically.	Feb. and June 1867
	<i>Registers of Complaints</i> The three volumes of registers of complaints, January 1867–May 1868, 1 (222), 2 (223), and 3 (223½), are arranged chronologically.	
	Volume 1 (222)	Jan.–Aug. 1867
	Volume 2 (223)	Aug.–Nov. 1867
	Volume 3 (223½)	Dec. 1867–May 1868
	<i>Indentures</i> Unbound indentures, June 1867 and January 1868, are arranged chronologically.	June 1867 and Jan. 1868
	<i>Records Relating to Murphy Schoolhouse</i> Unbound records relating to Murphy schoolhouse, March–June 1867, are arranged chronologically. Included are descriptions and dimensions of the schoolhouse, a cost estimate for repairs, and a value estimate.	Mar.–June 1867
63	<i>Applications for Rations</i> Unbound applications for rations, February–March 1868, are arranged by initial letter of surname of applicant.	Feb.–Mar. 1868
	<i>Monthly Reports of Destitutes Requiring Rations</i> Unbound monthly reports of destitutes requiring rations, August 1867–April 1868, are arranged chronologically.	Aug. 1867–Apr. 1868



NATIONAL ARCHIVES AND RECORDS ADMINISTRATION  
MICROFILM PUBLICATIONS

ROLL	DESCRIPTION	DATES
63 (cont.)	<i>Bills of Lading</i> Unbound bills of lading, February–November 1868, are arranged chronologically.	Feb.–Nov. 1868
	<i>Accounts with Planters for Supplies Furnished</i> The single volume of “Accounts with Planters for Supplies Furnished,” January–October 1868 (224), is arranged by name of planter and thereunder chronologically. It has a name index.	
	Volume (224)	Jan.–Oct. 1868
64	<i>Planters Receipts for Supplies</i> Unbound planters receipts for supplies, March–November 1868, are arranged chronologically.	Mar.–Nov. 1868
	<i>Journal of Business</i> The single-volume “Journal of Business,” March 1868 and July–November 1868 (221), is arranged chronologically. The March 1868 section relates to business transacted by those who had complaints concerning labor, labor contracts, and crime. The July–November 1868 section relates to daily office paperwork.	
	Volume (221)	Mar. 1868 and July–Nov. 1868
	<i>Miscellaneous Receipts and Certificates of Payment</i> Unbound miscellaneous receipts and certificates of payment, August 1866–February 1868, are unarranged.	Aug. 1866–Feb. 1868
	<i>Monthly Statements of Accounts Current</i> Unbound monthly statements of accounts current, January 1867–November 1868, are arranged chronologically.	Jan. 1867–Nov. 1868
	<i>Miscellaneous Records</i> Unbound miscellaneous records, December 1865–October 1868, are arranged by type of record. Included are returns of school property (October 1868); a special order (April 1868); and a report of sick and wounded (December 1865).	Dec. 1865–Oct. 1868



NATIONAL ARCHIVES AND RECORDS ADMINISTRATION  
MICROFILM PUBLICATIONS

ROLL	DESCRIPTION	DATES
64	<b>BAYOU SARA (AGENT AND ASSISTANT SUBASSISTANT COMMISSIONER)</b>	

(cont.) *Registers of Letters Sent*

The two volumes of registers of letters sent, May 1867–June 1868, 1 (231) and 2 (470) are arranged chronologically. Letters entered in the volumes are in volume 2 (228) and 5 (469) of the letters sent, January 1866–December 1868, described below.

Volume 1 (231)	May 1867–Mar. 1868
Volume 2 (470)	Mar.–June 1868

*Letters Sent*

The five volumes of letters sent, 1 (227), 2 (228), 3 (468), 4 (229), and 5 (469), cover the period January 1866–December 1868. Entries in volume 1 (227) are arranged in chronological order and numbered, and the remaining entries are arranged chronologically. Each volume has a name index. Entries in Volume 2 (228) also cross reference a case book, which is a single-volume register of complaints, May 1867–August 1868 (234), described below. Volume 4 (229) also contains a **list of contracts** for 1868 arranged numerically, and a **register of complaints** dated January 1866–May 1867, arranged numerically by case number. The name index to letters sent in this volume also indexes the complaints.

Volume 1 (227)	Jan. 1866–May 1867
Volume 2 (228)	May–Dec. 1867
Volume 3 (468)	Dec. 1867–Apr. 1868
Volume 4 (229)	Jan. 1866–Mar. 1867
	Feb.–Mar. 1868
Volume 5 (469)	Mar.–Dec. 1868

*Letters Sent*

Unbound letters sent, September 1866–July 1867, are unarranged.

Sept. 1866–July 1867

*Register of Letters and Circulars Received*

The single-volume register of letters and circulars received, January–April 1867 (466), is arranged chronologically. This volume also contains **letters sent**, October 1867–April 1868, that relate to contracts with freedmen. These letters are not duplicated in the five-volume series of letters sent described above.

Volume (466)	Jan.–Apr. 1867
--------------	----------------

*Registers of Letters Received*

The two volumes of registers of letters received, May 1867–November 1868, 1 (226) and 2 (467), are arranged chronologically by date received, and each volume has a name index. Volume 1 (226) also contains a **register of property issued**, March–June 1868, arranged chronologically.

Volume 1 (226)	May 1867–June 1868
Volume 2 (467)	Apr.–Nov. 1868



NATIONAL ARCHIVES AND RECORDS ADMINISTRATION  
MICROFILM PUBLICATIONS

ROLL	DESCRIPTION	DATES
65	<i>Unregistered Letters Received</i> Unbound unregistered letters received, December 1865–December 1868, are arranged chronologically by date received.	Dec. 1865–Dec. 1868
66	<i>Endorsements Received</i> The single volume of endorsements received, April–May 1868 (230), is arranged chronologically and has a name index. Entries in the volume cross reference letters sent in volume 5 (469) of the five-volume series of letters sent, January 1866–December 1868, described above.  Volume (230)	Apr.–May 1868
	<i>Monthly School Reports</i> Unbound monthly school reports, May 1866–October 1868, are arranged chronologically.	May 1866–Oct. 1868
	<i>Monthly Inspection Reports</i> Unbound monthly inspection reports, February 1866–October 1868, are arranged chronologically.	Feb. 1866–Oct. 1868
	<i>Reports of Persons and Articles Hired</i> Unbound reports of persons and articles hired, April 1866–October 1868, are arranged chronologically.	Apr. 1866–Oct. 1868
	<i>Monthly Reports of Cases Tried and Fines Imposed</i> Unbound monthly reports of cases tried and fines imposed, September–December 1866, are arranged chronologically.	Sept.–Dec. 1866
	<i>Miscellaneous Court Records and Complaints</i> Unbound miscellaneous court records and complaints, September 1865–November 1868, are arranged by case.	Sept. 1865–Nov. 1868
	<i>Register of Complaints</i> The single-volume register of complaints, May 1867–August 1868 (234), is arranged chronologically.  Volume (234)	May 1867–Aug. 1868



NATIONAL ARCHIVES AND RECORDS ADMINISTRATION  
MICROFILM PUBLICATIONS

ROLL	DESCRIPTION	DATES
66 (cont.)	<i>Indentures</i> Unbound indentures, December 1865–May 1868, are unarranged.	Dec. 1865–May 1868
	<i>Miscellaneous Records Relating to Supplies</i> Unbound miscellaneous records relating to supplies, March 1867–November 1868, are arranged by type of record. Included are affidavits of planters desiring supplies, monthly reports of supplies issued planters, planters' bonds and receipts for supplies, and monthly returns of quartermaster stores.	Mar. 1867–Nov. 1868
	<i>Accounts with Planters for Supplies Furnished</i> The single volume of "Accounts with Planters for Supplies Furnished," March–November 1868 (232), is arranged by name of planter and thereunder chronologically. It has a name index.	
	Volume (232)	Mar.–Nov. 1868
	<i>Returns of School Property</i> Unbound returns of school property, May 1866–October 1868, are arranged chronologically.	May 1866–Oct. 1868
	<i>Monthly Returns of Clothing, Camp, and Garrison Equipage</i> Unbound monthly returns of clothing, camp, and garrison equipage, January–July 1867, are arranged chronologically.	Jan.–July 1867
	<i>Soldiers' Claims for Bounty</i> Seven unbound soldiers' claims for bounty are dated December 1867.	Dec. 1867
	<i>Bills of Lading</i> Unbound bills of lading, March 1866–November 1868, are arranged chronologically.	Mar. 1866–Nov. 1868
	<i>Accounts with Freedmen</i> The single volume of accounts with freedmen, July 1866–November 1867 (233), is arranged by name of freedman and thereunder chronologically.	
	Volume (233)	July 1866–Nov. 1867



NATIONAL ARCHIVES AND RECORDS ADMINISTRATION  
MICROFILM PUBLICATIONS

ROLL	DESCRIPTION	DATES
67	<i>Accounts Current and Summary Statements</i> Unbound accounts current and summary statements, April 1866–October 1868, are arranged chronologically.	Apr. 1866–Oct. 1868
	<i>Miscellaneous Records Relating to Accounts</i> Unbound miscellaneous records relating to accounts, January 1866–January 1868, are arranged by type of record. Included are receipts, due bills, orders for payment of money, and bills of sale.	Jan. 1866–Jan. 1868
	<i>Miscellaneous Records</i> Unbound miscellaneous records, May 1866–August 1868, are arranged by type of record. Included are reports of indigent freedmen in West Feliciana Parish, September–October 1866; a statement of actual expenses for services rendered, May 1866; a statement of crops, August 1868; and a certificate of rental, Bayou Sara, January 1867.	May 1866–Aug. 1868
	<b>BRAGG HOME COLONY (ASSISTANT SUPERINTENDENT OF FREEDMEN)</b> <i>Letters, Telegrams, Special Orders, Circulars and Endorsements Received</i> The single volume of letters, telegrams, special orders, circulars, and endorsements received, February–December 1865 (168), is arranged chronologically with a name index.	Volume (168) Feb.–Dec. 1865
	<i>Register of Arrivals and Departures</i> The single-volume register of arrivals and departures, April–November 1865 (167), is arranged by arrival or departure and thereunder arranged in chronological order and numbered.	Volume (167) Apr.–Nov. 1865
	<i>Register of Rations and Clothing Issued</i> The single-volume register of rations and clothing issued, March–November 1865 (166), is arranged chronologically. The volume also contains a register of clothing issued for Freedmens Home Colony, by R. K. Diossy, March–November 1865, arranged by person to whom clothing was issued and thereunder chronologically. Also included is a register of clothing issued for Bragg Home Colony, October 1865, arranged by person to whom issued and thereunder chronologically. The volume has a name index.	Volume (166) Mar.–Nov. 1865



NATIONAL ARCHIVES AND RECORDS ADMINISTRATION  
MICROFILM PUBLICATIONS

ROLL	DESCRIPTION	DATES
67 (cont.)	<i>Register of Marriages</i> The single-volume register of marriages, March–September 1865 (165) is arranged in chronological order and numbered.	
	Volume (165)	Mar.–Sept. 1865
	<i>Register of Applications for Laborers</i> The single-volume register of applications for laborers, March–October (164), is arranged chronologically. The volume also contains a <b>register of complaints</b> , March–October, arranged chronologically. No year is given in either register.	
	Volume (164)	Mar.–Oct. (No Year)
<b>BRASHEAR CITY (SEE FRANKLIN)</b>		
<b>CARROLLTON (AGENT AND ASSISTANT SUBASSISTANT COMMISSIONER)</b>		
	<i>Register of Letters Sent</i> The single-volume register of letters sent, June–December 1868 (239), is arranged chronologically and has a name index.	
	Volume (239)	June–Dec. 1868
	<i>Registers of Letters Received</i> The three volumes of registers of letters received, May–August 1867 and March–December 1868, 1 (236), 2 (237), and 3 (238), are arranged chronologically by date received. Each volume has a name index. Volume 2 (237) also contains <b>letters sent</b> , April–August 1867 and March 1868, arranged chronologically, with a name index.	
	Volume 1 (236)	May–Aug. 1867
	Volume 2 (237)	Mar.–May 1868
	Volume 3 (238)	June–Dec. 1868
	<i>Complaints</i> The two volumes of complaints, April–October 1868, 1 (240) and 2 (241), are arranged chronologically.	
	Volume 1 (240)	June–Oct. 1868
	Volume 2 (241)	Apr. –May 1868
	<i>“Journal of Business” Relating to Complaints and Paperwork</i> The single-volume “Journal of Business,” April 1867–April 1868 (242), is arranged chronologically and has a name index.	
	Volume (242)	Apr. 1867–Apr. 1868



NATIONAL ARCHIVES AND RECORDS ADMINISTRATION  
MICROFILM PUBLICATIONS

ROLL	DESCRIPTION	DATES
67	<i>Register of Residents</i>	
(cont.)	The single-volume register of residents (154) is undated and arranged by initial letter of surname and thereunder by "resident" or "nonresident" of Carrollton.	
	Volume (154)	Undated

68	<i>Tax Receipts</i>	
	The single volume of tax receipts (151) is dated 1864 and arranged numerically.	
	Volume (151)	1864

**CHOFIELD PLANTATION (SEE NEW ORLEANS)**

**CLINTON (AGENT AND ASSISTANT SUBASSISTANT COMMISSIONER)**

*Letters Sent*

The four volumes of letters sent, June–August 1866, May 1867–June 1868, and August–December 1868, 1 (245), 2 (246), 3 (247), and 4 (248), are arranged in chronological order and numbered. Each volume has a name index. The letters dated August 8–September 26, 1868, numbered 83–125, are duplicated in volume 4 (248). Also in volume 1 (245) are letters sent, June–August 1866; **endorsements sent**, May–July 1868; and a **register of complaints**, October–December 1867.

Volume 1 (245)	June–Aug. 1866
Volume 2 (246)	May–Dec. 1867
Volume 3 (247)	Jan.–June 1868
Volume 4 (248)	Aug.–Dec. 1868

*Registers of Letters Received*

The two volumes of registers of letters received, May 1867–July 1868, 1 (243) and 2 (244), are arranged chronologically by date received, and each volume has a name index. Volume 1 (243) also has endorsements received.

Volume 1 (243)	May 1867–Jan. 1868
Volume 2 (244)	Jan.–July 1868

69 *Registered Letters Received*

Unbound registered letters received, May 1867–June 1868, are arranged numerically by page number. The letters are registered in the two volumes of registers of letters received described above.

May 1867–June 1868

*Unregistered Letters Received*

Unbound unregistered letters received, February 1866–December 1868, are arranged chronologically by date received.

Feb. 1866–Dec. 1868



NATIONAL ARCHIVES AND RECORDS ADMINISTRATION  
MICROFILM PUBLICATIONS

ROLL	DESCRIPTION	DATES
69 (cont.)	<i>Trimonthly Reports of Operations Sent</i> The two volumes of trimonthly reports of operations sent, January 1867–February 1868, 1 (249) and 2 (250), are arranged in chronological order and numbered. Each volume has a name index.	
	Volume 1 (249)	Jan.–Dec. 1867
	Volume 2 (250)	Jan.–Feb. 1868
	<i>Monthly Inspection Reports</i> Unbound monthly inspection reports, May 1866–November 1868, are arranged chronologically.	May 1866–Nov. 1868
	<i>Monthly School Reports of District Superintendent</i> Unbound monthly school reports of the district superintendent, February 1867–October 1868, are arranged chronologically.	Feb. 1867–Oct. 1868
	<i>Monthly School Reports of Agent</i> Unbound monthly school reports of the agent, February–November 1868, are arranged chronologically.	Feb.–Nov. 1868
	<i>Monthly Reports of Persons and Articles Hired</i> Unbound monthly reports of persons and articles hired, May 1866–September 1868, are arranged chronologically.	May 1866–Sept. 1868
	<i>Register of Complaints</i> The single-volume register of complaints, January–April 1868 (252) is arranged chronologically and has a name index. For a register of complaints dated October–December 1867, see volume 1 (245) of the four volumes of letters sent May 1867–December 1868, described above.	
	Volume (252)	Jan.–Apr. 1868
	<i>“Daily Journal” of Business Relating to Complaints and Paperwork</i> The single-volume “daily journal” of business relating to complaints and paperwork, May–October 1867 (251), is arranged chronologically and has a name index.	
	Volume (251)	May–Oct. 1867



NATIONAL ARCHIVES AND RECORDS ADMINISTRATION  
MICROFILM PUBLICATIONS

ROLL	DESCRIPTION	DATES
69 (cont.)	<i>Monthly Reports of Indigents and Destitutes</i> Unbound monthly reports of indigents and destitutes, October 1866–May 1868, are arranged chronologically.	Oct. 1866–May 1868
70	<i>Monthly Returns of School Property</i> Unbound monthly returns of school property, June 1866–August 1868, are arranged chronologically.	June 1866–Aug. 1868
	<i>Monthly School Reports of Receipts and Expenditures</i> Unbound monthly school reports of receipts and expenditures, June 1866–December 1868, are arranged chronologically.	June 1866–Dec. 1868
	<i>Records Relating to Supplies</i> Unbound records relating to supplies, dated 1868, are arranged by type of record. Included are applications and affidavits of planters for supplies, bonds of planters for supplies, monthly reports of supplies issued planters, and receipts for supplies.	1868
	<i>Accounts with Planters for Supplies Furnished</i> The single volume of accounts with planters for supplies furnished, March–October 1868 (253), is arranged by name of planter and thereunder chronologically. It has a name index.	Mar.–Oct. 1868
	<i>Miscellaneous Records</i> Unbound miscellaneous records, April 1867–October 1868, are arranged by type of record. Included are a statement of crops on plantations, undated; bills of lading, April 1867 and July–Oct. 1868; and indentures, April 1868.	Apr. 1867–Oct. 1868
	<b>COLUMBIA (AGENT AND ASSISTANT SUBASSISTANT COMMISSIONER)</b>	
	<i>Letters Sent</i> The four volumes of letters sent, February 1866–September 1868, 1 (254), 2 (255), 3 (256), and 4 (257), are arranged chronologically. There are name indexes in volumes 3 (256) and 4 (257). Volume 2 (255) also contains a <b>register of contracts</b> , 1866, arranged by name of plantation. Volume 4 (257) also contains <b>complaints</b> , 1868, unarranged; and volume 1(254) also contains a “ <b>day book</b> ” of accounts with freedmen, 1867, arranged by name of freedman and thereunder chronologically.	
	Volume 1 (254)	Feb. 1866–Aug. 1867
	Volume 2 (255)	Aug. 1867–June 1868
	Volume 3 (256)	June 1868–Sept. 1868
	Volume 4 (257)	Sept. 14–15, 1868



NATIONAL ARCHIVES AND RECORDS ADMINISTRATION  
MICROFILM PUBLICATIONS

ROLL	DESCRIPTION	DATES
70 (cont.)	<i>Letters Received</i> Unbound letters received, February 1866–June 1868, are arranged chronologically by date received.	Feb. 1866–Apr. 1867
71	<i>Letters Received (cont.)</i>	May 1867–June 1868
	<i>Monthly Inspection Reports</i> Unbound monthly inspection reports, March 1866–August 1868, are arranged chronologically.	Mar. 1866–Aug. 1868
	<i>Monthly Reports of Persons and Articles Hired</i> Unbound monthly reports of persons and articles hired, February 1866–April 1868, are arranged chronologically.	Feb. 1866–Apr. 1868
	<i>Miscellaneous Reports</i> Unbound miscellaneous reports, May 1867–April 1868, are arranged by type of record. Included are reports showing numbers, sex, and age of “unfortunates,” May 1867, and retained monthly education reports of the agent, February–April 1868.	May 1867–Apr. 1868
	<i>Indentures</i> Unbound indentures, October 1866–August 1867, are arranged chronologically.	Oct. 1866–Aug. 1867
	<i>Applications for Rations for Destitutes</i> Unbound applications for rations for destitutes, May–June 1867 and February–April 1868, are arranged chronologically.	May–June 1867 and Feb.–April 1868
	<i>Miscellaneous Records</i> Unbound miscellaneous records, 1866–68, are arranged by type of record. Included are accounts current and summary statements, affidavits, complaints, bills of lading, receipts, and a list of quartermaster stores.	1866–68

COVINGTON (SEE MADISONVILLE)

DE CROS STATION (SEE JESUITS BEND)



NATIONAL ARCHIVES AND RECORDS ADMINISTRATION  
MICROFILM PUBLICATIONS

ROLL	DESCRIPTION	DATES
71	<b>DONALDSONVILLE (AGENT)</b>	
(cont.)	<i>Letters Sent by the Agent for the Parish of Ascension</i>	
	The two volumes of letters sent by the agent for the Parish of Ascension, June–October 1866, 1 (260) and 2 (261), are arranged chronologically. There is a name index in volume 2 (261). Volume 1 (260) also contains <b>registers of applications</b> for relief from destitute whites and blacks (undated); a register of applications for relief (Oct. 1866–June 1868); a register of discharges (Feb. 1865–Apr. 1866); a <b>register of marriage licenses</b> (Aug. 1863–Feb. 1864) and <b>orders issued</b> (Jan.–Aug. 1863). Volume 261 also contains a <b>register of indigents</b> (1868), a <b>register of discharges</b> (1867), a <b>register of indentures</b> (undated), and a <b>complaint</b> (Sept. 1868).	
	Volume 1 (260)	June–Aug. 1866
	Volume 2 (261)	Aug.–Oct. 1866
	<i>Unregistered Letters Received</i>	
	Unbound unregistered letters received, February–October 1866, are arranged chronologically.	
		Feb.–Oct. 1866
	<i>Reports of Cases Tried and Fines Imposed</i>	
	Unbound reports of cases tried and fines imposed, March–October 1866, are arranged chronologically.	
		Mar.–Oct. 1866
	<i>Records of Industrial Farm at Miles Taylor Plantation</i>	
	The single volume of records of the industrial farm at Miles Taylor Plantation, April 1864–July 1865 (268), is arranged by type of record. Included are letters and orders received, letters sent, and weekly work reports, including field, carpentry, and blacksmith work. Mr. T. M. Bentley was in charge.	
	Volume (268)	Apr. 1864–July 1865
72	<i>Tax Rolls</i>	
	Unbound tax rolls are dated ca. 1865 and are unarranged.	
		ca. 1865
	<i>Miscellaneous Records</i>	
	Unbound miscellaneous records, 1865–66, are arranged by type of record. Included are inspection reports, accounts current, bills of lading, returns of school property, reports of persons and articles hired, and payrolls of laborers employed.	
		1865–66



NATIONAL ARCHIVES AND RECORDS ADMINISTRATION  
MICROFILM PUBLICATIONS

ROLL DESCRIPTION

DATES

72 DONALDSONVILLE (AGENT AND ASSISTANT SUBASSISTANT  
(cont.) COMMISSIONER)

*Letters Sent*

The three volumes of letters sent, April 1866–December 1868, 1 (262), 2 (263), and 3 (264) are arranged chronologically and each volume has a name index. Volume 1 (262) also contains letters received, May 1866–Apr. 1867, which are arranged chronologically.

Volume 1 (262)	Apr. 1866–Apr. 1867
Volume 2 (263)	Apr. 1867–Apr. 1868
Volume 3 (264)	Apr.–Dec. 1868

*Endorsements Sent and Received*

The single volume of endorsements sent and received is dated April 1867–September 1868 (265). Entries dated April 1867–February 1868, are arranged in chronological order and numbered. Entries dated March–September 1868 are arranged chronologically. The volume has a name index.

Volume (265)	Apr. 1867–Sept. 1868
--------------	----------------------

*Letters Received*

The single volume of letters received, April 1867–September 1868 (258), are arranged chronologically and the volume has a name index. For letters received, May 1866–April 1867, see volume 1 (262) of the three-volume series of letters sent, April 1866–December 1868 described above. For a register of letters received, September–December 1868, see the single-volume register of letters received (259) described below.

Volume (258)	Apr. 1867–Sept. 1868
--------------	----------------------

*Register of Letters Received*

The single-volume register of letters received, September–December 1868 (259), includes endorsements and is arranged chronologically. The volume has a name index. For letters received, see the unbound registered letters received, September–December 1868, described below. For other letters received, see volume 1 (262) of letters sent and volume (258) letters received listed above. The volume also contains a **register of contracts** approved, 1866, arranged numerically; a **register of payrolls** approved, 1866, arranged chronologically by date approved; **accounts of the agent** with the quartermaster department, June 1866–March 1867, arranged chronologically; **complaints**, 1867, arranged numerically; and **accounts of planters**, December 1866–February 1867, arranged chronologically.

Volume (259)	Sept.–Dec. 1868
--------------	-----------------



NATIONAL ARCHIVES AND RECORDS ADMINISTRATION  
MICROFILM PUBLICATIONS

ROLL	DESCRIPTION	DATES
72	<i>Registered Letters Received</i>	
(cont.)	Unbound registered letters received, September–December 1868, are arranged numerically by page number. The letters are entered in the single-volume register of letters received (259) described above.	
		Sept.–Dec. 1868
	<i>Unregistered Letters Received</i>	
	Unbound unregistered letters received, April 1866–December 1868, are arranged chronologically by date received.	
		Apr. 1866–Oct. 1867
73	<i>Unregistered Letters (cont.)</i>	Jan.–Dec. 1868
	<i>General and Special Orders Issued</i>	
	The single volume of general and special orders issued, June 1866–May 1867 (266), is arranged chronologically. The volume also contains an unidentified <b>name index</b> and <b>accounts with schoolteachers</b> , May 1866–August 1868, arranged chronologically.	
	Volume (266)	June 1866–May 1867
	<i>District Superintendents School Reports</i>	
	Unbound district superintendents school reports, January–October 1868, are arranged chronologically.	
		Jan.–Oct. 1868
	<i>Registers of Black Persons</i>	
	Unbound registers of black persons are undated and arranged by parish.	
		Undated
	<i>Court Cases</i>	
	The single volume of court cases, November 1866 (267), is arranged in chronological order and numbered. The volume also contains a “ <b>Journal of Business</b> ,” April 1867–December 1868, arranged chronologically, and a <b>register of rations</b> , June 1866 and July 1867, arranged in general chronological order.	
	Volume (267)	Nov. 1866
	<i>Miscellaneous Records Relating to Court Cases</i>	
	Unbound miscellaneous records relating to court cases, April 1866–February 1868, are unarranged.	
		Apr. 1866–Feb. 1868



NATIONAL ARCHIVES AND RECORDS ADMINISTRATION  
MICROFILM PUBLICATIONS

ROLL	DESCRIPTION	DATES
73	<i>Miscellaneous Records</i>	
(cont.)	Unbound miscellaneous records, 1866-68, are arranged by type of record. Included are inspection reports, receipts relating to school property, reports of persons and articles hired, bills of lading, accounts current, papers relating to the issuance of rations to destitutes, requisitions for forage, indentures, and abstracts. For a register of applications for relief, see volume 1 (260). For a register of indigents, a register of discharges, a register of indentures, and complaints, see volume 2 (261) above.	
		1866-68
74	<b>EVERGREEN (SEE MARKSVILLE)</b>	
	<b>FRANKLIN (SUBASSISTANT COMMISSIONER OF THE 3RD SUBDISTRICT)</b>	
	<i>Letters Sent</i>	
	The two volumes of letters sent, June 1867-December 1868, 1 (272) and 2 (273), are arranged in chronological order and numbered. There are name indexes for each volume.	
	Volume 1 (272)	June-Dec. 1867
	Volume 2 (273)	Jan.-Dec. 1868
	<i>Endorsements Sent</i>	
	The three volumes of endorsements sent, June 1867-December 1868, 1 (278), 2 (279), and 3 (280), are arranged chronologically. There is a name index in volume 1 (278).	
	Volume 1 (278)	June-Dec. 1867
	Volume 2 (279)	Jan.-June 1868
	Volume 3 (280)	June-Dec. 1868
	<i>Registers of Letters Received</i>	
	The two volumes of registers of letters received, June 1867-December 1868, 1 (269) and 2 (270), include endorsements. Volume 1 (269) is arranged alphabetically by initial letter of surname of writer and thereunder arranged in chronological order and numbered. Volume 2 (270) is arranged in chronological order and numbered. Both volumes have name indexes.	
	Volume 1 (269)	June 1867-Jan. 1868
	Volume 2 (270)	Jan.-Dec. 1868
	<i>Registered Letters Received</i>	
	Unbound registered letters received, June 1867-December 1868, are arranged as the registers of letters received, June 1867-December 1868, described above.	
	A-V	1867



NATIONAL ARCHIVES AND RECORDS ADMINISTRATION  
MICROFILM PUBLICATIONS

ROLL	DESCRIPTION	DATES
75	<i>Registered Letters Received</i> (cont.) 12-801	1868
	<i>Unregistered Letters Received</i> Unbound unregistered letters received, March-December 1868, are arranged chronologically by date received.	Mar.-Dec. 1868
	<i>Monthly Reports</i> The single volume of monthly reports, June 1867-March 1868 (284), is arranged chronologically. The volume also contains one special report, June 14, 1868.	
	Volume (284)	June 1867-Mar. 1868
	<i>Monthly and Special Reports</i> The single volume of monthly and special reports, May-December 1868 (285), is arranged by type of report and thereunder chronologically and has a name index.	
	Volume (285)	May-Dec. 1868
	<i>Reports of Persons and Articles Hired</i> Unbound reports of persons and articles hired, June 1867-December 1868, are arranged chronologically.	
		June 1867-Dec. 1868
	<i>"Journal of Business" Transacted</i> The single-volume "Journal of Business" transacted, June 1867-May 1868 (282), is arranged chronologically.	
	Volume (282)	June 1867-May 1868
<b>FRANKLIN (AGENT AND ASSISTANT SUBASSISTANT COMMISSIONER)</b>		
	<i>Letters Sent</i> The four volumes of letters sent, 1 (274), 2 (275), 3 (276), and 4 (277), cover the period January 1867-December 1868. Volume 1 (274) is arranged chronologically. Volumes 2 (275), 3 (276), and 4 (277) are arranged in chronological order and numbered. There are name indexes in volumes 1 (274), 3 (276), and 4 (277). Volume 4 (277) also contains a "Journal of Business" (June-December 1867), arranged chronologically.	
	Volume 1 (274)	Jan.-June 1867
	Volume 2 (275)	July-Dec. 1867
	Volume 3 (276)	Jan.-Sept. 1868
	Volume 4 (277)	Sept.-Dec. 1868



NATIONAL ARCHIVES AND RECORDS ADMINISTRATION  
MICROFILM PUBLICATIONS

ROLL	DESCRIPTION	DATES
75	<i>Endorsements Sent and Received</i>	
(cont.)	The single volume of endorsements sent and received, June 1867–December 1868 (281), is arranged chronologically and has a name index.	
	Volume (281)	June 1867–Dec. 1868
	<i>Register of Letters Received</i>	
	The single-volume register of letters received, July 1867–December 1868 (271), is arranged in chronological order by date received and numbered. There is a name index in the volume. The volume includes <b>letters received</b> , June 1867.	
	Volume (271)	July 1867–Dec. 1868
	<i>Registered Letters Received</i>	
	Unbound registered letters received, June 1867–December 1868, are arranged as the registers in volume (271) described above.	
		June 1867–Jan. 1868
76	<i>Registered Letters (cont.)</i>	Jan.–Dec. 1868
	<i>Unregistered Letters Received</i>	
	Unbound unregistered letters received, January 1865–December 1868, are arranged chronologically by date received.	
		Jan. 1865–Apr. 1867
77	<i>Unregistered Letters (cont.)</i>	May 1867–Dec. 1868
	<i>Narrative Trimonthly Reports of Business Transacted</i>	
	Unbound narrative trimonthly reports of business transacted, January–May 1866, are arranged chronologically.	
		Jan.–May 1866
	<i>Trimonthly Reports</i>	
	The single volume of trimonthly reports, July–December 1868 (286), is arranged chronologically, and has a name index.	
	Volume (286)	July–Dec. 1868
	<i>Monthly Inspection Reports</i>	
	Unbound monthly inspection reports, March 1866 and February 1867–December 1868, are arranged chronologically.	
		Mar. 1866; Feb. 1867–Dec. 1868



NATIONAL ARCHIVES AND RECORDS ADMINISTRATION  
MICROFILM PUBLICATIONS

ROLL	DESCRIPTION	DATES
77 (cont.)	<i>Monthly School Reports of District Superintendents</i> Unbound monthly school reports of district superintendents, January 1867–December 1868, are arranged chronologically.	Jan. 1867–Dec. 1868
	<i>Monthly School Reports of Agents</i> Unbound monthly school reports of agents, March–December 1868, are arranged chronologically.	Mar.–Dec. 1868
	<i>Monthly School Reports of Receipts and Expenditures</i> Unbound monthly school reports of receipts and expenditures, October 1866–September 1868, are arranged chronologically.	Oct. 1866–Sept. 1868
	<i>Property Reports of Schools</i> Unbound property reports of schools, November 1865–December 1868, are arranged chronologically.	Nov. 1865–Dec. 1868
	<i>Monthly Reports of Persons and Articles Hired</i> Unbound monthly reports of persons and articles hired, May 1866–May 1867, are arranged chronologically.	May 1866–May 1867
	<i>Court Records</i> Unbound court records, July 1864–November 1867, are unarranged.	July 1864–Nov. 1867
	<i>Register of Complaints</i> The single-volume register of complaints, February–June 1867 (288), is arranged chronologically and has a name index. The volume also contains <b>accounts</b> with the school at Bayou Cypres Mort, August–December 1867, arranged chronologically; <b>accounts</b> with the school at Franklin, April–December 1867, arranged chronologically; and a <b>list of Bureau stationary allowance</b> undated and unarranged.	Volume (288) Feb.–June 1867
	<i>Registers of Complaints</i> The two volumes of registers of complaints, June 1867–July 1868, 1 (289) and 2 (290), are arranged chronologically.	Volume 1 (289) June 1867–July 1868 Volume 2 (290) Feb.–May 1868



NATIONAL ARCHIVES AND RECORDS ADMINISTRATION  
MICROFILM PUBLICATIONS

ROLL	DESCRIPTION	DATES
77 (cont.)	<i>Indentures</i> Unbound indentures cover the period November 1865–July 1868 and are arranged chronologically.	Nov. 1865–July 1868
78	<i>Applications for Rations</i> Unbound applications for rations, May–September 1867 and January–April 1868, are arranged chronologically.	May–Sept. 1867; Jan.–Apr. 1868
	<i>Miscellaneous Records Relating to the Issuance of Rations to Destitutes</i> Unbound miscellaneous records relating to the issuance of rations to destitutes, April 1867–July 1868, are arranged chronologically.	Apr. 1867–July 1868
	<i>Monthly Returns of Stores and Reports of Clothing Issued and Received</i> Unbound monthly returns of stores and reports of clothing issued and received, January–July 1868, are arranged chronologically.	Jan.–July 1868
	<i>“Journal of Business”</i> The single-volume “Journal of Business,” November–December 1868 (283), is arranged chronologically. The volume also contains a “report of indigent and destitute whites and freed people in the Parish of St. Mary, Louisiana, applying for relief,” February–March 1868, arranged chronologically. For a “journal of business,” June–December 1867, see volume 4 (277) of the letters sent, January 1867–December 1868.	Nov.–Dec. 1868
	<i>Bills of Lading</i> Unbound bills of lading, December 1865–October 1868, are arranged chronologically.	Dec. 1865–Oct. 1868
	<i>Register of Taxes Collected for Schools</i> The single-volume register of taxes collected for schools, April–December 1867 (291), is arranged by school. The volume also includes a register (undated) arranged by initial letter of surname, containing a list of names, acreage and number of family.	Apr.–Dec. 1867



NATIONAL ARCHIVES AND RECORDS ADMINISTRATION  
MICROFILM PUBLICATIONS

ROLL	DESCRIPTION	DATES
78 (cont.)	<i>Accounts with Freedmen Relating to Schools</i> The single volume of accounts with freedmen relating to schools, April 1867–May 1868 (287), is arranged chronologically.	
	Volume (287)	Apr. 1867–May 1868
	<i>Accounts Current</i> Unbound accounts current, January 1865, March 1866, and January–December 1868, are arranged chronologically.	
		Jan. 1865; Mar. 1866; Jan.–Dec. 1868
	<i>Miscellaneous Records</i> Unbound miscellaneous records, January 1865–May 1868, are arranged by type of record. The records include invoices (January 1865–August 1866); lists of property (October 1865–January 1866); abstracts (September 1865–February 1868); and a list of clothing issued destitutes (undated). Also included are affidavits (April 1865); receipts (January 1866–March 1867); letters sent (September 1865–May 1866); lists of children (undated); monthly reports of numbers issued rations, clothing, and medicines (August 1866); reports of acres under cultivation, number of hands, number of schools (undated); and reports of indigents (May 1868).	
		Jan. 1865–May 1868
79	<b>GREENVILLE COLONY (SUPERINTENDENT)</b> <i>Register for Contrabands</i> The single-volume “register for contrabands,” July 1862–December 1863 (169), is arranged numerically. The volume also contains a register for contrabands (April 13, 1863), an unidentified list (August 1865), and an unidentified register arranged numerically that contains names and information on number of days worked, amount received and amount due (undated). In addition there is an unidentified list of names (undated) and a register of clothing issued, June 1865.	
	Volume (169)	July 1862–Dec. 1863
	<b>HAMMOND STATION (AGENT AND ASSISTANT SUBASSISTANT COMMISSIONER)</b> <i>Letters Sent</i> For letters sent and received, May–July 1866, see volume 1 (330) of the letters sent, October 1866–December 1868, that also includes these letters.  The two volumes of letters sent, July 1867–April 1868 and June–August 1868, 1 (298) and 2 (299), are arranged chronologically. Volume 2 (299) also contains <b>indentures, contracts, and complaints</b> , May–November 1867, arranged chronologically, and a “Journal of Business,” April 1868, arranged chronologically.	
	Volume 1 (298)	July 1867–Apr. 1868
	Volume 2 (299)	June–Aug. 1868



NATIONAL ARCHIVES AND RECORDS ADMINISTRATION  
MICROFILM PUBLICATIONS

ROLL	DESCRIPTION	DATES
79	<i>Letters Received</i>	
(cont.)	The single volume of letters received, July–November 1867 and June–July 1868 (297), is arranged chronologically. The volume also contains a register of letters received, April 1868, arranged chronologically.	
	Volume (297)	July–Nov. 1867; June–July 1868
	<i>Letters Received</i>	
	Unbound letters received, July–November 1867, are arranged chronologically by date received.	
		July–Nov. 1867
	<i>Endorsements Received</i>	
	The single volume of endorsements received, April–June 1868 (300), is arranged chronologically.	
	Volume (300)	Apr.–June 1868
	<i>Court Cases Settled</i>	
	Unbound court cases settled, April 1866–August 1867, are arranged chronologically.	
		Apr. 1866–Aug. 1867
	<i>Bills of Lading</i>	
	Unbound bills of lading, June–October 1867, are arranged chronologically.	
		June–Oct. 1867
	<i>Miscellaneous Records</i>	
	Unbound miscellaneous records, April–June 1866, are arranged by type of record. Included are indentures (April–June 1866), and retained monthly inspection reports, May–June 1866.	
		Apr.–June 1866
	<b>HOMER (ASSISTANT SUBASSISTANT COMMISSIONER)</b>	
	<i>Letters Received</i>	
	Unbound letters received, November–December 1866 and October 1867–December 1868, are arranged chronologically by date received.	
		Nov.–Dec. 1866; Oct. 1867–Dec. 1868



- 1

NATIONAL ARCHIVES AND RECORDS ADMINISTRATION  
MICROFILM PUBLICATIONS

ROLL	DESCRIPTION	DATES
79	<i>Miscellaneous Records</i>	
(cont.)	Unbound miscellaneous records, October 1867–December 1868, are arranged by type of record. Included are retained copies of letters sent (March–December 1868), trimonthly narrative reports of operations (January–December 1868), bills of lading (May–July 1868), monthly school reports of agents (April and September 1868), and monthly inspection reports (May and July 1868). There are also affidavits (October 1867 and January 1868), a list of stores transferred (January 1868), and a list of freedmen discharged for voting the radical ticket, April 1868.	
		Oct. 1867–Dec. 1868
	<b>HOUMA (AGENT AND ASSISTANT SUBASSISTANT COMMISSIONER)</b>	
	<i>Letters Sent</i>	
	The two volumes of letters sent, December 1865–December 1868, 1 (294) and 2 (295), are arranged in chronological order and numbered. Each volume has a name index.	
	Volume 1 (294)	Dec. 1865–Aug. 1868
	Volume 2 (295)	Sept.–Dec. 1868
	<i>Endorsements Sent and Received</i>	
	The single volume of endorsements sent and received, December 1865–October 1868 (292), is arranged chronologically and has a name index. The volume also contains a <b>register of orders received</b> , January–October 1868.	
	Volume (292)	Dec. 1865–Oct. 1868
	<i>Register of Letters Received</i>	
	The single-volume register of letters received, July 1865–August 1868 (293), is arranged chronologically and has a name index. For the actual letters received, see the unbound registered letters received, January 1866–October 1867, described below.	
	Volume (293)	July 1865–Aug. 1868
	<i>Registered Letters Received</i>	
	Unbound registered letters received, January 1866–October 1867, are arranged in chronological order by date received and numbered. The letters are entered in the single-volume register of letters received (293) described above.	
		Jan. 1866–Oct. 1867
80	<i>Unregistered Letters Received</i>	
	Unbound unregistered letters received, December 1865–December 1868, are arranged chronologically by date received.	
		Dec. 1865–Dec. 1868



NATIONAL ARCHIVES AND RECORDS ADMINISTRATION  
MICROFILM PUBLICATIONS

ROLL	DESCRIPTION	DATES
80 (cont.)	<i>Monthly Reports of Inspection</i> Unbound monthly reports of inspection, December 1867–November 1868, are arranged chronologically.	Dec. 1867–Nov. 1868
	<i>Reports of Persons and Articles Hired</i> Unbound reports of persons and articles hired, December 1867–November 1868, are arranged chronologically.	Dec. 1867–Nov. 1868
	<i>Reports of Indigents and Destitutes</i> Unbound reports of indigents and destitutes, January–July 1868, are arranged chronologically.	Jan.–July 1868
	<i>Register of Complaints</i> The single-volume register of complaints, August 1868 (296), is unarranged.	
	Volume (296)	Aug. 1868
	<i>"Journal of Business"</i> The single-volume "journal of business," May 1867–November 1868 (295½), is arranged chronologically.	
	Volume (295½)	May 1867–Nov. 1868
<b>JEFFERSON CITY (SEE CARROLLTON)</b>		
<b>JESUITS BEND (PROVOST MARSHAL, AGENT, AND ASSISTANT SUBASSISTANT COMMISSIONER)</b>		
	<i>Letters and Orders Sent and Received</i> The single volume of letters and orders sent and received, January 1863–November 1865 (540), is arranged chronologically. The volume also contains other <b>miscellaneous lists and registers</b> , such as a <b>register of lessees of plantations</b> and <b>lists of paroled prisoners</b> .	
	Volume (540)	Jan. 1863–Nov. 1865
	<i>Letters Sent</i> The single volume of letters sent, January–August 1868 (302), is arranged chronologically and has a name index.	
	Volume (302)	Jan.–Aug. 1868



NATIONAL ARCHIVES AND RECORDS ADMINISTRATION  
MICROFILM PUBLICATIONS

ROLL	DESCRIPTION	DATES
80 (cont.)	<i>Registers of Letters Received</i> The two volumes of registers of letters received, 1 (534) and 2(301), cover the period December 1865–August 1868. The entries in volume 1 (534) are arranged chronologically. Those in volume 2 (301) are arranged alphabetically by initial letter of surname of correspondent and thereunder chronologically. Volume 2 (301) also contains <b>endorsements sent</b> (August 1864–November 1865) and some <b>miscellaneous lists</b> .	
	Volume 1 (534)	Dec. 1865–May 1868
	Volume 2 (301)	Feb.–Aug. 1868
	<i>Letters Received</i> Unbound letters received, June 1865–August 1868, are arranged chronologically by date received. Some of the letters are entered in volumes 1 (534) and 2 (301) of the registers of letters received described above.	
		June 1865–Aug. 1868
	<i>Inspection Reports</i> Unbound inspection reports, November 1866 and April 1868, are arranged chronologically.	
		Nov. 1866; Apr. 1868
	<i>Returns of School Property</i> Unbound returns of school property, January 1866–August 1868, are arranged chronologically.	
		Jan. 1866–Aug. 1868
	<i>School Reports of Receipts and Expenditures</i> Unbound school reports of receipts and expenditures, May–August 1866, April–June 1867, and January–July 1868, are arranged chronologically.	
		May–Aug. 1866; Apr.–June 1867; Jan.–July 1868
	<i>Reports of Persons and Articles Hired</i> Unbound reports of persons and articles hired, May–July 1867 and January–April 1868, are arranged chronologically.	
		May–July 1867; Jan.–Apr. 1868
	<i>Monthly Returns of Quartermaster Stores</i> Unbound monthly returns of quartermaster stores, September 1866 and May 1867, are arranged chronologically.	
		Sept. 1866; May 1867



NATIONAL ARCHIVES AND RECORDS ADMINISTRATION  
MICROFILM PUBLICATIONS

ROLL	DESCRIPTION	DATES
80	<i>"Journal of Business"</i>	
(cont.)	The single-volume "Journal of Business," January–August 1868 (303), is arranged chronologically.	
	Volume (303)	Jan.–Aug. 1868
	<i>Miscellaneous Records</i>	
	Unbound miscellaneous records dated December 1866–February 1867 consist of three items.	
		Dec. 1866–Feb. 1867
81	<b>KENILWORTH PLANTATION (SEE NEW ORLEANS)</b>	
	<b>LABATUTS LANDING (SEE NEW ROADS)</b>	
	<b>LAKE PROVIDENCE (ASSISTANT SUBASSISTANT COMMISSIONER)</b>	
	<i>Letters Sent</i>	
	The four volumes of letters sent, February 1866–December 1868, 1 (310), 2 (311), 3 (312), and 4 (313), are arranged chronologically, and each volume has a name index. The last letters in volume 1 (310) are duplicated in volume 2 (311).	
	Volume 1 (310)	Feb. 1866–Apr. 1867
	Volume 2 (311)	Jan. 1867–Sept. 1867
	Volume 3 (312)	Sept. 1867–Apr. 1868
	Volume 4 (313)	Apr. –Dec. 1868
	<i>Register of Letters Received and Endorsements Sent and Received</i>	
	The single-volume register of letters received and endorsements sent and received, January–September 1868 (314), is arranged alphabetically by initial letter of surname of correspondent and thereunder chronologically.	
	Volume (314)	Jan.–Sept. 1868
	<i>Letters and Orders Received from the Assistant Commissioner and His Staff</i>	
	The three volumes of letters and orders received from the Assistant Commissioner and his staff, January 1866–December 1868, 1 (305), 2 (307), and 3 (309), are arranged chronologically and each volume has a name index.	
	Volume 1 (305)	Jan.–Dec. 1866
	Volume 2 (307)	Jan. 1867–June 1868
	Volume 3 (309)	June–Dec. 1868



NATIONAL ARCHIVES AND RECORDS ADMINISTRATION  
MICROFILM PUBLICATIONS

ROLL	DESCRIPTION	DATES
81	<i>Letters Received from Local Citizens</i>	
(cont.)	The three volumes of letters received from local citizens, February 1866–December 1868, 1 (304), 2 (306), and 3 (308), are arranged chronologically, and each volume has a name index.	
	Volume 1 (304)	Feb.–Oct. 1866
	Volume 2 (306)	Jan.–Oct. 1867
	Volume 3 (308)	Sept. 1867–Dec. 1868
82	<i>Letters Received</i>	
	Unbound letters received, January 1867–December 1868, are arranged chronologically.	Jan. 1867–Dec. 1868
	<i>Unregistered Letters Received</i>	
	Unbound unregistered letters received, February 1866–October 1868, are arranged chronologically by date received.	Feb. 1866–Oct. 1868
	<i>Orders and Circulars Received</i>	
	Unbound orders and circulars received, February 1866–October 1868, are arranged chronologically.	Feb. 1866–Oct. 1868
	<i>Monthly Inspection Reports</i>	
	Unbound monthly inspection reports, March 1866–October 1867, are arranged chronologically.	Mar. 1866–Oct. 1867
	<i>Miscellaneous School Reports</i>	
	Unbound miscellaneous school reports, May–October 1866, are arranged chronologically.	May–Oct. 1866
	<i>Land Reports</i>	
	Unbound land reports, February–September 1866, are arranged chronologically.	Feb.–Sept. 1866
	<i>Monthly Reports of Persons and Articles Hired</i>	
	Unbound monthly reports of persons and articles hired, April 1867–March 1868, are arranged chronologically.	Apr. 1867–Mar. 1868



NATIONAL ARCHIVES AND RECORDS ADMINISTRATION  
MICROFILM PUBLICATIONS

ROLL	DESCRIPTION	DATES
82	<i>Narrative Trimonthly Reports of Complaints</i> (cont.) Unbound narrative trimonthly reports of complaints, August–December 1867, are arranged chronologically.	Aug.–Dec. 1867
	<i>Monthly Reports of Destitutes</i> Unbound monthly reports of destitutes, May 1867–July 1868, are arranged chronologically.	May 1867–July 1868
	<i>Records Relating to Court Cases</i> Unbound records relating to court cases, February 1866–March 1867, are arranged by type of record. Included are complaints, affidavits, trials, powers of attorney, paroles, and leases.	Feb. 1866–Mar. 1867
83	<i>Indentures</i> Unbound indentures, March 1866–May 1868, are arranged chronologically.	Mar. 1866–May 1868
	<i>Applications for Rations</i> Unbound applications for rations, March 1867–July 1868, are arranged chronologically.	Mar. 1867–July 1868
	<i>“Journal of Business”</i> The single-volume “Journal of Business,” January–December 1867 (315), is arranged chronologically.	Jan.–Dec. 1867
	<i>Accounts with Planters for Supplies Furnished</i> The single volume of accounts with planters for supplies furnished, April–September 1868 (316), is arranged by name of planter and thereunder chronologically. It has a name index.	Apr.–Sept. 1868
	<i>Freedmen’s Accounts Settled</i> Unbound freedmen’s accounts settled, January 1866–October 1867, are arranged chronologically.	Jan. 1866–Oct. 1867







NATIONAL ARCHIVES AND RECORDS ADMINISTRATION  
MICROFILM PUBLICATIONS

ROLL	DESCRIPTION	DATES
84	<i>Register of Letters Received</i> The single-volume register of letters received, July 1867–December 1868 (329), is arranged alphabetically by initial letter of surname of writer and thereunder chronologically.	
	Volume (329)	July 1867–Dec. 1868
	<i>Registered Letters Received</i> Unbound registered letters received, July 1867–October 1868, are arranged by initial letter of surname of correspondent and thereunder arranged in chronological order by date received and numbered.	
		July 1867–Oct. 1868
	<i>Miscellaneous Monthly Reports</i> Unbound miscellaneous monthly reports, November 1867–December 1868, are arranged by type of report and thereunder chronologically. Included are inspection reports, November 1867 and August–October 1868, and reports of persons and articles hired, October–December 1868.	
		Nov. 1867–Dec. 1868
	<i>“Journal of Business”</i> The single-volume “Journal of Business,” April 1867–September 1868 (333), is arranged chronologically.	
	Volume (333)	Apr. 1867–Sept. 1868
	<b>MANSFIELD (ASSISTANT SUBASSISTANT COMMISSIONER)</b>	
	<i>Letters Sent</i> The single volume of letters sent, May–December 1868 (325), is arranged chronologically and has a name index.	
	Volume (325)	May–Dec. 1868
	<i>Register of Letters Received</i> The single-volume register of letters received, June–July 1868 (324), is arranged chronologically by date received. The volume also contains <b>letters received</b> , September–November 1868, arranged chronologically by date received and a name index.	
	Volume (324)	June–July 1868
	<i>Letters Received</i> Unbound letters received, July 1867–November 1868, are arranged chronologically by date received.	
		July 1867–Nov. 1868



NATIONAL ARCHIVES AND RECORDS ADMINISTRATION  
MICROFILM PUBLICATIONS

ROLL	DESCRIPTION	DATES
84 (cont.)	<i>Register of Complaints</i> The single-volume register of complaints, May–November 1868 (327), is arranged chronologically.	
	Volume (327)	May–Nov. 1868
	<i>Register of Marriages</i> The single-volume register of marriages, September–November 1865 (328), is arranged in chronological order and numbered.	
	Volume (328)	Sept.–Nov. 1865
	<i>List of Indigents</i> The single-volume list of indigents, January–May (326), is undated and arranged by initial letter of surname of indigent and thereunder chronologically. There is no year given in the volume.	
	Volume (326)	Jan.–May (No year)
	<i>Miscellaneous Records</i> Unbound miscellaneous records, August 1867–October 1868, are arranged by type of record and thereunder chronologically. Included are monthly inspection reports (February and October 1868); monthly school reports of the district superintendent, (September 1868); monthly reports of persons and articles hired (February 1868); estimate of clothing (undated); indentures (August 1867); and affidavits and applications of planters for supplies (February–May 1868).	
		Aug. 1867–Oct. 1868
	<b>MARKSVILLE (AGENT AND ASSISTANT SUBASSISTANT COMMISSIONER)</b>	
	<i>Letters Sent</i> The two volumes of letters sent, July 1866–October 1867 and May–December 1868, 1 (319) and 2 (320), are arranged chronologically and have name indexes.	
	Volume 1 (319)	July 1866–Aug. 1867
	Volume 2 (320)	Aug.–Oct. 1867; May–Dec. 1868
	<i>Register of Letters Received</i> The single-volume register of letters received, March 1866–December 1868 (318), is arranged chronologically and includes endorsements. The volume has a name index.	
	Volume (318)	Mar. 1866–Dec. 1868
	<i>Letters Received</i> Unbound letters received, March 1866–December 1868, are arranged chronologically by date received. Some of the letters are entered in the single-volume register of letters received (318) described above.	
		Mar. 1866–Oct. 1867



NATIONAL ARCHIVES AND RECORDS ADMINISTRATION  
MICROFILM PUBLICATIONS

ROLL	DESCRIPTION	DATES
85	<i>Letters Received (cont.)</i>	Oct. 1867–Dec. 1868
	<i>Trimonthly Narrative Reports of Operations</i> Unbound trimonthly narrative reports of operations, May 1867–December 1868, are arranged chronologically.	May 1867–Dec. 1868
	<i>Monthly School Reports</i> Unbound monthly school reports, May 1867–April 1868, are arranged chronologically. Included are school reports of the district superintendent, receipts, and expenditures. Arranged chronologically.	May 1867–Apr. 1868
	<i>Monthly Inspection Reports</i> Unbound monthly inspection reports, May 1866–October 1868, are arranged chronologically.	May 1866–Oct. 1868
	<i>Reports of Indigents</i> Unbound reports indigents, October 1866–March 1868, are arranged chronologically.	Oct. 1866–Mar. 1868
	<i>Indentures</i> Unbound indentures, July 1866–November 1868, are unarranged.	July 1866–Nov. 1868
	<i>“Journal of Business”</i> The single-volume “Journal of Business,” December 1867–November 1868 (321), is arranged chronologically.	
	Volume (321)	Dec. 1867–Nov. 1868
	<i>Miscellaneous Records Relating to the Issuance of Supplies to Planters</i> Unbound miscellaneous records relating to the issuance of supplies to planters, February–November 1868, are arranged chronologically. Included are monthly reports of supplies received and issued, lists of planters receiving supplies, bonds of planters for supplies, receipts of supplies, and affidavits.	Feb.–Nov. 1868



NATIONAL ARCHIVES AND RECORDS ADMINISTRATION  
MICROFILM PUBLICATIONS

ROLL	DESCRIPTION	DATES
85 (cont.)	<i>Accounts with Planters for Supplies Furnished</i> The single volume of accounts with planters for supplies furnished, April–December 1868 (323), are arranged by name of planter and thereunder chronologically. The volume has a name index.	
	Volume (323)	Apr.–Dec. 1868
	<i>Accounts</i> The single volume of accounts, March 1866–August 1867 (322), is arranged chronologically. The volume also contains one letter sent on May 28, 1868.	
	Volume (322)	Mar. 1866–Aug. 1867
	<i>Miscellaneous Records</i> Unbound miscellaneous records, January 1867–December 1868, are arranged by type of record.	
		Jan. 1867–Dec. 1868
<b>MERRITTS PLANTATION (SEE NEW ORLEANS)</b>		
<b>MILLIKENS BEND (PROVOST MARSHAL AND ASSISTANT SUBASSISTANT COMMISSIONER)</b>		
	<i>Letters Sent</i> The two volumes of letters sent, May 1867–December 1868, 1 (339) and 2 (340), are arranged chronologically. Volume 2 (340) has a name index.	
	Volume 1 (339)	May 1867–May 1868
	Volume 2 (340)	July–Dec. 1868
86	<i>Registers of Letters Received and Endorsements Sent and Received</i> The three volumes of registers of letters received and endorsements sent and received, May 1867–December 1868, 1 (336), 2 (337), and 3 (338), are arranged by time period. Each volume has a name index. The entries are arranged alphabetically by initial letter of surname of correspondent and thereunder chronologically.	
	Volume 1 (336)	May 1867–Feb. 1868
	Volume 2 (337)	Mar.–Aug. 1868
	Volume 3 (338)	Aug.–Dec. 1868
	<i>Letters and Orders Received</i> The two volumes of letters and orders received, May 1867–December 1868, 1 (334) and 2 (335), are arranged chronologically, and each volume has a name index.	
	Volume 1 (334)	May 1867–Oct. 1868
	Volume 2 (335)	Oct.–Dec. 1868



NATIONAL ARCHIVES AND RECORDS ADMINISTRATION  
MICROFILM PUBLICATIONS

ROLL	DESCRIPTION	DATES
86 (cont.)	<i>Letters Received</i> Unbound letters received, May 1867–December 1868, are arranged by volume number and thereunder according to their entry in volumes 1 (334) and 2 (335) of the two volumes of letters and orders received described above. Also, some are arranged according to their entry in volumes 2 (337) and 3 (338) of the three volumes of registers of letters received and endorsements sent and received, described above.	May 1867–Dec. 1868
	<i>Unregistered Letters Received</i> Unbound unregistered letters received, June 1867–September 1868, are arranged chronologically by date received.	June 1867–Sept. 1868
	<i>Circulars Received</i> Unbound circulars received, April 1866–December 1868, are arranged chronologically.	Apr. 1866–Dec. 1868
	<i>Trimonthly Reports of Operations</i> Unbound trimonthly reports of operations, March–December 1868, are arranged chronologically.	Mar.–Dec. 1868
	<i>Monthly Inspection Reports</i> Unbound monthly inspection reports, May 1867–December 1868, are arranged chronologically.	May 1867–Dec. 1868
	<i>Monthly School Reports</i> Unbound monthly school reports, January–December 1868, are arranged chronologically.	Jan.–Dec. 1868
	<i>Monthly School Reports of Receipts and Expenditures</i> Unbound monthly school reports of receipts and expenditures, May 1867–January 1868, are arranged chronologically.	May 1867–Jan. 1868
87	<i>Monthly Reports of Persons and Articles Hired</i> Unbound monthly reports of persons and articles hired, May 1867–December 1868, are arranged chronologically.	May 1867–Dec. 1868



NATIONAL ARCHIVES AND RECORDS ADMINISTRATION  
MICROFILM PUBLICATIONS

ROLL	DESCRIPTION	DATES
87 (cont.)	<i>Court Records</i> Unbound court records, May–December 1864, are unarranged.	May–Dec. 1864
	<i>Register of Rations Received at the Van Buren Hospital for Freedmen</i> The single-volume register of rations received at the Van Buren Hospital for Freedmen, January–March 1864 (343), is arranged chronologically. The volume also contains a <b>list of nurses</b> for the “small pox hospital,” and a <b>list of patients</b> at Freedmen’s General Hospital No. 2, Branch No. 2 (March–April 1864).	Jan.–Mar. 1864
	<i>List of Persons to Whom Rations Have Been Issued</i> The single-volume “list of persons to whom rations have been issued,” January–February 1868 (341), is arranged chronologically by date issued. The volume also includes a <b>list of destitute persons</b> (January–August 1868), unarranged.	Jan.–Feb. 1868
	<i>Miscellaneous Records Relating to Rations Issued</i> Unbound miscellaneous records relating to rations issued, May–August 1868, are unarranged. Included are monthly returns of stores issued to destitutes, abstracts, and vouchers.	May–Aug. 1868
	<i>Miscellaneous Records Relating to Issuance of Supplies to Planters</i> Unbound miscellaneous records relating to issuance of supplies to planters, March–October 1868, are unarranged.	Mar.–Oct. 1868
	<i>Certificates Permitting Occupation and Cultivation of Plantations</i> Unbound certificates permitting occupation and cultivation of plantations, March 1865, are arranged numerically.	Mar. 1865
	<i>“Journal of Business”</i> The single-volume “Journal of Business,” May 1867–December 1868 (342), is arranged chronologically.	May 1867–Dec. 1868







NATIONAL ARCHIVES AND RECORDS ADMINISTRATION  
MICROFILM PUBLICATIONS

ROLL	DESCRIPTION	DATES
88 (cont.)	<i>Orders and Circulars Received</i> Unbound orders and circulars received, April 1867–December 1868, are arranged chronologically.	Apr. 1867–Dec. 1868
	<i>Bills of Lading</i> Unbound bills of lading, May 1867–November 1868, are arranged chronologically.	May 1867–Nov. 1868
	<i>Miscellaneous Records</i> Unbound miscellaneous records, August 1867–February 1868, are arranged by type of record. Included is a report of freedmen claims prepared and forwarded (February 1868); a report of civilians employed (no date); and an abstract (August 1867).	Aug. 1867–Feb. 1868

**MONROE (AGENT AND ASSISTANT SUBASSISTANT COMMISSIONER)**

*Letters Sent*

The two volumes of letters sent, June 1867–December 1868, 1 (348) and 2 (349), are arranged chronologically. Volume 1 (348) has a complete name index, and volume 2 (349) has a partial name index. Volume 2 (349) also contains a “list of discharged soldiers and sailors in Parish Ouachita who have not received their arrears of bounty money,” April–August 1865, arranged numerically.

Volume 1 (348)	June 1867–June 1868
Volume 2 (349)	June–Dec. 1868

*Register of Letters Received*

The single-volume register of letters received, July 1867–December 1868 (346), is arranged by initial letter of surname of correspondent and thereunder arranged in chronological order and numbered. The volume includes endorsements.

Volume (346)	July 1867–Dec. 1868
--------------	---------------------

*Letters Received*

Unbound letters received, March 1866–December 1868, are arranged chronologically by date received.

Mar. 1866–Dec. 1868
---------------------

*Orders and Circulars Received*

Unbound orders and circulars received, February 1866–June 1867, are arranged chronologically by date received.

Feb. 1866–June 1867
---------------------



NATIONAL ARCHIVES AND RECORDS ADMINISTRATION  
M I C R O F I L M P U B L I C A T I O N S

ROLL	DESCRIPTION	DATES
88	<i>Trimonthly Reports of Operations</i>	
(cont.)	Unbound trimonthly reports of operations, April–December 1866, are arranged chronologically.	Apr.–Dec. 1866
	<i>Monthly Inspection Reports</i>	
	Unbound monthly inspection reports, February 1866–March 1868, are arranged chronologically.	Feb. 1866–Mar. 1868
	<i>Register of Contracts</i>	
	The single-volume register of contracts, January–August 1866 (353), is arranged and numbered by date forwarded. The volume also contains several lists relating to <b>contracts</b> (March 1866–January 1867), arranged by type of list; a <b>register of contracts</b> (January–June 1867), arranged and numbered by date forwarded; a <b>register of contracts approved</b> (January–February 1868); a <b>list of “names of indigent freed people in Parish Ouachita”</b> (January–March 1868); a <b>“list of colored destitutes to whom supplies have been issued”</b> (no date); a <b>list of rations issued to destitute freed people</b> (January–July 1868); a <b>list of indigent and destitute freed people applying for relief</b> (July 1868); and a <b>list of indigent whites</b> in Parish Ouachita (January–July 1868).	
	Volume (353)	Jan.–Aug. 1866
89	<i>Indentures</i>	
	Unbound indentures, March–November 1867, are arranged chronologically.	Mar.–Nov. 1867
	<i>Register of Sick and Wounded Freedmen</i>	
	The single-volume register of sick and wounded freedmen, November 1867–August 1868 (354), is arranged numerically.	
	Volume (354)	Nov. 1867–Aug. 1868
	<i>“Journal of Business”</i>	
	The single-volume “Journal of Business,” June 1867–November 1868 (351), is arranged chronologically.	
	Volume (351)	June 1867–Nov. 1868
	<i>Bills of Lading</i>	
	Unbound bills of lading, February–August 1867, are arranged chronologically.	Feb.–Aug. 1867



45

NATIONAL ARCHIVES AND RECORDS ADMINISTRATION  
MICROFILM PUBLICATIONS

ROLL	DESCRIPTION	DATES
89 (cont.)	<i>Miscellaneous Records</i> Unbound miscellaneous records, September 1865–November 1868, are arranged by type of record. Included are reports of indigents and helpless (October–December 1866 and January 1868); accounts current (December 1866–January 1867 and August 1868); monthly school reports of the district superintendent (June–November 1868); monthly school reports of teachers (November 1868); monthly reports of cases tried and fines imposed (September–October 1865); letters sent (April 1866–January 1867); invoices (April 1867); a list of stores (May 1866); a receipt (August 1867); and affidavits (December 1867).	Sept. 1865–Nov. 1868
<b>MONTGOMERY (ASSISTANT SUBASSISTANT COMMISSIONER)</b>		
<i>Letters Sent</i> The single volume of letters sent, June 1867–September 1868 (356), is arranged chronologically and has a name index.		
	Volume (356)	June 1867–Sept. 1868
<i>Register of Letters Received</i> The single-volume register of letters received, June 1867–August 1868 (355), is arranged chronologically by date received and has a name index.		
	Volume (355)	June 1867–Aug. 1868
<i>Trimonthly Reports</i> The single volume of trimonthly reports, June 1867–August 1868 (357), is arranged chronologically.		
	Volume (357)	June 1867–Aug. 1868
<i>Monthly Inspection Reports</i> Unbound monthly inspection reports, September 1867–August 1868, are arranged chronologically.		
		Sept. 1867–Aug. 1868
<i>Accounts with Planters for Supplies Furnished</i> The single volume of accounts with planters for supplies furnished, April–October 1868 (358), is arranged by name of planter and thereunder chronologically. The volume has a name index.		
	Volume (358)	Apr.–Oct. 1868
<i>Miscellaneous Records</i> Unbound miscellaneous records, August 1867–August 1868, are arranged by type of record. Included are monthly school reports of the district superintendent (August 1868); trimonthly reports of operations (August 1867); monthly reports of supplies received (May–August 1868); and bonds and affidavits (March 1868).		
		Aug. 1867–Aug. 1868



NATIONAL ARCHIVES AND RECORDS ADMINISTRATION  
MICROFILM PUBLICATIONS

ROLL	DESCRIPTION	DATES
89 (cont.)	<b>MOSSY FARM PLANTATION (SEE TRINITY)</b> <b>NAPOLEONVILLE (AGENT AND ASSISTANT SUBASSISTANT COMMISSIONER)</b>	
	<i>Letters Sent</i>	
	The two volumes of letters sent, May 1867–March 1868 and June–November 1868, 1 (380) and 2 (381) are arranged chronologically. Volume 1 (381) also contains complaints, May and July–August 1867, arranged chronologically.	
	Volume 1 (380)	May 1867–Mar. 1868
	Volume 2 (381)	June–Nov. 1868
	<i>Letters Sent</i>	
	Unbound letters sent, December 1866–May 1867, are arranged chronologically.	
		Dec. 1866–May 1867
	<i>Register of Letters Received</i>	
	The single-volume register of letters received, May–September 1867 (378), is arranged in general chronological order and has a name index. The volume includes endorsements sent and received.	
	Volume (378)	May–Sept. 1867
	<i>Letters Received</i>	
	The single volume of letters received, May 1867–February 1868 (379), is arranged in general chronological order and has a name index.	
	Volume (379)	May 1867–Feb. 1868
	<i>Letters Received</i>	
	Unbound letters received, May 1865–December 1867, are arranged chronologically by date received.	
		May 1865–Dec. 1867
90	<i>Miscellaneous Records</i>	
	Unbound miscellaneous records, March 1865–November 1868, are arranged by type of record. Included are monthly inspection reports (November 1868); monthly school reports of receipts and expenditures (August 1867 and May 1868); returns of school property (October 1867); reports of indigents and destitutes (December 1867); reports of rations issued (July 1866); police jury reports of rations issued (July 1866 and May 1867); bills of lading (August 1867); tax rolls (March 1865); payrolls (December 1865); receipts (April 1866); and bounty claims (May 1868).	
		Mar. 1865–Nov. 1868



NATIONAL ARCHIVES AND RECORDS ADMINISTRATION  
MICROFILM PUBLICATIONS

ROLL	DESCRIPTION	DATES
90 (cont.)	<b>NATCHITOCHEs (SUBASSISTANT COMMISSIONER OF THE 4TH SUBDISTRICT)</b>	
	<i>Letters Sent</i>	
	The two volumes of letters sent, June 1867–December 1868, 1 (361) and 2 (362) are arranged in chronological order and numbered. Volume 2 (362) has a name index.	
	Volume 1 (361)	June 1867–Oct. 1868
	Volume 2 (362)	Oct.–Dec. 1868
	<i>Endorsements Sent</i>	
	The three volumes of endorsements sent, June 1867–December 1868, 1 (366), 2 (367), and 3 (368), are arranged in chronological order and numbered. There are name indexes in volumes 2 (367) and 3 (368).	
	Volume 1 (366)	June 1867–Oct. 1868
	Volume 2 (367)	Oct.–Dec. 1868
	Volume 3 (368)	June 1867–Dec. 1868
	<i>Register of Letters Received</i>	
	The single-volume register of letters received, June 1867–December 1868 (359), is arranged chronologically and has a name index.	
	Volume (359)	June 1867–Dec. 1868
	<i>Letters Received</i>	
	Unbound letters received, February–December 1868, are arranged chronologically by date received.	
		Feb.–Dec. 1868
	<i>“Journal of Business”</i>	
	The two volumes of “Journals of Business,” July 1867–December 1868, 1 (371) and 2 (372), are arranged chronologically.	
	Volume 1 (371)	July 1867–Aug. 1868
	Volume 2 (372)	Sept.–Dec. 1868
	<b>NATCHITOCHEs (AGENT AND ASSISTANT SUBASSISTANT COMMISSIONER)</b>	
	<i>Letters Sent</i>	
	The three volumes of letters sent, July 1867–December 1868, 1 (363), 2 (364), and 3 (365), are arranged chronologically and each volume has a name index.	
	Volume 1 (363)	July 1867–May 1868
	Volume 2 (364)	May–Nov. 1868
	Volume 3 (365)	Nov.–Dec. 1868



NATIONAL ARCHIVES AND RECORDS ADMINISTRATION  
MICROFILM PUBLICATIONS

ROLL	DESCRIPTION	DATES
90	<i>Letters Sent</i> (cont.) Unbound letters sent, April–October 1866, are arranged chronologically.	Apr.–Oct. 1866
	<i>Endorsements Sent</i> The single volume of endorsements sent, November 1867–November 1868 (369), is arranged in chronological order and numbered. It has a name index.	
	Volume (369)	Nov. 1867–Nov. 1868
	<i>Register of Letters Received</i> The single-volume register of letters received, July 1867–November 1868 (360) is arranged in chronological order and numbered. The volume has a name index.	
	Volume (360)	July 1867–Nov. 1868
	<i>Registered Letters Received</i> Unbound registered letters received, July 1867–November 1868, are arranged as entered in the single-volume register of letters received (360) described above.	
		July 1867–Mar. 1868
91	<i>Registered Letters</i> (cont.)	Mar.–Nov. 1868
	<i>Unregistered Letters Received</i> Unbound unregistered letters received, January 1866–December 1868, are arranged chronologically.	
		Jan. 1866–Dec. 1868
	<i>Special Orders Issued</i> The single volume of special orders issued, July 1866–July 1867 (370), is arranged by year and thereunder numerically. It has a name index.	
	Volume (370)	July 1866–July 1867
	<i>Trimonthly Reports of Operations</i> Unbound trimonthly reports of operations, April 1866–August 1868, are arranged chronologically.	
		Apr. 1866–Aug. 1868
	<i>Monthly Inspection Reports</i> Unbound monthly inspection reports, April 1866–September 1868, are arranged chronologically.	
		Apr. 1866–Sept. 1868



NATIONAL ARCHIVES AND RECORDS ADMINISTRATION  
MICROFILM PUBLICATIONS

ROLL	DESCRIPTION	DATES
91	<i>Monthly School Reports of the District Superintendent</i> (cont.) Unbound monthly school reports of the district superintendent, March–October 1868, are arranged chronologically.	Mar.–Oct. 1868
	<i>Monthly School Reports of Receipts and Expenditures</i> Unbound monthly school reports of receipts and expenditures, April 1866–August 1868, are arranged chronologically.	Apr. 1866–Aug. 1868
92	<i>Monthly Returns of School Property</i> Unbound monthly returns of school property, April 1866–October 1868, are arranged chronologically.	Apr. 1866–Oct. 1868
	<i>Reports of Indigents and Helpless</i> Unbound reports of indigents and the helpless, June 1866–February 1868, are arranged chronologically.	June 1866–Feb. 1868
	<i>Monthly Reports of Persons and Articles Hired</i> Unbound monthly reports of persons and articles hired, April 1866–August 1868, are arranged chronologically.	Apr. 1866–Aug. 1868
	<i>Register of Complaints</i> The single-volume register of complaints, July 1867–July 1868 (374), is arranged chronologically.	July 1867–July 1868
	Volume (374)	
	<i>Indentures</i> Unbound indentures, January 1866–April 1868, are arranged chronologically.	Jan. 1866–Apr. 1868
	<i>Register of Indigent and Helpless Freedmen</i> The single-volume register of indigent and helpless freedmen, November 1867 (377), is arranged numerically. The volume also contains a <b>register of indigent and destitute whites</b> , Parish Natchitoches, arranged by month, (February–June 1868); a <b>register of indigent and destitute freed people</b> , Parish Natchitoches, arranged by month (February–June 1868); a <b>resister or indigent and destitute whites</b> , Parish Sabine, arranged by month, (February–June 1868); and a <b>register of indigent and destitute freed people</b> , Parish Sabine, arranged by month, (February and May 1868).	Nov. 1867
	Volume (377)	



NATIONAL ARCHIVES AND RECORDS ADMINISTRATION  
MICROFILM PUBLICATIONS

ROLL	DESCRIPTION	DATES
92	<i>Register of Supplies and Clothing Issued to Destitutes</i>	
(cont.)	The single volume of registers of supplies and clothing issued to destitutes, July 1867–July 1868 (376), is arranged separately by supplies (July 1867–July 1868) and clothing (Mar.–June 1868), and thereunder arranged chronologically.	
	Volume (376)	July 1867–July 1868
	<i>Accounts with Planters for Supplies</i>	
	The single volume of accounts with planters for supplies, March–October 1868 (375), is arranged by name of planter and thereunder chronologically.	
	Volume (375)	Mar.–Oct. 1868
	<i>Records Relating to Planters' Supplies</i>	
	Unbound records relating to planters' supplies, 1868, are arranged by type of record. Included are monthly reports of supplies issued to planters, planters' applications for supplies, and planters' bonds for supplies.	
		1868
	<i>"Journal of Business"</i>	
	The single-volume "Journal of Business," July 1867–December 1868 (373), is arranged chronologically.	
	Volume (373)	July 1867–Dec. 1868
	<i>Bills of Lading</i>	
	Unbound bills of lading, June 1866–October 1868, are arranged chronologically.	
		June 1866–Oct. 1868
93	<i>Miscellaneous Records</i>	
	Unbound miscellaneous records, 1866–68, are arranged by type of record. Included are accounts current, monthly returns of rations issued, receipts, monthly returns of stores, abstracts, and reports.	
		1866–68



NATIONAL ARCHIVES AND RECORDS ADMINISTRATION  
MICROFILM PUBLICATIONS

ROLL DESCRIPTION

DATES

93 NEW IBERIA (ASSISTANT SUBASSISTANT COMMISSIONER)

(cont.) *Letters Sent*

The three volumes of letters sent cover the period February 1866–October 1867 and August–December 1868. Volume 1 (383) is arranged in chronological order and numbered. Volumes 2 (447) and 3 (448) are arranged chronologically. There is a name index in volume 1 (383). Volume 1 (383) also contains “receipts of school tax” (August 1866–January 1867), arranged chronologically; a name list of “tickets sold” (June–November [no year]), arranged chronologically; a register of “destitute people applying for relief” (June–July [no year]), arranged chronologically; and accounts (July–August [no year]), arranged chronologically.

Volume 1 (383)	Aug.–Dec. 1868
Volume 2 (447)	Feb. 1866–Apr. 1867
Volume 3 (448)	Apr.–Oct. 1867

*Endorsements Sent and Received*

The single volume of endorsements sent and received, March 1866–December 1868 (382), is arranged chronologically.

Volume (382)	Mar. 1866–Dec. 1868
--------------	---------------------

*Register of Letters Received*

The single-volume register of letters received, February 1866–December 1868 (446) is arranged chronologically and has a name index. The volume also contains a register of special orders received (February 1866–November 1867).

Volume (446)	Feb. 1866–Dec. 1868
--------------	---------------------

94 *Registered Letters Received*

Unbound registered letters received, February 1866–December 1868, are arranged as registered in the single-volume register of letters received (446) described above.

Feb. 1866–Dec. 1868

*Unregistered Letters Received*

Unbound unregistered letters received, December 1865–December 1868, are arranged chronologically.

Dec. 1865–Dec. 1868

*Trimonthly Reports*

The single volume of trimonthly reports, October 1867–October 1868 (384), is arranged chronologically and has a name index.

Volume (384)	Oct. 1867–Oct. 1868
--------------	---------------------



NATIONAL ARCHIVES AND RECORDS ADMINISTRATION  
MICROFILM PUBLICATIONS

ROLL	DESCRIPTION	DATES
94 (cont.)	<i>Monthly Inspection Reports</i> Unbound monthly inspection reports, February 1866–October 1868, are arranged chronologically.	Feb. 1866–Oct. 1868
	<i>Miscellaneous Reports Relating to Schools</i> Unbound miscellaneous reports relating to schools, 1866–67, are arranged by type of report. Included are school reports of teachers and district superintendents, school reports of receipts and expenditures, and reports of school property.	1866–67
95	<i>Reports of Indigents and Destitutes</i> Unbound reports of indigents and destitutes, October 1866–May 1868, are arranged chronologically.	Oct. 1866–May 1868
	<i>Monthly Reports of Persons and Articles Hired</i> Unbound monthly reports of persons and articles hired, May 1866–December 1868, are arranged chronologically.	May 1866–Dec. 1868
	<i>Complaints</i> The single volume of complaints, August–October 1865 (452), is arranged by initial letter of the name of the complainant.	Aug.–Oct. 1865
	<i>Indentures</i> Unbound indentures, April–December 1866, are arranged chronologically.	Apr.–Dec. 1866
	<i>Register of Subsistence Stores Issued to Destitute Citizens</i> The single-volume register of subsistence stores issued to destitute citizens, April–June 1867 (451), is arranged chronologically by date issued. The volume also contains a <b>register of blank contracts</b> (February–April 1867), arranged chronologically by date delivered, and <b>accounts</b> (February 1866–February 1867), arranged chronologically.	Apr.–June 1867
	<i>Applications for Rations</i> Unbound applications for rations, April 1867–April 1868, are unarranged.	Apr. 1867–Apr. 1868



NATIONAL ARCHIVES AND RECORDS ADMINISTRATION  
MICROFILM PUBLICATIONS

ROLL	DESCRIPTION	DATES
95 (cont.)	<i>Accounts with Planters for Supplies Furnished</i> The single volume of accounts with planters for supplies furnished, January–December 1868 (386), is arranged by name of planter and thereunder chronologically. The volume has a name index.	
	Volume (386)	Jan.–Dec. 1868
	<i>“Journals of Business”</i> The two volumes of “Journal of Business,” April 1867–December 1868, 1 (385) and 2 (449), are arranged chronologically.	
	Volume 1 (385)	Mar.–Dec. 1868
	Volume 2 (449)	Apr. 1867–Mar. 1868
	<i>Accounts</i> The single volume of accounts, February 1866–June 1868 (450), is arranged in general chronological order.	
	Volume (450)	Feb. 1866–June 1868
	<i>Miscellaneous Records</i> Unbound miscellaneous records, 1866–68, are arranged by type of record. Included are records relating to the issuance of rations to destitutes, accounts current, records relating to the issuance of supplies to planters, invoices, abstracts, vouchers, and reports.	
		1866–68
96	<b>NEW ORLEANS—ASSISTANT SUBASSISTANT COMMISSIONER FOR ORLEANS PARISH LEFT BANK</b> (See Microfilm Publication M1483, <i>Records of the New Orleans Field Offices, Bureau of Refugees, Freedmen, and Abandoned Lands, 1865–1869</i> )	
	<b>NEW ORLEANS—HOSPITAL</b> (See M1483)	
	<b>NEW ORLEANS—ASSISTANT SUBASSISTANT COMMISSIONER FOR FOR ST. BERNARD AND PLAQUEMINE PARISHES</b> (See M1483)	
	<b>NEW ROADS (AGENT AND ASSISTANT SUBASSISTANT COMMISSIONER)</b>	
	<i>Letters Sent</i> The two volumes of letters sent, March 1866–September 1868, 1 (390) and 2 (391) are arranged chronologically. There is a name index in each volume. Volume 1 (390) also contains a list of contributors and amount given to “The Lincoln Land Association” (1867); accounts with freedmen (1867); and a “list of laborers employed on Frisbie Place” (December 1867).	
	Volume 1 (390)	Mar. 1866–June 1868
	Volume 2 (391)	June–Sept. 1868



NATIONAL ARCHIVES AND RECORDS ADMINISTRATION  
MICROFILM PUBLICATIONS

ROLL	DESCRIPTION	DATES
96	<i>Registers of Letters Received</i>	
(cont.)	The two volumes of registers of letters received, December 1866–September 1868, 1 (387) and 2 (388), are arranged chronologically by date received. Both volumes include endorsements, and each has a name index.	
	Volume 1 (387)	Dec. 1866–Feb. 1868
	Volume 2 (388)	Feb.–Sept. 1868
	<i>Registered Letters Received</i>	
	The single volume of registered letters received, April–December 1867 (389), is arranged according to their entry in the two volumes of registers of letters received, 1 (387) and 2 (388), described above. The volume has a name index.	
	Volume (389)	Apr.–Dec. 1867
	<i>Registered Letters Received</i>	
	Unbound registered letters received, December 1866–August 1868, are arranged and numbered in chronological order by date received and by date and page number of volume in which registered. The letters are entered in the two volumes of registers of letters received, 1 (387) and 2 (388), described above.	
		Dec. 1866–Aug. 1868
	<i>Unregistered Letters Received</i>	
	Unbound unregistered letters received, October 1866–October 1868, are arranged chronologically by date received.	
		Oct. 1866–Oct. 1868
97	<i>Trimonthly and Special Reports</i>	
	The two volumes of trimonthly and special reports, April 1866–September 1868, 1 (392) and 2 (393), are arranged chronologically and each volume has a name index.	
	Volume 1 (392)	Apr. 1866–May 1868
	Volume 2 (393)	May–Sept. 1868
	<i>Monthly Inspection Reports</i>	
	Unbound monthly inspection reports, March 1866–August 1868, are arranged chronologically.	
		Mar. 1866–Aug. 1868
	<i>Miscellaneous Reports Relating to Schools</i>	
	Unbound miscellaneous reports relating to schools, 1866–68, are arranged by type of report. Included are monthly school reports of the district superintendent, monthly school reports of receipts and expenditures, and reports of school property.	
		1866–68



NATIONAL ARCHIVES AND RECORDS ADMINISTRATION  
MICROFILM PUBLICATIONS

ROLL	DESCRIPTION	DATES
97 (cont.)	<i>Monthly Reports of Persons and Articles Hired</i> Unbound monthly reports of persons and articles hired, July 1866–August 1868, are arranged chronologically.	July 1866–Aug. 1868
	<i>Monthly Reports of Indigents and Destitutes</i> Unbound monthly reports of indigents and destitutes, February–April 1868, are arranged chronologically.	Feb.–Apr. 1868
	<i>Indentures</i> Unbound indentures, April 1866–February 1868, are unarranged.	Apr. 1866–Feb. 1868
	<i>Complaints</i> The single volume of complaints, March 1866–August 1868 (396), is arranged chronologically.	
	Volume (396)	Mar. 1866–Aug. 1868
	<i>“Journal of Business”</i> The single-volume “Journal of Business,” May 1867–September 1868 (395), is arranged chronologically.	
	Volume (395)	May 1867–Sept. 1868
	<i>Miscellaneous Lists and Registers</i> The single-volume of miscellaneous lists and registers (397) covers the period 1866–68. The volume contains accounts, a register of soldiers’ claims, a register of contracts, a register of freedmen, a register of rations, and lists of expenses.	
	Volume (397)	1866–68
	<i>Accounts</i> The single volume of accounts, May 1867–September 1868 (394), is arranged chronologically.	
	Volume (394)	May 1867–Sept. 1868
	<i>Miscellaneous Records</i> Unbound miscellaneous records, 1865–68, are arranged by type of record. Included are accounts current, bills of lading, monthly returns of quartermaster stores, receipts, abstracts, affidavits, bonds, and applications for rations by destitutes.	
		1865–68



NATIONAL ARCHIVES AND RECORDS ADMINISTRATION  
MICROFILM PUBLICATIONS

ROLL	DESCRIPTION	DATES
98	<b>PLAQUEMINE</b> (See M1483)	
	<b>PLAQUEMINE PARISH</b> (See M1483)	
	<b>POINT COUPEE</b> (SEE NEW ROADS)	
	<b>PORT HUDSON</b> (SEE CLINTON)	
	<b>PRAIRIE LANDING</b> (SEE TRINITY)	
	<b>ROST HOME COLONY</b>	
	<i>Register of Arrivals and Departures</i>	
	The single-volume register of arrivals and departures, February 1865–July 1866 (158), is arranged by arrival or departure and thereunder by year. The year 1865 is arranged chronologically, and 1866 is unarranged.	
	Volume (158)	Feb. 1865–July 1866
	<i>Records of Births and Deaths</i>	
	The single-volume record of births and deaths, February–November (161), is undated and arranged by birth or death and thereunder chronologically. The year is not listed.	
	Volume (161)	Feb.–Nov. (No year)
	<i>Register of Applications for Laborers</i>	
	The single-volume register of applications for laborers, February–April (162), is undated and arranged chronologically. The volume also contains a <b>register of complaints</b> (February–April), arranged chronologically. The year is not listed for either register.	
	Volume (162)	Feb.–Apr. (No year)
	<i>Register of Sick and Wounded Refugees and Freedmen</i>	
	The single-volume register of sick and wounded refugees and freedmen, September–December 1866 (163), is arranged by month and thereunder by adult male, adult female, male child, or female child.	
	Volume (163)	Sept.–Dec. 1866
	<i>Accounts of Rations and Clothing Issued at Rost Home Colony, Parish of St. Charles, By J. W. Horton</i>	
	The single volume of rations and clothing issued at Rost Home Colony, Parish of St. Charles, by J. W. Horton, February–December 1865 (160), is arranged chronologically and thereunder separately for rations and clothing.	
	Volume (160)	Feb.–Dec. 1865



NATIONAL ARCHIVES AND RECORDS ADMINISTRATION  
MICROFILM PUBLICATIONS

ROLL	DESCRIPTION	DATES
98	<b>ST. BERNARD</b> (See Microfilm Publication M1483)	
(cont.)	<b>ST. FRANCISVILLE (SEE BAYOU SARA)</b>	
	<b>ST. JAMES (SEE DONALDSONVILLE)</b>	
	<b>ST. JOSEPH—SUBASSISTANT COMMISSIONER FOR 6TH SUBDISTRICT</b> <b>(SEE VIDALIA)</b>	
	<b>ST. JOSEPH (AGENT AND ASSISTANT SUBASSISTANT COMMISSIONER)</b>	

*Letters Sent*

The five volumes of letters sent, August 1865–September 1868, 1 (461), 2 (462), 3 (455), 4 (463), and 5 (464), are arranged chronologically. Each volume has a name index. Volume 3 (455) also contains a **register of letters received and endorsements sent** (April–May 1867) and **circulars issued** (July 1866–March 1867). Volume 1 (461) also contains **endorsements sent** (November–December 1865) and **letters sent by the agent at East Pascagoula, MS** (February–March 1866).

Volume 1 (461)	Aug. 1865–Mar. 1866
Volume 2 (462)	Jan. 1866–Apr. 1867
Volume 3 (455)	Apr.–May 1867
Volume 4 (463)	June 1867–July 1868
Volume 5 (464)	Aug.–Sept. 1868

*Endorsements Sent and Received*

The single volume of endorsements sent and received, February 1866–March 1867 (454), is arranged chronologically and has a name index. The volume also contains a **register of complaints** (June 1866–May 1867), arranged chronologically. For endorsements, November–December 1865, see the series of letters sent in volume 1 (461), described above.

Volume (454)	Feb. 1866–Mar. 1867
--------------	---------------------

*Registers of Letters Received and Endorsements Sent and Received*

The three volumes of registers of letters received and endorsements sent and received, May 1867–August 1868, 1 (457), 2 (458) and 3 (460) are arranged by time period. The entries in volume 1 (457) are arranged chronologically. Those in volumes 2 (458) and 3 (460) are arranged alphabetically by initial letter of surname of correspondent and thereunder chronologically. Volume 1 (457) also contains **letters received** (June–July 1868).

Volume 1 (457)	May 1867–July 1868
Volume 2 (458)	June 1867–Aug. 1868
Volume 3 (460)	July–Aug. 1868



NATIONAL ARCHIVES AND RECORDS ADMINISTRATION  
MICROFILM PUBLICATIONS

ROLL	DESCRIPTION	DATES
98	<i>Letters and Orders Received</i>	
(cont.)	The four volumes of letters and orders received, August 1865–September 1866, May 1867–May 1868, and July–August 1868, 1 (452 ½), 2 (453), 3 (456), and 4 (459), are arranged chronologically. Volume 1 (452½) also contains <b>general orders issued</b> , (August 1865) and a <b>register of blacks</b> (no date).	
	Volume 1 (452½)	Aug. 1865–Mar. 1866
	Volume 2 (453)	Feb.–Sept. 1866
	Volume 3 (456)	May 1867–May 1868
	Volume 4 (459)	July–Aug. 1868
99	<i>Unregistered Letters Received</i>	
	Unbound unregistered letters received, February 1866–August 1868, are arranged chronologically by date received.	Feb. 1866–Aug. 1868
	<i>Trimonthly Reports of Operations</i>	
	Unbound trimonthly reports of operations, February 1866–August 1868, are arranged chronologically.	Feb. 1866–Aug. 1868
	<i>Monthly Inspection Reports</i>	
	Unbound monthly inspection reports, February 1866–September 1868, are arranged chronologically.	Feb. 1866–Sept. 1868
	<i>Miscellaneous Reports Relating to Schools</i>	
	Unbound miscellaneous reports relating to schools, 1866–68, are arranged by type of report. Included are monthly school reports of the district superintendent, monthly school reports of receipts and expenditures, and monthly returns of school property.	1866–68
	<i>Monthly Reports of Persons and Articles Hired</i>	
	Unbound monthly reports of persons and articles hired, February 1866–July 1868, are arranged chronologically.	Feb. 1866–July 1868
100	<i>Court Records</i>	
	Unbound court records, September 1865–February 1868, are arranged chronologically.	Sept. 1865–Feb. 1868
	<i>Indentures</i>	
	Unbound indentures, January 1867–July 1868, are arranged chronologically.	Jan. 1867–July 1868



NATIONAL ARCHIVES AND RECORDS ADMINISTRATION  
MICROFILM PUBLICATIONS

ROLL	DESCRIPTION	DATES
100 (cont.)	<i>"Journal of Business"</i> The single-volume "Journal of Business," June 1867–August 1868 (465), is arranged chronologically.	June 1867–Aug. 1868
	Volume (465)	June 1867–Aug. 1868
	<i>Miscellaneous Records</i> Unbound miscellaneous records, 1865–68, are arranged by type of record. Included are bills of lading, monthly reports of money received and expended, monthly reports of abandoned lands, lists of stores, and other reports.	1865–68
	<b>ST. MARTINSVILLE (SEE NEW IBERIA)</b>	
	<b>SHREVEPORT (SUBASSISTANT COMMISSIONER OF THE 7TH SUBDISTRICT)</b>	
	<i>Letters Received</i> Unbound letters received, May 1867–March 1868, are arranged chronologically.	May 1867–Mar. 1868
	<b>SHREVEPORT (AGENT AND ASSISTANT SUBASSISTANT COMMISSIONER)</b>	
	<i>Letters Sent</i> The single volume of letters sent, October 1865–December 1868 (439), is arranged chronologically and has a name index.	Oct. 1865–Dec. 1868
	Volume (439)	Oct. 1865–Dec. 1868
	<i>Register of Letters and Special Orders Received</i> The single-volume register of letters and special orders received, May 1867–December 1868 (437), is arranged in chronological order by date received and numbered, and it has a name index.	May 1867–Dec. 1868
	Volume (437)	May 1867–Dec. 1868
	<i>Letters Received</i> Unbound letters received, January 1865 and January 1866–November 1867, are arranged chronologically.	Jan. 1865, Jan. 1866–Nov. 1867
	<i>School Reports</i> Unbound school reports, November 1866–November 1868, are arranged chronologically. Included are property reports, teachers' and school superintendents' reports, reports of receipts and expenditures, and district superintendents' reports.	Nov. 1866–Nov. 1868



NATIONAL ARCHIVES AND RECORDS ADMINISTRATION  
MICROFILM PUBLICATIONS

ROLL	DESCRIPTION	DATES
100 (cont.)	<i>Reports of Persons and Articles Hired</i> Unbound reports of persons and articles hired, February–July 1867, are arranged chronologically.	Feb.–July 1867
	<i>Register of Complaints</i> The single-volume register of complaints, June–September 1866 (441), is arranged chronologically.	
	Volume (441)	June–Sept. 1866
	<i>Register of Marriages</i> The single-volume register of marriages, September 1865–January 1866 (442), is arranged in chronological order and numbered.	
	Volume (442)	Sept. 1865–Jan. 1866
	<i>Miscellaneous Records</i> Unbound miscellaneous records, September 1865–June 1868, are arranged by type of record. Included are inspection reports (July–October 1866 and June 1868); reports of numbers of acres overflowed (May 1866); accounts current (February–March 1867); receipt rolls of clothing issued (February–March 1868); an affidavit (January 1868); abstracts (September 1865); bills of lading (March–April 1868); final settlement with freedmen (January 1867); and a receipt for wages (February [no year]).	
		Sept. 1865–June 1868
101	<b>SHREVEPORT (SUPERINTENDENT OF EDUCATION)</b>	
	<i>Press Copies of Letters Sent</i> The single volume of press copies of letters sent, September 1869–September 1870 (440), is arranged chronologically.	
	Volume (440)	Sept. 1869–Sept. 1870
	<i>Register of Letters Received</i> The single-volume register of letters received, November 1869–March 1870 (438), includes endorsements and is arranged chronologically.	
	Volume (438)	Nov. 1869–Mar. 1870
	<b>SHREVEPORT (HOSPITAL)</b>	
	<i>Letters Sent</i> The single volume of letters sent, July 1865–November 1868 (410), is arranged chronologically.	
	Volume (410)	July 1865–Nov. 1868



**NATIONAL ARCHIVES AND RECORDS ADMINISTRATION**  
**M I C R O F I L M P U B L I C A T I O N S**

ROLL	DESCRIPTION	DATES
101 (cont.)	<i>Letters Received</i> Unbound letters received, February 1867 and November 1867–November 1868, are arranged chronologically.	Feb. 1867, Nov. 1867–Nov. 1868
	<i>Reports of Numbers Issued Rations, Medicines and Clothing</i> Unbound reports of numbers issued rations, medicines, and clothing, January–May 1868, are arranged chronologically.	Jan.–May 1868
	<i>Reports of Persons and Articles Hired</i> Unbound reports of persons and articles hired, June 1867–August 1868, are arranged chronologically.	June 1867–Aug. 1868
	<i>Morning Reports</i> The single volume of morning reports, July 1865–December 1867 (443), is arranged chronologically. The volume also contains a “scale of destitutes or freedmens rations” (no date and unarranged).	July 1865–Dec. 1867
	Volume (443)	
	<i>Hospital Register</i> The single-volume hospital register, July–December 1865 (444), is arranged chronologically. The volume includes such information as name, date admitted, date discharged or died, age, sex, and disease. The volume also contains a register of sick and wounded (January–October 1866), arranged chronologically; a “list of prices of can fruits” (February 1868), unarranged; a register of deaths (July–September 1865), arranged chronologically; and a “Freedmens Hospital, Shreveport, La., Form 50” (December 1867–May 1868), relating to provisions.	July–Dec. 1865
	Volume (444)	
	<i>Register of Sick and Wounded</i> The single volume register of sick and wounded, November 1865–May 1868 (445), is arranged chronologically by date admitted and numbered.	Nov. 1865–May 1868
	Volume (445)	
	<i>Miscellaneous Records</i> Unbound miscellaneous records, June 1867–October 1868, is arranged by type of record. Included are abstracts of issues to hospital (December 1867); monthly reports of attendants employed (December 1867–March 1868); statements of hospital fund (January–May 1868); abstracts (June 1867–June 1868); receipts (April 1867–April 1868); a list of stores received (January 1868); invoices of medicine and hospital supplies (April 1868); bills of lading (February–October 1868); and requests (January–June 1868).	June 1867–Oct. 1868



NATIONAL ARCHIVES AND RECORDS ADMINISTRATION  
MICROFILM PUBLICATIONS

ROLL	DESCRIPTION	DATES
102	<b>SPARTA (ASSISTANT SUBASSISTANT COMMISSIONER)</b>	
	<i>Letters Sent</i>	
	The single volume of letters sent, February–November 1868 (434), is arranged chronologically and has a name index. The volume also contains what may be a <b>register of letters sent</b> (June 1867–January 1868), arranged chronologically.	
	Volume (434)	Feb.–Nov. 1868
	<i>Register of Letters and Issuances Received</i>	
	The single-volume register of letters and issuances received, March 1866–January 1868 (433), is arranged by type of record and thereunder chronologically. The volume also contains a list of nine <b>contracts</b> for 1868.	
	Volume (433)	Mar. 1866–Jan. 1868
	<i>Register of Letters Received</i>	
	The single-volume register of letters received, March–October 1868 (432), is arranged chronologically and has a name index. The volume also includes endorsements.	
	Volume (432)	Mar.–Oct. 1868
	<i>Letters Received</i>	
	Unbound letters received, January 1867–February 1868, are arranged chronologically.	
		Jan. 1867–Feb. 1868
	<i>Register of Contracts</i>	
	The single-volume register of contracts, March 1866–April 1867 (436), is arranged by year and thereunder numerically. The volume also contains <b>complaints relating to cases of cruelty</b> (August–October 1866), arranged chronologically; <b>complaints relating to differences between freedmen and employers</b> (August–October 1866), arranged chronologically; <b>a list of indigent and helpless freedmen</b> (October 1866); and <b>a list of indigent and helpless whites</b> (September–October 1866).	
	Volume (436)	Mar. 1866–Apr. 1867
	<i>Indentures</i>	
	Unbound indentures, December 1865–November 1866, are unarranged.	
		Dec. 1865–Nov. 1868
	<i>“Journal of Business”</i>	
	The single-volume “Journal of Business,” April 1867–November 1868 (435), is arranged chronologically and has a name index.	
	Volume (435)	Apr. 1867–Nov. 1868



NATIONAL ARCHIVES AND RECORDS ADMINISTRATION  
MICROFILM PUBLICATIONS

ROLL	DESCRIPTION	DATES
102	<i>Affidavits</i>	
(cont.)	Unbound affidavits, September 1866 and September–October 1867, are arranged chronologically.	Sept. 1866, Sept.–Oct. 1867
 <b>SPRINGFIELD (SEE HAMMOND STATION)</b>		
 <b>THIBODEAUX (AGENT AND ASSISTANT SUBASSISTANT COMMISSIONER)</b>		
<i>Letters Sent</i>		
The single volume of letters sent, March–December 1868 (472), is arranged chronologically and has a name index.		
	Volume (472)	Mar.–Dec. 1868
 <i>Endorsements Sent and Received</i>		
The single volume of endorsements sent and received, April 1867–August 1868 (473), is arranged chronologically and has a name index. The volume also contains a <b>register of letters received</b> (September–October 1868), arranged chronologically.		
	Volume (473)	Apr. 1867–Aug. 1868
 <i>Letters Received</i>		
The single volume of letters received, May 1867–April 1868 (471), is arranged chronologically. The volume also contains a <b>register of letters received</b> (March–May 1867), arranged chronologically by date received; a <b>register of letters received</b> , (April–December 1868), arranged chronologically by date received; a <b>register of circulars received</b> (March 1866–May 1867), arranged generally chronologically; and a <b>numerical list of general and special orders and circulars received</b> (1867), arranged by issuing office and thereunder by type of order. There is a name index to the entire volume.		
	Volume (471)	May. 1867–Apr. 1868
 <i>Letters Received</i>		
Unbound letters received, January 1867–November 1868, are arranged chronologically by date received.		
		Jan. 1867–Apr. 1868
103	<i>Letters Received</i> (cont.)	Apr.–Nov. 1868
 <i>Monthly Inspection Reports</i>		
Unbound monthly inspection reports, August 1866–September 1868, are arranged chronologically.		
		Aug. 1866–Sept. 1868



NATIONAL ARCHIVES AND RECORDS ADMINISTRATION  
MICROFILM PUBLICATIONS

ROLL	DESCRIPTION	DATES
103 (cont.)	<i>Monthly School Reports of the District Superintendent</i> Unbound monthly school reports of the district superintendent, March–November 1868, are arranged chronologically.	Mar.–Nov. 1868
	<i>Monthly Reports of Persons and Articles Hired</i> Unbound monthly reports of persons and articles hired, November 1867–October 1868, are arranged chronologically.	Nov. 1867–Oct. 1868
	<i>Register of Complaints</i> The single-volume register of complaints, April 1867–October 1868 (476), is arranged chronologically. The volume also contains a <b>list of names</b> (September–October 1868), arranged chronologically.	
	Volume (476)	Apr. 1867–Oct. 1868
	<i>Accounts with Planters for Supplies Furnished</i> The single volume of accounts with planters for supplies furnished, April–December 1868 (474), is arranged by name of planter and thereunder chronologically. It has a name index.	
	Volume (474)	Apr.–Dec. 1868
	<i>Accounts</i> Unbound accounts, April 1867 (475), are arranged chronologically. The volume also contains a “list of indigent and destitute freedmen,” undated and unarranged.	
	Volume (475)	Apr. 1867
	<i>Miscellaneous Records</i> Unbound miscellaneous records, 1867–68, are arranged by type of record. Included are accounts current, bills of lading, monthly returns of quartermaster stores, receipts, abstracts, and invoices.	1867–68
	<b>TRENTON (SEE MONROE)</b>	
	<b>TRINITY (ASSISTANT SUBASSISTANT COMMISSIONER)</b>	
	<i>Letters Sent</i> The single volume of letters sent, July–October 1867 and August–December 1868 (478), is arranged chronologically and has a name index.	
	Volume (478)	July 1867–Oct. 1867 Aug.–Dec. 1868



NATIONAL ARCHIVES AND RECORDS ADMINISTRATION  
MICROFILM PUBLICATIONS

ROLL	DESCRIPTION	DATES
103 (cont.)	<p><i>Register of Letters Received</i></p> <p>The single-volume register of letters received, November–December 1868 (477), is arranged chronologically by date received. The volume also contains <b>trimonthly and special reports</b> (July 1867–November 1868), arranged chronologically. There is a name index to the entire volume.</p>	
	Volume (477)	Nov.–Dec. 1868
	<p><i>Letters Received</i></p> <p>Unbound letters received, May 1867–December 1868, are arranged chronologically by date received.</p>	May 1867–Dec. 1868
	<p><i>Complaints</i></p> <p>The single volume of complaints, August–November 1868 (479), is arranged chronologically. The volume also contains a “<b>journal of business</b>,” (November–December 1868), arranged chronologically.</p>	
	Volume (479)	Aug.–Nov. 1868
	<p><i>Miscellaneous Records</i></p> <p>Unbound miscellaneous records, March 1867–November 1868, are arranged by type of record. Included are copies of letters sent (November 1867–November 1868); monthly returns of stores (August 1868); monthly inspection reports (December 1867–February 1868); monthly reports of persons and articles hired (June 1867–November 1868); monthly reports of plantation supplies (May 1868); abstracts (March–October 1868); receipt rolls of clothing (August–October 1868); a list of articles lost or destroyed (no date); requisitions (no date); abstracts (May 1867–April 1868); receipts (August 1867–July 1868); and statements and affidavits (no date).</p>	Mar. 1867–Nov. 1868
104	<i>Miscellaneous Records</i> (cont.)	May 1867–Aug. 1868
	<b>VERMILLIONVILLE (AGENT AND ASSISTANT SUBASSISTANT COMMISSIONER)</b>	
	<p><i>Letters Sent</i></p> <p>The two volumes of letters sent, February 1866–December 1868, 1 (487) and 2 (488), are arranged chronologically, and both volumes have name indexes. Volume 1 (487) also contains <b>general orders received</b> (July 1866), unarranged, and an unidentified list (May 1868). Volume 2 (488) also contains <b>trimonthly reports</b> (April–December 1868). The name index in volume 2 (488) is to the entire volume.</p>	
	Volume 1 (487)	Feb. 1866–Apr. 1868
	Volume 2 (488)	May–Dec. 1868



NATIONAL ARCHIVES AND RECORDS ADMINISTRATION  
MICROFILM PUBLICATIONS

ROLL	DESCRIPTION	DATES
104	<i>Letters Sent Relating to Complaints</i>	
(cont.)	The single volume of letters sent relating to complaints, May–October 1866 (489), is arranged chronologically. The volume also contains a <b>register of contracts approved</b> (1866); <b>trimonthly reports</b> (April 1866–April 1868); a <b>register of indigent and helpless freedmen</b> (January–August 1867); a <b>register of indigent and destitute whites and freed people, Parish Lafayette</b> (1868); a <b>register of contracts approved</b> (1867); a <b>register of complaints</b> (February–July 1866); a <b>register of “blanks sold”</b> (1866–67); a <b>register of soldiers’ discharges received and forwarded</b> (1866–67); a <b>register of “freedchildren” apprenticed</b> (no date); a <b>list of “tuition tickets”</b> (September–December 1866), arranged chronologically; and an <b>“official roster”</b> (January 1, 1868).	
	Volume (489)	May–Oct. 1866
	<i>Endorsements Sent</i>	
	The two volumes of endorsements sent, March 1866–December 1868, 1 (490) and 2 (491), are arranged chronologically, and each volume has a name index. The last entries in volume 1 (490) are duplicated in volume 2 (491).	
	Volume 1 (490)	Mar. 1866–June 1868
	Volume 2 (491)	Jan.–Dec. 1868
	<i>Registers of Letters Received</i>	
	The two volumes of registers of letters received, March 1866–December 1868, 1 (485) and 2 (486), are arranged chronologically. The last entries in volume 1 (485) are duplicated in volume 2 (486). Both volumes have name indexes. For letters received, see the series of registered letters received, March 1866–December 1868, described below.	
	Volume 1 (485)	Mar. 1866–Aug. 1868
	Volume 2 (486)	Jan.–Dec. 1868
	<i>Registered Letters Received</i>	
	Unbound registered letters received, March 1866–December 1868, are arranged and numbered in chronological order by date received and numbered. The letters are entered in the two-volume series of registers of letters received, March 1866–December 1868, described above.	
		Mar. 1866–Dec. 1868
105	<i>Unregistered Letters Received</i>	
	Unbound unregistered letters received, January 1866–October 1868, are arranged chronologically by date received.	
		Jan. 1866–Oct. 1868
	<i>Register of Circulars Received</i>	
	The single-volume register of circulars received, May 1865–December 1867 (492), is arranged by issuing office, thereunder by year, and thereunder numerically. The volume also contains <b>orders received</b> (December 1867), arranged numerically.	
	Volume (492)	May 1865–Dec. 1867



NATIONAL ARCHIVES AND RECORDS ADMINISTRATION  
MICROFILM PUBLICATIONS

ROLL	DESCRIPTION	DATES
105 (cont.)	<i>Monthly Inspection Reports</i> Unbound monthly inspection reports, February 1866–October 1868, are arranged chronologically.	Feb. 1866–Oct. 1868
	<i>Monthly Reports of Persons and Articles Hired</i> Unbound monthly reports of persons and articles hired, February 1866–November 1867, are arranged chronologically.	Feb. 1866–Nov. 1867
	<i>“Journals of Business”</i> The two volumes of “Journals of Business,” March 1867–December 1868, 1 (493) and 2 (494), are arranged chronologically. Volume 2 (494) also contains a <b>register of complaints</b> (March 1867–January 1868), arranged chronologically. Both volumes have name indexes.	
	Volume 1 (493)	Aug.–Dec. 1868
	Volume 2 (494)	Mar. 1867–July 1868
	<i>Accounts with a Planter for Supplies Furnished</i> The single volume of accounts with a planter for supplies furnished, June–December 1868 (495), is arranged chronologically.	
	Volume (495)	June–Dec. 1868
	<i>Miscellaneous Records</i> Unbound miscellaneous records, 1866–68, are arranged by type of record. Included are accounts current, applications for rations, monthly returns of quartermaster stores, school reports, lists of destitutes, and bills of lading.	
		1866–68
	<b>VERNON (ASSISTANT SUBASSISTANT COMMISSIONER)</b>	
	<i>Letters Sent</i> The two volumes of letters sent, May 1867–September 1868, 1 (481) and 2 (482), are arranged chronologically. Both volumes have name indexes.	
	Volume 1 (481)	May 1867–May 1868
	Volume 2 (482)	May–Sept. 1868
	<i>Register of Letters Received</i> The single volume register of letters received, May 1867–September 1868 (480), is arranged chronologically and has a name index.	
	Volume (480)	May 1867–Sept. 1868



NATIONAL ARCHIVES AND RECORDS ADMINISTRATION  
MICROFILM PUBLICATIONS

ROLL	DESCRIPTION	DATES
105	<i>Orders and Circulars Received</i>	
(cont.)	Unbound orders and circulars received, November–December 1866 and May 1867–August 1868, are arranged chronologically.	
		Nov.–Dec. 1866 May 1867–Aug. 1868
	<i>“Journals of Business”</i>	
	The two volumes of “Journals of Business,” May 1867–September 1868, 1 (483) and 2 (484), are arranged chronologically. Volume 2 (484) also contains accounts, May 1867–August 1868, arranged chronologically. There is a name index in volume 2 (484) to “journal of business.”	
	Volume 1 (483)	May 1867–July 1868
	Volume 2 (484)	May 1867–Sept. 1868
106	<i>Miscellaneous Records</i>	
	Unbound miscellaneous records, 1867–68, are arranged by type of record. Included are statements of clothing received, bills of lading, court records, and inspection reports.	
		1867–68
<b>VIDALIA (SUBASSISTANT COMMISSIONER OF THE 6TH SUBDISTRICT)</b>		
	<i>Name Index to Letters Sent</i>	
	The single-volume undated name index is an index to the two volumes of letters sent, May 1867–December 1868 (496), described below.	
	Volume (496)	Undated
	<i>Letters Sent</i>	
	The two volumes of letters sent, May 1867–December 1868, 1 (509) and 2 (510), are arranged chronologically. For a name index to this series, see the single-volume name index (496) described above.	
	Volume 1 (509)	May 1867–Jan. 1868
	Volume 2 (510)	Jan.–Dec. 1868
	<i>Registers of Letters Received and Endorsements Sent</i>	
	The five volumes of registers of letters received and endorsements sent, 1 (499), 2 (517), 3 (518), 4 (519) and 5 (520), cover the period May 1867–December 1868. Entries in volume 1 (499) are arranged chronologically; others are arranged within each volume by initial letter of surname of correspondent and thereunder chronologically. There are name indexes in all volumes except volume 3 (518). Volume 1 (499) is cross-referenced in other volumes as volume “E.”	
	Volume 1 (499)	May–Nov. 1867
	Volume 2 (517)	Sept. 1867–Jan. 1868
	Volume 3 (518)	Jan.–May 1868
	Volume 4 (519)	May–Aug. 1868
	Volume 5 (520)	Aug.–Dec. 1868



NATIONAL ARCHIVES AND RECORDS ADMINISTRATION  
MICROFILM PUBLICATIONS

ROLL	DESCRIPTION	DATES
106	<i>Endorsements Received</i>	
(cont.)	The single volume of endorsements received, May–November 1867 (516), is arranged chronologically and has a name index. This volume parallels volume 1(499) of the registers of letters received and endorsements sent described above and cross-references that volume as “E.” Volume (516) is cross-referenced in volume 1 (499) as “D.”	
	Volume (516)	May–Nov. 1867
107	<i>Letters and Orders Received</i>	
	The three volumes of letters and orders received, April 1867–December 1868, 1 (500), 2 (502), and 3 (504), are arranged chronologically. There is a name index in volume 2 (502). Letters in volumes 1 (500) and 2 (502) are entered and cross-referenced in the registers of letters received and endorsements sent, May 1867–December 1868 (described above), as L. R. B vol. 1 and L. R. B vol. 2, respectively.	
	Volume 1 (500)	Apr.–Aug. 1867
	Volume 2 (502)	Sept. 1867–Jan. 1868
	Volume 3 (504)	Jan. 1867–Dec. 1868
	<i>Letters and Orders Received</i>	
	Unbound letters and orders received, June 1867–December 1868, are arranged chronologically. Some of these are entered in the registers of letters received and endorsements sent (May 1867–December 1868) described above or copied in the series of letters and orders received, April 1867–December 1868.	
		June 1867–Dec. 1868
	<i>Circulars Issued</i>	
	The single volume of circulars issued, May 1867–December 1868 (526), is arranged chronologically.	
	Volume (526)	May 1867–Dec. 1868
	<i>Reports of Assistant Subassistant Commissioner in the 6th Subdistrict Received and Forwarded</i>	
	The single volume of reports of assistant subassistant commissioners in the 6th subdistrict received and forwarded, November 1867–November 1868 (503), is arranged chronologically.	
	Volume (503)	Nov. 1867–Nov. 1868



NATIONAL ARCHIVES AND RECORDS ADMINISTRATION  
MICROFILM PUBLICATIONS

ROLL DESCRIPTION

DATES

107 VIDALIA (AGENT AND ASSISTANT SUBASSISTANT COMMISSIONER)

(cont.) *Letters Sent*

The six volumes of letters sent, August 1865–December 1868, 1 (497), 2 (511), 3 (512), 4 (513), and 5 (514), and 6 (515), are arranged chronologically. There are name indexes in volumes 2 (511) through 6 (515). Volume 1 (497) also contains endorsements sent and received for the period March–April 1866; an unidentified **three-entry register**; and **letters received** (February–April 1866), which were copied in volume 1 (498) of the registers of letters received, March 1866–December 1868, described below. Volume 2 (511) also contains a **register of complaints** (September 1865–December 1866).

Volume 1 (497)	Aug. 1865–Feb. 1867
Volume 2 (511)	Mar.–Nov. 1867
Volume 3 (512)	Nov.–Dec. 1867
Volume 4 (513)	Jan.–Mar. 1868
Volume 5 (514)	Mar.–July 1868
Volume 6 (515)	July–Dec. 1868

108 *Registers of Letters Received*

The eight volumes of registers of letters received, 1 (498), 2 (501), 3 (505), 4 (521), 5 (522), 6 (523), 7 (524), and 8 (525), cover the period March 1866–December 1868. There is no discernible arrangement in volumes 1 (498), 2 (505), and 4 (521). Volumes 2 (501) and 8 (525) are arranged chronologically, and volumes 5 (522)–7 (524), by initial letter of surname of correspondent and thereunder chronologically. There are name indexes in volumes 1 (498), 2 (501), and 3 (505). For the period March to October 1866, the complete letter was recorded.

Volume 1 (498)	Mar. 1866–May 1867
Volume 2 (501)	July–Nov. 1867
Volume 3 (505)	Feb. 1866–Dec. 1867
Volume 4 (521)	Jan.–Nov. 1867
Volume 5 (522)	Nov.–Dec. 1867
Volume 6 (523)	Jan.–Aug. 1868
Volume 7 (524)	July–Aug. 1868
Volume 8 (525)	July–Dec. 1868

*Letters Received*

The three volumes of letters received, November 1867–December 1868, 1 (506), 2 (507), and 3 (508) are arranged chronologically and each volume has a name index. For registers of letters received and for complete letters dated March–October 1866, see the series of registers of letters received, March 1866–December 1868, described above.

Volume 1 (506)	Nov.–Dec. 1867
Volume 2 (507)	Jan.–June 1868
Volume 3 (508)	June–Dec. 1868



NATIONAL ARCHIVES AND RECORDS ADMINISTRATION  
MICROFILM PUBLICATIONS

ROLL	DESCRIPTION	DATES
108	<i>Letters Received</i>	
(cont.)	Unbound letters received, February 1866–December 1868, are arranged chronologically. Some of these are entered in the registers of letters received, March 1866–December 1868, described above.	
		Feb. 1866–Dec. 1867
109	<i>Letters Received (cont.)</i>	Jan.–Dec. 1868
	<i>Special Orders and Circulars Received</i>	
	The single volume of special orders and circulars received, November 1865–October 1866 (527), is arranged chronologically. The volume also contains a “journal of business” (April–October 1867), arranged chronologically.	
	Volume (527)	Nov. 1865–Oct. 1866
	<i>Trimonthly Reports of Operations</i>	
	Unbound trimonthly reports of operations, March 1866–December 1868, are arranged chronologically.	
		Mar. 1866–Aug. 1867
110	<i>Trimonthly Reports (cont.)</i>	Sept. 1867–Dec. 1868
	<i>Monthly Inspection Reports</i>	
	Unbound monthly inspection reports, February 1866–November 1868, are arranged chronologically.	
		Feb. 1866–Nov. 1868
	<i>Monthly Reports of Persons and Articles Hired</i>	
	Unbound monthly reports of persons and articles hired, February 1866–December 1868, are arranged chronologically.	
		Feb. 1866–Dec. 1868
	<i>Records Relating to Schools</i>	
	Unbound records relating to schools, 1866–68, are arranged by type of record. Included are school reports of receipts and expenditures.	
		1866–68
	<i>Registers of Complaints</i>	
	The two volumes of registers of complaints, March–June 1867 and May–June 1868, 1 (528) and 2 (542), are arranged chronologically. For a register of complaints dated September 1865–December 1866, see volume 2 (511) of the six-volume series of letters sent, described above. Volume 1 (528) also contains a “journal of business,” October 1867–July 1868, arranged chronologically.	
	Volume 1 (528)	Mar.– June 1867
	Volume 2 (542)	May–June 1868



NATIONAL ARCHIVES AND RECORDS ADMINISTRATION  
MICROFILM PUBLICATIONS

ROLL	DESCRIPTION	DATES
110 (cont.)	<i>Register of Indigents</i> The single-volume register of indigents (530) is undated and arranged by initial letter of given name or surname.	
	Volume (530)	Undated
	<i>Register of Blank Forms Furnished to Planters</i> The single-volume register of blank forms furnished to planters, February–April 1866 (531), is arranged chronologically. The volume also contains a <b>list of indigents</b> , a <b>list of destitutes</b> , and a <b>list of indigents and destitutes</b> .	
	Volume (531)	Feb.–Apr. 1866
	<i>Register of Leased Plantations</i> The single-volume register of leased plantations, 1865 (532), is arranged by initial letter of surname of leasee. The volume also contains <b>lists of contracts approved</b> , <b>discharged soldiers applying for bounty</b> , <b>weekly rations issued to indigents and freedmen</b> , and a list of <b>planters and plantations</b> .	
	Volume (532)	1865
	<i>Accounts with Planters for Supplies Furnished</i> The single volume of accounts with planters for supplies furnished, March–September 1868 (529), is arranged by name of planter and thereunder chronologically. It has a name index.	
	Volume (529)	Mar.–Sept. 1868
111	<i>Accounts</i> The single volume of accounts, March–November 1867 (533), is arranged by name of person and thereunder chronologically. The volume also contains a time and payroll register (January–June 1867), arranged chronologically.	
	Volume (533)	Mar.–Nov. 1867
	<i>Miscellaneous Records</i> Unbound miscellaneous records, 1865–68, are arranged by type of record. Included are bonds of planters, applications for rations of destitutes, records relating to complaints, bills of lading, receipt rolls of clothing issued, accounts current, plantation reports, and records relating to the settlement of freedmen's accounts.	
		1865–68



NATIONAL ARCHIVES AND RECORDS ADMINISTRATION  
MICROFILM PUBLICATIONS

ROLL	DESCRIPTION	DATES
111 (cont.)	<b>WATERLOO (SEE NEW ROADS)</b> <b>UNIDENTIFIED RECORDS</b> <i>Unidentified Name Indexes</i> The three volumes of unidentified name indexes 1 (541), 2 (543), and 3 (no number) are undated.	
	Volume 1 (541)	Undated
	Volume 2 (543)	Undated
	Volume 3 (No Number)	Undated



NATIONAL ARCHIVES AND RECORDS ADMINISTRATION  
MICROFILM PUBLICATIONS

Microfilm Publication M1905

RECORDS OF THE FIELD OFFICES FOR THE STATE OF LOUISIANA,  
BUREAU OF REFUGEES, FREEDMEN, AND ABANDONED LANDS,  
1865-1872

**ROLL 103**

**SUBORDINATE OFFICE**

**THIBODEAUX (AGENT AND ASSISTANT SUBASSISTANT COMMISSIONER)**

*Letters Received (cont.)* Apr.-Nov. 1868

*Monthly Inspection Reports*  
Aug. 1866-Sept. 1868

*Monthly School Reports of the District Superintendent*  
Mar.-Nov. 1868

*Monthly Reports of Persons and Articles Hired*  
Nov. 1867-Oct. 1868

*Register of Complaints*  
Volume (476) Apr. 1867-Oct. 1868

*Accounts with Planters for Supplies Furnished*  
Volume (474) Apr.-Dec. 1868

*Accounts*  
Volume (475) Apr. 1867

*Miscellaneous Records*  
1867-68

**TRENTON (SEE MONROE)**

**TRINITY (ASSISTANT SUBASSISTANT COMMISSIONER)**

*Letters Sent*  
Volume (478) July 1867-Oct. 1867; Aug.-Dec. 1868

*Register of Letters Received*  
Volume (477) Nov.-Dec. 1868

*Letters Received*  
May 1867-Dec. 1868

*Complaints*  
Volume (479) Aug.-Nov. 1868

*Miscellaneous Records*  
Mar. 1867-Nov. 1868



NATIONAL ARCHIVES AND RECORDS ADMINISTRATION  
MICROFILM PUBLICATIONS

Roll 103

Target 1

*Letters Received (cont.)*

Apr.-Nov. 1868







18

Du R. F. A. L.  
Parish of Lafourche

Thibodaux, La. March 31<sup>st</sup> 1868

Captain Lucius H. Warren U.S.A.

U. S. A. General

(Also Lt. G. Morris Sub. Asst. Commr)

Captain,

Be kind

enough to send me as soon as convenient  
some blank forms for collection of Back Pay  
Bounty & pension by Father, mother, wife or orphan  
of deceased soldiers, as requested by my  
communication of March 6<sup>th</sup>.

Very Respectfully

your obed. Servt.

Francis Herberg

Asst. Sub. Asst. Commr.

Du R. F. A. L.



L 57. 8<sup>th</sup> Sub Dist of La. 1868.

H<sup>d</sup>. Q<sup>rs</sup> P<sup>r</sup> R. F. & L.  
8<sup>th</sup> Sub Dist of La.  
Thibodaux April 3<sup>rd</sup> 68.

Respectfully transmitted  
to Mr. J. Sternberg  
A. S. A. C. and attention  
invited to endorsement  
from H<sup>d</sup>. Q<sup>rs</sup> P<sup>r</sup> R. F.  
& L. District of La.

J. S. W.

J. S. W.

Sub Asst. Comm.

Recd back 8<sup>th</sup> Sub Dist of La. 24/63<sup>rd</sup> 68.



Raymond P. de Alameda  
March 31<sup>st</sup> 68

Procurer Marshal

(Whiteland.)

Sir,

Sir,

Paris

... much annoyed by and also by  
... that had been employed and  
... placed as and Engineer  
"He had been running a saw-mill on  
the place, by contract; which contract-  
states, "that if he fails to comply with  
its requirements, he is to give the mill  
up, at five days notice being given"  
Which I gave him early in last month  
but he had yet made no move to  
vacate the premises.  
And a day or two since he assumed  
he did not intend to leave, that



Mar 31/68

Lizzie C. Gallup

he had been advised to visit, possession, etc. etc. He was doing nothing with the mill, and every day complaining, advised not to have it left him. This old man is now in debt to me, and is making way with everything that can be moved about the mill.

I wish to rent my mill again, I could very soon have it running, and this "old man" put out the way.

I have been as patient - tried to finish as possible, but can hear with him no longer. Can you, Sir, render me any assistance in the card? And will you please advise me what can be done in the matter? can he not be put out at once?

By answering this at your earliest convenience you will confer a great favor.

Very Respectfully

Lizzie C. Gallup



Waverly Plantation March 31. '68.

---

Clotaire Bernard

---

Returning the agreement between him and  
Mr. Steinberg A. S. A. Commr; says that he  
will come in soon and personally tell him  
his meaning x x x

---



Waverly Plantation March 31<sup>st</sup> 1858  
Mr Francis Stearns

I have examined  
the Agreement you handed me yesterday  
and it is impossible for us all, to fill it  
up - and the Affidavit - I hardly can  
swear it - the bond - I can't tell,  
I intend to come up to morrow  
again - and sum of the Records -  
the crop - What belonging to the  
place - such as corn stubbles  
can't be for private ways -  
it is my Agreement with Pugh -  
as to what is my share, I can  
dispute of it - Myself I am  
in mind of advancement -  
I wish every thing to be done  
carefully - because being opposed  
to the Democrats - some of them  
are watching me, and will put  
me in trouble if they can -

Yours

Very respectfully

Abner Bernard



N<sup>o</sup> 24. 8<sup>th</sup> Sub & Dist of La. 1868.

H<sup>d</sup>. Q<sup>r</sup>s. Qu. R. Fr. A. L.  
District of La.  
New Orleans La. April 2<sup>nd</sup> 68.

Warren L. H.  
Capt. & A. A. A. Genl.

Transmits vouchers  
for month of March  
1868.

States that  
Capt. Lt. Col. E. C. Reeman  
will pay the amount  
to any person who may  
be designated, upon  
the same being returned  
to him properly signed.

Recd 8<sup>th</sup> Sub & Dist of La. April 6<sup>th</sup> 1868.

H<sup>d</sup>. Q<sup>r</sup>s. Qu. R. Fr. A. L.  
8<sup>th</sup> Sub & Dist of La.  
Thibodaux April 6<sup>th</sup> 1868.

Respectfully transmitted  
to Mr. J. Stenberg, as a  
Parish of Lafourche, Thi-  
bodeaux La.

E. P. 93

J. W. Morris.

Sub assist Comm.



HEADQUARTERS,  
Bureau of Refugees, Freedmen and Abandoned Lands,  
DISTRICT OF LOUISIANA.

No. 154 JULIA ST.

New Orleans, La., April 2<sup>nd</sup> 1868

Mr Francis Steinberg.

Asst Supt Asst Commissioner.

Thibodaux La.

Sir

I am directed by the  
Assistant Commissioner to transmit your  
Vouchers for the month of March. 1868.  
and to inform you that Bvt. Lieut Col.  
E. C. Beman: D. C. and A. A. L. M. will  
pay the amount to any person you may  
designate upon the same being returned  
to him properly signed:

Very Respectfully  
Your Obedient Servant.  
Charles W. Wren

Captain 39<sup>th</sup> U. S. Infantry  
Acty. Asst. Supt. General.



S. 197. Bu. R. F. & A. L. 68.  
W. 20. 8<sup>th</sup> Sub Dist of La. 1868.

Hd. Qrs Bu. R. F. & A. L.  
8<sup>th</sup> Sub Dist of La.  
Hibodeaux April 4<sup>th</sup> 1868

Respectfully forwarded  
to Capt. L. H. Warren.

A. A. A. General. Hd. Qrs  
Bn. R. F. & A. L. Dist  
of La.

J. S. Morris.

Sub asst Comm.

E. S. 72



Recd back 8<sup>th</sup> Sub Dist April 4<sup>th</sup> 1868

S. 197 (Bu. R. F. & A. L., La.) 1868

HEADQUARTERS  
BUREAU REFUGEES, FREEDMEN AND ABANDONED LANDS,  
STATE OF LOUISIANA

New Orleans, April 9<sup>th</sup>, 1868.

Respectfully returned to Mr.  
Francis Sternberg, asst sub  
asst. Commissioner, (Thro  
Mr. J. S. Morris, sub asst,  
Comm.) with information that,  
the decision of Assistant  
Commissioner, in this matter  
as stated in enclosed Com-  
munication from these Head-  
quarters - is final.

By order of  
Col. Maj. Genl. R. C. Buchanan,  
Asst Commissioner.

E. S. 21/270

Charles H. Warren  
Capt 39<sup>th</sup> U. S. Infantry,  
A. A. A.

W. J. R. W.



W20. 8" Sub Dist of La. 1868.

---

Hd. Qrs 8th Regt. A. S. L.  
8" Sub Dist of La.  
Thibodaux La. April 13<sup>th</sup> 68.

---

Respectfully transmitted  
to Mr. F. Sternberg, a.s.a. &  
and attention invited to  
endorsement from Hd.  
Qrs Dist of La.

Thomas Devine

Sub Asst Comm.

---

Recd back 8" Sub Dist of La. April 13<sup>th</sup> 68.



S. 181. Burk's Fall Co. 68

S. 63. 8<sup>th</sup> Sub Dist of La. 1868

On R. F. & L.  
Parish of Lafourche  
Thibodaux, La.  
April 5<sup>th</sup> 1868

Returning Francis  
1st Sub. Dist. Commr

Submits vouchers  
of C. Robichaux, late  
Commr of Election of this  
Parish which have been  
approved by Geo. P. Fernald

(2 Enclosures)

Recd. 8<sup>th</sup> Sub Dist of La. April 6<sup>th</sup> 68

H<sup>d</sup>. Qrs. Dep. Qr. F. & A. L.  
8<sup>th</sup> Sub District of La.  
Thibodaux April 6<sup>th</sup> 1868.

Respectfully forwarded  
to Capt. L. H. Warrens  
U. S. A. General. H<sup>d</sup>. Qrs.  
Dep. Qr. F. & A. L. Dist  
of La.

A. S. Morris  
Sub Asst Comm

S. 181. Burk's Fall Co. 68

Headquarters.  
Bureau R. F. and L. Lands  
District of Louisiana.  
New Orleans April 9<sup>th</sup> 1868.

Respectfully returned to Mr.  
Francis Sternberg, Asst Sub.  
Asst Commr (Thro' Mr. J. L.  
Morris, Sub. Asst Commr)  
for information as to whether or  
not, the party is a freedman,  
and attention directed to endorse-  
ment of April 4<sup>th</sup> inst. from  
these Headquarters.

By order of  
Bot Maj Genl. R. C. Buchanan  
Asst Commissioner.

Thomas H. Warren  
Capt 39<sup>th</sup> U. S. Infy.  
A. A. S. Genl.

68  
4/27



Du" R. P. A. L.  
Parish of Lafourche  
Thibodaux, La., April 5<sup>th</sup> 1868  
Captain Lucius H. Warren U.S.A.  
A. A. A. General  
Geo" H. S. Morris Sub. Asst. Commr.  
Captain,

Enclosed please  
find vouchers of P. Robichaux - late  
Commr of Election of this Parish, which  
have to be approved by Geo P. Fernald  
now at Collector's Office, Internal  
Revenue at New Orleans, and lately  
a Member of the Board of Registration  
for this Parish.

It is my wish, that the amount  
may be collected and forwarded to him  
through this office.

Very respectfully,  
Your Obedt Servt  
Francis Hemberg  
A. S. Sub. Asst. Commr.  
Du" R. P. A. L.



J  
F 63. 8<sup>th</sup> Sub Dist of La. 1868.  
H<sup>d</sup>. Q<sup>rs</sup> Q<sup>r</sup> R. F. A. L.  
8<sup>th</sup> Sub Dist of La.  
Thibodaux La. April 13<sup>th</sup> 1868.

Respectfully transmitted  
to Mr. J. Steinberg, a.  
S. A. C. and attention  
invited to endorsement  
from H<sup>d</sup>. Q<sup>rs</sup> Dist of La.

Thomas Dwyer  
Sub Asst Comm.

E. S. 110.

Rec<sup>d</sup>. back 8<sup>th</sup> Sub Dist of La. April 15<sup>th</sup> 1868.



S. 180, Bu R. F. & A. L., La. 68.

8th Sub Dist of La. 1868.

Bu R. F. & A. L.  
Parish of La. 1868  
Thibodaux, La. 1868

Stenberg Francis  
Asst. Sub. Asst. Comm.

Submitt Certificate  
of Mrs. Murrell a  
Freedwoman, whose claim  
has been for some time in  
the hands of Mr. Jones  
at Thibodaux, and desires  
to be notified through this  
Office, whether her claim has  
been allowed.

1868

EM

Recd. 8th Sub Dist of La. April 6. 68

H. Q. Bu R. F. & A. L.  
8th Sub District of La.  
Thibodaux April 6. 1868

Respectfully forwarded  
to Capt. L. H. Warren  
A. A. A. General, H. Q. Bu  
R. F. & A. L. District  
of La.

J. L. Morris.

Sub. Asst. Comm.

S. 180 (Bu. R. F. & A. L., La.) 1868

HEADQUARTERS,  
BUREAU REFUGEES, FREEDMEN AND ABANDONED LANDS,  
DISTRICT OF LOUISIANA,

New Orleans, April 18th 1868

Respectfully returned to Mr.  
Francis Stenberg, Asst. Sub. Asst. Comm.  
Parish of Lafourche. Through  
Mr. Thomas Deming, Sub. Comm.  
Thibodaux La. with the info-  
mation, that the claim of  
Comfort Merrill, on account  
of her son Andrew Jackson  
has not yet been allowed.  
When such notice is recei-  
ved at this Office you will  
be duly informed.

By order of  
Brig. Maj. Gen. R. C. Buchanan

Wm. H. Kellogg  
Capt. U.S. Inf.  
Actg. Asst. Adj. Gen.

1868  
4/18



I 44. 8<sup>th</sup> Sub-Dist of La. 1868.

H<sup>d</sup>. Geo Gu R. Fr A. L.  
8. Sub District of La.  
Thibodaux La. April 21<sup>st</sup> 68.

Respectfully transmitted  
to Mr. F. Sternberg a.s.c.  
and attention invited to  
endorsement from H<sup>d</sup>. Geo  
Gu R. Fr A. L. District  
of La.

W. P. 120.

Thomas Devine  
Sub Asst Comm.

Rec<sup>d</sup> back April 21<sup>st</sup> 68. 8. Sub Dist of La.

W. P. 120.



Bu<sup>o</sup> R. Fay A. L.  
Parish of Lafourche  
Thibodaux, La., April 5 1868

Captain Lucius H. Warren U. S. A.

A. A. A. General

(For<sup>o</sup> M<sup>o</sup> D. L. Morris Sub. Aft. Comr.)

Captain,

Enclosed please find  
Certificate of Mrs. Murrill, a freedwoman  
of this Parish whose claim has been for some  
time in the hands of M<sup>o</sup> Jones at your  
Head Quarters.

She desires to be notified through this  
office, whether her claim has been allowed.

Very respectfully

Your Obed<sup>t</sup> Serv<sup>t</sup>

Francis Heruberg  
Aft. Sub. Aft. Comr.  
Bu<sup>o</sup> R. Fay A. L.



S. 184, Rec'd Dak La 1868

S. 68. 8<sup>th</sup> Sub Dist of La. 1868  
D. C. F. & L.  
Prison of Rapin  
Shibadeau, La.  
April 6<sup>th</sup> 1868

James Francis  
1<sup>st</sup> Sub. Mpl. Comd

Submits Receipt  
for discharge of John  
Calvin who prays  
that he be notified of the  
name of the claim agent  
who now has his case in  
hand & whether or claim has  
been allowed.

(1 Enclosure)



Rec'd 8<sup>th</sup> Sub Dist of La. April 7<sup>th</sup> 68

H<sup>on</sup>. Genl. Geo. R. Fr. A. L.  
8<sup>th</sup> Sub Dist of La.  
Shibadeau, April 7<sup>th</sup> 1868.

Respectfully forwarded to  
Capt. J. H. Warren, A.  
S. General, H<sup>on</sup>. Genl.  
G. Fr. A. L. Dist of La.

J. S. Morris.

Sub Asst Com

Rec'd 8<sup>th</sup> Sub Dist of La. 1868

H<sup>on</sup>. Genl. Geo. R. Fr. A. L.  
8<sup>th</sup> Sub District of La.  
Shibadeau La. May 26<sup>th</sup> 1868

Respectfully transmitted  
to Lt. W. Bronson, U.S.A.  
A. S. C. and attention in-  
vited to endorsement from  
H<sup>on</sup>. Genl. Geo. R. Fr. A. L. Dist  
of La.

in absence of  
Thos. C. C. C.  
Sub Asst Com.  
John J. Sheridan  
Clerk  
in charge of office.

E. J. 2/10

Rec'd 8<sup>th</sup> Sub Dist of La. May 26<sup>th</sup> 1868



HEADQUARTERS,  
BUREAU REFUGEES, FREEDMEN AND ABANDONED LANDS,  
DISTRICT OF LOUISIANA.

New Orleans, May 22<sup>nd</sup> 1868

Respectfully returned to Lieut  
Nelson Bronson, A. S. A. Comr.  
Parish of Lafourche Terr:  
Mr. Thomas Sivins S. A. C.  
Thibodaux La; with the  
information, that the within  
named claim has not yet  
been allowed.

By order of:  
Col. Maj. Genl: R. C. Buchanan

*Thomas H. W. Jones*

Capt. 39<sup>th</sup> Infy regt  
Actg. Asst. Supt. Genl

5/59

S. 184. B. K. D. A. L. 68.  
F. 68. 8<sup>th</sup> Sub Dist of La. 1868  
Thibodaux, La.  
April 6<sup>th</sup> 1868

Submitted Francis  
of 1st Sub. Asst. Comr

Submits Receipt  
for discharge of John  
"Calmit" who prays  
that he be notified of the  
name of the claim agent  
who now has his case in  
hand & whether a claim has  
been allowed.

(1 Enclosure)



Recd 8<sup>th</sup> Sub Dist of La. April 7<sup>th</sup> 68

H. Q. Q. Q. Q. R. F. & A. L.  
8<sup>th</sup> Sub Dist of La.  
Thibodaux, April 7<sup>th</sup> 1868.

Respectfully forwarded to  
Capt. S. H. Warren  
U. S. Genl H. Q. Q. Q. R. F. & A. L.  
Dist of La.

T. S. W. Jones

Sub Asst Comr



Bu "R. Fay A. L."  
District of Lafourche  
Tribodaux, La

April 5<sup>th</sup> 1868

Capt<sup>l</sup> James H. Warren U.S.A.

U. U. U. General

(Proc. of G. S. Morris Sub. Asst. Commr)

Captain,

Enclosed please find  
Receipts for discharge of "John Calvin"  
late private Co G 81<sup>st</sup> U.S.C. & signed  
by the defunct St Clair Mandeville.

He prays that he be notified of  
the name of the Claim Agent who now  
has his case in hand and whether his claim  
has been allowed.

Very respectfully  
Your obed<sup>t</sup> Serv<sup>t</sup>

Francis Straberg  
Asst<sup>l</sup> Sub. Asst. Commr  
Bu "R. Fay A. L."



CLAIM FOR

BOUNTY.

Office U. S. Military Claim Agency, of St. Clair Mandeville,  
79 Customhouse Street,  
No. 1921



"G"

New Orleans, La., December 6<sup>th</sup> 1866

This is to Certify That I have this day receive from John Calvin  
a Private in Co "G", 81<sup>st</sup> Regt. U. S. Col. Infantry Vol.  
his **CERTIFICATE OF DISCHARGE**, upon which to prosecute his claim for Bounty. Said  
Certificate to be forwarded by me to the proper Department at Washington as proof of the validity of  
this Claim; and, I at the same time guarantee the return of the same to the applicant so soon as his  
claim shall have been examined and paid. Said Certificate is of the HONORABLE DISCHARGE of said  
John Calvin who was enlisted on the 5<sup>th</sup> day of March  
1865. Discharge dated at New Orleans La. Sept. 15/65 by reason of Disability

ST. CLAIR MANDEVILLE,  
U. S. Military Claim Solicitor.

RECEIPT FOR CERTIFICATE OF DISCHARGE.



Bu<sup>o</sup> H. Fay A. L.  
State of La.  
Office A. A. G. M. & D. O.  
New Orleans April 7<sup>th</sup> 1868

H. D. Armstrong D. O.  
and Q. M. Agent

Inclosed Memorandum  
Receipts for Bureau Stores  
ordnance stores and one horse  
Respectively



Bureau of Refugees, Freedmen and Abandoned Lands,

STATE OF LOUISIANA,

Office A. A. Q. M. & D. O., No. 154 Julia St.,

New Orleans, April 7<sup>th</sup>

1868

Mr J Stenberg  
Act. Commissioner  
Tribodoux La  
Sir

Enclosed herewith you will please find memorandum receipts for Bureau Stores Ordnance Stores and One Horse respectively: I am in possession of your Memorandum Receipt dated November 11<sup>th</sup> 1867 on which is borne every article enumerated in the enclosed memorandum receipts but as there is one consolidated receipt for the property of the two above mentioned Departments and for the Horse in your possession and as I am under the necessity of having a memorandum receipt for each class of property - that is for the property belonging to each Department - and for the Horse separate and distinct from all other property in order to make correct transfers to my successors I am under the necessity of requesting you as well as all other Offices of the Bureau having in their possession property for which I am responsible to the several Departments "over"



of the Government - to sign receipts for each particular  
class of property - Please give this matter your immediate  
attention, and on the remission to me of the enclosed  
Memorandum Receipts, duly signed by yourself, I will  
without delay return to you your original Memorandum  
Receipts dated 11<sup>th</sup> November 1857

Respectfully your

Obt Servant

W. B. Armstrong -

D. C. W. J. M. Agent



Waverly Plantation March 1<sup>st</sup> 1868,  
Mr Francis Hembery

Dear Sir,

Can you send me by the  
Boat, if you can, 40 Sheet of writing paper  
for Agreement purposes, and let me know  
what we have to pay for it, ~~so I can~~

Your humble servant

Very respectfully

Walter Bernard  
W. J. G. Hemmick



Br<sup>o</sup> J. J. Smith  
Office Disbursing Officer  
and A. A. G. M. J. S.  
New Orleans La.  
April 7<sup>th</sup> 1868

Transmit Check 1000  
for 99.77 for the service  
rendered by M<sup>r</sup> Stouber  
for the month of March  
1868.

*[Faint signature and stamp]*



Bureau of Refugees, Freedmen and Abandoned Lands,

OFFICE DISBURSING OFFICER AND ACTING ASSISTANT QUARTERMASTER,

New Orleans, La., April 7<sup>th</sup> 1868.

Mr. Francis Stenberg  
Asst. Sub Asst. Commissioner  
This is drawn to

Sir:

I have the honor to transmit herewith my check No 77  
on the Assistant Treasurer of the United States, at New Orleans,  
La., for Sixty nine and 17/100 Dollars and  
Cents in payment of your account for  
services as Asst Sub Asst Commissioner  
for the month of March 1868

The receipt of which you will please acknowledge without delay.

Very Respectfully,

Your obedient Servant.

Edmund M. Davis  
Bvt. Lt. Col. and D. O.



H<sup>d</sup> Q<sup>ty</sup> Nur. R. F. & A. L.

District of La.

New Orleans La. April 8. 1868.

---

The Asst Comm<sup>r</sup>, State of La.

by

Lucius H. Warren

Captain 39<sup>th</sup> U. S. Infantry &

A. A. A. Gen<sup>l</sup>.

---

Inform<sup>s</sup> M<sup>r</sup>. Francis Sternberg, A. S. A. Com<sup>r</sup>  
Parish of Lafourche La that if he is, as reported,  
candidate for Civil Office he will be expected to -  
at once - resign his position in the Bureau.

---



# 348.

HEADQUARTERS  
Bureau of Refugees, Freedmen and Abandoned Lands,  
DISTRICT OF LOUISIANA.

191 Julia Street,

New Orleans, La.,

April 8<sup>th</sup> 1868.

Mr Francis Sternberg,  
Asst. Sub Asst. Commissioner,  
Parish of Lafourche, La.

Sir,

It having been officially reported at these Headquarters that you are a candidate for office in the Parish for which you are now acting as Asst Sub Asst Commissioner of this Bureau, I am directed by the Assistant Commissioner to say, that while he does not wish to interfere with any ones Political preferences or advancement, at the same time, it is an established rule of this Bureau that no Agent can act in any other capacity than that for which he was



appointed. He therefore instructs me to inform you that if you are, as reported, a candidate for Civil Office you will be expected to-at once-resign your present position.

Very Respectfully,

Your Obedt. Servant

Merius H. Warner

Capt. 3<sup>d</sup> U. S. Infantry,

A. A. G.



S. 200. Bu R. F. A. L. Co.

L. 72. 8<sup>th</sup> Sub Dist of La. 1868.

Bu R. F. A. L.  
Parish of Lafourche  
Thibodaux La.  
April 9<sup>th</sup> 1868.

Stonberg Francis  
Asst. Sub. Asst. Comm.

Transmits Receipt  
for discharge of  
Emmanuel Davis,  
who prays that he  
be notified of the name  
of the Claim Agent who  
now has his cause in  
hand & whether his claim  
has been allowed.

(enclosure.)

Recd 8<sup>th</sup> Sub Dist of La. April 9<sup>th</sup> 68.

Hd. Qrs Bu R. F. A. L.  
8<sup>th</sup> Sub District of La.  
Thibodaux La. April 9<sup>th</sup> 1868.

Respectfully forwarded  
to Capt. L. H. Warren. A.  
A. General. Hd. Qrs. Bu  
R. F. A. L. Dist of La.

C. S. 103.

J. S. Morris.  
Sub Asst Comm.

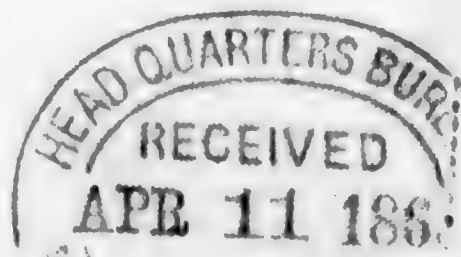

L. 72. Vol 2. 8<sup>th</sup> Sub Dist of La 1868.

Hd. Qrs Bu R. F. A. L.  
8<sup>th</sup> Sub District of La.  
Thibodaux La. May 26<sup>th</sup> 1868.

Respectfully transmitted  
to Lt. W. Prongon. U. S. A.  
A. S. A. C. and attention in-  
vited to endorsement from  
Hd. Qrs Bu R. F. A. L. Dist  
of La.

C. S. 216.

in absence of  
Thos. Civines  
Sub Asst Comm.  
John J. Sheridan  
Clerk  
in charge of office.

Receipt Returned

Recd back 8<sup>th</sup> Sub Dist of La. May 26<sup>th</sup> 68.



S. 200. R. F. A. L. Co. 1868.

S. 72. 8<sup>th</sup> Sub-Dist of La. 1868.

Br. R. F. A. L.  
Parish of Lafourche  
Thibodaux La.  
April 9<sup>th</sup> 1868.

Stenberg Francis  
1<sup>st</sup> Sub. Asst. Comm.

Francis Receipt  
for discharge of  
Carmichael Davis,  
who prays that he  
be notified of the name  
of the Claim Agent who  
now has his Case in  
hand & whether his claim  
has been allowed.

(1. enclosure.)

Recd. 8<sup>th</sup> Sub-Dist of La. April 9<sup>th</sup> 68.

H<sup>d</sup> Qrs R. F. A. L. Co.  
8<sup>th</sup> Sub-District of La.  
Thibodaux La. April 9<sup>th</sup> 1868.

Respectfully forwarded  
to Capt. L. H. Warren, A.  
A. General. H<sup>d</sup> Qrs. R.  
F. A. L. Dist of La.

C. P. 103.

J. S. Morris.  
Sub Asst Comm.

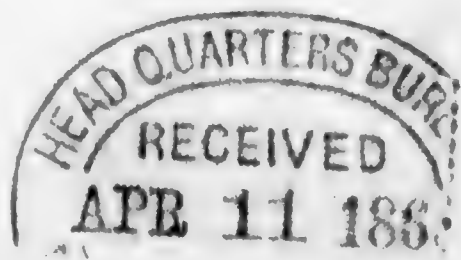

S. 200. R. F. A. L. Co. 1868.  
Adj. Com. Bureau R. F. A. L. Co.,  
District of Louisiana,  
New Orleans May 22<sup>nd</sup> 1868

Respectfully returned to Lieut.  
Nelson Bronson, A. S. A. Comm.  
Parish of Lafourche, Thro: Mr.  
Thomas Divins, S. A. Comm.  
Thibodaux La with the  
information that the within  
named claim has not yet  
been allowed.

By order of,  
Br. R. F. A. L. Co. R. C. Buchanan,

Charles H. Warren

Capt. 39<sup>th</sup> Infy U.S.A.  
Adj. Com. R. F. A. L. Co.

C. P. 51 507



Du" R. F. A. L.

Parish of Lafourche,

Thibodaux, La, April 9<sup>th</sup> 68

Captain Lewis H. Warren U. S. A.

Adj. Gen'l.

(Dtro No 5. L. Louis Sub Adj. Comr.)

Captain,

Enclosed please

find Receipt for discharge of  
"of" Emmanuel Davis late private Co. J  
75 U. S. C. T. signed by the "defunct"  
St. Clair Mandeville.

He prays that he be notified of the  
name of the Claim Agent who now  
has his case in hand and whether his  
claim has been allowed.

Very respectfully  
your obed<sup>t</sup> Servant

Francis Monberg

Asst Sub Adj Comr  
Du" R. F. A. L.



Office of H. Darling  
Mil. & Civil Claim Agent  
New Orleans Apr. 10. 1868

---

J. H. Darling

---

Forwarding vouchers for Paul Croom /: late  
Private Co. C "99" U.S.C. to Mr. F. Steenberg,  
A.S.A. Commr for to have it signed in presence  
of two witnesses and return x x x

---



Office of J. H. DARLING.  
Military and Civil Claim Agent,  
No. 10 Union Street.

New Orleans, La., April 10 1868

Francis Sternberg, A.S.A.C.

Bureau R. F. V. A. L. Bank of Lafourche.

Yours of the 8<sup>th</sup> is at hand

I enclose herewith duplicate vouchers  
for Paul Croom. late Pvt. Co. K. 99  
U.S. Col. Inf. to sign. please have this  
done in the presence of two witnesses  
who can write, and return them  
to me as soon as practicable &  
at the same time tell Croom that  
I will write for him through you,  
as soon as the money is ready  
to be paid him.

Oblige

J. H. Darling  
A.S.A.C.



No 1<sup>st</sup> Bur. F. R. & A. S.

Office D. O. & A. A. G. M.

New Orleans La. April 10. 1868.

---

Edgar Beman

1<sup>st</sup> Lieut Col. D. O. & A. G.

---

Forwards voucher & check for fuel for the  
month of April 1868.

---

*[Faint vertical text on the left side of the page, possibly bleed-through from the reverse side.]*

*[Faint vertical text on the right side of the page, possibly bleed-through from the reverse side.]*

*[Handwritten notes and scribbles in the center and right margin, including the word "Check" and other illegible characters.]*



Bureau of Refugees, Freedmen and Abandoned Lands,

OFFICE DISBURSING OFFICER AND ACTING ASSISTANT QUARTERMASTER,

New Orleans, La., April 10<sup>th</sup> 1868.

Mr. Francis Steruberg

Asst. Subj. Asst. Court

Thibodaux La.

Sir:

I have the honor to transmit herewith my check No. 104,  
on the Assistant Treasurer of the United States, at New Orleans,  
La., for         Six         Dollars and

        Cents         in payment of your account for  
Fuel for the month of April 1868

The receipt of which you will please acknowledge without delay.

Very Respectfully,

Your obedient Servant.

*Edward J. Manly*  
Bot. Lt. Col. and D. O.

Bur. R. F. & A. L.

Office D. O. & Q. M. Agent.

New Orleans La April 10. 1868.

---

W. B. Armstrong

Sole D. O. & Q. M. Agent.

---

Requests his receipts for clothing and accounts  
currents from Mr. Francis Sternberg, A. S. A. Com.

x x x x x

---



Bureau of Refugees, Freedmen and Abandoned Lands,

STATE OF LOUISIANA

Office D. O. and Q. M. Agent, No. ~~121~~ Julia St.,

New Orleans, April 10<sup>th</sup> 1868

Mr Francis Sternberg - A. S. A. Comd Bureau R. F. & L.

Sir,

Your letter of the 8<sup>th</sup> inst is received -

In answer to your inquiry, what article of clothing you are responsible for - I will repeat to you, what I stated to you on that subject on the 24<sup>th</sup> of March - I have your memorandum receipt dated November - 11<sup>th</sup> 1867 - for the following articles of Quartermaster clothing which you had received from Mr L. A. A. Robinson A. S. A. Comd your predecessor - (106) Wool Hats - (52) Blouses and (70) Great Coats -

On the 10<sup>th</sup> of February 1868 - I shipped you the following amounts of clothing - belonging to an other department - (The Bureau) as stated in my letter to you on the 13<sup>th</sup> of the same month - viz (50) wool under shirts - (30) pair Trousers Infantry - For this last shipment - I have not yet got your memorandum receipts - which were forwarded you on the 13<sup>th</sup> Feb for your signature - nor have I ever received any receipt note from you for the issue of any of this clothing - Brovt. Lt. Col. C. C. Beman D. O. & A. S. A. Bureau R. F. & L. authorizes me to say to you - that if receipts is not forwarded by you to me for this clothing without further delay - your personal pay will be stopped - Respectfully

W. B. Armstrong.

Levt. D. O. & Q. M. Agent - Bureau R. F. & L.

New Orleans La. April 14. 1868

---

Edgar Beman  
Port Lieut Colonel & Q. O.

---

Forwards vouchers to Mr. Francis Sternberg  
for correction and return.

---



New Orleans La

April 14<sup>th</sup> 1868

St. Francis Chambery

Dear Sir

That enclosed voucher in favor  
Madeline Meyer returned to you for correction  
It was explained to you that vouchers given  
for suits should have the certificate that  
the invoice had been reported by you on  
your Form 2, in this voucher you fail  
to make that certificate, Make three more  
conforming to copy enclosed & return to  
this Office

Respectfully

Wm. J. Brown,  
District Atty. D. D.  
A. A. G. M.

A. C. Burdett, A. F. & A. E.  
Office Genl. Supt of Education  
New Orleans April 17. 1868.

---

From R. Chase  
Genl. Supt of Education

---

Enclosed to Mr. F. Steinberg A. S. A. Commr.  
check for payment of Rent of Schoolbuilding for  
Febr. 1868.

---



HEADQUARTERS,  
Bureau of Refugees, Freedmen and Abandoned Lands,

(189 JULIA STREET.)

Office General Superintendent of Education,  
STATE OF LOUISIANA.

New Orleans, La., April 14<sup>th</sup> 1868.

Mr Francis Sternberg,  
Asst. Sub. Asst. Com.  
Parish Lafourche, La.

Sir

I have the honor to enclose here  
with check of \$10.<sup>00</sup> to Henry Grimes and  
one of \$10.<sup>00</sup> to John Kountoro for rent of  
School Building during February 1868.

Very Respectfully

Your Obedt. Servt.

Samuel R. Chase

Genl. Supt. Education

Bureau, N. O., La.

D 1. 8 Sub Dist of La. 1868.

Hd. Qrs Qu Co. F. A. L.  
District of La.  
New Orleans La. April 16. 68.

Stirling Wm H  
Capt. F. A. L. Gent.

Call attention to the numerous communications forwarded to Hd. Qrs. States that except in extraordinary cases, Fri Monthly Reports if made in accordance with instructions, will furnish all the necessary information

Recd 8 Sub Dist of La. April 20 1868

Hd. Qrs Qu Co. F. A. L.  
8. Sub Dist of La.  
Thibodaux La. April 20. 68.

Respectfully transmitted to Mr. F. Sternberg, a. s. a. c. Parish of Lafourche. Thibodaux La. who will confine himself to the instructions contained in the with

im  
E. P. H.

Thomas W. W.  
Sub Asst Comr



# 348.

HEADQUARTERS  
Bureau of Refugees, Freedmen and Abandoned Lands,  
DISTRICT OF LOUISIANA.

New Orleans, La., April 16<sup>th</sup> 1868.

Mr. Francis Sternberg,

Asst Sub Asst Commissioner,

Parish of Lafourche, La.

Thru Mr. Thomas Devine,

Sub Asst Commissioner,

Sir,

I am instructed by the Assistant Commissioner to inform you, that as your communications to these Headquarters, are much more numerous than those from any other Agent, it becomes necessary for him to take notice of the fact: You are therefore informed that, while the Assistant Commissioner is desirous of being kept well informed upon all affairs pertaining to your Parish, at the same time, it is thought that your tri-monthly reports, will, if

made in accordance with existing instructions from these Headquarters, - except in extraordinary cases - furnish all the information required.

Very Respectfully,

Your Obedt Servant,

W. H. Stetson  
Capt. 1<sup>st</sup> U. S. Infantry,

A. A. G.



Bur. R. F. & A. S.  
Office D. O. & A. A. Q. M.  
New Orleans La. April 21. 1868

---

Edgar Beman  
Vot Lieut<sup>t</sup> Colonel & J. Officer.

---

Forwards check for payment of Rent for  
stable and shoeing horses for signature and  
return -

---

Office 5/1/68

333103  
B...  
C...  
D...  
E...  
F...  
G...  
H...  
I...  
J...  
K...  
L...  
M...  
N...  
O...  
P...  
Q...  
R...  
S...  
T...  
U...  
V...  
W...  
X...  
Y...  
Z...

Bureau of Refugees, Freedmen and Abandoned Lands,

OFFICE DISBURSING OFFICER AND ACTING ASSISTANT QUARTERMASTER,

New Orleans, La., April 21<sup>st</sup> 1868.

Mr. Francis Sternberg.  
-Asst. Subj. Asst. Commr.  
Thibodaux La.

Sir:

I have the honor to transmit herewith my check No 149  
on the Assistant Treasurer of the United States, at New Orleans,  
La., for                     Elevens                     Dollars and  
                    Fifty                     Cents in payment of your account for  
Rent of Stable for the month of March 1868.  
and for Horse shoeing. " " "

The receipt of which you will please acknowledge without delay.

Very Respectfully,

Your obedient Servant.

*John J. Man*  
Bot. Lt. Col. and D. G.



Adj<sup>t</sup> Gen<sup>l</sup> Bur R. F & A. S.  
Office I. O. & A. C. M.  
New Orleans La April 22. 1868.

---

Edgar Beman  
M<sup>t</sup> Lieut<sup>t</sup> Col<sup>l</sup> & I. O

---

Requests from Mr. Francis Steinberg, A. S. A. C.  
an explanation why he finds among his vouchers  
one in favor of Mr. Turner for corn as he has  
drawn his forage regularly. x x

---

Bureau P. I. & A. L.  
New Orleans La  
April 22<sup>d</sup> 1868

Mr T. Olenberg  
A. & A. G.  
Ow

Among the vouchers  
cut from your Office I found one in  
favor of H. Franklin for corn pur-  
chased. I have your duplicate P. I.  
for your allowance forage in March  
and am at a loss to understand your  
purchasing forage & having the regular  
allowance furnished. An explanation  
required.

Respectfully  
O. J. S. M.  
A. L. & A. G.  
& A. A. G. M.



A. C. S. Bar R. F. & A. S.

New Orleans April 25. 1868

---

W. W. Wood

2<sup>nd</sup> Lieut 42<sup>nd</sup> U. S. Infantry

A. C. S.

---

Enclosed handing B/S. 74 for stores shipped  
for Mr. F. Sternberg A. S. A. C., Theboudaux La.

*[Faint, mostly illegible handwritten text, possibly bleed-through from the reverse side of the page.]*

62.

Office Adm. Bu. B. Food A. L.,  
New Orleans, La., April 25th, 1868.

Mr. Francis Sternberg,

A. S. A. C.,

Thibodaux, La.,

Sir:

Enclosed I hand you  
Bpl. 74, for stores shipped you this day for Mr.  
Thomas F. Foster, per Str. Flicker. The re-  
ceipt for these stores accompanies this Bpl.

Very Respectfully,

w. w. wood

2<sup>d</sup>. Lieut U. S. Infantry,  
A. S. A. C.



Office Act. Ass<sup>t</sup> Q. M.

Brushbar City May 1. 1868.

---

Jno H. Purcell

1<sup>st</sup> Lieut<sup>t</sup> 1<sup>st</sup> U. S. Inf. & A. A. Q. M.

---

Enclosing \$3. for hire of team engaged in  
cemeterial business. x x

x

x

---

Office Acting Asst. Quartermaster.

Prashear City La. May 1 1868

Francis Stenberg Esq.

Asst. Sub. Asst. Comm<sup>r</sup>.

Bureau R. F. & A. L.

Tribodaux La.

Sir.

I herewith enclose Three Dollars amount due  
St. Murphy for hire of Team by Wm Lee while  
engaged in Cemetery operations at your place.

Owing to my not having funds, is the reason of  
the account not being paid before

Please have the enclosed Vouchers signed and  
returned to me as soon as possible -

Very Respectfully,

Your Obedt. Servt.

J. H. C. C. C.  
1st. Lieut 1<sup>st</sup> Inf. V. A. S. M.



New Orleans May 2<sup>d</sup> 1868.

---

M. A. Foote

---

Inquires about a colored man Asher  
Felix and asks Capt Steinberg A. S. A. Commr.  
at Thibodaux La to let him know the part-  
iculars of the case x x x

---

R. H. MARR,  
M. A. FOUTE,  
G. W. H. MARR.

Office of MARR & FOUTE,  
ATTORNEYS,

No. 38 Union Street, New Orleans.

DIRECTIONS:

- FIRST—If a claim for collection belong to a partnership, the names, in full, of all its members, should be given. If it be against a partnership, the names in full, of the members thereof, at the time the obligation was created, should also be given, if known.
- SECOND—If the claim be on an open account, a copy of the original account or a specific statement of all the items should be sent. A simple balance should never be furnished.
- THIRD—Where the testimony of witnesses is necessary, it will greatly speed a case to specify, at the time of forwarding a claim, their names in full; and, where they reside out of this city, their residence, particular places where their depositions can most conveniently be taken, and the name of a Judge, Justice, or Louisiana Commissioner for taking them.
- FOURTH—When a record, or judgment from another State, is to be used, as the foundation of a suit, or as evidence, it should be authenticated and certified according to the laws of the United States. See Acts of Congress, March 26, 1791; 1 U. S. Stat. at Large p. 122, and March 27, 1804, 2 U. S. Stat. at Large, p. 293.
- FIFTH—Actions on negotiable instruments must be brought within five years from the time they are payable; on all open accounts within three years. Privileges on water-craft for supplies, materials, wages, &c., are limited to six months.
- SIXTH—When Attachment, or other Conservatory process is required, instruction must be given to the Attorney or Agent to make the proper affidavit and to execute the requisite bond.
- SEVENTH—The officers of the Court require, in all cases, a deposite of money, or a responsible city name, as security for costs.

New Orleans, May 2<sup>nd</sup> 1868

Francis Thompson, Esq.,  
 Capt. Sub. Capt. Commissioner  
 Bureau of Land and Oceans,  
 Thibodaux La.,  
 Sir,

A colored woman, who is in my employ, has begged me to learn something concerning her Brother (Ascher Felix, I believe by name) who is reported to be in jail in Thibodaux, on the charge of striking some beef or killing a cow &c. The woman seems faithful & honest, and my sympathies are with her. She has applied to the Bureau here, and has been recommended to apply to you. It appears that the Bro of the woman, (name at large) is the real offender. Will you have the goodness to look into this matter, and release, if possible, the victims of these people.

Please answer  
 Respectfully,  
 M. A. Foute



No 11  
11  
No Q<sup>ty</sup> Recd R. F. & A. S.  
Office Commissary of Subsistence.  
New Orleans May 5. 1868

---

W. W. Wood  
2<sup>nd</sup> Lieut 1<sup>st</sup> U. S. Inf<sup>try</sup>  
A. C. of S.

---

Returns to Mr. Francis Merrick, A. S.  
A. Comm<sup>rs</sup> Thibodaux for the receipt of Th<sup>at</sup>  
F. Forster of Lafourche Parish for correction  
& return \* \* \*

---

#44.

HEADQUARTERS  
Bureau of Refugees, Freedmen and Abandoned Lands,  
DISTRICT OF LOUISIANA.

New Orleans, La., May 5th, 1868.

Mr. Francis Stenberg,

A. S. A. C.

Thibodaux, La.,

Sir;

I return to you, herewith, for completion the receipt of Thomas F. Foster, of your parish, for supplies furnished him in the month of April. You will insert the date on this receipt where it should be inserted, and, also, on the corresponding copy in your office; and in all cases in future be very particular to forward only correct and complete receipts.

Very Respectfully,

W. A. Wood

L. Lieut. U. S. Inf., A. C. S.



Bur. R. F & A. S.

Office D. O & Asst Q. M.

New Orleans La May 7. 1868

---

Eggar Bemis

Port Lieut Col' & D. O.

---

Instructions for Lieut Nelson Bronson  
A. S. A. Genl. in making out requisitions  
of Subs. & Q. M. Stores.

---

Bureau of Refugees, Freedmen and Abandoned Lands,

OFFICE, DISBURSING OFFICER AND ACTING ASSISTANT QUARTERMASTER,

New Orleans, La., May 7, 1868.

Sir:

The old forms for issuing & accounting for Subs. Stores are ignored, & the enclosed forms adopted. All applicants for rations will be required to sign and the signatures witnessed on form # 62 in duplicate. When you have issued your Stores, or what you intend to issue, put up the amount on form # 62 and carry the total to form # 32 Abs. "L" also in duplicate, - then carry the amount from # 32 Abs. "L" to form # 15 of which No. quadruplicates are required - one copy for your papers, one copy for this office, & two copies (one copy with Sub Vouchers # 62 & Abs. "L" & one copy without) for Comr. A. F. & A. D., Washington, D. C. Subs. Stores will be accounted for separately from all other Stores.

Respy,

*Charles F. Brown*

Act. Asst. Q. M. & A. D.

St. Nelson Brownson  
D. A. C.

Thibadeaux  
La



N<sup>o</sup> Q<sup>to</sup> Sur R. F & A. L.  
Office Genl. Supt of Education  
State of Louisiana  
New Orleans May 8. 1868.

---

Francis A. Chase  
Genl. Supt of Education

---

Enclosing vouchers to Lieut. Nelson Bronson  
A. S. A. Comm<sup>r</sup> Parish Lafourche La for payment  
of rent for schoolhouses pro March for signature  
and return.

---

HEADQUARTERS,  
Bureau of Refugees, Freedmen and Abandoned Lands,  
(189 JULIA STREET,)

Office General Superintendent of Education,  
STATE OF LOUISIANA.

#1171.

New Orleans, La., May 5<sup>th</sup> 1868.

Genl Nelson Brown

Asst. Surg. Army Corps,

Mobile, Ala.

Lieutenant

I have the honor to enclose  
herewith vouchers of \$14<sup>00</sup> to John H. Hester  
and \$11<sup>00</sup> to Edward Mitchell for month of  
March also enclosed check of \$10<sup>00</sup> to Joseph  
Williams for March.

Please have the vouchers properly signed  
exactly same as name at top of vouchers and  
return to this office for payment.

Very Respectfully

Your Obedt. Servant  
G. M. A. Chase

Genl. Supt. of Education  
New Orleans, La.



Lafourche La. May 10. 1858

---

Lewis Guion

---

• Giving explanation to Lieut. Nelson Brown  
of S. A. Commr. Philodaux La why he has  
let imprison 2 freedmen for obtaining money  
under false pretenses. -

---

Lafourche La  
18th May 1868

St. Annons  
Lieut 4th Infantry U. S. A. C.  
Thibodaux La

Sir,

You favour of yesterday I received today. In regard to the facts connected with the imprisonment of James Madin & Paul Lewis prisoners they are as stated in the affidavit made by me before Judge Rogers J. P. viz: that at Newburg Penitentiary the accused to work for one month the expiration of the year at the rate of \$8.10 per month according to class pay payable monthly the fund from which to be advanced by me (as is customary) to be returned out of their wages. The partners commenced work on the 13th of April working up to the 1st of May between twelve & fourteen days. They needed money & clothes both of which I advanced to them though at the time they were owing me. On Saturday 2nd May their accounts were read to them so they might know how they stood and objection made to the same before the following Monday they had both left in my debt both as to money & goods furnished & with their work clothes which they failed to return. Under the law of the State respecting Offenses money & goods under false pretenses they were arrested & there being probable cause of guilt was sent to the town by the District Court & it was only in default



of their giving bail for the sum of Twenty five  
Dollars that they was sent to jail to await  
their trial - This kind prevents suspension features  
for unfortunately it is too common to find  
planters who had spent both money & time  
in bringing freedom's fund sections where  
they receive only nominal wages to where  
they get good wages, surrounded by the  
freedom of money & goods & the practice  
has almost become systematized.  
I feel that this frank statement of facts is due  
to the polite manner in which you have  
conveyed the expression of your wishes.

Very Respectfully  
Yr. Obedt.  
Lewis Guion

Confidential & May 10. 1858

Lewis Guion

Having explanation to Secret Nelson Brown  
of S. A. Com. Theologian & why he has  
let impostors & freedom for obtaining money  
under false pretenses.

Office Chief Q. M.  
5<sup>th</sup> Military District.  
New Orleans La May 13. 1868

Charles R. Tompkins  
Brig<sup>d</sup> Gen<sup>l</sup> Chief Q. M.  
Dist<sup>ct</sup> of La. & S. M. Dist<sup>ct</sup>

Informs Lieut Nelson Bronson A.S.A.C.  
at Thibodaux La, that commutation of Quarters  
and fuel are allowed to him x x x  
x x



Office Chief Quartermaster,  
FIFTH MILITARY DISTRICT,

New Orleans, La., May 13<sup>th</sup> 1868.

Lieut. Nelson Bronson.

42<sup>d</sup> Infy. acting S. A. Comd.

Bureau of A. F. & A. R.

Shibodeaux, La.

Sir:

Your communication of the 30<sup>th</sup> Ult. enclosing a copy of an order assigning you to duty as Acting Sub. Asst. Comd. of the Bureau of A. F. & A. R. at Shibodeaux, La. and asking to be furnished with quarters, has been received.

In consideration of there being no quarters under direction of this Department which can be assigned to you at your present station, the regulation allowance of fuel & quarters to which you are entitled may be commuted. Vouchers for the same properly prepared will be sent to

the Disbursing Officer of the Quar. M<sup>o</sup>.  
Dept. in this city (Capt. C. H. Hoyt. ag<sup>o</sup>).  
for payment.

There being no officers of the Quar.  
M<sup>o</sup>. Dept. at Shiloh & Co. Va. the cer-  
tificate required to form No. 21. Rev.  
Regulations of 1863, will be signed by  
an officer of this Dept. in this city

Very Respectfully,

Your Obedient Servant

Chas. H. Tompkins

Adj. Brig. Gen. & ag<sup>o</sup>  
Dist. of Va. & Sub. Dist.



H<sup>d</sup> Q<sup>rs</sup> Bur. R. F. & A. S.

Officr D. O. & A. A. Q. M.

New Orleans May 19. 1868

---

Edgar Beman

Port Lieut Col., D. O. & A. A. Q. M.

---

Forwards vouchers for signature and return  
to Lieut. Bronson A. S. A. C. at Thibodaux La,

---

Bureau of Refugees, Freedmen and Abandoned Lands,

OFFICE, DISBURSING OFFICER AND ACTING ASSISTANT QUARTERMASTER.

New Orleans, La.,

May 19<sup>th</sup>

1868.

Lieutenant M. Brownson

Shibodeaux La'

Lieutenant

Please find enclosed vouchers in favor of J. H. Thompson \$16<sup>53</sup>/<sub>100</sub> which have signed and return to this Office, I made the vouchers for the allowance \$34<sup>00</sup> Hay & \$32<sup>00</sup> Oats, as by so doing it reduced the price per pound somewhat. For the future will obviate the trouble of your purchasing by keeping your supplies.

Very Respectfully

Wm. J. Brownson  
Bt Lt Col D. C. & A. Q. M.



*N<sup>o</sup> Quarters New R. F. & A. L.  
Office Gen<sup>l</sup>. Sup<sup>t</sup> of Education  
State of La.  
New Orleans La. May 19. 1868.*

---

*Frank R. Chase  
Gen<sup>l</sup>. Sup<sup>t</sup> of Education*

---

*Forwarding check for \$ 30 for Rent of  
Schoolhouse in April 1868 to Lieut Nelson  
Bronson A. S. A. C. Parish Lafourche La.*

---

HEADQUARTERS,  
Bureau of Refugees, Freedmen and Abandoned Lands,

(189 JULIA STREET,)

Office General Superintendent of Education,  
STATE OF LOUISIANA.

New Orleans, La., May 14<sup>th</sup> 1868.

1198

Genl. William B. ...  
Asst. Sub. Asst. ...  
Parish Superintendents, &c.  
Lieutenant.

I have the honor to enclose  
herewith check of \$1000.00  
sent to Henry ...  
Building in April, 1868.

Very Respectfully,

Genl. Wm. B. ...

Grant A. Chase  
Genl. Supt. of Education,  
Bureau of Refugees, Freedmen  
& Abandoned Lands,  
State of Louisiana



New Orleans May 23-1868

C. B. Fisher.

Informing Lieut Nelson Bronson that  
the colored persons within named have to be  
sent to report to F. W. Jones Claim Clerk at the  
Freedmen's Bureau for identification to receive  
their bounty. x x x

New Orleans, May 23<sup>d</sup> 1868

Lieut Nelson Bronson  
Agt Freedmen's Bureau  
Charbonneau La

Sir

The following  
named persons residing in your  
vicinity, are required to report to  
F. W. Jones Claim Clerk at the  
Freedmen's Bureau 218 D'Orleans St  
in this City for identification to  
receive their Bounty collected  
by us - Will you please notify  
them accordingly.

Joshua Wandy & Co	92 <sup>d</sup>	W. D. L. T
Jackson Green & Co	75 <sup>th</sup>	do
Jacob Williamson & Co		do
Isome Riley & Co		do
John Howard	do	do
Buck Paine	do	do

Wesley Stafford F. Co 75<sup>th</sup> U.S.C.T.  
Robert Brown do do  
Lounisky Arsene B Co do  
Munro Jenkins A Co 10<sup>th</sup> Hy Art  
Robert Williams A Co 46<sup>th</sup> U.S.C.T.  
Marie Louise widow Dan Louise  
Co H. 3<sup>d</sup> La Native Guards dec  
Rosa Celestine Mother of Joseph  
Celestine Co F. 7<sup>th</sup> U.S.C.T. dec  
Felicity Butler Widow Louis  
Butler Co B. 75<sup>th</sup> U.S.C.T. dec

Yours respy  
C. B. Fisher  
165 Carondelet St

Lock Box 257.

Also Jacob Holes A Co 96<sup>th</sup> U.S.C.T.



H<sup>d</sup> Q<sup>rs</sup> New R. F. & A. L.  
Office Gen<sup>l</sup> Supt of Education  
State of Louisiana.  
New Orleans La May 23. 1868

---

Frank R. Chase.  
Gen<sup>l</sup> Supt of Education

---

Encloses checks for Mitchell and John  
Houston, each for \$10 for March 1868

---

# 208

HEADQUARTERS,  
Bureau of Refugees, Freedmen and Abandoned Lands,  
(189 JULIA STREET,)

Office General Superintendent of Education,  
STATE OF LOUISIANA.

New Orleans, La., May, 23<sup>rd</sup> 1868.

Chief Marshal, Bureau.  
Asst. Sub. Asst. Comdr.,  
Paris, Louisiana, La.  
Lieutenant.

I have the honor to enclose  
herewith check of Five (\$5.00) Dollars to  
John Christian also check of Five (\$5.00) Dollars  
to Edward Mitchell for travel costs.

Very respectfully,

Your obedt. Servant,

Frank A. Chase

Genl. Supt. of Education,

Bureau, N. O., La.



Office D. O & A. A. Q. A.

New Orleans May 25. 1862.

---

Edgar Beman

Bvt Lieut Col, D. O & A. A. Q. A.

---

Encloses vouchers to Lieut Nelson Bronson  
A. S. A. Commr. Thibodaux La for reimbursement  
of expenses, for signature and returns

---

Office D.O., & A.A.G.M.

New Orleans La May 25<sup>th</sup> 1868

Lieutenant Nelson Brown

47<sup>th</sup> U.S.I. area

Thibodaux La

Lieutenant

Enclosed please find vouchers for your actual expenses from N.O. to Thibodaux La forwarded for your signature and return to this Office accompanied with original order assigning you to Thibodaux that the payment of these expenses may be endorsed thereon. Copies as per your request will be made here. Stationery as requested in former communication will be sent above.

I am Lieutenant,

Most Respectfully,

Your Obedient Servant,

Edward J. Fox

At Large Cal D.O. & A.A.G.M.



2  
No. 1  
H. Q. New R. F. & A. S.  
Office Commissary of Subsistence  
New Orleans May 25, 1868

---

W. W. Wood  
2<sup>nd</sup> Lieut 1<sup>st</sup> U. S. Inf. & A. C. S.

---

Encloses a copy of the affidavit and bond  
in the case of Mr. George W. Turner for  
file x x x

---

#152.

HEADQUARTERS,  
Bureau of Refugees, Freedmen and Abandoned Lands,  
Office of Assistant Commissary of Subsistence.

New Orleans, La., May 20th, 1868.

Lieut. Nelson Brownson,  
A. S. A. C.,  
Thibodaux, La.,

Sir:

I respectfully re-  
turn to you, herewith enclosed, a copy of the  
Affidavit and Bond in the case of Mr.  
George W. Tucker, of your parish, there be-  
ing but one copy of each required at  
these Hd. Qrs. You will please file these  
in your office, and retain, also, one copy of  
each affidavit hereafter made.

The contract will be made out on the printed form.

Very Respectfully,  
Your Obedient Servant,

W. W. Wood  
2<sup>d</sup> Lieut. U. S. Inf.  
A. S. A.

(4 Enclosures) Blank contracts are sent you this day.



Thibodaux La. May 27. 1868

Nelson Bronson

2<sup>nd</sup> Lieut 42<sup>nd</sup> U. S. Infantry &  
A. S. A. Comm<sup>r</sup>

Request from the Ass<sup>t</sup> Commissarys Office  
to be furnished Blanks Recruiting Account Current  
and Copies of Form No. 18 Revised Recruiting  
Regulations. x x

Head Quarters,  
Bureau R. F. and A. Comds.  
District of Louisiana  
New Orleans, May 29. 1868.

Respectfully, returned to 2nd  
Lieut. Nelson Bronson, 42nd  
U. S. Infantry, with the infor-  
mation, that there are no such  
blanks as he requires, on hand.  
They may be ruled out by  
him, or sent for, to Washington.  
By Command of,

Col. Maj. Gen. R. C. Buchanan, U. S. A.  
Assistant Commissioner

*W. H. Cooper*  
1st Lieut. 39th U. S. Infantry  
Act. Asst. Adjt. General.

Office A. S. A. Cow Prof R. F. and A. S.  
Thibodeaux Las May 27<sup>th</sup> 1848  
Asst Adjutant General  
5<sup>th</sup> Mil District

Sir

I have the honor to  
request that I may be furnished with two Blank -  
Recruiting Account Currents; also two copies of Form 18.  
Revised Recruiting Regulations of 1843. if they are not  
the same thing

These papers are needed to make some corrections  
in past returns while on Recruiting Service

Very respectfully  
Your obt Servant  
W. S. A. Broun  
3<sup>d</sup> Lieut 42<sup>d</sup> Infantry U. S. A. C.



Office D. O. & A. A. Q. M.

New Orleans La May 29. 1868.

---

Edgar Beman

Post Sicut Col., D. O. & A. A. Q. M.

---

Encloses vouchers & check to Sicut Nelson  
Brunson A. S. A. Comm. for signature and  
return x x x x

---

Office S. O. & Adams  
New Orleans La May 29<sup>th</sup> 1858

Lieutenant Nelson Tronson  
Natchitoches La

Lieutenant

Have find enclosed Check \$370 in favor  
J. F. Thompson, and actual expenses vouchers  
which the Assistant Commissioner deems  
approving from the circumstances of your  
having chg<sup>d</sup> portage in N. O. & Natchitoches  
Army to 4<sup>th</sup> 1/2% & also cost of transporting your  
allowance of baggage by another & different  
route from the one travelled by yourself

Your Lieutenant

Most Respectfully

Your Obedt Servt

Edgar M. M. M.

Rt Lt Col S. O.



1717 Vol 2 8<sup>th</sup> Sub Dist of La. 1868.

H<sup>d</sup> Q<sup>r</sup> Qu R. F. S. L.  
District of La.  
New Orleans La. June 3<sup>rd</sup> 68.

Warren, L. H.  
Capt Adj Asst Adjt Genl.

Acknowledges receipt  
of Report of "Indigent &  
& Destitute Freedmen" for  
month of May, 1868.

Requests that in all  
cases personal satisfaction  
be attained as to the  
condition of persons  
applying for relief.

Recd 8<sup>th</sup> Sub Dist of La. June 5<sup>th</sup> 68

H<sup>d</sup> Q<sup>r</sup> Qu R. F. S. L.  
8<sup>th</sup> Sub District of La.  
Thibodaux La. June 5<sup>th</sup> 1868.

Respectfully transmitted  
to Lt W. Prangon, A.S.C.  
E. Parish of Lafourche  
Thibodaux La.

Thomas Devine  
Sub Asst Comm.

#492.

HEADQUARTERS,  
Bureau of Refugees, Freedmen and Abandoned Lands,  
DISTRICT OF LOUISIANA,

New Orleans, La., June 3<sup>d</sup> 1868

Lieut. Nelson Bronson

Asst. Sub. Asst. Courier

(Thro: Mr. Thomas Divine.

Sub. Asst. Courier. 8<sup>th</sup> Sub. Dist.)

Sir.

I am instructed by the Assistant Commissioner to acknowledge the receipt of your Report of "Indigent and Destitute Freedmen" for month of May 1868, and to request that you will in all cases satisfy yourself, as to the condition of persons applying for rations.

Very Respectfully,

Your Obedient Servant.

Wm. H. Warner

Captain, 39<sup>th</sup> U. S. Infantry.

Actg. Asst. Adj. General



H<sup>o</sup> Q<sup>r</sup> Nur R. F & A. L.  
Office of Ass<sup>t</sup> Comm. of Subsistence  
New Orleans La June 4. 1868

---

W. W. Wood  
2<sup>nd</sup> Lieut 1<sup>st</sup> Inf<sup>ry</sup> A. C. S.

---

Transmitting Duplicate Invoices and Receipts  
for rations shipped Lieut. Nelson Bronson,  
A. S. A. Comm<sup>r</sup>, for signature & return.

---

HEADQUARTERS,

Bureau of Refugees, Freedmen and Abandoned Lands,

Office of Assistant Commissary of Subsistence.

# 176

New Orleans, La., June 4<sup>th</sup>

1868.

Lieut. A. Bronson

Act. Commissioner

Thibodaux La

Lieutenant.

I have the honor to transmit herewith, duplicate Invoices and receipts for rations shipped you on the 3<sup>rd</sup> inst. per A. O. O. U. G. W. R. Roads. Via Lafourche crossing. you will please sign receipts and return them to this Office at your earliest convenience.

Respectfully yours.

Obedient servant,

W. W. Wood

3<sup>d</sup> Lieut 1<sup>st</sup> Inf<sup>y</sup> A. C. S. Bureau



Thibodaux La June 5. 1868

---

Thomas Divine  
Sub Ass<sup>t</sup> Comm<sup>r</sup>.

---

Communicating order fr. the Ass<sup>t</sup> Comm<sup>r</sup>,  
to send at once for H<sup>d</sup> Q<sup>r</sup> a report in relation  
to the condition and prospects of the crops on  
all those plantations throughout the Parish Lafourge  
which have been furnished with supplies under  
Circular N<sup>o</sup> 1.

---

#67.

H<sup>d</sup> Qrs Qu R. F. A. L.  
8<sup>th</sup> Sub District of La.  
Thibodaux La. June 5<sup>th</sup> 1868.

Lt Nelson Gronson.  
Asst Sub Asst Com.

Sir;

I am directed by the Qrt Major  
General. Asst Commissioner, to inform  
you, that you "at once" send a report to  
this office, in relation to the condition  
and prospects of the crops on all  
those plantations throughout your Parish,  
which have been furnished with supplies  
under Circular No 1. Current Series,  
stating name of planter & plantations.

Very Respectfully,  
Your Obedt Servt  
Thomas Irvine  
Sub Asst Commissioner.



H Q<sup>rs</sup> Bur R. F & A. L.  
Office Genl Supt of Education  
State of Louisiana  
New Orleans La. June 6<sup>th</sup> 1868

---

Frank R. Chase  
General Supt of Education

---

Forwards : check for \$ 10. for Edw. Mitchell  
x \$ 10 for John Houston for April 1868.

---

#237.2.2.

(189 JULIA STREET,)

HEADQUARTERS,

Bureau of Refugees, Freedmen and Abandoned Lands,

Office General Superintendent of Education,

STATE OF LOUISIANA.

New Orleans, La., June 6<sup>th</sup> 1868.

Sir: Nelson Brown.

Asst. Dir. Asst. Commr.

Parish Lafourche, La.

Acitevant.

I have the honor to enclose  
herewith checks of Twenty Dollars  
to Edward Mitchell, also check of Twenty  
Dollars to John Houston, for the month  
of April, 1868.

Very Respectfully,

John O. B. Stewart,

Financ. A. Chase

Genl. Supr. of Education,

Bureau of R. F. & A. L.



Mr. Bur. R. F. & A. L.

Office Genl. Supt of Education  
State of Louisiana

New Orleans Louisiana June 8. 1868.

---

Frank R. Chase

General Supt of Education.

---

Requesting Sicut Bronson A. S. A. Commr.  
Parish Lafourche La. to forward at once his report  
of Schools, Receipts and Expenditures for the month  
of May. x x x x  
x x x

---

7241.2.3

HEADQUARTERS,

Bureau of Refugees, Freedmen and Abandoned Lands,

(189 JULIA STREET,)

Office General Superintendent of Education,

STATE OF LOUISIANA.

New Orleans, La., June 8<sup>th</sup> 1868.

Serv. Nelson B. Brown.

Ass<sup>t</sup>. Supt., Ass<sup>t</sup>. Commr.

Parish of Lafourche, La.

Plantation.

I have the honor to inform you that your "Monthly Report of School Receipts and Expenditures" for the month ending May 31<sup>st</sup> 1868 has not been received. Please forward very soon.

For receipt to your School Property return, I have the honor to inform you that I hold your receipt for the articles named in the <sup>enclosed</sup> School Property return blank.

In addition to this, the Books, &c. sent you letter from this Office dated April 27<sup>th</sup> should be taken up, on your May return as by the time said letter reached I think you had received Mr Stearns.

I have no wish that you should receipt for any property that was not



be given.

I should not have given Mr Sternberg a receipt of non-irretrievable but for your receipt of all the property for which he was responsible.

Yours Respectfully,

Your Obedt. Servant,

Samuel A. Chase

Genl. Supt. of Education

Barren, N. Y., Aug. 14

If there are any Claims  
that have not been filed  
yet by the Claimants  
I would be pleased  
to have you send  
me the discharges &  
I will make up their  
papers for them and  
send them to you

New Orleans La  
June 9<sup>th</sup> 1868

Respectfully returned  
to Lieut W Benson.

No Bounty is granted  
to troops who were drafted  
during the War, all  
others are entitled to  
the Bounty.

I was under the  
impression that Mr  
Reese received from the  
claimants the vouchers  
that were required &  
that the claims were  
ready for payment  
or I should not have  
informed you of the  
matter

Yours

G. P. Rockfeller

for C. B. Fisher & Co  
Lock Box 257. over



Office Asst Com, Regt. F. & M.  
Rhodeans La June 7<sup>th</sup> 1865

C. B. Fisher

Sirs

I have the honor to request information as to whether colored troops drafted in Feb and March 1865 for one year or the war are entitled to bounty - If so I have some discharges to send you for collection

Those men whom you requested me to send to New Orleans for identification feel very much dissatisfied that they had to make the trip to New Orleans without receiving their money

That difficulty might be obviated by sending the necessary blanks to me for signature

Very respectfully  
Your obt servt  
Orelva Brownson  
Lieut 4<sup>th</sup> Inf a s a e

No 1<sup>st</sup> Bur R. F & A. S.  
Office Genl. Supt of Education  
State of Louisiana  
New Orleans Le June 10. 1868.

---

Francis R. Chase  
General Supt of Education

---

Forwards vouchers of \$30 to Henry Grimes  
for the month of May 1868 for signature and  
return.

---



1247. P. 2.

(189 JULIA STREET.)

HEADQUARTERS,

Bureau of Refugees, Freedmen and Abandoned Lands,

Office General Superintendent of Education,

STATE OF LOUISIANA.

New Orleans, La., June 11<sup>th</sup> 1868.

Sir  
Lieut. Nelson B. Benson  
Asst. Sub. U.S. Commr.  
Paris to Lafayette, La.  
Lieutenant.

I have the honor to enclose  
herewith vouchers of Thirty (30) Dollars  
to Henry Lewis for the month of  
May, 1868.

Please have them properly signed  
and returned to this office for payment.

Very Respectfully,

Wm. A. R. Stewart,

Frank A. Chase

Genl. Supt. of Education.

Bureau, U.S. and A.S.

721 Vol 2. 8<sup>th</sup> Sub Dist of La. 1868.

H<sup>d</sup> Q<sup>r</sup> Qu R, S. A. L.  
State of Louisiana.  
New Orleans La. June 10<sup>th</sup> 1868.

Warren, S. H.  
Capt. Act. Asst. Adjt. Genl.

Directs that the Freed-  
man Jack Thomas, be  
sent to the Freedmen's  
Hospital New Orleans.

Encloses transportation,

(1. enclosure.)

Recd 8<sup>th</sup> Sub Dist of La. June 13<sup>th</sup> 1868.

H<sup>d</sup> Q<sup>r</sup> Qu R, S. A. L.  
8<sup>th</sup> Sub District of La.  
Thibodaux La. June 13<sup>th</sup> 1868.

Respectfully transmitted  
to Lt. W. Bronson, a. s. a. c.  
Parish of Lafourche, Thi-  
bodaux La. Thomas D. King  
Sub Asst Com.  
E. J. 2/24



HEADQUARTERS,  
Bureau of Refugees, Freedmen and Abandoned Lands,  
STATE OF LOUISIANA.

New Orleans, La., June 10<sup>th</sup>, 1867.

Lieut. Nelson Brownson,

Agent Bureau Refugees, Freedmen and Abandoned Lands,  
Par. of Lafourche, Thibodaux, Louisiana.

Sir:

Brevet Major General ~~J. A. Moore~~, U. S. Army, Assistant Commissioner, &c., directs that you send to this city, for admission to the Freedmen's Hospital, the following named indigent and helpless freedpeople, notifying the Surgeon-in-Chief at these Headquarters of the mode of conveyance and the probable time of their arrival here.

~~Captain W. B. Armstrong~~, Assistant Quartermaster, will defray the expense of their transportation.

Jack Thomas,

Very respectfully,  
Your Obedient Servant,

Wm. H. W. W.

Captain 39<sup>th</sup> U. S. Infantry, Act. Sec'y & Adjt. General.

Certified Copy of Order, or Extract, on which the within transportation is given.

No 86

Headquarters Bureau S. F. & A. L. Dist: of La.  
New Orleans La, June 10<sup>th</sup> 1868.

Bot. Lt. Col. Edgar C. Beman  
A. A. Gen. & D. O.  
Colonel,

You will furnish transportation for Jack Thomas  
freedman suffering from blindness - From Thibodaux  
La, to New Orleans La,

To enter Freedmens Hospital.

By Order of Bot. Maj. Gen. R. C. Buchanan  
(Signed) Lucius H. Warren  
Capt. 39<sup>th</sup> Inf. Inf.  
A. A. A. G.

A TRUE COPY.

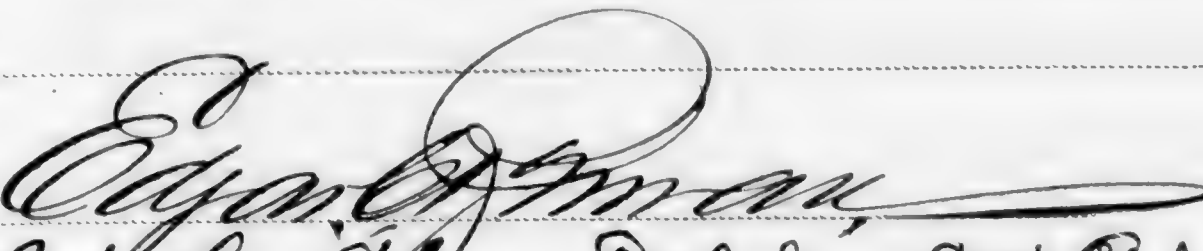
  
Bot. Lt. Col. D. O. & Capt. A. Q. M.

I Certify, on honor, that upon my own knowledge transportation was furnished for  
Men in accordance with within order.

Agent, Conductor, or Clerk.



*Sp*

**THIS ORDER NOT TRANSFERABLE. 1 Deck.**

**U.S. ORDER FOR TRANSPORTATION**  
NOT VALID UNTIL COUNTERSIGNED BY THE OFFICER ISSUING

No. 41532

New Orleans La. June 11<sup>th</sup> 1865

Transport *Jack Thomas*  
Co. *Destitute* Regiment *Freedman*  
From *Thibodaux La.* to *New Orleans La.*  
En. Route from *Thibodaux La.* to *New Orleans La.*

Signature of Officer issuing the order *Edward J. Manly* By order of the Quartermaster General *Levi B. Parsons*

*Edward J. Manly*  
Capt. Lt. Col. & D.O.

*Levi B. Parsons*  
Brig Gen & Chief of Rail & River Transp.

The holder of this order or the officer in charge of troops is required to fill the receipt below before signing, stating the exact number of men transported and the places from and to which transportation has been furnished.

1865

**I CERTIFY** on honor that  
has furnished transportation for  
From \_\_\_\_\_ to \_\_\_\_\_  
in compliance with the above order.



B. 258. Bu R. F. & A. L.

8<sup>th</sup> Sub Dist of La. 68.

Office Asst Sub Asst Com  
Parish of Lafourche La  
Thibodeaux La. June 11<sup>th</sup> 1868.

Bronson, N. Lt  
Asst Sub Asst Com

States that the District  
Court now in session is  
about to impanel a jury  
according to an old State  
Law to wit. from the  
assessment list of free  
white men.

Asks what course to pur-  
sue in case the above  
mentioned jury be im-  
paneled.

Rec'd 8<sup>th</sup> Sub Dist of La. June 11<sup>th</sup> 1868.

Hd Qrs Bu R. F. & A. L.  
8<sup>th</sup> Sub District of La.  
Thibodeaux La. June 12<sup>th</sup> 1868.

Respectfully forwarded to  
Capt E. H. Warren. A. A.  
Lt Genl Hd Qrs Bu R. F.  
& A. L. District of La.  
Thomas A. A. A.  
Sub Asst Com.

B. 258. (Bu R. F. & A. L., La.)

HEADQUARTERS  
BUREAU REFUGEES, FREEDMEN AND ABANDONED LA  
DISTRICT OF LOUISIANA.

New Orleans, June 16<sup>th</sup>

Respectfully returned to Lt. N. B.  
(thro: Mr. Thomas Divine. sub Asst-  
8<sup>th</sup> Sub District.)

The Assistant-Commissioner does  
what particular portion of the Civil  
Bill is impaired by the contrary  
action of the District-Court, - be  
any circumstance is at loss to  
he can find any right to inter-  
a matter of this kind, - until  
involving the rights of some fr  
under his charge, may be at  
St. Bronson  
will therefore attend solely  
duties assigned in existing  
from these Headquarters.

By Command of  
BREVET MAJOR GENERAL R. C. BUCHANAN

*Thomas A. A. A.*

Captain 39th U. S. I  
Act'g Ass't A



B. 258. Burk & A. h. a. S.

Q. 23. Vol. 2. 8. Sub Dist of La. 68.

Office Assit Sub Assit Com  
Parish of Lafourche La  
Thibodeaux La. June 11. 1868.

Bronson, N. Lt  
Assit Sub Assit Com

States that the District  
Court now in session is  
about to impanel a jury  
according to an, old State  
Law to wit, from the  
assessment list of free  
white men.

Asks what course to pur-  
sue in case the above  
mentioned jury be im-  
paneled,

Rec'd 8. Sub Dist of La. June 11. 1868.

H. Q. Q. P. R. F. S. A. L.  
8. Sub District of La.  
Thibodeaux La. June 12. 1868.

Respectfully forwarded to  
Capt E. L. Warren A. A.  
Lt. Genl H. Q. Q. P. R. F.  
S. A. L. District of La.  
Thomas A. A. A.  
Sub Assit Com.

C. O.  
7. 20.

Q. 23. Vol. 2. 8. Sub Dist of La. 1868.

H. Q. Q. P. R. F. S. A. L.  
8. Sub District of La.  
Thibodeaux La. June 18. 1868.

Respectfully transmitted to  
Lt N. Bronson, a. s. a. c.  
whose attention is invited to  
endorsement from H. Q. Q.  
P. R. F. S. A. L. Dist of La.  
Thomas A. A. A.  
Sub Assit Com.

C. O.  
7. 27.

Rec'd back 8. Sub Dist of La. June 18. 1868.



Bureau of R. F. and A. L.  
Parish of Lafourche, State of Louisiana  
Thibodaux, La., June 11<sup>th</sup> 1865

Captain Lucius H. Warren

U. S. A. General

(Through Mr. Thomas Divine, Sub Asst Comd.)

Captain,

I have received information,  
that the District Courts now in session, are about to impanel a  
Jury according to the provisions of an old State Law, to wit: "from  
the assessment list of free white men".

As this would seem to conflict with the "Civil Rights Bill",  
I have the honor to request, that I may be informed as to what course  
shall be pursued, in case a Jury should be impanelled, as above  
mentioned.

Very respectfully

Your obedient servant

Nelson Brown

Lieut. 4<sup>th</sup> Infantry, U.S.A.C.

Bureau of R. F. and A. L.



H<sup>d</sup> Q<sup>ty</sup> Bur R. F & A. S.  
Office. Ac<sup>ty</sup> Ass<sup>t</sup> Insp. General  
District of Louisiana  
New Orleans La June 13. 1868

---

W<sup>m</sup> H Sterling  
Capt. 1<sup>st</sup> U. S. Inf. Ac<sup>ty</sup> Ass<sup>t</sup> Insp. Genl.

---

Request that Lieut<sup>t</sup> Nelson Bronson,  
A. S. A. Comm<sup>r</sup>. Parish of Lafourche La  
forwards at once his Inspection Report  
for April 1868 and states the reason of the  
delay.

---

HEADQUARTERS,  
Bureau of Refugees, Freedmen and Abandoned Lands,  
DISTRICT OF LOUISIANA,

Office Act. Asst. Ins. General  
New Orleans, La., June 13th. 1868

Lieut. Nelson Bronson, A. S. A. C.  
Parish of Lafourche,  
Thibodaux, La.

Sir,

You will please forward the Monthly  
Inspection Report of your Parish, for April, 1868,  
without unnecessary delay, the same not having been  
received at this Office. You will also state reason of the  
delay.

Very Respectfully,  
Your Obedient Servant,  
M. J. Stelling  
Captain 1st. U. S. Infantry.  
Actg. Asst. Inspector General.



Vol 2. 8<sup>th</sup> Sub Dist of La. 1868

H<sup>d</sup>. Qrs Qu R. Fr A. Lands  
8<sup>th</sup> Sub District of La.  
New Orleans La. June 13<sup>th</sup> 1868.

Warren, L. H.

Capt. 1st Asst Adjt Genl

States that Brig. Lieut  
Col E. C. Beman, A. Q. C.  
and A. N. G. M. has this  
day been instructed to send  
(2,550.) Rations for distribution  
to the destitute.

H<sup>d</sup>. Qrs Qu R. Fr A. L.  
8<sup>th</sup> Sub District of La.  
Thibodeaux La. June 15<sup>th</sup> 1868.

Respectfully transmitted to  
Lt N. Robinson, asst. Sub  
asst Com. Parish of Lafourche  
Thibodeaux La.

Thomas Dwyne

Sub Asst Com.

E. C. Beman  
2/26

Pr. Dec 10 1868

HEADQUARTERS,  
Bureau of Refugees, Freedmen and Abandoned Lands,  
DISTRICT OF LOUISIANA,  
No. 197 Julia Street,

New Orleans, La., June 13, 1868.

Lieut Nelson Brownson,  
Assistant Sub Assistant Commissioner,

Parish of Lafourche, La.,

(Thro' Mr Thomas Smith,  
Sub Assistant Commissioner.

SIR:

I am directed by the Assistant Commissioner to inform you, that Bv't Lieu't Co'l EDGAR C. BEMAN, D. O. and A. A. Q. M., has this day been instructed to send to you by the most practicable route, 2550 RATIONS for distribution to the destitute. The same will be issued and accounted for in accordance with existing instructions.

You will in addition, state in your Tri-monthly-Report, receipt of rations, giving bulk in pounds, and will, in subsequent Tri-monthly-Reports, state number of pounds remaining on hand.

Very Respectfully,

Your Obedient Servant,

Thomas H. Warren

Captain 39th U. S. Infantry,  
Act'g Ass't Adj't General.



Thibodeaux, June 18/68

Nelson Bronson  
Lieut. 42<sup>d</sup> Infy

Regarding the issue  
of sub. stores to Mr  
J. F. Foster. Planter

B. 265. Bu. of A. R. Co. U.S.  
Head. Qu. Bureau Dist. A. S.  
Dist. of La.  
New Orleans, La., June 20, 1868.

Respectfully returned  
to Lieut. N. Bronson.  
Supplies can only be  
issued planters on the  
properly executed papers  
herein required.  
No affidavit has been  
received from Mr Foster  
for but one month  
supplies.  
By order, &c.

Thomas H. Walker  
Capt. 39 Infy  
a. a. a. 9.  
3/11/3

27<sup>th</sup> Vol. 5. Sub. Dist. of La.  
H. Q. Bu. of A. R. Co. U.S.  
8<sup>th</sup> Sub. District of La.  
Thibodeaux La. June 23<sup>rd</sup> 1868.

Respectfully transmitted  
to Lt. N. Bronson, a. s. o. c.  
and attention invited to  
enclosed circulars for fu-  
ture guidance.  
Thomas Devine  
Sub. Asst. Com.

Recd 8<sup>th</sup> Sub. Dist. of La. June 23<sup>rd</sup> 1868.

Bureau of R. F. and A. L.  
Parish of Lafourche, State of La.  
Thibodaux, La, June 18. 1868

Lieut. W. W. Wood

A. C. I.

Lieutenant,

Mr. ~~T. P.~~ Foster of this

Parish applied for advances of Subsistence Stores under the provisions of Circular No. 1, about two months ago, and received 1 bbl of Pork and 2 bbls of Cornmeal for the month of May, since when none has been furnished. -

He therefore asks, that the same amount may be sent for June 1868.

Very respectfully

Your obedient servant

Wilson Perrean

Lieut. 42<sup>d</sup> Infantry

A. S. A. C.



Head Quarters B of R F and A S  
Office Act Commissary of Subsistence  
New Orleans La June 18<sup>th</sup> 1848

Wood W W  
Lieut<sup>ad</sup> A. A. C. S. B of R F and A S

Forwards duplicate invoices  
and receipts for stores shipped  
on the 17<sup>th</sup> inst.

# 233

HEADQUARTERS,

Bureau of Refugees, Freedmen and Abandoned Lands,

Office of Assistant Commissary of Subsistence.

New Orleans, La., June 18<sup>th</sup>

1868.

Lieut. A. Bronson

A. A. Commissioner

Thibodaux La

Lieutenant.

I have the honor to transmit herewith, duplicate  
Invoices and receipts, for Subsistence, shipped you on  
the 17<sup>th</sup> inst, per A. O. O. No. C. M. R. Road, via Lafourche  
crossing, you will please sign receipts and return  
to this Office, at your earliest convenience.

Respectfully your

Obt. Servant

w w wood

2<sup>d</sup> Lieut, 1<sup>st</sup> Inf, No A, C, S, Bureau P. S. & A. L



N<sup>o</sup> Q<sup>m</sup> Rec. R. F & A. S.  
Office Genl. Supd<sup>t</sup> of Education  
New Orleans La June 20. 1868.

---

Franc. R. Chase  
Genl. Supd<sup>t</sup> of Education

---

Enclosed check to Lieut<sup>t</sup> Nelson Bronson  
A. S. A. C. Lafourche Parish La, in favor of  
Henry Grimes for April 1868

---

HEADQUARTERS,  
Bureau of Refugees, Freedmen and Abandoned Lands,  
(189 JULIA STREET,)

Office General Superintendent of Education,  
STATE OF LOUISIANA.

V. L. # 217

New Orleans, La., June 20<sup>th</sup> 1868.

Lieut. Nelson Prouson,  
Asst. Sec. Asst. Com.  
Paris, La.

Lieutenant,

Please be good  
to enclose herewith check of \$30.00 to Henry Grimes  
for the month of April 1868.

Very respectfully,  
Wm. Pitt Stewart.

F. Mann, A. Chase  
Gen. Supt. Education  
Care of J. Frank A. Lewis, La.



B. 269 Bu R F. A. L.

Q 26 Vol 2 8<sup>th</sup> Sub Dist of La 1868.

Office Asst Sub Asst Comd  
Tarrish of Lafourche La.  
Thibodaux La June 21<sup>st</sup> 1868.

Gronson N Lt

Asst Sub Asst Comd.

Requests to be informed  
in behalf of S. T. Tucker,  
if before his crop has matured,  
or afterwards, he should be  
able to reimburse the Bureau  
for the stores furnished him,  
will the Bureau deliver up  
to him the full control  
of his crop, if not will,  
he be allowed to send his  
crop to his own merchant in  
New Orleans to be sold. (W. C.  
Kimball & Co) provided they  
are thoroughly reliable.

Recd 8<sup>th</sup> Sub Dist of La June 21<sup>st</sup> 1868.

H<sup>d</sup> Qrs Bu R F. A. L.  
8<sup>th</sup> Sub District of La  
Thibodaux La June 22<sup>nd</sup> 1868.

Respectfully forwarded to  
Capt L. H. Warren, A. A.  
A. Comd H<sup>d</sup> Qrs Bu R F. A. L.  
8<sup>th</sup> Sub District of La.  
Thomas J. Quinn  
Sub Asst Comd.

Q 26 Vol 2 8<sup>th</sup> Sub Dist of La 68

H<sup>d</sup> Qrs Bu R F. A. L.  
8<sup>th</sup> Sub District of La.  
Thibodaux La June 26<sup>th</sup> 1868.

Respectfully transmitted  
to Lt N. Gronson, a. s. u. c.  
and attention invited to  
endorsement from H<sup>d</sup> Qrs  
Bu R F. A. L. Dist of La.

in absence of  
Thos. J. Quinn  
Sub Asst Comd  
John J. Sheridan  
Clt. in charge of office

E. J.  
2/322

Recd Bu R F. A. L. 8<sup>th</sup> Sub Dist of La June 26<sup>th</sup> 1868.



B. 269 Bu R F & A L La.

Q 26 2002 5 Sub Dist of La 1868.

Office Asst Sub Asst Com  
Parish of Lafourche La.  
Thibodaux La June 21 1868.

Gronson N Lt

Asst Sub Asst Com.

Requests to be informed  
in behalf of W. C. Tucker,  
if before his crop has matured,  
or afterwards, he should be  
able to reimburse the Bureau  
for the stores furnished him,  
will the Bureau deliver up  
to him the full control  
of his crop, if not will  
he be allowed to send his  
crop to his own merchant in  
New Orleans to be sold. (W. C.  
Himball & Co.) provided they  
are thoroughly reliable.

Recd 8 Sub Dist of La June 21 1868.

Hd Qrs Qu Co, F. A. L.,  
8th Sub District of La  
Thibodaux La June 22 1868.

Respectfully forwarded to  
Capt E. H. Warren, A. A.,  
A. Cent Hd Qrs Qu Co, F. A.  
L. District of La.

Thomas D. ...  
Sub Asst Com.

B. 269 (Bu. R. F. & A. L., La.)

1868

HEADQUARTERS  
BUREAU REFUGEES, FREEDMEN AND ABANDONED LANDS.  
DISTRICT OF LOUISIANA.

New Orleans June 24<sup>th</sup> 1868.

Respectfully returned to Lt. N. Gronson,  
(Care Mr. Thomas Divine, 8th Dist. Comr,  
8th Sub District) with the information,  
that no deviation will be made  
from present requirements, gov-  
erning the issue of supplies to  
planters, and promulgated in  
Circular #1. C. S., and crop will be  
held subject to order of the Bureau.

By Command of

BREVET MAJOR GENERAL R. C. BUCHANAN.

Charles H. Warren

Act. Lt. Col. U. S. A. Captain 39th U. S. Infantry.

Act'g Ass't Adj't General.

CC  
5/123



Office A.A. Com B of R.F. and A.L.  
Hibodan, La Jan 31<sup>st</sup> 1868

Capt L.H. Warren  
A.A.G. B. of R.F. and A.L.

Sir

(Thro Mr Thos Divins S.A.C. & Dist. La) I have the honor to request in behalf of Doct Geo W Tucker (who is being furnished with Rations under the provisions of Circular No. 1.) to be informed if at any time before the Crop has matured or after if the Said Dr Tucker should be able to raise the money in payment for all stores furnished: Will the Bureau or will it not deliver up to the owner the full control of his Crop;

Also will the Bureau allow the Said Dr Tucker to send his Crop to his own Merchants for sale (W.C. Kimball & Co No. 99. Poydras Street N.O.) provided they are thoroughly reliable

This information is asked from the fact that the Doctor did not understand when he Executed the bond the fact that he was obliged to send his Crop to such houses as the Bureau may see fit to designate

Very respectfully

Your obedient Servant

Alfred Brownson  
Lieut 42<sup>d</sup> Infantry A.S.A.C

Ad Q<sup>m</sup> Dur R. F & A. L.  
Office Genl. Supt<sup>t</sup> of Education  
New Orleans La June 23. 1868.

---

Frank R. Chase  
Genl. Supt<sup>t</sup> of Education

---

Communications in relation to the establish-  
ment of a new school at Raceland x x

---



Feb. 2. 1868

Headquarters Bureau Refugees, Freedmen and Abandoned Lands,  
(206 ST. CHARLES STREET.)

Office General Superintendent of Education,  
STATE OF LOUISIANA.

New Orleans, La., June 21<sup>st</sup> 1868

Miss Wilbur Browder,  
Asst. Sub. Asst. Commr.,  
Missis. Superior Co. Sch.  
Sattermont.

In reply to yours of the 17<sup>th</sup> inst  
in regard to a new school to be established  
at Raceland, I have the honor to state  
that any Benches or Desks needed will  
be sent to you, landed at Raceland if  
you so request.

Should other assistance be re-  
quired, please recommend the amount needed  
and for what purpose.

Very Respectfully,

Wm. C. Brown,  
General A. Chase  
Genl. Supt. of Education,  
Bureau, R. F. & A. L.

N<sup>o</sup> 12 Bur. P. F & A. S.  
Office Genl. Supt of Education  
New Orleans La June 23. 1868

---

Frank R. Chase  
Genl. Supt of Education

---

Instructions in relation to school property.

---



Vol. 2. # 253

Headquarters Bureau Refugees, Freedmen and Abandoned Lands,

(206 ST. CHARLES STREET.)

Office General Superintendent of Education,

STATE OF LOUISIANA.

New Orleans, La., June 23<sup>rd</sup> 1865.

Lieut Nelson Broussard.

Asst. Secy, Asst. Commr.

Parish of Lafourche, La.

Lieutenant.

Yours of June 16<sup>th</sup> is received but there is a slight error in the return. You will see by your invoices that some of the articles are under the wrong headings.

As by some means the Fourth Quarter invoices of April 27<sup>th</sup> were not received, you are sustained in omitting them from your return.

In regard to the missing 42 Desks and 4 Blackboards, please make a statement of the case to this office.

As this property has been in use in your Parish for more than three years, probably this apparatus has become worn out and utterly worthless. If you so represent the case I think I may obtain the necessary authority to have the same dropped.

(over)

In regard to the other property you can  
expect that on form 42, after approval  
by these Headquarters.

Very Respectfully,

Your Obedt. Servant,

Francis A. Chase  
Genl. Supt. of Education  
Bureau, H. H. & A. Funds,  
State of Louisiana.



B. 280 Bu R J. A. Kals

P. 31. Vol 2. 8<sup>th</sup> Sub Dist of La. 68.  
Office Asst Sub Asst Com.  
Parish of Lafourche La.  
Thibodeaux June 28<sup>th</sup> 1868.

Gronson, N. Lt  
Asst. Sub Asst Com.

Requests that a  
Standard or Recruiting  
Flag may be sent  
him for the use of  
his office on the coming  
4<sup>th</sup> of July.

Recd 8<sup>th</sup> Sub Dist of La June 29<sup>th</sup> 1868.

H<sup>d</sup>. Qrs Bu R. F. A. L.  
8<sup>th</sup> Sub District of La.  
Thibodeaux La. June 29<sup>th</sup> 1868.

Respectfully forwarded  
to Capt E. H. Warren  
A. S. A. Genl H<sup>d</sup>. Qrs  
Bu R. F. A. Land  
District of La.

E. D.  
2/68.

Thomas Divine  
Sub Asst Com.

P. 31. Vol 2. 8<sup>th</sup> Sub Dist of La. 68.

H<sup>d</sup>. Qrs. Bu R. F. A. L.  
8<sup>th</sup> Sub District of La.  
Thibodeaux La. July 2<sup>nd</sup> 1868.

Respectfully transmitted  
to Lt J. Gronson, a. s. a. c.  
and attention invited to  
endorsement from H<sup>d</sup>. Qrs.  
District of La.

E. D.  
1/68.

Thomas Divine  
Sub Asst Com.

Recd back 8<sup>th</sup> Sub Dist of La July 2<sup>nd</sup> 1868.



B. 280. Bu R. F. A. L. 68.

Q. 31. Oct 2. 8<sup>th</sup> Sub Dist of La. 68.

Office Asst Sub Asst Comm.  
Parish of Lafourche La.  
Thibodaux June 28<sup>th</sup> 1868.

Gronson, St. Lt  
Asst. Sub Asst Comm.

Requests that a  
standard or Recruiting  
Flag may be sent  
him for the use of  
his office on the coming  
4<sup>th</sup> of July.

Recd 8<sup>th</sup> Sub Dist of La June 29<sup>th</sup> 1868.

H<sup>d</sup> Qrs Bu R. F. A. L.  
8<sup>th</sup> Sub District of La.  
Thibodaux La. June 29<sup>th</sup> 1868.

Respectfully forwarded  
to Capt E. H. Warren  
A. S. A. Genl H<sup>d</sup> Qrs  
Bu R. F. A. L. 8<sup>th</sup>  
District of La.

E. B.  
2/1868.

Thomas Devine  
Sub Asst Comm.

B. 280. Bu R. F. A. L. 68.

Headquarters  
Bureau R. F. A. L. 8<sup>th</sup> Sub District  
District of Louisiana  
New Orleans, La. July 1<sup>st</sup> 1868.

Respectfully returned to Lieut  
St. Bronson, Asst Sub Asst Comm.  
Thru Mr Thomas Devine, Sub  
Asst Comm. with information,  
that there are no flags in poss-  
ession of the Bureau.

By command of  
Col Maj Genl R. G. Buchanan,  
Asst Commissioner  
M. H. Warren

Col Lieut Colonel U.S.A.  
Captain 39<sup>th</sup> Infantry  
A. U. A. General

E. B.  
5/1/30.



Office A.S.A. Com Bd of R.F. and A.S.

Thibodaux La June 28<sup>th</sup> 1868

Capt. L. H. Warren

A.A.A.G. Bd of R.F. and A.S.

Sir

I have the honor to request (I trust  
or Reluctant) Mr Thomas Divine S.A.C.) that a Storm Flag may be issued to me  
for the use of this office on the coming fourth:

From the best information which I can obtain I have reason  
to believe that there is not a United States Flag in the Parish

Very respectfully

Your obt Servant

Nelson Brownlow

Lieut 42<sup>d</sup> Infantry

H<sup>d</sup> Q<sup>rs</sup> Bur. R. F. & A. S.

Office D. O. & A. S. Q. A.

New Orleans La. July 1. 1868

---

Edgar C. Beman  
Bot Lieut Col' & D. O.

---

Enclosed cheer to Lieut Nelson Brownson, A.  
S. A. Comm' Parish Lafourche, in favor of C. C.  
Williams for hauling.

---

*Vertical handwritten notes on the right margin, including the name "Brownson" and other illegible scribbles.*

*Vertical handwritten notes in the lower middle section, including the name "Brownson".*



Bureau of Refugees, Freedmen and Abandoned Lands,

OFFICE DISBURSING OFFICER AND ACTING ASSISTANT QUARTERMASTER,

New Orleans, La., July 14 1868

Mr. Nelson Bronson  
Asst. Sub. Asst. Comm.  
Thibodaux La.

Sir:

I have the honor to transmit herewith my check No. 695  
on the Assistant Treasurer of the United States, at New Orleans,  
La., for Twelve Dollars and  
00 Cents in payment of your account for  
C. C. Williams - Hauling - June - \$12.00

The receipt of which you will please acknowledge without delay.

Very Respectfully,

Your obedient Servant

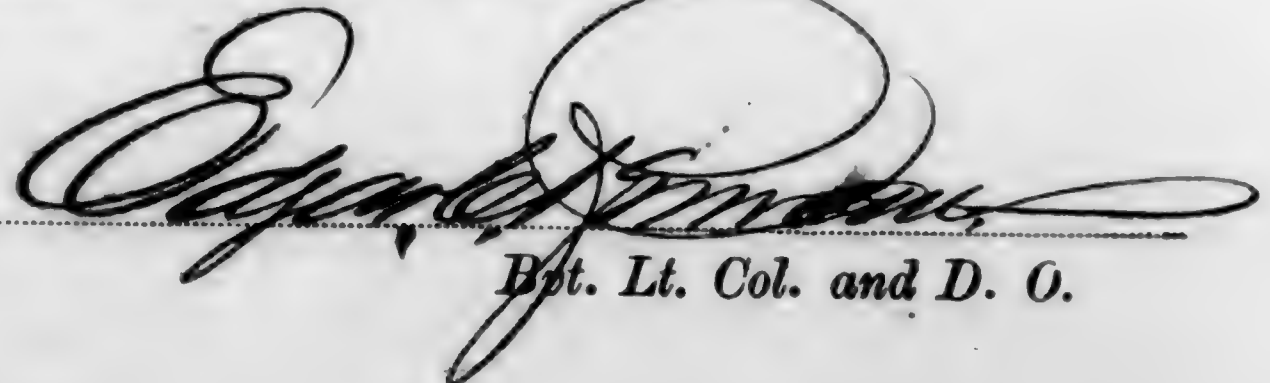
  
Bpt. Lt. Col. and D. O.

Head Quarters Bureau of R. F. & A.  
Office General Supt of Education  
New Orleans La July 2<sup>d</sup> 1868

Chas Frank R  
Genl Supt Education R. F. & A.

Forwards Vouchers of Army Lines  
for \$30.<sup>00</sup> for June 1868 for  
signature



Vol. 2, #292.

HEADQUARTERS,  
Bureau of Refugees, Freedmen and Abandoned Lands,  
(189 JULIA STREET,)

Office General Superintendent of Education,  
STATE OF LOUISIANA.

New Orleans, La., July 2<sup>nd</sup> 1868.

Wm. Miller Brewer,

155<sup>th</sup> Sub. St. Louis.

Parish Adjutant, La.  
Lieutenant,

I have the honor to enclose herewith vouchers of \$30<sup>00</sup> to Henry Grimes for the month of June, 1868.

Please have the vouchers properly signed (exactly the same as the name at the top of the voucher) and return to this office for payment.

If you forward bank vouchers from 22, receipt signed, as per letter from this office of February 4<sup>th</sup> it will greatly facilitate payments and avoid the risks by mail.

Very Respectfully,

Your Obedt. Servant,

Samuel R. Chase

Genl. Supt. of Education,  
Bureau R. F. and A. L.,

July 17, 1868

Thos. J. McAuliffe  
Teacher



Raceland Colored School La  
July 17<sup>th</sup> 1860  
Alem Brown Esq<sup>r</sup>  
Sir.

In compliance  
with instructions, I report the following  
School property for the use of this school  
received on the 16<sup>th</sup> inst.

Sixteen Benches  
Twenty Common Desks  
Two Blackboards.

Five Benches, and four Desks were partly  
broken, but the pieces were received and fixed  
so that they are fit for use.

The Day School has  
already increased to fifty scholars, nor a  
single case of absence or tardiness since its com-  
-mencement. Classes opened to Night School  
for the improvement in knowledge of the  
adult freedmen, numbering at present  
forty scholars of both sexes, ranging  
from twelve to fifty years of age.

I shall send you my School Report for  
July, at the close of the present month.

I am Sir,  
Very respectfully,  
J. M. Auliffe  
Teacher,



Bureau of Refugees, Freedmen and Abandoned Lands,  
(189 Julia Street.)

Office General Superintendent of Education,  
STATE OF LOUISIANA.

New Orleans Aug. 18<sup>th</sup>, 1868.

Respectfully returned  
to Mr. Henry Grimes.  
Attention invited to  
endorsement of Lewis  
Bronson - We cannot  
make the appropriate  
allowance for, under  
the circumstances -  
If, however, the school  
is in actual need,  
for support of teacher,  
an application for  
assistance, through Superintendent  
Bronson, will be favorably  
considered at  
this office to an amount  
depending upon the  
number of pupils -  
You have our hearty sym-  
pathy.

H. T. (over)  
Bd. Capt. U.S. Co. 2nd Regt. Col. 1st Div. 2nd Corps

8/2, 2, 131 HEADQUARTERS Aug 12, 1868  
L. T. V. C. D. O. May 10, 1865

Thibodeaux, La.  
July 7<sup>th</sup> 1868

Grimes.  
Henry.

Refers has organized  
school at Pugh's Plan-  
tation, numbering 70  
pupils, is in charge of  
Mr. J. McAuliffe

House fitted up  
The house, but yet needs  
repairs, requires \$70.00  
or \$80.00 to make the  
house comfortable, this  
plantation is 3 miles from  
Baceland,

AVR

Recd. O.R.G. July 10<sup>th</sup> 1868

Thibodeaux La July 11<sup>th</sup> 1868.  
Dear friend

Major K. Chase  
I have the honor to inform  
you that we have organized  
a school at the Pugh plantation  
it now numbers about 70.  
and children are coming every  
day. Mr. J. M. C. McAuliffe is the  
teacher and the school is under  
good discipline and is doing well  
we have fitted up the house the  
best we could for the present  
but it lacks something yet  
to make it comfortable.  
I knew that you had promised  
us something in that direction and  
this is our hope of getting the house  
fitted up. please excuse us for  
being so hasty we are desirous to  
see the work of education  
go on.



131 HEADQUARTERS Aug 13 1868  
I. C. W. O. May 10 1868

Miss Deane, Sec.  
July 7<sup>th</sup> 1868

Dear Sir,  
Henry.

Preferres has organized  
school at Pugh's Plan-  
tation, numbering 70  
pupils, is in charge of  
Mrs J. McAuleff

House fitted up  
the house, but yet needs  
repairs. Reports \$70.00  
or \$80.00 to make the  
house comfortable, this  
plantation is 3 miles from  
Macedonia,

Yours

Recd. O. S. G. July 10<sup>th</sup> 1868

This Deane La July 11<sup>th</sup> 1868.  
Dear friend

Major R. Chase  
I have the honor to inform  
you that we have organized  
a school at the Pugh plantation  
it now numbers about 70.  
and children are coming every  
day. Mr. J. M. C. Auliffe is the  
teacher and the school is under  
good discipline and is doing well  
we have fitted up the house the  
best we could for the present  
but it lacks something yet  
to make it comfortable.

I know that you have promised  
us something in that direction and  
this is our hope of getting the house  
fitted up. please excuse us for  
being so hasty we are desirous to  
see the work of education  
go on.

Office A. S. G. Com B of R. F. A. S.  
Milledale La Aug 15<sup>th</sup> 1868

Respectfully returned to  
Lieut 42<sup>nd</sup> Piers G. S. E. Bureau  
of R. F. A. S. with the information  
that I cannot recommend this  
appropriation for the reason  
that the school house in  
question is rented only for  
a temporary period of time  
and no contract can be made  
for the use of the building for  
any specified period

Richard Brandon  
Lieut 42<sup>nd</sup> Piers G. S. E.

Bureau R. F. A. S.  
State of Louisiana







Dear friend dont think that we  
are trying <sup>to</sup> hurry you but only when  
it meets your approbation to do  
this we will feel under grate  
obligations to such a friend.  
if we had the deats and about  
70 or 80 dollars we could  
make the house very  
comfortable and grate good  
might be done there. the  
Plantation is about 3 miles  
below Naaland. at Frankers  
Pughs Plantation the house  
is. where the school is going on  
we are gratefull to you in our hartes  
for what you have all ready done.  
your name will never be forgotten  
among the peope of this place.

Respectfully  
yours obedante

D. T. J.

Henry Grimes

H<sup>d</sup> Q<sup>rs</sup> Bur R. F & A. S.  
Office Genl. Supt of Education  
New Orleans La July 8. 1868.

---

Francis R. Chase  
Genl. Supt of Education

---

Enclosures check for \$10 in favor of Edward  
Mitchell and ditto for \$10 in favor of John  
Houston to Lieut Nelson Bronson A. S. A. Com.  
for the month of May 1868

---



9/2 #340

Headquarters Bureau Refugees, Freedmen and Abandoned Lands,

(206 ST. CHARLES STREET.)

Office General Superintendent of Education,

STATE OF LOUISIANA.

New Orleans, La., July, 8<sup>th</sup> 1865,

Lieut Nelson Benson,  
Asst. Surg. Asst. Comd.,  
Parish Lafourche, La.,  
Lieutenant

I have the honor to enclose  
herewith check of \$1000 to Edward  
Mitchell and check of \$1000 to Pierre  
Houssier for May, 1865,

Very Respectfully,

Simon O. Chase

Simon O. Chase

Genl. Supt. of Education

Bureau R. F. and A. L. La.

A<sup>d</sup> Q<sup>r</sup>. Bur R. F & A. L.  
Office Genl. Supt<sup>d</sup> of Education  
New Orleans La. July 9. 1868

---

Frank A. Chase  
Genl. Supt<sup>d</sup> of Education

---

Intforms Sicut Nelson Bronson A. S. A. Com.  
Parish Lafourche La that school-property is  
shipped for his parish, and intforms him how to  
pay the freight.

---



V. 2. 7319

Headquarters Bureau Refugees, Freedmen and Abandoned Lands,

(206 ST. CHARLES STREET.)

Office General Superintendent of Education,

STATE OF LOUISIANA.

New Orleans, La., July 9<sup>th</sup> 1868

Lieut Nelson Broussard

Asst. Surg. Asst. Comdr.,

Parish Lafourche, La.,

Lieutenant,

I have sent you the following  
school property, to Thibodeaux, viz,  
(20) Quantity Benches,

(20) Common Desks,

(2) Blackboards,

I could not send them by the  
"Dimes" as she will not take Bureau  
freight, perhaps she will take it for  
you. You will have to do the best you  
can to get the property taken to Race-  
land. You can pay the freight and  
have the clerk of the boat, or whoever  
carries it, sign Receipts in Blank vouchers  
(No. 11.) and send to me and I will send you  
a check for the amount.

Very Respectfully,

Your Obedt. Servant,

(over)

Frank A. Chase  
Genl. Supt. Education  
Bureau, P. O. Wash. D. C.



Office I. O. & A. A. Q. M.

New Orleans La July 13. 1868.

---

Edgar C. Benson  
Br<sup>t</sup> Lieut<sup>t</sup> Col<sup>l</sup> & I. O.

---

Enclosure cheer to Lieut<sup>t</sup> Nelson Benson,  
A. S. A. Com., in favor of Mess<sup>rs</sup> C. P. Pennington  
& Co for horse-shoeing and medicaments and  
attendance

---

Offic' D. O. Kragin  
New Orleans La<sup>y</sup> July 13<sup>th</sup> 1861

Lieutenant Nelson Brownson  
Thibodaux La<sup>y</sup>  
Lieutenant

These find enclosed, vouchers in favor of  
Messrs J. P. Reiniger & Co for services rendered  
in shoring horse & medicine & attendance for  
same. You will please make them over separately  
vouchers for shoring & one for medicine & attendance  
in accordance with form enclosed

Respectfully  
E. J. Brownson  
B. L. Caldwell



A<sup>d</sup> Quarters Bur R. F & A. L.  
Office Genl. Supt of Education  
New Orleans July '4. 1868.

---

Frank R. Chase  
Genl. Supt of Education

---

Encloses check for \$30 to Nelson Bronson,  
Lieut & A. S. A. C. Parish Lafourche La. in  
favor of H. Grimes for the month of June 1868.

---

72<sup>330</sup>

Headquarters Bureau Refugees, Freedmen and Abandoned Lands,

(206 ST. CHARLES STREET.)

Office General Superintendent of Education,

STATE OF LOUISIANA.

New Orleans, La., July 14<sup>th</sup> 1868,

Lieut Nelson B. Brownson,

Asst. Sub. Asst. Commr.,

Parish Lafourche, La.

Lieutenant.

I have the honor  
to enclose herewith check of Thirty  
(\$30.00) Dollars to Henry Corines for the  
month of June, 1868.

Very Respectfully,

(Per O. B. B. Servant.)

Francis A. Chase

Genl. Supt. of Education

Bureau, R. F. Smith, Sec.



Mr Q<sup>r</sup> Bur R. F & A. L  
Office Genl Supt of Education  
New Orleans La July 17. 1868

---

Francis R. Chase  
Genl Supt of Education

---

Encloses copies of "Howards Federal Union"  
Constitution for distribution to the various min-  
isters and teachers and request Mr. Nelson Bron-  
son to do all in his power to have ~~each~~ every  
freedman, woman and child represented by the  
small sum of one Cent.

---

HEADQUARTERS,  
Bureau of Refugees, Freedmen and Abandoned Lands,  
(189 JULIA STREET,)

Office General Superintendent of Education,  
STATE OF LOUISIANA.

New Orleans, La., July 17<sup>th</sup> 1868.

Lieut. Nelson Brinson  
Ass't. Sub-Ass't. Comm.  
Paris Lafourche Sr.

Lieutenant

Private

Honor to enclose herewith copies of the "Howard  
Federal Union" Constitution and request you to  
give them to the various ministers and teachers  
in your Parish, and do all in your power to have  
every Freedman - woman and child represented by  
the small sum of "one cent".

This is a just tribute to the Christian  
General who has done so much for this race.

Very Respectfully

Yours Obedt. Servant

Samuel A. Chase

Genl. Supt. Education  
Bureau of Refugees, Freedmen and Abandoned Lands



Bur R. F & A. L.

Office D. O & A. A. G. M.

New Orleans July 22. 1868.

---

Edgar C. Beman

Br<sup>o</sup> Lieut<sup>t</sup> Col & D. O.

---

Informs that he has to draw his forage  
allowance from Mr. Thomas Divine

---

Bureau of Refugees, Freedmen and Abandoned Lands,

OFFICE P. O. & A. A. QUARTERMASTER, NO. 206 ST. CHARLES ST.

New Orleans, July 22<sup>d</sup> 1868

Lieutenant N. Proctor  
Thibodaux La,  
Lieutenant

The Trunks shipped to Mr  
Thomas Divine will answer for your  
allowance for the month of August.  
This will be sufficient authority for Mr  
Divine to deliver the same to you

Very Respectfully  
Your Obedt Servt  
C. J. Adams  
Bt Lt Col U. S. A.





72373

HEADQUARTERS,  
Bureau of Refugees, Freedmen and Abandoned Lands,  
(189 JULIA STREET,)

Office General Superintendent of Education,  
STATE OF LOUISIANA.

New Orleans, La., Aug. 6<sup>th</sup> 1868.

Genl. Nelson Brown,

A. P. U. C.,

Genl;

Enclosed,

please find Checks payable to order,  
as follows:-

John Houston. \$10.<sup>00</sup> for June

Ed. Mitchell. \$10.<sup>00</sup> for June.

Henry Grimes. \$30.<sup>00</sup> for July -

In full for rent.

H. W. Reed,

Genl. & Genl. Sup. of Ed -



No 2<sup>d</sup> Bur A. F. & A. S.  
Office Gen. Supt of Education  
New Orleans La. Aug. 14. 1868

---

H. H. Peirce  
Post Capt. 1<sup>st</sup> Lieut 1<sup>st</sup> Infantry  
Gen. Supt of Education

---

Requesting that Lieut Nelson Bronson  
A. S. A. C., send answer to endorsement of  
July 7 and letter of July 9. 1868.

---

U.S. # 412,

**HEADQUARTERS**  
Bureau of Refugees, Freedmen and Abandoned Lands,  
(189 Julia Street.)

Office General Superintendent of Education,  
STATE OF LOUISIANA.

New Orleans Aug. 14<sup>th</sup> 1868.

Genl. Nelson Brown,

A. P. A. E.,

Sir;

Enclosed

of July 7<sup>th</sup> and letter of July  
9<sup>th</sup> 1868 - sent you from  
this office - are yet unans-  
wered - Please attend and  
oblige -

Very truly,  
W. F. Pierce,  
Col. Cap. U.S.A. & Genl. 1<sup>st</sup> Inf.,  
Genl. Inf. 2<sup>d</sup> Ede.



H<sup>d</sup> Q<sup>r</sup> Bur R. F & A. L.

Office D. O & A. A. Q. M.

New Orleans La Aug. 17. 1868.

---

Egar C. Beman

1st Lieut Col<sup>o</sup>, D. O & A. A. Q. M.

---

Enclosing checks for payment school-rents,  
rent for stable, storehouses, horse-shoing, postage  
and Hauling; - to acknowledge the receipt.

---

Bureau of Refugees, Freedmen and Abandoned Lands,

OFFICE DISBURSING OFFICER AND ACTING ASSISTANT QUARTERMASTER,

New Orleans, La., August 17<sup>th</sup> 1868.

Lieut. Nelson Bronson.

Ast: Sub: Ast: Comr

Thibodeaux La.

Sir:

I have the honor to transmit herewith my check No 941.  
on the Assistant Treasurer of the United States, at New Orleans,  
La., for Sixty Seven

Fifty Six

Cents in payment of your accounts for viz:

own acct. - Postage - July \$4 56

Chas. C. Williams - Hauling - June 7 75

Mr H. Ragan - Office Rent - " 15 00

R. Higginbotham - " - July - 2 25

" " " Store H. " - " - 5 00

Louis S. Meyer - Office Rent - June 75 00

Virginia Faber - Stable " - " - 10 00

" " " - Store H. " - " - 5 00

C. P. Binning 100, Horse Shaving - " - 3 00

\$ 67 56  
100

The receipt of which you will please acknowledge without delay.

Very Respectfully,

Your obedient Servant.

*Edw. J. Ransom*  
Bvt. Lt. Col. and D. O.



Thibodaux La. Aug. 20. 1868.

Nelson Bronson  
Lieut 42<sup>nd</sup> Inf<sup>ys</sup> & A. S. A. Comm<sup>d</sup>

Requesting that Br<sup>g</sup> Col. Edgar Bemans  
D. C. & A. G. M. furnish him a copy of the  
Contract, Bond & Affidavit of Thomas F  
Foster who received supplies of the Gov. under  
the provision of Circular No. 1. \* \*

#359.

Office A. C. S. Bu. A. T. C. S.

St. Louis, La., Aug. 22/68

Respectfully returned to Lieut  
N. Bronson, asac, Safford's  
parish, La., with copy of  
bond and affidavit of Thomas  
F. Foster, as requested.

The asst. Comm. directs that  
Mr Foster sign both copies  
of enclosed contract, and  
that two persons witness  
the signatures of the freed-  
men named, and that  
of Mr Foster. After you  
have approved the contract,  
one copy will be returned,  
the other filed in your office.

*[Signature]*  
J. L. Inf. Acs.

Office A. S. A. Com Coy R F & A. S.  
Hibernia La August 20<sup>th</sup> 1868

Bot Lt Col E. C. Beman

D. C. & A. S. Com Coy R F & A. S.

Sir

I have the honor to request that I may be furnished with a copy of the Contract, Bond & Affidavit, of Thomas F. Foster, who received Supplies from the Govt under the provisions of Circular No. 1. My Predecessor informs me that he forwarded duplicates to Head Quarters, and retained none himself consequently there is no record of the transaction in this office except the receipt for Supplies

Very respectfully  
Your obt Servant  
Wilson Brown  
Lieut 42<sup>d</sup> Infantry A S A ©



H<sup>d</sup> Q<sup>rs</sup> Bur. R. F & A. L.  
Office Genl. Supt of Education  
New Orleans Aug. 21. 1868

---

H. H. Pierce  
Bvt Capt U. S. Army, 1<sup>st</sup> Lieut 1<sup>st</sup> Inf<sup>y</sup>  
Genl. Supt of Education

---

Enclosing checks for school-rents.

---

Mr. 4447

HEADQUARTERS,  
Bureau of Refugees, Freedmen and Abandoned Lands,  
(189 JULIA STREET,)

Office General Superintendent of Education,  
STATE OF LOUISIANA.

New Orleans, La., Aug. 21<sup>st</sup> 1868.

Genl. Nelson Bronson,  
A. S. A. C.,

Lieutenant;

Enclosed,

please find checks payable to order, as follows:-

- Thos. McAuliffe - \$20.<sup>00</sup> - for July.
- Ed. Mitchell - \$10.<sup>00</sup> - " "
- John Houston - \$10.<sup>00</sup> - " "

In full for rent

Very Respectfully,  
W. H. Pierce,  
Bot. Capt. U. S. A. Lt. 1<sup>st</sup> Infy.,  
Genl. Sup. Educ.



Pay Department U. S. Army  
Dist of New Orleans  
New Orleans La Aug. 27. 1868

---

Jno S. Walker.  
Paymaster U. S. Army.

---

Cheque in favor of Nelson Bronson 2<sup>d</sup> Lieut  
42<sup>nd</sup> U. S. Inf<sup>ty</sup> in payment of your account for  
August. 1868.

---

Pay Department, U. S. A.,  
DISTRICT OF NEW ORLEANS.

New Orleans, La., *Aug.* 27<sup>th</sup> 1868.

Sir:

I have the honor to enclose herewith Check No. 1154,  
on Assistant Treasurer of the United States, at New Orleans,  
for *One hundred and twenty one* Dollars  
*and thirty cents.*

in payment of your account for *August* 1868.

Please acknowledge receipt.

Very Respectfully,

Your Obedt. Servant,

*J. M. Mackey*  
Paymaster, U. S. A.

*Nelson Brown*  
*2<sup>d</sup> Lieut. 42<sup>d</sup> Infy*  
*Shibden*  
*La.*



No 13 Bur F. R. & A. S  
Office Suprd of Education  
New Orleans La Aug. 28. 1868.

---

H. H. Pierce.  
Br<sup>g</sup> Capt. U. S. Army & Gen<sup>l</sup> Supd of Education

---

Encloses vouchers for signature and return  
for payments.

---

2489

HEADQUARTERS,  
Bureau of Refugees, Freedmen and Abandoned Lands,  
(189 JULIA STREET,)

Office General Superintendent of Education,  
STATE OF LOUISIANA.

New Orleans, La., Aug. 28<sup>th</sup> 1868.

Lieut. Nelson G. Brown  
A. S. A. Comdr. G. B. B. & C.  
Thibodaux La.

Sir;

Enclosed please find  
duplicate Vouchers, Form 22, to be signed in  
blank as per headings - Signatures to exactly  
correspond with headings - as to spelling - Prompt-  
ness is necessary - in order to expedite payments.

Very Respectfully,  
W. H. Pierce,  
1st Lt. Capt. U. S. A. & Genl. Supt. Ec. Bu. & C.



Thibodaux La Aug. 31. 1868.

---

Wm Woods

Sub Ass<sup>t</sup> Comm<sup>r</sup> 8<sup>th</sup> S. Distr

---

Instructions for making out and briefing  
reports and returns to Lieut Nelson Brenson  
A. S. A. Comm<sup>r</sup> Thibodaux La.

---

LS #18

Head Quarters P. T. & A. Lands.  
8<sup>th</sup> Sub District, Dist. of La.  
Thibodeaux, La. August 31<sup>st</sup> 1858

Lieut Nelson Bronson  
Asst Sub Asst Commissioner  
Bureau P. T. & A. Lands.  
Thibodeaux, La.

Sir

My attention has been called to the incomplete, brief, & imperfect manner, in which many of the "Reports" of Asst Sub Asst Comrs in my Sub District are compiled.

Your attention is directed to the manner in which you will, in future, compile your "Tri-Monthly Reports," as per Blank Form herewith enclosed. Too great care cannot be taken in compiling your "Reports" giving all the information required on each subject, also in "General Remarks," give such information as you have, in regard to your Parish, as you deem of interest or importance. Should you fail to obey these instructions, it will be considered an act of negligence on your part, & will be reported accordingly.

Very Respectfully.

Your Obedient Servant

Wm Woods  
Sub Asst Comr 8<sup>th</sup> Sub Dist of La



Office Asst Q. M. U. S. Army  
New Orleans Septbr 1. 1868

---

H. Hoyt,  
Asst Q. M. U. S. Army

---

Encloses check in favor of Lieut Nelson  
Bronson 42<sup>d</sup> Inf<sup>ys</sup> A. S. A. C. Thibodaux La for  
commutation of Quarters & fuel.

---

Office Assistant Quartermaster, U. S. Army,

New Orleans, La. September 1<sup>st</sup> 1868

Mr Nelson Brown

42<sup>nd</sup> Infantry A.S.C.

Major General

Sir: I enclose herewith Check No. 1441 on Assistant  
Treasurer of the United States at New Orleans, La., payable  
to the order of yourself for \$ 33.<sup>49</sup>/<sub>100</sub>  
in payment of your account for commutation of quarters - fuel  
for the month of August 1868.

Please acknowledge receipt.

Very Respectfully,

Your Obedient Servant,

C. H. Hryl  
Captain



Thibodaux La. Septbr. 5. 1868

---

Wm Woods

Sub Ass<sup>t</sup> Comm<sup>r</sup>. 8<sup>th</sup> S. Dist.

---

Calling the attention of Mr. Nelson Bronson,  
A. S. A. Comm<sup>r</sup>. to the within given instructions  
for making out reports, to be strictly observed.

---

#31

Head Quarters Bu. R. F. & A. Lands,  
1<sup>st</sup> Sub District, District of La.,  
Thibodeaux, La., Sept 5<sup>th</sup> 1868.

Lieut Nelson Bronson  
Asst Sub Asst Commr,  
Bureau R. F. & A. Lands,  
Thibodeaux, La.

Sir,

Your attention is directed to the following "Instructions," viz:  
Under the head of "Inspections" in your "Tri-Monthly Reports," state the number of Plantations "inspected" and as nearly as possible the number of working hands employed on said Plantations, the average wages received by them, also, to the best of your knowledge, the number of acres of land under cultivation, and kind of crops raised.

You will also state in your next "Tri-Monthly Report," whether or not, you have delivered a copy of Circular No. 16. G. S. H. G. R. Bu. R. F. & A. Lands, New Orleans, La. of date Sept 1<sup>st</sup> 1868, to the Civil Authorities of your Parish.

Very Respectfully

Your Obedient Servant

Wm Woods

Sub Asst Commr,

1<sup>st</sup> Sub District



---

Office Genl Supt of Education  
Habit Bureau Ret. <sup>4</sup>/<sub>5</sub> La Lande.  
New Orleans, La, Sept 9<sup>th</sup> 1868

---

Percy, H. H. Col Capt, U.S.A.  
Genl Supt of Education.

---

Encloses check for Thirty (\$30.<sup>00</sup>)  
Dollars payable to order of Henry  
Grimis. in full for services and  
rent for August 1868.

Directs that enclosed receipt  
be signed by H. Grimis and return-  
ed to his Office.

---

W. 2. # 3711

Headquarters Bureau Refugees, Freedmen and Abandoned Lands,

(206 ST. CHARLES STREET)

Office General Superintendent of Education,  
STATE OF LOUISIANA.

New Orleans, La., Sept. 9<sup>th</sup> 1868

Mr. John H. Van Antwerp  
A. S. A. Contr. Bu. &c  
Thibodeaux La.

Sir,

Enclosed please find  
check payable to order as follows:—

Henry Grimes \$30<sup>00</sup>/<sub>100</sub>

in full for rent and services for August-1868

Upon delivery of the check, you will have the  
enclosed Receipt signed by Mr. Grimes, and return  
at once to this Office.

Very Respectfully

Your obedient servant  
H. H. Pierce,

1<sup>st</sup> Lt. Capt. U. S. A. Genl. Supt. Contr. Bu. &c



Office a. a. a. Genl. H<sup>d</sup> Davis  
Bureau R. F<sup>th</sup> A. S.

New Orleans La Sept 16<sup>th</sup> 1868

Warren L. W. Bot Lt Col reja.  
a. a. a. General

Encloses commission from Secy  
War appointing J. H. Van Antwerp  
a. S. a. C. Bu R F<sup>th</sup> A. S. for  
the Parish of Lafourche, also the  
Oath of office.

Directs the same to be sworn to  
and returned to his office.

*Lafourche*  
*Warren L. W.*  
*1868*  
*Antwerp*

# 913.

HEADQUARTERS



Bureau of Refugees, Freedmen and Abandoned Lands,  
DISTRICT OF LOUISIANA.

New Orleans, September 16<sup>th</sup> 1868.

Mr. J. H. Van Diverp,

Asst. Sub. Asst. Commissioner,  
Bureau R., F. and A. Lands,

Shibodeaux La

Sir:

I am instructed by the Assistant Commissioner, to enclose your appointment also Oath of Office required to be taken which you will please execute and return to these Headquarters, as soon as possible.

Very Respectfully,

Your Obedient Servant,

Charles H. Walter

Br't Lieut Col. U. S. A.,

Captain 39th Infantry,

Act'g Asst Adj't General.



---

---

Office Genl Supt of Education  
Hd Qrs Bureau R. F and A Lands  
New Orleans La September 18/68

---

---

Pierce H. H. Brot Capt U.S.A.  
Genl Supt of Education

---

Gives directions how to fill up the  
new School Reports.

Requests full and explicit report of  
schools.

Is willing to extend all the encourage-  
ment and assistance possible to extend  
schools.

---

---

72-573

Headquarters, Bureau Refugees, Freedmen and Abandoned Lands,

(206 ST. CHARLES STREET.)

Office General Superintendent of Education,

STATE OF LOUISIANA.

New Orleans, La., Sept. 18, th. 1865,

Mr. Peter H. Van Antwerp,

A. S. A. Comm.,

Thibodaux, La.,

Sir:

A new blank form has been sent you this month, upon which is consolidated the matter required at this office, and formerly, reported on the "Monthly School Report," and the Report of Schools, Receipts, and Expenditures. Hereafter, you will please report upon this blank, dispensing with the Report of Schools, Receipts, and Expenditures, and the old form of "Dist. Supr., Monthly School Report," which will be no longer required.

It will be observed that the first six spaces, directly following the column headed "Receipts and Patrons," are designated to account for all monies passing through the hands of the A. S. A. Comm., whether collected from tuition, tax or other sources, and together with the next three



spaces in order, are to be filled by the Agent. The remaining questions will be, as before, answered from the "Teachers Report,"

Permit me to call your attention to the importance of making this report full <sup>and explicit</sup>. Let every question be answered, according to your best knowledge, founded upon carefully collected information; too little attention has been paid this subject in many instances,

This office is willing to extend to you all the encouragement <sup>and assistance</sup> possible, and with a proper degree of exertion on your part, I see no reason why this great improving work should not be completely successful.

Very Respectfully,

W. H. Perce,

Col. Secy., U. S. A.,

Comm. Supr., Education,

Office Gen<sup>l</sup> Supt Education  
Hd qrs Bureau R. F<sup>and</sup> A. Lands  
New Orleans Sept 24 1868

---

Pierce H. H. Bot Capt U.S.A.  
Gen<sup>l</sup> Supt of Education

---

Enclosed vouchers to be signed in  
blank and returned to his office  
as soon as possible.

---



9/2 # 595-

Wm

Hd. Qrs. Cav. R. F. and A. S.  
Office Genl. Supt. of Education  
State of Louisiana  
New Orleans La. Sept. 24<sup>th</sup> 1868

Mr. John H. Van Antwerp  
A. S. St. Louis Buss.  
Thibodaux La.

Sir;

Please have the en-  
closed Envelopes signed, signature to correspond  
exactly with heading, as to spelling, and return,  
as soon as possible, to this office.

Very Respectfully

Your obedient servant

*[Signature]*

1<sup>st</sup> Lt. Capt. U. S. A. 2<sup>nd</sup> Lieut. 1<sup>st</sup> & Adj.  
Genl. Supt of Education



V. 157 Bu R F A L La.

V. 3. Vol 2, 5<sup>th</sup> Sub Dist of La.

Office U.S.A. Bu R F A L La.

Parish Lafourche, La.

Shibodeaux, La, Sept 25<sup>th</sup> 1868.

Van Antwerp, J. H.  
Asst Sub Asst Comdr

States that daily applications are made at his Office, for relief, by freedmen, many of them in a destitute & starving condition.

Has referred such cases to the Police Jurors of the Parish, who have refused assistance, alleging that there is no money in the Treasury, & unable to say when there will be. Asks if any aid can be rendered through the Bureau?



Recd Hd Qrs 8<sup>th</sup> Sub Dist of La. Sept 25 68

Head Quarters Bu R F A L La.

8<sup>th</sup> Sub District, Dist of La.

Shibodeaux, La. Sept 25<sup>th</sup> 1868.

Respectfully forwarded to Bvt Major B. T. Hutchins, U.S.A., General, Bureau R. F. & A. Lands, New Orleans, La., with the additional information that there are in each Parish of this Sub District a few freedpeople, such as sick, crippled, old & infirm, who are absolutely objects of charity & who have, since the supplies from the Bureau have been stopped, subsisted only on the charity of themselves or their own color who are nearly as poor as themselves. The Civil Authorities have been notified that they would be expected to take care of their own poor in accordance with Order No. 13, G.O. of June 29<sup>th</sup> 1868, yet they have rendered the destitute no assistance whatever.

I am convinced from actual observation that unless assistance is given by the Government, many of these unfortunate freedpeople will die of actual starvation.

EB  
2/68

Wm Woods  
Sub Asst Comdr  
8<sup>th</sup> Sub Dist of La.

V. 157 (Bu. R. F. & A. L., La.) 1868.

HEADQUARTERS,  
BUREAU REFUGEES, FREEDMEN AND ABANDONED LANDS,  
DISTRICT OF LOUISIANA.

New Orleans, Sept. 28<sup>th</sup> 1868.

Respectfully returned to Mr. J. H. Van Antwerp, U.S.A., through Mr. Wm. Woods, U.S.A., 8<sup>th</sup> Sub District, attention directed to Order #13 from these Headquarters, enclosed.

By Command of

BREVET MAJOR GENERAL EDWARD HATCH,

E. Hatch

Bvt Major U. S. A., Captain 6th Cavalry,  
Act'g Ass't Adj't General.

EB  
2/68



#10

Office of A.S.A.C. Bu R. 7<sup>th</sup> A.S.  
Parish of Lafourche La.  
Thibodeaux Sept 25<sup>th</sup> 1868.

Bot Major B. T. Hutchins

A. C. C. Gen. Bu. R. 7<sup>th</sup> A.S.

New Orleans La

Sir

I have the honor to submit the following (through  
Mr W<sup>m</sup> Woods S. A. C.).

Daily applications are being made through this office for relief, by freedmen, many of whom are in a destitute and starving condition. The Gov<sup>t</sup> rations being all expended, I have referred all such cases to the Police Jurers of the Parish as per Order No 13 of date June 29 1868. Hd. Brs N. O. where they have been refused assistance for the reason, alleged that there is no money in the Treasury, and are unable to say when there will be,

I would therefore ask if any aid can be rendered them through the Bureau.

Very Respectfully  
Your Oth Serv  
J. N. Van Tine  
A.S.A. Com<sup>r</sup>

Head Quarters Bureau Re: F. & A. H.  
8<sup>th</sup> Sub District, Dist of La.  
Thibodaux, La. Sept 30<sup>th</sup> 1868

---

Respectfully forwarded to Mr.  
J. C. Van Antwerp A. S. A. Comr.

---

Wm Woods  
Sub Ass't Comr  
8<sup>th</sup> Sub Dist of La.

---

EB  
2/69



Providence La

Sept 25. 1868

James Henry

States that they have  
procured a suitable loca-  
-tion & building for school  
purposes.

Applies for a "Subvention"  
of One Hundred Dollars  
from the Bureau.

Thibodaux, La, Sept. 25. 1868

John H. Van Antwerp, Esq.  
A. S. C. Bureau of A. S. C. L.  
Parish of Lafourche

Sir,

In pursuance to a conversation with Capt. Pierce, Gen'l Supt. of Education, I have the honor to apply for a subvention of One hundred Dollars from the Bureau, needed for School Purposes in this Parish.

We have acquired a piece of ground suitable for the erection of a Schoolhouse, about fourteen miles below Thibodaux, on the right bank on the Bayou Lafourche, in a favorable location, where a Schoolhouse is urgently needed, and our title to said property has been recorded according to law.

We have also acquired a suitable building, which, however, has to be transported from a distance, repaired, and built up anew, for which purpose the assistance applied for is urgently needed, as the people of this section are unable to possibly do any more.

I, therefore, take the liberty to submit the matter to your favorable consideration.

Very respectfully

Your obedient servant

Henry G. Limes

Minister in charge M. E. Church  
Parish of Lafourche, La

leave in name Genl Supt Ed<sup>d</sup> - H H Pierce



---

Office of Sub. Asst Commissioner  
8<sup>th</sup> Sub District La. B. R. F & A. L.

Shreveport Sept 28 1868

---

Woods W<sup>m</sup> Sub Asst Commis<sup>r</sup>  
8<sup>th</sup> Sub District La

---

Instruct the A. S. A Com<sup>r</sup> to embody  
in his tri-monthly, the number of  
Schools in his Parish, also the ag-  
gregate number of children attending,  
the condition, and future prospects  
of the same.

---

# 39

Head Quarters Bureau R. F. & A. Lands.  
8<sup>th</sup> Sub District, District of La.  
Thibodeaux, La., Sept 28<sup>th</sup> 1868.

Mr J. N. Van Antwerp.  
Asst Sub Asst Commr.  
Bureau R. F. & A. Lands.  
Thibodeaux, La.

Sir.

You are hereby instructed that, under the head of "Freedmen's Schools" in your "Tri-Monthly Reports," you will, in future, state the number of schools in operation in your Parish, <sup>and</sup> the aggregate number of scholars in attendance, also give all other information you may have, relative to the present condition, <sup>and</sup> future prospects of said schools.

Very Respectfully

Your Obedient Servant

J. M. Woods

Sub Asst Commr.

8<sup>th</sup> Sub Dist of La.



V. 161. Bu R F & A. L. La. 65

Office of Asst. Sub. Asst. Commr  
Parish of Lafourche,  
Thibodaux, La., Sept 29 1868.

Van Antwerp, J. H.  
A. J. A. Commr.

Asks permission to visit New  
Orleans on necessary private  
business & matters connected  
with the Bureau in the Parish.



V. 161. (Bu. R. F. & A. L., La.,) 1868.

HEADQUARTERS,  
BUREAU REFUGEES, FREEDMEN AND ABANDONED LANDS,  
DISTRICT OF LOUISIANA.

New Orleans, October 1<sup>st</sup>, 1868.

Respectfully returned to Mr  
J. H. Van Antwerp, Asst.  
Sub Asst. Commr. (From Mr.  
H. M. Woods, Sub Asst. Commr.  
3<sup>rd</sup> Sub District.) Approved.

Mr Van Antwerp will, upon  
his arrival in this city, report  
in person at these Headquarters.

By Command of

BREVET MAJOR GENERAL EDWARD HATCH,

Bvt Major U. S. A., Captain 6th Cavalry,

Act'g Asst Adj't General.

Edw  
Hatch

Head Quarters Bu R. F. & A. L. La.  
3<sup>rd</sup> Sub District, District of La.  
Thibodaux, La., October 2<sup>nd</sup> 1868

Respectfully forwarded to Mr  
J. H. Van Antwerp, Asst. Commr  
Parish Lafourche La. Thibodaux, La.  
in absence of  
H. M. Woods

Sub Asst Commr  
3<sup>rd</sup> Sub Dist of La  
J. W. Gallett  
Act'g in Charge of Office.

J. W. Gallett  
2/69.

#12

Office of A. S. A. C. Bu R. F. A. L.  
Parish of Lafourche La.  
Thibodeaux Sept 29 1868.

Bot Maj. B. F. Hutchins

A. A. Genl Bu R. F. A. L.

New Orleans La

Sir

I have the honor respectfully to apply for permission to visit New Orleans for 5 days, on necessary private business, as also on matters connected with the Bureau in this Parish.

Very Respectfully

Your Obedt Servt

J. W. Van Tine

A. S. A. C.



---

Office General Sup of Education  
New Orleans La. Oct 1 1868

---

Pierce 1414

G. S. E. B. R. F. A. S.

---

authorises to make necessary  
repairs on the Lincoln School  
building "to the amount  
of 40<sup>00</sup>. Miss Williams to  
receive aid to the amount  
of \$15 for Sept."

---

Received Oct. 3. 68.

No. #103

Headquarters, Bureau Refugees, Freedmen and Abandoned Lands,  
(206 ST. CHARLES STREET.)

Office General Superintendent of Education,  
STATE OF LOUISIANA.

Rec'd 3<sup>2</sup>

New Orleans, La., Oct. 1<sup>st</sup>, 1868.

Mr. J. H. Van Antwerp,  
A. S. A. C.,  
Sir;

Yours of 28<sup>th</sup>  
Ult. at hand. You are hereby author-  
ized to make the necessary repairs on  
the "Lincoln School Building" - to the  
amount of \$41.<sup>00</sup> as estimated -  
As soon as complete, you will  
forward to this office vouchers, form  
22, properly signed in blank by  
the party - furnishing labor & materials,  
also a detailed bill of items of ex-  
pense - Miss Williams will receive  
aid from Sept. 1<sup>st</sup> 1868. to the amt.  
called for, \$15.<sup>00</sup> pr. month -

Am glad to hear such good  
news from schools in your Par-  
ish - Spare no pains.

I. H. Pierce,  
Bot. Capt. U. S. A.,  
Genl. Supt. Edc.



Office of Sub Ast Commissioner  
8<sup>th</sup> Sub District La Pu R F + A L.

Thibodeaux October 5<sup>th</sup> 1868

Woods W<sup>m</sup> Sub Ast Comm<sup>r</sup>  
8<sup>th</sup> Sub District La

Instruct the Ast S. Ast Comm<sup>r</sup>  
to make an inspection of the Parish  
with a view of ascertaining the damage  
done to Props, buildings &c by the storm

#54

Head Quarters Bureau Re. P. & L. Lands.  
8<sup>th</sup> Sub District, District of La.  
Thibodeaux, La. October 5<sup>th</sup> 1868

Circular Letter.

You will proceed, at once, to make a thorough "Inspection" of your Parish with a view of ascertaining the extent of damage done to crops, Buildings, Stock, &c. &c. by the late storm, and report the same to this office with the least possible delay.

Very Respectfully

Your Obedient Servant

Wm Woods

Sub Ass't Commr

8<sup>th</sup> Sub Dist of La

Mr. J. N. Van Antwerp  
Ass't Sub Ass't Commr,  
Thibodeaux, La.



Thibodeaux La

Oct 5<sup>th</sup> 1868

Rockefeller S. R.

Returns letter, with  
the papers of Geo Walker,  
as requested.

Office of A.S.A.C. Bu R7. & A.L.  
Parish of Lafourche

Thibodaux Oct 15 1868

Mr G. R. Rockefeller.

New Orleans La

Sir

Robert Brown who was to have brought  
up the papers for George Walker to sign, says he omitted  
to ask you for them when at your office, and requests  
me to write to you and ask that you send the papers  
to me for the said George Walker to sign, which  
when done I will return to you

Very respectfully

Your Obl Serv

J. Van Antwerp  
A.S.A.C.

I enclose the papers as requested.  
I have filled them up as I learned  
he did not write, so let him make  
his mark, and have 2 witnesses  
to his signature. & return to  
Lock Box 257

Yours  
G. R. Rockefeller



Office of Special Agent  
Ben R. F and A Sands  
New Orleans Octo 10 1868

---

Sauvignet. C. G.

Special Agent

---

Encloses duplicate vouchers to  
Genl G. W. Ballou, with the  
request to have them signed  
by Louisiana Nelson & witnessed  
& returned without delay to his Office

---

(111)

HEADQUARTERS  
Bureau of Refugees, Freedmen and Abandoned Lands,  
DISTRICT OF LOUISIANA, - - OFFICE OF SPECIAL AGENT,

New Orleans, October 10<sup>th</sup> 1868

Mr J. H. Van Antwerp.

A. S. A. C. Bu R. F. & A. L.

Thibodeaux La

Sir

Enclosed please find duplicate vouchers to Col Brig Genl Geo. W. Balloch, which I have the honor to forward to you, for the purpose of having the same signed by Louisiana Nelson widow of John Nelson, late a private Co "G" 77<sup>th</sup> U.S. and returned to this Office.

The signature is to be witnessed by two persons. Her residence is in Thibodeaux. Mr Crook Dunn of the same place knows her, and can give you all information necessary to find her.

By giving this your special attention, you will greatly oblige

Yours Very Respectfully,

C. S. Savin

Special Agent



Office of Gen<sup>l</sup> Supt Educ<sup>n</sup>  
H<sup>d</sup> q<sup>rs</sup> Bureau R F<sup>th</sup> A L.  
New Orleans Octo 16 1868.

---

Pierce H. N. Bot Capt  
Gen<sup>l</sup> Supt Educ<sup>n</sup>

Understands that the Methodist  
Church in this place is not occu-  
pied as a school house by the  
Bureau. It deemed practicable  
to rent a building for school  
purposes, for which the Bureau  
will allow \$15. per month.

---

1868

Vol. # 670

Headquarters, Bureau Refugees, Freedmen and Abandoned Lands,  
(206 ST. CHARLES STREET.)

Office General Superintendent of Education,  
STATE OF LOUISIANA.

Oct 16

New Orleans, La.,

186

Mr. J. H. Van Antwerp,  
A. D. A. C.,

Sir;

I understand that there is a Methodist Church in Thibodaux - not occupied as a school-house by the Bureau - which might be obtained for that purpose - by the payment of a small rent - say \$15.00 per month. Perhaps I am misinformed and, it is already occupied by one of your teachers. If, however, there is such a building still vacant, and, you deem it practicable to open another school in the place, please attend to the matter at once. I will pay a reasonable rent. Let me hear from you -

Very Respectfully,  
J. H. Percé,  
Col. Capt. U. S. A.,  
Genl. Supr. Educ.



New Orleans, La.  
Oct 23. 1868

Pierie H. H.  
G. S. E. B. R. F. & A. L.

Calls attention to extract from  
letter War Department Oct 6  
to Port Maj Genl Hatch,  
gives instructions to embrace  
said requirements in  
Monthly Reports.

Oct. 27.

72-1613  
Headquarters, Bureau Refugees, Freedmen and Abandoned Lands,  
(206 ST. CHARLES STREET.)

Office General Superintendent of Education,  
STATE OF LOUISIANA.

New Orleans, La., October 23<sup>rd</sup> 1868.

Mr J. H. Taw Antwerp,  
Asst. Sub. Asst. Com.,  
Thibodeaux La.,  
La.

Your attention is called to the following extract from a letter dated, New Dept. Oct. 6<sup>th</sup> 1868, to Post. Maj. Gen. E. Hatch, Asst. Com. viz:

XXX To carry out the terms of this arrangement, your Superintendent will be required hereafter to embrace in his Report the number of scholars in each separate school; designating the teacher of each by name. He must be able to verify these Reports as to the number of scholars.

He will, also, in his Report, state the number of buildings occupied for freedmen's schools; giving the name of the owner and by whom occupied. XXX

You will, please, in future, embrace the



information required in the above extract  
in your Monthly Reports thereby enabling this  
office to fulfill the above requirement.

Very Respectfully,

H. V. Pierce,

Bot. Captain U. S. A.,

Gen. Sup. Education.

New Orleans La  
Oct 29, 1868

1 Demas Edgar C  
Port of Coly, D.O.

Notifies that my receipt for  
property transferred by Mr  
Van Antwerp is on file in  
his Office. Asks for memorandum  
deem receipt for one horse

Received. 10.30.68



New Orleans La  
Oct 29<sup>th</sup> 1868

Mr Wm M. Kenzler,  
A. S. A. Commissioner,  
Thebadeaux La,

Sir

I am receipt to Mr Sawtice's, for  
property transferred to you by him, is  
on file in this office. The house for which  
you receipted to him is the only property  
on your receipt for which I am  
responsible, and for which, you will  
please forward me, memorandum  
receipt.

Respectfully &c,  
C. M. A. M. A.  
C. M. A. M. A.

New Orleans La

Oct 29 1868

Pierce H H

G. S. E. B. B. F. & A. L.

Encloses checks for McAuliff,  
Militia of Houston for Aug.  
68. Receipts to be returned.

Received Oct 30.



Headquarters, Bureau Refugees, Freedmen and Abandoned Lands,  
(206 ST. CHARLES STREET.)

Office General Superintendent of Education,  
STATE OF LOUISIANA.

New Orleans, La., Oct. 29<sup>th</sup>, 1868.

Mr. Wm S. McKencie,  
A. S. A. E.,

Sir;  
Enclosed, please

find checks payable, as follows:-  
Thos. J. McAuliffe - \$30.<sup>00</sup> for Aug. 1868.  
Ed. Mitchell - \$30.<sup>00</sup> " " "  
John Houston - \$15.<sup>00</sup> " " "  
See full for amt &c. Return  
Receipts.

Very Truly,  
W. T. Pierce,  
Col. Capt. U. S. A.,  
Genl. Supr. Educ.

New Orleans

Nov 9 - 1868

Education

Genl. Supt. of.

<sup>5.</sup>  
Vouchers for services of  
Teachers and Rent of  
School Buildings. Form  
22, in duplicate to be  
mailed each month so  
as to reach Hd. Qrs. on or  
15<sup>th</sup> of the month for which  
they are drawn.

Recd. Nov. 17. 1868.



Ms. #143

Headquarters, Bureau Refugees, Freedmen and Abandoned Lands,  
(206 ST. CHARLES STREET.)

Office General Superintendent of Education,  
STATE OF LOUISIANA.

New Orleans, La., Nov. 9<sup>th</sup> 1868.

Mr. Wm. S. McKeuzie,  
A. S. A. C.,

Sir:

Please forward to this office, each month, duplicate vouchers, Form 22, properly signed, in blank, for services of teachers and rent of school-buildings in your district.

Mail them so as to reach this office about the 15<sup>th</sup> of the month for which they are intended.

The proper Forms will be sent to your address this day.

Very Respectfully,  
H. H. Pierce,

Col. Capt. U. S. A.,

Gen. Sup. Education.

New Orleans  
Nov. 12. 1868.

Education  
Genl Supt of

Encloses Ck. in full  
for Rent. etc.



Headquarters, Bureau Refugees, Freedmen and Abandoned Lands,

(206 ST. CHARLES STREET.)

Office General Superintendent of Education,

STATE OF LOUISIANA.

New Orleans, La., Nov 15<sup>th</sup>, 1868,

Mr Wm S. Mc Kenzie,

A. S. A. Comm.

Point Lafourch, La

Sir,

Enclosed, please find Checks payable  
to order as follows:

- 1 Thomas J. Mc Auliffe \$30<sup>00</sup>, for Sept 1868
- 1 Francis Williams \$15<sup>00</sup>, " " "
- 1 Edward Mitchell \$30<sup>00</sup>, " " "
- 1 John Houston \$15<sup>00</sup> for Sept 1868,
- 1 Henry Guines \$30<sup>00</sup> for Sept, 1868,
- In full for rent, &c,

Return Receipts

Very Truly,

W. H. Pierce,

1st Lt Capt, U.S.A.,

Genl. Supt, Education,

New Orleans

Nov. 19. 1868

Education

Genl. Supt.

Directs that application  
be made at once for a teacher  
in place of Mr. McAuliffe  
who can no longer be toler-  
ated on acct. of his drunken  
habits.



Headquarters, Bureau Refugees, Freedmen and Abandoned Lands,  
(206 ST. CHARLES STREET.)

Office General Superintendent of Education,  
STATE OF LOUISIANA.

New Orleans, La., Nov. 19<sup>th</sup> 1868.

Mr. Wm. P. McKeuzie,  
A. P. A. C.,

Sir;

I am informed from a reliable source, that Mr. W. Auliffe, although a competent teacher, is in the habit of drinking to excess. I will tolerate no such examples in freedmen schools. You will at once make application, or proper hint, for a teacher in his stead.

Very truly,  
J. H. J. Fessenden,  
Bot. Capt. U. S. A.,  
Genl. Supr. Educ.

N<sup>o</sup> 1200 R. F. & A. S.  
Office of Genl. Supt of Education  
New Orleans Novbr 21. 1868.

---

A. A. Pierce  
Brig. Genl. & Genl. Supt of Education

---

Instructions to Wm S. McKenzie A. S. A. C.  
in relation to building a schoolhouse on Bayou  
Lafourche -

---



92-849

Headquarters, Bureau Refugees, Freedmen and Abandoned Lands,  
(206 ST. CHARLES STREET.)

Office General Superintendent of Education,  
STATE OF LOUISIANA.

New Orleans, La., Nov. 21<sup>st</sup> 1868.

Mr. Wm. J. McKenzie,  
A. S. U. C.,

Sir:

Yours of 17<sup>th</sup>  
inst. in regard to building a  
house on Bayou Lafourche and  
calling for \$100. assistance as  
promised your predecessor, at  
hand. Enclosed, please find  
form of lease, which I wish you  
to be guided by in its general  
tenor. If there are regularly elected  
Trustees of the Church, they should  
sign. Of course, you will vary the  
form to suit names, &c.

Return original lease, together with  
this copy to me. Forward Voucher,  
form 11, signed by Mr. Bibbet  
in blank - together with bills of items -  
and the Check will be sent as  
soon as Voucher and appraisement

by Asst. Commissioner.

Very truly,  
J. H. F. P. C.,  
Pub. Copy. U.S.A.  
Asst. Reg. Etc.

10/11/11  
From  
W. H. P. C.  
10/11/11



New Orleans

Nov 23. 1868

Education Genl. Supt.

1<sup>st</sup> Action in case of McAuliffe  
approved.

2<sup>nd</sup> Retain no incompetent  
teachers. Plenty of well  
educated applicants.

No. 828

Headquarters, Bureau Refugees, Freedmen and Abandoned Lands,  
(206 ST. CHARLES STREET.)

Office General Superintendent of Education,  
STATE OF LOUISIANA.

New Orleans, La., Nov. 23 1868.

Mr. Wm. S. McKenzie,  
A. P. A. E.,  
Sir;

Your of 19<sup>th</sup>  
inst. at hand. Your action,  
in case of Mr. Kauliffe, is ap-  
proved. Your Applications  
for teachers will be filled as  
soon as possible. Houston's  
signature to receipt indicates  
very little scholarly ability:-  
don't retain any really in com-  
petent teachers:- there are  
plenty of worthy, needy, well educa-  
ted applicants.

Very truly,  
J. S. Pierce,  
Brig. Capt. U. S. A.,  
Genl. Insp. & Sec.



NATIONAL ARCHIVES AND RECORDS ADMINISTRATION  
MICROFILM PUBLICATIONS

Roll 103

Target 2

*Monthly Inspection Reports*  
Aug. 1866–Sept. 1868

Consolidated  
~~MONTHLY~~ REPORT

OF

*1880*

*The book and*

for

*Retained copies*

for

*of Monthly*

For

*Inspection*

Rec

*Reports*



Consolidated  
~~MONTHLY~~ REPORT

OF

*1<sup>st</sup>* Lieut. C. P. M. Taggart

Asst. Inspr. Freedmen

the Parish of *Lafourche*, La.

the ~~month~~ ending

1866.

forwarded *August 4<sup>th</sup>* 1866

B. R. F. and A. L., 1866







✓ P. Doak & Co.	Ocadia	12	4	16	8	9	17	33	250	150	100	500	16	7	7	60														
✓ Chat. M. Gillis	Orange Grove	4		4	4	4	8			40	25	65		4	65															
✓ L. Bush	Haydel	5	3	8	1	1	9		250	100	150			5	350															
✓ Palmyra Richard	Thibodaux	1		1			1		20	10	30			1	30															
✓ L. W. God.	Lockport	17	10	8	3	38	2	3	4	6	15	53			10	20	No Contract													
✓ T. Lawley	Picuzi	31	20	18	12	81	2	3	8	6	19	100	4	6	10	300	150	200	950	54		11	75	do.	do.					
✓ Mrs. John Abadie	Fourly Point	2	1	1	4	8					8					5	15	20		2	13			do.	do.					
✓ Charles F. Gaudin	Morning Star	8	2	2	3	15		1	2	3	18					70	90	160		8		16	16	00	do.	do.				
✓ J. Miguel	Lake Long	5	3	2	2	12	1	1	4	1	7	19				80	75	100	80	335	8					do.	do.			
✓ W. G. Deferes	Barrataria	10	7	4	1	22		2	1	1	4	26				60	75	50	185	18						do.	do.			
✓ H. H. Michels	Bourgeois Place	2	1			3			2	1	3	6				6	15	54	75	3			3	12	00	do.	do.			
✓ Lagarde Bros.	Lagarde	5	3			8			4	1	5	13				2	35	35	72	8			5	10	00	do.	do.			
✓ N. P. Gaillard	Gaillard	5	5			10			4	3	7	17				50	50	70	200	10			7	11	00	do.	do.			
✓ Valery Vietname	Vietname	6	4			10			3	2	5	15				26	11	23	60	10	1	1/3					do.	do.		
✓ C. G. Thibodaux	Raceland	15	8			23	2		1	4	7	30				8	150	115	273	23			17	12	00	do.	do.			
✓ L. Blanc & Bros	Tanner	5	3			8			2	3	5	13				30	50	70	150	8							do.	do.		
✓ William Kuntz	Kuntz	2	1			3			1	1	2	5				10	22	32	3								do.	do.		
✓ Oscar Leprie	Leprie	5	3			8			1		1	9				30	12	40	82	8							do.	do.		
✓ Kenille Brough	Liblae															100		100										do.	do.	
✓ Mrs. Lufrid Froelaine	Lufrid Froelaine	6	4	1	5	16	1	1			2	18				70		50	120				6					do.	do.	
✓ L. C. Aubert	Lummy Side	13	15	6	6	40	1	1			2	42				40	100	140					7					do.	do.	
✓ J. F. Thibodaux	Raceland	10	8	3	2	23	1	3	2	2	8	31				200	100	300					18					do.	do.	
✓ Witteridge & Irving	Raceland	23	18	11	13	65	4	3	6	2	15	80				200	100	100	400				41					do.	do.	
✓ J. P. Bernier	Orange	4	3	3	2	12			2	2	4	16				100		70	270				8					do.	do.	
✓ Thimothé Fedus	Bernard Place	6	2	2	2	12	1	1			2	14				1	1	4	40	35	79		6	12				do.	do.	
✓ H. Verne & Bernard	Netre	29	20	11	9	69			1	1	2	71				1	1	2	175	80	150	405	29	30	14	00		do.	do.	
✓ Mrs. Maria Colluis	China Grove	15	9	8	10	42			2	2	4	44				14	50	75	139				15	14	15			do.	do.	
✓ Theodor Topp & Co	Bourgeois	2				2					2					25	2	50	57				2	12				do.	do.	
✓ George N. Tucker	Hond ward	19	7	1	3	30			1	1	2	32				200		200					19		13	00		do.	do.	
✓ Mrs. Maria Colluis	China Grove	17	13	8	7	45			1		1	46				30		70	100										do.	do.
✓ P. Justicia Theriot	Theriot	25	12	18	20	75			1		1	76				250		200	450				37			9	00	No Contract		
✓ David C. Tugh	Tugh	6	4	3	2	22					22		1	4	5	40	40	40	120				6			9	00	do.	do.	
✓ L. Luthon	Luthon	4	1	4	2	11					11						8	18	26				4	14				do.	do.	
✓ Rogan & Guillot	Archange	4	4	3	2	13					13		1	3	5	40	40	40	90				8			10	00	do.	do.	
✓ Haroly	Haroly	15	19	6	4	44			1	1	2	46																	do.	do.

Grand Totals 583 350 180 183 1296 23 82 128 131 364 1660 30 72 4602 2508 120 3 3412 10645 132 476 47 562 468 60

STATION: Thibodaux La.  
 DATE: August 3<sup>rd</sup> 1866.

NOTE—The back of this Return may also be used for Remarks, and all the information required by Paragraph 3 of Circular No. 35 will be correctly noted.  
 NOTE—This Return will be made promptly on the last day of each month.  
 NOTE—All over fourteen years of age are considered adults.

T. P. McTaggart  
 1<sup>st</sup> Lieut. & Regt. Agent  
 Parish of Lafourche La.



*Forwarded*

186

*Rec. B. R. F. and A. L.,*

186



# MONTHLY REPORT

OF

*M. Robinson* Asst. Sub. Dist. Court,  
Asst. Insp. Freedmen. *Br. C. T. S.*

for the Parish of *Lafourche*..... La.

for the month ending *September*.....

..... 1867

Forwarded *October 1<sup>st</sup>*..... 1867

Rec. B. R. F. & A. L..... 1867



Monthly Report of *W. M. Robinson and S. L. West*

Assistant Inspector of Freedmen for the Parish of *St. Charles*

State of Louisiana,

for the Month ending on the *thirtieth*

day of *September*

1867.

NAME OF OWNER OR LESSEE OF PLANTATION.	NAME OF PLANTATION.	NUMBER OF FREEDMEN ON PLANTATION.										No. of Children Attending Schools.			NUMBER OF ACRES UNDER CULTIVATION.							KIND OF CONTRACT HANDS ARE EMPLOYED UNDER & NUMBER OF HANDS EMPLOYED UNDER EACH.				Average Monthly Wages.		REMARKS.							
		WORKING HANDS.					AGED AND HELPLESS.					No. of Schools.	Male.	Female.	Total.	Acres of Sugar.	Acres of Cotton.	Acres of Rice.	Acres of Tobacco.	Acres of Corn.	Acres of other Cereals.	Total Acres Cultivated.	Rations, Clothing, Quarters, Fuel and Wages.	Rations and Wages.	Wages only.	Share of Crop.	No. of Acres rented to Free men.		No. of Acres sold to Freedmen.	Average Monthly Wages.					
		Male.	Female.	Male.	Female.	Total.	Male.	Female.	Male.	Female.	Total.																			Aggregate.	\$	Cts.			
<i>Crichton &amp; Douglas</i>	<i>Hellon</i>	34	1	4	1	40	1	1	1	3	43				150																				<i>No contract</i>
<i>Thompson</i>	<i>R. H. Allen</i>	42	12			54	1	3		4	58				350	3																			<i>"</i>
<i>Cedar Grove</i>	<i>Andrew Collins</i>	6	3	1		10	3	2		5	15				32			40																	<i>"</i>
<i>Morning Star</i>	<i>St. Claude</i>	10		1	1	12	1	1							80																				<i>"</i>
<i>John Williams</i>	<i>Sighton</i>	61	14	3								6	4	10	348			50																	<i>"</i>
AGGREGATE.																																			

Station: \_\_\_\_\_  
Date: \_\_\_\_\_ 186

*W. M. Robinson*  
Asst. Insp. Freedmen.  
*West*  
Parish of \_\_\_\_\_

NOTE.—The back of this Return may also be used for Remarks, and all the information required by Paragraph 3 of Circular No. 35 will be correctly noted.  
NOTE.—This Return will be made promptly on the last day of each month.  
NOTE.—All over fourteen years of age are considered adults.



*St. Louis*  
*Suburban*

*Lafayette*

*Parishes*

*St. Louis*

*Parishes*

MONTHLY REPORT

OF

*Francis Sternberg*  
Asst. Inspr. Freedmen,

For the Parish of *Lafayette* La.,

For the month ending *December*

*thirty first* 1867

Forwarded *December 31st* 1867

Rec. B. R., F. & A. L., ..... 1867







MONTHLY REPORT

OF

*Francis Kumborg*  
Asst. Inspr. Freedmen,

For the Parish of

*La Fourche, La.,*

For the month ending

*December* ..... 1867

Forwarded ..... 186

Rec. B. R., F. & A. L., ..... 186







# MONTHLY REPORT

OF

*Francis Sternberg A.S.A. C.W.*

— Asst. Inspr Freedmen.

for the Parish of *Lafourche* La.

for the month ending *March*

*31<sup>st</sup>* 186*8*

---

Forwarded *April* 186*8*

Rec. B. B. F. & A. L. 18*5*



Monthly Report of

*Francis Sterberg* Assistant Inspector of Freedmen for the Parish of  
for the Month ending on the *thirty first* day of

*Lafourche*  
*March*

State of Louisiana,

1868

NAME OF OWNER OR LESSEE OF PLANTATION.	NAME OF PLANTATION.	NUMBER OF FREEDMEN ON PLANTATION.													No. of Children Attending Schools.	NUMBER OF ACRES UNDER CULTIVATION.						KIND OF CONTRACT HANDS ARE EMPLOYED UNDER & NUMBER OF HANDS EMPLOYED UNDER EACH.				Average Monthly Wages.		REMARKS.					
		WORKING HANDS.					AGED AND HELPLESS.					Aggregate.	No. of Schools.	Acres of Sugar.		Acres of Cotton.	Acres of Rice.	Acres of Tobacco.	Acres of Corn.	Acres of other Cereals.	Total Acres Cultivated.	Rations Clothing Quarters, Fuel and Wages.	Rations and Wages.	Wages only.	Share of Crop.	No. of Acres rented to Free men.	No. of Acres sold to Freedmen.		Average Monthly Wages.				
		Male.	Female.	Male.	Female.	Total.	Male.	Female.	Male.	Female.	Total.																		¢	cts.			
<i>Blotain Bernard</i>	<i>Maverley</i>	15				15	2	1	10	7	20	35			20	4		300	10	334			15	200								<i>The hands are working on share of crop &amp; I expect will make a good thing this year, but are now short of provisions for which M. Bernard is now making application</i>	
<i>C. Broussau</i>	<i>Broussau</i>	24	5	4		33		12	21	9	42	75			300			150		450		33											<i>Hands well satisfied school will be established if any time to do it</i>
<i>Henry Verges</i>	<i>Jean Nebre</i>	22		8		30		35	20	25	80	110			350			150		500		30											<i>Hands well satisfied, school could be established</i>
<i>Johnson's Plantation leased to Freedmen</i>	<i>Johnson</i>																																<i>Population fluctuating no figures to be got at this month - school in very good condition, a part of the people in danger of starvation of which a Report has been made. - New raised Corn, potatoes etc.</i>
<i>Vicks' Plantation leased to Freedmen</i>	<i>Vicks'</i>																																<i>Same condition as Johnson's Plantation school improving.</i>
<i>Robt Tucker's Plantation occupied by Freedmen</i>	<i>Tucker</i>																																<i>In more condition than the two foregoing ones, as the plantation is in litigation, so that the poor Freedmen as it cannot make any crop at least not much.</i>
<i>Dr. Tucker</i>	<i>Dr. Tucker</i>	8				8		8	14	7	29	37			100			150		250		8											<i>Many of the men left not liking the contract, which nevertheless is fair &amp; only 8 left</i>
	AGGREGATE.	69	5	12		86	2	63	65	48	171	267			770	4		750	10	1534		71		15	200								

Station: *Thibodaux, La*

Date: *March 31st 1868*

*Francis Sterberg*  
Asst. Insp. Freedmen.

Parish of *Lafourche*

NOTE.—The back of this Return may also be used for Remarks, and all the information required by Paragraph 8 of Circular No. 35 will be correctly noted.

NOTE.—This Return will be made promptly on the last day of each month.

NOTE.—All over fourteen years of age are considered adults.



# MONTHLY REPORT

OF

*Lieut Nelson Bronson 42<sup>d</sup> Inf*

*Asst. Insp. Freedmen.*

for the Parish of *Lafourche* La.

for the month ending *June*

*30<sup>th</sup>* 1868

Forwarded *July 2<sup>d</sup>* 1868

Rec. B. R. F. & A. L. 186

*Returned*



Monthly Report of *Lieut Nelson Broadow 42<sup>d</sup> Infantry* Assistant Inspector of Freedmen for the Parish of *Lafourche* for the Month ending on the *Thirtieth* day of *June* 1868.

State of Louisiana,

NAME OF OWNER OR LESSEE OF PLANTATION	NAME OF PLANTATION	NUMBER OF FREEDMEN ON PLANTATION.											No. of Children Attending Schools.			NUMBER OF ACRES UNDER CULTIVATION.						Kind of Contract Hands are Employed Under & Number of Hands Employed Under Each.				Average Monthly Wages.		REMARKS.				
		WORKING HANDS.					AGED AND HELPLESS.					Aggregate.	No. of Schools.	Male.	Female.	Total.	Acres of Sugar.	Acres of Cotton.	Acres of Rice.	Acres of Tobacco.	Acres of Corn.	Acres of other Cereals.	Total Acres Cultivated.	Rations, Clothing, Quarters, Fuel and Wages.	Rations and Wages.	Wages only.	Share of Crop.		No. of Acres rented to Freedmen.	No. of Acres sold to Freedmen.	Average Monthly Wages.	
		CHILDREN.		CHILDREN.		Total.	Male.	Female.	Male.	Female.	Total.																				Dolls.	Cts.
		Male.	Female.	Male.	Female.																											
<i>Thomas P Donelson &amp; Co</i>	<i>Acadia</i>	<i>25</i>	<i>2</i>	<i>2</i>	-	<i>29</i>	-	-	-	-	<i>29</i>	-	-	-	<i>50</i>	-	-	-	<i>130</i>	-	<i>170</i>	-	-	-	-	-	-	-	<i>12</i>	<i>00</i>	<p><i>The people are all happy and contented and are working well in school have been satisfied from the fact that most of these plantations are worked by agents who do not under the same strict laws for the welfare of the people the the owner probably would if he kind among them</i></p>	
<i>Lewis Griow</i>	<i>Ridgefield</i>	<i>13</i>	-	-	-	<i>13</i>	<i>1</i>	<i>1</i>	-	-	<i>2</i>	<i>15</i>	-	-	<i>100</i>	-	-	-	<i>110</i>	-	<i>210</i>	-	-	-	-	-	-	-	<i>12</i>	<i>00</i>		
<i>Senise &amp; Bernard</i>	<i>Live Oak</i>	<i>22</i>	<i>18</i>	<i>4</i>	-	<i>44</i>	<i>3</i>	<i>1</i>	-	-	<i>4</i>	<i>48</i>	-	-	<i>120</i>	-	-	-	<i>130</i>	-	<i>250</i>	-	-	-	-	-	-	<i>14</i>	<i>00</i>			
<i>R H Allen</i>	<i>Ricuzza</i>	<i>50</i>	<i>20</i>	<i>22</i>	<i>8</i>	<i>100</i>	<i>1</i>	-	-	-	<i>1</i>	<i>101</i>	-	-	<i>460</i>	-	-	-	<i>540</i>	-	<i>1100</i>	-	-	-	-	-	-	<i>15</i>	<i>00</i>			
AGGREGATE.		<i>110</i>	<i>40</i>	<i>28</i>	<i>8</i>	<i>186</i>	<i>5</i>	<i>2</i>	-	-	<i>7</i>	<i>193</i>	-	-	<i>730</i>	-	-	-	<i>900</i>	-	<i>1630</i>	-	-	-	-	-	-	-	-	-		

Station: *Thibodaux La*  
 Date: *June 30<sup>th</sup>* 1868

*Nelson Broadow*  
*Lieut 42<sup>d</sup> Infantry Asst. Insp. Freedmen.*  
 Parish of *Lafourche La*

NOTE.—The back of this Return may also be used for Remarks, and all the information required by Paragraph 3 of Circular No. 35 will be correctly noted.  
 NOTE.—This Return will be made promptly on the last day of each month.  
 NOTE.—All over fourteen years of age are considered adults.



# MONTHLY REPORT

OF

*Lieut Nelson Proudon 42<sup>d</sup> Inf*

*Asst. Insp. Freedmen.*

for the Parish of *Lefourche* La.

for the month ending *July*

*31<sup>st</sup>* 1868

Forwarded *July 31<sup>st</sup>* 1868

Rec. B. R. F. & A. L. 186

*Retained*



Monthly Report of *Lieut Nelson Broussard 42<sup>d</sup> Infantry* Assistant Inspector of Freedmen for the Parish of *Lafourche*  
 for the Month ending on the *Thirty First* day of *July* 1868.

State of Louisiana,

NAME OF OWNER OR LESSEE OF PLANTATION.	NAME OF PLANTATION.	NUMBER OF FREEDMEN ON PLANTATION.												No. of Children Attending Schools.			NUMBER OF ACRES UNDER CULTIVATION.						Kind of Contract Hands are Employed Under & Number of Hands Employed Under Each.				Average Monthly Wages.		REMARKS.			
		WORKING HANDS.					AGED AND HELPLESS.					Aggregate.	No. of Schools.	Male.	Female.	Total.	Acres of Sugar.	Acres of Cotton.	Acres of Rice.	Acres of Tobacco.	Acres of Corn.	Acres of other Cereals.	Total Acres Cultivated.	Rations, Clothing, Quarters, Fuel and Wages.	Rations and Wages.	Wages only.	Share of Crop.	No. of Acres rented to Freedmen.		No. of Acres sold to Freedmen.	Average Monthly Wages.	
		CHILDREN.		Total.			CHILDREN.		Total.																						Dolls.	Cts.
		Male.	Female.	Male.	Female.	Total.	Male.	Female.	Male.	Female.	Total.																					
<i>L. C. Aubert</i>	<i>Aubert Plantation</i>	8	2	-	-	10	-	-	-	-	10	-	-	-	12	-	30	-	-	-	42	-	-	-	10	-	-	-	-	-	<i>Hands working for 1/2 crop; do not give the Planter good satisfaction; says he will not employ freedmen again upon shares</i>	
<i>Thomas F. Foster</i>	<i>Aubert Plantation</i>	1	-	-	-	1	-	-	-	-	1	-	-	-	-	-	3	-	-	-	45	-	-	-	-	-	-	-	-	-	<i>Draws supplies from the government had these hands two months ago but discharged all but one</i>	
<i>Doct L. C. Ewing</i>	<i>Ariel Plantation</i>	25	10	-	-	35	-	-	-	-	35	-	-	-	100	-	100	-	-	-	300	-	-	-	35	-	-	-	-	14 00	<i>Destitute provided for by planter</i>	
<i>Doct L. C. Ewing</i>	<del><i>Raceland</i></del> <i>Raceland Plantation</i>	60	15	-	-	75	-	-	-	-	75	-	-	-	400	-	-	-	-	-	400	-	-	-	75	-	-	-	-	14 00	<i>Destitute provided for by Planter</i>	
<i>J. W. Tucker</i>	<i>Laurel Valley Plantation</i>	35	2	-	-	37	3	-	-	-	40	-	-	-	100	-	-	-	-	250	-	350	-	37	-	-	-	-	14 00			
AGGREGATE.		129	29	-	-	158	3	-	-	-	161	-	-	-	612	-	133	-	795	-	1540	-	147	-	10	-	-	-	-			

Station: *Thibodaux La*

Date: *July 31<sup>st</sup>* 1868

*Nelson Broussard 42<sup>d</sup> Infantry*  
Asst. Insp. Freedmen.

Parish of *Lafourche La*

The back of this Return may also be used for Remarks, and all the information required by Paragraph 3 of Circular No. 35 will be correctly noted.  
 This Return will be made promptly on the last day of each month.  
 All over fourteen years of age are considered adults.



# MONTHLY REPORT

OF

*Lieut Nelson Browder*

*Asst. Inspr Freedmen.*

for the Parish of *Safourchis* La.

for the month ending *August*

*31<sup>st</sup>* 1868

Forwarded *September 1<sup>st</sup>* 1868

Rec. B. B. F. & A. L. 1868

*(Retained Copy)*



Monthly Report of *Lieut Nelson Broussard 42<sup>d</sup> Inf* Assistant Inspector of Freedmen for the Parish of *Lafourche* for the Month ending on the *Thirty First* day of *August* 1868 State of Louisiana,

*Lafourche*  
*August* 1868

State of Louisiana,

NAME OF OWNER OR LESSEE OF PLANTATION.	NAME OF PLANTATION.	NUMBER OF FREEDMEN ON PLANTATION.										No. of Children Attending Schools.	NUMBER OF ACRES UNDER CULTIVATION.						KIND OF CONTRACT HANDS ARE EMPLOYED UNDER & NUMBER OF HANDS EMPLOYED UNDER EACH.				Average Monthly Wages.		REMARKS.						
		WORKING HANDS.					AGED AND HELPLESS.						No. of Schools.	Acres of Sugar.	Acres of Cotton.	Acres of Rice.	Acres of Tobacco.	Acres of Corn.	Acres of other Cereals.	Total Acres Cultivated.	Rations, Clothing, Quarters, Fuel and Wages.	Rations and Wages.	Wages only.	Share of Crop.		No. of Acres rented to Free men.	No. of Acres sold to Freedmen.	¢	Cts.		
		Male.	Female.	Male.	Female.	Total.	Male.	Female.	Male.	Female.	Total.																			Aggregate.	Male.
<i>L. G. Aubert</i>	<i>Aubert's Plantation</i>	5	-	-	-	8	-	-	-	-	8	-	-	-	12	30	35	77	-	-	-	1/3	-	-	-	-	-	-	-	<i>Working on shares Planter complains that they do not work well</i>	
<i>Thomas F. Foster</i>	"	3	-	-	-	3	-	-	-	-	3	-	-	-	-	3	45	48	-	-	-	1/3	-	-	-	-	-	-	-	<i>Working on shares Planter draws supplies from Government</i>	
<i>J. S. Perkins</i>	<i>Upper Tew</i>	60	-	4	-	64	-	-	-	-	64	-	-	200	-	-	50	250	-	-	-	-	-	-	-	14	00	-	-	<i>This plantation is in excellent condition the freedmen are happy well cared for and receive good wages</i>	
"	<i>Uncle Peter</i>	40	-	3	-	43	-	-	-	-	43	-	-	100	-	-	100	200	-	-	-	-	-	-	-	14	00	-	-	<i>Same as above</i>	
<i>L. C. Ewing</i>	<i>Ariel</i>	25	10	-	-	35	-	-	-	-	35	-	-	100	100	100	300	-	-	-	-	-	-	-	-	14	00	-	-	<i>Good Condition Crop large and freedmen well satisfied</i>	
"	<i>Roadland</i>	60	15	-	-	75	-	-	-	-	75	-	-	400	-	-	400	800	-	-	-	-	-	-	-	14	00	-	-	<i>Same as above</i>	
<i>J. W. Tucker</i>	<i>Saint Valley</i>	35	2	-	-	37	-	-	-	-	37	-	-	100	-	-	250	350	-	-	-	-	-	-	-	14	00	-	-	" " "	
<i>H. E. Leclary</i>	<i>Highland</i>	18	-	-	-	18	-	-	-	-	18	-	-	175	50	125	350	-	-	-	-	-	-	-	-	14	00	-	-	" " "	
<i>Thomas P. Donaldson &amp; Co</i>	<i>Acadia</i>	25	2	2	-	29	-	-	-	-	29	-	-	50	-	120	170	-	-	-	-	-	-	-	-	12	00	-	-	<i>Some dissatisfaction as to treatment but freedmen are willing to remain to the end of the year</i>	
<i>Lewis Guion</i>	<i>Ridgefield</i>	13	-	-	-	13	1	1	-	-	2	15	-	100	-	110	210	-	-	-	-	-	-	-	-	14	00	-	-	<i>Good Crop and freedmen satisfied</i>	
<i>Simons &amp; Bernard</i>	<i>Live Oak</i>	22	18	4	-	44	3	1	-	-	4	48	-	120	-	130	250	-	-	-	-	-	-	-	-	14	00	-	-	<i>Freedmen well satisfied no complaints from the plantation during the season</i>	
<i>R. H. Allen</i>	<i>Ringa</i>	50	20	22	8	100	1	-	-	-	1	101	-	460	-	340	1000	-	-	-	-	-	-	-	-	14	00	-	-	<i>Freedmen well contented, Crop large</i>	
<i>George W. Tucker</i>	<i>Homeswood</i>	8	5	-	-	13	2	1	-	-	3	16	-	-	100	150	250	-	-	-	-	-	-	-	-	14	00	-	-	<i>Freedmen satisfied, no complaints Planter draws Government supplies</i>	
<i>Coltain Bernard</i>	<i>Haverly</i>	15	4	-	-	19	1	1	-	-	2	21	-	20	4	300	10 334	-	-	-	-	-	-	-	-	12	00	-	-	<i>No Complaints, Freedmen contented</i>	
<i>C. Broseau</i>	<i>Broseau</i>	24	5	4	-	33	2	8	10	7	27	60	-	300	-	150	450	-	-	-	-	-	-	-	-	12	00	-	-	<i>Same as above</i>	
<i>Henry Vergez</i>	<i>Jean Weber</i>	22	-	8	-	30	4	5	8	11	28	58	-	350	-	150	500	-	-	-	-	-	-	-	-	14	00	-	-	" " "	
<i>C. C. Williams</i>	<i>Johndon</i>	30	11	-	-	41	7	11	13	9	40	81	1	14	16	30	120	30 150	-	-	-	1/3	150	-	-	-	-	-	-	-	<i>Freedmen rent the land and work their own crop mostly Corn - freedmen well satisfied</i>
<i>Robert Tucker</i>	<i>Tucker</i>	11	8	3	-	22	5	9	14	8	36	58	-	-	-	70	10 80	-	-	-	-	1/3	80	-	-	-	-	-	-	<i>Same as above</i>	
<i>C. C. Williams</i>	<i>Vicks</i>	23	12	11	13	59	4	7	9	13	33	92	1	23	34	57	100	20 120	-	-	-	1/3	120	-	-	-	-	-	-	-	<i>Same as above</i>
<i>William H. Nelson</i>	<i>Boulton Place</i>	30	5	3	-	38	-	-	-	-	38	-	-	175	-	250	425	-	-	-	-	-	-	-	-	14	00	-	-	<i>No Complaints, freedmen work well and are paid promptly</i>	
<i>William D. Burton</i>	<i>Camp Stevens</i>	20	9	5	-	34	2	1	-	-	3	37	-	200	-	200	400	-	-	-	-	-	-	-	-	12	00	-	-	<i>Same as above</i>	
<i>William A. Shaffer</i>	<i>Shaffer Plantation</i>	30	8	2	-	40	-	-	-	-	40	-	-	200	-	100	300	-	-	-	-	-	-	-	-	14	00	-	-	<i>Freedmen generally well paid and seem satisfied</i>	
<i>C. Legarde</i>	<i>Mc Cloud's</i>	15	3	2	-	20	-	-	-	-	20	-	-	100	-	200	300	-	-	-	-	-	-	-	-	14	00	-	-	<i>No Complaints, No dissatisfaction</i>	
<i>Gustav Sebacher</i>	<i>Sabache</i>	65	8	3	-	76	-	-	-	-	76	-	-	350	-	250	600	-	-	-	-	-	-	-	-	15	00	-	-	<i>This planter pays the highest wages in the Parish and pays cash weekly the freedmen work harder and better than on any plantation which I have inspected.</i>	
"	"	38	3	5	-	46	-	-	-	-	46	-	-	300	-	100	400	-	-	-	-	-	-	-	-	15	00	-	-	" " "	

AGGREGATE 690 148 81 21 940 32 45 54 48 179 1119 2 37 50 87 38 12 - 287 - 450 70 83 14

The feeling between the races although somewhat disturbed by political excitement at the present time, is as far as my Experience goes for the most part amicable, and all cases of Abuse, Outrage, or ill treatment on the part of the whites toward the freedmen can generally be traced as the result of insolence, or a spirit of independence on the part of the freedmen, which the white have in consequence of former prejudices is ill disposed to bear: My opinion is that the mutual interest existing between the laborer and his Employer, is sufficiently strong as a general thing to preserve amicable relations between the races: I have noted a disposition on the part of the whites to attribute all the faults of the freedmen to the bad advice which they receive from the so called Carpet Baggers and Scallawags and while they look upon the freedmen with charity they extend all their malice on every stranger or northern man, as a man who has incendiary designs upon the community no matter what may be his business position or calling. The crops consisting of Corn, Cane, Rice, and Potatoes are very abundant and are producing an unprecedented heavy yield all over the Parish.

Station: *Mitadoux La*  
Date: *August 31<sup>st</sup> 1868*

*Nelson Broussard*  
Lieut. 42<sup>d</sup> Infantry Asst. Inspr. Freedmen.

Parish of *Lafourche La.*

NOTE.—The back of this Return may also be used for Remarks, and all the information required by Paragraph 3 of Circular No. 35 will be correctly noted.  
NOTE.—This Return will be made promptly on the last day of each month.  
NOTE.—All over fourteen years of age are considered adults.



MONTHLY REPORT  
OF

*J. H. Van Antwerp*

*Asst. Insp. Freedmen.*

*For the Parish of Lafourche La.*

*For the month ending September*

*30<sup>th</sup> 1868.*

*Forwarded October 2<sup>d</sup> 1868.*

*Rec. B. R. F. & A. L. 1868.*

*Retained*



**MONTHLY**

**REPORT**

of *J. H. Van Hook* Assistant Inspector of Freedmen for the Parish of *Shreveport* for the Month ending on the *Thirtieth* day of *September*

Assistant Inspector of Freedmen for the Parish of *Lafourche* day of *September*

*Lafourche*

1868.

State of Louisiana,

NAME OF OWNER OR LESSEE OF PLANTATION.	NAME OF PLANTATION.	NUMBER OF FREEDMEN ON PLANTATION.										No. of Children Attending Schools.	NUMBER OF ACRES UNDER CULTIVATION.							KIND OF CONTRACT HANDS EMPLOYED UNDER AND NUMBER OF HANDS EMPLOYED EACH.		No. of Acres Rented to Freedmen.	No. of Acres Sold to Freedmen.	AVERAGE MONTHLY WAGE.		REMARKS.					
		WORKING HANDS.					AGED AND HELPLESS.						MALE.	FEMALE.	TOTAL.	ACRES OF SUGAR.	ACRES OF COTTON.	ACRES OF RICE.	ACRES OF TOBACCO.	ACRES OF CORN.	ACRES OF OTHER CEREALS.			TOTAL ACRES CULTIVATED.	RATIONS, CLOTHING, QUARTERS, FUEL AND WAGES.		RATIONS AND WAGES.	WAGES ONLY.	SHARE IN CROPS.	Dolls.	Cts.
		MALE.	FEMALE.	CHILDREN.	MALE.	FEMALE.	MALE.	FEMALE.	CHILDREN.	MALE.	FEMALE.																				
<i>R. H. Allen</i>	<i>Rieszi</i>	75	44	22	8	149	0	2	0	0	2	152	500	0	0	0	500	1000	0	0	0	0	0	0	0	0	14	00	<i>Freedmen contented and work well, are paid wages &amp; rations, prospect of a large crop</i>		
<i>A. Collins</i>	<i>Collins</i>	10	0	0	0	0	0	0	0	0	10	10	50	0	0	0	50	136	0	0	0	0	0	0	0	12	00	<i>Working under a contract for wages, for one year 1/2 payable monthly, seem satisfied and work faithfully</i>			
<i>Chas F. Gaudin</i>	<i>Gaudin</i>	2	0	0	0	0	0	0	0	0	2	2	50	0	0	0	50	100	0	0	0	2/3	0	0	0	0	0	<i>Working on shares with the planter, finding their own teams and rations.</i>			
<i>E. H. Lawless</i>	<i>Lawless</i>	6	2	7	3	18	0	0	0	0	18	18	60	0	0	0	30	90	0	0	0	0	0	0	0	12	00	<i>Working on wages, but do not give much satisfaction, Crop prospects only moderate.</i>			
<i>W. C. Webb</i>	<i>Webster</i>	58	20	11	9	98	0	0	0	0	98	98	0	0	0	0	200	100	400	0	0	0	1/3	400	0	0	0	<i>Freedmen rent the land and raise their own crop, mostly corn, are contented &amp; satisfied.</i>			
<i>C. C. Williams</i>	<i>Wicks</i>	15	8	5	2	30	4	7	9	21	50	1	23	22	45	0	0	0	120	30	150	0	0	0	0	0	1/3	150	<i>Same as the above.</i>		
<i>L. G. Aubert</i>	<i>Aubert</i>	8	16	0	0	0	0	0	0	0	24	24	10	25	190	205	0	0	0	0	0	0	0	0	0	0	0	0	<i>Working on shares, find themselves, do not give much satisfaction, Planter will not make same agreement for next year.</i>		
<i>J. C. Foster</i>	<i>do</i>	3	0	0	0	0	0	0	0	0	3	3	12	45	57	0	0	0	0	0	0	0	0	0	0	0	0	0			
<i>J. P. Tucker</i>	<i>Tuckers</i>	34	1	0	0	0	0	0	0	0	35	35	200	0	0	0	200	400	0	0	0	0	0	0	0	0	0	0	<i>Working for wages and rations, and give satisfaction to Planter, Crop looking finely</i>		
<i>Doct G. L. Lewis</i>	<i>Lewis</i>	15	0	0	0	0	0	0	0	0	15	15	200	0	0	0	100	50	350	0	0	0	0	0	0	0	0	0	<i>Same as above</i>		
AGGREGATE		226	01	45	22	445	4	9	9	0	2	466	1	23	22	45	1700	37	1595	150	2866	0	0	0	0	0	0	0			

Station: *Thibodaux*  
Date: *September 30<sup>th</sup>* 1868.

*J. H. Van Hook*  
Asst. Inspr. Freedmen.

NOTE.—The back of this Return may also be used for Remarks, and all the information required by Paragraph 3 of Circular No. 85 will be correctly noted.  
NOTE.—This Return will be made promptly on the last day of each month.  
NOTE.—All over fourteen years of age are considered adults.

Parish of \_\_\_\_\_



NATIONAL ARCHIVES AND RECORDS ADMINISTRATION  
MICROFILM PUBLICATIONS

Roll 103

Target 3

*Monthly School Reports of the District Superintendent*  
Mar.-Nov. 1868

**REPORT OF SCHOOLS,**  
**(DISTRICT SUPT.)**

State of

Thibodeaux

Retained copies

of

Reports

of schools

Forwarded, \_\_\_\_\_

Received, \_\_\_\_\_



# DISTRICT SUPERINTENDENT'S MONTHLY SCHOOL REPORT

To Bureau R. F. & A. L., for the month of March, 1868, Parish Lafourche District, State of Louisiana

A School under the distinct control of one Teacher, or a Teacher with one assistant, is to be reported as one School.

To contain one entire calendar month, and to be forwarded as soon as possible after the close of the month.

No. of Day Schools.	No. of Night Schools.	NAME AND LOCATION OF SCHOOL.	PRESENT SESSION.		SOCIETIES, &c., PATRONS.	No. Schools sustained by Freedmen.	No. Schools sustained in part by Freedmen.	No. Teachers transported by Bureau.	No. School Buildings owned by Freedmen.	No. School Buildings furnished by Bureau.	TEACHERS.		NO. PUPILS ENROLLED. (Both Day and Night Schools.)		No. Pupils enrolled last Report.	No. left School this Month.	No. New Scholars this Month.	Average Attendance.	No. of Pupils paying Tuition.	No. of White Pupils.	No. always Present.	No. always Punctual.	No. over 16 years of Age.	No. in Alphabet.	No. Spell and Read easy Lessons.	No. advanced Readers.	No. Geography.	No. Arithmetic.	No. Higher Branches.	No. Writing.	No. Needle-work.	No. Free before the War.	No. Sabbath Schools.	No. Teachers in Sabbath Schools.	No. Pupils in Sabbath School.
			When opened.	When to close.							White.	Col'd.	Male.	Fem'e.																					
1	0	Lincoln, Thibodaux			none	1	0	0	0	0	1	2	78	82	65	0	95	140	0	0	140	140	0	50	50	10	15	25	0	10	0	0	1	1	40
1	1	Webster, Johnson			none	1	0	0	0	0	0	1	7	5	14	8	4	15	0	0	15	15	2	4	6	5	4	6	3	7	0	0	1	1	20
1	1	Vicks, Plantation			none	1	0	0	0	0	0	1	20	10	0	1	3	25	18	0	25	25	2	4	9	5	0	4	0	4	0	0	1	1	40
<b>TOTALS.</b>						<b>3</b>	<b>0</b>	<b>0</b>	<b>0</b>	<b>0</b>					<b>79</b>	<b>4</b>	<b>102</b>	<b>180</b>	<b>18</b>	<b>0</b>	<b>180</b>	<b>180</b>	<b>4</b>	<b>58</b>	<b>65</b>	<b>20</b>	<b>19</b>	<b>35</b>	<b>3</b>	<b>21</b>	<b>0</b>	<b>0</b>	<b>3</b>	<b>3</b>	<b>100</b>

- To these questions give exact or approximate answers, prefixing to the latter the word "about."
- How many of above Schools are graded? 3 How many grades? 2
  - How many Day or Night Schools, within your knowledge, not reported above? unknown Whole No. of Pupils (estimated) in all such Schools, unknown No. Teachers in all, White, Colored,
  - How many Sabbath Schools, within your knowledge, not reported above? unknown Whole No. of Pupils (estimated) in all such Schools, unknown No. Teachers in all, White, Colored,
  - How many Industrial Schools? none Whole No. Pupils in all, none State the kind of work done, none
  - Whole amount of Tuition paid by Freedmen during the month, none
  - Whole amount of expenses for the above Schools by the Bureau for the month, none
  - Grand total of expenses for support of above Schools by all parties for the month, none
  - Whole No. of High or Normal Schools, none How many pupils in all? none
  - State the public sentiment towards Colored Schools, Fair
  - Remarks. Sufficient attention cannot be paid to School matters by the undersigned for want of time  
Francis H. H. H.  
asa



[Form 2, Ed.]

REPORT OF SCHOOLS,  
(DISTRICT SUPT.)

State of

Thibodeaux

Retained copies

of

Reports

of schools

Forwarded, .....

Received, .....



**REPORT OF SCHOOLS,**  
**(DISTRICT SUPT.)**

State of \_\_\_\_\_

*March*

1868.



# DISTRICT SUPERINTENDENT'S MONTHLY SCHOOL REPORT

To Bureau R. F. & A. L., for the month of March, 1868, Parish Lafourche District, State of Louisiana

A School under the distinct control of one Teacher, or a Teacher with one assistant, is to be reported as one School.

To contain one entire calendar month, and to be forwarded as soon as possible after the close of the month.

No. of Day Schools.	No. of Night Schools.	NAME AND LOCATION OF SCHOOL.	PRESENT SESSION.		SOCIETIES, &c., PATRONS.	No. Schools sustained by Freedmen.	No. Schools sustained in part by Freedmen.	No. Teachers transported by Bureau.	No. School Buildings owned by Freedmen.	No. School Buildings furnished by Bureau.	TEACHERS.		No. PUPILS ENROLLED. (Both Day and Night Schools.)		No. Pupils enrolled last Report.	No. left School this Month.	No. New Scholars this Month.	Average Attendance.	No. of Pupils paying Tuition.	No. of White Pupils.	No. always Present.	No. always Punctual.	No. over 16 years of Age.	No. in Alphabet.	No. Spell and Read easy Lessons.	No. advanced Readers.	No. Geography.	No. Arithmetic.	No. Higher Branches.	No. Writing.	No. Needle-work.	No. Free before the War.	No. Sabbath Schools.	No. Teachers in Sabbath Schools.	No. Pupils in Sabbath School.
			When opened.	When to close.							White.	Col'd.	Male.	Fem'e.																					
1	0	Lincoln's School			none	1	0	0	0	0	1	2	82	65	0	95	140	0	0	140	140	0	50	50	10	15	25	0	10	0	0	1	1	40	
1	1	Webster, Johnsonville			none	1	0	0	0	0	0	1	8	14	8	4	15	0	0	15	15	2	4	6	5	4	6	3	7	0	0	1	1	20	
1	1	Vick's Plantation			none	1	0	0	0	0	0	1	20	10	0	1	3	25	18	0	25	25	2	4	9	5	0	4	0	4	0	1	1	40	
<b>TOTALS:</b>						<b>3</b>	<b>0</b>	<b>0</b>	<b>0</b>	<b>0</b>				<b>79</b>	<b>4</b>	<b>102</b>	<b>180</b>	<b>18</b>	<b>0</b>	<b>160</b>	<b>180</b>	<b>4</b>	<b>58</b>	<b>65</b>	<b>20</b>	<b>19</b>	<b>35</b>	<b>3</b>	<b>21</b>	<b>0</b>	<b>0</b>	<b>3</b>	<b>3</b>	<b>100</b>	

This Report is incomplete unless each blank is filled by a number or cypher.

- To these questions give exact or approximate answers, prefixing to the latter the word "about."
- How many of above Schools are graded? 3 How many grades? 2
  - How many Day or Night Schools, within your knowledge, not reported above? unknown Whole No. of Pupils (estimated) in all such Schools, unknown No. Teachers in all, White, Colored,
  - How many Sabbath Schools, within your knowledge, not reported above? unknown Whole No. of Pupils (estimated) in all such Schools, unknown No. Teachers in all, White, Colored,
  - How many Industrial Schools? none Whole No. Pupils in all, none State the kind of work done, none
  - Whole amount of Tuition paid by Freedmen during the month, none
  - Whole amount of expenses for the above Schools by the Bureau for the month, none
  - Grand total of expenses for support of above Schools by all parties for the month, none
  - Whole No. of High or Normal Schools, none How many pupils in all? none
  - State the public sentiment towards Colored Schools, Fair
  - Remarks. Sufficient attention cannot be paid to school matters by the undersigned for want of time  
Francis M. Mendenhall  
ASAC



*Retained Copy!*

[ED. FORM, No. 4.]

# MONTHLY REPORT

OF

*#* Sub-Assistant Commissioner (or Agent),

District of

*Lafourche*

State of

*March*

, 1868.

Forwarded....., 1868.

Received, S.D....., 1868.

## SUB-ASSISTANT COMMISSIONER'S (OR AGENT'S) MONTHLY REPORT

on Education of Freedmen and Refugees in Sub-District, State of Louisiana in charge of Francis Herberg  
for the Month of March 1868, [in accordance with order contained in Circular No. 5, Bureau R., F., & A.L.]

1. Name of your Sub-District? Parish Lafourche
2. Whole number of Refugee or Freedmen's Schools in the District? 3 Day? 3 Night? 3 Sabbath? 3
3. Location of Schools? Ljubl School, Canal Street Thibodaux, Webster School Johnson's Plantation, School on Dick's Plantation
4. Whole number of Teachers? 5 White? 0 Colored? 5
5. Names and post-office address of Day-School Teachers? Miss Josephine Williams & Miss Nancy Johnson Thibodaux, Rev John Houston Johnson's Plantation Lafourche Crossing, M. Edward Mitchell, Dick's Plantation Lafourche Crossing
6. Whole number of School-houses for Freedmen in your District? 3 Their condition, capacity, value, and by whom owned? Condition of these School Houses good. Ljubl School here in M. C. Church seats probably 150 children is owned by Church. Webster School House on Johnson Place belongs to Place seats probably 75. School house at Dick's same capacity owned by church.
7. Number of your visits to Schools? Day? Night? Sabbath? Visit almost daily one School or the other
8. Number of educational meetings held by you during the month? 4 Where? in Meth. C. Church
9. Number and names of places, now destitute, in which Day-Schools might be organized? About 1 dozen more, should be established, on Racine, Mavorley, Jean Weber, Braussieu, Place Lockport &c, Lafourche Crossing
10. Number of pupils (estimated) who would attend such Schools?  
One thousand
11. Amount which would probably be raised by the Freedmen, for school purposes, in each destitute neighborhood?  
unknown, but Freedmen very poor
12. What efforts are you making to secure the support of schools by pupils, parents, boards of education, or the State government? A collation was held last week which netted about \$60. - A committee for the support of schools is in active operation, State Govt unknown
13. Whole number of additional School-houses, for Freedmen, now wanted in your Sub-District? 10-12 (one is building but needs help from Bureau)
14. Could you organize your Sub-District into School Districts, each with a School Committee pledged to carry on schools therein? Have not time to do so
15. To what extent would help from without be needed in such cases? unknown, the more help the better
16. What is the public sentiment as to the education of the Freedmen and Poor Whites?  
Fair

17. Are Night-Schools for Adults needed in your District? Much In what way could they be carried on? Am unable to suggest any plan, except by Govt paying the teacher
18. What more can this Bureau do for educating the children of Refugees (or Poor Whites)? Separate schools should be organized, the Bureau furnishing every thing, without which nothing can be done, as the Carriers will not allow their children to go to school with the negroes
19. How long will Northern charitable aid be needed for Freedmen and Refugee Schools of your District?  
Very long I suppose, but no aid is given at present nor has been to my knowledge

I hereby certify, on honor, that I have given personal attention to the matters herein named, and that the answers given are, according to my best knowledge and belief, correct.

Francis Herberg  
Sub-Ass. Com. Bureau R., F., & A.L.



[Ed. Form, No. 2.]

**REPORT OF SCHOOLS,**  
(DISTRICT SUPT.)

State of .....

*April* .....

1868

Forwarded, .....

Received, .....



# DISTRICT SUPERINTENDENT'S MONTHLY SCHOOL REPORT

To Bureau R. F. & A. L., for the month of April, 1868, Parish Lafourche District, State of Louisiana

A School under the distinct control of one Teacher, or a Teacher with one assistant, is to be reported as one School.

To contain one entire calendar month, and to be forwarded as soon as possible after the close of the month.

No. of Day Schools.	No. of Night Schools.	NAME AND LOCATION OF SCHOOL.	PRESENT SESSION.		SOCIETIES, &c., PATRONS.	No. Schools sustained by Freedmen.	No. Schools sustained in part by Freedmen.	No. Teachers transported by Bureau.	No. School Buildings owned by Freedmen.	No. School Buildings furnished by Bureau.	TEACHERS.			No. Pupils enrolled last Report.	No. left School this Month.	No. New Scholars this Month.	Average Attendance.	No. of Pupils paying Tuition.	No. of White Pupils.	No. always Present.	No. always Punctual.	No. over 10 years of Age.	No. in Alphabet.	No. Spell and Read easy Lessons.	No. advanced Readers.	No. Geography.	No. Arithmetic.	No. Higher Branches.	No. Writing.	No. Needle-work.	No. Free before the War.	No. Sabbath Schools.	No. Teachers in Sabbath Schools.	No. Pupils in Sabbath School.	
			When opened.	When to close.							White.	Col'd.	Male.																						Fem'e.
1	0	Lincoln's Plantation			none	1	0	0	0	0	0	2	38	34	160	0	0	140	0	0	140	140	0	50	50	10	15	25	0	10	0	0	1	1	40
1	1	Webster, Johnson's Plant - 1			none	1	0	0	0	0	0	1	7	8	15	0	0	15	0	0	15	15	2	4	6	5	4	6	3	7	0	0	1	1	20
1	1	Vicks' Plantation			none	1	0	0	0	0	0	1	20	10	30	0	0	25	18	0	25	25	4	4	9	5	0	4	0	0	0	1	1	40	
TOTALS.						3	0	0	0	0			205	0	0	175	18	0	480	180	458	65	20	19	35	3	21	11	0	3	3	100			

This Report is incomplete unless each blank is filled by a number or cypher.

To these questions give exact or approximate answers, prefixing to the latter the word "about."

1. How many of above Schools are graded? 3 How many grades? 2
2. How many Day or Night Schools, within your knowledge, not reported above? 0 Whole No. of Pupils (estimated) in all such Schools, 0 No. Teachers in all, 0 White, 0 Colored, 0
3. How many Sabbath Schools, within your knowledge, not reported above? 0 Whole No. of Pupils (estimated) in all such Schools, 0 No. Teachers in all, 0 White, 0 Colored, 0
4. How many Industrial Schools? 0 Whole No. Pupils in all, 0 State the kind of work done, 0
5. Whole amount of Tuition paid by Freedmen during the month, 0
6. Whole amount of expenses for the above Schools by the Bureau for the month, 0
7. Grand total of expenses for support of above Schools by all parties for the month, 0
8. Whole No. of High or Normal Schools, 0 How many pupils in all? 0
9. State the public sentiment towards Colored Schools, Fair
10. Remarks. Sufficient attention cannot be paid to School Matters by the undersigned for want of time

*Francis H. Stenberg*  
*Assistant*



*Return*

[ED. FORM, No. 4.]

# MONTHLY REPORT

OF

Sub-Assistant Commissioner (or Agent),

District of *Lafayette*

State of *Louisiana*

*April*, 1868. *8*

Forwarded *May 24*, 1868.

Received, S.D. \_\_\_\_\_, 1868.

*West* SUB-ASSISTANT COMMISSIONER'S (OR AGENT'S) MONTHLY REPORT

on Education of Freedmen and Refugees in Sub-District, State of *Louisiana* in charge of *Francis Herberg*  
for the Month of *April* 1868, [in accordance with order contained in Circular No. 5, Bureau R., F., & A.L.]

1. Name of your Sub-District? *Parish of Lafourche*
2. Whole number of Refugee or Freedmen's Schools in the District? *3* Day? *3* Night? *3* Sabbath? *3*
3. Location of Schools? *Lincoln School Canal Street Thibodaux, Webster School, Johnson's Plantation, School on Vick's Plantation*
4. Whole number of Teachers? *5* White? *0* Colored? *5*
5. Names and post-office address of Day-School Teachers? *Miss Josephine Williams & Miss Nancy Johnson Thibodaux Rev. John Houston Johnson's Plantation, Lafourche Crossing, Mr. Ed. Mitchell, Vick's Plantation, Lafourche Crossing, Rev. Henry Holmes, Thibodaux*
6. Whole number of School-houses for Freedmen in your District? *3* Their condition, capacity, value, and by whom owned? *Condition good Lincoln School in M.E. Church, seating 200 children owned by Church, Webster Schoolhouse belongs to Johnson's Plantation seats 100, Schoolhouse at Vick's belongs to Plantation seats 100*
7. Number of your visits to Schools? Day? Night? Sabbath? *almost daily visits*
8. Number of educational meetings held by you during the month? *4* Where? *Meth Episcopal Church*
9. Number and names of places, now destitute, in which Day-Schools might be organized? *many more should be organized Ricini, Waverley, Jean Neve, Proussian, Sabatier, Perkins, Plantations, Locks, Lafourche Crossing*
10. Number of pupils (estimated) who would attend such Schools? *One thousand*
11. Amount which would probably be raised by the Freedmen, for school purposes, in each destitute neighborhood? *unknown, but probably considerable*
12. What efforts are you making to secure the support of schools by pupils, parents, boards of education, or the State government? *School society is organizing & will if conducted energetically have good results - State Government is entirely nonest*
13. Whole number of additional School-houses, for Freedmen, now wanted in your Sub-District? *10-12. one in process of construction*
14. Could you organize your Sub-District into School Districts, each with a School Committee pledged to carry on schools therein? *This will be done shortly by School Society*
15. To what extent would help from without be needed in such cases? *any help would be acceptable*
16. What is the public sentiment as to the education of the Freedmen and Poor Whites? *Fair*
17. Are Night-Schools for Adults needed in your District? *yes* In what way could they be carried on? *am unable to suggest any fixed plan, the School Society are deliberating about the subject*
18. What more can this Bureau do for educating the children of Refugees (or Poor Whites)? *Very little, unless by establishing separate schools furnishing everything, as the poor whites are very much so & so ignorant as to rather let their children grow up in ignorance than to let them attend negro schools*
19. How long will Northern charitable aid be needed for Freedmen and Refugee Schools of your District? *until reconstruction is completed perhaps somewhat longer but now it given now*

I hereby certify, on honor, that I have given personal attention to the matters herein named, and that the answers given are, according to my best knowledge and belief, correct.

*Francis Herberg*  
Sub-Assst. Com., Bureau R., F., & A.L.



[ED. FORM, No. 4.]

# MONTHLY REPORT

OF

Sub-Assistant Commissioner (or Agent),

District of

*Lafourche*

State of

*Louisiana*

*May 31<sup>st</sup>*, 1868.

Forwarded

*June 4<sup>th</sup>*, 1868.

Received, S.D.

, 1868.

## SUB-ASSISTANT COMMISSIONER'S (OR AGENT'S) MONTHLY REPORT

on Education of Freedmen and Refugees in Sub-District, State of *Louisiana* in charge of *Sgt Nelson Broun*  
for the Month of *May* 1868, [in accordance with order contained in Circular No. 5, Bureau R., F., & A.L.]

1. Name of your Sub-District? *Lafourche*  
2. Whole number of Refugee or Freedmen's Schools in the District? *3* Day? *1* Night? *3* Sabbath?  
3. Location of Schools? *Thibodeaux 1<sup>st</sup> District, Johnsons Plantation & Vicks. Plantation*

4. Whole number of Teachers? *4* White? *0* Colored? *4*

5. Names and post-office address of Day-School Teachers? *Martha J. Randolph, Thibodeaux La*  
*Rev John Houston, Thibodeaux La*  
*Edward Mitchell, Thibodeaux La*

6. Whole number of School-houses for Freedmen in your District? *3*. Their condition, capacity, value, and by whom owned? *Lincoln School is a church owned by the Freedmen Capacity 300. Condition good; Lockport School small Capacity 50. owned by the Johnson Estate Vicks School Church owned by Johnson Estate Capacity 300 Condition Poor*

7. Number of your visits to Schools? *3* Day? *3* Night? *0* Sabbath? *0*

8. Number of educational meetings held by you during the month? *0* Where? *0*

9. Number and names of places, now destitute, in which Day-Schools might be organized? *Perkins Plantation; Lockport, and Raceland if houses can be procured or teachers*

10. Number of pupils (estimated) who would attend such Schools? *300*

11. Amount which would probably be raised by the Freedmen, for school purposes, in each destitute neighborhood? *None*

12. What efforts are you making to secure the support of schools by pupils, parents, boards of education, or the State government? *An Educational Society meets weekly to devise the best means of carrying on and supporting the schools*

13. Whole number of additional School-houses, for Freedmen, now wanted in your Sub-District? *Three*

14. Could you organize your Sub-District into School Districts, each with a School Committee pledged to carry on schools therein? *Probably*

15. To what extent would help from without be needed in such cases? *I think if proper houses could be treated the schools would support themselves*

16. What is the public sentiment as to the education of the Freedmen and Poor Whites? *favorable generally*

17. Are Night-Schools for Adults needed in your District? *yes* In what way could they be carried on? *They can probably be carried on without outside assistance as soon as the warm weather is over*

18. What more can this Bureau do for educating the children of Refugees (or Poor Whites)? *Nothing*

19. How long will Northern charitable aid be needed for Freedmen and Refugee Schools of your District? *Until the Freed People can be sufficiently impressed as to the importance of educating their children*

I hereby certify, on honor, that I have given personal attention to the matters herein named, and that the answers given are, according to my best knowledge and belief, correct.

*Nelson Broun* 3<sup>d</sup> Lieut  
42<sup>d</sup> Inf Sub-Asst. Com., Bureau R., F., & A.L.



[ED. FORM, No. 2.]

REPORT OF SCHOOLS,  
(DISTRICT SUPT.)

State of *Louisiana*

*May 31<sup>st</sup>* 1868

Forwarded, *June 4<sup>th</sup>* 1868

Received, \_\_\_\_\_



# DISTRICT SUPERINTENDENT'S MONTHLY SCHOOL REPORT

To Bureau R. F. & A. L., for the month of May, 1868, Parish of Lafourche 1<sup>st</sup> District, State of Louisiana

A School under the distinct control of one Teacher, or a Teacher with one assistant, is to be reported as one School.

To contain one entire calendar month, and to be forwarded as soon as possible after the close of the month.

This Report is incomplete unless each blank is filled by a number or cypher.	No. of Day Schools.	No. of Night Schools.	NAME AND LOCATION OF SCHOOL.	PRESENT SESSION.		SOCIETIES, &c., PATRONS.	No. Schools sustained by Freedmen.	No. Schools sustained in part by Freedmen.	No. Teachers transported by Bureau.	No. School Buildings owned by Freedmen.	No. School Buildings furnished by Bureau.	TEACHERS.		No. PUPILS ENROLLED. (Both Day and Night Schools.)		No. Pupils enrolled last Report.	No. left School this Month.	No. New Scholars this Month.	Average Attendance.	No. of Pupils paying Tuition.	No. of White Pupils.	No. always Present.	No. always Punctual.	No. over 10 years of Age.	No. in Alphabet.	No. Spell and Read easy Lessons.	No. advanced Readers.	No. Geography.	No. Arithmetic.	No. Higher Branches.	No. Writing.	No. Needle-work.	No. Free before the War.	No. Sabbath Schools.	No. Teachers in Sabbath Schools.	No. Pupils in Sabbath School.
				When opened.	When to close.							White.	Col'd.	Male.	Fem'e.																					
	3	0	Lincoln School	Dec	July		0	0	0	1	1	0	2	67	46	107	0	6	109	0	0	103	103	11	23	18	35	35	46	0	12	0	2	1	5	77
	1	0	Webster "	"	"		0	0	0	1	1	0	1	12	20	29	4	5	25	0	0	25	25	4	3	6	20	5	8	6	9	0	0	1	1	30
	1	0	Vicks "	"	"		0	0	0	1	1	0	1	40	35	50	0	25	75	5	0	68	68	1	12	33	20	6	6	5	39	0	0	1	4	135
TOTALS.	3	1								3		0	4	119	161	186	4	36	209	5	0	196	196	16	38	57	75	46	60	11	60	0	2	3	10	232

To these questions give exact or approximate answers, prefixing to the latter the word "about."

1. How many of above Schools are graded? 3 How many grades? 2
2. How many Day or Night Schools, within your knowledge, not reported above? Not known Whole No. of Pupils (estimated) in all such Schools, Not known No. Teachers in all, — White, — Colored, —
3. How many Sabbath Schools, within your knowledge, not reported above? Not known Whole No. of Pupils (estimated) in all such Schools, Not known No. Teachers in all, — White, — Colored, —
4. How many Industrial Schools? None Whole No. Pupils in all, None State the kind of work done, None
5. Whole amount of Tuition paid by Freedmen during the month, None
6. Whole amount of expenses for the above Schools by the Bureau for the month, ~~None~~ \$50.100
7. Grand total of expenses for support of above Schools by all parties for the month, ~~None~~ \$50.100
8. Whole No. of High or Normal Schools, None How many pupils in all? None
9. State the public sentiment towards Colored Schools, Good
10. Remarks. Scholars are advancing in some instances with great rapidity much difficulty is experienced in procuring proper teachers

Albery Broadson  
Lieut 42<sup>nd</sup> Infantry U.S.A.C.



[ED. FORM, No. 4.]

# MONTHLY REPORT

OF

Sub-Assistant Commissioner (or Agent),

District of .....

State of .....

*June* ....., 1868.

*Returned*

Forwarded ....., 1868.

Received, S.D. ...., 1868.

## SUB-ASSISTANT COMMISSIONER'S (OR AGENT'S) MONTHLY REPORT

on Education of Freedmen and Refugees in <sup>Parish of Lafourche</sup> Sub-District, State of Louisiana in charge of St. Nelson Bronson  
for the Month of June 1868, [in accordance with order contained in Circular No. 5, Bureau R., F., & A.L.]

1. Name of your Sub-District? Parish of Lafourche  
2. Whole number of Refugee or Freedmen's Schools in the District? 4 Day? 1 Night? 4 Sabbath?  
3. Location of Schools? Thibodaux, Johnson's Plant, Vicks Plant, Raceland

4. Whole number of Teachers? 5 White? 1 Colored? 4

5. Names and post-office address of Day-School Teachers? Martha J. Randolph, Thibodaux, Rev. John Houston  
Thibodaux, La, Ed. Mitchell, Thibodaux, Thos Mc. Culiffe, Raceland

6. Whole number of School-houses for Freedmen in your District? 4 Their condition, capacity, value, and by whom owned? Lincoln School in  
M. C. Church owned by Freedmen, capacity 300, Condition good, Webster School, capacity 50 condition good  
owned by Johnson estate, Vicks School owned by Vicks estate, capacity 300 condition poor, School at Raceland see Report

7. Number of your visits to Schools? 4 Day? 4 Night? 0 Sabbath? 0

8. Number of educational meetings held by you during the month? 0 Where? 0

9. Number and names of places, now destitute, in which Day-Schools might be organized? Perkins Plantation, Lockport etc

10. Number of pupils (estimated) who would attend such Schools? 300

11. Amount which would probably be raised by the Freedmen, for school purposes, in each destitute neighborhood? none

12. What efforts are you making to secure the support of schools by pupils, parents, boards of education, or the State government? an educational  
Society meets weekly to devise the best means of carrying on, supporting the schools

13. Whole number of additional School-houses, for Freedmen, now wanted in your Sub-District? Two

14. Could you organize your Sub-District into School Districts, each with a School Committee pledged to carry on schools therein? Probably

15. To what extent would help from without be needed in such cases? I think if proper houses could be rented the  
schools would support themselves

16. What is the public sentiment as to the education of the Freedmen and Poor Whites? favorable generally

17. Are Night-Schools for Adults needed in your District? yes In what way could they be carried on? they can probably be carried  
on without outside assistance, as soon as the warm weather is over

18. What more can this Bureau do for educating the children of Refugees (or Poor Whites)? nothing

19. How long will Northern charitable aid be needed for Freedmen and Refugee Schools of your District? until the Freed People can  
be sufficiently impressed as to the importance of educating their children

I hereby certify, on honor, that I have given personal attention to the matters herein named, and that the answers given are, according to my best knowledge and belief, correct.

St. Nelson Bronson  
Asst. Sub-Asst. Com., Bureau R., F., & A.L.  
Dist. 42<sup>d</sup> La.



[ED. FORM, No. 2.]

REPORT OF SCHOOLS,  
(DISTRICT SUPT.)

State of *Louisiana*

*July Term* 186*8*

*Reamer*

Forwarded, *July 3<sup>d</sup>*

Received, \_\_\_\_\_



# DISTRICT SUPERINTENDENT'S MONTHLY SCHOOL REPORT

To Bureau R. F. & A. L., for the month of June, 1868, Parish Lafourche 8th Sub-District, State of Louisiana.

A School under the distinct control of one Teacher, or a Teacher with one assistant, is to be reported as one School. To contain one entire calendar month, and to be forwarded as soon as possible after the close of the month.

No. of Day Schools.	No. of Night Schools.	NAME AND LOCATION OF SCHOOL.	PRESENT SESSION.		SOCIETIES, &c., PATRONS.	No. Schools sustained by Freedmen.	No. Schools sustained in part by Freedmen.	No. Teachers transported by Bureau.	No. School Buildings owned by Freedmen.	No. School Buildings furnished by Bureau.	TEACHERS.		No. PUPILS ENROLLED.		No. Pupils enrolled last Report.	No. left School this Month.	No. New Scholars this Month.	Average Attendance.	No. of Pupils paying Tuition.	No. of White Pupils.	No. always Present.	No. always Punctual.	No. over 16 years of Age.	No. in Alphabet.	No. Spell and Read easy Lessons.	No. advanced Readers.	No. Geography.	No. Arithmetic.	No. Higher Branches.	No. Writing.	No. Needle-work.	No. Free before the War.	No. Sabbath Schools.	No. Teachers in Sabbath Schools.	No. Pupils in Sabbath School.
			When opened.	When to close.							White.	Col'd.	Male.	Fem'e.																					
1		Lincoln Canal Street Feb 1		none		1		1			2	43	50	118	15	35	133	0	0	110	110	5	29	28	31	34	37	0	31	0	1	1	5	73	
1		Roberts Johnson Plant Jan 1		none		1					1	18	15	32	8	4	30	0	0	28	20	3	4	10	75	14	13	8	16	0	0	1	1	1	40
1		Vick's Plantation Feb		none		1					2	50	50	75	7	9	75	0	0	75	11	8	20	30	10	11	40	10	12	0	0	1	3	78	
<b>TOTALS.</b>						<b>3</b>		<b>1</b>	<b>3</b>		<b>5</b>	<b>11</b>	<b>95</b>	<b>220</b>	<b>22</b>	<b>48</b>	<b>238</b>	<b>0</b>	<b>0</b>	<b>213</b>	<b>148</b>	<b>16</b>	<b>46</b>	<b>68</b>	<b>86</b>	<b>57</b>	<b>90</b>	<b>18</b>	<b>53</b>	<b>0</b>	<b>1</b>	<b>3</b>	<b>9</b>	<b>191</b>	

- To these questions give exact or approximate answers, prefixing to the latter the word "about."
1. How many of above Schools are graded? 3 How many grades? 2
  2. How many Day or Night Schools, within your knowledge, not reported above? 1 Whole No. of Pupils (estimated) in all such Schools, 100 No. Teachers in all, 1 White, 1 Colored, 0
  3. How many Sabbath Schools, within your knowledge, not reported above? 0 Whole No. of Pupils (estimated) in all such Schools, 0 No. Teachers in all, 0 White, 0 Colored, 0
  4. How many Industrial Schools? 0 Whole No. Pupils in all, 0 State the kind of work done, 0
  5. Whole amount of Tuition paid by Freedmen during the month, 0
  6. Whole amount of expenses for the above Schools by the Bureau for the month, \$50
  7. Grand total of expenses for support of above Schools by all parties for the month, \$50
  8. Whole No. of High or Normal Schools, 0 How many pupils in all? 0
  9. State the public sentiment towards Colored Schools, fair
  10. Remarks. The School reported below is the new one at Raceland, the teacher of which has not as yet furnished a Report.

Alison Brandon  
Lieut. 42d Regt, A.S.C.



[ED. FORM, No. 2.]

REPORT OF SCHOOLS,  
(DISTRICT SUPT.)

State of *Louisiana*  
*July 31<sup>st</sup>* 1868

*R*

Forwarded, *August 4<sup>th</sup>* 1868

Received, \_\_\_\_\_



# DISTRICT SUPERINTENDENT'S MONTHLY SCHOOL REPORT

To Bureau R. F. & A. L., for the month of July, 1868, Parish Lafourche 8<sup>th</sup> Sub District, State of Louisiana

A School under the distinct control of one Teacher, or a Teacher with one assistant, is to be reported as one School.

To contain one entire calendar month, and to be forwarded as soon as possible after the close of the month.

No. of Day Schools.	No. of Night Schools.	NAME AND LOCATION OF SCHOOL.	PRESENT SESSION.		SOCIETIES, &c., PATRONS.	No. Schools sustained by Freedmen.	No. Schools sustained in part by Freedmen.	No. Teachers transported by Bureau.	No. School Buildings owned by Freedmen.	No. School Buildings furnished by Bureau.	TEACHERS.		NO. PUPILS ENROLLED.		No. Pupils enrolled last Report.	No. left School this Month.	No. New Scholars this Month.	Average Attendance.	No. of Pupils paying Tuition.	No. of White Pupils.	No. always Present.	No. always Punctual.	No. over 16 years of Age.	No. in Alphabet.	No. Spell and Read easy Lessons.	No. advanced Readers.	No. Geography.	No. Arithmetic.	No. Higher Branches.	No. Writing.	No. Needle-work.	No. Free before the War.	No. Sabbath Schools.	No. Teachers in Sabbath Schools.	No. Pupils in Sabbath School.
			When opened.	When to close.							White.	Col'd.	Male.	Fem'e.																					
1	0	Lincoln (Coral St)	Feb	unknown	None	0	1	0	1	1	0	2	75	47	193	16	6	123	0	1	112	112	1	23	29	31	34	34	0	37	0	0	1	4	70
1	0	Webster (Orchard Plant)	Jan	"	"	0	1	0	0	1	0	1	19	16	33	4	6	28	0	0	28	20	10	5	16	12	20	14	15	14	0	0	1	1	30
1	0	Picks Plantation	Dec	"	"	0	1	0	0	1	0	2	50	30	75	0	5	70	0	0	60	60	4	12	20	10	20	30	10	28	0	0	1	4	100
1	1	Raceland School	July	"	"	0	1	0	0	1	1	0	52	48	0	0	100	100	0	0	100	100	3	10	40	50	0	0	0	40	0	0	1	1	100
TOTALS.																																			

1. How many of above Schools are graded? 4 How many grades? 2
2. How many Day or Night Schools, within your knowledge, not reported above? 0 Whole No. of Pupils (estimated) in all such Schools, 0 No. Teachers in all, 0 White, 0 Colored, 0
3. How many Sabbath Schools, within your knowledge, not reported above? 0 Whole No. of Pupils (estimated) in all such Schools, 0 No. Teachers in all, 0 White, 0 Colored, 0
4. How many Industrial Schools? 0 Whole No. Pupils in all, 0 State the kind of work done, 0
5. Whole amount of Tuition paid by Freedmen during the month, \$0.00
6. Whole amount of expenses for the above Schools by the Bureau for the month, \$80.00
7. Grand total of expenses for support of above Schools by all parties for the month, \$80.00
8. Whole No. of High or Normal Schools, 0 How many pupils in all? 0
9. State the public sentiment towards Colored Schools, Fair
10. Remarks. These schools will I think become self supporting in part as soon as the present crop is developed

*Judson Brown*  
Lieut 42<sup>d</sup> Infantry A.S.O.

To these questions give exact or approximate answers, prefixing to the latter the word "about."

This Report is incomplete unless each blank is filled by a number or cypher.



[ED. FORM, No. 4.]

# MONTHLY REPORT

OF

Sub-Assistant Commissioner (or Agent),

District of *Lafourche*

State of *Louisiana*

~~Aug 1st~~ *July*, 1868.

*R*

Forwarded *August 4<sup>th</sup>*, 1868.

Received, S.D. \_\_\_\_\_, 1868.

## SUB-ASSISTANT COMMISSIONER'S (OR AGENT'S) MONTHLY REPORT

on Education of Freedmen and Refugees in Sub-District, State of *Louisiana* in charge of *St. Nelson Broadow*  
for the Month of *July* 1868, [in accordance with order contained in Circular No. 5, Bureau R., F., & A.L.]

1. Name of your Sub-District? *Parish of Lafourche*  
2. Whole number of Refugee or Freedmen's Schools in the District? *4* Day? *1* Night? *4* Sabbath?  
3. Location of Schools? *Thibodaux, Johnsons Plantation, Vicks Plantation, Raceland*

4. Whole number of Teachers? *6* White? *1* Colored? *5*

5. Names and post-office address of Day-School Teachers? *Thomas Mitchell Raceland Parish of Lafourche*  
*Martha J. Randolphs Thibodaux La., Rev John Houston, Thibodaux La., Edward Mitchell*  
*Thibodaux La.*

6. Whole number of School-houses for Freedmen in your District? *4* Their condition, capacity, value, and by whom owned? *Lincoln School in*  
*M. E. Church owned by Freedmen Condition good Capacity 300. Webster School Capacity 50. Condition good owned by Johnsons*  
*estate. Vicks School owned by Vicks Estate Capacity 300. Condition poor, Raceland School Capacity 300. owned by the Pugh Estate*  
7. Number of your visits to Schools? *2* Day? *0* Night? *0* Sabbath? *needs some repairs.*  
8. Number of educational meetings held by you during the month? *0* Where? *0*

9. Number and names of places, now destitute, in which Day-Schools might be organized? *Lockport, Live Oak Plantation*

*Lafourche Crossing*  
10. Number of pupils (estimated) who would attend such Schools? *300*

11. Amount which would probably be raised by the Freedmen, for school purposes, in each destitute neighborhood? *None unless each scholar*  
*could be taxed a small amount for his tuition*

12. What efforts are you making to secure the support of schools by pupils, parents, boards of education, or the State government? *An Educational*  
*Society meets weekly to devise the best means of organizing carrying on and supporting*  
*the schools*

13. Whole number of additional School-houses, for Freedmen, now wanted in your Sub-District? *Three*

14. Could you organize your Sub-District into School Districts, each with a School Committee pledged to carry on schools therein? *probably*

15. To what extent would help from without be needed in such cases? *If the rent of the School Houses was paid the*  
*schools would support themselves*

16. What is the public sentiment as to the education of the Freedmen and Poor Whites? *Generally favorable*

17. Are Night-Schools for Adults needed in your District? *Yes* In what way could they be carried on? *If a comfortable School House*  
*is provided the people will ensure the prompt attendance of the scholars*

18. What more can this Bureau do for educating the children of Refugees (or Poor Whites)? *Nothing*

19. How long will Northern charitable aid be needed for Freedmen and Refugee Schools of your District? *until the Freedmen become less*  
*improvident or until property in the State can be taxed for their support*

I hereby certify, on honor, that I have given personal attention to the matters herein named, and that the answers given are, according to my best knowledge and belief, correct.

*Nelson Broadow*  
Sub-Asst. Com., Bureau R., F., & A.L.



[Ed. Form. No. 2.]

REPORT OF SCHOOLS,  
(DISTRICT SUPT.)

State of *Louisiana*  
Parish of *Lafourche*

*August* 1868

*Retained*

Forwarded, *September 4<sup>th</sup> 1868*

Received, \_\_\_\_\_



# DISTRICT SUPERINTENDENT'S MONTHLY SCHOOL REPORT

To Bureau R. F. & A. L., for the month of August, 1868, Lafourche District, State of Louisiana

A School under the distinct control of one Teacher, or a Teacher with one assistant, is to be reported as one School.

To contain one entire calendar month, and to be forwarded as soon as possible after the close of the month.

No. of Day Schools.	No. of Night Schools.	NAME AND LOCATION OF SCHOOL.	PRESENT SESSION.		SOCIETIES, &c., PATRONS.	No. Schools sustained by Freedmen.	No. Schools sustained in part by Freedmen.	No. Teachers transported by Bureau.	No. School Buildings owned by Freedmen.	No. School Buildings furnished by Bureau.	TEACHERS.		No. PUPILS ENROLLED.		No. Pupils enrolled last Report.	No. left School this Month.	No. New Scholars this Month.	Average Attendance.	No. of Pupils paying Tuition.	No. of White Pupils.	No. always Present.	No. always Punctual.	No. over 10 years of Age.	No. in Alphabet.	No. Spell and Read easy Lessons.	No. advanced Readers.	No. Geography.	No. Arithmetic.	No. Higher Branches.	No. Writing.	No. Needle-work.	No. Free before the War.	No. Sabbath Schools.	No. Teachers in Sabbath Schools.	No. Pupils in Sabbath School.
			When opened.	When to close.							White.	Col'd.	Male.	Fem'e.																					
1	0	Lincoln (Canal St) Feb 1 unknown	Open			0	1	0	1	1	0	2	86	59	123	3	25	130	0	2	120	120	7	23	44	40	34	34	0	37	0	2	1	4	80
1	0	Webster (Johnson Plant) Dec 1	"		"	0	1	0	0	1	0	1	12	8	35	15	0	19	0	0	18	15	2	5	10	15	6	15	0	11	0	0	1	1	30
1	0	Vicks Plantation Dec 1	"		"	0	1	0	0	1	0	2	50	30	80	0	0	70	0	0	60	60	4	12	20	10	20	30	10	28	0	0	1	4	100
1	0	Raceland School July 1 Jan 1	"		"	0	1	0	0	1	1	0	62	43	100	0	5	80	60	0	80	70	33	16	54	30	27	27	0	57	0	0	1	1	100
<b>TOTALS.</b>						0	4	0	1	4	1	5	210	140	338	18	30	299	60	2	278	265	46	56	128	95	87	106	10	133	0	2	4	10	310

This Report is incomplete unless each blank is filled by a number or cypher.

1. How many of above Schools are graded? 4 How many grades? 2
2. How many Day or Night Schools, within your knowledge, not reported above? 0 Whole No. of Pupils (estimated) in all such Schools, 0 No. Teachers in all, 0 White, 0 Colored, 0
3. How many Sabbath Schools, within your knowledge, not reported above? 0 Whole No. of Pupils (estimated) in all such Schools, 0 No. Teachers in all, 0 White, 0 Colored, 0
4. How many Industrial Schools? 0 Whole No. Pupils in all, 0 State the kind of work done, 0
5. Whole amount of Tuition paid by Freedmen during the month, \$ 34.75
6. Whole amount of expenses for the above Schools by the Bureau for the month, \$ 70.00
7. Grand total of expenses for support of above Schools by all parties for the month, \$ 104.75
8. Whole No. of High or Normal Schools, 0 How many pupils in all? 0
9. State the public sentiment towards Colored Schools, favorable generally
10. Remarks. The freedmen seem to have the impression that their education will be provided for in some manner free of Exp. paid to themselves and after repeated attempts I find it impossible to make them contribute any reliable sum however small for the support of their schools

*Wilson Proctor Lieut 42<sup>nd</sup> Infantry  
ASAC Parish of Lafourche*



59	
40	
48	
37	
35	
<hr/>	
213	

210	
142	
<hr/>	
2-2	

[ED. FORM, No. 4.]

# MONTHLY REPORT

OF

Sub-Assistant Commissioner (or Agent),

District of *Lafourche*

State of *Louisiana*

*August 31<sup>st</sup>*, 1868.

Forwarded *September 2<sup>d</sup>*, 1868.

Received \_\_\_\_\_, 1868.



*Sub.* SUB-ASSISTANT COMMISSIONER'S (OR AGENT'S) MONTHLY REPORT

on Education of Freedmen and Refugees in Sub-District, State of Louisiana in charge of St Nelson Broadow 42<sup>d</sup> Inf  
for the Month of August 1868, [in accordance with order contained in Circular No. 5, Bureau R., F., & A.L.]

1. Name of your Sub-District? St Nelson Lafourche 4 0 4
2. Whole number of Refugee or Freedmen's Schools in the District? 4 Day?  Night?  Sabbath?
3. Location of Schools? Thibadoux, Johnsons Plantation, Vicks Plantation, Raceland, Sabbath schools are held also at each of these places, the night schools are all closed for the present it being near the rolling season
4. Whole number of Teachers? 6 White? 1 Colored? 5
5. Names and post-office address of Day-School Teachers? Thomas Mc Aleiffe Raceland Parish of Lafourche  
Martha J Randolph Thibadoux La. Rev John Houston Thibadoux La. Edward Mitchell  
Thibadoux La
6. Whole number of School-houses for Freedmen in your District? 4 Their condition, capacity, value, and by whom owned? Lincoln School in M.E. Church owned by freedmen condition good Capacity 300 Webster School Capacity 50, owned by Johnson Estate Condition good Vicks school owned by Vicks Estate Capacity 300. Condition Poor Raceland School Capacity 300
7. Number of your visits to Schools? 3 Day? 3 Night? 0 Sabbath? 0
8. Number of educational meetings held by you during the month? 0 Where? 0
9. Number and names of places, now destitute, in which Day-Schools might be organized? Lockport, Live oak Plantation Lafourche crossing
10. Number of pupils (estimated) who would attend such Schools? 300
11. Amount which would probably be raised by the Freedmen, for school purposes, in each destitute neighborhood? The amount would be very uncertain while many of the freedmen are willing to pay from 50 to 75 cents per month for the tuition of their children not one third who promise will pay up
12. What efforts are you making to secure the support of schools by pupils, parents, boards of education, or the State government? An Educational Society composed of freedmen meets weekly to devise the best means of organizing carrying on and supporting the schools
13. Whole number of additional School-houses, for Freedmen, now wanted in your Sub-District? Three
14. Could you organize your Sub-District into School Districts, each with a School Committee pledged to carry on schools therein? I have broached the subject to several prominent freedmen but have not thus far met with any encouragement
15. To what extent would help from without be needed in such cases? If the heat of school houses were paid the schools would support themselves, provided we could find suitable teachers
16. What is the public sentiment as to the education of the Freedmen and Poor Whites? Generally favorable
17. Are Night-Schools for Adults needed in your District? yes In what way could they be carried on? If a comfortable school house is provided and a teacher the people will ensure prompt attendance
18. What more can this Bureau do for educating the children of Refugees (or Poor Whites)? nothing unless to build school houses at proper intervals
19. How long will Northern charitable aid be needed for Freedmen and Refugee Schools of your District? until the freedmen become less improvident or until property in the state can be taxed for their support

I hereby certify, on honor, that I have given personal attention to the matters herein named, and that the answers given are, according to my best knowledge and belief, correct.

Nelson Broadow 42<sup>d</sup> Inf  
Sub-Asst. Com., Bureau R., F., & A.L.

# Report of Schools.

(DISTRICT SUPERINTENDENT.)

---

---

Parish of *Lafourche.*

State of *Louisiana.*

---

---

*September.* 1868

---

---

*Retained.*

---

---

Forwarded *October 3* 1868.

Received ..... 186







**Report of Schools.**

(DISTRICT SUPERINTENDENT.)

Parish of *Lafourche*  
State of *Louisiana*

*November 1868*

*Retained Copy*

Forwarded *December 8<sup>th</sup> 1868*

Received \_\_\_\_\_ 186







[ED. FORM, No. 4.]

# MONTHLY REPORT

OF

Sub-Assistant Commissioner (or Agent),

District of *Lafayette*

State of \_\_\_\_\_

*Nov*

, 1868.

*Retained Copy*

Forwarded \_\_\_\_\_, 1868.

Received, S.D. \_\_\_\_\_, 1868.



## SUB-ASSISTANT COMMISSIONER'S (OR AGENT'S) MONTHLY REPORT

on Education of Freedmen and Refugees in <sup>Parish Lafourche</sup> Sub-District, State of Louisiana in charge of William Hollenback  
for the Month of November 1868, [in accordance with order contained in Circular No. 5, Bureau R., F., & A.L.] W. H.

1. Name of your Sub-District? Parish Lafourche
2. Whole number of Refugee or Freedmen's Schools in the District? 4 Day? 4 Night? 0 Sabbath?
3. Location of Schools? Thibodeaux Johnsons Plan & Vicks Plan
4. Whole number of Teachers? 5 White? 0 Colored? 5
5. Names and post-office address of Day-School Teachers? Martha J. Randolph William Dunn  
Susan M. Master, John Huston, Edward Mitchell  
Thibodeaux La.
6. Whole number of School-houses for Freedmen in your District? 6 Their condition, capacity, value, and by whom owned? hired
7. Number of your visits to Schools? 2 Day? 2 Night? 0 Sabbath? 0
8. Number of educational meetings held by you during the month? 0 Where? 0
9. Number and names of places, now destitute, in which Day-Schools might be organized? 2
10. Number of pupils (estimated) who would attend such Schools? 0
11. Amount which would probably be raised by the Freedmen, for school purposes, in each destitute neighborhood? 0 after the  
Rolling Season is over and Freedmen have been paid their wages they  
will all be willing to contribute liberally
12. What efforts are you making to secure the support of schools by pupils, parents, (boards of education, or the State government)? I have  
Conversed with Planters & Freedmen and have tried to impress upon  
their minds the necessity of Educating the Freed Children
13. Whole number of additional School-houses, for Freedmen, now wanted in your Sub-District? 2
14. Could you organize your Sub-District into School Districts, each with a School Committee pledged to carry on schools therein? No
15. To what extent would help from without be needed in such cases? am unable to say
16. What is the public sentiment as to the education of the Freedmen and Poor Whites? Friendly for whites opposed  
to the Education of Blacks as a general rule
17. Are Night-Schools for Adults needed in your District? No In what way could they be carried on? ---
18. What more can this Bureau do for educating the children of Refugees (or Poor Whites)? purchase suitable books  
which are very much needed in this District Parish
19. How long will Northern charitable aid be needed for Freedmen and Refugee Schools of your District? ---

I hereby certify, on honor, that I have given personal attention to the matters herein named, and that the answers given are, according to my best knowledge and belief, correct.

Hollenback  
Sub-Asst. Com., Bureau R., F., & A.L.  
Parish Lafourche

NATIONAL ARCHIVES AND RECORDS ADMINISTRATION  
MICROFILM PUBLICATIONS

Roll 103

Target 4

*Monthly Reports of Persons and Articles Hired*  
Nov. 1867–Oct. 1868



No. 2

Francis Scribner  
A. S. A. C. Quartermaster.  
At Fort deaux

REPORT

Substance  
of  
Reports  
of Persons  
and Articles  
used

No. 2

*Francis Striber*

*A. S. A. C. Quartermaster.*

*At Fort deaux*

REPORT

OF

PERSONS AND ARTICLES HIRED,

*For November 1867*

*Thibodeaux*



Report of Persons and Articles employed and hired at *Thibodaux, Louisiana*, during the month of *November 1867*, by *Francis Sternberg, A.S.A.*

Running Number.	No. of Each Class.	NAMES of PERSONS and ARTICLES	Designation and Occupation.	Service During			Rate of Hire or Compensation.			Date of Contract Agreement or Entry Into service.	BY WHOM OWNED.	Amount of Rent or Pay in the Month.		REMARKS. Showing by whom the buildings were occupied, and for what purpose and how the vessels and men were employed during the month. Transfers and discharges will be noted under this head.	Time and amount due and remaining unpaid			
				From	To	Days	Dolls	Cents	Days Month or Voyage.			Dolls	Cents		From	To	Dollars.	Cents.
1	1	One Building (Room)	Office	1	30	1 mo	12	00	mo	Louisa Cowles	12	00	Occupied by Francis Sternberg Asst. Sub. Asst. Comm. Bureau Parish of Lafourche, at Thibodaux, La.					
2	1	One Stable	Stable	1	30	1 "	8	00	"	Louisa Cowles	8	00	Occupied by Francis Sternberg Asst. Sub. Asst. Comm. Bureau for use of One Gov. Horse service Bureau					
3	1	C. P. Bunnings	Blacksmith	Nov	19		1	75	Job		1	75	Shoeing one Gov. Horse in the service of the Asst. Sub. Asst. Comm. Parish of Lafourche					
4	1	Sam Garrison	Cartman	Nov	18			25	"			25	Hauling Public Forage from Lafourche Crossing, to Thibodaux, La.					
5	1	Elisha Tucker	Cartman	Nov	29			1	00			1	00	Hauling 4 loads of School property from Mrs Parks' School to the Office of the Asst. Sub. Asst. Comm. Parish of Lafourche; distance of 1 1/2 miles				
6	2	Elisha Tucker	Cartman	Nov	13			25	"			25	Hauling One Disk and 1 Sack Equipments from Lafourche Crossing, La, to Thibodaux, La the same being Govt property sent to the A.S.A. by 2 mat No 7					

Amount of Rent and hire during the month

2325 Total amount due and remaining unpaid

I CERTIFY, on honor, that the above is a true copy of all the persons and articles employed and hired by me during the month of *November*, 1867 and that the observations under the head of "Remarks," and the statement of amounts due and remaining unpaid, are correct.

EXAMINED: and Approved

*Lieut Col. 1st U. S. Infy*  
*Asst. Comm. 4th La* COMMANDING.

*Francis Sternberg*  
*Asst Sub Asst Comm* QUARTERMASTER.  
*Parish of Lafourche La*

No. 2

---

Quartermaster.

At

REPORT

OF

PERSONS AND ARTICLES HIRED,

For *December* 1867



Report of Persons and Articles employed and hired at *Thibodaux, Louisiana*, during the month of *December* ~~November~~ *1867*, by *Francis Sternberg, Asst. Q. M.*  
*Parish of Lafourche, State of Louisiana*

Running Number.	No. of Each Class.	NAMES of PERSONS and ARTICLES	Designation and Occupation.	Service During The Month.			Rate of Hire or Compensation.			Date of Contract Agreement or Entry Into service.	BY WHOM OWNED.	Amount of Rent or Pay in the Month.		REMARKS. Showing by whom the buildings were occupied, and for what purpose and how the vessels and men were employed during the month. Transfers and discharges will be noted under this head.	Time and amount due and remaining unpaid			
				From	To	Days	Dolls	Cents	Days Month or Voyage.			Dolls	Cents		From	To	Dollars.	Cents.
1	1	One Building (1 Rm)	Office	1	31	31	12	00	months		Louisa Cole	12	00	Occupied by Francis Sternberg Asst. Sub. Asst. Com. 1st Regt. I. L. Parish of Lafourche, at Thibodaux, La.				
2	1	One Stable	Stable	1	31	31	8	00	months		Louisa Cole	8	00	Occupied by Francis Sternberg Asst. Sub. Asst. Com. 1st Regt. I. L. for use of one Govt. Horse, service of Bureau				
3	1	Antun Blanchard	Cartman	Decr	22		2	00	Job			2	00	Hauling Public Forage from Lafourche crossing to Thibodaux, La.				
Amount of Rent and hire during the month												22	00	Total amount due and remaining unpaid				

I CERTIFY, on honor, that the above is a true copy of all the persons and articles employed and hired by me during the month of *December*, 1867, and that the observations under the head of "Remarks," and the statement of amounts due and remaining unpaid, are correct.

EXAMINED: *and approved*

*Lieut. Col. 1st U. S. Infy*  
*Asst. Com. for La.*

COMMANDING.

*Francis Sternberg*  
*Asst. Sub. Asst. Com. 1st Regt. I. L.*  
*Parish of Lafourche, La.*  
QUARTERMASTER.

No. 2.

Francis Sterberg  
Capt. Sub. Asst. Comdr. <sup>1st Regt. U.S. Cavalry</sup> Quartermaster.

At Tibodaux La

REPORT

OF

PERSONS AND ARTICLES HIRED,

For February, 1868



Report of Persons and Articles employed and hired at *Thibodaux La*, during the month of *February 1868*, by *Francis Sternberg* *1st Sub. Capt. U.S.A.*

Examining Number	No. of Each Class	NAME of PERSONS and ARTICLES	DESIGNATION AND OCCUPATION	SERVICE DURING THE MONTH			RATE OF HIRE OR COMPENSATION			DATE OF CONTRACT AGREEMENT OR ENTRY INTO SERVICE	BY WHOM OWNED	Amount of Rent or Pay in the Month		REMARKS. Showing by whom the buildings were occupied, and for what purpose and how the vessels and men were employed during the month. Transfers and discharges will be noted under this head.	Time and amount due and remaining unpaid			
				From	To	Days	Dolls	Cents	Days, Month or Voyage			Dolls	Cents		From	To	Dollars	Cents
				1	1	One Building (1 Room)	Office	1	29			29	15		00	month	Louisa Cole	15
2	1	One Stable	Stable	1	29	29	10	00	month	Louisa Cole	10	00	Occupied by Francis Sternberg, 1st Sub. Capt. U.S.A., for use of one Govt Horse, service of Bureau.					
3	1	One Building (1 Room)	Store room	1	29	29	10	00	month	Louisa Cole	10	00	Occupied by Francis Sternberg, 1st Sub. Capt. U.S.A., for use as Store Room for clothing and stores for					
4	1	Edmond Sam		1	3	3	5	00	job		5	00	For watching and carrying for one insane woman turned over to me for forwarding same to Asylum, for which civil auth. could not provide					
5	1	Jacob Latta		1	1	1	2	00	"		2	00	For bringing one Govt Horse from Lafourche crossing to Thibodaux La. The horse having been sent to me for my use					
6	1	Oseme Malbrouck	Cartman	1	1	1	-	75	"		-	75	For having Public Subistence Stores from the Steamboat to my storehouse					
Amount of Rent and hire during the month .. ..											42	75	Total amount due and remaining unpaid .. ..					

I Certify, on honor, that the above is a true copy of all the persons and articles employed and hired by me during the month of *February*, 1868 and that the observations under the head of "Remarks," and the statement of amounts due and remaining unpaid, are correct.

EXAMINED:  
*Col Major General U.S.A.*  
*1st Sub. Capt. U.S.A.* Commanding.

*Francis Sternberg*  
 1st Sub. Capt. U.S.A. Quartermaster  
 Parish of Lafourche

No. 2.

*Sternberg A. S. A. C.*  
*Bu "B. G. A. A." Quartermaster.*  
*At Tibodaux Louisiana*

REPORT

OF

PERSONS AND ARTICLES HIRED.

For *the month of March* 1868



REPORT of Persons and Articles employed and hired at *Thibodaux Louisiana* during the Month of *March 1868*, by *Francis Sternberg A.S.C.* *Parish of Lafourche*

Running Number.	No. of Each Class.	NAMES of PERSONS and ARTICLES	Designation and Occupation	Services During The Month			Rate of Hire or Compensation			Date of Contract Agreement or Entry Into Service	BY WHOM OWNED	Amount of Rent or Pay in the Month		REMARKS. Showing by whom the buildings were occupied, and for what purpose, and how the vessels and men were employed during the month. Transfers and discharges will be noted under this head.	Time and amount due and remaining unpaid			
				From	To	Days	Dollars	Cents	Days Month or Voyage			Dollars	Cents		From	To	Dollars	Cents
1	1	One building (Office)	Office	1	31	1 mo	15	00	mo	March 1 <sup>st</sup>	Horony	15	00	Occupied by Francis Sternberg U.S.A.C. Bu. R. & A.L. Parish of Lafourche at Thibodaux La.				
2	1	One Room (Store room)	Store room	1	31	1 mo	5	00	mo	March 1 <sup>st</sup>	Horony	5	00	Occupied by Francis Sternberg A.S.C. Bu. R. & A.L. for storage of public subsistence stores.				
3	1	One Stable	Stable	1	31	1 mo	10	00	mo	March 1 <sup>st</sup>	Maddison Myers	10	00	Occupied by Francis Sternberg A.S.C. Bu. R. & A.L. for use of one of our Gun boat Service Boats.				
4	1	Osene Malbrook	Cartman	1	March	job	2	50	job	job	job	2	50	Handling Office furniture and public sub. stores to the new office as there rented by A.S.C.				
5	2	Osene Malbrook	Cartman	8	March	job	6	00	job	job	job	6	00	Handling sub. stores from the boat to the store room, loading unloading and rolling and storing barrels.				
6	3	Osene Malbrook	Cartman	17	March	job	7	50	job	job	job	7	50	Handling sub. stores from the boat to the store room, loading unloading and rolling and storing barrels.				
7	4	Osene Malbrook	Cartman	23	March	job	"	25	job	job	job	"	25	Handling public storage from the boat to stable at Thibodaux La.				
8	1	C.P. Birmingham	Blacksmith	1	March	job	1	50	job	job	job	1	50	Shoing one public horse in the service of the A.S.C. Parish of Lafourche.				

Amount of Rent and hire during the month

47 75

Total amount due and remaining unpaid

I CERTIFY, on honor, that the above is a true copy of all the persons and articles employed and hired by me during the month of *March*, 1868 and that the observations under the head of "Remarks," and the statement of amounts due and remaining unpaid, are correct.

Examined and Approved:

*But Maj. Genl U.S.A. A.S.C.*  
*A.S.C. for La.* Commanding.

*Francis Sternberg*  
*A.S.C. Bu. R. & A.L.* Quartermaster.



No. 2.

Francis Stenberg A. S. A. C.

Det<sup>d</sup> R. Inf. A. C. Quartermaster.

At Tibodaux Louisiana

## REPORT

OF

PERSONS AND ARTICLES HIRED.

For the Month of March 1862



REPORT of Persons and Articles employed and hired at *Thibodaux, Louisiana*, during the Month of *March 1868*, by *Francis Stenberg* of *Lafourche Parish*

Running Number.	No. of Each Class.	NAMES of PERSONS and ARTICLES	Designation and Occupation	Services During The Month			Rate of Hire or Compensation			Date of Contract Agreement or Entry Into Service	BY WHOM OWNED	Amount of Rent or Pay in the Month		REMARKS. Showing by whom the buildings were occupied, and for what purpose, and how the vessels and men were employed during the month. Transfers and discharges will be noted under this head	Time and amount due and remaining unpaid			
				From	To	Days	Dollars	Cents	Days Month or Voyage			Dollars	Cents		From	To	Dollars	Cents
1	1	One Building (1 Room)	Office	1	31	1 mo	15	00	mo	March 1 <sup>st</sup>	Thibodaux	15	00	Occupied by Francis Stenberg Aft. Sub. Aft. Cour "Bt" R.F. & A.L. Parish of Lafourche at Thibodaux La.				
2	1	One Room (Store Room)	Store room	1	31	1 mo	5	00	mo	March 1 <sup>st</sup>	Thibodaux	5	00	Occupied by Francis Stenberg Aft. Sub. Aft. Cour "Bt" R.F. & A.L. For storage of Public Subsistence Stores.				
3	1	One Stable	Stable	1	31	1 mo	10	00	mo	March 1 <sup>st</sup>	Madeline Myers	10	00	Occupied by Francis Stenberg Aft. Sub. Aft. Cour "Bt" R.F. & A.L. for use of one Gov. Horse Service Bureau.				
4	1	Orenie Malbrook	Cartman	1	month	job	2	50	job	Job		2	50	Handling office furniture and public subsist <sup>n</sup> stores to the new office & store created by A. S. A. C.				
5	2	Orenie Malbrook	Cartman	8	month	job	6	00	job	Job		6	00	Handling subsist <sup>n</sup> stores from the boat to the Store room, loading unloading and rolling & storing barrels.				
6	3	Orenie Malbrook	Cartman	17	month	job	7	50	job	Job		7	50	Handling subsist <sup>n</sup> stores from the boat to the Store room, loading unloading and rolling & storing barrels.				
7	4	Orenie Malbrook	Cartman	23	month	job	"	25	job	Job		"	25	Handling public Forage from the boat to the Stable at Thibodaux La.				
8	1	C. P. Binnings & Co	Blacksmiths	1	28	month	1	50	job	Job		1	50	Shoing one public horse in the service of the Aft. Sub. Aft. Cour <sup>t</sup> Parish of Lafourche.				

Amount of Rent and hire during the month

47 75

Total amount due and remaining unpaid

I CERTIFY, on honor, that the above is a true copy of all the persons and articles employed and hired by me during the month of *March*, 1868 and that the observations under the head of "Remarks," and the statement of amounts due and remaining unpaid, are correct.

Examined: and approved:

*Robt Maj Genl. U.S.A. Commanding.*  
*Aft. Cour for La*

*Francis Stenberg*  
*Aft. Sub. Aft. Cour*  
*Bt R.F. & A.L. Quartermaster.*



No. 2.

Francis Sternberg  
A. S. A. C. <sup>Quartermaster.</sup> Bu" Co. 1st Regt. Ill. I. C.  
At Tibodaux, La.

## REPORT

OF

PERSONS AND ARTICLES HIRED.

For

March

1868



REPORT of Persons and Articles employed and hired at *Thibodaux, Louisiana*, during the Month of *March 1868*, by *Francis Sternberg, A. S. A.*  
*Parish of Lafourche*

Running Number.	No. of Each Class.	NAMES of PERSONS and ARTICLES	Designation and Occupation	Services During The Month			Rate of Hire or Compensation			Date of Contract Agreement or Entry Into Service	BY WHOM OWNED	Amount of Rent or Pay in the Month		REMARKS. Showing by whom the buildings were occupied, and for what purpose, and how the vessels and men were employed during the month. Transfers and discharges will be noted under this head	Time and amount due and remaining unpaid			
				From	To	Days	Dollars	Cents	Days Month or Voyage			Dollars	Cents		From	To	Dollars	Cents
1	1	One Building (4 Rooms)	Office	1	31	1 mo	15	00	mo	March 1 <sup>st</sup>	Horong	15	00	Occupied by Francis Sternberg Asst. Sub Asst. Comd. In. R. S. & A. L. Parish of Lafourche, at Thibodaux				
2	1	One Room (Storeroom)	Storeroom	1	31	1 mo	5	00	mo	March 1 <sup>st</sup>	Horong	5	00	Occupied by Francis Sternberg Asst. Sub Asst. Comd. In. R. S. & A. L. for storage of Public Subsistence stores				
3	1	One Stable	Stable	1	31	1 mo	10	00	mo	March 1 <sup>st</sup>	Madeline Myers	10	00	Occupied by Francis Sternberg Asst. Sub Asst. Comd. In. R. S. & A. L. for use of one Cont. Horse Service Bureau				
4	1	Oseme' Malbrook	Cartman	1	March	job	2	50	job	Job		2	50	Hauling Office Furniture and Public Subsistence stores, to the new Office & storeroom rented by A. S. A. C.				
5	2	Oseme' Malbrook	Cartman	8	March	job	6	00	job	Job		6	00	Hauling Subsistence stores from the Boat to the Storeroom, loading un- loading and rolling, storing barrels				
6	3	Oseme' Malbrook	Cartman	17	March	job	7	50	job	Job		7	50	Hauling Subsistence stores from the Boat to the Storeroom, loading un- loading and rolling, storing barrels				
7	4	Oseme' Malbrook	Cartman	23	March	job	-	25	job	Job		-	25	Hauling public storage from the Boat to the Stable at Thibodaux				
8	1	C. P. Birrings, C.	Blacksmith	1	23	March	1	50	job	Job		1	50	Shoeing one public horse in the service of the Asst. Sub Asst. Comd. Parish of Lafourche.				

Amount of Rent and hire during the month

47 75 Total amount due and remaining unpaid

I CERTIFY, on honor, that the above is a true copy of all the persons and articles employed and hired by me during the month of *March*, 1868  
and that the observations under the head of "Remarks," and the statement of amounts due and remaining unpaid, are correct.

Examined: and approved?

Bot. Maj. Gen. U.S.A. Commanding.  
Asst. Comd. for Ia

Francis Sternberg  
Asst. Sub Asst. Comd. In. R. S. & A. L. Parish of Lafourche  
termaster.



No. 2.

Francis Stenberg A. S. A. C.

Bat. R. F. A. L. Quartermaster.

At Philodaux La.

REPORT

OF

PERSONS AND ARTICLES HIRED.

For the Month of March 1868



REPORT of Persons and Articles employed and hired at Tibodaux La, during the Month of March, by Francis Stenberg A.S.M.C.

- Lafourche

Running Number.	No. of Each Class.	NAMES of PERSONS and ARTICLES	Designation and Occupation	Services During The Month			Rate of Hire or Compensation			Date of Contract Agreement or Entry Into Service	BY WHOM OWNED	Amount of Rent or Pay in the Month		REMARKS. Showing by whom the buildings were occupied, and for what purpose, and how the vessels and men were employed during the month. Transfers and discharges will be noted under this head	Time and amount due and remaining unpaid			
				From	To	Days	Dollars	Cents	Days-Month or Voyage			Dollars	Cents		From	To	Dollars	Cents
1	1	One building (one room) office	Office	1	31	1 mo	15	00	M <sup>o</sup>	March 1 <sup>st</sup>	Francis Stenberg	15	00	Occupied by Francis Stenberg A.S.M.C. Bu "A.S.M.C." Parish of Lafourche at Tibodaux La.				
2	1	One room (store room) store room	Store room	1	31	1 mo	5	00	M <sup>o</sup>	March 1 <sup>st</sup>	Francis Stenberg	5	00	Occupied by Francis Stenberg A.S.M.C. Bu "A.S.M.C." for storage of public stores.				
3	1	One Stable	Stable	1	31	1 mo	10	00	M <sup>o</sup>	March 1 <sup>st</sup>	Madeline Myer	10	00	Occupied by Francis Stenberg A.S.M.C. Bu "A.S.M.C." for use of one Govt horse service Bureau.				
4	1	<del>Some Mallards</del>	<del>Cartman</del>	<del>1</del>	<del>31</del>	<del>1 mo</del>	<del>2</del>	<del>50</del>	<del>job</del>	<del>job</del>	<del>job</del>	<del>2</del>	<del>50</del>	<del>Hauling office furniture &amp; public stores from the boat to the new office &amp; store rented by A.S.M.C.</del>				
5	2	<del>Some Mallards</del>	<del>Cartman</del>	<del>8</del>	<del>31</del>	<del>1 mo</del>	<del>4</del>	<del>00</del>	<del>job</del>	<del>job</del>	<del>job</del>	<del>6</del>	<del>00</del>	<del>Hauling sub stores from the boat to the store room, loading, unloading &amp; rolling &amp; storing barrels.</del>				
6	3	<del>Some Mallards</del>	<del>Cartman</del>	<del>17</del>	<del>31</del>	<del>1 mo</del>	<del>7</del>	<del>50</del>	<del>job</del>	<del>job</del>	<del>job</del>	<del>7</del>	<del>50</del>	<del>Hauling sub stores from the boat to the store room, loading, unloading and rolling &amp; storing barrels.</del>				
7	4	<del>Some Mallards</del>	<del>Cartman</del>	<del>23</del>	<del>31</del>	<del>1 mo</del>	<del>6</del>	<del>25</del>	<del>job</del>	<del>job</del>	<del>job</del>	<del>6</del>	<del>25</del>	<del>Hauling public forage from the boat to the stable at Tibodaux La.</del>				
8	1	<del>C.P. Brimings &amp; Co</del>	<del>Black smith</del>	<del>18</del>	<del>31</del>	<del>1 mo</del>	<del>1</del>	<del>50</del>	<del>job</del>	<del>job</del>	<del>job</del>	<del>1</del>	<del>50</del>	<del>Shoing one public horse in the service of the U.S. A.S.M.C. Bu of Lafourche.</del>				

Nalbrocks

Report of your office - store room + stable - on No 2. Make vouchers for amount dating the 4 charges in one voucher.

Amount of Rent and hire during the month

47-75 Total amount due and remaining unpaid

I CERTIFY, on honor, that the above is a true copy of all the persons and articles employed and hired by me during the month of March, 1868 and that the observations under the head of "Remarks," and the statement of amounts due and remaining unpaid, are correct.

Examined: and approved.

Francis Stenberg Commanding.

Francis Stenberg Quartermaster.



No. 2.

Lieut Nelson Bondow  
Asst Com Bureau of R.F. & A.S.  
~~Quartermaster~~

At Thebodecamp La

REPORT

OF

PERSONS AND ARTICLES HIRED.

For The Month of May 1868

Retained

11



REPORT of Persons and Articles employed and hired at Philodeaux La, during the Month of May 1868, by Lieut Nelson Bronson A.S.A Com  
Parish of Lafourche La

Running Number.	No. of Each Class.	NAMES of PERSONS and ARTICLES	Designation and Occupation	Services During The Month			Rate of Hire or Compensation			Date of Contract Agreement or Entry Into Service	BY WHOM OWNED	Amount of Rent or Pay in the Month		REMARKS. Showing by whom the buildings were occupied, and for what purpose, and how the vessels and men were employed during the month. Transfers and discharges will be noted under this head	Time and amount due and remaining unpaid			
				From	To	Days	Dollars	Cents	Days Month or Voyage			Dollars	Cents		From	To	Dollars	Cents
1	1	One Building (one Room)	Office	1 <sup>st</sup>	31 <sup>st</sup>	31	15	00	month	May 1 <sup>st</sup> 1868	Jacob Meyer	15	00	Occupied as office of A.S.A Com for Parish of Lafourche by Lieut Nelson Bronson 42 <sup>d</sup> Infan <sup>y</sup>				
2	1	One Room	Store Room	1	31	31	5	00	month	May 1 <sup>st</sup> 1868	Jacob Meyer	5	00	Occupied by Lt Nelson Bronson A.S.A Com Bureau of R.F. & A.L. for Storage of Clothing and Substit - one Store				
3	1	One Stable	Stable	1	31	31	10	00	month	May 1 <sup>st</sup> 1868	Edmond Bazil	10	00	Occupied for use of one Govt Horse in the Service of Nelson Bronson Lt 42 <sup>d</sup> Infan <sup>y</sup> A.S.A Com Bureau of R.F. & A.L.				

Amount of Rent and hire during the month Thirty (\$30.00) Dollars \$ 30.00 Total amount due and remaining unpaid

I CERTIFY, on honor, that the above is a true copy of all the persons and articles employed and hired by me during the month of May, 1868 and that the observations under the head of "Remarks," and the statement of amounts due and remaining unpaid, are correct.

Examined : \_\_\_\_\_  
Commanding.

Nelson Bronson  
2<sup>d</sup> Lieut 42<sup>d</sup> Inf A.S.A. Com. ~~Quarter Master~~

No. 2.

---

Lieut. Nelson Bronson 42<sup>d</sup>  
A. I. a. & Parish of Lafourche <sup>Infty</sup>

---

At Thibodaux, La

## REPORT

—OF—

PERSONS AND ARTICLES HIRED.

---

For June 1868

---

Retained Copy

---

.



REPORT of Persons and Articles employed and hired at Thibodaux, Louisiana, during the Month of June 1868, by Lieut. Nelson Bronson, 42<sup>d</sup> Infy. A. S. A. C. Parish of Lafourche

Running Number.	No. of Each Class.	NAMES OF PERSONS AND ARTICLES.	Designation and Occupation.	Services During The Month.			Rate of Hire or Compensation.			Date of Contract, Agreement or Entry Into Service.	By Whom Owned Or Employed.	Amount of Rent or Pay in the Month.		REMARKS. Showing by whom the buildings were occupied, and for what purpose, and how the vessels and men were employed during the month. Transfers and discharges will be noted under this head.	Time and amount due and remaining unpaid.			
				From 1868	To 1868	Days	Dollars	Cts.	Days, Month or Voyage.			Dollars	Cts.		From 1868	To 1868	Dollars	Cents
1	1	One Building (one room)	Office	June 1 <sup>st</sup>	June 30 <sup>th</sup>	1 mo	15	00	month	May 1 <sup>st</sup> 1868	Jacob Meyer	15	00	Occupied by Lieut. Nelson Bronson, A. S. A. C. Parish of Lafourche, at Thibodaux, as Office	June 1 <sup>st</sup>	June 30 <sup>th</sup>	15	00
2	1	One Room	Store Room	1	30	1 mo	5	00	month	May 1 <sup>st</sup> 1868	Jacob Meyer	5	00	Occupied by Lieut. Nelson Bronson, A. S. A. C. Parish of Lafourche, at Thibodaux, as Storeroom for Public Sub. Stores & Clothing	1 <sup>st</sup>	30 <sup>th</sup>	5	00
3	1	One Stall	Stable	1	30	1 mo	10	00	month	May 1 <sup>st</sup> 1868	Edmond Bazil	10	00	Occupied by Lieut. Nelson Bronson, A. S. A. C. Parish of Lafourche, at Thibodaux, for stabling of one foot. Horse, service Bureau	1 <sup>st</sup>	30 <sup>th</sup>	10	00
Amount of Rent and Hire during the Month											30	00	Total amount due and remaining unpaid	30	00			

I Certify, on honor, that the above is a true copy of all the persons and articles employed and hired by me during the month of June, 1868 and that the observations under the head of "Remarks," and the statement of amounts due and remaining unpaid, are correct.

Examined and Approved:

Commanding.

Nelson Bronson  
Lieut. 42<sup>d</sup> Infantry  
A. S. A. C. Parish of Lafourche



No. 2.

Lieut Nelson Broudon 42<sup>d</sup> Infantry  
A.S.A.C. Parish of Lafourche

At Thibodaux La

REPORT

—OF—

PERSONS AND ARTICLES HIRED.

For

July

1868

Returned



REPORT of Persons and Articles employed and hired at Thibodaux Louisiana during the Month of July 1868 by Lieut Nelson Bronson 42<sup>d</sup> Infantry ASAC Parish of Lafourche

Running Number.	No. of Each Class.	NAMES OF PERSONS AND ARTICLES.	Designation and Occupation.	Services During The Month.			Rate of Hire or Compensation.			Date of Contract, Agreement or Entry Into Service.	By Whom Owned Or Employed.	Amount of Rent or Pay in the Month.		REMARKS. Showing by whom the buildings were occupied, and for what purpose, and how the vessels and men were employed during the month. Transfers and discharges will be noted under this head.	Time and amount due and remaining unpaid.			
				From	To	Days	Dollars	Cts.	Days, Month or Voyage.			Dollars	Cts.		From	To	Dollars	Cents
1	1	One Building (One Room)	Office	July 1	July 31	1	15	00	month	July 1 <sup>st</sup> 1868	William H Ragan	15	00	Occupied by Lieut Nelson Bronson 42 <sup>d</sup> Infantry ASAC Parish of Lafourche at Thibodaux La. as Office	July 1 <sup>st</sup>	July 31 <sup>st</sup>	15	00
2	1	One Room	Store Room	" 1	" 31	1	5	00	month	July 1 <sup>st</sup> 1868	William H Ragan	5	00	Occupied by Lieut Nelson Bronson 42 <sup>d</sup> Infantry ASAC Parish of Lafourche at Thibodaux La as Store Room for Public Clothing and School Property and Substitutes Stores.	July 1	July 31	5	00
3	1	One Stable	Stable	" 1	" 31	1	10	00	month	July 1 <sup>st</sup> 1868	Virginia Faber	10	00	Occupied by Lieut Nelson Bronson 42 <sup>d</sup> Infantry ASAC Parish of Lafourche at Thibodaux La for Stabling on Government Horses in the service of the Bureau	July 1	July 31	10	00

Amount of Rent and Hire during the Month (~~\$30.00~~) Thirty Dollars - \$30.00 Total amount due and remaining unpaid \$30.00

I Certify, on honor, that the above is a true copy of all the persons and articles employed and hired by me during the month of July, 1868 and that the observations under the head of "Remarks," and the statement of amounts due and remaining unpaid, are correct.

Examined and Approved:

Commanding.

Nelson Bronson  
2<sup>d</sup> Lieut 42<sup>d</sup> Infantry ASAC Bureau of P<sup>r</sup> & A<sup>d</sup> Parish of Lafourche La.



No. 2.

*Lt. Nelson Bronson 4th Regt*  
*A. S. A. C. Quartermaster*

*At Tibodausa La*

REPORT

OF

PERSONS AND ARTICLES HIRED,

For August, 1868

*Retained Copy*



Report of Persons and Articles employed and hired at Thibodaux Louisiana during the month of August 1868, by Lieut Nelson Broadow 42<sup>d</sup> Infantry  
A.S.A.C. Parish of Lafourche La

Iteming Number	No. of Each Class	NAME of PERSONS and ARTICLES	DESIGNATION AND OCCUPATION	SERVICE DURING THE MONTH			RATE OF HIRE OR COMPENSATION			DATE OF CONTRACT AGREEMENT OR ENTRY INTO SERVICE	BY WHOM OWNED	Amount of Rent or Pay in the Month		REMARKS. Showing by whom the buildings were occupied, and for what purpose and how the vessels and men were employed during the month. Transfers and discharges will be noted under this head.	Time and amount due and remaining unpaid			
				From	To	Days	Dolls	Cents	Days, Month or Voyage			Dolls	Cents		From	To	Dollars	Cents
1	1	One Building (one Room)	Office	Aug 1	Aug 31	1 mo	15	00	month	July 1 <sup>st</sup> 1868	William H Rogan	15	00	Occupied by Lieut Nelson Broadow 42 <sup>d</sup> Infantry A.S.A.C. Parish of Lafourche at Thibodaux La as Office.	Aug 1 <sup>st</sup>	Aug 31 <sup>st</sup>	15	00
2	1	One Rooms	Store Room	" 1	" 31	1 mo	5	00	month	July 1 <sup>st</sup> 1868	William H Rogan	5	00	Occupied by Lieut Nelson Broadow 42 <sup>d</sup> Infantry A.S.A.C. Parish of Lafourche at Thibodaux La as Store Room for Public Clothing and School Property	August 1 <sup>st</sup>	August 31 <sup>st</sup>	5	00
3	1	One Stable	Stable	" 1	" 31	1 mo	10	00	month	August 1 <sup>st</sup> 1868	C.P. Binings & Co	10	00	Occupied by Lieut Nelson Broadow 42 <sup>d</sup> Infantry A.S.A.C. Parish of Lafourche at Thibodaux La for Stabling one government horse in the service of the Bureau	August 1 <sup>st</sup>	August 31 <sup>st</sup>	10	00

Amount of Rent and hire during the month .. .. \$30.00 Total amount due and remaining unpaid .. .. \$30.00

I certify, on honor, that the above is a true copy of all the persons and articles employed and hired by me during the month of August, 1868 and that the observations under the head of "Remarks," and the statement of amounts due and remaining unpaid, are correct.

EXAMINED: \_\_\_\_\_  
 Commanding.

Nelson Broadow 3<sup>d</sup> Lieut 42<sup>d</sup> Infantry A.S.A.C.  
 Bureau of R.F. and L. Parish of Lafourche

No. 2.

---

*J. H. Van Antwerp*  
*a.s.a.c.*

*At Tibodious*

REPORT

—OF—

PERSONS AND ARTICLES HIRED.

*For September* 1868

---

*Returned copy*



REPORT of Persons and Articles employed and hired at *Thibodeaux La*, during the Month of *September 1868*, by *J. H. Van Antwerp*  
*U.S.A.C. Parish of Lafourche La*

Running Number	No. of Each Class	NAMES OF PERSONS AND ARTICLES.	Designation and Occupation.	Services During The Month.			Rate of Hire or Compensation.			Date of Contract, Agreement or Entry Into Service.	By Whom Owned Or Employed.	Amount of Rent or Pay in the Month.		REMARKS. Showing by whom the buildings were occupied, and for what purpose, and how the vessels and men were employed during the month. Transfers and discharges will be noted under this head.	Time and amount due and remaining unpaid.			
				From	To	Days	Dollars	Cts.	Days. Month or Voyage.			Dollars	Cts.		From	To	Dollars	Cents
1	1	<i>One building (one room)</i>	<i>Office</i>	<i>1<sup>st</sup></i>	<i>30<sup>th</sup></i>	<i>31</i>	<i>15</i>	<i>00</i>	<i>17<sup>th</sup></i>	<i>July 1<sup>st</sup> 1868</i>	<i>William H. Rogan</i>	<i>15</i>	<i>00</i>	<i>Occupied by J. H. Van Antwerp U.S.A.C. Parish of Lafourche at Thibodeaux La as Office</i>				
2	1	<i>One Room</i>	<i>Store Room</i>	<i>1<sup>st</sup></i>	<i>30<sup>th</sup></i>	<i>30</i>	<i>5</i>	<i>00</i>	<i>17<sup>th</sup></i>	<i>July 1<sup>st</sup> 1868</i>	<i>William H. Rogan</i>	<i>5</i>	<i>00</i>	<i>Occupied by J. H. Van Antwerp U.S.A.C. Parish of Lafourche at Thibodeaux La as store room for Public Clothing &amp; other property.</i>				
3	1	<i>Stable</i>	<i>Stable</i>	<i>1<sup>st</sup></i>	<i>30<sup>th</sup></i>	<i>30</i>	<i>10</i>	<i>00</i>	<i>17<sup>th</sup></i>	<i>Aug 1<sup>st</sup> 1868</i>	<i>C. P. Broussard</i>	<i>10</i>	<i>00</i>	<i>Occupied by J. H. Van Antwerp U.S.A.C. Parish of Lafourche at Thibodeaux La for stabling the Government Horses in the service of the Bureau.</i>				

Amount of Rent and Hire during the Month

*30 00*

Total amount due and remaining unpaid

I Certify, on honor, that the above is a true copy of all the persons and articles employed and hired by me during the month of *September*, 1868 and that the observations under the head of "Remarks," and the statement of amounts due and remaining unpaid, are correct.

Examined and Approved:

Commanding.

*J. H. Van Antwerp U.S.A.C.*  
*Parish of Lafourche La*



No. 2.

---

*J. H. Van Antwerp.*  
*at Tribodeaux & La*

R E P O R T

— OF —

Persons and Articles Hired

*For October. 1868.*

---

---

John W. Madden, stationer and printer, 73 Camp st.



Report of Persons and Articles employed and hired at Thibodeaux La, during the Month of October, by J. H. Van Antwerp  
A.S.C. Parish of Lafourche.

RUNNING NUMBER.	No. OF EACH CLASS	NAMES OF PERSONS AND ARTICLES.	DESIGNATION AND OCCUPATION.	SERVICES DURING THE MONTH.			RATE OF HIRE OR COMPENSATION.			DATE OF CONTRACT, AGREEMENT OR ENTRY INTO SERVICE.	BY WHOM OWNED OR EMPLOYED.	AMOUNT OF RENT OR PAY IN THE MONTH.		REMARKS. SHOWING BY WHOM THE BUILDINGS WERE OCCUPIED, AND FOR WHAT PURPOSE, AND HOW THE VESSELS AND MEN WERE EMPLOYED DURING THE MONTH. TRANSFERS AND DISCHARGES WILL BE NOTED UNDER THIS HEAD.	TIME AND AMOUNT DUE AND REMAINING.		
				FROM.	TO.	DAYS.	DOLLARS.	CTS.	DAYS, MONTH OR VOYAGE.			DOLLARS.	CTS.		FROM.	TO.	DOLLARS.
1	1	One Building (1 Room)	Office	1 <sup>st</sup>	25 <sup>th</sup>	25	15	00	per mo	Octo 1 <sup>st</sup> 1868	Antoine Joseph	12	50	Occupied by J. H. Van Antwerp A.S.C. Parish of Lafourche at Thibodeaux La. as Office.			
2	1	One Room	Store Room	1 <sup>st</sup>	25 <sup>th</sup>	25	5	00	per mo	Octo 1 <sup>st</sup> 1868.	Antoine Joseph	4	17	Occupied by J. H. Van Antwerp A.S.C. Parish of Lafourche at Thibodeaux La. as Store Room for Public Clothing and School Property.			
3	1	Stable	Stable	7 <sup>th</sup>	25 <sup>th</sup>	25	10	00	per mo	Aug 1 <sup>st</sup> 1868.	C. P. Binnings & Co.	8	33	Occupied by J. H. Van Antwerp A.S.C. Parish of Lafourche at Thibodeaux La for Stabling One Government Horse in the Service of the Bureau.			

Amount of Rent and Hire during the Month — Twenty five dollars — \$ 25 00 Total amount due and remaining unpaid

I CERTIFY, on honor, that the above is a true copy of all the persons and articles employed and hired by me during the month of October, 1868, and that the observations under the head of "Remarks," and the statement of amounts due and remaining unpaid, are correct.

Examined and Approved by command of

By't MAJ. GEN. ROBT C BUCHANAN, U. S. A.,  
Assistant Commissioner Louisiana.

By't Lieut. Col. U. S. A., Capt. 39th Infty. A. A. A. G.

J. H. Van Antwerp  
at. Sub. Ass't Com'r B. R., F. and A. L.  
Parish of Lafourche La

No. 2.

---

William S. Mc Kenzie A.S.A.C.

At *Providence,*

REPORT

— OF —

Persons and Articles Hired

For the month of *October* 1868.

---

John W. Madden, stationer and printer, 73 Camp st.



**Report** of Persons and Articles employed and hired at *Thibodeaux La.*, during the Month of *October*, by *Wm S. McKenzie a SAC*  
*Parish Lafourche*

RENTING NUMBER.	No. of Each Class	NAMES OF PERSONS AND ARTICLES.	DESIGNATION AND OCCUPATION.	SERVICES DURING THE MONTH.			RATE OF HIRE OR COMPENSATION.			DATE OF CONTRACT, AGREEMENT OR ENTRY INTO SERVICE.	BY WHOM OWNED OR EMPLOYED.	AMOUNT OF RENT OR PAY IN THE MONTH.		REMARKS. SHOWING BY WHOM THE BUILDINGS WERE OCCUPIED, AND FOR WHAT PURPOSE, AND HOW THE VESSELS AND MEN WERE EMPLOYED DURING THE MONTH. TRANSFERS AND DISCHARGES WILL BE NOTED UNDER THIS HEAD.	TIME AND AMOUNT DUE AND REMAINING UNPAID.			
				FROM	TO	DAYS	DOLLARS	CTS.	DAYS, MONTH OR VOYAGE.			DOLLARS	CTS.		FROM	TO	DOLLARS	CTS.
1	1	One building One Room	Office	26	30	5	15		p.m.	Oct 1. 1868	Antoine Joseph	2	50	Occupied by Wm S. McKenzie a SAC Parish of Lafourche at Thibodeaux La. as Office.				
2	1	One Room	Storeroom	26	30	5	5		p.m.	Oct 1. 1868	Antoine Joseph	3	3	Occupied by Wm S. McKenzie a SAC Parish of Lafourche at Thibodeaux La. as storeroom for public clothing and school property				
3	1	Stable	Stable	26	30	5	10		p.m.	Aug. 1. 1868	C. P. Pennington	1	66	Occupied by Wm S. McKenzie a SAC Parish of Lafourche at Thibodeaux La. for stabling one Government horse in service of bureau.				

Amount of Rent and Hire during the Month

\$ 4 99

Total amount due and remaining unpaid

I CERTIFY, on honor, that the above is a true copy of all the persons and articles employed and hired by me during the month of *October*, 1868, and that the observations under the head of "Remarks," and the statement of amounts due and remaining unpaid, are correct.

Examined and Approved by command of

BY T. MAJ. GEN. ROBT C. BUCKANAN, U.S.A.,  
Assistant Commissioner Louisiana.

By't Lieut. Col. U. S. A., Capt. 39th Infty. A. A. A. G.

*William S. McKenzie*  
a Sub. Ass't Com'r B. R., F. and A. L.

No. 2.

---

*J. H. Van Antwerp*  
*in Thibodeaux La*

R E P O R T

— OF —

Persons and Articles Hired

*For October, 1868.*

---

John W. Madden, stationer and printer, 73 Camp st.

*Retained*

---



**Report** of Persons and Articles employed and hired at *Thibodeaux La*, during the Month of *October*, by *J. N. Van Antwerp*  
*A. S. A. C. Parish of Lafourche La*

RENTING NUMBER.	No. of Each Class	NAMES OF PERSONS AND ARTICLES.	DESIGNATION AND OCCUPATION.	SERVICES DURING THE MONTH.			RATE OF HIRE OR COMPENSATION.			DATE OF CONTRACT, AGREEMENT OR ENTRY INTO SERVICE.	BY WHOM OWNED OR EMPLOYED.	AMOUNT OF RENT OR PAY IN THE MONTH.		REMARKS. SHOWING BY WHOM THE BUILDINGS WERE OCCUPIED, AND FOR WHAT PURPOSE, AND HOW THE VESSELS AND MEN WERE EMPLOYED DURING THE MONTH. TRANSFERS AND DISCHARGES WILL BE NOTED UNDER THIS HEAD.	TIME AND AMOUNT DUE AND REMAINING UNPAID.			
				FROM.	TO.	DAYS.	DOLLARS.	CTS.	DAYS, MONTH OR VOYAGE.			DOLLARS.	CTS.		FROM	TO	DOLLARS.	CTS.
1	1	<i>One Building (4 Rooms)</i>	<i>Office</i>	<i>1<sup>st</sup></i>	<i>25<sup>th</sup></i>	<i>25</i>	<i>15</i>	<i>00</i>	<i>per mo</i>	<i>Octo 1<sup>st</sup> 1868</i>	<i>Antoine Joseph</i>	<i>12</i>	<i>50</i>	<i>Occupied by J. N. Van Antwerp A. S. A. C. Parish of Lafourche at Thibodeaux La as Office</i>				
2	1	<i>One Room</i>	<i>Store Room</i>	<i>1<sup>st</sup></i>	<i>25<sup>th</sup></i>	<i>25</i>	<i>5</i>	<i>00</i>	<i>per mo</i>	<i>Octo 1<sup>st</sup> 1868</i>	<i>Antoine Joseph</i>	<i>4</i>	<i>17</i>	<i>Occupied by J. N. Van Antwerp A. S. A. C. Parish of Lafourche at Thibodeaux La as Store Room for Public Clothing &amp; School Property.</i>				
3	1	<i>Stable</i>	<i>Stable</i>	<i>1<sup>st</sup></i>	<i>25<sup>th</sup></i>	<i>25</i>	<i>10</i>	<i>00</i>	<i>per mo</i>	<i>Aug 1<sup>st</sup> 1868</i>	<i>C. B. Bannings etc</i>	<i>8</i>	<i>33</i>	<i>Occupied by J. N. Van Antwerp A. S. A. C. Parish of Lafourche at Thibodeaux La for Stabling one Government Horse in the service of the Bureau.</i>				

Amount of Rent and Hire during the Month *Twenty five dollars* ————— *\$ 25 00* Total amount due and remaining unpaid

I CERTIFY, on honor, that the above is a true copy of all the persons and articles employed and hired by me during the month of \_\_\_\_\_, 1868, and that the observations under the head of "Remarks," and the statement of amounts due and remaining unpaid, are correct.  
 Examined and Approved by command of

By't MAJ. GEN. ~~ROBT C BUCHANAN~~, U. S. A.,  
 Assistant Commissioner Louisiana.

By't Lieut. Col. U. S. A., Capt. 39th Infy. A. A. G.

Sub. Ass't Com'r B. R., F. and A. L.



NATIONAL ARCHIVES AND RECORDS ADMINISTRATION  
MICROFILM PUBLICATIONS

Roll 103

Target 5

*Register of Complaints*

Volume (476)

Apr. 1867–Oct. 1868

Volume pages were filmed sequentially.  
Blank pages were not filmed.



476

LOUISIANA.

Journal of cases referred to this Office

Complaints

Whitman &

J. J.





Opened by J. L. Rich Apr 14<sup>th</sup> 1867  
Rec<sup>d</sup> Apr 13<sup>th</sup> 1867.

Rhodeaux, Ga

---

Complaints re

476

Rhodeaux

P. H.



1867

Apr 13 John Lucas & Simon Walker complained that they worked twenty four days each for Maj Nelson and that they had no contract, said Nelson would not pay them

Above case was referred to the Civil Authority. Judge J. A. Rogers

Apr 19<sup>th</sup> Simon Jones complains that Mr Dick Pugh struck him with a stick without any cause and that he had not had any words with him

" 19 Referred to Civil Authority - J Rogers Justice  
Martha Long & Patsy Jackson

Complained that the husband of Patsy whipped her cruelly, and of less case referred to Civil courts

James Rogers  
Justice of Peace

April 25, 1867

Stanley (Colored) complained that Mr C. M. Gillis struck him <sup>with a gun</sup> on the head and knocked him down because he came onto his premises without his permission - Case referred to Civil authority



May 1/67 Nathan Brown  
asked if Mr Theriot could  
put him in jail if he  
refused to work for him answer  
no

May 9 Flemming Bunn and  
Sandy Ebb ask for settlement  
with Mr Cha Gaudet for labor  
to the amt of \$3,500 which  
labor was performed December 1865  
As the man had no means of paying  
at present but would in have in six  
months he settled by giving his note for  
amt due

1867

June 24 Case of Mrs Mary Washing-  
ton. Who complains that having  
brought an action against Mrs Cy-  
rille Prevot, for the recovery of property  
with held from her, and also for hav-  
ing been held as a slave, although  
free at the time, that she placed her  
case in the hands of Thomas P.  
Sherburne Attorney and Counsellor  
at Law, nearly three years ago, that  
she has paid him and his partners  
quite a large sum of money at  
different times, and that he prom-  
ised to have her case brought before  
the District Court, which met at New-  
Orleans last April, and that he failed to  
fulfill his promise.

Mrs Sherburne resides  
in New Orleans, and Mrs Wash-  
ington declares that he has been bri-  
bed by the defendants to let the  
matter drop.

July 3rd Case of Henry Speed.

Who complains that  
in January 31st 1866. he sold  
a parcel of land to Mrs A D Daming  
white. Mrs Daming gave  
Speed his note for \$50 payable  
March 1st 1866. Since that time he



1864

Complaints

Action of the Bureau

has only paid \$20 on account.

July 5th Case of Mrs Elizabeth Page  
Who complains that her boy Joseph Walpole Page, worked a month for Samuel Johnson at \$10 a month. S. Johnson had only paid the boy \$2. As the man had agreed to give the boy \$10, he was requested pay the balance due which he did.

August 7th Case of Samuel Hooper, Morrison, Richards and Nathaniel Wilson, who complain that they each worked for Mr. James McConick. The 1st from the eleventh of February to the last of March, the second from the 20th of Jan. to the last of July, and the third from the 12th of Jan. to the last of July. That as they had heard that Mr. McConick was a hard man to get along with, they had had made contracts, no contract, but had consented to work for him as long as they could agree together. That as Mr. McConick had not complied with other terms of the verbal contract, and had refused to let them have the use of his mule, and farming implements and for other reasons they had left him.

And that upon quitting, he had refused to return the half months wages that had been held back by him.

Sent for Mr. McC. and represented to him that as he had no proof, but that the statement of these men was true he would infallibly love his case if brought into court. See him for and does he settled by paying them the balance claimed.

Date 1864

Complaints

Action of the Bureau

September 4th Wm. Scott complains that having agreed to work for Mrs. A. Gallup of Bayou de l'Alouette, for wages varying from \$15 to \$20 per month, that Mrs. Gallup had turned him away with out having paid him anything, he (Scott) having worked for her three months.

Case referred to Bureau of the Peace at Raceland La.

October 3rd Rayson Eps who complains that he was struck, and severely hurt by Robert Perkins, overseer on Scudder Perkins Plantation, on account of a few words they had together in regard to work, resulting in Perkins calling Eps a liar and striking him.

Case referred to Bureau of the Peace at Raceland La.







Jan 27 Peter Brown complains, that his son, who was restored to him by the action of the Bureau, was not paid by his employer, Mr. Oldhausen, as much as he ought to have been, having only received \$50 for nearly four years' services. - Besides that these \$50. - were turned over by Mr. Oldhausen to Mr. Butler, Agent of Bureau, who bought him a suit of clothes & delivered the rest of the money (\$33.-) as well as the boy to a Mr. Jones, who seems to have been a totally irresponsible person, as he only took the boy to Galveston & left him there to shift for himself, exposing the boy, without money or provisions, to much suffering. Peter Brown now prays, that Mr. Oldhausen be compelled to pay \$6. - the current wages, for months for the time he worked, deducting the \$50. - already paid, of which he also desires that a satisfactory account be given by Mr. Butler. -

Reference to Peter Brown

Feb 28 Waddy Brooks complains that he receives a horse from another colt, now about 3 years ago, in exchange of one of his own, & that now a suit is made against him by original owner Mr. Walsh

Went into court & defended case myself, but the evidence for the prosecution being conclusive no judgment was entered against Brooks. as was expected to find the man from whom he got the horse, which he will try to do.

March 4 Saddy Cross complains Mr. Theophile Thibodaux, got a search warrant to search Ruben Cross's house when he came he cocked his pistol on complainant, without telling him who he was, or reading his search warrant. He was there with nine men, and entered Saddy Cross's house without warrant. Mr. Carter shot & wounded him afterwards with a below doublebarreled shot gun, - the buckshots (munkies) are get in arm & shoulder. - Mr. Carter who was one of the nine men fired on complainant, without having orders from Mr. Thibodaux, who, it appears is some Deputy Sheriff & commanded the party. Mr. Carter behaved very ill swore to kill the d-d son of a b-d (which he has done before) Complainant fired after Mr. Carter had fired but did not hit anybody. Mr. Thibodaux fired also afterwards but did not hit anybody. - Complainant asked Mr. Thibodaux to read the search warrant, but he refused & it seems had no warrant to search complainant's house. Nothing suspicious was found in complainant's house. He was then arrested & put under bonds for \$500. - while Carter run off & is not to be found. - He was advised by his lawyer not to spend the paid \$75 in advance to Mr. Moore his lawyer & was brought in guilty & sentenced to six months in Parish Prison, costs \$100 fine. - His wife's mule was taken to pay the fine & the Sheriff sold him without his consent, or his wife's whom the property is found to be. - Besides \$50. - was taken



from his pocket by Mr. Thibodaux,  
the jailer when he was arrested, & never  
accounts for blades & shotguns were  
confiscated & sold by Judge Rogers.  
The affair occurred about Septbr 66.

He complains about so much illtreatment in jail, that he had to  
break out, was caught again  
There seems to be something rotten in New Orleans  
He also reports illtreatment in jail generally, to all  
inmates, that cold people are beaten in jail.

Andy Reiss complains Mr. Henry Mudgett  
won't pay him bill of 65 presents bill # 81

Joseph Zenon  
complain that Mr. Holden won't properly  
settle with him

refers  
to R. D. D.

Fanny Reiss complains that Mr.  
Pulledge abuses & beats her.

July 9<sup>th</sup> 1868.

Jerry Willis (Col) complains of  
William L Scheffer driving him  
off from a piece of land rented by  
him and taking his crop away from  
him.

The following communication was  
sent to him

Officer USA Com B of R F W D L  
Thibodaux La July 9<sup>th</sup> 1868

Mr William L Scheffer  
Sir

Information  
has been received at this office that  
Jerry Willis (Col) was rented a piece of  
land on your plantation with your know-  
ledge and consent that the party renting

him that land had full control of said  
land. that Jerry Willis had raised  
a crop on said land without being  
protested in the raising of said crop  
up to this time: that you have now driven  
him off the place and taken his crop away  
from him

You are required to appear at this  
office at your earliest convenience  
and show cause for your action in  
this matter: Fail not under penalty of  
having your crop seized and proceedings  
instituted against you for damages  
at once

Very respectfully  
Your obt servant  
Wilson Brandon  
Lieut 42<sup>d</sup> Infantry asac



Sept 30 1868

Fred Wartz, complains that Sam Kirichlow hired him in the month of April at the rate of \$12<sup>00</sup> per mo. and refuses to pay him the amount due him (having received some on account is unable to say how much is actually due him) Wartz states that he left him for the reason that the said Kirichlow charged him with one week's ration which Wartz says he did not receive, and refuse to render him an ace

Mr. Commissioner of the firm of Critchlow & Co. states in answer to the Complaint of Fred Wartz that he has a verbal contract with one his hands to work for him until the entire crop is made at the rate of \$12 per mo & ration 1/2 to be paid at the end of each month, the balance to

The following communication was sent to him -

Verbal Contract

Office A.S.A.C. Sept 20/68  
Theodore Com. Sep 17/68  
Mr Sam Kirichlow or Critchlow  
Sir

at the end of the year or termination of the contract. The said Wartz was not discharged but left of his own accord for the reason that he was charged with one week's ration which Wartz says he did not receive, but proof is shown that the ration was given to another person for him, as had frequently occurred.

Complaint having been made at this office by Fred Wartz, that you refuse to pay him the amount due him, (he having left your employ.) You are hereby requested to call at this office as soon as possible, and explain the matter.

Very Respectfully  
J. Van Antwerp  
A.S.A.C.

Wartz claims the balance of wages due him, say the \$2 which cannot be due him had he not forfeited his contract

DECISION

Wartz has no claim on Critchlow beyond the amount front wages for the time he has worked. Directed Wartz to return to his work, when Critchlow will carry out the contract, otherwise he will forfeit his claim.

Check Oct 1/68

Sept 30 1868

Sept 30 1868

Dickie Banks complains that he has been working under a contract with Mr. Gordon weekly. Says 15/68 at the monthly wage of \$12 & ration and was discharged Sept 26/68 and asks that a settlement be made with him -

upon an investigation of this matter held in this office this day Mr. Gordon appeared who stated that he did not discharge the Plaintiff but that he left of his own accord in violation of his verbal contract with Gordon, and that he had used insulting and abusive language to Gordon, and that Gordon told him if he left he would do so at his own peril, and would prosecute whatever remedy there was under the contract which was to pay 1/2 monthly the balance at the end of contract - say \$2 weekly.

The following communication was sent him -

Sept 29/68

Mr. W. Gordon  
Sir

Dickie Banks has made complaint to me that he has been working for you under a contract made Jan 15/68 for the monthly wage of \$12 and that you have discharged him in violation of said contract without paying him his wage for done.

Very Respectfully  
J. Van Antwerp  
A.S.A.C.

You are hereby requested to call immediately at this office & explain the matter, and thereupon wait any measures which may involve you in cost.

Very Respy  
J. Van Antwerp  
A.S.A.C.

The contents of the statements and evidence to the whole affair I have read and find for Dickie.



Oct 19

Senior Navell complains that he  
has worked for Frederick Bernard  
for 19 1/4 days and that he has been  
paid for 5 1/2 days only, and that  
he has been clocked 4 1/2 days - he  
therefore claims for balance say  
4 1/2 days -

Requested Mr Bernard to appear.

Oct 19 1868  
Case dispute of Mr B  
having produced a receipt  
from the previous date  
this day in full for services  
rendered.



1868										
Sept	11	Joseph Barker	his mark	x	1	Mat				
"	15	Lucas Roberts	his mark	x	1	"				
"	14	Isaac Williamson	his mark	x	1	"				
"	21	Sam Washington	his mark	x	1	"				
Oct	5	Antoine Lough	his	x	1	"				
	10	John Perry	his mark	x	1	"				
	20	Abner M. Harts	his mark	x	1	"				



NATIONAL ARCHIVES AND RECORDS ADMINISTRATION  
MICROFILM PUBLICATIONS

Roll 103

Target 6

*Accounts with Planters for Supplies Furnished*  
Volume (474) Apr.-Dec. 1868

Volume pages were filmed sequentially.  
Blank pages were not filmed.

LOUISIANA.

*Journal de la Compagnie  
des Indes Orientales  
de la Louisiane  
de 1763 à 1769*



W. W. WILLIAMS  
WHOLESALE & RETAIL  
**STATIONER**  
76 Camp St.  
New Orleans.

Thibodeaux. La

accounts with planters  
for supplies

Miss G

Lafayette

474

A  
B  
C  
D  
E  
F  
G  
H  
I  
K  
L  
M  
N  
O  
P  
Q  
R  
S  
T  
U  
V  
W  
Y



Foster, H. F.

E  
F  
G  
H  
I  
K  
L  
M  
N  
O  
P  
Q  
R  
S  
T  
U  
V  
W  
X  
Y



Tucker, George W.

2

R  
S  
T  
U  
V  
W



Thomas F. Foster; L. O. Auden's Plantation Parish of Lafourcade  
Dr in account with Bureau of Refugee, Freedmen and Abandoned Lands Louisiana 1868

1868	April 29	From Bonds Corn Meal	10 00	1868	April 29	Supplies delivered	
"	"	One Bond Well Pork	24 20			to Planter	
		cost of transportation by U. S. Dept	1 60			Receipt Bond given for supplies	
			\$35 80	Dec. 17. 1868	By Cash		\$35 80



Doct George W. Tucker Homewood Plantation Parish of Lafourche  
in account with Bureau of Refugees Freedmen & Abandoned Lands Louisiana

1868		1868					
June	22	Three Barrels Corn Meal	15 60	June	22	Supplies delivered to Planter	
"	"	Two Hundred pound of Bacon at 15¢	45 00	"	"	Receipt Bond Given for Supplies	
"	"	Cost of Transportation by S.M. Dept	2 25				
July	14	Four Barrels Corn Meal	20 00	July	14	Supplies delivered to Planter	
"	"	Two Barrels Milled Pork	54.00	"	"	Receipt Bond Given for Supplies	
"	"	Cost of Transportation by S.M. Dept	3.50				
				Oct 28	By Dept		140 35
			<u>140 35</u>				<u>140 35</u>



John Jones ...  
*Dr on account of* ... *to* ... *of* ...

1868				1868		
Jan'y 1 <sup>st</sup>	To Balance	200 00	By	Supplies used		
	To Cash	20 00		Receipt		
	To [unclear]			By Cash		
	To [unclear]	25 00		By [unclear]		
	To [unclear]	25 00		By Bank		250 00
		220 00				220 00

N.B.  
 The above is furnished as for ...  
 kept in this book.  
 The words supplies delivered to planter Receipt<sup>ed</sup> Bond  
 given for supplies<sup>r</sup> shall be written in red ink.



NATIONAL ARCHIVES AND RECORDS ADMINISTRATION  
MICROFILM PUBLICATIONS

Roll 103

Target 7

*Accounts*

Volume (475) Apr. 1867

Volume pages were filmed sequentially.  
Blank pages were not filmed.

LOUISIANA.

*Part 1*  
*1810*  
*1811*



Thibodaux, La

---

Cash 7c

List of fundagents



475-



1  
Cash Book showing all monies  
passing through my hands belonging  
or pertaining to the Freedman's Bureau  
while Agent of the Parish of Lafourche

Opened Apr 1<sup>st</sup> 1867

J. L. Rich  
Agent P. B. S. A. S.



# Cash

# Dr

To amt rec'd Apr 1<sup>st</sup> 1867 \$00000000

"	"	"	"	2	"	do
"	"	"	"	3	"	do
"	"	"	"	4	"	do
"	"	"	"	5	"	do
"	"	"	"	6	"	do
"	"	"	"	7	"	do
"	"	"	"	8	"	do
"	"	"	"	9	"	do
"	"	"	"	10	"	do
"	"	"	"	11	"	do
"	"	"	"	12	"	do
"	"	"	"	13	"	do
"	"	"	"	14	"	do
"	"	"	"	15	"	do
"	"	"	"	16	"	do
"	"	"	"	17	"	do
"	"	"	"	18	"	do
"	"	"	"	19	"	do
"	"	"	"	20	"	do
"	"	"	"	21	"	do
"	"	"	"	22	"	do
"	"	"	"	23	"	do
"	"	"	"	24	"	do
"	"	"	"	25	"	do
"	"	"	"	26	"	do
"	"	"	"	27	"	do
"	"	"	"	28	"	do
"	"	"	"	29	"	do
"	"	"	"	30	"	do

\$00000000

# Cash

# Cr

Apr 1867 Cash paid out

00000000

00000000



List of Indigent and Destitute Freedmen

Name	Age	Sex	Cause of Destitution	Remarks
Caout Jones	100	Male	Old & Feeble	
McLinda Thomas	70	Female	" " "	+ 2nd husband 2 children blind
Harry Laughlin	25	Male	Sick with Rheumatism	
Molly Smith	70	Female	Old & Feeble	
Clarissa Jones	70	"	" " "	+
Reuben Knox	71	Male	" and Raptured	+
Joe Shelvey	74	"	" " Crippled	+
Edward Mitchell	90	"	Sick	
Thos Williams	60	"	Old & Crippled	+ and wife
Nancy Thomas	50	Female	Blind	
Julia Lister	45	"	Younger helper	+
Maria "	12	"	" " "	+
Lemon "	10	"	" " "	+
Clement	6	Male	" " "	+
Milly Thompson	40	Female	Essence of	from children
Virgil "	12	Male	Young	
David "	10	"	"	
Felicia "	8	Female	"	
Caroline "	3	"	"	
Ann Stephens	24	"	Crippled	
Eliza Harris	87	Female	Old & Feeble	+
Harriet Campbell	55	Female	Crippled	
Brian "	"	Male	Sick with Rheumatism	+
Maria Biffin	75	Female	Old & Feeble	+
Elizabeth Page	43	"	Blind	+ from children
Abner Collins	53	Male	Crippled	+
William Tolliver	30	"	"	+ lost one arm wife & child
Laura Maxwell	14	Female	"	+ " " hand
Mary Legard	60	"	"	+
Chesney Conley	90	"	Old & Crippled	+
George Gibbs	70	Male	do	+ wife & grand child
Sam Ward	76	"	"	
Milly Coleman	30	Female	Crippled	One foot gone

Name	Age	Sex	Cause of Destitution	Remarks
Phoebe Ann Cook	80	Female	old age	+ 2nd child
Sylvia Geo	90	"	" " "	+
Polly Collins	94	"	" " "	
Sarah Russ	50	"	Sickly	
Larrence Bergeris	70	Male	old & feeble	
Edward Houser	73	"	" " "	
William Hall	50	"	Sick & Feeble	+ Rheumatism
Charles Howell	93	"	old age	+
Simon Johnson	50	"	Crippled	+ one Leg, one child
Mansfield Tucker	72	"	old & feeble	+ 2 small children one is crippled
Milly Justice	60	Female	"	
Chloe Jackson	94	"	" " "	+
Henry Homan	40	Male	Crippled	+ then children
Jacob King	55	"	"	
Sam Washington	90	"	old & feeble	+ and wife 2 children
Lewis Young	100	"	Crippled	+ one Leg wife 2 children
Emanuel Gibson	80	"	old & feeble	+
Henry Langdon	70	"	" " "	+
James Ballard	70	"	" " "	+
Lucy Foster	71	Female	" " "	+
Rachel Bailey	69	"	" " "	
Thomas Valentine	60	Male	" " "	+
Ollena Hill	79	nt	" " "	
Charlotte Johnson	68	Female	" " "	+
Lewis Moore	113	Male	Crippled	+
Eliza Edwards	88	Female	old & feeble	
Charles Sanders	80	Male	Crippled	+
Mahinda Johnson	56	Female	"	from arm
Louisa Ward	48	"	"	+ " "
Alex Simon	47	Male	"	
Wilson Hunt	75	"	old & feeble	
Jesse Jones	80	"	" " "	
James Taylor	78	"	" " "	+
John Honston	40	"	Crippled	+
Celia Fisher	80	Female	Old & Feeble	



Name	Age	Sex	Cause of Destitution	Remarks
India Houston	9	female	young & helpless	+
Joseph Houston	7	male	do	+
Charlotte Jackson	40	Female	Sick & crazy	+ 3 children
Otto Popfer	68	male	old & ruptured	+
Lizzy Haines	70	"	" " old & feeble	
Jaw Herfer	60	Female	" " Sickly	
Louis Herfer	65	male	" " "	
Isaac Rice	69	"	" " feeble	Rup. lined
Eligah Canada	70	"	" " Crippled	+
Martha Williams	62	"	" " "	
Jenny Washington	75	Female	" " Feeble	
Alex Boucard	78	male	" " "	+
Mary Williams	100	Female	" " "	+
Dorcas Wilson	78	male	" " "	+
Frances "	73	Female	" " "	+
Willie Gaines	80	"	" " "	
Mary Ann Jayne	30	"	Crippled	
Moses Smith	44	male	"	5 Children
Lucas "	10	"	"	+
Clarence "	8	Female	"	+
Arms "	6	"	"	+
Quases "	2	male	"	+
Betty "	Infant	Female	"	+
Joseph Massenburg	70	male	"	+
Jenny "	70	Female	"	+
Mary Isaacs	100	"	old & feeble	+
Mary Ann Gaudin	46	"	Sick	Temporary
Henry Basil	70	male	old & sick	" (Daisy man)
Charity Hill	60	Female	" " "	
Margaret Sandy	66	"	Blind	
Isaac Rice	74	male	old & feeble	
Maria Thompson	56	Female	Crazy	
Albert King	50	male	Sick	
Nelly King	10	Female	young	
John Johnson	58	"	Sickly	

Name	Age	Sex	Cause of Destitution	Remarks
Robert Wells				
Jerome Morris				
Nathan Brown				



## List of Destitute Whites

- Mrs Rosanna Fitch and 5 Children destitute +  
" Maria Fitch and 5 Children  
" Adoniram Badeaux and 4 Children +



NATIONAL ARCHIVES AND RECORDS ADMINISTRATION  
MICROFILM PUBLICATIONS

Roll 103

Target 8

*Miscellaneous Records*  
1867-68

No. 10.

---





No. 10.

Francis Struberg, A. S. C.

Acting Quartermaster, U. S. Army,

At Philadelphia, Pa.

ACCOUNT CURRENT,

For November 1867



No. 10.

Dr.

The UNITED STATES in account current with

*Francis Struberg, Asst Sub Asst Comd*

*Bureau R. F. & A. L.*

Quartermaster U. S. Army, on account of the

Quartermaster's Department, at

*Fort Adams, La.*

in the quarter ending on the

*thirtieth* day of *November*

186 *8*

Cr.

To amount of purchases, per Abstract A .....

To amount of expenditures, per Abstract B .....

To amount of transfers to officers, per Abstract B b. ....

To balance due the United States, carried to new account .....

By balance on hand per last account .....

By cash received from .....

Dollars.

Dollars.

I certify that the above is a true statement of all the moneys which have come into my hands on account of the Quartermaster's Department, during the <sup>month</sup> quarter ending on the *30<sup>th</sup>* day of *November* 186 , and that the disbursements have been faithfully made. ~~The~~ balance due the United States is ~~in~~ and is deposited in

*Francis Struberg*  
*Asst Sub Asst Comd*  
 Quartermaster  
*Bureau R. F. & A. L.*



No. 10.

Francis Struberg, A.S.A.C.

~~Qu. R. S. & A. S. Quartermaster, U. S. Army,~~

At Shibodans, La.

ACCOUNT CURRENT,

For

December

1867

No. 10.

Dr.

The UNITED STATES in account current with *Francis Sternberg, A. S. A. C. Bu. N. F. A. L.* Quartermaster U. S. Army, on account of the  
Quartermaster's Department, at *Thibodaux, La* in the ~~quarter~~ <sup>month</sup> ending on the *thirty first* day of *December* 186*7*

Cr.

To amount of purchases, per Abstract A .....	By balance on hand per last account .....
To amount of expenditures, per Abstract B .....	By cash received from .....
To amount of transfers to officers, per Abstract B b. ....	
To balance due the United States, carried to new account .....	
Dollars.	Dollars.

I certify that the above is a true statement of all the moneys which have come into my hands on account of the Quartermaster's Department, during the ~~quarter~~ <sup>month</sup> ending on the *31<sup>st</sup>* day of *December* 186*7*, and that the disbursements have been faithfully made. ~~The~~ balance due the United States is in and is deposited in

*Francis Sternberg*  
*Quartermaster*  
*Bureau N. F. A. L.*



*Retained*

No. 10.

*Francis Semberg*  
*Apt. sub. Apt. Comr<sup>s</sup>*  
*Quartermaster, U. S. Army,*  
*Ba "R. F. and A. L.*  
*Tribodaux, La.*

At

ACCOUNT CURRENT,

For *March* 186*8*

No. 10.

Dr.

The UNITED STATES in account current with Francis Sternberg, Asst Subaltern ~~Quartermaster U. S. Army~~, on account of the  
 Quartermaster's Department, at Thibodaux, La in the ~~quarter~~<sup>month</sup> ending on the thirty first day of March 1868

Cr.

<p>To amount of purchases, per Abstract A .....</p> <p>To amount of expenditures, per Abstract B.....</p> <p>To amount of transfers to officers, per Abstract B b.....</p> <p>To balance due the United States, carried to new account.....</p>	<p>_____</p> <p>_____</p> <p>_____</p> <p>_____</p>			<p>By balance on hand per last account .....</p> <p>By cash received from</p>	<p>_____</p> <p>_____</p>				
Dollars.	_____			Dollars.	_____				

I certify that the above is a true statement of all the moneys which have come into my hands on account of the Quartermaster's Department, during the ~~quarter~~<sup>month</sup> ending on the 31<sup>st</sup> day of March 1868, and that the disbursements have been faithfully made. The balance due the United States is in \_\_\_\_\_ and is deposited in \_\_\_\_\_

Francis Sternberg  
~~Asst Subaltern~~ <sup>Quartermaster</sup>  
 Bn. R. S. & A. L.



No. 10.

Lt Gilson Brouder 42<sup>d</sup> Reg  
ASA Co. Regt R 7<sup>th</sup> A.C. I

Quartermaster, U. S. Army,

At Tiboduanx La

ACCOUNT CURRENT,

For May 31<sup>st</sup> 1868

No. 10.

Dr.

The UNITED STATES in account current with *Lieut Nelson Bronson 42<sup>d</sup> Inf A.S.C. Com. B. of R. F. and A.C.* Quartermaster U. S. Army, on account of the ~~Quartermaster's Department~~, at *Parish Lafourche La* in the ~~quarter~~ *month* ending on the *31<sup>st</sup>* day of *May* 186*8* Cr.

To amount of purchases, per Abstract A .....		By balance on hand per last account .....	
To amount of expenditures, per Abstract B .....		By cash received from .....	
To amount of transfers to officers, per Abstract B b .....			
To balance due the United States, carried to new account .....			
<i>No Funds</i>		<i>No Funds</i>	
Dollars.		Dollars.	

I certify that the above is a true statement of all the moneys which have come into my hands on account of the ~~Quartermaster's~~ *B. of R. F. and A.C.* Department, during the ~~quarter~~ *month* ending on the *31<sup>st</sup>* day of *May* 186*8*, and that the disbursements have been faithfully made. The balance due the United States is in *and is deposited in*

*Nelson Bronson*  
*Lieut 42<sup>d</sup> Infantry A.S.C. B. of R. F. and A.C.*



No. 10.

Quartermaster, U. S. Army,

ACCOUNT CURRENT,

June 1868

Retained

No. 10.

Dr.

The UNITED STATES in account current with Lieut. Nelson Bronson, 42<sup>d</sup> Infy, A.S.C. Quartermaster U. S. Army, on account of the Bureau of R. I. & U. L. ~~Quartermaster's Department~~, at Thibodaux, La in the ~~quarter~~ <sup>month</sup> ending on the thirtieth day of June 1868

Cr.

To amount of purchases, per Abstract A .....		By balance on hand per last account .....	
To amount of expenditures, per Abstract B .....		By cash received from .....	
To amount of transfers to officers, per Abstract B b .....			
To balance due the United States, carried to new account .....			
<i>No Funds</i>		<i>No Funds</i>	
			Dollars.

I certify that the above is a true statement of all the moneys which have come into my hands on account of the Bureau of R. I. & U. L. ~~Quartermaster's Department~~, during the ~~quarter~~ <sup>month</sup> ending on the 30<sup>th</sup> day of June 1868, and that the disbursements have been faithfully made. The balance due the United States is in \_\_\_\_\_ and is deposited in \_\_\_\_\_

Nelson Bronson  
Lieut. 42<sup>d</sup> Infy, A.S.C. ~~Quartermaster~~



BILL OF LADING  
FOR  
UNITED STATES PROPERTY.

FORWARDED

From New Orleans La

To Shibodeaux La

April 26<sup>th</sup>, 1867.

DUPLICATE.

The Original Bill of Lading must be presented for collection of freight, to

Capt W.B. Armstrong Agent

J D Rich

will please fill the blank receipts, and return this B. L. at once to

This Office

New Orleans La

REQUISITION.

Office Assistant Quartermaster, U. S. A.

*New Orleans La April 26<sup>th</sup> 1867*  
The Steamer "*New-Era*"

and connecting lines, will, without delay, furnish transportation for the public property specified below, from *New Orleans La* to *Shibodeaux La* the freight to be paid by *Captain W.B. Armstrong Asst* Quartermaster, U. S. A., at *New Orleans La*, at \_\_\_\_\_ rates.

*W.B. Armstrong*  
Captain & Asst. Quartermaster, U. S. A.  
*B.R. & Co. La*

DUPLICATE BILL OF LADING

*New Orleans La April 26<sup>th</sup> 1867*  
Received from *Captain W.B. Armstrong A. G. U. S. Army*, United States Army,

the following articles of public property, as specified below, (contents and value unknown,) in apparent good order, to be forwarded to *Shibodeaux La* by the Steamer "*New-Era*" and connecting lines, there to be delivered in like good order and condition, unto *J. D. Rich Agent*

at *Shibodeaux La* Freight to be paid by the proper Officer of the United States, at \_\_\_\_\_ rates, and on the original Bill of Lading only.

MARKS.	Nos.	PACKAGES, &C.	CONTENTS.	Pd. WEIGHT.
<i>J. D. Rich</i>	<i>9</i>	<i>Nine Bbls</i>	<i>Corn Meal</i>	<i>1845</i>
<i>Shibodeaux La</i>	<i>2</i>	<i>Two Bbls</i>	<i>Port</i>	<i>447</i>
<i>La</i>		<i>One Bbl nearly empty</i>		
			<i>J. D. Melancon</i>	

*20*  
*Twenty-two Bbls + 4 bushels*

*Handwritten notes in left margin*



186

Received of \_\_\_\_\_  
the public property specified within, in good order and condition.

Quartermaster

I certify the within weight \_\_\_\_\_  
pounds, to be correct.

Quartermaster.

The \_\_\_\_\_ has advanced charges,  
in amount \_\_\_\_\_ Dolls. \_\_\_\_\_ Cents,  
on the public property specified within, as set forth in attached vouchers, which I certify to be correct, and not to have been  
paid by me.

Quartermaster.

BILL OF LADING

FOR

UNITED STATES PROPERTY.

FORWARDED

From New Orleans La  
To St. Anthony La  
April 26<sup>th</sup>, 186<sup>5</sup>.

DUPLICATE.

The Original Bill of Lading must be pre-  
sented for collection of freight. to

Capt W.B. Armstrong Agt in

A D Rich

will please fill the blank receipts, and return this B. L. at once to

This Office  
New Orleans La

BILL OF LADING

FOR

UNITED STATES PROPERTY.

FORWARDED

From *New Orleans La*

to *Providence La*

*April 26<sup>th</sup> 1867*

---

DUPLICATE.

---

Freight Payable on Original Bill only.



*Tri* ~~D~~ UPLICATE

BILL OF LADING

*New Orleans La April 26<sup>th</sup> 1867*

Received from *Captain S.B. Armstrong A.C. U.S.* United States Army,  
 the following articles of public property, as specified below, (contents and value unknown,) in appar-  
 ent good order, to be forwarded to *Thibodaux La*  
 by the *Steamer "New Era"* and connecting lines,  
 there to be delivered in like good order and condition, unto *J.D. Rich Agent*  
 at *Thibodaux La* Freight to be paid by the proper Officer of the United States,  
 at \_\_\_\_\_ rates, and on **the Original Bill of Lading only.**

MARKS.	Nos.	PACKAGES, &c.	CONTENTS.	Pd. WEIGHT.
<i>J.D. Rich</i>	<i>9</i>	<i>Nine Bbls</i>	<i>Corn Meal</i>	<i>1845#</i>
<i>Thibodaux La</i>	<i>2</i>	<i>Two Bbls</i>	<i>Pork</i>	<i>447</i>
		<i>One Bbl nearly empty</i>	<i>of Melancon</i>	

*Twenty two hundred & ninety two lbs*

BILL OF LADING

FOR

UNITED STATES PROPERTY.

FORWARDED

From *New Orleans, La*

To *Thibodaux, La*

*July 5<sup>th</sup>*, 186*7*

---

---

TRIPLICATE.

---

---

*The Original Bill of Lading must be presented  
for collection of Freight.*

---

---

---

---

*This B. L. will be retained by the Consignee.*





BILL OF LADING  
FOR  
UNITED STATES PROPERTY.

FORWARDED

From *New Orleans La*  
To *Thibodaux La*  
*July 15<sup>th</sup>, 1867*

---

---

TRIPLICATE.

---

---

*The Original Bill of Lading must be presented  
for collection of Freight.*

---

---

---

---

*This B. L. will be retained by the Consignee.*





[No. 1.]

New Orleans La July 13 1867.

RECEIVED from *Capt W.B. Armstrong Agent CS Bureau* in the service of the United States, at

*New Orleans La*, on this *15* day of *July*, 1867, *7000*

pounds of corn, and *meal 1120* pounds of pork, for distribution among the people of *Parish*

*Sapouich La*, "to prevent starvation and extreme want," as provided in Joint Resolution of Congress, approved March 30, 1867, to be accounted for on No. 5, as per Circular.

(SIGNED)

*J. A. A. Robinson*  
*Act Subst Comm Dist of La*

[IN TRIPLICATE,—one for officer making the transfer, one for Commissioner of Freedmen's Bureau, and one for Receiver.]



BILL OF LADING

FOR

UNITED STATES PROPERTY.

FORWARDED

From *New Orleans La*  
To *Thibodaux La*  
*August 5*, 186*7*

---

---

TRIPLICATE.

---

---

*The Original Bill of Lading must be presented  
for collection of Freight.*

---

---

---

---

*This B L. will be retained by the Consignee.*

---

---





BILL OF LADING

FOR

UNITED STATES PROPERTY.

FORWARDED

From *New Orleans La*

To *Shibodeaux La*

*August 12*, 186*7*

---

---

TRIPLICATE.

---

---

*The Original Bill of Lading must be presented  
for collection of Freight.*

---

---

---

---

*This B. L. will be retained by the Consignee.*





[No. 1.]

New Orleans La. Aug 13 1867.

RECEIVED from Capt W.B. Armstrong Agent in the service of the United States, at

New Orleans La, on this 13 day of August, 1867, 75 1/2

pounds of corn, and 1300 pounds of pork, for distribution among the people of Parish

Lafourche La, "to prevent starvation and extreme want," as provided in Joint Reso-  
lution of Congress, approved March 30, 1867, to be accounted for on No. 5, as per Circular.

(SIGNED)

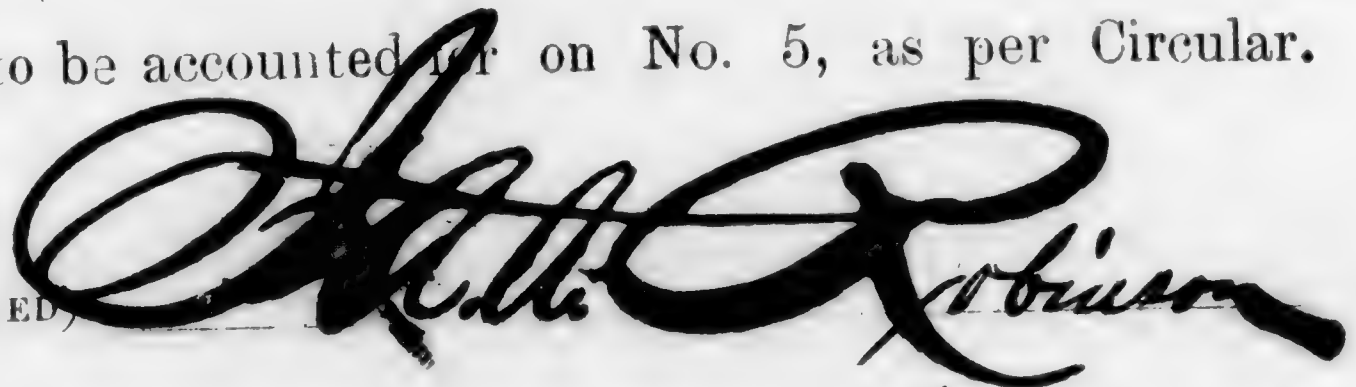

[IN TRIPLICATE,—one for officer making the transfer, one for Commissioner of Freedmen's Bureau, and one for Receiver.]

BILL OF LADING

FOR

UNITED STATES PROPERTY.

FORWARDED

From *New Orleans La*

To *Thibodauxville La*

*Sept 14*, 186*7*

TRIPPLICATE.

*The Original Bill of Lading must be presented  
for collection of Freight.*

*This B. L. will be retained by the consignee*





BILL OF LADING

FOR

UNITED STATES PROPERTY.

FORWARDED

From *New Orleans La*

To *Mobile La*

*Nov. 12<sup>th</sup>, 1867*

TRIPPLICATE.

*The Original Bill of Lading must be presented  
for collection of Freight. to*

*W. B. Armstrong  
Disby Officer*

*This B. L. will be retained by the Consignee.*





BILL OF LADING

FOR

UNITED STATES PROPERTY.

FORWARDED

From New Orleans

To Providence La

November 16, 1867

---

---

TRIPLICATE.

---

---

*The Original Bill of Lading must be presented  
for collection of Freight.*

---

---

---

---

*This B. L. will be retained by the Consignee.*





BILL OF LADING

FOR

UNITED STATES PROPERTY.

FORWARDED

From *New Orleans*

To *La Fourche Crossing*

*Dec 13*, 186*7*.

---

---

TRIPLICATE.

---

---

*The Original Bill of Lading must be presented  
for collection of Freight.*

---

---

---

---

*This B. L. will be retained by the Consignee.*





---

BILLS OF LADING

---

FOR

UNITED STATES PROPERTY.

Rhode Island

Bills

of  
Lading

---

*This B. L. will be retained by the Consignee.*



**BILL OF LADING**

FOR

**UNITED STATES PROPERTY.**

**FORWARDED**

From New Orleans La  
To Providence La  
December 28<sup>th</sup>, 1867

**FEDERAL OFFICE**





BILL OF LADING

FOR

UNITED STATES PROPERTY.

FORWARDED

From *New Orleans*

To *Shreveport*

*Dec 30, 1867*

TRIPPLICATE.

*The Original Bill of Lading must be presented  
for collection of Freight.*

*This B. L. will be retained by the Consignee.*





BILL OF LADING

FOR

UNITED STATES PROPERTY.

FORWARDED

From New Orleans La

To Shiboducum La

January 31<sup>st</sup>, 1865.

TRIPPLICATE.

*The Original Bill of Lading must be presented  
for collection of Freight.*

*This B. L. will be retained by the Consignee.*





BILL OF LADING

FOR

UNITED STATES PROPERTY.

FORWARDED

From New Orleans La

To Shiboducum La

February 6<sup>th</sup>, 1868.

---

---

TRIPLICATE.

---

---

*The Original Bill of Lading must be presented  
for collection of Freight.*

---

---

---

---

*This B. L. will be retained by the Consignee.*





BILL OF LADING

FOR

UNITED STATES PROPERTY.

FORWARDED

From New Orleans La

To Shibouy La

February 10<sup>th</sup>, 1868.

---

---

TRIPLICATE.

---

---

*The Original Bill of Lading must be presented  
for collection of Freight.*

---

---

---

---

*This B. L. will be retained by the Consignee.*





BILL OF LADING  
FOR  
UNITED STATES PROPERTY.

FORWARDED

From New Orleans La

To Philadelphia

March 7, 1868.

**TRIPLICATE.**

*The Original Bill of Lading must be presented  
for collection of Freight.*

*This B. L. will be retained by the Consignee.*





BILL OF LADING

FOR

UNITED STATES PROPERTY.

FORWARDED

From *New Orleans La*

To *Rhodeport La*

*March 17<sup>th</sup>*, 1868.

---

---

TRIPLICATE.

---

---

*The Original Bill of Lading must be presented  
for collection of Freight.*

---

---

---

---

*This B. L. will be retained by the Consignee.*





BILL OF LADING

FOR

UNITED STATES PROPERTY.

FORWARDED

From New Orleans La

To Thibodeaux La

March 21., 1868.

---

---

TRIPLICATE.

---

---

*The Original Bill of Lading must be presented  
for collection of Freight.*

---

---

---

---

*This B. L. will be retained by the Consignee.*





BILL OF LADING

FOR

UNITED STATES PROPERTY.

FORWARDED

From New Orleans La

To Philadelphia La

April 7, 1868.

*W. L.*  
TRIPPLICATE.

*The Original Bill of Lading must be presented  
for collection of Freight.*

*2/11*  
This B. L. will be retained by the Consignee.

TRIPLICATE  
BILL OF LADING.

*New Orleans La*  
*Port of Call. & Co. Deman*  
 public property, as specified below, (contents and value unknown,)  
*Philip Adams*  
*to the order of* *Lowell*  
*Francis*  
 take good order and condition, unto  
 Freight to be paid by  
 at *New Orleans La*, and on  
*Regular* rates.

Nos.	PACKAGES, &C.	CONTENTS.
<i>2</i>	<i>Sacks</i>	<i>Oats</i>
<i>1</i>	<i>Pale</i>	<i>Hay</i>
	<i>Only 218 lbs</i>	<i>Oats recd</i>





BILL OF LADING

FOR

UNITED STATES PROPERTY.

FORWARDED

From New Orleans La

To Rhodeaux La

April 21", 1868

---

---

TRIPLICATE.

---

---

*The Original Bill of Lading must be presented  
for collection of Freight.*

---

---

---

---

*This B. L. will be retained by the Consignee.*





302  
BILL OF LADING

FOR

UNITED STATES PROPERTY.

FORWARDED

From New Orleans La

To Riboucaux La

June 18<sup>th</sup>, 1868.

---

---

TRIPLICATE.

---

---

*The Original Bill of Lading must be presented  
for collection of Freight.*

---

---

---

---

*This B. L. will be retained by the Consignee.*





BILL OF LADING

FOR

UNITED STATES PROPERTY.

FORWARDED

From *New Orleans*

To *Safourche Crossing La*

*June 3<sup>rd</sup>*, 1868.

---

---

TRIPLICATE.

---

---

*The Original Bill of Lading must be presented  
for collection of Freight.*

---

---

---

---

*This B. L. will be retained by the Consignee.*





BILL OF LADING

FOR

UNITED STATES PROPERTY.

FORWARDED

From *New Orleans La*

To *Shiboumoy La*

*June 3<sup>rd</sup>*, 1868

---

---

TRIPLICATE.

---

---

*The Original Bill of Lading must be presented  
for collection of Freight.*

---

---

---

---

*This B. L. will be retained by the Consignee.*





BILL OF LADING

FOR

UNITED STATES PROPERTY.

FORWARDED

From New Orleans La

To Shibouani La

June 17, 1868.

---

---

DUPLICATE.

---

---

The Original Bill of Lading must be presented for collection of freight.

---

---

Lieut A Bronson

will please fill the blank receipts, and return this B. L. at once to

2<sup>d</sup> Lieut W. H. Howell, 1<sup>st</sup> Inf

New Orleans La





BILL OF LADING

FOR

UNITED STATES PROPERTY.

FORWARDED

From *New Orleans La*

To *Shibodeaux La*

*June 17<sup>th</sup>*, 1868.

---

---

TRIPLICATE.

---

---

*The Original Bill of Lading must be presented  
for collection of Freight.*

---

---

---

---

*This B. L. will be retained by the Consignee.*





BILL OF LADING  
FOR  
UNITED STATES PROPERTY.

FORWARDED

From..... *New Orleans La* .....

To..... *Shibaudann La* .....

..... *July 13* ..... 1868 .

TRIPPLICATE.

*The Original Bill of Lading must be presented  
for collection of Freight.*

*This B. L. will be retained by the Consignee.*



Payable by Freedmen's  
BUREAU.

TRIPPLICATE  
BILL OF LADING.

New Orleans, La., July 13<sup>th</sup> 1868,

Received from *Brig Lt Col. E. C. Bernan, D. O. V. A. A. C. M.* United States Army,  
the following articles of public property, as specified below, (contents and value unknown,) in apparent good order, to  
be forwarded to..... *Thibodeaux, La.,*  
by the..... *Str. Nina Simms,* and connecting lines,  
there to be delivered in like good order and condition, unto..... *The A. S. A. Co.,*  
*Qu. R. F. and A. C.,* Freight to be paid by..... *The D. O. and A. A.*  
Quartermaster, U. S. A., at..... *New Orleans, La.,* and on the Original Bill of  
Lading only, at..... *Card* rates.

MARKS.	NOS.	PACKAGES, ETC.	CONTENTS.	PD. WEIGHT.
<i>G. W. Tucker,</i>	<i>14</i>	<i>Barrels</i>	<i>Corn Meal</i>	<i>880</i>
<i>Cans A. S. A. Co.,</i>	<i>2</i>	<i>"</i>	<i>Miss Pork</i>	<i>660</i>
<i>Thibodeaux</i>				
<i>La.</i>				
		<i>Original Cost</i>	<i>Fr. Charges.</i>	<i>Total Cost.</i>
<i>14 Bbls Meal</i>		<i>20.00</i>	<i>2.00</i>	<i>22.00</i>
<i>2 " Pork</i>		<i>34.00</i>	<i>1.50</i>	<i>55.50</i>
	<i>\$</i>	<i>74.00</i>	<i>3.50</i>	<i>77.50</i>

BILL OF LADING

FOR

UNITED STATES PROPERTY.

FORWARDED

From *New Orleans La*

To *Lafayette Crossing*

*July 8<sup>th</sup>*, 186*8*.

**TRIPLICATE.**

*The Original Bill of Lading must be presented  
for collection of Freight.*

*This B. L. will be retained by the Consignee.*





BILL OF LADING

FOR

UNITED STATES PROPERTY.

FORWARDED

From *New Orleans La*

To *Sajourche Crossing La*

*July 27*, 1868 .

---

---

TRIPLICATE.

---

---

*The Original Bill of Lading must be presented  
for collection of Freight.*

---

---

---

---

*This B. L. will be retained by the Consignee.*





BILL OF LADING

FOR

UNITED STATES PROPERTY.

FORWARDED

From *New Orleans La*

To *Lafourche Crossing*

*August 21*, 1868.

---

---

TRIPPLICATE.

---

---

*The Original Bill of Lading must be presented  
for collection of Freight.*

---

---

---

---

*This B. L. will be retained by the Consignee.*





BILL OF LADING

FOR

UNITED STATES PROPERTY.

FORWARDED

From New Orleans La

To Safourche Crossing La

November 7. 1868., 186 .

---

---

TRIPLICATE.

---

---

*The Original Bill of Lading must be presented  
for collection of Freight.*

---

---

---

---

*This B. L. will be retained by the Consignee.*





BILL OF LADING

FOR

UNITED STATES PROPERTY.

FORWARDED

From *New Orleans La*

To *Safarthe Crossing La*

*November 19<sup>th</sup>*, 1868.

---

---

TRIPLICATE.

---

---

*The Original Bill of Lading must be presented  
for collection of Freight.*

---

---

---

---

*This B. L. will be retained by the Consignee.*









No. 23.

*Francis Sternberg*  
*Asst Sub Asst Comd.*  
*Bureau R. F. A. Qr. Mr.*

MONTHLY RETURN

OF

QUARTERMASTER'S STORES

received and issued

in the

Month ending *30<sup>th</sup>* of *November*

18 *67*

*Re*

No. 23.  
**NOTE.**

*Two to be sent to the Quartermaster General's Office,  
one with abstracts and vouchers, and one without them.*

**MONTHLY RETURN OF QUARTERMASTER'S STORES**

Received, issued, and remaining on hand  
at *Thibodaux, La.* in the month  
of *November*, 18*67*.

By *Francis Sternberg*  
*Act Subst Commis Quar*  
*Bureau R. F. & A. L.* Quartermaster

**NOTE**

The property on this return will be classed as follows, viz:

1. Fuel.
2. Forage.
3. Straw.
4. Stationery.
5. Barrack, Hospital, and Office furniture.
6. Means of transportation, including harness, &c.
7. Building materials.
8. Veterinary tools and Horse medicines.
9. Blacksmiths' tools.
10. Carpenters' tools.
11. Wheelwrights' tools.
12. Masons' and Bricklayers' tools.
13. Miscellaneous tools for fatigue and garrison purposes.
14. Stores for expenditure—such as Iron, Steel, Horse-shoes,  
Rope, &c., &c., to be classed alphabetically



Monthly Return of Quartermaster's Stores received

CLASSES . . . . .		1. FUEL.				
DATE.	ABSTRACTS, &c.	WOOD.			COAL.	
		Cords.	Feet.	Inches.	Anthracite.	Bituminous.
		No.	No.	No.	Pounds.	Pounds.
	Per last return . . . . .	On hand . . . . .				
	Abstract D . . . . .	Received by purchase . . . . .				
	" E . . . . .	" from officers . . . . .				
	" N . . . . .	Fabricated, taken up, &c. . . . .				
Total to be accounted for . . . . .						
Per Abstract F . . . . .	Fuel . . . . .					
" G . . . . .	Forage . . . . .					
" H . . . . .	Straw . . . . .					
" I . . . . .	Stationery . . . . .					
" K . . . . .	Special issues . . . . .					
" L . . . . .	Expended, sold, &c. . . . .					
" M . . . . .	Issued and transferred . . . . .					
Total issued and expended . . . . .						
Total remaining on hand . . . . .						
CONDITION . . . . .	1 In good order . . . . .					
	2 Unfit for service, but repairable . . . . .					
	3 Totally unfit for service . . . . .					

and issued at *Thibodaux, Louisiana* in the Month

2. FORAGE.				3. STRAW.	4. STATIONERY.											
Corn.	Oats.	Hay.	Podder.	For Bedding.	Foolscap Paper.	Letter Paper.	Folio-post Paper.	Envelope Paper.	Envelopes.	Blank Books.	Blank Books.			Ink.	Ink Powder.	Wafers.
Pounds.	Pounds.	Pounds.	Pounds.	Pounds.	Qrs.	Qrs.	Qrs.	Qrs.	No.	No.	No.	No.	Botts.	Papers.	Ozs.	
/																



ending on the 30<sup>th</sup> of November, 1867, by Francis Sternberg, Asst. Sub Asst. Commissioner, Bureau of P. F. & A. L.

4. STATIONERY.

Abstract, &c.	Sealing Wax.		Steel Pens.		Quills.		Office Tape.		Inkstands.									
	Ozs.	No.	Gross.	No.	Pieces.	No.	No.	No.	No.	No.	No.	No.	No.	No.	No.	No.	No.	No.
O. H.	/																	
D.																		
E.																		
N.																		
F.																		
G.																		
H.																		
I.																		
K.																		
L.																		
M.																		
1																		
2																		
3																		

Here insert any extra leaves that may be required

6. Means of Transportation

Horses																	
No	/																
0																	
1																	
"																	
1																	
"																	
"																	
"																	
"																	
"																	
"																	
0																	
1																	
1																	
"																	
"																	

by the number of articles borne on the Return.



Abstract, &c.

O. H.  
D.  
E.  
N.

F.  
G.  
H.  
I.  
K.  
L.  
M.

1  
2  
3

I CERTIFY, on honor, that the foregoing Return exhibits a true and correct statement of all the Property which has come into my hands, on account of the Quartermaster's Department, during the month ending on the *thirtieth* of *November*, 18 *67*.

*J. Lewis Struberg*  
Asst. Quartermaster  
Bureau R. F. A. D.

No. 27.

---

No. 1 ABSTRACT E. Books QR. 4867.

---

LIST OF STORES RECEIVED FROM

L. A. Robinson  
Francis Hamburg, A. A. C.

Bu. R. F. A. C. Quartermaster U. S. Army,

at Philadelphia, Pa.



No. 27.

LIST OF QUARTERMASTER'S STORES, &c.,

*Transferred by* *William A. Sub. Asst. Com. Qu.* *Quartermaster*  
*R. H. and A. S.*  
 U. S. Army, to *Francis Steubert A. S. C. R. F. and S.* *Quartermaster U. S. Army,*  
 at *Thibodaux, La.*, on the *17<sup>th</sup>* day of *November*, 186*7*.

NUMBER OR QUANTITY.	ARTICLES.	COST WHEN NEW.		CONDITION WHEN DELIVERED.	REMARKS.
		Dolls.	Cts.		
<i>1</i>	<i>Coat Horse</i>	<i>None</i>		<i>Serviceable</i>	

I CERTIFY that I have this day *Transferred* to *Francis Steubert A. S. C. R. F. and S.* *Quartermaster U. S.*  
 Army, at *Thibodaux, La.*, the articles specified in the foregoing list.  
*William A. Sub. Asst. Com. Qu.*  
*Asst. of Asst. Com. Qu.*  
*R. H. and A. S.* *Quartermaster.*

LIST OF QUARTERMASTER'S STORES, &c., transferred by *W. Robinson* A. Sub. Asst. Comd. *Qu.* Quartermaster  
*R. H. and A. J.* U. S. Army, to *Francis Stenberg* A. S. A. C. *R. H. and A. J.* Quartermaster U. S. Army,  
 at *Thibodaux, La.*, on the *17<sup>th</sup>* day of *November*, 1864.

NUMBER OR QUANTITY.	ARTICLES.	COST WHEN NEW.		CONDITION WHEN DELIVERED.	REMARKS.
		Dolls.	Cts.		
<i>One</i>	<i>Wart. Horse</i>	<i>None</i>	<i>None</i>	<i>Servicable</i>	

I certify that I have this day *transferred* to *Francis Stenberg* A. Sub. Asst. Comd. *Qu.* Quartermaster U. S.  
 Army, at *Thibodaux, La.*, the articles specified in the foregoing list.  
*W. Robinson*  
 Asst. Sub. Asst. Comd. *Qu.* Quartermaster.  
*R. H. and A. J.*



Abstract E.

Abstract of Articles received  
from Officers at Thibodaux, La,  
during the month of November 86  
by Francis Sterberg, Asst.  
Sub Asst Comr Bureau R. I. & A. L.

---

Abstract "E"

Abstract of Articles received from Officers at Tibodaux,  
La., during the month of November 1867, by Francis  
Sternberg, Asst. Sub Asst. Commissioner, Bureau R. F. & A. L.

Date	No of Voucher	From whom received	By Means of Transportation	
			No	Articles
Nov 11	1	S. A. H. Robinson, A. S. A. C.	1	
Total			1	

I certify, that the above Abstract is correct

Francis Sternberg  
Asst Sub Asst Comr  
Bureau R. F. & A. L.



No. 23.

*Francis Sternberg*  
*Asst Sub Asst Comr.*  
*Bureau R. I. & A. L.* Qr. Mr.

---

MONTHLY RETURN  
OF  
QUARTERMASTER'S STORES  
received and issued

in the

Month ending *31<sup>st</sup>* of *December*

*1867*

---

No. 23.

NOTE.

*Two to be sent to the Quartermaster General's Office,  
one with abstracts and vouchers, and one without them.*

MONTHLY RETURN OF QUARTERMASTER'S STORES

Received, issued, and remaining on hand

at *Thibodaux, La.* in the month  
of *December*, 18 *67*.

By *Francis Sternberg*  
*Asst Sub-Asst Commissioner*  
*Bureau A. S. & A. L.* Quartermaster

NOTE

The property on this return will be classed as follows, viz:

1. Fuel.
2. Forage.
3. Straw.
4. Stationery.
5. Barrack, Hospital, and Office furniture.
6. Means of transportation, including harness, &c.
7. Building materials.
8. Veterinary tools and Horse medicines.
9. Blacksmiths' tools.
10. Carpenters' tools.
11. Wheelwrights' tools.
12. Masons' and Bricklayers' tools.
13. Miscellaneous tools for fatigue and garrison purposes
14. Stores for expenditure—such as Iron, Steel, Horse-shoes,  
Rope, &c., &c., to be classed alphabetically



Monthly Return of Quartermaster's Stores received

CLASSES . . . . .		1. FUEL.				
DATE.	ABSTRACTS, &c.	WOOD.			COAL.	
		Cords.	Feet.	Inches.	Anthracite.	Bituminous.
		No.	No.	No.	Pounds.	Pounds.
Per last return . . . . .	On hand . . . . .					
Abstract D . . . . .	Received by purchase . . . . .					
"    E . . . . .	"    from officers . . . . .					
"    N . . . . .	Fabricated, taken up, &c. . . . .					
Total to be accounted for . . . . .						
Per Abstract F . . . . .	Fuel . . . . .					
"    G . . . . .	Forage . . . . .					
"    H . . . . .	Straw . . . . .					
"    I . . . . .	Stationery . . . . .					
"    K . . . . .	Special issues . . . . .					
"    L . . . . .	Expended, sold, &c. . . . .					
"    M . . . . .	Issued and transferred . . . . .					
Total issued and expended . . . . .						
Total remaining on hand . . . . .						
CONDITION . . . . .	1 In good order . . . . .					
	2 Unfit for service, but repairable . . . . .					
	3 Totally unfit for service . . . . .					

and issued at *Thibodaux, Louisiana* in the Month

2. FORAGE.				3. STRAW.	4. STATIONERY.											
Corn.	Oats.	Hay.	Fodder.		For Bedding.	Foolscap Paper.	Letter Paper.	Folio Post Paper.	Envelope Paper.	Envelopes.	Blank Books.	Blank Books.		Ink.	Ink Powder.	Wafers.
Pounds.	Pounds.	Pounds.	Pounds.		Pounds.	Qrs.	Qrs.	Qrs.	Qrs.	No.	No.	No.	No.	Botts.	Papers.	Ozs.
/																



ending on the 31<sup>st</sup> of December, 1867, by Francis Sternberg, Asst

Sub Asst. Commissioner, Bureau of A. F. and C. L.

4. STATIONERY.

Abstract, &c.	Sealing Wax.		Steel Pens.		Quills.		Office Tape.		Inkstands.											
	Qrs.	No.	Gross.	No.	Pieces.	No.	No.	No.	No.	No.	No.	No.	No.	No.	No.	No.	No.	No.	No.	No.
O. H.	/																			
D.																				
E.																				
N.																				
F.																				
G.																				
H.																				
I.																				
K.																				
L.																				
M.																				
1																				
2																				
3																				

Here insert any extra leaves that may be required

6. Means of Transportation

Abstract, &c.																				
1	/																			
"																				
"																				
"																				
"																				
"																				
"																				
"																				
"																				
"																				
"																				
"																				
"																				

by the number of articles borne on the Return.



		Abstract, &c.																				
O.	H.																					
D.																						
E.																						
N.																						
		F.																				
		G.																				
		H.																				
		I.																				
		K.																				
		L.																				
		M.																				
1																						
2																						
3																						

		Abstract, &c.																				
1																						
2																						
3																						

I CERTIFY, on honor, that the foregoing Return exhibits a true and correct statement of all the Property which has come into my hands, on account of the Quartermaster's Department, during the month ending on the *thirty first* of *December*, 18*64*.

*J. Ruess Stenberg*  
*Asst. Surg. Genl.*  
 Bureau R. I. Anst. Co.



Lieut Nelson Browder

A.S.A. Coon Bureau of R.F. & D.E.

no. 1, at

Thibodeaux

2000

South 42 - Johnson by A.S.A. B.



Lieut Nelson Brown

A.S.A. Coon Bureau of R.F. & A.S.

at  
Theodecamp. La

Report

of

Indigent and Destitute Freedmen

for

The Month of May 1868

Printed & Published by G.S.N.S.

1  
Office A.S.A. Com Bureau of R.F. & A.S.  
Philadelphia La May 31<sup>st</sup> 1868

Report of Indigent and Destitute Freed People in the Parish  
of Lafourche. La. applying for relief during the month of  
May 1868.

Name	Age	Sex	Cause of Destitution	Name of Police Investigating to Destitution	Date when Reported	Remarks
Emmanuel Gibson	72	Male	Old Age	S. J. G. Moore	Jan 17. 1868	No funds have been provided by this parish for the purpose of assisting the indigent and destitute
Francois Morton	76	"	" "	" " "	" 6. 1868	
Maria Morton	69	Female	" "	" " "	" " "	
Serena Ardogne	27	"	Feeble & Unhealthy	" " "	Feb 9. 1868	
Emma Ardogne	1	"	Young & helpless	" " "	" " "	
Victor Ardogne	3	Male	" "	" " "	" " "	
Joe Ardogne	30	"	Sickly & helpless	" " "	" " "	
Peter Ardogne	7	"	Young & helpless	" " "	" " "	
Josephine Ardogne	9	Female	" "	" " "	" " "	
Rosa Ardogne	5	"	" "	" " "	" " "	
Sam Washington	85	Male	Old Age	" " "	Jan 8. 1868	
Louy Anna Cook	78	Female	" "	" " "	" 1. 1868	
E. Chiasson	33	"	Sick & helpless	" " "	" " 1868	
P. Coutelle	41	"	" "	" " "	Mar 4. 1868	
Andre Coutelle	8	Male	Young & helpless	" " "	Mar 4. 1868	
Annina Coutelle	6	Female	" "	" " "	" " "	



Name	Age	Sex	Causes of Destitution	Name of Police Officers who certified to Destitution	Date when Reported	Remarks
Amelia Coutelle	7	Female	Young & Helpless	J T Gismore	Mar 4 1868	
Lenny Coutelle	10	"	" "	" " "	" " "	
George	81	Male	Old Age	" " "	Jan 9 1868	
Marie Congo	74	Female	Old Age	" " "	" " "	
Marie Griffin	69	"	" "	" " "	" " "	
Violette	79	"	" "	" " "	" " "	
Sully Robertson	73	"	" "	" " "	" " "	
Moses Smith	39	Male	Crippled	" " "	Feb 12 1868	
Marion Ward	69	Female	Old & Feeble	" " "	Jan 3 1868	
Peter	88	Male	Old Age	" " "	Jan 1 1868	
<sup>Davis</sup> Rachel Cabis	72	Female	" "	" " "	Jan 14 1868	
Isaac Williams	90	Male	" "	" " "	Jan 13 1868	
Wilson Wright	77	"	" "	" " "	" " "	
Augustine Wright	73	Female	" "	" " "	" " "	
Francis Foret	92	Male	" "	" " "	Jan 4 1867	
Edward Houser	88	"	" "	" " "	Jan 13 1868	
Edward Daily	76	"	" "	" " "	" 9 "	
Julia Daily	71	Female	" "	" " "	" " "	
Samuel Cornoy	75	Male	" "	" " "	Jan 2 1867	
Lucy Fletcher	73	Female	" "	" " "	Jan 6 1868	
Charlotte Shadow	71	"	" "	" " "	" " "	

Name	Age	Sex	Causes of Destitution	Name of Police Officers who certified to Destitution	Date when Reported	Remarks
Francis Wilson	92	Male	Old Age	" "	Jan 3 1867	
Corcoran Wilson	69	"	" "	" "	" " "	
Valette Williams	94	Female	" "	" "	" " "	
Nancy Walker	25	"	Sickly	" "	Jan 5 1868	



Edward Daily	76	"	"	"	"	"	"	79	"
Julia Daily	71	Female	"	"	"	"	"	"	"
Samuel Cornoy	75	Male	"	"	"	"	"	Jan 2, 1867	"
Lucy Fletcher	78	Female	"	"	"	"	"	Jan 6, 1868	"
Charlotte Johnson	71	"	"	"	"	"	"	"	"

White	Age	Sex	Destitution	Certifying to Destitution	When Reported,	Remarks
Francis Wilson	92	Male	Old Age	"	Jan 3, 1867	
Coreos Wilson	69	"	"	"	"	
Valette Williams	94	Female	"	"	"	
Nancy Walker	25	"	Sickly	"	Mar 5, 1868	
Simon Johnson	29	Male	"	"	"	
Mansfield	68	"	Old & Feeble	"	Feb 11, 1868	
Rosa	52	Female	"	"	"	
Marie	10	"	Young & E	"	"	
Peter Brown	76	Male	Old Age	"	Jan 1, 1868	
Samuel Washington	79	"	"	"	"	
Virgil Johnson	47	"	Sickly	"	"	
Louvy Glasper	38	"	Crippled	"	Apr 2, 1868	
Sarah Grocey	33	Female	Sickly	"	Mar 30, 1868	
Dinole	83	"	Old Age	"	Jan 7, 1868	
George Rivins	40	Male	Crippled	"	Feb 7, 1868	
Commer Jones	87	"	Old Age	"	Jan 3, 1868	
Benema Adams	35	"	Sickly	"	Mar 9, 1868	
Lewis Ardognu	45	"	"	"	Apr 13, 1868	
Sarah Ardognu	43	Female	"	"	"	
J. Boudreau	39	"	"	"	"	
Amelia Boudreau	33	"	"	"	"	
Lewis Morre	35	Male	"	"	Mar 6, 1868	



Simon Johnson	60	Male	Crippled	S. T. Grist	Jan 12 1868
Amelia Brossen	70	Female	old Age	"	Jan 1. 1867
Lewis Gouag	49	Male	Sickly	"	Mar. 8. 1868
W. L. Talifere	46	"	Crippled	"	" " "
Jim Ballard	87	"	Old Age	"	Jan 2. 1868
Celestin Cload	43	Female	Sickly	"	Feb 19. 1868
Betsy Simons	73	"	Old Age	"	Jan 1868
Angelique Nichols	70	"	"	"	" "
Harry Nelson	82	Male	"	"	" "
Emile Doucer	47	"	Sickly	"	Jan 17. 1868
Louis Doucer	7	"	Young	"	" " "
Sally Pope	40	Female	Sickly	"	" 5 "
Thomas Valentis	75	Male	old Age	"	" 11 1868
Edmond Bazil	37	"	Feeble	"	April 9. 1868
Josephine Myers	48	Female	"	"	" " "
Lacy Hall	80	"	Old Age	"	Jan 4. 1868
C. D. Rodrigaz	70	Male	"	"	" " "
Jean Baptiste	76	"	"	"	" " "
Wilson Wink	82	"	"	"	" " "
Mary Charles	39	Female	Sickly	"	Apr 3. 1868
Edward Bailey	87	Male	old Age	"	Feb 13. 1868
Jean Bodreau	34	Male	Sickly	"	Mar 11. 1868

Biot Williams	39	Male	Sickly	S. T. Grist	Apr. 4. 1868
Caroline Williams	79	Female	Old Age	"	Feb 3. 1868
Joseph Rabin	9	Male	Young	"	" " "
Gaspard Bavoisa	68	"	Old & Feeble	"	Jan. 9. 1868
Luisa Gou	71	Female	"	"	" " "



Jean Baptiste	76	"	"	"	"	"
Wilson Wink	82	"	"	"	"	"
Mary Charles	39	Female	Sickly	"	"	Apr 2, 1868
Edward Bailey	87	Male	old Age	"	"	Feb 13, 1868
Jean Rodrigue	34	Male	Sickly	"	"	Mar 11, 1868

Biot Williams	39	Male	Sickly	J.F. Bristow	Apr. 4, 1868
Caroline Williams	79	Female	Old Age	"	Feb 3, 1868
Joseph Rabin	9	Male	Young &c	"	" " "
Gaspard Bavoise	68	"	Old & Feeble	"	Jan 9, 1868
Sylvia Gee	71	Female	"	"	" " "
Charles Sanders	75	Male	"	"	" " "
Souder Henry	87	"	"	"	" " "
Mary Isaacs	83	Female	"	"	" " "
Covin Rodriguez	47	Male	Sickly	"	Not Known
Lydia Johnson	78	Female	Old Age	"	Jan 1868
Wm Hall	69	Male	"	"	Mar 30, 1868
James Henry	49	"	Sickly	"	" " "
John Gray	75	"	Old Age	"	Jan 1868
Geoville Rodriguez	37	"	Sickly	"	Not Known
Covis	73	Female	Old Age	"	Jan 1868
Rose	13	"	Young &c	"	" "
Julia	12	"	"	"	" "
Josephine	10	"	"	"	" "
Marie	6	"	"	"	" "
Victorine	4	"	"	"	" "
Esther	2	"	"	"	" "
Joseph	16	Male	Sickly	"	Not Known no Record



Paul	15	Male	<sup>crippled</sup> Young	St Griston	April - 1868
Sean	13	"	"	"	not known
Georges	12	"	"	"	"
Antoine	10	"	"	"	"
Valentine	8	"	"	"	"
Marie	6	Female	"	"	"
Sarah	7	"	"	"	"
Georges	6	Male	"	"	"
Victor	4	"	"	"	"
Paul	3	"	"	"	"
Patrick	2	"	"	"	"
Charles	1	"	"	"	"
J. Thierd	42	"	Sickly	"	Apr 5. 1868
Josephine	36	Female	"	"	"
Marie	5	"	Young	"	"
A. Andrea	47	Male	Sickly	"	Mar 9 1868
Rosa	36	Female	"	"	"
Delphine	17	"	"	"	"
Anna	16	"	"	"	"
Emile	14	Male	"	"	"
Sean	12	"	Young	"	"
Leow	10	Female	"	"	"
Baptiste	8	Male	"	"	"
Marguerite	29	Female	Sickly	"	Mar 12
Julia	4	"	Young	"	"

Henry	8	Male	Young	St Griston	Mar 12
Rosa	39	Female	Sickly	"	" 2
Louis	7	Male	Young	"	"
Collier	66	"	Old & Feeble	"	Jan 3 1868



Anna	16	"	"	"	"	"	"	"
Emile	14	Male	"	"	"	"	"	"
Leau	13	"	Young &c	"	"	"	"	"
Leow	10	Female	"	"	"	"	"	"
Baptiste	8	Male	"	"	"	"	"	"
Marguerite	29	Female	Sickly	"	"	Mar 12	"	"
Julia	4	"	Young &c	"	"	"	"	"

Henry	8	Male	Young &c	St Bris word	Mar 12			
Rose	39	Female	Sickly	"	"	"	2	
Louis	7	Male	Young &c	"	"	"	"	
Agller	66	"	Old & Feeble	"	"	Jan 3 1868		
Marguerite	38	Female	Sickly	"	"	Mar 30, 1868		
Louise	9	"	Young &c	"	"	"	"	"
Delphine	7	"	"	"	"	"	"	"
Daniel	72	Male	Old Age	"	"	Jan 9, 1868		
Josephine	70	Female	"	"	"	"	"	"
Amy	73	"	"	"	"	"	"	"
Josephine	5	"	Young &c	"	"	"	"	"
Marie	12	"	"	"	"	"	"	"
John	9	Male	"	"	"	"	"	"
Marguerite	5	Female	"	"	"	"	"	"
Law	13	Male	"	"	"	"	Not known	
Henry	12	"	"	"	"	"	"	"
Marguerite	11	Female	"	"	"	"	"	"
Julia	9	"	"	"	"	"	"	"
Henry	14	Male	"	"	"	"	"	"
Baptiste	12	"	"	"	"	"	"	"
Paul	9	"	"	"	"	"	"	"
Leau	6	"	"	"	"	"	"	"



Louis	6	Male	Young	St. Griswold	Not Known
Marie	4	Female	" "	" "	Not Known
Josephine	3	"	" "	" "	" "
Antoine	7	Male	" "	" "	" "
Sean	6	"	" "	" "	" "
Dick	4	"	" "	" "	" "
Jesse	78	"	Old Age	" "	March 3 <sup>rd</sup>
Silas Bout	<sup>Not Known</sup>	"	Not Known	" "	April 5
Milly	"	Female	Sickly	" "	" 9

I Certify that the above is a correct list of indigent and Destitute Freedmen as shown by the records of this office for the month of May 1868

Nelson Browder  
Lieut 42<sup>d</sup> Infantry A.S.A.C.

Lieut Nelson Browder

U.S.A. Comm Bureau of R.F. & I.S.



Report of  
Indigent and Destitute  
Freedmen

for the month ending  
June 30<sup>th</sup> 1868

by

Lieut Nelson Broun 4<sup>th</sup> Deputy  
A.S.A.C. Bureau of R. F. and H. S.

Lafayette



Office Asst Com B of R F and A L

Thibodaux La June 30<sup>th</sup> 1868

Report of Indigent and Destitute Freed People in the Parish of Lafourche La. applying for relief during the month ending June 30<sup>th</sup> 1868.

Names	Age	Sex	Name of Police Inspector Certifying to Destitution	Date of Report	Remarks
Cannon Jones	100	Male	J T Griswold	June 6 <sup>th</sup> 1868	old and feeble
Melinda Thomas	70	Female	" "	" " "	" "
Harry Laughlin	25	Male	" "	" " "	Sick with Rheumatism
Kelly Smith	70	Female	" "	" " "	Old and feeble
Clarrissa Jones	70	"	" "	" " "	" "
Reuben Knott	71	Male	" "	" " "	" and Ruptured
Joe Shelovey	74	"	" "	" " "	" " Crippled
Edward Mitchell	30	"	" "	" " "	Sick and feeble
Thomas Williams	60	"	" "	" " "	Old and Crippled
Nancy Thomas	50	Female	" "	" " "	Blind
Julia Lasher	45	"	" "	" " "	Sick and feeble
Maria Lasher	12	"	" "	" " "	Young and helpless
Susaw Lasher	10	"	" "	" " "	" " "
Clement Lasher	6	Male	" "	" " "	" " "
Millo Thompew	40	Female	" "	" " "	Enciente 4 children
Virgil	12	Male	" "	" " "	Young and helpless
David	10	"	" "	" " "	" " "



Felicia Thompson	8	Female	"	"	June 6. 1868	Young & Helpless
Caroline "	3	"	"	"	"	"
Ann Stephens	24	"	"	"	8	Crippled
Isaac Harris	87	Male	"	"	"	Old & Feeble
Harriet Bloomfield	55	Female	"	"	"	Crippled
Morton Bloomfield	50	Male	"	"	"	Sick & Feeble
Maria Griffin	75	Female	"	"	"	Old & Feeble
Elizabeth Page	43	"	"	"	"	Sick & Feeble
Abram Collins	53	Male	"	"	"	Crippled
William Collins	30	"	"	"	"	Last one arm
Laura Maxwell	14	Female	"	"	"	"
Mary Legarde	60	"	"	"	"	Sick and Feeble
Henry Conley	90	Male	"	"	"	old & Feeble
George Gibbs	70	"	"	"	"	"
Rosina Gibbs	64	Female	"	"	"	"
Samuel Gibbs	12	Male	"	"	"	Young & Helpless
Samuel Ward	76	"	"	"	"	Old & Feeble
Milla Coleman	30	Female	"	"	"	Crippled Last one foot
Phoebe Ann Cook	80	"	"	"	9	old and Feeble
Sylvia Lee	90	"	"	"	"	"
Polly Collins	94	"	"	"	"	"
Sarah Russ	50	"	"	"	"	Sickly
Lawrence Bergeris	70	Male	"	"	"	old & Feeble
Edward Houser	73	Male	"	"	June 9. 1868	Old & Feeble
William Hall	50	"	"	"	"	Sick & Feeble
Charles Howell	93	"	"	"	"	Old age
Simon Johnson	50	"	"	"	"	Crippled



Phoebe Ann Coode	80	"	"	"	9	"	old and Feeble
Sylvia Gee	90	"	"	"	"	"	"
Polly Collins	94	"	"	"	"	"	"
Sarah Russ	50	"	"	"	"	"	Sickly
Lawrence Bergeris	70	Male	"	"	"	"	old and Feeble

Edward Houser	73	Male	"	"	June 9. 1868	"	Old and Feeble
William Hall	50	"	"	"	"	"	Sick and Feeble
Charles Howell	93	"	"	"	"	"	Old Age
Simon Johnson	50	"	"	"	"	"	Crippled
Wansfield Tucker	72	"	"	"	"	"	Old and Feeble
Millie Tucker	60	Female	"	"	"	"	"
Chloe Jackson	94	"	"	"	"	"	"
Henry Horner	40	Male	"	"	"	"	Crippled
Jacob King	55	"	"	"	"	"	"
Saul Washington	90	"	"	"	"	"	old and Feeble
Lewis Young	40	"	"	"	"	"	Crippled
Emmanuel Gibson	80	"	"	"	"	"	Old and Feeble
Henry Langford	70	"	"	"	"	"	"
James Ballard	70	"	"	"	"	"	"
Luay Fletcher	71	Female	"	"	"	"	"
Rachel Bailey	69	"	"	"	"	"	"
Thomas Valentini	68	Male	"	"	"	"	"
Ottawa Hill	79	"	"	"	"	"	"
Charlotte Johnson	68	Female	"	"	"	"	"
Lewis Moore	43	Male	"	"	"	"	Crippled
Eloise Edwards	88	Female	"	"	"	"	old and Feeble
Charles Sanders	80	Male	"	"	"	"	old and Crippled



				3		
Mattie Johnson	<del>48</del>	Female	"	"	June 9. 1848	Crippled
Lorraine Wood	48	"	"	"	" " "	"
Alexander Simon	47	Male	"	"	" " "	"
Wilson Hunt	75	"	"	"	" " "	old and Feeble
Pesse Jones	80	"	"	"	" " "	" "
James Taylor	78	"	"	"	" " "	" "
John Houston	40	"	"	"	" " "	Crippled
Lucia Fisher	80	Female	"	"	" " "	old and Feeble
Julia Houston	9	"	"	"	" " "	Young and helpless
Joseph Houston	7	Male	"	"	" " "	" "
Charlotte Jackson	40	Female	"	"	" 15 "	Sick and Crazy
Otter Pope	68	Male	"	"	" " "	old and Ruptured
Lazus Haines	70	"	"	"	" " "	" " Feeble
Lewis Harper	65	"	"	"	" " "	old and sickly
Jane Harper	60	Female	"	"	" " "	" " "
Isaac Rice	69	Male	"	"	" " "	" " Ruptured
Elijah Canada	70	"	"	"	" " "	" " Crippled
Mathew Williams	62	"	"	"	" " "	" " "
Jenny Washington	75	Female	"	"	" " "	" " Feeble
Alexander Concord	78	Male	"	"	" " "	" " "
Mary Williams	100	Female	"	"	" " "	" " "
Dorcas Wilson	78	Male	"	"	" " "	" " "
Frances Wilson	73	Female	"	"	" " "	" " "
Wille Gaines	80	"	"	"	" " "	" " "

Mary Ann Jayne	30	Female	"	"	June 15. 1848	Crippled
Moses Smith	44	Male	"	"	" " "	"



Mary Williams	100	Female	"	"	"	"	"	"	"
Dorcas Wilson	78	Male	"	"	"	"	"	"	"
Frances Wilson	73	Female	"	"	"	"	"	"	"
Wille Gaines	80	"	"	"	"	"	"	"	"

Mary Ann Gayne	30	Female	"	"	June 15. 1868	Crippled
Moses Smith	44	Male	"	"	"	"
Luce Smith	10	"	"	"	"	Young <sup>d</sup> Helpless
Clarissa Smith	8	Female	"	"	"	"
Aune Smith	6	"	"	"	"	"
Moses Smith	2	Male	"	"	"	"
Betty Smith	Infant	Female	"	"	"	"
Joseph Massenberg	70	Male	"	"	"	Old <sup>d</sup> Feeble
Lenny Massenberg	74	Female	"	"	"	"
Mary Isaacs	100	"	"	"	"	"
Mary Ann Gauds	46	"	"	"	"	Sickly
Henry Ruzil	70	Male	"	"	"	Old <sup>d</sup> Sickly

I certify that the above is a correct report of Indigent and Destitute Freedmen who have applied for relief during the month ending June 30<sup>th</sup> 1868

Wilson Brown  
 Lieut 42<sup>d</sup> Infantry A.S.A.C.

Bureau of R. F. and A. L.  
Parish of Lafourche, State of La.  
Office Ass. Sup. Ass. Com.  
- The Woodland, Jan 31, 1868

---

Hernberg, Francis  
Ass. Sup. Ass. Com.

---

Submits report of condition  
of the Parish, for the 11 days  
ending Jan. 31. —

RC



Bureau of Refugees, Freedmen and Abandoned Lands,  
PARISH OF LAFOURCHE, STATE OF LOUISIANA.  
OFFICE ASSISTANT SUB ASSISTANT COMMISSIONER.

Thibodaux, La., January 31<sup>st</sup> 1868

Captain Lucius H. Warren  
A. A. A. General

Captain,

I beg leave to submit the following  
as a tri-monthly Report of the condition of my Parish, for the  
eleven days ending this day.

I respectfully refer to my last tri-monthly Report, in which  
I faithfully described the condition of the Parish, and now am  
sorry to be forced to repeat, that the evils, which I then pointed  
out to you, are yet on the increase.

Notwithstanding the assurance received from Rapides Parish  
as well as from your Office, the laborers expected from there have not  
arrived. - I have written again and again, praying that they  
might be forwarded promptly, but four weeks have not been sufficient  
to accomplish a distance made by boat in forty eight hours. -

The evil consequences, I dreaded so much, are being speedily  
noticed, as the colored people in this Parish are now mostly out  
of employ, most of the seed cane is lost by this delay, which will  
give another short crop, the conduct of the colored people is getting  
worse and worse & large numbers will soon be on the hands  
of the Government. - I beg you to believe, that I have labored

energetically and faithfully for the welfare of the colored race, and that the responsibility for the disturbed state of my Parish does not rest on my shoulders. —

I particularly beg leave to call your attention to the fact, that all the Planters, who have engaged the hands expected, have lost very largely by their confidence in the Bureau.

I again beg leave to remind you of the clothing so much needed and promised since three months. —

Very respectfully

Your obedient servant

Francis A. Stenberg

Asst. Sub. Asst. Comr.

Bureau of R. F. & A. L.



Office of President of Police Jury  
Parish of Lafourche La

---

Authorization for Mr. F. Steinberg,  
A. S. A. Commr. to provide with and conduct  
5 crazy freedwomen & colored men to N. Orleans,  
La where it will be provided for such people.

---

11/10/77  
Steinberg  
11

School Meeting  
Next Monday Night  
in the School Room

every people  
to N. O. Lane  
conduct  
meeting

3  
for June



Office President of the  
Police Jury Parish of  
Lafourche State of Louisiana

There being no deputy Sheriff  
~~available~~ occupied to day, and there being  
no one acquainted with the au-  
thorities in New Orleans Capt  
Stimbergh of the Freedmen's  
Bureau is hereby authorized  
to proceed with & conduct  
five negro freedmen & send  
them to the City of New Orleans  
and place some in the Hospital  
for such persons provided.

It is thought indispensably  
necessary for Capt. Stimbergh  
to accompany them for the  
above reasons.

J. J. Guissard  
President Police  
Jury

Thibodaux La. April 1. 1868.

Nelson Branton  
2<sup>nd</sup> Lieut 12<sup>th</sup> U.S. Infantry

Requisition for Stationery.

No. 38.

No. .... Abstract I, ..... Qr. 186

STATIONERY.

F.B. # 107 = F. 32 = 1868.

Issued to \_\_\_\_\_ 186

Respectfully returned with the information that Mr F. Clougen late Asst Sub Asst Com B R A & Co L at Thibodaux La draw the allowance of Stationery for the Quarter ending June 30<sup>th</sup> 1868. Should an additional supply be requisite for the business transactions of your Office you will please make Special Requisitions (Forms enclosed) stating the necessity for the same in the body of the Requisitions, sign and forward to this Office and when the same are approved the Stationery will be furnished. You will

also state for what month the Stationery is required,

Edgar J. Simon  
Adj Cal D.O. Va. Ag. M.

*[Vertical handwritten notes, mostly illegible]*

*[Vertical handwritten notes, mostly illegible]*



No. 38—(VOUCHER TO ABSTRACT I.)

REQUISITION for Stationery for *3<sup>d</sup> Lieut Nelson Bronson 42<sup>d</sup> Infantry*  
 stationed in *Thibodeaux La* for the *Quarter*  
 commencing on the *first* of *April* 186*8*, and ending on the *thirtieth*  
 of *June* 186*8*

Quires of Letter Paper.	Quires of Foolscap Paper.	Envelopes.	Number of Steel Pens.	Ounces of Wafers.	Ounces of Sealing Wax.	Pieces of Office Tape.	Bottles of Ink.			
=	1 1/2	12	6	1/8	=	=	1	=	=	=

I CERTIFY that the above requisition is correct, and that I have not drawn Stationery for any part of the time specified.

*Nelson Bronson*

*3<sup>d</sup> Lieut 42<sup>d</sup> Infantry*

Received, at ..... on the ..... of ..... 186 ,  
 of ..... Quartermaster, U. S. Army,  
 ..... quires of letter paper, ..... quires of foolscap paper,  
 Envelopes, ..... Steel Pens, ..... ounces of wafers, ..... ounces of  
 sealing wax, ..... pieces of tape, ..... Bottles of Ink,  
 ..... in full of the above requisition.

(SIGNED IN DUPLICATE.)

*Nelson Bronson*  
*Lieut 42<sup>d</sup> Infantry*

No. 38.

No. .... Abstract I, ..... Qr. 186

STATIONERY.

Issued to

186

186  
No. 38

Handwritten notes in vertical columns, including the name "Wm. H. ...".



No. 38—(VOUCHER TO ABSTRACT I.)

REQUISITION for Stationery for 2<sup>d</sup> Lieut Nelson Broadson 42<sup>d</sup> Inf  
 stationed in Thibodeaux La for the Quarters  
 commencing on the first of April 1868, and ending on the thirtieth  
 of June 1868

Quires of Letter Paper.	Quires of Foolscap Paper.	Envelopes.	Number of Steel Pens.	Ounces of Wafers.	Ounces of Sealing Wax.	Pieces of Office Tape.	Bottles of Ink.			
= 1 1/2	12	6	1/8	=	=	1	=	=	=	

I CERTIFY that the above requisition is correct, and that I have not drawn Stationery for any part of the time specified.

Nelson Broadson

2<sup>d</sup> Lieut 42<sup>d</sup> Infantry

Received, at ..... on the ..... of ..... 186 ,  
 of ..... Quartermaster, U. S. Army,  
 ..... quires of letter paper, ..... quires of foolscap paper,  
 Envelopes, ..... Steel Pens, ..... ounces of wafers, ..... ounces of  
 sealing wax, ..... pieces of tape, ..... Bottles of Ink, .....  
 ..... in full of the above requisition.

(SIGNED IN DUPLICATE.)

Nelson Broadson  
2<sup>d</sup> Lieut 42<sup>d</sup> Infantry

Theodore E. April 13. 1868.

---

F. Sternberg  
A. S. A. Commr.

---

Inform Mr. Simon that a freedman, Colman  
Person has complained that he owes him \$9.50.  
Requests that he pay that colored man, or send  
to the Bureau an explanation, why he declines the  
payment.

---

RE



Du<sup>o</sup> R. F. & C. L. Parish of Lafourche  
Thibodaux, La. April 13<sup>th</sup> 1868

M<sup>r</sup> Simon

Sir,  
Colman Parson

a Freedman of this Parish complains  
that you are indebted to him in the  
sum of \$ 9.50 for services rendered  
and refuse to pay him the same.

You will therefore please pay him  
or furnish this office with satisfactory  
reasons why you decline doing so.

Very Respectfully

Your Obed<sup>t</sup> Servant  
in the absence of

J. Sternberg

A. H. S. A. C.  
M. W. V. S.  
Clark

Settled  
the 15<sup>th</sup> of  
Simon will  
to Colman  
that part  
of salary

Receiver of Francis  
Stenberg A.S.A., the  
sum of Eight Dollars  
& 30 cents on A/c of  
M<sup>r</sup>. Thieriot

Nelson<sup>de</sup> Bradford  
mark

witnesses:

Paul Barrett



Nelson Crawford and family

\$

Camilia Crawford

\$ 10.00 par 26 jours de travail  
13 jours douvrage donnais  
Avance par tabac

5 00  
20  
4 80

Piter Crawford

\$ 10.00 par 26 jours douvrage  
12 1/2 jours douvrage donnais  
Avance par tabac. 20 Giraps. 30

4 81  
50  
4 31

Williams Crawford

\$ 4.00 par 26 jours douvrage  
10 1/2 jours douvrage donnais

1 60

Mary Crawford

\$ 8.00 par 26 jours douvrage  
7 1/2 jours douvrage donnais  
Avance par prison

2 85  
25  
2 60

Déménagement

3 Charaites @ \$5.00  
Soiage d'un mulais

15 00

1 00  
16 00  
13 31  
2 69

Camilia Crawford \$ 4.80

Peter Crawford \$ 4.31

Williams Crawford \$ 1.60

Mary Crawford \$ 2.60

13.31

5. -

4 81

1 60

2 85

14 26

95

13 31

8.31

Received of Mr. Theriot the  
sum of Eight Dollars, thirty cents  
for Nelson Crawford - full balance  
Francis Therberg  
ASA

Receipt of  
Asa Webster  
for \$6.25

Chairman's name H. Warren M.D.

Received of  
D. F. A. S.  
for the purchase of  
the book on the  
2nd April 1868

Misc

Thompson



Bureau of Land Office  
Parish of Lafourche  
Thibodaux La<sup>4</sup> April 6<sup>th</sup> 1868

Captain Lucius H. Warren U.S.A.

Receipt of  
Asa Webster

for \$6.25

MOO

Thibodaux

Shuboclean + Los May 12<sup>th</sup> 1848  
Received of Lieut Nelson Broulow 42<sup>d</sup> Infantry \$3.25  
the same being the Balance in full of My account against  
Peter Wunder for \$1.<sup>25</sup>/<sub>100</sub>

Witnesses

Asa <sup>his</sup> Webster  
mark

Witness Thomas Deane



Bureau R. P. & A. Co.  
Parish of Lafourche State of La.  
Thibodaux, Feb 21 1860

Receiver of M. P. Chas Gaudé  
the sum of Ten Dollars (\$10-)  
on ac of this bill.

Francis Stenberg  
Asst. Auditor

Witness  
J. S. Morris

Subst. Court  
in charge of the Dist. Ct.

Paid by cash & p. p. \$12.50 Twelve  
Dollars & fifty cents.

Francis Stenberg  
Asst. Auditor

Thibodeaux & Co  
May 10<sup>th</sup> 1867 -

Six months from date I promise  
to pay to Flemming Banks or order  
Fifty Dollars with interest at the  
rate of eight per cent per annum value  
received

Chas. Landri.



March 8. 1868

Receiver of Francis Sternberg A. S. A. C. the sum  
of Ten Dollars (\$10.00) on ac of Mr. Chas Gaudé

Witness

Flemming <sup>his</sup> Banks  
mark

March 8. 1868

I herewith acknowledge the credit of Twelve Dollars  
& fifty cents marked by Francis Sternberg A. S. A. C. on  
the Bill of Chas Gaudé to be correct

Witness

Flemming <sup>his</sup> Banks  
mark

*Handwritten notes in the left column, possibly a name or address.*

No. 19.

No. ABSTRACT B. Qr. 186 .

*John H. Rough*

Dollars 11 <sup>60</sup>/<sub>100</sub>.

Paid \_\_\_\_\_ of \_\_\_\_\_, 1868.

*Jan 4<sup>th</sup> 60*  
*Mar 16<sup>th</sup> 60*

*B 26 8<sup>th</sup> Sub Dist of La 1868*







No. 19.

The United States,

To John H. Brough A. S. A. Com. B. R. F. & A. S.

Dr.

DATE.		DOLLARS.	CTS.
	For the actual expense of his transportation while traveling under orders in the discharge of his duty as <del>clerk to Major Asst. Sub. Asst. Com.</del> <u>clerk to Major Asst. Sub. Asst. Com. B. R. F. &amp; A. S. Parishes St. James &amp; Ascension</u> , <del>Paymaster United States Army</del> , from <u>the 1<sup>st</sup> day of Jan'y 1868</u> to <u>the 31<sup>st</sup> day of March 1868</u> per annexed statement <u>herewith attached</u> .	# 11.	60

I certify, on honor, that John H. Brough was, during the time above specified, employed as clerk in the Pay Department, United States Army; and that the journeys charged for in the above account were performed by him in the discharge of his official duties under my orders.

John H. Brough  
~~Paymaster U. S. Army~~

Ascension Parish COUNTY, La.

On this Thirty-first day of March, one thousand eight hundred and sixty-eight, personally appeared before me, the subscriber, John H. Brough A. S. A. Com. &c. and made oath, in due form of law, that the above account is correct and just, and exhibits the actual expense of his transportation for and during the journey above specified.

(Subscribed in duplicate.)

Octave Ferrero  
 Clerk of 4<sup>th</sup> Dist. Court Justice of the Peace.

RECEIVED at \_\_\_\_\_, the \_\_\_\_\_ of \_\_\_\_\_, 186 \_\_\_\_\_, of \_\_\_\_\_, Quartermaster United States Army, \_\_\_\_\_ dollar \_\_\_\_\_ and \_\_\_\_\_ cents, in full of the above account.

(SIGNED IN DUPLICATE.)

John H. Brough  
~~A. S. A. Com.~~



Invoice of  
property received from  
Lt Nelson Bronson this 11<sup>th</sup>  
day Sept 1868 for which  
I have signed

Retained

Received from Lt Nelson Bronson 42<sup>d</sup> U.S. Infy A.S.A.C.  
 Parish of Lafourche at Thibodaux La this 11<sup>th</sup> day Sept 1865  
 the following property pertaining to Bureau R.7<sup>th</sup> and A. Lands.

No	Article	Condition when del <sup>d</sup>	Cost when rec <sup>d</sup>
Fifty three 53	Wool Hats.	Damaged	Not known
Seven 7	Blank Books.	None	" "
One 1	Ink Stand	"	" "

Received from <sup>Br</sup> Lt Col Edgar C. Beman U.C. and A.A.G.M.  
 Bureau of R.7<sup>th</sup> and A.L. this 11<sup>th</sup> day Sept 1868. at Thibodaux La  
 the following property pertaining to duty in the Bureau of R.7<sup>th</sup> + A.L.

No	Article	Condition when del <sup>d</sup>	Cost when rec <sup>d</sup>
One (1)	Saddle	Worn	not known
One (1)	Bridle	"	" "
One (1)	Saddle Blanket	"	" "

Received from <sup>Br</sup> Lt Col Edgar C. Beman U.C. & A.A.G.M. Bureau of  
 R.7<sup>th</sup> and A.L. at Thibodaux La this 11<sup>th</sup> day of Sept 1868 the  
 following Government Property. viz

No	Article	Condition when rec <sup>d</sup>	
One (1)	Barrel Horse	Good.	



Retained

No: 27.

No 1 *Ret School Property*  
~~ABSTRACT E.~~ Qr. 1868

LIST OF STORES

Quartermaster, U. S.

at

School Property

LIST OF ~~QUARTERMASTER STORES~~ <sup>sc.</sup>  
 A.S.A.C. ~~Bof R. 7<sup>th</sup> U.S.~~  
 Quartermaster U.S.

Transferred by Lieut Nelson Brouson 42<sup>d</sup> Infantry  
 Mr John H Van Antwerp A.S.A.C. Bof R. 7<sup>th</sup> U.S.  
 at Thibodaux Louisiana, on the 11<sup>th</sup> day of September 1868

NUMBER OR QUANTITY.	ARTICLES.	COST WHEN NEW.		CONDITION WHEN DELIVERED.	REMARKS.
		Dolls.	Cts.		
1	Fifteen	15			Elementary Charts
2	Six	6			Charts
3	Two	2			Outline Maps
4	Forty Two	42			Spelling Books
5	Sixty Seven	67			First Readers
6	Sixty Nine	69			Second "
7	Forty Five	45			Third "
8	Ten	10			Geographies No 1
9	Ten	10			" No 2
10	Fifteen	15			" No 3
11	Seventy Two	72			Primary Arithmetics
12	Ten	10			School "
13	Seven	7			Grammars 1 <sup>st</sup> Lesson
14	Thirty	30			Slates
15	Seven	7			Teachers Desks
16	Forty Six	46			Common Desks
17	Eighty Four	84			Benches
18	Four	4			Black Boards

I CERTIFY, that I have this day transferred to Mr John H Van Antwerp A.S.A.C. Bof R. 7<sup>th</sup> U.S. Quartermaster U.S. at Thibodaux Louisiana the articles specified in the foregoing list.

Nelson Brouson Lieut 42<sup>d</sup> Infantry  
 A.S.A.C. Bof R. 7<sup>th</sup> U.S.



Rehanna

List of School Property &c transferred by John H Van Antwerp A.S.C. Bu. R.F. of Orleans  
 to William E. McKenzie A.S.C. Bu. R.F. of T. at Thibodeaux La. October 26 1868.

	Number or Quantity	Articles	Cost when new		Condition when delivered	Remarks
			\$	cts		
1	(15) Fifteen	Elementary Charts			Done	
2	(6) Six	Charts			"	
3	(2) Two	Outline Maps			"	
4	(43) Forty three	Spelling Books			"	
5	(67) Sixty seven	First Readers			"	
6	(69) Sixty nine	Second G <sup>o</sup>			"	
7	(45) Forty five	Third G <sup>o</sup>			"	
8	(10) Ten	Geographies N <sup>o</sup> 1			"	
9	(10) Ten	G <sup>o</sup> N <sup>o</sup> 2			"	
10	(15) Fifteen	G <sup>o</sup> N <sup>o</sup> 3			"	
11	(72) Seventy two	Primary Arithmetic			"	
12	(10) Ten	School G <sup>o</sup>			"	
13	(7) Seven	Grammars 1. Lesson			"	
14	(30) Thirty	Slates			"	
15	(7) Seven	Teacher's Desks			"	
16	(46) Forty six	Common G <sup>o</sup>			"	
17	(84) Eighty four	Stools			"	
18	(4) Four	Black Boards			"	

J. Van Antwerp

I certify that I have this day transferred to William E. McKenzie A.S.C. Bu. R.F. of T. at Thibodeaux La. the articles specified in the foregoing list  
 J. Van Antwerp A.S.C.



Retained.

List of Property pertaining to Sur. R. F. A. S. transferred by John H. Van Antwerp A.S.  
 A. C. B. R. F. A. S. to William S. McKenzie A. S. A. C. B. R. F. A. S. at  
 Thibodeaux La. on the 26<sup>th</sup> day of October 1868.

Number or Quantity	Articles	Cost when acquired			Condition when delivered
		Doll.	Cts.	—	
(53) Fifty three	Wool Hats			Not known	Damaged
(7) Seven	Blank Books				Worn
(1) One	Ink Stand				Q.

I certify that I have this day transferred to William S. McKenzie A.S.  
 A. C. B. R. F. A. S. at Thibodeaux La. the articles specified in  
 the foregoing list.  
 J. H. Van Antwerp  
 A. S. A. C. B. R. F. A. S.



No. 45.

No. .... Abstract M., ..... 186

*List of* .....

Stores Transferred To

---

No. 45.

RECEIVED, at *Shibodeaux* on the *31<sup>st</sup>* of *January* 186*8*,  
of *Francis Sternberg, A. S. A. C.* D. C. Bureau R. F. & A. L. La.,  
the following *LM* stores.

NO. OR QUANTITY.	ARTICLES.	\$	CTS.	<i>Condition</i>
<i>(1) One</i>	<i>Horse</i>	<i>unknown</i>		<i>Good</i>

*W. B. Armstrong*  
*for LM* B. R. F. and A. L. La.

(Signed in Duplicate.)



No. 45,

No. .... Abstract M., ..... 186

*List of* .....

Stores Transferred To

---

No. 45.

RECEIVED, at *Shibodeaux La.* on the *31<sup>st</sup>* of *January* 186*8*,  
of *Francis Hornberg A. S. A. C.* D. O. Bureau R. F. & A. L. La.,  
the following *L. M.* stores.

NO. OR QUANTITY.	ARTICLES.	\$	CTS.	Condition
<i>(1) One</i>	<i>Horse</i>	<i>unknown</i>		<i>Good</i>

*W. B. Armstrong*  
D. O. & Magr B. R. F. and A. L. La.

(Signed in Duplicate.)



No. 27.

No. .... Abstract & ..... Q. 186..

LIST OF STORES RECEIVED FROM

at .....

No. 27.

LIST OF *Government Property* *Stores, &c., transferred by John H. Van Antwerp, A. S. A. G. A.,*  
*B. R. F. and A. I. La., to William S. Menze, A. S. A. C. Quartermaster, U. S. Army,*  
at *Thibodeaux La* on the *26<sup>th</sup>* day of *October* 1868

NUMBER OR QUANTITY	ARTICLES	COST WHEN NEW		CONDITION When Delivered.	REMARKS
		Dolls.	Cts.		
(1) One	Sorrel Horse			Good	
(1) One	Saddle			Worn	
(1) One	Bridle			D.	
(1) One	Saddle blankets			G.	

*Not known*

I CERTIFY that I have this day *transferred* to *Wm S Menze, A. S. A. C. B. R. F.*  
*Army, and A. I. La. at Thibodeaux La* the articles specified in the foregoing list. *Quartermaster U. S.*

*J. Van Antwerp*  
*A. S. A. G. A.*  
*W. and Q. M. Adj. B. R. F. and A. I. La.*



No. 27.

---

No. \_\_\_\_\_ ABSTRACT E. \_\_\_\_\_ QR. 186

LIST OF STORES \_\_\_\_\_

~~Quartermaster, U. S.~~

at \_\_\_\_\_

Stores pertaining to Bof R.F. & A.S.

LIST OF ~~QUARTERMASTER'S STORES~~

Received

by Lieut Nelson Braden A.S.A. Comd  
Bof R.F. & A.S.

~~from~~ from Mr Francis Stenberg A.S.A. Comd

at Thibodaux La

on the

day of

May

1868

NUMBER OR QUANTITY	ARTICLES.	COST WHEN NEW.		CONDITION WHEN DELIVERED.	REMARKS.
		Dolls.	Cts.		
15	Fifteen			Worn	
6	Six			Worn	
2	Two			Worn	
42	Forty Two			Worn	
90	Ninety			Worn	
55	Fifty Five			Worn	
26	Twenty Six			Worn	
82	Eighty Two			Worn	
30	Thirty			Worn	
35	Thirty Five			Worn	
7	Seven			Worn	
	Elementary Charts			Worn	
	Charts			Worn	
	Cutting Knives			Worn	
	Spelling Books			Worn	
	First Readers			Worn	
	Second Readers			Worn	
	Third Readers			Worn	
	Arithmetics			Worn	
	Slates			Worn	
	Geographies			Worn	
	Grammars			Worn	
	Benches			Worn	
	Black Boards			Worn	
	Teachers Desks			Worn	
	Common Desks			Worn	

I CERTIFY that I have this day received from Mr Francis Stenberg A.S.A. Comd Bof R.F. & A.S. at Thibodaux La the articles specified in the foregoing list.

2<sup>d</sup> Lieut 43<sup>d</sup> Infantry A.S.A.C.



NATIONAL ARCHIVES AND RECORDS ADMINISTRATION  
MICROFILM PUBLICATIONS

Roll 103

Target 9

**TRENTON (SEE MONROE)**

**TRINITY (ASSISTANT SUBASSISTANT COMMISSIONER)**

*Letters Sent*

Volume (478)    July 1867–Oct. 1867  
                          Aug.–Dec. 1868

Volume pages were filmed sequentially.  
Blank pages were not filmed.



LOUISIANA.

Letter Book.

—  
Letters Sent —



478

LOUISIANA.

17  
District Court  
of the Eastern District  
of Louisiana  
New Orleans

Letter Book  
—  
Letters Sent



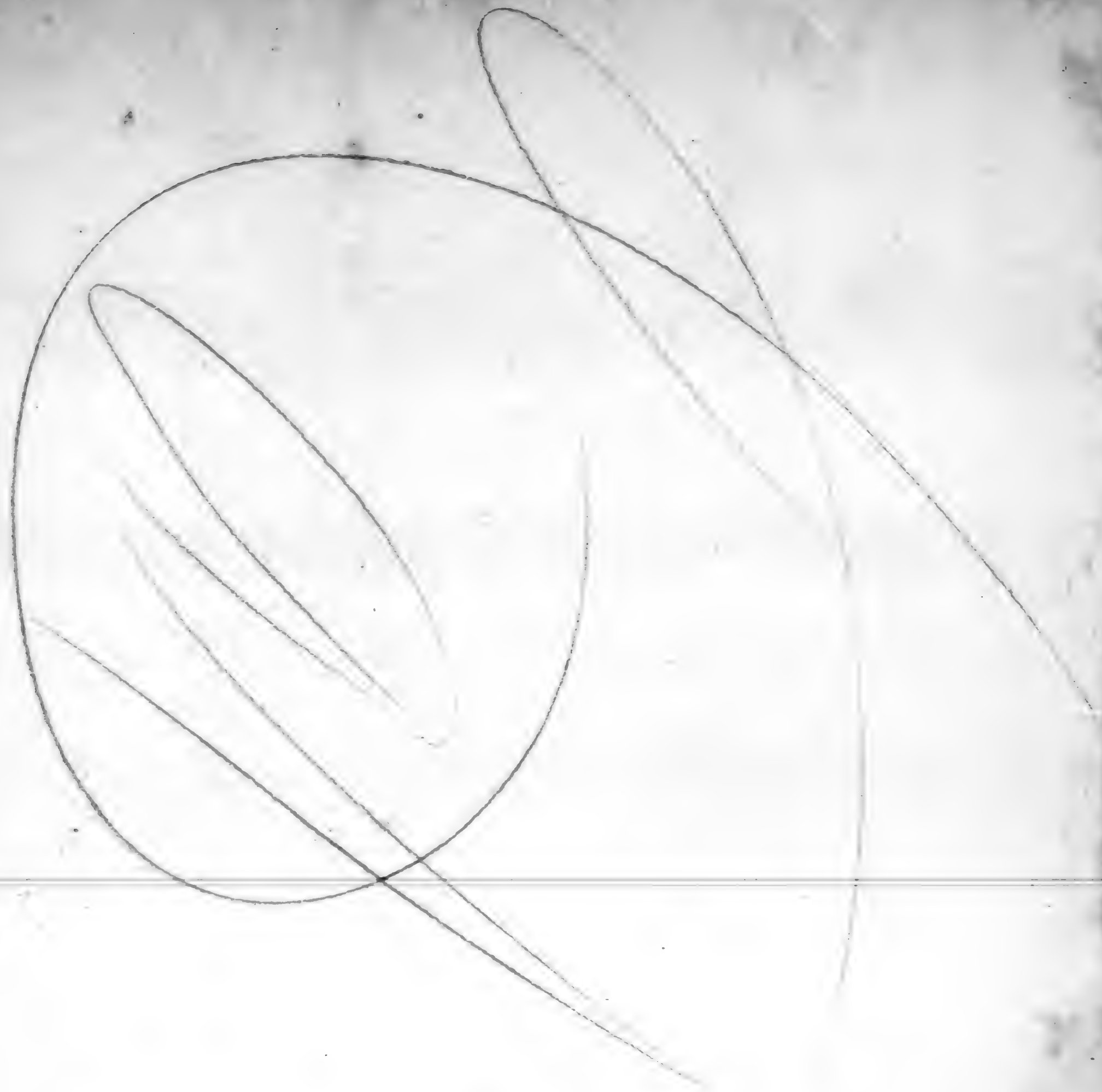

Trinity, La.  
Prairie/Landing.

Letters sent

from July 3/67

to Dept 19/68  
Index 94.

478

Orms



Office Asst Sub Asst Comr.  
 Bureau R. & A. Lands.  
 Catahoula Parish, La.  
 July 3<sup>rd</sup> 1867.

H. B. Armstrong, Capt & A. Q. M.  
 Bureau R. & A. L.

Sir

I have the honor to transmit you herewith Requisition and Receipts for 5000 pounds of Corn meal and 800 pounds of Beans (shelled) one cask 14" for Mr. H. A. Kermeyer, Care of Delmon & Washland, Trinity, La. which has been received.

I enclose of Requisition for forage for my horse for July, and Report of "Persons and Articles" hired by me during the month of June with abstracts of all of which I trust you will find correct, also the amount of Postage paid by me on letters and packages on public service during the month of June

Respectfully Yours Obt Servt.  
 W. Johnston Lemmon.  
 U. S. A.  
 Bureau R.



Office Asst Sub Asst Comm  
Bureau R. F. & A. L.  
Catahoula Parish, La.  
July 6<sup>th</sup> 1867

M. J. Armstrong  
Capt & A. Q. M.  
Bureau A. F. & A. L.  
Sir

I have the honor to transmit you herewith my vouchers for my pay for the month of June, which you will please pay to Mr. S. B. Brennan who I have written to call on you.

Respectfully Yours,  
Obt. Servt.  
M. Johnston Lemmon.  
Asst Sub Asst Comm  
Bureau R. F. & A. L.

Office Asst Sub Asst Comm.  
Bureau R. F. & A. L.  
Catahoula Parish, La.  
July 8<sup>th</sup> 1867.

M. J. Armstrong  
Capt & A. Q. M.  
Bureau R. F. & A. L.

Sir

I have the honor to transmit you herewith Abstracts of Receipts during the month of June Receipts from Mr. Milton Wilson for 4 Barrels and one box 833 pounds of Corn Meal, shipped me on the 5<sup>th</sup> of June, to Wilsons Lousiana Concordia Parish, La. Also monthly returns of public property.

Respy Yours  
Obt. Servt.  
M. Johnston Lemmon.  
A. F. & A. L.  
Bureau R. F. & A. L.



Office Asst Sub Asst Comm.  
Bureau R. Ft. A. L.  
Catahoula Parish, La.  
July 8<sup>th</sup> 1868.

M. B. Armstrong.  
Capt. A. S. M.  
Bureau R. Ft. A. L.

Sir

I have the honor to transmit you herewith Requisitions and receipts for 1667 pounds of Corn Meal and 267 pounds of Pork shipped me per Steamer "Leaker" on the 3<sup>rd</sup> Inst to Houma, La. which has been received in good order, also bill of lading for the same.

I sent you all of the receipts for the 25 barrels of meal and 4 barrels of Pork shipped me in care of Shreveport & Washland, La. I should, if I had one of them, will you please return me one of them and oblige.

Respectfully Yours  
Obt Servant,  
M. Johnston Lemmon.  
Asst Sub Asst Comm.  
Bureau R. Ft. A. L.

Office Asst Sub Asst Comm.  
Bureau R. Ft. A. L.  
Catahoula Parish, La.  
July 14<sup>th</sup> 1867.

M. B. Armstrong.  
Capt. A. S. M.  
Bureau R. Ft. A. L.

Sir

I am entirely out of Blank Certificates of Application. Will you please send me two in care of Shreveport & Washland" as I will need that many.

Respectfully Yours  
Obt Servant,  
M. Johnston Lemmon.  
Asst Sub Asst Comm.  
Bureau R. Ft. A. L.

Office Asst Sub Asst Comm.  
Bureau R. Ft. A. L.  
Catahoula Parish, La.  
July 27<sup>th</sup> 1867

M. B. Armstrong, Capt. A. S. M.  
Bureau R. Ft. A. L.

Sir

I have the honor to transmit you herewith Bill of Lading for 434 lbs of Hay and 372 lbs of oats which was received in good order.

Respectfully Yours  
Obt Servant,  
M. Johnston Lemmon.  
Asst Sub Asst Comm.  
Bureau R. Ft. A. L.



Office Asst. Sub. Asst. Commr.  
Bureau R. F. & A. L.  
Catahoula Parish, La.  
August 1<sup>st</sup> 1867.

L. O. Parker, Sr. 1<sup>st</sup> U. S. A.,  
Capt. & A. Q. M.,  
Bureau R. F. & A. L.

Sir,

There are a great many Old, Cripple, Deaf, Mute, and Blind freedmen in this Parish, who are unable to make a subsistence under any circumstances whatever.

Some of them need medical attention and clothing very bad. They came to me nearly naked and I furnished them such as I could get for them at my own expense.

Some of them have been thrown out of home and have no place to stay.

Will you please instruct me what course to pursue with

Respectfully Yours,  
Capt. Secut.  
W. Johnston Lemmon  
Asst. Sub. Asst. Commr.  
Bureau R. F. & A. L.

Office Asst. Sub. Asst. Commr.  
Bureau R. F. & A. L.  
Catahoula Parish, La.  
August 1<sup>st</sup> 1867

M. B. Armstrong,  
Capt. & A. Q. M.,  
Bureau R. F. & A. L.

Sir

I have the honor to transmit you herewith Subsistence Returns for July, also receipts from Mr Campbell for 1667 pounds of Meal and 267 pounds of Pork. Shipped me July 3<sup>rd</sup> to Slavery Mound, Concordia Parish, La, which I turned over to Mr C, on the recommendation of some of the first men of the Parish to issue to the indigent poor of Concordia Parish.

Respectfully Yours  
Capt. Secut.  
W. Johnston Lemmon,  
Asst. Sub. Asst. Commr.  
Bureau R. F. & A. L.



Office Asst Sub Asst Commr,  
Bureau R. F. & A. L.  
Catahoula Parish, La.  
August 8<sup>th</sup> 1867.

M. B. Armstrong,  
Capt & A. Q. M.,  
Bureau R. F. & A. L.

Sir

I have the honor to ask you to please send me some blanks, forms No. 2, 24, 23 and Certificates of Applications, also some blank forms to bind children out, indicating.

Respectfully  
Yours

M. Johnston Lemmon,  
Asst Sub Asst Commr  
Bureau R. F. & A. L.

Office Asst Sub Asst Commr,  
Bureau R. F. & A. L.  
Catahoula Parish, La.  
August 9<sup>th</sup> 1867.

M. B. Armstrong,  
Capt and A. Q. M.,  
Bureau R. F. & A. L.

Sir

Yours of the 11<sup>th</sup> and 26<sup>th</sup> of July, come to hand to day. I have never received the Requisitions, Receipts or bills of lading for the four barrels and one box of meal shipped me on the 5<sup>th</sup> of June per Steamer "Idaho" to Wilsons Landing, Concordia Parish, La. I have enquired of the Master of the "Idaho" for them, and he promised to look them up for me, but he now says they are missing, lost.

I acknowledged the receipt of the meal in my report for June.

Will you please address all communications to me to Trinity, as the boats do not stop at Prairie Landing when they have no freight, and my mail gets scattered along the river and I do not get it sometimes for two or three weeks.

Respectfully Yours

M. Johnston Lemmon,  
Asst Sub Asst Commr,  
Bureau R. F. & A. L.



Office Asst Sub Asst Commr.  
Bureau R. F. & A. L.  
Catahoula Parish, La.  
August 10<sup>th</sup> 1867

St. B. Armstrong,  
Capt & A. Q. M.  
Bureau R. F. & A. L.

Sir

I have the honor to transmit you herewith my Voucher for July, properly signed and would, respectfully ask you to send the amount <sup>for July</sup> \$99.40 to Mrs M. Johnston Lemmon, Millerburg, Holmes County, Miss. and send me the express receipt.

Respectly Yours

O. B. Serot.

M. Johnston Lemmon,  
Asst Sub Asst Commr.  
Bureau R. F. & A. L.

Office Asst Sub Asst Commr.  
Bureau R. F. & A. L.  
Catahoula Parish, La.  
August 16<sup>th</sup> 1867.

St. B. Armstrong,  
Capt & A. Q. M.  
Bureau R. F. & A. L.

Sir

I have the honor to transmit you herewith Report of Persons and Articles for June and July, and hope you will find them correct.

I was called to the upper part of the Parish, on business, hence the cause of me not sending them sooner.

I send you Postage account for June, will report it quarterly hereafter.

Respectly Yours

O. B. Serot.

M. Johnston Lemmon,  
Asst Sub Asst Commr.  
Bureau R. F. & A. L.



Office Asst Sub Asst Comm.  
Bureau R. F. & A. Lands.  
Catahoula Parish, La.  
August 21<sup>st</sup> 1867

M<sup>r</sup> H. Sterling Capt 1<sup>st</sup> U.S.C.  
A. A. A. Genl.  
Bureau R. F. & A. L.  
New Orleans, La.

Sir

I have the honor to transmit you herewith letters from Mr C. A. Hooper and Mr W. L. Dileo, in behalf of his Sister Father Dr D. H. Mettall.

Dr Mettall is a gentle man of integrity and viracity, and any statement he makes can be fully relied upon. I have seen and conversed with Mr Hooper and I find, he is in a very critical position. The worms has entirely destroyed his crops, and his merchants has refused to advance him further supplies, and he cannot possibly feed his freed people much longer.

I have had a great many applications within the last few days from planters, asking permission to discharge a part of their freed people, as their crops are destroyed and their merchants has refused to advance them further supplies, but I have deferred the matter for advice and instructions.

The most of the freedmen in this Parish are working for a part of the crops and as the worms has destroyed "with a few exceptions" both Cotton and Corn, and they

see they are not going to make any thing, they are becoming very much dissatisfied, careless and indifferent about their work, and almost unmanageable.

Circumstances will compel the most of the planters to discharge a part or all of the freedmen in their employ, and there is no work for them to do here, where by they can possibly make a support.

The following gentlemen Mr Charles Jones, Mr Re. Smith, Mr Liddell Mr Spencer Mr Ballou, Mr Boatman, Mr Horton and others, men of intelligence, viracity, and responsibility, has made me the following proposition. They agree to furnish the freedmen that will necessarily have to be discharged, by their present employers with good and comfortable quarters, incl clothing, shoes and rations, if I will put them together and let the women gather what little crops there is left and let the men work upon the lands.

Some same gentlemen are urging the Police Jurores of the Parish, to levy a tax on the land holders "some of them offering to give \$3 per acre on their land," for the purpose of remunerating the freedmen for their labor, and I think they will succeed in their intention. This is the only Parish in the State that can be levied successfully in account of the Mississippi levee. The old levee survey, it only requires about fifty miles of levee on an average of 10 feet high and nearly two thirds of that distance is now levied and only wants a little repairing to put it in good order to withstand the floods of the present year.



Office Asst Sub Asst Comm,  
Bureau R. Faw A. L.,  
Catahoula Parish, La.  
August 31<sup>st</sup> 1867

M<sup>rs</sup> H. Stirling, Capt 1<sup>st</sup> U.S.A.  
A. A. A. Genl.  
Bureau R. Faw A. L.,  
New Orleans, La.  
Sir

I have the  
honor to transmit you herewith the  
Monthly Report of the 10<sup>th</sup> Inst.  
The Report was forwarded from  
this, and ~~remains~~ to have been  
received, and forwarded from the  
Office of the Sub Asst Comm. in due  
time, and I presume has been mis-  
carried and lost.

Respectfully,  
O. H. Serat,  
M. Johnston Lemmon,  
Asst Sub Asst Comm,  
Bureau R. Faw A. L.

Office Asst Sub Asst Comm,  
Bureau R. Faw A. L.,  
Catahoula Parish, La.  
August 31<sup>st</sup> 1867

Saul C. Gold, Capt U. K. C.  
Sub Asst Comm,  
5<sup>th</sup> Sub Div of La.  
Sir

I have  
the honor to transmit you herewith  
my appointment as Asst Sub  
Asst Comm. Bureau R. Faw A. L.

Respectfully,  
O. H. Serat,  
M. Johnston Lemmon,  
Asst Sub Asst Comm,  
Bureau R. Faw A. L.



Office Asst Sub Asst Comm,  
Bureau R, Fann A. L.  
Catahoula Parish, La.  
Sept 1<sup>st</sup> 1867.

M. B. Armstrong Capt + A. Q. M.  
Bureau R, Fann A. L.  
Sir

I have the honor to transmit you herewith Abstract of Subsistence Stores Received and issued during the month of August.

Respectfully Your Obedt Servt,  
M. Johnston Lemmon,  
Asst Sub Asst Comm,  
Bureau &c.

Office Asst Sub Asst Comm,  
Bureau R, Fann A. L.  
Catahoula Parish, La.  
Sept 1<sup>st</sup> 1867.

M. B. Armstrong Capt + A. Q. M.  
Bureau R, Fann A. L.  
Sir

I have the honor to transmit you herewith Account Current, and Report of Persons and Articles Used, for the month of August.

Respectfully Your Obedt Servt,  
M. Johnston Lemmon,  
Asst Sub Asst Comm,  
Bureau R, Fann A. L.

Office Asst Sub Asst Comm,  
Bureau R, Fann A. L.  
Catahoula Parish, La.  
Sept 1<sup>st</sup> 1867.

M. B. Armstrong, Capt + A. Q. M.  
Bureau R, Fann A. L.  
Sir

I have the honor to transmit you herewith Monthly Report of Quarter Master's Stores for the month of August 1867.

The horses mentioned in the return has been pickt and totally unfit for service for several weeks.

Respectfully Your  
Obedt Servt,  
M. Johnston Lemmon,  
Asst Sub Asst Comm,  
Bureau &c.

Office Asst Sub Asst Comm,  
Bureau R, Fann A. L.  
Catahoula Parish La  
Sept 7<sup>th</sup> 1867

M. B. Armstrong, Capt + A. Q. M.  
Bureau R, Fann A. L.  
Sir

I have the honor to transmit you herewith Expenses of transportation &c. I could not get them compiled to sooner, hence the cause of the delay.

Respectfully Your Obedt Servt,  
M. Johnston Lemmon,  
A. S. A. C., Bu &c.



Office Asst Sub Asst Commr,  
Bureau R, Fam A, Lands,  
Catahoula Parish, La.  
Sept 7<sup>th</sup> 1867.

L. O. Parker Lt 1<sup>st</sup> U. S. A.,  
Act Genl Supt of Ed.,  
Bureau R, Fam A, L,  
Sir

I have the honor to transmit you herewith School Report for August.

I could open several schools for the children of freedmen, but I fear the 5 per cent of the freedmen wages will be very small indeed, as the crops in this Parish are almost an entire failure, and the freedmen are all working for a part of the crops. However I will do the best I can under the circumstances.

Office Asst Sub Asst Commr,  
Bureau R, Fam A, L,  
Catahoula Parish, La.  
Sept 8<sup>th</sup> 1867

M. B. Sterling Capt 1<sup>st</sup> U. S. A.,  
A. A. A. Genl,  
Bureau R, Fam A, L,  
Sir

I transmit you herewith a copy of Tri Monthly Report of August 20<sup>th</sup> 1867 and have the honor to state to you that I forwarded my Report of the 20<sup>th</sup> U. S. A. in due time, and can only attribute its delay to the inefficiency and neglect of the Post Masters or Carriers.

Respectfully Your Obedt Servt,  
M. Johnston Lemmon,  
Asst Sub Asst Commr,  
Bureau R, Fam A, L,

Office Asst Sub Asst Commr,  
Bureau R, Fam A, Lands,  
Catahoula Parish, La.  
Sept 9<sup>th</sup> 1867.

S. C. Holt Capt 2<sup>nd</sup> U. S. A.,  
S. A. C. 3<sup>rd</sup> Sub Dir of Ed.,  
Sir

I have the honor to state to you that I have but one U. S. Horse in my possession and he has been sick and total unfit for service for several weeks.



Office Asst Sub Asst Commr,  
Bureau R. Ft A. La.  
Catahoula Parish, La.  
Sept 15 1867.

L. O. Parker Lt, 10th U.S.I.  
A. A. A. Genl.  
Bureau R. Ft A. La.  
New Orleans, La.

Sir

I have  
the honor to transmit you the fol-  
lowing names of freedmen "stating diseas-  
es" for transportation to the freedmen  
Hospital New Orleans.

Charles Haller, Very poor leg.  
Lewis Bohannon, Cripple and poor eyes  
Maria Riding, Almost blind,  
Abalipa Anderson, Rheumatism & Insane  
Anthony Benjamin, Paralyzed,  
Ellen Crossgrove Rheumatism & Insane  
Isabella Johnson, Cripple with one leg.

There is none of the above that  
can make a support under any  
circumstances.

Office Asst Sub Asst Commr  
Bureau R. Ft A. Lauds.  
Catahoula Parish, La.  
Sept 16 1867.

A. B. Armstrong, Capt & A. Q. M.  
Bureau R. Ft A. La.  
New Orleans, La.

Sir

I have the  
honor to transmit you herewith a  
Certificate of the condition of the U.  
S. Horse now in my service.  
I have used every effort to have him  
cured, but all in vain. He is still  
growing worse, and the people object  
very much to me keeping him in the  
neighborhood and insist on me selling  
him to prevent the disease from spread-  
ing.

Please inform me immediately  
what to do.



Office Asst Sub Asst Comr  
Bureau R. F. and A. S. D.  
Catahoula Parish, La.  
Sept 16<sup>th</sup> 1867

We the undersigned hereby certify  
that the U. S. Horse.

Office Asst Sub Asst Comr.  
Bureau R. F. and A. S. D.,  
Catahoula Parish, La.  
Sept 27<sup>th</sup> 1867.

W. B. Armstrong, Capt + A. Q. M.,  
Bureau R. F. and A. S. D.,  
New Orleans, La.

Sir

I have the  
honor to transmit you herewith. Req-  
uisition for Storage, and would beseech  
you to send me my quar-  
terly amount of Pens, Ink, Paper, Enve-  
lopes, Postage, &c., as I have no  
blank Requisitions, No 38.



Office Asst Sub Asst Comm.  
Bureau R. Ft. A. S. L.  
Catahoula Parish, La.  
Oct. 5<sup>th</sup> 1867.

Samuel C. Gold, Capt. U. S. A.  
Sub Asst Comm. 5<sup>th</sup> Sub Div. La.  
Monroe, La.  
Sir

Some time ago while in the discharge of my duties, I was followed "unknown to me" some distance by a very bad and malicious freedman with two guns to shoot me. but it appears he was unable to overtake me, as I was on horse back and he was a foot.

Since then another very bad freedman has threatened to waylay me and shoot me &c. he and another one told me a few days ago that no d. d. white man would be over them much longer, that this country belonged to them and they was going to have it &c. &c.

There is no jail or place of confinement in this Parish and I do not know what to do with them.

Can I send them to your place with charges &c. I would respectfully ask what to do in such cases.

I have undoubted evidence that the freedmen are arming themselves throughout the Parish for some bad purpose.

Office Asst Sub Asst Comm.  
Bureau R. Ft. A. S. L.  
Catahoula Parish, La.  
Oct. 9<sup>th</sup> 1867.

M. R. Armstrong  
Capt. & A. Q. M.  
Bureau R. Ft. A. S. L.  
New Orleans, La.  
Sir

I have the honor to transmit you herewith Postage Account for the quarter ending on the 30<sup>th</sup> of Sept. 1867 and Report of Treasurers and Articles found during the month of Sept<sup>r</sup>.

Respectfully,  
Obt. Servt.  
W. Johnston Lemmon  
Asst Sub Asst Comm.  
Bureau R. Ft. A. S. L.



Harrisonburg, Va.  
Oct 10<sup>th</sup> 1867.

Capt Mr Johnston Lemmon.

Dear Capt

I had the honor to receive a letter from you yesterday asking me to give you the particulars of the murder perpetrated on Secity Island, by the negroes Anderson, Jackson and George; I happened to be at Dr Nuttall's place the night the tragedy occurred, I was ready with my horse saddled to return to Harrisonburg, early Tuesday morning when a great commotion broke out at Dr Nuttall's, I immediately galloped up there "to the aid" and found to my horror young Periston lying upon the floor, his skull broken in three places and stabbed several times, his regular hair shaved by one cut, I immediately sent for Justice Green, with his constable and posse who arrived upon the ground about 10 o'clock A.M. Two Physicians Dr Peck and Curry were called upon, who made a post mortem examination who were sworn and gave the particulars of the mode of killing as above mentioned.

A search warrant was issued by Green as this was a robbery all legally armed, who in company with the Justice proceeded to search the neighboring places, on Dr Peck's place they found Anderson and Jackson in a house with part of the stolen property, bloody clothes &c. Jackson and Anderson are brothers, formerly my property and consummate scoundrels from their birth,

Jackson said that he could show the cipher printed in a field, which he did and indicated George a freedman of Dr Peck's, all of them were arrested and tried at Justice Green's house, George and Anderson made a full and free confession, detailing their diabolical plans and murder.

The money stolen was \$440, some twenty or thirty dollars worth of dry goods and groceries, The negroes under charge of the constable and posse, "for fear of a rescue" started to town Monday night about midnight and on the road Anderson made his escape, the other two in attempting to make their escape were killed "as I understand" my information is that they were killed, in attempting to break guards. I do not know the facts positively, nor do not know the parties.

The murderer Anderson made his escape, crossed the Susquehanna River, into Concordia Parish, passed by a band of freedmen of Henry Daniel and Samuel Bowman, he swam the river getting away from them.

They hailed the other bank and Mr King, and a freeman on Mrs Kinsey's place, after trying to detain him but without success, he fired and shot him down, his body was identified as Anderson Smith the murderer, one of the murderers of Periston, King was for the most magistrate and was tried and regularly acquitted. The murder was one of extraordinary magnitude and deprived a family of a very promising member of the same. I left for Harrisonburg as soon as the body was dressed and the Dr held an examination, on my own business, and of course only have stated



what I have learned as to the subsequent proceedings in this important matter. We have no jails in this County and Criminals go without justice when they should be put to the strict penalty of the law.

Beauly Island is generally unsafe. Highway robberies are common of late in open day and the parties suspected are still at large.

Had this affair been committed by white men, and I am of the Pinckston family, knowing the want of jails and the uncertainty of the law, I would of made it my private and public business to hunt down the murderers and shoot them on the spot.

As it is I cannot say how I would of acted. By referring to the records of Justice Lewis Court you will find on the record all the testimony, Confessions &c. there correctly set down.

The wife of Jackson was running to the fact before the commission and assisted in securing the stolen property and hiding the two criminals, Anderson and Jackson in her house, also a boy Wesley formerly my property was a party to the plot, but did not participate in its execution. They are still at large owing to a want of jails in this Parish, and means to send them out, or to some other Parish jail. The above facts you will ascertain by visiting the locality and your presence is much desired by the citizens generally up there.

I am sir with respect yours Truly &c  
Wm L. Dileo,

Office Asst Sub Asst Comr,  
Bureau R. T. A. L.  
Catahoula Parish, La.  
Oct 13<sup>th</sup> 1867

A. B. Armstrong  
Capt. U. S. M.  
Bureau R. T. A. L.

Sir

I have the honor to transmit you herewith, Abstracts of Articles lost or destroyed showing what become of the U. S. Horse in my possession.

Will you please send me blank Requisitions to make a requisition for another Horse.

Very Respectly  
Your obt. Servt.  
W. Johnston Lemmon,  
Asst Sub Asst Comr,  
Bureau R. T. A. L.



Office Asst. Sub Asst. Comm.  
Bureau R. & A. S. L.  
Catahoula Parish, La.  
Oct. 14<sup>th</sup> 1867

J. M. Lee, Lt 39<sup>th</sup> U.S. I.,  
A. A. A. Genl.  
Bureau R. & A. S. L.  
Sir

I have the honor to transmit you herewith a Petition from the most worthy and respectable Citizens of the Parish, asking for protection from a band of outlaws, and freedmen, who are roaming over the country driving off and burning their stock almost daily. One of the bands of outlaws, "White Man" was lately convicted of murder, and there is indictment against two others of the same gang for murder. They say they are well prepared and defy the Civil authorities to attempt to arrest them.

The within enclosed letter gives a correct statement of affairs in this Parish, and I would respectfully recommend that a company or a part of one of U. S. Troops, Cavalry be immediately sent to this Parish to assist the Civil authorities in restoring order and peace.

Very Respectly  
Your obt. Servt.,  
M. Johnston Lemmon,  
Asst. Sub Asst. Commr.  
Bureau R. & A.

Catahoula Parish, La.  
October 14<sup>th</sup> 1867.

Capt M. J. Lemmon,  
Asst. Sub Asst. Commr.  
Catahoula Parish, La.  
Dear Sir,

The undersigned citizens of Little and Black Rivers in this Parish, find themselves forced, from the inability of the Civil authorities to act in their behalf, to call on you for protection from the constant and increasing loss of stock and other property, by the wanton and lawless acts of the freedmen or a portion of them, and as we believe, an organized band of white men, as you are aware the Parish is without a Jail - we are informed the Sheriff of an adjoining Parish refuses to receive in his Jail parties convicted and sent from this Parish, our Civil authorities, are, apparently without power either to enforce or execute the law, and this state of affairs, becoming more and worse, cannot be arrested, without resort to mob law, or an appeal to our Military authority for protection, which we know if exercised will give prompt and speedy relief in the premises. As good and law-abiding citizens we deplore a resort to the resort of mob law, and beg of you to take such steps, and make such report to the proper Military authority, as you may deem necessary.

We would beg to suggest that a Company of Cavalry be sent to this Parish to arrest the lawless parties, and disarm the freedmen and all other violators



of law and order,

We are Capt.  
 Very Respectfully  
 Your Obedt Servts,  
 L. C. Spencer,  
 E. B. Barron,  
 R. L. Norton,  
 J. A. Boatman,  
 S. J. R. Liddell,  
 John Hoyt,  
 Jno G. Snyder,  
 J. Warren,  
 J. H. Starn,  
 Charles Jones,

State of Louisiana }  
 Parish of Catahoula }

I the undersigned  
 authority, do hereby certify that the  
 above and foregoing petition represents  
 the true condition of affairs in this  
 Parish of Catahoula, and I believe  
 a force of U.S. Troops is necessary  
 to put down theft and keep good  
 order,

Jno G. Snyder,  
 Justice of the Peace,

Office Asst. Sect. Asst. Commr.  
 Bureau of Land, A. L.  
 Catahoula Parish, La.  
 Dec 15 1867.

J. M. Lee 1<sup>st</sup> Lt 39 U.S. I.  
 A. C. U. Genl.  
 Bureau of L. A.

Sir,

I have the  
 honor to state to you that my present  
 office is in a very inconvenient place,  
 it is two miles and a half from the River  
 "Traine Ldg." and it is a very difficult matter  
 to get freight from the River



Officer, Asst. Sub. Asst. Com  
Bureau of N. F. & L. S.  
Mossy from Plant  
Catahoula Parish La  
Aug 4<sup>th</sup> 1868

The Sketches of Letters written  
by Mr. Johnson, numerous, my  
predecessor will be found locked and  
of file in this Office for reference  
when required

A. H. Camp  
Asst. A. S. L. S.

Officer Asst. Sub. Asst. Com  
Bureau of N. F. & L. S.  
Mossy from Plantation  
Catahoula Parish La  
Aug 4<sup>th</sup> 1868

S. C. Gold Case  
Sub Asst Com. S. F. Dis  
Sir

I have the honor  
to report to you in compliance with  
Spec Order No 80 dated Headquarters  
Bureau of N. F. & L. S. State of La  
New Orleans, La July 29<sup>th</sup> 1868  
I relieve Mr. Johnson Asst. Com  
Asst. Sub. Asst. Com B. F. & L. S.  
Parish of Catahoula La on the 3<sup>rd</sup>  
of August 1868

I am Sir, your obedient servant  
A. H. Camp  
Asst. Sub. Asst. Com B. F. & L. S.

Officer Asst. Sub. Asst. Com  
Bureau of N. F. & L. S.  
Mossy from Plant  
Catahoula Parish  
Aug 10<sup>th</sup> 1868

Asst. Lt. Col. S. C. Beaman  
D. O. A. A. 2. M. B. F. & L. S.  
Sir

I have the honor to apply  
to you for blank Plantation Contracts (See form) for  
15 Stationary, form 14 Abstract (C) There is no  
Stationary in the Office all I have used since I  
arrived here has been purchased out of my private funds  
Please forward to me the necessary Stationary at your



coldest commencement

I am Sir your obedient servant  
J. H. Camp  
A. S. A. S. A. S. A. S. A. S.

Officer, Asst. Sub. Asst. Com  
Bureau of P. H. & S  
Money from Plant Cotehula Parish  
Aug 11<sup>th</sup> 1868

Asst. Asst. Col. W. W. Warren  
Capt 39<sup>th</sup> U.S. Infy  
A. S. A. S. A. S. A. S. A. S.

Sir  
I have the honor  
to apply to you for a Clerk in this  
Office. There is a great amount  
of writing to do in and it is impossible  
for me to do all of my writing in the Office  
and visit the Plantations in the Parish  
(which is very large) to enable me  
to report as the instructions from  
Headquarters require. The Parish is  
very large and requires a great <sup>amount</sup> of  
traveling to be thoroughly posted in  
the Parish

I am Sir your obedient  
servant  
J. H. Camp  
A. S. A. S. A. S. A. S. A. S.

Officer Asst. Sub. Asst. Com  
Bureau of P. H. & S  
Money from Plant  
Cotehula Parish La  
Aug 15<sup>th</sup> 1868

Asst. Asst. Col. E. C. Keaman  
Capt 39<sup>th</sup> U.S. Infy  
D. O. S. A. S. A. S. A. S.  
Bureau of P. H. & S  
Sir

I have the honor  
to transmit you the enclosed Abstracts  
for Stationery and Bills of heading for  
(1) one Package containing (2) one Rem  
better Paper (3) nine packs of Officer  
envelopes (1) one piece of blotting paper  
(1) one Pencil (2) two Pen holders (3) Pens  
(1) one Port Red Ink (1) Port Black Ink  
(1) one Port Mucilage (3) pieces Office Paper  
for Mr. J. Deane. I enclose you for  
Blank Plant Agreements, also  
Blanks for Officer's stable hire Requisitions  
for Storage (also form (14)) I have none  
for my Horse of fine Bills of heading  
for (1) Book of Day (2) books of Vets  
but it has not been received here  
as yet

The owner of the Building  
occupied for Officer was here to see me  
about her rent she (Mrs. M. Riddick) informs  
me she has not received the rent for  
July & July. please inform me if  
it has been forwarded from your Office

I am Sir your obedient servant  
J. H. Camp  
A. S. A. S. A. S. A. S. A. S.



Officer, Asst. Sub, Asst. Com  
 Bureau of A. T. & S.  
 Messy from Asst  
 Catahoula Parish La  
 Aug 16<sup>th</sup> 1868

L. H. Warren  
 Brevet Lt Col, U.S.A.  
 a a Sgt Genl

Sir

I have the honor  
 to state to you that the Freedmen  
 who worked on Mr James Dunkley's  
 plantation for the year of 1867 was told  
 me with regards to the \$23,100 that they  
 they had refused to receive on the ac-  
 count of it not being the whole am-  
 -ount due them which amounted to a  
 total of \$436,000 leaving a balance of \$197,000  
 still due Mr freedmen came to me  
 and told me they was willing to  
 take what Mr Sumner told Mr  
 Sumner told me he had the money  
 in New Orleans and would send it  
 to me the above amount has not  
 been paid

Officer Asst Sub Asst Com  
 Bureau of A. T. & S.  
 Catahoula Parish La  
 Aug 22<sup>nd</sup> 1868

L. H. Warren  
 Brevet Lt Col, U.S.A.  
 Capt 33<sup>rd</sup> Regt  
 a a Sgt Genl

Sir

I have the honor to  
 acknowledge of receiving from your Office  
 Circular No 15 dated Sept 3, 1868 and  
 State of La & A. La Aug 24 1868 of  
 how delinced Copies of the above Circular  
 to Mr White of White & Ransy and  
 sent me direct to Mr Nakson and will  
 delinced me to Messrs Alexander & Watson  
 as soon as I am able to get out  
 I have down with the Swamp fever

I remain Sir your  
 most obedt Servant

A. S. Camp  
 Asst. Sub, Asst. Com



Officer Asst Sub Asst Com  
Bureau of A. T. & A. S.  
Massy from Plant  
Catahoula Parish La  
Aug 24<sup>th</sup> 1868

L. N. Mason  
Bent Lt Col U.S.A  
Capt 39<sup>th</sup> Regt U.S. Infy  
Co A Asst of Foot

Sir

I have the honor to state in reply to yours of the 20<sup>th</sup> Inst. I would state that I never settled with the freedmen employed by Mr. W. G. Pick as I never received any thing to do with them with

I forwarded you all the information I had ever had on the subject on the 21<sup>st</sup> of Aug 1868

Signed W. G. Sumner

W. G.

Officer Asst Sub Asst Com  
Bureau of A. T. & A. S.  
Massy from Plant  
Catahoula Parish La  
Aug 24<sup>th</sup> 1868

L. N. Mason  
Bent Lt Col U.S.A  
Capt 39<sup>th</sup> Regt U.S. Infy  
Co A Asst of Foot  
Bureau of A. T. & A. S.

Sir

I have the honor to forward you a reply to your letter. When it was received there was no papers in this Office connected with Mr. W. G. Pick's settlement with his freedmen. As Mr. G. Sumner being away I could forward no information. This is the first opportunity of giving you the desired information. I forward you enclosed the letter of Mr. G. Sumner with regard to the matter which I have this day received.

I remain Sir your obedient  
Servt

L. N. Mason  
Asst. A. T. & A. S.



Office Asst Sub Asst Com  
 Messy from Atlant  
 Catahula Parish La  
 Aug 24<sup>th</sup> 1868

A. N. Price  
 Lett<sup>r</sup> Sup Education  
 B. R. F. W. A. L.

Sir

I have the honor  
 to reply to your communication of Aug 11<sup>th</sup>  
 1868 and would state I made out the  
 Monthly School Return the day after  
 my arrival here which was on  
 the 4<sup>th</sup> inst and forwarded it on  
 the first which was on the 6<sup>th</sup>  
 to your Office

I am Sir your obedt servt.  
 A. N. Price  
 A. N. Price

Office Asst Sub Asst Com  
 Messy from Atlant  
 Catahula Parish La.

Office Asst Sub Asst Com  
 Trinity Catahula Parish La  
 Sept 2<sup>nd</sup> 1868

A. N. Price  
 Capt. U.S.A.  
 Lett<sup>r</sup> Sup Education

Sir

I have the honor in  
 reply to your letter informing me you had  
 employed two teachers to send up in my Parish  
 to teach. I am now to suggest to you the im-  
 propriety of persons coming up in these  
 swamps during this month that are not  
 acclimated to them. Last and this month  
 is the two most sickly months in the  
 year. The fever is or has been in nearly  
 every house in my Parish. I was taken  
 down less than two weeks after my  
 arrival here and am just getting out  
 then my Dr tells me I must not  
 go out in the sun if possible this  
 month or I may be taken down again

Before these teachers come up it  
 will be necessary for me to go through  
 the Parish and locate the schools and  
 find places for them to board. I can  
 write you where or at what point on the  
 river they should stop. Conynsamer's in this  
 Parish is almost impossible to get if do  
 they know how to charge and there is no  
 wagon roads. It will be necessary to put  
 such books as will be required

There is about 12 Poor White Children in this  
 Parish whose parents are not able to send them  
 to school they being very poor. There was a  
 school started here and the teacher had to break  
 up the school on the account of not being



able to get money to pay her Board  
The Parish is Bankrupt their paper  
is not worth 10 Cents the \$100 and the people  
are very poor

I wish you would instruct me  
with regards to collecting the School Tax  
(shall it be collected) I think if it  
was collected it would give a sufficient  
amount to carry on the schools in the  
Parish that we would want but little  
aid from other sources during the next  
year

I write you for Colored Teachers on  
the account of a great many of the Planters  
having objections to lady Teachers and it is  
so hard to get boarding for them

I will attend to their schools as soon  
as I am able to ride

I am Sir your obedient servant  
J. H. Camp  
A. S. A. Com. B. N. T. S. A. S.

Officer Trinity A. S. A. Com. B. N. T. S. A. S.  
Sept 11<sup>th</sup> 1868

Mr James Dumbly Sr  
Sir

I have received part  
of the money that is due your hands for balance  
in the year of 1867 and will pay it to them  
on Saturday Afternoon Sept 12<sup>th</sup> at my Office

My health will not permit me to ride  
to your place or I would pay them there

I am Sir your obedient servant  
J. H. Camp  
A. S. A. Com. B. N. T. S. A. S.

Officer, Art, Sub, Post, Com  
Bureau of N. T. S. A. S.  
Trinity Parish Sea  
Sept 19<sup>th</sup> 1868

L. M. Warren  
Capt. Cal. M. S. A.  
A. S. A. Adjt. Genl

Sir

I have the honor  
to apply to you for a leave of absence  
to attend a Court in Baton Rouge  
also to visit New Orleans on business  
of importance to me, It will require  
but a few days. I have written to my  
superior to have the case set down let me  
know that I would lose no time from  
my duties

I remain your obedient servant  
L. M. Warren  
A. S. A. Com. B. N. T. S. A. S.



Officer and Sub Asst Com  
Bureau of P. H. & S. Hands  
Parish of Catahoula La  
Thirtieth Sept 25<sup>th</sup> 1908

J. H. Barron Esq  
Sub Asst Com  
5<sup>th</sup> Sub Div of Sea

Sir

I have just received my return of the 10<sup>th</sup> inst which you have returned with a new form of instructions for making out my reports of course all of interest in my Parish. I was sick with the fever at the time I wrote it and am just recovering from my sickness (a relapse) and am not able to re-write my Try Monthly Report also my Books from nervousness.

Therefore please except my returns of the 10<sup>th</sup> & 20<sup>th</sup> and forward them to Headquarters as they are fast due and I will conform to your new Program in my Monthly Return.

I remain your obedient servant

J. H. Barron  
Asst. Com. P. H. & S. La

The Serial and endorsement of Sub Asst Com 5<sup>th</sup> Sub Div of Sea is on page 88 & 89  
Report Book

Officer and Sub Asst Com  
Bureau - P. H. & S. Hands  
Catahoula Parish La  
Thirtieth Sept 27<sup>th</sup> 1908

Lat of M. Lee  
Act Asst Ins Genl  
Sir

I have the honor to reply to your communication dated Headquarters P. H. & S. Div of Sea New Orleans Sept 23<sup>rd</sup> 1908 and would most respectfully state that I have not had any Blank Monthly Inspection Returns since I have been in this Office. I have written for the several times.

I could not find a Blank form therefore I made so full a report to the Adjutant Genl in my Monthly (or Try Monthly) Report as possible in compliance with his Circular letter of Aug 21<sup>st</sup> as my health would permit for I was not hardly able to sit up (having the fever) and am just recovering from having a relapse three times on the account of riding in the sun to try to do my duty.

I furthermore understood the Circular letter of Aug 21<sup>st</sup> to relate to the making out of my Try Monthly.

I will make out and forward you a written statement immediately and would request you to send me Blank Monthly Inspection Returns.

I am Sir your most obedient  
servant

J. H. Barron  
Asst. Com. P. H. & S. La



Officer, asst. Sub. Asst. Com  
Bureau of A. F. & A. Genl.  
Catahoula Parish La  
Trinity Oct 14 1868

Brut. Lt. Col. E. C. Biman  
D. O. V. A. A. M.  
Sir

I have the honor  
in reply to your letter of Sept 21<sup>st</sup> 1868  
to state I have the Complat. list  
of bills of lading dated July 29<sup>th</sup> 1868  
from your Office. But would state  
the Garage has never been received by the  
Agent of the Bureau for Catahoula Parish  
hence the bills of lading has never been  
signed and forwarded to your Office. I return  
them to you

These bills of lading was  
mentioned in my communication to  
you of Aug 15<sup>th</sup> 1868

I remain your obedt  
servt

J. H. Camp  
A. S. A. Com. B. R. F. & A. La

Officer, asst. Sub. Asst. Com  
Bureau of A. F. & A. Genl.  
Catahoula Parish La  
Trinity Oct 14 1868

Mr. J. H. Biman  
Sub. Asst. Com  
5<sup>th</sup> Sub. Dist  
Sir

I have the honor to  
return my Ory promptly and respectfully  
ask it to be forward to the Dep. water upon  
the same funds as my returns of the  
10<sup>th</sup>

My returns of the 30<sup>th</sup> which is  
the only return made out since I  
received your instruction is made out  
out in Compliance thereto. I have  
no Clerk and my eyes are so weak  
from recent illness I can write but  
little at a time

I am Sir your obedt servt

J. H. Camp  
A. S. A. Com. B. R. F. & A. La

Mr. J. H. Biman  
Sub. Asst. Com  
5<sup>th</sup> Sub. Dist.



Officer Asst. Dub. Asst. Com  
Bureau of N. T. & A. Co.  
Catahoula Parish La  
Trinity Oct 24 1868

Brut. Lt. Col. G. C. Beman  
D. C. & A. Co. 2<sup>d</sup> M

Sir

I have the honor  
to transmit you herewith my vouchers  
No 114 (Abstract B) for actual Expenses  
of transportation during the month  
of September 1868 for \$13,700 American  
Dollars currency. Please pass  
the amount of vouchers to Capt  
Geo Baldy A. D. C. Headquarters  
Am. Legion La and oblige

your most obedt servt  
P. D. C. Camp  
A. C. Co. B. T. & V. A. Co

Officer, Asst. Dub. Asst. Com  
Bureau of N. T. & A. Co.  
Catahoula Parish La  
Trinity

Officer, Asst. Dub. Asst. Com  
Bureau of N. T. & A. Co.  
Catahoula Parish La  
Trinity Oct 22<sup>d</sup> 1868

Brut. Lt. Col. G. C. Beman  
D. C. & A. Co. 2<sup>d</sup> M

Sir

I have the honor  
to apply for Horse for me M. S.  
Horse in my employ as Asst. Dub.  
Asst. Com Bureau of N. T. & A. Co.  
for Catahoula Parish

Also I would respectfully  
ask you to send your Draft for  
rent of Office and stable and  
my pay for the month of Sep-  
-tember 1868 and oblige your  
obedient servant

P. D. C. Camp  
A. C. Co. B. T. & V. A. Co



Officer and Sub Agent  
Bureau of A. S. & A. S.  
Catahoula Parish La.  
Trinity Oct 30<sup>th</sup> 1868

Act of the Law  
a B. S. & A. S.  
B. S. & A. S.

Sir

I have the honor to forward you the enclosed returns of how the buyers of your mat had the Blanks until now and I make you as full a report as possible of how visited as many Plantations in my Parish as possible with a view to make a full report with regard to the Freedmen, Crops, and the number of acres under Cultivation. The enclosed on the first of them ever made out and if there is any irregularity in them compute it to my ignorance of your mode of making them out.

I find in visiting the Plantations a great deal of dissimilarity between the Freedmen & Planters of an opinion that many of the Freedmen will share their fate of each year since the War - how nothing at the end of the year of our doing any thing in my power to prevent it I have taken several cases before the Civil Courts and seized the Crops of Planters by the name of Eliza Cotton has said (using his own words) that no shipper when he left his place should carry off any thing

but what he had eaten during the year and what he had on his back no matter what he made. This man Cotton cannot get a dollar worth in this place on Credit I expected of him an order on his merchants in N. O., to have this share of the Crops set aside from his account and placed to the Credit of Mr. S. Black, a merchant here who the Freedmen has been trading with and had given a Bill of Sale to of that Cotton since I received his order and alarmed him to ship his Cotton he has told his neighbors that he would beat the Bureau and Freedmen yet that he had an order from Genl. Hatch to ship his Cotton.

If he has permission and is alarmed to ship and handle the Freedmen's share of the Crops of our country he will cheat them out of it as he has every one here he has dealt with. As it is he cannot handle their money.

While making my inspection in the lower part of my Parish on the 14<sup>th</sup> I was taken down with a dense fever and could not get a doctor and was placed on the first steamer came along it was going to N. O. I was also afflicted with my eyes and could not see. I was absent from my Parish four days while absent I was under the care



of Dr H. M. Justice No 5 North St I returned to my Parish as soon as I could learn my Bird to trail I remained at No 5 North St which in the City

I wish you would send me more Blank Inspection Reports  
Remain your obedient  
Servant

J. H. McCarty  
A. A. C. B. R. F. & Co

Handings

Officer assigned to  
Bureau of M. P. R. L. S.  
Catahoula Parish Sec.  
Thruout Oct 30<sup>th</sup> 1868

Brat Maj B. T. Hutchings  
A. A. C. B. R. F. & Co  
Sirs

I have the honor to  
transmit you the following  
I have been informed by Mr Black  
a Merchant of Trinity through his  
Merchant in N. O. (Also by others)  
that the Brat Commissioner has  
reciev'd a report that I had been  
playing a rascally game with both  
the Planters and the Freedmen  
in my Parish. The Charge of  
preclaim to be purchaser of the  
blackest dye. And due most deeply  
fully ask for the matter to be investi-  
gated and let the responsibility rest  
on the fitty party.

I have reported every Case of Transacted

that I have been connected with to  
Headquarters which will be found in  
my Reports of Aug 10<sup>th</sup> & 31<sup>st</sup> Sept 8<sup>th</sup> & 10<sup>th</sup> of  
report Sept 20<sup>th</sup> & 30<sup>th</sup> to the general  
fund also of Oct 10<sup>th</sup> & 20<sup>th</sup>

I shall report the Case of  
Mr Elyja Cotton and his Freedmen.  
The Freedmen had traded with  
I Black a Merchant in Trinity  
and had given Mr Black a Bill  
of Sale of their share of the  
Cotton. And before any of the Prop  
was shipped I required of Mr Cotton  
as his Merchant an Order setting  
their share aside from his A/c  
and placed to the A/c of the  
Freedmen of being the wish  
of the Freedmen as he Mr  
Cotton had often said he did not  
care for the Bureau he did not  
intend any day or should leave his  
place with anything but what he had  
eaten and what he had on his back  
no matter how much he had made during  
the year. His Merchants on face Division  
of A/c refused to sign Mr E Cotton's Order on  
them stating they deny my authority altogether  
If something is not done in this Case  
the freedmen will be cheated out of their  
share altogether for Mr. Cotton cannot get  
a Dollars worth of Credit in Trinity (where  
he is known). I have acted in Compliance  
with instructions from A/c's. In case of  
Mr Cotton his Freedmen asked me to get an  
Order from him as his Merchant setting their  
share of the Prop aside or make a Division  
of the Prop at the fir portion had given I Black  
a Bill of sale for it as they was unwilling  
I did it at their request



Officer A. A. Co  
 Bureau of A. F. & C. Co  
 Calahanla Parish La  
 Christmas Eve 2<sup>d</sup> 1858

Brut Maj B. F. Hutchins  
 A. A. Co  
 Sir

I have the honor  
 to forward you the following  
 Mr Charles James was in  
 Christmas this day also Mr G  
 Cotton he James was heard to  
 tell Mr Cotton that he had a  
 special order from Adepts to  
 prevent me from stopping them  
 James & Cotton from shipping  
 or interfering with their Crops  
 The two then Charles James used  
 the largest portion of the Provision  
 shipped by the Bureau for the  
 destitute while the Johnson Summo  
 was Bureau Agent of this Parish  
 it could be proved that James took  
 Barrels of Pork & meat from  
 this place to his Plantation  
 on the same day after Mr human  
 had refused old destitute people  
 and had told them the rations  
 was all out Also Mr Jacob  
 Jarrett got from human and Clark  
 (human's predecessor) Pork & meat  
 This Jarrett is the man who killed  
 Clark on the account of rations  
 and afterwards had some trouble  
 with human for he wanted Jarrett  
 to pay him for the and Jarrett  
 would not This James had

never paid his Freedom any money  
 his paper is in the hands of several  
 Freedom for months previous years  
 since the War some of it I have seen  
 without date and without signature  
 and when he has been asked to settle  
 with them for their last year's A. F. C.  
 he has told them he had not sold  
 the Cotton yet and in this way  
 he has robbed his Freedom human  
 told me that if he had not gone to  
 one of the most influential men  
 among the Freedom on his plantation  
 and paid him over \$1000 to delay  
 and through his influence he  
 Agent any Freedom would have  
 left the plantation, as it was a  
 number left ~~James~~ this Chas  
 James's son Mr James who is  
 conducting his plantation who  
 whipped the Freedom with a  
 cane while he held a staff  
 cocked in the other which was  
 reported ~~Aug 23<sup>rd</sup> / 27~~ and was ordered to  
 have the cane tried and he is now bound  
 over to appear before the Criminal Court  
 It is from this plantation you  
 sent me an order to seize the  
 Crops for shipping his Crops and  
 would not carry out the Contract  
 These two men Chas James and  
 Eliza Cotton <sup>and Jacob Jarrett</sup> will deprive the  
 Freedom if they are not prevented  
 by the Bureau  
 The Election Rolls is closed  
 and through the precaution and  
 vigilance of Mr W. D. Cherry the  
 Justice of the Peace also Chairman



of the Registry Board Enjoining  
 all Signers to read and peruse the  
 Article and if finer Amalgam there  
 has not been any trouble in the Town  
 of Trinity

I know your sheet about  
 A. S. C. Camp  
 A. S. C. Camp, A. S. C. Camp, A. S. C. Camp

Officer, Act. Dub. West. Con  
 Bureau of N. F. & S.  
 Catahoula Parish, La.  
 Trinity Nov 6<sup>th</sup> 1868.

Capt. M. W. Price

Sir

I have the honor  
 to reply to your letter of the 4<sup>th</sup> and  
 must give you with regards  
 to my Monthly School Report  
 being a major one

Since I have been in this Parish  
 and before I entered upon any duties  
 in the Bureau and from the first  
 liberation of the Colored People I  
 have been a strong Advocate of  
 their Education

Since I have been in Charge  
 of this Parish I have used all  
 the influence that laid in my  
 power for the purpose of establishing  
 Schools also Sunday Schools in  
 the Parish. I would most respect-  
 fully refer you to my Monthly Report

of Aug 31<sup>st</sup> (No 4) Report of Schools for Aug 31<sup>st</sup>  
 (No 2) Report of Schools (No 2) Sept 30<sup>th</sup>  
 also Teachers Report

Now the Collection of the Collection  
 is over of known there will be no  
 trouble to re establish a School in  
 Harrisonburg with a good Colored Teacher  
 living there. with the aid of the  
 Bureau there is no School House  
 but one can be hired or built

Mr Marshall the Minister who  
 is teaching School in Harrisonburg  
 and has 43 Scholars 17 paying the  
 balance are poor Children he preaches  
 to both white & Colored on the  
 Sabbath & Sundays a day he advocates  
 so Colored Schools and the Education  
 of the Freed People he promised  
 me this morning to do all he  
 could to establish Schools for  
 the Freedmen in the Parish

Mr Planters or several of  
 them has offered to set apart  
 land for School & Church purposes  
 if I can build on it they have  
 no House I have a frame of a  
 Building on the Black River  
 and part lumber to finish it  
 which was intended for a Church  
 and School House Mr G. Leman  
 my predecessor collected \$20.<sup>25</sup> towards  
 completing it he had the frame  
 put up and then it stands

The Building was given by Mr Bidell  
 Leman put the money in his  
 pocket

When I made out my last  
 Monthly Report to you I felt



perfectly disheartened I had rode  
 many a day in the Sun sometimes  
 with a fever on me attending to  
 my Dutys, Schools, Inspection  
 and investing Cases when the  
 "Krudmen" had an imperty dealt  
 with, and have operation to appear  
 me at every step, for dinner  
 hour he here of how he had  
 at also satisfied to learn this I  
 have had to contend with and  
 by acting with an even hand to  
 wards all I have gained the respect  
 (but not the esteem) of many by  
 interfering with nothing but what  
 my Duty called me. They will  
 not have esteem for any Yankee as  
 they call us and are on the watch  
 youst us I have not interfered  
 with their Politics but mind  
 my Official Business

I wish you would write me  
 what you could do with regards  
 to Schools for the "Krudmen"

- 1<sup>st</sup> With regards to School Houses
  - 2<sup>nd</sup> The payment of Teachers
  - 3<sup>rd</sup> Furnishing of proper Books
- and please your most obedt  
 Servt

J. A. P. Corups  
 O. S. C. B. R. F. & A. L.

Office apt fut apt Comr  
 Division R. F. & A. L.  
 Parish of Batoula.  
 Trinity La Nov 10<sup>th</sup> 1868

Hutchins B. H. Capt Major  
 A. A. A. Gray  
 Bureau R. F. & A. L.  
 New Orleans La  
 Major = { Tys. Sgt. Bowme. Sub Act Comr. 5<sup>th</sup> Sub District }  
 I have the honor to report my arrival  
 here last evening. I assumed the duties appertain-  
 ing to this parish this morning.

Very truly  
 your obt servant,  
 Van R. Hilliard  
 apt. fut. apt. Commissary

Office A. F. A. Comr Bureau R. F. & A. L.  
 Trinity La Nov 13<sup>th</sup> 1868

Birman E. C. Lt. Col  
 O. S. C. B. R. F. & A. L.  
 New Orleans La  
 Col.

I have the honor to transmit  
 herewith travelling expense accounts.

October 29 <sup>th</sup>	5.50
November 5 <sup>th</sup>	5.50
Nov 4 <sup>th</sup>	10.50
Total Amount	\$ 21.50

If you find this all  
 correct. Please be kind enough to send me by  
 mail a check, for the amount, payable to my  
 order -  
 My Respect  
 your obedt servant.  
 Van R. Hilliard



Officer apt Sub apt Comm  
Bureau R.F. and A.L. Land  
Parish of Catahoula  
Trinity La Nov 13<sup>th</sup> 1868.

Recd  
Beman E. C. Lt Col  
D.O. and A.A. 2 M.  
Bureau R.F. and A.L.  
New Orleans La

fol =

I find that the supply of Forage and Stationery, now on hand at this office will hardly last this month out - I have no blank requisition forms for Forage or Fuel.

I have bought some fuel and am I correct in using form No 11 for such a purchase?

Very Truly -  
Your Obedient servant -

Van R. Hilliard  
apt. fut. apt. Comm.

Officer apt Sub apt Comm.  
Bureau R.F. & A.L.

Parish of Catahoula Trinity La Nov 17<sup>th</sup> 1868

Lt J. M. Lt.  
Acty. apt Insp Genl. Bureau R.F. & A.L.  
New Orleans La

Lt -

I have the honor to inform you, that on the 10<sup>th</sup> inst, I assumed the duties of a p. a. c. R. F. & A. L. for this Parish. I do not find with the papers transferred to me, <sup>here</sup> any retained copies of Inspection Reports of Plantations in this Parish. Nor is there in this office, any blank monthly reports for such inspections. I would most respectfully ask you to forward to me here, such blank forms as I may need -

(over)

I am -  
Very Truly -  
Your Obedient servant -  
Van R. Hilliard  
apt. fut. apt. Comm.

Officer apt. fut. apt. Comm  
Bureau R.F. & A.L.

Beman E. C. Apt Lt. Col  
D.O. & A.A. 2 M.  
Bureau R.F. & A.L.  
New Orleans La  
Parish of Catahoula  
Trinity La Nov 18<sup>th</sup> 1868.

fol =

I have the honor to transmit herewith requisitions for Stationery for the month of December -

There is not sufficient Stationery on hand in this office to last this month out -

I am Very Truly -  
Your Obedient servant -

Van R. Hilliard  
apt. fut. apt. Comm.

Officer apt. fut. apt. Comm. Bureau R.F. & A.L.  
Parish of Catahoula - Trinity La Nov 18<sup>th</sup> 1868.

J. H. H. Camp Esq

Kind Sir =

You must remember the case of Isaiah King (freedman) & John Gray a planter in Concordia Parish - King come to my office today & told me his case. By referring to the books I find that you have reported his case to Lt Lar. & also to the Bureau officer (Mr Hamilton) of Concordia Parish. King also told me that he left with you a book

(over)



in which was the contract between him, & Mr Gray. I find a copy of the contract, but not the book with the original document in. I also find a copy of an ape between King & Gray. Please be kind enough to let me know where the book in which the original contract is to be found.

Very Truly -  
Your Obedt Servant -  
Wm R Killiard  
Apt. Feb. Apt. Four.

Office Apt. Feb. Apt. Four -  
Bureau R. F. and A. L.  
Parish of Catahoula.  
Trinity - La Nov 20<sup>th</sup> 1868.

Brig Major B. I. Hutchins -  
A. S. A. Genl.  
Bureau R. F. and A. L.  
New Orleans, La.

Major (Through Mr L. M. Bowen Subapt Com. 5<sup>th</sup> Sub District)  
I have the honor to submit the following Report of the transactions of the Bureau in the Parish of Catahoula for the ten days ending Nov 20<sup>th</sup> 1868.

Contracts approved & forwarded  
Applications for Supplies

Amount Recd.

(See attached list of Government property Recd from J. H. H. Camp a. f. a. Com.)  
List of Govt property Recd at Trinity, La Nov 10<sup>th</sup> 1868 from J. H. H. Camp a. f. a. C.

One Horse	Twenty one Show Hets - Damaged
One Saddle	One Saddle
One Bridle	One Report
One Blanket	One Complaint
One Saddle	One Provision
One Bridle	One Officers Manual
Twelve Pack boots	One Manual of School Laws & College
Twenty one Pairs Shoes	

Amount Issued - Four  
Complaints - Four

Complaints. Three Complaints were amicably settled & one was refused to civil authority. Said Complaints were not of sufficient importance to merit reporting by detail.

Inspections. Three Plantations were inspected in the Parish in the last ten days - I do not find with the papers transferred to me here by my predecessor, any retained Copies of monthly Inspection Reports of Plantations in this Parish.

How Freedmen are working. The Freedmen are very industrious & working well - Several of the Planters have informed me, that the Freedmen were working since the election better than ever. Many of the Freedmen have an interest in the crops. And it is a great inducement for them to work well now as the Cotton is matured, ready for picking. As far as I know, as a general thing employers treat them well - & a mutual understanding exists, as to fair treatment for fair services.

Moral Condition. The Moral Condition of the freedmen is not very good. but I have great confidence in the influence of Education to benefit them in this respect.

Schools. I have not succeeded in opening any new schools during the time I have been here. I have spoken to a few freedmen on the subject, they seem to take a great interest in having their children taught - The white people here, are not much in favor of having such schools.

Plantations & Crops. The Condition of plantations & Crops is very good considering the overflow of last spring - The corn has been all gathered & I am informed that there is an abundant yield over that of last year. The Cotton crop is nearly all gathered & it will yield, this year from three fourths of a bale to a bale per Acre.

Feeling of Races. The feeling between the white & freed people seems to be friendly, in far as labor is concerned.



excepting in some cases where the plantations have been worked on shares - The freed men tell me that they get along much better since the election is over - I must say, that were it not for the government protection, through this Bureau - that the freed people in this Parish would not have many, if any political or social rights -

Health - The health of both races in this Parish is good - nothing but a few cases of fever exists -

Remarks - On the 10<sup>th</sup> inst I received Mr J. H. Camp & assumed the duties of the Bureau for this Parish in compliance with Special Order #122, dated 4<sup>th</sup> 2<sup>d</sup> Bureau, R. F. & A. L. State of La. Nov 6<sup>th</sup> 1865 - I find that it will be a hard matter for a Bureau officer, a true Union man who tries to do his whole duty, to get along peacefully with the white people of this Parish - They tell me that they may like me personally, but that they have no respect for the duties I am here to perform. I have no fear of my life being taken, nor do I intend to be driven away. But I shall hardly be contented to remain here for any great length of time -

I am -  
Very Truly -  
Your Obedient servant -  
Wm R. Hilliard  
agt - sub agt Commissions.

Office agt. sub agt. Com  
Bureau R. F. & A. L.  
Parish of Catahoula  
Trinity La Nov 20<sup>th</sup> 1865.

To  
Mr J. L. Bowen -  
sub agt Com. 5<sup>th</sup> sub district.  
Bureau R. F. & A. L.  
Morrow, La.

fir = I have the honor  
to transmit herewith a Receipt for <sup>(dated Nov 17<sup>th</sup> 1865)</sup> Circular # 19  
from your Office.

Very Respectfully  
Your Obedient servant -  
Wm R. Hilliard  
agt - sub agt. Com.

Office agt. Bureau R. F. & A. L.  
Parish of Catahoula.  
Trinity La Nov 23<sup>rd</sup> 1865.

fir = I have the honor to acknowledge the receipt of  
one copy of Circular # 19 - dated 4<sup>th</sup> 2<sup>d</sup> Bureau R. F. & A. L. State of La - Nov 14<sup>th</sup> 1865 -

Very Respectfully  
Your Obedient servant -

Wm R. Hilliard  
agt - sub agt Com  
Bureau R. F. & A. L.

Lt. W. W. Woods  
Acty agt. Adjt. Genl.  
Bureau R. F. & A. L.  
State of La.  
New Orleans - La -



Office Agent Bureau R.F. & A.L.  
Parish of Catahoula -  
Trinity La Nov 21<sup>st</sup> 1868

Sir =

I have the honor to acknowledge the Receipt  
of one copy of Circular No 20 Dated 14<sup>th</sup> 2<sup>nd</sup> Bureau  
R.F. and A.L. State of La. New Orleans La Nov 21<sup>st</sup> 1868

Very Respectfully  
Your Obedt servant -  
Van R. K. Hilliard  
Agent Bureau R.F. & A.L.  
Parish of Catahoula - La -

Mitchins G.T. Post Major -  
a. a. a. Genl.  
Bureau R.F. & A.L.  
State of La.  
New Orleans La.

Office a. f. a. l. Bureau R.F. & A.L.  
Parish of Catahoula - Trinity La Nov 21<sup>st</sup> 1868

Bureau Post Lt Col L.C.  
D.O. & a. a. s. M.  
Bureau R.F. & A.L.  
New Orleans La  
fol =

I have the honor to  
transmit herewith duplicate Bill of Lading of Hay,  
& Oats. received here this day -

Very Respectfully  
Your Obedt servant -  
Van R. K. Hilliard  
a. f. a. l. Bureau R.F. & A.L.

Office. apt. sub. apt. Comm  
Bureau R.F. & A.L.  
Parish of Catahoula Trinity La Nov 30<sup>th</sup> 1868

Bureau E. b. Post Lt Col  
D.O. & a. a. s. M.  
Bureau R.F. & A.L.  
New Orleans La

fol = I have the honor  
to transmit herewith my Report of Personal Article  
Kind. for month of November - 1868  
Mr Wm & Cherry  
will present the vouchers for payment -

Very Respectfully  
Your Obedt servant -  
Van R. K. Hilliard  
a. f. a. l. Bureau R.F. & A.L.

Office a. f. a. l. Bureau R.F. & A.L.  
Parish of Catahoula Trinity La Nov 30<sup>th</sup> 1868

Lee J. M. Lieut -  
39<sup>th</sup> Regt. Infantry  
Acty. apt. Insp General  
fol = I have the honor to

transmit herewith  
Inspection Report for month of November 1868 -

Very Respectfully  
Your Obedt servant -  
Van R. K. Hilliard  
a. f. a. l. Bureau R.F. & A.L.



Office of A. C. Burman R. F. and A. L.  
Parish of Catahoula Trinity La Nov 30<sup>th</sup> 1865.

Divice H. H. Burt Capt -  
Genl Supt of Education -  
Burman R. F. & A. L.  
New Orleans La

Bapt = I have the honor to

Transmit herewith

"District Supt Report of Schools"  
and "A. C. Burman Monthly Report" for month  
of November - 1865 -

Very Respectfully  
your Obedt Servant -  
Tom R. Hilliard  
A. C. Burman R. F. & A. L.  
Parish of Catahoula

Office of A. C. Burman R. F. & A. L.  
Parish of Catahoula Trinity La Nov 30<sup>th</sup> 1865.

Witcham B. T. Brig Major -  
A. A. A. Genl -  
Burman R. F. & A. L.  
New Orleans La

Major = (Through Mr. D. H. Brown Sub Supt. La. - 5<sup>th</sup> Sub District.)  
I have the honor to ~~submit~~ submit the follow-  
ing Report of the transactions of the Burman in the Parish of  
Catahoula for the ten days ending November 30<sup>th</sup> 1865 -

Contracts approved & forwarded -	None
Applications for supplies -	None
Amount Rec <sup>d</sup> & Paid -	None
Complaints	Three

Complaints - These Complaints were amicably settled -  
None were referred to civil authority - said complaints  
were not of sufficient importance to merit reporting by  
detail -

Inspections

Five plantations in this Parish were inspected  
in the last ten days - owing to my not finding in this  
office any retained copies of Inspection Reports - I  
cannot tell which plantations have, or have not been  
inspected this year -

Law Freedom  
are working

The freedmen must be working well  
as no complaints to the contrary have been made by  
the planters - I think the freedmen will work  
well in a future - if they get a fair settlement with the  
planters for this year's labor - I learn that some of  
the principle planters seem to think that a freedman should  
only have at the end of the year's labor, what clothes he  
may have on his back - That freed people should be  
satisfied with enough to eat & wear - It is a fact  
that only a few of the freedmen will have much due  
them on settlement - yet that little should be paid  
them - I am told that several of the planters in this  
Parish have not settled with their freedmen for the last  
three years -

Moral Condition

The moral condition of the freedmen is  
not very flattering -

Schools

I find at this present time, that there  
are only two small schools (one day & one night) in this  
Parish - The freed people are very anxious to have their children  
taught - I do not think the white people would interfere with  
though they are not much in favor of having the freed people's  
children educated - there are enough children at either  
Trinity or Harrisburg, to fill a good school -

Crops

I shall do all I can to have schools started -  
The cotton is nearly all picked - The  
crops have been much larger this year than it was expected  
they would be - If this Parish could be protected from the  
over flows of the Mississippi River - it would be a very  
productive one -

Felling of  
Races

The feeling between the white & freed people  
seems to be friendly as far as labor is concerned -  
The planter must show some little regard for the  
freedmen - if he wishes to succeed in making crops -



yet many of the planters seem to act as if the freedmen had no social or political rights which a white man was bound to respect.

Remarks -

Meigs White & Ramsey, and E. J. Robinson planters, have informed me that they have paid their indebtedness to this Bureau for subsistence furnished them. This office has not yet received any official notices of such payments.

On the 24<sup>th</sup> inst I forwarded (through Lieut. A. C. Brown, 5<sup>th</sup> Sub District) my resignation as 1<sup>st</sup> Lieut. A. C. Brown, Bureau R. F. & A. I hope that it will be accepted at once.

Very Respectfully -  
Your Obedt servant -

Wm R. Hilliard  
1<sup>st</sup> Lieut. A. C. Brown, Bureau R. F. & A.

Office A. C. Brown, Bureau R. F. & A.  
Parish of Orleans, Trinity La Dec 1<sup>st</sup> 1868

Wood W. W. Lieut 1<sup>st</sup> Lieut. A. C. Brown, Bureau R. F. & A.

Lieut =

In compliance with your request of Nov 25<sup>th</sup> 1868 I have the honor to transmit herewith Bond of White & Ramsey, said Bond has not been signed by their bondsmen Meigs White & Ramsey. I have informed me that they have paid their indebtedness to this Bureau.

Very Respectfully -  
Your Obedt servant -

Wm R. Hilliard  
A. C. Brown, Bureau R. F. & A.

Office 1<sup>st</sup> Lieut. A. C. Brown, Bureau R. F. & A.  
Parish of Orleans, Trinity La Dec 3<sup>rd</sup> 1868.

Hutchins B. T. Post Major:

A. A. A. Genl  
Bureau R. F. & A.  
New Orleans La

Major = (Through Mr J. H. Brown, 5<sup>th</sup> Sub District) I have the honor to transmit herewith my account servant for the month of November 1868. I do not find in this office any blank forms for making out the above mentioned account.

Very Respectfully -  
Your Obedt servant -

Wm R. Hilliard  
A. C. Brown, Bureau R. F. & A.  
Parish of Orleans

Office A. C. Brown, Bureau R. F. & A.  
Parish of Orleans, Trinity La Dec 7<sup>th</sup> 1868.

Wood W. W. 2<sup>nd</sup> Lieut. A. C. Brown, Bureau R. F. & A.  
New Orleans La.

Lieut =

I have the honor to inform you that I received this day the Bond of Meigs White & Ramsey with my letter of transmittal of the 1<sup>st</sup> inst. with your endorsement thereon of the 4<sup>th</sup> inst.

I would respectfully return to you herewith the Bond signed by Meigs White & Ramsey's surety. It is the only copy of the bond that I found in this office.

Mr E. J. Robinson of this Parish informs me that he received in N. O. Meigs White & Ramsey - have paid his indebtedness to this Bureau for subsistence furnished him. I am Obedt  
Wm R. Hilliard



Office Assistant Sub-Assistant Commissioner  
Bureau R. F. and A. Lands  
Parish of Catahoula  
Cinity - La Ore <sup>the</sup> 11/10/18.

Mitchell B. T. Knight Mayor

A. A. Gaul  
Bureau R. F. and A. Lands  
New Orleans La.

Major = (Through Mr. J. L. Bowen, Sub-Assistant Com. 5<sup>th</sup> Sub-District)  
I have the honor to submit the following report  
of the transaction of the Bureau in the Parish of Catahoula  
for the ten days ending December 10<sup>th</sup> 1868.

Contracts approved & forwarded -	None
Application for Supplies	None
Amount Rec <sup>d</sup> & Issued	None
Complaints	Two

Complaint

Two Complaints were amicably settled  
said complaints were not of sufficient importance to  
warrant reporting by detail.

I received on the 9<sup>th</sup> inst  
from Mr. J. L. Bowen Sub-Assistant Commissioner, 5<sup>th</sup> Sub-District  
a letter of instruction from the Assistant Commissioner  
District of Louisiana. Directing, to cause appi-  
= dices to be made and proper steps taken for the  
arrest, and trial of persons of committing an outrage  
against Expanded Right "colored" or Society Island of  
the Parish - on or about the 4<sup>th</sup> day of November 1868.  
Enclosed therewith was an affidavit of Mrs. Jean B.  
"colored" concerning same. I have not yet taken  
any action in the matter.

Inspection

One plantation has been inspected  
in the last ten days. I find the quarters for the  
freemen, to be, as a general thing, in a comfortable condition.  
Most all of the freemen have a small portion of  
land allotted to them for garden purposes.

How freemen  
are getting on

There has been no complaints made  
to me, by either planter, or freemen, as regards labor -  
excepting in some few cases where the planter has been

Very anxious to work all day of a pleasant Saturday,  
when there was every prospect of some hoisting stormy weather.  
The freemen in their agreements with planters, approved by  
the Bureau, have in most all cases agreed to work <sup>after</sup> ~~after~~ noon,  
whenever in the judgment of the employer it  
may be necessary for the rearing of the crops. While  
the cotton is now all ready for picking it is greatly to  
the interest of the freemen, who are working the plantation  
in chains to improve every moment. Yet most all of the  
freemen seem to think that Saturday afternoon is a time  
for pleasure, and not for labor.

Moral Condi-  
tion

The Moral Condition of the freemen  
is not the best. It must not be expected of a  
race of people brought up in slavery and ignorance, to  
become wise, & virtuous, all at once.

Schools -

I have not succeeded in opening any  
new schools for freemen children nor do I think it prop-  
= ertable to do so until after New Year - The school on  
the Ackland plantation, was closed for the year, on the  
4<sup>th</sup> inst.

Plantation &  
Crops -

A few more pleasant days, will enable  
the planters to secure all of their cotton.

Feeling of  
Races -

I see no change in the feeling between  
the white & freed people, different from what I have previously  
by reported. The white people here, have no respect for a  
black man, only as far as labor is concerned. If the  
planter wishes to succeed in making crops, he must  
show some little regard for the laborer.

Health

The health of both races in this  
Parish is good.

Remarks

I would ever more, most respect-  
= fully, call your attention to the fact, of my having  
on the 24<sup>th</sup> of last November forwarded to the Board of Trustees  
of this Bureau, my Resignation as an Assistant Sub-Assistant  
Commissioner. I do hope that the Assistant Commissioner  
if he has not already done so, will at once accept my  
resignation, and relieve me from duty here, as soon as  
it can consistently be done.

(Bow)



I am  
Very Respectfully  
your Obedient servant -

Van R. K. Hilliard  
Assistant Sub-Inspector  
Parish of Calcasieu

Office A. J. A. Commissioner  
Parish of Calcasieu  
Trinity La Dec 10<sup>th</sup> 1868

Parish of Calcasieu  
New Orleans La  
Cal.

I have the honor to  
transmit herewith ~~the~~ Requisitions for Fuel - for  
months of November, and December, 1868.

I would have  
forwarded them to you on the 1<sup>st</sup> inst. had it not  
been for the fact of my having on the 24<sup>th</sup> of last  
November forwarded to the headquarters of this Parish  
my Resignation as an A. J. A. Commissioner -  
and expected to have been relieved from duty here  
before this time. I have purchased fuel to  
fill the requisitions using Form No 12 for your  
voucher -

I hope to be in New Orleans in a few  
days

Very Respectfully  
your Obedient servant  
Van R. K. Hilliard  
Assistant Sub-Inspector  
Parish of Calcasieu

Endowment on letter II # Returned to Mr J. H. Brown - f. d. 5<sup>th</sup> sub district

Office A. J. A. Par R. F. + R. L.  
Parish of Calcasieu  
Trinity La Dec 12<sup>th</sup> 1868

Respectfully returned to Mr J. H. Brown f. d. Louis -

Action will be taken in accordance with  
instruction from the Assistant Commissioner -

Van R. K. Hilliard  
A. J. A.  
Parish of Calcasieu

Office A. J. A. Par R. F. + R. L.  
Parish of Calcasieu. Trinity La. Dec 12<sup>th</sup> 1868

Walter H. B. Stearns  
A. J. A. Genl.  
Par R. F. + R. L.  
New Orleans La.

Major -  
I would most  
respectfully request of you to send me a few  
Blank Monthly Inspection Reports -

Very Respectfully  
your Obedient servant -  
Van R. K. Hilliard  
A. J. A. Commissioner  
Parish of Calcasieu



Office of Lt. Col. R. F. 2nd Lt. -  
Parish of Catahoula - Trinity La. Dec 14<sup>th</sup> 1864

Wood W.W.

2<sup>d</sup> Lieut. 1<sup>st</sup> Inf. Arty -  
A. A. S. Genl.

Par. R. F. & H. - New Orleans La.

Lieut =

I would respectfully inform you that I rec<sup>d</sup> this day. The Inspection Reports of Mr J. M. K. Camp late A. S. G. with your endorsement of the 12<sup>th</sup> inst. on the wrapper. I will make any report that you may call for as soon as I receive any blank Monthly Reports for which I wrote to Sgt Major B. T. Hutchins A. S. G. for on the 12<sup>th</sup> inst.

I forwarded on the 1<sup>st</sup> inst. my Inspection Report for month of November -

I did not find in this Office with the papers transferred to me by my predecessor a retained copy of any Inspection Report. The fact is, that I found the books, papers and unsettled business of the Bureau to be in such a confused condition that on account of it - and also of the hostile feelings of the white residents of this Parish towards any free Union man. One who tries to do his whole duty - that I forwarded my resignation to the A. S. Genl on the 2<sup>nd</sup> inst of last month. I am anxiously every day to be relieved from my duties here -

I Am Sir - Very Respectfully -  
Your Obedt Servant -

*W. R. Milliard*  
A. S. G. Parish of Catahoula

Office of Lt. Col. R. F. 2nd Lt. -  
Parish of Catahoula - Trinity La. Dec 15<sup>th</sup> 1864

Lieut. J. M.

1<sup>st</sup> Lieut 29<sup>th</sup> Inf Arty  
A. A. S. Genl  
Par. R. F. & H.  
New Orleans La.

Lieut =

I received back yesterday, through sub A. S. Genl. 3<sup>rd</sup> sub District. My Inspection Report for Mo of November -

I would respectfully return to you said Report, to which, in compliance with your request. I have added an estimate of ~~Plantations~~ in this Parish, which have not been inspected, the amount of which I have added to that of those I inspected making ~~the~~ total in the Parish -

I Am Sir -  
Very Truly -  
Your Obedt Servant -  
*W. R. Milliard*  
A. S. G. Parish of Catahoula



Office of the Superintendent of Schools  
Parish of Calcasieu  
Trinity La Dec 15<sup>th</sup> 1866

Orman G. S. St. L. La.  
D. O. 2nd A. S. M.  
Orman R. F. 2nd A. S.  
New Orleans La

fol =

I would most res-  
pectfully ask of you to send me a few blank forms  
No 22. "Forms + articles hand."

I am fir.

Very Truly  
Your Obedt servant.

Van R. K. Hilliard  
A. S. of the Parish of Calcasieu.

Office of the Superintendent of Schools  
Parish of Calcasieu  
Trinity La Dec 19<sup>th</sup> 1866

Mr J. F. Marshall  
Harrisonburg La.

fir =

I enclose herewith vouchers  
for rent of schoolhouse - month of October 1866 -  
which of you will sign, and return to  
Capt G. M. Dinter Genl Supt of Education.  
New Orleans La - the money will  
be sent you.

I am fir.

Very Respectfully  
Your Obedt servant.

Van R. K. Hilliard  
A. S. of the Parish of Calcasieu.

A. Index B.

Armstrong Capt. W. B. Ant.  
Q. No. 3, 4, 5, 6, 7, 9, 10, 11, 12, 13, 15, 19, 23, 25, 31.

Brennan E. B. 4.

Andersen Abalino 22.  
Andersen Jackmont Dec. 28.  
Alexander Watson 41.

Bratton 15, 34.  
Braham Lewis 22.  
Benjamin Anthony 22.  
Comman Samuel 29.  
Cimman E. C. St. Col. 37, 39, 50, 52.  
53, 71, 72, 73, 78, 81, 85, 96.

Brown J. M. Sub. Ant. Com. 48, 51.

77.  
Black D. 57.

Brown J. D. 85, 86.



C.

Campbell 9

Cotton 15, 34, 38.

Cosgrove Ellen 22.

Cuny Dr. 28.

Camp J. H. D. 73, 74, 94.

C.

Ditto M. S. 14.

Daniels Henry 29.

Dunkley James 46, 46.

E.

D.



*W*

*Wald Saml. C. 17, 21, 34.*

*Green Julia 22.*

*Garrett J. 34.*

*H.*

*Hooper C. A. 14.*

*Hout John 34.*

*Hutchings P. V. Capt. Maj. 56, 38.*

*Hutchins P. V. Capt. Maj. + U.S. Gen.  
71, 74, 82, 85, 86, 93, 44.*

*D.*

*J.*

*Jones Charles 15, 34.*

*Johnson Isabella 22.*

*Johnson W. 34.*



*K.*

*King*

*29.*

*L.*  
*Semmon M. Johnson 12, 28, 33, 43.*

*Siddill 15, 34.*  
*See J. M. St. 39' Vol. I. 32, 35, 49, 54, 72.*  
*81, 95.*  
*Louisiana State of 34.*

*M.*

*M.*  
*Marshall J. C. 96.*



C

P

Parker S. C. Lt. 1<sup>st</sup> Regt. Inf. 8.  
20. 22.

Peniston Dr. 28.  
Peck Dr. 28.  
Peck M. J. 12. 43.  
Piel H. M. 44. 45. 60.  
Pierce H. H. Bot. Capt. 83.

Q

R

Redrick 15.  
Ridina Maria 22.  
Robinson 41.  
Robertson E. J. 54. 55.



W

Shenkent & Koshland 3, 6, 7.

S

Sterling M. H. Capt. 1<sup>st</sup> Reg. D. 14.

16, 21.

Spencer 15, 34.

Smith Anderson 29.

Snyder John C. 34.

Stur J. W. 34.

Sustine D. W. No. 56.

W

W

Wilson Milton 5.

Wuttall W. D. S. 14, 28.

Wooten 15, 34.

Waller Charles 22.

Wesley 30.

Warren S. M. Capt. St. Col. 38, 40, 41, 43.

White & Ransy 11, 24.

Warren S. M. Capt. St. Col. 43, 47.

Wood W. W. St. 77, 84, 85, 94.

W



*Q.*

*Q.*

*Q.*

NATIONAL ARCHIVES AND RECORDS ADMINISTRATION  
MICROFILM PUBLICATIONS

Roll 103

Target 10

*Register of Letters Received*

Volume (477) Nov.-Dec. 1868

Volume pages were filmed sequentially.  
Blank pages were not filmed.



477

LOUISIANA.

1  
L. J. ...  
...  
...  
Louisiana









Officer Apt Sub Apt Honor,  
Bureau R. F. & A. L.  
Parish of Catahoula, La  
July 1<sup>st</sup> 1867.

Wm A. Sterling Capt 1<sup>st</sup> U. S. Inftry,  
A. A. A. Genl Bureau R. F. & A. L.  
New Orleans, La

Sir

I have the honor to transmit you the following Report. I have but little or nothing to add to my last report, both the freedmen and the planters are getting along very well. I have not heard a complaint from either in the last two weeks.

Fears are entertained of serious damages from the back waters of Red River which is now overflowing some of the finest cultivated plantations in the Parish.

Respectfully Your Obedt Servant  
M. Johnston Lemmon  
A. S. A. Comr,  
Bureau & C.



Officer Apt Sub Apt Comr,  
Bureau R. F. & A. Lands.  
Catahoula Parish, La  
July 10<sup>th</sup> 1867.

Wm H. Sterling, Capt 1<sup>st</sup> U.S. Infy,  
A. A. A. Genl Bureau R. F. & A. L.  
New Orleans, La.  
Sir

I have the honor to transmit you the following report. The weather has been very unfavorable for the planters, for the last two weeks, as it has rained more or less every day, and both the planter and freedmen are becoming uneasy and dissatisfied at the prospects of the crop, however the freedmen are working remarkably well under existing circumstances.

The water receding very slowly and a great many of the plantations are still inundated.

I opened another School last week, and will open a couple more as soon as I can get teachers.

Respy Your Obt Servt.  
W. Johnston Lemmon  
A. S. A. C.  
Bureau &c.

Officer Apt Sub Apt Comr,  
Bureau R. F. & A. L.  
Catahoula Parish, La.  
July 20<sup>th</sup> 1867.

Wm H. Sterling Capt 1<sup>st</sup> U.S. Infy,  
A. A. A. Genl, Bureau R F. & A. L.  
New Orleans, La.  
Sir

I have the honor of transmitting you the following report. We have had beautiful weather for the past five days and the "freedmen" are working with a much better will and energy than they had been doing for some time previous, and there is a much better feeling existing between the planters and freedmen than heretofore.

The schools that I have in operation are prospering every day.

The Cotton and Corn Crops in this Parish will be very light indeed. I do not think there will be one planter in twenty that will pay expenses.

They are entertained of the cotton all being destroyed by the caterpillars which has made its appearance in several places in the Parish, but should the weather continue warm and dry for the next week or two I think it will entirely destroy them. The high water is subsiding very fast.

Respy Your Obt Servt.  
W. Johnston Lemmon.  
A. S. A. C. Bureau &c.



Office Asst Sub Asst Comm.  
Bureau R. F. & A. L. Lunds.  
Catahoula Parish, La.  
August 1<sup>st</sup> 1867

L. O. Parker, 1<sup>st</sup> Lt 1<sup>st</sup> U. S. A.  
A. A. A. Seal  
Bureau R. F. & A. L.

Sir

I have the honor of transmitting you the following reports. We have had very fine weather for the past two weeks and the Planters are getting along very finely with the cultivation of their crops.

The freed people are working very well indeed. There are quite a number of the cotton being eaten up by the Caterpillars which has made its appearance on several plantations. They are very numerous on Col. Choze Jones plantation, but they are very small yet and have not as yet eaten the crop very bad.

Office Asst Sub Asst Comm.  
Bureau R. F. & A. L. Lunds.  
Catahoula Parish, La.  
August 10<sup>th</sup> 1867

L. O. Parker, 1<sup>st</sup> Lt U. S. A.  
A. A. A. Seal,  
Bureau R. F. & A. L.

Sir

I have the honor to transmit you the following report. I have but little to add to my last report.

The Planter and freed people are getting along very well, and the freedmen are working very well under existing circumstances.

The Cotton worm has made its appearance throughout the whole Parish and will undoubtedly destroy the whole Cotton crop.

Quite a number of the planters have expressed a desire to discharge a part or all of their freed people.

People in their employ. Stating that their merchants would stop their supplies, but as yet I have prohibited them from discharging any of them.

I have been trying to get a couple of gentlemen to furnish uncleared land for them to cut wood on, or to start a couple of wood yards to give them employment, for the planters cannot possibly hold out much longer.



Office Asst Sub Asst Comr.  
Bureau R. F. and A. L.  
Catahoula Parish, La.  
August 20<sup>th</sup> 1867

Wm. H. Sterling Capt 1<sup>st</sup> U. S. I.  
A. A. A. Genl.  
Bureau R. F. and A. L.

Sir

I have the honor of transmitting you the following Report. The most of the freed people in this Parish are working for a part of the crop and as the Caterpillars and Cut worms are destroying the Cotton and Corn, and they see they are not going to make very much they are becoming very much dissatisfied, & take but little or no interest in trying to save the crops, some of them have quit work and left the plantation.

Some of the planters want to discharge their hands but I have prohibited them from doing so as yet.

There is a very friendly feeling existing between the races in this Parish.

I have not heard a freedman complain of ill treatment by his employer for over a month. The general condition of the schools are very good. The freed people take but little or no interest in them. It is almost impossible to get the consent of the Parents to allow their children to go to school for fear they will have to keep support it.

Their moral condition is very much on the decline.

over

The condition of the plantations and crops is very discouraging indeed both to the freedmen and planters.

There is little or no sickness here what few cases I have heard of was only Chills and fever.

Respectfully Yours

Wm. Johnston

Wm. Johnston Lemmon.  
A. B. A. Co. B. & C.

Office Asst Sub Asst Comr.  
Bureau R. F. and A. L.  
Catahoula Parish, La.  
August 31<sup>st</sup> 1867.

Wm. H. Sterling Capt 1<sup>st</sup> U. S. I.  
A. A. A. Genl.  
Bureau R. F. and A. L.

Sir

I have the honor of transmitting you the following report, I mentioned in my report heretofore that the Caterpillars and Cut worms was destroying the cotton and Corn in this section of the country.

They are now more numerous than at any time heretofore and will undoubtedly destroy at least one half of all the crops raised in this Parish, and in consequence thereof the merchants are withholding supplies from a great many of the planters and they are compelled to discharge their hands.

The freed people are becoming very much dissatisfied and unmanageable, they are leaving the plantations of their own

over



accord and paying and submitting upon  
the country. There were several  
came to me this week and wanted me  
to discharge them from their present employ-  
ment. I asked them where they was going  
or what they intended to do for a living if  
I discharged them. They said their coun-  
try owed them a living, and they was  
going to hang it, that the women was  
eating up their crops and they was not  
going to make anything, and that they  
would rather steal for a living, than  
to work for nothing.

Several of the planters have caught them  
killing their cattle & dogs in the woods and  
have reported the cases to me, there is  
no civil law or jail or place of confine-  
ment here and I would respectfully ask  
what I will do in such cases as these.

Their moral condition is growing worse &  
worse every day in fact the country is really  
in an alarming condition. The desperadoes here  
are urging them to arm themselves with  
guns, powder, knives, etc, and to be ready  
to use them whenever called upon to use them  
"even long". They see them they are invited  
to the aid of this country and if they  
cannot get them by voting for them, they  
must take them by force. They now go  
so far as to carry their guns and pistols  
with them to preaching on the sabbath days  
and the ministers carries their revolvers  
into the pulpit with them. Mr C Jones  
who is a gentleman of vicinity told me  
today that one of his old family servants  
to have just warned him to be ready  
to leave the country at a moment's warning.

She said there was a secret organization  
among the freed people, that they was arm-  
ing themselves and would give the white  
men some trouble before long.

I have been requested and petitioned  
by a great many of the most respectable  
citizens of the Parish to ask you to send  
some troops into this Parish.

Under existing circumstances I think it  
advisable and would respect fully ask  
that a company of soldiers be sent to  
live in this Parish.

The freed people have but very little inter-  
est in the education of their children  
the health of the Parish is very good  
indeed. I have not heard of a case of  
Cholera or yellow fever this season.



Office Asst. Surg. West. Army,  
Bureau R. F. Am. A. S.,  
Catahoula Parish, La.  
Sept. 10<sup>th</sup> 1867.

Wm. H. Sterling Capt 1<sup>st</sup> U.S. A.  
A. A. A. Genl.  
Bureau R. F. Am. A. S.

Sir

I have the honor to transmit you the following reports. I mentioned in my reports here before that the worms were destroying the Cotton very fast, but the destruction witnessed in the last ten days is almost heart rending. Fields that looked green and promising for a good crop ten days ago, has now wither from leaf or baw, left upon its side. The first appearance of the worms in this Parish "that I heard of," was on Col. Cho's former plantation. He at once employed his whole force at killing the worms, and building small fires all over the plantation and burning the plants as lanterns and carried through the cotton for a couple of hours every evening burning the fleas.

By this means he has, so far, saved his Cotton, and if no preventing providence hereafter he will make a very good crop.

The planters are working very diligently to get Levee Districts established to get to work upon the Levee so as to give employment to the freed people that has and will have to be discharged by the planters.

I am still using every effort to

establish schools throughout the Parish, but I must wish but little encouragement from the freed people. They take but little or no interest in anything now but politics. They are very careless and indifferent about their work, and a great many of them have quit their employer and are roaming over the country and are killing stock and subverting upon the country. Complaints are made to me every day about the freed people killing their stock, but there is no jail in this Parish, and there has been no provisions made to forward them to another Parish, so I cannot do anything in the case.

Some are entertained of trouble with the freed men, as some of them have made some very hard threats and are annoying themselves and are carrying them with wherever they go.

I think it would be advisable to have a company of troops stationed in this Parish to prevent any disturbance from arising. Their moral condition is very much on the decline.



Office Asst. Sub. Asst. Commr.  
Bureau R. T. Am. A. L.  
Catahoula Parish La.  
Sept. 20<sup>th</sup> 1867.

M. H. Sterling, Capt 1<sup>st</sup> U.S.A.  
A. A. A. Seal.  
Bureau R. T. Am. A. L.  
Sir

I have the honor to transmit you the following report. There is but little or nothing transpiring here since my last report worthy of note. The cotton worms has disappeared by walking off and the planters are very hopeful that they will not reappear. The freed people are very much encouraged and are working with more energy and a better will than for some time past, and the good feeling between the races is improving also.

I mentioned in my last report that fears were entertained of serious trouble from the free people of the Parish. They have made some very hard threats, "of what they was going to do &c" in my presence, and they are still arming themselves for some purpose.

There is considerable excitement here in regard to the building of the levee on Little and Black Rivers. The planters hold a meeting tomorrow, and the Police Jurors meet next Monday to form laws and Sub Districts to be lay before the State Commissioners.

The moral condition of the freed people is better than when last reported.

I am trying to establish two or three Churches, and hope to better their  
"evils"

condition. I opened a school last week, but it is very hard work to get the children to attend.

The weather is fair and pleasant and the planters are all busy gathering their little crops.

Respectfully Your Obedt. Servt.  
M. Johnston Lemmon,  
A. S. A. C.  
1<sup>st</sup> Sub. C.

Office Asst. Sub. Asst. Commr.  
Bureau R. T. Am. A. L.  
Catahoula Parish La.  
Sept 30<sup>th</sup> 1867.

M. H. Sterling, Capt 1<sup>st</sup> U.S.A.  
A. A. A. Seal.  
Bureau R. T. Am. A. L.  
Sir

I have the honor to transmit you the following report. There is but little transpiring here at present worthy of note.

The Election held on the 27<sup>th</sup> and 28<sup>th</sup> inst passed off very quietly and satisfactorily to all parties. I doubt very much if they ever held an election in this State that passed off so quietly and peacefully as it did.

The freed people are all quiet now and I think are working some better than they have been doing for some time past.

There has been several moods yards opened on Black River and I have gathered up all the freed people that has been discharged and was out of employ<sup>ment</sup>  
"evils"



and got them employment at cutting and hauling wood etc. which makes things much more quiet in this part of the Parish, and I think will add greatly to their moral condition.

The planters are all very busy gathering their crops which is going to be very light indeed. There is considerable sickness in this part of the Parish of Chiles and fever, but no deaths as I have heard of.

Respectly Yours  
Oct 10th  
M. J. Houston  
A. S. C. C.  
Bureau

Officer Asst Sub Asst Comm  
Bureau R. F. A. L.  
Catahoula Parish La  
Oct 10<sup>th</sup> 1867

J. M. Lee Lt. 1<sup>st</sup> U. S. A.  
A. U. C. C.  
Bureau R. F. A. L.  
Bureau

I have the honor to transmit you the following report. I have but little to add to my last in regard to the crops. The planters are all very busy gathering their cotton and putting up the hay.

The freed people are working tolerable well, and the feeling between the

race appears to be tolerably good.

There was a young man "a merchant" by the name of "Perrison of Society Island" murdered by three fugitives on the night of the 30<sup>th</sup> of Sept. last.

The particulars as near as I have been able to gather them is, as follows.

The three fugitives called at Doctor Perrison's after they had all retired for the night, and called them up and requested to go into the store to buy some goods. Stating they could not leave their work during the day.

Dr Perrison called his son a young man, and told him to go to the store and get the boys what they wanted.

One of the fugitives stood at the door near to the door door, one stood at the door to keep watch and the other one went into the store with the Perrison, and while the Perrison was measuring some molasses, the fugitives that went into the store called him, "Stranger" "Mr Perrison" on the back of the head with a stone laid up in a heavy weight, bruising his skull very badly.

He was hit in the forehead which broke his skull also, and he lay his throat cut from ear to ear, the fugitives that was suspected were arrested at once, and confessed to the murder, and while the Sheriff was conveying them to Vidalia to jail, they tried to escape, and one of them was shot and killed, and the other two was taken from the Sheriff by a large party of our



citizens and hanged to a tree.

I will go up to the Island in a few days and investigate the matter and report you fully.

A. M. Weston reported to me to say that he caught three freedmen a day or two ago, killing one of his cows.

They took as much of it as they could carry and left the rest lay in the woods. This will show you that the moral condition of the freed people is not very good in this section of the country at present.

Respectfully Yours  
 O. H. Bennett,  
 Mr. John L. Garrison,  
 A. S. U. C.,  
 Bureau.

Office Asst Sub Asst Commr  
 Bureau R. F. A. L.  
 Catahoula Parish, La.  
 October 20<sup>th</sup> 1867

J. M. Lee, Lt 39<sup>th</sup> U. S. I.,  
 A. S. U. C. Asst.  
 Bureau R. F. A. L.  
 Sir

I have the honor to transmit you the following report. The weather has been quite warm and pleasant for the last ten days and the cotton is maturing and opening very fast. The freedmen are working some better than usual, occasioned I presume by the near approach of the

time when they will realize the benefits of their year's labor.

As I stated before the crops are going to be very light in this Parish, and as the freedmen are generally working for a part of the crops they are not going to realize much for their year's labor.

I hope soon to improve their moral condition and I have two churches in the course of construction which I will have completed in the course of three or four weeks more.

I have not been able to open many schools for the freedmen on account of the little interest and support the freedmen give them, and the 5 per cent of the freedmen's wages will be very small indeed.



Office Asst Sub Asst Comm.  
Bureau R. & A. Lands.  
Catahoula Parish, La  
Oct 31<sup>st</sup> 1867

J. M. Lee, Lt 39<sup>th</sup> U.S. I.  
A. A. A. Genl.  
Bureau R. & A. L.

Sir

I have the honor to transmit you the following reports. I have but little to add to my last report in regard to the moral condition of the freedmen and the feeling existing between the masses.

There is but little work to do on the plantations as the cotton is maturing and opening very slow, but the planters generally keep their hands together and fear them to keep them from roaming over the country and giving mischief.

I sent you a petition some time ago from some of the most respectable citizens of the Parish, asking for troops to restore and keep order and peace and to prevent mob law in the Parish which was then threatened.

Since then, after the submission of those law abiding citizens there has been a company or band of regulators formed and have taken the law into their own hands, they hanged three white men and cut one freedmen's throat.

At last accounts they was in hot permit of several other white and colored men and perhaps even this they seem show the same fair of

Comrades, they appear to be determined to rid the country of all such characters and I am unable to say to what extent it will be carried if not stopped.

I have the honor to transmit you herewith a letter from Mr W. L. Dices giving the particulars of the shooting and hanging of those freedmen on Sicily Island.

Very Respectfully.

Your Obedt Servt.

W. Johnston Garrison.

A. G. A. C.

Bureau R. & A. L.

Office Asst Sub Asst Comm.  
Bureau R. & A. Lands.  
Catahoula Parish, La  
November 20<sup>th</sup> 1867

J. M. Lee, Lt 39<sup>th</sup> U.S. I.  
A. A. A. Genl.  
Bureau R. & A. L.

Sir

I have the honor to transmit you the following report.

I was traveling through the upper portion of the Parish and Sicily Island on the 10<sup>th</sup> Inst since the cause of my not forwarding my report of the 10<sup>th</sup>

I examined into the case of the murder of Mr Peirson of Sicily Island by three freedmen and found it as stated in Mr W. L. Dices letter and heretofore reported. One of the murderers was



shot and died on Texas River while trying to escape his captors.

I was unable to learn what became of the other two, but it is very evident they were either shot or hanged.

During the trial before Esq. Smith, they all made a free and full confession of the murder. Their object being to steal and plunder.

The Vigilance committee is still being at work in the river, but their movements are kept so secret that it is almost impossible for any one to learn them.

The crops in the river and on Seely Island are very light indeed, they are now nearly all gathered and there are a great many freedmen out of employment, who must buy food and clothing for their families, but have not the means and are unable to get them.

The planters are not going to plant so extensively next season as they did this, and will plant more Corn and peas and less Cotton.

The best of feeling appears to exist between the two races and the moral condition of the freedmen is improving.

The health of the country is very good indeed. Since writing the above I was told, the Vigilance Committee had caught and executed three more men, in St. James Parish, a Mr Jos Wells a Mr Pool and Matt Bonin, all of this Parish.

Office Asst. Surg. Asst. Commr.  
Bureau R. F. A. L. La.  
Calabondia Parish, La.  
Dec 1<sup>st</sup> 1867.

J. M. Lee, 1<sup>st</sup> Lt 39<sup>th</sup> U.S.I.  
A. A. A. Asst.  
Bureau R. F. A. L. La.  
Sir

I have the honor to transmit you herewith the following report. I have but little to add to my last report in regard to the state of affairs in general. The crops will be much lighter than anticipated a few weeks ago. They are quite well gathered now and the planters are discharging their freed people, but are still giving them a chance to make a supply by cutting and hauling wood to the river.

The moral condition of the freed people is improving. I have succeeded in building a very nice Church 24 x 40 feet for the freed people, to be used as a church and school house. I have another one in contemplation which I will get finished by the last of this month. The best of feeling exists between the races and every thing is passing off as pleasantly as a new summer day.



Office Asst. Surg. Asst. Comm.  
Bureau R. T. A. L.  
Catahoula Parish, La.  
Decr 20<sup>th</sup> 1867.

J. M. Ke. Lt. 49<sup>th</sup> U.S.I.  
A. C. A. Genl.  
Bureau R. T. A. L.

Sir

I have the honor to transmit you herewith the following reports. I was traversing through the upper part of the Parish on the 10<sup>th</sup> Inst. since the cause of me not forwarding my Tri Monthly report of that date.

We have had delightful weather for the last few weeks which has enabled the planters to gather all of their crops and give them time to make arrangements for the coming year. There will be a great many planters in this Parish that will not be able to engage in planting another season. Their crops have been so light and they will feel so heavily in debt to their merchants in the City that they will not want to get supplies furnished them.

I have secured a great many contracts in the last twenty days and I have not found one planter in the Parish that has paid expenses.

Those planters that are able and will engage in planting next season will not work more than half as many hands as they did this season.

There has been a great many freed men discharged within the last few

months that are in a very destitute condition indeed. They are destitute of both clothing and food and cannot get any work to do and they will certainly have to resort to stealing or starvation.

There will be several thousands in this Parish that will be unable to get employment in the party of the coming season and they have not got the means to get elsewhere, and unless there is some provision made for them they will undoubtedly suffer greatly. There is thousands of acres of good land that they could lease or rent very low if there was provision to do them until a crop could be raised.

The worst of feeling exists between the races. The moral condition of the freed people is improving greatly. I have succeeded in building them a very nice Church on Black River, and have commenced one on Little River, which I will soon have finished.

I have but very little trouble making settlements between the planters and the freed people. The most of the planters try to justify and respect their contracts with the freed people and respect and obey the Bureau orders &c.

The Vigilance Committee is still at work in the upper part of the Parish (called the lower). They hanged a white man by the name of Murray on the 14<sup>th</sup> Inst.

Very Respectfully  
Yours Obt. Servt.  
M. Johnston Ammon.

A. G. A. L.  
Bureau R. T. A. L.



Office Asst Sub Asst Comm.  
Bureau R. T. & A. Co.  
Catahoula Parish, La.  
January 1<sup>st</sup> 1865,

D. A. Ward, Capt 39<sup>th</sup> U. S. I.,  
A. A. S. Genl.,  
Bureau R. T. & A. Co.

Sir, I have the honor to transmit you the following report. I have carefully examined the within named plantations during the past months and with a very few exceptions have found the freedmen very orderly and respectful to their employers.

The freedmen, as a general thing appear to be very much discouraged and low spirited, and the causes are there in almost every instance.

The planters, keep whiskey, Tobacco &c, &c, which they sell to the freed people at exorbitant prices, and when they come to sell at the end of the year the planters bring them out in debt, and they are turned out of doors without a cent of money, a manufactory to eat, or clothes enough to keep them warm, which is enough to discourage the most energetic and strongest hearted people in the world.

Only yesterday a poor old freedman came to me almost naked, and in a suffering condition, who had just been thrown out of his house, without a moment's warning, in the rain and sleet, by a Mr Jacob Garritt, who he had served and labored for for the last twenty five years.

I bought the poor old man some ration's

and some clothing and shoes for himself and family, which he said, was more than Mr Garritt had given him in the past year. Then I find a planter fulfills his contract with agreement with the freed people. He has but little or no trouble with them, and they work well and are cheerful and happy. For instance there is Mr James Demorey who has twenty eight hands in his employ who has only lost about two hundred and fifty days during the whole year from sickness and all other causes, and they are only indebted to him for supplies advanced about \$21.00 which is not quite \$1 a piece, and I will not be to say there is not a more happy or contented set of people in the Parish, than those in Mr Demorey's employ.

I hope some means will be adopted to prevent the planters from selling the freed people so much whiskey and unnecessary articles the coming year, for their moral condition at present, is very good much better in fact than could be expected, under existing circumstances, and whiskey has more of a demoralizing effect upon them than all other vices combined.

I am unable to say what kind of contracts will be made with the freed people for the coming year. The greater number of the planters in this part of the country are so advanced in money matters that they will not be able to afford more than half the number of hands they now have. There are a great many freed people throughout the whole Parish who are out of employment now.

Very Respy Yours Obedt Servt,  
W. Johnston Linnow,  
A. S. A. C. Genl.



Office Asst Sub Asst Comr,  
Bureau R. I. <sup>and</sup> A. L. L.  
Catahoula Parish, La.  
January 1<sup>st</sup> 1848.

J. M. L. 1<sup>st</sup> Lt 39<sup>th</sup> U. S. I.

A. A. A. Seal,  
Bureau R. I. & A. L.

Sir I have the  
honor to transmit you the following  
report. Since my last report I have  
visited as many plantations as time would  
permit, and I find generally a very  
good feeling existing between the two  
races, but the friendliness and good feeling  
on the part of the white man "in a  
great many instances" is only assumed,  
and extends only as long and as far as he  
is pecuniarily benefited. As long as  
the poor freedman was laboring for them,  
and they thought they were making some  
thing out of them, they would praise  
them and speak kindly to them, but now  
since the year work is gone and they  
have got all out of them that they can  
get, they cast them aside, and if one  
of them dares to ask his employer for the  
rewards of his labor, and demands justice  
due them, they are cursed, and abused, and  
turned out of doors without a mouthful  
to eat or clothes to keep them warm.

The planters who during the working  
season, fawned, and flattered, and made  
the greatest pretensions towards their bonds  
are the first ones to refuse to pay them,  
and the first ones to turn them out of doors.

Yesterday Mr Jacob Garret turned  
several families of his old and most  
own

valued servants, out of his quarters in the  
rain and sleet, because they would not  
agree "upon his terms" to live with him  
during the coming year. Mr G. says he  
does not care a damn for the Bureau  
or its Agents, that he has put one Agt  
out of the way, which ought to be a good  
warning to all other Bureau Agents not to  
interfere with and to keep away from him.  
He acts and speaks very disrespectful  
about and towards the Bureau &c.

The crops in this Parish are very  
light indeed, and the whole blame ap-  
pears to be attached to the inefficiency  
of the labor that the freedmen will  
not work without the behest and  
unless they are continually drove to it.

It is very true some of the freedmen do  
not work as well as they could, and should  
so but I attach more blame to the planter  
for the inefficiency of the labor than I do  
to the freedpeople.

About two thirds of the planters through  
out the whole country, reap, what they  
sow, a small store for the accommodation  
of their freedpeople, which consists of  
the most inferior quality of Whiskey  
and Tobacco and Tobacco and Whiskey,  
which they sell to the freedpeople at the  
most exorbitant prices, and in this way  
take the advantage of the freedmen's  
ignorance, and when they come to settle  
at the end of the year they find their  
whole year's wages taken up in Whiskey  
and Tobacco, and they are turned out of  
doors without a cent of money, a mouth-  
ful of food, or clothes to keep them  
warm, and they are consequently



losing all confidence in the planter and they are so discouraged and disheartened that they have no energy or ambition to do anything.

There are several families in this Parish that are out of employment and have no money, or any visible means of support, and it is really a mystery to me how they manage to live.

I have just heard of the murder of two more freedmen near Harrisburg in this Parish on the night of the 27<sup>th</sup> Inst. I will investigate the matter and report the particulars.

The Civil authorities never take any notice of outrages of any character where freedmen are interested.

I have not heard of a Planter that has made any arrangements for planting for the coming year, and I fear by all accounts that those that are cautious, and disposed to plant will not be able to get any assistance from their merchants.

Office Asst. Sect. Asst. Commr.  
Bureau Re. & A. Lands,  
Catahoula Parish, La.  
January 20<sup>th</sup> 1863.

J. M. Lee, 1<sup>st</sup> Lt. 39<sup>th</sup> U.S.I.,  
A. A. A. Keul,  
Bureau Re. & A. L.

Sir,  
I have the honor to transmit you the following report. I was absent from home on an inspection tour on the 10<sup>th</sup> Inst. since the cause of my not forwarding my report of that date. The planters and the freed people are at a stand still.

The Planters with a few exceptions, have as yet been unable to make arrangements for supplies for the present year, and consequently are unable to contract with the freedmen.

Those that are able and are planting about are offering from 16 to 18. per month or one fourth of the crops and rations and clothes. As a general thing the feeling between the races is very bad.

Their moral condition is tolerable good. They are but little or no interest whatever in education, and I find it impossible to induce them to send their children to school.

I have but very little trouble in settling accounts between the planters and the freedmen, as most of the planters try to do what is right and settle very fairly.

I stated in my last report that there had been two more freedmen murdered near Harrisburg. I recently



the matter as far as I was able, but have been unable to learn who the murder was done or why they committed the deed.

There was a Vigilance Committee formed in the hills, last year to rid the country of a lot of bad men, some of whom were men, some women, that had a personal diffidence with another, shot him down at night, and burnt his property and it is all laid to the Committee.

The place the freedmen lived on belonged to Miss Newman, near Hamletburg, who told me every building on the plantation was burned to the ground.

I applied to the magistrate and Sheriff to assist me to hunt the murderers, but they refused, saying it was not safe to go in to hunt on such business unless they had a detachment of U. S. Cavalry to assist and protect them.

Office Asst. Sub Asst. Commr.  
Bureau No. 7, Ave. A, L. A.,  
Catahoula Parish, La.  
January 31<sup>st</sup> 1868.

L. A. Harris, Capt 39<sup>th</sup> U. S. A.  
A. A. A. Local,  
Bureau No. 7, Ave. A, L.

Sir

I have the honor to transmit you the following report. I have visited over thirty plantations within the last ten days, and have not been able to make one contract. The planters, with a few exceptions are not offering as large wages or interest in the crops as they have formerly done, and a great many of the freedmen refuse to work for them, and are going on deserted plantations and into vacant houses all over the Parish, and it is really a mystery to me, how they manage to live, for there is not one in an hundred that has any money, or a bushel of corn.

The planters are very slow about making final settlements, and is creating a great deal of dissatisfaction among the freed people.

The planters are also very slow about contracting. There are but very few indeed, in this Parish that will be able to plant, unless they can get assistance from the commission merchants in the City, who they are now patiently waiting on to see what they will be able to do for them.

The freed people have been disorganized



so, today since the holidays that I have not been able to keep up but on school, but will start where so soon as they get organized and settled down to work.

Their moral condition is tolerable good. I occasionally hear of the killing of a hog or beef in the woods, but not so frequently as last summer and fall.

The planters are generally going to plant very largely of corn and not any little cotton, and try to raise stock,

Respectfully Yours

Obt. Servt.

M. Johnston Garrison.

A. G. A. C.

Bureau of A. C.

Office Asst. Sub. Asst. Commr.  
Bureau of A. C. Affairs,  
Catalanusa Parish, La.  
February 1<sup>st</sup> 1865.

D. A. Hard, Capt. 39<sup>th</sup> U. S. A.

A. G. A. C.

Bureau of A. C.

Sir I have the honor to transmit you the following report. I have visited over forty plantations within the last four weeks, and am sorry to say, I have not been able to make any contract between the planters and the freed people for the purpose of

planting. The majority of the freedmen made nothing "In fact come out in debt" last year and they are very much distressed and are moving as rapidly as possible on deserted plantations and into every vacant house in the country, and it is really a mystery to me how they manage to live for there is not a cent in there by that time a dime of money.

The planters are so entirely broken up, and so far, have failed, to get any assistance from their Commission Merchants and consequently cannot enter into any agreement or contract with the freed people for the purpose of planting.

I fear there will be but very little planting done in this section of the country, unless there is some uniform assistance given to the planters.

I did not insert in this report, "as you will see" the plantations I have inspected during the last month as they had not hired any freedmen, or had not made any arrangements for planting, and was moving every day from plantation to plantation.

I hope to be able to give you a better report at the end of this month.



Office Asst Sub Asst Comr.  
Bureau R. F. and A. Lands,  
Catahoula Parish, La.,  
February 10<sup>th</sup> 1868.

L. H. Warren, Capt 39<sup>th</sup> U.S.A.  
A. A. A. Genl.,  
Bureau R. F. and A. Lands.

Sir

I have the honor to transmit you the following report. There is a much better feeling and understanding existing between the planter and the freed people at present than there was ten days ago, occasioned by the good news and glad tidings to the broken planters and destitute freed people of the Bureau R. F. and A. Lands proposing to advance to advance supplies to them for the present year. The planters are now engaging and contracting with the freed people by proposing to send forward their application for relief. I presume that some of the planters in this Parish will avail themselves of the proposition offered by the Bureau to furnish supplies.

There is already quite a change, and I am glad to say, for the better in the moral as well as in the social condition of the freed people.

The health of the country is very good. The weather has been cold, wet and miserable for the past few weeks and the planters are very much behind with their work.

Office Asst Sub Asst Comr.  
Bureau R. F. and A. Lands,  
Catahoula Parish, La.,  
March 1<sup>st</sup> 1868.

L. H. Warren, Capt 39<sup>th</sup> U.S.A.  
A. A. A. Genl.,  
Bureau R. F. and A. Lands.

Sir

I have the honor to transmit you herewith the following report. I was absent on an inspection tour on the 20<sup>th</sup> Ult. Hence the cause of my not forwarding Tri Monthly Report of that date. I find a much better feeling and understanding existing now between the two races, than there was a year and a half ago. The planters are all contracting and preparing to raise a crop the coming season, and the freed people are working well and cheerfully and appear to be determined to make a good crop.

The most of the planters are contracting with the freed men, this year for an interest in the crop, as they are not able to pay them wages.

There are but very few unemployed freed people in the Parish at present that is able to work.

The "so called" Vigilance Committee came into Trinity last night and told all the freed people in the place to leave giving them just ten days to pack up and get out of the Parish, or they "the Committee" would serve them as they had served others in the South, that is hang them to a tree.

over,



I have applied to the Civil authorities but can get no assistance, and I would most respectfully ask that a few U.S. Troops be sent me immediately or I fear serious difficulties will occur,

Very Respy Yours,  
 Wm. Johnston  
 U. S. A. C. Bureau

Office Asst Sub Asst Commr,  
 Bureau R. 4<sup>th</sup> Div A. C. L.  
 Catahoula Parish, La.  
 March 2<sup>d</sup> 1868.

D. A. Ward, Capt 39<sup>th</sup> U.S.I.,  
 A. A. S. Genl.,  
 Bureau R. 4<sup>th</sup> Div

Sir I have the honor to transmit you the following report. I have visited a great many plantations during the month, not mentioned in this report as they are not contracted with their freed people. There are but very few planters in the Parish that is able to pay money wages, and the contracts throughout the whole Parish, will about average with those specified, within. Since issuing of Circular No 1 C. S. Hd Qrs Bureau & C New Orleans, La Jan 23<sup>rd</sup> 68 there has been a great demand for labor. The freed men are in fine spirits and are working very well and appear determined to make a good crop this year which I think they will do with the assistance of a little encouragement.

Office Asst Sub Asst Commr,  
 Bureau R. 4<sup>th</sup> Div A. C. L.  
 Catahoula Parish, La.  
 March 4<sup>th</sup> 1868.

Lt H. H. H. Capt 39<sup>th</sup> U.S.I.  
 A. A. S. Genl.,  
 Bureau R. 4<sup>th</sup> Div

I have the honor to state to you, that in compliance with Paragraph III. Circular No 35 and Paragraph II. Circular No 19. Series of 1867, I was absent on an inspection tour on the 10<sup>th</sup> of January 1868. Hence the cause of my not forwarding my Tri Monthly Report of that date.

I spent as much time as I possibly can "without neglecting my duties in the office" with the planters and freed people, to learn their habits and customs, and the means of emancipation, &c, which has been a great source of benefit in this Parish, back to the planters and freed people.



Office Asst Supt Asst Commr,  
Bureau R. & A. Lands,  
Catahoula Parish, La.  
March 10<sup>th</sup> 1868,

L. H. Warren, Capt 39<sup>th</sup> U.S. A.  
A. A. A. Genl,  
Bureau R. & A. L.

Sir

I have the honor to transmit you herewith the following report. The weather has been very brisk and disagreeable for the last ten days, and the planters have been able to do but very little work.

The freed people are working very well indeed, this spring, much better than I have seen them do, since they have been free. The only trouble with the planters and freedmen now, is something to eat, which they are making preparation to get from the Government, and if this country is not visited by another overflow, I believe there will be a better crop made here this year than has been done for several years past.

The very best of feelings exists between the two races. They are beginning to realize their true position towards each other and are trying to work to each others advantage &c.

I received from Mr. H. B. Armstrong, D. O. & D. M. Agt, Bureau R. & A. Lands, on the 29<sup>th</sup> Ult 2875 pounds of meal and 400 pounds of Pork to issue to the indigent &c.

I have issued 70.4 pounds of,

meal and 155 pounds of Pork, and have 2171 pounds of meal and 315 pounds of Pork on hand yet.

Very Respy Yours,

Obt. Servt

W. Johnston Lemmon,  
A. S. A. L.  
Bureau L. C.

Office Asst Supt Asst Commr,  
Bureau R. & A. Lands,  
Catahoula Parish, La.  
March 20<sup>th</sup> 1868,

L. H. Warren, Capt 39<sup>th</sup> U.S. A.  
A. A. A. Genl,  
Bureau R. & A. L.

Sir

I have the honor to transmit you the following report. The weather is warm and pleasant and the planters are very busy engaged planting Corn &c. The freedmen are working better now than I ever saw them and seem to be contented, and happy and are in high anticipation of an excellent crop, which they certainly will make if there is not an overflow.

There is some little fear of an overflow as the water is rising very rapidly in the rivers, in this part of the country, and I hear they are rising rapidly elsewhere.

All that is wanting now is provision. Most of the planters are dependent on



ding upon the government for supplies,  
They are waiting anxiously for supplies  
every day, but none have been  
received as yet, as I have not received  
any blanks. The cause of  
delay, I cannot imagine.

I had on hand from last  
report 2171 pounds of Meal and  
345 pounds of Pork. I issued  
704 pounds of Meal and 115 pounds  
of Pork on the 17<sup>th</sup> Inst and 704  
pounds of Meal and 115 pounds of  
Pork on the 19<sup>th</sup> Inst leaving a balance  
of 763 pounds of Meal and 115 pounds  
of Pork remaining on hand.

Very Respectly Your  
Obedt Servt.  
M. Johnston Lemmon,  
A. S. A. C.,  
Bureau of

Office Asst Dist Asst Comm  
Bureau of <sup>Land</sup> A. Lands,  
Catalpaula Parish, La.  
March 28<sup>th</sup> 1868.

L. A. Harrow, Capt 39<sup>th</sup> U. S. A.,  
A. A. A. C.,  
Bureau of A. L.  
Sir

I have  
the honor to state to you, that in  
compliance with Paragraph III, Circular  
No 35 Series of 1866 - and Paragraph  
II, Circular No 19 Series of 1867,  
I was absent on an inspection tour on  
the 20<sup>th</sup> of February 1868, since the cause  
of my not forwarding the monthly report  
of that date.

I spend as much time as circumstances  
will permit among the planters  
and freed people throughout the whole  
Parish to learn their ways and to  
advise with and encourage them.

Very Respectfully  
Your Obedt Servt.  
M. Johnston Lemmon,  
A. S. A. C.,  
Bureau of



Officer Asst Sub Asst Comr.  
Bureau N. F. & A. L. L.  
Catahoula Parish La.  
April 1<sup>st</sup> 1868.

Lt. W. Warren Capt 39<sup>th</sup> U. S. I.  
A. A. A. Asst.  
Bureau N. F. & A. L. L.

I have the honor  
to transmit you the following report.

The matter has been warm and pleasant  
for the last few days, and the planters  
and freed people are getting along admir-  
ably well. In fact the freed people  
are doing and working better than I  
have seen them do since they have been  
free, and if no promoting providence  
I think they will succeed in raising  
good crops this season.

The very best of feeling prevails bet-  
ween the two races, and the moral  
condition of the freed people is generally  
very good.

There is still some complaint in the white  
part of the Parish about the freedmen depre-  
ciating on the stock etc, and I have not heard of  
four more freedmen being killed, two shot and  
one hanged but I have been unable to learn the  
particulars of the case. There is a set of  
lawless white men in the white part of the  
Parish, that commits a great many depredations  
and blames it on the freed people.

I have issued 460 pounds of Pork and 2816  
pounds of meal, to the indigent, and have 59  
pounds of meal on hands yet.

Officer, Asst. Sub. Asst. Comr.  
Bureau of N. F. & A. L. L.  
Catahoula Parish.  
Aug 4<sup>th</sup> 1868

Went to Col. W. Warren Capt 39<sup>th</sup> U. S. I.  
Asst. Asst. Genl  
His

I have the honor  
to report my arrival here on the  
27<sup>th</sup> and of my releasing Mr. M. Johnson a  
Sumner Asst. Sub. Asst. Comr. Bureau N. F. &  
A. L. L. at this place in compliance  
with Spcl Order No 80 dated New Orleans  
New Orleans La Bureau of N. F. & A. L. L.  
State of Louisiana July 29<sup>th</sup> 1868

I found Mr. Sumner sick in bed  
he informed me he had been sick  
for the last month and had not  
been able to properly attend to his  
duties in the Office. I will look  
over the papers in the Office and  
put up the books and give you  
a more full report. Upon my  
arrival here I found the books and  
papers of the Office and a letter  
from your Office giving Mr. Sumner  
permission to remove the Office of  
the Bureau from Pine Bluff to  
Missy from Plantation it is dated  
Mar 14<sup>th</sup> 1868 There is but two  
Quons in the Parish Natchitoches the  
County Jail and Trinity one has  
about 100 houses the other (Trinity) is  
fourteen Trinity is the largest

Mr. Sumner will leave here for  
Baton Rouge in charge of Brig. Capt  
Morris 20<sup>th</sup> M. S. G. G. G. G. G.



Officer Asst Sub Asst, Com  
Bureau of F. & A. Lands  
Catahoula Parish La  
Sept 1<sup>st</sup> 1867

Report to Capt W. B. Armstrong  
for Postal Charges & Sund Accts  
Also Acct of horse hire since death of horse

Report to D. A. Ward, Capt 39<sup>th</sup> U. S. Infy  
A. A. G. Genl. B. R. F. & A. L.  
In answer to Circular letter Oct 29<sup>th</sup> 1867  
Number of Acres under Culti-  
-vation in the Parish 10,000  
Working hands Schools

Report of Postal & Acctd Current for Oct  
1867 also Requisitions for Forage for Horses  
I have had a hired horse since the  
U. S. horse in my service died and  
am and have been out of forage for  
some time and it is impossible to  
get any here

I am very respectfully yours  
Abert Serot

Officer Asst Sub Asst, Com  
Bureau of F. & A. Lands  
Catahoula Parish La  
Nov 10<sup>th</sup> 1867

D. A. Ward Capt 39<sup>th</sup> U. S. Infy  
A. A. G. Genl. B. R. F. & A. L.

In answer to Circular letter  
of Oct 29<sup>th</sup> 1867 I have the honor to report of  
have traveled all over my District during the  
Summer and fall and would estimate the  
numbers of Acres under cultivation at  
Ten thousand acres

Very respectfully yours Abert Serot  
Number of Working hands 8,000  
Thousand four hundred males six  
hundred females

And Independent Freed People three hundred  
Four Schools Sixty Scholars  
Some of the old Freed people are able  
to work a little and support themselves  
by making themselves generally useful about  
the house and quarters

Very respectfully yours Abert Serot



Officer Asst. Sub. Asst. Com  
Bureau R. F. & A. Lands  
Catahoula Parish La  
Dec 1<sup>st</sup> 1867

Surgeon in Chief  
Hudman's Hospital  
New Orleans La  
Sir

I have the honor  
to forward you this day per Steamer two  
Crippled & Destitute Hudman  
W and A B

I have sent for and received Trans-  
portation for five other Destitute Hudman  
but it is impossible to get them to leave  
home as they call it without using  
force

Very respectfully your obedient  
Servant

A. S. A. Com. of R. F. & A. Lands.

Officer, Asst. Sub. Asst., Com  
Bureau R. F. & A. Lands  
Catahoula Parish La  
Dec 1<sup>st</sup> 1867

Mr W. B. Armstrong  
D. C. & M. Asst  
Bureau R. F. & A. Lands  
Sir

I have the honor  
to transmit you herewith Abstracts of  
Subsistence Stores to be issued to Destitute

Hudman of Catahoula Parish during the  
Month of November

I have but (31) thirty one pounds  
of Pork left on hand from my last  
issue (Oct) and I issued it <sup>all</sup> out one time  
to the most needy Hudman in the  
Parish

Very respectfully your obedient  
Servant

A. S. A. Com. of R. F. & A. Lands

Officer, Asst. Sub. Asst., Com  
Bureau R. F. & A. Lands  
Catahoula Parish La  
Dec 1<sup>st</sup> 1867

D. A. Ward Capt 3<sup>rd</sup> U. S. Infy  
A. A. of Fuel  
Bureau of R. F. & A. Lands  
Sir

I have the honor  
to transmit you herewith my monthly  
Report for November and in reply  
to your favor of Oct 28<sup>th</sup> I would state  
that I only came in possession of this  
Office on the 21<sup>st</sup> May last and was  
told by Capt Clark (the Genl of Belvoir)  
that it was not necessary to make out  
those Monthly Inspection returns unless  
particularly ordered to do so hence the  
cause of me not forwarding Reports of May  
June, & July. Aug. I will try and give  
you a better Report for next month.

Very respectfully your obedient Servant

A. S. A. Com. of R. F. & A. Lands



Officer, Asst. Sub. Asst. Com  
Bureau of A. T. & S. Hands  
Catahoula Parish La  
Dec 14<sup>th</sup> 1868

J. M. Lee 1<sup>st</sup> Lt 38<sup>th</sup> U.S. Inf  
A. A. A. Genl  
Bureau of A. T. & S. Hands  
Sir

I have the honor  
to transmit you herewith a statement  
of Freedmen's Indebtedness to Mr  
McAcraun and to state to you that  
I will ship per steamer Homeyer on the  
16<sup>th</sup> inst just to Messrs M. Gillis & Co on  
account of the above mentioned Freedmen  
Three Bales of Cotton weighing 430-  
430-435 Total 1295 lbs

Very respectfully yours  
Wm. A. A. Genl

A. S. A. Com, B. T. & S. Hd

Officer Bureau A. T. & S. Hd  
Catahoula Parish La  
Dec 14<sup>th</sup> 1868

Messrs M. Gillis & Co

Please find enclosed a  
statement of the indebtedness of the freedmen  
to Mr McAcraun for ~~supplies~~ furnished  
them through you. You will deduct the  
amount from the proceeds of the three bales of  
Cotton I shipped you for them, and remit the  
balance to me through the quarters B. T. & S. Hd.

Very respectfully yours  
Wm. A. A. Genl

A. S. A. Com, B. T. & S. Hd

Officer A. S. A. Com  
Bureau A. T. & S. Hands  
Catahoula Parish La  
Jan 16<sup>th</sup> 1868

J. M. Lee 1<sup>st</sup> Lt 38<sup>th</sup> U.S. Inf  
A. A. A. Genl  
Bureau of A. T. & S. Hands  
Sir

I have the honor  
to transmit you herewith report  
of Arsons and Articles seized for  
the month of December 1867

I sent to Mr W. B. Armstrong  
D. O. & Q. M. Lt. Bureau of A. T. & S. Hd.  
for blanks No 2 and waited some  
time for them. Hence the cause of  
my not forwarding these  
 sooner

Very respectfully yours  
Wm. A. A. Genl

A. S. A. Com, B. T. & S. Hd

Officer A. S. A. Com  
B. T. & S. Hd  
Catahoula Parish La  
Jan 16<sup>th</sup> 1868

Mr W. B. Armstrong D. O. & Q. M. Lt  
B. T. & S. Hd A. S. Hd. La  
Sir

I have the honor to trans-  
mit you herewith Acct Current and Postage  
Acct for the quarter ending on the 31<sup>st</sup> of  
Dec 1867

Very respectfully yours

Wm. A. A. Genl



Officer

Feb 1<sup>st</sup> 1868

L. N. Warren  
A. A. A. Genl

Sir

I have the honor to  
transmit you herewith Report of  
Persons and Articles with Packets  
for the Month of Jan'y 1868

A. S. A.

Officer

Feb 3<sup>rd</sup> 1868

L. N. Warren  
A. A. A. Genl

I have the honor to  
transmit you herewith a Draft from  
Eli Adams (Col) on Messrs Bess & O'Brien  
~~for~~ One hundred & thirty six <sup>57</sup>/<sub>100</sub>  
payable to my order and endorsed  
Also Bill of Sale of eight Bales  
of Cotton and letter from Messrs Bess  
& O'Brien Eli Adams shipped said  
Cotton subject to my orders and request  
to have his business settled by the  
Bureau of N. H. & A. S.

Officer

Feb 5<sup>th</sup> 1868

L. N. Warren  
A. A. A. Genl

Sir

I have the honor  
to transmit you a true Copy of  
the Contract and Agreement by and  
between M. Jacob Farrett and the  
free people in his employ during  
the year 1867. The classifying of the  
free 12 on the contract and the number  
dependant on them has been done since  
I saw the contract some two months  
ago and I think below the Clothing  
has been crossed line the contract was  
made and signed for the free men has  
made Affidavit that M. J. Farret did give  
to give the Clothing. The blank space  
in the contract for James Dett & co  
is left below as you see in the Copy  
The classifying and number of  
dependants is fully stated as I am  
personally acquainted with every one in  
the place

I correct it in red ink



Officer Asst. Sub Asst. Com  
 Bureau of R. F. & A. Lands  
 Black River Parish of Catahoula Co.  
 Feb 6<sup>th</sup> 1868

The following is a correct statement of the settlement this day made in the presence of the undersigned witnesses witness Jacob Jarrett and the freedmen there in named, which freedmen express their entire satisfaction in said settlement. The account of sales of 16 Bales of Cotton gave a total amount of \$725.75 and the share of each was \$13.29

C. Johnson 3/4 share @ \$13.29	\$46.50
Jerry Nans 1/4	22.75
His Wife	32.75
Kelcor Wife and Daughter	37.25
Bob & Mother (Old Charles)	27.75
Seaman & Henry	13.00
Jupiter	13.00
Paul	13.00

The above named freedmen acknowledge their indebtedness to Jacob Jarrett as follows

C. Johnson	\$46.50
Kelcor	25.40
Jerry Nans	22.75
His Wife	32.75
Bob & Mother (Old Charles)	27.75
Seaman & Henry	13.00
Jupiter	13.00
Paul	13.00

Witness J. Nelson Carrigan  
 Geo. S. Davis

We the undersigned do certify on honor that the above is a true Copy  
 Signed H. B. Luthersman  
 R. Brown

I Certify on honor that the above and foregoing is a true and correct Copy  
 Signed M. J. Lemmons  
 A. S. A. B. R. F. & A. L.

Officer

Feb 20<sup>th</sup> 1868

L. H. Warren

Sir

I have the honor to transmit you the following report. The Planters are all Contracting and making arrangements for the coming season. As the freedmen made dutch light crops last year they are very much discouraged and are very slow about Contracting however the majority of them have engaged themselves and I fear labour will be a little scarce in this Parish the coming season. If the Planters succeed in making arrangements for supplies. The wary heat of feelings prevails between the two races and the moral condition of the freedmen is good.

The so called Vigilance Committee is still roving over the Country but I have not heard of their committing any depredations lately.



Office

Feb 28<sup>th</sup> 1868

L. H. Warren

Sir

I have the honor to report of having an Order on Messrs Marshall & Smith & Co for \$120<sup>00</sup> the amount due the padmen in Settlement. Employed by Mr A James on the Emily Plantation during the year 1867

Office

W. A. Sterling

Sir

I have the honor to transmit you the following report. I have but little to add to my last report. In regards to the general Condition and welfare of the padmen they are all working admirably well and the crops are looking well and are in good condition. The only trouble we have now are Planters having padmen who were under contract with others. There are now entertained in this country some of the Plantations are now almost entirely

inundated and the water is rising two feet in every 24 hours which will soon cover the whole country

Office

Sir

In answer to Circular No 7 Dated New Orleans B. N. F. & A. S. Sea New Orleans Sea Nov 9<sup>th</sup> 1867. I have the honor to state to you that I receive my Mail sent direct from New Orleans & D. by way of St. Michaels Miss. Mail sent through the Sub Asst Com 5<sup>th</sup> Dis Sea goes by way of St. Michaels Miss and Trinity to New Orleans thence back to Trinity to me. It necessarily takes from 2 to 3 weeks for a Communication to reach me. The Postmaster at Trinity told me to day that the Steamers Wickshury and Frank Carson the Quichito River the weekly Packets had commenced carrying the the Mail which is the shortest and quickest route by which the Mail can be sent either direct or through the Sub Asst Com.



Office

Mar 24<sup>th</sup>

B. B. Keeler

Sir

I transmit to my report of the Settlement or Pay rolls showing the Payment of the freed people employed by Mr Jacob Jarrett during the year of 1867

Office

Mar 21

We the undersigned do hereby acknowledge the receipt of the amount set opposite our names helped from the hands of Mr Johnson Assessor Asst Sub Asst Com B. N. G. & D. A. Sea at being the amount due us on Settlement with Jacob Jarrett for labour performed on  
during  
the year 1867

Mar 18<sup>th</sup>

Recd of Mr J. B. 136 <sup>37</sup>/<sub>100</sub>

Witness

J. McChum

I certify on honor that the above statement is correct  
M. J. S.

Office

Capt

L. A. Warner

Sir

I have the honor to transmit you the following Report there is nothing transpired of note since my last Report worthy of note. The freed men are cheerful and happy and are getting along admirably well.

The water still keeps rising and is overflowing some of the finest Crops in the Parish and great fears are entertained of another foul over flow which will ruin the planting interest in this Country. The Planters are working on the heavy's day and night and may be able to dam a portion of the Guarn's lands.

The Crops that are not overflowed are in fine order and condition. There is no more sign of the appearance of the Cotton Cat-  
apilla.

The moral condition of the freedmen is tolerably good



Officer

Apr 20<sup>th</sup> 1868

L. H. Warren

Sir

I have the honor to transmit the following report.

I have but little to add to my last report in regards to the general condition and welfare of the freed people I am glad to say they are generally working and doing very well and the crops look very favorably.

The election of the 13<sup>th</sup> & 18<sup>th</sup> passed off very quietly and satisfactorily to all parties. The moral condition of the freedmen is generally very good. I received from Mr. C. & C. Beaman D. C. & A. Q. L. M. on the 12<sup>th</sup> just 2675<sup>00</sup> \$ Corn meal and 428<sup>00</sup> \$ of Pork for distribution among the indigent and destitute people of Catahoula Parish. I have issued 704<sup>00</sup> \$ of Meal and 115<sup>00</sup> \$ of Pork and now have 1871<sup>00</sup> \$ of meal and 313<sup>00</sup> \$ of Pork on hand.

Officer and Sub Agent Gen  
Bureau of A. Q. L. M.  
Catahoula Parish La  
May 1<sup>st</sup> 1868

Wm. H. Sterling

Sir

I have the honor to transmit the following report  
I have just heard of the murder of three more men in the upper part of the Parish by the so called Vigilant Committee some says some says they was white men and others say they was freedmen that was murdered. Murder has become such a common occurrence in this part of the Country that there is but little notice taken of it and nothing said about it.

The weather is warm and pleasant and the freed people are working remarkably well. The moral condition of the freed people are good and the crops generally look very favorably. As the labor in the swamps has been very scarce and the prospects for a good crop is very favorable.

There is some very ill disposed persons living and persuaded freedmen <sup>(under false pretenses)</sup> to leave their present employers and go and work for them which is causing a great deal of trouble at present. There has been entertained of on other our plan as the matter has been raising very fast until the last few days it is now on a stand there is but little land available.



Officer Asst. Sub. Asst. Com.  
Bureau of N. F. & A. Bonds  
New York from Plant  
Colahanta Parish La  
May 14<sup>th</sup> 1868

Wm. H. Murray Capt 39<sup>th</sup> Regt I. I.  
Co. C. 2<sup>nd</sup> Regt  
Bureau of N. F. & A. Bonds  
Sir

I have the honor  
to transmit you the following report  
I have just heard of the murder  
of three men in the upper part  
of the Parish

These pay rolls show the  
payment of the free people employed  
on Edw. Plant by  
during the year of 1867

The problem was working in  
so many different places that  
it took some time to get them  
together hence the delay in forwarding  
this pay roll

Officer Asst. Sub. Asst. Com.  
Bureau of N. F. & A. Bonds  
Colahanta Parish La  
May 20<sup>th</sup> 1868

W. H. Murray Capt 39<sup>th</sup> Regt I. I.  
Co. C. 2<sup>nd</sup> Regt  
Bureau of N. F. & A. Bonds  
Sir

I have the honor

to transmit you the following report  
I have but little to add to my  
last report, in regard to the  
general welfare and condition of the  
free people. They all working well  
and are more contented cheerful and  
happy in this part of the Country  
than they have or I ever have seen  
The part of them not found a Compl-  
sint white or colored

Some of the Planters are greatly  
alarmed about the appearance  
of the cotton caterpillar at this early  
season of the year of them examined  
of the worms now found on the cotton  
with some of the oldest Planters in  
the Parish and they say they are  
nothing but gross worms and not  
the genuine Cotton destroyer (Caterpillar)  
Fear is entertained of another full  
surplus. The river at this place is  
bank full and still rising an inch  
and a half every twenty four hours  
A great deal of the low lands and  
where the levees are broken is now  
entirely inundated



Officer

May 31

W. H. Stirling

Sir

I have the honor to state that the very best of feelings exist between the Planters and the freed people. And the latter are very industrious and orderly and are cheerful and happy they work more cheerful and with more energy and ambition than they have done since the war

Officer

June 5<sup>th</sup> 1868

L. H. Warren

Sir

I have the honor to transmit the following report  
As a general thing the Whites are very much opposed to the education of the freedmen and wanted to through every obstacle in the way they possibly could to prevent establishing the schools

of hired a young White man last summer to teach and he opened a school of 60 scholars but could not get board in the Country except in Colored families and he gave up the school and left it would be almost impossible for a teacher to get board in a white family

As a general thing the Whites are very much opposed to the freed people holding meetings of any kind and have positively forbidden them from holding meetings on their Plantations

Officer

June 10<sup>th</sup> 1868

L. H. Warren

Sir I have the honor to report that the following report, there is no change in the situation and condition of the freed people they are all working cheerful and happy with the anticipation of a good crop which they will certainly make by all appearance at present where they are not employed

There is no change in their moral condition which is generally good the very best of feelings



exists between the races. I have not heard a complaint from either party for weeks. The tides at this place is now stationary, and will probably be falling in a few days, which will give those which were overflowed an opportunity of planting our or Colum

Officer

June 13<sup>th</sup> 1868

A. W. Warren

Sir

I have the honor to forward you a report and payroll showing the payment of freed people by Messrs C & B

During the year of 1868 the amount due them \$198<sup>00</sup>/<sub>100</sub> The freed people are living at so many different places now that it is almost impossible to get them together at one time hence the cause of the delay in paying them

Officer

June 13<sup>th</sup> 1868

A. W. Warren  
Sir

Sir I have the honor to report you a list of indigent and destitute applying for relief during the month of May 1868. The list was made out by Mr H Reddick member of Police Jury and handed me to day hence the cause of the delay

Francis McClure	45	Matilda Jones	45
Alice	" 10	Mrs. May	" 14
Frank	" 14	Burn	" 7
Ann	12	Lee	" 5
Frank South	40	Erasmus Colby	14
Erasmus	30	" "	12
Willie	5	Mary Paul	50
Mary	3	Pauline	15
		John	12



Office

June 20<sup>th</sup> 1868

L. H. Mearns

Sir

I have the honor to transmit you the following report in ~~response~~ <sup>regards</sup> I have nothing to add to my last report in regard to the general condition and ~~of~~ the freed people they are all working as usual very well indeed and appear to be cheerful and happy and contented I have not heard a word of complaint from a Planter or freedman for weeks their moral condition is tolerably good I have not heard of a depredation committed by them for a long time. The water has commenced pouring and will probably fall sufficiently to enable those that are overplowed to plant Corn

I have now on hand 208 Paces and 129 <sup>14</sup>/<sub>10</sub> Bushels

Office

July 1<sup>st</sup> 1868

C. C. Beaman

Sir

I have the honor to report the list of Clothing issued to destitute People during the months of March & April 1868

Office

July 1<sup>st</sup>

C. C. Beaman

Sir

I have the honor to transmit you the following report of P & A for the month of June 1868 and state to you that I always pay Mr Reddick the Rent when he signs the receipt to send you April and May's Rent not received yet



Officer, Asst. Sub. Asst. Com  
Bureau of A. F. & S. L. S.  
Catahoula Parish La  
July 1<sup>st</sup> 1868

Lt. H. Warren Capt 39<sup>th</sup> U. S. I. I.  
Asst Asst Asst Genl  
Sir

I have the honor  
to transmit you the following report  
There is nothing transpiring since  
my last report worthy of note.  
The freed people unusually well  
and enjoying themselves very well  
and if no preventing providence they  
will succeed in making excellent  
Crops this season

Their moral condition is very  
good, and the very best of feeling  
exists between the two races

The health of the country is  
very good, I have issued all the  
Provisions I had on hand from  
my last report to the subject  
and distribute and so they now  
all have an opportunity to raise  
Vegetables this season I think they  
can get along without further  
assistance

Officer, Asst. Sub. Asst. Com  
Bureau of A. F. & S. L. S.  
Catahoula Parish La  
Aug 4<sup>th</sup> 1868

Saml C Gold Esq  
Sub Asst Com B. F. & S. L. S.  
5<sup>th</sup> Dist La  
Sir

I have the honor  
to report that I have relieved Mr  
W. Johnson Secretary A. F. & S. L. S.  
Catahoula Parish La in compliance  
with Special Order No 90 Dated Headquarters  
Bureau of A. F. & S. L. S. State of Louisiana  
New Orleans La July 29<sup>th</sup> 1868

I am Sir your obedient  
servant

A. B. Camp  
A. F. & S. L. S. Com B. F. & S. L. S.

Officer, Asst. Sub. Asst. Com  
Bureau of A. F. & S. L. S.  
Catahoula Parish La  
Aug 10<sup>th</sup> 1868

Brut Lt Col Lt. H. Warren  
Capt 39<sup>th</sup> U. S. I. I.  
Asst Asst Asst Genl  
B. F. & S. L. S.

Sir

I have the honor  
to transmit you the following report  
in compliance with Special Order No 80  
Dated Headquarters Bureau of A. F. & S. L. S.



State of Louisiana New Orleans July 29<sup>th</sup>  
1868 I received Mr. M. Johnson summons ad.  
a. Cur. B. N. H. & Co. for the Parish of  
Orleans of this State giving him  
receipts for all Property he turned over  
to me belonging to the Bureau of B. N.  
H. & Co.

Brut Capt Morris 20<sup>th</sup> U.S. Druff  
with ten men came up on the 27<sup>th</sup>  
place with me from Baton Rouge  
and arrested Mr. M. J. Johnson upon an  
Order from Headquarters N. O. La and  
conveyed him to Baton Rouge

I find the freed people are not  
contented and there is a considerable  
ill feeling between them and the  
Planters. Since the overflow dam  
ran up their Contracts and are working  
for themselves and living in the most  
deplorable condition. Their food consists  
principally of Fish they eat Pumpkins  
and Corn when they can get it  
they steal it from the fields they are  
working on & have and adjoining fields

Others do nothing but steal, they  
will not work and this class is the  
most troublesome this causes much trouble  
between the Planters and freedmen

I have had several complaints made  
by the freed Women stating the freedmen  
was in the habit of Whipping them  
out of all reason with a Cornbush  
there is no Jail in this Parish  
hence the cause of so much steal-  
ing and Murder. About the middle  
of last month there was a store in  
the Town of Elmire broken into and  
three freedmen was arrested by the

Citizens of the place and accused of  
breaking open the store (the store  
was owned by a Mr. Black) one of the  
three men men arrested was released  
the other two was kept in confinement  
they was removed from where they was  
first confined and taken to a hut and  
told they was waiting for a boat they  
was given in charge of a freedman  
and the freedman logophile he was  
on guard he fell asleep at night  
and when he awoke the Prisoner  
was gone and could not since be  
found. It is rumored they was  
taken out and drowned while  
he slept

I feel confident if there was  
a Jail in the Parish there  
would be less crime committed

The Planters in this Parish  
are not well disposed towards the  
Bureau and they are <sup>not</sup> disposed to  
conceal their feelings and express  
their sentiments upon every opportunity  
that offers they look upon it with  
utter contempt and will try and  
get every agent of the Bureau in to  
disrepute at Headquarters if he will  
not condescend to their wishes through  
their reports some how give me  
to understand that they had no  
use for the Bureau. Nothing  
can be done with regards to  
bringing crime to Justice in this  
Parish while this state of things  
last. There has been but one  
District Court (I understand) held  
in this Parish since the commence



of the and that dit last May, there was several Cases for Murder brought before it but none convicted last Saturday evening while I was sitting in my room reading close by the window I heard two Cases dropped by the gate it was after a heavy rain and very dark therefore I could not see any person

Charr has not had any report forwarded from this Office since since I have been informed by Mr. Cummings when I arrived here I found him sick in bed and he informed he had not been able to attend to the duties for over a month. His Books and papers has not been posted since November except some few in long of this year and his letters Book is in the same condition he told me he has been sick so long and had not been able to post his Books but he has retained a Copy of all of his communications and I am posting his Books as fast as possible

I have received within the last few days information from the Planters in the Parish who has found the Cotton Worm on their Plantations but they are sure they appear to be the first Crops, as nothing but the frost worm has been seen previous to this and the Planters think the Cotton Crops will suffer but little this year from them for they will come to late to do much damage except to the young Cotton planted since

the overflow the old Crops is four weeks in advance of last year I think a fair Crop will be raised throughout the Parish of Cottin

The Corn Crops is very poor as a general thing in the Parish there will not be over a half of a Crop raised

I am Sir your most obedient  
Servant

J. H. Camp  
A. S. C. C. P. B. H. J. L. S.

Office, Asst. Sub. Asst. Com  
Missy from Abant  
Catahoula Parish La  
Aug 21<sup>st</sup> 1865

L. N. Warren,  
Asst. Asst. Com  
Capt 33<sup>rd</sup> Regt  
A. S. C. C.

Sir

I have the honor to transmit you the following report  
I have visited the most of the Plantations in the land part of my Parish generally the Crops look well the Corn is light but the Cotton Crops look very well  
I have had but a minute gain of late the Planters are fearful of it affecting their Cotton it has commenced to rot in the bolls and if this weather continues the Crop will suffer severely  
I have but little to add to



my last report. On the 18<sup>th</sup> of August  
Plantations, when I returned to my  
Office I was taken down with the  
Swamp fever and have been confined  
to my Bed and had Dr to attend me  
therefore I am not able to make  
you a lengthy report

I remain yours obedt  
Servt

J. H. Camps  
A. S. A. Com. B. T. H. & L. S.

Officer, Asst. Sub. Asst. Com  
Bureau of A. S. & L. S.  
Messy from Plant Sea  
Aug 27<sup>th</sup> 1868

Act. W. M. Woods

A. S. Com. Sea  
B. T. H. & L. S.

Sir

I have the honor  
to make you the following report  
I have visited the Plantations  
of White & Ramsey, Alexander &  
Woods. The Crops was injured  
by the overflow and are injured  
by the late rains the farms  
are shedding the Corn is a failure  
Mr Robinson Plantation was  
overflowed and there is but an  
family remaining on the place or  
premises. They planted Corn after  
the overflow but the worms are  
destroying the shoots of the ear

I have hunted up the receipts for  
supplies of the month of June and  
had them signed and forwarded them to you  
I have no monthly return blanks  
to your Department

I am Sir your obedt Servt

J. H. Camps  
A. S. A. Com. B. T. H. & L. S.

Officer, Asst. Sub. Asst. Com  
Bureau of A. S. & L. S.  
Messy from Plant  
Catahousa Parish Sea

Aug 31<sup>st</sup> 1868

Act. W. M. Woods

Asst. Sub. Asst. Com.

Capt 31<sup>st</sup> Messy

A. S. Asst. Sub. Asst. Com.

Sir

I have the honor  
to transmit you the following report  
I have visited the Plantations in the  
lower part of my Parish and find the  
Crops doing very well and the Planters  
have commenced to pick. The old Crop  
of Corn is light. The Crops planted after  
the overflow is looking well as a general  
thing. I have just returned from an  
inspection in the Little River Country  
they suffered very much from the  
overflow. There was but little land  
that was not under water. They planted  
Cotton and Corn after the fall of the water  
some of the Crops look well, some of  
the Planters complain of the farms  
shedding very fast on the account of the



late rains. The Corn is suffering greatly in the Little River Country from the worms they eat the shoot which forms the ear they entirely destroy it therefore the young Corn crops as a general is a failure except for fodder

I have seen in my travels the green Cotton Caterpillars they are willing up. There is no doubt now of their existence in this Country

The Planters have thought they was they cross warm there is a plenty of them also they have been a benefit during the wet weather for they have kept the grass down

The majority of the Freed people are working very well

There was a case when a son of a Planter beat one of the freedmen with a Club while he held a shot gun the other hand. I have reported the case to Headquarters he defied the Bureau the has boasted often he did not allow any Bureau Agent to meddle with the business of his Plantation

This is not the first time of having been informed this young man has beat the man on the Place

The above occurred on Mr. Cho Jones Plantation. The case is composed of the statement of Joseph Johnson freedman and the letters that passed between Mr. Jones (who beat the man) and myself after the letters passed between us I took a full statement from the freedman and forwarded all of the papers to Headquarters for your consideration

There is a Justice of the Peace

in Trinity but he has no Constable The person who was elected will not serve therefore our Justice Court is perfectly blocked

An Agent of the Bureau is almost treated with contempt in a great many cases

There is some Planters who if our Confident wishes to do right They gain there are those who would shoot you from behind a beam of pine or at night they will not come out and face you but take you always at your disadvantage

If something is not done our the authority of the Govt sustained the freed people will have but little benefit of the Bureau in this Parish

I am Sir your most obedt  
Servt

J. H. Camp  
A. A. Agt. Sub. B. P. H. & L. S.

Officer Asst. Sub. Asst. Com  
Bureau of P. H. & L. S.  
Catahoula Parish La  
Aug 31<sup>st</sup> 1864

L. N. Warren  
Asst. Asst. Com. U. S. A.  
A. A. Agt. Sub. B. P. H. & L. S.  
Sir

I have the honor to reach you the following Special Report While on my inspection tour through my Parish I found a number of Old and decrepit others old and blind freed people who are depending on the charity of the



Planters for their sustenance

The Planters from the failure of this  
crop of last year and the surplus of this,  
are not able to supply these Poor People  
They do the best they can for them, but the  
old people suffer both for food and clothing

These Poor People are entirely unable  
to earn the least support for  
themselves

I have now but some Coats,  
Hats, and Shoes on hand

I am Sir your obedient  
servant

J. B. Campbell  
S. S. A. Com. B. F. & A. Co.

Office West End West Co  
Bureau of R. F. & A. Co.  
Catahoula Parish La  
Aug 31<sup>st</sup> 1868

A. A. Price  
Brig Genl U. S. A.  
Genl Supt of Education  
His

In compliance with  
your Circular Letter dated Aug 15<sup>th</sup> and your  
letter dated Aug 26<sup>th</sup> 1868 I have the  
honor to make the following report

I have since my arrival here which  
was Aug 3<sup>rd</sup> of this year taken a great in-  
terest in the Education of the Freed People  
I have since they were set free seen the  
necessity of their Education and instruction

I have encouraged learning and shall  
exert all of my influence at all times  
for its advancement

While on my prospective tour of  
free conference with the Planters and  
freed People with regards to schools and  
the Education of their Children

The Planters that generally from Little  
River to the lower part of the Parish are  
in favor of schools

Mrs Mary Cateoff on the Southland  
Plantation furnishes the house for school  
purposes. There is many more Children  
on the place and the adjoining place to  
make a large school but the Parents  
refuse to send them

Dr Horner on the Southland Plantation  
started a school on his place and hired  
a teacher, found him, and gave a building  
for school purposes



The Children attended very well at first  
 then they rebelled to send the Children and  
 it almost (day & months) the school was  
 broken up for the want of Schollars  
 Mr J. H. Boston, on little Peas  
 of this Parish started a school on  
 his plantation and his daughter taught.  
 The Children attended very well at first  
 but finally broke up by the inattention  
 of the Children

I am satisfied in my mind  
 that if Teachers was procured by the  
 Bureau and paid punctually with  
 proper Books. Several schools  
 could be established in the Parish and  
 do well

The upper part of this Parish  
 nothing can be done there is no safety  
 for any person who is a stranger in the  
 Parish. I have been threatened several times  
 since I have been up here

The Teacher who is on Ackland  
 plantation has not received any pay  
 since he has been teaching and this  
 is the second year I cannot see how  
 he lives. He is in debt to several  
 planters. And if he does not get relief  
 shortly he will have to give up his  
 school. I have seen him several  
 times during the month, and promised  
 to try and do something for him in my  
 report. I think Colored Teachers would  
 be the best for this Parish and they must  
 not say much for if they planters  
 sets out against the Teacher the Teacher  
 had better leave the Parish

I remain your obedt servt  
 J. H. Camp  
 a S. C. B. R. S. & C.

Office of S. C. B. R. S. & C.  
 Bureau of A. F. W. S. L.  
 Trinity Colabanta Parish  
 Aug 31<sup>st</sup> 1868

L. H. Warren  
 Capt. det. Col. U. S. A.  
 A. A. A. feel

Sir

I have the honor  
 to report to you of my carrying out your  
 Order in the case of Mr. Ken Lykes Biering  
 & Mary Johnson I have received and delivered  
 the freedwomen their Clothing

I remain your obedt servt  
 J. H. Camp  
 a S. C. B. R. S. & C.

Office of S. C. B. R. S. & C.  
 Bureau of A. F. W. S. L.  
 Trinity Colabanta Parish  
 Sept 4<sup>th</sup> 1868

L. H. Warren  
 Capt. det. Col. U. S. A.  
 A. A. A. feel

Sir

I have the honor to  
 report in compliance with instructions  
 from Headquarters dated Sept 1<sup>st</sup> 1868 with regards  
 to the removal of my Office from  
 from Plant to Trinity

I will state I received my Order in the  
 24<sup>th</sup> of Aug and hired a Building in Trinity the  
 same day for an Office. but there is no  
 papers of any kind that I could get for any



reasonable price. I could not find any thing but a one mule Cart and it was liable to break down before it would take a load of therefore had to wait for a cart to get my things transported I have been very sick with the dysentery and am still sick, last month and this is the two worst months in the year

I had to commence my monthly reports before the end of the month as far as I could. to get them off in time on account of having the fever every other day hence some of my Communications dated at the old Office

I remain your obedient servant

J. H. Camp  
A. S. A. Com. B. N. F. & A. S.

Officer, Asst. Dir. Asst. Com.  
Bureau of B. N. F. & A. S.  
Trinity Catawba Branch Sta  
Sept 8<sup>th</sup> 1868

S. M. Warren  
Brut. det. Cal. M. S. A.  
A. S. Asst. Genl

Sir

I have the honor to transmit you a statement of the amount of indebtedness of Geo. D. Dickens to the freed people who worked for him in the year of 1867 in the Cape Land Plant situated on Sicily Island about 18 miles above Harrisonburg. He raised 100 Bales of Cotton in more last year

Mr Sumner went up there to settle

the accounts of the freed people Mr Dickens showed Mr Sumner a copy he said was of a letter to his Merchant in D. C. to reserve \$10000 to pay his hands with. Mr Sumner looked over his accounts (of which I have a copy in my Office) he found he had his men charged 60¢ per day for rations when they were not at work. Mr Sumner told him he would not allow him but 20¢ per day. Mr Dickens then told Mr Sumner that he did not recognize the Bureau he considered the whole thing an unconstitutional and he would not allow any person to come on his place and settle his accounts with his hands he would blow any persons brains out who would attempt or meddle with his business

This is the report of Mr. M. J. Sumner (when I returned) when he turned over the Papers to me

And from the Corrier of the morning here I think he will try and cheat the man he has with him this year also. Blanks has been sent to him but he has not returned them to the Office

The old hands of last year left him they are working for Mr T. J. Smith and others. On the account of my sickness I have not been able to get up there for since I have been up here

I am Sir your obedient servant

J. H. Camp  
A. S. A. Com. B. N. F. & A. S.

Sept 27<sup>th</sup> 1868

Report returned and ordered to be forwarded



Officer, 1st, Sub, 1st, Com  
Bureau of P. F. & A. S.  
Trinity, Catahoula Parish La  
Sept 12<sup>th</sup> 1868

L. S. Warren  
Brut, 1st, Col, U. S. A  
A. A. Adj't Genl  
Sir

I have the honor to  
make you the following report and accom-  
panying it the Pay roll showing the Class  
No of Shares of each hand in the Crops, Time em-  
ployed, Time lost, Time Worked, Amount <sup>due</sup> each  
person draws, Best Time Deducted, Total Amount due  
each person. Amount Paid by G. J. Sumner <sup>and</sup>  
the Amount Paid by J. W. W. Camp <sup>(to each person) and Paid by the State</sup> Sept 12<sup>th</sup> 1868  
I divided the \$135.00 between the Freed People  
per (Ct) on (S) as near as practicable since had but  
a small amount due them I paid them in full  
Trusting this will meet with your ap-  
proval

I remain your obedient Servt  
J. W. W. Camp  
A. A. Com, B. F. & A. S.

Officer, 1st, Sub, 1st, Com  
Bureau of P. F. & A. S.  
Trinity, Catahoula Parish La  
Sept 12<sup>th</sup> 1868

L. S. Warren  
Brut, 1st, Col, U. S. A  
A. A. Adj't Genl  
Sir

I have the honor to  
transmit you the following report  
The Freed People are working well, the  
Cotton Worms are destroying the Cotton on  
some of the Plantations in the Parish  
badly. There has been but few Complaints  
since my last report. There was one  
Complaint made by Moses Merrill freedom  
who had worked since gang with a man  
by the name of Elias Hamilton on a  
Plantation six miles above French fork in  
the Mills in this Parish it is 20 odd  
miles from Trinity

About three weeks since the freedom  
made a complaint against the Planter  
Whip for wanting to whip his child  
I ascertained from him that it was  
on the account of a dispute between  
two children 3 years old. I told him  
to return and attend to his Crops and  
keep his Child from the other

He returned on the 9<sup>th</sup> and showed  
me his back, it had been cut by  
a Strap. I suppose he had not  
received less than a hundred lashes.

He stated to me on the night  
of the 7<sup>th</sup> four men came to his Cabin  
and called him out and took him  
to the woods. He asked them if



They was going to kill him they told him no. but they should whip him which they did. He says he knows one of them it was the Butler of the Planters who he was working for. I wanted to send for the man but the Madman dare not to appear against him.

I am confident it was done to drive him away to get his share of the crop I understand the crop looked well.

These Hills is the hardest place in the Parish a stranger is not safe passing through them. There is a great many Desperadoes living there. These men are feared by the respectable portion of the Parish therefore they are permitted to run at large and are not solicited by the law.

There is a great many Planters in this Parish who have promised the prudent to sign Contracts but have evaded it they think by doing so they will not have the Agent of the Bureau to interfere in their settlement with the prudent. It has been reported to me by prudent or several Plantations that they cannot get the Planters to sign the Bureau Contracts. Some of the Planters have signed a contract with one prudent and have from 12 to 20 working for them. It is intended to evad a settlement with their hands through the Bureau. Some of these Planters are those who the Bureau had to send an Officer from New Orleans to settle their accounts of last year.

I remain your obedt Servt

J. H. Camp

A. C. C. Co. B. F. & Co.

Officer, Asst. Sub. Asst. Com.  
Bureau of R. F. & A. Co.  
Parish, Catahoula, Parish, La.  
Sept 21<sup>st</sup> 1868

B. J. Hutchins

Brig. Maj. U. S. A.

A. C. C. Co. Asst. Genl.

Sir

I have the honor to transmit you the following report. There is but little to add to my last report. The Freed People I found on my inspection tour working well gathering their crops. The Corn <sup>will</sup> not be more than a half crop in the Parish. The Worms have damaged the Cotton to what extent I cannot as yet state as they are now working on some plant there is but few leaves and young forms left, a few Plantations in the Parish has escaped the Worms entirely thus far but the young forms are shedding which will injure the crop some.

While on my last inspection through my Parish I was taken down sick with the fever by riding in the sun of an getting better this my short report. There is sickness in my family and a great deal of the Plantations among the freed people.

I remain your obedt Servt

J. H. Camp

A. C. C. Co. B. F. & Co.







Officer of Asst. Dub. Asst. Com  
Bureau of A. F. & W. Bonds  
Parish of Catahoula La  
Trinity Sept 30<sup>th</sup> 1868

Brvt Maj B. E. Metchings  
A. A. & F. Bureau of A. F. & W. Bonds  
New Orleans La

Through Mr. John N. Brennan Sub. Sec. Com  
5<sup>th</sup> Sub Div of La

Sir

I have the honor  
to transmit you the following Report  
On the 9<sup>th</sup> Moses Merrill <sup>(of Louisiana)</sup> reported  
to pier his back was cut by a  
trap inflicted by four men on the  
night of the 2<sup>nd</sup> which is reported in  
full in my report of the 10<sup>th</sup>.

The freedmen has reported to me  
of not getting justice on ~~the~~ Charles  
Gause Plantation the latter is taken  
and shipped without weighing this is  
belonging to a squad that has been  
put off from time to time the Planter  
telling the other Contract was like  
other squads on the place who had  
signed Bureau Contract <sup>(after it was paid)</sup> they asked  
<sup>Mr. Jones</sup> to have their share set aside and  
they was told if their Contract stated  
so all right if not put it on the  
live Bank <sup>be keeping at the time they had no other Contract</sup> and it was shipped to  
New Orleans without weighing

On the 22<sup>nd</sup> Dick Taylor and other  
freedmen came to my Office and  
made a Complaint against Mr. J.  
Hemmon, and Whife and served out  
an Attachment before Justice Wm

Cherry of Trinity against him for trying  
to defraud them by shipping all of the  
produce from the Plantation and leave  
the rent unpaid saying their share  
of the Crop responsible there for. The  
Trial is set for the 1<sup>st</sup> of Sept.

I have visited a large number of  
Plantations in my Parish during the  
month and found the freed people  
as a general thing working gathering  
their Crops

The Plantations have suffered  
by the Malaria some few in the  
Parish have escaped, but the agri-  
culty has suffered more or less. In many  
if not nearly all in my Parish  
has suffered by the shedding of  
the farms

The Malaria has injured the  
shoot of the Corn planted since  
the overplow since not more than  
a half Crop of Cotton or Corn is  
expected by the Planters to be  
raised in the Parish

The Moral Condition of the  
freed people is improving  
There is not a good feeling ex-  
isting between the two races <sup>(as of which to see)</sup> on the  
account of many of the Planters  
acting unfair with the freedmen with  
regards to their settlement and divi-  
sion of the Crops. On the west  
of the Plantations in the Parish  
they are working the Crops on shares  
and the Planter wants to ship  
the whole Crop without dividing  
it according to their agreement at the  
commencement of the year



There is but few Planters in my Parish who will settle fairly with the freedmen without the interference of the Bureau. They have kept from signing any Contract with the Bureau thinking they would not be interfered with in their Settlement they charge them what they please to cover the amount they are indebted to them.

The Schools in my Parish is doing well there has been an addition of four this month and after the gathering of the Crops I am satisfied they will do better still. There was two Colored Teachers sent in by Capt Rice for Sup<sup>t</sup> of Education but on the account of the Political feeling in the Parish I did not consider it judicious to send them in the Country and open schools for they was not in the Parish twenty four hours before that was a story circulated that they came up here on Political business and some of the well disposed Citizens informed me that if they commenced to teach school they might be interfered with by a set of men in the Parish and he persuaded and from what they had heard they would advise me to send them back to New Orleans until after the Election. The Children are now in the Crops gathering Cotton and the Planters are opposed to starting any more schools until after the gathering of the Crops. The health of the Parish is much better than it has been there is still a great deal of sickness

Among both Whites and freedmen in the Parish but it is becoming more healthy I do not think there is a family but has had sickness in it in the Parish but has had sickness in it during the summer.

Mr James had his trial this day for assault and battery on Joseph Johnson freedman and was bound over to appear before the Dis Court.

I am Sir your obed<sup>t</sup> Servant

A. H. Camp  
A. H. Camp, Bureau Agent & Co.



Officer, Asst. Surg. Genl. Co.  
 Division of R. I. & L. Co.  
 Catahoula Parish, La.  
 Trinity Sept 30<sup>th</sup> 1868

Serent J. M. Lee,  
 Asst. Asst. Surg. Genl.  
 Sir

I have the honor  
 to acknowledge the following report

I have inspected a large number of  
 Plantations in my Parish. I found the  
 freed people working very well & thriving their  
 Crops

The moral condition of the freedmen  
 are improving. There has been a great deal  
 of sickness among them this last two months  
 but the health of the Parish is improving  
 It has been as sickly among the Whites  
 as the freedmen. There has been the same  
 -le sickness among the Whites

There is not a good feeling existing  
 generally between the two Races and of  
 regret the Cause. It is caused by many  
 of the Planters acting unfair with regards  
 to the Division and Settlement of the Crops

The Planters want to Ship the entire  
 Crops and settle with the freedmen when  
 it is convenient for them. And the freedmen  
 wants the Crops divided at the fair according  
 to their Contract

There has been a great many Planters  
 who has promised to sign Contracts but  
 have evaded doing so through out the season  
 thinking to make a Settlement by the Bureau  
 Genl by do doing. This course is pursued  
 to deprive the freedmen of their just dues.

The Planters claim if they have not

Signed the Bureau Contracts the Genl has no  
 right to interfere in the freedmans case

The Freedmen on Prosser farm Plant  
 made a complaint to me against Capt. Sumner  
 & Whife and did out an Attachment against the  
 Shipment of the Cotton before Mr. J. Cherry  
 Justice of the Peace. He was & was trying  
 to deprive the freedmen out of their share of  
 the Crops and leave them to pay the rent of  
 the Place

The Freedmen on Seth Miller Place has  
 did out an Attachment against A. C. Williams  
 before the same Justice for trying to  
 deprive them out of their share of the  
 Crops

The Freedmen on Mr. Charles Jones  
 Plantation has reported to me of Mr  
 Jones (who has charge of the Plantation  
 for his father) shipping the Cotton  
 of the freedmen with his without weigh-  
 ing it to John Nelson. The freedmen  
 to whom it belonged has asked for a  
 written Contract during the year (or summer)  
 and was sent off by telling them they  
 was working on the same terms as those  
 who had signed Contracts. But when  
 their Cotton (or 4 Bales of it) was ready to  
 ship Mr Jones told them, when they asked  
 for their share to be set aside if their  
 Contract stated it all right if not to take it  
 to the River for shipment, he knowing  
 at the same time they had no written Contract  
 and shipped it without weighing

There is but few Plantations in  
 the Parish that has escaped the Worms  
 and the. And the Corn that was planted  
 after the surplus has been injured by  
 Worms eating the shoot forming the ear







improving but there is a great deal of sickness yet

While traveling in the upper part of Pisah Island I was informed of a man (White) being hung for Public Stealing but could not learn his name this happened but a few days before I was up there but no information could be gained with regards to it. Also two Freedmen was run out of the Parish they were accused of killing Slaves but it could not be traced to them but they was told to leave and that is sufficient warning for a person in this Parish either White or Black and they are none the wiser after it occurred than before the news was spread

You will perceive by my former reports that when I first relieved my Predecessor in this Parish that I was shot at twice in one evening while sitting in my Room reading by Candle light I was reported by me in my first Report of Aug 10<sup>th</sup> 1868

I have been traveling in my Parish nearly all of the time since the my last Report I returned to my Office last evening with a Chill & fever I have a fever on me now while writing this Report

I am Sir your most  
obedient Servant

J. A. Camp  
A. S. C. Com. B. P. S. & A. S.

Office, Asst. Sub. Asst. Com  
Bureau of R. F. & Lands  
Catahoula Parish La  
Privately Oct 20<sup>th</sup> 1868

Brnt Maj. B. F. Hutchins  
A. S. Asst. Com. B. P. S. & A. S.

Through John W. Baum Sub Asst Com  
5<sup>th</sup> Sub Dis La

Sir

I have the honor  
to transmit you the following  
Report

I have had Complaints  
made to me since my last Report  
against several of the Planters on  
the account of their wanting to  
Ship all of the Cotton raised on  
the Plant's with out dividing the  
Crop according to agreement. I have  
taken steps to have this evil  
remedied

The Freedmen are working very  
well gathering their Crops

The Crops have been injured  
by the Worms but 1/2 Crop will  
be raised Worms stopped working

The Moral Condition of the  
Freedmen is not good

The feeling between the  
Races is not good in many  
cases the Planters are inclined to  
act unfair and cheat the Freedmen  
and the Freedmen are suspicious  
of the Planter



The School at Harrisonburg closed in the middle of this month he was not paid and could not get any assistance and had to close or rather the school in Oakland Plant is still going on

The health of the Parish is improving I was taken down very low while in the lower part of my Parish with the fever and my eyes was effected so I could not see I could not get a Doctor and I was placed on the first Boat come along it was going to New Orleans and I was attended the three days that I was there by Dr H. W. Justice No. 8 North St I was absent from my Parish four days

Every thing is going along quietly Politically the Regulators are progressing I remain your obedient servant

J. B. N. Camp  
A. A. Can B. N. & V. A. Co

Office Asst Sub Asst Com  
Bureau of N. T. & A. Co  
Catahoula Parish La  
Trinity October 31<sup>st</sup> 1868

Best Maj B. T. Hutchings  
A. A. Can B. N. & V. A. Co

Through John & Brown Sub. Asst. Com  
5<sup>th</sup> Sub Div of La  
Sir

I have the honor to make you the following Report I have had the Freedmen make the following reports against Planters of my Parish

Freedmen Against Mr. C. Cotton to secure their share of the Crops of Cotton I prevented him shipping the same until he gave an order on his Merchants in N. O., letting their share of the Crops short from his account subject to their Merchants Order (Mr. J. Black) Mr. Cotton had the same here of never paying this Depto he cannot get any Credit here he has said since he shipped he would beat the Bureau and Freedmen yet in the end

I have an Order from Messrs. ~~W. H. & W. H.~~ and Wharton, Mr. Boatman, and A. C. Wilking on their Merchants letting the Freedmen's share aside also Leathman & Brown these gentlemen gave their orders without any signature I have inspected a large number of Plantations during the month on the account of making a full prospective Report The Freedmen are working very



well getting their Crops

The Crops are looking very well considering the surplus and worms the Crops will be raised of Corn and Cotton

The Moral Condition of the Freedmen are not improving

The feelings between the two Races are not good on the account of many of the Planters not dealing fair with them in the division of the Crops and there is an unpleasant feeling between the Freedmen on the account of Politics there is a great many who has not registered on the account of a rumor among them that they cannot vote the Republican Ticket & have not heard any thing of the kind except through the Freedmen

The School on Oakland Plant is open but the School at Harrisburgh is closed and the Teacher gone to work on a Plantation to keep from starving he could not get his pay for teaching the Freed people are to have to pay school bills

The health of the Parish is quite better it has improved since my last report

I have just been informed that two of them Alexander & Watson Plantation has been hurt one attacked the other with an Ax. intending to kill her she is badly hurt

I have been informed by persons here through their Purchasers in N.C. that I have been reported

to the East Commissioners as Acting a Rascally farmer with the Planters and Freedmen of deny the Charge and respectfully ask for an investigation the report has been made by some dishonest person to me unknown who I suppose I have prevented from cheating the Freedmen

My Try Monthly Special Reports of Aug 10<sup>th</sup> 31<sup>st</sup> Sept 5<sup>th</sup> 11<sup>th</sup> 20<sup>th</sup> 30<sup>th</sup> and October 10<sup>th</sup> 20<sup>th</sup> contains my actions in behalf of Mr. Johnson Sumner Mr. Jones son of the James O. E. Wilkins Elijah Collier and others

I remain your obedient

Servant

D. W. Camp

Officer U.S.A. Com  
Bureau of P. T. & A. So  
Catahoula Parish La  
Trinity Jan 2<sup>nd</sup> 1868

Act of Mr. Lee  
A. A. Jones  
his

I have the honor to lay before you a Complaint from Isaiah King who has worked with a man by the name of John Gray in Concordia Parish. They Black Kings occupying my Parish they raised a Crops of Cotton and Corn 45 Bush Corn & have shipped 11 Bales of Cotton on the 27<sup>th</sup> of Jan. All on Oct 26<sup>th</sup> they would not



give him the work and have not divided  
neither Corn or Cotton. His share  
of the Crop is 1/4

The Freedman was run off of  
the Place and was told if he returns  
he will get shot. This man in  
my Office he has been to me  
twice before and I have written to  
Mr A Hamilton same month since  
with regards to the matter but  
have not heard from him with regards  
to the matter

The Freedman on the River is  
badly treated by the Planters I have  
had several complaints but  
they are out of my Parish and  
I have referred them to N. D. S. L.

The N. B. S. L. survey for 441  
the per date  
I remain yours obedt  
servt

J. H. B. Camp  
A. S. L. C. in N. B. S. L. A. S.

Nov 16<sup>th</sup> 1868. Pines N. H.  
Capt U. S. A.  
Genl Supt  
Education

Mr J. H. B. Camp  
A. S. L. C  
S. H.

Hd. Qr Bureau R. F. and A. L.  
Office Genl Supt. of Education La  
New Orleans La. Nov 12<sup>th</sup> 1868

In reply to yours of the  
6<sup>th</sup> inst. If land can be secured to freedmen  
by Lease - or, leased securely for a  
term of years, I will construct school  
houses - when needed - If assistance  
is required for teachers, make applications on  
proper blanks, and all will be granted -  
If books are needed send in a  
list of your wants - and I'll try to supply  
I want you to look well to the future in-  
terest of the freedmen, in the matter of  
lands - See that they are amply protected  
in their rights - Put your application in  
definite form - and - I'll assist all in  
my power -

Very Truly  
(signed) H. H. Pines  
Br. Capt U. S. A.  
Genl Supt. Edu.

Nov 15 1868 Pines N. H.  
Capt U. S. A.  
Genl Supt  
Education

Mr J. H. B. Camp  
A. S. L. C  
S. H.

Hd. Qr Bureau R. F. and A. L.  
Office Genl Supt. of Education -  
New Orleans La. Nov 9<sup>th</sup> 1868

Please forward to this  
office, each month, duplicate Vouchers, Form  
22, properly signed, in blank, for services of  
teachers and, rent of school buildings, in  
your district.

Mail them so as to reach this  
office



offices about the 15<sup>th</sup> of the month for which they are intended. The proper forms will be sent to your address this day.

Very Respectfully  
(signed) H. H. Pierce  
Post Capt U.S.A.  
Gen. Supt. Ed.

Nov 20  
1868.

Brown J. H.  
Henry Peterson  
Clerk for J. H.  
Brown on leave  
of absence  
Sub-Asst  
Commissioner

H. H. Dr. Brown R. F. & A. L.  
3<sup>rd</sup> Sub. District of Louisiana  
Monroe, La. Nov 17<sup>th</sup> 1868.

Circular

In compliance with instruction from the Assistant Commissary of Subsistence, dated New Orleans La. Nov 12<sup>th</sup> 1868. hereafter the Factors certificates will be called for from the offices of the A. S. of S. thus rendering it necessary for the Posters to transmit Commissioners Certificate only.

This certificate may be forwarded to the office of the Asst Comm of Subsistence before the planter pays his indebtedness, and it should at all events be given immediately after the A. S. of S. receives information that a planter has paid.

(signed) Henry Peterson, Clerk  
for John H. Brown.  
(on leave of absence)  
Sub-Asst Comm  
3<sup>rd</sup> Sub District of La.

Nov 26  
1868. B. H. G. S. & A. A. 2. H.

Bureau R. F. & A. L.  
Office D. S. & A. A. 2. H.  
New Orleans Nov 23<sup>rd</sup> 1868.

Mr Van R. H. Hilliard -  
A. S. of S. Trinity La.  
for -

In answer to your dated Nov 13<sup>th</sup> 1868 - I would most respectfully state that the money for the 4<sup>th</sup> Qu - 1868. Oct 1<sup>st</sup> to Dec 31<sup>st</sup> has been furnished Mr J. H. Camp your predecessor. Forage for the mos Sept - Oct & Nov was also shipped to Mr Camp - Your allowance of Forage has per instruction Mr J. H. Brown been shipped to his care & will be by him forwarded to you. No 11 are not the proper forms for purchase Vouchers. I enclose you #12 upon which you will please make your purchase also send you Form Requisitions which please fill in duplicates & return. Do not hesitate to make any enquiry - as anything you are in doubt about will be cheerfully answered.

Very Respectfully  
Per Order B. H. G. S. & A. A. 2. H.  
Per Whipple - Clerk

Dec 1<sup>st</sup>  
1868 Wood W. W.  
Lieut 1<sup>st</sup> U.S. Art  
A. S. of S.  
Bureau R. F. & A. L.

Head In Bureau R. F. & A. L.

Mr Van R. H. Hilliard -  
A. S. of S.  
Trinity La.  
for =

You will at once forward to this office the Bond of White & Ranney of your Parish. Said Bond was forwarded to your Office June 11/68. to be signed by their bondsmen. You will give this matter your immediate attention -

Very Resp<sup>t</sup> for O. H. J. Wood.  
2<sup>nd</sup> Lieut 1<sup>st</sup> U.S. Art. A. S. of S.



Dec 7<sup>th</sup> 1868  
Wood W.W.  
a.c.f.  
Bureau R.F. & A.L.

Enclosure or letter of transmittal from this Office  
dated Dec 1<sup>st</sup> 1868

Respectfully returned. This bond will if possible be signed by the sureties. Messrs White & Ramsey have not as yet paid their indebtedness to the Bureau.

(Signed) W.W. Wood  
2<sup>d</sup> Lt 1<sup>st</sup> Infy -  
a.c.f.

Dec 9<sup>th</sup> 1868  
Blutcher R.T.  
Majr U.S.A.  
Capt 6<sup>th</sup> Cavalry  
A.R. General

U.S. Bureau R.F. & A.L.  
District of La. New Orleans Nov 30<sup>th</sup> 1868

Mr John H. Bowen  
Sub Aft Comm 5<sup>th</sup> Sub District  
Monroe, La.

I have the honor to call your attention to the case of outrage against Emanuel Right Colored and enclose for your information copy of affidavit of Moses Green for colored, concerning same.

The Aft Commissioner directs that you cause affidavits to be made and proper steps taken against the parties therein mentioned, for their arrest and trial on the charges as therein specified.

Very Respectfully  
Your Obedt Servant.

(Signed) B.T. Hutchins  
Majr U.S.A. Capt 6<sup>th</sup> Cavalry A.R. General

(Enclosure on the above letter)  
Head Qr 5<sup>th</sup> Sub District R.F. & A.L. Monroe La  
Dec 3<sup>d</sup> 1868

Brown J.H.  
Sub Aft Com  
5<sup>th</sup> Sub District  
Monroe La.

Respectfully forwarded to Mr Van R. Hilliard A. J. A. Com. and request immediate action be taken in accordance with instructions from the Assistant Commissioner.

This letter to be returned to this office  
(Signed) J. H. Bowen  
Sub Aft. Commissioner  
5<sup>th</sup> Sub District of La.

Dec 11<sup>th</sup>  
Brown J.H.  
Sub Aft Com  
5<sup>th</sup> Sub District  
of Louisiana

Headquarters Bureau R.F. & A.L.  
5<sup>th</sup> Sub District of Louisiana  
Monroe La December 7<sup>th</sup> 1868

Circular Letter -

In compliance with instructions from U.S. Bureau R.F. & A.L. Dist of La. dated New Orleans Dec 2<sup>d</sup> 1868. Each Sub Aft Com of this District, will immediately report to Headquarters, New Orleans, when Cotton or other crops have been shipped to Commission Merchants in the City, by planters, before paying their indebtedness to the Bureau, or making a settlement with the freed people in their employ, giving the names, names of the parties to whom the shipment has been consigned, amount and kind of crops shipped, together with marks on cases, also date of shipment and name of steamer.

(Signed) John H. Bowen  
Sub Aft Commissioner  
5<sup>th</sup> Sub District of Louisiana  
Mr Van R. Hilliard  
A. J. A. Com

Dec 12<sup>th</sup> 1868  
Wood W.W.  
2<sup>d</sup> Lt 1<sup>st</sup> Infy  
a.c.f.

U.S. Bureau R.F. & A.L.  
Office Assistant Com of Submitter  
New Orleans Dec 10<sup>th</sup> 1868

Mr Van R. Hilliard  
A. J. A. Com  
Trinity La.

By direction of the Aft Com you will inform Mr C. Robertson of your Parish, that his indebtedness to the Com in the sum  
(over)



of \$94.60 was paid the 9<sup>th</sup> inst.  
This bond will not be cancelled  
until the certificate of the sub. apt. Comr  
& the sub. dist is received, as required by  
Circular 19. C.S. from the Hd. Qrs -

Very Respectfully  
(signed) W. W. Wood  
2<sup>d</sup> Lieut 1<sup>st</sup> U.S. Infantry  
A. S. D. General

related upon.

(signed) J. M. L. 29  
1<sup>st</sup> U.S. Infantry  
A. S. D. General

Dec 14  
1868  
Wood W. W.  
2<sup>d</sup> Lt 1<sup>st</sup> U.S. Infantry  
A. S. D. General

(Enclosure on Envelope)

Headquarters  
Hon R. F. 2<sup>d</sup> Lt of La Office A. S. D. Genl.  
New Orleans, La Dec 12<sup>th</sup> 1868

Respectfully referred to Mr Van RK Hilliard  
A. J. A. Comr, Parish of Catahoula, attention invited  
to the enclosed Reports, forwarded to this office,  
by Mr J. H. H. Camp. Late A. J. A. Comr -  
Mr Hilliard will at once complete and  
forward to this office. Monthly Inspection Report  
for the month of November 1868 -

(signed) W. W. Wood  
2<sup>d</sup> Lieut 1<sup>st</sup> U.S. Infantry  
A. S. D. General

Dec 14<sup>th</sup>  
1868  
Lee J. L.  
1<sup>st</sup> Lt 39<sup>th</sup> U.S. Infantry  
A. S. D. General

Enclosure, on enclosure of Inspection  
Report. Month of Nov. which was returned to this office  
Hd Qrs Hon R. F. 2<sup>d</sup> Lt  
Dist. La. Office A. S. D. General.  
New Orleans La Dec 4<sup>th</sup> 1868.

Respectfully returned to Mr Van RK Hilliard  
A. J. A. Comr (Hon sub. apt. Comr. & the sub. dist. La)  
for compliance with Par 2. Cir 15. C.S. from  
the Hd Qrs - All of the Plantation not inspected  
will be estimated together. The total of those  
inspected, and those estimated making the total  
in the Parish - Immediate compliance with  
the requirements of Circular referred to is to be



A Index B

Armstrong H. C. W. C. D. M. 38.  
46, 49.  
Alexander & Norton 101, 102.

Bowie Matt. 20.  
Bros. & C. Brian 50.

Bales & Mather 32.  
Beamon E. C. N. O. & A. Q. M. 32, 67.

109.  
Black 71.  
Boatman J. M. 11.  
Brown J. M. Sub. Ant. Com. 28, 29.

91, 96, 100.  
Black D. 101.  
Boatman & Wilkins A. O. 101.  
Bowen J. H. 108, 109, 110, 111.

C D

Carrigan J. P. 32.  
Cramp J. M. M. 14, 28, 29.  
Collaw Elijah 103.  
Cramp J. H. H. 107, 109, 112.

Ditto H. S. 19.  
Dunckley James 25.  
Davis Jno. S. 52.  
Dickens J. L. 10.



E.

Ellyz Eugene 7 S. 65.

D.

Dorris Dr. 79.

J.

Jarrett Jacob 24, 26, 51, 52, 56

Jillis & Co. 48.  
Jold Samuel C. 69.  
Jray John 113.  
Jreer Miss Jn. 116.

H.

Hamilton Elias 55.

Hutchings B. D. Brit. Maj. U.S.A. 87.  
90, 96, 99, 101, 110.  
Hilliard Van. R. K. 109, 110, 112.



J.

*K.*  
Kuler P. P. 56.  
King Jack 113.

Jones Jas. Col. 4, 16, 46, 90.  
Johnson C. 52.  
James C. 54.  
Jones Matilda W. S. & S. 15.  
James Wm 76, 93.  
Johnson Rudy  
Jones Charlett & Wm 95, 103.

*S.*  
See J. W. St. 1<sup>st</sup> Def. D. 14, 16, 18  
19, 21, 22, 26, 29, 48, 49, 94, 103, 112.  
Logan & Minny 52.  
Lemmon Johnson 56, 69, 70, 103, 103.

*M.*

McCum J. 56.  
McCure S. A. D. M. 65.  
Miller Seth 95.

*N.*

Newman & Bro. 30.  
Neal, Wife & daughter 32.  
Neri & James 55, 90.

*O.*

Owens Eli 56.



P.

Parker S. O. 1<sup>st</sup> Lt. U.S. 4.5.

Perister Dr. 15.14.

Pool 20.65.

Priest H. H. But. Capt. 9. Gen. Supt.

79.92.  
Pierce H. H. Capt. U.S.A. 107.

Petersen Henry 100.

Q.

Q.

Quath D. E. W. 9M 15.

Reddek 47.

Right Emanuel 116.



S.

Sterling Dr. H. Capt 1<sup>st</sup> Reg. Inf. 1<sup>st</sup> Div.  
1, 2, 3, 6, 7, 10, 12, 13, 54, 59, 60, 62.

Surgeon in Chief of Dr. H. New C.  
46.

Harret J. 37.

Smith W. J. & Co. 54.

Smith P. O. 53.

U.

J.

Daylin Dick 90.

V.

Piens Jerry 52.



Marlow 16.  
Wells James 20.

Ward D. A. Capt. U.S. A.  
U.S. A. Serv. 24, 32, 36, 44, 45, 47.

Warren S. Lt. Capt. 39 U.S. A.  
U.S. A. Serv. 31, 34, 35, 37, 38, 39, 41, 42,  
43, 50, 51, 53, 54, 57, 58, 60, 62, 63, 64, 65, 66, 68,  
69, 73, 75, 77, 81, 82, 84, 85, 87.

Woods M. W. Lt. U.S. A. Comm.  
74, 110, 111, 112.

Wilkins A. E. 113.

White & Ramsey 109, 110.



NATIONAL ARCHIVES AND RECORDS ADMINISTRATION  
MICROFILM PUBLICATIONS

Roll 103

Target 11

*Letters Received*

May 1867–Dec. 1868







Cotton Ridge La.  
May 7. 1867.

Crossgrove S. D.

States that he and his family are in a dreadful condition. Families of colored people are scaffolded in the stables, Gin House, & cabins, & a family in garret of his own house. His place has been overflowed a month, & he does not know how much longer it will last. His family consists of six persons, and he has 49 freed people to take care of, and has no means of procuring food for them. Asks that some assistance be afforded him.

1867

6957 (Bu. R. F. & A. L., La.) 1867

HEADQUARTERS  
BUREAU REFUGEES, FREEDMEN AND ABANDONED LANDS,  
STATE OF LOUISIANA.

New Orleans, May 27 1867

Respectfully referred to Mr. M. Johnston Leonard, Asst. Sub Dist Com. (this: Capt. S. C. Gold, Asst. Com. & Munros) for investigation and report.

By order of St. Maj. Gen. J. M. Moore

Wm. Stelling  
Capt. U.S. Army, ad. a. Genl

Head Quarters  
Bu. R. F. and A. L.  
& the Sub Dist La  
Monroe, La June 1. 1867.

Respectfully forwarded to Mr. Johnston Leonard, whose attention is called to the above, to the endorsements.

Daniel A. Wood, Capt. U.S. Army  
& the Sub Dist La

Witnessed June 10,



Cotton Ridge May 7 1864

Messrs Gilmer, Hopkins & Co

Sirs

This leaves us in a dreadful condition; we are surrounded by water on all sides, two families of negroes scaffolded up in the cabins, two families at the stable and the balance in the gin house - my own family scaffolded up in the house one family of negroes in the garret of my house, and I have no means in the world to purchase provisions for them - I have been in this condition for one month to day and I cannot tell how much longer I will be in this condition, there are six in my own family - sixteen freedmen and fifteen women and eighteen children making in all fifty five let me know if you can render me any assistance by so doing you will confer a lasting favor on.

Yours Very Respectfully  
S. D. Crossgrove

6 white persons  
16 Freedmen  
15 Women  
18 Children  

---

55 in all

4 miles from Trinity



New Orleans La.  
May 18<sup>th</sup> 1867.

May 18<sup>th</sup> 1867

Commissioner Assistant.

Relating to distribution  
of Rations to the  
destitute.

1867



# 539.

HEADQUARTERS,  
Bureau of Refugees, Freedmen and Abandoned Lands,  
DISTRICT OF LOUISIANA.  
No. 164 JULIA STREET.

New Orleans, La., May 18<sup>th</sup> 1867

Mr. M. Johnston Lemmon

Asst. Sub. Asst. Commr. Bureau R. F. F. L.  
Catahoula Parish, La.

Sir,

I am directed by the Assistant Commissioner to inform you that rations have been shipped to Captain E. C. Clark for distribution in accordance with the provisions of Civil Act No. 11 W. D. Bureau R. F. F. L. to those persons actually in need of the same to prevent actual suffering. - some of these rations were sent to Story's Landing, Black River, for issue to those destitute persons in Concordia Parish bordering on Black River, who could be more conveniently reached by the Agent of Prairie Landing than by William Brown, Agent for Concordia Parish at Vidalia. You will see the persons mentioned in the enclosed papers, if their plantations are overflown and they destitute, rations can be issued to them.



and the freedpeople dependent on them until  
the water recedes, and the plantations can  
be cultivated again; but rations cannot  
be issued where freedpeople are actually  
employed in cultivating a plantation - The papers  
will be returned with a report of your action in the matter.

Very respectfully,

Your obedient servant,

Wm. J. Stirling  
Captain, 1<sup>st</sup> U.S. Infy.  
A. A. S. General



N-97 (Bu. R. F. & A. L., La.) 1867

Harrisonburg, La.  
Catahoula Parish.

May 17, 1867

22

Wilson, Esq. & 2 others  
members Board of Registered.

Represent that there are  
some 30 or 40 indigent people in  
that vicinity who need immedi-  
ate relief. That Capt. Clark, the  
Judge of the Parish, is 50 miles from  
them at Prairieville, and they  
have no means of applying to him.  
I recommend that provisions  
be sent to that point for their relief  
& recommend that Mr. H. J. Spann  
a worthy local citizen be appointed  
to distribute the same.

1867-68

N-97 (Bu. R. F. & A. L., La.) 1867

HEADQUARTERS  
BUREAU REFUGEES, FREEDMEN AND ABANDONED LANDS,  
STATE OF LOUISIANA.

New Orleans, May 22 1867

Respectfully referred to Mr. M

J. L. Linnon - Asst. Secy. Com.

Je. Prairie Landing - of Mr.

H. J. Spann will receipt to

Mr. Linnon for the rations now

at Harrisonburg - he can issue

them, and more will be sent

there if required on Mr.

Linnon's application for the same

By order of St. Atty Genl J. A. Howard

E. J.  
2/550.

Wm. H. Estlin

Capt. U.S. Infy - Ad. Genl.



Horseneburg

Cotcharles Parish La Moy 18/67

Capt N. H. Sterling  
A. H. Guil

Captain

We the undersigned board of Agents  
of Voters, for this Parish, would respectfully represent  
that there are between thirty (30) <sup>(40)</sup> forty (40) individuals  
~~individuals~~ <sup>persons</sup> in this vicinity who require immediate  
relief. They are principally women & children and  
to obtain relief through Capt Clark of the Bureau  
would be almost impossible, as he lives at  
Prairie Landing about fifty (50) miles from here and  
they are unable to get a sled to him for supplies.  
From the fact they have no means of transportation  
and no money to employ any. We therefore respectfully  
recommend that you appoint a proper person here  
(Horseneburg) to distribute the relief <sup>very</sup> and would  
recommend for that purpose Mr. H. S. James a  
worthy and loyal citizen of this place

We have honor to be

Captain

Yours Obedt Servants  
Edw S Wilson  
Thos B Waters  
Jm H Dewick



N. 20. (C. of A. C. Bu. Ref. & A. L., La.) 1867

Concordia Parish La.  
Police Jury ward No. 8.  
May 25<sup>th</sup> 1867

Wilson Milton, Esq.  
Member of Police Jury

Requests assistance for the within named families both "white" & "col" in his ward, as Police Jury of Concordia Parish La. They have been entirely overflown, and have no present means of obtaining food &c. The family of Clayton is now suffering from sickness &c.

N. 20. (C. of A. C. Bu. Ref. & A. L., La.) 1867

Office of J. A. Cour. Bu. of Ref. & A. L.  
Parish of Concordia La.  
Vidalia May 27/67

Respectfully forwarded to Capt. J. H. Hastings, Sub. Asst. Comr. Bu. of Ref. & A. L., 6<sup>th</sup> Sub. Dist. of La., with recommendation that these families are worthy of assistance, but there being no possible way of procuring subsistence to that part of the Parish unless by shipment via Red River, to which no authority is granted to make any such expense. It is therefore recommended that they be furnished with such assistance as they are able to furnish from New Orleans La. direct to the landing mentioned within.

D. B. Brown  
Capt. Bu. of Ref. & A. L.  
Asst. Comr. Bu. of Ref. & A. L.  
191 St. Parish of Concordia

George Bu. Ref. & A. L., La.  
6<sup>th</sup> Sub. Dist. Dist. of La.  
St. Joseph La May 31<sup>st</sup> 1867

Respectfully forwarded to Capt. W. C. Sterling, U.S.A. et al. The suggestion of Lt. Major B. B. Brown as a course is approved with the information that it is impossible to relieve the wants of the destitute from any one point in a parish.

J. H. Hastings  
Capt. V. B. C. Sub. Asst. Comr.  
6<sup>th</sup> Sub. Dist. Dist. of La.

N. 102. (Bu. R. F. & A. L., La.) 1867

HEADQUARTERS  
BUREAU REFUGEES, FREEDMEN AND ABANDONED LANDS,  
STATE OF LOUISIANA.

New Orleans, June 5<sup>th</sup> 1867

Respectfully referred to W. M. Johnston Leemon, Asst. Asst. Comr. for Prairie Land, he with the information that Capt. W. B. Pennington Agill has been directed to send 500 rations to Wilson's Landing for the relief of the within named persons. Mr. Leemon will immediately proceed to Wilson's Landing and see that the same are properly distributed. This relief being furnished by Charitable Associations at the north returns for the same will not be made to Washington.

By order of  
Sterling Cecil J. Holloway Asst.  
W. C. Sterling  
Capt. 1<sup>st</sup> U. S. Infy A. A. Galt

(115) June 10



Concordia Dr. La  
Baltimore, Ward No 8.  
May 25<sup>th</sup> 1867

Major B. B. Brown  
Asst Com 13th Reg. F. A. C.  
Challinor

Dr Sir

Your note of April 27<sup>th</sup> is at hand and in compliance herewith furnish the required information, so far as I have been able to ascertain.

His entire ward has been inundated, and more or less distress consequent.

There has been about One thousand (1000) Acres of Cotton, and Four Hundred (400) " " " " Corn destroyed. - also a large amount of Stock has been lost.

The following named persons in this ward, are "from my own personal knowledge, in view of assistance to prevent actual suffering."

- |              |                     |                   |
|--------------|---------------------|-------------------|
| Thomas Lucas | 36 <sup>th</sup> St | Colonia (one leg) |
| Mary Featt   | 70 <sup>th</sup> St | "                 |
| Hannah Black | 75 <sup>th</sup> St | "                 |

over



	Age	Sex	Color
Maria Dick	65	Female	Colored
Jan Johnson	17	"	"
Arthur Johnson	25	Male	"
Dr. M. Clayton	36	"	White
Mrs M. E. Clayton	35	Female	"
L. E. Clayton	12	"	"
Robert Clayton	10	Male	"
Lawrence Clayton	8	"	"
Henry Clayton	7	"	"
Sam Clayton	5	"	"
Harmon Hamme	5 1/2	"	"
Mrs Hamme	60	Female	"

& Mr. Holmes. to whom "indigent or helpless condition." I cannot certify.

I am  
 Very Respectfully  
 Milton Wilson  
 Police Juror. Ward 108

In regard to Mr Clayton's family I would beg especially to state, that they are absolutely destitute, suffering from sickness and dependent entirely upon charity. - Meal or Flour, Meat, Rice, Sugar or Molasses, Coffee, would meet their wants. - in fact any thing you could furnish to sustain life. Please send supplies to my care - Wilson's Landg. Black River, and I will attend to the distribution - would like to have enough for one month which would save trouble and expense. Enclosed you will also find lists furnished me by Messrs Taylor & Daniel.



Head Quarters R. I. 2d A. C.  
District Louisiana  
New Orleans, La. May 29<sup>th</sup> 1867.

Howell, Major Genl. J. et. al. by  
Sterling, Capt Wm. H. 1<sup>st</sup> U.S. Inf  
A. A. A. Genl.

Directs M Johnson Senior  
Asst. Sub. Asst. Comr. to take  
statement of Chas Jones;  
Pelu Auger; Ransom Reddick  
John Roger, Jack Branch,  
Jacob Garrett, John Davis,  
Elisha Reddick, George Branch,  
and Thomas Williams, in  
form of Affidavit, respecting  
the alleged misdemeanor  
in Office by Capt E. L  
Clark, late adjut for  
the Parish of Catahoula  
Has he been interested  
in any Plantations, give  
location and Name of  
Owners. - the rations issued  
to them if any, or any  
information you can get  
respecting Capt Clark

Head Quarters R. I. 2d A. C.  
5 Sub District Jas  
Monroe La. June 1<sup>st</sup> 1867  
Respectfully forwarded  
Saml C. Ford Capt M. A.  
Sub Asst. Comr  
5 Sub Dist Jas



#583.

HEADQUARTERS,  
Bureau of Refugees, Freedmen and Abandoned Lands,  
DISTRICT OF LOUISIANA.

No. 154 JULIA STREET.

New Orleans, La., May 27<sup>th</sup> 1867

M. M. Johnson Lemmon

Asst Sub Asst Commr - Bureau R. F. & L.

Prarie Landing, Black River La.  
(Thru Capt. S. C. Gold.)

Sir,

I am directed by Pt. Maj. Geil J. A. Moore  
U. S. A. Asst. Commr. for you to direct you to see the  
undermentioned persons, and take any statements  
they may have to make (in the form of affidavits)  
respecting the alleged misdemeanors in office  
committed by Capt. C. S. Clark, late Agent of  
this Bureau for your parish, and any misapplication  
of rations by that Officer - You will also  
find out if he has been interested in any  
plantations, give their location, names of owners,  
the amount of rations issued to them, if any, and  
any information you can gather respecting the  
administration of the affairs of the Bureau by  
Captain Clark -

The following persons can give you some



information -

Charles Jones

Peter Kuger

Ransom Reddick

John Badger

Jack Branch

Jacob Garrett

John Davis

Noah Reddick

George Branch

Thomas Williams

You will be careful to have all the facts reported substantiated by affidavits, and furnish the information requested with as little delay as possible.

Very respectfully,

Your obedient servant,

Wm. H. Stelling  
Captain 1<sup>st</sup> U.S. Infy  
"A. A. A. Gen'l



New Orleans La.  
June 4<sup>th</sup> 1867.

June 4<sup>th</sup> / 67

Commissioner Aft.

Forwards copy of letter  
sent the 29<sup>th</sup> inst, and  
asks for result of in-  
vestigation.



#645.

HEADQUARTERS,  
Bureau of Refugees, Freedmen and Abandoned Lands,  
DISTRICT OF LOUISIANA.  
No. 154 JULIA STREET.

New Orleans, La., June 4<sup>th</sup> 1867

Mr. M. Johnston Lemmon  
Asst Sub Asst Commissioner  
Prairie Landing, Black River La.  
Sir

I am directed by the Asst  
Commissioner to enclose copy of communication  
sent you on 29<sup>th</sup> ult. and direct you to forward  
the result of your investigation to these Head-  
quarters as early as possible.

Very Respectfully  
Your Obedt Servt

M. J. Stealing  
Captain 125 U.S. Infy  
Asst Asst Adj't Genl



Respectfully returned to  
Mr. Lemmon, whose  
attention is called to  
endorsement. of Genl  
Morris. Dist. Comd  
Saml. C. Cold. C. M. P.  
Sub Dist Comd  
5th Sub Dist. La

L. 2. Bu. at 5th & 4th  
5th Sub Dist. La.  
Monthly Report of  
Mr. Johnston Lemmon, A. C.  
Bureau N. S. & L.  
Catahoula Parish, La.  
June 10th 1867.

Division No. 2, Cerappon  
of Concordia Parish, bordering  
on Black River, ground west  
of the plantation certainly  
irrigated yet, will not be  
able to plant unless this season.  
Received 50 bushels from Capt  
J. H. Armstrong, A. D. M., at Wilson's  
Landing, Concordia Parish La.  
for the individual owners, freightmen  
all expenses charged & are  
Contracted.

Rec'd at Canal & Sub Dist. La. June 22/67

Head Quarters Bu. N. S. & L.  
5th Sub Dist Louisiana  
Morris, La, June 22 1867

Respectfully forwarded  
Saml. C. Cold. C. M. P.  
Sub Dist Comd  
5th Sub Dist La

5th Sub Dist Louisiana  
Head Quarters, Bureau N. S. & L.  
District of Louisiana  
New Orleans. June 26th 1867

Respectfully returned to Mr. M. Johnston  
Lemmon. A. D. M. Sub Dist Comd. La. with the  
information that 4 bbls & 1 box of seed  
containing 833 lbs were shipped to  
him at Wilson's Landing, per Steamer Idaho  
on the 5th inst - Mr. Lemmon will  
please state how much seed was  
actually received, and who signed  
for the same

By order of  
Rt. Hon. Genl J. H. Morris

S. Parker

2d Lieut. 1st U. S. Regt  
Art. & G. S.



Officer A. J. A. C. Bureau N. H. & F.  
Catahoula Parish, La.  
June 10<sup>th</sup> 1867.

Mr. G. Sterling,  
Capt 1<sup>st</sup> U.S. Infy.  
A. S. A. Col. B. K. & F. S.

Sir:

I have the honor of transmitting you the following report. The A. S. Corp. group communication of "May 7" to Messrs Wilson & Co. has been received and your instructions complied with. The Messrs Wilson and several others in that vicinity received supplies on or about the 20<sup>th</sup> of May last from charitable associations of New Orleans, which relieved their wants until their merchants resumed their supplies. Their plantations are partially inundated yet and they will be unable to plant cotton this season.

Mr. Milton Wilson's "Police Journal No. 8, Levee Parish," communication to Capt & Maj W. B. Brown A. S. A. C. B. K. & F. Vidalia, Levee Parish, La. has been received and orders and instructions complied with. I found but 150 fifty rations at Mr Wilsons for me in place of 1000 five hundred as was stated Capt W. B. Armstrong, A. S. M., was directed to send me.

Where the waters have subsided sufficiently



for the pleasure to receive planting the "freemen" are working  
cheerfully and contented.

Respectfully Your Obedient Servant,  
M. Johnston  
A. G. A. Com.  
B. K. & S. Co.

*[Faint, illegible handwritten text, possibly bleed-through from the reverse side of the page.]*



Muir La

June 12<sup>th</sup> 1867

June 12 - 1867

Circular  
No. 2



Head Quarters Br R. F. A. L.  
5th Sub District of Louisiana  
Monroe La June 12th 1864

Circular  
No 2

Asst. Sub. Com. Commissioners of  
this District will make and forward  
to these Head Quarters by the 20th of  
each month, a monthly report, stating  
the condition of the freedmen in their  
respective Parishes; the state of feeling  
existing between the races; and a full  
statement of the condition of the  
Educational Department of the  
Bureau.

Saml C. Good Capt. U.S.A.  
Sub. Asst. Com.  
5th Sub Dist. of La

M. S. L.



Office A.S. A.C. Burdett  
Catahoula Parish La.  
June 17<sup>th</sup> 1867.

W. Johnson Leumond  
A.S. A.C. Comm

who will see the produce  
of Wallace, and order  
him to report to W. J.  
Leumond A.S. A.C.  
Catahoula Parish La.

Samuel C. Gold  
Sub Dist Com  
5<sup>th</sup> Sub Dist La.

Head Quarters Bu R. F. A. C.  
5<sup>th</sup> Sub Dist Louisiana  
Monroe July 1<sup>st</sup> 1867.  
Respectfully returned  
to M. J. Leumond.  
A.S. A.C. Comm  
Samuel C. Gold Capt.  
Sub Dist Com  
5<sup>th</sup> Sub Dist La.

States that Mr. Wallace formerly  
left his contract with  
Dr. MacCallum and  
is working on Saw mill  
near Monroe. Has a  
helpless wife and five  
small children, asks  
to have him returned at  
expense of Dr. MacCallum.

Office Asst Sub Dist Com  
Smith of Louisiana & Monroe  
Monroe July 1<sup>st</sup> 1867  
Respectfully returns  
back - Frederick Wallace  
Wallace cannot be

Head Quarters Bu R. F. A. C.  
5<sup>th</sup> Sub. Dist. Louisiana  
Monroe June 26<sup>th</sup> 1867.

found. Cha. H. Leumond  
Asst Sub Dist Com  
Bu R. F. A. C.

Respectfully referred  
to Chas. C. Leumond as a  
C. Burdett A.C.



Officer A.G.C. B.R.A. & T. Landes,  
Catahoula Parish, La.  
June 17<sup>th</sup> 1867.

Saml C Gold Capt. U.S.A.  
Sub Adj Com B.R.A. & T.  
Morrow La

Sir

there is a  
freedman by the name of Wm Mucciacci  
working on a Saw Mill near your place  
Morrow who is under contract with Dr. Wm  
Calhoun of this Parish. for the present year.  
Mucciacci has a helpless wife and five  
small children at Dr Calhoun's without  
any means of support only what she  
get from the Bureau.

If you can find  
him and send him down to me for  
Dr C. he will pay all expenses.

Respectfully Yours  
Wm. Johnston Semmon  
A.G.C. B.R.A. & T.



26<sup>th</sup> Quad. List of Louisiana  
New Orleans June 29. '67.

Howes Botolph Gulf St.  
Asst Comm

Letter directing Captain  
Armstrong et. G. M. to ship  
to M. J. Lemmon 3000  
rations



HEADQUARTERS,  
Bureau of Refugees, Freedmen and Abandoned Lands,  
DISTRICT OF LOUISIANA.  
No. 154 JULIA STREET

New Orleans, La. June 29<sup>th</sup> 1867

Mr. W. J. Linneman,  
Asst. Surg. West Coast, Texas, R. F. A. S.,  
Prairie Landing, Black River, La.

Sir

By direction of Asst. Surg. J. A. Mower, West Coast  
I have the honor to inform you that Capt. W. B. Armstrong,  
A. G. M., has been directed to ship to you, addressed  
in care of Messrs. Linker & Rushman, Trinity,  
3000, rations for the relief of the destitute in  
your Parish, for which you will make return  
on the blanks sent herewith to Capt. W. B.  
Armstrong, A. G. M., and forward a report of the  
number of rations issued to you to this office in  
the usual manner.

Captain W. B. Armstrong, with ship 1000  
rations to Flavery Landing Black River on  
Wednesday next. The steamer "Idaho" is then  
leaving the city on that day.

You will therefore proceed to Flavery Landing

(over)



and issue the rations to the indigent persons in  
Concordia Parish. Planks will be sent with the  
ration. I have the honor to be

Very Respectfully  
your Obedt. Servt.  
(Signed) L. C. Parker  
2d Lieut 125th Inf. Army  
U. S. A.

Official Copy respectfully furnished to  
Captain J. C. Gold for his information  
L. C. Parker  
3d Lieut 125th Inf. Army  
U. S. A.



New Orleans La.  
June 29<sup>th</sup> 1867.

Commissioner of the  
———

Forward, rations for  
distribution among  
the destitute.



#183.

HEADQUARTERS,  
Bureau of Refugees, Freedmen and Abandoned Lands,  
DISTRICT OF LOUISIANA.  
No. 154 JULIA STREET.

New Orleans, La.,

June 24<sup>th</sup> 1867

Mr. W. J. Lemmon

Asst Sub-Asst Com Bureau F. & A.

Prairie Landung, Black River, La.

Sir,

By direction of Major Genl J. A. Mower, Asst Com of  
I have the honor to inform you that Capt W. B. Armstrong  
Adj. M. has been directed to ship to you, addressed  
in care of Messrs Sinker & Washman, Trinity, 3000  
rations for the relief of the Destitute in your Parish,  
for which you will make returns on the blanks sent herewith  
to Capt. W. B. Armstrong Adj. M., and forward a report  
of the number of persons issued to go to this office in  
the usual manner.

Captain W. B. Armstrong will ship 1000 rations to  
Floury Mound Landung Black River on Wednesday next per Steamer  
Adalor, or other steamer leaving the city on that day.

You will therefore proceed to Floury Mound and issue  
the rations to the indigent persons in Concordia Parish.  
Blanks will be sent with the rations.

(over)



I have the honor to be  
Very respectfully,  
Your obedient servant,

L. O. Parker

Lieut 1<sup>st</sup> U.S. Regt Art. & G. Genl

Recd June 29<sup>th</sup> 1867

New Orleans La.

June 29<sup>th</sup> 1867

Commissioner of the

General Land Office  
Washington

the certificate.



1. 100 (B. 100) P. 100. 6.  
Office Sub Dist Comm  
Parish of Catahoula  
Louisiana July 1. 1867

Common, M. Johnson  
A. S. T. Comm

There are quite a number  
of very old infirm & crippled  
Freedmen in this Parish,  
that cannot work, & have no  
one to depend upon, or any  
way to make a support.  
Some of them are without  
shoes & clothing.

Head Quarter U. S. A. & T. L.  
& the Sub Dist Louisiana  
Monroe, La. July 6<sup>th</sup> 1867  
Respectfully returned to  
M. J. Johnson - there is  
no place provided for

old and crippled Freedmen  
that I knew of, except  
for those requiring medical  
treatment, who may be  
sent to the Hospital in  
New Orleans, by sending  
their names and giving  
a statement of their cases.

Rations & clothing will be  
furnished from Headquarters upon  
proper application, for those  
who are not able to  
provide for themselves.

J. C. Speer Capt.  
Sub Dist Comm  
& the Sub Dist. La

M. J. Johnson July 10<sup>th</sup> 1867



Office A. G. O., B. R. F. A. S.  
Catahoula Parish, La

July 1<sup>st</sup> 1867.

Samuel C. Gold, Capt U. S. A.  
Sub Asst Commissioner,  
5<sup>th</sup> Sub Dis, Dis, Louisiana,  
Monroe, La.

Sir

there are quite  
a number of very old infirm and crippled  
"freedmen" in this Parish, that cannot work,  
and have no one to depend upon, or any way  
to make a support. Some of them are  
without homes, and clothing.

Has the Bureau made any provision  
for them.

Respectfully Your Obedt Servt,  
M. Johnston Lemmon,  
A. G. O., B. R. F. A. S.  
Catahoula Parish,  
Louisiana,



New Orleans La  
July 17, 1867.

July 17<sup>th</sup> / 67

Commissioner A. S. T.

Instructions as to  
supplying teachers and  
the payment of salaries.



HEADQUARTERS,  
Bureau of Refugees, Freedmen and Abandoned Lands,  
STATE OF LOUISIANA.

(154 JULIA STREET.)

Office General Superintendent of Education.

# 160

New Orleans, La., July 17<sup>th</sup> 1867.

Mr M. J. Lemmon  
Apt Sub Apt Comm  
Parish Catahoula La

In reply to yours of July 8<sup>th</sup> I have  
the honor to state, that teachers will be supplied  
from this Office, upon the requisition of  
Apt Sub Apt Comm, stating what sex, color,  
and about what salaries can be paid them.  
Also what conveniences for board can be had.

The salaries of teachers will have to  
be paid by the Freedmen themselves either  
by tuition or 5% tax

Very Respectfully

M. Parker

2<sup>nd</sup> Lt. 1<sup>st</sup> Regt. U.S.A.

Act Gen Supt. of Edch.



New Orleans La.  
July 18<sup>th</sup> 1867

July 18<sup>th</sup> / 67

Commencement Aft.

In regard to making  
reports.



HEADQUARTERS,  
Bureau of Refugees, Freedmen and Abandoned Lands,  
STATE OF LOUISIANA.  
(154 JULIA STREET.)

Office General Superintendent of Education.

#163

New Orleans, La. July 18<sup>th</sup> 1867.

Mr Johnston Linnon  
Apt Supt. Apt Comm  
Parish Catahoula

Sir

Your Official duties in regard to Schools and School Reports, are to make a Monthly Report of Schools Receipt and Expenditures at the end of each month

This report will give the location and name of the teacher in each school, number of pupils in each according to blanks headed as above. You will furnish teachers with blanks for their reports, which will be consolidated by you on the District Supt's Report, and forwarded as soon as possible after the 15<sup>th</sup> of each month. Should you fail to receive the Reports from teachers you will send as  
(over)



correct a report as you can from your  
own information of each school.

Very Respectfully

L. O. Parker

2<sup>nd</sup> Lieut 1<sup>st</sup> Regt. U. S. A.  
Act. Gen Supt Edot.



L. 113 Bu. R. F. A. L. La. - 67

Headquarters Bu. R. F. A. L. La.  
5th Sub Dist of Louisiana

Monroe, La. Aug 20/67

Respectfully referred to  
M. Johnson Linnon as the  
whose attention is called to  
endorsement of Pt. Mag. Gen.  
J. at Monroe asst Comr  
David C. Gold Capt 9th

Sub Dist Comr  
5th Sub Dist La

L. 113 Bu. R. F. A. L. La. - 67

L. 113 Bu. R. F. A. L. La. - 67

Office A. C. Bureau R. F. A. L.  
Catahoula Parish. La.

Aug 1st 1867.

M. Johnson Linnon.  
A. C. Bureau & C.

There are a great many old  
crippled, deformed and blind  
free men in this Parish unable  
to make a support. Some  
of them need clothing and  
medical attention & some of  
them have no home or  
place to stay. Want in-  
structions -

Headquarters Bu. R. F. A. L.  
5th Sub Dist Louisiana

Monroe La Aug 10/1867

Respectfully forwarded  
to Pt. Mag. Gen. J. at Monroe  
Asst Comr.

David C. Gold Capt 9th  
Sub Dist Comr 5th Sub Dist

L. 113 Bu. R. F. A. L. La. - 67

L. 113 Bu. R. F. A. L. La. - 67

Headquarters Bu. R. F. A. L.  
State of Louisiana,

New Orleans Aug 14 1867.

Respectfully returned to Mr.  
M. Johnson Linnon as the  
Capt. St. Gold Sac. In all  
cases where freed people are  
sick, helpless and destitute  
and in consequence will be  
unable to be supported by the  
Government, an application  
should be made for transpor-  
tation to the Insane Hospital  
in this City. In the mean-  
time rations - if there are any  
may be issued to such cases.

By order of  
Abel J. D. J. Messer  
S. Parker  
3/40 2nd Lieut. U.S.A.  
aaadund



Office Apt Sub Apt Comr.  
Bureau R. F. Am A. Lands,  
Catahoula Parish. La.,  
Aug 1<sup>st</sup> 1867.

L. O. Parker. Lt 1<sup>st</sup> U.S. Infly  
A. A. A. Genl Bureau R. F. A. L.  
New Orleans, La.

Sir

There are a great many old, crippled,  
deformed and blind freedmen, in this  
Parish who are not able to make a sup-  
-port under any circumstances whatever.

Some of them need medical attention  
and clothing very bad. They come to  
me nearly naked and I furnished them  
such as I could get for them at  
my own expense. Some of them  
have been thrown out of a home and  
have no place to stay.

Will you please instruct me what  
course to pursue with them.

Respectfully Your Obedt Servt,

M. Johnston Lemmon,



Monroe La  
Aug. 13. 1867

Gold. Saml. C

Will send 18 lbs. as soon  
as he receives a supply

Aug 13<sup>th</sup> / 67



H. 25  
Paul Quarter On R.F. & A.C.  
5th Sub Dist of Louisiana  
Monroe, La, August 15. 1867

W. Johnson Sumner  
At. J. A. Combs On R.F. & A.C.  
Oran Landing, La.

Sir,

I have the honor to  
state in reply to your letter of 11th inst, that I have  
made requisition for a supply of blanks, and  
shall send you same as soon as received. —

I am at present entirely out of blanks.

Very Respectfully  
Your obt. servt.  
Wm. C. Gold Capt. U.S.A.  
Sub Asst Commr  
5th Sub Dist. La.







#1074

HEADQUARTERS,  
Bureau of Refugees, Freedmen and Abandoned Lands,  
DISTRICT OF LOUISIANA.  
No. 154 JULIA STREET.

New Orleans, La., August 16<sup>th</sup> 1867

Wm. M. Johnston Lummon

S. S. S. C. Du. R. F. and A. L.

Parish, Catahoula La.

Mrs. Capt. C. G. M. M.

Sir;

In reply to that portion of your Tri-monthly Report of the 10<sup>th</sup> inst., reporting a desire of quite a number of planters to discharge a part or all of the freedmen, I am directed by the Asst. Comr. to say, that in all cases where planters discharge freedmen employed under contract approved by this Bureau, if you are satisfied that the planter cannot pay the men for labor performed, there can be no objection made to their discharge, but, that it is your duty in such cases to see that the freedmen are paid for services rendered to date of discharge, or, in case the employer is unable to pay, that a sufficient amount of the crops or other property is taken possession of to satisfy their claims. Whenever a seizure is made the parties interested will at once be notified of the fact and a full



report forwarded to these Headquarters.

This information is intended  
for your guidance, and is not to be made  
public.

Very Respectfully

Your Obedt. Servt.

L. O. Parker

2<sup>d</sup> Lieut. 1<sup>st</sup> U. S. Infy

A. A. S. G.



T 143. (Bu. R. F. & A. L. La.) 1867

S. R. 56-Office A. S. A. C. St. Mary La. 1867  
Parish of Catahoula La

29  
August 17th 1867

B-416-3<sup>d</sup> subdistrict of La-1867

Wrapper

Thompson Sarah

Petition of

Represents that she lived her son Albert, to one A. H. Howard, to remain with him so long as she was satisfied with his treatment of the boy & paid his wages promptly.

That Howard has taken her son away from that part of the State, and has not paid her a cent of wages for her services, up to date. Thinks he intends to defraud her & her son &c. She is informed that Howard is located at Donaldsonville and requests that Bureau Agent collect the pay due her \$5.00 a month from last November, from Howard, also amount of his passage to Waterproof La. and that her son be sent to that place, care of J. A. Seddon Esq. Etc.

Prairie Landing

Wrapper-(... Enclosures.)

A. D. ?

T 143. (Bu. R. F. & A. L. La.) 1867

HEADQUARTERS  
BUREAU REFUGEES, FREEDMEN AND ABANDONED LANDS,  
STATE OF LOUISIANA.

New Orleans, August 27 1867

Respectfully referred to  
S. R. Capt. J. Brough A. S. C.  
(by Capt. M. W. Tyler S. A. C.)  
who will, - if the within  
statement is correct - is cor-  
rect - collect from Mr. A. H.  
Howard the amount due  
Mrs. Sarah Thompson for  
services of her son Albert  
and also a sufficient a-  
mount to pay his passage  
to the place within men-  
tioned. The money col-  
lected for services rendered,  
and the boy will be sent as  
requested.

By order of  
S. R. Maj. Genl. J. A. Howard  
E. O. Parker  
3/1027 adju. child. Insty  
adju. Insty

20 Bu R F & A L La 1867

Office A. S. A. C. B. R. F. & A. L. La.  
Parishes of James & Ascension  
Donaldsonville La. Aug. 29 1867

Respectfully referred back to  
St. L. O. Parker A. S. A. C. B. R. F. & A. L. La.  
(through Capt. M. W. Tyler S. A. C.)  
with the information that the  
within named party, A. H. Howard  
did reside in the vicinity of this  
place, but has lately removed  
from the place, and as far as I  
can ascertain, has gone to  
Franklin in St. Mary Parish  
La.

E. O. Parker  
St. Capt. J. Brough  
A. S. C.

RECEIVED  
BUREAU OF REFUGEES, FREEDMEN AND ABANDONED LANDS  
NEW ORLEANS, LA.



T. 143 (Bu. R. F. & A. L. La.).....1867

S. R. 56-Office A. S. A. C. St. Mary-La---1867  
Parish of Catahoula La

29  
August 17<sup>th</sup> 1867

B-46-3<sup>d</sup> subdistrict of Sa- 1867

Wrapper

Thompson Sarah

Petition of

Represents that she lived her son Albert, to one A. W. Howard, to remain with him so long as she was satisfied with his treatment of the boy & paid his wages promptly.

That Howard has taken her son away from that part of the State, and has not paid her a cent of wages for his services, up to date. Thinks he intends to defraud her & her son &c. She is informed that Howard is located at Donaldsonville and requests that Bureau Agent collect the pay due her, \$5.00 a month from last November, from Howard, also amount of his passage to Waterproof La, and that her son be sent to that place, care of J. A. Seddon Esq. Etc.

Prairie Landing  
Wrapper-(... Enclosures.)

A. W. ?

T. 143 (Bu. R. F. & A. L. La.).....1867

HEADQUARTERS  
BUREAU REFUGEES, FREEDMEN AND ABANDONED LANDS,  
STATE OF LOUISIANA.

New Orleans, August 22, 1867

Respectfully referred to  
Mr Capt. H. Brown (A. S. C.)  
and Capt. M. W. Tyler (A. S. C.)  
who will, if the within  
statement is correct, collect  
from Mr A. W. Howard the amount due  
Mrs Sarah Thompson for  
services of her son Albert  
and also a sufficient amount  
to pay his passage to the place  
mentioned. The money collected  
for services rendered, and the  
boy will be sent as requested.

By order of  
Wm. A. R. G. J. A. M. H. W. S. R.  
M. Parker  
3/1027 and 1/11, 1867  
admission

B 46-

Rec'd, Bureau R. F. & A. L. La.  
at Sub. Dist - Dist of Sa  
New Orleans, Aug 22, 1867

Respectfully transmitted -  
E. J. S. 81 & B. 20

H. W. Tyler  
Captain, U. S. A.  
Sub-assistant Com.

Rec'd back, at 10<sup>o</sup> Sept 27/67  
Rec'd off. of ac. of R. F. & A. L. La. 7/27-67  
Rec'd, at 10<sup>o</sup> Aug 22, 1867



B 46-3<sup>d</sup> published of Dec. 1864

1864

Dec 1864  
B. 46-3



143 (Bu. R. F. & A. L. La.) 1867

B46-3<sup>d</sup> Sub District of La - 1867

New Orleans, La

September 14<sup>th</sup> 1867

Wrapper

Bureau R. Fraud A. L. La  
per Lieut. S. C. Parker  
A. A. A. General

Refers to Lieut. J. W. Keller

A. S. A. C. a letter of Sarah  
Thompson (Wife of Trinity, Parish of  
Catahoula, stating that Nov 3<sup>d</sup> 1866,  
her legs, Albert Thompson was hired  
to Mr. A. W. Howard - that she was to  
receive the sum of Five Dollars monthly  
for his services, and that Mr Howard  
removed from the Parish and has  
never paid her anything

Directs that the amount  
due this woman from Nov 3<sup>d</sup> 1866, be col-  
lected and a draft sent her, to the  
care of J. A. Seddon, Waterproof La; also,  
that a sufficient additional amount  
be collected, to pay her own passage to  
that place, per steamer "Grey Eagle", or  
"National" Three Enclosures

Wrapper - (T. Enclosures.)

ac

Recd 3<sup>d</sup> Sub District of La Sept 19<sup>th</sup> 1867

143 (Bu. R. F. & A. L. La.) 1867

HEADQUARTERS  
BUREAU REFUGEES, FREEDMEN AND ABANDONED LANDS,  
STATE OF LOUISIANA.

New Orleans, September 4<sup>th</sup> 1867

Respectfully referred to Lieut

J. W. Keller, A. S. A. Comdr.

Trav. An. in; S. W. Purser A. A. C.

who will comply with the instruc-  
tions contained in endorsement

from these Headquarters, on the  
enclosed paper, dated Aug 22<sup>nd</sup>

By order of

Sot. Maj. Genl. J. A. Mower U. S. A.

E. S. L. O. Parker  
3125.

2<sup>nd</sup> Lieut. 1<sup>st</sup> U. S. Infy.  
A. A. A. Genl.

Headquarters Bureau R. Fraud A. L. La  
3<sup>d</sup> Sub District of Louisiana  
Franklin La. Sept, 9<sup>th</sup> 1867

Respectfully transmitted

E. B. Tol 42  
J. W. Purchas

Capt. G. R. C. Brevet Major 26<sup>th</sup> Regt.  
Sub. Assistant Commissioner

S. D. St. Office A. S. A. C. St. Mary La - 1867

Office Ad. S. G. Bur. R. F. & A. L. La.  
Parish St. Mary Louisiana  
Franklin Nov 1<sup>st</sup> 1867.

Respectfully returned to Lieut. J. M.  
Lee, 39<sup>th</sup> U. S. Infy. A. S. A. Comdr. Bur.  
R. F. & A. L. with the information, that  
the within named A. W. Howard does  
not reside in this town, neither in this  
Parish.

Mr. W. B. Person Parish Assessor  
says, that he met a Mr. Howard in  
Orleans City in July or August, and  
that said Howard took there a steamer  
bound for Galveston. Person des-  
cribes him as a tall man of middle  
age; he did not know his given name  
neither whence he came.

J. W. Keller  
1<sup>st</sup> Lieut. 42<sup>nd</sup> U. S. Infy &  
Apt. Sub. Apt. Commissioner

Three Enclosures  
Headst. Bureau R. F. & A. L. La.  
3<sup>d</sup> Sub Dist of Louisiana  
Franklin La Nov 1<sup>st</sup> 67.

Respectfully forwarded.  
E. B. Tol 59  
J. W. Purchas  
Capt. V. R. C. and Brevet Major  
Sub. Asst. Commissioner.

Recd back 3<sup>d</sup> Sub Dist of La Nov 1<sup>st</sup> 1867  
Recd Office A. S. A. C. St. Mary La Sept 9<sup>th</sup> 1867.



(Bu. R. F. & A. L. La.)-----186

*T. 143.* (Bu. R. F. & A. L., La.) 1867

HEADQUARTERS  
BUREAU REFUGEES, FREEDMEN AND ABANDONED LANDS,  
STATE OF LOUISIANA.

New Orleans, November 7<sup>th</sup> 1867

Respectfully referred to Mr. M. J. Summon, A. S. A. C. (Thos. Capt. S. C. Gold, S. A. C.) who will cause the enclosed papers to be delivered to the petitioner, calling her attention to the foregoing endorsements.

By order of  
Brig. Maj. Genl. J. A. Mower, U.S.A.  
E. P.  
3/22/67 *J. M. Lee*  
1st Lieut 39<sup>th</sup> U.S. Infy.  
A. A. A. Genl.

*Recd at Hdqrs 5 Sub Dist Nov 15/67*

*T. 1. Bu R F & A L - La - '67*

Headquarters Bureau R. F. & A. L.  
of the Sub Dist of Louisiana  
Monroe, La, November 15. 1867

Respectfully referred to Mr. M. J. Summon, A. S. A. C. whose attention is called to endorsement of Brig. Maj. Genl. J. A. Mower Chief Commr

*S. C. Gold*  
Capt U.S.A. Sub Chief Commr  
of the Sub Dist of La.

Wrapper—(4 Enclosures.)



The State of Louisiana  
Parish of Catahoula  
To Major Genl Joseph C. Moore  
Bureau of A. S. & S.  
for State of Louisiana.

General, The petition of the undersigned a Freedwoman of the aforesaid Parish & State respectfully represents  
First. Your petitioner is about forty years of age, quadroon, a resident of this Parish for the past sixteen years, principally in the town of Trinity, and is now and has been for the past twelve months in such bad state of health as to be incapacitated for hard work.

Second. Petitioner has a son named Albert Thompson about fourteen years of age whom she hired out to a white man named A. W. Howard. as will more fully appear by the following copies of said Howard's proposition, now in my possession.  
"Copy." Trinity La Nov 3<sup>rd</sup> 1866  
Sarah Thompson F. W. C.

I will give you five dollars per month for Albert's services besides feeding & clothing him, if this satisfies you  
over-



I will take him to Haramburg with  
me for one year answer and let  
me know (Signed) A.W. Howard.

I refused to accept this offer as I did  
not want to have my son bound for a year,  
but agreed that Mr Howard should take  
him as long as I was satisfied with  
his treatment of my child, and his clothing  
&c. was satisfactory, and his wages paid to  
me promptly, as appears by the following  
obligation to wit copy:

(2) Trinity La Nov 3 1866.

I do hereby agree to pay Sicut Thompson  
the sum of five dollars on the  
third day of each month as  
long as said Sicut Thompson's  
son Albert remains in my  
service from this date,

Signed A.W. Howard.

Soon after getting my child in his  
possession, Mr Howard left this  
Parish taking my son with him and  
has never paid me one cent for  
the service of my son and has carried  
him off without my knowledge or  
consent and I believe is keeping him  
away from me for the purpose of getting  
the service of my child without paying

him or me, and thus depriving me of my  
fast rights and working a serious injury  
to my son as I presume he is not  
allowed any advantages of education,  
and is away from the proper control and  
supervision which none can exercise over  
a child, like a mother.

Petitioner has been informed that said  
Howard is now, or was recently, located at  
Donalds Mills in the State, and petitioner  
most respectfully prays that the amount  
due him to wit, Five Dollars per month  
from Nov 3<sup>rd</sup> 1866 to date of payment,  
be collected by the proper officer of  
the Treasury Bureau from said Howard  
and sent to him in a draft or check on a  
New Orleans Bank, that said son Albert  
Thompson be sent on steamer "Grey Eagle"  
or "National" to Care of J. A. Seddon Esq  
at Waterproof La, to whom care may also  
be sent the child's wages, and that said Howard  
be condemned to pay all costs of collecting and  
sending my son and his earnings to me,

As in duty bound with you pray.

Witness  
Sicut Thompson  
W. E. Brewer  
J. P. Bourgeois  
Personally appeared before  
the undersigned Clerk of the Parish Sicut



Thompson S. W. C. together with the  
 subscribing witnesses to wit Wm E. Driver  
 and S. D. Downen they being witnesses  
 of lawful age and domicil and signed  
 the foregoing petition in my presence  
 and the said Sarah Thompson S. W. C.  
 also produced to me the two original  
 papers signed "A. W. Howard" copies  
 of which are embodied in the foregoing  
 petition, and the said Sarah Thompson  
 further made oath that the statements  
 and allegations in the petition aforesaid  
 are correct and true.

279 278

Thompson  
 Sarah  
 Downen  
 Driver  
 7/16/67  
 Bue - paper made by Co -

In testimony whereof I have hereunto  
 affixed my signature and seal Official  
 in this Parish of Calcasieu State of  
 Louisiana this seventeenth day of  
 August A.D. 1867. John S. Downen  
 J. P. Not Pub.



Handwritten flourish or scribble.



Aug 21<sup>st</sup> 1867

Monroe La.

Aug. 21<sup>st</sup> 1867

Circular Letter.



Head Quarters R. I. & A. L.  
5<sup>th</sup> Sub Dist. of Louisiana  
Monroe, La, August 21<sup>st</sup> 1867.

Circular Letter.

The attention of each Sub  
Asst Commissioner is called to the informal  
manner in which they have hitherto forwarded  
Reports and Official Communications to Head  
Quarters Bureau R. I. & A. L. New Orleans.

Hereafter all Reports and Official  
Communications will be addressed to the  
A. A. A. General Bureau R. I. & A. L. at  
Head Quarters New Orleans, and send  
through this Office as hitherto.

Particular attention will be paid  
to the orders and circulars in making  
all Reports.

Saml C. Good Capt U.S.A.  
Sub Asst Commr  
5<sup>th</sup> Sub District, La

Mr. H. J. Sumner  
A. S. A. Commr



L. 1214 Bu R. F. & A. L., La. 47

Office Bureau Refugees  
Parish of Catahoula, La.  
Aug. 21. 1867.

Leamon M. J. A. S. A. Com  
Parish of Catahoula, La.

Transmits letters from C. A. Hooper  
& H. L. Ditts, the latter in behalf of his step  
father, C. R. Nuttall, in relation to freed-  
men employed by them & asking permission  
to discharge them, as they are unable to feed  
& pay them longer, on account of their crop  
being entirely destroyed by the worms.

He has many applications like the above &  
most of the planters will have to discharge all  
or part of their laborers. States that Mr.  
Charles Jones, & others, responsible & good men,  
have offered to take the freedmen whose are  
discharged, give them good quarters, fuel,  
quarters, clothing shoes, rations &c., if he,  
(Leamon) will get them together; the  
men to work on the levees in the Parish, and  
the women to gather what little crop is left.  
These gentlemen are urging the Police Jury  
to lay a tax on the land holders to remuner-  
ate freedmen for their labor, and thinks  
they will succeed etc. Asks instructions.

(2 Enclosures)

L. 1214 (Bu. R. F. & A. L., La.) 1867

HEADQUARTERS  
BUREAU REFUGEES, FREEDMEN AND ABANDONED LANDS,  
STATE OF LOUISIANA.

New Orleans, August 26. 1867.

Respectfully returned to Mr  
M. Leamon A. S. A. (through  
Capt S. B. Gold S. A.) If the  
within named parties are un-  
able to pay their laborers, no  
objection will be made to their  
discharging them, provided they  
are paid to the date of dis-  
charge. Every effort will how-  
ever be made, to keep the  
freedpeople employed as much  
of the time as possible in order  
to prevent their becoming an  
expense to the Government.

By order of  
Col. May Genl J. M. Moore.  
E. S. Parker  
3107 7<sup>th</sup> St. 1<sup>st</sup> U. S. Dist.  
Acty Asst Adjt Genl

L. 1214 Bu R. F. & A. L., La. 47  
Headquarters Bu R. F. & A. L.  
5<sup>th</sup> Sub Dist Louisiana  
Monroe La Aug 31. 1867

Respectfully forwarded  
to Mr M. J. Leamon  
A. S. A. C. whose attention  
is called to endorsement  
of Col May Genl J. M.  
Moore Acty Asst Genl

Samuel C. Gold  
Capt V. R. C. Sub Dist Court  
5 Sub Dist La

Headquarters Bu R. F. & A. L.  
5<sup>th</sup> Sub Dist La  
Aug 31. 1867



Officer Apt Sub Apt Comdr.  
Bureau R. F. & A. L.  
Catahoula Parish, La.  
Augt 21<sup>st</sup> 1867.

M<sup>r</sup> H. Sterling, Capt 1<sup>st</sup> U. S. Infy.  
A. A. A. Genl. Bureau R. F. & A. L.  
New Orleans, La.

Sir

I have the honor to transmit you herewith letters from Mr C. A. Keoper, and Mr W. L. Wills, in behalf of his Step Father Mr D. L. Nuttall;

Dr Nuttall is a gentleman of integrity and viracity and any statement he makes can be fully relied upon. I have seen and conversed with Mr Keoper and I find he is in a very critical position. The worms has entirely destroyed his crop and his merchant has refused to advance him further supplies, and he cannot possibly, feed his friends people much longer. I have had a great many -



applications within the last few days, from planters, asking permission to discharge a part or all of their freedpeople, as their crops are destroyed and their merchants has refused to advance them further supplies. But I have deferred the matter for advice and instructions.

The most of the freedmen in this Parish are working for a part of the crop, and as the worms has destroyed (with a few exceptions) both Cotton and Corn, and they see they are not going to make anything, they are becoming very much dissatisfied, careless & indifferent about their ~~work~~ and almost unmanageable.

Circumstances will compel the most of the planters to discharge a part or all of the freedmen in their employ, and there is no work for them to do here whereby they can possibly make a support.

The following Gentlemen Mr Chas. Jones Mr Reddick, Mr Liddell, Mr Spencer, Mr Cotton, Mr Boatman, Mr Wootan and others, men of intelligence, variety and responsibility, has made me the following proposition. They agree to furnish the -

freedmen that will necessarily have to be discharged by their present employers with good and comfortable quarters, fuel, clothing, shoes and rations if I will gather them together and let the women gather what little crop there is left and let the men work upon the levees,

Thus some Gentlemen are urging the Police Jurors of the Parish to levy a tax on the land holders (some of them offering to give \$3 per acre on their land) for the purpose of remunerating the freedmen for their labor, and I think they will succeed in their enterprise.

This is the only Parish in the state that can be levied successfully, independent of the Mississippi levee; The old levee survey shows it only requires about fifty miles of levee on an average of four feet high and nearly two thirds of that distance is now levied and ~~only~~ wants a little repairing, to put it in good order to withstand the floods of the present year.

Respectly Your Obedt Servt  
W. Johnston Lemmon.



N. 29<sup>th</sup> Bn P. I. & S. L. Ia. (67)  
Headquarters Bn P. I. & S. L.  
State of Louisiana  
New Orleans Aug 22/1867

27  
Major B. H. May Genl J. A.  
Asst. Commr

State, that tri-monthly  
Report for Aug 10<sup>th</sup> 67  
has not been received.  
directs that it be forwarded  
immediately and state how  
the delay has occurred.

Headquarters Bureau P. I. & S. L.  
5<sup>th</sup> Sub Dist of Louisiana  
Monroe La Aug 27. 1867

Respectfully forwarded  
to Mr W. J. Sumner  
A. S. Commr who will  
make Report in accordance  
with the instructions of the  
Bureau.

with enclosed Circular,  
and forward the same  
through this Office without  
delay. The Books of the  
this Office show that your  
Report called for within  
was forwarded from this  
Office August 10/67. but  
I suppose has not reached  
Headquarters. -

Samuel C. Gold Capt P. I.  
Sub Asst Commr  
5<sup>th</sup> Sub Dist. Ia.



HEADQUARTERS,  
Bureau of Refugees, Freedmen and Abandoned Lands,  
STATE OF LOUISIANA.

New Orleans, Aug 25<sup>th</sup> 1866

Mr. W. G. Lemon  
Agent, Sec. Subdist. District,  
Prairie La. Black River, La.

Sir: Give Capt J. C. Cox further Comd

The Assistant Commissioner of this Bureau.

for this State, desires me to call your attention to the fact, that  
your Three Monthly Report for the  
last days ending Aug 10<sup>th</sup> 1866, as called for by Circular  
No. 36 of Dec 30<sup>th</sup> 1865, from these  
Headquarters, has not been received. You will please forward  
this report immediately, and state how this delay  
has occurred.

Very respectfully,

Your obedient servant,

D. Parker

Captain and Assistant Adjutant General.

2<sup>nd</sup> Lieut 1<sup>st</sup> Regt. Inf.  
Acty Asst Adj't Genl.



HEADQUARTERS,  
Bureau of Refugees, Freedmen and Abandoned Lands,  
STATE OF LOUISIANA.

New Orleans, Aug 25<sup>th</sup> 1866

Mr. W. G. Lemmon  
Agent, Sec., District,  
Prairie La. Black River La.

Sir: Your letter of the 10<sup>th</sup> inst. is received.

The Assistant Commissioner of this Bureau for this State, desires me to call your attention to the fact, that your Three Monthly Report for the ten days ending Aug 10<sup>th</sup> 1866, as called for by Circular No. 36, of Dec. 30<sup>th</sup> 1865, from these Headquarters, has not been received. You will please forward this report immediately, and state how this delay has occurred.

Very respectfully,

Your obedient servant,

L. O. Parker

Captain and Assistant Adjutant General.

2<sup>d</sup> Lieut 1<sup>st</sup> Regt. Inf.  
Acty Asst Adj't Genl.



Aug 15 / 67

Head Quarters Bn R F 5th  
District of Louisiana  
New Orleans La Aug 25/67.

Major B. May Gulf of  
Asak Louis

Letter to Mr J. Sumner  
et. J. et. C. stating that Capt  
M. B. Armstrong et. J. et. C.  
has been directed to ship  
in care of Clinton & Hookland  
at Trinity 25 Bbl shell  
and 5 Bbls Pork

Head Quarters Bn R F 5th  
5th Sub Dist Louisiana  
Monroe La Aug 20/67  
Respectfully ordered to Mr  
J. Sumner et. J. et. C.

Saml C. Gold Capt 7th  
Sub Asak Louis  
5th Sub Dist La

The Adjutant General's Office New Orleans La Aug 20. 1867



#1072

HEADQUARTERS,  
Bureau of Refugees, Freedmen and Abandoned Lands,  
DISTRICT OF LOUISIANA.  
No. 154 JULIA STREET.

New Orleans, La., August 15<sup>th</sup> 1867

Mr. M. J. Simon  
U. S. A. C. Du R. F. and S. S.  
Parish of Catahoula, La.  
Through Capt S. C. Gold S. A. C.

Sir

I am directed by Sgt Maj Guil J. A. Mower  
to inform you that Capt W. S. Armstrong S. C. A. C.  
has been directed to ship to you, in care of Steuker  
and Rockland at Trinity, La. 25 Bbls Meal and  
5 Bbls Pork.

You will make returns on blank sent,  
and return same to Capt Armstrong, making the  
usual report to this office at the end of each  
month of the number of persons to whom  
rations have been issued &c

Very Respectfully  
Your Obedient Servant  
W. Parker

2<sup>d</sup> Lieut 1<sup>st</sup> U. S. Infantry  
Actg Asst Adjt General



Monroe La.  
Aug 27<sup>th</sup> 1867

Aug 27<sup>th</sup> 1867

Circular Letters.



Headquarters Bureau R. F. & A. S.  
5th Sub District of Louisiana  
Monroe La August 27. 1867

Circular Letter.

The attention of Asst Sub Asst  
Commissioners is called to the indifferent manner  
in which the Tri Monthly Reports are made;  
also to the fact, that there is in many instances  
an unnecessary delay in forwarding them.

Hereafter the following subjects, as well as  
all others worthy of mention, will be reported  
upon in full.

Whether or not the Freedmen are working  
well and are well treated by their employers.

Their moral condition

General condition of Schools and whether  
the Freed people take much interest in them.

General condition of all Plantations,  
stating condition of the Crops, and mentioning  
the kind being raised.

State of feeling existing between Whites  
and Blacks, and during the prevalence of  
yellow fever or any other disease of an  
epidemic character, the number of cases  
as near as possible will be given.

am



with such other information as may be of interest  
to the Bureau.

The Assistant Commissioner is constantly  
calling my attention to the manner in which  
these Reports have hitherto been made.

In future a strict compliance with this  
Circular will be required.

Samuel C. Gold. Capt IRL  
Sub Asst Commr  
5th Sub Dist. La.

Mr. W. J. Johnson  
Asst. Commr.



Monroe La  
Aug. 27, 1867.

Circular Letter

Aug 27" 1867



Headquarters Bureau R. I. & A.  
5th Sub Dist of Louisiana  
Monroe, La, Aug 27. 1867

Circular Letter.

In compliance with instructions  
from Headquarters Bureau R. I. & A. New  
Orleans La, dated August 22. 1867, I have  
the honor to request you to forward me  
without delay, your appointment as Agent  
Bureau R. I. & A. to enable me to make  
a Report of the same to Headquarters,  
after which it will be returned.

Saml. C. Gold Capt. U.S. A.  
Sub Post Commr  
5th Sub Dist. La

Mr. W. Johnson  
St. Louis



No. 37. Bu R.F. & N. L. - La - 67  
Head Quarters Bureau R.F. & N. L.  
State of Louisiana  
New Orleans La Aug 30. 1867.

Sept 6  
Major Bot. Maj. Genl. J. T.  
Chief Commissioner

States that the Tri Monthly  
Report for Aug 30. 1867.  
has not been received, directs  
that it be forwarded imme-  
diately, and state how the  
delay occurred.

No. 38. Bu R.F. & N. L. - La - 67

Headquarters Bureau R.F. & N. L.  
5th Sub Dist of Louisiana  
Monroe, La, Sept 6. 1867

Respectfully forwarded  
to Mr. M. J. Simmons  
Chief Sub Dist Court

Sam. A. Gold  
Capt. V. R. C. Sub Dist Court  
5th Sub Dist. La

Recd at Monroe 5 Sub Dist La Sep 6/67.



HEADQUARTERS,  
Bureau of Refugees, Freedmen and Abandoned Lands,  
STATE OF LOUISIANA.

New Orleans, August 30<sup>th</sup> 1867.

Mr. M. J. Lemmon

Asst. Sub. Asst. Commr.  
Agent, Co., District,

Prairie Landg. Bk. No. 1a.

Sir: Through Capt. S. C. Gold. Sub Asst Commr.

The Assistant Commissioner of this Bureau,  
for this State, desires me to call your attention to the fact, that  
your Tri Monthly Report for the  
ten days ending Aug 20<sup>th</sup> 1867, as called for by Circular  
No. 36, of December 30<sup>th</sup> 1865, from these  
Headquarters, has not been received. You will please forward  
this report immediately, and state how this delay  
has occurred.

Very respectfully,

Your obedient servant,

L. O. Parker

~~Captain and Assistant Adjutant General~~

2<sup>nd</sup> Lieut 1<sup>st</sup> U. S. Infy  
A. A. A. Genl.



Monroe La.  
Aug 31 1867

Aug 21<sup>st</sup> 1867

Circular Letter.



Headquarters Bureau P. F. & A. L.  
5<sup>th</sup> Sub District of Louisiana  
Monroe, La. August 31<sup>st</sup> 1867.

Circular Letter

The Assistant Commissioner having received instruction, from Headquarters of the Bureau, to suspend the issue of supplies, under the Act of Congress, approved March 1866, on and after August 30<sup>th</sup> 1867. no more supplies will at present be issued.

He has however requested that this State be excepted. Any rations that the Agents of the Bureau may have on hand will be issued to those only, whose condition is such, that they require immediate relief

Saml A. Gold

Capt. U.S.A. Sub Dist Commr  
5<sup>th</sup> Sub Dist. of Louisiana

Mr. Wm. Johnson Sumner  
A. J. C. Commr



N. 42 Bull F & O. La. 67  
Headquarters Bureau R. F. & O.  
State of Louisiana  
New Orleans Sept 6/1867

Major Benjamin Paul J. A.  
Asst Commissioner

States that the Bi-Monthly  
Report for Aug 31, 1867, has  
not been received - Pricts, that  
it be forwarded immediately,  
and state where the delay  
occurred.

N. 42 Bull F & O. La. 67

Headquarters Bureau R. F. & O.  
5th Sub Dist of Louisiana  
Monroe, La, Sept 6/1867

Respectfully forwarded to  
Mr W. J. Sumner A. S. C. C.  
who will make report in  
accordance with enclosed  
circular, and forward the same  
through this Office without  
delay.

Paul C. Gold  
Capt F. R. C. Sub Asst Comm  
5th Sub District La

Recd at Monroe 5 Sub Dist La, Sept 16/67



HEADQUARTERS,  
Bureau of Refugees, Freedmen and Abandoned Lands,  
STATE OF LOUISIANA.

New Orleans, September 6<sup>th</sup> 1867.

Mr. M. J. Remmon

Apt. Sub. Apt. Comis.  
~~Agent, &c.,~~ District,

Prairie Landg. Catahoula La.

(Fire Capt. S. C. Tolle S. A. C.)

Sir:

The Assistant Commissioner of this Bureau, for this State, desires me to call your attention to the fact, that your Tri Monthly Report for the ten days ending August 31<sup>st</sup> 1867, as called for by Circular No. 36, of December 30, 1865, from these Headquarters, has not been received. You will please forward this report immediately, and state how this delay has occurred.

Very respectfully,

Your obedient servant,

L. O. Parker

~~Captain and Assistant Adjutant General.~~

2<sup>nd</sup> Lieut. 1<sup>st</sup> U. S. Infy.  
A. A. A. Genl.



Merrill L  
Sept 7, 1867

Sept 7<sup>th</sup> 1867

Circular Letter



Head Quarters Bureau P. I. & M.  
5<sup>th</sup> Sub District of Louisiana  
Monroe, La., September 7<sup>th</sup> 1867.

Circular Letter.

Assistant Sub Assistant Commissioners  
will without delay forward to this Office  
a report of the number of Government Horses  
now in their possession.

Any Agent of this Bureau having  
two horses, will at once turn one of them  
over to Mr W B Armstrong - Quartermaster  
Agent for this Bureau, who will furnish  
transportation for the same.

Saml. C. Gold

Capt U.S.A. Sub Asst Commr  
5<sup>th</sup> Sub District La.

Mr W. J. Lemmon  
U.S.A. Commr



L 139 Bu K. Ad La - 67

Office Bureau R. F. & A. H.  
Catahoula Parish, La.  
Sept 15<sup>th</sup> 1867.

Sumner W. J. A. S. H. C.  
Catahoula Parish, La.

Transmits names and other  
information, respecting freed  
people, who require removal to  
freedmens Hospital, N. O.

S. L. S. # 1166. Sept 21<sup>st</sup> 67.

L 139 Bu K. Ad La - 67

Headqrs. Bureau R. F. & A. H.  
State of Louisiana  
New Orleans Sep 23<sup>rd</sup> 1867.

Respectfully returned. — Order  
for transportation enclosed  
The Surgeon-in-Chief at these  
Headqrs will be notified of the  
probable time of arrival of  
the within named parties at  
this City

By order of  
Maj Genl. J. A. Mower U.S.A.  
Asst Commr

J. M. S. 3/157  
J. M. S.  
1<sup>st</sup> Lieut 39<sup>th</sup> U.S. Infy  
A. S. A. Genl.

S. 17 Bu R. F. & A. H. - La - 67

Headquarters Bureau R. F. & A. H.  
5<sup>th</sup> Sub Dist of Louisiana  
Morrison, La, Octbr 1<sup>st</sup> 1867

Respectfully returned to  
Mr. W. J. Sumner et. al. et. c.  
transportation order enclosed.

Wm. C. Gold  
Capt U.S.A. Sub Dist Comm  
5<sup>th</sup> Sub Dist: La

Recd at 5<sup>th</sup> Sub Dist La Oct 2. 1867



Office Asst Sub Asst Commr.  
Bureau R. F. & A. L.  
Catahoula Parish, La  
Sept 15<sup>th</sup> 1867.

L. O. Parker, Lieut 1<sup>st</sup> U. S. Infy.  
Bureau R. F. & A. L.  
New Orleans, La.

Sir

I have the honor to transmit you the following names of freedmen "stating diseases" for transportation to the Freedmans Hospital, N. O.

Charles Waller, Very poor leg-  
Lewis Bohannaw, Cripple & poor Eyes.  
Maria Riding, Almost Blind  
Abalina Anderson, Rheumatism & Insane  
Anthony Benjamin, Paralyzid-  
Ellen Lerargrove, Rheumatism & old & infirm,  
Isabella Johnson - Cripple <sup>with</sup> one leg.

There is none of the above that can make a support under any circumstances.

Respectly Your Obedt Servant.

M. Johnston Lemmon.

A. G. C., Bureau &c.



Monroe La  
Sept. 18<sup>th</sup> 1867

Sept 18<sup>th</sup> 1867

Circular Letter



Head Quarters Bureau P. F. & A. S.  
5<sup>th</sup> Sub District of Louisiana  
Monroe, La. Septbr 18<sup>th</sup> 1867.

Circular Letter.

In compliance with instructions from  
Head Quarters, Bureau P. F. & A. S. dated New  
Orleans, La. Septbr 14<sup>th</sup> 1867. - Agents of this District  
will at once furnish this Office with the following  
information - viz:

Where borne - (give State or Country)

Give Name of State in which you resided at the  
time of appointment.

Give your annual Compensation.

You will also give the Name, and make the  
same Report for your Clerk, or other employees  
you may have.

Saml C. Gold  
Capt & A. C. Sub Asst Comm'r  
5<sup>th</sup> Sub Dist of Louisiana

M<sup>r</sup> M. J. Sumner  
A. S. at Louis



L 144 Bu. N. F. A. L. Co. 67

L 19 Bu. N. F. A. L. Co. 67

Office Chief Sub Chief Commr.  
Parish of Catahoula  
Catahoula Parish Oct 5th 1867

Leimon. W. Johnson  
Sub Sub Chief Commr.

States that sometime ago discharging his duties, he was followed by a malicious Freedmen with a gun to shoot him, but being Horroclack, and he all foot, was unable to overtake him. - Since then another bad freedmen has threatened to way lay and shoot him &c, and that one told him, that no white men would be over them much longer, that this country belonged to them, and was going to have it. - This is no jail in this Parish, and do not know what to do with them - ask - whether he can send them to Monroe with charges &c.  
Have no doubt evidence the freedmen are arming themselves in this Parish for some bad purpose.

Recd. at 5th Sub Dist La Oct 15. 1867

L 19 Bu. N. F. A. L. Co. 67

Headquarters Bureau R.F. & C.L.  
5th Sub District of Louisiana  
Monroe, La, Octbr 15th 1867

Respectfully forwarded to  
Brig. Maj. General J. A. Mower  
Sub Commissioner for  
instructions.

David G. Gold  
Capt. U.S. Sub Chief Commr  
5th Sub Dist. La.

L 144 Bu. N. F. A. L. Co. 67  
Headquarters  
Bureau R.F. & C.L. Dist of La  
New Orleans Oct 21st 1867

Respectfully returned to Mr. W. J. Remmon, the Sub Chief Commr of this Capt. U.S. Sub Chief Commr. The matters referred to will be arrested and turned over to civil authorities - nearest Catahoula - for trial and in future - if necessary - he will call upon the commanding officer of the nearest military post for troops to protect him when interfered with during the performance of his official duties.

Attest of  
Brig. Maj. Genl. J. A. Mower  
J. M. Lee  
Supt. of Prison and General



Officer Apt Sub Apt Comr.  
Berrian R. F. & A. L.  
Catahoula Parish, La  
Octr 5<sup>th</sup> 1867.

Saml C Gold Capt V. R. C.  
S. A. C. 5<sup>th</sup> Sub Dis. La  
Murren La.

Sir

Some time ago while in the discharge of my duties I was followed (unknown to me) some distance by a very bad and malicious freedman with his gun to shoot me. but it appears he was unable to overtake me as I was on horse back and he was a foot. Since then another very bad freedman has threatened to way lay me and shoot me &c he and another one told me a few days ago that no d d white man would be over them much longer that this country belonged to them & they was going to have it &c &c. There is no jail or place of confinement in this Parish and I do not know what to do with them



Can I send them to your place with  
charges &c. I would respectfully ask  
what to do in such cases.

I have undoubted evidence that  
the freedmen are arming themselves  
throughout the Parish for some bad  
purpose.

Respy Your obt Servant  
M. Johnston Linnson  
A. S. A. C. Bureau

1900







New Orleans La  
Oct 28, 1867.

D. A. Ward  
Capt & Inspector General

Call for Reports.

Oct 28<sup>th</sup> / 67  
A. A. G. Ford

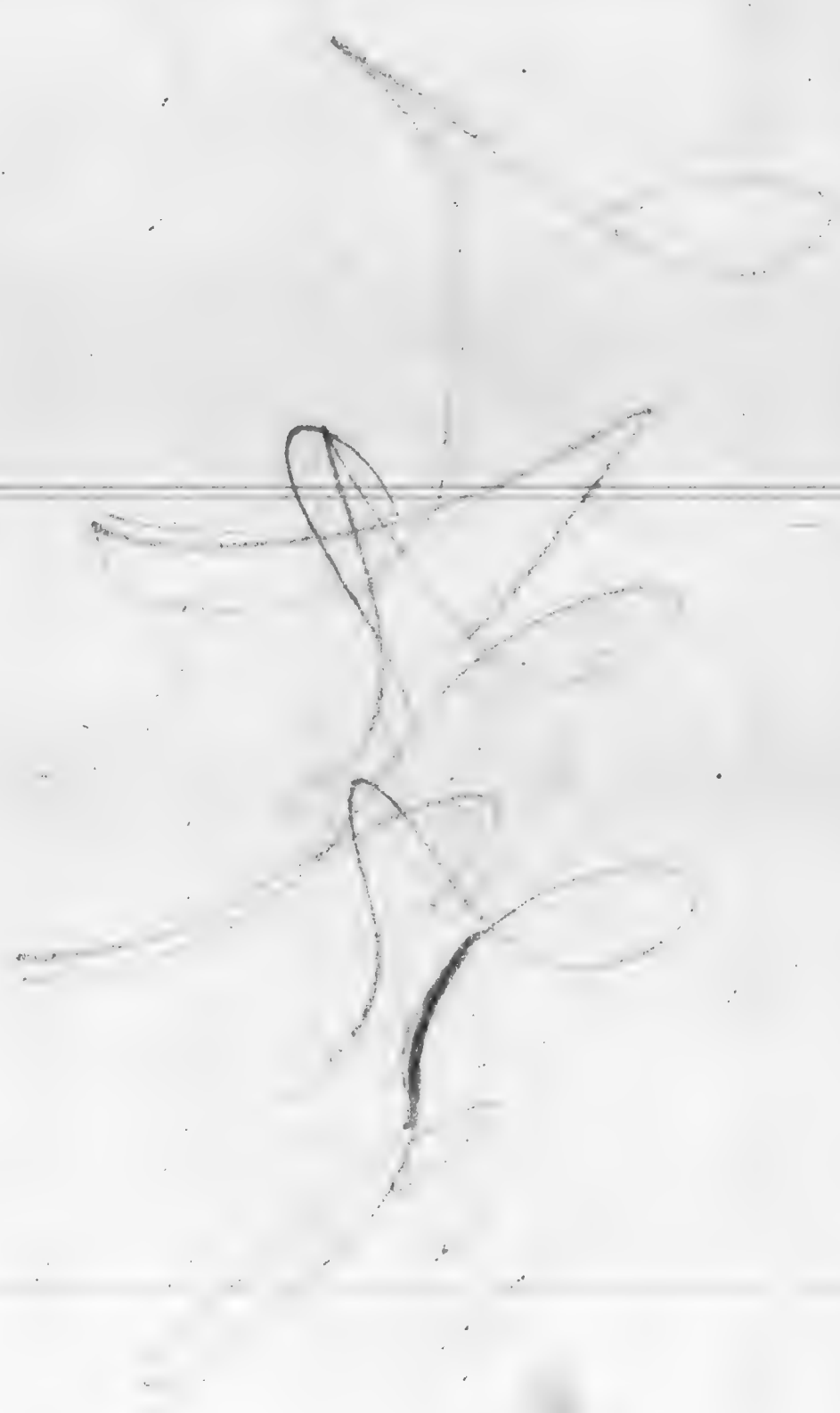
A large, faint, and somewhat illegible handwritten signature or scribble, possibly reading "A. A. G. Ford", is written in the right-hand column of the document. The ink is very light and the strokes are somewhat messy.



HEADQUARTERS,  
Bureau of Refugees, Freedmen and Abandoned Lands,  
STATE OF LOUISIANA.

New Orleans, Oct 28<sup>th</sup> 1867.

Mr M. J. Semmon  
Agent, &c., Parish of Catahoula  
Prairie Edg Ark Riv. Lo.

Sir:

The Assistant Commissioner of this Bureau,  
for this State, desires me to call your attention to the fact, that  
your Monthly Inspection Report for the  
Months of Jan. Mar. Apr May 1867, as called for by Circular  
No. 36 of Dec 30<sup>th</sup> 1865, from these  
Headquarters, has not been received. You will please forward  
these Reports immediately, and state how this delay  
has occurred.

Very respectfully,

Your obedient servant,

W. A. Ward  
act Inspector  
Captain and Assistant ~~Adjutant~~ General.



Mourne La  
Oct. 26, 1867

Oct 26<sup>th</sup> 1867

Circular Letter



Headquarters Bureau R. F. & C. L.  
5<sup>th</sup> Sub District of Louisiana  
Monroe, La., October 26<sup>th</sup> 1867.

Circular Letter

It is frequently noticed that many of the Reports of the  
Asst Sub Asst Commissioners in this District are forwarded  
direct to Headquarters Bureau R. F. & C. L. New Orleans.

All Reports and Official Communications will be  
addressed to the A. S. A. General at Headquarters New Orleans,  
and sent through this Office as heretofore.

Particular attention is called to comply with instructions  
contained in Circular Letter of August 21<sup>st</sup> 1867 from  
this Office, and Circular No. 11 of 1867 from Head  
Quarters New Orleans, requiring Official Communications  
to be sent through the proper channels.

J. C. Gold  
Capt & R. C. Sub Asst Comdr  
5<sup>th</sup> Sub Dist of Louisiana

Mr. W. J. Semmon  
A. S. A. Comdr



Dec 27/67

*[Faint, illegible handwritten text, likely bleed-through from the reverse side of the page.]*



Cap<sup>t</sup> Lemmon

Tuesday Dec 27th 1847

Dear Sir,

Your kind favor of 25<sup>th</sup> inst is rec<sup>d</sup>. In reply thereto I can only say that the seizure of property at Opelousa by you for the benefit of a treacherous hireling is in my opinion illegal and unjust, the affair however does not concern me as I had transferred the property to Mr. Frank J. Bourne as agent for Messrs. W. St. Litchford & Co. N. O. who furnished supplies to Camp on the plantation.

Mr. B. was first to pay the farmers, next the brewer; and the balance if any to Messrs. Litchford, as the hireling did not accept the arrangement but wanted to go - his claim in fact, (before the freedom) he must now take his chance under - Civil Law as I am not aware that the "Bureau" was created for the benefit of that class of persons. My <sup>primary</sup> remedy is to take out an injunction to stay your proceedings to sell the property.

I regret this state of affairs very much as the legal delays will necessarily retard the payment of their wages to the freedmen but as I have already paid to them



more than the entire value of the crop  
raised on the plantation I do not con-  
sider that they are damaged by the delay  
in fact by the terms of the contract with  
the Freedmen they claim only expenses to the  
crop and no farther.

I cannot see any propriety in your seizure  
of stock on this place and also two several  
Mules and Cows the property of Messrs  
Payne & Huntington New Orleans, your detention  
of said property will subject you to damages  
and I trust you will immediately return it  
without giving me further trouble in the premises  
as you say in your letter that the property under  
seizure is worth double the claim of the Freedmen

It is a matter of deep mortification to me  
that this proceeding should have occurred on  
my premises, but I fully exonerate you from  
any misconduct in the matter - fully aware  
as I am that it was inaugurated by a  
traitor to further his own selfish ends.

Hoping soon to have the pleasure of a  
personal acquaintance and tendering the hospi-  
tality of Denmark to yourself and family

Yours,

Yours Respectfully  
Saml J Rowan

Vertical text on the left margin, possibly a list or index, partially illegible.



Monroe La.

January 6, 1868.

Circular Letter.

Relating to reports of  
destitute Refugees and  
Freedmen.

1868



May 4<sup>th</sup> 1868



Acknowledge Receipt

Headquarters Bureau R.F.A.H.  
5th Sub Dist of Louisiana  
Monroe, La, January 6. 1868

Circular Letter

Assistant Sub Assistant Commissioners  
of this District will with the least possible delay  
make and forward to these Headquarters a list  
of all the destitutes in their respective Parishes  
on the enclosed forms.

Should there be both whites and freed people  
a separate report will be made for each.

These Reports will be based upon information  
obtained after a personal investigation has been  
made, or from positive evidence of  
parties well acquainted with the facts.

W. M. J. Sumner  
A. G. A. Comr

Saml. Child  
Sub Asst Comr  
5th Sub Dist of Louisiana



New Orleans La.  
January 16, 1868

Fromy 16<sup>th</sup> / 68  
Sup<sup>r</sup> Schools

Frank B. Chase.  
Genl Supt. Educ.

Relative to promptly  
forwarding School  
Reports &c.

1868



HEADQUARTERS,  
Bureau of Refugees, Freedmen and Abandoned Lands,  
STATE OF LOUISIANA.  
Office General Superintendent of Education.

189  
(7 JULIA STREET.)

New Orleans, La.,

Jan 21<sup>st</sup> 1868.

No. 12  
Mr. M. S. Lemmon  
U. S. Sub. U. S. Commr.  
Parish of Catahoula

Sir,

I have forwarded  
by mail to your address copies of the daily school  
register.

You will furnish one for the use of each  
school in your district.

Teachers who keep this simple  
register correctly cannot fail in making their reports  
to you promptly and correctly.

Should more copies of the  
register be needed, they will be furnished upon  
your application to this office.

You will take particular  
pains to report every Day Night and Sabbath  
school in your district. Should a teacher fail  
to make proper reports in time you will report  
the school from your latest information.

Your attention is particularly called



To Par<sup>gh</sup> II circular No 16 Q. S. of 1867 from  
these Headquarters,

I am

Very Respectfully  
S. M. A. Chase  
Gen<sup>l</sup> Supt of Education  
Bureau of R. I. and A. S.



P. 7. Bu R F + H Sa - 68  
Headquarters Bureau R F + H  
District of Louisiana  
New Orleans, Jan 16. 1868

Fuchanan. R C

Post Maj Genl & Asst Commr

Enclosure 124 <sup>27/100</sup> Dollars  
proceeds of 3 Bales Cotton,  
shipped to Messrs M Gillis & Co.  
Presents that you at once  
pay over the amount to the  
proper Auditors by Mr  
M. Sacrament's Estate.

Forward to Headquarters  
receipt for the enclosed  
amount with receipt of  
Auditors, signed & returned  
and enclosed papers to  
be returned.

Rec: Hd Qrs 5th Sub Dist of La  
Jan 23. 68

P. 7. Bu R F + H Sa 68

Headquarters Bu R F + H  
5th Sub Dist of Louisiana  
Maurice Sa Jan 23. 68

Respectfully forwarded to  
Mr. M. Johnson Commr  
A. S. A. Commr

Supt. of Gold  
Sub Asst Commr  
5th Sub Dist of La



# 4/4

HEADQUARTERS,  
Bureau of Refugees, Freedmen and Abandoned Lands,  
DISTRICT OF LOUISIANA.

No. 191 JULIA ST.,

New Orleans, La., *January 16<sup>th</sup>* 1868.

Mr M. J. Lemmon  
Asst. Sub. Asst. Commr  
Parish of Catahoula La  
Thro Mr S. C. Gold  
Sub. Asst. Commissioner,

Sir

I have the honor to en-  
close herewith 124 <sup>37</sup>/<sub>100</sub> Dollars being  
proceeds of Sale of 3 Bales of Cotton ship-  
ped by you to Messrs M. Gilles & Co Com-  
mission Merchants, of this City.

The Assistant Commissioner  
directs that, you at once pay over  
the above amount to the proper freed-  
men to whom it is due by Mr M.  
Lacraux's Estate, for lack clothing  
1 over



and forward to these Head Quarters  
with the least possible delay, receipt  
for the enclosed amount together  
with Receipt roll of freedmen to  
whom it is due properly signed <sup>and</sup>  
witnessed, also returned enclosed papers

Very Respectfully  
Your Obedt Servant  
Lucius W. Warren  
Capt 39<sup>th</sup> U S Infantry  
A. A. G.



P. O. O. R. F. & A. La - '68

Headquarters Bureau R.F. & A.  
District of Louisiana  
New Orleans, La, Jan 18. 1868

Puchanan R. C.

Post Major Genl Post Louis

Enquires whether you have on file in your Office a copy of the Contract, entered into between Wm. J. Garrett and his Employees during the year 1867 - if so, directs that a certified Copy of same be sent to these Ad. G. O.

Should there not be a Copy of the Contract, you will ascertain and report with the least possible delay the time under which said people were employed by Wm. Garrett during the time specified

Ad. G. O. 5th Sub Dist. La  
January 25 '68

P. O. O. R. F. & A. La 68

Headquarters Bureau R.F. & A.  
5th Sub Dist of Louisiana  
Monroe, La, Jan 25. '68

Respectfully forwarded  
to Mr. M. J. Lemmon  
A. S. A. Louis

Sam. C. Gold  
Sub Dist Louis  
5th Sub Dist of La



#104.

HEADQUARTERS,  
Bureau of Refugees, Freedmen and Abandoned Lands,  
DISTRICT OF LOUISIANA.  
No. 191 JULIA ST.,

New Orleans, La., January 18<sup>th</sup> 1868.

Mr M. J. Lemmon,

Asst. Sub. Asst. Comr.

Parish Catahoula, La.

Thru Mr S. C. Gold

Sub. Asst. Commissioner

Sir,

I am directed by the Assistant Commissioner, to enquire whether you have on file in your office a copy of the contract, or agreement, entered into between Mr J. Garrett of your Parish and his employees during the year 1867, and if so. He directs that a certified copy of the same be at once sent to these Head Quarters.

Should there not be a copy of the contract on file in your office - The



Assistant Commissioner also directs that  
you ascertain and report with the least  
possible delay the terms under which  
freedpeople were employed by Mr Garrett  
during the time specified

Very Respectfully

Your Obedt Servant

James H. Warren

Capt 39<sup>th</sup> U S Infantry

A.W.G.



New Orleans La.  
July 18 1868

Saml. C. Gould  
Sub. Aft. Comd

Requests that labours  
may be sent to him

July 19<sup>th</sup> 1868



#10.

Headquarters Bureau A. S. A.  
5<sup>th</sup> Sub Dist of Louisiana  
Monroe, La, January 18<sup>th</sup> 1868

M. J. Semmon Esq  
A. S. A. Com's Bureau A. S. A.

Trinity, La.

Sir.

Several Plantations near Monroe are wanting more hands this year than they are able to get at this place; and as there is an abundance of unemployed freedmen in your Parish, I wish you if possible to send to Monroe twenty five or thirty freedmen as they can find good homes here.

Judge Richardson states, that he will pay the expenses of twenty five to Monroe, and give them wages or interest in the Crops. If you can send them, please do so on first boat, and state to the Captain that their expenses will be paid here.

Very Respectfully

Your obt Servant

Saml C. Gold

Sub Asst Comr 5<sup>th</sup> Sub Dist of La



New Orleans La  
January 21 1868

Jan 21"/68

Frank R. Chase  
Genl. Supt. Edc<sup>y</sup>

Forwards the "Vanguard  
of Freedom" manual  
with instructions as to its  
distribution.



HEADQUARTERS,  
Bureau of Refugees, Freedmen and Abandoned Lands,  
(189 JULIA STREET,)

Office General Superintendent of Education,  
STATE OF LOUISIANA.

New Orleans, La., January 21<sup>st</sup> 1868.

#24  
Mr M. J. Lemon  
Apt-Sub. Apt-Comm.  
Parish of Catahoula

Dear Sir,

I have forwarded by  
this days mail copies of the "Vanguard of  
Freedmen Manual"

Place one copy in the hands of  
each teacher within your District - or to such  
other persons as you may think will take a more  
lively interest in the matter.

It is designed that - a division be  
formed in connection with each school and the  
number of members will be given on each school  
report - to this office.

Additional copies may be furnished from  
the Genl Secretary at cost.

The vital importance of this matter  
and the best-interests of the freedman for their  
future welfare requires that - it should receive your



earnest-attention and the united efforts of  
all interested in the elevation of the race.

Very Respectfully

Your Obedt-Servt-

Samuel A. Leese  
Genl. Supt. of Education  
Bureau R. F. <sup>and</sup> A. S.



New Orleans La.  
July 25 1868

Frank R. Chase  
Genl. Supt. Eden.

Calls attention to requirements  
of Circular No. 5 Series of 1867.

July 25<sup>th</sup>/68



HEADQUARTERS,  
Bureau of Refugees, Freedmen and Abandoned Lands,  
(189 JULIA STREET.)

Office General Superintendent of Education,  
STATE OF LOUISIANA

N<sup>o</sup> 32  
New Orleans, La., Jan'y 23<sup>rd</sup> 1868.  
Mr. M. J. Lemmon  
Asst. Sub. Asst. Comm<sup>r</sup>s  
Parish of Catahoula  
Sir,

A blank for  
Asst. Sub. Asst. Commissioners has been prepared,  
copies of which have been sent to you.

It found  
that while in some parishes there is faithful  
conformity to the requirements in Circular N<sup>o</sup> 45  
C. S. of 1867 from Major Genl. C. A. Howard,  
Commissioner, in many others there has been  
"great deficiency or entire neglect."

The questions  
now issued will be answered by the Asst.  
Sub. Asst. Commissioners and promptly  
forwarded to this office on the last day of  
of each month. This blank does not  
conflict with any other report required by  
this office as it presents almost a new set  
of facts enquired for.



Very Respectfully  
G. Mann R. Chase  
Genl Supr of Education  
Bureau of A<sup>nd</sup> U.S.



July 28 1868  
New Orleans La.

Bres + O'Brien

Relative to the case  
of Eli Adams

July 28 1868

After account also and account  
concerning with us which you will  
do us the favor to explain to him  
and much oblig

Yours truly  
D. W. O'Brien



New Orleans January 28. 1868

Captain

M. J. Simon

Agent Freedman's Bureau

John R. Liddell Esq.

Dear Sir,

Having received Eight Bales Cotton raised by Eli Adams a Freedman, to whom we made advances for raising the said cotton, and in as much, as the Bill of Lading states that the proceeds are to be held subject to Freedman Bureau order, we drop you this on the subject.

After coming to a settlement with Eli Adams, whatever amount he may be due you out of the Balance of (\$136.<sup>57</sup>) One Hundred & Thirty Six <sup>57</sup>/<sub>100</sub> I due him ~~by~~ by us, as per account sales enclosed in Adams letter, you will please take his (Adams) order on us, drawn to the order of the Freedman's Bureau in this City for the same, and upon receipt of it, we will pay it over



to Head Quarters of Freedman's  
Bureau in this City.

We enclose to you Eli Adams  
letter, account sales and account  
current with us which you will  
do us the favor to explain to him  
and much oblig

Yours Respectfully  
D. S. O'Brien

Jan'y 28<sup>th</sup> 1868

Jan'y 28<sup>th</sup> 1868

New Orleans La.

B. S. O'Brien

Relative to the care  
of Eli Adams



New Orleans La.  
Feb. 2, 1868

Feb 2<sup>nd</sup> / 68.

Frank R. Chase  
Genl. Supt. of Edw.

Relative to forwarding  
Reports.



HEADQUARTERS,  
Bureau of Refugees, Freedmen and Abandoned Lands,  
(189 JULIA STREET,)

Office General Superintendent of Education,  
STATE OF LOUISIANA.

#36

New Orleans, La., Feb 2<sup>nd</sup> 1865.

Mr. M. J. Lemmon  
Asst. Sub-Ass't Commissioner,  
Parish of Catahoula

Sir.

The "Reports of the Schools" {Form No. 2} required by this office on the 15<sup>th</sup> of each month, will in future be made and forwarded on the last day of each month.

Reports required by this office on the last day of each month. "Reports of Schools," "Monthly report of Schools Receipts and Expenditures" and Ass't Sub-Ass't Commissioner Monthly Reports.

Promptness in forwarding these reports and correctness in making them up is indispensable, as the delay of a single report delays the reports of the Gen'l Supt of Education to Major Gen'l Howard.

Very Respectfully  
Emma A. Chase  
Gen'l Supt of Education  
Bureau of R. & A. L.



New Orleans La.  
February 4, 1868

Frank R. Chase  
Secy. Supt. of Ed. cv.

Relating to the support  
of schools for Freedmen.

Feb 4/1868



HEADQUARTERS,  
Bureau of Refugees, Freedmen and Abandoned Lands,  
(189 JULIA STREET,)

Office General Superintendent of Education,  
STATE OF LOUISIANA,

No. 111  
New Orleans, La., February 4<sup>th</sup> 1865.  
Mr. M. J. Lemmon  
Asst. Sub-Ass. Commissioner  
Parish of Catahoula

Sir. Where a school building can be furnished free of charge and it is positively necessary for the support of the teacher that assistance be given you will report the case to this office and if favorably considered a small amount may be given the teacher monthly provided that you forward blank vouchers (Form No. 22) receipt signed.

This assistance will only be given to worthy and competent teachers who make their reports promptly and correctly.

These teachers should hold a certificate from this office.

Very Respectfully  
R. M. A. Chase  
Genl Supt of Education  
Bureau of R F & A L



Catanaula  
Washington D.C.  
Feb. 5<sup>th</sup> 1868

Feb 5<sup>th</sup> / 1868  
War Dept

Commissioner Aft.

Acknowledys receipt  
of Statement of Provision

40



War Department,  
Bureau Refugees, Freedmen, and Abandoned Lands,

Washington, Feb 5<sup>th</sup> 1868.

Sir:

Your Statement of Provisions received, transferred, and distributed under Joint Resolution of Congress, approved March 30, 1867, "to prevent starvation," &c., for the months of \_\_\_\_\_

October 1867

have been received and examined at this office, and sent to the Third Auditor of the Treasury for settlement.

Remark: Statement requires of provisions rec'd - issued and remaining on hand for Oct 1867.

By order of Maj.-Gen. O. O. Howard.

Very respectfully, &c.

*A. A. Miles*

A. A. Inspector-General.

*J. M. Lemmon, A.S.A.C.*  
Catahoula Parish - La -



O. N. 24 Bu. R. F. & H. La. '68  
Headquarters Bureau of Field  
District of Louisiana  
New Orleans, Febr 8<sup>th</sup> 1868

Buchanan, A. C. Post Major Genl  
U. S. A. & Asst Comr

States that Mr W. B. Armstrong  
D. O. & Agent has been instructed  
to send to you 2871 Rations  
for the destitute in Catahoula  
Parish.

Recd Hd Qrs 5 Sub Dist La Febr 27. 68

O. N. 24 Bu. R. F. & H. La. '68  
Headquarters Bureau of Field &  
5<sup>th</sup> Sub District of Louisiana  
Monroe, La, February 27. 1868

Respectfully forwarded  
to Mr. M. J. Sumner A. S. A. Comr

Paul C. Gold

Sub Asst Comr  
5<sup>th</sup> Sub Dist of La



HEADQUARTERS,  
Bureau of Refugees, Freedmen and Abandoned Lands,  
DISTRICT OF LOUISIANA.

No. 191 JULIA ST.

New Orleans, La., February 8, 1868.

Mr. M. J. Lemmon

Assistant Sub Assistant Commissioner,

Bureau Refugees, Freedmen and Abandoned Lands,

Parish of Catahoula, Louisiana.

SIR:

I am directed by the Assistant Commissioner, to inform you that MR. W. B. ARMSTRONG, Disbursing Officer and Quartermaster's Agent, has this day been instructed to send to you, by the most practicable route,

2871 RATIONS for distribution to the "destitute." The same will be issued and accounted for in accordance with existing instructions. you will in addition <sup>state</sup> in your Tri Monthly Report receipt of rations giving bulk in pounds, and will in subsequent Tri Monthly Reports state number of pounds remaining on hand

By Order of

Genl. Major Genl. R. C. Buchanan U.S.A.  
Asst. Commissioner &c.

Monis H. Warner  
Capt 39th U.S. Infantry

Acting Asst. Adjt. General



L. 41. Bu. R. T. A. L. La. 68.  
Office, Asst. Sub. Asst. Comm.  
Parish Catahoula La  
Prairie Landing Feb 24 1868

Semmon, M. J.

Mr

Asst. Sub. Asst. Comm.

Inquiries of a  
planter can pay for the  
supplies furnished by the  
Bureau, at any time  
during the year; also, if  
the Bureau will require a  
planter to ship the whole  
crop raised, to the merchant  
designated, or only a suf-  
ficient amount to liqui-  
date his indebtedness for  
supplies furnished.

L. 41. Bu. R. T. A. L. La. 68.  
Headquarters,  
Bu. R. T. A. Lands,  
District of Louisiana,  
New Orleans Feb 24 1868.

Respectfully returned to  
Mr. M. J. Semmon, Asst  
Sub Asst Commr, Thro  
Mr. S. C. Gold, Sub Asst  
Commr, who is informed  
that Circular No 1, C. S.  
from these Headquarters  
of date Jan 23<sup>rd</sup> 1868, is  
considered sufficiently  
explicit and definite for  
the guidance of all  
parties concerned. Its  
provisions will be strictly  
complied with, and no  
deviation from its require-  
ments will be allowed.  
The whole crop will  
be forwarded to the Mer-  
chant, in this city,  
designated in the bond  
and, from the profits

accruing from the sale  
of the crops, the amount  
due this Bureau will  
be deducted.

By order of  
Maj. Gen. R. C. Buchanan,  
Asst. Commissioner.

Wm. H. Warner  
Capt 39<sup>th</sup> U.S. Infy  
i. a. a. g.

6374/24



Officer A. G. A. Comr.  
Bureau R. T. & A. L.  
Catahoula Parish, La.  
February 21<sup>st</sup> 1868.

L. H. Warren, Capt 39<sup>th</sup> U. S. Infy.  
S. A. of Louisiana  
Bureau R. T. & A. L.

Sir,

By request of quite  
a number of the planters of this Parish, I  
take the honor to ask you the following  
questions,

Can a planter pay for the supplies  
furnished him by the Bureau, at any time during  
the year, and release himself from all bonds to  
give for said supplies?

Will a planter, "drawing supplies  
from the Bureau," be required to ship his  
crop, to the merchant designated by  
the Bureau to receive it, or only a sufficient  
quantity of the crop, to liquidate his



indebtedness for the supplies furnished him,

Very Respectfully,  
Your Obedt Servant,  
W. Johnston Linnow,  
Adj. to Comd.  
of ...

S. S. Bu. Cl. F. & A. L. La. '68

Headquarters Bureau of Field  
5th Sub District of Louisiana  
Monroe, La. February 29th 1868.

Respectfully forwarded  
to Mr. M. J. Linnow  
Chief Sub-District Commr

Paul C. Gold

Sub-District Commr  
5th Sub-District of La



L. S. Bu R. F. + A. L. La. '68

---

Headquarters Bureau R. F. + A. L.  
5<sup>th</sup> Sub District of Louisiana.  
Monroe, La. February 29<sup>th</sup> 1868.

---

Respectfully forwarded  
to Mr. W. J. Sumner  
Act Sub Act Commr

Paul C. Gold  
Sub Act Commr  
5<sup>th</sup> Sub Dist of La

---



B. 17. Bu R F & S. - La - '68

Headquarters Bureau R F & S  
State of Louisiana  
New Orleans, La, Febr 18<sup>th</sup> 1868

B. 17. Bu R F & S. - La - '68

Headquarters Bureau R F & S  
5<sup>th</sup> Sub District of Louisiana  
Monroe, La, February 24 1868

Chas. C. Buchanan  
Sub Commr

Respectfully forwarded  
to Mr W. J. Garrison  
Catahoula Parishes

States that your 3<sup>rd</sup> Monthly  
Report ending January 10<sup>th</sup> 1868  
has not been received. You will  
forward this Report immediately  
and state how this delay has occurred.

Samuel Gold

Sub Dist Commr  
5<sup>th</sup> Sub Dist of Louisiana

Recd at 5 Sub Dist La Febr 24 1868



HEADQUARTERS,  
Bureau of Refugees, Freedmen and Abandoned Lands,  
STATE OF LOUISIANA.

New Orleans, February 18<sup>th</sup> 1868

Mr M. J. Lemmon,  
asst Agent, &c., Asst Commr District,

Swaine Landing La.

Thru Mr J. C. Gold sub Asst Commr  
Sir:

The Assistant Commissioner of this Bureau,  
for this State, desires me to call your attention to the fact, that  
your Tri-monthly Reports for the  
ten days ending Jan'y 10 1868, as called for by Circular  
No. 36, of December 30 1865, from these  
Headquarters, has not been received. You will please forward  
this Report immediately, and state how this delay  
has occurred.

Very respectfully,

Your obedient servant,

J. M. Lee

Recd Captain and Assistant Adjutant General.



New Orleans La  
July 26 1868.

Special Orders

No. 25.

July 26<sup>th</sup> / 68



HEADQUARTERS,

Bureau of Refugees, Freedmen and Abandoned Lands,  
STATE OF LOUISIANA.

New Orleans, La., February 26, 1868.

SPECIAL ORDERS

No. 25.

(Extract.)

11. Capt. W. W. Webb, 4<sup>th</sup> U. S. Cavalry, having been ordered to report to these Headquarters for temporary duty, by virtue of S. O. No. 34, Par. 7, dated, Headquarters, District of Louisiana, New Orleans, La., February 24, 1868, will, during the temporary absence on leave of Mr. J. C. Gold, perform the duties of Sub Asst. Commissioner 5<sup>th</sup> Sub District.

By order of Brt. Maj. Genl. R. C. Buchanan, U. S. A.

Assistant Commissioner, Bureau of Refugees, Freedmen and Abandoned Lands

Mr. M. J. Demmon,

Asst. Sub. Asst. Commr.

Praine Land, La.

Thomas W. Warren  
Capt. 3<sup>rd</sup> U. S. Infy.  
a. a. a. g.



O. 30. Bu R F + A. S. La - '68  
Headquarters Bureau R F + A  
District of Louisiana  
New Orleans, La, Feb 26. '68

Rochester C. C.  
Asst Maj Genl Asst Cavir

Transmit Check No. 148  
for \$279.<sup>00</sup> drawn by  
Wells, Fargo & Co to your order,  
dated New Orleans Feb 18. 68

Receipts enclosed receipt be  
signed, and at once returned.  
Also directs to pay over  
to the Treasurer the amount,  
and that Receipt Ball, properly  
signed and witnessed be  
forwarded to these Head  
Quarters.

W. H. G. 5th Sub Dist La  
March 7. 1868.

O. 30. Bu R F + A. S. La - '68

Headquarters Bureau R F + A  
5th Sub District of Louisiana  
Monroe, La, March 7. 1868

Respectfully forwarded  
to Mr M. J. Lemmon  
Asst Sub Dist Cavir

W. H. G.

Sub Asst Cavir  
5th Sub Dist of La

Feb 26<sup>th</sup> 1868

Communication  
from  
Headquarters

James Dumbly



# 264.

HEADQUARTERS,  
Bureau of Refugees, Freedmen and Abandoned Lands,  
DISTRICT OF LOUISIANA.

197 Julia Street.

New Orleans, La.,

February 26<sup>th</sup> 1868.

Mr M. J. Lemmon,

Asst Sub Asst Commissioner,

Par. of Catahoula, Truinity, La.

(Thro. Mr S. C. Gold. Sub Asst Comr.)

Sir;

I have the honor to transmit herewith  
Check No. 148, for the sum of \$249<sup>49</sup>/<sub>100</sub> Dollars,  
drawn by Messrs Scalle Day and Co. payable  
to your order - dated New Orleans, February 18<sup>th</sup> 1868.

The Assistant Commissioner directs, that the  
enclosed receipt be signed, and at once returned  
to these Head Quarters. He also directs, that you  
without delay pay over to the proper freedmen  
to whom it is due, the amount named in  
the enclosed check, and that Receipt Roll,  
for such payment, properly signed, and  
1 over /



witnessed; be forwarded to these  
Head Quarters, with the least possible  
delay.

Very Respectfully,

Your Obedient Servant,

Men<sup>r</sup> H. W. Warren

Captain 3<sup>d</sup> U.S. Infantry

Actg. Ass't. Adjt. General.



L 73. Bu R F & A L La '68  
Office, asst. sub. asst. comm.  
Parish of Catahoula La  
Praini Landing Mar 6/68

Sammon M. J.  
Mr  
Asst. sub. asst. comm.

Requests to  
be furnished with  
Blank contracts and  
the necessary blanks  
for the issue of supplies.



L 73 (Bu. R. F. & A. L., La.) 1868

HEADQUARTERS,  
BUREAU REFUGEES, FREEDMEN AND ABANDONED LANDS,  
DISTRICT OF LOUISIANA.

New Orleans, March 16<sup>th</sup> 1868

Respectfully returned to Mr  
M. J. Sammon (Asst. sub. asst. comm.)  
(thru Mr S. C. Gold fac)  
with the information that  
a supply of the within  
named blanks has  
this day been sent direct  
by mail.

By order of  
Col Maj Gen R. C. Buchanan  
Asst Commissioner

Lucius W. Moore  
Capt 39<sup>th</sup> Regt Infy Army

Recd at New Orleans La  
March 19 68

P 36 Bu R F & A L La '68  
Headquarters Bureau R F & A L  
5<sup>th</sup> Sub District of Louisiana  
Monroe, La, March 19. 1868

Respectfully forwarded  
to Mr M. J. Sammon  
Asst Sub Asst Commissioner

W. W. Webb  
Captain 4<sup>th</sup> U.S. Cavalry  
Sub Asst Commr 5<sup>th</sup> Sub Dist  
La.



Office Apt Sub Apt Com.  
Bureau R. F. & A. Lands.  
Catahoula Parish, La.  
March 6<sup>th</sup> 1868.

L. H. Warren, Capt 39<sup>th</sup> U. S. A.  
A. T. T. Genl.  
Bureau R. F. & A. L.

Sir

I have the honor to ask you to send me some Blaine Contracts. Affidavits and Applications and Receipts and Bonds. I am entirely out of those Blaine and there are a great many planters waiting to contract and apply to the Government for supplies.

Very Respy Yours  
Wm. Johnston

Wm. Johnston

T. J. H. Co.

Wm. Johnston & Co.



B. 35 Bu R F & H La '68.

Headquarters Bureau R F & H  
District of Louisiana  
New Orleans, March 11. 1868

Rochester Pot May Genl R. C.  
Asst Commissioner

Transmit Check No. 121  
for \$120<sup>00</sup>/<sub>4</sub> and Check No. 61.  
for \$153<sup>35</sup>/<sub>4</sub>.

Directs enclosed receipts to  
be signed and at once returned,  
and to pay over to the proper  
holders on the Elmley  
Plantation, and those  
employed by Mr M Laccoux,  
and that Receipt Rolls signed  
and witnessed be forwarded  
to Headquarters without  
delay.

At 5th Co 5th Sub Dist La March 19 '68

B. 35 Bu R F & H La '68

Headquarters Bureau R F & H  
5th Sub District of Louisiana  
Monroe, La, March 19. 1868

Respectfully forwarded  
to Mr M. J. Lemmon  
Asst Sub Asst Commissioner

W. W. West

Captain 4th U.S. Cavalry  
Sub Asst Commissioner  
5th Sub Dist of Louisiana



#229.

HEADQUARTERS,  
Bureau of Refugees, Freedmen and Abandoned Lands,  
DISTRICT OF LOUISIANA.

No. 191 JULIA ST.,

New Orleans, La., March 11<sup>th</sup>, 1865.

Mr. M. J. Lummon

Asst. Dist. Asst. Court,

Parish of Catahoula, La.

(Pres. S. C. Gold. Sub Asst. Court.)

Sir,

I have the honor to transmit herewith, check No. 121. for the sum of (\$120<sup>00</sup>/<sub>100</sub>) One hundred and twenty Dollars; and check No. 61. for the sum of (\$153<sup>35</sup>/<sub>100</sub>) One hundred and fifty three <sup>35</sup>/<sub>100</sub> Dollars.

The Assistant Commissioner, directs, that the enclosed receipts be signed, and at once returned to these Headquarters, and that you pay over to the proper freedmen, to whom it is due - on the "Clusley Plantation", and those employed by Mr. M. Lacraux, - the amounts



named in the enclosed checks, and that  
Receipt Rolls, for such payments, properly  
signed and witnessed, be forwarded to  
these Headquarters, with the least possible  
delay.

Very Respectfully,

Your Obedient Servant,

Meris H. Warr

Captain 3<sup>d</sup> U.S. Infantry,

Actg. Asst. Adjt. General.



B. 34. Bu R F + A. L. La - '68  
Headquarters Bureau R F + A. L.  
District of Louisiana  
New Orleans La March 12 '68

Buchanan. Col Maj. Genl R. C.  
Asst Commissioner

Directs that you at once  
forward to the Ad Comd  
a copy of the Contract  
approved by you and entered  
into by Mr J. Garrett  
and the Freedmen in his  
employ for the present year

Recd Ad Comd Sub Dist La, March 17 '68

B. 34. Bu R F + A. L. La - '68  
Headquarters Bureau R F + A. L.  
5th Sub Dist of Louisiana  
Mouree, La, March 17. 1868

Respectfully forwarded  
to Mr M. J. Sumner  
A. S. A. Commissioner.

W. W. Webb  
Captain 4th Cavalry  
Sub Asst Comm 5 Sub Dist  
La

Recd Sub Dist, 24.



#  
238.

HEADQUARTERS  
Bureau of Refugees, Freedmen and Abandoned Lands,  
DISTRICT OF LOUISIANA.

191 Julia Street,

New Orleans, La., March 12 1868.

Mr N. J. Lemmon,  
Asst Sub Asst Commissioner  
Parish of Catahoula, La.  
Thru Mr J. C. Gold,  
Sub Asst. Commissioner,

Sir

The Assistant  
Commissioner directs, that you  
at once forward to these Head  
quarters, a copy of the contract  
approved by you, and entered into  
by Mr J. Garrett, of your Parish  
and the freedmen in his employ.



for the present year. <sup>Regulations</sup> according to Bureau,

Very Respectfully,

Your obt. Servant,

Wm. S. Warner

Capt, 39<sup>th</sup> U.S. Infantry,

A. A. A. G.



HEADQUARTERS  
BUREAU REFUGEES, FREEDMEN AND ABANDONED LANDS,  
STATE OF LOUISIANA

New Orleans, February 27<sup>th</sup> 1868

Respectfully returned (to Mr. George H. Ballis, Sub Asst Commr, 6<sup>th</sup> Sub District, La.) The action of Mr. Rush is approved. It was the duty of the Sub Asst Commissioner, to return this communication to Mr. Sumner with the approval of the endorsement of Mr. Rush. The request of the Planters cannot be granted.

Mr. Sumner will in future confine his duties to his own Parish, without interfering with the Parishes under the charge of other Asst Sub Asst Commissioners. Mr. Rush will be notified of this action.

By order of  
Bvt. Maj. Genl. R. C. Buchanan,  
Asst Commissioner.  
Merrill W. Warner  
Capt 39<sup>th</sup> U.S. Infantry  
a.a.a.g. general

Wrapper—(..... Enclosures.)

Aug. O. Sub Asst Commr - to S. A. Hays  
Office Sub A. Commr. Bureau  
Refugee N. L. 6<sup>th</sup> Sub Dist of  
La. Vidalia March 6-1868

Respectfully returned to Mr. Johnston H. Sumner as a Commr. Catahoula Parish La ( thro. Mr. Christian Rush as a Commr. Concordia Parish ) and attention directed to endorsement of A. A. A. Genl. Demaree New Orleans La of date Feb 27<sup>th</sup> 1868

Geoff. Pollock  
Sub A. Commr  
6<sup>th</sup> Sub Dist of La

Rec'd A. A. A. Genl. Demaree March 9<sup>th</sup> 1868

L. 10 a. 3. 60 Per Com. 1868  
Office A. S. A. Commissioner  
Parish of Concordia La.  
Vidalia March 12<sup>th</sup> 1868

Respectfully returned to Mr. Mr. Johnston Sumner A. S. A. Commr. Bu. & C. Catahoula Parish La. and attention invited to endorsement of Capt. Lucius H. Warren A. A. Genl. of date of February 27<sup>th</sup> 1868

  
A. S. A. Commissioner  
Parish, Concordia  
La.



R. B. C. Sub Dt. of La. 33 18  
S. A. (C. A. S. A. Co. Par. Com.)

Parish of Concordia Feb. 16<sup>th</sup> 1868

Horton J. W. and other citizens  
of Concordia Parish near Black  
River request Hon. W. J. Lemmon A.  
S. A. Co. Bu. Ref. C. Catahoula Parish  
to obtain authority to attend to  
their business pertaining to the Bureau  
from the fact that it is some thirty  
odd miles <sup>to the A. S. A. Co.</sup> and during the winter  
time the roads are very bad, and  
during high water the roads are  
impassible for wagons

R. B. C. Sub Dt. of La. 33 18

S. 42. Bu. Ref. C. Catahoula Parish

?

Prairie Landing  
via  
Vidalia.

Co. (C. A. S. A. Co. Par. Com.) Feb 17<sup>th</sup>



Parish of Concordia Feby. 16. 1868

Mr. M. Johnson Lemmon

Apt. Sub Apt. Comr. Bureau R. F. & A. Lands  
Parish of Catahoula La.

Sr

We the undersigned  
Planters of the Parish of Concordia and residents of  
Black River & Vicinity respectfully request of you to  
obtain Authority to attend to our business pertaining  
to the Bureau R. F. & A. L. We request this from the fact  
that the distance from this portion of this Parish to the  
office of Apt. Sub. Apt. Comr. Bureau is some thirty odd  
miles and during the winter season the road for a portion  
of the route is very bad and during high water the  
route is impassible for wagons. By complying with  
our petition you will very much oblige us

Very Respectfully

Your Obed. Sots

J. M. Horton

W. B. Urnsden

Wm. J. Normant

J. M. Holmes

Milton Wilson

Isaac N. Beard

J. E. Rowke

J. M. S. over

J. L. Lewis



New Orleans La.  
March 12<sup>th</sup> 1868

A. A. Supt. General

Enclosed drafts for  
\$134<sup>00</sup> &c.

Mar 12<sup>th</sup> 1868  
J. M. G. G.



Office Acty. Asst. Insp. Genl.  
Hd. Qrs. Dist. La. B. D. T. & A. S.  
New Orleans La. March 12<sup>th</sup> 1868,  
Mr. W. J. Lemmons.

Asst. Sub. Asst. Com  
Port of Catahoula.

Sir:

I have the honor  
to transmit by your receipt enclosed the sum  
of one hundred and thirty four dollars and  
sixty cents (\$134.<sup>60</sup>/<sub>100</sub>) amt. of draft drawn in  
my favor by Mr. Jacob Gauntt planter in  
settlement made under my supervision with  
Frederick employed by him during 1867  
on the Whittier Ridge & Cutaw plantations.  
The sum of dollars (\$19.<sup>00</sup>/<sub>100</sub>) excess of amt  
of the original draft — \$115.<sup>60</sup>/<sub>100</sub> — is the  
sum I collected of Mr. Gauntt on the trip  
down the river in settling the acct. of the  
man Simon Gambol (or Edmund Gaudison)  
who called to see me the evening of my settlement  
in behalf of the others and to whom some things were



due.  
A portion of this \$19<sup>100</sup> is the amount  
allowed for one animal sold by Mr. G.,  
for the fair Gombol in New Orleans.  
Please prepare receipts in duplicate and  
transmit them one copy for file with the  
other papers in the case.

I am

Very Respectfully,  
Your Obedt. Servt.  
Wm. W. Wood

St. Mary, Va.  
A. A. G. 1.



B 38 Bu R F + A L La '68

Headquarters Bureau R F + A L  
District of Louisiana  
Monroe, La, March 14. 1868

Buchanan Post Major General  
R. C.  
Asst Commissioner

States that authority to  
change your Station from  
Prairie Landing to  
Mossy Grove (Plantation)  
is granted. Direct that  
in future you be more  
cautious in cases of this  
character, which require  
first the approval of  
the Asst Commissioner

Asst Com 5th Sub Dist La March 19 '68

B 38 Bu R F + A L La '68

Headquarters  
Bureau R F + A L  
5th Sub Dist of Louisiana  
Monroe, La, March 19. 1868

Respectfully forwarded  
to Mr M. J. Sumner  
Asst Sub Asst Commissioner

W. W. Webb  
Captain 4th Cavalry  
Asst Asst Com 5th Dist La



# 251.

HEADQUARTERS,  
Bureau of Refugees, Freedmen and Abandoned Lands,  
DISTRICT OF LOUISIANA.

NO. 154 JULIA ST.

New Orleans, La., March 14<sup>th</sup>, 1868.

Mr M. J. Lemmon,

Asst Sub Asst Commissioner,

Parish of Catahoula, La,

Thro Mr S. C. Gold

Sub Asst Commissioner,

Sir,

I am, directed by the Assistant Commissioner to inform you that, authority to change your station from Prairie Landing, to Mossy Grove, Plantations, is granted, and to say that an application to change your station, does not carry with it authority to do so before the action of the Assistant Commissioner, is made known.

The Assistant Commissioner, also directs that, in future you be more careful



in cases of this character, and that no action  
in cases which require the approval of the  
Assistant Commissioner, be taken until you  
have first obtained such authority.

Very Respectfully,

Your Obedt Servant,

Meris H. Warner

Capt, 39<sup>th</sup> U.S. Infantry,

Actg Asst, Adj't, General.



Monroe Louisiana  
March 16, 1868.

Circular Letter

Relating to carelessness  
of Agents in making  
their reports.



Mar 16" 1868

by  
am

S



# 11

Please acknowledge receipt

Headquarters Bureau I. F. & A. L.  
5<sup>th</sup> Sub District of Louisiana  
Monroe, La., March 16<sup>th</sup> 1868.

Circular Letter

The Assistant Commissioner directs me to call your attention to the carelessness heretofore shown in many cases by Agents of this Bureau in forwarding carelessly prepared papers and vouchers to Headquarters New Orleans, will no longer be tolerated.

The Bureau Manual contains explicit information as to the proper method of preparing papers and vouchers, and together with Circular instructions, affords so little room for ignorance, that it can alone be attributed to carelessness.

Acting Sub Agent Commissioners, are directed to forward no papers of any description, until they are certain of their being properly filled out; that no omissions have been made; that receipts are filled out in writing, dates and figures legibly written; and that the general appearance of the document is clean, neat, precise in its language, and correct throughout.

W. W. Webb

Captain 4<sup>th</sup> U.S. Cavalry  
Sub Agent Commr, 5<sup>th</sup> Sub Dist of La

Mr M. J. Sumner  
A. S. A. Commr



Monroe La.  
March 18, 1868

Mar 19" 1868

Circular Letter

Instructions relative to  
unimportant questions asked  
by Agent regarding Circular  
No. 1 N<sup>o</sup> 25, N. Orleans.



Please acknowledge receipt.

#12.

Headquarters Bureau R. F. & A.  
5<sup>th</sup> Sub District of Louisiana  
Monroe, La, March 18<sup>th</sup> 1868.

Circular Letter.

The Assistant Commissioner calls my attention to the fact, that numerous and irrelevant questions are frequently asked by many of the Agents of this Sub District, in relation to the Supplies to be furnished planters under the provisions of Circular No. 1. Current since from Headquarters New Orleans.

The instructions are explicit, clear and positive, and no deviation will be made therefrom. Agents must conform themselves to what is specified in the Circulars.

Hereafter the unnecessary questions of the Character described, will not be forwarded to Headquarters New Orleans, but, will be returned to the Agents asking, or forwarding them.

W. W. Webb  
Captain 4<sup>th</sup> U. S. Cavalry  
Sub Dist Commr, 5<sup>th</sup> Sub Dist of La

Mr M. J. Lemmon  
A. S. A. Commr



B. 43. Bu A F & A L La 68

Headquarters Bureau A F & A L  
District of Louisiana  
New Orleans La March 18 1868

Buchanan Col Major Genl A C  
Asst Commissioner

Transmits Check # 235  
drawn by Messrs G M Bayley  
& Co on the Citizen Bank of  
New Orleans La, dated March  
18. 1868 for \$198 <sup>65</sup>/<sub>100</sub>. Directs  
enclosed receipt be signed  
and at once returned to Hd  
Quarters, and pay over to  
the proper fundmen employed  
by Messrs Calhoun & Rumson,  
that Receipt Roll signed  
and witnessed be forwarded  
to these Headquarters with  
the least possible delay

Recd Hd Qrs 5 Sub Dist La  
March 25 68

B. 43. Bu A F & A L La 68

Headquarters Bu A F & A L  
5th Sub District of Louisiana  
Monroe La March 25 1868

Respectfully forwarded  
to Captain W J Semmon  
A S & Commissioner

W. W. Webb

Captain 4th Cavalry  
Sub Asst Comm 5th Sub Dist La



H 267

HEADQUARTERS,  
Bureau of Refugees, Freedmen and Abandoned Lands,  
DISTRICT OF LOUISIANA.

197 Julia Street.

New Orleans, La., March 18<sup>th</sup> 1868.

Mr M. J. Lemmon,  
Assistant, Sub Assistant Commissioner,  
Parish of Catahoula, La.,

Thro Mr S. C. Gold,  
Sub Assistant Commissioner,

Sir,

I have the honor to transmit  
herewith Check #235 drawn by Messrs G. M. Bayley  
& Co on the Citizen Bank of Louisiana,  
of New Orleans, La, dated March 18, 1868, for  
One hundred and Ninety eight <sup>65</sup>/<sub>100</sub> (\$198 <sup>65</sup>/<sub>100</sub>)  
Dollars,

The Assistant Commissioner directs,  
that the enclosed receipt be signed, and at  
once returned to these Head Quarters, and

that you pay over to the proper Freedmen -  
to whom it is due - employed by Miss Calhoun  
and Brunson, - the amount named in the  
enclosed check, and that Receipt Roll for  
such payment, properly signed and witnessed,  
be forwarded to these Head Quarters with the  
least possible delay.

Very Respectfully,

Your Obedt Servant,

Memis H. Warren

Capt, 39<sup>th</sup> U. S. Infantry,

a. a. a. g.



B. 41. Bu RD + H La '68  
Headquarters Bureau RD + H  
State of Louisiana  
New Orleans March 19, 1868

Rushman & Haly Gul R. C.  
Chief Commissioner

States that your Tri-  
Monthly Report ending  
February 20<sup>th</sup> 1868 has  
not been received.

You will forward this  
Report immediately, and  
state how this delay has  
occurred.

R. C. Haly  
S. A. C. 5 Sub Dist La  
March 24, 68

B. 41. Bu RD + H La '68

Headquarters Bureau RD + H  
5<sup>th</sup> Sub Dist of Louisiana  
New Orleans March 24, 1868

Respectfully forwarded  
to Mr W. J. Sumner  
et al et Commissioner

W. W. Webb  
Capt 4<sup>th</sup> Reg Cavalry  
S. A. C. 5 Sub Dist La

HEADQUARTERS,  
Bureau of Refugees, Freedmen and Abandoned Lands,  
STATE OF LOUISIANA.

New Orleans, March 19<sup>th</sup> 1868.

Mr. M. P. Lemmon  
asst sub Asst Com'r  
Agent, etc., District,

Catahoula La.

Sir:

Thro Mr J. C. Gold.

Sub Asst. Com'r

The Assistant Commissioner of this Bureau,  
for this State, desires me to call your attention to the fact, that  
your Tri-monthly Report for the  
ten days ending July 20<sup>th</sup> 1868, as called for by Circular  
No. 36, of December 30<sup>th</sup> 1865, from these  
Headquarters, has not been received. You will please forward  
this Report immediately, and state how this delay  
has occurred.

Very respectfully,

Your obedient servant,

Wm. S. Cooper

Lieut and <sup>acting</sup> Assistant Adjutant General.



Monroe La.  
March 20 1868

Recd) March 4 1869

Circular Letter

Relative to Transplantation  
and admission into  
Freedmen's Hospital N.Y.

# 13.

Please acknowledge receipt

Headquarters Bureau P. F. & A. L.  
5th Sub District of Louisiana  
Monroe, La. March 20th 1868

Circular Letter.

Assistant, Sub Assistant Commissioners of this  
Sub District will at once report to Headquarters  
Bureau P. F. & A. L., New Orleans, La., in all cases,  
where transportation for freed people to New Orleans  
for admission to the Freedmen's Hospital, has  
been requested and furnished, whether or not  
the freed people are willing to accept the same  
upon its reception.

M. H. Garrison  
H. S. A. Comr

W. W. Webb  
Captain 4th Cavalry  
Sub Dist Comr, 5th Sub Dist of La



L. 84, Bu R F & A L  
L. 14, Bu R F & A L - La - '68  
Office Asst Sub Asst Comis  
Bureau R. F. & A. Lands  
Catahoula Parish March 21. 1868

Lemmon, M. J.

A. A. Comis

Ask for leave of absence  
for four or six days to  
visit New Orleans on  
private business.

Rec'd at B. 5<sup>th</sup> Sub Dist La. March 24 '68

L. 14, Bu R F & A L - La - '68  
Headquarters Bureau R F & A L  
5<sup>th</sup> Sub District of Louisiana  
Monroe, La, March 24. 1868.

Respectfully forwarded  
to Captain L. H. Warren  
A. A. General.

W. W. Webb  
Captain 4<sup>th</sup> U. S. Cavalry  
Sub Asst Comis 5<sup>th</sup> Sub Dist La

Headquarters Bu R F & A L  
5<sup>th</sup> Sub Dist of La  
Monroe April 3<sup>rd</sup> 1868.

L. 84, Bu R F & A L - La - '68

Headquarters  
Bureau R. F. & A. Lands,  
District of Louisiana,  
New Orleans March 30<sup>th</sup> 1868.

Respectfully returned to Mr.  
M. J. Lemmon, Asst Sub,  
Asst Comis, (Thru Capt  
H. H. Webb, Sub Asst Comis)

Request granted.

By order of  
Brig Maj Genl R. C. Buchanan,  
Asst Commissioner.

Cherish W. Mann  
Capt 39<sup>th</sup> U. S. Infy  
A. A. Genl

EP  
2/25/68

Office Asst Sub Asst Commr.  
Bureau R. F. + A. L.  
Catahoula Parish, La.  
March 21<sup>st</sup> 1868.

L. H. Warren, Capt 39<sup>th</sup> U. S. A.  
A. A. A. Local,  
Bureau R. F. + A. L.

Sir

I have the  
honor to ask for leave of absence for  
or six days, for the purpose of visit-  
ing New Orleans, on private business.

Very Respectfully Yours

Wm. Johnston

Asst Sub Asst Commr.

Bureau R. F. + A. L.



G. 14 Bu R. F. W. H. '68

---

Headquarters Bu R. F. W. H.  
3<sup>rd</sup> Sub Dist of Va  
Monroe April 3<sup>rd</sup> 1868.

---

Respectfully forwarded

Samuel C. Gold  
S. A. C. Bu R. F. W. H.  
3<sup>rd</sup> Sub Dist Va.

---

New Orleans La.  
March 24, 1868.

Frank R. Chase  
Genl. Supt. Edw.

---

Requests that reports  
be forwarded promptly.

Gen. Term 29 - 68.

School



HEADQUARTERS.

Bureau of Refugees, Freedmen and Abandoned Lands,

(189 JULIA STREET,)

Office General Superintendent of Education,

STATE OF LOUISIANA.

New Orleans, La., March 24<sup>th</sup> 1868.

Mr. W. P. Lemmon,  
Asst. Sub. Asst. Comr.  
Parish of Calhoun, La.  
Sir,

I have the honor to inform you that the "Asst. Sub. Asst. Comr. Monthly Report" required of you on the last day of each month, has not yet been received for the month ending February 29<sup>th</sup> 1868.

You will make and forward the same to this office with as little delay as possible.

In future I hope to receive this report promptly.

Very Respectfully,

Your Obedt. Servt.  
James A. Leese  
Genl. Supt. of Education  
Bureau, R. F. & A. L. Co.



L. 97 Bur 3rd La. 68.

L. 16 Bu A F & L La - 68

Office of S. A. Com'r  
Parish of Catahoula  
March 28<sup>th</sup> 1868.

From M. Johnson  
A. S. M. C.

States that he has offered  
to pay the freedmen  
employed by Mr. James  
Dunckley the \$274<sup>47</sup> sent  
him, which they request  
him to hold for them until  
the balance due on their  
cotton is received.

Halle Day & Co.

See L. # 338 up C. 1/18.

Wm. H. Johnson Sub Dist Cas  
April 3. 1868

L. 16. Bu A F & L La - 68

Headquarters Bureau A F & L  
5<sup>th</sup> Sub District of Louisiana  
Monroe, La, April 3. 1868

Respectfully forwarded  
to Captain L. H. Warren  
et. et. et. General

Samuel C. Gold  
Sub Asst Comm'r  
5<sup>th</sup> Sub Dist of Louisiana

L. 97. Bur 3rd La 68.

Head Quarters,  
Bureau R. F. and A. Lands,  
State of Louisiana  
New Orleans, April 11, 1868.

Respectfully returned to Mr.  
M. J. Lemmon, asst sub asst  
Comm'r, (Thru Mr. S. C. Gold, sub  
asst Comm'r,) whose attention is  
called to enclosed copies of  
communications from Halle  
Day & Co and Jas Dunckley  
also copy of statement of Mr  
Dunckley's account with  
Halle, Day & Co.

The freedmen can obtain  
the balance due them if an  
order for the amount (\$157<sup>47</sup> / 100)  
is obtained from Mr Dunckley  
and forwarded through the  
Bureau Agent for collection.

By order of  
Col Maj Genl R. C. Buchanan,  
Asst Commissioner.

James H. Warren  
Capt 39<sup>th</sup> U S Infantry  
a. a. a. g.



Officer Asst Sub Asst Commr.  
Bureau R, F. & A. S.  
Catahoula Parish, La.  
March 28<sup>th</sup> 1868,

L. A. Warren. Capt 39<sup>th</sup> U. S. I.  
A. A. A. Genl.  
Bureau R, F. & A. S.

Sir

I have the honor to state to you that I have offered to pay the Freed People employed by Mr James Duckley during the year 1867 the \$279<sup>49</sup>/<sub>100</sub>. sent me for them, but as there is a balance due them on their cation, they request me to hold the money now in my hands until I receive the balance,

Very Respectfully  
Yours Obed Servant

M. Johnston Lemmon,  
A. S. A. C. Bude, (over)

The within statement is correct.

Geo. L. Buckley

Dec 30 1868

Communication

to

Washington

James Buckley

Dec 16 On RR & M. Co 68





James Buckley

Secretary

to  
Commissioner

Mar 22<sup>d</sup> 1868

L. 16 On R.P. & A.H. Sa 68

Honorable Comm R.P. & A.H.  
5th Sub Dist of Louisiana  
New Orleans, La, April 24, 1868

Respectfully forwarded  
to Mr W.J. Summers  
Acting Commissioner, whose  
attention is invited to  
endorsement of the  
Act Commissioner

J. C. Gold

Sub Dist Comm  
5th Sub Dist of La



L 108. Bu R & H La '68  
L 19. Bu R & H La '68

Office chet Sub Asst Comr  
Parish of Catahoula  
March 28<sup>th</sup> 1868

Common M. J. M  
A. S. A. Comr

States that he failed to  
make his Tri-monthly Report  
of February 20. 1868. for the  
reason, that he was absent  
on an inspection tour.

On A. S. A. Sub Dist of La  
April 10. '68

L. 19. Bu R & H La '68

Headquarters Bureau R & H  
5<sup>th</sup> Sub Dist of Louisiana  
Monroe, La, April 10. 1868

Respectfully forwarded to  
Captain J. H. Warren  
A. S. A. General

Samuel C. Gold  
Sub Asst Comr  
5<sup>th</sup> Sub Dist of La

L 108. Bu R & H La '68

Headquarters Bureau R. & H  
District of Louisiana  
New Orleans La. April 14<sup>th</sup> 1868.

Respectfully returned to Mr.  
W. J. Lemon Asst Sub Asst  
Comr (thru Mr. S. C. Gold, ~~Sub~~  
Asst-Comr, 5<sup>th</sup> Sub. District. La)  
who will prepare and forward  
to these Headquarters, without  
delay, a Tri-monthly Report  
for the ten days ending Feb'y  
20<sup>th</sup> 1868.

By Command of Bot. Maj. Genl. R. C.  
Buchanan. U.S.A.

Wm. J. Stirling  
Captain 1<sup>st</sup> U.S. Infantry  
Actg. Asst. Adjt. General.

EPB  
4/28/68



Office Asst Sub Asst Comm.  
Bureau R. F. & A. Lands.  
Catahoula Parish, La.  
March 28<sup>th</sup> 1868.

L. A. Warren. Capt 39<sup>th</sup> U. S. I. C.  
A. A. A. Genl.  
Bureau R. F. & A. L.  
Sir

I have the honor to state to you, that in compliance with Paragraph III Circular No 35. Series of 1865, and Paragraph II. Circular No 19. Series of 1867. I was absent on an inspection tour, on the 20<sup>th</sup> of February 1868. Since the cause of my not forwarding the Monthly Report of that date. I spend as much time as circumstances will permit among the planters and freed people, throughout the whole Parish, to learn their wants, and to advise with, and encourage them, &c.

Very Respectfully  
Yours  
Obt. Servt.  
M. Johnston Lemmon,  
A. S. A. C., Bureau.



L. 19. Bu R. A. L. L. - 68.

Headquarters Bu R. A. L. L.  
3<sup>rd</sup> Dist of Louisiana  
Monroe April 21<sup>st</sup> 1868.

---

Respectfully referred  
to Mr. W. J. Simmons  
whose attention is  
invited to endorsement  
of A. A. General.

Saml. C. Good  
S. A. C. Bu R. A. L. L.  
3<sup>rd</sup> Sub Dist of Louisiana

B 48 On Rd & A 1<sup>st</sup> 168

Headquarters Bu R & A  
State of Louisiana  
New Orleans April 1<sup>st</sup> 1868

Subsidiary Bu R & A  
Act Commissioner

States that Bu R & A Col  
Edgar A. Demas has  
been instructed to ship  
you 1605 Rations for  
distractions of your  
Parish.

Recd 5<sup>th</sup> Sub Dist April 6<sup>th</sup> 1868

B 48 On Rd & A 1<sup>st</sup> 168

Headquarters Bu R & A  
3<sup>rd</sup> Sub Dist of Louisiana  
Monroe April 6<sup>th</sup> 1868

Respectfully forwarded  
to Mr. M. J. Lemmon  
A. S. A. Comr

J. M. Good  
S. A. 3<sup>rd</sup> Sub Dist La.



HEADQUARTERS,  
Bureau of Refugees, Freedmen and Abandoned Lands,  
DISTRICT OF LOUISIANA,

No. 191 Julia Street,

New Orleans, La., *April 1<sup>st</sup>* 1868.

*M. M. J. Lemmon*

Assistant Sub Assistant Commissioner

Parish of *Catahoula*, La.,

(Thro' *M. S. C. Gold*,

Sub Assistant Commissioner.

SIR:

I am directed by the Assistant Commissioner to inform you, that Bv't Lieu't Co'l EDGAR C. BEMAN, D. O. and A. A. Q. M., has this day been instructed to send to you by the most practicable route, *1605* RATIONS for distribution to the destitute. The same will be issued and accounted for in accordance with existing instructions.

You will in addition, state in your Tri-monthly-Report, receipt of rations, giving bulk in pounds, and will, in subsequent Tri-monthly-Reports, state number of pounds remaining on hand.

Very Respectfully,

Your Obedient Servant,

*Thomas W. Ware*

Captain 39th U. S. Infantry,  
Act'g Ass't Adj't General.

HEADQUARTERS,  
Bureau Refugees, Freedmen and Abandoned Lands,  
DISTRICT OF LOUISIANA.

New Orleans, April 15<sup>th</sup> 1868.

Respectfully returned to Mr. J. Lemmon, A. S. A. C., with the information that a properly executed copy of the bond must accompany these papers. The bond will be stamped in accordance with regulations, viz, five cents for every one hundred dollars of the bond. Affidavits, and in fact all the papers, are made out in duplicates only, one copy of which is retained, the other forwarded to this office.

By command of Col. M. G. Fort  
R. C. Bushyhead, Asst. Comr.

Wm. A. Stirling  
Captain Prov. Inf.,  
A. S. A. C.

EB  
4/20/68

2<sup>nd</sup> Bu. R. F. & A. L. - 65

Headquarters Bu. R. F. & A. L.  
3<sup>rd</sup> Sub Dist of La.  
New Orleans April 20<sup>th</sup> 1868.

Respectfully forwarded  
to Mr. M. J. Lemmon whose  
attention is invited to the  
forging endorsement.

Saul C. Coeds  
S. C. Bu. R. F. & A. L.  
3<sup>rd</sup> Sub Dist of La.



April 21/1868

O. Wash

and A. C. Wash

Amesbury Wash

Office Apt. Sub. Apt. Camr. Du. &c.  
Parish of Concordia La.

Vidalia La. April 21<sup>st</sup> 1868

Mr. M. J. Sumner  
A. P. Camr. Du. Ref. &c.  
Catahoula Parish La.

Sir  
The bearer of this Sophia  
Byers (F.) complains against Mr. Lewis Ker  
of Catahoula Parish.  
As the parties are out of my jurisdiction, I  
refer her to you.

Very Respectfully  
Y<sup>r</sup> Obedt. Servt.  
Christian Rush  
A. P. Camr.  
Parish of Concordia  
La.

Per. Post

Chuk



Memoranda  
May 5 1868

May 5<sup>th</sup> 1868

Sauls Gold  
S. A. Comr.

---

Relative to Freedmen  
who quit their contracts

#61.

Headquarters Bu. R. & A.  
5th Sub Dist of Va

Monrovia May 3<sup>rd</sup> 1866.

W. M. Faxon

A. S. Com Bu. R. & A.

Sir,

In reply to your communication bearing date the 1<sup>st</sup> inst, in regard to Freedmen quitting their Contract. I would refer you to letter dated at Headquarters Bu. & New Orleans, Feb 1<sup>st</sup> 1866, and state that when contracts with Freedmen are made and approved by you, and the Freedmen quit their contracts without good and sufficient cause, you should use your utmost endeavors, to have them return and amply with their agreements.

Persons employing Freedmen knowing them to be under contract with other parties, should be brought before the civil Courts by the parties with whom they were under contract.

Very Respectfully

Your Obedt servt

Saml. G. Wood S. M. Com  
5th Sub Dist of Va



L 151 Bu R F & A L La 68  
L 26 Bu R F & A L La 68

Office Asst Sub Asst Comm  
District of Catahoula  
May 7th 1868

Sumner M J W  
Asst Comm

Transmits list of indigent  
and destitute Whites  
and Freedpeople.

Tri Monthly Report  
ending May 10. 1868.

Asst Comm 5th Sub Dist La  
May 19. '68

L 26 Bu R F & A L La 68

Headquarters Bureau R F & A L  
5th Sub Dist of Louisiana  
Maurice, La, May 19. 1868

Respectfully forwarded  
to Captain S. H. Warren  
Act. Asst. General

Samuel C. Gold  
Sub Asst Comm  
5th Sub Dist of La

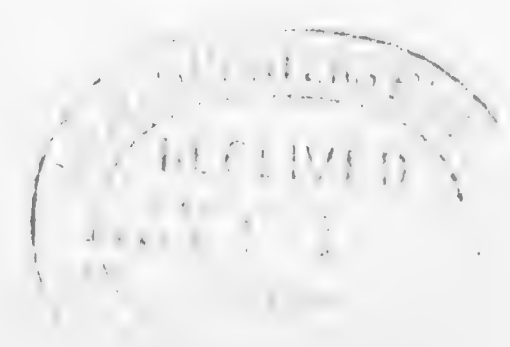

L 151 (Bu. R. F. & A. L., La.) 1868

HEADQUARTERS  
BUREAU REFUGEES, FREEDMEN AND ABANDONED LANDS,  
STATE OF LOUISIANA.

New Orleans, May 22 1868

Respectfully returned to Mr. J. H. Johnston  
Sumner Asst Sub Asst Comm.  
Through Mr. Samuel C. Gold Sub  
Asst Comm 5th Sub Dist for corrections.

An application for rations to  
be issued to "Indigent, and  
"Helpless" whites and freed people  
must be accompanied with a  
report, giving the name, age,  
sex, cause of destitution, and  
the names of the Police Jurors  
certifying to the same, in accor-  
dance with Circular No 19 series  
of 1867.

By order of  
Bvt. Maj Genl. J. C. Buchanan, U.S.A.

Lucius H. Warren  
E B  
5/19/68  
Captain 39th U.S. Infantry  
Actg Asst Adjt General



Office Asst Sub Asst Comm.  
Bureau R. <sup>Fans</sup> A. Lunds.  
Mossy Grove.  
Catahoula Parish, La.  
May 7<sup>th</sup> 1868,

M. H. Sterling, Capt 1<sup>st</sup> U. S. A.

A. A. A. Genl.  
Bureau R. <sup>Fans</sup> A. L.  
Sir

I have the honor  
to transmit you here with, duplicate list  
of indigent and destitute whites and freed  
peoples, forwarded from this office March  
1<sup>st</sup> 1868. Those persons are very destitute  
and apply to me daily for assistance, and  
I would respectfully ask that assistance  
be given them.

Very Resptly Yours  
O. S. Servt.

M. Johnston Lemmon,  
A. S. A. C., Bu & S.



A. H. C. & Co. J. H. J. & Co. '68  
Headquarters Co. R. F. S. S.  
3<sup>rd</sup> Sub District of Louisiana  
New Orleans May 26<sup>th</sup> 1868.

Respectfully forwarded  
to Mr. M. Johnson Leisner  
of S. S. Morris whose attention  
is invited to the foregoing  
endorsement.

Samuel C. Good  
Sub Asst Comm  
3<sup>rd</sup> Sub Dist La.

<i>Whites</i>	Age	Sex		Age	Sex
Alice Lockier	4	M	Litha McIntire	30	F
David Lockier	8	M	Henry Hamister	4	M
Wm Lockier	11	"	Ella "	2	F
Edmund Duncle	9	"	Eliza Bailey	35	"
Mary Ship	35	F	Francis Lockier	14	M
Maggie "	8	"	Letitia Mudden	10	F
Benjamin "	11	M	Freddy "	4	M
Rosa "	5	F	John "	7	"
Louisa Smith	28	"	Lucy "	7	F
James "	13	M	Lydia "	11	"
Bernavista "	6	"	Sallie Jones	30	"
Roma "	9	F	Henry "	4	M
Eliza "	11	"	Lena "	7	F
Mary Mayors	9	"	Matilda "	14	"
Wm "	6	M	Rachel "	10	"
Sallie Walker	42	F	Filly Deshey	12	"
Silman "	12	M	Shelby "	9	M
Jo "	9	"	Elizabeth "	14	F
Wm "	5	"	Anna Roelied	12	"
Mary Smith	60	F	Julia Fairbanks	38	"
Wm "	78	M	Palmer Hamilton	39	"
Stacy Hodkins	8	F	Sarah "	18	"



Name	Age	Sex	Parent	Age	Sex	Name	Age	Sex	Parent	Age	Sex
Gokey Hamilton	11	F	Calend			Adelina Montgomery	114	F	Ellen Whiting	55	F
Amanda "	11	"	Lee Young	70	M	Lucy "	18	"	Billy Montgomery	85	M
Daniel "	8	M	Harriet "	7	F	Fanny "	114	"	Darcus Taylor	75	F
Millie "	5	"	George Ann "	5	"	Jenny "	10	M	Martha Joyce	20	"
Mollie Douglass	54	F	Mary "	3	"	Peter "	6	"	Mickey "	4	"
Mollie Temple	13	"	Louisa Johnson	40	"	Stacie "	10	F	Judy Driscoll	6	"
Matilda "	6	"	Fatey Norton	30	"	Mary Jones	11	"	Susan "	4	"
Martha "	10	"	Marinda Jones	41	"	Moses Newyman	44	M	Laura Martin	7	"
Elinora "	13	"	Lewis Johnson	5	M	John Stokes	141	F	Fannie "	8	"
Horace Douglass	5	M	Minnie "	6	F	Matilda "	12	"	Spencer "	7	"
Joe Hicks	60	"	Jenny "	12	M	Nancy "	9	"			
John "	8	"	Abraham	3	"	Ruben	6	M			
Mary McClure	40	F	Mary Ann Jones	7	"	Ann Eldridge	3	F			
Frank "	12	M	Simon Batwells	70	"	Simon "	7	M			
Alice "	8	F	Aster Green	50	"	Mary	11	F			
Judson "	4	M	Sam Johnson	18	M	Adilia Williams	80	"			
Naoma "	4	F	Ellen Jackson	40	F	John Colson	87	M			
A. B. Mailey	60	M	Susan "	16	"	Harry How	79	"			
Sarah "	38	F	Nathan "	12	M	Rebecca Hardman	75	F			
Laura "	11	"	Wash "	9	"	Emily Wilson	6	"			
Laura "	9	"	Pacey "	6	F	Jana "	11	M			
Gene Grant	5	M	James "	4	M	Bella Sargant	50	F			
Riley "	2	"	Abby Green	3	F	Sarah Nixon	91	"			
			Lura "	6	"	John "	4	M			



L. 138, 19th Dec 1868

Office of Asst Sub Asst Comd  
W. B. R. St A. S. Comd  
Catahoula Parish La  
Mossy Grove May 11/68

Summon M.D.  
Asst Sub Asst Comd

Asks for transportation  
for three indigent freed-  
men to be sent to  
A. C. Hosp

Rec'd Office Surgeon-in-Chief May 11/68

Office of Surgeon-in-Chief  
W. B. R. St A. S. Comd  
New Orleans La May 11/68

Respectfully referred to  
Capt. L. H. Harrod  
U. S. A. with the  
remark that it does not  
appear that the within  
named freedmen are sick  
or diseased. They are  
probably fit subjects  
for the Dependents'  
Home Branch of the A. C.  
Hosp; But if the U.  
S. A. Comd have the  
means it is suggested  
that it would be  
economy to subsist  
them where they are.

A. C. Smytholder  
Surgeon-in-Chief  
W. B. R. St A. S. Comd  
Dist. La.



(Officer Asst Sub Asst Commr.  
Bureau R, Hous A. S.

Massy Grove,  
Catahoula Parish, La.  
May 7<sup>th</sup> 1868.

Mr A. C. Sartzwelder,  
Surgeon in Chief,  
Freedmen's Hospital,

Sir

I have the honor to state to you, that there are three old indigent freedmen here, who have no homes or means of support, and I would respectfully ask for transportation to send them to the Freedmen's Hospital, N. C. Their names are Lee Young, Burr White and Henry Bealmer.

Very Respectfully  
Yours Obedt Servt,

M. Johnston  
A. S. A. C. Bureau R. Hous A. S.

HEADQUARTERS,  
Bureau Refugees, Freedmen and Abandoned Lands,  
DISTRICT OF LOUISIANA

New Orleans, May 13<sup>th</sup> 1868.

Respectfully returned to Mr. W. Johnston Sumner  
(thro: Dr. A. C. Swartzwelder - Surgeon-in-Chief).  
with the information, that his request is  
not granted.

Mr. Sumner's attention is directed to the  
endorsement of the Surgeon-in-Chief, and  
informed that cases of the nature of  
those mentioned within, will not be re-  
ceived at the Hospital. They should be  
reported upon the "Indigent" List.

Mr. Sumner will in future forward  
his applications through the proper  
channels to the Acting Asst. Adj. General.

By Command of  
Brig. Major General R. C. Buchanan.

*James H. Warr*  
Captain, 39<sup>th</sup> U.S. Infantry.  
Actg. Asst. Adj. General.

*ED. 5/13/68*

*Copies of Surgeon in Chief  
10<sup>th</sup> 14<sup>th</sup> 21<sup>st</sup> R. F. A. L.  
New Orleans La May 14/68*

*Respectfully returned to  
Mr. W. Johnston Sumner  
Asst. Adj. Gen. attention called  
to endorsement of A. A. Adj.  
Genl.*

*A. C. Swartzwelder  
Surgeon in Chief  
D. R. F. A. L.  
New Orleans*



N. 2 (C.A.S.A.C. Par. Com.) 15 1868

Huntley, Catahoula Parish  
May 30<sup>th</sup> 1868

Mr Lewis B.

Acknowledges favor of Mr. Rush in reference to two women who left his place. States that his contract is approved by Capt. Semmon who says it is just.

Requests that the two women be compelled to return to their contract. States that one of the men on Dr. Perry's place had shown knowing they were under contract.

States that an old man on Dr. Perry's place has a clock, belonging to his wife, which he refuses to give up and threatened his life. Appeals to the Jury for aid in the absence of law.

Recd. at St. Louis Par. Com. 1 May 28 1868

N. 2 (C.A.S.A.C. Par. Com.) 1868

Office Asst. Sub. Asst. Comr. Bu. Refr.  
Parish of Concordia La.  
Vidalia May 29<sup>th</sup> 1868

Respectfully referred to Mr.

Mr. J. Semmon Asst. Sub. Asst. Comr. Catahoula Parish, (Thro. Mr. Sam'l C. Gold Sub. Asst. Comr.

5<sup>th</sup> Sub. Dist.) with the information that I will take action in the within case upon his application, approved by the Asst. Commissioner.

No certificate was enclosed as stated within.

Christian Rush

Asst. Sub. Asst. Comr.  
Parish of Concordia La.

N. 7. Bu. & Fy. H. - La - 18

Headquarters Bureau & Fy. H.  
5<sup>th</sup> Sub. Dist. of Louisiana  
Monroe, La, June 8<sup>th</sup> 1868

Respectfully forwarded to Captain M. J. Semmon et. & et. Comr. Parish of Catahoula.

Sam'l C. Gold

Sub Asst Comr.  
5<sup>th</sup> Sub. Dist. of La

Recd. July - 4 1868



Thurley, Catahoula Parish.  
May 25<sup>th</sup> 1868.

Captain Rush. 3  
Bridalia 3  
Dear Sir

Your favour, in reference to two women, who left my place some time ago, was duly received. My Contract is approved by Captain Lemon, the Agent for my Parish, who also says that it is very just in all of its requirements. Now, dear Sir, as you said that you would compel these two women to return to their contract, I will be greatly obliged to you to do so. My contract is made according to the regulations of the Bureau. This I will show you when you come out. One of the men on Mr Percy's place hired these two women, and took them to a neighbouring place, knowing that they were under contract to me. I enclose a certificate to this effect, from the party to whom he took them to live. So please give me the benefit of your aid, in arresting & bringing him to justice. Another old man on the Percy place has a clock, belonging to my wife, which he refuses to give up, and he has threatened my life. I appeal to you for redress, in the absence of Civil Law. Please write me by the return of the mail, saying when you can come out, and I will send my boat for you. We live only a few hundred yards from Mr Percy.



If you will come out, I will send for you, and when  
you come, I will go with you to Mr Percys, or meet  
you there, and you can get my clock for me,  
and return the women to the place here.

By so doing, you will confer a great favour on  
Yrs very respectfully  
Louis, Clerk

May 28

No 52 Bu Rpt of S. La 168

Headquarters Bu Rpt of S. La  
District of Louisiana

New Orleans La May 21 1868

Asst Comdr of 23  
Hamm Capt S. H.  
A. A. General

Transmits sheet No 514  
for \$65.39. Directs that  
duplicate receipts for  
same be forwarded and  
instructions in regard  
to payment of the  
money to the proper  
functionaries.

3rd Sub Dist May 23 1868

No 52 Bu Rpt of S. La 168

Headquarters Bu Rpt of S. La

3rd Sub Dist of S. La

Monroe La May 23 1868

Respectfully forwarded

to Mr J. J. Leveque

A. S. A. C.

J. J. Gold

Sub Asst Comdr

3rd Sub Dist of S. La



#451

HEADQUARTERS,  
Bureau of Refugees, Freedmen and Abandoned Lands,  
DISTRICT OF LOUISIANA,

New Orleans, La., May 20<sup>th</sup> 1868

Mr. M. Johnston Linnou,

Asst. Sub. Asst. Commr.

Parish of Catahoula. La.

(Thro: Mr. Saml. C. Gold.

Sub. Asst. Commr 5<sup>th</sup> Sub. District).

Sir.

I have the honor to enclose herewith duplicate Account Sales of Six (6) Bales Cotton, by Messrs. Alcus, Sherck and Auley, together with statement, also check for the sum of Sixty five <sup>39</sup>/<sub>100</sub> Dollars, being one-fourth of net proceeds of sale of said Cotton, due Freedmen.

The Assistant Commissioner directs, that duplicate receipts for said check be forwarded to these Headquarters immediately upon receipt of the same, and that you without delay, pay over to the proper freedmen, employed by Mr. J. B. Cotton, on the "Preston plantation" to whom it is due, the amount

named in said check, and that Receipt-Roll for such payment properly signed and witnessed, be forwarded to these Headquarters, with the least possible delay, together with the return of the enclosed papers.

Very Respectfully.

Your Obedient-Servant.

Lewis H. Warner

Captain, 39<sup>th</sup> U. S. Infantry.

Actg. Asst. Adjt. General.



Witnessed and  
Testimony by the  
Asst. Surg. Gen. Comd.  
C. G. Clark  
1867

May 29<sup>th</sup> / 68

New Orleans La  
May 29<sup>th</sup> 1868

Court Assistant

Enquires what evidence  
exists regarding the transac-  
tions of Capt. C. G. Clark late  
Southern Agent

#583.

HEADQUARTERS,  
Bureau of Refugees, Freedmen and Abandoned Lands,  
DISTRICT OF LOUISIANA.  
No. 154 JULIA STREET.

New Orleans, La., May 29<sup>th</sup> 1867

Mr. M. Johnson Levee  
Assistant Sub Agent Commissioner  
Bureau R. F. and A. Lands  
Prairie Landing, Black River.

Sir,  
I am directed by Brigadier General  
J. A. Mower U.S.A. Assistant Commissioner &c.  
to direct you to see the undermentioned persons,  
and take any statements they may have to make  
(in form of affidavits) respecting the alleged  
misdemeanors in office committed by Capt. E. L. Clark  
late Agent of this Bureau for your parish, and  
any misapplication of rations by that Officer —  
You will also find out if he has been interested  
in any plantations, give their location, names  
of owners, the amount of rations issued to them,  
if any, and any information you can  
gather respecting the administration of the affairs  
of the Bureau by Captain Clark.

The following persons can give you some in-



- formation.

Charles Jones.  
John Badger.  
John Davis.  
Thomas Williams.  
Peter Kruger.

Jack Branch  
Noah Reddick.  
Ransom Reddick.  
Jacob Garrett  
George Branch

You will be careful to have  
all the facts reported substantiated by affi-  
-davits, and furnish the information  
requested with as little delay as possible.

Very Respectfully

Your Obedient Servant

(Signed) Wm. H. Sterling

Captain 1<sup>st</sup> U.S. Infantry

Act Asst Adjt General

Official

Wm. H. Sterling

Captain 1<sup>st</sup> U.S. Infantry  
Act Asst Adjt General

O. 55. Qu R F & Ak. La '68

Headquarters Bureau R F & Ak  
District of Louisiana  
New Orleans, La, May 29 '68

Cushman Post May Quit R C  
Act Commission

Directs to ascertain whether  
or not the clothing mentioned  
in the enclosed papers was  
received and issued to the freedmen  
also whether or not the  
freedmen should pay one fourth  
of cost of baling materials.  
also Directs, if this statement  
is correct, the \$279<sup>49</sup>/<sub>100</sub>  
be at once paid over to the  
freedmen.

Rec'd R F & Ak 5th Sub Dist La  
June 2 '68

O 55 Qu R F & Ak. La 68

Headquarters Bureau R F & Ak  
5th Sub Dist of Louisiana  
Monroe, La, June 2. 1868.

Respectfully forwarded to  
Mr M. J. Lemmon  
U. S. At. Commr

Paul C. Gold  
Sub At. Commr  
5th Sub. Dist of La

May 29<sup>th</sup> 1868

Communication  
from  
Headquarters

James Dunkley



#484.

HEADQUARTERS,  
Bureau of Refugees, Freedmen and Abandoned Lands,  
DISTRICT OF LOUISIANA,

New Orleans, La., May 29<sup>th</sup> 1868.

Mr. M. Johnston Lemmon.

Agt. Sub. Asst. Comisr

Parish of Catahoula. La.

(Thro: Mr. Saml. C. Gold.

Sub. Asst. Comisr - 5<sup>th</sup> Sub District.)

Sir.

I have the honor to acknowledge the receipt of your communication of the 4<sup>th</sup> inst. and in reply to enclose herewith statement of Messrs. Tolle. Day & Co.

The Assistant Commissioner directs that you ascertain whether or not the clothing mentioned in <sup>the</sup> enclosed papers was received and issued to the freedmen; also whether or not it was stipulated in contract of freedmen with Mr. Duckley that the former, (the freedmen) should pay one-fourth of cost of baling materials, if so this amount must be considered by the laborers as paid from their portion of proceeds

of crop together with that of cost of clothing if furnished them.

The Assistant Commissioner also directs, that should these statements prove to be correct, the amount Two hundred seventy nine <sup>49</sup>/<sub>100</sub> Dollars, now in your hands be at once paid over to freedmen, and instructions from these Headquarters of date February 26<sup>th</sup> 1868, complied with, with the least possible delay.

Very Respectfully,

Your Obedient Servant

Wm. H. W. W. W.

Captain, 39<sup>th</sup> U. S. Infantry.

Actg. Ass't. Adj't General.



Monroe La  
June 4, 1868.

June 4<sup>th</sup> 1868

Samuel C. Gold  
S. A. Stewart

Mr J. de A. Stewart  
has Bureau manual.

Received

and say 11

Beavers

from the 1868



Headquarters Bu. R. F. & M.  
5th Sub District of Pa  
Harrisburg Pa July 4<sup>th</sup> 1868.

Sir:  
You will report to this office  
by return mail, or with the least  
possible delay, whether you  
have a Bureau Manual  
(Officers Manual Bu. R. F. & M.)

Very Respectfully  
Your obt<sup>d</sup> Serv<sup>t</sup>  
Saul C. Gold  
Sub-Sub Com<sup>d</sup> Bu. R. F. & M.  
5th Sub District of Pa.

M. J. Sumner Esq  
Asst. Adm. Com<sup>d</sup>  
Trenton Pa.

Monroe La.  
June 1<sup>st</sup> 1868

June 1<sup>st</sup> 1868

Circular Letter

Requiring the number  
and condition of Crops  
in different Parishes.



HEAD QUARTERS,  
BUREAU OF REFUGEES, FREEDMEN & ABANDONED LANDS

FIFTH SUB-DISTRICT OF LOUISIANA.

MONROE, LA: June 1<sup>st</sup> 1868.

Circular Letter.

Assistant Sub Assistant Commissioners  
of this District will make and forward to this Office  
by the fifteenth day of each month a Report  
stating the number and condition of Crops  
on all Plantations in their respective Parishes,  
which have been furnished with supplies under  
the Provisions of Circular No. 1 C. S. from  
Headquarters in New Orleans, La, dated  
January 23<sup>d</sup> 1868.

strict compliance with this Circular  
will be required.

David C. Gold  
Sub Act Commr  
5th Sub Dist of Louisiana

Mr W. J. Sumner  
S. J. A. Comr

June 10/68

W. W. Wood  
2<sup>d</sup> St. La. f.

Prairie Laundry

June 10<sup>th</sup> 1968

Received of W. W. Wood  
the sum of \$10.00  
for the month of June  
1968. This amount is  
in full for the month  
of June 1968. The  
balance of the account  
is \$0.00. W. W. Wood  
Prairie Laundry

W. W. Wood  
Prairie Laundry  
2<sup>d</sup> St. La. f.



#191.

HEADQUARTERS,  
Bureau of Refugees, Freedmen and Abandoned Lands,  
Office of Assistant Commissary of Subsistence.

New Orleans, La., June 10th, 1868.

Mr. W. J. Leimon,  
A. S. A. C.,  
Prairie Landing, La.

Sir:—

I return to you,  
herewith, the "Agreement with Freedmen"  
between certain freedpeople and Joseph A. White,  
planter, of your Parish. You will please  
have the same made on the blank form  
enclosed, and in accordance with the  
instructions noted in pencil marks. The  
supplies, however, will be forwarded without  
delay.

Very Respectfully,  
W. W. Wood  
2<sup>d</sup> Lieut. 1<sup>st</sup> Inf., A. S. A.

O. G. Bu R. I. & A. La '68

Headquarters Bureau R. I. & A.  
District of Louisiana  
New Orleans, June 13. 1868

Buchanan Post Major R. C.

Post Comdr

States that Post Major  
E. C. Cuman. P. C. & A. G. M.  
has been instructed to send  
to you

135 Rations for  
distributions.

W. H. G. 5th Sub Dist. La, June 21 68

O. G. Bu R. I. & A. La '68

Headquarters Bureau R. I. & A.  
5th Sub District of Louisiana  
New Orleans, La, June 21<sup>st</sup> 1868

Respectfully forwarded to  
Mr W. J. Simmons  
A. J. A. Comdr

Samuel Gold

Sub Aft Comdr  
5th Sub Dist of La

W. H. G.



HEADQUARTERS,  
Bureau of Refugees, Freedmen and Abandoned Lands,  
DISTRICT OF LOUISIANA,  
No. 191 Julia Street,

New Orleans, La., June 18<sup>th</sup>, 1868.

*Robert Johnston Leannon*  
Assistant Sub Assistant Commissioner,

Parish of *Catahoula*, La.,

(Thro' *Wm. S. Gold*,  
Sub Assistant Commissioner.

SIR:

I am directed by the Assistant Commissioner to inform you, that Bv't Lieu't Co'l EDGAR C. BEMAN, D. O. and A. A. Q. M., has this day been instructed to send to you by the most practicable route, ~~135~~ RATIONS for distribution to the destitute. The same will be issued and accounted for in accordance with existing instructions.

You will in addition, state in your Tri-monthly-Report, receipt of rations, giving bulk in pounds, and will, in subsequent Tri-monthly-Reports, state number of pounds remaining on hand.

Very Respectfully,

Your Obedient Servant,

*Thomas W. Warren*

Captain 39th U. S. Infantry,  
Act'g Ass't Adj't General.

June 17/68.

W. W. Wood  
2<sup>d</sup> St. & Cal.

Pruned Landings

June 17<sup>th</sup> 1868

A. C. S.

Received of W. W. Wood  
the sum of \$100.00  
for the purchase of  
land in the town of  
Pruned Landings  
in the county of  
San Diego  
California  
this 17<sup>th</sup> day of June  
1868

W. W. Wood

Pruned Landings



# 224

HEADQUARTERS,  
Bureau of Refugees, Freedmen and Abandoned Lands,  
Office of Assistant Commissary of Subsistence.

New Orleans, La., June 17<sup>th</sup>

1868.

Mr. W. J. Lemmon  
Asst. Commissioner  
Prairie Landing La

Sir

I have the honor to transmit herewith duplicate  
Invoices and receipts for Subsistence shipped you  
on the 16<sup>th</sup> inst per Steamer Beacon. you will please  
sign receipts and return them to this Office at  
your earliest convenience.

Respectfully your  
Obt. Servant

W. Wood

2<sup>d</sup> Lieut. 1<sup>st</sup> Inf. Regt. A. C. S. B. R. S. & L.

New Orleans La.

June 29 1868

Orders

No 13

Relating to discontinuance  
of issuing rations to the  
destitute Freedmen.

895



Reports

of

W. Johnson Sumner

from

Oct 15 67 to Aug 14 1868

G. M. C.

HEADQUARTERS BUREAU OF REFUGEES, FREEDMEN  
AND ABANDONED LANDS, DISTRICT OF LOUISIANA,  
NEW ORLEANS, LA., June 29th, 1868. }

ORDERS {  
No. 13. }

In view of the fact that corn and vegetables are becoming plenty throughout the Parishes of this State, and as it is thought that the few decrepit and infirm persons can be provided for by the civil authorities, the issuing of rations by the Bureau to Indigent and Helpless will be discontinued for the present, after such supplies in the hands of Agents have been issued.

Assistant Sub Assistant Commissioners will therefore notify the Police Jurors in their respective Parishes, that they will be expected to provide for their own poor, as required by law.

By order of

BVT. MAJ. GEN. R. C. BUCHANAN, U. S. A.

Assistant Commissioner.

LUCIUS H. WARREN,

Bv't Lien't Colonel U. S. A.

Captain 39th Infantry.

Act'g Ass't Adj't Gen'l.

OFFICIAL:

*W. C. Wood*  
Act'g Ass't Adj't Gen'l.







K. 14. Burd J. A. L. Co. W.

Hambley July 13<sup>th</sup> 1868

Wm. Lewis Barron  
Trinity Catahoula Parish La

Reports that two freed women  
who contracted with him for  
labor, left his place and  
went into Concordia Parish,  
on another place to labor.  
Stated the case to Mr.  
Linnon, Agent of the Bureau  
in Catahoula Parish, who referred  
him to Mr. Ruck Agent in  
Concordia Parish. Mr. Ruck  
has not attempted to trace  
the clothes of the women in  
his possession, they owe him  
\$100 - reports information  
as to what he shall do in  
the case.

Dr. Precy Plant  
Concordia Par -

K. 14. Burd J. A. L. Co. W.  
R. 278 - O. sub. dist La 1868

Officer Sub. Court Comm. Rec.  
R. J. and A. L. 6<sup>th</sup> Sub. Dist. La.  
Vincennes La. Aug. 13<sup>th</sup> 1868.

Respectfully returned to  
Post. Sheriff W. T. Success

Wm. Barron A. A. A. Court.  
Rec. New Orleans and after  
been advised to the enclosed  
statement of Mr. Here and  
Suphe Pier. After hearing  
both parties, it is my opinion  
that of this nephew of Er  
Cor. Barron had his just  
deserts he would this day  
be within the walls of the  
Penitentiary, for his infidelity  
and other obvious conduct toward  
this event.

I would respectfully request  
that a J. A. C. for the Parish of  
Catahoula, when this man has  
needed, be instructed to call on  
Mr. Here and order him to give  
the women their clothing, (a valuable)  
Thank R. D. Barron  
Post. Sheriff #13 Hambley, Sub. Dist. La.





1868

~~K 12 Bu R. A. F. Co - '68~~

Headquarters Bu R. A. F.  
Sub Dist of Va

Warren Va Aug 22 1868

Respectfully forwarded  
to Mr J. A. H. Camp  
A. S. A. whose attention  
is invited to the foregoing  
endorsements

Paul G. Galt

Sub Adj. Genl

Sub Dist, Va

Monday, July 13<sup>th</sup> 1868.

Genl. Buchanan.  
Comd'g Fifth Military Dist  
Adpts. New Orleans.

Dear Sir.

Some time ago, two freedwomen, who were hired to me for this year, left me, and refused to return to their labor. My contract is duly approved by Captain Guion, the Bureau Agent for this (Katahoula) Parish. I appealed to him for redress. He told me that as the women had gone over into another Parish (Concordia), I would have to get the Bureau Agent of that Parish to enforce their return. I thereupon appealed to Captain Rush the Agent for Concordia for redress. He replied that if my contract was made in accordance to the Bureau regulations, and approved by the Agent in this Parish, he would see that the women returned to their contract. I immediately assured him of the fact, and he replied that he would come out at his earliest convenience and attend to it. Now, I can prove that Captain Rush has been on the place where these women live, since he wrote me the last letter, and that place is only a few hundred yds from my residence.



When these two women left my place, they left all of their clothing &c, which I at once took charge of, and locked up. I asked Captain Simon what I should do with these clothes, and he told me to keep them until the women returned to fulfill their contract. It has now been three months since these women left, and by Captain Simon's instructions, I have had their clothes in my possession ever since.

These women declare that they will not work for me again under any circumstances.

If you will have the kindness to instruct me what to do in the premises, I shall be most thankful to you. These women are in my debt, to the amount of fifteen dollars. I do not wish to keep their clothing &c, if it is proper that they should have them. As I wish to abide by all laws in such cases, I shall be pleased to comply with your instructions in this case. I have all of the correspondence between Captain Simon & Rush & myself.

I trust that you will pardon my intruding upon your time & attention, as I have appealed in vain to the Bureau Agents mentioned above. For the truth of my statements, and for my respectability, I would most respectfully refer you to my Uncle, Ex Gov: Baker.

Most respectfully your obed<sup>t</sup> serv<sup>t</sup>  
Lewis. B. Ker.

P.S. My address is

Lewis. B. Ker.  
Trinity  
Catahoula Parish  
La.



---

---

Statement

of  
Sophie Beer

&  
Neddy Johnson

---

---



Personally came before me, at my Office, this Eighth day of August 1868.  
Sophie Beer and Meedy Johnson - Freedwomen -  
Sophie Beer makes the following statement:

Mr. Kerr called us up one morning and told us to raise up a sick horse, I told him I was not able to raise him, as I was then large in family way. Mr. Kerr then said nothing more till after breakfast, when he told me that all of us staid too long, I said no sir I did not, you are very hard to please, and you want me to do as much as a man, which I cannot, and when Saturday comes, I am going home, if he said if I did he would send for the Provost Marshall. when I told him, that was just what I wanted, as I thought I would get Justice and right from him, he then made for me and struck me on the left cheek with a green sapling, making a deep cut in my cheek and left a mark there for life; he next struck me on the right arm and cut me very deep, leaving a scar there for life, he next knocked me down getting astride on me and beat me with both hands and filled my eyes with mud. I begged of him to get off of me as I was in family way and he was too heavy on me, he told me he did not care if I was big with ten children that he was going to kill me, I got away from him and managed to get to Doctor Perley's place where I was confined of a dead child. Mr. Kerr's wife told me in the presence of this girl, Meedy Johnson that I ought to have been killed, in place of my child. Meedy Johnson left with me



as she was afraid he would treat her the same way. I have no husband or friends to take our part or look after our interests, or I would have Mr. Kern arrested, <sup>and</sup> I have been afraid of him. I am afraid to go past his house now and would sooner kill myself than be compelled to go back to him.

Frank D. Bennett  
1<sup>st</sup> Lt. A. S. U. S. Army  
Sub Asst. Quar. C. S. B. D. La.

Statement  
Sophie Beer  
W. E. Johnson



---

---

Statement

J. Ferr.

---

---

Personally came and appeared before  
me, at my office, this Eighth day of Augt. 1868.  
Mr. L. Kerr who makes the following statement:

One morning, while out riding toward the field  
I met Sophie Pier going to her work quite late  
I asked her what kept her so late, she answered  
that she was not too late. I told her that if she  
did not do any better, she could not stay on my  
place, and that I would send for Provost-Marshal  
She answered that she did not care for the Provost-  
Marshal, that if he dared to put his foot on the  
place to interfere with her in any way, she would  
feel sorry for it, and commenced abusing me in a  
wonderful manner. I told her to hush up; but  
to no avail, I warned <sup>her</sup> that if she did not stop  
abusing me in this manner. I would strike her  
and again she kept on abusing, when I rode <sup>up</sup> to  
her and struck her several times with my hands,  
after which she, and Maudy Johnson left me and  
went to work on one Dr. Percy's place, in the  
Parish of Concordia, where they formerly belonged.  
The clothing is now in my possession and am ready to give  
it up, when ordered so to do.

Frank D. Gentry  
12<sup>th</sup> Lt. 43<sup>rd</sup> Infy. U.S.A.  
Sub Ass't Quar. C. Sub D. La.



New Orleans La  
July 17<sup>th</sup> 1868

July 17<sup>th</sup> 68

Frank R. Chase  
Genl. Supt. Edc<sup>n</sup>

Relative to the contribution  
of one cent each by every  
colored person as a tri-  
bute of regard for Genl.  
Howard.

HEADQUARTERS,  
Bureau of Refugees, Freedmen and Abandoned Lands,  
(189 JULIA STREET,)

Office General Superintendent of Education,  
STATE OF LOUISIANA.

New Orleans, La., July 17<sup>th</sup> 1868.

Mr. J. L. Linn  
Asst. Sub. Asst. Com.  
Parish of Catahoula La.

Sir

I have the honor  
to enclose herewith copies of the "Howard Federal  
Union" Constitution and request that you give  
them to the several ministers and teachers in your  
Parish and do all in your power to have every  
Freedman woman and child represented in the  
small sum of "one cent"

It is a just tribute  
to the Christian General who has done so  
much for this race.

Very Respectfully  
Your Obedt. Servant,

Samuel A. Chase  
Sub. Supt. Education,  
Care of Freed. A. A. S.



B511 Bn R. H. A. L. Va. 68  
Headquarters Bn A. S. H.  
District of Louisiana  
New Orleans July 23<sup>rd</sup> 1868

Buchanan Bn Maj. Gen. R. C.  
Asst Comd

Directs in the case  
of the firm people  
employed by Mr  
A. J. Beck. that you  
at once report whether  
they have been settled  
write

Recd at Dist Hdq July 31<sup>st</sup> 1868

B511 Bn R. H. A. L. Va. 68

Headquarters Bn A. S. H.  
2<sup>nd</sup> Sub Dist of Va

Monroe July 30<sup>th</sup> 1868

Respectfully forwarded  
to Mr. W. J. Sumner  
A. S. H.

Small York  
Sgt of Asst Comd  
3<sup>rd</sup> Sub Dist of Va

#681.

HEADQUARTERS  
Bureau of Refugees, Freedmen and Abandoned Lands,  
DISTRICT OF LOUISIANA.

New Orleans, July 23<sup>rd</sup>, 1868.

Mr M Johnston Sumner,  
Asst Sub Asst Commissioner,  
Bureau R. T. and A. Lands,  
Pat. of Catahoula, Prairie Landng, La.

Sir,

The Assistant Commissioner directs that in the case of freedpeople employed by Mr. H. J. Peck - reported in your communication of January 31<sup>st</sup>, 1868, - you at once report whether or not they have been settled with, and that you forward such information as you may have since learned in relation to the case.

Very Respy, Your Obedt. Serv't.

Charles H. Warner

Post Lieut. Col. U.S.A. Capt 39<sup>th</sup> Infantry  
Actg Asst Adj. General



C. B. B. Bu. R. F. & A. L.

Office A. S. A. Com. Bu. R. F. & A. L.  
Parish of Catahoula, La.  
Mossy Grove, August 14<sup>th</sup> 1868.

Camp J. H. K. M.  
A. S. A. C.

Request permission to remove his office to Trinity,  
States Parish, Louisiana, and Mossy Grove, are only  
plantations, and are respectively 8, and 6 miles  
from Trinity, which is the nearest Post Office.

Prairie Landing

✓

6153 (Bu. R. F. & A. L., La.) 1868

HEADQUARTERS  
BUREAU REFUGEES, FREEDMEN AND ABANDONED LANDS,  
DISTRICT OF LOUISIANA.

New Orleans August 12<sup>th</sup> 1868.

Respectfully returned to Mr. J. K.  
Camp, A. S. A. Com.  
(Through Saml. C. Gold, Sub. Asst. Com.)  
permission to change his Office from  
Prairie Landing to Trinity is here-  
by granted.

By Command of  
BREVET MAJOR GENERAL R. C. BUCHANAN.

Charles H. Warner  
Bvt Lieut. Col. U. S. A., Captain 39th Infantry,  
Act'g Ass't Adj't General.

51  
9/19/68

Rec'd Aug 24<sup>th</sup> 1868

C. B. B. Bu. R. F. & A. L. '68

Headquarters Bu. R. F. & A. L.  
5<sup>th</sup> Sub District of La.  
Mossy Grove Aug. 18<sup>th</sup> 1868.  
Respectfully forwarded  
to Mr. J. H. K. Camp  
Act Sub. Asst. Com.

Saml. C. Gold  
Sub. Asst. Com.  
5<sup>th</sup> Sub Dist La.

EB  
74

Rec'd 5<sup>th</sup> Sub Dist La Aug. 18<sup>th</sup> 1868.

Office Ad. A. Com. B. N. T. & A. L.  
Mossy from San Catalula Parish La  
Aug 4<sup>th</sup> 1868

Brat Lt. Col. S. H. Warren  
Capt 39<sup>th</sup> U. S. Army  
Adj. Genl. A. J. T. Genl  
Sir

In compliance with  
your order before leaving San Blas  
I will state. Terre Landin is  
not a Post Office Station but  
the name of a Plantation. Also  
Mossy Grove is a Plantation the  
nearest Post Office Station is Trinity.  
Terre Landin is (8) Miles and Mossy  
Grove is (6) Miles from the Post Office  
and Trinity is the nearest P. O.

I would recommend that an Order  
be given from Headquarters that the Office  
of the Receiver for Calabula Parish be  
located at Trinity as it is the



C. 153 Bu. R. F. & A. L. L.

Office A.S.A. Com. Bu. R. F. & A. L. L.  
Parish of Catahoula. La.  
Mossy Grove, August 4, 1868.

Camp J. H. K. M.  
A.S.A. Com.

Request permission to remove his office to Trinity,  
States Prairie Landing, Mossy Grove, are only  
Mantation, and are respectively 8 and 6 miles  
from Trinity, which is the nearest Post Office.

Prairie Landing

Add Mossy Grove  
Mantation to Trinity.

C. 153 (Bu. R. F. & A. L. L., La.)

HEADQUARTERS  
BUREAU OF REFUGEES, FREEDMEN AND ABANDONED  
LANDS,  
DISTRICT OF LOUISIANA

New Orleans August 12<sup>th</sup>, 1868.

Respectfully returned to Mr. J. K.

to Camp. A.S.A. Com.  
(Through ~~Mr. J. K. M.~~ Gold and Asst. Com.)

permission to change his office from  
Prairie Landing to Trinity is here-  
by granted.

By Command of  
BREVET MAJOR GENERAL R. C. BUCHANAN.

*R. C. Buchanan*

Bvt. Lieut. Col. U. S. A., Captain 39th Infantry,  
Act'g Asst. Adj't General.

7/1/68  
8/2

Rec. Aug 24<sup>th</sup> 1868

Last Office Camp and most Central  
I am Sir your most obedient  
Servant

*J. H. K. M.*  
A. S. A. Com. B. R. F. & A. L.



183 Bu 2 Prt of La '68  
Headquarters Bu 2 Prt of La  
District of Louisiana  
New Orleans Aug 10<sup>th</sup> 68  
Wm. F. N. W.  
A. C. S.

Directs that you  
forward to this office  
without delay, receipts  
of Robertson, Alexander,  
& Wooten and White & Ranney,  
for supplies shipped  
there in June 1868.

Prairie Landing

Rec<sup>d</sup> 5<sup>th</sup> Sub Dist La Aug 14<sup>th</sup> 68

183 Bu 2 Prt of La - '68  
Headquarters Bu 2 Prt of La  
5<sup>th</sup> Sub Dist of La  
New Orleans Aug 14<sup>th</sup> 1868  
Respectfully forwarded  
to Wm. F. N. W.  
Asst Sub Dist Com.

Samuel C. Gold  
Sub Dist Com.  
5<sup>th</sup> Sub Dist La



#340.

HEADQUARTERS

Bureau of Refugees, Freedmen and Abandoned Lands,  
Office of Assistant Commissary of Subsistence.

New Orleans,

August 10<sup>th</sup> 1868.

Mr J. B. B. Camp

a. s. a. c. Catahoula Parish, La.

Sir:

You will please forward direct to this office, without delay, the following named planters receipts for supplies shipped them in June, 1868, which are still due from your parish.

messrs

Robertson,

Alexander & Wooten,

and White & Ramsey.

Very respectfully

W. Wood

25 St. P. Infy

Asst.

Thro. sub asst. Commr.

5th sub dist. of La.

At 85: Bu R. P. A. F. La - '68  
Headquarters Bu. R. P. A. F.  
District of Louisiana  
New Orleans Aug 26 '68

Atch. Edmund Bot. May. Genl.  
Asst. Com'

States in reply to your  
telegram of the 21<sup>st</sup> inst  
that Mr. M. J. Lemon  
is not in the City and  
that his whereabouts is  
not known at Ad. Qms.  
Direct that in future  
when private telegrams  
are sent by you, they  
must be prepaid.

Rec<sup>d</sup> of the Sub Dist Aug 29<sup>th</sup> 1868.

At 85: Bu R. P. A. F. La - '68

Headquarters Bu. R. P. A. F.  
5<sup>th</sup> Sub Dist of La  
Monroe Aug 29<sup>th</sup> 1868

Respectfully forwarded  
to Mr. J. H. A. Camp  
A. S. A. C.

Genl. C. G. G. G.  
Subst. Com'  
5<sup>th</sup> Sub Dist

Rec<sup>d</sup> of the Sub Dist Aug 29<sup>th</sup> 1868.



#805.

HEADQUARTERS

Bureau of Refugees, Freedmen and Abandoned Lands,  
DISTRICT OF LOUISIANA.

New Orleans, August 26<sup>th</sup> 1868.

Mr. J. H. H. Camp,  
Asst. Sub. Asst. Comr. P. R. F. & L.  
Parish of Catahoula  
Trinity, La,  
(Through Mr. Saul C. Gold,  
Sub. Asst. Comr. 5<sup>th</sup> Sub. District)

Sir,

I have the honor to acknowledge the receipt of your telegram of the 21<sup>st</sup> inst. together with that of Dr. C. J. Farrar and am instructed by the Assistant Commissioner to inform you, that Mr. W. J. Timmon is not at present in this city, nor is his whereabouts known at these Headquarters.

The Assistant Commissioner also instructs me to inform you, that in future, when

Private telegrams are sent by you to these  
Headquarters, they must be prepaid.

Very Respectfully,

Your Obedt. Servt.  
Merrill H. Warner

Br. Lieut. Col. 71st Cap. 39 Infy  
Actg. Ass't. Adjt. Genl.



C. 45. On R. F. & H. La '68

Office Subst Subst Comm  
Parish of Catahoula  
August 31<sup>st</sup> 1868

Camp, Mr. J. H. H.

A. J. A. Louis

After special Report,  
states: a number of  
old, crippled and blind  
Free people in this Parish  
are suffering for want  
of food and clothing  
and the Planters are not  
able to assist them.

W. H. H.

On the 5<sup>th</sup> Sub Dist La  
Sept 13. 1868

C. 45. On R. F. & H. La '68

Headquarters Bureau R. F. & H.  
5<sup>th</sup> Sub Dist of Louisiana  
Monroe, La, Sept 13. 1868

Respectfully returned to  
Mr. J. H. H. Camp  
et. of C. H. who will report  
the destitute Free people  
within named to the  
Civil Authorities for  
assistance.

J. A. Gold

Subst Subst Comm  
5<sup>th</sup> Sub Dist of La  
E. D. 7<sup>th</sup>

Recd Sept 20<sup>th</sup> 1868

Officer, Asst. Surg. Asst. Com  
Bureau of M. S. & A.

Catahoula Parish La

Aug 31<sup>st</sup> 1868

L. N. Harris

Asst. Surg. Asst. Com

A. A. Asst. Surg. Asst. Com

Sir

I have the honor  
to make you the following special  
report. While on my inspection  
Tour through my Parish I found a number  
of old and decrepid, others old and blind poor  
people who are depending on the charity  
of the Planter's for their sustenance

The Planter's from the failure of the Crops  
of last year and the surplus of this, are  
not able to support these poor people  
they do the best they can for them but the  
old people suffers badly for food and  
Clothing these poor people are entirely



unable to earn the least support  
for themselves

I have now but some Peato. Hats.  
and shoes on hand

I am Sir your most obedt  
servt

J. A. D. Camp  
Asst Sub Mast Com 10 A. H. I. L. L.

---

Hd Qrs Bu RFAH  
District of Louisiana  
New Orleans Sept 1. 68

---

Assistant Commissioners

---

Prints that letters sent  
to Hd Qrs must be  
prepaid

---

---



# 851.

HEADQUARTERS

**B**ureau of Refugees, Freedmen and Abandoned Lands,  
DISTRICT OF LOUISIANA.

New Orleans, September 1<sup>st</sup> 1868.

Mr. Jam. C. Gold,  
Sub Asst. Commr.

Monroe, La.

Sir,

I am instructed by the Assistant Commissioner to call your attention to the frequent receipt of Communications from your office and Sub District, at these Headquarters, - on which postage is due, - within the last two (2) days, three (3) Communications have been received from your office, on which were, respectively due, eighteen (18) fifteen (15) and nine (9) cents.

I am also instructed to inform you that, in future all Communications forwarded

by you, must be prepaid before being  
mailed to these Headquarters.

Very Respectfully,

Your obt. Servt.  
Charles H. Warr

Brig. Genl. Col. 24th. Capt. 39<sup>th</sup> July.

A. A. A. Genl.



New Orleans La.  
Sept. 1<sup>st</sup> 1868

Commissioner Aft.

Asks why an order to  
remove Agents Office has  
not been complied with.

Recd Sept 14<sup>th</sup> 1868

# 850.

HEADQUARTERS  
Bureau of Refugees, Freedmen and Abandoned Lands,  
DISTRICT OF LOUISIANA.

New Orleans, September 1<sup>st</sup> 1868.

Mr. J. H. H. Camp,  
Asst. Sub. Ass't. Comm'r. Parish of Catahoula,  
Trinity, La.,

Sir,

I am instructed by the Assistant Commissioner, to call your attention to endorsement sent you from these Headquarters of date August 12<sup>th</sup> to remove your office from Prairie Landing to Trinity La. and to direct, that you at once report, why the requirements of this endorsement were not complied with by you immediately upon its receipt. He also directs, that if said endorsement has not been complied with ere receipt of this, that you remove your office forthwith  
over,



twenty four hours after the receipt of this communication.

Very Respectfully

Your obedt. Servt.

Thomas W. Warner

Br. Lieut. Col. 21st Regt. 39th Infy.

Acty. Asst. Adjt. Genl.

Post at Parish of Catahoula  
Louisiana  
L

New Orleans La  
Sept. 1<sup>st</sup> 1868

Commissioner Assistant

Relating to the pay-  
ment of laborers by  
H. J. Peck.

Communication from  
New Orleans  
for H. J. Peck  
Account of Settlement  
of his hand for  
1867

1868

Recd. Oct. 21, 1868



# 852.

HEADQUARTERS  
Bureau of Refugees, Freedmen and Abandoned Lands,  
DISTRICT OF LOUISIANA.

New Orleans, September 1st. 1868.

Mr. J. H. H. Camp.

a. s. a. c. Parish of Catahoula.

Prairie Landing La.

Sir,

I am instructed by the Assistant Commissioner to inform you, that no action can be taken by the Bureau, in the case of the freedmen employed by Mr. W. J. Peck, in the year 1867, and that the remedy of the laborers lies, in suing Mr. Peck in the civil court for their unpaid wages.

Messrs. Ober, Atwater, & Co., as shown by their own letters, never promised to apply the proceeds of the 10 Bales of Cotton, shipped to them, to the payment of the freedmen's claims, and Mr. Peck alone is responsible

for the disposition made of the funds, which were  
placed to his credit by Ober, Auditor, &c.

I am, Sir,

Very Respectfully

Your Obedient Servant.

Frederic H. Wain

Bvt. Lt. Colonel U.S.A.

Captain 39<sup>th</sup> Infantry

Act. Asst. Adjt. General.



New Orleans La  
Sept. 3<sup>d</sup> 1868.

Commissioner Assistant

---

Encloses funds for the  
payment of certain  
Freedmen.

Sept 3<sup>d</sup> 1868

Communication

from

Headquarters

with Draft for

\$235.<sup>00</sup> per Payment

of Brigades Dunkley's

hands for the year of

1867

New York 8<sup>th</sup> 1868



#867.



HEADQUARTERS

Bureau of Refugees, Freedmen and Abandoned Lands,  
DISTRICT OF LOUISIANA.

New Orleans, September 3<sup>rd</sup> 1868.

Mr. J. H. H. Camp,

Asst. Sub Asst. Comr.

Catahoula Parish, Trinity, La.,

(through Mr. Saml. C. Ford, Sub Asst. Comr.

5<sup>th</sup> Sub District.)

Sir,

I have the honor to transmit herewith  
Check No. 1088 for the sum of Two hundred  
and thirty five <sup>50</sup>/<sub>100</sub> Dollars drawn by Robert  
Col. Edgar C. Beman, D. C. payable to your  
order - dated New Orleans La. September 3<sup>rd</sup> 1868.

The Assistant Commissioner directs, that the  
enclosed receipt be signed and at once  
returned to these Head Quarters. He also  
directs that you without delay pay over  
pro rata to the proper freedmen to whom

By Mr James Duvelley  
it is due, the amount named in the  
enclosed Check and that Receipt Roll,  
for such payment, properly signed and  
witnessed, be forwarded to these Head-  
Quarters with the least possible delay.

Very Respectfully,

Your Obedient Servant

Samuel H. Warner

Brig. Genl. Col. Regt.

Capt. 39th Infy.

Actg. Asst. Adj't Genl.



Sept 3/68

---

W. W. Wood  
20th Xmas

---

W. W. Wood  
20th Xmas

W. W. Wood  
20th Xmas

# 347.

HEADQUARTERS  
Bureau of Refugees, Freedmen and Abandoned Lands,  
Office of Assistant Commissary of Subsistence.

New Orleans, September 3d, 1868.

Mr J. N. N. Camp  
a. s. a. c., Catahoula Parish.

Sir,

By direction  
of the Assistant Commissioner you will inform  
Messrs Alexander & Hooton, cultivating the  
woolton plantation, Catahoula Parish, that their  
indebtedness to this Bureau for subsistence  
supplies has been canceled this day, by a  
draft on Messrs Oglesby & Co. (eight) - in the sum  
of \$94.60.

Very respectfully

W. W. Wood  
2d Lieut. & Infy.  
a. c. s.



Sept 3/68.

W. W. Wood

20th May

W. W. Wood  
20th May

#348.

HEADQUARTERS  
Bureau of Refugees, Freedmen and Abandoned Lands,  
Office of Assistant Commissary of Subsistence.

New Orleans, September 3<sup>d</sup> 1868.

Mr J. H. K. Camp  
a. s. a. c., Catahoula Parish.

Sir,

Enclosed you  
will find the cancelled bond of Messrs  
Alexander & Wootton, which you will return  
to them, after entering on your books.  
Messrs Alexander & Wootton are by direction  
of the Asst. Comr., released from all obligations  
to the Government.

Very respectfully

W. W. Wood  
25 Sept. 3. Inf.

acs.



C. 171. Bu. R. F. & A. L. La. '68.

Office of Asst. J. A. C. Comdr.  
Parish of Catahoula  
Trinity, La., September 5<sup>th</sup> 1868.

Camp, J. H. H.  
Asst. J. A. C. Comdr.

Enclosed petition of one Sept  
Jones, who applies for assistance  
in the support of a third freed  
woman, who he has supported  
for several years, and is unable  
to do so any longer, state that  
he (Camp) supplied her with a  
pair of shoes.

C. 171. (Bu. R. F. & A. L., La.,) 1868.

HEADQUARTERS  
BUREAU REFUGEES, FREEDMEN AND ABANDONED LANDS,  
DISTRICT OF LOUISIANA.

New Orleans, September 9<sup>th</sup> 1868.

Respectfully returned to Mr.  
J. H. H. Camp, Asst. J. A. C. Comdr.  
Parish of Catahoula, (through Mr.  
John H. Brown, J. A. C. Comdr.  
5<sup>th</sup> Sub-Dist.) attention direct-  
ed to Circular No. 1 Current Series  
from these Headquarters, copy  
enclosed. — The within named  
freedwoman must be provided for  
by the Civil Authorities.

By Command of Edward Hatch  
BREVET MAJOR GENERAL

Meritt W. Warr

By't Lieut. Col. U. S. A., Captain 39th Infantry,  
Act'g Ass't Adj't General.

rec'd Sept 20<sup>th</sup> 1868

C. 48. Bu. R. F. & A. L. La '68

Headquarters Bu. R. F. & A. L.  
5<sup>th</sup> Sub Dist of Louisiana  
New Orleans, La., Sept 14. 1868

Respectfully forwarded to  
Mr. J. H. H. Camp, Asst. J. A. C.  
whose attention is called  
to the endorsement of  
the Asst. Commissioner.

Samuel C. Field  
Sub Dist Comdr  
5<sup>th</sup> Sub Dist of La

Officer, Asst. Sub. Asst. Com.  
Bureau of P. H. & S.  
Christy Catawba Parish La  
Sept 5<sup>th</sup> 1909

L. H. Warren  
Capt. 1st. Cal., U. S. A.  
A. A. Dept. Genl  
Sir

I have the honor  
to apply to you for relief for Mariah  
Smith whose petition is enclosed I have  
seen her and find her destitute of clothing  
and she tells me she has lived on the  
charity of Mr. Joseph Juss. since  
she was blind and appealed to me  
for relief as Agent of the Bureau I  
have nothing but char. I saw her a few

I am Sir your obedient Servant

A. D. Camp  
Asst. Sub. Asst. Com. B. P. H. & S.



Trinity La Cataboula Parish  
September 5<sup>th</sup> 1858

J. N. H. Camp

U. S. A. Com Bureau

Sir:

I have at my house a  
Free Woman named Mariab Smith who is  
totally Blind. She has no relation in this State  
and depends entirely upon charity. I have  
supported her since she has been blind,  
which has been several years, I am not able to  
support her and apply to you for assistance  
for her.

I remain Respectfully &c

Dear Sir

We the undersigned citizens being fully aware  
of the correctness of the above statement, recommend  
the same may be favorably received

A. Koskham

Isaac Sinker

L. Maritz

G. Lehmann

C. H. Snyder

J. Y. Snyder

Sam Block



C. 150. Bu R F & A L., La.,  
C. 47. Bu R F & A L., La. '68

Office Act Sub Dist Court  
Parish of Catahoula  
Sept 5th 1868.

Camp, Mr S. H. H.  
A. S. A. Court

Transmits Statement  
of indebtedness of  
Geo D. Pickens to his people  
for labor in 1867.

(1 Enclosure)

Recd for Sub Dist La  
September 13 1868

C 47 Bu R F & A L., La. '68

Headquarters Bu R F & A L.  
5th Sub Dist of Louisiana  
Monroe, La, Sept 16. 1868

Respectfully forwarded  
to Col W. H. W. W.  
A. S. A. General

Saml C. Gold  
Sub Dist Court  
5th Sub Dist of La



C. 150. (Bu. R. F. & A. L., La.,) 1868

HEADQUARTERS  
BUREAU REFUGEES, FREEDMEN AND ABANDONED LANDS,  
DISTRICT OF LOUISIANA.

New Orleans, September 21<sup>st</sup> 1868.

Respectfully returned to Mr.  
J. H. H. Camp, Sub Dist Court  
through Mr. John H. Bowen, Secy. Com.  
5th Sub Dist, who will  
advise and assist the freedmen  
in bringing suit in the civil  
Court against Mr. Dickens, for  
the amount justly due them.

By Command of  
BREVET MAJOR GENERAL ~~EDWARD BLANCHARD~~  
Edward Hatch,  
Act'g Ass't Adj't General.  
By't Lieut. Col. U. S. A., Captain 38th Infantry,  
Wm. Hutchins,  
Act'g Ass't Adj't General.

Recd for 5th Sub Dist of La  
September 26. 1868



Office Asst. Sub. Asst. Com.  
Bureau of P. O. & A. S.  
County Catahoula Parish La.  
Sept 5<sup>th</sup> 1868

L. W. Warren  
Brut. Lt. Col. U. S. A.

a a Asst. Genl

Sir

I have the honor to  
transmit you a Statement of the amount  
of indebtedness of Geo. D. Dickens to the  
Free People who worked for him by the days  
work in the year of 1867 on the Copeland  
Plantation situated on Sicily Island about  
18 miles above Natchitoches. He raised 100  
Bales of Cotton or more in last year

Mr Sherman went up there to settle  
the accounts of the freedmen Mr Dickens  
showed Mr Sherman a copy he said was  
of a letter to his merchant in S. C. to  
reserve \$1,000<sup>00</sup> to pay his bond with  
Mr Sherman looked over his accounts



(of which I have a Copy in my Office)  
he found he had his hands charged 66¢  
per day for rations when they were not at most  
Mr Garrison told him he would not allow  
him but 20¢ per day. Mr Dickens then told  
Mr Garrison that he did not recognize the  
Bureau he considered the whole thing un-  
Constitutional and he would not allow  
any person to come on his place and settle  
his accounts with his hands he would  
blow any persons brains out who would attempt  
it or meddle with his business

This is the report of Mr S. Garrison  
(whom I relieved) when he turned the papers  
over to me.

And from the Character of the man up  
here I think he will try and cheat the  
man he has with him this year also  
Blanks has been sent to him but he has  
not returned them to the Office

The old hands of last year left him  
they are working for Mr C. H. Smith and others

On the account of my sickness I have  
not been able to set up that ~~for~~ since

I have been up here  
I am Sir your obedt Servt  
A. A. Camp  
A. S. A. Co. B. B. F. & Co

Ch. 47 Ch. 27 Ch. 17 Ch. 10. 68

Investigator, Ch. 27 Ch. 17  
5th Dist of Louisiana  
Stamur, La., Sept. 26. 1868.

Respectfully forwarded to  
Mr. J. H. H. Camp, A. S. A. Co.  
and attention directed to the  
endorsement of the Assistant  
Commissioner.

Mr. Camp will take early  
steps in this matter, in  
accordance with the intention  
of said endorsement, and  
can rely upon my assistance  
that this Office is authorized  
to give.

John W. Brown

Dist. Atty Genl  
5th Dist of La

6/41



of the man up  
by and about the  
This year also  
to him but he has  
the Office  
last year left him  
J. H. Smith and others.  
distances of four  
to that distance

C. 47 Bu A F & M. La. '68

Headquarters, Bu A F & M  
5th Sub Dist of Louisiana  
New Orleans, La, Sept 26. 1868.

Respectfully forwarded to  
Mr. J. H. H. Camp, A. S. C.  
and attention directed to the  
endorsement of the Assistant  
Commissioner.

Mr. Camp will take early  
steps in this matter, in  
accordance with the instructions  
of said endorsement, and  
can rely upon every assistance  
that this Office is authorized  
to give.

John W. Downey  
Sub Dist Commr  
5th Sub Dist of La

ED  
77.

57209

Amount brought forward	\$ 1401.33
James Richards	53.30
William Richards	31.66
Total Amount	\$ 1425.99
	\$ 1425.99

C. W. BUR F. A. H. Co. W.

(Enclosure)

C. W. Bur F. A. H. Co.

1867

Trinity



Table showing the amt of contributions of Geo. D. Perkins to his fund for the year of 1867

Names	\$	Cts	Names	\$	Cts
Paul Hart	45	63 <sup>1/2</sup>	Brought forward	814	94 <sup>1/2</sup>
Henry Brass	16	96	Sarah Amos	6	77
Shed Brass	20	98	Joseph Salisbury	60	74
Levi Brass	70	13 <sup>1/2</sup>	Eddy Nathans	22	22
Barkah Amos	24	52 <sup>1/2</sup>	Martha Richards	31	62 <sup>1/2</sup>
Amos Brass	25	57 <sup>1/2</sup>	Martin Richards	69	27 <sup>3/4</sup>
Isaac Morton	71	04 <sup>1/2</sup>	Simon Nathans	93	21 <sup>1/2</sup>
Edw Rollins	17	93	Emanuel Wright	5	35 <sup>1/2</sup>
Stewart Brass	37	46 <sup>3/4</sup>	Catharine Butts	1	54
Banyan Rollins	48	14 <sup>3/4</sup>	Chairy Bird	11	94
Abram Jackson	58	80 <sup>3/4</sup>	Lawrence Amos	10	11
Shed Davis	43	35 <sup>1/2</sup>	Lilly Brown	16	64
Rachel Davis	24	06 <sup>1/4</sup>	Moran Bird	2	28
Robert Jordan	5	15	James Amos	37	86
Milton Howard	59	01 <sup>1/2</sup>	Ginney Richards	1	18
William Rollins	47	59 <sup>1/2</sup>	Nicy Richards	42	
Comfort Jordan	1	63 <sup>1/4</sup>	Howard Amos	30	11 <sup>1/4</sup>
Claracy Rollins	22	48 <sup>1/2</sup>	Birdy Davis	33	63 <sup>3/4</sup>
Jeffery Amos	76	13	John Davis	58	16 <sup>1/4</sup>
Carson Amos	33	90	James Pinkney	54	60
	\$ 914	94 <sup>1/2</sup>	Brought forward	\$ 1340	13 <sup>3/4</sup>

Amount brought forward	\$ 1340 13 <sup>3</sup> / <sub>4</sub>
James Richards	5330
Ellen Richards	3166
Total Amount	\$ 1425 09 <sup>3</sup> / <sub>4</sub>
	\$ 1429 82

57409

Wm. B. R. Fall 1855

(In course)

647 B. R. Fall 1855

1807

Trinity



C. 49 Bu R & A H Sa '68  
Office Asst, Sub Asst Comm  
Parish of Catahoula  
Trinity, La, September 10. 1868

Camp, Mr. J. H. A  
A. S. A Comm

Tri Monthly Report  
ending September 10th 1868.  
States. The freed people working  
well. The Cotton worms are destroying  
the Cotton on some Plantations. He has  
had but few Complaints since his  
last Report. - Relates complaint  
of Masses Armoire, as Elias  
Hamilton, twenty miles from  
Trinity, with particulars concern-  
ing the same. Planters refuse  
to sign Contracts, in order to  
evade settlements through Bureau  
Officials

W D Adams Bu R & A H  
5th Sub Dist of La Sept 21st

C. 49 Bu R & A H Sa '68  
Headquarters, Bu R & A H  
5th Sub Dist of Louisiana  
Monroe, La, Sept 21. 1868

Respectfully returned to  
Mr J. H. A. Camp A. S. A. C. M.  
with information, that I am  
directed by the Assistant  
Commissioner, to insist upon  
the Tri Monthly Reports  
from every Asst, Sub Asst,  
Commissioner in this Sub  
District, being prepared  
with a System <sup>of</sup> uniform-  
ity. - Accompanying this  
you will find a formula  
for your guidance; let  
your Reports embrace all  
these points in their proper  
order, and return through  
this Office with the least  
delay possible.

Condense your report of  
the outrage on Masses Armoire  
but give all the particulars.

J. W. Brown  
Sub Asst Comm

5th Sub Dist of La

(1 Enclosure)



Office, Asst. Sub. Asst., Com  
Bureau of, A. F. & A. Co  
Trinity Catahoula Parish La  
Sept 10<sup>th</sup> 1868.

L. N. Warren  
Asst. Det. Col. U. S. A  
A. A. Dept. Genl

Sir

I have the honor to  
transmit you the following Report  
The Freed People are working well  
the Cotton more or destroying the Cotton  
on some of the Plantations in the Parish  
badly. There has been but few complaints  
since my last report. There was  
one complaint made by Moses Semwill  
freedman who had worked since gang  
with a man by the name of Elias  
Hamilton on a plantation six miles above  
French fork in the Hills in this  
Parish it is 20 odd miles from Trinity,



About three weeks since the freedman made  
a complaint against the Planter who says for  
wanting to whip his Child. I ascertained  
from him that it was on the account of  
a dispute between two Children 3 years old  
and I told him to return and attend to his  
Crop and keep his child from the other

He returned on the 2<sup>nd</sup> and showed me  
his back, it had been cut by a strip of  
Suppose he had not received less than a  
hundred lashes. He stated to me on the  
night of the 7<sup>th</sup> four men came to his  
cabin and called him out and took him into  
the Woods. He asked them if they was going  
to kill him, they told him no, but they  
should whip him, which they did, he says  
he knows one of the it was the brother of the  
Planter who he was working for  
I wanted to send for the man but the freed-  
man dare not appear against the man

I am confident it was done to drive  
him away to get his share of the Crops of  
the other hand the Crops looked well. These  
Wills is the hardest place in the Parish

a stranger is not safe passing through  
them. There is a great many Respects  
living there, these men are feared by the  
respectable portion of the Parish there-  
fore they are permitted to run at large  
and are not molested by the law

There is a great many Planters in this  
Parish who have promised the freedman to  
sign Contracts but have evaded it they think  
by so doing they will not have the Agent  
of the Bureau to interfere in their settlement  
with the freedman. It has been reported  
to me by freedmen on several Plantations  
that they cannot get the Planters to sign  
the Bureau Contracts, some of the Planters  
have signed a contract with me freedman and  
have given 12 to 20 working for them. It  
is intended to evade a settlement with their  
hands through the Bureau; some of these  
Planters are those who the Bureau had  
to send Officers from Headquarters to settle their  
accounts last year

I am Sir your obedient servant

J. R. Camp  
A. S. A. Can. B. R. S. A. S.



Sept 18/68

---

W. W. Wood  
2<sup>d</sup> St. K. C.

Prairie Landing



L.S.  
To. 7. Sept. 18<sup>th</sup> 1868.

HEADQUARTERS  
Bureau of Refugees, Freedmen and Abandoned Lands,  
Office of Assistant Commissary of Subsistence.

New Orleans, September 18<sup>th</sup> 1868.

Mr. J. H. A. Camp,  
Asst. Sub. Dist. Commissioner  
Bureau R. F. and A. Lands.  
Catahoula Parish La.

Sir:

I enclose you here-  
with the account current of Messrs. Alexander  
and Wootton, of Catahoula Parish, in settle-  
ment of their account with the Government.

It should have accompanied the  
letter from this office dated September 3<sup>rd</sup>.

Very respectfully

Your obedient servant.

W. W. W. W. W.  
2<sup>nd</sup> Lieut. 1<sup>st</sup> Infantry  
A. C. S. Bureau R. F. and A. L.

Sept 21<sup>st</sup> 1968

Letter  
of D. O. L., M.D.  
Enquiry of  
Bills of Reading

Recd Sept 29<sup>th</sup> 1968 and Oct 1<sup>st</sup> 1968



Bureau of Refugees, Freedmen and Abandoned Lands,

OFFICE P. O. & A. A. QUARTERMASTER, NO. 206 ST. CHARLES ST.

New Orleans, Sept. 21<sup>st</sup> 1868

A. F. W. Camp  
A. S. W. B. W.

Sir

I have the honor to  
request information regarding the Duplicate Bill  
of Lading of Forage shipped to M. J. Lemmon  
July 29<sup>th</sup> 1868.

You will please forward, if  
in your possession, said duplicate to this office.

Very Respectfully

Wm. J. Fox  
Brig. Genl. Col. <sup>and</sup> S. O.

C. 50. Ou R Jy d. h. La '68.

Office Act Sub Post Comm  
Parishes of Catahoula  
Trinity, La, Septer 21. 1868

Camp. Mr J. H. H.

A. S. A. Comm

Tri Monthly Report ending  
Septer 20<sup>th</sup> 1868.

Qu R Jy d. h. La '68.  
5<sup>th</sup> Sub Dist of La. Septer 25 '68

C. 50. Ou R Jy d. h. La '68

Headquarters Ou R Jy d. h  
5<sup>th</sup> Sub Dist of Louisiana  
Mauris, La, Septer 25. 1868.

Respectfully returned to  
Mr J. H. H. Camp, A. S. A. C.  
Parish of Catahoula, for the  
same reason, that this Tri-  
Monthly of the 10<sup>th</sup> inst.  
was returned to him for  
amendment.

Attention is directed to the  
endorsement from this  
Office of the 21<sup>st</sup> Inst  
and strict compliance with  
the instructions therein given  
is required.

No communications through  
this Office will be approved  
unless they fully meet the  
requirements of the Assistant  
Commissioners.

John W. Brown  
Sub Post Comm  
5<sup>th</sup> Sub Dist of La

E. B. J.



Officer, Asst. Sub. Asst. Com  
Bureau of P. O. & L.  
Trinity Catahoula Parish La  
Sept 21<sup>st</sup> 1908

B. F. Hutchins  
Asst. Maj. U. S. A.  
A. A. Capt. Genl

Sir

I have the honor  
to transmit you the following report  
I have but little to add to my  
last report. The Free People I found  
on my inspection have working well  
gathering their crops in not more  
than a half crop in the Parish

The Worms has damaged the Cotton.  
to what extent I am not able to state  
at present as they are still working.  
On some Plantations there is but few  
leaves or young forms left. A few  
Plantations in the Parish has escaped

Then thus far but the young forms  
are shedding which will damage the Crops  
to some extent

Nearly every Planter has sickness in  
his family, and a great deal of sickness  
the last two months among the negroes  
on the Plantations

While on my last inspection  
Clark J was taken down with the fever  
caused by riding in the Sun hence  
my short report

I am Sir your obt. Servant  
J. H. W. Camp  
and a Com B. P. F. D. and



Officer Dist. Club. Asst. Com  
Bureau of R. & A. Bands  
Catahoula Parish La  
Trinity Oct 14<sup>th</sup> 1908

Mr. John W. Brown  
Sub Asst Com  
3<sup>rd</sup> Sub Dis La

Sir

I have the honor  
to return my very thanks and respect-  
fully ask it to be forwarded to Headquarters  
upon the same grounds as my return  
of the 15<sup>th</sup>

My return of the 20<sup>th</sup> which  
is the only return made out since  
I received your instructions is mad  
out in compliance thereto. I have  
no check and my eyes are so weak  
from recent illness I can write but little  
at a time

I remain your obedient servant  
J. W. Brown  
i. d. a. Com. Co. R. & A. B.

Office, Asst. Sub, Asst. Com  
Bureau of P. F. & A. Bands  
Parish of Catahoula La  
Trinity Sept 25<sup>th</sup> 1868

J. H. Brown, Esq  
Sub Asst Com. 5<sup>th</sup> Sub Div of Reg  
Sir

I have just received  
my Return of the 10<sup>th</sup> Inst which you have returned with  
a New form of instructions for making out my Reports

Its course all of interest in my Parish. I was  
sick with the fever when I wrote it and am now just  
recovering from my sickness (a relapse) and am not  
able to re-muddle my try Monthly Report of the 10<sup>th</sup>  
also my Report Book from nervousness

Therefore please except my Returns of the  
10<sup>th</sup> & 20<sup>th</sup> Inst and forward them as they are un-  
post due and I will conform to your new  
Course in my Monthly Return

I am Sir your obedt Servt

J. H. Brown  
A. S. A. Com, P. F. & A. B.



Sept 24<sup>th</sup> 1868

J. M. Lee  
a a pro fult.

New Orleans La.  
Sept 24<sup>th</sup> 1868

Commissioner of the  
—

Requires Inspection  
Report to be furnished.

Recd Sept 28<sup>th</sup> 1868

HEADQUARTERS  
Bureau of Refugees, Freedmen and Abandoned Lands,  
DISTRICT OF LOUISIANA.  
No. 206 ST. CHARLES STREET.

New Orleans, September 24<sup>th</sup> 1868.

Mr. J. H. H. Camp.  
a. s. a. c. Parish of Catahoula.  
Trinity La.

Sir,

No Report of Inspection  
of your Parish, has been received at  
this Office, for the month of August.  
Your attention is called to Circular  
Letter, from Headquarters, Bur: R. F.  
and A. S., dated August 21, 1868, and  
you will please comply therewith,  
stating the reason of your delay in  
doing so.

Very Respectfully  
Your Obedt. Servant.

J. M. Lee  
1st Lieut. 39<sup>th</sup> U. S. I.  
Act. Asst. Ins. General.

New Orleans La.  
Sept. 30<sup>th</sup> 1868

W. B. Armstrong  
Date ~~filled~~  
Quantity

Returns from 38 for  
corrected.

Office of D. O. & M. Sgt  
Bureau R. F. & A. L.

New Orleans Sept. 30<sup>th</sup> 1868

Mr. I. H. Ho. Camp A. S. C.

Dear Sir,

I respectfully return you  
the Form No 38 - for correction - You will  
please remember - that I am really the  
issuing officer of these articles - but that  
you deliver them to such persons as you  
may think ready and worthy to receive  
them - and you sign officially as the  
witness in every case - to the signature or  
mark of the person receiving the articles -  
You will leave the head and foot of the  
roll to be filed up by me - You will  
observe you hold these articles merely on  
memorandum receipts - and only account



to me for them, by issue in the  
way I have above indicated -

The rolls will be made out in  
duplicate - Please forward as early as  
you can down to your latest issue -

Respectfully Yours -

W. B. Armstrong

Leate D. O. & De K. Sgt.  
Bureau R. F. A. L.

Oct 6<sup>th</sup>

W. B. Armstrong  
Asst Secy

Acknowledgment  
of Clothing rolls  
for

Aug & Sept 1868

Recd Oct 24<sup>th</sup> 1868



Office of Q. O. & Decker Sgt

Bureau R. F. & A. L.

New Orleans Oct-6<sup>th</sup> 1868

Mr. L. H. Ho. Camp A. S. A. Comd

Sir -

Yours of the 3<sup>rd</sup> inst with  
clothing receipt rolls, is received -  
I inclose you three sets of blanks -  
for future use -

Respectfully yours -

W. B. Armstrong -

Leate Q. O. & Decker Sgt

Bureau R. F. & A. L.

Off. of the S. G. 1888.  
L. J. P. 1888  
Catahoula Parish  
Trinity Nov 2nd 1888.

Camps. J. N. P.  
A. S. A. C.

Relating to the  
deframing of his  
share of the crop, of  
Lemuel King. (c)

250. P. R. F. A. K. 1888  
Sta. for. 1. Bev. R. J. A. L.  
Office A. A. S. G.

New Orleans Nov. 16. 1888.

Respectfully referred to  
Capt. Maj. B. P. H. H. H.  
A. A. S. G.

J. W. Lee  
1st Lt. 39. M. S. S.  
A. A. S. G.

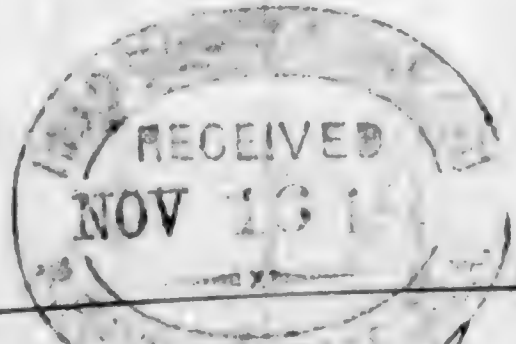

Presd. off. A. A. S. G. Nov. 17 1888

C. J. P. 1888  
L. J. P. 1888  
C. J. P. 1888  
L. J. P. 1888



Office, Dist. Sub. Sect. Com  
Bureau of C, F, & A, L  
Catahoula Parish La  
Trinity Nov 28 1868

Dear Mr. Lee  
A Grasp Jump  
Sir

I have the honor  
to lay before you a Complaint from  
Jesiah King who has worked  
with a man by the name of John  
Fray in Concorda Parish on Black  
River adjoining my Parish they  
sowed a Crop of Cotton and Corn  
65 Bushel of Corn and have shipped  
11 Bales of Cotton on the schooner  
Allen on Oct 24<sup>th</sup> they would not  
give him the mark and have not  
divided neither Corn or Cotton his  
share of the Crop according to Contract  
is 1/4 The Kidman was run off  
of the place and was told if he returns



he will get what he is now  
 in my Office he has been to me  
 twice before and I have written  
 to Mr A Hamilton same weeks  
 since with regards to the matter  
 but have not heard from him with  
 regards to it The Bundren on  
 the River is had for some  
 Planters I have had several complaints  
 but they are out of my Parish and  
 I have referred them to Nidalia  
 The 11 Bales averaged over 440 lbs  
 per Bale

I remain your obedient  
 servant

C. H. Camp

to the Rev B B W A

279. 1/2  
 J. H. Camp  
 Catawba Parish  
 Family - Nov 2nd 1888.

Camps - J. H. Camp  
 A. A. A.

Relating to the  
 shipment of his  
 share of the crop, of  
 Spanish Iron - (2)

250. 1/2  
 Mr. J. M. 1000. P. 24 A. 2.  
 Office A. A. S. S.

Mr. William Wm. 16. 1888  
 Respectfully referred to  
 Mr. Wm. P. P. 1888  
 A. A. A.

J. H. Camp  
 Nov 21. 39. 11. 1. S.  
 A. A. S. S.



Recd. 11 A. A. S. S. Nov 17 1888



L 250 (Bu. R. F. & A. L., La.) 1868

HEADQUARTERS,  
Bureau Refugees, Freedmen and Abandoned Lands,  
DISTRICT OF LOUISIANA

New Orleans, November 18, 1868.

Respectfully referred to Mr  
Alexander Hamilton,  
Asst. Sub Asst. Commr (Third  
Mr. Geo. W. Rollins Sub Asst.  
Commr 6<sup>th</sup> Sub District) for  
immediate investigation and  
report.

Mr. Hamilton will  
render all assistance in his  
power to the within named  
freedman to enable him to  
obtain his share of crop or  
its value.

Mr. Hamilton's attention  
is directed to existing instruc-  
tions from these Headquar-  
ters governing cases of this  
nature.

By Command of  
Bvt. Maj. Genl. Edward Hatch U.S.A.  
Asst. Commissioner

L. V. Hutchins  
Bvt. Maj. U.S.A. Capt. 1<sup>st</sup> Cavalry  
Actg. Asst. Adj. Genl.

Prairie Landings  
Recd as act sub Dist La Nov 20 1868

R 315-08 act 6<sup>th</sup> Dist La 1868

Office Sub Asst Commr Bu R F & A L  
6<sup>th</sup> Sub Dist of Louisiana Nov 24 1868

Respectfully referred to Mr. A. L. Hamilton (Asst. Commr Bureau of Refugees, Freedmen and Abandoned Lands) for immediate investigation and report.

Geo. Rollins  
Sub Asst. Commr. 6<sup>th</sup> Sub Dist of La

EB  
3/1/83

C. B. C. 15. O. A. S. C. 2. Pol. Y. A. S. C. 1  
Office Sub Asst. Commr Bu + C  
Tennessee + Concordia  
Vidalia La. Nov. 27 1868

Respectfully returned to  
Bvt. Maj. B. S. Hutchins  
Asst. Commr. B. R. 4<sup>th</sup> & 5<sup>th</sup>  
District of Louisiana

(Thru Mr. Geo. W. Rollins S. P. C.  
6<sup>th</sup> Sub Dist.) detailed report  
has been received as directed  
by foregoing endorsement

Alexander Hamilton  
Asst. Commr Bu + C  
Tennessee + Concordia Va

Recd as act sub Dist La Nov 27 68  
Enclosure

R 250. Bu R F & A L  
R 318-08 act 6<sup>th</sup> Sub Dist La 1868

Office Sub Asst Commr Bu. R. F.  
and A. Lands 6<sup>th</sup> Sub Dist Dist of  
Louisiana, Vidalia Nov. 25 1868

Respectfully returned to Bvt.  
Maj. B. S. Hutchins a. a. g.  
Bureau R. F. and A. Lands, New  
Orleans Louisiana

Attention invited to the foregoing  
endorsement of Mr. A. L. Hamilton  
U.S.A. Commr. and enclosed report.

Geo. Rollins  
Sub Asst. Commissioner  
6<sup>th</sup> Sub Dist. Dist. La

EB  
3/1/83

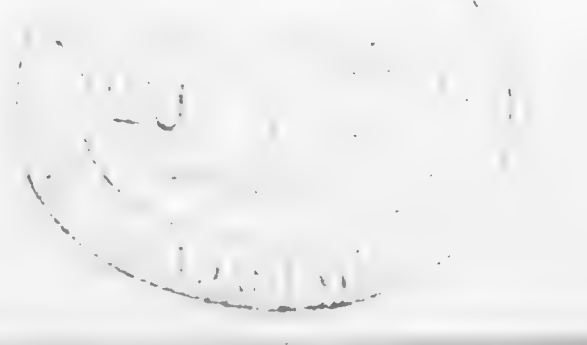



W. (Bu. R. F. & A. L., La.) 1868

HEADQUARTERS  
BUREAU REFUGEES, FREEDMEN AND ABANDONED LANDS,  
DISTRICT OF LOUISIANA.

New Orleans December 8<sup>th</sup> 1868.

Respectfully returned to Mr. Van  
R. N. Hilliard a.s.a.c.  
Parish of Catahoula La. 5<sup>th</sup>  
S. John R. Town S. C. Court  
5<sup>th</sup> Sub District, Attention directed  
to Statement of Mr. Alexander  
Hamilton A. S. A. Court.

By Command of Edward Hatch, Major  
BREVET MAJOR GENERAL R. C. BUCHANAN.

*Meritt H. Warren*

By't Lieut. Col. U. S. A., Captain 39th Infantry,  
Act'g Ass't Adj't General.

88  
57342

Rec'd at Cas 5<sup>th</sup> Sub Dist  
December 12. 1868

W. (Bu. R. F. & A. L., La.) 1868

Headquarters  
Bureau R. F. & A. L.  
5<sup>th</sup> Sub District of Louisiana  
New Orleans December 12. 1868.

Respectfully forwarded  
to Mr. Van R. N. Hilliard  
A. S. A. Court. Attention  
invited to foregoing endorse-  
ment of Capt. Lieut. Col  
L. H. Warren, U. S. A.  
General, and to Statement of  
Mr. Alexander Hamilton  
Act. Sub. Dist. Court.

*John A. Power*

Sub. Dist. Commission  
5<sup>th</sup> Sub. Dist. of La.

Wrapper - (..... Enclosures.)



No. 447. Prud'ral 68

Office Asst Sub Asst Commr Gen  
Parishes of Texas and Concordia  
Vedalia La Nov 27<sup>th</sup> 1868

Hamilton Hebender.

6<sup>th</sup> Div. U.S.A. Commr.

States that he fully investigated  
the case of complaint of Deauch  
Kings John Gray the former  
with others the 26<sup>th</sup> of June 1868 contract  
ed to be in for the latter for 1/2 net price  
That plaintiff repeatedly absented him  
self with permission, and was told of he  
did it again he need not return - when  
the plaintiff left with his family went  
out to reside in Catonsville Maryland  
So far from defendant ever trying to  
short plaintiff he solicited his return  
That Mr John <sup>Ray</sup> Ray seem to be an honest  
and fair man - Examined also Sales  
of Tex C/O - 3938 lbs - amty 10<sup>th</sup> 83.7.68  
now in the hands of Mr Edis Young  
Merchant at Vedalia and that as soon  
as returns of 4 more bins - shipped to St. L.  
understand, will make a settlement -  
By communication from J. H. Gray

Rec'd O.S.A. See at Dec 1<sup>st</sup> 1868

250. Prud'ral 68

Rec'd Office Parish of Catahoula Dec 16<sup>th</sup> 1868

L. S. B<sup>#</sup> 153 Office of S. A. Com<sup>r</sup> B. R. F<sup>ca</sup> of Lands  
Parishes of Sensus & Concordia La.  
Vidalia, La. New Orleans 27<sup>th</sup> 1868

Genl & Major B. T. Hutchins  
S. A. of Sens. B. R. F<sup>ca</sup> of Lands  
New Orleans, La

Sir:

In compliance with endorsement from Hon. Genl  
B. R. F<sup>ca</sup> of L. District of Louisiana, dated New Orleans  
La. Nov. 18<sup>th</sup> 1868. I have the honor to report that  
I have fully investigated the complaint of Daniel  
King (C) against John Gray Plautin, and find the  
facts in the case to be as follows.

Daniel King, his wife, and two other hands, contracted  
with John Gray, Jan 26<sup>th</sup> 1868, to labor for him, for  
"One half net proceeds" of crop. King it appears has  
been in the habit of leaving the plantation for  
several days at a time, the last time he absented him-  
self was during the height of the cotton picking season  
as he was leaving, Mr. Gray met him, and told him  
if he went away this time, he need not return.

(over)



King took this for a virtual discharge, and removed his wife and goods into Catahoula Parish - Mr Gray, aware that so far from threatening to shoot him should he return, to the place, he had at one time solicited his return, and is ever now willing that he should come back.

I have examined "Accounts of Sales" of Ten (10) Bales of Cotton shipped by Mr Gray to J. B. to the Commission Merchant New Orleans, La. Weight 3938

All proceeds of same \$8537.63 These funds are now in the hands of Mr Peter Young, Merchant of Vidalia, and will remain there until a Settlement can be effected between Gray & King.

I have inspected the books and accounts of Mr Gray, and a settlement will be effected in this Office as soon as the proceeds of four or five additional Bales which will be shipped during the ensuing week are received by Mr Young.

I appreciate no difficulty in effecting a Settlement satisfactory to both Gray & King - Mr Gray seems disposed to act fairly & honestly and has placed his accounts etc in my hands in order to facilitate a Settlement.

When ready to make such Settlement I will

request Mr J. H. C. Camp, A. S. J. Com<sup>o</sup> Catahoula Parish, La. to notify King to appear at this Office

In reference to statement of Mr Camp that he has communicated with me in relation to the foregoing, I have the honor to inform you, that if Mr Camp's letter was received at this Office, it would have met with instant attention, but I have never received a communication of any kind from him.

Very Respectfully  
Your Obedient Servant  
Alexander Hamilton  
A. S. J. Com<sup>o</sup> B. R. J. & Land  
Parishes of Iberville & Concordia



Nov - 168

W W Wood  
St. Xerxes

Forwards official copy  
of affidavit of Moses  
Green relative Doubt-  
-rages.

(Enclosure)

H. 94. Bu R. Frsch. Lab 8

Monsieur. La.

Referred to P. L.

see 108 ✓



State of Louisiana }  
Parish of Concordia } 88

Personally appeared before me this tenth day of November A.D. 1868. at the Court House in the town of Vidalia La, Parish and State aforesaid, one Moses Green Jr "colored" who deposes and swears. I Moses Green Jr have lived with Mr Joe Beck on Sicily Island. Parish of Catahoula more than a half of a year. Some five miles from where I lived were Glenns Mills. The next day after the election about Nov 4<sup>th</sup>, after night I saw by the light of pine knots and in the house Mr John Grange, Horace Pierson, DeBlack, Judge Sap, Mr Roach and Alex Curry all white men who asked when they came up where Emanuel Right "colored" was, I told them that he Emanuel was in the house. they called him out and tied his hands across with a grass rope and took him about two miles and between Mr Henry Green place and that of Mr Peter Lovelace and stripped Emanuel Right naked of clothes and Mr Horace Pierson and DeBlack. both at one time with two Bull whips and a large strap whipped him "Emanuel Right" as many as one hundred lashes. then Judge Sap and Alex Curry took the same whips and whipped him Emanuel Right until they said they had given him ninety lashes apiece. then Mr Roach and Mr Grange took the same whip and whipped Emanuel till they said they whipped him eighty lashes each then they let him loose all bloody on his thighs, arms and back. He was gagged while being whipped so he could not cry out much. I was the only colored person who saw the whipping. I stayed with Emanuel and as they got through whipping him Mr Grange shot Emanuel Right with a double Barrel Shot Gun loaded with shot the charge entering the under portion of the thigh above the knee, when he fell down and lay on he was killed <sup>I thought he was killed</sup> all the white men who had done this then went away. I went to Emanuel and found that he was not killed and helped him to his house, and to



bed, where he was. when I come away with my father, his wife, one little brother and fathers grand-child.

We left every thing because my father was threatened to be whipped like Emmanuel Right because he and Emmanuel Right would not vote the Democrat-ic ticket as they did not vote at all nor go near the place to vote

I heard six or seven men who had families say that they was coming away to keep from being killed because they would not vote the way the White men wanted them to vote as all the Black men that I know wanted to vote the Radical ticket and dared not do it - and just as I was coming away I saw <sup>about</sup> twenty or thirty white men on horse back. some with guns and some with pistols, all armed, said they was going over to Mr Joe Loulaco place to whip some of the Black people to death and going up to Franklin Parish for more men -

My father has left every thing and dare not for any thing go back out there for fear of being killed -

Sworn to and subscribed to before  
me this tenth day of November  
A. D. 1868 at Vidalia. La.

"Signed" <sup>his</sup> Mose <sup>x</sup> Green for  
marks

"Signed" J. M. Mump  
Clerk 15th Dist. Court and Justice of the Peace in and for the Parish of Concordia La.  
"Signed" Richard Hatchford  
"Signed" Scott Rollins

Official Copy Respectfully furnished for the information of  
Mr. John W. Board. No. 1121. Cor. 1<sup>st</sup> & 2<sup>nd</sup> Dist. Monroe La.

W. W. Wood  
"Signed" A. R. Board



New Orleans La.  
Nov 23 1868

Lt Col. E. C. Beman  
D. O. Ho

Relative to duties  
of A. S. A. Beman.

B. Bu R. F. and H. L. La 1868.

Office D. O. A. A. 2 M.

New Orleans La Nov 23 1868

Beman E. C. Post Lt Col

D. O. and A. A. 2 M.

Beman R. F. and H. L.

Rec. C. A. Beman R. F. and H. L. "Catahoula"  
Duties of Lt Col 26<sup>th</sup> - 1868 -

Bureau of Refugees, Freedmen and Abandoned Lands,

OFFICE D. O. & A. A. QUARTERMASTER, No. 206 ST. CHARLES ST.

New Orleans, Louisiana 23<sup>d</sup> 1868

Mr. Van R. Walcott  
A. R. Com. Truist Lt  
Sir;

In answer to yours dated  
Nov 13<sup>th</sup> 1868 I would most respectfully state that  
Stationery for the 4<sup>th</sup> Quar 1868 Oct 1<sup>st</sup> to Dec 31<sup>st</sup>  
has been furnished Mr J. H. Camp your predecessor  
Forage for the months Sept Oct & Novem was  
also shipped to Mr Camp. Your allowance of  
Forage has in me traction Mr J. H. Bowen has  
shipped to his care & will be by him forwarded  
to you. Will care that the proper form for purchase  
vouchers. I enclose you # 12 upon which you  
will please make your purchases. Also send  
you Fuel Requisition which please fill in duplicate  
& return - don't hesitate to make any enquiries  
as anything you are in doubt <sup>about</sup> - ~~as they~~ will be  
cheerfully answered

Very Respectfully,  
Per order Bt Lt Col E. C. Berman  
Quartermaster



W# Bureau R F & A L

1865 -

Ed. L. Bureau R F & A L  
Office Apt Comy of Pub  
New Orleans Nov 28<sup>th</sup> 1865

---

Wood. W. W. Lieut 1<sup>st</sup> U. S. Infy.  
A. C. J. -

You will at once forward to  
this office the Bond of White  
& Ramsey of your Parish -

---

Trinity

Rec<sup>d</sup>. Parish of Catechoula - Trinity La. Dec 1<sup>st</sup> 1865

HEADQUARTERS

Bureau of Refugees, Freedmen and Abandoned Lands,

Office of Assistant Commissary of Subsistence.

New Orleans, Nov: 28<sup>th</sup> 1868.

Mr. J. H. Hilliard,

J. H. C.

Orleans, La

Sir,

You will at once forward to this office the Bond  
of White & Ramsey of your parish.

Said bond was forwarded to your office for  
to be signed by their bondsmen

You will give this letter your immediate  
attention

Very Respectfully

Your Obedt. Servt.

J. H. C. J. H. C.



Trinity, Louisiana  
Dec. 1, 1868.

Jan R. K. Hilliard  
Asac, Catahoula Par.

Returns bond of  
Messrs White and  
Ramsey, who say  
they have paid their  
indebtedness to this  
Bureau.

Rec'd. offic' a.c.s. Dec. 4/1868.

Ed. 2rs. Bu. R. 7 r a. 2.  
Offici' a. c. s.  
New Orleans, Dec. 4/68.

Respectfully returned.  
This bond will if  
possible be signed  
by the sureties.  
Messrs White & Ramsey  
have not, as yet,  
paid their indebtedness  
to this Bureau.

2/4  
6/12  
245

at at at at at  
25th Dec 1868  
a.c.s.

IV Bureau & F. A. L. 1868

Officer A. B. S.  
New Orleans Dec 4/68

Wm W. Wood.  
2<sup>d</sup> Lt 1<sup>st</sup> Infy.  
a. c. s.

Returns bond to be signed  
by sureties. Messrs White  
& Ramsey have not yet paid  
their indebtedness to this Bureau.

Trinity

Rec'd. Offici' Bank of Catahoula. Dec 7/68



Officer Apt. Sub. Apt. Commissioner  
Bureau R. F. and R. L.

Parish of Calcasieu -

Trinity La Ore 1<sup>st</sup> 1866.

Lieut W. W. Wood 1<sup>st</sup> U. S. Infy -  
A. C. of Bureau R. F. & R. L.  
New Orleans - La

Lieut =

In compliance with  
your request of Nov 28<sup>th</sup> 1866 - I have the honor to transmit  
herewith, the Bond of White & Ramsey. Said bond has not  
yet been signed by the bondsmen. Messrs White & Ramsey inform  
me, that they have paid their indebtedness to this Bureau -

Very Respectfully  
Your Obedt servant

Van R. K. Hilliard -  
A. C. of R. F. & R. L.



C. B. 153. ad. aff. A. A. S. G.

Headquarters  
De. R. F. and A. L. Dist. La.  
Office S. A. J. General.  
New Orleans. La. Dec. 4. '68

Respectfully returned to  
Mr. Van R. K. Killiard  
A. J. A. Comr. (Thru. Sub.  
West. Comr. 5th Sub. West. La.)  
for compliance with Par.  
2. Cis. 18. C. from these  
Headquarters. All of the  
Plantations not inspected  
will be estimated, together.  
The total of those inspected  
and those estimated making  
the total in the Parish.  
Immediate compliance with  
the requirements of Circular  
referred to is insisted upon.

J. M. Lee  
1st Lieut. 39th Infantry  
S. A. J. General.

Asst. Com. 5th Sub. Dist. La, Dec 10 '68

L. 95. Qu. D. & A. La '68

Headquarters  
Bureau R. F. & A. Lauds  
5th Sub District of Louisiana  
Maurice, La, Febr 10, 1868.

Respectfully forwarded  
to Mr Van R. K. Killiard,  
A. J. A. Comr. whose  
attention is invited  
to the foregoing request  
of the Acting Asst. Insp't  
General.

John W. Bowry  
Sub Asst Comr  
5th Sub Dist of La

600  
2/19

Rec'd Dec 14<sup>th</sup> 1868  
Office Parish of Catahoula

W. Burman R. F. & H. 1865

Wd 2 Burman R. F. & H.  
Office of Apt Comy of Subsistence  
New Orleans Dec 10<sup>th</sup> 1865.

Wood. W. W.  
2<sup>d</sup> Lt 1<sup>st</sup> Regt f. Infy  
A. C. f.

By direction of the Apt Comy. you will  
inform Mr E. S. Robertson of your  
Parish, that his indebtedness to the  
Govt in the sum of \$94.60. was  
paid the 9<sup>th</sup> inst. - His bond will  
not be cancelled until the certifi-  
cate of the sub Apt. Comy, 3<sup>rd</sup> sub comy  
has been used.

Trinity  
Rec<sup>d</sup>. Office Parish of Catahoula, Dec 12/65



HEADQUARTERS

Bureau of Refugees, Freedmen and Abandoned Lands,  
Office of Assistant Commissary of Subsistence.

New Orleans, Dec. 10th 1868.

Mr Van R. K. Billiard  
a. s. a. c., Calahoula Parish  
Trinity, La.

Sir,

By direction  
of the Asst. Comr. you will inform Mr  
E. S. Robertson of your Parish, that his  
indebtedness to the Govt. in the sum of  
\$ 04.60 was paid the 9th inst. inst. inst.  
His bond will not be cancelled, until  
the certificate of the Sub Asst. Comr., 5th Sub  
Dist., is received, as required by Circular  
19, C. S., from these Hd. Qs.

Very respectfully

*[Signature]*

Edw. S. Johnson

Acc.

NATIONAL ARCHIVES AND RECORDS ADMINISTRATION  
MICROFILM PUBLICATIONS

Roll 103

Target 12

*Complaints*  
Volume (479)

Aug.-Nov. 1868

Volume pages were filmed sequentially.  
Blank pages were not filmed.



479

**LOUISIANA.**

*Journal  
de la  
Natchez  
Louisiana*



Trinity Sa

---

Complaints

Contracts

Journal of business

---

479



Officer, Act, Sub, Asst., Can  
Aug 15<sup>th</sup> 1868

Colian Plant }  
W. W. C. Boyd }

Y<sup>rs</sup> man Walker presume  
states no agreement has been signed for  
the year of 1868 he wishes a contract  
but cannot get Mr Boyd to make one  
The agreement is of Cops between  
them

Officer, act, sub, asst., Can  
Aug 15<sup>th</sup> 1868

Quita Plant }  
Jacob Forrett }

Paul Johnson  
Complained that Mr Forrett owes him for  
3 loads Wood \$2.00 (hauling Wood)  
Bob Johnson  
Complains that Mr Forrett owes him for  
3 loads Wood the same amount to be divided  
\$1.00 each



Office Asst Adj Asst Com  
Aug 27<sup>th</sup> 1868

Complaint of Joseph Johnson on  
Chas Jones Plantation Against Mr Jones  
States Mr Jones sent to the field  
for a mule that belonged to his squad  
to haul wood, and he did not send it  
Mr Jones came to the field with a  
double barrel shot gun and drove him  
to the house and there beat him  
with a stick

Letter

Office Asst Adj Asst Com  
Aug 27<sup>th</sup> 1868

Mr Mr Jones  
Sir

There has been a  
Complaint made by Joseph Johnson  
a freedman on your Plantation of your  
drawing a shot gun on him and driving  
him to the house from the field and  
there beating him

This manner of conducting a  
Plantation must be stopped or I shall  
be forced to institute measures to  
stop it

I am Sir your obedient servant  
W. H. Camp  
A. S. C. Com, B. A. T. D. A. A

Letter of Mr Jones

Elmo Aug 27<sup>th</sup> 1868

Mr J. N. N. Camp

I have received  
your note upon Complaint of Joseph  
Johnson and refuse to take any  
notice of it whatever I do not  
recognize your authority in the premises  
I will not explain to you why  
and about the lawful person my  
reasons for acting as I did I but  
only say that the next time any  
thing of the kind occurs things will  
go differently any measures you have  
to institute to manage my place for  
me will be met as a free man  
I should meet any attempt at  
opposition and that is now my  
determination

Respectfully yours  
Sign William Jones

A more full statement taken  
and sent to Headquarters for investigation  
with my report on the case

Report

Dates Office A. S. C. B. A. T. D. A. A  
Aug 27<sup>th</sup> 1868

Col L. H. Mason  
A. S. C. Com

Sir

I have the honor  
to forward you the enclosed report made by  
Joseph Johnson a freedman on the Elmo



Plantation belonging to Mr Chas Jones  
 against Mr William Jones who has charge  
 of the Plantation while his father Chas  
 Jones is absent. I refer you to the  
 statement of Joseph Johnson (who has  
 other Whidneys) also my letter which is  
 marked No(1) and his answer No(2) There is  
 no force here to assist me if I am ordered  
 to carry out any of the orders of the Bureau.  
 If I send for a planter to come to my  
 Office he sends me back word if I want him  
 to come to his place. Therefore you see  
 the Bureau orders are granted and  
 the orders of the Bureau stand at.  
 I am at a loss how to act under the  
 existing circumstances. There has been  
 no orders received since the state has  
 been turned over to the civil authorities  
 I therefore forwarded this case to you  
 for your consideration and instructions.

There is no civil justice here

I remain as your obedt servant

J. H. Camp  
 A. S. A. Can B. A. F. & A. S.

The above case was tried and the  
 prisoners Mr Jones bound over to  
 appear before the District Court  
 (Criminal) at its next session

Office Post Sub Post Com  
 Bureau, B. F. & A. S.  
 Trinity Catahoula Parish  
 Sept 23<sup>rd</sup> 1868

Comptant

Made by Dick Taylor, Chas  
 Overstreet, Chas Crawford, Charles Whiting  
 and Squire out an attachment and seized  
 the crop on Monday from Plant before  
 Mr Cherry Justice of the Peace Ward  
 No 11 Trial set for Thursday Oct 14<sup>th</sup> 1868  
 Oct 1<sup>st</sup> The above case Judgment rendered  
 in favor of Prudman Subject to settlement

Office A. S. A. Can  
 Bureau of B. F. & A. S.  
 Trinity Sept 26<sup>th</sup> 1868

Mr. A. E. Wilkerson  
 Sir

It has been reported  
 to me by the Prudman working on your  
 Plantation that you are about to ship  
 three shares of Cotton the Cotton Crops with  
 yours without a division of the same (which  
 is according to Contract

I therefore forbid you shipping any Cotton  
 raised on the Little Miller Place for the year  
 of 1868 under the penalty of the law.

Until after a proper division is made  
 of the same

I am Sir your obedt servant

Prudman

Arthur Danks

Ephraim King

Richard King

J. H. Camp

A. S. A. Can B. F. & A. S.



Officer, Asst. Asst. Com  
Bureau N.F. & A.S.  
Prinaty Sept 26<sup>th</sup> 1868

To whom it may concern

Know ye that I  
have in behalf of Cuba Quincy  
Ephraim King, Richard King this day  
forbidden any person or persons <sup>the</sup> ship-  
Any of the Cotton raised on the Little  
Hills Place by A. E. Wilkins and the  
ship named Frederick <sup>and further more</sup> ~~is~~ <sup>to be</sup>  
Steam Boat to receive the same  
under the penalty of the law  
for I shall hold them responsible  
for the same.

As there has not been a division  
of the Crops according to agreement  
A. E. Wilkins  
Asst. Asst. Com  
B. A. S. & A. S.

The above was settled between  
the Frederick and A. E. Wilkins their  
share of the Crops being set apart

Complaint Oct 12<sup>th</sup> 1868

Against Chas James by Rich  
Brant & family an Almon Plant to furnish  
ration & storage and give C James 1/2 of Cotton  
Crop and 1/2 Corn and Rice

Officer, Asst. Asst. Com  
Bureau of N. F. & A. S.  
Calapoula Parish La  
Prinaty Oct 11<sup>th</sup> 1868

The Case of Troutman & Dickens vs  
Frederick for labor for the year of  
1867 which was referred to Head  
quarters and returned to me with  
orders to prosecute it in a Civil  
Court, was this day referred to the  
law by Henry Troutman & Dickens  
before L. S. Duke, Justice of the  
Peace at Morrisburg

Shad Davis for } \$433.50  
Rachel " Whip } \$44.00 \$477.50

William Howard \$59.01

Abram Jackson \$99.70

The remainder of the Frederick to enjoy  
in the suit

Complaint Oct 12<sup>th</sup> 1868

of the Frederick against  
Elijah Cotton from Durant Place  
Ackland Place Ackland Frederick  
Law Mr S Black & Bill of Sale  
of their Cotton 1/4 and Durant they placed  
their share in the hands of the Bureau  
1/2 Crop



Rept page 103

Office of A. S. A. C. B. R. F. V. & L.  
Catahoula Parish  
Kinisty Jan 2<sup>d</sup> 1868

Complaint of Asaiiah King against  
John Gray Plaintiff vs Deining  
himself of his place to take  
him of his share of the crop  
of lush corn 11 Bales Cotton shipped  
by report on page 103 to set of the  
law made full dated Jan 2<sup>d</sup> 1868

Copy of Agreement  
State of Louisiana  
Parish of Catahoula La

We the undersigned preudmen  
do agree to make an agreement for the  
year of 1868 for one half of the crop they  
raise (or make) and do agree to make according to directions  
of the managers & managers and do all necessary work on  
the place for the making and gathering the crops.  
The said managers & managers to furnish all teams  
and farming utensils required and the undersigned  
preudmen to pay for the disbursements both for the slaves  
and 1/3 one third of the teams until the crops is  
gathered and sold

Signed  
Asaiiah King } Eliza an Gray  
Sarah King }

Account of Asaiiah King  
with John Gray

Aug 29	14 gds of striped Cotton	30 <sup>c</sup>	\$4.20
	14 " " " " " "	20 <sup>c</sup>	2.80
	6 " " " " " "	30 <sup>c</sup>	1.80
	1 pr shoes		2.25
	Received 2 Nations for 2 months		\$11.05

A Letter

Office of A. S. A. C. B. R. F. V. & L.  
Catahoula Parish La  
Kinisty Jan 2<sup>d</sup> 1868

Chas O Bannor

Complaint I am informed by  
Vina Robinson who Joseph Gentry  
struck this morning  
I have had a great deal of trouble  
with preudmen shipping Thomas  
I will have every man furnished  
in future who make treat or beats  
Thomas. The colored people are  
now free and are governed by the  
same law as the white man  
if a man strikes a woman or  
beats the same says he shall  
be fined and imprisoned  
Please read this to Joseph  
and abide

J. R. R. Camps  
A. S. A. C. B. R. F. V. & L.

Complaint Jan 2<sup>d</sup> 1868

Arman Johnson against A. S. A. C. B. R. F. V. & L.  
Agreement to furnish ourselves and 1/2  
Poule free and divide the crop 1/2  
wants his share of the crop divided  
at the fair and not at his price



Nov 3<sup>rd</sup> 1868

Complaint of  
Ambrose Beckley & Jeff Chalkley  
against Mr. Abner Heston in Hills  
Merchant Mr. Wm. H. Harrison  
places that Craft 74 in hands of Bureau

Office, A. S. C. B. R. V. A. S.  
Calahoula Parish La  
Private Nov 3<sup>rd</sup> 1868

J. W. Darling Esq  
No 121 Market St  
Air

Carroll Davis a  
Private in Co (D) 78<sup>th</sup> Regt. M. C. A.  
has applied to me having  
your Receipt No 4857 Dated S. O. July  
19<sup>th</sup> 1867 to write to you as Lt of the  
Bureau for this Parish to ascertain  
from you what has been done by  
you with his Papers

If you have heard from the yet  
Please write me. Direct of W. H.  
Camp, A. S. C. B. R. V. A. S.  
Calahoula Parish La  
I remain your obedt servant  
J. W. Darling  
A. S. C. B. R. V. A. S.

Tuesday November 10<sup>th</sup> 1868.

In compliance with special order No 122.  
dated 24<sup>th</sup> March Bureau of R. & A. L. State of  
La. New Orleans. Nov 6<sup>th</sup> 1868. I assumed the  
duties of asst. sub. aft. Commissioner of said  
bureau, for the point of Catahoula.  
V. J. Capt. P. H. H. Camp relieved -  
No business -

Wednesday Nov 11<sup>th</sup> 1868.

Was in the office all day overhauling the books &  
papers appertaining to the duties in this Parish -  
Wm. G. Bruce, Planter & George H. Turner  
freemen brought to my office contracts, & acf. for  
years 1865/7. They come to an amicable settlement  
the acf. showed Turner's indebtedness to Bruce to be  
\$330.69. They agreed to settle the matter by said  
Turner, giving to said Bruce, Two Bales Cotton, & four  
two year old calfs.

Mark Brown (freemen) employed  
on Chas. Jones Ridge Plantation. complains that  
Mr Jones cheated him out of half of his pay (\$150.00)  
for the year 1866. Yet "Brown's" papers show that he has  
received the full pay.

Thursday Nov 12<sup>th</sup> 1868.

Visited Harrisonburg to swear before the Clerk  
of the Court to my travelling expense acf. of last  
month. Made the acquaintance of several  
Planters who informed me that the freemen were  
working very well. I also learnt that they were making  
about 3/4 of a bale of cotton to the acre -  
No business at the office.



Friday November 13<sup>th</sup> 1868

Thos. Bannan (freedman) a school teacher on Ackland plantation, informed me that some time last spring he raised by subscription amongst the freedmen some money to build a <sup>age</sup> school house & that he let Mr Johnston Lennons have thirty Dollars of the amount to keep for him - that Mr Lennons refuses to return the money - that he has turned the matter over to Mr Cheney for collection -

Saturday Nov 14<sup>th</sup> 1868

Thos Jefferson Davis (Freedman) employed by C. H. Hooper on Birch Park Plantation. brings me a Receipt signed Gustave Archim. U.S. claim Agt. Dated Trinity Aug 10<sup>th</sup> 1867. Office Alexandria, La. letter Bot 32. which shows that the papers have been taken to obtain claim for bounty awards of pay & application for pension, for an old freedman employed on Mr Hooper's place, Liddy Hughes, wife of the late Samuel Hughes. Hughes was a private in Co H. 6<sup>th</sup> Regiment U.S. Col. Art. Vols. I told Jefferson, that I would try to find out, about Mrs Hughes papers.

Manda Brent (a freedman) employed on Mr Boyds plantation. complains that Levi Brent, a freedman employed on Capt Collet's place. to whom she was never married, but with whom she has been living for now three years & by whom she has had two children, has deserted her & is going to be married this evening to one Jane Lerney. My advice to Manda was, to go to the wedding & tell the person who was going to marry Levi & Jane the same story she had told to me.

Mr L. E. Boyzeman, who works land owned by C. A. Hooper. told me that he owed to Estharris (freedman) the sum of five Dollars, & that he would pay it, as soon as he could.

Sunday Nov 15<sup>th</sup> 1868

No Business - (Spent the day on Mr Chas. Jones plantation -)

Monday November 16<sup>th</sup> 1868

No Business. [It rained all day]. Spent the day looking over the books & papers appertaining to the office.

Tuesday Nov 17<sup>th</sup> 1868

Rec<sup>d</sup> from H<sup>d</sup> Dr Bannan R. F. & A. L. Blank Form # 22.  
Rec<sup>d</sup> a communication from Capt H. H. Pierce. Gen. Insp. Education.

Wednesday Nov 18<sup>th</sup> 1868

Isaiah King a freedman employed on John Gray's plantation "Concordia Parish" wishes to know what Mr J. H. Camp has done in regard to his being drove off the plantation & not allowed to have his share of the crop. By referring to the books I find that Mr Camp has written about the matter to St. Hill. La. Act. Agt. Just. Genl B. R. F. & A. L. & also to A. Hamilton act. sub. act. Court. Parish of "Concordia".

King says that he left with Mr Camp a book with the contract in - between him & Mr Gray. I find a copy of that contract, but not the original document. I also find a copy of an affidavit of what Mr Gray had let Mr King have. I gave Isaiah King the copy of affidavit & contract.

I wrote to Mr J. H. H. Camp to know what he did with the original contract.



Thursday Nov 19<sup>th</sup> 1868

No Business

Friday Nov 20<sup>th</sup> 1868

Received Circular # 19. dated  
Nov 2<sup>nd</sup> Bureau R.F. and A.L. 5<sup>th</sup> sub Dist of Louisiana -  
Monroe La. Nov 17<sup>th</sup> 1868

Saturday Nov 21<sup>st</sup> 1868

Inspected the plantations of John Ogden  
Alexander Watson & Elijah Cotton

Sunday Nov 22<sup>d</sup> 1868

A Complaint was made by Robinson Brown  
a freedman, employed on frogs boats plantation (up Lake River  
that in looking over their account Mr Coats had charged him  
with provisions which he had never had. I told Robinson  
Brown that it would be best for him, if I was present when they  
settled their acc.

Wrote a letter to Mr John Smith, Orifping Springs  
P.O. Warren Co. Kentucky, for an old blind freedman, Mariah  
Byder Smith.

Monday Nov 23<sup>d</sup> 1868

Received a copy of Circular  
# 19. from Head Quarters B. R. F. & L.  
Rec<sup>d</sup> Blank Pay Roll of Laborers Employed -  
The freedmen in town of Trinity report  
that they have some thirty or more children that could  
be sent to school.

Tuesday Nov 24<sup>th</sup> 1868

Wrote my Resignation.

Wednesday Nov 25<sup>th</sup> 1868

Mr E. S. Robertson, Planter, cultivating  
the Mayo & Boban Plantation, called at the office and  
informed me that his Merchants in New Orleans, Messrs  
Fellows, Ferguson & Harney had paid his indebtedness  
to this Bureau, for subsistence furnished him.

It rained all day.

Thursday November 26<sup>th</sup> 1868

Mr Geo. H. Bowen subapt  
Commissioner, 5<sup>th</sup> sub District visited the office.  
Rec<sup>d</sup> from H. A. L. New Orleans Circular No 20.  
Blank Inspection Monthly Reports. Teachers abstract  
A. No 2. Fuel Requisitions. Teachers Monthly school  
Reports. Applications for assistance for Teachers, and  
blank Applications for Teachers.

Friday Nov 27<sup>th</sup> 1868

Visited the school on the Ack-  
land (Mrs Metcalfe) plantation.

Saturday Nov 28<sup>th</sup> 1868

Mr White of the firm of White &  
Ramsay, Planters sent me word that their indebtedness  
to this Bureau, for subsistence furnished them, had  
been paid.

Sunday Nov 29<sup>th</sup> 1868

No Business



Monday November 3<sup>rd</sup> 1868

Samuel Davis, a freedman, late a private Co II. 48<sup>th</sup> Regt U.S. Colored Troops - Infantry - Discharged New Orleans La. Jan'y 6<sup>th</sup> 1866 - By Reason of f. Order in 2<sup>d</sup> Capt. La. 1865 - Showed me a Receipt dated New Orleans - July 19<sup>th</sup> 1867. Signed J.K. Darling U.S. Military Claims Agent. for his discharge papers to secure what bounty may be due him.

I told Davis that I would try to find out about his bounty.

Tuesday December 1<sup>st</sup> 1868

The freedmen, working with Mr. Elijah Cotton the Ackland (Musketts) plantation. Are very anxious to know what disposition has been made of their share of Twenty eight Bales of Cotton shipped by Mr. Cotton, to New Orleans, some time since.

I told the freedmen that I would try to find out what had been done with their share of the Cotton.

Wednesday December 2<sup>d</sup> 1868

Inspected Col. Jones' Elmley plantation.

Thursday December 3<sup>d</sup> 1868

Jack Thompson, a freedman working by the year for W. B. Brater, Planter. Complains that after having had some words with Mr. Brater yesterday, that he was driven off the plantation - From what I learnt from Thompson's story. I thought that both parties were to blame.

I told Thompson to go back to the plantation, and to tell Mr. Brater that he was ready to go to work. (It Rained all day)

Friday December 4<sup>th</sup> 1868

Thompson O. Barron (freedman) School Teacher on the Ackland plantation, called at the office & informed me that he has never had any pay for his services as Teacher, from the Bureau, during the two years that he has been teaching. Both Mr. Johnson & Mr. Camp - & a f. a. c. b. informed him, that he should have pay from the Bureau.

O. Barron informed me that he had closed his school for this year.

Saturday December 5<sup>th</sup> 1868

Wrote a letter to Col. J. W. Prentiss. Natches. Miss. for Mathew Davis (freedman) late a private. Co H. 6<sup>th</sup> Regt U.S. Colored Troops - to secure what bounty was due him.

Sunday Dec 6<sup>th</sup> 1868

No Business. (It rained most all day)

Monday Dec 7<sup>th</sup> 1868

Received back, from act of Com. of Subscribers, of this Bureau: the Bonds of Messrs White & Ramsey, for signatures of their surety. I found Mr. Brown & had him sign the Bond. I then sent the Bond back to Lieut. W. W. Wood a. a. c. o. f.

Tuesday December 8<sup>th</sup> 1868

Mr. Alexander & Mr. Rice - Woston, brought with them to this office their accounts against the freedmen, who are working this plantation on shares. I did not look over the a/c, as it was decided not to do so, until the final settlement.



Wednesday, December 9<sup>th</sup> 1865.

No Business -

Thursday, December 10<sup>th</sup> 1865.

Isaac Parker "Colored", showed me a receipt from Mr J. H. Camp for a vote against J. H. Boatman for \$31.00 being due said Parker. I do not find with the papers transferred to me in this office any such vote - Since writing the above, I have found the said vote, and given it to Parker, and taken from him Mr J. H. Camp's receipt.

I received, last evening, from Mr J. H. Brown Sub Assistant Commissioner of the 1<sup>st</sup> Sub District of La - a letter of instruction from the Assistant Commissioner of this State directing, to cause affidavits to be made, and proper steps taken for the arrest and trial of Fortis accused of committing an outrage against Emanuel Right "Colored" on Sicily Island of this Parish, on or about the 4<sup>th</sup> day of November 1865 - Enclosed therewith was an affidavit of Moss from Mr "Colored" concerning same.

Friday, December 11<sup>th</sup> 1865.

No Business -

Saturday, December 12<sup>th</sup> 1865.

Received notice from A. E. that Mr E. J. Robertson of this Parish has paid his indebtedness to the Govt. (\$94.60) Received from Hd. Q. Bureau, Official Roster for December 1865, & Special Order No 135. Wrote to A. J. D. Gaud for some Blank Monthly Reports -

Sunday Dec 13<sup>th</sup> 1865

No Business -

Monday Dec 14<sup>th</sup> 1865.

Rec<sup>d</sup> from Head Quarters A. S. Inspector General's Office Inspection Reports which had been forwarded there by my predecessor - Mr J. H. Camp - I also received, through Sub Assistant Comm & 1<sup>st</sup> Sub District, my Inspection Report for month of November, with a request to add to it an estimate of all the plantation not inspected.

Tuesday Dec 15<sup>th</sup> 1865.

Forwarded to Headquarters Inspr Genl Office - my Inspection Report for month of November, with an addition thereto of an estimate of all the plantation in the Parish which have not been inspected.

Wednesday, December 16<sup>th</sup> 1865.

Sent a letter to Mr E. J. Robertson ~~informing~~ him that his indebtedness to the Bureau - was paid the 9<sup>th</sup> inst. I also forwarded to him a blank pay roll.

Received a communication from Mr Alexander Hamilton, A. S. C. P. R. F. & H. L. Parish of Concordia - through Head Quarters, informing this office that when Mr John Gray, Planter Concordia Parish, was ready to settle with I. Raiah King (C) a notice would be sent him -



Thursday December 17<sup>th</sup> 1868

Mr. J. M. Butler, pastor of this parish wished to know if I could fill out certificates of Apprenticeship of some minor orphan of fortune. I referred Mr. Butler to the State laws with regard to apprenticeship.

Friday Dec 18<sup>th</sup> 1868

Rec'd from H. S. Ordan #18 - to close up the Bureau



NATIONAL ARCHIVES AND RECORDS ADMINISTRATION  
MICROFILM PUBLICATIONS

Roll 103

Target 13

*Miscellaneous Records*  
May 1867–Nov. 1868



Landing

No

---

Returned copies

of

Letters sent

Misc. reports

Louisiana,  
Prairie Landing.  
(or Trinity.)

---

Retained Copies of Letters  
Sent <sup>and</sup> Permits to Ships  
Cotton. 1868.

---

Monthly Report of Stores.  
1868

---

Monthly Report of Asst-  
Supt. for the Parish of  
Catahoula 1868.

---

Report of Persons <sup>and</sup> Articles  
Hired at Catahoula. La.  
for June 67. <sup>and</sup> Sept Oct <sup>and</sup>  
Nov. 1868.

---

Monthly Reports of Planters  
Supplies - Parish of Livingston  
May + June. 1868

---

Plaquemine La

Letter Received  
Unentered

1865-66-67

276/



(No. 25.)

*ert. No.* .....

CLAIMANT.

*ate* .....

*Co.* .....

*Regt.* .....

*S. C. T.*

*Amount due \$* .....

BY WHOM WITHDRAWN.

OFFICE MARK

*A. G. O. | F. B. | 187 .*

Offered to B. H. H. Jones  
Church of Calcutta  
Lousiana Presby.

Out E & Clark  
P. H. H. Jones  
Monthly Report - for  
February 1887

RC



Office Agent - B. H. H. H. H. H.  
Parish of Catahoula Prairie Landings  
Louisiana Feb 11 1867

Capt. J. M. H. Sterling  
Act. Asst. General  
B. H. H. H. H. H. H. H.  
Louisiana

Captain

I have the honor to transmit herewith a Consolidated Inspection Report representing very nearly the entire planting interest of the Parish. This Report, when compared with my Final Inspection Report of the year 1866, represents a slight decline in the amount of monthly wages given to freedmen, but a considerable advance where a share of the crop is conferred, also a greater proportion of the latter form of Contract than has heretofore existed; this change is attributable to a comparative exhaustion of the cash capital of the cotton factor (the result of a signal failure of the cotton crop of last year), consequently producing a like embarrassment with the planter.

In a pecuniary sense, "a share of the crop" is specially acceptable to both the planter and freedmen, it divides the contingencies of the same between







Dec 17/67

Mr Jacob Ferritt

---

Office Bureau R. F. A. L.  
Catahoula Parish, La  
Decr 17<sup>th</sup> 1867.

Mr Jacob Garritt,  
Sir

You will  
make out your accounts <sup>in full</sup> against  
the "freemen" who were in your employ  
on M. R. Plant during the present  
year & forward the same to this office  
at your earliest convenience

Respectfully Yours &c  
M. D. L.



Dec 167

Messrs Schuck & Auty

---

Officer A. S. A. Corns,  
Bureau R. F. & A. Lands,  
Catahoula Parish, La  
Dec 1867.

Messrs Messrs Scherck & Auley,  
New Orleans, La.

Gents,

I have  
this day shipped you for Steamer  
Seven bales Cotton marked  
(J.B.C.) & " weighing 2900 lbs, you will  
please pay one fourth the net proceeds  
of the Cotton to the Agt Bureau R. F. &  
A. Lands, New Orleans, La. and credit  
the balance to the ac of Mr J. B.  
Cotton,

Respectfully Yours &c,  
Mr. Johnston  
Agt Bureau



Dec 12/63  
Genl Forreth

---

order from General H. H.  
Van Hook & Co

Office &c - Dec 18<sup>th</sup> 1891  
is hereby permitted to ship <sup>the</sup> 10 boxes of cotton  
raised on Whites Ridge plantation upon  
his agreeing to settle fairly & honestly with  
the grower as soon as the cotton is  
sold & he gets return of sales &c.  
M J L,



Office Bombay Dec 17  
Mr J. G. Sir the ~~enclosed~~ permit I  
give you in the 16" (just to ship)  
the 10 bales of cotton raised on DTR  
D. during the present year is hereby  
revoked - you will hold the cotton  
until further orders from these H. S.  
Mr J L & Co

Dec 17/65  
Gresham Street

Aug 6/68  
M. J. Lillis & Co

---



July 6, 1867.  
Messrs. W. C. Miller & Co. No. 125  
Ship you Mr. Lucius D. Parker, 3  
which was turned over to me by Mr. W. C. Miller  
estate for over clothing and fuel in his  
sundry money for year 1867. You will find  
the account on my enclosed which you  
will please pay to the acct of  
Wm. D. Parker

Feb 7 / 69

Frank Corbett



Office Boston

Feb 7 -

Mr J. Sumner Entomologist, Bees River  
Leakerville Parish La

Sir - I have carefully examined  
the within settlement, and find it  
incorrect and unjust - and respectfully  
disapprove it

R -

Feb 6/69  
A. A. Paul

Little Sea

RC



Officer Asst' Sub Asst Comm.  
Bureau T. F. & A. Lands,  
Catahoula Parish, La.  
Feb 6<sup>th</sup> 1868.

L. H. Warren, Capt 39<sup>th</sup> U. S. A.  
A. A. A. Genl.  
Bureau T. F. & A. L.

Sir

I have the honor to state to you, that there are several planters in this Parish <sup>who</sup> wish to avail themselves of the privilege of drawing rations, for their free people in their employ, from the Bureau.

Will you please send me some blank contracts, Requisitions, Bonds, Affidavits, Books &c

Very Respectfully  
Your Obt. Servt.  
M. Johnston Lemmon,  
A. G. A. C. Bureau





Feb 8 1868

L A Warren Capt - 3911 S I

Sir

I have the honor to transmit you the following statement - an old freedman by the name of Dick Taylor formerly the property of Mr Jacob Garrett. had a broken down mule given him in the fall of 1864 by the federal soldiers, he kept the mule as his own, feeding and taking care of it himself & no one ever used it unless they asked him for it. In the spring of 1867 Mr Garrett & Capt Clark hired the mule of Dick Taylor to work in the crop at 50¢ per day. which Mr G. acknowledged to me a few weeks ago while trying to make a settlement; a few weeks ago between Mr G & his freed people Mr Garrett brought forward an account against Dick Taylor from the years 1865 & 1868 to the amount of \$200 & wanted me to take the mule away from Dick Taylor and give it to him for the debt. I told him I did not have the authority to do so & that he could not take the mule from the freedman unless done so by Law. Law. A few days afterwards he filed a petition stating the mule was his property & got out an attachment & had it seized by the sheriff. We met according to agreement

at the residence of Mr Charles Jones for trial. Mr Grant supplied  
the magistrate Mr Jos G. Snyder with whiskey and got him  
drunk and he told Mr G. the property was his. and ordered the  
sheriff to deliver it to him without opening court or having any kind  
of a trial whatever. A few moments before the magistrate gave  
the property to Mr G. he told me he believed the mule to  
be Dick Taylors for he said he knew Mr G. to be a liar  
a scoundrel and a thief & that alone was sufficient evi-  
dence to convince him that the mule belonged to Dick T  
& Mr G. was trying to cheat him out of it. I called  
on the magistrate and asked for an appeal to the  
District Court but he would not grant it. As I  
cannot get the civil authority to act in behalf of the  
freedman I would respectfully ask for advice and  
instructions &c I will refer you to the following gentlemen  
who were present when the magistrate gave Mr G. the  
mule without a trial Mr Noah Reddick Mr H. Ramey  
Mr Jos Whit & Mr Charles Jones who is now in  
the city

Edw G. G.

A. A. G. G.

Letter Sent.

Receipt

Mr John M. Linn

A. A. C. B. G.

RC



Feb 15/68

Oh! Rush

A. S. C. C.

Quercus Purish

---

Office A. J. A. Comm.  
Bureau R. F. & A. L.  
Catahoula Parish, La.  
Feb 15<sup>th</sup> 1868.

Mr Christian Rush.  
A. J. A. Comm.  
Bureau R. F. & A. L.  
Concordia Parish La.

Sir quite  
a number of the planters of your  
Parish bordering on Belk River have  
called on, and requested me to attend  
to the business pertaining to the Bureau  
R. F. & A. L. with them, which I will  
be happy to do so upon your approval  
and the approval of the Assistant Com-  
missioner of La.



Mossy Grove, Catahoula  
Parish La. May 1, 1868.

Mr. Johnnie Lemmond

Letter Sent  
Report of Murders  
cases.

RL

Office Asst Sub Asst Comm.  
Bureau R. Ft A. L.  
Massy Snow,  
Catahoula Parish, La.  
May 1<sup>st</sup> 1868,

Wm H. Sterling, Capt 1<sup>st</sup> U. S. S.  
A. A. A. Soil.  
Bureau R. Ft A. L.  
Sir

I have the  
honor to transmit you the following  
report. I have just heard of the  
murder of three more men in the upper  
part of the Parish, by the "so called"  
vigilance committee, some say, there  
was white men and others say they  
was freedmen that was murdered.

Murder has become such a general  
thing and common occurrence in  
this part of the country that there  
is but little notice taken of it, and it



is almost impossible to learn the particulars of it.

The weather is warm and pleasant and the freedpeople are working remarkably well. As labor has been very scarce in the swamp part of the Parish, and the prospect for good crops is very favorable at present. There is some very ill disposed persons persuading and hiring freedmen "under false promises and pretences" to leave their present employers and go and work for them, which is causing a great deal of trouble at present.

Fears have been entertained of another overflow as the waters have been rising very fast until within the last few days. The Rivers are now on a standstill and there is but very little land under cultivation inundated.

The crops generally looks very favorable. The moral condition of the freedpeople is very good.

I had on hand from last report 1267 pounds of Meal and 198 pounds of Pork which I have issued to the indigent and destitute.

Very Respectfully  
Yours Obedt Servt.

M. Johnston Lemmon

A. G. A. C.  
Bureau R. F. A. L.

No 22

Wm. D. Cherry

Office of Stable rent

\$ 25.00

10.00

\$ 35.00

Sept 1868

---



No 22  
The United States

To William O. Cherry Dr

1868		Dollars	Cts
	For Rent of One Room occupied for Office of Asst Sub Asst Com Bureau of M.H. & S. Parish of Catahoula La	25	00
	For Rent of One Building occupied as stable for one Horse U.S. Horse in the Service of the Asst-Sub Asst Com Bureau of M.H. & S. Parish Catahoula La	10	00
		\$35	00

Copy for Sept 1868

No 22

Chas Overstreet

\$ 2.00

Aug 28<sup>th</sup> 1868

Receipt (No 2)

1868



No 22

The United States

To Chas Chesnut Dr

1868

For

Services rendered hauling and  
Property of Bureau Office & Forge  
from Office & stable to River.  
Remaining Office of Bureau of H. H.  
& S. B. from Massy from the Trinity  
by Special Order from Headquarters N.C.  
Dated Aug 13<sup>th</sup> 1868

3 00

Copy paid Sept 1868

No. 22.

No. ....

ABSTRACT "B."

*Sept (No 2)* 186 *3*

*Aug 28<sup>th</sup> 1868*

Dollars *3.00*

*Paid* .....

John W. Madden, stationer and printer, 73 Camp st.



# The United States,

To *Joseph Smith* Dr.

1868.

DOLLARS.

CTS.

APPROVED AND ORDERED PAID:

Bret. Maj. Gen. U. S. A., Asst. Commissioner.

*For*  
Services rendered hauling  
U.S. Property belonging to Bureau  
from River to Office & Stable at  
Trinity Catahoula Parish La  
Remaning Office

*Aug 28<sup>th</sup> 1868*

I certify that the above account is correct and just; that the services were rendered as stated; and that they were necessary for the public service, and that the services have been reported by me according to the Army Regulations, as per my Report of "Persons and Articles," for *Sept* 1868

*Cady*

Received, at \_\_\_\_\_ the day of \_\_\_\_\_ 1868.

of \_\_\_\_\_ Disbursing Officer, Bureau R. F. and A. L.,

the sum of \_\_\_\_\_ Dollars

and \_\_\_\_\_ Cents, in full of the above account.

[ DUPLICATES. ]

*his*  
*Joseph X Smith*  
*master*

No 22

Joseph Lane

\$1000

Sept 1868



No 22  
The United States

Chas Joseph Leone Dr

1869		Dollars	Cts
	<p>Blue</p> <p>Services rendered taking care of one U.S. Horse and Office of the Asst Sub Asst Com Bureau of Fish at Pt. Catahoula, Louisiana for the month of Sept 1869 commencing on the 1st and ending on the 30</p>	10	00

Copy for Sept 1868

No 22

Wm. Pearson

\$3.00

Sept 1808

---



No 22

The United States

To William Adams Esq

His

Services rendered <sup>during</sup> ~~by~~ me  
U.S. Horse in the service of the  
Asst Sub Asst Com Bureau of R  
F. & C., Catahoula Parish La

200

Copy for Sept 1868

---

Pruman R.F. and A. Lands.

---

Account Current  
in the month of November. 1848.

---

By  
Jas R. Hilliard a.f.a.c.  
Pruman R.F. + A.L. Louisiana,  
Parish of Catehouly.  
Trinity - La.

---

---





---

---

No. 15.

---

MONTHLY RETURN OF STORES

~~RETURNED TO~~  
BUREAU R., F. & A. L.

~~IN THE~~  
Month of \_\_\_\_\_ 186

---

---



Monthly Return of Stores pertaining to Bureau R., F. and A. L. By *M. J. Lemmon, A. G. A. C., Bureau R., F. & A. L., Catahoula Parish, La.*

ABSTRACTS.		<i>Horns</i>	<i>Saddles</i>	<i>Bridles</i>																
Per last return.	On hand.	/	/	/																
" Abstract D.	Received by purchase																			
" " E.	" from Officers,																			
" " N.	Fabricated, taken up, &c																			
Total to-be accounted for.		/	/	/																
Per Abstract F.	Fuel.																			
" " G.	Forge.																			
" " H.	Straw.																			
" " I.	Stationery.																			
" " K.	Special Issues.																			
" " L.	Expended, Sold, &c.																			
" " M.	Transferred.																			
Total Issued and Expended.																				
Total Remaining on hand.		/	/	/																

I certify that the above Return is correct, *M. J. Lemmon, A. G. A. C., Bureau R.*

No. 15.

---

MONTHLY RETURN OF STORES

— PERTAINING TO —

**BUREAU R., F. & A. L.**

— IN THE —

---

*Month of* ..... 186

---



# Monthly Return of Stores pertaining to Bureau R., F. and A. L.

ABSTRACTS.		Bounds of Bors.	Bounds of Corn Med.
Per last return,	On hand.	4602875	
" Abstract D,	Received by purchase,		
" " E,	" from Officers.		
" " N,	Fabricated, taken up, &c.		
Total to be accounted for,		4602875	
Per Abstract F,	Fuel,		
" " G,	Forage,		
" " H,	Straw,		
" " I,	Stationery,		
" " K,	Special Issues,		
" " L,	Expended, Sold, &c.,	4602872	
" " M,	Transferred,		
Total Issued and Expended,		4602872	
Total Remaining on hand,		572	

I Certify that the above Return is correct,

*M. Johnston Lemmon*  
 Asst Sub Asst Comm. Bu & C



No. 15.

---

MONTHLY RETURN OF STORES

-- PERTAINING TO --

**BUREAU R., F. & A. L.**

— IN THE —

*Month of* .....

186

---



# Monthly Return of Stores pertaining to Bureau R., F. and A. L.

## ABSTRACTS.

Per last return,	On hand.	83 561 <sup>14</sup> / <sub>100</sub>
" Abstract D,	Received by purchase,	
" " E,	" from Officers,	95 594
" " N,	Fabricated, taken up, &c.	
Total to be accounted for,		178 1155 <sup>14</sup> / <sub>100</sub>
Per Abstract F,	Fuel,	
" " G,	Forage,	
" " H,	Straw,	
" " I,	Stationery,	
" " K,	Special Issues,	
" " L,	Expended, Sold, &c.,	83 561 <sup>14</sup> / <sub>100</sub>
" " M,	Transferred,	
Total Issued and Expended,		83 561 <sup>14</sup> / <sub>100</sub>
Total Remaining on hand,		95 594

*I Certify that the above Return is correct,*











No. 15.

---

MONTHLY RETURN OF STORES

-- PERTAINING TO --

**BUREAU R., F. & A. L.**

-- IN THE --

---

*Month of* .....

186

---







No. 15.

MONTHLY RETURN OF STORES

-- PERTAINING TO --

**BUREAU R., F. & A. L.**

— IN THE —

*Month of* .....

186



# Monthly Return of Stores pertaining to Bureau R., F. and A. L.

ABSTRACTS.		Sounds of Borne.	Sounds of Borne Meal.	Old Borne Meal.																
Per last return,	On hand.		57	8																
" Abstract D,	Received by purchase,																			
" " E,	" from Officers.		428	2675																
" " N,	Fabricated, taken up, &c.																			
Total to be accounted for,			428	2732	8															
Per Abstract F,	Fuel,																			
" " G,	Forage,																			
" " H,	Straw,																			
" " I,	Stationery,																			
" " K,	Special Issues,																			
" " L,	Expended, Sold, &c.,		345	2170	10															
" " M,	Transferred,																			
Total Issued and Expended,																				
Total Remaining on hand,			345	2170	10															

*I Certify that the above Return is correct,*



No. 15.

*Return*

---

MONTHLY RETURN OF STORES

— PERTAINING TO —

**BUREAU R., F. & A. L.**

— IN THE —

---

Month of *August* 186*8*

---



# Monthly Return of Stores pertaining to Bureau R., F. and A. L.

ABSTRACTS.		Horse.	Saddles.	Ridles.	Blankets.													
Per last return,	On hand.																	
" Abstract D,	Received by purchase,																	
" " E,	" from Officers,	1	2	2	1													
" " N,	Fabricated, taken up, &c.																	
Total to be accounted for,																		
Per Abstract F,	Fuel,																	
" " G,	Forage,																	
" " H,	Straw,																	
" " I,	Stationery,																	
" " K,	Special Issues,																	
" " L,	Expended, Sold, &c.,																	
" " M,	Transferred,																	
Total Issued and Expended,																		
Total Remaining on hand,																		

I Certify that the above Return is correct,

*A. H. Camp*  
*A. H. Camp*



*December*  
*1864*

MONTHLY REPORT

OF

*W. J. Seaman*

Asst. Inspr Freedmen.

for the Parish of *Catahoula* La.

for the month ending *31st*

*December* 186*4*

Forwarded *Jan 1st* 186*5*

Rec. B. B. F. & A. L. *Jan 10* 186*5*







their employers. The "hard work" as a general thing, appears to be very much discouraged, and low spirited, and the cause as there, in almost every instance. The planter has Whiskey and Tobacco, so which they see to sell for people at market prices, and when they come to settle at the end of the year, they find their whole year's wages taken up, and the planter brings them out in debt, and they are taken out of doors, without a cent of money, a blanket to cover, or clothes to wear, to keep them warm, which is enough to discourage the most energetic and strong hearted people in the world. Only yesterday a poor old freedman came to me almost naked and in a suffering condition who had not been shown out of house in the rain and sleet without a moment's warning, by Mr Jacob Garrison, who he has served and labored for, for the last twenty five years. I bought the poor old man some notions and some clothes, and shoes for himself and family which he said, were more than Mr Garrison, has given him in the past year.

There I find a planter fulfills his contract and agreement with the freed people he has but little or no trouble with them and they work well and are cheerful and happy. An instance here is Mr James Dunsley who has twenty eight hands in his employ who have not lost about two hundred and fifty days during the whole year, from sickness and all other causes, and they are only indebted to him, for supplies, advanced about \$21. which is not quite \$1 a week, and I will venture to say, there is not a more faithful or better conducted set of people in the Parish than those in Mr Dunsley's employ.

I hope some means will be adapted to prevent the planters from selling the freed people so much Whiskey and unnecessary articles, the coming year, for their moral condition at present is very good, much better, in fact, than could be expected under the existing circumstances, and Whiskey & fine has more of a demoralizing effect upon them than most all other vices combined.

I am unable to say what number of contracts will be made with the freed people for the coming year. The greater number of the planters in this part of the country are so reduced in money matters that they will not be able to work more than half the number of hands they now have. There are a great many freed people throughout the whole Parish, who are out of employment and will have to be assisted unless they can get employment soon.



# MONTHLY REPORT

OF

*Asst. Inspr Freedmen.*

for the Parish of *Catahoula* La.

for the month ending *date not shown*

..... 186

---

*Forwarded* ..... 186

*Rec. B. R. F. & A. L.* ..... 186





# MONTHLY REPORT

OF

---

*Asst. Insp. Freedmen.*

*for the Parish of* ..... *La.*

*for the month ending* ..... *date not shown*

..... 186

---

---

*Forwarded* ..... 186

*Rec. B. R. F. & A. L.* ..... 185





MONTHLY REPORT

OF

*Wm Johnson Senior*  
Asst. Insp. Freedmen.

For the Parish of *Catahoula* LA.,

For the month ending *Feb'y*

.....186

*8*

Forwarded..... 186

Rec. B R F & A L..... 186





No. 2

*Quartermaster.*

*At*

REPORT

OF

PERSONS AND ARTICLES HIRED,

*For*

*June*

*1867*

Report of Persons and Articles employed and hired at \_\_\_\_\_, during the month of \_\_\_\_\_, by \_\_\_\_\_

Running Number.	No. of Each Class.	NAMES of PERSONS and ARTICLES.	Designation and Occupation	Service During The Month.			Rate of Hire or Compensation.			Date of Contract Agreement or Entry Into service.	BY WHOM OWNED.	Amount of Rent or Pay in the Month.		REMARKS. Showing by whom the buildings were occupied, and for what purpose and how the vessels and men were employed during the month. Transfers and discharges will be noted under this head.	Time and amount due and remaining unpaid			
				From	To	Days	Dolls	Cents	Days Month or Voyage.			Dolls	Cents		From	To	Dollars	Cents
		One Room	Office	1	30	30				June 1, 1867.	J. Garrett.			occupied as Office of Asst. Sub: Asst. Comd. Bu. R. F. & A. L. for the Parish of Catahoula La, occupied as stable for one U. S. Horse, in the service of the Asst. Sub: Asst. Comd. Bu. R. F. & A. L. for the Parish of Catahoula La - showing one U. S. Horse.				
		One Building	Stable	1	30	30				June 1 <sup>st</sup> 1867	J. Garrett.							
		about Crawford.	Blacksmith							June 12, 1867,		2 00		Transporting supplies for distribution to the destitute in the Parish of Catahoula La -				
		Judley Bradley.								June 18 1867								
		Clem Johnson.								" " "								
		Liles Harrison.								" " "								
												Amount of Rent and hire during the month		Total amount due and remaining unpaid				

I Certify, on honor, that the above is a true copy of all the persons and articles employed and hired by me during the month of \_\_\_\_\_, 1867 and that the observations under the head of "Remarks," and the statement of amounts due and remaining unpaid, are correct.

EXAMINED:

COMMANDING.

QUARTERMASTER.



No. 2.

At *Catahoula*

REPORT

—OF—

Persons and Articles Hired

For *Sept* 1868

John W. Madden, Stationer and Printer, 73 Camp st., N. O.

*Retained*



Report of Persons and Articles employed and hired at *Trinity Catabula Parish La*, during the Month of *September*, by *J. H. Camp*  
*Asst. Com. Bureau of U.S. & L.*

PLANNING NUMBER.	NAMES OF PERSONS AND ARTICLES.	DESIGNATION AND OCCUPATION.	SERVICES DURING THE MONTH.		RATE OF HIRE OR COMPENSATION.			DATE OF CONTRACT, AGREEMENT OR ENTRY INTO SERVICE.	BY WHOM OWNED OR EMPLOYED.	AMOUNT OF RENT OR PAY IN THE MONTH.		REMARKS. SHOWING BY WHOM THE BUILDINGS WERE OCCUPIED, AND FOR WHAT PURPOSE, AND HOW THE VESSELS AND MEN WERE EMPLOYED DURING THE MONTH. TRANSFERS AND DISCHARGES WILL BE NOTED UNDER THIS HEAD.	TIME AND AMOUNT DUE AND REMAINING UNPAID.			
			FROM	TO	DAYS.	DOLLARS.	CTS.			DOLLARS.	CTS.		FROM	TO	DOLLARS.	CTS.
	<i>One Room</i>	<i>Office</i>	<i>1<sup>st</sup></i>	<i>30<sup>th</sup></i>				<i>Sept 1<sup>st</sup> 1868</i>	<i>W. S. Cherry</i>	<i>25</i>	<i>00</i>	<p>Occupied as Office of Asst. Com. Bureau of U.S. &amp; L. Parish of Catabula La</p> <p>Occupied as stable for <i>U.S. Horse</i> in the service of the Asst. Com. Bureau of U.S. &amp; L. Catabula Parish La</p> <p>For services rendered taking care of one <i>U.S. Horse</i> and Office of the Asst. Com. Bureau of U.S. &amp; L. Catabula Parish La</p> <p>For services rendered taking one <i>U.S. Horse</i> in the service of the Asst. Com. Bureau of U.S. &amp; L. Catabula Parish La</p> <p>For services rendered hauling property of Bureau in Office and Horse from Office and stable to him removing Office of Bureau of U.S. &amp; L. from New Orleans to Trinity by <i>Exp. Boat</i> from Headquarters dated Aug 12<sup>th</sup> 1868</p> <p>For services rendered hauling <i>U.S. Property</i> belonging to Bureau from him to Office and stable</p> <p>For Transportation of School Teachers in employ of Bureau of U.S. &amp; L. from Trinity to New Orleans La two Teachers <i>See Bill W. A. Hall</i></p>				
	<i>One Building</i>	<i>Stable</i>	<i>1</i>	<i>30</i>				<i>Sept 1<sup>st</sup> 1868</i>	<i>W. S. Cherry</i>	<i>10</i>	<i>00</i>					
	<i>Joseph Lane</i>	<i>Labourer</i>	<i>1</i>	<i>30</i>	<i>20</i>	<i>10</i>	<i>00</i>	<i>Sept 1<sup>st</sup> 1868</i>								
	<i>W. Mason</i>	<i>Blacksmith</i>					<i>3</i>	<i>00</i>	<i>Sept 8<sup>th</sup> 1868</i>							
	<i>Chs. Guatret</i>	<i>Teamster</i>					<i>3</i>	<i>00</i>	<i>Aug 29<sup>th</sup> 1868</i>							
	<i>Joseph Smith</i>	<i>Teamster</i>					<i>3</i>	<i>00</i>	<i>Aug 29<sup>th</sup> 1868</i>							
	<i>St. Cleons</i>	<i>Chiropractor</i>					<i>15</i>	<i>00</i>	<i>Sept 10<sup>th</sup> 1868</i>							

Amount of Rent and Hire during the Month

Total amount due and remaining unpaid

I CERTIFY, on honor, that the above is a true copy of all the persons and articles employed and hired by me during the month of *September*, 1868, and that the observations under the head of "Remarks," and the statement of amounts due and remaining unpaid, are correct.

Examined and Approved by command of

By't MAJ. GEN. ROBT C. BUCHANAN, U. S. A.,  
 Assistant Commissioner Louisiana

Sub. Ass't Com'r B. R., F. and A. L.

By't Lt Col. U. S. A., Capt. 39th Infty. A. A. G.



*At* .....

R E P O R T

— OF —

Persons and Articles Hired

*For* *October* 1868

John W. Madden, Stationer and Printer, 73 Camp st., N. O.

*Retained*

**Report** of Persons and Articles employed and hired at *Trinity Catholic Parish La.*, during the Month of *October*, by *John H. Camp*  
*Asst. Com. Bureau of U.S. A.*

Running Number.	No. of Each Class.	NAMES OF PERSONS AND ARTICLES.	DESIGNATION AND OCCUPATION.	SERVICES DURING THE MONTH.			RATE OF HIRE OR COMPENSATION.			DATE OF CONTRACT, AGREEMENT OR ENTRY INTO SERVICE.	BY WHOM OWNED OR EMPLOYED.	AMOUNT OF RENT OR PAY IN THE MONTH.		REMARKS. SHOWING BY WHOM THE BUILDINGS WERE OCCUPIED, AND FOR WHAT PURPOSE, AND HOW THE VESSELS AND MEN WERE EMPLOYED DURING THE MONTH. TRANSFERS AND DISCHARGES WILL BE NOTED UNDER THIS HEAD.	TIME AND AMOUNT DUE AND REMAINING UNPAID.			
				FROM	TO	DAYS.	DOLLARS.	CTS.	DAYS, MONTH OR VOYAGE.			DOLLARS.	CTS.		FROM	TO	DOLLARS.	CTS.
		<i>One Building</i>	<i>Office</i>	<i>1<sup>st</sup></i>	<i>31<sup>st</sup></i>	<i>31</i>				<i>Oct 1<sup>st</sup> 1868</i>	<i>M. J. Shaw</i>	<i>25</i>	<i>00</i>	<i>Occupied as Office of Asst Sub Asst Com Bureau of U.S. A. Catholic Parish La</i>	<i>Sept 28<sup>th</sup></i>	<i>Sept 30<sup>th</sup></i>	<i>25</i>	<i>00</i>
		<i>One Building</i>	<i>Stable</i>	<i>1<sup>st</sup></i>	<i>31<sup>st</sup></i>	<i>31</i>				<i>Oct 1<sup>st</sup> 1868</i>		<i>10</i>	<i>00</i>	<i>Occupied as Stable for an U.S. Horse in the Service of the U.S. Com B. R. F. &amp; A. Catholic Parish La</i>	<i>Sept 1<sup>st</sup></i>	<i>Sept 30<sup>th</sup></i>	<i>10</i>	<i>00</i>
		<i>Mr Mason</i>	<i>Blacksmith</i>				<i>3</i>	<i>00</i>		<i>Oct 3<sup>rd</sup> 1868</i>				<i>For services rendered shoring in U.S. Horse in the Service of the U.S. Com B. R. F. &amp; A. Catholic Parish La</i>				
		<i>Joseph Lane</i>	<i>Labourer</i>	<i>1</i>	<i>31</i>	<i>31</i>	<i>10</i>	<i>00</i>		<i>October 1<sup>st</sup> 1868</i>				<i>For services rendered taking care of Office and an U.S. Horse in the Service of the U.S. Com B. R. F. &amp; A. Catholic Parish La</i>				
		<i>Stinks &amp; Krockland</i>	<i>Merchants</i>				<i>5</i>	<i>00</i>		<i>Oct 3<sup>rd</sup> 1868</i>				<i>To use Card of Asst Wood for the use of Office of the U.S. Com B. R. F. &amp; A. Catholic Parish La</i>				
Amount of Rent and Hire during the Month														Total amount due and remaining unpaid				

I CERTIFY, on honor, that the above is a true copy of all the persons and articles employed and hired by me during the month of \_\_\_\_\_, 1868, and that the observations under the head of "Remarks," and the statement of amounts due and remaining unpaid, are correct.

Examined and Approved by command of

By't MAJ. GEN. ROBT C. BUCHANAN, U. S. A.,  
 Assistant Commissioner Louisiana

By't Lt Col. U. S. A., Capt. 39th Infy. A. A. A. G.

Sub. Ass't Com'r B. R., F. and A. L.



- Retained No. 2. Copy -

Wm R. Hilliard A. J. P. R. R. F.

St. Trinity, Catahoula Parish, La.

R E P O R T

- OF -

Persons and Articles Hired

For November

1868.

John W. Madden, stationer and printer, 73 Camp st.







---

Monthly Report of  
Plantation Supplies

May 1868

---

Monthly Report of Supplies Received and Issued in the Parish of *Livingston*, Louisiana, in accordance with Circular from Headquarters, Bureau of Refugees, Freedmen and Abandoned Lands, State of Louisiana, dated January 23rd, 1868, by *J H Murphy* Assistant Sub-Assistant Commissioner, during the month of *June*, 1868.

Name Of Planter.	Designation of Plantation.	FREEDPEOPLE ON PLANTATION.								AGGREGATE SUPPLIED WITH RATIONS	SUPPLIES FURNISHED				COST OF SUPPLIES BEFORE FURNISHED TO PLANTER.				Full Cost of Supplies at the time of Delivery to Planter.	Remarks.			
		EMPLOYED			UNEMPLOYED, (AGED AND CHILDREN.)				CORN MEAL.		HARD BREAD.	PORK.	BACON.	BEFORE SHIPMENT.		Freight, Etc., for Delivery to Agent.		While on Hands of Agent and for Delivery to Planter.					
		Men.	Women.	TOTAL.	Men.	Women.	Children.	TOTAL.						Dolls.	Cts.	Dolls.	Cts.	Dolls.			Cts.	Dolls.	Cts.
<i>Wm. Overstreet</i>	<i>Overstreet Place</i>	6	2	8	0	0	2	2	20	600	200			43	60	2	71		46	31			
<b>TOTAL,</b>										600	200			43	60	2	71		46	31			
On Hand Last Report,																							
Total Received During the Month,										600	200												
Total to be Accounted for,										600	200												
Issued to Planters During the Month,										600	200												
Remaining on Hand to be Accounted for,																							

Station : *Hammond Station*  
 Date : *June 31<sup>st</sup> 1868*

*J H Murphy*  
 Assistant Sub-Assistant Commissioner.  
 Parish of *Livingston* Louisiana.



---

Monthly Report  
Plantation Supplies  
May-June 1868

---

Monthly Report of Supplies Received and Issued in the Parish of *Livingston*, Louisiana, in accordance with Circular from Headquarters, Bureau of Refugees, Freedmen and Abandoned Lands, State of Louisiana, dated January 23rd, 1868, by *P. H. Murphy* Assistant Sub-Assistant Commissioner, during the month of *May*, 1868.

Name Of Planter.	Designation of Plantation.	FREEDPEOPLE ON PLANTATION.								SUPPLIES FURNISHED				COST OF SUPPLIES BEFORE FURNISHED TO PLANTER.				Full Cost of Supplies at the time of Delivery to Planter.	Remarks.			
		EMPLOYED			UNEMPLOYED, (AGED AND CHILDREN.)				AGGREGATE SUPPLIED WITH RATIONS	CORN MEAL.	HARD BREAD.	PORK.	BACON.	BEFORE SHIPMENT.		Freight, Etc., for Delivery to Agent.				While on Hands of Agent and for Delivery to Planter.		
		Men.	Women.	TOTAL.	Men.	Women.	Children.	TOTAL.						Pounds.	Pounds.	Pounds.	Pounds.			Dolls.	Cts.	Dolls.
<i>Mr Overstreet</i>	<i>Overstreet Place</i>	6	2	8	0	0	2	2	10	400		200			34	20	1	79		35	99	
<b>TOTAL,</b>		6	2	8	0	0	2	2	10	400		200			34	20	1	79		35	99	
On Hand Last Report,																						
Total Received During the Month,										400				200								
Total to be Accounted for,										400				200								
Issued to Planters During the Month,										400				200								
Remaining on Hand to be Accounted for,																						

Station: *Hammond Station*  
 Date: *May 31<sup>st</sup> 1868*

*P. H. Murphy*  
 Assistant Sub-Assistant Commissioner.  
 Parish of *Livingston* Louisiana.



No. 244.

RECEIPT FOR SUPPLIES

In the Month of

June, 1868.

Wm Overstreet,

Parish of Livingston, La.

\$ 46.31.

# RECEIPT FOR SUPPLIES.

No. 246

Parish of Livingsstone State of Louisiana.

Hammock Station June 27 1868.

**RECEIVED** of 2<sup>nd</sup> Lieut W. W. Wood 1<sup>st</sup> Regt.

Assistant Commissary of Subsistence, Bureau Refugees, Freedmen and Abandoned Lands,  
State of Louisiana, at Amite City La

the following articles and quantities of Subsistence, viz:

<u>100 Six hundred lbs (131) Three</u> Barrels of Corn Meal, valued at \$	15	50
..... Pounds of Hard Bread, "		
<u>1 1/2</u> Barrels of Mess Pork, "	28	00
..... Pounds of Bacon, "		
Add cost of Transportation, .....	2	41
Total .....	46 31	

for issue to the freedpeople in my employ for the month of June, 1868,  
as per my affidavit applying for said supplies, dated May 26<sup>th</sup>, 1868.

And I hereby Agree and Bind myself, to reimburse to the United States, through the Bureau Refugees, Freedmen and Abandoned Lands, State of Louisiana, before the expiration of the year 1868, the full cost of the subsistence as above specified, agreeably to stipulations contained in my bond, filed in the office of the Bureau Agent of Livingsstone Parish, dated April 6<sup>th</sup>, 1868; and to send my crop to market in the city of New Orleans, to such Merchant as the Assistant Commissioner of the Bureau may designate, with the understanding that the proceeds of the crop shall be subject to my order, after the deduction of the amount due for the supplies furnished me, and a proper settlement with the freedmen for whom they were obtained, and also with the Merchant, by whom it is sold.

*Witnesses:*

(Signature,)

E. Miller  
.....  
Geo. F. Austin  
.....

Wm. Corratut  
.....

NOTE — To be signed in duplicate, and witnessed by two persons.  
One copy for Parish Agent, and one copy for A. C. S., Bureau R., F. and A. Lands, New Orleans.



Receipt for Supplies,  
April, 1868,  
Of<sup>m</sup> Overstreet,  
Livingston Parish, La.,  
~~\$ 35.99.~~

R/L.  
71.

# RECEIPT FOR SUPPLIES.

Plantation,  
 Parish of Livingston, State of Louisiana.

Received of 2<sup>d</sup> Lieut. N. W. Hood, 1<sup>st</sup> U.S. Infantry, Assistant  
 Commissary of Subsistence, Bureau Refugees, Freedmen and Abandoned Lands, State of  
 Louisiana, this thirteenth day of May, 1868,

<u>2, Two Barrels</u> Corn Meal, valued at \$	10 00
Hard Bread, "	
<u>1, One Barrel</u> Pork, "	24 20
Bacon, "	
Add cost of Transportation, _____ \$	1 79
	35 99

for issue to the freedpeople in my employ for the month of April 1868,  
 as per my affidavit applying for said supplies, dated Overstreet  
 Plantation, Parish of Livingston, State of Louisiana,  
April 6th, 1868.

(SIGNATURE.)

William Overstreet

I hereby agree and bind myself to reimburse to the United States through the  
 Bureau Refugees, Freedmen and Abandoned Lands, State of Louisiana, before the expira-  
 tion of the year 1868, the full cost of the subsistence as above specified, agreeably to  
 stipulations contained in my bond, filed in the office of the Bureau Agent of  
Livingston, Parish, dated April 6th, 1868, and  
 to send my crop to market in the city of New Orleans, to such Merchant as the Assistant  
 Commissioner of the Bureau may designate, with the understanding that the proceeds of  
 the crop shall be subject to my order, after the deduction of the amount due for the supplies  
 furnished me, and a proper settlement with the freedmen for whom they were obtained,  
 and also with the merchant, by whom it is sold.

WITNESS:

(SIGNATURE.)

P. A. Murphy

William Overstreet

Note—Sign in duplicate.—One copy for Parish Agent, and one copy for A. C. S., Bureau R. F. and A. Lands, New Orleans.

*R/L.*  
*7/1.*



MICROCOPY

M

1

9

0

5

ROLL

1

0

3

EMD

MFW



# IMAGE EVALUATION TEST TARGET (QA-3)

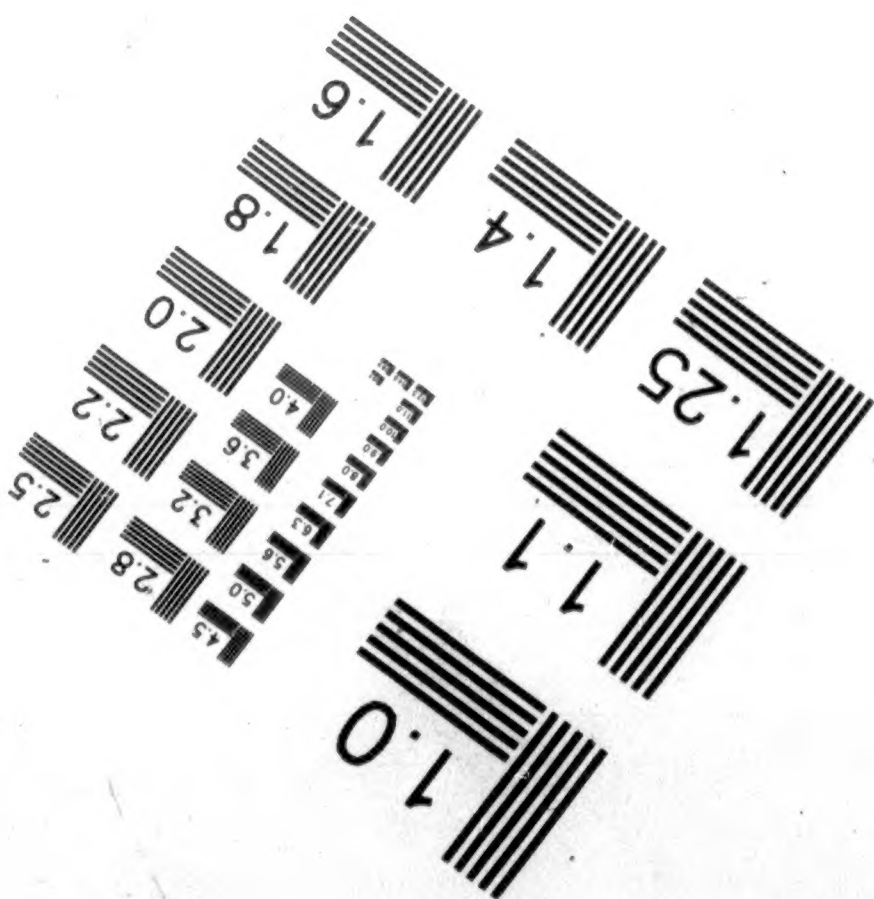
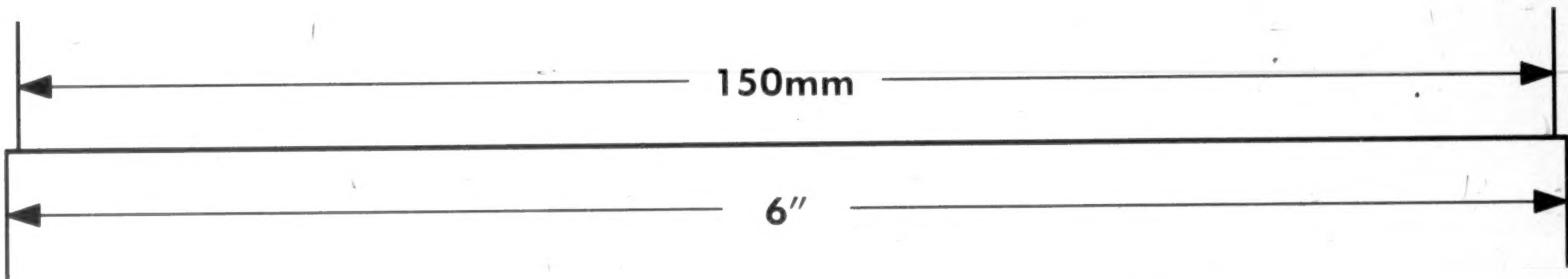
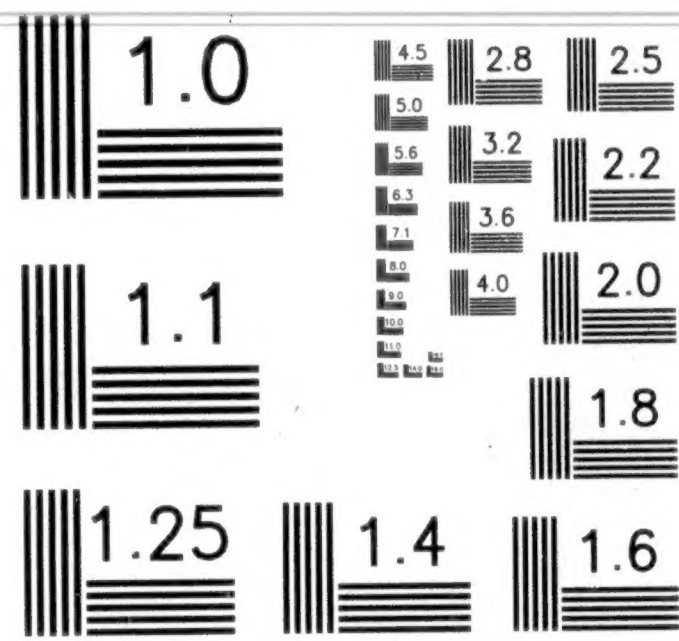
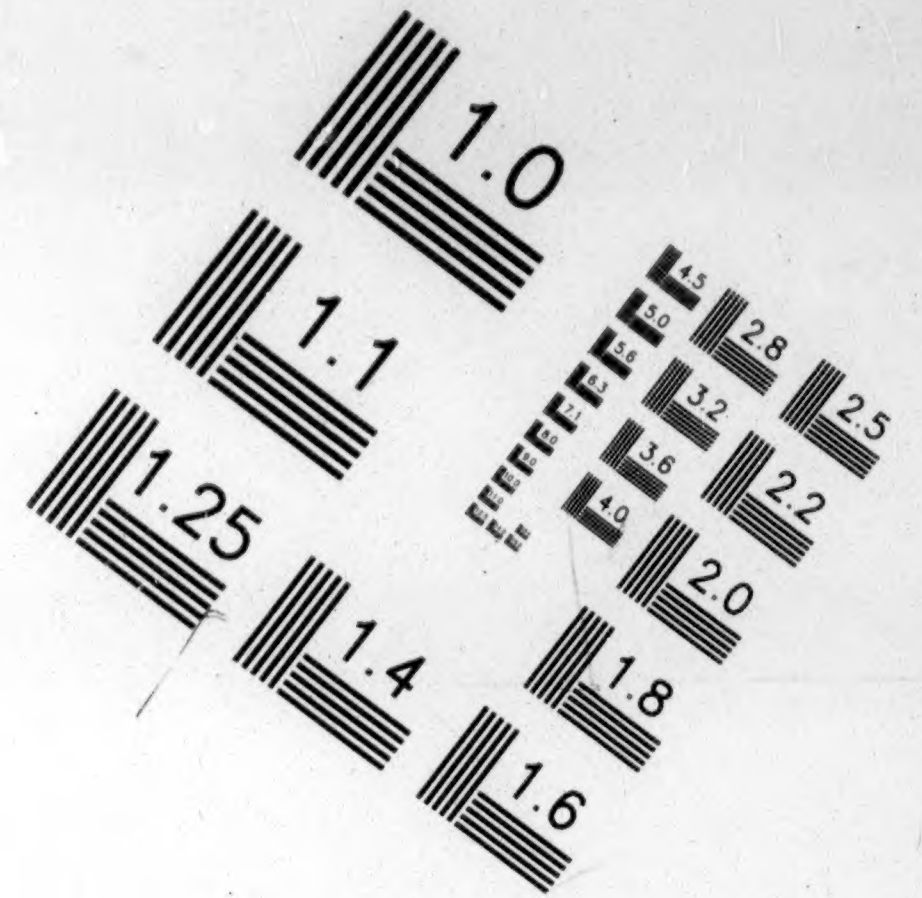
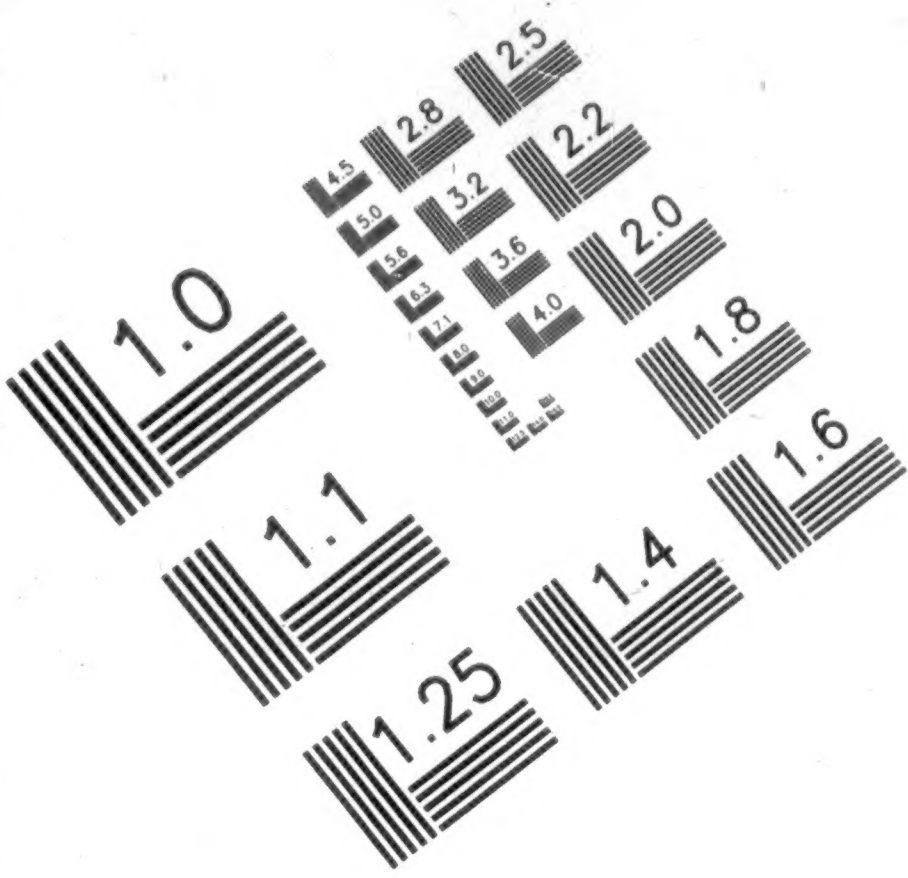

**APPLIED IMAGE, Inc**  
 1653 East Main Street  
 Rochester, NY 14609 USA  
 Phone: 716/482-0300  
 Fax: 716/288-5989

© 1993, Applied Image, Inc., All Rights Reserved

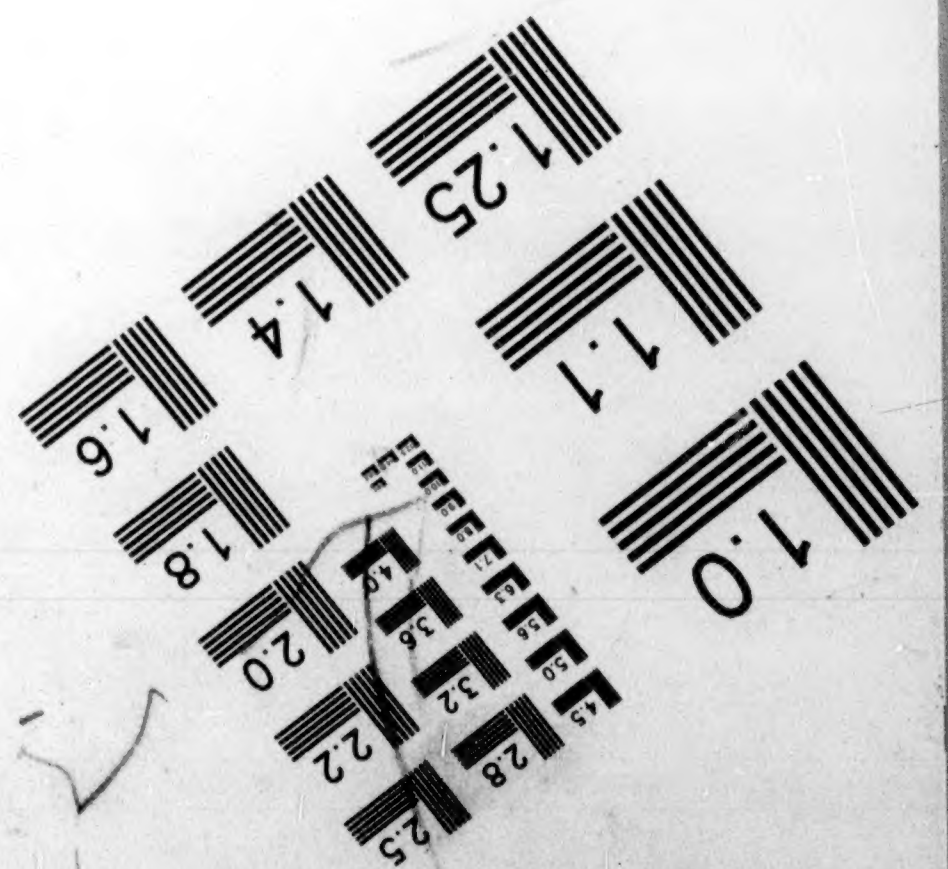



**THE END**

**PLEASE**

**REWIND**

