

UC-NRLF

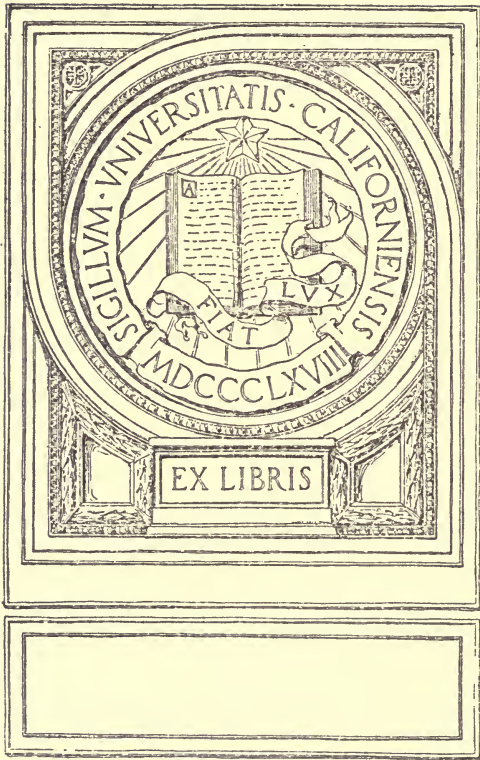

LB 32 334



EX LIBRIS







# THE RECOVERY OF VOLATILE SOLVENTS

BY

CLARK SHOVE ROBINSON

Assistant professor of chemical engineering at the Massachusetts Institute of  
Technology; formerly chemical engineer with E. B. Badger and Sons  
Co., author of ELEMENTS OF FRACTIONAL DISTILLATION.

*FIRST EDITION*

*The* CHEMICAL CATALOG COMPANY, *Inc.*

19 EAST 24<sup>TH</sup> STREET, NEW YORK, U. S. A.

1922

TP 155  
R6

COPYRIGHT, 1922, BY  
*The* CHEMICAL CATALOG COMPANY, *Inc.*  
*All Rights Reserved*

TO WHOM  
IT MAY COME

Press of  
J. J. Little & Ives Company  
New York, U. S. A.

## TABLE OF CONTENTS

	PAGE
PREFACE . . . . .	5
CHAPTER	
I. GASES AND VAPORS . . . . .	9
II. VAPORIZATION . . . . .	14
III. LIQUID MIXTURES . . . . .	18
IV. DISTILLATION OF LIQUID MIXTURES . . . . .	22
V. CONDENSATION OF MIXED VAPORS . . . . .	26
VI. RATE OF REACTION . . . . .	29
VII. ADSORPTION . . . . .	31
VIII. ADSORPTION OF MIXED GASES . . . . .	41
IX. RATE OF ADSORPTION . . . . .	47
X. RECOVERY OF ADSORBED VAPORS . . . . .	53
XI. ADSORPTION APPARATUS FOR SOLVENT RECOVERY . . . . .	58
XII. SOLVENT RECOVERY BY CONDENSATION AT CONSTANT PRESSURE . . . . .	70
XIII. CONDENSATION WITH COOLING WATER . . . . .	77
XIV. COOLING WITH REFRIGERATION . . . . .	89
XV. HEAT OF VAPORIZATION IN THE ABSENCE OF GASES . . . . .	90
XVI. VAPORIZATION IN THE PRESENCE OF INERT GASES . . . . .	93
XVII. THE GAS UNDER NATURAL CIRCULATION . . . . .	97
XVIII. THE GAS UNDER FORCED CIRCULATION . . . . .	100
XIX. APPARATUS USED IN FORCED CIRCULATION OF GASES . . . . .	115
XX. SOLVENT RECOVERY BY COMPRESSION AND COOLING . . . . .	120
XXI. SOLVENT RECOVERY BY SCRUBBING . . . . .	132
XXII. SCRUBBING APPARATUS . . . . .	147
XXIII. SPECIAL ABSORBENTS . . . . .	153
XXIV. EXTRACTION BY SOLVENTS . . . . .	158
ABSTRACT OF LITERATURE ON SOLVENT RECOVERY . . . . .	163
VAPORIZATION DATA FOR VARIOUS SOLVENTS . . . . .	182



## PREFACE

Among the many applications of chemical engineering to the industries, that of the recovery of volatile solvents is among the most recent. This is due to several facts. In the first place the industries making use of solvents in appreciable amounts were up to within recent years of very limited extent, both as to numbers and as to size, and in the second place, the increasing cost of the solvents themselves as well as their increasing scarcity in many cases has only recently forced the industries to attempt their recovery. There has also arisen a new field in which the methods of solvent recovery are applicable which was not known a few years ago, that of the recovery of gasolene from natural gas. In view of the newness of the industry it is therefore not surprising that there has so far appeared no book dealing exclusively with this important subject, but it is rather surprising to find that the technical literature is full of references to it. The author has been able to make a search of the literature of the last forty years and has found, especially in the patent literature, a great mass of information to do with this subject, the greater part of which is included in the abstract of literature which goes to make up a portion of this volume. He believes from his experience in this field, that this portion of the book will be of the very greatest aid to engineers in connection with their design of solvent recovery apparatus, especially in connection with the search of the previous art in making patent applications. He has been very much surprised to find that, in many cases, devices that he believed to be new had been anticipated many years before. In fact he believes that so far as basic principles of solvent recovery are concerned, there is very little opportunity for inventors in this field and that future improvements in solvent recovery must lie largely in design of suitable apparatus and in improved applications of old principles. It is to be regretted that space was not available in this book for a more extended survey of the work of previous investigators, than has been included in the abstracts given, but the author has attempted to give as much of the story of each reference as the space allowed, with reference to such abstract journals

as are available, so that the reader will be able to follow up the references in which he is particularly interested.

The recovery of volatile solvents does not involve any new principles with which the skilled chemical engineer is unfamiliar, and anyone well trained along chemical engineering lines will find that a considerable portion of this book, at the start at least, consists of the most elementary principles of chemical engineering. But in a book of this sort it is impossible to take anything for granted concerning the technical training of the reader, without diminishing the value of the book to a very large number and restricting its field to those who do not need it. The author believes that the average engineer to whom this book will appeal has had a good engineering training in non-chemical lines, and that it is necessary to lead up to the subject in the manner in which he has done it. In his experience as a salesman of chemical engineering equipment, largely to engineers of the nonchemical type, he has frequently found it necessary to give the prospective customers a fairly complete course in the special type of chemical engineering principles which are used in solvent recovery work, and he has found by experience that the method of presentation used in this book is most advantageous.

It has therefore been the object of the author to present in as simple and complete form as possible, the fundamental principles involved in solvent recovery, illustrating them with frequent examples, to discuss the various factors entering into the design of solvent recovery equipment, and to give descriptions of the standard forms of apparatus used in the more common cases.

The book is therefore divided into six portions. The first part (Chapters I to VI) deals with the elementary principles. The second part (Chapters VII to XI) discusses the application of solid adsorbing agents to solvent recovery. The third part (Chapters XII to XIX) has to do with the recovery of vapors by condensation and cooling. Part four (Chapter XX) includes the use of cooling and compression combined. Part five (Chapters XXI to XXIII) takes up the use of scrubbing by means of liquids, while the last part includes the abstract of previous literature already mentioned, and a short chapter dealing with extraction by solvents and some vaporization data.

There are two phases of the greatest importance in the operation of most solvent recovery plants which the author has practically omitted from this work, namely, the evaporation of the solvent from the material in which it has been used, and the subsequent fractional



distillation of the recovered solvent to separate it from the absorbing liquid or from other substances present. The reason for this is two-fold. In the first place both of these processes are specialized operations of the first magnitude, deserving separate treatises of considerable length, the brief treatment possible in this sort of book being of practically no value. The second reason is the fact that both of these subjects have been covered in other books that are easily available to all. The principles involved in the evaporation of the solvent will be found to have been exhaustively handled from the standpoint of chemical engineering design by W. K. Lewis in his recent article on drying in the *Journal of Industrial and Engineering Chemistry* (1921, p. 427), and in the textbook of Chemical Engineering by Walker, Lewis and McAdams, under the chapter "Drying." The subject of fractional distillation has been given treatment by Sidney Young in his recent "Distillation Processes and Principles," and by the present author in his "Elements of Fractional Distillation." The author has felt justified, therefore, in omitting these very important operations, and refers the reader to the books mentioned above for very satisfactory treatments of these processes.

Many novel and interesting problems arise in the solution of every solvent recovery problem, which are not always easy to answer at once. For instance, in the recovery of gasolene from natural gas, one of the important factors is the oil which is used in the absorption towers. It is of very great importance that the best oil for the purpose be used, and every plant manager is concerned in this respect. The ease with which the oil picks up the solvent must not be sacrificed in order to facilitate the subsequent recovery by distillation. The change in the viscosity of the oil with the temperature, and its molecular weight affect appreciably the rate of absorption, while the vapor pressure of the oil must be considered as well. The author has repeatedly emphasized the fact that no two problems are the same and that it is quite impossible to even recommend any particular procedure or material for general adoption with the least certainty that it will be satisfactory. This is true with respect to the oil problem mentioned above. The best oil for the purpose will depend entirely upon the conditions at each particular plant, and even at any one plant the best oil will change with changing prices. There is no general solution of the solvent recovery problem.

The sources from which the author has drawn his information are in general, three: his personal experience of seven years in the field

of solvent recovery, the technical literature on the subject, and the information given him by the several concerns engaged in the design and erection of solvent recovery equipment. The author wishes to express at this point his very great appreciation of the assistance which he has derived from these concerns, and of their spirit of coöperation. He wishes especially to thank the following firms for material which he has used in this book.

E. B. Badger and Sons Company.  
Edouard Battaille et Cie.  
B. F. Sturtevant Co.  
Ernest Scott and Co.  
C. H. Wheeler Mfg. Co.  
Silica Gel Corporation.  
Bregeat Corporation.  
Lewis Recovery Corporation.  
Gasoline Recovery Corporation.  
William Garrigue and Company.

He also wishes to acknowledge the willingness of others on whom he has drawn less freely, to assist in any way possible. In fact, of all the firms with whom he has corresponded with respect to obtaining information for this book, only one was unwilling to place at his disposal any information that they had which he might desire. Such a spirit of coöperation speaks well for the future of chemical engineering in the United States.

The author is also indebted to the following for permission to use illustrations:

Journal of Industrial and Engineering Chemistry.  
Chemical and Metallurgical Engineering.  
D. Van Nostrand & Co., for illustrations from Rogers' Manual of Industrial Chemistry, and Chalmers' Production and Preparation of Vegetable Oils.  
John Wiley & Sons, for illustrations from Harding & Willard's Mechanical Equipment of Buildings.

Finally the author wishes to repeat that in all his experience in the field of solvent recovery, there were no two problems that ever came up alike, and that the solution in every case was different from every other solution. It is necessary to handle each individual problem on its own merits, basing the solution on the experience gained in previous work, tempered by a proper application of the principles of chemical engineering.

CLARK S. ROBINSON.

Cambridge, July 31, 1922



# THE RECOVERY OF VOLATILE SOLVENTS

## CHAPTER I

### GASES AND VAPORS

#### The Gas Laws

A substance, under suitable conditions, may exist in the form of a liquid, a solid, or a vapor. When in the vapor state it is subject to the laws governing that state, the gas laws. These laws have to do with the effect of changes in pressure and temperature upon the condition of the vapor. Increasing the temperature of a vapor tends to increase its volume, lowering the temperature having the reverse effect. If the pressure on a given amount of gas is kept unchanged, it has been found that temperature changes have definite effects upon its volume. For instance, if the gas be at  $0^{\circ}$  C., and is cooled  $1^{\circ}$  C. at constant pressure, the gas will be found to have decreased in volume approximately  $\frac{1}{273}$  of its volume at  $0^{\circ}$ . If the gas be cooled another degree, its volume would be decreased to  $2\frac{1}{273}$  of its volume at  $0^{\circ}$ . It would appear that if the gas were to be cooled to  $-273^{\circ}$  C., its volume would become zero. Actual gases and vapors, however, condense and become solid before this temperature, which is known as Absolute Zero ( $-273.1^{\circ}$  C. or  $-459.5^{\circ}$  F.), is reached, the hypothetical gas which follows this law throughout all temperature ranges being known as the Perfect Gas.

#### The Effect of Temperature on Vapors

The effect of temperature on volume at constant pressure can be expressed mathematically by the equation

$$(1) \quad \frac{V_1}{T_1} = \text{constant} = \frac{V_2}{T_2}$$

where  $V$  represents the volume of the gas, and  $T$  the absolute temperature, that is, the number of degrees above absolute zero.

*Example 1.* A certain vapor at 1 atmosphere pressure at 15° C. occupies 100 cubic feet. What will be its volume at 100° C.?

$$\frac{V_1}{T_1} = \text{constant} = \frac{V_2}{T_2}$$

$$\frac{100}{(273 + 15)} = \frac{V_2}{(273 + 100)}$$

$$V_2 = 129.5 \text{ cubic feet at } 100^\circ \text{ C.}$$

*Example 2.* A gas occupies 100 liters at 60° F., what will be its volume at 500° F.?

$$\frac{100}{(459.5 + 60)} = \frac{V_2}{(459.5 + 500)}$$

$$V_2 = 184.6 \text{ liters at } 500^\circ \text{ F.}$$

### The Effect of Pressure on Vapors

Doubling the pressure at constant temperature on a Perfect Gas halves its volume. This can be expressed by the equation:

$$(2) \quad PV = \text{constant}$$

Equation (1) and (2) can be combined giving

$$(3) \quad \frac{PV}{T} = \text{constant (the Perfect Gas Law)}$$

where  $P$  represents absolute pressure.

*Example 3.* A vapor occupies 1 cubic foot at 100 pounds per square inch gauge pressure and 400° F. What will be its volume at 0. pound gauge and 200° F.?

$$\frac{P_1 V_1}{T_1} = \frac{P_2 V_2}{T_2}$$

(0. pounds gauge pressure = 14.7 pounds absolute)

$$\frac{(100 + 14.7) (1)}{(459.5 + 400)} = \frac{(14.7) (V_2)}{(459.5 + 200)}$$

$$V_2 = 5.98 \text{ cu. ft.}$$

### Deviations from Gas Laws

The deviation of actual gases and vapors from the Perfect Gas Laws is greater, the greater the pressure on the gas, and the nearer

the gas to its condensation temperature. More complicated equations have been developed to express more exactly the behavior of actual gases with respect to changes in temperature and pressure. These are, however, beyond the scope of this book. The deviations of actual gases from the Perfect Gas Law at ordinary pressures is not excessive, 3% being about the maximum, which is within the permissible error in most engineering work, and the simplicity of calculations of vapor volumes usually warrants its use.

### Mixtures of Vapors. Partial Pressure

When a gas or vapor consists of a mixture of two or more gases or vapors, each individual vapor behaves as if it were alone present in the space occupied in the mixture. Thus if a mixture of equal volumes of oxygen and nitrogen be held at one atmosphere pressure, the actual pressure exerted by the nitrogen (its Partial Pressure) would be one half atmosphere, and if the oxygen were to be removed from the mixture by some suitable chemical, the pressure exerted by the residual nitrogen against the walls of the containing vessel, would equal the Partial Pressure, one half atmosphere.

There is accordingly a relation between the pressure which a given gas exerts when in a mixture of gases, and the percentage by volume of the gas in the mixture. If  $100 x$  represents the percentage by volume of the given gas in the mixture, the Partial Pressure ( $p$ ) of the gas can be calculated by the equation:

$$(4) \quad p = P x, \text{ where } P \text{ is the total pressure exerted by the mixture.}$$

*Example 4.* Air consists of a mixture of 20.9% by volume of oxygen, 78.1% by volume of nitrogen, and 1.0% by volume of argon, with negligible amounts of other gases. If air exists at 760 mm. of mercury pressure, calculate the respective partial pressures of the constituents.

$$\begin{array}{l} \text{Oxygen} \quad p = 760 \times .209 = 158.8 \text{ mm.} \\ \text{Nitrogen} \quad p = 760 \times .781 = 593.6 \text{ mm.} \\ \text{Argon} \quad p = 760 \times .010 = 7.6 \text{ mm.} \end{array}$$

### Avogadro's Law

Another relationship between gases and vapors is that of Avogadro, that equal volumes of different gases at the same temperature and pressure contain the same number of molecules. This means that

in a volume of air containing just one thousand molecules, there would be 209 molecules of oxygen, 781 of nitrogen, and 10 of argon, and that the symbol  $x$  in equation (4) represents that fraction of the total molecules consisting of the gas in question. This is known as the molecular or mól fraction.

$$100 x = \text{percentage by volume.}$$

### Calculation of Percentage by Weight

In order to calculate the percentage by weight of the constituents of a gas if the percentage by volume is known, the molecular weights of the respective constituents must be known.

*Example 5.* Calculate the percentage by weight of the constituents of air. The molecular weights are: oxygen ( $O_2$ ) = 32, nitrogen ( $N_2$ ) = 28, argon (A) = 40.

*Basis for calculation, 100 molecular weights of air.*

$$\text{Weight of } O_2 = 20.9 \times 32 = 669$$

$$\text{Weight of } N_2 = 78.1 \times 28 = 2185$$

$$\text{Weight of A} = 1.0 \times 40 = 40$$

$$\text{Total weight} = \underline{2894}$$

$$\text{Percentage by weight of } O_2 = \frac{669 \times 100}{2894} = 23.11\%$$

$$\text{Percentage by weight of } N_2 = \frac{2185 \times 100}{2894} = 75.51\%$$

$$\text{Percentage by weight of A} = \frac{40 \times 100}{2894} = 1.38\%$$

$$\text{Total} = \underline{100} \quad \%$$

### Calculation of Percentage by Volume

The reverse calculation, that of volume percentage from weight percentage is made as follows:

*Example 6.* Dry flue gas at an absolute pressure of 15 pounds per square inch has the following analysis *by weight*.

$CO_2$  (Carbon Dioxide) = 14.7%,  $O_2$  = 8.6%,  $N_2$  = 76.7%.

Calculate the analysis in percentage by volume. The molecular weight of  $CO_2$  = 44.

*Basis for calculation, 100 parts by weight of flue gas.*

$$\text{Mols of CO}_2 = \frac{14.7}{44} = .334$$

$$\text{Mols of O}_2 = \frac{8.6}{32} = .269$$

$$\text{Mols of N}_2 = \frac{76.7}{28} = 2.74$$

$$\text{Total mols} = 3.343$$

$$\text{Percentage by volume of CO}_2 = \frac{.334 \times 100}{3.343} = 10.0\%$$

$$\text{Percentage by volume of O}_2 = \frac{.269 \times 100}{3.343} = 8.0\%$$

$$\text{Percentage by volume of N}_2 = \frac{2.74 \times 100}{3.343} = 82.0\%$$

---

$$\text{Total} = 100 \%$$

## CHAPTER II

### VAPORIZATION

#### Vapor Pressure

All substances, either liquid or solid, vaporize to some extent, the degree depending upon conditions of temperature and external pressure. At any given temperature a substance has a definite tendency to pass into the vapor state, and this tendency, when measured in terms of pressure, is called its Vapor Pressure. If a substance be confined in a given space at a fixed temperature, it will vaporize until the partial pressure of the substance in the space above the liquid (or solid) is equal to its vapor pressure at that temperature, and no further vaporization will occur unless some of the vapor is removed, thus lowering its partial pressure.

Within limits of ordinary pressures the partial pressure of a liquid in equilibrium with the vapor space above it is independent of the presence of other gases and vapors.

#### Clapeyron Equation

There is no simple rule for expressing the relation between the temperature and the vapor pressure of a substance. A modified form of the Clapeyron equation gives an approximate relation which is of considerable value.

$$(5) \quad \frac{d \log_e P}{dT} = \frac{L}{RT^2}$$

where  $\log_e P$  is the natural or Napierian logarithm ( $2.303 \times \log_{10}$ ) of the pressure  $P$ ,  $T$  is the absolute temperature,  $L$  is the latent heat of vaporization of one mol of the substance, and  $R$  is the gas constant (1.99 when  $L$  is expressed in heat units per unit molecular weight). This equation can be used over short temperature ranges, on the assumption that  $L$  is a constant ( $L$  changes slightly with the temperature), in its integrated form:



$$(6) \quad \log_{\circ} \frac{P_2}{P_1} = \frac{L}{R} \left( \frac{1}{T_1} - \frac{1}{T_2} \right)$$

*Example 7.* The vapor pressure of water at 100° C. is 14.7 pounds per square inch, calculate the vapor pressure at 150° C. The latent heat of vaporization of water at 100° C. is 964.6 calories per gram mol.

$$\log_{\circ} \frac{P_2}{14.7} = \frac{964.6}{1.99} \left( \frac{1}{100 + 273} - \frac{1}{150 + 273} \right)$$

$$2.303 \times \log_{\circ} \frac{P_2}{14.7} = 1.542$$

$$\log_{\circ} P_2 = \frac{1.542}{2.303} + \log_{\circ} 14.7 = 1.835$$

$$P_2 = 68.4$$

The actual vapor pressure of water at 150° C. is 69.3 pounds per square inch. This indicates the degree of accuracy of this equation for such temperature changes.

### Trouton's Rule

Frequently, occasion arises for an approximate vapor pressure curve for a substance whose latent heat of vaporization is not known. Such an approximation can be obtained if the boiling point of the liquid at atmospheric pressure be known, by the use of Trouton's Rule:

$$(7) \quad \frac{L}{T} = 20.5$$

where  $L$  is expressed in gram calories per gram mol, and  $T$  is the boiling temperature in degrees Centigrade absolute (°K). This rule does not hold for water, acids, or alcohols, but for most other organic liquids is fairly close to the fact.

*Example 8.* Benzol boils at 80.2° C. at 760 mm. pressure. What is its boiling temperature at 300 mm. pressure?

$$\frac{L}{(80.2 + 273.)} = 20.5 \quad L = 7250.$$

$$\log_{\circ} \frac{760}{300} = \frac{7250}{1.99} \left( \frac{1}{T_2} - \frac{1}{273 + 80.2} \right)$$

$$T_2 = 324.^{\circ}\text{K} = 51^{\circ}\text{C}.$$

The temperature at which the vapor pressure of benzol is actually 300 mm. is 52.8° C.

## Hildebrandt Curves

Values for  $\frac{L}{T}$  can be read off Fig. 1, using curve A for most organic liquids, and curve B for water, ammonia, and alcohols. The abscissae are the ratios of the vapor pressures in atmospheres to the tempera-

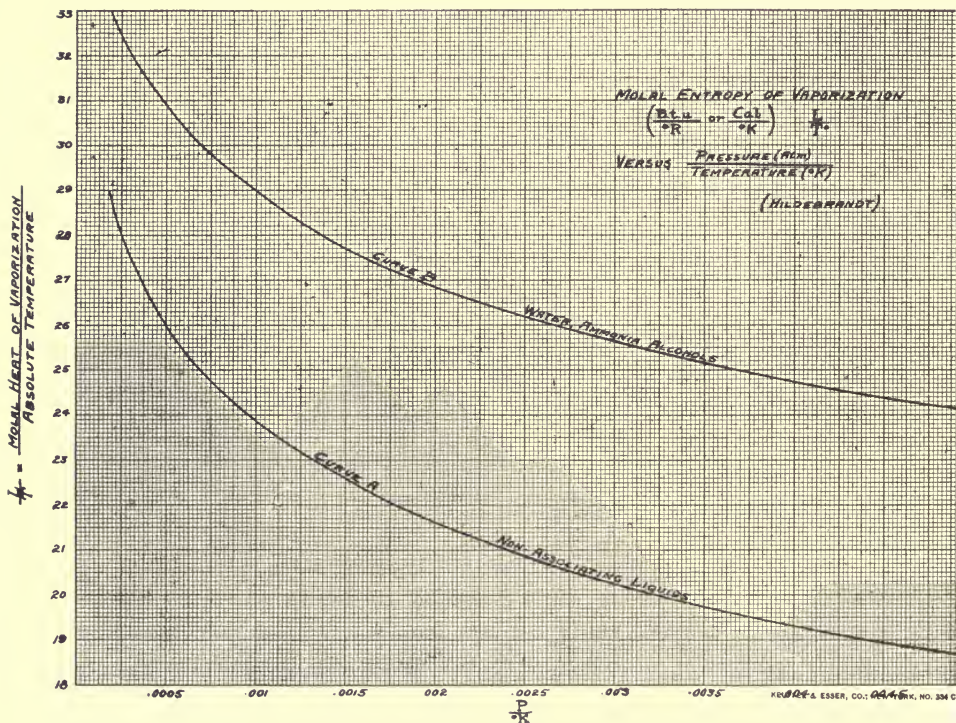

FIG. 1. Hildebrandt's Curves for the Determination of Heats of Vaporization.

tures in °K (°C. absolute). Thus for benzol boiling at 80.2 at 760 mm. (1 atmosphere),  $\frac{P}{T} = \frac{1}{273 + 80.2} = .00283$  and  $\frac{L}{T} = 20.45$ .

 $P_w - P_1$  Curves

Where two points on a vapor pressure curve are known, there is another approximate method. This consists in plotting the vapor pressures of water as ordinates and as abscissae the vapor pressures



of the liquid in question at the same temperatures. Thus at  $50^{\circ}\text{C}$ ., the vapor pressure of water is 91.98 mm. while that of ethyl alcohol at the same temperature is 219.8 mm. These two pressures would give one point on the curve A shown on Fig. 2.

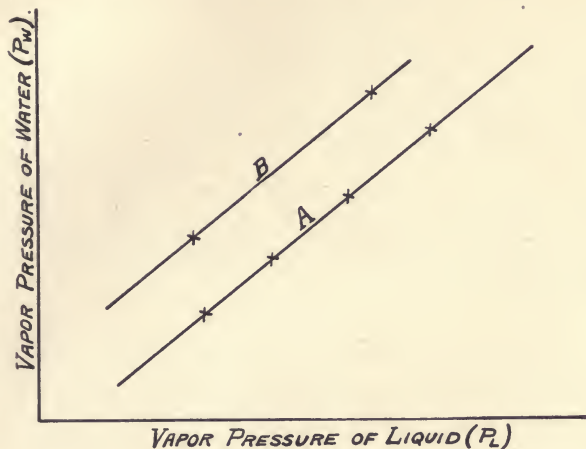

FIG. 2.  $P_W$ - $P_L$  Curves for the Estimation of Vapor Pressures.

A series of points are found to lie on what is practically a straight line, curve A. Therefore if two points for any liquid be known, a line drawn through them, curve B, will give a vapor pressure curve which is remarkably near the true one.

## CHAPTER III

### LIQUID MIXTURES

#### Raoult's Law

The vapor pressure of a volatile liquid is lowered by the introduction into it of soluble substances, the lowering being approximately proportional to the amount of foreign substance added. The effect is expressed by Raoult's Law:

$$(8) \quad p = p_o x_o$$

where  $p$  is the vapor pressure of the liquid after the addition of the foreign substance;  $p_o$  is the vapor pressure of the pure liquid at the same temperature, and  $x_o$  is the mol fraction of the pure liquid in the mixture.

*Example 9.* Water has a vapor pressure of 760 mm. at 100° C. What will be the vapor pressure of a 10% sugar solution at that temperature? The molecular weight of water is 18 and that of sugar is 342.

Basis = 100 parts of solution

$$\frac{10}{342} = .0292 \text{ mols sugar}$$

$$\frac{90}{18} = 5.00 \text{ mols water}$$

—————  
5.0292 total mols

$$\text{mol fraction of water} = \frac{5.00}{5.0292}$$

$$p = \frac{5.00}{5.0292} \times 760. = 755.8 \text{ mm.}$$

The vapor pressure of the water at 100° C. has therefore been lowered 4.2 mm. by the dissolved sugar.

Salts, acids, and other substances which dissociate in aqueous solution give a greater vapor pressure lowering than is calculated from their molecular weight. Solutions of substances in organic solvents

are usually not dissociated, but are sometimes "associated," giving effective vapor pressure lowerings less than that calculated. Raoult's Law can be safely used for most liquids from values of  $x_0$  from 1.00 down to 0.95. Below 0.95 it is not safe except in special cases.

### Henry's Law

A volatile substance dissolved in a solvent exerts a vapor pressure proportional to the amount of the substance present. This can be expressed by the equation:

$$(8a) \quad p = a x,$$

where  $p$  is the vapor pressure,  $x$  is the mol fraction of the volatile material, and  $a$  is a constant. Raoult's Law is therefore a special case of Henry's Law where  $a = p_0$ . Henry's Law is to be used for dilute solutions, where  $x$  is less than 0.05.

*Example 10.* The vapor pressure of ammonia over an aqueous solution containing 1.95%  $\text{NH}_4\text{OH}$  is 7.6 mm. Calculate the vapor pressure of a solution containing 1.0%  $\text{NH}_4\text{OH}$ .

For very dilute solutions, mol percentage ratios are practically equivalent to weight percentage ratio, therefore:

$$\frac{p_2}{7.6} = \frac{1.0}{1.95}$$

$$p_2 = 3.9 \text{ mm.}$$

For very dilute solutions of substances like ammonia in water, where there is a chemical combination between the two substances, Henry's Law does not hold exactly. The above calculation is therefore only approximate, and for more accurate calculations the relation between the constant of Henry's Law and the concentration should be determined experimentally. (See 1922 Thesis, Calingaert & Huggins, Mass. Inst. Technology.)

### Mixtures of Two Volatile Liquids

Two volatile liquids when mixed lower each others vapor pressures. This is shown in Fig. 3 at some fixed temperature  $t$ , for two liquids,  $A$  and  $B$ .

In this diagram vapor pressures are shown as ordinates and mol percentage of  $B$  ( $x_B$ ) as abscissae. The left hand side represents pure  $A$  and the right hand side pure  $B$ . If mixtures of  $A$  and  $B$  followed

Raoult's Law in all proportions, which is unusual, the vapor pressure of *B* would be represented by the straight line *AD*, while that of *A* would be represented by the straight line *CB*. The sum of the two pressures or the total pressure would therefore be shown by the straight

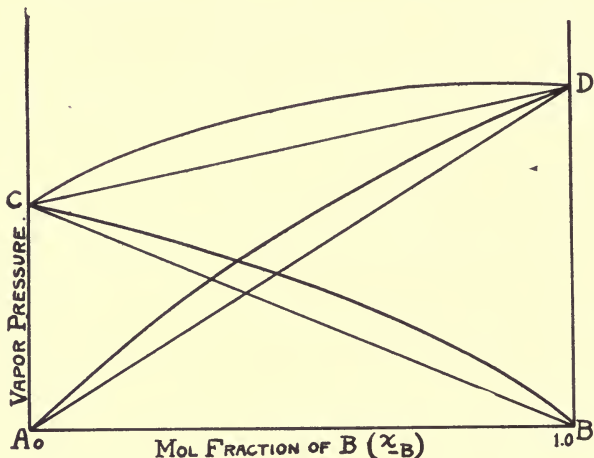

FIG. 3. Vapor Pressure Diagram for Mixtures of Two Volatile Liquids.

line *CD*. If the mixture does not follow Raoult's Law, the lines will not be straight, their shape being obtained by experiment. The curved lines connecting the points *A*, *B*, *C*, and *D* show a common type of such mixtures.

### Partially Miscible Liquids

If the two volatile liquids do not mix completely, an important modification of the vapor pressure diagram is obtained. The diagram in Fig. 4 shows such a mixture of two liquids *A* and *B*, *A* being soluble in *B* to the extent indicated by the point *C*, and *B* being soluble in *A* to the extent indicated by the point *D*.

If equal parts of *A* and *B* are mixed, two layers will be formed, one of which will have the composition *D*, and the other will have the composition *C*. The vapor pressure of pure *A* is represented by the point *E*, and that of *B* by the point *F*. The vapor pressure of *A*, if the mixture follows Raoult's Law within the limits of solubility, will follow along the straight line *EB*, the line stopping at the limit of solubility of *B* in *A*, the remaining dotted line merely indicating the direction. Similarly, the vapor pressure of *B* will follow the line *FA*, stopping at

*H*. For mixtures between the compositions *D* and *C*, where two layers are present, the vapor pressure of *A* will remain constant at the value *H*, as indicated by the horizontal line *GJ* and *HK* respectively. For mixtures between the compositions of pure *A* and *B*, if they follow Henry's Law, the vapor pressure of *B* will be represented by the straight line *KA*, and in the case of *A* by the straight line *JB*. The

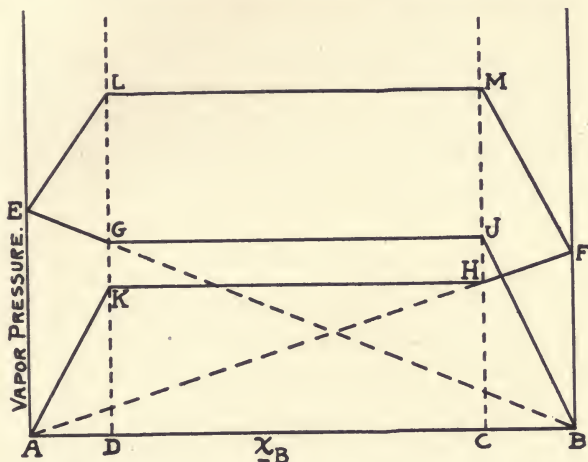

FIG. 4. Vapor Pressure Diagram for Mixtures of Two Partially Miscible Liquids.

total pressure of such a mixture will be represented by the lines *EL*, *LM*, and *MF*, the total pressure being greater than that of either of the pure substances alone. In case the mixtures fail to follow Raoult's and Henry's Law, the lines *EG*, *AK*, *HF*, *JB*, *EL*, and *MF* will not be straight, but the lines *GJ*, *KH*, and *LM* will always be straight and horizontal.

### Completely Immiscible Liquids

Where the liquids mixed are practically completely insoluble in each other, they will form separate layers, the partial pressure of each will be that of the pure liquid and the total pressure the sum of the two.



## CHAPTER IV

### DISTILLATION OF LIQUID MIXTURES

The composition of the vapor evolved from a mixture of two or more volatile liquids has a definite relation to the composition of the liquid from which it comes. For liquid mixtures which follow Raoult's Law, this composition can be calculated, but for others it is necessary to obtain experimental data.

#### Binary Mixtures

For binary mixtures of liquids soluble in each other in all proportions, the relation between the composition of the vapor and of the liquid can be shown by means of a diagram such as is shown in Fig. 5.

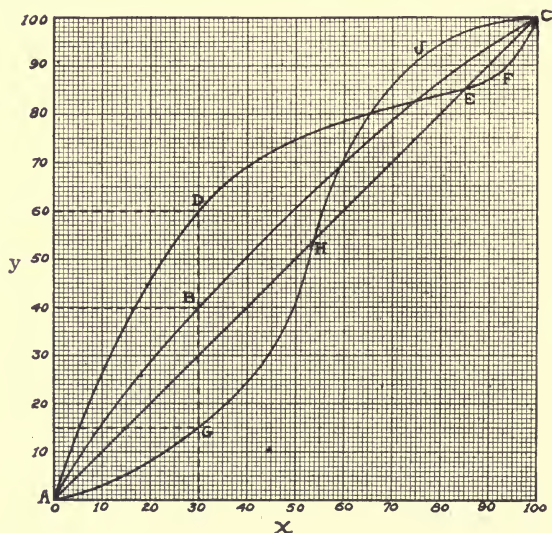

FIG. 5.  $x$ - $y$  Diagram Giving Relation between Composition of Liquid and Vapor for Mixtures of Two Volatile Liquids.

In this diagram the abscissae  $x$  represent composition of the liquid mixture in %  $A$ , while the ordinates,  $y$ , represent the composition of

the vapor evolved by the liquid, also expressed in % *A*. Suppose that the curve *A B C* represents the relation between the composition of the liquid and the vapor for a certain mixture. Then a liquid with 30% of the one component will produce a vapor containing 40% of that component. Or if the curve *A D E F C* represented the relation, the vapor in equilibrium with a 30% would contain 60% of that component.

### Types of Liquid Mixtures

There are in general three types of liquid mixtures soluble in all proportions. The first type, represented by the curve *A B C*, produces a vapor which is always richer in the more volatile component than the liquid. The second type, represented by the curve *A D E F C*,

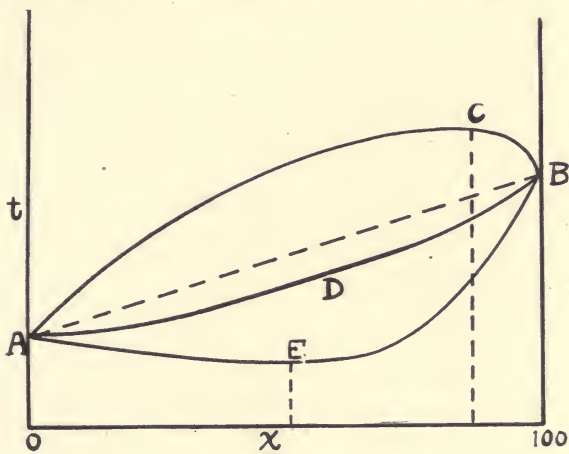

Fig. 6. Boiling-point—composition Diagram for Binary Mixtures.

produces a vapor which is richer than the liquid in the more volatile component up to the composition represented by the point *E*. For greater concentrations (between *E* and *C*) the vapor is poorer in that component, and at the point *E*, the vapor has the same composition as the liquid from which it comes. Such a mixture of liquids forms a mixture, at the composition *E*, of constant boiling point. The liquid composition remains unchanged when a mixture of constant boiling point is being distilled, and the total vapor pressure curve passes through a maximum at that composition.

On the other hand, a mixture illustrated by the curve *A G H J C*

has a point of minimum vapor pressure at the composition  $H$ , and such a mixture is known as one of maximum boiling point. The boiling point curves of these mixtures at constant pressure are shown in the following diagram (Fig. 6) which has temperature as ordinates and composition as abscissae.

In this diagram the curve  $A D B$  is the boiling point curve of mixtures similar to that giving the curve  $A B C$  in Fig. 5. The curve  $A E B$  corresponds to  $A D E F C$  in Fig. 5, the point  $E$  being the minimum boiling mixture. The curve  $A C B$  corresponds to  $A G H J C$  in Fig. 5, the point  $C$  being the maximum boiling point.

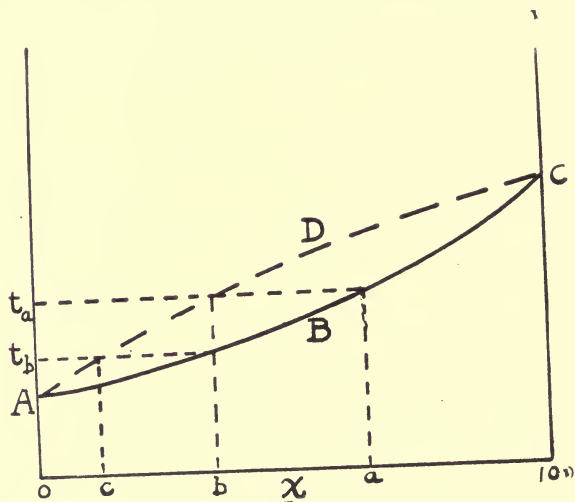

FIG. 7. Vapor Pressure Diagram for Mixtures of Two Partially Miscible Liquids.

Liquids which are not miscible in all proportions, within the range in which two layers are present, act in a similar manner to constant boiling mixtures, the composition of the vapor remaining unchanged, so long as the two layers are present. When one of the layers has disappeared, the remaining layer behaves like one of the preceding types of miscible liquids.

The relation between the liquid and vapor can also be shown on the temperature composition diagram (Fig. 7).

In this diagram, the curve  $A B C$  is the boiling point curve at constant pressure for a binary mixture which forms no constant boiling mixtures, and the curve  $A D C$  represents the vapor in equilibrium with it. Thus a mixture of the composition,  $a$ , boils at the given pres-



sure at the temperature  $t_a$ , giving a vapor whose composition is  $b$ . The vapor of the composition  $b$  can be condensed and would boil at the temperature  $t_b$  giving a vapor of the composition  $c$ . If this process be repeated, a vapor consisting of pure A would be obtained finally. This continued reboiling of condensed vapors is the basis for the separation of volatile liquids by fractional distillation.

Mixtures of liquids which form constant boiling mixtures either of the minimum or maximum variety cannot be separated completely into their pure components by fractional distillation alone, one product of complete fractionation always being the constant boiling mixture, and the other, one of the pure components.

## CHAPTER V

### CONDENSATION OF MIXED VAPORS

The condensation of mixed vapors can be readily followed by means of the  $t$ - $x$  diagram. Fig. 8 is such a diagram for a binary mixture, miscible in all proportions, and completely separable by fractional distillation.

The pure liquid  $A$  boils at the temperature  $C$ , while  $B$  boils at the temperature  $D$ . The boiling point curve of the mixture is represented

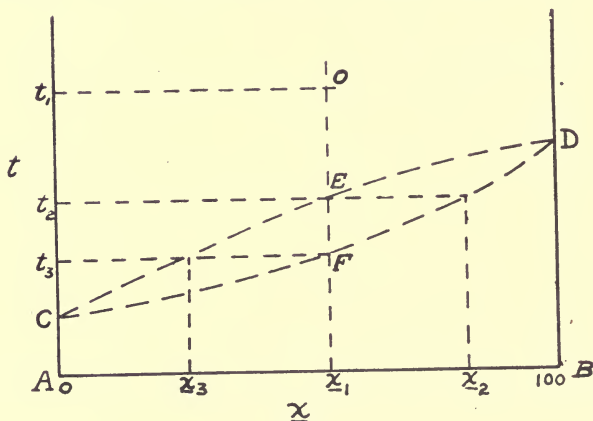

FIG. 8. Boiling-point—composition Diagram illustrating Condensation of Vapor.

by the curve  $C D F$ , while the vapor in equilibrium with the liquid is shown by the curve  $C E D$ , as explained in the preceding chapter.

Suppose that a vapor mixture of the composition  $x_1$  is at the temperature  $t_1$ . It will be superheated vapor at this temperature, and if the temperature be gradually lowered, no change in the vapor other than a decrease in volume will occur until all of the superheat has been lost, which will occur when the temperature has reached  $t_2$ . At this point condensation will commence, the liquid first appearing having the composition  $x_2$ . The remaining vapor will therefore become richer in the component  $A$ , as cooling continues, while the liquid,

though still richer in  $B$  than the original composition  $x$ , will gradually grow poorer with respect to that component. If all the liquid condensed is kept in contact and equilibrium with the remaining vapor, when the temperature has dropped to  $t_3$ , all the vapor will have condensed, and the condensate will have the original composition of the vapor  $x_1$ . The last of the vapor to condense under these conditions will have the composition  $x_3$ .

### Differential Condensation

If the liquid in such a condensation process be removed from contact with the vapor as fast as it forms, the final concentration of the vapor will not be limited by the value  $x_3$ , but the vapor will grow progressively richer in  $A$ , until the final vapor to condense will consist of pure  $A$ . It is therefore possible to obtain separation of vapor mixtures by means of condensation as well as by distillation, and both processes are combined in fractional distillation.

### Mixtures of Vapors and Gases

A gaseous mixture may consist of several substances which condense easily at ordinary temperatures together with some that are condensible only at much lower temperatures, such as the so-called permanent gases, air, carbon dioxide, and others. Under these conditions, the condensible vapors condense practically alone, the liquid containing only such amounts of the non-condensibles as may be soluble in them at the condensation temperature. The amount of vapor remaining in the gas can be calculated from the vapor pressure curves of the condensed vapor, and the amount condensed can be obtained by difference.

*Example 11.* Air at  $120^\circ\text{F}$ . and normal barometer (29.92) inches of mercury (Hg.), is passed over benzene ( $\text{C}_6\text{H}_6$ ) until it is saturated at that temperature. The mixture of air and vapor is then removed to a condenser where it is cooled to  $100^\circ\text{F}$ . Calculate the pounds of benzene condensed per pound of air. The vapor pressure of benzene at  $120^\circ\text{F}$ . is 10.2" Hg., and at  $100^\circ$  is 6.5" Hg. The molecular weight of benzene is 78, and that of air is 29.

Total pressure = 29.92" Hg. (normal barometer)

Since the air is saturated at  $120^\circ$  with benzene, the partial pressure of benzene in the air will equal the vapor pressure at that temperature.

Similarly the partial pressure at 100° will equal the vapor pressure at 100°.

$$\begin{aligned} \text{At } 120^\circ \text{ partial pressure of benzene} &= 10.2'' \\ \text{partial pressure of air} &= 29.92 - 10.2 = 19.7 \end{aligned}$$

$$\text{mols of benzene per mol of air} = \frac{10.2}{19.7} = .518 \text{ mols}$$

$$\begin{aligned} \text{At } 100^\circ \text{ partial pressure of benzene} &= 6.5'' \\ \text{partial pressure of air} &= 29.92 - 6.5 = 23.3'' \end{aligned}$$

$$\text{mols of benzene per mol of air} = \frac{6.5}{23.3} = .279 \text{ mols}$$

$$\text{mols of benzene condensed per mol of air} = .518 - .279 = .239 \text{ mols}$$

$$\text{pounds of benzene condensed per pound of air} = \frac{.239 \times 78}{29} = .64 \text{ lbs.}$$

*Answer.*

*Example 12.* A mixture of air and ethyl alcohol vapor at 120° F. is cooled to 80° F., during which 50 pounds of alcohol are condensed per 1000 cubic feet of the original mixture. Calculate the percentage by volume of the alcohol in the original mixture. Barometer normal. Molecular weight of ethyl alcohol is 46. Vapor pressure of alcohol at 120° F. is 8.1'' Hg., and at 80° is 2.5'' Hg.

1 molecular weight of a gas in pounds (1 pound mol) occupies 359 cubic feet at standard conditions (32° F. and 14.7 lbs. absolute pressure).

1000 cubic feet of the original mixture would contain

$$\frac{1000 \times (459.5 + 32)}{359 \times (459.5 + 120)} = 2.365 \text{ mols of air + alcohol}$$

of which there are  $A$  mols of alcohol and  $(2.365 - A)$  mols of air.

The air at 80° F. would contain  $(2.365 - A) \frac{2.5}{(29.92 - 2.5)}$  mols of

alcohol. The alcohol condensed per 1000 cubic feet is 50 pounds or

$$\frac{50}{46} = 1.09 \text{ lb. mols. Therefore:}$$

$$1.09 + (2.365 - A) \frac{2.5}{(29.92 - 2.5)} = A.$$

$A = 1.195$  mols of alcohol in original mixture.

$$\text{Percentage by volume of alcohol} = \frac{1.195}{2.365} = 50.5\%$$

## CHAPTER VI

### RATE OF REACTION

All engineering processes require time for their completion, and in many cases the speed or rate at which the process progresses can be estimated by the use of the previously mentioned laws and other relations. The study of this speed is generally called Rate of Reaction.

The rate at which a process or reaction progresses is proportional to the driving force which is causing the reaction to proceed. This driving force is known as the Potential of the reaction, and the greater the potential, the greater the speed. Thus the rate of flow of heat from one body to another is proportional to the temperature difference. The rate of dissolving of a salt is proportional to the concentration difference between the solution and a saturated solution. In solvent recovery work, the rates at which the reactions progress are often proportional to similar potential differences.

#### Rate of Flow of Heat

One of the commonest and simplest of such reactions is the Rate of Flow of Heat. The introduction of heat into the volatilizing solvent, and its removal from the condensing solvent, are reactions which occur in all solvent recovery processes. The usual form of the equation for heat flow by conduction is the following:

$$(9) \quad \frac{d Q}{d \Theta} = k A \Delta t$$

where  $Q$  is the amount of heat flowing during the time  $\Theta$ ,  $A$  is the area of the heating surface through which the heat passes,  $\Delta t$  is the temperature difference between the hot and the cold bodies, and  $k$  is a proportionality constant, usually called the coefficient of heat transfer.

Where the flow of heat is by radiation instead of conduction, equation (9) does not hold, as the rate of flow is proportional to the fourth power of the absolute temperature, as shown in the following equation:



$$(10) \quad \frac{d Q}{d \Theta} = c A T^4$$

where  $T$  is the absolute temperature and  $c$  is the radiation coefficient of the substance.

#### Rate of Evaporation

The rate of evaporation of a volatile substance from a surface into a gas is proportional to the difference between the vapor pressure of the substance on the surface, and its partial pressure in the surrounding gas. This is expressed by the equation:

$$(11) \quad \frac{d W}{d \Theta} = k A (P - p)$$

where  $d W$  is the weight of substance vaporized per unit time  $d \Theta$ ,  $A$  is the area of the vaporizing surface,  $P$  the vapor pressure of the substance,  $p$  its partial pressure in the surrounding gas, and  $k$  is a proportionality constant.

In solvent recovery, evaporation of solvent from solid residue involves diffusion of solvent from the interior to the surface, as the surface evaporates. This diffusion rate can be expressed by a similar equation:

$$(12) \quad \frac{d W}{d \Theta} = k A \frac{C - c}{l}$$

where  $C$  and  $c$  are the solvent concentrations of the interior and the surface respectively, and  $l$  is the distance from the interior to the surface.

#### Rate of Condensation

In condensation of solvent vapor by cooling or by solution equation (11) is applicable, in this case  $P$  being the partial pressure of the vapor and  $p$  the vapor pressure of the condensed or dissolved solvent in contact with it.

The use of the above equations is discussed under the appropriate headings in the latter portion of the book.

## CHAPTER VII

### ADSORPTION

#### Solution in Liquids

A gas or vapor when brought into contact with a liquid in which it is soluble, passes into solution until the vapor pressure of the dissolved vapor becomes equal to the partial pressure of the vapor in the surrounding gas, when further solution will cease, equilibrium having been established. Under these conditions the dissolved vapor will be uniformly distributed throughout the dissolving liquid, and the amount of vapor dissolved per unit volume of liquid will not be affected by the surface exposed to contact between the vapor and the liquid, the surface affecting only the rate of solution. It is true that at the liquid surface, the concentration of the dissolved vapor is greater than at other points in the liquid, but since in most cases the ratio of surface to volume of a liquid is not great, this surface effect does not appreciably affect the total amount of vapor dissolved.

#### Adsorption on Solids

When gas or vapor is brought into contact with a solid substance, there is the same tendency for the vapor to pass into solution in the solid, the vapor collecting on the surface of the solid.<sup>1</sup> But since the solubility of gases and vapors in most solids is exceedingly small, that actually dissolved in the interior of the solid can usually be neglected. However, many solid materials, such as charcoal, activated by treatment with superheated steam at a high temperature, activated anthracite coal, silica gel, ferric hydroxide gel, and others, possess the power to absorb or "adsorb" gases and vapors on their surfaces to an unusual degree. The mechanism by which this surface adsorption takes place is not actually known, as the effects are beyond the powers of the most powerful microscope, but a careful study by numerous investigators, some of whom are mentioned later, indicate at the present that the

<sup>1</sup>R. E. Wilson, *Physical Review*, U. S. XVI, July (1920), p. 8.

adsorption is caused by the combination of three separate effects. The first of these is probably the formation on the surface of the solid of a layer of the adsorbed vapor, one molecule deep. The second effect consists of the formation of a second layer of vapor of variable thickness held by the attraction between the solid and the vapor, the thickness depending on the strength of the attraction. The third effect is that of the collection on the surface in sub-microscopic capillary openings of a more or less condensed layer of vapor. The three effects are cumulative, and adsorbing agents possess them in varying proportions to a greater or less degree. They may be shown by the following diagram taken from the above article.

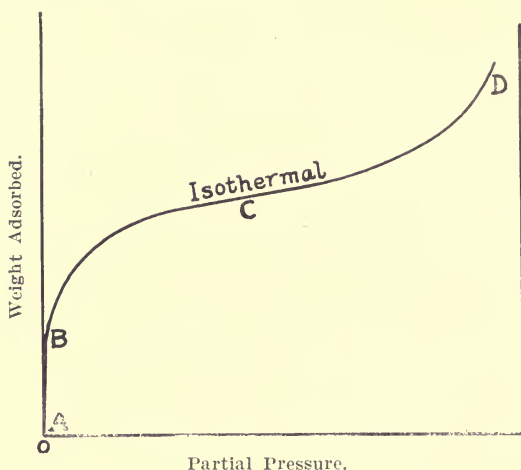

FIG. 9. Diagram Showing Adsorption of Vapor by Solid.

This diagram shows the weight of adsorbed vapor per unit weight of adsorbing solid as a function of the partial pressure of the vapor in equilibrium with the solid. The solid will adsorb vapor from *A* to *B* when the partial pressure of the vapor in the gas is practically zero. This is the one molecular layer. When that layer is full an increase in pressure is needed to increase the adsorption as indicated by the portion of the curve from *B* to *C* which is the range of further adsorption due to molecular attraction, while the last range from *C* to *D* and further is that due to capillary condensation.



Common Adsorbing Agents

The two following diagrams show how a number of adsorbing agents absorb water when exposed to air of varying humidity at a

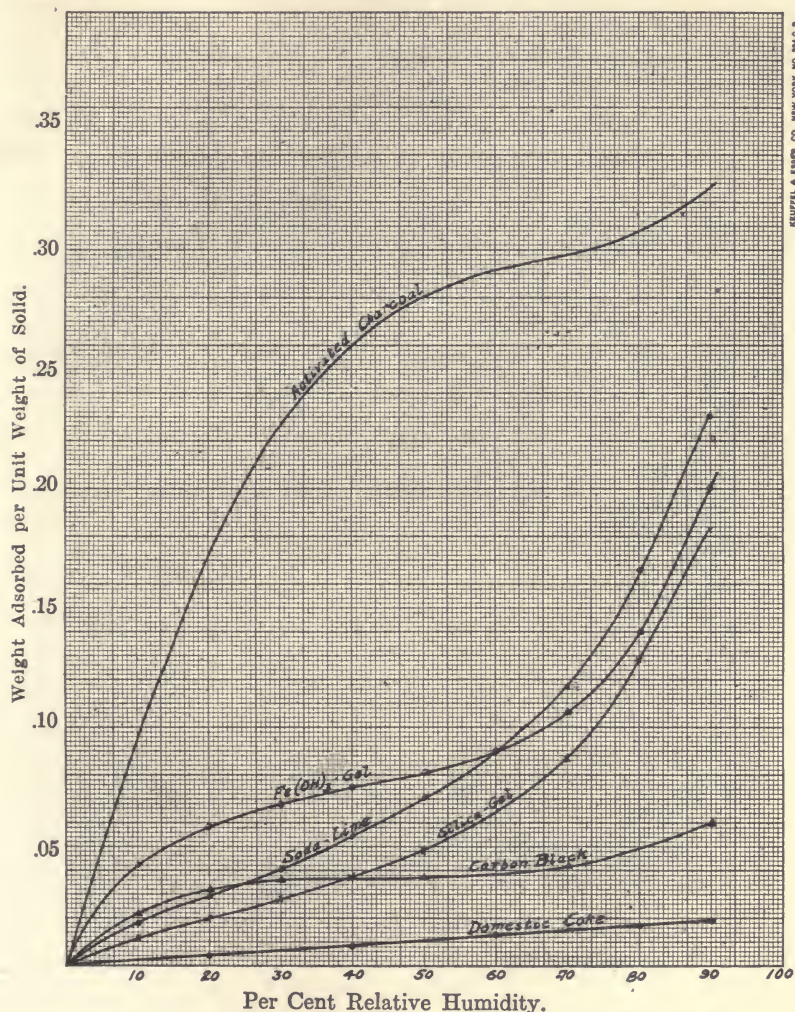

FIG. 10. Weight of Water Vapor Adsorbed on Several Solids.

constant temperature of 25° C.<sup>1</sup> The first shows the weight of water

<sup>1</sup>Data from Research Laboratory of Applied Chemistry, Massachusetts Institute of Technology.

vapor absorbed per unit weight of solid as a function of relative humidity for the following substances:

- Activated charcoal
- Ferric hydroxide gel ( $\text{Fe}(\text{OH})_3 \cdot n \text{H}_2\text{O}$ )
- Silica gel ( $\text{SiO}_2$  in  $\text{H}_2\text{O}$ )
- Soda-lime ( $\text{NaOH} + \text{CaO}$ )
- Carbon black
- Domestic coke

The same data are plotted in the second diagram for the first three solids, using weight (grams) adsorbed per unit gross volume (cubic

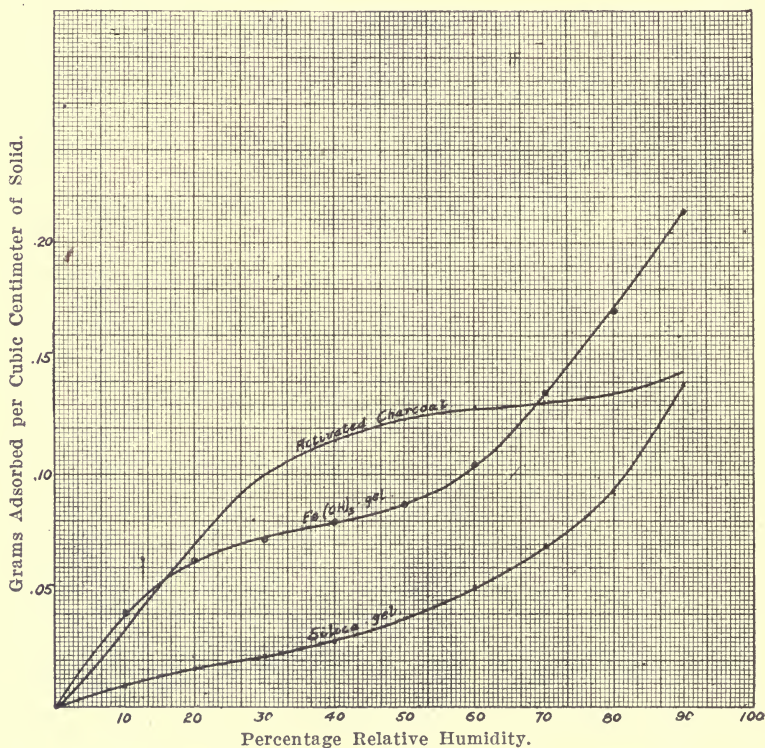

FIG. 11. Weight of Water Adsorbed per Cubic Centimeter of Solid.

centimeter) of solid. These curves indicate how the solids vary in their adsorbing powers. It should be stated also that the adsorptive power of any one will depend on the method of its preparation, and also on the character of the vapor adsorbed. It is difficult to reproduce adsorbing agents of identical capacity.



The above curves illustrate the type of adsorption effect peculiar to the several substances. Thus, charcoal depends largely on adsorption due to attraction, while silica gel is largely of the capillary type. Ferric hydroxide gel is intermediate.

While the value of an adsorbing agent depends partly on the surface exposed per unit weight of solid, this is a minor factor, visible porosity not being a sign of a satisfactory material. Thus pumice, although of extreme porosity, is of little value for this purpose.

### Capillary Adsorption

It is well known that the vapor pressure of a liquid held in a fine capillary is less than that of the same liquid at the same temperature when exposed in large bulk, due to surface tension effects. Under proper surface conditions, therefore, it might be possible for actual liquid to appear in surface capillaries and remain in equilibrium with vapor whose partial pressure is far below that of bulk liquid at that temperature. The small size of the capillaries in adsorbing agents prevents their being seen under the microscope, but some of the effects observed can be readily explained if looked at from this standpoint. For instance, in solids such as silica gel, which depend for their adsorption largely on capillary condensation, it is apparently true that when the partial pressure of the vapor in equilibrium with the solid equals the saturation pressure, the volume of vapor adsorbed, measured as liquefied vapor, is independent of the nature of the vapor, a condition which might be easily explained by assuming the capillaries to have become full, when further adsorption would cease.

The problem is further complicated by the variation in the size of the capillaries. The increase in the capacity of solids with increasing partial pressure of the vapor may be explained by the supposition that the smaller capillaries fill up first under lower partial pressures when the surface tension effects would be greater, the larger capillaries filling afterwards when the pressure is increased.

### Adsorption Equation

The relation between the amount of vapor adsorbed and the partial pressure for solids of the silica gel type has been the subject of work by Patrick and others.<sup>1</sup> They have found that a modified form

<sup>1</sup>*J. Am. Chem. Soc.*, 42, p. 946 (1920).

## ADSORPTION OF SULPHUR DIOXIDE BY SILICA GEL

Exp. No.	t° C.	c.c. SO <sub>2</sub> gas adsorbed per gm. gel.	p Partial pressure SO <sub>2</sub> in mm.	P Vapor pressure SO <sub>2</sub> at t° in mm. Hg.	D Density of liquid SO <sub>2</sub> at t°	σ Surface tension of liquid SO <sub>2</sub> at t°	$\frac{p\sigma}{P}$	V vol. SO <sub>2</sub>
XII	100°	12.04	229.9	21143.	1.111	9.25	.1007	.031
	100	17.78	397.0	21143.	1.111	9.25	.1738	.0457
	100	21.99	544.2	21143.	1.111	9.25	.238	.0566
XIX	100	24.65	671.5	21143.	1.111	9.25	.284	.0634
	80	16.73	192.19	13680.	1.192	13.1	.184	.0401
	80	18.66	224.73	13680.	1.192	13.1	.215	.0446
	80	27.70	407.88	13680.	1.192	13.1	.390	.0663
	80	34.17	575.32	13680.	1.192	13.1	.551	.0818
XVIII	80	37.41	671.95	13680.	1.192	13.1	.644	.0897
	40	7.50	9.44	4712.	1.3111	21.0	.042	.0163
	40	16.40	31.37	4712.	1.3111	21.0	.140	.0357
	40	25.25	64.77	4712.	1.3111	21.0	.289	.0550
	40	33.66	110.00	4712.	1.3111	21.0	.490	.0733
	40	41.88	189.13	4712.	1.3111	21.0	.843	.0913
	40	55.54	299.78	4712.	1.3111	21.0	1.338	.1210
	40	75.07	567.52	4712.	1.3111	21.0	2.533	.1635
	40	82.16	692.20	4712.	1.3111	21.0	3.09	.1788
	40	67.17	448.60	4712.	1.3111	21.0	2.00	.1462
XXIII	30	11.85	9.50	3496.	1.3556	22.75	.062	.0250
	30	25.72	40.56	3496.	1.3556	22.75	.264	.0543
	30	36.51	82.32	3496.	1.3556	22.75	.536	.0770
	30	47.77	141.46	3496.	1.3556	22.75	.921	.1007
	30	61.33	241.77	3496.	1.3556	22.75	1.573	.1293
	30	77.52	408.02	3496.	1.3556	22.75	2.66	.1635
	30	91.65	572.10	3496.	1.3556	22.75	3.855	.1933
	30	99.29	702.40	3496.	1.3556	22.75	4.57	.2093
XXIV	0	31.47	10.43	1162.	1.435	28.5	.256	.0627
	0	49.60	31.83	1162.	1.435	28.5	.781	.0988
	0	67.94	67.47	1162.	1.435	28.5	1.645	.1353
	0	80.91	105.35	1162.	1.435	28.5	2.58	.1611
	0	92.89	147.05	1162.	1.435	28.5	3.605	.1851
	0	103.55	190.59	1162.	1.435	28.5	4.67	.2062
	0	116.60	245.57	1162.	1.435	28.5	6.01	.2321
	0	128.47	310.58	1162.	1.435	28.5	7.62	.256
	0	139.03	366.57	1162.	1.435	28.5	8.98	.277
	0	156.79	467.79	1162.	1.435	28.5	11.47	.312
	0	173.82	585.96	1162.	1.435	28.5	14.36	.346
	0	185.18	720.15	1162.	1.435	28.5	17.66	.3685
	XXIX	-34.4	53.31	4.22	232.6	1.5302	36.2	.66
-34.4		81.50	13.85	232.6	1.5302	36.2	2.16	.152
-34.4		108.18	29.02	232.6	1.5302	36.2	4.52	.202
-34.4		137.17	50.07	232.6	1.5302	36.2	7.78	.256
-34.4		162.60	73.45	232.6	1.5302	36.2	11.43	.304
-34.4		192.06	116.62	232.6	1.5302	36.2	18.12	.359
-34.4		206.50	205.59	232.6	1.5302	36.2	31.95	.386
XXVI	-54	31.19	0.40	88.3	1.565	39.0	.177	.057
	-54	80.00	4.16	88.3	1.565	39.0	1.84	.146
	-54	110.47	9.85	88.3	1.565	39.0	3.91	.202
	-54	143.19	17.55	88.3	1.565	39.0	7.75	.262
	-54	170.93	27.50	88.3	1.565	39.0	12.15	.312
	-54	207.89	44.70	88.3	1.565	39.0	19.75	.389
	-54	207.89	44.70	88.3	1.565	39.0	19.75	.389
XXV	-80	50.30	0.13	8.8	1.6295	44.5	.66	.088
	-80	98.82	0.58	8.8	1.6295	44.5	2.93	.173
	-80	145.82	1.65	8.8	1.6295	44.5	8.34	.259
	-80	181.84	3.05	8.8	1.6295	44.5	15.4	.319
	-80	206.67	4.60	8.8	1.6295	44.5	23.25	.362
	-80	229.83	8.30	8.8	1.6295	44.5	41.9	.403
	-80	229.83	8.30	8.8	1.6295	44.5	41.9	.403

of the Freundlich adsorption equation,  $W = a P^{\frac{1}{n}}$ , can be made to fit adsorption by silica gel with considerable precision. This modification has the form:

$$(13) \quad V = K \left( \frac{p \sigma}{P} \right)^{\frac{1}{n}}$$

where  $V$  is the volume of the condensed vapor measures as liquid per unit weight of adsorbing solid,  $p$  the partial pressure of the adsorbed vapor in equilibrium with the solid,  $P$  is the vapor pressure of the liquid at the same temperature,  $\sigma$  is the surface tension of the liquid at that temperature, and  $K$  and  $n$  are constants independent of the nature of the vapor, and dependent only on the physical characteristics of the adsorbing solid. It should be clearly understood that this equation, as developed by Patrick, holds only for that part of the adsorption due to the capillary condensation and has not been applied to adsorption due to molecular attraction.

### Adsorption of Sulphur Dioxide by Silica Gel

The results of some experiments by Patrick, etc., on the adsorption of sulphur dioxide ( $\text{SO}_2$ ) by silica gel (specially prepared  $\text{SiO}_2 \cdot n \text{H}_2\text{O}$ ) are given in the table on page 36. The  $\text{SO}_2$  used was free from all other gases and vapors.

These data have been plotted in the diagram on Fig. 12, on logarithmic paper, plotting  $\frac{p \sigma}{P}$  against  $V$ , the former scale having been folded in order to get all the points on one plot. The lower line is therefore a direct continuation of the upper end of the upper line. The fact that these data approximate a straight line indicated the reliability of the empirical equation (13), since it may be written in the logarithmic form as follows:

$$(14) \quad \log. V = \log. K + \frac{1}{n} \log. \frac{p \sigma}{P}$$

which is the equation of a straight line.

From this line the values of  $K$  and  $\frac{1}{n}$  were found to be 0.1038 and 0.447 respectively. These values are of course applicable only to the particular sample of silica gel which was used in the experimental work.



## Use of Patrick's Equation

Knowing the constants  $K$  and  $\frac{1}{n}$  for any particular adsorbing agent of this type, it is possible by means of the above equation to predict the volume of condensed vapor of any sort whatever which can be

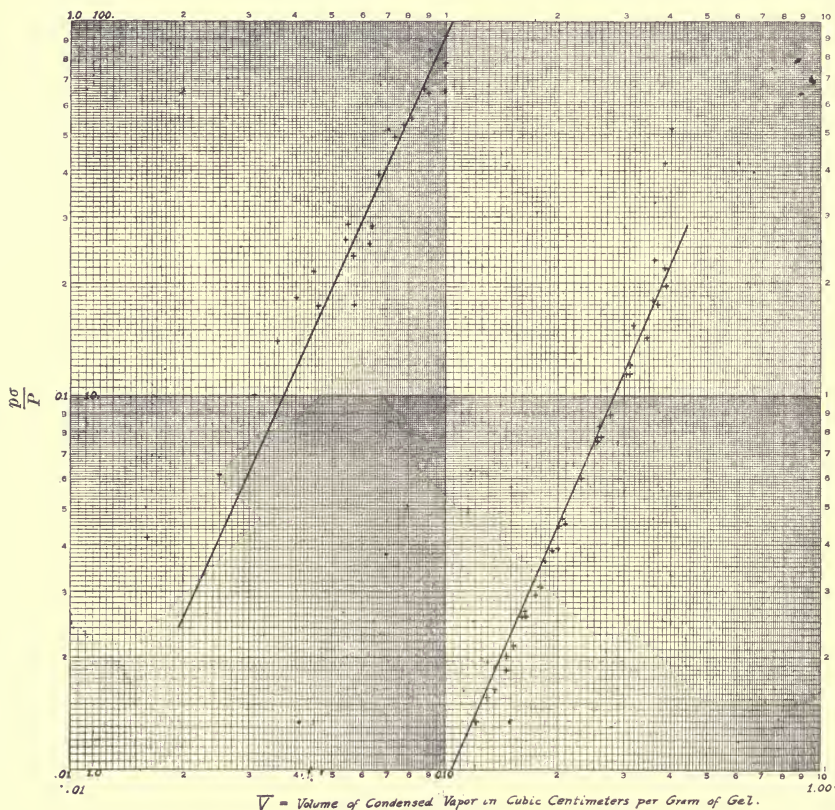

FIG. 12. Adsorption of  $\text{SO}_2$  on Silica Gel—plotting  $\frac{p\sigma}{p}$  versus  $V$ .

adsorbed by the solid under specified conditions of partial pressure and temperature.

*Example 13.* Silica gel is in contact with pure  $\text{SO}_2$  gas at  $30^\circ \text{C}$ . When equilibrium is reached the partial pressure of the gas is found to be 600 mm. Using the constants obtained by Patrick, calculate the weight of gel which would be required to adsorb 100 pounds of  $\text{SO}_2$ .

Data:

$$\log. V = \log. 0.1038 + .447 \log \frac{p \sigma}{P}$$

where  $p = 600$ ,  $P = 3496$ , and  $\sigma = 22.75$

$$\log. V = \log. 0.1038 + .447 \log. \frac{600 \times 22.75}{3496}$$

$$\log. V = -.984 + .447 \times .591 = -.720$$

$V = 0.191$  c.c. of liquid  $\text{SO}_2$  per gm. of gel.

The density of liquid  $\text{SO}_2$  at  $30^\circ = 1.3556$

$0.191 \times 1.3556 = 0.259$  gms.  $\text{SO}_2$  per gm. gel

or 25.9 lbs.  $\text{SO}_2$  per 100 lbs. gel

$$\frac{100 \times 100}{25.9} = 386 \text{ lbs. gel to adsorb 100 lbs. SO}_2$$

Answer.

*Example 14.* Suppose the residual gas from Example 13, consisting of 100 pounds of  $\text{SO}_2$  at 600 mm. pressure and  $30^\circ$  C. be removed from the gel, and brought into contact with 100 pounds of fresh gel. Calculate the weight of  $\text{SO}_2$  which would now be adsorbed, and the resulting partial pressure of the gas.

Data:

$$\log. V = \log. 0.1038 + .447 \log. \frac{p \times 22.75}{3496}$$

Basis of calculation: 1 gm. gel and 1 gm.  $\text{SO}_2$

$$1 \text{ gm. SO}_2 = \frac{1}{1.3556} = 0.738 \text{ c.c. liquid SO}_2$$

let  $X =$  weight of  $\text{SO}_2$  adsorbed

$1 - X =$  weight of  $\text{SO}_2$  left in gas

then  $\frac{1 - X}{1} = \frac{p}{600}$ , where  $p$  is the final gas pressure

or  $p = 600(1 - X)$

$$\frac{X}{1.3556} = \text{c.c. liquid SO}_2 \text{ adsorbed} = V$$

$$\text{then } \log. \frac{X}{1.3556} = -.984 + .447 \log. 600(1 - X)$$

solving for  $X$ ,

$$\begin{aligned} \log. \frac{X}{(1 - X) .447} &= -.984 + \log. 1.3556 + .447 \log. 600 \\ &= + 0.390 \end{aligned}$$

The value of  $X$  can be obtained graphically as follows, substituting different values for  $X$  and calculating the corresponding values of

$$\log. \frac{X}{(1-X) .447}$$

X	1-X	log. X	log. (1-X)	.447 log. (1-X)	log. $\frac{X}{(1-X) .447}$
.3	.7	-.522	-.155	-.0694	-.453
.5	.5	-.301	-.301	-.1345	-.1655
.7	.3	-.155	-.522	-.234	+.079
.8	.2	-.097	-.699	-.313	+.216
.9	.1	-.045	-1.000	-.447	+.402

Plot X against  $\log \frac{X}{(1-X) .447}$  and where the curve crosses the value of the latter at +0.390 will give the correct value of X. This has been done on Fig. 13, or X = 89.

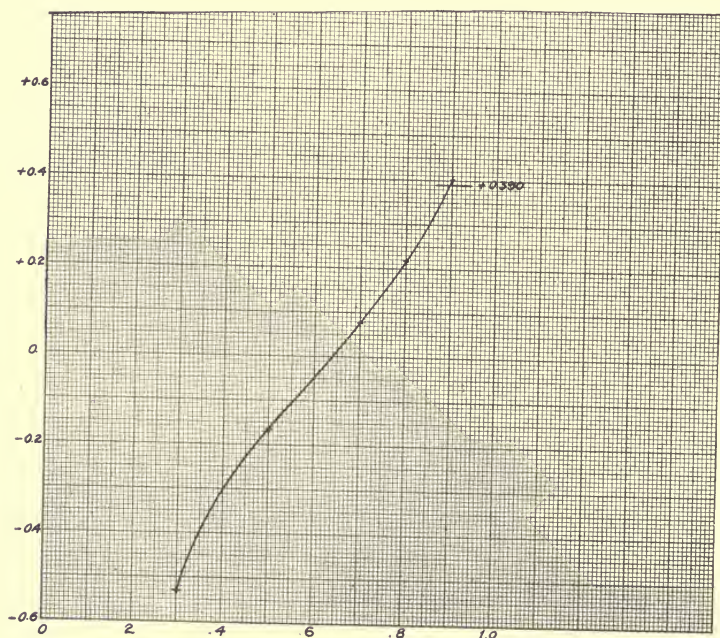

FIG. 13. Curve Showing Method of Solution of Equation in Example 14.

Therefore 89 pounds of  $\text{SO}_2$  would be adsorbed and the resulting pressure of the  $\text{SO}_2$  would be:

$$\frac{11}{100} \times 600 = 66 \text{ mm.}$$

*Answer.*



## CHAPTER VIII

### ADSORPTION OF MIXED GASES

#### Condensation of Mixed Vapors

Mixtures of gases and vapors, when brought into contact with an adsorbing medium, are not condensed in the same proportion as they exist in the gaseous phase, but in general approximately inversely according to their relative volatilities. A mixture of a very volatile vapor and a slightly volatile one will, when brought into contact with an adsorbing agent, produce a condensed vapor containing a much greater proportion of the less volatile vapor than exists in the gas. An example of this is given by Miller.<sup>1</sup>

#### Mixture of Sulphur Dioxide and Air

Mixtures of  $\text{SO}_2$  and air at several temperatures were brought into contact with silica gel, and when saturated, the weight of  $\text{SO}_2$  adsorbed per unit weight of gel was determined. At ordinary temperatures,  $0^\circ\text{C}$ . to  $40^\circ\text{C}$ ., the vapor pressure of air is so great that practically none adsorbs in comparison with the  $\text{SO}_2$ , and such a mixture of air and  $\text{SO}_2$  should therefore behave in a similar manner to pure  $\text{SO}_2$ . The following data were read from plots in Miller's article (see above).

<i>Percentage <math>\text{SO}_2</math> in Gas</i>	<i>Temperature</i>	<i><math>\text{SO}_2</math> Adsorbed as Percentage by Weight of Gel.</i>
1	$30^\circ\text{C}$ .	2.4%
2	30	3.9
3	30	5.1
4	30	5.9
5	30	6.6
6	30	7.2
7	30	7.7
8	30	8.0
1	40	1.6
2	40	2.7
3	40	3.4
4	40	4.1
5	40	4.7
6	40	5.3
7	40	5.8
8	40	6.3

<sup>1</sup> *Chem. and Met. Eng.*, 23 (1920), p. 1155.

The equation (13) discussed in the previous chapter should apply in this case,  $K$  and  $\frac{1}{n}$  not being known. It is assumed that the total pressure on the mixed gas was 760 mm.

Percentage $SO_2$ in Gas	$p$	$P$	$t$	$V$	$\sigma$	$D$	$\frac{p \sigma}{P}$
1%	7.6 mm.	3496	30°	.0177	22.75	1.3556	.0495
2	15.2	3496	30	.0288	22.75	1.3556	.099
3	22.8	3496	30	.0377	22.75	1.3556	.1485
4	30.4	3496	30	.0436	22.75	1.3556	.198
5	30.8	3496	30	.0487	22.75	1.3556	.247
6	45.6	3496	30	.0532	22.75	1.3556	.297
7	53.2	3496	30	.0568	22.75	1.3556	.346
8	60.8	3496	30	.0591	22.75	1.3556	.396
1	7.6	4712	40	.0122	21.0	1.3111	.034
2	15.2	4712	40	.0206	21.0	1.3111	.068
3	22.8	4712	40	.0259	21.0	1.3111	.102
4	30.4	4712	40	.0313	21.0	1.3111	.135
5	38.0	4712	40	.0359	21.0	1.3111	.169
6	45.6	4712	40	.0404	21.0	1.3111	.203
7	53.2	4712	40	.0442	21.0	1.3111	.237
8	60.8	4712	40	.0481	21.0	1.3111	.271

In the above table the symbols have the same meaning as in Chapter VII.  $V$  was calculated as follows:

$$V = \frac{2.4}{100} \div 1.3556 = .0177 \text{ c.c. liquid } SO_2 \text{ per gm. of gel.}$$

These data have been plotted as before on logarithmic paper, Fig. 14, and the points are found to lie on approximately a straight line as shown. The equation for this particular sample of silica gel would therefore be

$$V = 0.11 \left( \frac{p \sigma}{P} \right)^{.617}$$

as determined by the slope and intercept of the line.

This work indicates that for mixtures of condensible vapors with inert gases, the empirical equation derived by Patrick is sufficiently close to the truth for engineering purposes when used with gels of this type, and in general it may be stated that the presence of air or other inert gas has practically no effect upon the weight of vapor adsorbed, the chief difference in behavior from a pure vapor being in a much slower rate of adsorption.



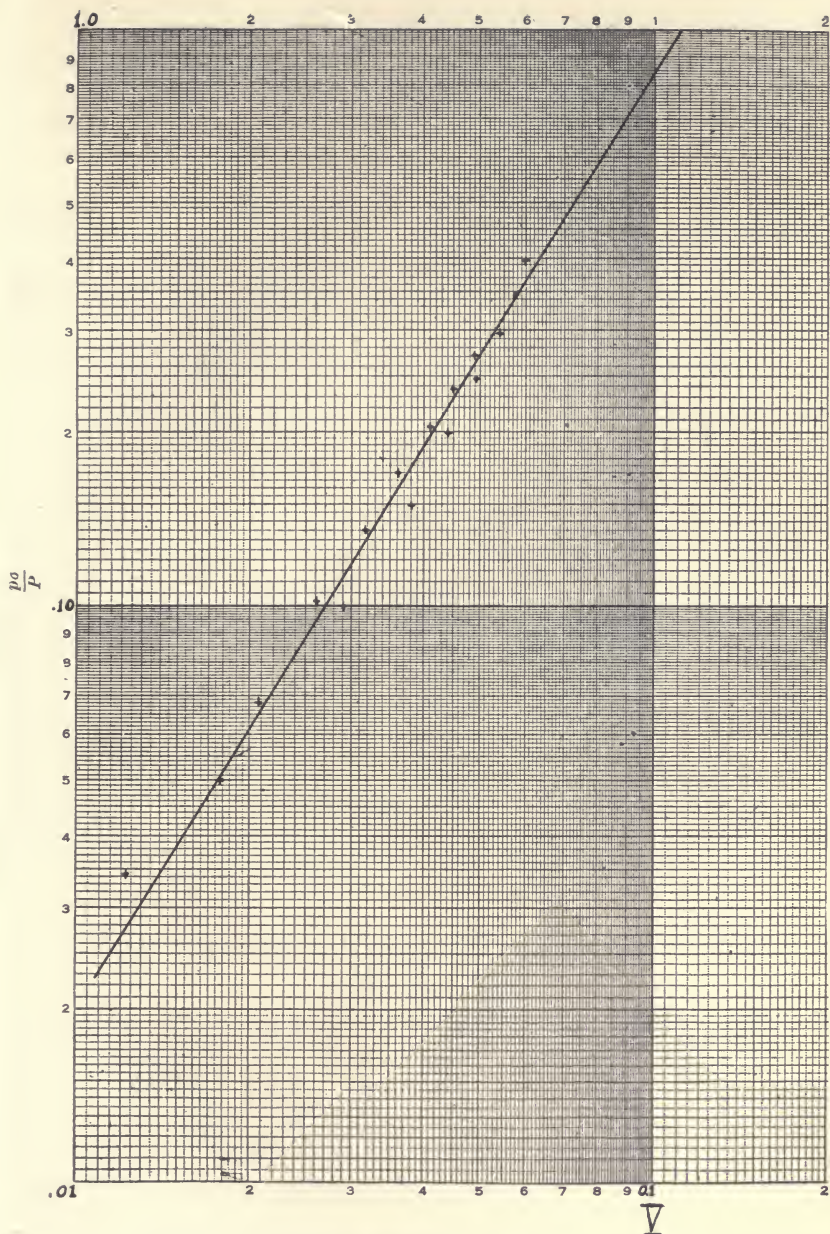

FIG. 14. Adsorption of  $\text{SO}_2$  from Air on Silica Gel.

## Adsorption of Ether and Air

Further work by Miller<sup>1</sup> on the adsorption of other vapors from air by silica gel is summarized below:

## ETHYL ETHER IN AIR

Percentage Ether in Air	t°C.	Percentage Ether Adsorbed						$\frac{p \sigma}{P}$
		by Gel.	p	P	V	$\sigma$	D	
1.00%	25°	14.6%	7.6	534	.206	16.0	.709	.227
3.08%	25°	15.7%	23.4	534	.221	16.0	.709	.701

The corresponding values of  $K$  and  $\frac{1}{n}$  were calculated and found to be .226 and .063 respectively.

## Adsorption of Benzene and Air

## BENZENE VAPOR IN AIR

Percentage Benzene in Air	t°C	Percentage Benzene Adsorbed	p mm.	P mm.	$\sigma$	D	$\frac{p \sigma}{P}$	V	V (calc.)	Devia- tion
0.65	25.°	15.3%	4.9	96	29.5	.873	1.505	.175	.178	+ .003
3.34	25.°	19.7%	25.4	96	29.5	.873	7.81	.226	.222	-.004
9.00	25.°	21.6%	68.3	96	29.5	.873	21.0	.247	.252	+ .005

Calculating the average values of  $K$  and  $\frac{1}{n}$  for these tests, they were found to be as follows:

$$K = 0.170 \quad \frac{1}{n} = 0.131$$

$V$  was then calculated in each case using these values, and the results are included above, the average deviation being only 0.004.

## Adsorption of Water Vapor and Air

## WATER VAPOR IN AIR

t° C.	Percentage Water Adsorbed	p mm.	P mm.	$\sigma$	D	$\frac{p \sigma}{P}$	V	V (calc.)	Devia- tion
30°	25.7%	31.8	31.8	69.1	.996	69.1	.258	.268	+ .010
30°	22.5	16.65	31.8	69.1	.996	36.2	.226	.226	0.
30°	15.6	8.5	31.8	69.1	.996	18.5	.156	.190	+ .034

These tests gave  $\frac{1}{n} = 0.263$  and  $K = .278$  and the calculated values of  $V$  were found to deviate from the determined by about 0.014.

<sup>1</sup> *Chem. and Met. Eng.*, 23 (1920), p. 1219.



Since silica gel is made by the partial dehydration of silicic acid, it would be expected that the adsorption of water vapor on the gel would have more of the character of a chemical affinity and less of capillary condensation, than would be the case in the adsorption of hydrocarbons, for instance, for which there would be little molecular

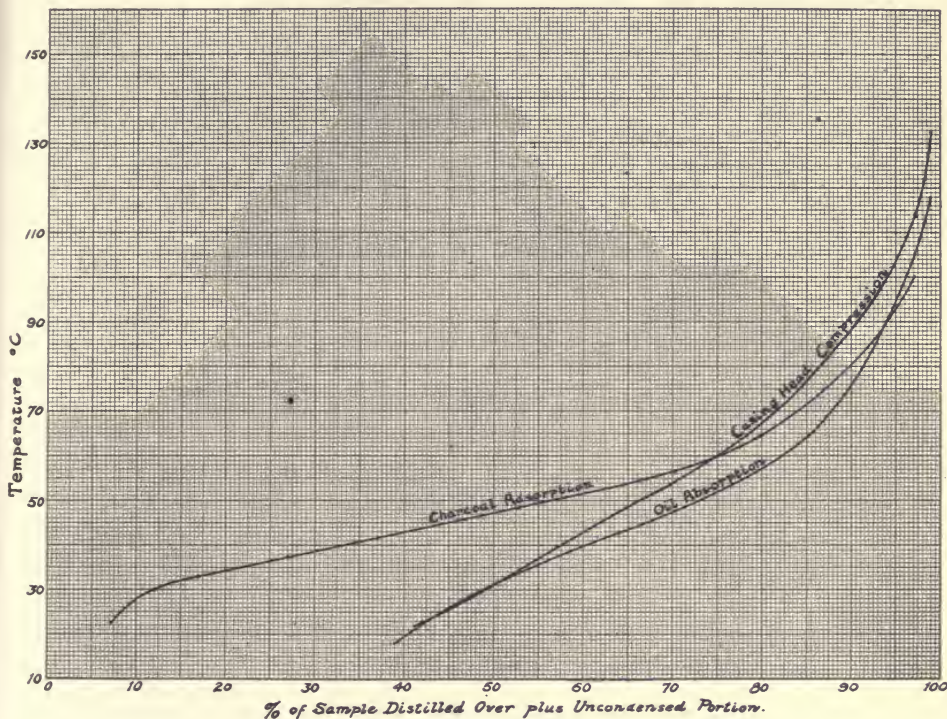

FIG. 15. Composition of Gasolene from Natural Gas, Obtained by Three Different Processes.

attraction. It would therefore be expected that the gel would deviate from the Patrick equation in the case of water. The above data show this to be true.

### Adsorption of Mixed Vapors from Gases

The adsorption of mixed vapors from air or other inert gas, while following the same general rules as the single vapors, is complicated by the selective action of the adsorbing medium. When air containing a mixture of substances of varying volatility is brought into contact

with the adsorbing medium, the more volatile vapors are readily adsorbed at the start, but as the solid approaches saturation the more volatile vapors revaporize as the less volatile condense, so that when equilibrium is reached, the adsorbed vapor consists largely of the less volatile constituents. Tests made by Burrell and others<sup>1</sup> on the adsorption of mixed gasolene vapors from natural gas show this selective effect very clearly. The diagram,<sup>2</sup> Fig. 15, shows the Engler distillation curves of such gasolene obtained from the same natural gas by compression, oil absorption, and by adsorption on charcoal. It will be seen that the last contains much less very volatile material than either of the others. The first portions of all the samples were so volatile that they were uncondensed on distillation.

<sup>1</sup>*Chem. and Met. Eng.*, 24 (1921), p. 156.

<sup>2</sup>Reconstructed from Fig. 6, p. 159, *Chem. and Met. Eng.*, 24 (1921).

## CHAPTER IX

### RATE OF ADSORPTION

The rate of adsorption of a vapor by a solid is proportional to the difference between the partial pressure of the vapor in the gas in contact with the solid and the vapor pressure of the condensed vapor actually present in the capillaries of the solid at the same time. Thus, at the start of the adsorption, if the solid is free of condensed vapor, the rate of adsorption is a maximum, usually very great. As soon as any vapor has condensed, however, the rate of adsorption will decrease until, when the solid has become saturated with the vapor, the vapor pressure will equal the partial pressure and adsorption will cease. The mathematical analysis of the rate of adsorption for vapors or solids is difficult, involving differentials of the second order. Those interested can find a discussion of the analysis in an article by W. K. Lewis.<sup>1</sup>

#### Canister Test

Considerable work is available in the literature regarding the rate of adsorption. In general, tests have been made by passing gases of known concentration at specified rate of flow and at constant temperature through a known mass of the adsorbent. The action of the adsorbent on the gas can be illustrated by the following diagram:

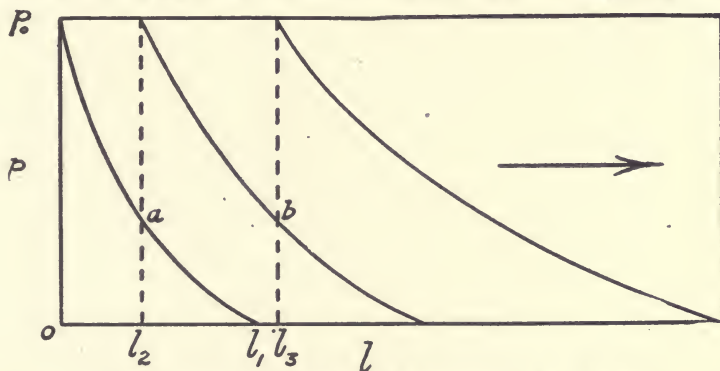

FIG. 16. Diagram Illustrating Adsorption in a Canister.

<sup>1</sup>"The Principles of Counter-current Extraction," *J. Ind. Eng. Chem.*, 8 (1916), p. 825.



In this diagram the rectangle represents a box filled with adsorbent, with gas carrying adsorbable vapor from left to right. The horizontal coordinate represents the length of the box  $l$ , and the vertical coordinate, the partial pressure of the vapor in the gas  $p$ . At the start, when no vapor has entered the box, the partial pressure of the vapor is  $p_0$ . The vapor then coming in contact with fresh adsorbent, is rapidly condensed in passing through the box, the partial pressure decreasing along the curve  $p_0 a l_1$ . At  $l_1$  the curve becomes practically tangent to  $p = 0$ , and therefore beyond that point the gas contains practically no vapor.

The solid at the entrance end soon adsorbs enough vapor to reduce its adsorbing capacity, and therefore after a short time will be saturated with respect to the entering vapor as far as the point  $l_2$ , the vapor condensing in a new curve  $b$ , at that time. The saturation of the solid will proceed, until the time is reached when the solid has been saturated as far as the point  $l_3$  and the partial pressure curve reaches  $p = 0$  at the right hand end of the diagram. At this time appreciable amounts of uncondensed vapor will start to leave the apparatus with the exit gases. This point is known as the "break point" of the sample. Further flow through the apparatus will increase the partial pressure in the exit gas until finally the partial pressure will be the same as the entering gas, when no more vapor can be adsorbed and the solid is saturated throughout for that particular set of conditions of partial pressure and temperature.

This progressive saturation of an adsorbent can be shown by a diagram as follows:

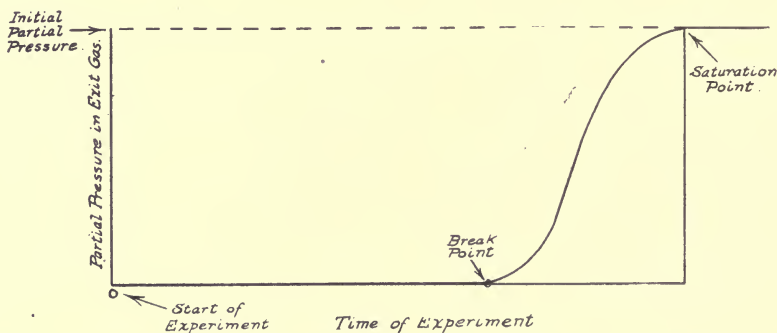

FIG. 17. Diagram Showing Concentration of Vapor in Gas Leaving Adsorbing Agent During Canister Test.

## Adsorption by Charcoal

A number of tests of rate of adsorption for various materials have been made. The following are taken from an article on Gas Mask Absorbents by Lamb, Wilson and Cheney.<sup>1</sup>

## TESTS ON ACTIVATED CHARCOAL

Source of Charcoal	Time of Activation with Steam at 900° C.	Weight Absorbed Percentage	Time in Minutes
Sycamore	18 min.	41.	7.3
Cedar	60	78.	16.0
Mountain mahogany	60	32.	16.3
Ironwood	60	31.	20.8
Brazil nut	120	46.	32.2
Ivory nut	120	48.	47.0
Columbe nut	120	51.	53.4
Babassic nut	210	85.	58.7
Cocoanut	120	61.	58.7
Cocoanut	180	72.	64.4
Briquetted sawdust	120	53.	40.0
Briquetted carbon black	240	53.	50.5
Briquetted bituminous coal	165	58.3	46.8
Briquetted anthracite coal	480	53.	40.7

These tests were made by passing dry air containing 7500 parts per million of chlorpicrin ( $C(NO_2)Cl_3$ ) at the rate of 1000 c.c. per minute through a tube containing the charcoal, 1.41 cm. inside diameter and 10 cm. long. The time recorded was the number of minutes before chlorpicrin appeared at the exit end in concentration greater than 1% of the entering concentration, that is, 75 parts per million, corresponding practically to the break point in the above diagram.

Another set of tests given in the same article indicate the absorptive values of different dry charcoals against various gases.

## Conditions of Tests

Vapor concentration	= 0.1%
Mesh of absorbent	= 8 to 14
Depth of absorbent	= 10 cm.
Rate of flow per sq. cm. per min.	= 500 cc.
Relative humidity of air	= 50%
Temperature	= 20° C.

Times corrected to 99% efficiency of absorption.

Further tests on the Rate of Adsorption of gases by charcoal are given by Harned.<sup>2</sup> These tests show the effect of the method of preparation of the charcoal on the adsorption rate.

<sup>1</sup> *J. Ind. Eng. Chem.*, 11 (1919), p. 420.

<sup>2</sup> *J. Am. Chem. Soc.*, 42 (1920), p. 372.

## TIME IN MINUTES

Material	Chlorine	Chlorpicrin	Phosgene	Hydrocyanic acid	Arsine	Cyanogen Chloride	Trichloromethylchlorformate
Poor U. S. A. coconut	270	120	175	20	18	55	50
Medium U. S. A. coconut	370	350	260	25	25	65	65
Good U. S. A. coconut	420	620	310	27	30	75	70
Wood charcoal, French		25	75	9	0	1	20
Wood charcoal, British		70	90	18	4	5	30
Peach stone		190	135	30	25	65	60
Treated wood, German		230	105	20	20	22	25

## Rate of Adsorption by Silica Gel

Tests were made by Miller<sup>1</sup> on the rate of adsorption of sulphur dioxide from dry air at 20° C. In these tests the rate of flow was 200 c.c. per square centimeter per minute through 5 grams of gel, cross section of flow 2 square centimeters.

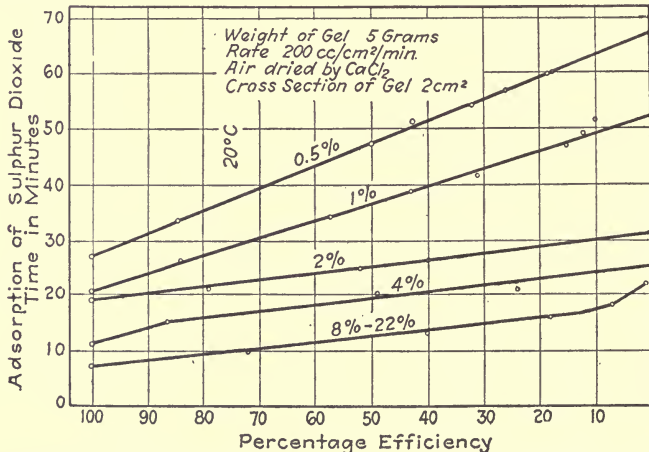

FIG. 18. Results of Tests on the Adsorption of Sulphur Dioxide from Air by Silica Gel, the Percentage of Sulphur Dioxide in the Air Being Indicated on the Respective curves.

Similar tests were made on the rate of adsorption by silica gel of ether, acetone, benzene, water vapor and gasolene.<sup>2</sup>

<sup>1</sup> *Chem. and Met. Eng.*, 23 (1920), p. 1155.

<sup>2</sup> *Chem. and Met. Eng.*, 23 (1920), p. 1219.

### Rate of Adsorption of Gasolene by Charcoal

Some tests on the rate of adsorption by activated charcoal, of gasolene from natural gas are given by Burrell.<sup>1</sup> Using gas containing 400 gallons of gasolene per million cubic feet, and passing it through a tower 5 feet high at the rate of 40 cubic feet per square inch of base area, the following efficiency curve was obtained:

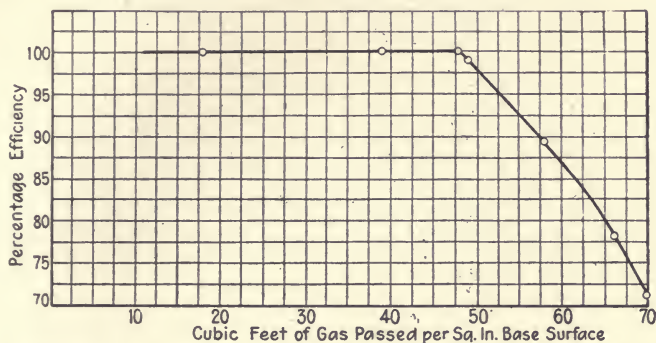

FIG. 19. Results of a Test on the Adsorption of Gasoline from Natural Gas by Charcoal.

The rate of adsorption of gasolene is complicated by the fact that it is a mixture of a number of substances of varying vapor pressures.

### Bohart and Adams Equation

An empirical equation for the rate of adsorption has been derived by Bohart and Adams,<sup>2</sup> in which "c" represents the concentration of the vapor which is being adsorbed at any point during its passage through the adsorbing solid, the distance through which it has passed being "x", "a" is the residual vapor capacity of the solid at any time, and "v" is the rate of flow of vapor per hour expressed in terms of volume of solid saturated per hour if completely saturated.

The rate at which the capacity of the solid to adsorb diminishes is indicated by the equation:

$$(15) \quad \frac{\delta a}{\delta t} = -k a c$$

and the rate at which the gas loses vapor is indicated by the equation:

<sup>1</sup>*Chem. and Met. Eng.*, 24 (1921), p. 156.

<sup>2</sup>*J. Am. Chem. Soc.*, 42 (1920), p. 528.

$$(16) \quad \frac{\delta c}{\delta x} = \frac{-k}{v} a c$$

These equations when combined and integrated gave the following, where  $c_0$  and  $a_0$  represent initial vapor concentration and capacity respectively

$$(17) \quad \frac{c}{c_0} = \frac{10^{0.4343 k c_0 t}}{10^{0.4343 k \frac{a_0 x}{v}} - 1 + 10^{0.4343 k c_0 t}}$$

$$(18) \quad \frac{a}{a_0} = \frac{10^{0.4343 k \frac{a_0 x}{v}}}{10^{0.4343 k \frac{a_0 x}{v}} - 1 + 10^{0.4343 k c_0 t}}$$

These equations, while open to criticism, on account of the assumptions as to rate of adsorption, give curves which fit the experimental data very well.



## CHAPTER X

### RECOVERY OF ADSORBED VAPORS

#### Vaporization of Adsorbed Vapor

Adsorbed vapors can be revaporized by bringing into contact with the solid, gas containing the vapor in question at such a concentration that its partial pressure is less than the vapor pressure of the condensed vapor on the solid. The maximum rate of revaporization at a given temperature occurs when the gas contains no vapor whatever. The adsorbed vapors can also be revaporized by raising the temperature of the solid in the absence of any other gas to such a point that the vapor pressure of the adsorbed vapor equals the external pressure, when revaporization will start. In order for it to continue under these conditions, the temperature must be progressively raised, the temperature required for complete revaporization often being very high.

#### Vaporization of Sulphur Dioxide

Patrick<sup>1</sup> found that the adsorption of air free  $\text{SO}_2$  by silica gel was reversible, and that in the recovery of the  $\text{SO}_2$  by revaporization, the relations determined in a previous chapter held true. But if other gases be present when the  $\text{SO}_2$  is adsorbed the recovery is no longer reversible, the adsorption and revaporization curves being similar to those in the following diagram:

From this diagram it is evident that under these conditions, an adsorbing agent in equilibrium with a gas containing a vapor of the partial pressure "a," would adsorb "b" per cent of that vapor, but if the adsorbed vapor be revaporized, vaporization would not begin until the partial pressure of the vapor in contact with the solid is reduced to the value "c."

<sup>1</sup> *J. Am. Chem. Soc.*, 42 (1920), p. 963.

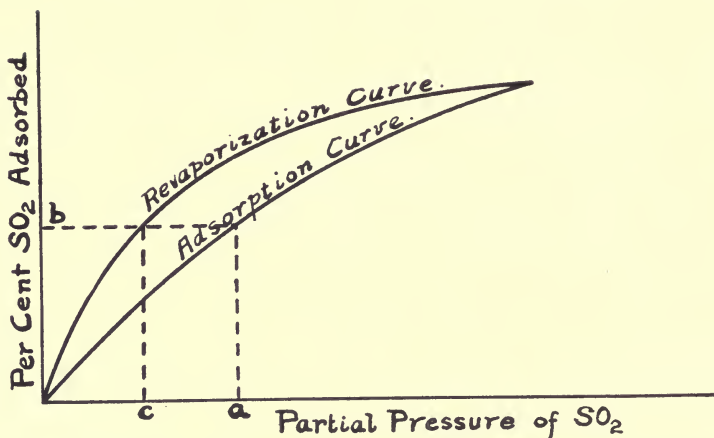

FIG. 20. Adsorption and Revaporization of Sulphur Dioxide by Silica Gel.

#### Type of Adsorbing Agent

The effect of the type of adsorbing agent on the recovery of adsorbed vapor is shown in the following diagram.<sup>1</sup>

This diagram shows the percentage of vapor adsorbed, based on the weight adsorbed at the break-point as 100% when air saturated with chlorpicrin at 0° C. is passed through.

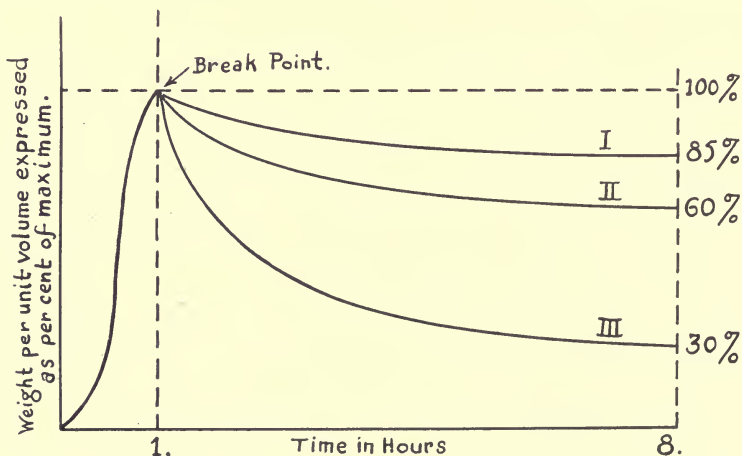

FIG. 21. Revaporization of Chlorpicrin from Adsorbents.

<sup>1</sup> From R. E. Wilson, verbally.

- I. U. S. Army charcoal.
- II. Ferric hydroxide gel.
- III. German Army charcoal (this curve is also representative of silica gel).

When the break-point was reached, air, free from chlorpicrin, was passed through the solid at the same rate and temperature, the condensed vapor revaporizing as shown, those solids of the capillary condensation type giving up their vapor more readily than the others. Of course, raising the temperature would have accelerated this tremendously.

### Gas Used in Re-Vaporization

In recovery operations, where a gas is used as a carrier to assist in removing the condensed vapor, the gas may consist either of the so-called permanent gases, air, carbon dioxide, and so forth, or it may consist of some easily condensable vapor, such as steam. In either case the revaporization can be carried out as indicated above, but when the gas or vapor is cooled afterwards to recover the vapor in liquid form, whether or not an inert gas or vapor was used makes a great difference in the recovery. When steam is used as the carrier gas, it can all be condensed in a suitable condenser, and the revaporized vapor will *all* condense along with it, giving complete recovery of the vapor. But if air or gas be used, cooling will not condense it, and only a portion which it carries will be condensed, the balance, in amount dependent on the vapor pressure and temperature, being rejected with the waste air. Of course if the air is used over again, this loss can be largely avoided if the apparatus has no leaks. It is therefore usual to recover adsorbed vapors by the use of easily condensable vapor, either saturated or superheated, as may be convenient, and the use of inert gas for such purposes is confined almost exclusively to recirculating systems.

### Steaming Silica Gel

Experiments by Miller<sup>1</sup> in recovering vapors from silica gel are tabulated below:

#### Exp. I:

One hundred grams of gel containing 29 grams adsorbed ether, heated to 107° C. liberated 10.2 grams of ether. Steam was then blown through it for 15 minutes, liberating 14.4 grams additional

<sup>1</sup> *Chem. and Met. Eng.*, 23 (1920), p. 1219.

with .755 grams of condensed steam. Further steaming gave no ether. There was considerable loss of ether due to insufficient cooling of the distillate.

Exp. II:

Steaming silica gel containing 33.8% acetone at 105° C. gave complete recovery of the acetone, using 1.63 grams of steam per gram of acetone.

Exp. III:

Steaming gel containing 21% benzene gave fairly complete recovery of the latter using about 2.5 grams of steam per gram of benzene.

### Air in Re-Vaporization

The following plot from Miller shows the effect of air at varying velocities on the removal of water from silica gel. Curves

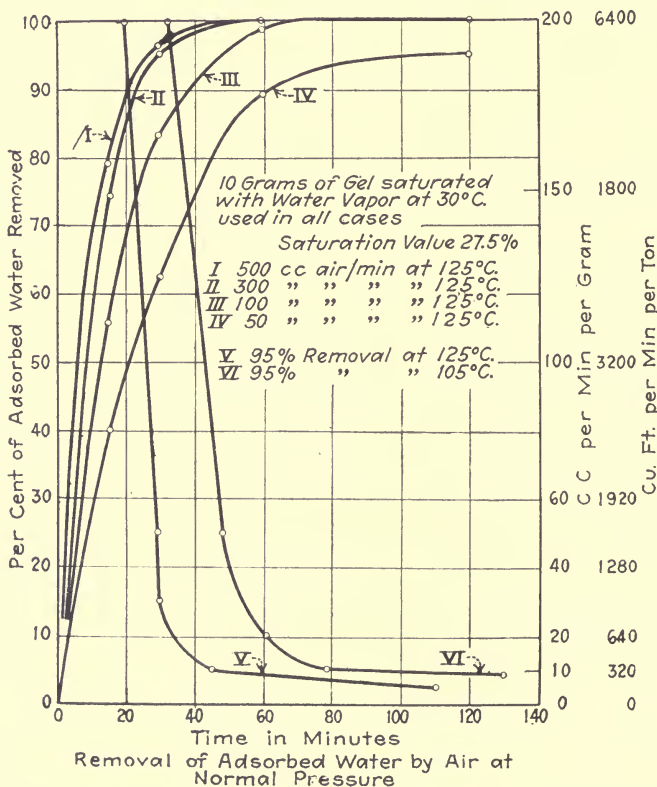

FIG. 22. Removal of Adsorbed Water from Silica Gel by Air.

1, 2, 3, and 4 show the percentages of water removed for air rates of 5 to 50 c.c. per min. per gram of gel. Curves 5 and 6 show the rate of air flow against time required to remove water at 120° C. and 105° C. respectively.

#### Exp. IV:

Silica gel containing 15% and 24.7% of petroleum ether, when steamed at 107° C. required 15 grams of steam in 30 minutes to remove 85%, and 11 grams of steam in 10 minutes to remove 23 grams respectively.

### Steaming Charcoal to Recover Gasolene

Tests by Burrell<sup>1</sup> on the removal of adsorbed gasolene from charcoal indicate the following steam consumption in the recovery of the gasolene from the charcoal.

TABLE I. HEAT REQUIREMENTS

Weight of gallon gasolene, lb.....	5.5
Saturation of 13 per cent by weight required, lb. of charcoal .....	42.3
Specific heat of charcoal .....	0.3
Specific heat of gasolene.....	0.58
Latent heat of gasolene, B.t.u. per lb.....	100.
Average b.p. of gasolene, deg. F.....	210
Highest temperature of distillation, deg. F. ....	400
Temperature of charcoal by saturated steam, deg. F. ....	230
Superheat (400—230), deg. F. ....	170
Superheat required for charcoal ( $42.3 \times 0.3 \times 170$ ) .....	2,157
Heat to raise charcoal 60 to 230 deg. F. ....	170
Heat required to raise charcoal 60 to 230 ( $42.3 \times 0.3 \times 170$ ) .....	2,157
Distillation of 60 per cent made without superheat.	
Heat required for gasolene distillation (60 to 230 plus latent heat) ( $5.5 \times 150 + 0.58$ ) + ( $5.5 \times 100$ ), B.t.u. ....	1,030
Superheat required for 40 per cent of gasolene distilled.....	411
Heat required for first 60 per cent distilled, B.t.u. ....	618
Total heat required to raise to temperature of superheat, B.t.u. ....	2,775
Total amount superheat required, B.t.u. ....	2,568
Theoretical amount of heat required, B.t.u. ....	5,343
Specific heat superheated steam 15 lb. 400 deg. F. ....	0.5
Superheat available per lb. of steam $0.5 \times (400 - 230)$ , B.t.u. ....	85
$2568 \div 85$ , lb. of water.....	30.21
Boiler feed water, deg. F. ....	200
Boiler heat required (200 to 400 deg. F.), B.t.u. per lb. ....	1,089
Total amount boiler heat required ( $30.21 \times 1089$ ), B.t.u. ....	32,900
Boiler hp. per gal. gasolene per day.....	0.045

<sup>1</sup> *Chem. and Met. Eng.*, 24 (1921), p. 156.



## CHAPTER XI

### ADSORPTION APPARATUS FOR SOLVENT RECOVERY

#### Essential Parts of Recovery Apparatus

All types of apparatus for the recovery of solvents by adsorption consist of three primary parts: first, the adsorber, or container for the adsorbing medium; second, the source of supply of heated vapor or gas for revaporizing the solvent from the solid; and, third, the condenser for recovering the revaporized solvent. The numerous modifications and accessories depend upon the materials used, local conditions, and the designing engineer.

#### Removal of Heat of Adsorption

There is one detail in solvent recovery work, regarding which there is required for large scale commercial operation, considerably greater attention than is the case with the laboratory scale. The latent heat of condensation or adsorption of a condensing vapor must be removed as rapidly as it is liberated in order to prevent rise of temperature of the adsorbent. Little attention need be paid to this heat effect when the apparatus is small, since, owing to the fact that in small apparatus the ratio of outside surface (of a tank) to contents, is relatively great, the heat evolved is readily lost by conduction and radiation from the surface of the container to the surroundings. On the other hand, in large scale equipment, such heat effects become serious, and special provisions must be made to take care of them.

The simpler types of adsorption apparatus are intermittent in operation. For such apparatus, the relation between the capacity and the size of the adsorber can be expressed mathematically by the following differential equation: <sup>1</sup>

$$(19) \quad u \frac{\delta N}{\delta l} = A \frac{\delta n}{\delta \Theta}$$

where  $u$  is the gas velocity;  $N$  is the percentage of vapor adsorbed;  $l$  is the length of the adsorber;  $n$  is the concentration of the vapor in the gas;  $A$  is the area of cross section of the adsorber;  $\Theta$  is time.

<sup>1</sup> From W. K. Lewis verbally.

On account of the complicated relation between  $N$  and  $n$ , however, the use of this equation is impracticable, and for purposes of design, recourse must be had to data derived from small scale experimental work.

An example of the calculations involved in the design of a suitable adsorption apparatus is given in the following pages.

*Example 15.* It is desired to recover benzol from air by adsorption with activated charcoal. There are to be handled 10,000 cubic feet of air per hour containing 5% by volume of benzol vapor, temperature 70° F., barometer normal.

$$\frac{500}{359} \times \frac{492}{530} \times 78 \text{ (molecular weight of benzol, } C_6H_6)$$

$$= 101. \text{ pounds of benzol to be condensed per hour.}$$

The heat of adsorption of benzol at 70° F. is about 360. B.t.u. per pound.<sup>1</sup> The heat which must be removed per hour in the adsorber is therefore:

$$360 \times 101 = 36,000. \text{ B.t.u. (approx.) per hour.}$$

The weight of air per hour would be about:

$$\frac{10000}{359} \times \frac{492}{530} \times 29 \text{ (mol. weight of air)} = 750 \text{ pounds per hour.}$$

Since its specific heat is about 0.24, the air would be heated in the adsorber, providing there were no other means of removing the heat evolved, to a temperature of about

$$70^\circ \text{ F} + \frac{36000}{0.24 \times 750} = 270^\circ \text{ F.}$$

It is therefore necessary to cool the air either before or during adsorption in order to avoid heating the adsorbing medium to such a temperature that its adsorption capacity is seriously lowered. This cooling may be done in two ways. The adsorber may be built with internal cooling surfaces, by which the gas passes while in contact with the adsorbing solid. Or the gas may pass through a multiple stage adsorber, with intermediate cooling between the stages. Either method is satisfactory, the better one depending on local conditions. However, since it is always easier to construct an apparatus to do one thing alone, better results will probably be obtained by making the adsorber and cooler as separate units.

Where interstage cooling is used the number of stages required will depend on the allowable rise in temperature of the air. Where a total rise of 20° F. might be permitted in the particular case in question, there would be required

<sup>1</sup>For heats of adsorption see Lamb and Coolidge, *J. Am. Chem. Soc.*, 42 (1920), p. 1164.

$$\frac{200}{20} = 10 \text{ or ten stages with nine intercoolers (not including final cooler).}$$

Each intercooler must therefore remove an average of

$$\frac{36000}{10} = 3600 \text{ B.t.u. per hour.}$$

Air coolers may be either direct or indirect, that is, the air may be cooled by direct contact with the cooling medium, such as a water spray, or it may be cooled by contact with cooling surfaces which are kept cool by some cooling medium such as water on the other side as in the case of tubular condensers. The former or direct cooling is always less expensive if the nature of the gases and vapors handled will permit its use. It is suitable where the gas or vapor is not appreciably soluble in the cooling medium. For instance, in this case benzol is not appreciably soluble in water. Therefore the air containing the benzol vapor may be passed through a water spray which would cool it to the desired temperature without dissolving the benzol. On the other hand, if the vapor in the air were alcohol which is soluble in water, indirect cooling must be used.

For direct cooling with spray chambers of standard design, the size of chambers required may be figured approximately from the following equation:

$$(20) \quad \frac{Q}{\Theta} = (ha) V \Delta t$$

where  $\frac{Q}{\Theta}$  represents the heat to be removed per unit time, as in this case, 3600 B.t.u. per hour,  $(ha)$  is the coefficient of cooling in multi-stage coolers, where the air remains substantially saturated with water after the first stage, and will have a value under these conditions of about 30 B.t.u. per cubic foot of spray chamber volume per hour per degree Fahrenheit difference between water and air temperature,  $V$  is the volume of the spray chamber, and  $\Delta t$  the average difference in temperature between the water and air.

Thus suppose the cooling water to rise in temperature from 50° to 60°, and the air to cool from 80° to 60°, the value of  $\Delta t$  would be

$$\frac{80 + 60}{2} - \frac{60 + 50}{2} = 25^\circ.$$

Therefore  $3600 = 30. \times V \times 25.$

$V = 4.7$  cubic feet, the volume of the intercooling spray chamber required.

Air washers of this type have one or more banks of atomizing spray nozzles, the air being blown by means of a fan through the spray, usually in the direction of the spray. The air then passes through a set of plates giving a zigzag passage for the purpose of removing the water entrained by the air. The water may be recirculated through the sprays, being cooled or heated as the case may be, the loss of water by evaporation being made up from some external source.

For indirect cooling, the amount of cooling surface depends almost entirely on the velocity of the air by the surface. An approximate equation for air flowing through small pipes is as follows:

$$(21) \quad \frac{Q}{\Theta} = 4.0 \times V^{0.8} \times A \times (\Delta t)$$

where  $V$  is the pounds of air flowing per square foot of cross section of the pipe per second, and  $\frac{Q}{\Theta}$  is the heat transferred in B.t.u. per hour, and  $A$  is the area of cooling surface in square feet. (*Note.*—For reasonable air velocities, the resistance to flow of heat of the dividing walls if of metal, and of the liquid film on the cooling water side, may be neglected.) Thus if the 750 pounds of air in question be flowing through a tubular cooler consisting of ten 2-inch inside diameter tubes in parallel, the amount of cooling per foot of length of the tube would be calculated as follows:

Area of cross section of 2" tube = 3.14 sq. in. = .0218 sq. ft.

10 tubes would have  $10 \times .0218 = .218$  sq. ft.

Therefore  $V = \frac{750}{.218 \times 3600} = .96$  lbs. per sq. ft. per sec.

The surface of a 2" tube 1 ft. long is

$$\frac{12 \times 2 \times 3.14}{144} = 0.52 \text{ sq. ft.}$$

The surface of the ten tubes would therefore be 5.2 square feet per foot of length.

If the water and air be at the same temperature as before, therefore

$$\Delta t = 25^\circ \text{ and}$$

$\frac{Q}{\Theta} = 4.0 \times (.96)^{.8} \times 5.2 \times 25 = 510$  B.t.u. per hour per foot of length of the tubes.





Since there are 3600 B.t.u. to be removed per hour the cooler must have tubes  $\frac{3600}{510} =$  approximately 7 feet long.

Design of Coolers

It should be appreciated that the design of a cooler, or of any apparatus, for that matter, should involve an economic balance between the cost of the cooler and the cost of operating it. In such a case the cooler may be made smaller with higher air velocity, and do the same amount of work, but the cost of forcing the air through it with the increased friction due to the higher velocity may more than offset the saving in cooler cost. As a general rule standard equipment will be found most suitable on this account, as it has run the gauntlet of costs, and is probably the least expensive in the end.<sup>1</sup>

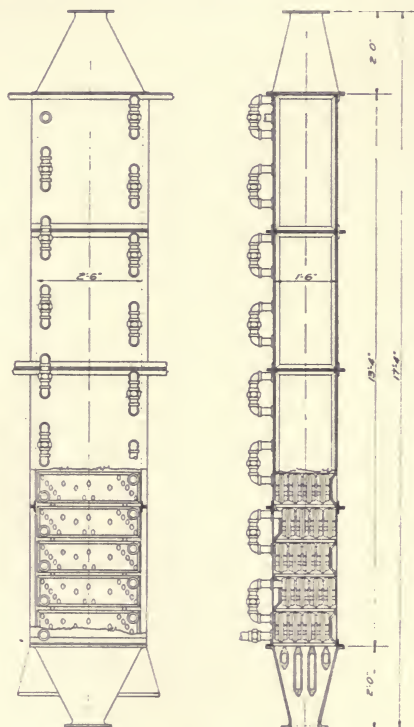

FIG. 24. Silica Gel Cooler.

<sup>1</sup>For further information on coolers see Walker, Lewis, and McAdams, "Chemical Engineering."

## Silica-Gel Adsorption Plant

The problem of cooling the gases during the adsorption without recourse to intercoolers has been solved by the Silica Gel Corporation by using the gel in the form of a powder which is carried along by the gas or air in suspension while adsorption is taking place, the air and powder being brought into intimate contact during its travel with cooled surfaces. The method is shown in the following diagram, Fig. 23, which represents a three step counter-current adsorption plant, the gel powder entering at the right at *A* and leaving at *B*, while the gas containing the solvent enters at *C*, and leaves at *D*. The operation of the system is as follows:

The gel is raised by means of an elevator and discharged into the supply tank *E* from which it is delivered continuously by the screw conveyor *F* to the chamber *G* where it meets the nearly dissolved air coming from the previous step. The mixture of gas and gel then passes up through the cooler *H*, which is constructed as shown in the following diagram, of radiator-like sections through which cooling water is passing. The mixture is then discharged to the cyclone dust collector *I*, where the bulk of the gel is separated from the gas, the gel being delivered to the previous step, while the exhausted gas goes to a final bag filter *J* to remove the last of the gel, before leaving the system. The saturated gel is delivered from the hopper *B* to an activator which is illustrated in the following figure. This consists of a rotary cylindrical shell through which the gel is passed from right to left, coming into contact with longitudinal flues which are heated by hot gases from some suitable furnace. The gel and

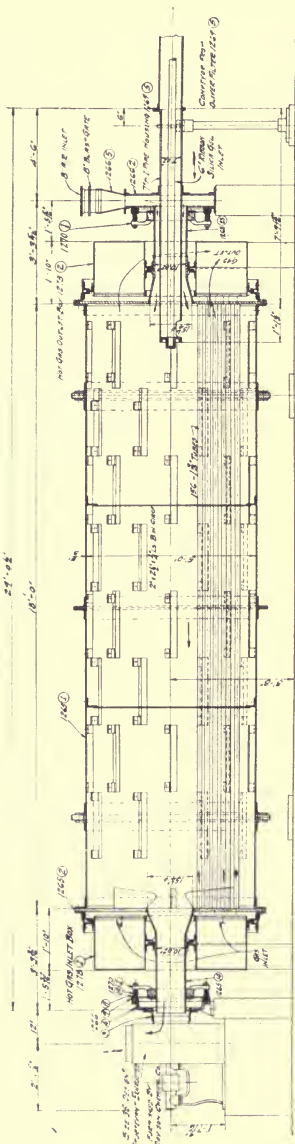

FIG. 25. Silica Gel Activator.

liberated solvent are then discharged axially from the left hand end of the machine to suitable condensers and dust collectors.

### Burrell Adsorption Plant

The apparatus used by Burrell<sup>1</sup> for the extraction of gasoline from natural gas by adsorption on activated charcoal is shown in the following diagrams.

The absorbers are filled with cocoanut shell charcoal of from 8 to 14 mesh which when packed to a depth of 5 feet is said to offer from

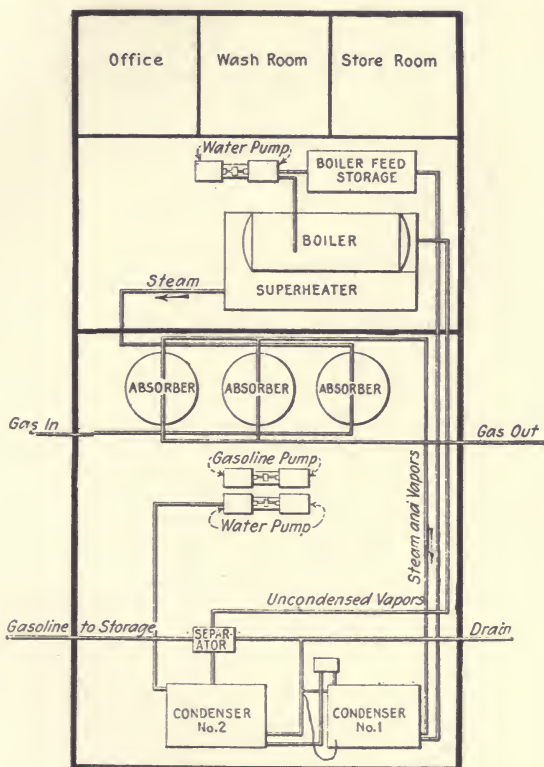

FIG. 26. Gasoline Adsorption Plant.

1 to 2 pounds per square inch pressure resistance to flow of gas when the gas is passing through at the rate of 40 cubic feet per hour per square inch of cross sectional area.

In this particular case temperature rise is not serious, since the

<sup>1</sup> Chem. and Met. Eng. 24 (1921), p. 156.

gases are dilute, and the heat evolved serves principally to drive out of the charcoal the more volatile portions of the gasolene which it is not desired to collect. A temperature rise of  $60^{\circ}$  has been observed.

The use of three absorbers permitted one to be cut out of the system when saturated, for gasolene removal and reactivation while the

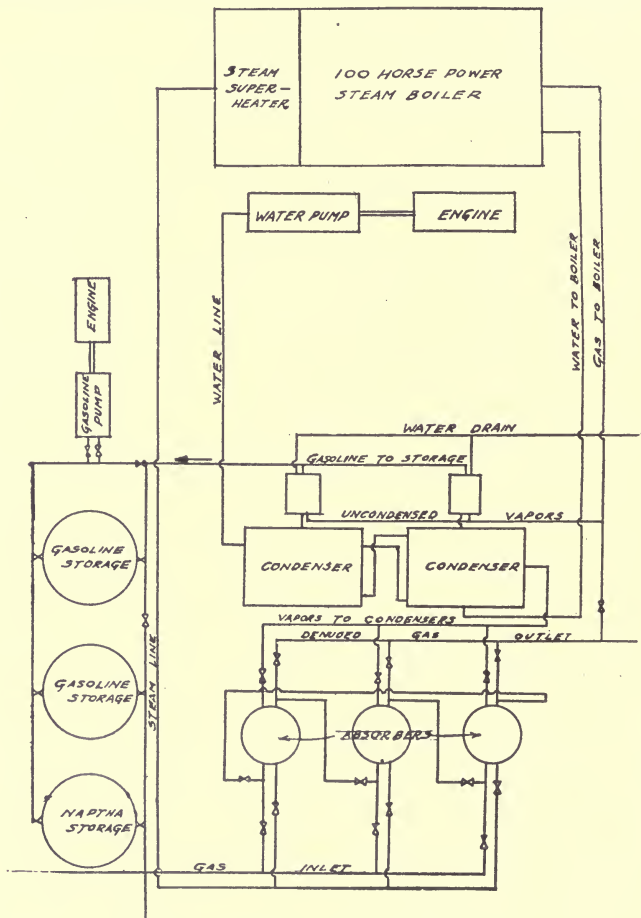

FIG. 27. Gasoline Adsorption Plant.

other two are operating in series. The gasolene is recovered by passing through the charcoal steam up to  $400^{\circ}$  F. superheat, and condensing the mixed steam and gasolene in the condensers as shown. The table on page 57 indicates the heat consumption for this process.

There are at the present time (April, 1922) three plants of one thousand gallons daily capacity in operation using this process for the recovery of gasolene from natural gas, and there are two more of

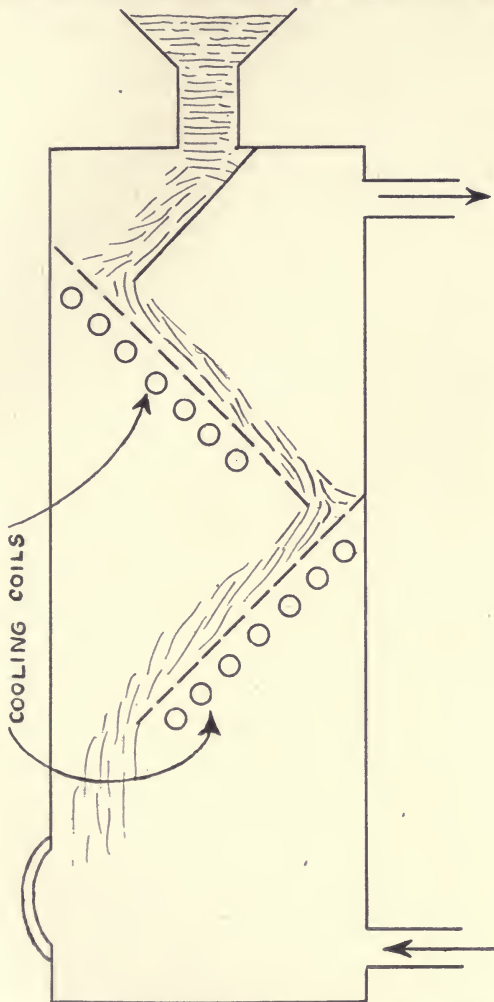

FIG. 28. Wilson and Lamb's Adsorption Tower.

1100 gallons capacity under erection. The use of saturated steam has superseded superheated steam for the recovery of the gasolene from the charcoal, the steam consumption averaging 8 pounds per pound of gasolene distilled.



The following patents apply to this process:

1,402,340—January 2, 1922—Burrell, Oberfell, and Voess.

1,382,889—June 28, 1921—Burrell, Voess, and Canter.

1,382,890—June 28, 1921—Burrell, Voess, and Canter.

### Wilson and Lamb's Plant

Wilson and Lamb propose to use ferric hydroxide gel  $\text{Fe}(\text{OH})_3 \cdot n\text{H}_2\text{O}$  (patent applied for), as a solid adsorbing agent in a suitable apparatus to give continuous counter-current contact between the solid and gas. Such an apparatus might be constructed as shown in the following diagram, Fig. 28.

Such an apparatus is suitable only for hard non-friable solids, easily pulverized solids, such as charcoal, not being especially satisfactory on account of the dust produced.

Another device, Fig. 29, to give counter-current contact between

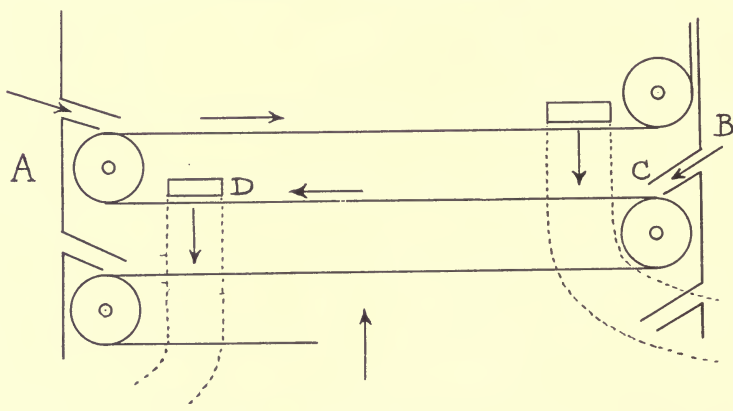

FIG. 29. Wilson's Adsorption Apparatus.

the adsorbing medium and other solid material containing solvent which is to be removed is indicated by Wilson as follows:

A perforated belt is repassing through a chamber through which is rising a current of gas. Solid material containing the solvent to be vaporized falls from a hopper *B* onto the belt where it travels slowly to the point *D* where it is removed from the belt and discharged from the apparatus. The adsorbing agent enters from a similar hopper *A* onto that portion of the belt immediately above, and travels counter-current to the solid from *B*. The gas picks up solvent, being cooled in the process, and when coming into contact with the adsorbent above

gives it up again, being reheated at the same time, by the heat of adsorption.

The very recent use of solid adsorbents in solvent recovery accounts for the small amount of descriptive matter available at the present time. In general it may be stated that the field of solid adsorbents lies in the handling of dilute gases rather than concentrated.

#### Suitability of Adsorbing Agents

So far as individual adsorbing agents are concerned, charcoal has the greatest capacity, but is not suitable for high temperatures, or for gases containing oxygen or other oxidizing agents. Silica gel and ferric hydroxide gel (the former is patented for this use, and the other is under application) are chemically inert, the former especially so: However, for water vapor, they are not as satisfactory as charcoal on account of the chemical attraction which must be overcome in removing the water afterwards. The silica gel is the better of the two in this connection. So far as the writer is aware, there are no other adsorbing agents commercially available at the present time.

## CHAPTER XII

### SOLVENT RECOVERY BY CONDENSATION AT CONSTANT PRESSURE

#### Superheated Vapor

It has been pointed out in Chapter V that a volatile material may exist in either the solid, liquid, or vapor state, and that it is possible under specific conditions to have one, any two, or all three forms of the material present at the same time. Thus if temperatures be high enough and pressures be low enough, it is possible to have the substance entirely in the vapor state, for various combinations of temperature and pressure. Vapor under these conditions is in the *superheated* condition.

#### Saturated Vapor

If vapor and liquid be present together, the temperature may be varied, but the pressure (the vapor pressure of the substance) will depend upon the temperature. Or the vapor pressure may be varied and the temperature of the substance will change correspondingly. The relation between the temperature and the vapor pressure gives the vapor pressure curve for the liquid.

If all three forms of the substance be present at the same time, neither the temperature nor the pressure can be varied, because the three can exist together at one specific temperature and pressure only. Thus ice, water, and water vapor can exist together at approximately 0° C. and 4.6 mm. pressure.

*Example 16.* Cotton cloth from a dry cleaning operation contains liquid benzol (benzene,  $C_6H_6$ ). It is desired to remove the benzol from the cloth and to recover it.

(a) The cloth is introduced into an air free chamber *A*, at a temperature of 20° C. (68° F.) at which temperature benzol has a vapor pressure of 74.7 mm. The benzol will immediately start to vaporize. This will require heat (the latent of vaporization). If the heat is not forthcoming from the surroundings, the heat will be furnished by the liquid benzol itself which will therefore drop in temperature. If, on the other hand, heat is furnished from the surround-

ings rapidly enough to keep the temperature at  $20^{\circ}$  C. the benzol will continue to vaporize until the whole chamber is filled with benzol vapor at the pressure of 74.7 mm.

Suppose now that an exhausting pump *B* is started. The benzol vapor will be removed by it, thus tending to lower its pressure in the chamber. As soon as this occurs, more of the benzol will vaporize, and the process will continue until all of the liquid has vaporized.

The benzol vapor exhausted by the pump may be discharged into a condenser *C* at substantially the same pressure at which it existed in the vaporizing chamber. Suppose that the tubes in the condenser be at a temperature of  $10^{\circ}$  C. ( $50^{\circ}$  F.) at which temperature the vapor pressure of benzol is 45.4 mm. The vapor coming into contact with the tubes can exist only when its pressure is 45.4 mm. and therefore, in order that the pressure shall fall from 74.7 mm. to 45.4 mm., some of the benzol condenses. This condensation gives out heat which

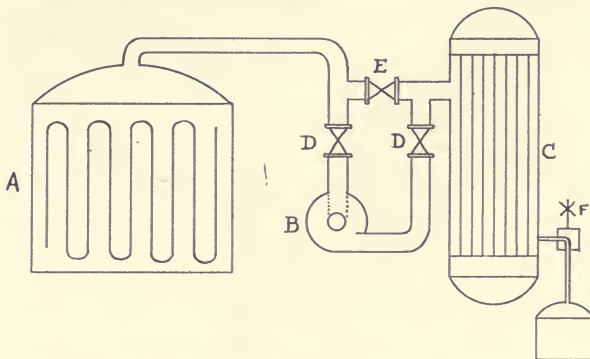

FIG. 30. Diagram Illustrating Solvent Recovery by Simple Condensation.

must be absorbed by the cooling water in the tubes or the temperature of the cooling surface will rise. It is therefore necessary to supply more cooling water in order to keep the temperature at  $10^{\circ}$  C. As rapidly as the vapor condenses, fresh vapor furnished by the pump arrives, and the process continues until all of the benzol on the cloth has evaporated.

Suppose now that the exhauster has been replaced by an open pipe, by closing the valves *D*, *D*, and opening the valve *E*. The pressure in the vaporizing chamber was 74.7 mm. and that at the surface of the condenser was 45.4 mm. A difference in pressure between these two points would have caused the vapor to flow from the cloth to the condenser and the evaporation would therefore have continued as before without the aid of a pump so long as there was a difference in temperature between the cloth and the condenser.

(b) The benzol laden cloth is introduced into a chamber containing air at  $20^{\circ}$  C. and at atmospheric pressure (29.92 inches or 760 mm.). The pressure of the air does not appreciably affect the

partial pressure of the benzol which remains at 74.7 mm. Since, however, the benzol vapor will occupy space, either some of the air must be removed from the chamber or the total pressure in the chamber will rise until it has reached 834.7 mm. which is the sum of 760 (the partial pressure of the air) and 74.7 mm. (the partial pressure of the benzol). Suppose that the air is removed by opening the air vent valve *F* to keep the total pressure constant at 760 mm., then the partial pressure of the benzol will still be 74.7 mm. and that of the air will be 685.3 mm. which is the difference between 760 and 74.7.

Under these conditions the mol fraction of the benzol in the air-benzol mixture will be

$$\frac{74.7}{760} = .0983$$

and the percentage by volume of the benzol in the air will be 9.83.

The weight percentage of benzol in the air mixture is calculated as follows:

$$\begin{aligned} \text{Molecular weight of benzol} &= 78 \\ \text{Molecular weight of air} &= 29 \end{aligned}$$

In 100 mols of mixture there are 9.83 mols of benzol and 90.17 mols of air. The weight of each of these will be:

$$\begin{aligned} 9.83 \times 78 &= 767 \\ 90.17 \times 29 &= 2615 \\ \hline \text{Total} &= 3382 \end{aligned}$$

$$\text{Weight percentage of benzol} = \frac{767 \times 100}{3382} = 22.7\%$$

The weight of benzol in one cubic foot of the mixture is calculated as follows:

100 pound mols of the mixture contain 767 lbs. of benzol.  
 100 pound mols of a gas occupy at standard conditions  
 $100 \times 359$  cu. ft. or

$$100 \times 359 \times \frac{(273 + 20)}{273} = 38500 \text{ cu. ft. at } 20^\circ \text{ C.}$$

Therefore the pounds per cubic foot will be

$$\frac{767}{38500} = .0199 \text{ lbs. per cu. ft.}$$

The presence of the air will not affect the condensation at the condenser, except that it interferes with the flow of heat from the condensing vapor to the surface of the cooling tubes. The partial pres-



sure of the vapor is reduced at the surface to 45.4 mm. making the total pressure there

$$45.4 + 685.3 = 730.7 \text{ mm.}$$

Since this is less than the pressure of 760 mm. in the chamber the gas mixture will tend to flow in the direction of the condenser, and the condensation will continue as before. It is probable, however, that in such an apparatus, the air remains practically stationary except as convection currents due to heating and cooling may be set up, and that the benzol vapor actually passes through the air from the cloth to the condenser by diffusion, which is of course a very slow process. It is therefore true that solvent recovery in the absence of air or other non-condensing gases is much more rapid than when air is present, unless the apparatus is designed to permit vigorous circulation of the air between the cloth and the condenser. The residual benzol left in the air at 45.4 mm. pressure will not of course be condensed.

### Stokes Vacuum Apparatus

An example of this method of solvent recovery is shown in the Stokes Vacuum Solvent Recovery Apparatus illustrated in Fig. 31. This apparatus is suitable for the recovery of alcohol from the dregs of extract making, the removal of benzol from rubber impregnated materials, the removal of solvent from wood chips after rosin extraction, and for similar purposes. It consists of a steam jacketed cylindrical drum *A*, in which the material containing the solvent is brought into contact with the hot walls by means of a suitable stirring device driven by the gearing *B*.

The apparatus after charging is put under a vacuum by means of the vacuum pump *C* which is joined to the drum through a dust collector *D* and the surface condenser *E*.

The air leaving the apparatus will be saturated with solvent at the temperature of the condenser *E*, and since under a high vacuum, the gas exhausted may consist largely of uncondensed vapor, the gas is delivered from the pump to another surface condenser *F* where the gas is under atmospheric pressure and the bulk of the solvent vapor passing through the pump will be condensed.

### Mixture of Condensable Vapors

The foregoing has referred to a single condensable vapor. Suppose now that the solvent to be vaporized and condensed be composed of a mixture of two or more liquids of different boiling points and

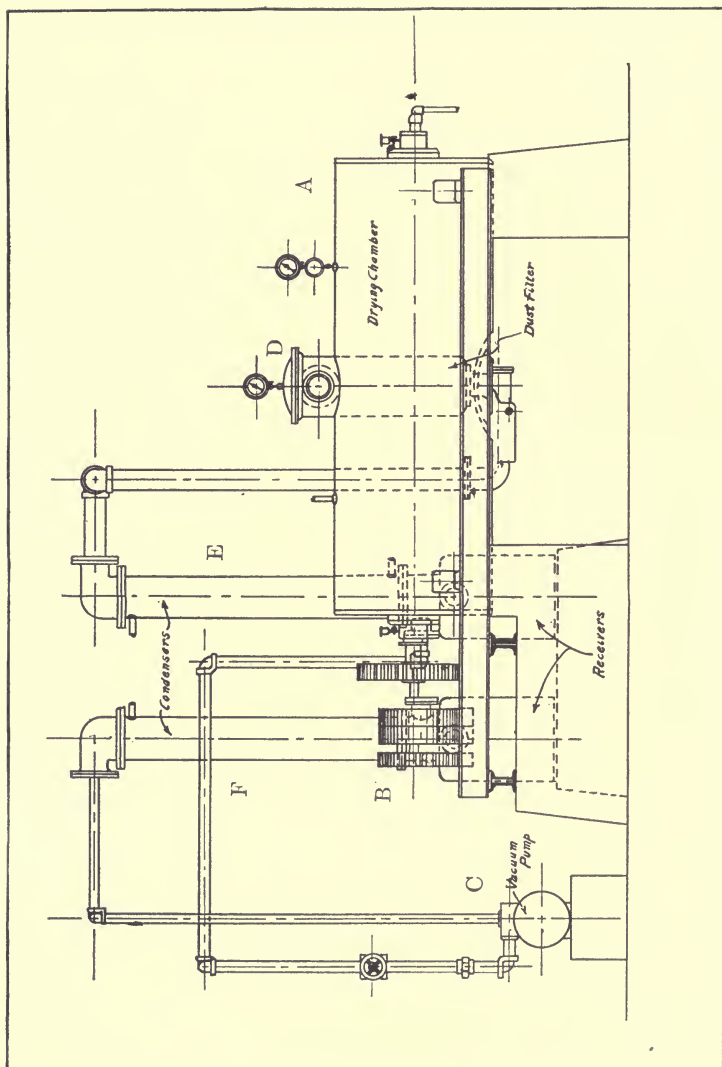

FIG. 31. Stokes' Vacuum Solvent Recovery Apparatus.

vapor pressures.<sup>1</sup> While the liquid is vaporizing, the residual liquid is becoming increasingly richer in the less volatile components, the vapor pressure of the mixture is constantly decreasing, and therefore the weight of vapor per unit volume of air is growing less, until when the last of the solvent vaporizes, it consists wholly of the least volatile component, and its partial pressure in the air is that of this particular component, as if it had been alone present during the vaporization.

This gradual decrease of the concentration of the solvent vapor in the gas is not especially serious when mixtures of substances of similar volatility are being vaporized, but when the solvent consists of a mixture of substances with widely different boiling points, this factor is of considerable importance. For example when gasolene, which is a mixture of hydrocarbons with boiling points ranging from 50° C. to 300° C., is used as a solvent, it is extremely difficult to remove its last traces, since they consist of substances of low volatility and the amount of them which will be carried off per unit volume of air is very small, except at high temperatures.

Thus the vapor pressure of gasolene which starts to boil at 50° C. may be calculated for a temperature of 20° C. by the method given in Chapter II.

$$\ln \frac{760}{p_2} = \frac{L}{1.99} \left( \frac{1}{273 + 20} - \frac{1}{273 + 50} \right)$$

where  $L = 20.5 \times (273 + 50) = 6600$

$$\ln \frac{760}{p_2} = \frac{6600}{1.99} (.00341 - .00309) = 1.065$$

$$\frac{760}{p_2} = 2.9$$

$$p_2 = 262 \text{ mm.}$$

Therefore at 20° C., at the start of the vaporization the weight of gasolene contained in one cubic foot of the air-gasolene mixture would be (assuming gasolene to have an average molecular weight of 125)

$$\frac{262}{760} \times \frac{125}{359} \times \frac{273}{(273 + 20)} = 0.112 \text{ lbs. per cu. ft.}$$

And at the end of the evaporation when the component boiling at 300° C. was being vaporized alone, the weight of gasolene per cubic foot would be calculated in the same way as follows:

<sup>1</sup>The reader is referred to Chapter III and Chapter V for the behavior of such mixtures during vaporization and condensation.

Vapor pressure of the solvent at 20° C.

$$\ln \frac{760}{p_2} = \frac{L}{1.99} \left( \frac{1}{273 + 20} - \frac{1}{273 + 300} \right)$$

$$L = 20.5 \times (273 + 300) = 11750$$

$$\ln \frac{760}{p_2} = \frac{11750}{1.99} (.00341 - .00174)$$

$$\frac{760}{p_2} = 18500$$

$$p_2 = .041 \text{ mm.}$$

Therefore at 20° C., at the end of the vaporization, the weight of gasolene per cubic foot would be

$$\frac{.041}{760} \times \frac{125}{359} \times \frac{273}{(273 + 20)} = .0000175 \text{ lbs. per cu. ft.}$$

Or in other words, at the start, 9.0 cubic feet of mixture will be required to carry one pound of gasolene, while at the end nearly 60,000 cubic feet are necessary.

Of course the obvious answer to such a question is the use of gasolene with a much shorter boiling point range, a special cut for the purpose.

## CHAPTER XIII

### CONDENSATION WITH COOLING WATER

#### Types of Condensation

Solvent vapors may be condensed by the removal of heat at the condensation temperature in two ways, by direct cooling or by indirect cooling. Direct cooling consists of bringing the vapor into direct contact with the cooling medium, as in the jet condenser. Indirect cooling introduces a dividing wall between the vapor and the cooling medium, as in the surface condenser. The direct cooling method is divided into two classes, first where the condensing vapor is soluble in the cooling medium, and second, where it is insoluble. The first class comes under the general subject of solution by scrubbing and will be discussed in detail in another chapter. The second class may be properly considered at this point.

#### Direct Cooling

Benzene is practically insoluble in water. Therefore if benzene vapor be brought into contact with water at a temperature lower than that of the vapor itself, flow of heat from the vapor to the water will occur with condensation of the vapor and rise in temperature of the water. If sufficient water is present to prevent its reaching vapor temperature, all of the vapor will condense, and there will issue from the condenser a mixture of benzene and water which, unless emulsification has occurred, will separate on standing into two layers, and the benzene and water may be separated by decantation.

Direct acting condensers for condensing steam are in general suitable for this work.

In case the solvent recovery apparatus is to work under a vacuum, the jet condenser may be of the barometric type, or of the wet vacuum pump type.

Condensers similar to tower scrubbers are also suitable, the plate type, or the tower filled with coke, rock, or other filling material being used. Those are however better suited for the condensation of vapor



when contained in air or other gas and are almost exclusively used under these circumstances where direct cooling is desired.

Water velocities in jet condensers are usually in the neighborhood

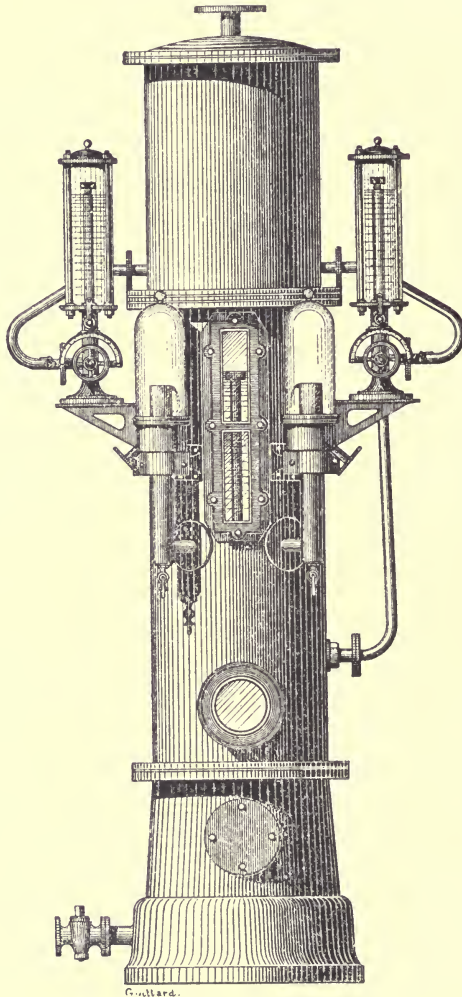

FIG. 32. Continuous Decanter.

of from 5 to 10 feet per second. In plate and filled type towers the average velocity of the water flowing down through them is from 1 to 3 gallons per minute per square foot of cross section of the tower.

When mixtures of condensible vapors and non-condensable gases

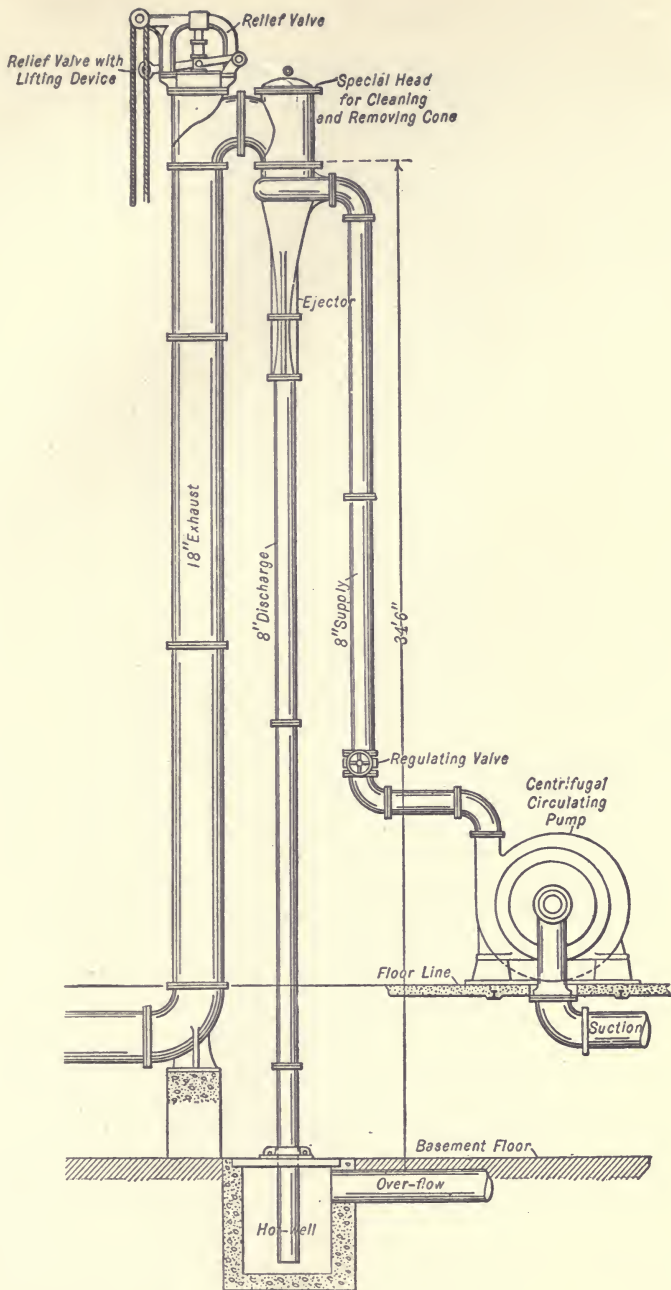

FIG. 33. Barometric Condenser.

such as benzene vapor in air are used in direct coolers, it is necessary to remove the gas from the cooler after the vapor has been condensed, by some suitable exhausting pump. In the case of towers and counter-current jet condensers, the gases are removed at the top, while in vacuum jet condensers using a wet vacuum pump, the air is removed by that pump. This last type is therefore used when the percentage of gases in the vapor is relatively small.

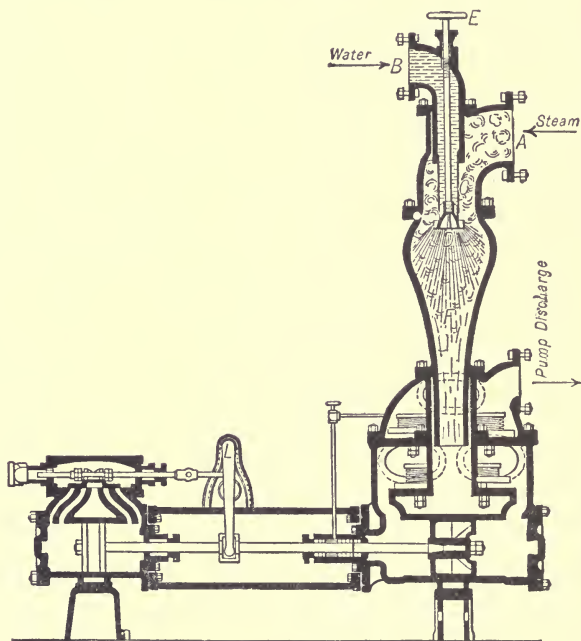

FIG. 34. Jet Condenser with Wet Vacuum Pump.

### Indirect Cooling

Indirect or surface coolers and condensers are used when the solvents are water soluble, or when it is desired to keep insoluble solvents dry and out of contact with water. The latter is difficult even with surface condensers, as moisture in the air will frequently condense simultaneously with the solvent vapor. Surface condensers are also used with insoluble solvents when the amount of solvent in the air is small, in order to avoid the mechanical difficulties of separating by decantation a small amount of solvent from a large amount of water. The objection to the use of direct cooling with soluble liquids

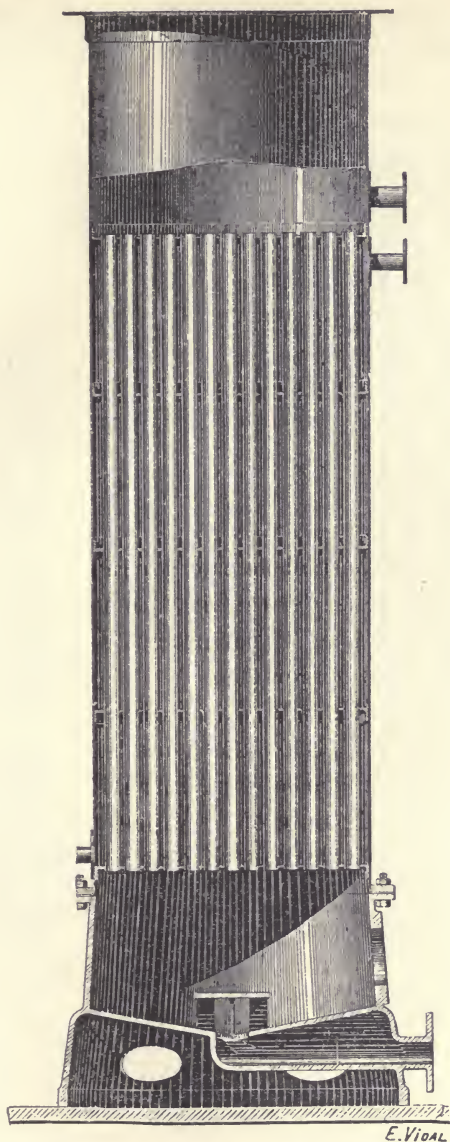

FIG. 35. Simple Tubular Cooler.

is the necessity of using distillation as another step in the final recovery of the solvent.

The factors entering into the design of coolers will be discussed in

a later section. The chief things to be remembered in the selection of a surface cooler are that the velocities of the water and the vapor

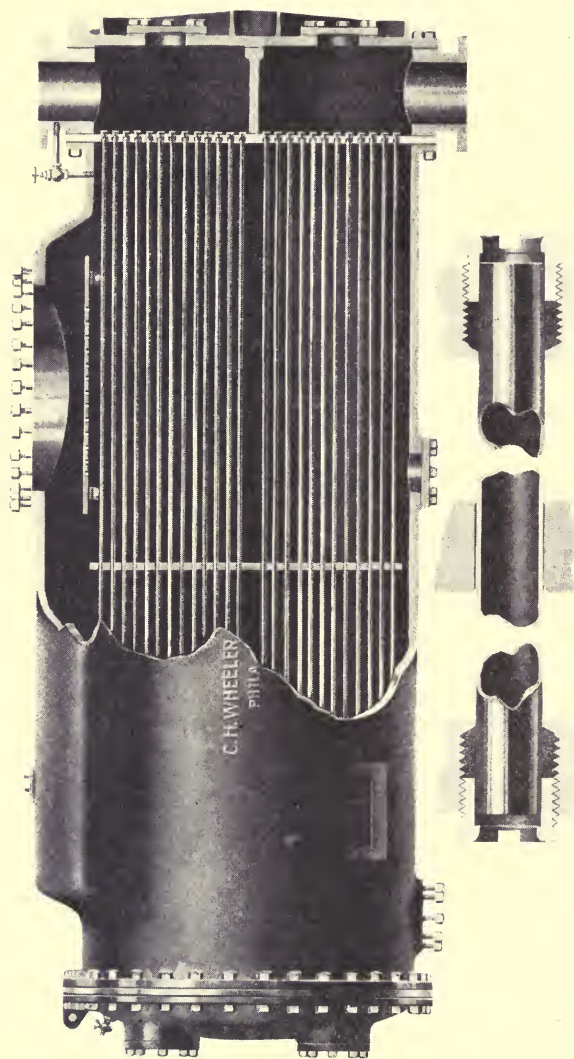

FIG. 36. Two-pass Condenser of the Type Suitable for Solvent Recovery.

should be as high as possible without undue friction or back pressure, it should be counter-current, and there should be no opportunity for the formation of dead spaces or pockets for stagnant fluid. Where



dirty cooling water is used, the water surfaces should be easily accessible for cleaning.

The simplest type of cooler is the coil through which water is passed, fastened against the wall of the chamber. This type is least expensive per square foot of heating surface for small installations, but is not easily arranged for high air or vapor velocities and is therefore not very efficient. It is very bulky.

A similar type is the double pipe cooler or condenser, familiar to users of refrigeration apparatus. This type has great capacity per square foot of cooling surface on account of the possibility of obtaining high liquid and vapor velocities and it can be constructed easily out of stock fittings, but it is bulky and expensive to install.

A third type of surface cooler is the tubular condenser. These are relatively inexpensive per square foot of cooling surface, but are of small capacity as it is difficult to get high fluid velocities around the tubes. In order to accomplish this the tubular coolers are often made multi-pass, which increases their capacity at increased cost per square foot of heating surface by increasing fluid velocities.

### Cooling Water

Cooling water for condensers should be abundant and at low temperature. In many solvent recovery operations the efficiency of the recovery depends largely upon the ability to cool the gases to low temperatures, which means cooling water at low temperatures and in considerable amounts to avoid undue temperature rise. Some plants are fortunately located as to water, having abundant supply at low temperatures both summer and winter. Other plants are not so well situated, and restrictions as to quantity and temperature, especially in the summer, place real handicaps on efficient solvent recovery operations. For such, methods of reusing and recooling the cooling water are of great importance.

There are two methods in common use for recooling water, both depending upon the evaporation of part of the water into air, the heat of vaporization effecting the cooling of the remainder. The evaporation and therefore the cooling obtained under these circumstances depends upon the temperature and the humidity of the air, best results being in general obtained when the air is relatively dry, although it is possible to cool water with saturated air. If water at any temperature whatever be brought into contact with sufficient quantities of air

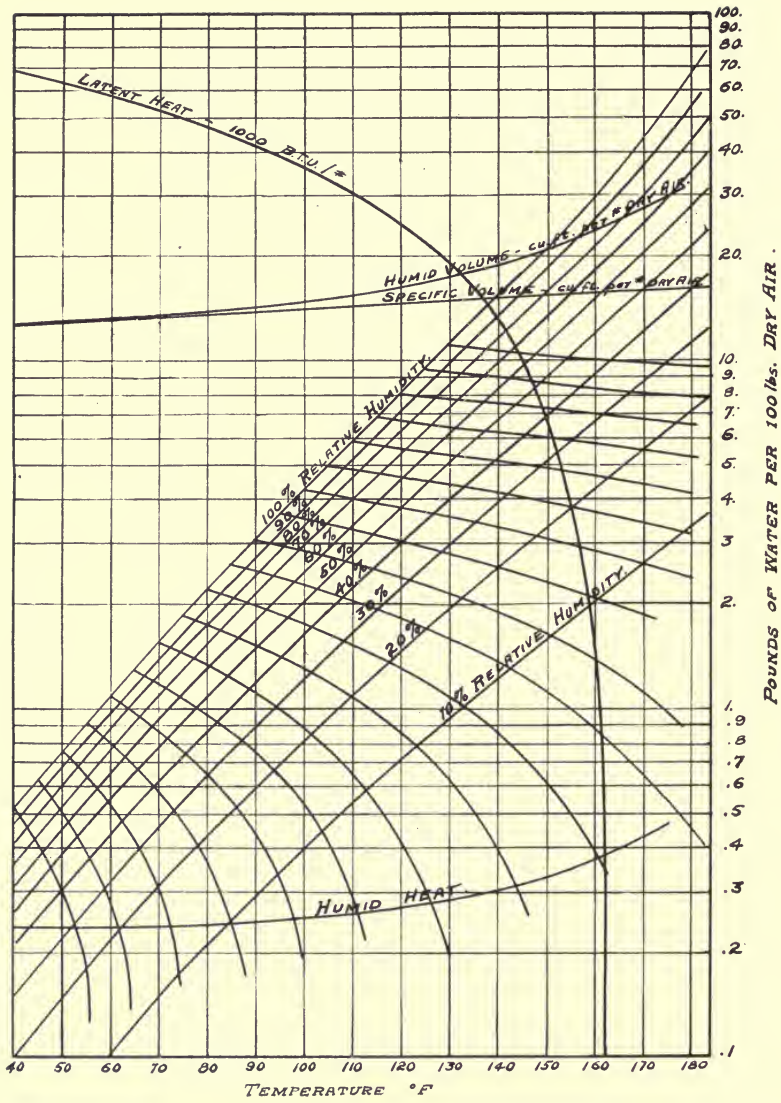

FIG. 37. Humidity Chart.

at 120° F. and 5% relative humidity (which is the condition said to exist at times in the desert regions of the Southwest), both the water and the air can be cooled to wet bulb temperature which is about 70° F.



FIG. 38. Spray Cooling Pond.

Such cooling is obtained by the use of spray ponds or cooling towers, the use of cooling ponds without sprays requiring such large areas (2 to 4 B.t.u. per square foot of pond surface per degree Fahrenheit temperature difference between the water and the air, plus or minus several hundred per cent depending upon atmospheric conditions) that they are economical only under very special circumstances.



### Humidity Chart

In order to estimate cooling of water by air, the use of a humidity chart is required. Such a chart is given in Fig. 37.

On this chart the curve marked 100% relative humidity gives the weight of water expressed as pounds per hundred pounds of dry air

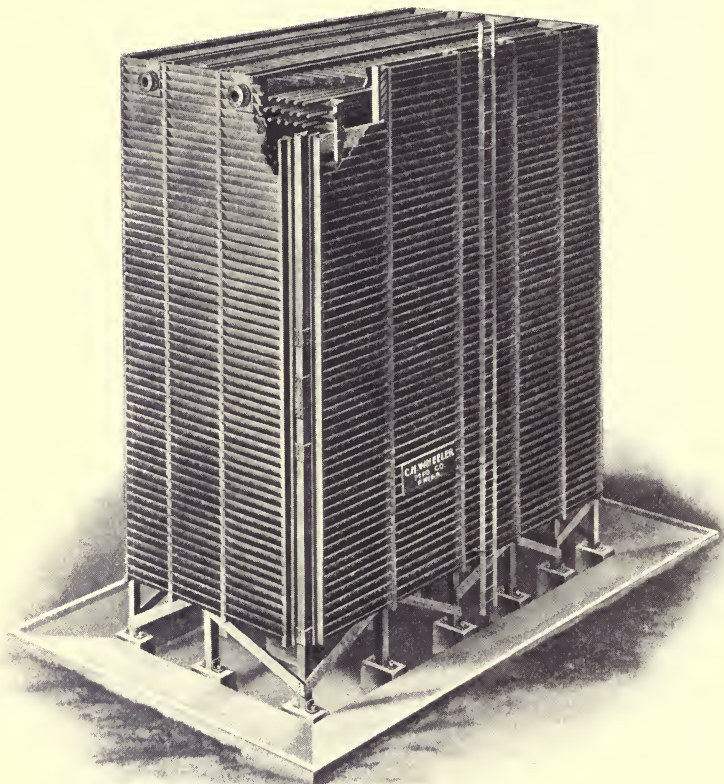

FIG. 39. Atmospheric Cooling Tower.

which saturated air will hold at the temperature in question. For instance, saturated air at 70° F. will contain 1.55 pounds of water vapor per one hundred pounds of dry air. If the air on the other hand has a relative humidity of 50%, it will contain 0.77 pounds as read from the 50% curve.

The curves running about at right angles to the humidity curves are adiabatic cooling curves. For instance when water is brought into

contact with air at some specific temperature and relative humidity, for instance  $78^{\circ}$  and 50%, the air will fall in temperature along the adiabatic curve, up to the left, until the 100% line is reached at  $65^{\circ}$  which is the wet bulb temperature. Adiabatic cooling infers no heat

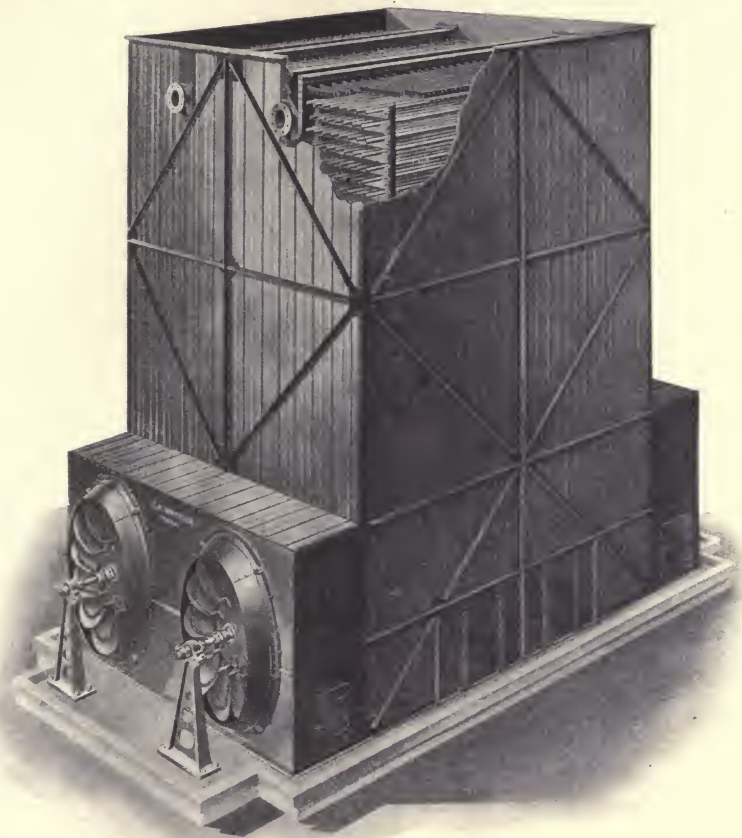

FIG. 40. Forced Draft Cooling Tower.

lost to or recovered from the surroundings. If the water is left in contact with the air, it too will eventually reach the wet bulb temperature of the air if present in suitable amount, but cannot be cooled below that point which is the end of adiabatic evaporation.

It is obvious that the portion of the water which is evaporated in cooling the remainder, is lost so far as reuse is concerned, and must



be made up by fresh water. This loss will vary according to conditions, but averages between 0 to 5% in most cases.

Spray cooling ponds of the type shown in Fig. 38 require about 2 to 4 square feet of area for each gallon of water sprayed per minute, the water being pumped against a pressure of about 6 to 7 pounds per square inch in order to operate the spray nozzles. Cooling may be improved by respraying the water. Water losses due to evaporation and intrainment amount to less than 3% of the water sprayed.

Atmospheric cooling towers of the type shown in Fig. 39 have approximately the following dimensions:

<i>Gallons of water per minute</i>	<i>Ground area square feet</i>	<i>Height in feet</i>
100	11 x 17	20
300	19 x 25	30
500	19 x 37	30
700	19 x 48	30
1000	19 x 66	30

Such towers should cool the water to within 2° to 20° F. of the wet bulb temperature depending upon atmospheric conditions. The power consumption of these towers is that consumed in pumping the water to the top of the tower.

Forced draft towers of the type shown in Fig. 40 are usually designed on the basis of 6.5 gallons of water per square foot of ground area of tower per minute, and will cool to within a few degrees of wet bulb temperature, depending on the height of the tower, standard towers being 25–30 feet high. The power consumption will be that of pumping the water to the top of the tower plus that of blowing the air, the latter being about equal to the former.

## CHAPTER XIV

### COOLING WITH REFRIGERATION

It frequently happens that the temperature required to remove the solvent vapor from the gas in which it comes from the vaporizing chamber is lower than can be obtained by the use of cooling water. Under such circumstances artificial cooling by mechanical refrigeration is used. It is not usually advisable to attempt the cooling of vapor laden gases entirely by refrigeration if they are at a temperature considerably above the temperature to which the gases will finally be cooled, but it is better to cool as much as possible with water, and then finish with refrigeration. In small installations, however, it will prove more economical to do all the cooling with refrigeration in order to avoid excessive first cost of double cooling equipment.

The technique of cooling by means of mechanical refrigeration is similar to that of water cooling. It should be borne in mind when low temperatures are desired, that the presence of much moisture in the vapor laden gases frequently causes trouble due to the formation of ice on the cooling surfaces with the subsequent insulation against flow of heat. This trouble can be avoided only by the use of dried gases in the recovery apparatus, which is not often warranted, the cure being more expensive than the original trouble.

While there are many methods of obtaining mechanical refrigeration, in general three are used. The first of these is the compression and subsequent expansion doing work in a cylinder or turbine of air or other inert gas. The second consists in the compression and condensation of some readily condensible vapor such as ammonia, carbon dioxide, or sulphur dioxide, and the subsequent expansion to the vapor state through a throttling valve. The third makes use of the solubility of such vapors in some less volatile liquid such as water, by absorption under low pressure and revaporization under high pressure, condensation and expansion as before. These systems are known as the dense air, the compression, and the absorption systems respectively. For detailed information on this subject the reader is referred to "Mechanical Refrigeration" by Macintire (Wiley) and to Mark's "Mechanical Engineers' Handbook" (McGraw-Hill).

## CHAPTER XV

### HEAT OF VAPORIZATION IN THE ABSENCE OF GASES

Vaporization of a solvent in the absence of gases will occur when the temperature of the solvent is raised to such a point that the vapor pressure of the liquid becomes equal to the external pressure on the liquid. It will then continue at that temperature so long as the vapor is removed from the liquid and the heat of vaporization is supplied.

#### Heating by Direct Contact

The heat of vaporization may be transmitted to the liquid by direct contact of the liquid with a suitable heating surface. Thus the water in a boiler receives its heat from contact with the hot flues. Where a solid comes into contact with a hot surface, it is assumed that the flow of heat from that surface to the solid is very rapid, and that the diffusion of the heat through the solid to the interior is relatively slow. It is therefore necessary to insure continual and frequent contact between fresh, cold surfaces of the solid with the heating surface, which is usually accomplished by agitating or tumbling the solid around in its container.

In the case of a liquid the flow of heat from the solid heating surface to the liquid depends chiefly upon the velocity of the liquid by the surface and its viscosity. No accurate information is available at the present time for this. Where the boiling liquid is water the coefficient of heat conductivity will depend upon the pressure, velocity, and arrangement of heating surface and will vary perhaps from 400 to 1000 B.t.u. per square foot per hour per degree Fahrenheit temperature difference between the solid and the liquid. For more viscous liquids, the value will be lower, being probably inversely proportional to the viscosity relative to water under similar conditions.

#### Heating by Radiation

The heat of vaporization may be transmitted to the vaporizing solvent by direct radiation through space from steam coils or other hot surface. The rate of flow of heat by radiation is given by the formula (Stephan-Boltzmann):

$$(22) \quad \frac{Q}{\Theta} = b T^4$$

where  $Q$  is the amount of heat radiated per time  $\Theta$  per unit of radiating area,  $T$  is the absolute temperature of the radiating surface, and  $b$  is a constant.

When a small body is entirely surrounded by a large one, the radiation between the two is given approximately by the formula:

$$(23) \quad \frac{Q}{\Theta} = p C \left[ \left( \frac{T_1}{100} \right)^4 - \left( \frac{T_2}{100} \right)^4 \right]$$

where  $T_1$  and  $T_2$  represent the absolute temperatures of the two surfaces,  $C$  is the radiation coefficient (when English units are used  $C = 0.162$  B.t.u. per hour per square foot of radiating surface of the inner body per  $\left( \frac{^\circ \text{Fabs}}{100} \right)^4$ ), and  $p$  is its relative blackness as compared with a perfect black body which will absorb or radiate 100% of the heat passing. The approximate relative blackness of common substances is given in the following table:<sup>1</sup>

Theoretical black body .....	1.00	Dull brass .....	.23
Highly oxidized iron and steel.....	.90	Polished copper .....	.10
Most oxides, salts, organic substances	.90	Polished tin .....	.10
Glass .....	.90	Nickel .....	.35
Oxidized copper .....	.72	Silver (bright) .....	.03
Aluminum paint .....	.50		

*Example 17.* Calculate the heat delivered by direct radiation only by a black iron steam pipe per foot of length, 3-inch outside diameter, whose surface is at 250° F. to the walls of a surrounding cylinder whose inside surface is at a temperature of 200° F.

Surface of 1 ft. of pipe 3" diameter = .785 sq. ft.

Assume  $p = 0.9$

$$\frac{Q}{\Theta} = .785 \times 0.9 \times 0.162 \left[ \left( \frac{250 + 459.5}{100} \right)^4 - \left( \frac{200 + 459.5}{100} \right)^4 \right]$$

= 72. B.t.u. per hour by radiation alone. (Of course the total heat lost will be the sum of the heat of convection and the heat of radiation.)

When the body is large compared with the surroundings the rate of heat flow by radiation is calculated from the following equation:

$$(24) \quad \frac{Q}{\Theta} = \frac{\left( \frac{T_1}{100} \right)^4 - \left( \frac{T_2}{100} \right)^4}{\frac{1}{p_1 C} + \frac{1}{p_2 C} - \frac{1}{C}}$$

when  $p_1$  and  $p_2$  are the relative radiation coefficients of the two bodies.

<sup>1</sup> Walker, Lewis, and McAdams, "Flow of Heat Notes."

*Example 18.* A certain fabric is dried by passing it horizontally over rollers underneath a bank of steam pipes. If the outside of the steam pipes is at a temperature of 300° F. and the surface of the fabric is at 100° F., calculate the rate of heat radiation per square foot per hour between the two surfaces.

The preceding equation holds for two parallel surfaces of equal extent. Assume  $p_1$  and  $p_2$  both 0.90.

$$\frac{Q}{\Theta} = \frac{\left(\frac{759.5}{100}\right)^4 - \left(\frac{559.5}{100}\right)^4}{\frac{1}{.9 \times .162} + \frac{1}{.9 \times .162} - \frac{1}{.162}} = 180 \text{ B.t.u. per hr. by direct radiation.}$$



## CHAPTER XVI.

### VAPORIZATION IN THE PRÉSENCE OF INERT GASES

#### Heating by Gases

In the presence of inert gases, the heat of vaporization may be transmitted to the vaporizing solvent by direct contact with hot surfaces, or by radiation as before. It is more often transmitted wholly or in part by contact with the heated gas. Under these conditions the gas gives up heat to the solvent, being itself cooled in the process. This heat exchange may be considered independently from the other method of heat transmission.

#### Specific Heat of Gases

The specific heat of gases at constant pressure varies with the temperature, but for most solvent recovery work large temperature changes are rarely encountered and it is usually sufficiently precise to consider the specific heat a constant for any particular gas.

For diatomic gases such as  $H_2$ ,  $O_2$ ,  $N_2$ ,  $CO$ ,  $NO$ ,  $HCl$ ,  $HBr$ , the molal heat capacity may be expressed by the equation:

$$(25) \quad 6.5 + .0010 T$$

where  $T$  is the temperature of the gas in degrees Centigrade absolute. Thus the *specific heat* of Oxygen (molecular weight = 32) at  $100^\circ C$ . would be

$$\frac{6.5 + .0010 (273 + 100)}{32} = .215$$

As stated above such a value for the specific heat of oxygen may be used safely with small temperature changes, but in case the change is large its average specific heat may be calculated from the above by means of the following equation:

$$(26) \quad \text{Sp. heat average} = \frac{6.5 + .0005 (T_2 + T_1)}{32}$$

where  $T_2$  and  $T_1$  are the final and initial gas temperatures in  $^\circ C$ ., absolute.

The molal heat capacity of greater than diatomic gases is greater, but there is no simple relation. The average specific heats of some gases are given in the following table between the temperature limits stated.

Gas	Molecular weight	Temperature limits degrees Centigrade	Specific heat
Water vapor (H <sub>2</sub> O) .....	18	130 to 250	.480
Hydrogen sulphide (H <sub>2</sub> S) .....	34	10 to 200	.245
Carbon dioxide (CO <sub>2</sub> ) .....	44	at 0°	.1952
Sulphur dioxide (SO <sub>2</sub> ) .....	64	at 100°	.2169
		10 to 200	.154
Ammonia (NH <sub>3</sub> ) .....	17	20 to 210	.513
Methane (CH <sub>4</sub> ) .....	16	100 to 200	.592
Chloroform (CHCl <sub>3</sub> ) .....	119.5	28 to 118	.144
Ethylene (C <sub>2</sub> H <sub>4</sub> ) .....	28	10 to 200	.404
Ethyl alcohol (C <sub>2</sub> H <sub>5</sub> OH) .....	46	110 to 220	.453
Ethyl ether ( (C <sub>2</sub> H <sub>5</sub> ) <sub>2</sub> O ) .....	74	70 to 225	.480
Benzene (C <sub>6</sub> H <sub>6</sub> ) .....	78	116 to 218	.375
Methyl alcohol (CH <sub>3</sub> OH) .....	32	101 to 225	.458
Acetone ( (CH <sub>3</sub> ) <sub>2</sub> CO ) .....	58	129 to 233	.413

### Adiabatic Heating by Gases

In the case when all of the heat which is furnished for the vaporization of the solvent comes from the heat in the gas alone and from no other source, a heat balance may be written as follows:

$$(27) \quad s (T_1 - T_2) = r (H_2 - H_1)$$

This states that the drop in temperature ( $T_1 - T_2$ ) of one unit weight of air (one pound), multiplied by its heat capacity  $s$  equals the increase in the solvent content of the air in pounds of solvent per pound of solvent free air ( $H_2 - H_1$ ) multiplied by the latent heat of vaporization  $r$  of the solvent. In order to be exact the heat capacity used should be that of one pound of solvent free air plus the average heat capacity of the solvent contained in it during the course of the vaporization.

*Example 19.* Air at 200° F. is passed over a solid saturated with alcohol, the alcohol content of the entering and leaving air being 0.07, and 0.10 pounds of alcohol per pound of alcohol free air respectively. Calculate the drop in temperature of the air if the unvaporized alcohol remains unchanged in temperature and all of the heat of vaporization comes from the heat of the air.

Latent heat of vaporization of alcohol = 372 B.t.u. per lb.

Average specific heat of air = 0.24

Average specific heat of alcohol vapor = .45

Heat capacity of 1 lb. of air +  $\frac{.10 + .07}{2}$  lbs. of alcohol

$$\text{vapor} = 0.24 + \frac{.10 + .07}{2} \times .45 = 0.28 \text{ approximately}$$

$$0.28 (200 - T_2) = 372 (.10 - .07)$$

$T_2 = 160^\circ$ , the temperature to which the air will be cooled.

The condensation of the alcohol from the air in a condenser will, of course, start only when the temperature of the air has been reduced to the dew point for the particular concentration, and condensation will continue only with further temperature lowering. The heat to be removed will be calculated in a similar manner, including the heat of cooling the air and vapor plus the heat of condensation of that portion of the vapor condensed.

### Humidity Charts for Solvents

The weight of solvent which a gas can pick up when furnishing all of the heat of vaporization is very much less than that possible

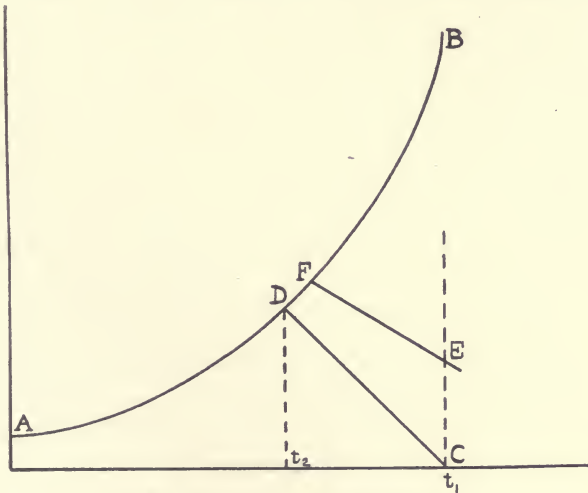

FIG. 41. Humidity Chart for Solvents.

when the heat comes from outside sources on account of the lowering in temperature of the gas. The temperature to which a gas will drop under such circumstances depends upon the amount of solvent already

present in it. Passing air through alcohol contained in a well insulated vessel should lower the temperature of the air and alcohol both until equilibrium is reached in the same manner as occurs when water evaporates adiabatically into air. The mechanism by which such an evaporation will occur may be shown on a diagram similar to a humidity chart.

The figure represents a modified vapor pressure curve  $A B$  for alcohol, plotting the weight of alcohol associated with one pound of alcohol free air as a function of the temperature. If air containing no alcohol and at some temperature  $t_1$  be brought into contact with alcohol adiabatically, it will cool off as it picks up alcohol vapor along some such line as  $C D$  and the temperature  $t_2$  corresponding to the point  $D$  would be what might be called the alcohol wet bulb temperature of the air under these circumstances.

If the air had contained some amount of alcohol corresponding to the point  $E$  at the start, the cooling would have progressed along a similar line  $E F$ , the resulting wet bulb temperature being higher. Such a chart may be readily constructed along the lines laid down by W. M. Grosvenor for humidity charts in the *Trans. Am. Inst. Chem. Eng.* (1908).

## CHAPTER XVII

### THE GAS UNDER NATURAL CIRCULATION

The vaporization and condensation of solvent in the presence of air or other inert gas may occur when the air currents are due to natural convection only, or to the forced convection with fans or blowers, or to a combination of the two. The simplest type of the former method is shown diagrammatically as follows:

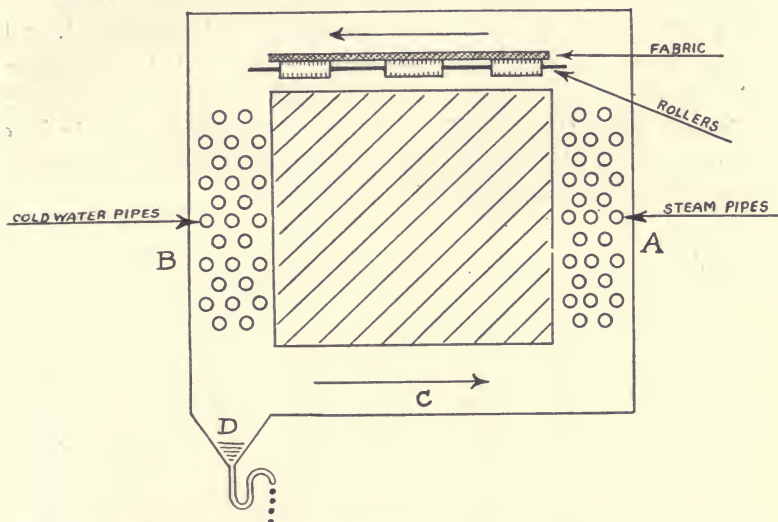

FIG. 42. Solvent Recovery Apparatus for Natural Circulation.

This represents the end elevation of an enclosed chamber through which a fabric is passing on rollers perpendicular to the page. This chamber is connected at both sides with vertical air passages *A* and *B* which contain steam pipes and water pipes respectively, these passages being connected underneath as indicated at *C*. The air heated by the steam pipes in *A* is displaced upward by the denser cooled air in *B* causing a counter-clockwise circulation of warm air past the drying fabric, the solvent condensing from the air in *B* dripping down to a suitable receiver *D* as shown.



### Air Velocity Due to Convection Currents

The air velocity developed in such an apparatus is low, in the vicinity of a very few feet per second. It depends upon the difference in weight between the column of heated air on the one side and the column of cooled air on the other. This can be calculated from the formula:

$$(28) \quad \Delta P = 39.7 \left( \frac{1}{T_2} - \frac{1}{T_1} \right) h$$

where  $\Delta P$  is the pressure difference in pounds per square foot,  $T_1$  and  $T_2$  are the average temperatures Fahrenheit absolute of the hot and cold columns respectively, and  $h$  is the height of the columns in feet. The rate at which the air will flow will also depend upon the frictional resistance to flow of air through the passages. This friction loss can be approximated by the method given by Wilson, McAdams, and Seltzer.<sup>1</sup> To this friction loss must be added the resistance due to bends, obstructions such as heating and cooling coils, and so forth.

Kent<sup>2</sup> gives the following table for the volume of air in cubic feet per minute circulated through a passage one foot square and of varying heights, the outside air at 32° F.

<i>Height of duct in feet</i>	<i>Temperature of air in duct in ° F.</i>								
	37	42	47	52	57	62	82	132	182
10	77	108	133	153	171	188	242	342	419
15	94	133	162	188	210	230	297	419	514
20	108	153	188	217	242	265	342	484	593
25	121	171	210	242	271	297	383	541	663
30	133	188	230	265	297	325	419	593	726
35	143	203	248	286	320	351	453	640	784
40	153	217	265	306	342	375	484	683	838
45	162	230	282	325	363	398	514	723	889
50	171	242	297	342	383	419	541	760	937

It is seen from this table which makes only an empirical and constant allowance for friction and none at all for entrance and exit pressure drops, that only low gas velocities are to be expected in such types of natural draft apparatus.

### Friction Loss of Air through Heaters

The friction loss of air through heaters is not accurately known for the low velocities obtained in natural draft circulation. For

<sup>1</sup>*J. Ind. Eng. Chem.*, 14 (1922), p. 105.

<sup>2</sup>Eighth edition, p. 655.

higher velocities it has been determined by a number of investigators. An accurate table has been published by the B. F. Sturtevant Co. for their heaters, which consist of banks of steam pipes on triangular centers. The table follows:

FRICTION LOSS IN INCHES OF WATER AT 65° F.

Velocity of air at right angles to pipes in feet per minute, measured as though the pipes were absent	Number of rows of pipe in the heater	Pipes 1.281" outside diam. 2½" triangular centers	Pipes 1.660" outside diam. 2¾" triangular centers
600	8	.06	.06
	16	.09	.09
	24	.12	.13
	32	.15	.17
800	8	.10	.10
	16	.16	.16
	24	.22	.23
	32	.27	.30
1000	8	.16	.16
	16	.25	.25
	24	.34	.36
	32	.43	.47
1200	8	.21	.23
	16	.35	.38
	24	.49	.53
	32	.63	.69
1500	8	.33	.36
	16	.55	.59
	24	.77	.83
	32	.99	1.08
1800	8	.48	.51
	16	.79	.85
	24	1.10	1.20
	32	1.42	1.55
2100	8	.65	.70
	16	1.08	1.17
	24	1.50	1.64
	32	1.94	2.11

Further information regarding flow of gases under natural draft may be obtained from Meier's "Mechanics of Heating and Ventilating," McGraw-Hill Book Co., New York, 1912.

## CHAPTER XVIII

### THE GAS UNDER FORCED CIRCULATION

The use of natural draft in solvent recovery chambers is usually restricted to apparatus of small size, forced circulation being used in most large apparatus. The latter has many advantages.

#### Mechanism of Evaporation

The evaporation of a solvent from the surface of a solid is a complex process. The solvent which is on the surface of the solid at the start will evaporate readily enough, but that which is in the interior must diffuse to the surface before evaporation can occur, and in some cases diffusion is very slow. Furthermore, the appearance at the surface is only part of the process, for after vaporization there, the vapor must diffuse from the surface through a more or less stationary air film adhering to the surface before it meets the air flowing by and is picked up and carried away. Vaporization is therefore a process of double diffusion, and the rate at which it occurs depends upon the factors controlling these diffusions.

Suppose that the solid being freed of solvent is of the nature of blotting paper through which the liquid diffuses with great rapidity. Under these conditions the rate of evaporation is more dependent on the relatively slow diffusion through the air film than would be the case in the drying of a gelatinous material such as smokeless powder through which solvent diffuses very slowly and under which conditions the air film is of considerably less importance.

The diffusion of the solvent vapor through this air film depends upon the temperature and corresponding viscosities of the vapor and the air, upon the difference in partial pressure of the solvent on the two sides of the film, and upon the thickness of the film itself. Under similar conditions of temperature and partial pressure, the greater the velocity of the air by the surface, the greater the effect of tearing away the film, and the thinner it becomes, the rate of diffusion becoming correspondingly greater. This fact explains why in the drying of textile fibers, leather-board, paper, and all other

materials of that nature, through which liquids diffuse rapidly, every effort is made to give high gas velocities by the surfaces, while in drying colloidal materials like smokeless powder, natural draft is often used and is very satisfactory. A very complete discussion of the rate of diffusion with respect to the evaporation of water can be found in an article by W. K. Lewis on Drying.<sup>1</sup>

### Laboratory Experiments on Rate of Drying

For data on the rate of evaporation of solvents, it is necessary to conduct laboratory experiments with respect to the material in question, as rate of evaporation can be determined in no other way. An apparatus used by the author for this purpose has been found to be very satisfactory. This is shown in the following diagram. This

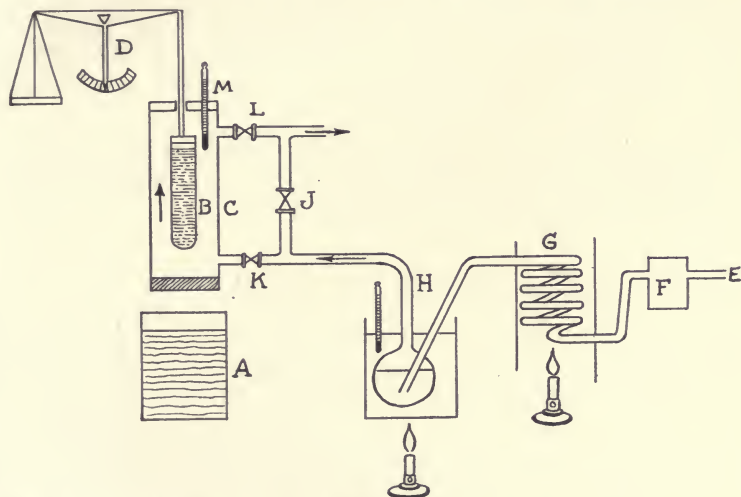

FIG. 43. Laboratory Apparatus for Measurement of Rate of Drying of Films.

particular design was for the purpose of drying thin films of cellulose nitrate, rubber, and so forth, but can be readily modified to suit the material in question.

It consists of test tube *B* suspended in a glass jacket *C* through which water vapor free air is passing in the direction shown by the arrow. The test tube is fastened by a thin wire to one arm of an analytical balance *D*, the wire passing through a small opening in a cork in the upper end of the cylinder. At the start the stopper in

<sup>1</sup>In the *J. Ind. Eng. Chem.* (1921).

the bottom of the cylinder is removed, and the tube is lowered into a jar *A* containing the solution of the cellulose nitrate in the solvent, giving the film to be dried. It is then raised, the cylinder closed, and the tube weighed accurately. It is usually necessary to have the tube full of water to keep it from swinging and hitting the cylinder walls when the air is turned on. The air is then passed around the tube, being measured by a suitable meter at *F*, heated by a coil at *G*, and partially saturated with vapor of the solvent at *H*.

The tube is weighed at stated intervals by opening the by-pass valve *J* and closing *K* and *L*, which gives quiescent conditions without interfering with the air flow. The temperature is measured at *M*. The partial pressure of the vapor in the entering air is calculated by weighing the absorption bulb *H* before and after the run, and from the total volume of air used.

This apparatus permits the determination of accurate data with varying temperature, saturation, and gas velocity, and its results can be safely used if properly interpreted in the design of plant apparatus.

Forced draft is also of great value in connection with the heating and cooling of the air, as the capacity of heaters and coolers is an important function of the gas velocity.

### Flow of Heat under Forced Draft

The rate of flow of heat between a gas and a solid surface such as the surface of a pipe has been carefully studied. At the present time the following formulae are as far as the author knows most nearly correct of any that have been published. The following have been taken with some corrections from an article on Heat Transfer by Lewis, McAdams and Frost, presented at the January (1922) meeting of the American Society of Heating and Ventilating Engineers.

#### Gases Outside Pipes

Where air is flowing outside pipes and at right angles to them the Carrier formula is used.

$$(29) \quad h = \frac{22.3 w}{1.42 + w} \quad \begin{array}{l} \text{for 1'' pipes arranged to give about} \\ \text{50\% minimum clear area} \end{array}$$

where *h* is the coefficient of heat transfer between the solid surface and the air, in B.t.u. per hour per square foot of surface exposed per



degree Fahrenheit temperature difference between the solid surface and the air, and  $w$  is the mass velocity in pounds of air per second per square foot of cross section of the heater or cooler through which the gas is flowing at the line of centers.

The total heat flowing per hour  $Q$ , in an actual apparatus may be calculated if  $h$  is known, from the following heat flow equation. (Newton's)

$$(30) \quad Q = h A \Delta t$$

where  $A$  is the total square feet of heating or cooling surface in the apparatus, and  $\Delta t$  is the average temperature difference between the walls and the air.

*Example 20.* A certain heater consisting of copper pipes 4 feet long, and 1 inch outside diameter and with 1 inch between pipes, arranged on triangular centers, has ten pipes in each row with ten

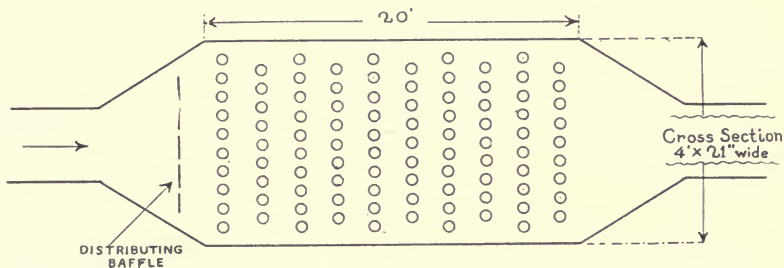

FIG. 44. Diagram of Heater in Problem 20.

rows deep. The pipes contain steam at 10 pounds per square inch gauge pressure (24.7 pounds absolute) and the average temperature of the air passing by the pipes is 100° F. The heater is handling

$$4.0 \text{ lbs. } \frac{4 \times 359 \text{ cu. ft.} \times (460 + 100)}{29 \text{ (mol. wt.)} \times 492} = 56.3 \text{ cu. ft. at } 100^\circ \text{ F.}$$

(See Page 28)

of air per second.

$$w = \frac{4.0}{\frac{11 \times 1}{144} \times 4} = 13.1$$

$$h = \frac{22.3 \times 13.1}{1.42 + 13.1} = 20.1$$

The true coefficient of heat transfer between the condensing steam inside the tubes and the air outside includes the coefficients of heat flow through the metal of the pipe and from the steam to the metal on the inside, but since in the case of heating or cooling air, the resistance to flow of heat from the steam to the metal and through the metal itself is so small in comparison with that from the metal to the air, that the two former are neglected, and the film coefficient figured by the Carrier equation is taken as that of the whole coefficient.

The pressure of 24.7 pounds absolute is equivalent to 239.4° F.

$$\Delta t = 239.4^\circ - 100^\circ = 139.4^\circ$$

$$A = 100 \text{ tubes} \times 4' \text{ long} \times \frac{\pi}{12} = 104.7 \text{ sq. ft.}$$

Therefore  $Q = 20.1 \times 104.7 \times 139.4 = 283,500$  B.t.u. per hr., which is the amount of heat delivered to the air, and since the air is flowing at the rate of 4. pounds per second, and since the specific heat of air is about 0.24, then the rise in temperature of the air will be:

$$\frac{283,500}{4. \times 3600 \times .24} = 85^\circ \text{ F.}$$

### Gases Inside Pipes

Where gases are flowing inside of pipes, the Weber equation applies. This is:

$$(31) \quad h = \frac{0.88 v^{0.8} C_p T^{0.5} S^{0.2}}{M^{0.3}}$$

In this equation,  $h$  is the film coefficient as in the Carrier equation in the same English units;  $v$  is the mass velocity in pounds per square foot of cross section of pipe per second;  $C_p$  is the mean specific heat of the gas at constant pressure;  $T$  is the average temperature of the gas in °F. absolute (°F. + 459.5);  $S$  is the reciprocal of the mean hydraulic radius in feet (in circular pipes  $S = \frac{4}{d}$  where  $d$  is the inside diameter of the pipe in feet), and  $M$  is the molecular weight of the gas (air is 29).

*Example 21.* Carbon monoxide (CO, molecular weight = 28) is flowing through a tubular heater inside the 2' inside diam. tubes, which are 10 feet long, with steam on the outside. The average temperature of the gas is 100° F. and that of the steam 239.4° F. (24.7 pounds absolute pressure). The average velocity of the gas, calculated on its volume at 100° F. is 100 feet per second. Calculate the heat given up by each tube per hour,  $Q/\Theta$ , and the rise in temperature of the gas.

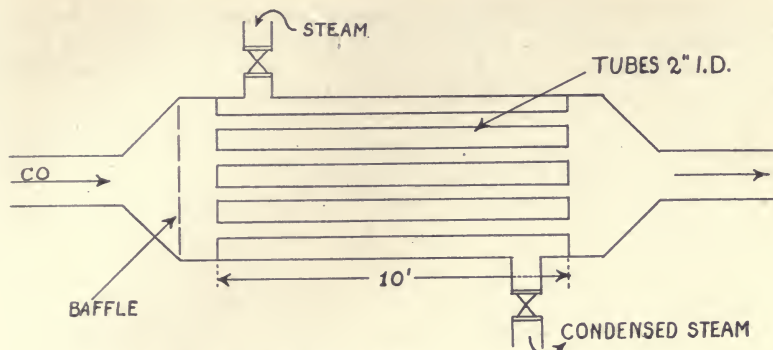

FIG. 45. Diagram of Heater in Problem 21.

$Q = h A \Delta t$  (assuming that  $h$  = the overall coefficient as in the preceding example).

$$v = \frac{100 \text{ (ft. sec.)} \times 28 \text{ (mol. wt.)} \times 492^\circ}{359 \text{ (pd. mol. vol.)} \times (460^\circ + 100^\circ)} = 6.85 \text{ lbs. per sq. ft. per sec.}$$

$$v^{0.8} = \text{anti log. (0.8 log. 6.85)} = 4.66$$

$$MC_p \text{ (for CO at } 100^\circ \text{ F.)} = 6.5 + .0010 T \text{ (where } T \text{ is } ^\circ\text{C absolute,}$$

$$100^\circ \text{ F.} = \frac{(100^\circ + 460^\circ) \times 5}{9} = 311^\circ \text{ C absolute).}$$

$$C_p = \frac{6.5 + .0010 (311)}{28} = .243$$

$$T^{0.5} = \sqrt{460 + 100} = 23.7$$

$$S^{0.2} = \left(\frac{4}{2/12}\right)^{0.2} = \text{anti log. (0.2 log. 24)} = 1.89$$

$$M^{0.3} = \text{anti log. (0.3 log. 28.)} = 2.72$$

$$h = \frac{0.88 \times 4.66 \times .243 \times 23.7 \times 1.89}{2.72} = 16.4$$

$$A = 10 \times \pi \left(\frac{1}{12}\right)^2 = 5.23 \text{ sq. ft.}$$

$$\Delta t = 239.4^\circ - 100^\circ = 139.4^\circ \text{ (as before)}$$

$$Q = 16.4 \times 5.23 \times 139.4 = 11970 \text{ B.t.u. per tube per hr.}$$

The rise in temperature of the gas will be:

$$\frac{6.85 \times \pi \left(\frac{1}{12}\right)^2 \text{ (area of tube)} \times 3600 \times .243}{11970} = 91.6^\circ \text{ F.}$$

There are no data available to determine the coefficient of heat flow outside of pipes and at right angles to them for gases other than

air. The author suggests that a good guess may be made if such a calculation is necessary, in the following manner:

(1) Calculate  $h_1$  for the gas inside the pipes by Weber's formula for the particular gas at the given temperature, velocity, etc.

(2) Calculate  $h_2$  for *air inside* pipes for the same conditions.

(3) Calculate  $h_3$  for *air outside* pipes by Carrier's formula for the conditions under which the gas is to flow.

(4) Estimate the coefficient needed  $h_4$  by the following ratio:

$$\frac{h_4}{h_3} = \frac{h_1}{h_2}$$

### Condensing Vapor

The coefficient of heat transfer for a condensing vapor containing no non-condensable gases from the vapor to a solid condensing surface may be calculated by McAdams and Frost formula:

$$(32) \quad h = 2200 \frac{k}{z}$$

where  $k$  is the thermal conductivity of the condensed vapor, and  $z$  is its viscosity relative to water at 68° F.

Table	Thermal conductivity of liquids (approximate)
Water	.35
Ether	.08
Acetone	.10
Methyl alcohol	.12
Ethyl alcohol	.10
Benzene	.08
Toluene	.07
Petroleum	.09
Cylinder oil	.07

#### Example 22.

$h$  for condensing steam at 212° F.

$$z = .28$$

$$h = 2200 \times \frac{.35}{.28} = 2750$$

$h$  for condensing benzene at 176° F.

$$z = .33$$

$$h = 2200 \times \frac{.08}{.33} = 530$$

$h$  for condensing alcohol at 172° F.

$$z = .48$$

$$h = 2200 \times \frac{.10}{.48} = 460.$$

In the case where the condensing vapor contains non-condensable gases the author has developed an equation which applies to condensing steam only under conditions such as are obtained in evapora-

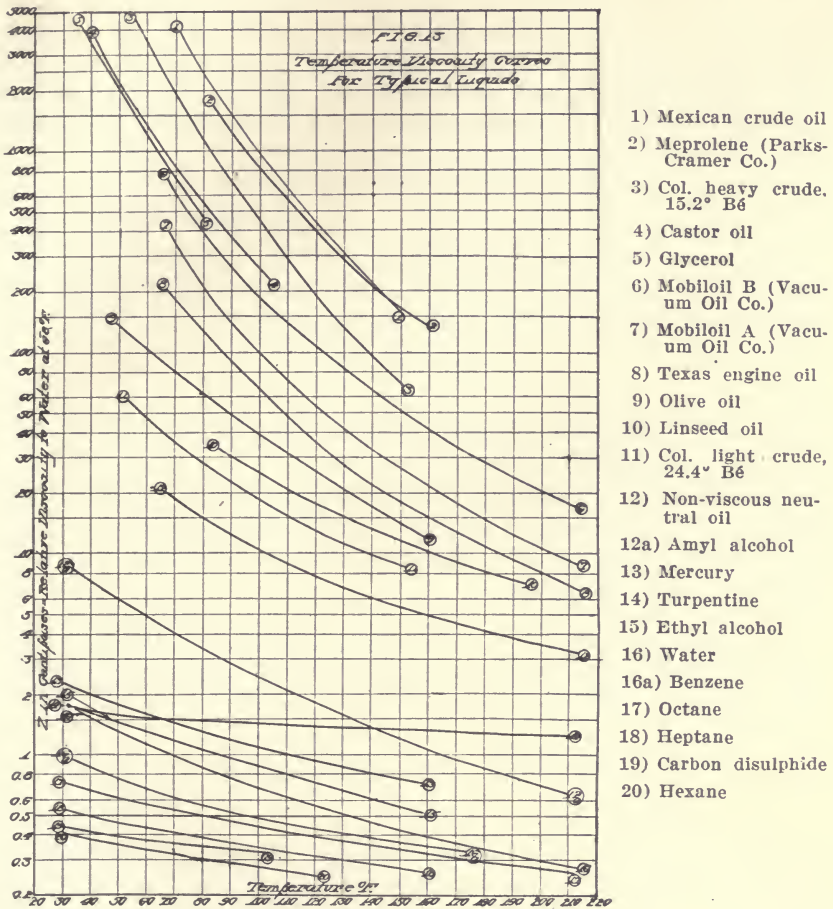

Fig. 46. Relative Viscosity of Liquids.

tors. This applies only to average percentages by volume of the steam in the steam air mixture of from 99% to 67%.

$$(33) \quad \log_{10} h = 1 + .0246 X$$

where X is the average per cent steam.

*Example 23.* Steam enters a condenser containing 2% of non-condensable gas, and the gas leaving the condenser contains 70%



water vapor. The film coefficient of heat transfer would therefore be approximately:

$$\log_{10} h = 1 + .0246 \left( \frac{98 + 70}{2} \right)$$

$$h = 1160.$$

Where the condensing vapor is other than water, nothing is available. The author suggests in absence of better, a combination of the last equation with the McAdams and Frost formula for pure vapors.

### Heat Flow to a Moving Liquid

Condensers and coolers usually have some fluid such as water separated from the condensing vapor by a dividing wall. The film coefficient of heat transfer between a moving liquid and a solid surface is given by the Frost and Manley equation:

$$(34) \quad h = \frac{712 c k u^{0.8} S^{0.17}}{z}$$

where  $c$  is a smoothness constant, varying from 1.0 for smooth drawn copper pipe, and 0.5 for standard steel pipe to 0.3 for dirty steel pipe,  $k$  is the thermal conductivity of the liquid as before,  $u$  is the liquid velocity in feet per second,  $z$  is the viscosity relative to water at 68° F., and  $S$  is the reciprocal of the mean hydraulic radius in feet, as in the Weber equation above.

*Example 24.* Water at 68° F. is flowing at the rate of 2.0 feet per second through a 2" inside diameter clean steel pipe. Calculate the film coefficient of heat transfer between the liquid and the wall of the pipe.

$$h = \frac{712 \times .5 \times .35 \times (2)^{0.8} \left( \frac{4}{2/12} \right)^{0.17}}{1.0} = 382$$

The overall coefficient of heat transfer between two points where there are a number of varying resistances to heat flow throughout the path of flow can only be calculated by considering the several resistances separately and then combining their effects. This is done by adding the several resistances, which are the reciprocals of the several individual conductivities, and the reciprocal of their sum will be the overall conductivity coefficient. Thus in the case of a condenser, there is the film coefficient from the condensing vapor to the wall of the tube, there is the conductivity through the metal of the tube itself and there is the film coefficient between the tube and the condenser water.

If  $h_v$  represents the vapor film coefficient,  $k_m$  the conductivity through the metal, and  $h_1$  the liquid film coefficient, then  $H$ , the overall coefficient, will be calculated as follows:

$$(35) \quad H = \frac{1}{\frac{1}{h_v} + \frac{1}{k_m} + \frac{1}{h_1}}$$

The conductivity of the metals per average square foot of surface (the average of the inside and outside surfaces of relatively thin tubes) is the coefficient of the metal per foot of thickness ( $k$ ), divided by the thickness in feet ( $l$ ).

$$(36) \quad k_m = \frac{k}{l}$$

$k$  = B.t.u. per hour per square foot per foot of thickness per degree Fahrenheit temperature difference.

AVERAGE VALUES FOR THE CONDUCTIVITY OF COMMON METALS

Material	Temperature range ° F.	$k$
Silver .....	64	243.
Copper .....	68	238.
Aluminum .....	32 to 212	85.
Zinc .....	64	64.
Brass .....	32 to 212	55.
Iron (wrought) .....	32 to 527	40.
Iron (cast) 3.5% C. ....	86	36.
Tin .....	32	35.
Steel .....	82	32.
Nickel .....	68 to 392	32.
Lead .....	59	20.

Values for other solids may be found in any handbook of mechanical engineering.

Where the solid wall consists of more than one layer of different metals, the individual resistances are added in place of the one resistance as given.

*Example 25.* A condenser receives steam at 212° F. and is cooled by water under the conditions stated in example on page 108 where the film coefficient on the water side was calculated to be 382. That on the steam side was found, on page 106, to be 2750. If the steel tube were  $\frac{1}{8}$ " thick the coefficient " $k_m$ " for the metal would be

$$32 \times 12 \times 8 = 3070.$$

If the condenser had been in the form of a flat plate, the value of  $H$  would then have been figured by means of equation (35), or

$$\frac{1}{H} = \frac{1}{\frac{1}{2750} + \frac{1}{3070} + \frac{1}{382}}$$

$$H = 302.$$

But since the condenser consists of a tube, the inside area of which is less than the outside, and for each unit length (foot) of tube the actual areas should be used, and  $H'$  (the overall coefficient per foot of tube) calculated as follows:

The inside area of one foot of 2" inside diam. pipe is

$$\frac{2\pi}{12} = 0.523 \text{ sq. ft.}$$

The outside area (diameter = 2.25") is

$$\frac{2.25\pi}{12} = 0.589 \text{ sq. ft.}$$

The average area of the metal in the pipe is really the logarithmic mean of the inside and outside areas, but for thin walled pipes the arithmetic mean is sufficiently precise, and is

$$\frac{0.523 + 0.589}{2} = 0.556 \text{ sq. ft.}$$

To calculate  $H'$  proceed as follows:

$$\frac{1}{H'} = \frac{1}{\frac{1}{2750 \times .589} + \frac{1}{3070 \times .556} + \frac{1}{382 \times .523}}$$

$$H' = 161.$$

To compare  $H$  as figured for a flat plate and  $H'$ , the latter must be divided by the average area of the pipe per foot of length, or .556 sq. ft.

$$\frac{161}{.556} = 290$$

as compared with 302 for the flat plate. This deviation becomes more marked as the ratio of thickness of the metal to the diameter of the pipe increases.

### Drop in Pressure through Coolers

The factor next in importance to the coefficient of heat transfer in the design of condensers is the drop in pressure of the fluids passing through them. In general it may be stated that the more rapid the flow of fluid the greater the coefficient of heat transfer and the

greater the drop in pressure. The design of condensers therefore becomes an economic balance between the saving in heating surface and the increased cost of pumping the gas or liquid.

The drop in pressure experienced when a fluid passes through an apparatus is due to a combination of several effects of which the principal ones are friction and change of velocity. The change in potential head due to a change in the height of the fluid above some fixed level must also be considered.

### Contraction Losses

When the passage through which the fluid passes has cross sections of varying area, causing increases or decreases in the fluid velocity, the pressure drops experienced at such points are known as contraction and expansion losses respectively. The loss in pressure expressed as equivalent feet of head for sudden contraction losses is given by the equation:

$$(37) \quad \Delta p = \frac{k u^2}{2 g}$$

where  $u$  is the linear velocity of the fluid in the smaller cross section,  $g$  is 32.2, and  $k$  is a constant to be determined from the following diagram (Fig. 47).

*Example 26.* Water is flowing through a pipe 4" in diameter which is reduced suddenly to 2" diameter. The velocity in the 2" pipe is 4 feet per second.

$$\Delta p = \frac{k(4)^2}{64.4} \quad k \text{ from the diagram is found for}$$

$$\frac{A_2}{A_1} = .25 \text{ to be } 0.405$$

$$\Delta p = .062 \text{ feet of water pressure drop.}$$

Enlargement losses may be determined from the formula

$$(38) \quad \Delta p = \frac{(u_1 - u_2)^2}{2g}$$

Thus the water issuing from the 2" pipe as above into a 4" pipe would suffer a pressure drop of

$$\frac{(4 - 1)^2}{2g} = .144 \text{ feet of water pressure drop.}$$

For flow of compressible fluids such as air or vapor where the pressure drop is considerable (more than 10% of the absolute pressure on the fluid), the reader is referred to Mark's "Mechanical Engineer's Handbook" or any book on Thermodynamics.



## Pressure Drop in Circular Pipes

The pressure drop for fluids flowing circular pipes is calculated from the Fanning formula:

$$(39) \quad \Delta p = \frac{2 f l s u^2}{g d}$$

where  $l$  is the length of the pipe in feet plus the equivalent length of elbows and other constructions.

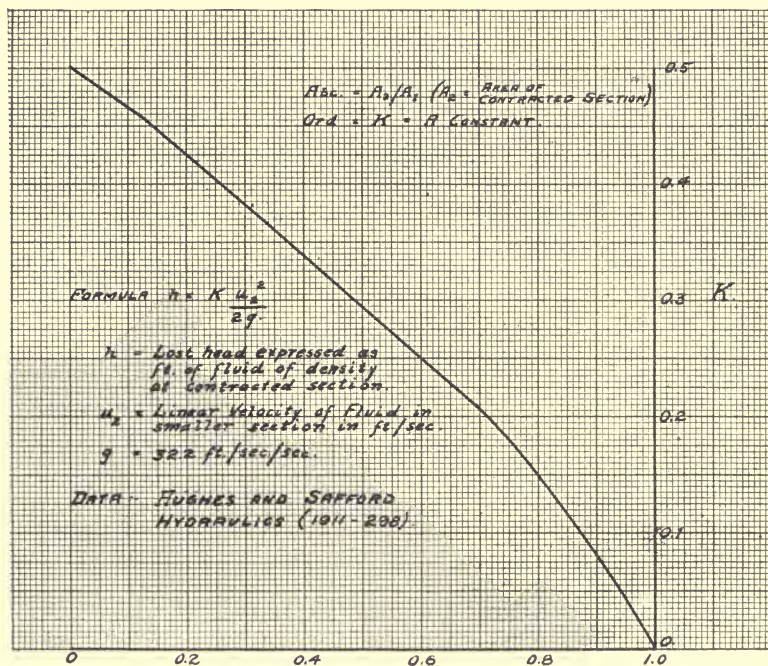

Fig. 47. Constant for Equation of Contraction Loss.

Equivalent lengths, expressed as diameters of additional lengths of pipe (Walker, Lewis and McAdams).

90° elbows	1" to 2½"	— 30 diameters.
	3 to 6	— 40 "
	7 to 10	— 50 "
Tees	1 to 4	— 60 "
Crosses		— 50 "
Globe valves	1 to 2½"	— 45 "
	3 to 6	— 60 "
	7 to 10	— 75 "



- s = the weight in pounds of one cubic foot of the fluid.
- u = the average velocity of the fluid in feet per second.
- g = 32.2.
- d = inside diameter of pipe in feet.
- $\Delta p$  = pressure drop in pounds per square foot.
- f = the friction factor to be determined from the following plot.

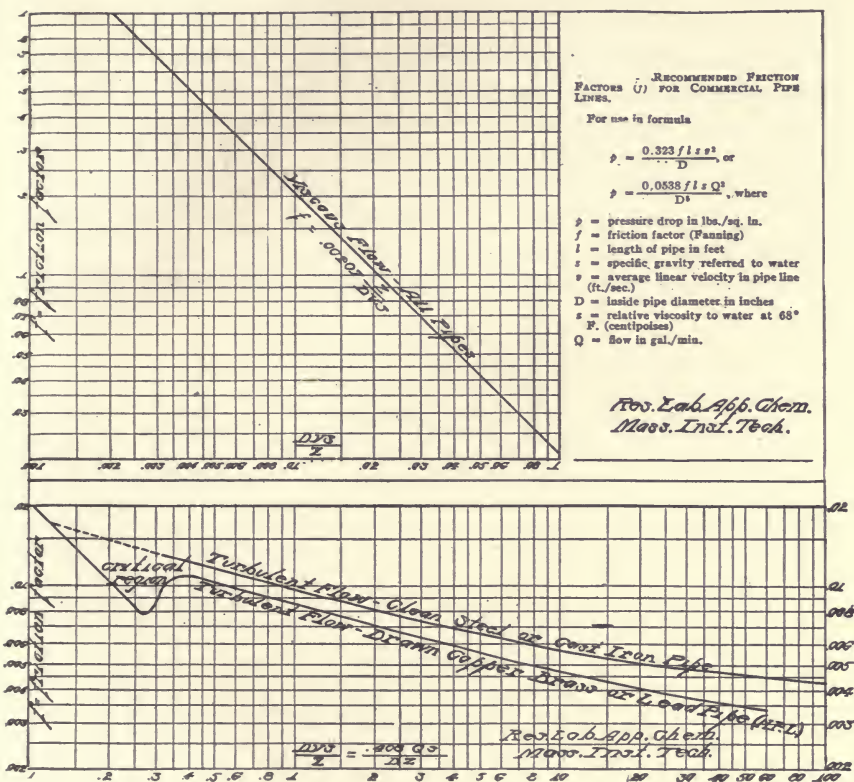

FIG. 48. Friction Factor of Flow Through Pipes.

(Fig. 12. Wilson, McAdams, and Seltzer. *J. Ind. Eng. Chem.*, Feb., 1922), in which  $f$  is plotted against  $\frac{Dus}{z}$  where

- D = the inside diameter of the pipe in inches
- S = the specific gravity of the liquid
- z = its viscosity relative to water at 68° F.

(See Fig. page 107.)

*Example 27.* Calculate the drop in pressure of water at 68° F. flowing through 1000 feet of 3" pipes at a velocity of 2 feet per second.

$$\frac{D u s}{z} = \frac{3 \times 3 \times 1}{1} = 6. \text{ and therefore } f = .0061 \text{ from the diagram.}$$

$$s = 62.4, u = 2, g = 32.2, d = .25$$

$$\Delta p = \frac{2 \times .0061 \times 1000 \times 62.4 \times (2)^2}{32.2 \times .25} = \begin{array}{l} 378 \text{ lbs. per sq. ft.} \\ = 2.63 \text{ lbs. per sq. in.} \end{array}$$

For pipe sections other than circular, such as the annular space in a double pipe cooler, it is suggested that in place of  $d$  in the Fanning formula,  $4m$  be substituted where  $m$  is the hydraulic radius in feet (the area in square feet divided by the perimeter in feet), and that the same thing be done in determining  $f$ . For very low velocities in non-circular passages the friction may be much higher than this calculation would indicate (due to non-turbulent flow).

For pressure drop for air at right angles to the outside of pipes, see page 99.

## CHAPTER XIX

### APPARATUS USED IN FORCED CIRCULATION OF GASES

The principles involved in the vaporization and condensation of solvents in the presence of gases are the same whether the gas be inert and non-condensable in the usual sense of the word, or if it be superheated vapor of the solvent in question, as is the case in the DuPont recovery apparatus (refer to Patent description). While it is possible to use the inert gas only once, discarding it after leaving the condenser, and heating fresh gas, this is not often done except in special cases. It is usually returned to the system after partial removal of the solvent. A diagrammatic representation of the usual type of plant is given below.

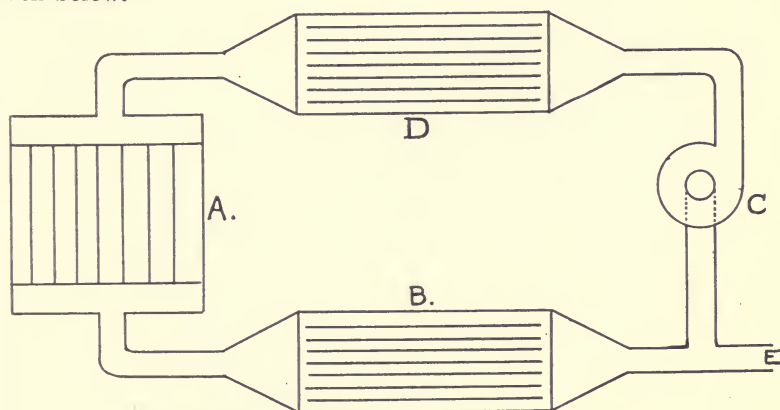

FIG. 49. Diagram of Gas Circulation System.

This consists of a drier *A* in which the solvent is vaporized, the condenser *B*, in which part of the solvent is condensed and removed from the system, the blower *C*, and the reheater *D*. Fresh gas enters at *E* to replace what is lost in leaks in the rest of the apparatus. Once the apparatus is in operation the fresh gas entering is usually negligible as compared with the volume circulated.

A well worked out design for a plant making use of this method of recovery is given in the following diagram.<sup>1</sup> In this diagram the drier

<sup>1</sup> From "Explosion-proof Process of Solvent Recovery," B. F. Dodge, *Chem. and Met. Eng.*, 26, March 1, 1922. U. S. Patent.

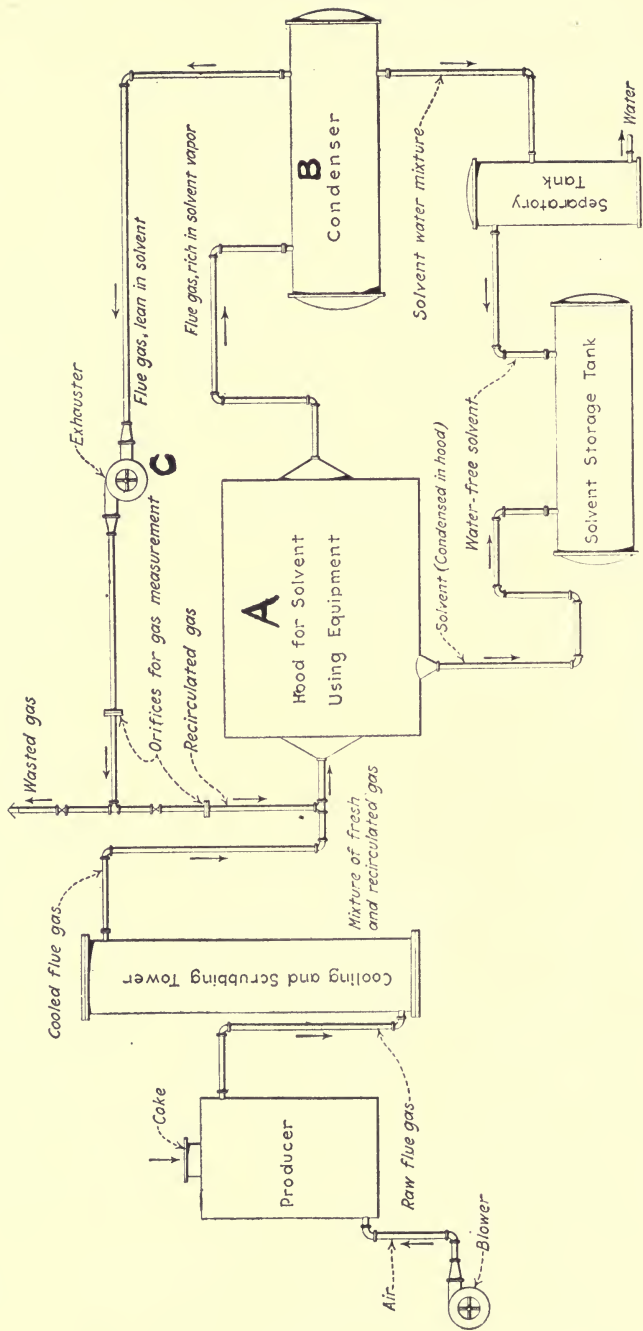

Fig. 50. Example of System Using Gas Circulation.

is indicated by the letter *A*, the cooler by *B*, and the blower by *C*, as in the previous figure. In this case, however, the heat for vaporizing the solvent is furnished by steam pipes inside of the drier itself, instead of by a preheater as before. In many cases a combination of the two methods is used. In the present case, the gas used as a circulating medium is a washed producer gas, produced as indicated in the diagram. The separator tank is for the purpose of removing from the condensed solvent by decantation, any water which may have been condensed in the cooler along with it.

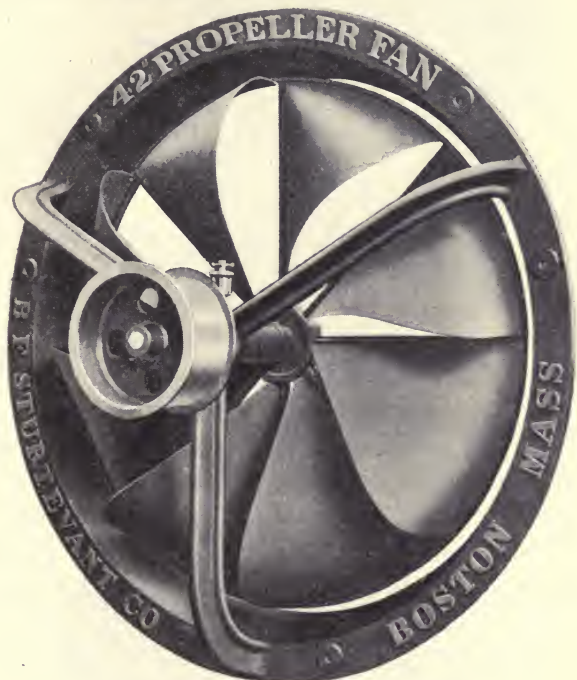

FIG. 51. Propeller Type of Fan.

### Fans and Blowers

The use of forced circulation in solvent recovery requires suitable blowers or fans. Any of the well known makes are suitable, the chief thing that is necessary to consider being the pressure drop against which the fan must operate.

For handling large amounts of gases under very low pressure drops, below one inch of water, the following type of fan is suitable. (Propeller type.)



This type of fan is very rarely used, however, as pressure drops of such small amounts are not common in solvent recovery work.

For any volume of gas up to a maximum pressure drop of 8" of water fans similar to the following are available (multi-vane type).

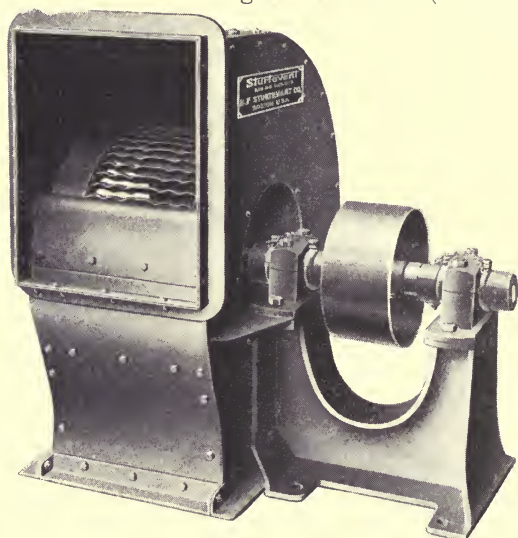

FIG. 52. Multi-vane Type of Fan.

For pressure drops up to 15 inches and for any volume, fans of the Steel Plate or Planing Mill Exhaustion types are suitable, as illustrated in the following cut.

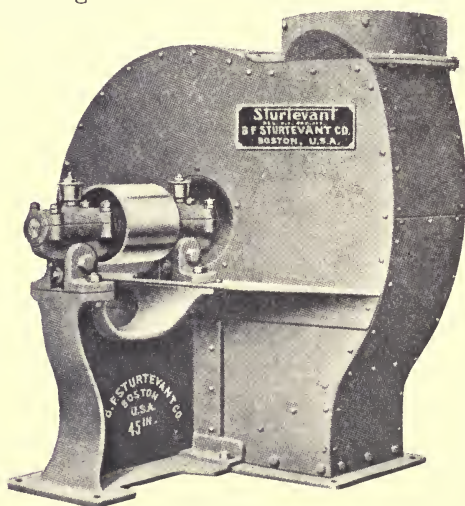

FIG. 53. Steel Plate Fan.

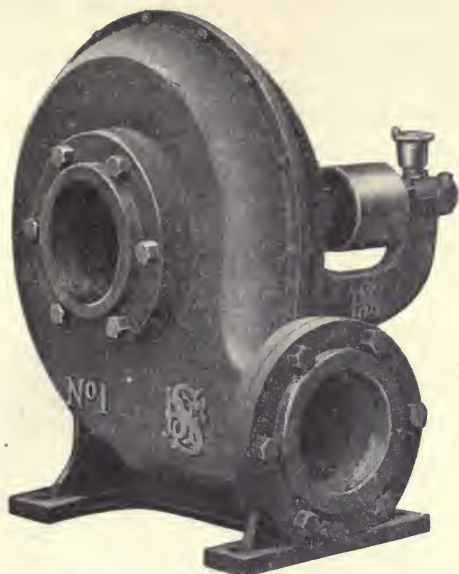

FIG. 54. Gas Booster or Blower.

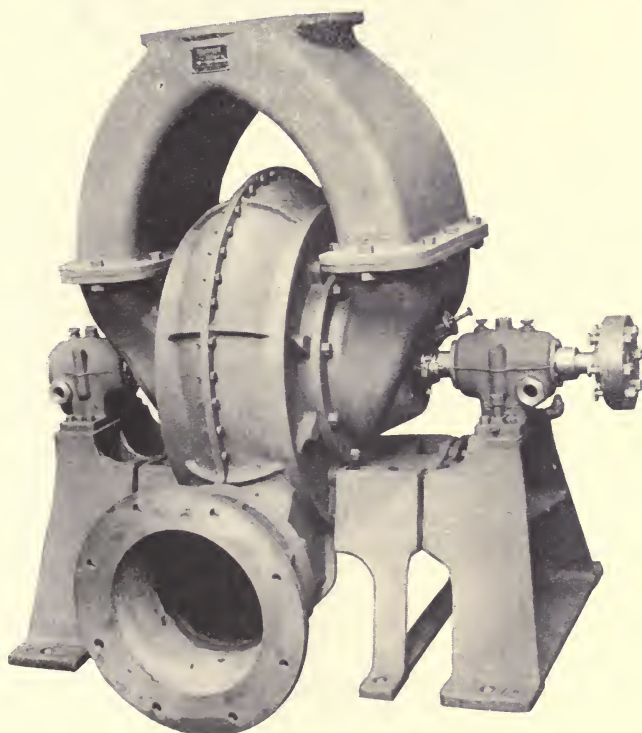

FIG. 55. Pressure Blower.

For volumes up to 10,000 cubic feet per minute at 18 inches of water pressure, the booster type may be used.

For volumes up to 20,000 cubic feet per minute and 42-inch water pressure, the type of gas blower shown in Fig. 55 is available.

Higher back pressures require blowers of the positive pressure type, among the best known being the Roots or Connersville type. The construction of these rotary blowers is shown in the following cut.

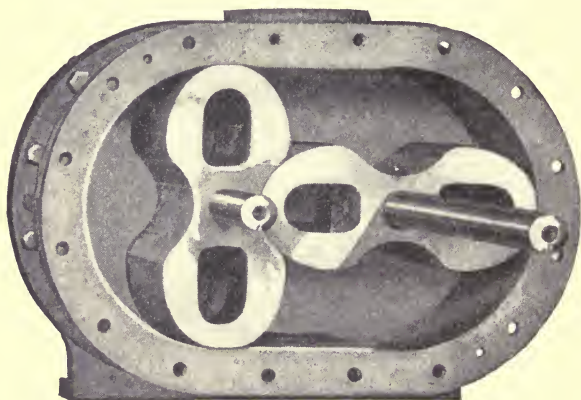

FIG. 56. High Pressure Blower.

These blowers are available for any amounts of gas up to pressures of 10 pounds per square inch.

For pressure drops of still greater magnitude, compressors of the reciprocating or turbine type are required.

The actual power consumption of the fan is the theoretical power consumption of the fan divided by the efficiency. The fan efficiency depends upon the conditions under which it operates, but where a suitable fan is chosen, the efficiency may be taken as from 40% to 50%.

*Example 28.* The theoretical power required to blow 10,000 cubic feet of air at 32° F. and normal barometer (29.92 inches mercury) per minute against a back pressure of 6 inches of water, is calculated as follows:

$$\text{Work } (W) = NRT \log_e \frac{p_2}{p_1}$$

for perfect gases (and approximately for ordinary gases) at constant temperature where

APPARATUS USED IN FORCED CIRCULATION OF GASES 121

$N$  = number of molecular weights of gas handled

$R$  = the gas constant (1544)

$T$  = absolute temperature (in this case taken as ° F.abs.)

$$N = \frac{10,000}{359} = 27.8 \text{ lbs. mols}$$

$$T = 492^\circ \text{ F.abs.}$$

$$W = 27.8 \times 1544 \times 492 \times \log_e \frac{29.92 + \frac{6}{13.6}}{29.92} \text{ (specific gravity of mercury = 13.6)}$$

$$W = 317,000 \text{ foot pounds}$$

$$\text{Horse power} = \frac{317,000}{33,000} = 9.3$$

If the efficiency of the blower be taken as 40%, the actual power required will be

$$\frac{9.3}{.40} = 23.3 \text{ horse power.}$$

## CHAPTER XX

### SOLVENT RECOVERY BY COMPRESSION AND COOLING

#### Work of Compression. Perfect Gases

The compression of a perfect gas from the pressure  $p_1$  to some other pressure  $p_2$  at constant temperature  $T$  requires an amount of work  $W$  as indicated by the following equation:

$$(40) \quad W = R T \log_e \frac{p_1}{p_2}$$

for one mol of a gas where  $R$  is the gas constant, 1.99 when measured in heat units.

When the compression is adiabatic, that is when no heat enters or leaves the system, the work required to compress one mol of the gas is given as follows:

$$(41) \quad W = \frac{(p_1 V_1 - p_2 V_2)}{k - 1}$$

where  $k$  is the ratio of the specific heat of the gas at constant pressure to that at constant volume, being 1.4 for diatomic gases such as oxygen and air.  $V$  represents the volume of the gas in proper units, such as cubic feet.

#### Actual Gases

The relation between the pressure and the volume of a perfect gas at constant temperature is given by the equation

$$(42) \quad P V = \text{constant}$$

For air and other gases of that type this relation is given as follows:

$$(43) \quad P V^n = \text{constant}$$

the value of  $n$  being one for isothermal compression in the case of perfect gases. For adiabatic changes the value of  $n$  is equal to  $k$  for perfect gases and in the case of air in the ordinary cases of air compression,  $n$  is equal to 1.3 approximately.



For gaseous mixtures  $k$  is estimated as follows:

$$K_{av} = \frac{M_{av} C_{Pav}}{M_{av} C_{Vav}}$$

$$M_{av} C_{Pav} = \frac{M_1 C_{P1} x + M_2 C_{P2} (1-x)}{M_1 C_{V1} x + M_2 C_{V2} (1-x)}$$

$$M C_P - M C_V = R = 1.99$$

where  $x$  is the mol fraction of component (1) and  $(1-x)$  that of component (2), whose molecular weights and specific heats at constant pressure are  $M_1$  and  $C_{p1}$  and  $M_2$  and  $C_{p2}$  respectively.

The temperature obtained after an adiabatic compression or expansion is calculated as follows:

$$(44) \quad \frac{T_2}{T_1} = \left( \frac{p_2}{p_1} \right)^{\frac{n-1}{n}}$$

and the work done on the gas during the compression is calculated by the equation

$$(45) \quad W = \frac{n (p_2 V_2 - p_1 V_1)}{n-1}$$

*Example 29.* One mol, 29 pounds, of air is compressed adiabatically in a compressor without a water jacket to remove the heat, from one atmosphere to five atmospheres pressure, the initial being 70° F. Calculate the theoretical work needed to do this and the temperature of the air after the compression. (The actual work needed will, of course, be the theoretical work divided by the efficiency of the compressor.)

Assume that the value of  $n$  in this case is 1.3.

$$V_1 = 359 \times \frac{460 + 70}{460 + 32} = 387 \text{ cu. ft.}$$

$$p_1 V_1^{1.3} = p_2 V_2^{1.3}$$

$$V_2 = \left( \frac{p_1 V_1^{1.3}}{p_2} \right)^{\frac{1}{1.3}} = 111 \text{ cu. ft.}$$

$$W = \frac{1.3 (5 \times 111 - 1 \times 387)}{1.3 - 1} = 730 \text{ foot-atmospheres or}$$

$$730 \times 14.7 \times 144 = 1,546,000 \text{ foot pounds.}$$

If this amount of air were to be compressed in the time of one minute, there would be required an amount of power equal to

$$\frac{1,546,000}{33,000} = 47 \text{ horsepower.}$$

The temperature of the air after the compression would be calculated as follows:

$$\frac{T_2}{530} = \left(\frac{5}{1}\right)^{\frac{0.3}{1.3}} \text{ whence } T_2 = 769^\circ \text{ F. abs.} = 309^\circ \text{ F.}$$

The theoretical work that a gas will do when it expands adiabatically doing work in a cylinder is exactly the equivalent to the work required to compress it between the same pressure limits. The actual work that it will do in this case is, however, the theoretical work multiplied by the efficiency of the expansion engine. The temperature that will be reached in such an expansion will be the theoretical temperature corrected for the heat developed in the cylinder by friction.

It is not feasible to attempt to cool the gas by expansion through a throttling valve as is done in the case of condensible vapors below their critical temperatures, as the cooling obtained this way, known as the Joule-Thompson effect, is relatively small compared to that obtained by expansion in a cylinder doing work.

### Vapors

Those gases that exist below their critical temperatures are ordinarily called vapors as it is possible to cause them to condense if the pressure on them is sufficiently raised. Most of the vapors that one has to do with in solvent recovery work are substances that are liquid at ordinary temperatures and at atmospheric pressure. And it is only by raising their temperature or lowering the pressure at which they are present that they may be obtained in the gaseous condition.

A vapor that consists of only one substance may exist in either the saturated or the superheated condition. When in the former, its pressure corresponds to a definite temperature, while when in the superheated condition its pressure and temperature may be varied independently of each other.

When a pure vapor is in the saturated condition, some of the same substance in the liquid condition can be introduced into it if at the same temperature, without changing the pressure or temperature. When this happens the vapor is in the wet or moist condition and heat can be applied to the mixture of vapor and liquid without any other effect than vaporizing some of the liquid at constant temperature and pressure. When enough heat has been supplied to vaporize all of the liquid present, any further application of heat will cause the temperature to rise and the vapor will become superheated.

The effect of temperature and pressure upon a pure vapor may best be shown by means of what is known as the temperature-entropy diagram, Fig. 57. The expression, entropy, is used to indicate a mathematical device for measuring the availability of the energy in a vapor; that is, when a vapor undergoes a change in entropy, the energy that it contains has become more or less available according to the direction of the change. Such a diagram for pure steam is shown in the following figure, where ordinates represent temperature

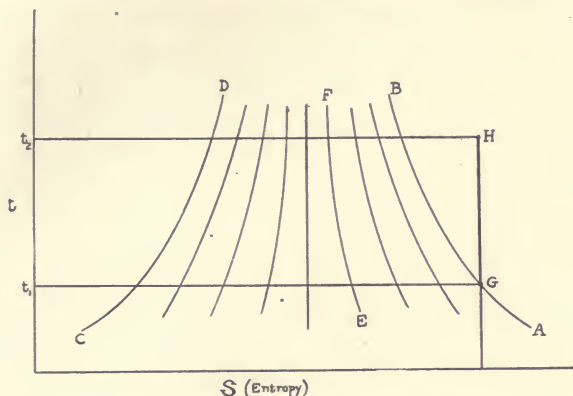

FIG. 57. Temperature-Entropy Diagram.

and abscissae represent entropy. In this figure the line  $AB$  is the line for saturated steam without any liquid water, while the line  $CD$  shows the change in the temperature with the entropy for liquid water without any water vapor. The intermediate lines are for mixtures of steam and water, the line  $EF$ , for instance, representing that for a mixture of 60% steam and 40% water.

Suppose that water-free or dry steam exist at the temperature  $t_1$  represented by the point  $G$ , and that it be compressed adiabatically, without heat either entering or leaving the system, until it has risen to the temperature  $t_2$  represented by the point  $H$ . It will now be in the superheated condition.

The amount of work needed to change it to this condition may be read directly from another chart shown in the following figure, Fig. 58, which is a chart of total energy in the vapor, measured in the form of heat, plotted against entropy. In this chart the line representing dry saturated vapor is shown by the line  $AB$  as in the previous chart, while the line representing a mixture of 60% steam and 40% water is

shown by the line  $EF$ . The point  $G$  is the same as that in the previous chart, as is the point  $H$ . The lines  $JK$ ,  $LM$ , etc., are lines of constant number of degrees of superheat, while those marked  $OP$ ,  $QR$ , etc., are lines of constant pressure. In the chart on page 125 the number of degrees of superheat to which the vapor has been raised is represented by the distance  $GH$  or  $t_2 - t_1$  and the point  $H$  on the chart on page

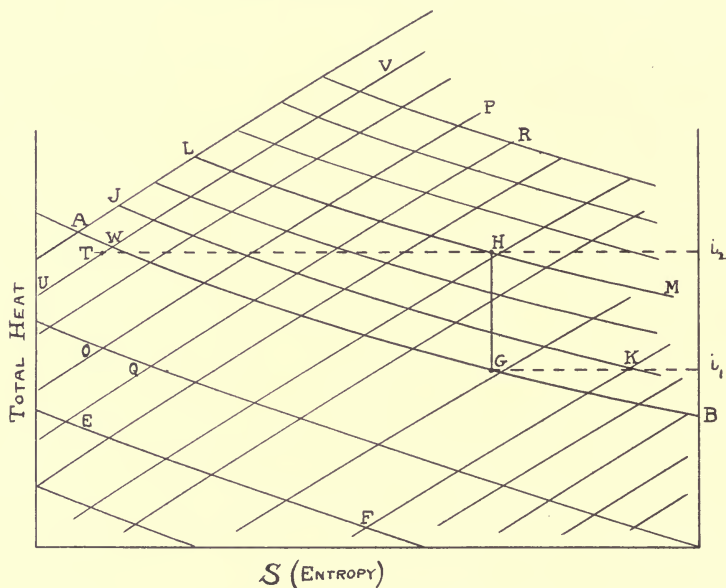

FIG. 58. Total Heat-entropy Diagram.

126 lies on the corresponding line of constant number of degrees of superheat. The increase in energy of the vapor due to this compression is indicated by the difference between  $i_2$  and  $i_1$  and represents the amount of work that was done on the vapor during the compression.

When a vapor expands adiabatically doing work in an expansion engine, the amount of work done may be determined in a similar manner. Any good book on thermodynamics of the steam engine will give a full discussion of this subject and steam tables are available for making the necessary calculations. So far as other vapors than steam are concerned, there are available tables of properties for ammonia, sulphur dioxide, and such other substances as are used in mechanical refrigeration, but for most of the solvents in common use,



the writer knows of no such data available. In the absence of such information, the most that can be done without extended investigations will be to use the steam tables as if for water, making such modifications as are necessary to allow for the variation in vapor pressure and vapor density in the substance in question from the corresponding values for water.

### Mixtures of Vapors and Gases

The problem of compressing a mixture of a vapor and a gas is almost always that of the vapor in the superheated condition, and therefore it becomes one of a mixture of two gases and can in general be solved as indicated above on page 121. That of the expansion of a vapor or a gas is much more complicated.

The expansion of a pure vapor doing work has been indicated above. However when the expansion takes place through an expansion valve or nozzle, it occurs practically under conditions of constant energy, except as friction is developed, and the resulting condition of the vapor can be read off the total heat—entropy diagram given above. For instance, suppose that the superheated vapor at the point *H* was allowed to expand through a throttling valve from the pressure corresponding to the point *H* to some lower pressure indicated by the point *T*, the temperature of the gas at the end of the expansion will be that corresponding to the pressure if the line *HT* has crossed the saturation line *AB*, while if the point *T* had remained on the upper side of this line the temperature obtained would be that corresponding to the pressure plus the number of degrees of superheat corresponding to the location of the end of the expansion.

### Advantages of Compression

The reason for compressing a mixture of a gas and a vapor is two-fold. In the first place, the partial pressure of the vapor in the mixture is increased in proportion to the increase in the total pressure. This permits the condensation of the vapor at temperatures considerably above that at which it would condense at ordinary pressures.

For instance, suppose that a gas at atmospheric pressure is saturated with benzene vapor at 20° C., at which temperature the vapor pressure of benzene is 74.7 mm. of mercury. If this mixture be compressed to five atmospheres pressure, the temperature being kept at 20° C. by contact with cooling surfaces in the compressor and re-



ceiver, the partial pressure of the benzene vapor would have become  $5 \times 74.7$  mm. But at  $20^{\circ}$  C., the vapor pressure of benzene is 74.7 mm. Therefore in order to keep this partial pressure constant, four fifths of the benzene must have condensed. The heat which must have been removed during this compression at constant temperature would have been the sum of that due to the compression of the gas, calculated as above, and that due to the condensation of the four fifths of the benzene at constant pressure and temperature.

The second reason for compressing the gaseous mixture is the fact that a compressed gas, when cooled, and then allowed to expand doing work, will cool itself to a low temperature, much below that which can be obtained without the use of mechanical refrigeration.

The two effects may be utilized singly or together, or, of course, in connection with any of the other types of solvent recovery.

For instance, the gas mentioned in the previous example, containing 74.7 mm. of benzene and at five atmospheres pressure, could be expanded in a cylinder or turbine doing work, and reduced to a low temperature as indicated on page 124, the theoretical temperature drop, neglecting the presence of the benzene vapor, being in the vicinity of  $200^{\circ}$  F. The partial pressure of the benzene in this case would therefore drop to  $74.7 \div 5 = 14.9$  mm. But at  $-130^{\circ}$  F. the vapor pressure of benzene is very low, in the vicinity of 1 to 2 mm. and therefore most of the benzene in the gas would have condensed before that temperature was reached. But in condensing, the heat of condensation would have been liberated, thus decreasing the drop in temperature of the gas, the net result being a combination of the three effects, the cooling due to the expansion, the heating due to the condensation of the benzene, and the heating due to friction. It is difficult to predict the actual temperatures thus obtained, but under some circumstances,  $-100^{\circ}$  F. would not be unreasonable to expect.

The final operation in a plant using this process of compression and subsequent expansion is that of the heat interchanger, the cold gas more or less freed of solvent being used to cool the hot gas leaving the compressor. The surface required in the heat interchanger may be readily calculated by the methods given above.

In general the apparatus required for such a plant would consist of those indicated in the following diagram.

In this diagram the gas and vapor mixture passes successively through the compressor, water cooler, heat interchanger, expansion

engine, heat interchanger, and to the exhaust, the condensed solvent being tapped off at each point as indicated.

A plant very nearly the duplicate of this has been in operation in the writer's vicinity, the only change being the introduction of a pre-cooler for the air before entering the compressor for the purpose of removing as much heat as possible and lightening the load on the compressor. The air was then compressed in two stages with an inter-

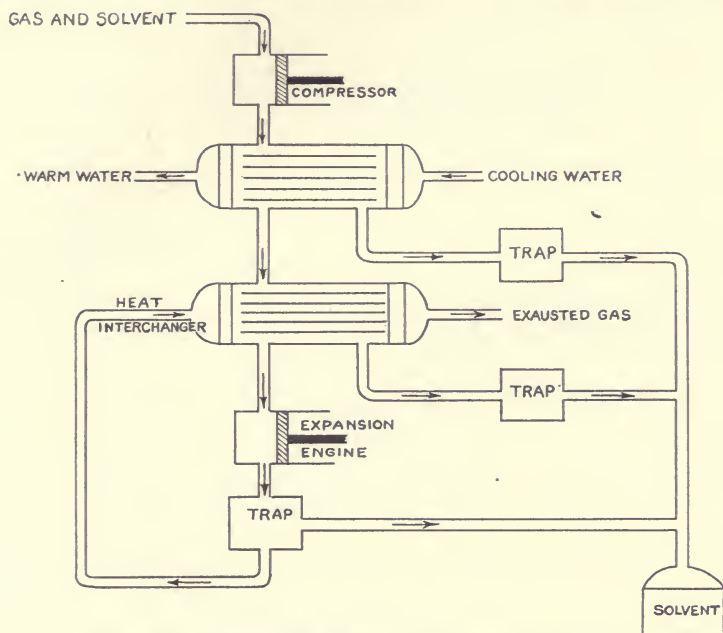

Fig. 59. Compression System for Solvent Recovery.

cooler to 100 pounds pressure. The temperature produced after expansion, the engine doing work against friction, in the form of a hand brake, produced a temperature so low that the engine and the subsequent heat interchanger were very coated with ice at all times.

The chief improvement to be made in such an installation as the above would be the use of the work done in the expansion engine for the compression of the original gas, the difference being made up by additional power from an outside source. This principle of the recovery of power is the basis of the well known Claude and the Norton processes for the liquefaction of the so-called permanent gases.

A modern plant (Lewis Recovery Corp.) utilizing this principle is

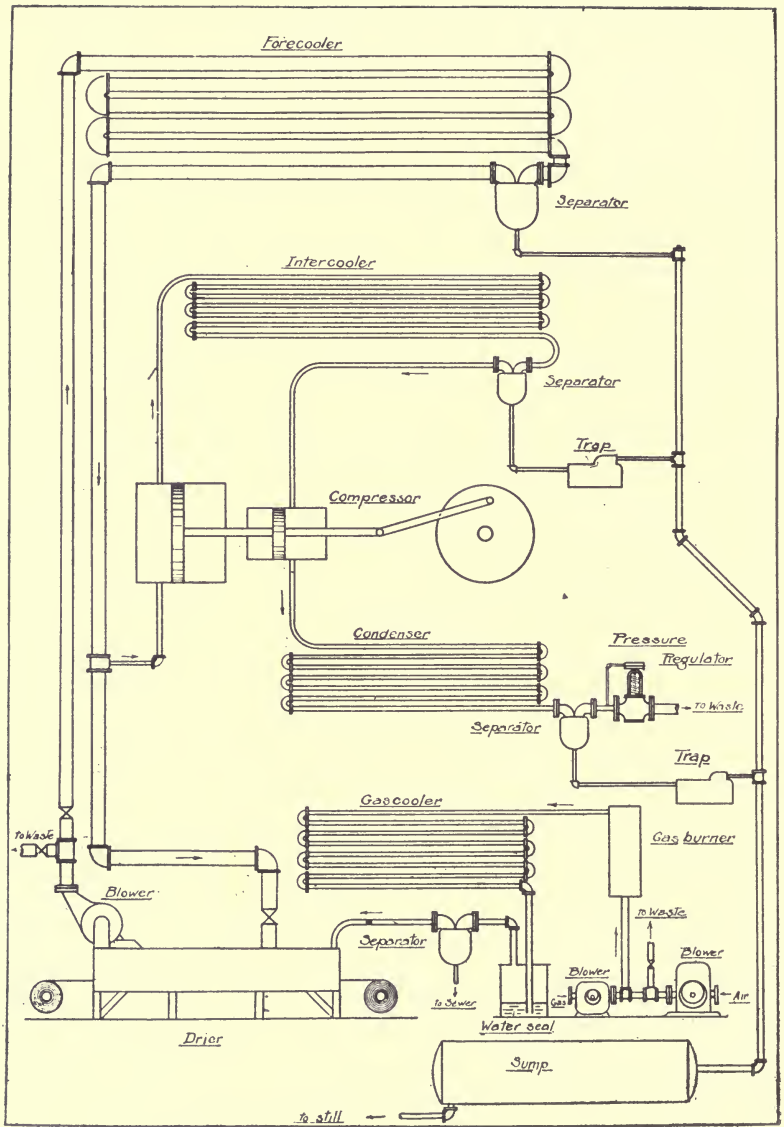

FIG. 60. Example of Compression System.

shown in the accompanying diagram, Fig. 60. In this, the gas is taken from a drier by the blower and passes in succession through a fore-cooler, the compressor, the intercooler, the expansion engine, the latter assisting in compressing the gas, then to a final condenser and then to the outside air. Suitable separators and traps are indicated for removing the solvent. In this particular case the gas used is made by burning illuminating gas as shown.

In very many cases where the compression system is used, the gas after leaving the recovery apparatus is discarded and not recirculated, as is usually the case in the condensation system and in the scrubbing system, the solvent having been so thoroughly removed from the air.

In general the compression system is most suitable for use when a relatively rich gas in small volumes must be treated and the gas is not to be recirculated.

The problem of the design of suitable compressors, either of the reciprocating type or of the turbine type, and the design of expansion engines, would require more space than can be devoted to it in this volume. The reader is referred to standard books on Air Compressors and to the excellent abstracts in Mark's "Mechanical Engineers' Handbook" (McGraw-Hill Book Co.).

Little difficulty is to be experienced in the compression of the gas and standard designs may be followed closely, but in the expansion, considerable trouble may be expected from the formation of ice or in some cases, solidified solvent, in the expansion engine. Numerous devices have been tried for overcoming this difficulty, which is especially great in the manufacture of liquid air and other processes requiring extremely low temperatures, at which temperatures frozen water vapor becomes for all practical purposes like so much sand, which scores the cylinders, destroys valve seats, and so forth. In such cases the water vapor is usually removed from the gas before expansion, by means of a dehydrating agent. But this is, of course, not possible in solvent recovery work, and in such cases the cylinders are often lubricated with glycerine or other oily material in which the water is soluble and which will retard the formation of crystals. Others have tried electrically heated valves. The author is of the opinion that the expansion turbine offers the best solution of the problem, although he does not know of any use of it in solvent recovery work at the present time.

## CHAPTER XXI

### SOLVENT RECOVERY BY SCRUBBING

Gases containing solvent vapors in small amounts can be most economically treated by scrubbing with a liquid in which the vapor is soluble. Except for solid adsorbents, which have not as yet come into general use, this is the only method available for large volumes of gas, as cooling without compression will not cause condensation in the more dilute mixtures, and compression of large volumes of gas is too expensive.

The principles involved in the solution of the vapor in the liquid are clearly given in Chapter III, Raoult's Law stating that the partial pressure of a volatile material over its solution in a solvent is equal to the vapor pressure of the pure material at that temperature, multiplied by the mol fraction of the material in the solution; while Henry's Law states that for dilute solutions, the partial pressure of the volatile material is proportional to its mol fraction in the solution. These are indicated as follows:

$$(46) \quad \text{Raoult's Law, } p = p_0 x_0$$

$$(47) \quad \text{Henry's Law, } p = a x_0$$

In the special case where  $p_0 = a$ , Henry's Law and Raoult's Law are identical.

The essential features of this method of solvent recovery are shown in the diagram on the following page.

This consists of a scrubbing tower *A* of some suitable construction, through which the gas containing the solvent vapor passes, entering at *B* and leaving at *C*, the scrubbing liquid entering at *D* and leaving at *E*. The scrubbing should always be counter-current, except in very special cases, as the maximum concentration of solvent in the liquid is obtained with counter-current flow. The liquid leaving the scrubber is then subjected to a fractional distillation in order to remove the solvent from it and to recover it for reuse. This is done by taking the scrubber liquid through a heat interchanger *F* where it is heated nearly to the boiling point by counter-current indirect contact with



the hot liquid discharged from the still. The heated liquid then enters the fractionating column *G* at the point *H*, and runs down through it into the boiling section *M* from which it passes to heat interchanger *F* and then to a cooler *Q*, being pumped from that back to the scrubbing column *A*.

The action of the fractionating column *G* is as follows: The vapor generated in the section *M* rises through the column and causes the volatile solvent dissolved in the less volatile liquid to vaporize, the

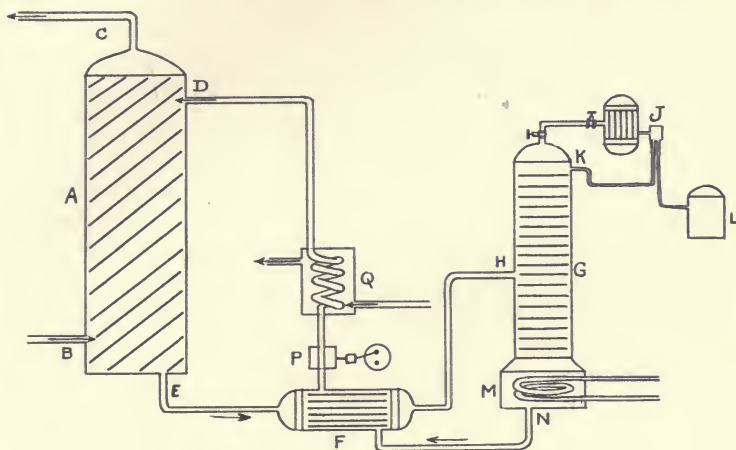

FIG. 61. Diagram of Scrubbing System.

column being so designed and the rate of boiling being so conducted that by the time the scrubbing liquid has run down through the column to the section *M*, practically all of the solvent has been boiled out of it, and it is in the condition in which it leaves the still at *N*. The vapor rising through the column consists at the bottom of practically pure vaporized scrubbing liquid with very little solvent in it, but the concentration of solvent rises in the vapor as it passes up through the column, until when the vapor leaves the top of the column, it consists of practically pure solvent, if the column has been properly designed and is correctly operated. The solvent vapor is condensed in the condenser *J* and part of it is taken to the solvent receiving tank *L*, and the balance is allowed to run back into the top of the column at *K* and runs down through the column, washing out of the ascending vapor the vapor of the scrubbing liquid.

The design of a suitable still to be used in connection with solvent

recovery equipment is a very specialized problem and those interested are referred to the author's work on that subject.<sup>1</sup>

In any sort of an operation involving scrubbing, the maximum concentration that can be obtained is that where the partial pressure of the solvent over the solution equals the partial pressure of the solvent vapor in the gas in contact with it. This can be obtained theoretically only when the time of contact between the gas and the liquid is infinitely long, in an apparatus of infinite length. Practically this equilibrium condition can be very nearly reached in apparatus of commercial length. It usually happens, however, that it is not economical to attempt equilibrium concentration, the apparatus very commonly reaching only within 50% of the equilibrium concentration. This is considered a satisfactory concentration for most work.

As stated in a previous chapter, the force that causes the solvent vapor to pass from the gas into the liquid is the difference between the vapor pressure of the solvent vapor in the gas in contact with the liquid and the partial pressure of the solvent from the liquid itself, the rate at which the solvent passes from one to the other being directly proportional to this difference. This is expressed in the following equation:

$$(48) \quad \frac{dW}{d\Theta} = k (P - p)$$

where  $dW$  is the amount of solvent vapor picked up by the liquid in the time  $d\Theta$ ,  $k$  is a constant depending upon conditions,  $P$  is the partial pressure of the solvent in the gas, and  $p$  is the vapor pressure of the solvent in equilibrium with the liquid.<sup>2</sup>

The mechanism by which the solvent vapor passes from the gas to the liquid may best be indicated by the following method: Imagine a spherical drop of liquid in contact with gas. This drop may or may not be moving in relation to the gas in contact with it, but in either case there is around the drop in direct contact with its surface what amounts to a stationary film of gas through which the solvent vapor must diffuse in order to get into the liquid. After coming into contact with the liquid the vapor then dissolves forming a solution or increasing the strength of that already there. This forms a layer of solution on the surface of the drop, and this surface layer would soon

<sup>1</sup>"The Elements of Fractional Distillation," McGraw-Hill Book Co., New York, 1922.

<sup>2</sup>"The Principles of Counter-Current Extraction," W. K. Lewis, *J. Ind. Eng. Chem.*, 8, 1916, p. 827.

become saturated with respect to the gas and further solution would stop were it not for the fact that this surface solution diffuses slowly from the surface into the interior of the drop. The whole operation of solution then involves the diffusion of the vapor through two distinct layers or films and the factors governing the rate of scrubbing are largely those that affect the behavior of these films.

As has been mentioned in connection with the discussion of the flow of heat through surface films in a previous chapter, the thickness of the film is affected by a number of external factors. The greater the velocity of the gas by the surface of the liquid, the thinner the film and the more rapidly the solvent will diffuse through it, and therefore the more rapidly will the scrubber remove the solvent from the gas. Other factors influence the thickness of this gas film on the liquid, such as temperature, gas viscosity, and the like.

The film of more or less saturated liquid on the surface of the drop is also affected by external conditions. If the liquid is in vigorous motion, the stirring action in the interior of the drop will assist materially in removing the solution from the surface to the interior. The temperature and therefore the viscosity of the liquid are also of importance in the rate of mixing.

In most types of scrubbers it is difficult to measure the area of the liquid exposed to the action of the gas, as the liquid is usually in more or less violent agitation and is frequently in the form of a finely divided spray. About the only type in which it is possible to get even an approximate idea of the surface of contact is the slat scrubber when there is just enough liquid running down through it to wet the surfaces of the slats. It has therefore been necessary in all other types of scrubbers to make use of an empirical measure of surface area. Suppose, for instance, that the scrubber consists of a tower down through which is falling a constant spray of liquid in the form of finely divided drops. It is assumed that so long as scrubbing conditions remain uniform, the number of drops in one cubic foot of the tower is the same as in any other cubic foot of the tower. And if the surface area of each drop averages the same, the actual total surface area per cubic foot will be the same for all parts of the column. The coefficient of diffusion in the rate of solution equation given on the preceding page is therefore given as per cubic foot of tower and is called  $ka$ . And if the difference in the partial pressures in the same equation be indicated by  $\Delta p$ , the equation will be written:

$$(49) \quad \frac{dW}{d\Theta} = ka V \Delta p$$

where  $V$  represents the volume of the tower in cubic feet.<sup>1</sup>

In all cases of the absorption of a vapor by a liquid, there is a heat effect. This is the sum of the heats of condensation and the heat of dilution of the condensed vapor in the solvent. In the case of very dilute vapors the heat effect is usually neglected, but where the concentration of the vapor in the gas is fairly great, the heat effect is considerable and cannot be neglected except in calculations of the most approximate character. It frequently happens that the temperature of the gas and that of the liquid are different at the start of the absorption. The heat of absorption tends to raise the temperature of the liquid and the gas in contact with it, and the rate of flow of heat between the two depends upon the difference in the temperatures of the liquid and the gas. The rate of heat flow is given by the same equation as that for flow through solids:

$$(50) \quad \frac{dQ}{d\Theta} = H A \Delta T$$

In this equation the area  $A$  can be replaced by the equivalent  $ha V$  where  $ha$  represents the coefficient of heat transmission per cubic foot of volume of the tower and  $V$  represents the volume of the tower in cubic feet. The equation then becomes:

$$(51) \quad \frac{dQ}{d\Theta} = ha V \Delta t$$

Under certain circumstances the coefficients  $ha$  and  $ka$  have a definite value, namely when the apparatus is functioning as an adiabatic humidifier with the vaporizing liquid at constant temperature. This condition does not occur, so far as the writer knows, in any type of solvent recovery apparatus, and the actual values of  $ha$  and  $ka$  to be expected *must be determined in apparatus of a similar nature to that which is going to be used in the plant, under such conditions that the values to be expected can be calculated from the experimental ones.*

The coefficient of heat transfer,  $ha$ , for scrubber towers of various types are given by Whitman and Keats in the following diagram, showing the effect on this coefficient for a plate column, a coke tower, a Maclaurin scrubber, and a spray chamber.

<sup>1</sup> See "Rates of Absorption and Heat Transfer between Gases and Liquids," W. G. Whitman and J. L. Keats, *J. Ind. Eng. Chem.* 14, p. 186, 1922.



It should be pointed out that the solid portions of the curves are experimental, while the dotted portions are extrapolated. The values given apply in equation when  $ha$  is given as B.t.u. per cubic foot of

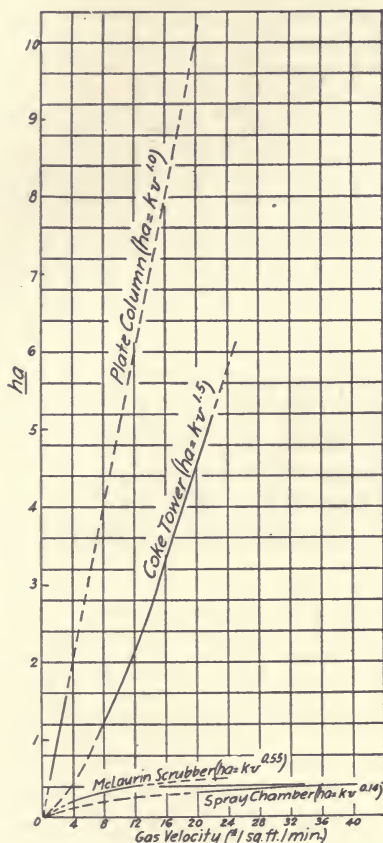

Fig. 62. Coefficients of Heat Transfer for Scrubbing Towers.

tower, per hour per degree Fahrenheit difference between the liquid and the gas.

The coefficient of diffusion  $ka$  was determined for these towers and the results are given in rounded off form calculated for a gas velocity of 12 pounds per square foot of cross section of tower per minute, in the following table, where  $ka$  is pounds absorbed per cubic foot of tower per minute per millimeter vapor pressure difference between the



substance dissolved in the scrubbing liquid and its partial pressure in the vapor in contact with the liquid.

	$ka$	Water-rate
Coke tower .....	.007	20
Maclaurin scrubber (centrifugal spray) .....	.002	100
Spray chamber (humidifier type) .....	.001	20
Plate column (cap style plates) .....	.018	20
Laboratory bubbler (perforated plates) .....	.045	0.5

The water rate was expressed as pounds of water per square foot of cross section of tower per minute.

The effect on the coefficients of absorption of changes in the rates of flow of gas and of liquid have been studied, and the reader is referred to the above mentioned article by Whitman and Keats for further information in this regard. In general, increasing velocities of gas cause nearly proportional increases in the absorption coefficient, while changes in the rate of flow of liquid have less effect. It may be stated that while there is little data yet available to prove it, the absorption coefficient becomes greater as the temperature rises due to decreased viscosity of the liquid, and that the molecular weight of the vapor being absorbed is also a factor.

The size of a scrubber required to conform to given specifications may be readily determined from the foregoing equations.

### Nomenclature

$W$  = pounds of dry gas passing through the scrubber per minute.

$w$  = pounds of scrubbing liquid used per minute.

$H_o$  = pounds of solvent entering the scrubber in the gas per pound of dry gas.

$H_1$  = pounds of solvent leaving in the gas per pound of dry gas.

$P_o$  = humidity of exit scrubbing liquor as explained below.

$P_1$  = humidity of entrance scrubbing liquor (usually zero).

$t_o$  = temperature of exit scrubbing liquor.

$t_1$  = temperature of entrance scrubbing liquor.

$T_o$  = temperature of entrance gas.

$T_1$  = temperature of the exit gas.

$x$  = height of the scrubbing tower in feet.

$A$  = total cross section area of the tower in square feet.

$ka$  = coefficient of diffusion of the vapor between the gas and the scrubbing liquid expressed as pounds per cubic foot of tower per pound humidity difference per hour.

$ha$  = coefficient of heat transfer in B.t.u. per cubic foot of tower per degree Fahrenheit temperature difference between the gas and the liquid per hour.

$s$  = humid heat as explained later.

The nomenclature used above is similar to that used by Grosvenor,<sup>1</sup> in humidification and drying modified to suit the special conditions of scrubbing.

The humidity of the scrubbing liquid is expressed as pounds of solvent vapor per pound of gas when the partial pressure of the solvent vapor in the gas is the same as that above the liquid in question. This permits the partial pressure difference of the solvent vapor between the gas and the liquid to be expressed in pounds per pound of dry (solvent free) gas, which is very advantageous in the following calculations.

The humid heat is the heat in B.t.u. needed to raise one pound of vapor free gas plus the solvent that it contains, one degree Fahrenheit.

It should be understood that the coefficients  $ha$  and  $ka$  are over all coefficients, combining the coefficients of diffusion and heat transfer of the gas films on the surface of the liquid and the diffusion of the vapor and the heat into the liquid after having passed through the surface film. In order to predict accurately the value of these coefficients for any particular conditions, the proper values of the film coefficients should be accurately known. This is not the case at the present time although there is a great deal of research being conducted in this regard. It is therefore necessary, until these unobtained data are available, to make use of the approximate values already obtained and quoted above, and to make reasonable allowances to provide satisfactory factors of safety.<sup>2</sup>

In order to make the calculations of reasonable simplicity the following assumptions are made. These assumptions are justifiable for most cases of solvent recovery by scrubbing, and in those cases where this is not true, allowance may be made after the completion of the calculations.

(1) Adiabatic operation, that is, there is no heat taken from the tower during the operation by cooling coils or by radiation and convection to the surroundings.

<sup>1</sup> *Tr. Am. Inst. Chem. Eng.*, 1908.

<sup>2</sup> For further information see the following references: W. K. Lewis, *J. Ind. Eng. Chem.*, 8, p. 827 (1916), *Trans. Am. Soc. Mech. Eng.* (1922); Walker, Lewis and McAdams, "Chemical Engineering Notes"; C. S. Robinson, *Trans. Am. Soc. Mech. Eng.* (1922).

(2) The evaporation of the scrubbing liquid can be neglected.

(3) The solvent dissolved in the scrubbing liquor in dilute solution follows Henry's Law.

(4) The increase in weight of the scrubbing liquid due to the solvent vapor that it picks up can be neglected.

### Heat Balance

$$(52) \quad (1) \quad w dt = W s dT + W r' dH$$

where  $r'$  (a negative quantity) is the heat of solution of the solvent vapor in the scrubbing liquid. This equation may be integrated approximately by assuming that  $s$  and  $r'$  have average values between the limits between which the tower is working, giving

$$(53) \quad (2) \quad w (t_1 - t_0) = W s (T_1 - T_0) + W r' (H_1 - H_0)$$

### Flow of Heat

$$(54) \quad (3) \quad W s dT = h a A dx (T - t).$$

This equation may be easily integrated on the assumption that  $(T - t)$  average is the arithmetic mean between the bottom and the top of the scrubber, which is very nearly true for counter-current operation, by which nearly all scrubbers operate, giving

$$(55) \quad (4) \quad W s (T_1 - T_0) = h a A x \left( \frac{T_1 - t_1 + T_0 - t_0}{2} \right)$$

### Diffusion of Solvent Vapor

$$(56) \quad (5) \quad W dH = k a A dx (H - P)$$

which may be integrated by similar assumptions as those made in (4), giving

$$(56) \quad (6) \quad W (H_1 - H_0) = k a A x \left( \frac{H_1 - P_1 + H_0 - P_0}{2} \right)$$

W. K. Lewis (see above reference) has shown that for towers of this type it is approximately true that

$$(57) \quad (7) \quad \frac{h a}{k a} = s \text{ (closely enough for most engineering work)}$$

Therefore by dividing (6) by (4) and substituting (7), there is obtained

$$(58) \quad (8) \quad \frac{H_1 - H_0}{T_1 - T_0} = \frac{(H_1 - P_1 + H_0 - P_0)}{(T_1 - t_1 + T_0 - t_0)}$$

The application of these equations to counter-current scrubbing is made in the following manner.

In scrubbing operations there are usually known, established as conditions to be met, the following:

- (a) The volume of gas per minute =  $W$  (expressed in pounds)
- (b) The weight of vapor in the gas =  $H_0$
- (c) The fraction of the vapor to be recovered =  $\frac{H_0 - H_1}{H_0}$
- (d) The temperature of the scrubbing liquid entering =  $t_1$
- (e) The solvent humidity of the scrubbing liquid entering =  $P_1$  (usually zero)
- (f) The temperature of the gas entering =  $T_0$
- (g)  $ka$  and  $ha$  must have been previously determined by experiment on a tower similar in construction to that which it is proposed to use.

The unknown relations are therefore:

- (h) The weight of the scrubbing liquid =  $w$
- (i) The temperature of the exit liquid =  $t_0$
- (j) The solvent humidity of the exit liquid =  $P_0$
- (k) The temperature of the exit gas =  $T_1$
- (l) The volume of the scrubber =  $Ax$

The solvent humidity of the exit liquid,  $P_0$ , depends upon the weight of the solvent vapor dissolved in the liquid during its passage through the tower, the weight of the scrubbing liquid, and the temperature,  $t_0$ . This may be expressed by the following equation:

$$(9) P_0 = \text{function of } t_0, (H_0 - H_1), \text{ and } \frac{W}{w}$$

Since the relation between the pressure and the temperature is complicated (Clapeyron equation), it is difficult though possible to work with the temperature  $t_0$  unknown, and it is better to take  $t_0$  as known and to determine the necessary value of  $t_1$  to make the conditions fit the other known values stated above. This has the added advantage that  $P_1$  is usually zero, thus disposing of another unknown quantity.

### Size of Scrubber

The size of the scrubber may be determined directly from equation (6) in terms of one other unknown,  $w$ . This may best be shown by means of an illustration, scrubbing acetone from air by means of water. Therefore take the following quantities as given:

$W$ , weight of air per minute = 100 lbs.

$H_0$ , humidity (acetone) of the entering air = 0.069 lbs. of acetone per pound of acetone free air.

$H_1$ , humidity of exit air (90% recovery) = 0.0069 lbs.

$T_0$ , temperature of entering air = 80° F.

$t_0$ , temperature of exit water = 80° F.

$ka$ , for an air velocity of 500 ft. per min. in slat filled towers = -0.4

$P_1$ , humidity of entering water (assume acetone free water) = 0.

To calculate  $P_0$  proceed as follows:

Molecular weight of acetone = 58

Vapor pressure of pure acetone at 80° F. = 260 mm.

The vapor pressure of acetone over dilute solutions may be figured from Henry's law, using data from the following journal *Z. Physik. Chem.* 39 (1902), p. 485.

*Note.* For a very complete list of references with reference to vapor pressures of mixtures of solvents and scrubbing liquids see the author's work on the Elements of Fractional Distillation.

Henry's Law gives the equation

$$P_0x = 2.0 \times 260 \times \frac{W (H_0 - H_1)}{\frac{58}{w}} = p \text{ (the vapor pressure)}$$

substituting in the proper value of  $W$  there is obtained the relation

$$P_0x = \frac{1000}{w} = p$$

therefore assuming normal barometric pressure, 760 mm.

$$P_0 = \frac{58p}{29 (760 - p)} = \frac{2000}{760w - 1000}$$

where 29 is the molecular weight of air.

Equation (6) would therefore give

$$100 (0.069 - 0.0069) = 0.4Ax \frac{0.0069 - 0. + 0.069 - \left( \frac{2000}{760w - 1000} \right)}{2}$$

$$\text{whence } Ax = \frac{23550 - 31000}{57.7w - 2076}$$

This relation between  $Ax$  and  $w$  can best be shown in the form of a curve as follows



DATA FOR DIAGRAM

$Ax$	$w$
...	36
1420	50
630	100
495	200
408	...

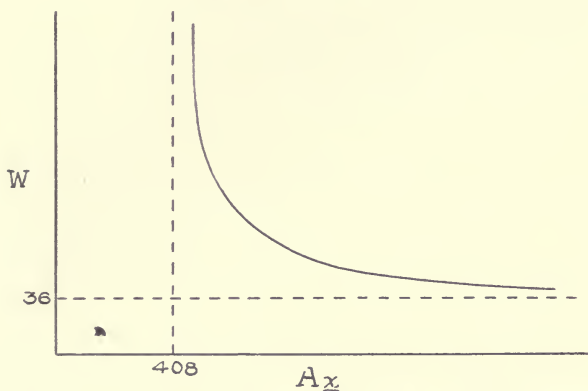

Fig. 63. Relation between Size of Towers and Weight of Scrubbing Liquid.

This curve indicates that a scrubber operating under the chosen conditions can recover 90% of the acetone only when its volume is greater than 408 cubic feet and when it is using over 36 pounds of water per minute, the necessary amount of water required being read off the curve as shown.

The selection of the most economical size of tower should be the result of an economic balance between the cost of the tower per unit product and the cost of operating it as indicated in the following figure, the total cost per unit being the sum of the two costs shown. The size of the tower corresponding to the lowest point on the curve being

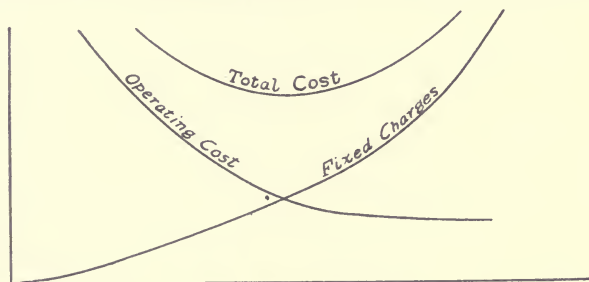

Fig. 64. Economic Balance.

the most economical one to use. The basis for such an economical balance is the curve in the first figure.

### Temperature of the Scrubber Water

The temperature of the liquid leaving the tower was selected to be 80° F. It is therefore necessary to calculate the temperature of the feed water which would be needed to produce this desired temperature. This may be done by solving simultaneously equations (4), (6), and (8), giving the relation

$$(59) \quad (9) \quad W = \frac{\frac{w (t_1 - t_0)}{s (2T_0 - t_1 - t_0) + r' (2H_0 - P_1 - P_0)}}{1 + \frac{2w (t_1 - t_0)}{ka Ax s (2T_0 - t_1 - t_0) + r' (2H_0 - P_1 - P_0)}}$$

*Note.* This equation seems complicated, but when the proper values for the letters are substituted, it becomes very simple.

If now proper values for  $w$  and  $Ax$  have been selected from an economic balance based on the curve shown above, the suitable values may be substituted in equation (9) and  $t_1$ , the feed temperature required, determined.

Thus in the example chosen, the substitutes are as follows:

$$r' = -310 \text{ (heat evolved) B.t.u. per lb. Landolt-Börnstein.}$$

$$s = 0.25 \text{ approximately.}$$

Suppose that  $w$  and  $Ax$  have been chosen as 100 and 630 on the basis of the economic balance referred to, respectively, then

$$P_0 = \frac{2000}{760 \times 100 - 1000} = 0.0267 \text{ and}$$

$$100 = \frac{\frac{100 (t_1 - 80)}{0.25 (160 - t_1 - 80) - 310 (0.138 - 0 - 0.0267)}}{1 + \frac{200 (t_1 - 80)}{-0.4 \times 630 \times 0.25 (160 - t_1 - 80) - 310 (0.138 - 0.0267)}}$$

Solving for  $t_1 = 63.1^\circ \text{ F.}$ , a temperature rise of  $17^\circ$ .

In a similar manner the temperature of the air leaving the scrubber may be calculated.

The author has recalculated the values given by Whitman and Keats for  $ka$  and has added some values obtained by himself and believes that the following values are as close an approximation to the fact as it is possible to obtain from the very incomplete data available at present.

In this table,  $ka$  is given for water at ordinary room temperature and for air velocity of one pound per square foot of cross section of tower per minute. In the absence of better information, it may be assumed that the value of  $ka$  is proportional to the gas velocity and inversely proportional to the relative viscosity of water at 68° F. Thus in a coke filled scrubber operating at an air velocity of 0.1 pounds of air per square foot of cross section of tower per minute, and using a wash oil whose relative viscosity was 50, the value of  $ka$  to use in the foregoing equations would be:

$$\frac{10.0 \times 0.1}{50} = 0.02$$

The much better way to determine the value would of course be to run a small scale scrubbing experiment, if possible on the same type of scrubber, using the oil which would be used in the actual plant, and to use also substantially the same gas velocity, determining the value of  $ka$  and substituting that in the equation.

The pressure drop to be expected is expressed in inches of water per foot of height of tower when the gas velocity is 0.1 pound of gas per square foot per minute. The actual pressure drop can then be calculated from the formula:

$$(60) \quad \text{pressure drop} = \frac{W x}{\Delta p}$$

	$ka$	$\Delta p^1$
Plate scrubber with boiling caps.....	5.0	1.0
Centrifugal scrubber .....	2.1	.0016
Slat filled scrubber .....	0.2	....
Spray scrubber .....	0.3	.0015
Coke filled scrubber (3" lumps) .....	10.0	.0057

<sup>1</sup> These pressure drops are for water rates of the magnitude of those indicated in the table on page 138, and changes of any magnitude in the rate will affect the pressure drop considerably.

The pressure drop in plate towers is practically constant over moderate changes in gas velocity, on account of the fact that the static head of the liquid comprises the bulk of the resistance to flow of gas.

The foregoing calculations were based on the assumption that the operation of the tower was adiabatic, that is, that there was no external cooling of the gas or liquid while it was in the tower. The calculation indicated that a temperature rise of approximately 17° F. could be expected. A rise of this amount would not be serious in most scrubbing operations, but if the gas had been richer in acetone so that a richer solution could have been obtained from the bottom of the

scrubber, the temperature rise would have been considerably greater, invalidating to a considerable extent the calculations, and also interfering with the effectiveness of the scrubber on account of the rise in the temperature of the water and the corresponding increase in the vapor pressure of the dissolved solvent.

Under such circumstances it is almost always necessary to cool the gas or the liquid or both during their passage through the scrubber. This has been done in two ways. Cooling coils are frequently installed in the tower. The other method consists in the withdrawal of the liquid a number of times as it travels down through the tower and cooling it by means of outside cooling coils. The former method is the better for small installations, while the latter is the better for large units. The methods to be used in the calculation of the cooling surfaces for such coolers are identical with those described under the design of condensers and the reader is referred to that section.

If the cooling in the tower is sufficient to keep the scrubbing liquid at substantially constant temperature, the size of the tower may be figured as before from equation (6), while the calculation of the temperature rise is of course unnecessary.

Usually cooled towers will lie immediately between the two extremes of complete cooling and adiabatic operation.

## CHAPTER XXII

### SCRUBBING APPARATUS

#### Scrubbing Towers

The scrubbing tower in a solvent recovery plant has as its function the bringing into intimate contact of the gas carrying the solvent vapor, and the scrubbing liquid. This contact may be either counter-current or parallel current, usually the former. It is usually continuous, although certain systems employing intermittent operation with respect to the scrubbing liquid have been put into more or less successful operation.

The continuous counter-current scrubber is usually of the vertical type, making use of the fall of the scrubbing liquid due to gravity, with the gas rising under pressure from a fan or blower.

The simplest form of this type of scrubber is the filled type, a vertical, usually a cylindrical shell containing various forms of filling or packing. The filling may be lumps of stone or coke, or it may consist of special manufactured forms, either dumped in as is the case with the small hollow cylinders known as Raschig rings, or carefully packed as is the case with the special forms made for the acid and allied industries.

The coke tower has a high coefficient of absorption and is very satisfactory for nearly all materials. It has, however, one disadvantage. Unless very great care is taken the coke will pack unevenly in the tower. This means that the flow of liquid and gas will not be uniform over the entire cross section of the tower and that the contact between them will be poor. This by-passing can be avoided to a considerable extent by carefully screening the coke to one size before dumping into the tower. Large towers should have the lumps from three to four inches in size, while in smaller towers, smaller sizes down to  $\frac{1}{4}$  of an inch are suitable. The second cause of uneven distribution is the method of applying the scrubbing liquid on top of the coke. Formerly a bank of perforated pipes or troughs were popular, but these have been superseded to a considerable degree by pressure sprays, delivering solid cones of spray and so arranged to apply the liquid uni-



formly over the entire top surface of the coke. The coke should not extend to the bottom of the tower, but should be supported on a metal or wooden grid above the bottom, preferably high enough to enable a man to crawl in and inspect the grid, a suitable man-hole being provided for this purpose. The towers are usually constructed of steel, but the author believes that in most cases, wooden towers would be just as satisfactory and considerably less expensive to install and maintain.

The use of Raschig rings made of suitable materials, metals, glass, or stoneware (small hollow cylinders whose length equals the diameter) has permitted the operation of towers with the low pressure drop of the coke tower with considerably improved distribution on account of the uniformity of the filling. These rings should be carefully dumped into the towers when the latter are full of water, thus diminishing breakage.

Special stoneware flings carefully placed by hand, are less frequently used in solvent recovery work on account of their expense. They insure, however, very uniform gas and liquid distribution with low pressure drop.

For large installations where a very low pressure drop must be had, the slat tower is very popular. In such a tower the surface exposed to contact is practically the surface of the slats, and this type of tower requires very uniform distribution of the scrubbing liquid at the top to insure satisfactory operation.

A number of horizontal scrubbers are on the market, such as the horizontal ammonia washers used in gas works. The chief advantage of these is the low pressure drop available, but their absorption coefficients are probably low.

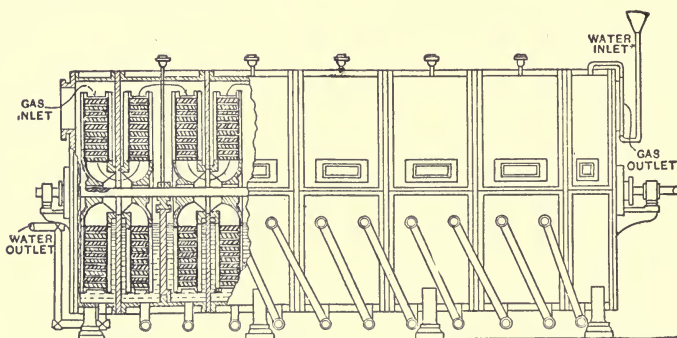

FIG. 65. Horizontal Gas Scrubber (from Rogers' Industrial Chemistry).

Plate scrubbers are very efficient in bringing into contact the liquid and the vapor. They operate, however, under considerable pressure drop, due to the static head of liquid on the plates which must be overcome. These towers are of the perforated plate or of the boiling cap plate type.

The former are efficient if operated within their working range, but if the gas velocity falls too low, the plates will drain through the holes, and the scrubbing action nearly cease. The plates must also be very carefully leveled. For large sizes they are less satisfactory than the boiling cap type,

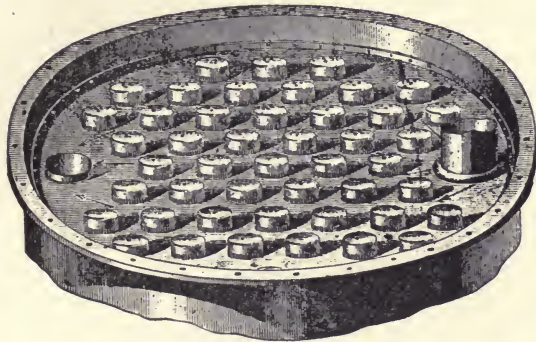

FIG. 66. Plate from Boiling Cap Type of Scrubbing Column.

which are, however, considerably more expensive. The latter are much more flexible in operation, it being possible to vary the gas and liquid rates over wide ranges without seriously interfering with the operation.

The customary velocities used in the various types of scrubbing towers are given in the following table:

Plate towers .....	1 ft. per sec.
Slat towers .....	10 ft. per sec.
Coke towers .....	2 ft. per sec.

These velocities can be increased or decreased at the expense or gain of back pressure as indicated in the previous chapter.

The rate of flow of liquid is limited only by that amount that will flood the tower, this amount depending on the design and the rate of flow of air. The water rates indicated in the previous chapter are about the usual ones in practice.

## Variation in Concentration

In many industries, especially those where unit operations are semi-intermittent, the concentration of the solvent in the air leaving the plant is subject to considerable variation. This is illustrated by the following diagram constructed from data obtained in a French plant making smokeless powder.

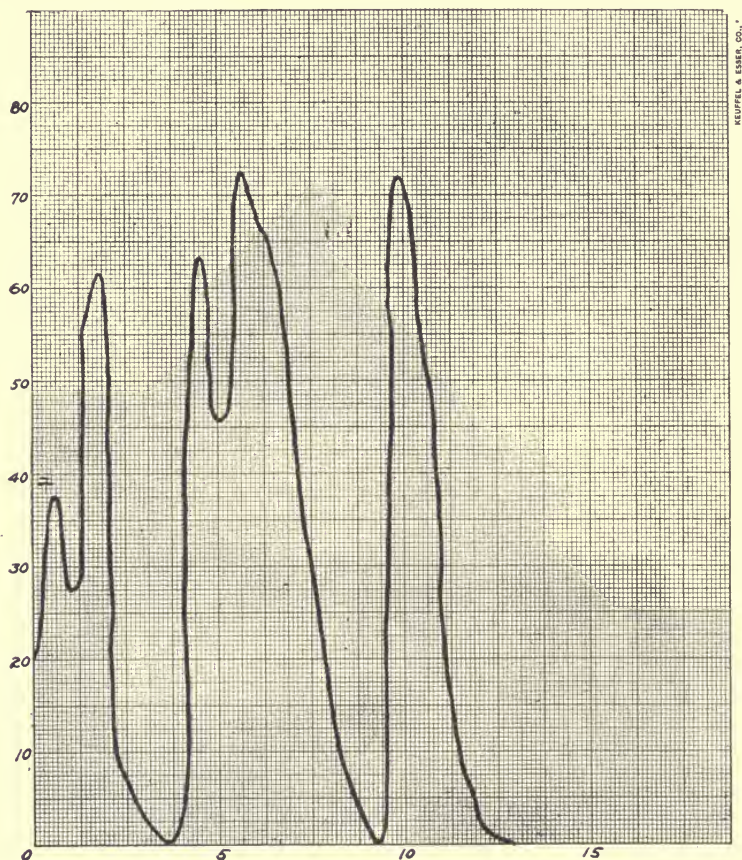

FIG. 67. Variation of Solvent Content of Air from a Plant Making Smokeless Powder. Ordinates are Grams per Cubic Meter. Abscissae are Minutes.

The average height of the curve was found by means of a planimeter to be 31. grams per cubic meter. The apparatus would therefore be designed on that average concentration as a basis.



In actual operation, the loss of solvent due to non-absorption will be greatest at the peaks of the curve but if scrubbing conditions remain constant, the percentage loss should remain constant at all times. Constant scrubbing conditions would be obtained in cases similar to the one given where the variations in concentration were over short time intervals. But in those cases where the variation occurs relatively infrequently and the concentration remains substantially constant over considerable periods of time, it is customary to modify scrubbing conditions to suit the concentration. This may be done most easily by changing the rate of feed of scrubber liquor so as to produce a more uniform concentration of solvent in the scrubber liquor leaving the absorption apparatus. The difficulty of this method lies in the necessity for continual attention on the part of the operator, although it is quite possible to design automatic feed controls to take care of the change in concentration of the effluent liquor.

### Illustrations of Plants

An example of a simple installation for scrubbing is given by the Bregeat absorption system illustrated in the following diagram.

The scrubber in this case is in two sections to save head room, making it necessary to pump the scrubbing liquid from the bottom of one to the top of the other. This permits the use of either section alone if necessary. The scrubber is connected with a continuous still as was shown in Fig. 61, the design of which is varied to suit the character of the solvent. The solid lines indicate the arrangement when the solvent is insoluble in water, while the dotted lines are for a soluble material such as alcohol.





## CHAPTER XXIII

### SPECIAL ABSORBENTS

The use of liquids as absorbing media for solvent vapors has been discussed in previous chapters. There is a special case of absorption which should be discussed separately, that is, where the absorbing liquid and solvent react chemically with the formation of a less volatile compound.

The most common example of such an absorbent is sulphuric acid, which is used for absorbing the vapors of alcohol and ether from air. These two substances combine with the sulphuric acid to form a less volatile substance called ethyl sulphuric acid which can be decomposed afterwards regenerating the sulphuric acid and liberating a mixture of ether and alcohol, the relative proportions of which in the resultant vapor depending upon the concentration and temperature of the ethyl sulphuric acid. As the process is usually carried out, a considerable proportion of the alcohol absorbed by the acid is liberated in the form of ether. It so happens in such cases on account of the great volatility of the ether, the percentage of that in the original gas actually absorbed by the acid is considerably less than that of the alcohol absorbed, so that that portion of the alcohol recovered which is obtained in the form of ether does not wholly make up for the ether loss in the original process, and therefore there is no accumulation of ether by the system at the expense of alcohol. Actually there is a considerable net loss of both alcohol and ether which has to be made up from some outside supply.

The use of sulphuric acid for absorbing these two solvents is very common in Europe, but is less common in the United States. While it has many advantages, notable among which being the very low vapor pressure of these solvents over their solution in it, the very great difficulty of handling such a corrosive liquid, coupled with the necessity of reconcentrating it after each time it is used, makes its use exceedingly troublesome and expensive. There seems to be but little doubt that it will gradually be superseded by other processes, notably solid adsorption.

The author has included a series of curves, very kindly placed in his hands by the Bregat Corporation, showing the effects of temperature and dilution on the solubility of these solvents in sulphuric acid.

The following figure, No. 69, is based on data furnished by the

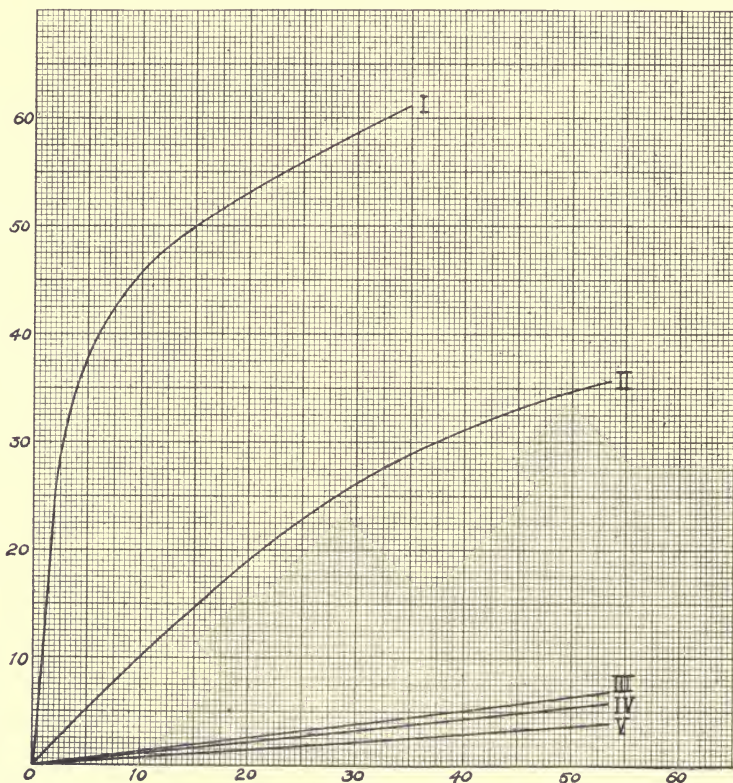

Fig. 69. Equilibrium between Mixtures of Ether and Air, and Ether in Solvents. Ordinates are Percentages of Ether in the Solvent. Abscissae are Partial Pressures of Ether in mm. of Mercury.

1. Sulphuric Acid.
2. m- Cresol.
3. Amyl Alcohol.
4. Butyl Alcohol.
5. Ethyl Alcohol.

Bregat Corporation. It represents the solubility of ethyl ether in several solvents at 20° C., except butyl alcohol, which is at 15° C. This diagram is given for the purpose of showing the effect on the

solubility of a substance in a solvent of the chemical relations between them.

It is a principle which is not well understood at the present time, that if two volatile liquids have a tendency towards immiscibility, the partial pressure of each above a mixture of the two is greater than that calculated from Raoult's Law, while if there is a tendency towards chemical combination, the partial pressures will be less than that calculated from Raoult's Law. Frequently both effects are combined giving great irregularities.

This is illustrated in the present case. The concentration of ether in sulphuric acid which would give a partial pressure in the vapor in equilibrium with it at 20° C. of 50 mm. is about 10% by weight according to Raoult's Law, while the actual concentration is something above 60%, due to the tendency for the combination of the ether and acid to form ethyl sulphuric acid.

In a similar manner m-cresol (the chief constituent of the Bregat absorbent) will absorb ether at 20° to a concentration of 35%, while according to Raoult's Law, a partial pressure of 50 mm. corresponds to 8.5%.

On the other hand, the concentration corresponding to 50 mm. for ether in ethyl alcohol should be 18.5% by Raoult's Law while it is actually about 4% indicating a distinct tendency towards immiscibility. This tendency is less marked in the case of amyl alcohol, but is actually existent in the case of water, which is often considered the lowest member of the alcohol series. Mixtures of ether and methyl alcohol should show even greater deviation than is the case with ethyl alcohol.

It should be the object of designers of absorbing equipment, therefore, to select as absorbing liquids those which have the tendency towards chemical combination, rather than the reverse, since the amount of absorbing liquid required for a given problem, and the size of the absorbing equipment will be considerably lessened thereby. But care should be taken that the subsequent recovery of the solvent by distillation is not too difficult.

Another factor of importance in the selection of the absorbing liquid is the inevitable presence of water vapor in the gas carrying the solvent vapor. The ideal absorbing liquid should be unaffected by the presence of this water. Such a liquid would therefore be one in which water is substantially insoluble, as is the case with the members of the benzene and the methene series of hydrocarbons. Those liquids



which absorb water readily will frequently do so at the expense of the solvent. This effect in the absorbing of ether by sulphuric acid is shown clearly in the accompanying diagram, Fig. 70, which is similar to the preceding one, for acid of several strengths, indicating that 60% acid has but one-third of the absorbing power for ether of that of 100% strength.

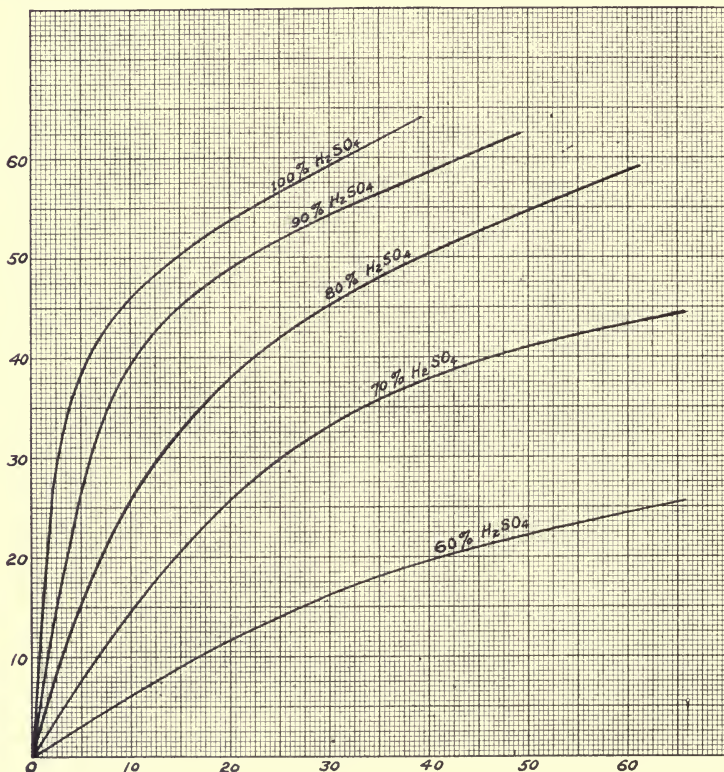

FIG. 70. Equilibrium between Mixtures of Ether and Air, and Ether in Sulphuric Acid of Several Concentrations. Ordinates are Percentages of Ether in Solution. Abscissae are Partial Pressures of Ether in mm. of Mercury.

The selection of the best absorbent for a particular case should be the result of an economic balance involving the cost of the recovery of the solvent plus the value of the lost solvent and the losses of absorbent, and the cost of the equipment required. The author has repeatedly emphasized the fact that every solvent recovery problem has features different from any other problem, and it is very unusual

that the same apparatus will be the best in other cases than the one for which it was designed. This is just as true in the case of the selection of the absorbent liquid, and therefore the greatest care should be used in making the selection. Unless actual experience with very similar cases is available, the author strongly advises the installation of an experimental laboratory scrubber in which suitable liquids may be tested. Such experiments are the only sure basis for satisfactory design.



## CHAPTER XXIV

### EXTRACTION BY SOLVENTS

The extraction of oils and fats by means of volatile solvents involves the recovery of the solvent in two ways, first, its separation from the extracted oil, usually by means of distillation, which is not in the province of this book, and the second, its separation from the residual extracted solids. This latter separation may be accomplished in three ways.

The first method is that of the displacement of the liquid solvent adhering to the solid by means of another liquid such as water in which the solvent may or may not be soluble. Application of this method has been noted in the bibliography attached to this book, one excellent example of the method being that of the displacement of the ether from smokeless powder grains by means of liquid alcohol. The essential features for the successful operation of this method consist in using slow upward displacement with a liquid whose specific gravity is greater than that of the displaced solvent, taking every precaution to avoid mixing, either by convection currents or by stirring. Furthermore, since stirring must be avoided, it follows that the method will work only with solids which have uniformly distributed openings between the particles, other solids giving unequally distributed flow and by-passing with the corresponding imperfect removal of the solvent. It should also be noted that in any case that portion of the displaced solvent last leaving the container will consist of a mixture of the two liquids and will require separation, by decantation if the liquids are immiscible, or by fractional distillation if they are miscible.

The second method of recovering the solvent from the extracted solid makes use of the direct application of heat by contact with hot walls, pipes, or direct radiation. The mechanism of this process has been discussed in some detail in Chapter XV. The essential thing with respect to this method is the continual movement of the solid by the source of heat. This is necessary on account of the extreme slowness with which heat flows through dried solids. There are in general two methods by which this can be accomplished, the first consisting

of the use of a plow or scraper which continually brings fresh solid into contact with the heating surface, while the second makes use of a rotary drum or kiln into which the moist solid is introduced, either continuously or intermittently, the walls of which are heated externally. The author has seen both methods in successful operation.

The third method of recovering the solvent from the extracted solids and the one most commonly used, either alone or in combination with the second method, involves the circulating through the moist solid of a gas or vapor to furnish part or all of the heat of vaporization, to assist in bringing the heat more readily into contact with the solvent, and to decrease the partial pressure required for the solvent to vaporize. The effect upon the temperature required for vaporization has been discussed in Chapter XVI. It remains, therefore, to state that it makes no difference in the vaporization as to whether a gas or a condensible vapor is used, this affecting only the problem of subsequent condensation. On account of the relative ease of handling a condensible vapor, such vapors are almost always used, the most common one being steam, either saturated or superheated, depending on the temperature required.

Steam under considerable pressure may in many cases be counted upon to furnish enough mixing and stirring of the solid when released with its correspondingly considerable velocity, to obviate the necessity for mechanical mixing otherwise required. It is frequently true, however, that mechanical plows, scrapers, or stirrers, are desirable for the purpose of cutting down the time of contact necessary and the consequent steam consumption. Which method is best is wholly a question of the special problem and of the design of the extractor, bottom dumping extractors usually making use of the scraper type, while side dumping use the plow which gives automatic discharge of the dried solid when the outlet gate is opened. Basket type extractors are, so far as the author knows, used without mixers of any kind, depending upon the percolation of the steam into the interior of the mass.

An excellent example of a complete oil extraction plant (Ernest Scott and Sons) is shown in the figure on page 160.

In this apparatus the residual solvent is removed by blowing steam through the extractor. The steam is blown downward at the start to assist the removal of the heavy vapor by downward displacement, and after the bulk of the solvent has gone to the condensers the direction of the steam is reversed, the mixed vapors passing out of

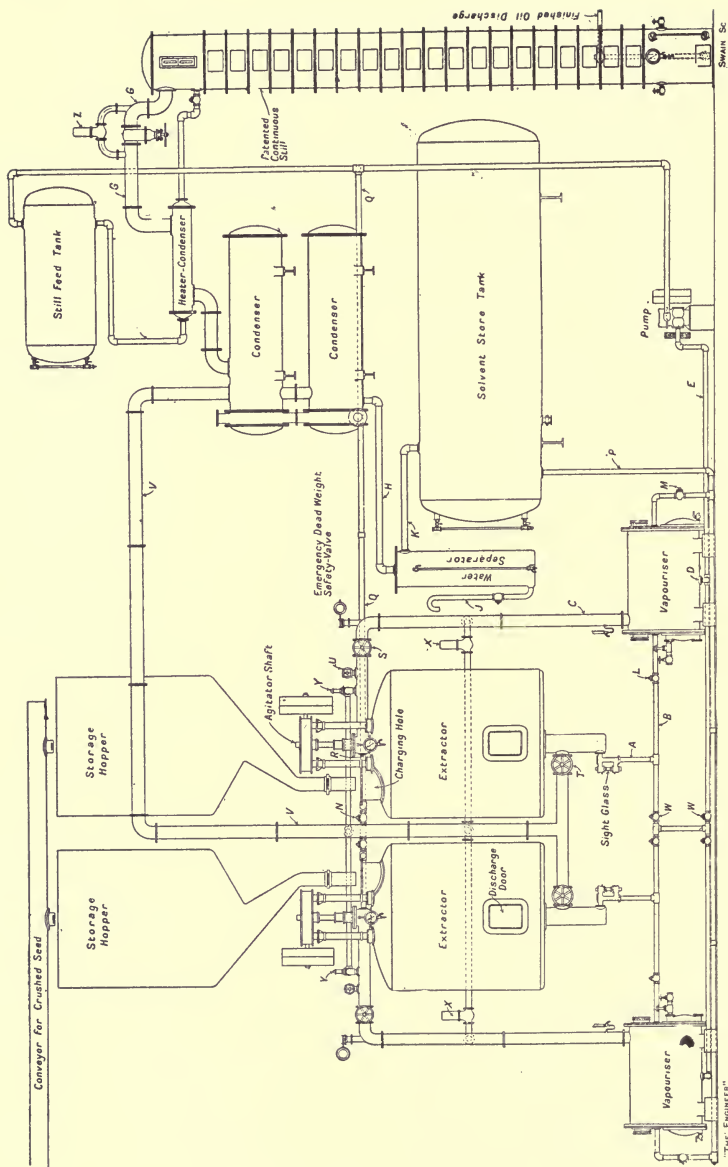

Fig. 71. Scott Oil Extraction Plant.

the top of extractors to the condensers as before. The condensed benzene vapors together with the water are separated by decantation as described in a previous chapter. A complete description of this equipment will be found in Chalmer's "Production and Treatment of Vegetable Oils," Van Nostrand, 1919.

Another illustration of the recovery of the solvent from oil extraction is given by the Garrigue system shown on page 162, the first figure showing the elevation of the system, and the second, the details of the extractor.

The extractor is a horizontal rotating drum fitted with both closed and open steam pipes. After the oil and solvent have been withdrawn from the drum to the still for separation, the residual solvent is volatilized by means of closed steam, the drum being under vacuum to keep the temperature down, and the last traces of solvent are afterwards removed by open steam, this method decreasing the steam consumption for this part of the process, and improving the quality of the meal.





## ABSTRACT OF LITERATURE ON SOLVENT RECOVERY

1. Utilization of Absorbing Agents for Aqueous Vapors in Evaporating Sugar Solutions. Degener. German Patent 17,846, August, 1881. *J. Soc. Chem. Ind.*, 1882, p. 242.

The use of absorbents such as sulphuric acid, calcium chloride, and similar dehydrating agents for absorbing water vapor from air in evaporation of sugar solutions under a vacuum.

2. New Arrangement in the Process of Extracting Soluble Substances by Means of Volatile Solvents, in the Recovery of the Solvents Used, and the Construction of the Apparatus. E. B. Hart. German Patent 19,185, November, 1881. *J. Soc. Chem. Ind.*, 1882, p. 439 (cut of apparatus).

An extraction apparatus of the usual laboratory type consisting of an upper and lower chamber separated by a perforated plate, and fitted with two condensers for recovering the solvent left in the material, first by indirect heat, and then by the use of open steam under a vacuum.

3. Apparatus for Cooling Gases and Vapors. Weldon. English Patent 6,066, May 18, 1885. *J. Soc. Chem. Ind.*, 1886, p. 325 (illustration).

A vertical stoneware tower with a series of horizontal water cooled glass tubes for cooling corrosive gases.

4. Apparatus for the Absorption of Gases and Vapors by Liquids. Rohrmann and Hiller. English Patent 8,630, July 16, 1885. *J. Soc. Chem. Ind.*, 1886, p. 423.

An absorption tower with plates arranged for surface contact only between the liquid and the gas, giving no static head. Provision is made for external cooling to remove heat of solution.

5. Apparatus for the Absorption of Gases by Liquids and Solids. Lunge and Rohrmann. English Patent 10,355, September 1, 1885. *J. Soc. Chem. Ind.*, 1886, p. 468.

An absorption tower with plates designed to give contact between the liquid and the gas on the lower side as well as on the upper, using perforated plates and external cooling.

6. Condensation Apparatus. Steinmuller. German Patent 31,238, September 13, 1885. *J. Soc. Chem. Ind.*, 1885, p. 737 (illustration).

A special type of condenser for vapor immiscible with water using both indirect and direct cooling.

7. Absorption Apparatus for the Condensation of Gases and Vapors by Liquids. Lunge and Rohrmann. *Chem. Zeit.*, 11, p. 693. *J. Soc. Chem. Ind.*, 1887, p. 528 (illustration).

A description of the tower noted in (5).

8. An Improved Process for Recovering Volatile Solvents Retained in Substances Treated therewith. Lake. English Patent 10,280, June 24, 1889. *J. Soc. Chem. Ind.*, 1890, p. 325.

A method of recovering the solvent in the liquid state from an extracted material by downward displacement with steam, suitable only for immiscible solvents (water should do as well as steam).

9. Improvements in Methods for the Recovery and Utilization of Certain Vaporized Solvents. Whiting and Lawrence. English Patent 6,405, April 14, 1891. *J. Soc. Chem. Ind.*, 1891, p. 656. U. S. Patent 450,501, April 14, 1891.

The residual solvent after extraction (see U. S. Patent 170,424, 1875), is vented while still hot to a condenser, the solvent remaining is then removed with superheated steam, the condensed solvent being recovered by decantation. (Suitable for immiscible solvents only.)

10. Apparatus for Driving off Heavy Vapors of Solvents. The Parent Syndicate Oil Extractor Co., Ltd. English Patent 5,040, March 8, 1893. *J. Soc. Chem. Ind.*, 1894, p. 240.

The extracted material is forced through an inclined jacketed trough by means of a screw conveyor and the vapors are taken to a water cooled condenser.

11. Apparatus for Extracting Substances by Volatile Solvents. J. Meikle. English Patent 10,701, May 31, 1893. *J. Soc. Chem. Ind.*, 1894, p. 622.

The material to be extracted is placed in an upper percolation chamber with a water cooled dome. The condensed solvent filters through into the lower chamber and is revaporized.

12. Process for the Recovery of Volatile Solvents from Gases. Heinzerling. English Patent 12,390, July 4, 1892. *J. Soc. Chem. Ind.*, 1893, p. 591. (Valuable illustration.)

The gas containing the volatile material is cooled to about room temperature, compressed to 2 to 6 atmospheres, then cooled indirectly by water to 8°–10° C. It then goes to a recuperator which cools it to –20° to –50° C., and is then expanded, preferably in a cylinder doing work, thus being cooled 20° to 30° more. The condensed vapor, in the form of liquid or solid, is removed in the usual way. Plugged up coolers are cut out of the system for cleaning, and electrically heated valves avoid clogging.

13. Process and Apparatus for Recovering Volatile Solvents from Collodion Coatings on Paper. De Groussiers. English Patent 13,562, July 15, 1895. *J. Soc. Chem. Ind.*, 1895, p. 886. (Valuable illustration.)

The coated paper travels continuously through a closed apparatus in contact with vigorously circulated heated air. The air passes to a condenser, and is reheated and recirculated. The drying chamber is also heated with steam pipes.

14. Drying and Absorbing Apparatus. Saatman. English Patent 15,565, August 19, 1895. *J. Soc. Chem. Ind.*, 1896, p. 641.

A tower with automatic tilting plates for bringing solids and gases into counter current contact. (Suitable for adsorption.)

15. Improvements in the Process and Apparatus for Treating Raw Wool, etc., with Solvents. Maertens. English Patent 16,889, September 10, 1895. *J. Soc. Chem. Ind.*, 1895, p. 1044. U. S. Patents 545,899 and 545,900.

Counter current extraction in the presence of an inert gas such as carbon dioxide, which is also used for removing the adhering solvent from the extracted fibers. The final traces of solvent are removed by heating under a vacuum and then blowing air through the wool. The apparatus for recovering the solvent for reuse includes condensation and distillation.

16. Apparatus for Separating Solvent from Oleaginous Material. Lester and Riccio. English Patent 23,159, December 3, 1893. *J. Soc. Chem. Ind.*, 1896, p. 283.

The vapor of the solvent is compressed mechanically and used for heating the vaporizing mixture. (This is the usual compression evaporation, but the theory stated is incorrect.)

17. Extracting Solids with Solvent Liquids. Fairley. English Patent 1666, January 23, 1896. *J. Soc. Chem. Ind.*, 1897, p. 227.

Counter-current extraction in an inclined screw conveyor.

18. Separating Oil from its Volatile Solvent. Metzger. English Patent 15,050, July 7, 1896. *J. Soc. Chem. Ind.*, 1896, p. 817. U. S. Patents 563,391, 563,866, 566,406, 566,599, all in 1896.

Steam distillation is avoided by agitating with water at the vaporization temperature of the solvent, thus avoiding decomposition due to contact with high temperature steam.

19. Separation of Naphtha, etc., from Oil. Metzger. English Patent 15,597, July 19, 1896. *J. Soc. Chem. Ind.*, 1896, p. 817.

The atomized mixture is steam distilled, the remaining solvent being removed by heated air under slight suction.

20. Apparatus for the Extraction of Fats, etc., by means of Volatile Solvents. Merz. English Patent 16,766, July 28, 1896. *J. Soc. Chem. Ind.*, 1896, p. 792.

Soxhlet apparatus on a large scale, the residual solvent being removed from

the extracted mass by the use of superheated solvent vapor followed by superheated steam.

21. Process for the Separation of Gases and Vapors from Mixtures. Kubierschky. English Patent 17,780, September 2, 1899. *J. Soc. Chem. Ind.*, 1900, p. 30.

A counter-current absorber in which the liquid flows to chambers of successively lower pressure, the gas being compressed from step to step. The chambers are filled with coke or any suitable filling material.

22. Recovery of Solvent in Soap Emulsions from Degreasing Wool. Erben. English Patent 19,688, November 2, 1900. *J. Soc. Chem. Ind.*, 1901, p. 359.

The soap is treated with acid, diluted, and the immiscible solvent recovered by decantation.

23. Separation of Solvents from Oily Emulsions. Maertens. English Patent 9872, May 29, 1900. *J. Soc. Chem. Ind.*, 1901, p. 372. U. S. Patents 615,030, 630,293, 630,294, 630,295, 630,296.

Process similar to No. 22 using different chemicals to destroy the emulsion. Distillation afterwards is specified.

24. Explosion Limits of Combustible Gases and Vapors with Air. Eitner. *J. Soc. Chem. Ind.*, 1902, p. 395.

Gas	Per cent lower limit	Per cent upper limit
CO	16.0	72.65
H	9.25	65.1
Water-gas	12.1	65.4
C <sub>2</sub> H <sub>2</sub>	3.25	51.3
Coal-gas	7.75	18.8
C <sub>2</sub> H <sub>4</sub>	4.0	14.3
Alcohol	4.0	13.6
CH <sub>4</sub>	6.0	12.5
Ether	2.7	7.55
C <sub>6</sub> H <sub>6</sub>	2.6	6.4
Pentane	2.35	4.85
Benzine	2.3	4.8

25. Drying and Absorbing Apparatus. Saatman. English Patent 8942, May 1, 1902. *J. Soc. Chem. Ind.*, 1902, p. 695.

Apparatus similar to (14) but with intermediate cooling plates.

26. Apparatus for Cleansing Gases. Fowle and others. English Patent 22,282, October 14, 1902. *J. Soc. Chem. Ind.*, 1903, p. 1121 (illustration).

Important as the earliest of the modern centrifugal gas scrubbers.

27. Process for Separating Solvents from Nitrocellulose, etc. Du Pont. U. S. Patent 712,406, October 28, 1902. *J. Soc. Chem. Ind.*, 1902, p. 1556.

In the drying of smokeless powder grains the surface hardening is prevented by displacing the ether from the alcohol-ether mixture by the addition of more alcohol, the displaced ether being removed from the solution in contact with the powder by bubbling air through it, the alcohol then being removed by evaporation afterwards.

28. Process of Recovering Volatile Solvents. Febre. French Patent 332,087, May 18, 1903. *J. Soc. Chem. Ind.*, 1903, p. 1207.

The recovery of the solvent vapor from the air by combined refrigeration and pressure.

29. Condensing and Cooling Vapors, etc. Brown and Chandler. English Patent 5485, March 5, 1904. *J. Soc. Chem. Ind.*, 1904, p. 858.

A special type of condenser, air cooled with the air cooling surface sprayed with water to remove the heat by evaporation of the water.

30. Process and Apparatus for the Recovery from Air of the Vapors of Volatile Solvents. Bouchaud-Praceiq. French Patent 341,690, March 26, 1904, p. 859.

The air containing the solvent is filtered, dried with a suitable drying agent,



and then scrubbed with a suitable liquid in a tower. Illustration—alcohol and ether vapors. The final recovery of the solvent is by the use of fractional distillation.

31. Chemical Absorption Apparatus. Schauche. U. S. Patent 755,705, March 29, 1904. *J. Soc. Chem. Ind.*, 1904, p. 435.

A special type of plate scrubbing tower.

32. Process for the Recovery of Solvents Used in Fat Extraction. Kirchner. German Patent 178,185, April 20, 1904. *J. Soc. Chem. Ind.*, 1904, p. 1244.

In condensing the solvent vapors, a seal pipe is attached to the condenser for withdrawing the liquid without letting any of the vapors escape.

33. Process and Apparatus for Recovering Benzene Used in Dry-Cleaning. Delhotel. French Patent 344,848, July 14, 1904. *J. Soc. Chem. Ind.*, 1904, p. 1213.

The fabric is dried by passing heated air through it, which is then cooled by passing up through a tower down through which cold water is flowing, the benzene being separated from the water by decantation. The air is then reheated and recirculated.

Addition to the above patent May, 1905. *J. Soc. Chem. Ind.*, 1905, p. 1169.

The introduction of a heat interchanger between the drier and the cooling tower.

34. Degreasing with Volatile Solvents with Solvent Recovery. Bataille. French Patent 345,367, August 3, 1904. *J. Soc. Chem. Ind.*, 1905, p. 25.

A dry cleaning apparatus consisting of a steam-jacketed, revolving cylinder connected with a boiling kettle, condenser, and solvent supply tank. When the extraction is completed, the material is dried by the circulation of an inert gas, such as carbon dioxide, through the condenser, heater, extractor, etc. The apparatus is suitable for india-rubber coated fabrics.

35. Process for the Recovery of Volatile Solvents. Soc. J. Jean et Cie., etc. French Patent 350,149, September 11, 1904. *J. Soc. Chem. Ind.*, 1905, p. 1161.

The mixture of air and solvent vapor is scrubbed with glacial acetic or phosphoric acid, and afterward recovered by a suitable process. For instance, benzene is recovered by diluting the acetic acid and decanting.

36. Separation of Solvent from Substances from which the Fat has been Extracted. Bergmann. French Patent 335,964, October 12, 1903. *J. Soc. Chem. Ind.*, 1904, p. 328.

The solvent is displaced by a liquid which has a greater affinity than the solvent for the extracted matter, and which has no action on the solvent. For example, benzene is displaced by water with or without salts in solution.

37. Recovery of Vapors Heavier than Air by Refrigeration. Aurenque. French Patent 349,843, November 4, 1904. *J. Soc. Chem. Ind.*, 1904, p. 747.

The drying chamber has openings in the floor which lead away the settling solvent vapor to condensing coils below.

37a. Process for the Recovery of Alcohol and Ether Vapors from Air in Artificial Silk Works. Dervin. French Patent 350,298, November 8, 1904. *J. Soc. Chem. Ind.*, 1906, p. 71.

Air is passed in succession through two batteries of absorption towers fed with concentrated sulphuric acid and cooled with water to prevent the temperature from rising above 18°–20° C. In the first series of towers the ether, alcohol, and moisture are all absorbed at first, but as the acid becomes diluted, its power of absorbing ether diminishes, and finally only the alcohol and moisture are retained, the ether passing to the second series of towers. When the acid in the second series is saturated, it is distilled in vacuo for the recovery of the ether and is then used again. After several distillations this acid becomes saturated with ethyl sulphuric acid, and is then transferred to the first series of towers to absorb alcohol and moisture, the alcohol being removed subsequently by known methods.

38. Centrifugal Apparatus for the Absorption of Gases by Liquids. Kestner and others. English Patent 29,178, December 31, 1904. *J. Soc. Chem. Ind.*, 1906, p. 61. (Illustration.)

A centrifugal scrubber of the parallel flow type, both water and gas passing downward. There are numerous modifications.

39. Apparatus for the Recovery of Volatile Liquids from Air and Gases by Refrigeration. Hesketh. English Patent 1287, January 23, 1905. *J. Soc. Chem. Ind.*, 1905, p. 1161.

The gas is refrigerated and after the removal of the condensed solvent, it is cooled further by humidification with water. The gas then passes through a heat interchanger, cooling the incoming air containing solvent.

40. Process for the Separation of Vapors of Volatile Solvents from Air. Barbezat. French Patent 361,389, April 17, 1905. *J. Soc. Chem. Ind.*, 1906, p. 683.

The gases are compressed, cooled, and then expanded through a turbine doing work. Cooling causes condensation and the liquid is then removed in a centrifugal separator.

41. Recovery of Solvents from Artificial Silk Bobbins. Douge. French Patent 356,835, April 21, 1905. *J. Soc. Chem. Ind.*, 1906, p. 71.

The alcohol and ether are extracted by a counter-current tank system with water at 30° to 35° C.

42. Apparatus for the Absorption of Soluble Substances by Liquids. Clark. English Patent 11,776, June 15, 1905. *J. Soc. Chem. Ind.*, 1906, p. 632.

A scrubbing tower of the centrifugal type.

43. Process for the Complete Recovery of Volatile Solvents. Mallet. French Patent 349,997, June 16, 1905. *J. Soc. Chem. Ind.*, 1905, p. 1004.

The air from the spreaders is compressed, then passed through an air condenser, then an indirect water condenser, then a direct cooler, using as cooling liquid, one in which the solvent is not soluble. This direct cooler is built like the plate column of a fractionating still. In case the direct cooler uses a liquid in which the solvent is soluble, the liquid mixture produced goes to a continuous fractionating still.

44. Separation of Vapors (Water, Alcohol, Ether, etc.) Soluble in Sulphuric Acid from Air. De Chardonnet. French Patent 361,648, July 26, 1905. *J. Soc. Chem. Ind.*, 1906, p. 973.

The air is blown through atomized sulphuric acid in lead chambers, the temperature being so regulated as to absorb water in the first chamber and alcohol or ether in the last. The latter solvents are then recovered by distillation.

45. Apparatus for Condensing Vapors of Volatile Solvents. Heymann and others. English Patent 17,435, August 10, 1904. *J. Soc. Chem. Ind.*, 1905, p. 1053. (Illustration.)

A counter-current oil scrubber of special design.

46. Non-oxidising Gaseous Medium for Carrying Vapors of Combustible Gases. Martini and Huneke. French Patent 359,108, October 31, 1905. *J. Soc. Chem. Ind.*, 1906, p. 308.

A combustible gas such as coal gas is mixed with the quantity of air necessary for complete combustion and the mixture is burned continuously in a closed chamber in the absence of air. The gaseous products of the combustion are led through a cooling device into a carbureter containing gasoline or some similar substance, for the production of carburetted gas. It is claimed that this non-oxidising vehicle for the combustible vapor is safer than air or the exhaust gases from gas engines, boiler furnaces, etc., whilst being cheaper than carbon dioxide.

47. Apparatus for Washing Gases and Vapors. Feld. French Patent 360,373, December 12, 1905. *J. Soc. Chem. Ind.*, 1906, p. 467. (Illustration.) U. S. Patent 829,261 (1906).

The modern Feld type of centrifugal scrubber.

48. Apparatus for Recovering the Vapors of Volatile Solvents. Bouchaud-Praceiq. U. S. Patent 806,866, December 12, 1905. *J. Soc. Chem. Ind.*, 1906, p. 524. (Illustration.)

A frame for holding the material containing the volatilizing solvent is located in a drying chamber so that the vapors settle by gravity to the bottom and flow through a solid drying agent like calcium chloride, to the base of a vertical scrubber filled with pumice, the flow of air being by gravity, as the air in the scrubber is lighter than the air in the vaporizer.



49. Process for the Recovery of Volatile Solvents in the Air from Factories. Douge. French Patent 362,611, January 22, 1906. *J. Soc. Chem. Ind.*, 1906, p. 745. (Theoretically unsound.)

50. Recovery of Solvent from Nitrocellulose Artificial Silk. Chardonnet Co. French Patent 371,985, February 6, 1906. *J. Soc. Chem. Ind.*, 1907, p. 468.

The solvent in the silk is removed by a steam distillation, the resulting aqueous solution being separated by fractional distillation.

51. Process and Apparatus for Distilling off and Recovering Solvents Used in Manufacturing Smokeless Powder. Nikolsky. English Patent 3661. February 14, 1906. *J. Soc. Chem. Ind.*, 1906, p. 868.

The cordite grains are placed in chambers jacketed with hot water and the solvent vapor pumped off to a condenser slowly to prevent blistering.

52. Process for Separating the Vapors of Volatile Liquids from Gases. Barbezat. French Patent 372,524, February 20, 1906. *J. Soc. Chem. Ind.*, 1907, p. 518.

In recirculation processes the gas passes through a recuperator between the drying chamber and the condenser.

53. Recovery of the Vapors of Volatile Liquids. Diaminti and Lambert. French Patent 372,888, March 3, 1906. *J. Soc. Chem. Ind.*, 1907, p. 518. U. S. Patent 919,832, April 27, 1909.

The condensed solvent leaving the condenser comes in contact with very cold surfaces, avoiding subsequent reevaporation.

54. Use of the Previous Patent (53) in Artificial Silk Manufacture. French Patent 372,889, March 3, 1906. *J. Soc. Chem. Ind.*, 1907, p. 525.

Air is circulated at 40° C., and is then cooled in the preceding apparatus.

55. Recovery of Ether and Alcohol Vapor from Air. De Chardonnet. French Patent 376,785, June 21, 1906. *J. Soc. Chem. Ind.*, 1907, p. 1040.

The gas passes through a chamber counter-current to water which at the start contains a small percentage of alcohol to absorb the ether. The solvent is recovered by fractional distillation.

56. Recovery of Alcohol and Ether from Air. De Chardonnet. French Patent 377,673, July 17, 1906. *J. Soc. Chem. Ind.*, 1907, p. 1088.

The air is washed counter-current with amyl alcohol or other high boiling alcohol to remove the ether. The ethyl alcohol present in the air is previously removed by the process in (55).

57. Recovery of Volatile Solvents in Artificial Silk Manufacture. Brecquet. German Patent 196,699, February 10, 1907. *J. Soc. Chem. Ind.*, 1908, p. 558.

The solvent vapors are absorbed in a liquid fat or fatty acid, diluted if necessary with oil of a low melting point. The solvent is then recovered by distillation.

58. Process for Separating One or More Vapors from Mixtures. Meursgerken. English Patent 14,097, June 18, 1907. *J. Soc. Chem. Ind.*, 1907, p. 1189.

Separation is obtained by adjusting the dew-point of the vapor in question by the introduction of inert gases and by temperature control.

59. Apparatus for Drying Coated Fabrics. Spenle. English Patent 17,780, August 3, 1907. *J. Soc. Chem. Ind.*, 1908, p. 746.

The apparatus consists of an enclosed vertical spreader, the fabric passing over rollers at the top and bottom, heat being radiated to it from vertical steam pipes. The sides of the chamber are cooled to condense the vapor and to induce circulation. The top of the chamber is heated to prevent condensation there, and drops from falling onto the fabric.

60. Recovery of Volatile Solvents. Harrison and others. English Patent 23,888, October 29, 1907. *J. Soc. Chem. Ind.*, 1908, p. 1196.

Oil or Glycerine is used as an absorbent. Addition to English Patent 9941 (1907).

The absorption of acetone from cordite smokeless powder by counter-current scrubbing with concentrated calcium chloride solution using a Wolff bottle train.

61. Absorption Tower. Goe. der Tentetewschen. Chem. Fabr. French Patent 382,081, September 11, 1907. *J. Soc. Chem. Ind.*, 1908, p. 225. (Illustration.)

## ABSTRACT OF LITERATURE ON SOLVENT RECOVERY 169

A bell type plate tower with water jacketed shell to remove heat of condensation.

62. Recovery of Volatile Solvents. Dubois. French Patent 384,907, December 11, 1907. *J. Soc. Chem. Ind.*, 1908, p. 494.

The use of multiple effect evaporation to remove the volatile solvents from extracted oils, fats, etc.

63. Gas Washer. Fowler and Medley. English Patent 27,391, December 11, 1907. *J. Soc. Chem. Ind.*, 1908, p. 1196.

Improvement on the centrifugal scrubber described in (26).

64. Absorption Column. Kubierschky. French Patent 384,982, December 12, 1907. *J. Soc. Chem. Ind.*, 1908, p. 494.

The column is divided into a number of bell-sealed compartments, each being provided with a number of perforated plates. The lower part of each compartment communicates by a pipe with the upper part of the compartment immediately over it.

65. Recovery of Solvents from Coated Fabrics. Bataille. French Patent 387,325. *J. Soc. Chem. Ind.*, 1908, p. 820.

Air is circulated under a hood over the spreader on which the fabric is being dried, the pressure being controlled to avoid loss to the surroundings, some of the air being withdrawn continually, cooled, reheated, and recirculated.

66. Recovery of Vapors of Alcohol and Ether from Air. Chardonnet. French Patent 387,054, February 8, 1908. *J. Soc. Chem. Ind.*, 1908, p. 803.

On account of the poor recovery obtained by scrubbing with sulphuric acid or by simple refrigeration, these methods are replaced by the compression and refrigeration processes of Linde, Pictet, and others.

67. Process for the Recovery of Volatile Liquids. Soc. "L'Air Liquide" (Claude). French Patent 397,791, March 6, 1908. *J. Soc. Chem. Ind.*, 1909, p. 880.

The gases are cooled, compressed, expanded in cylinders doing work, reheated by recuperators, etc., in the usual "Claude" fashion. Precautions are taken to keep the temperature produced above the freezing point of the condensed vapor in order to avoid clogging the apparatus.

68. Recovery of Solvents from Rubber Coated Fabrics. Labruyere. French Patent 391,499, June 20, 1908. *J. Soc. Chem. Ind.*, 1908, p. 1164.

Special water cooled condensing surfaces are built around the spreader and air forced through them under slight external pressure. The last of the solvent in the fabric is driven off by a vigorous air blast.

69. Recovery of Solvents from Nitrocellulose Silk. Tubize. French Patent 401,262, July 15, 1908. *J. Soc. Chem. Ind.*, 1909, p. 1084.

Sulphuric acid of 62° Be' is used for scrubbing the air instead of 66° Be', so that the acid may be recovered by evaporation in lead instead of platinum.

70. Apparatus for Scrubbing Gases and Vapors with Liquids. Feld. English Patent 15,683, July 23, 1908. *J. Soc. Chem. Ind.*, 1909, p. 1239.

Improvement in the previous scrubber (47) using eliminators to separate the water and gas in the column.

71. Fractional Condensation of Vapors. Löwenstein. U. S. Patent 898,980, September 15, 1908. *J. Soc. Chem. Ind.*, 1908, p. 1008.

The condenser is cooled by boiling liquid of the same composition as the vapor supposed to condense therein, the heat for the boiling supplied by heat of condensation. The pressure is regulated.

72. Process for the Recovery of Volatile Solvents. Perks. French Patent 397,435, December 15, 1908. *J. Soc. Chem. Ind.*, 1909, p. 691.

The concentrated gases taken from the machine go to the recovery apparatus, while the dilute gases from the rest of the room are vented separately to the atmosphere.

73. Process for the Separation of Volatile Solvents from Substances which are Insoluble in Water. Wilhelm. German Patent 213,246, April 19, 1909. *J. Soc. Chem. Ind.*, 1909, p. 1078.

The solvents are steam distilled from a suspension of the material in water.

74. Recovery of Volatile Liquids Lost in Industries. Claude. *Comptes rendus* 1909, vol. 149, pp. 780-782. *J. Soc. Chem. Ind.*, 1909, p. 1239.

The dilute air is compressed to 4 atmospheres, and cooled to  $-90^{\circ}$  C. in recuperators in order to remove the water and solvent before expanding in cylinders. The energy consumed is about  $\frac{1}{20}$  horse-power hours per cubic meter of air treated.

75. Apparatus and Process for Recovering Volatile Solvents. Crépelle-Fontaine. French Patent 396,664. *J. Soc. Chem. Ind.*, 1909, p. 597.

A distilling column for separating alcohol and ether.

76. Apparatus for Treatment of Vapors with Liquids. Bliemeister. German Patent 243,838, January 8, 1909. *J. Soc. Chem. Ind.*, 1912, p. 374.

A drum made of parallel bars is rotated in a casing through which gas is passing, the liquid being sprayed on the drum continuously.

77. Collection and Recovery of Alcohol and Ether Vapor from Air. De Chardonnet. French Patent 413,359, May 24, 1909. *J. Soc. Chem. Ind.*, 1910, p. 1100.

Part of the alcohol in the artificial silk is dissolved out by water, the remainder together with the ether being absorbed from the air in towers, first by amyl alcohol which takes out the ether and part of the alcohol, second by dilute alcohol, and finally by water. The solvents are recovered by fractional distillation.

78. Process for the Recovery of Vapors of Volatile Liquids from Air. Claude. French Patent 413,571, May 29, 1909. *J. Soc. Chem. Ind.*, 1910, p. 1092. (Illustration.)

The air is recirculated, being compressed, cooled in a heat interchanger, expanded, reheated, etc. The expansion assists in driving the compressor.

79. Apparatus and Process for Recovering the Alcohol and Ether Lost in Air. Crépelle-Fontaine. French Patent 401,182, July 9, 1909. *J. Soc. Chem. Ind.*, 1909, p. 1078.

The gases pass through a bubbler-type plate tower, the absorbing liquid being recirculated through the tower and being cooled each time at the base.

80. Recovery of the Vapors of Volatile Solvents. Fournaud. French Patent 416,064, July 28, 1909. *J. Soc. Chem. Ind.*, 1910, p. 1371.

The artificial silk filament is enclosed during the spinning and small amounts of air are drawn by it at high velocity.

81. Recovery of Volatile Solvents. Smith and others. English Patent 18,605, August 12, 1909. *J. Soc. Chem. Ind.*, 1910, p. 1092.

The solvent is absorbed by oil while in the compression cylinder of the compressor. It is separated from the oil by distillation.

82. Column Apparatus for Absorbing Gases by Liquids. Walter. French Patent 407,792, October 11, 1909. *J. Soc. Chem. Ind.*, 1910, p. 615. (Illustration.)

Spiral plates with partitions causing the gas to pass through the liquid.

83. Recovery of Solvents (alcohol and ether) Used in the Manufacture of nitrocellulose products. De Sauverzac. French Patent 420,086, November 12, 1909. *J. Soc. Chem. Ind.*, 1911, p. 353.

The material is soaked in a liquid in which the solvents are alone soluble, for instance, 400 parts water, 600 parts alcohol, 200 parts aluminum chloride or other chloride.

84. Absorption of Gases and Vapors by Liquids. Schon. French Patent 412,883, February 21, 1910. *J. Soc. Chem. Ind.*, 1910, p. 1093.

Cup-shaped bells are alternately dipped and raised to bring fresh liquid film in contact with gas without agitation of the liquid.

85. Recovery of Volatile Liquids. Claude. French Patent 425,992, April 20, 1910. *J. Soc. Chem. Ind.*, 1911, p. 942. (Illustration.)

Part of the vapor laden air is cooled by compression and expansion and is used to cool the remainder of the air in a cooler and heat interchanger, being afterwards mixed with the cooled remainder for recirculation after heating.

86. Means for Collecting the Vapors from the Manufacture of Artificial Silk. Tubize. English Patent 11,729, May 11, 1910. *J. Soc. Chem. Ind.*, 1910, p. 1004.

A device for enclosing the apparatus producing the filament.



## ABSTRACT OF LITERATURE ON SOLVENT RECOVERY 171

87. English Patent 17,696, July 26, 1910. *J. Soc. Chem. Ind.*, 1911, p. 942.

An improvement on (26) and (63), the liquid being injected between the whirling discs by means of nozzles.

88. Process of Recovering Volatile Solvents of Cellulose Esters from Gases. Wohl. German Patent 241,973, November 13, 1910. *J. Soc. Chem. Ind.*, 1912, p. 225.

Counter-current absorption by layers of the fresh cellulose esters, the gases preferably compressed and cooled.

89. Process for Recovering Vapors of Volatile Liquids. Claude. French Patent 435,073, December 14, 1910. *J. Soc. Chem. Ind.*, 1912, p. 321.

Recirculated air is compressed and cooled several times, finally being allowed to expand to produce cooling to below the dew point.

90. Apparatus for Scrubbing Gases. Hart. English Patent 29,391, December 17, 1910. *J. Soc. Chem. Ind.*, 1912, p. 177.

The gas is blown tangentially into a vertical cylindrical shell, causing to rotate centrally supported blades which distribute the liquid in thin films onto various baffle plates.

91. Apparatus for Subjecting Gases to the Action of Liquids. Feld. U. S. Patent 983,037, January 31, 1911. *J. Soc. Chem. Ind.*, 1911, p. 272.

Same as (47).

92. Absorber for Gases and Vapors. Smith and others. English Patent 7536, March 25, 1911. *J. Soc. Chem. Ind.*, 1911, p. 1000.

A scrubbing tower with vertical rotating shaft with bristles, gauze, etc., dipping into the liquid on the plates.

93. Process for the Recovery of Volatile Liquids from extractions. Donard. French Patent 429,827, May 5, 1911. *J. Soc. Chem. Ind.*, 1911, p. 1300.

The residual solvent is vaporized by blowing through it superheated solvent vapor, the last traces being removed by means of a vacuum pump.

94. Process and Apparatus for Recovering Volatile Liquids. Early and others. French Patent 429,934, May 19, 1911. *J. Soc. Chem. Ind.*, 1911, p. 1301. *Chemical Abstracts* 6, p. 2022 (1912).

A direct cooler of the tower type for immiscible solvents, using refrigerated water. The gases bubble through perforated plates, and the water overflows alternately at the center and at the periphery.

95. Absorber for Gases. Honigmann. German Patent 255,534, June 11, 1911. *J. Soc. Chem. Ind.*, 1913, p. 351.

A vertical centrifugal scrubber of the Feld type using scoops attached to the central shaft.

96. Apparatus for the Absorption of Vapors from Dilute Gases by Liquids. Moscicki. English Patent 17,355, July 29, 1911. *J. Soc. Chem. Ind.*, 1912, p. 801.

A horizontal chamber containing suitable filling material through which the gas passes horizontally. The chamber is separated into sections by a series of vertical partitions, and the liquid trickles downward from the top of each section, being pumped back to the top of the same partition, the excess liquid fed flowing counter-current to the next partition.

97. Apparatus for Recovering Volatile Solvents from Air. Collard. U. S. Patent 1,003,089, September 12, 1911. *Chemical Abstracts* 5, p. 3884 (1911).

98. Process for Removing Alcohol Vapor from Air. Zuckendorf. French Patent 434,904, October 6, 1911. *J. Soc. Chem. Ind.*, 1912, p. 354.

The air containing the alcohol is humidified by the introduction, by means either of a spray or of the vapor, of water or any other substance in which alcohol is soluble, and the whole is then cooled in a condenser, most of the alcohol coming out with the water.

99. Apparatus for Washing Gases. Hulett and others. English Patent 23,813, October 27, 1911. *J. Soc. Chem. Ind.*, 1912, p. 801. Addition to English Patent 18,129, August 28, 1908.

A rotary scrubber with horizontal revolving trays, the liquid spraying over the serrated edges by centrifugal force.

100. Apparatus for Treating Vapors with Liquids. Fowler and Medley. English Patent 23,864, October 28, 1911. *J. Soc. Chem. Ind.*, 1912, p. 1167.

Improvement in method of introducing liquid into rotary scrubber described in (26) and (63).

101. Absorption of Vapors of Volatile Liquids. Wohl. English Patent 23,995, October 30, 1911. Chemical Abstracts 6, p. 2170 (1912), and 7, p. 1415 (1913).

102. Process and Apparatus for Absorbing Gases. Arnaud. French Patent 438,195. *J. Soc. Chem. Ind.*, 1912, p. 628.

The gas and scrubbing liquid are forced under pressure through an injector, thus securing intimate contact. The mixture passes to a settling chamber to remove the liquid, from which the gas is withdrawn, expanded, reheated and reused, while the liquid is taken to another chamber under lower pressure where the dissolved gas is released.

103. Extraction of Oils by Volatile Solvents. Merz. *Chimiste*, 3, pp. 85-87 (1912). Chemical Abstracts 6, p. 2698 (1912).

A discussion of modern practice in oil extraction.

104. Absorption Apparatus. Aminoff. U. S. Patent 1,019,003, February 27, 1912. *J. Soc. Chem. Ind.*, 1912, p. 321.

The liquid flows down through an inclined trough fitted with baffles of such a nature as to cause the gas to bubble through the liquid in passing to the next higher compartment.

105. Recovery of Volatile Solvents Used in the Manufacture of Plastic Nitro-cellulose objects. Delpech. French Patent 441,551, February 28, 1912. *J. Soc. Chem. Ind.*, 1912, p. 916.

The objects are soaked in a warm aqueous solution of hygroscopic salts, in which the solvent is soluble. The solvent is afterwards recovered by distillation. See French Patent 436,440, November 16, 1911.

106. Method of Scrubbing Gases. Lymm. English Patent 11,452, May 14, 1912. *J. Soc. Chem. Ind.*, 1912, p. 1167.

An improvement upon the Feld type of centrifugal scrubber.

107. Separation and Recovery of Solvents from Residues of Oil Extractions. Zipser. French Patent 444,194, May 23, 1912. *J. Soc. Chem. Ind.*, 1912, p. 1137.

The residual solvent is vaporized by passing through the material hot or cold air or gas, and the solvent is recovered from the gas in the usual way.

108. Absorber for Gases. Smith and others. English Patent 14,652, June 22, 1912. *J. Soc. Chem. Ind.*, 1913, p. 780.

A counter-current absorption tower fitted with corrugated plates close enough together so that the corrugations form liquid seals on the next lower plate. There may be perforations for the gas at alternate sides of the plates, or the plates may be rotated by a central shaft.

109. Means for Absorbing Vapor from Air. Schon. English Patent 16,510, July 15, 1912. *J. Soc. Chem. Ind.*, 1913, p. 275.

A double chamber, the liquid dripping through the porous bottom of the upper chamber into the lower, through which the gas is passing. The porosity of the plate controls the flow of liquid.

110. Absorber for Gases. Miguet. French Patent 460,877, October 15, 1912. *J. Soc. Chem. Ind.*, 1914, p. 65. (Illustration.)

Air enters the absorption chamber under the liquid which it forces up through vertical tubes like an air lift, the mixture of air and liquid discharging from the top of the tubes onto suitable packing material such as coke, down through which the air and liquid percolate, the liquid being recirculated while the air escapes from a point near the bottom.

111. Apparatus for Washing Gases. Thieseu. U. S. Patent 1,042,840, October 29, 1912. *J. Soc. Chem. Ind.*, 1912, p. 1167.

A special design of centrifugal blower with the scrubbing liquid introduced inside the blower by means of numerous spray nozzles, the rotating blades and baffles bringing the liquid and gas into intimate contact.

112. Apparatus for Scrubbing Gases. Hart. English Patent 27,654, November 30, 1912. *J. Soc. Chem. Ind.*, 1913, p. 817. Addition to English Patent 29,391, December 17, 1910.

A device similar to a centrifugal separator where the gas enters tangentially



and comes into contact with the liquid, giving it a rapid whirling motion thus securing rapid mixing.

113. Recovery of Volatile Solvents. Houdard and Vasseur. French Patent 448,665, December 2, 1912. *Chemical Abstracts* 7, p. 2459 (1913).

A steam ejector is used to draw the vapors from the vaporizing chamber to the condenser.

114. Absorber for Gases. Smith and others. English Patent 28,510, December 10, 1912. *J. Soc. Chem. Ind.*, 1913, p. 969.

The plates of a scrubbing tower are given a circular reciprocating motion similar to that in a gyratory crusher by means of an eccentric at the base. The plates may be either of the cap type or of the rotating centrifugal type.

115. Separation of Vapor from Gases by Adsorption on Charcoal or other Adsorbing Agent. Behrens. German Patent 251,695, January 16, 1912. *J. Soc. Chem. Ind.*, 1913, p. 75.

The adsorption is carried on at atmospheric or increased pressure and at a temperature between the critical temperatures of the gases to be separated from each other. The adsorbed gases are later recovered by diminishing the pressure.

116. Apparatus for Absorbing Gases by Liquids. Dejeane. French Patent 453,793, January 30, 1913. *J. Soc. Chem. Ind.*, 1913, p. 780. (Illustration.)

Vertical cylindrical tower filled with special superimposed conical sections.

117. Absorption Apparatus with Tangential Gas Inlets. Flasche. German Patent 271,786, March 21, 1913. *J. Soc. Chem. Ind.*, 1914, p. 541.

The gas enters tangentially below the liquid causing the circulation of the liquid down through a central slotted hood.

118. Spraying Apparatus for Washing Gases. Fowler and Medley. English Patent 10,963, May 9, 1913. *J. Soc. Chem. Ind.*, 1914, p. 632.

Specification cut, Fig. 2.

Addition to (100).

119. Absorption Tower. Kubierschky. German Patent 269,995, May 16, 1913. *J. Soc. Chem. Ind.*, 1914, p. 341. Addition to German Patent 194,567.

An important type of reaction tower illustrated in *Z. angew. Chem.*, 1919, p. 32 and pp. 149-155.

120. Apparatus for Recovering Volatile Solvents from Fabrics. Hopewell. U. S. Patent 1,063,686, June 3, 1913. *J. Soc. Chem. Ind.*, 1913, p. 241. *Chemical Abstracts* 7, p. 2477 (1913).

The coated fabric enters and leaves the apparatus through openings sealed with a suitable liquid. In the apparatus it passes over heated mangles of successively higher temperatures. The air at the start is driven out by steam, and that collecting later is removed through an automatic valve to a vacuum pump. The vapor is condensed as shown.

121. Apparatus for Absorbing Gases. Schon. Addition to French Patent 459,589, June 23, 1913. *J. Soc. Chem. Ind.*, 1915, p. 786.

See (109).

122. Process for Separating Solvents from Fats. Bodin and others. French Patent 460,746, July 26, 1913. *J. Soc. Chem. Ind.*, 1914, p. 91. *Chemical Abstracts* 8, p. 3130 (1914).

The solvent is brought into contact tangentially with a heated surface to give high velocity to liquid and vapor.

123. Apparatus for Recovering Solvents from Laquering. Rowland. U. S. Patent 1,069,033, July 29, 1913. *Chemical Abstracts* 7, p. 3241 (1913).

The coated articles are carried by a suitable conveyor from the dipping room to a steam heated drying room, the air from this room being exhausted to a suitable condenser.

124. Packing for Absorption Towers. Moritz. French Patent 462,877, September 23, 1913. *J. Soc. Chem. Ind.*, 1914, p. 302.

The use of staggered horizontal baffles in a vertical filled type tower, the baffles by the filling.

125. Apparatus for Washing Gases. Thiesen. English Patent 21,427, September 23, 1913. *J. Soc. Chem. Ind.*, 1914, p. 241.

Addition to (111).

126. Filling for Absorption Towers. Nitrogen Products Co. and others. English Patent 26,269, November 15, 1913. *J. Soc. Chem. Ind.*, 1914, p. 241.

The filling unit consists of three or more blades of any shape radiating from a central boss.

127. Apparatus for Washing Gases. Kirkham and others. English Patent 7958, April 4, 1913. *J. Soc. Chem. Ind.*, 1914, p. 341.

Addition to English Patent 18,129 of 1909. *J. Soc. Chem. Ind.*, 1909, p. 873.

128. Recovery of Solvents from the Manufacture of Rubber Goods, etc. Boecler. English Patent 22,638, October 7, 1913. *J. Soc. Chem. Ind.*, 1914, p. 703. *Chemical Abstracts* 9, p. 872 (1915).

The spreaders or rollers are completely enclosed and the lower portion under the spreader is water jacketed to condense the settling vapors.

129. Recovery of Volatile Solvents Used in the Manufacture of Plastic Materials (such as artificial silk). Barthélemy. *Les Matieres Grasses*, 7, pp. 4208-4213, 4236-4238 (1914). *J. Soc. Chem. Ind.*, 1914, p. 915. *Chemical Abstracts* 9, pp. 245, 1259 (1915).

The absorption of ether by sulphuric acid is a function of the concentration of the acid. 66° acid will absorb about one molecular weight of ether per molecular weight of acid from air containing only a few parts of ether per thousand, while acid containing one or more molecular weights of water will absorb none. An equimolal mixture of ether and acid is deprived of the ether by a current of moist air (see French Patent 350,298, of 1905. *J. Soc. Chem. Ind.*, 1906, p. 71,925). Carbon bisulphide vapor can be absorbed by alcoholic KOH. Benzene can be absorbed by hot concentrated sulphuric acid or by mixed acid.

130. Extraction of Fats by Volatile Solvents. Kosel. *Siefensieder Z'tg.* 41, pp. 1319-1322, 1342-1345 (1914). *Chemical Abstracts* 9, p. 1256 (1915). Description of plant.

131. Apparatus for Separating Condensable Vapors from Air. Fries Sohn. German Patent 316,652, January 24, 1914. *J. Soc. Chem. Ind.*, 1920, p. 437A.

A double pipe cooler with projections on the outside of the inner pipe to improve the coefficient of heat transmission.

132. Filling for Absorption Towers. Raschig. English Patent 6288, March 12, 1914. *J. Soc. Chem. Ind.*, 1914, p. 907. U. S. Patent 1,141,266, June 1, 1915.

133. Apparatus for Recovering Solvents. Du Pont. English Patent 10,351, April 27, 1914. *J. Soc. Chem. Ind.*, 1915, p. 601. *Chemical Abstracts* 9, p. 2726 (1915).

An enclosed chamber with natural circulation by convection currents, using heating and cooling coils.

134. Extracting Oils with Volatile Solvents. Turner. U. S. Patent 1,104,456, July 21, 1914. *Chemical Abstracts* 8, p. 3130 (1914).

135. Apparatus for Washing Gases. Feld. U. S. Patent 1,110,914, September 15, 1914. *J. Soc. Chem. Ind.*, 1914, p. 999. (Illustration.) Extension of French Patent 475,387, May 19, 1914. *J. Soc. Chem. Ind.*, 1916, p. 31.

A rotating slotted bell with slots under the liquid. The gases enter the bell at the top and bubble through the slots.

136. Apparatus for Washing Gases. Croziat. French Patent 476,913, December 29, 1914. *J. Soc. Chem. Ind.*, 1916, p. 591.

A perforated plate tower with concentric stepped plates.

137. Recovery of Volatile Solvents in the Rubber Industry. Hoffman. *Kunststoffe*, 5, pp. 131-133, 134-136 (1915). *Chemical Abstracts* 9, p. 2327 (1915). Description with cuts of several patented spreaders listed elsewhere.

138. Filling Material for Tower. Raschig. German Patent 292,622, May 6, 1915. Addition to German Patent 286,122. See (132).

139. Recovery of Volatile Solvents other than Petroleum Compounds. Frischer. English Patent 7098, May 11, 1915. *J. Soc. Chem. Ind.*, 1916, p. 681. *Chemical Abstracts* 10, p. 2788 (1916).

The gas is washed first with a liquid of about the same composition as the solvent in the air, and then is washed with an emulsion of animal or vegetable oils in water.

140. Apparatus for Washing Gases. Zöhe. U. S. Patent 1,168,451, January 18, 1916. *J. Soc. Chem. Ind.*, 1916, p. 294.

Special apparatus for surface absorption.

141. Recovery of Volatile Solvents. Pooley and Scott. English Patent 103,682, January 31, 1916. *Chemical Abstracts* 11, p. 1760 (1917).

The use of the usual column still for separating solvent from dissolved oils.

142. Absorbing Apparatus. Rhoades. U. S. Patent 1,171,648, February 15, 1916. *J. Soc. Chem. Ind.*, 1916, p. 410.

The gases pass through a series of upper and lower tanks, meeting the liquid in the upper tank and both descending to the lower where the gas is caught under a bell and led to the upper tank of the next series, while the liquid is pumped to the upper tank of the preceding series, counter-current to the gas.

143. Filling Material for Absorption Towers. Raschig. German Patent 297,379, February 19, 1916. *J. Soc. Chem. Ind.*, 1917, p. 700. An assortment of miscellaneous shapes.

144. Recovery of Volatile Solvents from Air by Sulphuric Acid. Lehner. German Patent 303,396, September 10, 1916. *J. Soc. Chem. Ind.*, 1920, p. 214A.

A counter-current series of towers through which the air passes in series, the acid being recirculated in each tower, being pumped at intervals to the next tower in the series.

145. Process for Separating Vapors from Gases. Linde. German Patent 302,674, September 12, 1916. *J. Soc. Chem. Ind.*, 1918, p. 328A.

The cooled gas is washed with a refrigerated liquid of approximately the same composition as the condensed vapor.

146. Absorption Tower. Hiller. U. S. Patent 1,199,380, September 26, 1916. *J. Soc. Chem. Ind.*, 1916, p. 1207.

The gas is injected into the absorption apparatus by the absorbing liquid. The heat of solution is removed by means of external cooling. The liquid is partially recirculated.

147. Apparatus for the Recovery of Solvents from Coated Fabrics. Lynah. U. S. Patent 1,228,225. *J. Soc. Chem. Ind.*, 1917, p. 869. *Chemical Abstracts* 11, p. 2164 (1917).

The apparatus consists of a feeding chamber and an evaporating chamber all covered with a vapor tight cover, sealed with liquid, and a suitable connection for withdrawing the air from the chamber to the condenser, and for returning it to the apparatus.

148. Filling Material for Towers. Oates and others. English Patent 109,915, January 23, 1917. *J. Soc. Chem. Ind.*, 1917, p. 1170.

Hollow, slotted, pear-shaped sections superimposed.

149. Filling Material for Towers. Goodwin. English Patent 110,260, January 23, 1917. *J. Soc. Chem. Ind.*, 1917, p. 1228.

Two truncated cones joined at the apex, perforated or otherwise.

150. Recovery of Vapor Absorbed in Sulphuric Acid (alcohol, ether, etc.). Hermann. German Patent 300,733, March 6, 1917. *J. Soc. Chem. Ind.*, 1920, p. 765A.

The diluted acid is distilled either with closed or open steam in a fractionating column.

151. Recovery of Volatile Solvents. Baker. U. S. Patent 1,218,616, March 13, 1917. *Chemical Abstracts* 11, p. 1532 (1917). See (133).

152. Recovery of Alcohol Remaining in Extracted Material. Schunert. German Patent 311,812, April 8, 1917. *J. Soc. Chem. Ind.*, 1919, p. 886A.

The alcohol is removed by upward displacement with cold water, the upper concentrated portion being removed by decantation.

153. Apparatus for Separating Vapors from Gases. Frohrieb. U. S. Patent 1,222,751, April 17, 1917. *J. Soc. Chem. Ind.*, 1917, p. 585.

The absorbent in the form of a belt travels through a chamber containing suitable baffles to bring the gas into contact with it. The slack of the belt is squeezed by rollers to remove the liquid.



154. Apparatus for Adjusting the Head of Liquid in Absorption Towers Arranged in Series. Schad. German Patent 309,387, February 5, 1917. *J. Soc. Chem. Ind.*, 1919, p. 211A.

155. Recovery of Volatile Solvents by Condensation. Persch. English Patent 116,590, June 20, 1918. *J. Soc. Chem. Ind.*, 1918, p. 495A.

The gas mixture is heated to the boiling temperature of the solvent to be condensed and then cooled. Non-oxidising gases such as nitrogen may be used. (The author is unable to understand the philosophy of this process.)

156. Apparatus for Recovering Solvent. Kniffen. U. S. Patent 1,236,719, August 14, 1917. *J. Soc. Chem. Ind.*, 1917, p. 1087. See (133) and (151).

157. Process for Recovering Volatile Liquids. Bregeat. English Patent 128,640, August 21, 1917. *J. Soc. Chem. Ind.*, 1919, p. 612A. *Chemical Abstracts* 13, p. 2983 (1919). English Patent 131,938, March 25, 1918. *J. Soc. Chem. Ind.*, 1919, p. 751A. *Chemical Abstracts* 14, p. 326 (1920). U. S. Patents 1,315,700 and 1,315,701, September 9, 1919. English Patent 127,309, April 11, 1917. *J. Soc. Chem. Ind.*, 1919, p. 521A. *Chemical Abstracts* 13, p. 2428 (1919).

The use of phenol or its homologues as a scrubbing medium.

158. Recovery of Alcohol and Ether from Air. Craig and others. English Patent 129,024, September 26, 1917. *J. Soc. Chem. Ind.*, 1919, p. 612A.

The ether is removed first by scrubbing with refrigerated alcohol, the alcohol then being removed by scrubbing with cold water or other solvent for alcohol. A tower similar to that in English Patent 25,993 of 1901 is used.

159. Apparatus for Treating Gases and Vapors. Frischer and Drees. German Patent 323,474, October 30, 1917. *J. Soc. Chem. Ind.*, 1920, p. 774A.

The washing chamber is divided into compartments in which are different washing liquids.

160. Recovery of Volatile Solvents in the Manufacture of Impregnated Fabrics. Sestini. *Annali Chim. Appl.* 10, pp. 117-130 (1918). *J. Soc. Chem. Ind.*, 1919, p. 123A. *Chemical Abstracts* 13, p. 997 (1919).

161. Recovery of Solvents from Air. Knoedler and Dodge. *J. Ind. Eng. Chem.*, 10,593-595 (1918). *Chemical Abstracts* 12, p. 2045 (1918).

Description of a plant for recovering mixtures of methyl and ethyl alcohol, acetone, and camphor vapors from air from the drying of Welsbach mantles.

The air containing 4% solvents at 80° C. is cooled in the heat interchanger to 10° C. then scrubbed with water at 5° C. non-counter-current, the water being cooled and recirculated to increase concentration. The discharged air averages 0.9% solvent. The cost (1918) of recovering the solvent including distillation was \$0.26 per gallon.

162. Recovery of Volatile Solvents by Simple Condensation. Ponchon. *Chimie et Industrie*, 1, pp. 481-491 (1918). *Chemical Abstracts* 13, p. 364 (1919). A discussion of theory and practice, illustrated.

163. Perforated Plates for Absorption Towers. Papling. German Patent 323,296, January 17, 1918. *J. Soc. Chem. Ind.*, 1920, p. 774A.

The holes in the plates are shaped like Venturi tubes in order to insure a smaller pressure drop for the gas in passing through them.

164. Separating Solvents Used in Extracting Oils and Fats. Minekishi and Tochiku. Japanese Patent 31,986, January 9, 1918. *Chemical Abstracts* 12, p. 2255 (1918).

The oil and solvent mixture flows through a special steam heated vaporizing chamber.

165. Apparatus for Washing Gases. Davidson and others. English Patent 115,006, January 18, 1919. *J. Soc. Chem. Ind.*, 1918, p. 290A. (Illustration.)

Centrifugal type scrubber similar to that in English Patent 9302 of 1914. *J. Soc. Chem. Ind.*, 1914, p. 1082.

166. Recovery of Solvents and Volatile Liquids. Lloyd and Wild. English Patent 122,685, January 26, 1918. *J. Soc. Chem. Ind.*, 1919, p. 170A. *Chemical Abstracts* 13, p. 1375 (1919).

The spreader has a close fitting hood, under which dried air is circulated over the fabric. The air is then taken to a condenser, and is reheated and recirculated.

167. Recovery of Solvents from Smokeless Powder. Du Pont. U. S. Patent 1,294,066, February 11, 1919. *Chemical Abstracts* 13, p. 1152 (1919).

A portion of the vapor from the powder is cooled and condensed, the balance being circulated in a superheated condition to act as a carrier for that removed. In the accompanying cut "c" is a heater for superheating the circulating vapor.

168. Method of separating Volatile Substances. Barstow and Griswold. U. S. Patent 1,261,005, April 2, 1919. *J. Soc. Chem. Ind.*, 1918, p. 398A. *Chemical Abstracts* 12, p. 1589 (1918).

The counter-current steam distillation of residues from extractions.

169. Process for Recovering Volatile Vapors. Barth. U. S. Patent 1,264,479, April 30, 1918. *J. Soc. Chem. Ind.*, 1919, p. 398A.

Mixture is cooled to condense some of the vapors and then diluted with a suitable inert gas to render it non-explosive before discharging it into the atmosphere.

170. Method of Removing Ether from Sulphuric Acid. Barbet. English Patent 117,259, June 19, 1918. *J. Soc. Chem. Ind.*, 1919, p. 521A. (Illustration.) *Chemical Abstracts* 12, p. 2417 (1918).

The mixture is distilled under a vacuum in order to avoid decomposition of the ether.

171. Process and Apparatus for Recovering Vapors of Alcohol and Ether from Air. Barbet. English Patent 101,723, October 6, 1916. *J. Soc. Chem. Ind.*, 1918, p. 45A.

The vapors are absorbed by dilute sulphuric acid in a plate tower, the acid then being distilled to recover the ether and reused, in a continuous process.

172. English Patent 101,875, October 12, 1916. *J. Soc. Chem. Ind.*, 1918, p. 45A. *Chemical Abstracts* 11, p. 280 (1917).

Automatic valve for (171).

173. Distilling Volatile Substances. Foster. U. S. Patent 1,277,895, September 3, 1918. *Chemical Abstracts* 12, p. 2417 (1918).

The gases containing the vapors are compressed and cooled to remove the vapor. They are then reheated by the heat of compression of the vapor laden gas, and are then reheated further by the hot exhaust of the engine driving the compressor, and are then reused.

174. Drying Smokeless Powder. Gathmann. U. S. Patent 1,289,150, December 31, 1918. *Chemical Abstracts* 13, p. 793 (1919).

Recirculated gases under controlled solvent humidity, by controlling condensation temperature, prevent surface hardening of the powder.

175. Theory of Absorption Towers for Nitric Acid Manufacture. Partington and Parker. *J. Soc. Chem. Ind.*, 1919, p. 75 T—80 T. (A good article.) *Chemical Abstracts* 13, p. 2109 (1919).

176. New Method of Absorption of Gases. Moscicki. *Chim and Ind.*, 1919, p. 1303-1316. *J. Soc. Chem. Ind.*, 1920, p. 143A.

Gases flow horizontally through the liquid insuring good contact with little drop in pressure.

177. Resistance of Absorption Tower Packing to Gas Flow. Zeisberg. *Am. Inst. Chem. Eng.*, December, 1919. *Chem. and Met. Eng.*, 1919, 21, pp. 765-767. *J. Soc. Chem. Ind.*, 1920, p. 143A. *Chemical Abstracts* 14, 1920, p. 599. (Important.)

178. Recovery of Volatile Solvents. Razons. *L'industrie Chimique*, 6, 169-172, 195-197, 229-231 (1919). *Chemical Abstracts* 14, p. 314 (1920).

179. Recovery of Solvents. *Caoutchouc et Gutta Percha*, 16, pp. 9758-9761 (1919). *Chemical Abstracts* 13, p. 1548 (1919). Description of Bregeat apparatus.

180. Recovery of Volatile Solvents. Levy. English Patent, January 27, 1919. *J. Soc. Chem. Ind.*, 1920, p. 214A. *Chemical Abstracts* 14, p. 2685 (1920).

The solvent is adsorbed in two chambers filled with charcoal, one being used as an absorber while the other is being heated to recover the solvent.

181. Recovery of Volatile, Inflammable Solvents. Lewis and Green. English Patent 152,374, January 31, 1919. *J. Soc. Chem. Ind.*, 1920, p. 773A. Canadian Patent 199,907, May 11, 1920. *Chemical Abstracts* 14, p. 2401 (1920).

The use of specially prepared flue gas as a carrier for the vapor.



182. Recovery of Solvents from Nitro Compounds. Cram. Canadian Patent 188,801, February 18, 1919. *Chemical Abstracts* 13, p. 793 (1919).

The solvent is removed by solution in warm water from which it is recovered by distillation. The compounds are then dried with air.

183. Apparatus for the Recovery of Solvents from Airplane Wings. Du Pont. English Patent 123,752, February 20, 1919. *J. Soc. Chem. Ind.*, 1920, p. 387A.

184. Recovery of Volatile Solvents from Coated Fabrics. Du Pont. English Patent 131,732, May 5, 1919. *Chemical Abstracts* 14, p. 104 (1920).

The use of "dead oil" (coal tar distillate from 240°–350° C.) for absorbing the acetates of ethyl and propyl alcohol.

185. Recovering Solvents. Du Pont. English Patent 130,962, May 5, 1919. *Chemical Abstracts* 14, p. 211 (1920).

The use of wood tar distillate boiling between 205° and 245° C. as an absorbent. A complete plant is specified.

186. Recovery of Volatile Solvents. Plumbridge. English Patent 141,210, May 14, 1919. *J. Soc. Chem. Ind.*, 1920, p. 392A. *Chemical Abstracts* 14, p. 2534 (1920).

The coated fabric is dried in a closed spreader with internal air circulation, the air being withdrawn continually to a compressor and cooler.

187. Recovery of Volatile Solvents. Pooley and Scott. English Patent 127,909, June 22, 1917. *J. Soc. Chem. Ind.*, 1919, p. 521A.

High gas velocity is obtained in the drying chamber by means of internal fans.

188. Absorption Apparatus. Torrance. U. S. Patent 1,311,627, July 29, 1919. *J. Soc. Chem. Ind.*, 1917, p. 706A.

The gas and liquid pass at high velocity together through a tubular absorber, the liquid being trapped off and delivered to another absorber enough below the level of the first to compensate for the loss of head by friction in the first.

189. Recovery of Rubber Solvents. Morron. U. S. Patent 1,312,452, August 5, 1919. *Chemical Abstracts* 13, p. 2616 (1919).

The solvent is dissolved from the rubber by some solvent in which the rubber solvent is soluble but in which the rubber is not soluble. For instance, benzene may be dissolved in alcohol and recovered by agitating the alcohol with paraffine oil and decanting.

190. Absorption Plant. Hechenbleikner. U. S. Patent 1,314,802, September 2, 1919. *J. Soc. Chem. Ind.*, 1919, p. 805A. *Chemical Abstracts* 13, p. 2742 (1919).

A series of towers counter-current with respect to the liquid, but alternately counter-current and parallel-current with respect to the gas.

191. Process of Separating Aqueous and other Vapors from Gases. Paris. U. S. Patents 1,320,167 and 1,320,168, October 28, 1919. *J. Soc. Chem. Ind.*, 1919, p. 940A.

The gases are cooled by expansion in the presence of substances like glycerine which prevent crystallization of the condensed vapor and also act as lubricant for the compressor.

192. Process and Apparatus for the Recovery of Ether and Alcohol Vapors Contained in the Air of Factories. Barbet. U. S. Patent 1,326,432, December 30, 1919. *Chemical Abstracts* 14, p. 603 (1920).

A combination scrubber and continuous still for washing the air with dilute sulphuric acid and a subsequent partial distillation of the scrubber liquor, reusing the acid. In the diagram E is the scrubber and F-F' the still.

193. Absorption of Gases in Spray Systems. Baker. *Chem. and Met. Eng.*, 1920 (22), pp. 122–124. *J. Soc. Chem. Ind.*, 1920, p. 179A. *Chemical Abstracts* 14, pp. 600, 1009 (1920).

A description of the Ceco centrifugal spray scrubber.

194. Distillation and Rectification. Gay. *Chimie et Industrie*, 3, pp. 157–166 (1920). *Chemical Abstracts* 14, p. 1479 and p. 3355, and *Chemical Abstracts* 4, pp. 178–188 (1920).

A theoretical discussion of fractional distillation.

195. Recovery of Volatile Solvents in the Artificial Silk Industry. Hegel. *Kunststoffe* 10, pp. 25–27, 43–45 (1920).

A review of thirty-four patents.

## ABSTRACT OF LITERATURE ON SOLVENT RECOVERY 179

196. Drying Powder in Tunnels with Solvent Recovery. Weissenberger. *Z. ges. Schiess-Springstoffwerker*, 15, pp. 33-36 (1920). *Chemical Abstracts* 14, p. 2419 (1920).

A good description of counter-current recovery.

197. Industrial Processes for the Recovery of Volatile Solvents. *Rev. Prod. Chim.* 23, p. 237 (1920). *Chemical Abstracts* 14, p. 2681 (1920). A description of the Bregeat process (q. v.).

198. Apparatus for Washing Gases. Fowler. English Patent 143,291, February 14, 1919. *J. Soc. Chem. Ind.*, 1920, p. 475A.

Two or more horizontal shafts with discs revolving at high speed, dip into the liquid. The liquid is fed in by spray nozzles and the air is baffled between the revolving discs. The excess liquid overflows.

199. Absorption Tower. Gay. English Patent 144,374, March 7, 1919. *J. Soc. Chem. Ind.*, 1920, p. 537A. *Chemical Abstracts* 14, p. 2876 (1920). Special type of plate tower.

200. Filling Material for Absorption Towers. Künstler and Co. German Patent 319,558, October 2, 1917. *J. Soc. Chem. Ind.*, 1920, p. 507A. Metal strips wound up into spirals.

201. The Recovery of Solvents from Smokeless Powder. Du Pont. U. S. Patent 1,334,360, March 23, 1920. *Chemical Abstracts* 14, p. 1609 (1920).

A modification of (167).

202. Method and Apparatus for Separating Gases and Vapors. Patrick and others. U. S. Patent 1,335,348, March 30, 1920. *J. Soc. Chem. Ind.*, 1920, p. 392A. *Chemical Abstracts* 14 (1920), pp. 1195, 1418, 1599, and 2400.

The use, in the separation of vapors from gases, of the adsorption of the vapor by means of gels whose capillaries are of such a size that when water vapor is adsorbed from air at 15° C, a large part of that adsorbed occurs between the partial pressure limits of 3. and 11. mm. of mercury.

203. Method of Treating Gas-vapor Mixtures. Lummus. U. S. Patent 1,336,360, April 6, 1920. *J. Soc. Chem. Ind.*, 1920, p. 372A. *Chemical Abstracts* 14, p. 1599 (1920).

The mixed vapor and gas is partially condensed in a condenser and the issuing residual mixture is scrubbed in a plate scrubbing tower with the condensate from the condenser, cooled to a lower temperature by means of a supplementary cooler.

204. Recovery of Volatile Solvents. Schmidt. English Patent 141,739, April 15, 1920. *Chemical Abstracts* 14, p. 2534 (1920).

The absorbent is placed in a special drying chamber with large surface exposure. 205. Apparatus for Reclaiming Solvents. Gerli and Ross. U. S. Patent 1,345,083, June 29, 1920. *J. Soc. Chem. Ind.*, 1920, p. 563A. *Chemical Abstracts* 14, p. 2534 (1920).

The material in strips is passed over rollers in a closed chamber, being impregnated and dried in the same chamber under vacuum, the vaporized solvent being removed by the vacuum pump and condensed.

206. Limits of Inflammability of Combustible Vapors. Le Chatelier and others. *Comptes Rendues* 126 (21), pp. 1510-1513.

A brief discussion of the problem.

207. Safety in the Evaporation of Volatile Solvents. Lewis. Address before the 10th annual Safety Congress of the National Safety Council, Boston, Mass., September 27 (1920).

A description of the requirements for satisfactory operation of solvent recovery systems and description of a process using cleaned flue-gas as a gaseous vehicle for the solvent.

208. Explosion-proof Process of Solvent Recovery. Dodge. *Chem. and Met. Eng.* 26, March 1, 1922.

A description of the Lewis process for solvent recovery using a cleaned flue-gas as the gaseous vehicle.

209. The Vapor Pressures of Dilute Alcohol Mixtures. Thomas. *J. Soc. Chem. Ind.*, 41, p. 33T (1922).

An experimental confirmation of Henry's Law for dilute alcohol solutions,

210. The Recovery of Alcohol Vapor from Air. Thomas. *J. Soc. Chem. Ind.*, 41, p. 34T (1922).

The theory of the simple absorption of a vapor from a gas by a liquid when Henry's Law is followed by the solution, with experimental application to dilute alcohol and water mixtures and air.

211. Theory of gas scrubbing towers, with internal packing. Van Arsdel. *Chem. and Met. Eng.*, 23, p. 1115 (1922).

A mathematical discussion of the rate of absorption, referring to Donnan and Mason. *J. Soc. Chem. Ind.*, 39, p. 236T (1920).

212. Tower packing efficiencies. Jorgensen. *Chem. and Met. Eng.*, 24, p. 741 (1921).

Capacity factors on brick and slat filled towers, with reference to sulphuric acid manufacture.

213. Adsorption (sic) of volatile materials by cresol. Weissenberger. *Kunststoffe*, 11, pp. 145-7, 155-7 (1921). *Chemical Abstracts* 16, p. 599 (1922).

Scrubbing vapor laden gases with cresol.

214. Recovering volatile solvents. Bassett and Sadtler. U. S. Patent 1,395,940, November 1, 1921. *Chemical Abstracts* 16, p. 599 (1922).

Volatile solvents such as ether whose vapors are relatively insoluble in water but are soluble in dilute alcohol, are recovered by absorption in 40%-70% alcohol.

215. The recovery of volatile liquids in the industry. Mariller. *Technique Moderne* 12, p. 361 (1920). *Chemical Abstracts* 16, p. 449 (1922).

216. The separation of volatile materials from difficultly absorbable gases. Berl and Andress. *Z. angew. Chem.* 34, pp. 369 and 377 (1921). *Chemical Abstracts* 16, p. 450 (1922).

A study of the adsorption of various organic solvents from air and water vapor by means of charcoal.

217. Note on the recovery of alcohol vapor from air. Drummond. *J. Soc. Chem. Ind.*, 40, p. 285T (1921). *Chemical Abstracts* 16, p. 769 (1922).

218. Tunnel drying of smokeless powder. Weissenberger. *Z. ges. Schiess-Sprengstoffwerke* 16, pp. 169 and 179 (1921). *Chemical Abstracts* 16, p. 1866 (1922).

TABLE OF VAPORIZATION DATA OF VARIOUS  
SOLVENTS

PAGES 182-183



TABLE  
 VAPORIZATION DATA FOR

Name	Formula	Molecular weight	Latent heat of vaporization*	Heat of solution*
Acetaldehyde	CH <sub>3</sub> CHO	44.	248	147
Acetone	(CH <sub>3</sub> ) <sub>2</sub> CO	58.1	226	78
Aniline	C <sub>6</sub> H <sub>5</sub> NH <sub>2</sub>	93.1	196	39
Benzaldehyde	C <sub>7</sub> H <sub>5</sub> CHO	106.1	156	..
Benzene	C <sub>6</sub> H <sub>6</sub>	78.1	169	..
N-Butyl Alcohol	C <sub>4</sub> H <sub>9</sub> OH	74.1	258	..
Carbon Bisulphide	CS <sub>2</sub>	76.	153	..
Carbon Tetrachloride	CCl <sub>4</sub>	154.	83	..
Chlorobenzene	C <sub>6</sub> H <sub>5</sub> Cl	112.5	133	..
Chloroform	CHCl <sub>3</sub>	119.4	106	..
M-Cresol	C <sub>6</sub> H <sub>4</sub> (CH <sub>3</sub> )OH	108.1	181	..
O-Cresol	C <sub>6</sub> H <sub>4</sub> (CH <sub>3</sub> )OH	108.1	...	..
P-Cresol	C <sub>6</sub> H <sub>4</sub> (CH <sub>3</sub> )OH	108.1	...	45
Decane	C <sub>10</sub> H <sub>22</sub>	142.2	109	..
Diethyl Acetate	CH <sub>3</sub> CH(OC <sub>2</sub> H <sub>5</sub> ) <sub>2</sub>	118.1	...	..
Do-decane	C <sub>12</sub> H <sub>26</sub>	170.2	...	..
Ethyl Acetate	CH <sub>3</sub> CO <sub>2</sub> C <sub>2</sub> H <sub>5</sub>	88.1	159	63
Ethyl Alcohol	C <sub>2</sub> H <sub>5</sub> OH	46.1	375	98
Ethyl Benzoate	C <sub>6</sub> H <sub>5</sub> CO <sub>2</sub> C <sub>2</sub> H <sub>5</sub>	150.1	116	..
Ethyl Butyrate	C <sub>2</sub> H <sub>5</sub> CO <sub>2</sub> C <sub>2</sub> H <sub>5</sub>	116.1	131	..
Ethyl Ether	(C <sub>2</sub> H <sub>5</sub> ) <sub>2</sub> O	74.1	155	143
Ethyl Propionate	C <sub>2</sub> H <sub>5</sub> CO <sub>2</sub> C <sub>2</sub> H <sub>5</sub>	102.1	144	..
Heptane	C <sub>7</sub> H <sub>16</sub>	100.2	133	..
Hexane	C <sub>6</sub> H <sub>14</sub>	86.1	143	..
Isoamyl Alcohol	C <sub>5</sub> H <sub>11</sub> OH	88.1	216	57
Isoamyl Acetate	CH <sub>3</sub> CO <sub>2</sub> C <sub>5</sub> H <sub>11</sub>	130.1	120	..
Isobutyl Acetate	CH <sub>3</sub> CO <sub>2</sub> C <sub>4</sub> H <sub>9</sub>	116.1	131	..
Isobutyl Alcohol	C <sub>4</sub> H <sub>9</sub> OH	74.1	249	..
Methyl Acetate	CH <sub>3</sub> CO <sub>2</sub> C <sub>2</sub> H <sub>5</sub>	74.1	175	..
Methyl Alcohol	CH <sub>3</sub> OH	32.	472	112
Methyl Butyrate	C <sub>2</sub> H <sub>5</sub> CO <sub>2</sub> CH <sub>3</sub>	102.1	143	..
Methyl Isobutyrate	C <sub>3</sub> H <sub>7</sub> CO <sub>2</sub> CH <sub>3</sub>	102.1	135	..
Methyl Isopropyl Ketone	CH <sub>3</sub> COC <sub>2</sub> H <sub>5</sub>	86.1	160	..
Methyl Propionate	C <sub>2</sub> H <sub>5</sub> CO <sub>2</sub> CH <sub>3</sub>	88.1	160	..
Nitrobenzene	C <sub>6</sub> H <sub>5</sub> NO <sub>2</sub>	123.1	142	..
Nitrotoluene-O-	C <sub>6</sub> H <sub>4</sub> (CH <sub>3</sub> )NO <sub>2</sub>	137.1	...	..
Nonane	C <sub>9</sub> H <sub>20</sub>	128.2	...	..
Octane	C <sub>8</sub> H <sub>18</sub>	114.2	128	..
Phenol	C <sub>6</sub> H <sub>5</sub> OH	94.1	...	-6.
Propyl Propionate	C <sub>2</sub> H <sub>5</sub> CO <sub>2</sub> C <sub>2</sub> H <sub>5</sub>	116.2	130	..
Toluene	C <sub>6</sub> H <sub>5</sub> CH <sub>3</sub>	92.1	155	..
Water	H <sub>2</sub> O	18.	965	..
O-Xylene	C <sub>6</sub> H <sub>4</sub> (CH <sub>3</sub> ) <sub>2</sub>	106.1	148	..
M-Xylene	C <sub>6</sub> H <sub>4</sub> (CH <sub>3</sub> ) <sub>2</sub>	106.1	147	..
P-Xylene	C <sub>6</sub> H <sub>4</sub> (CH <sub>3</sub> ) <sub>2</sub>	106.1	146	..

\* *Latent Heat of Vaporization.* This heat effect is in B.t.u. per pound at the *Heat of Solution.* This is the heat evolved in B.t.u. when one pound of the concentrated solution be produced instead of a very dilute one, the heat effect this heat effect, see any textbook of Physical Chemistry.

*Boiling Temperature.* This table shows the temperature in °C. at which the of the column.

*Specific Gravity.* Specific gravity is given at room temperature. For more

ABSTRACT OF LITERATURE ON SOLVENT RECOVERY 183

A

VARIOUS SOLVENTS

Boiling temperatures* in °C. at different pressures (in mm.)							Specific gravity*
760	100	50	30	20	10	5	
20.8	....	....	....	....	...	...	0.80
56.6	....	....	....	....	...	...	0.797
183.9	119.4	101.9	90.9	82.8	69.2	57.9	1.022
178.3	112.5	95.3	83.5	75.2	62.0	50.1	1.046
80.2	25.8	11.6	1.8	-4.3	-13.6	-22.1	0.879
117.6	69.8	56.9	48.0	41.5	31.0	21.7	0.824
46.0	-5.8	-18.0	-23.7	-26.5	-29.4	...	1.292
76.8	22.1	7.6	-2.2	-9.2	-32.5	...	1.63
131.8	70.4	53.7	42.7	34.5	21.8	10.4	1.112
61.2	....	....	....	....	...	...	1.526
200.5	138.0	120.8	109.5	101.3	87.8	76.0	1.033
190.1	127.4	110.3	98.9	90.6	77.6	65.5	1.039
201.1	138.4	121.3	110.1	101.8	88.6	76.5	1.033
173.0	107.0	90.0	78.0	68.0	55.0	...	....
102.2	47.3	32.8	25.0	20.2	...	...	....
214.5	145.5	126.0	113.8	103.0	88.0	...	0.766
77.2	25.9	12.4	3.1	-3.8	-14.2	-23.9	0.924
78.2	33.9	21.8	12.9	6.3	-4.3	-14.7	0.736
213.4	....	....	....	....	86.0	...	1.066
119.9	62.6	46.1	....	....	...	...	1.036
34.6	-11.1	-24.0	....	....	...	...	0.73
99.0	44.9	30.8	21.1	13.6	2.1	-7.8	....
98.4	41.6	26.4	16.3	9.5	-2.1	...	0.712
69.0	15.6	1.5	-7.9	-15.0	-25.7	-34.1	0.663
130.1	80.7	66.9	58.4	51.5	40.3	30.2	0.824
148.0	....	....	....	....	...	...	0.857
116.3	59.7	43.7	....	....	...	...	....
107.9	61.7	47.3	40.2	33.9	21.2	11.1	0.803
57.1	8.9	-4.5	....	....	...	...	0.95
64.7	20.6	8.1	0.2	-6.8	-16.5	-25.0	0.78
102.8	48.0	33.0	23.2	15.6	4.2	-6.1	1.029
92.3	38.8	24.2	14.6	7.7	-3.6	-13.8	....
88.9	....	32.1	23.2	17.9	11.9	...	....
79.7	28.1	14.1	4.8	-1.8	-12.6	-22.3	....
208.3	139.9	120.2	108.2	99.1	85.4	72.9	1.20
220.4	150.6	131.7	119.2	109.6	94.8	81.8	1.163
149.5	86.0	70.0	59.0	49.0	38.0	...	0.733
125.8	65.6	50.2	39.3	31.3	19.1	7.7	0.708
181.4	120.2	104.7	93.8	85.8	73.5	62.5	1.08
122.2	65.1	48.0	....	....	...	...	....
110.4	51.8	36.3	25.5	17.9	6.0	...	0.882
100.0	51.7	38.3	29.9	22.3	11.4	1.3	1.00
144.0	81.2	64.1	52.6	44.5	...	...	0.756
139.2	76.9	60.2	49.1	....	30.0	...	0.878
138.9	76.4	59.5	48.0	....	...	...	0.862

boiling temperature at 760 mm. pressure.  
 liquid is dissolved in a very large amount of water at room temperature. If a  
 will be smaller than shown in the table. For a method for the calculation of  
 pure substance in question will boil when under the external pressure at the head  
 accurate data see Landolt-Bornstein Chemische Physicalische Tabellen.



## INDEX

- Adiabatic heating of gases, 94  
 Adsorbed vapor, heating of, 53  
 Adsorbing agents, common, 33  
   suitability of, 69  
 Adsorption, 31  
   apparatus, 58  
   by charcoal, 49  
   capillary, 35  
   equation, 35  
   of benzene and air, 44  
   of ether and air, 44  
   of mixed gases, 41  
   of mixed vapors from air, 45  
   of water vapor and air, 44  
   on solids, 31  
   rate of, 47  
   removal of heat of, 58  
 Air velocity due to convection currents, 98  
 Aminoff, patent, 172  
 Apparatus used in forced circulation systems, 115  
 Arnaud, patent, 172  
 Aurenque, patent, 166  
 Avogadro's law, 11  
  
 Baker, patents, 175, 178  
 Barbet, patents, 177, 178  
 Barbezat, patents, 167, 168  
 Barometric condenser, 79  
 Barstow and Griswold, patent, 177  
 Barth, patent, 177  
 Barthélemy, recovery of solvents, 174  
 Bassett and Sadtler, patent, 182  
 Bataille, patents, 166, 169  
 Behrens, patent, 173  
 Benzene and air, adsorption of, 44  
 Bergmann, patent, 166  
 Bliemeister, patent, 170  
 Blowers and fans, 117  
 Bodin, patent, 173  
 Boecler, patent, 174  
 Bohart and Adams equation, 51  
 Bouchaud-Praceiq, patents, 165, 167  
 Brequet, patent, 168  
 Bregeat, patent, 176  
   scrubbing apparatus, 151  
 Brown and Chandler, patent, 165  
 Burrell adsorption plant, 65  
  
 Canister test, 47  
 Capillary adsorption, 35  
 Charcoal adsorption, 49  
 Chardonnet Co., patents, 168, 169  
 Clapeyron equation, 14  
 Clark, patent, 167  
 Claude, patents, 170, 171  
   recovery of volatile liquids, 170  
 Collard, patent, 171  
 Compressing gases, work of, 120, 122  
 Compression of vapors, 124  
 Compression systems, advantages of, 127  
 Condensation of mixed vapors, 26  
   at constant pressure, 70  
   rate of, 30  
   with cooling water, 77  
 Condenser, barometric, 79  
   jet, with wet vacuum pump, 80  
   simple tubular, 81  
   two-pass, tubular, 82  
 Condensible vapors, mixtures of, 73  
 Coolers, design of for adsorption apparatus, 60  
 Cooling tower, atmospheric, 86  
   forced draft, 87  
 Cooling water, 83  
 Craig, patent, 176  
 Cram, patent, 178  
 Crepelle-Fontaine, patent, 170  
 Croziat, patent, 174  
  
 Davidson, patent, 176  
 Decanters, continuous, 78  
 De Chardonnet, patents, 167, 168, 170  
 Degener, patent, 163  
 De Grousillers, patent, 164  
 Dejeane, patent, 173  
 Delhotel, patent, 166  
 Delpech, patent, 172  
 Dervin, patent, 166  
 De Sauverzac, patent, 170  
 Diaminti and Lambert, patent, 168  
 Differential condensation, 27  
 Direct cooling with cooling water, 77  
 Distillation of liquid mixtures, 22  
 Dodge, recovery apparatus, 179  
 Douard, patent, 171  
 Douge, patents, 167, 168



- Drummond, alcohol vapor, 182  
 Drying, laboratory experiments on rate of, 101  
 Dubois, patent, 169  
 du Pont, patents, 165, 174, 177, 178, and 179
- Early, patent, 171  
 Eitner, explosion limits, 165  
 Erben, patent, 165  
 Ether and air, adsorption of, 44  
 Evaporation, mechanism of, 100  
   rate of, 30  
 Explosion limits of gases and vapors, 165  
 Extraction by solvents, 158
- Fairley, patent, 164  
 Fans and blowers, 117  
 Febre, patent, 165  
 Feld, patents, 167, 169, 171, and 174  
 Flasche, patent, 173  
 Forced draft, heat flow under, 102  
 Foster, patent, 177  
 Fournaud, patent, 170  
 Fowle and others, patent, 165  
 Fowler, patent, 179  
 Fowler and Medley, patents, 169, 171, and 173  
 Friction, loss air outside of pipes, 99  
 Fries Sohn, patent, 174  
 Frischer, patent, 174  
 Frischer and Drees, patent, 176  
 Frohrieb, patent, 175
- Garrigue oil extraction plant, 161  
 Gas laws, 9  
   deviations from, 10  
 Gases, specific heat of, 93  
 Gasolene, rate of adsorption by charcoal, 51  
   steaming charcoal to recover, 57  
 Gathmann, patent, 177  
 Gay, distillation, 178  
   patent, 179  
 Gerli and Ross, patent, 179  
 Goe der Tentetewschén, patent, 168  
 Goodwin, patent, 175
- Harrison, patent, 168  
 Hart, patents, 163, 171, and 172  
 Heat conductivity, coefficients of, 109  
   flow, gases inside pipes, 105  
   outside pipes, 103  
   to moving liquids, 108  
   under forced draft, 102  
   with condensing vapors, 106  
   of adsorption, removal of, 58  
   vaporization, 90  
   rate of flow of, 29
- Heating by direct contact, 90  
   gases, 93  
   radiation, 90  
 Hechenbleikner, patent, 178  
 Hegel, recovery of solvents, 178  
 Heizerling, patent, 164  
 Henry's law, 19  
 Hermann, patent, 175  
 Hesketh, patent, 167  
 Heymann, patent, 167  
 Hildebrandt curves, 16  
 Hiller, patent, 175  
 Hoffman, recovery of solvents, 174  
 Honigmann, patent, 171  
 Hopewell, patent, 173  
 Houdard and Vasseur, patent, 173  
 Hulett, patent, 171  
 Humidity chart for solvents, 95  
   water vapor, 84
- Jet condenser with wet vacuum pump, 80  
 Jorgensen, scrubbing towers, 182
- Kestner, patent, 166  
 Kirchner, patent, 166  
 Kirkham, patent, 174  
 Kniffen, patent, 176  
 Knoedler and Dodge, recovery of solvents, 176  
 Kosel, extraction of fats, 174  
 Kubierschky, patents, 165, 169, and 173  
 Künstler and Co., patent, 179
- Labruyere, patent, 169  
 Lake, patent, 163  
 Le Chatelier, inflammability of vapors, 179  
 Lehner, patent, 175  
 Lester and Riccio, patent, 164  
 Lewis, evaporation of solvents, 179  
   and Green, patent, 177  
   Recovery Corp. compression system, 130  
   forced circulation system, 116  
 Linde, patent, 175  
 Liquid mixtures, 18  
   distillation of, 22  
   types of, 23  
 Lloyd and Wild, patent, 176  
 Löwenstein, patent, 169  
 Lummus, patent, 179  
 Lunge and Rohrmann, patent, 163  
   absorption apparatus, 163  
 Lymm, patent, 172  
 Lynah, patent, 175
- Maertens, patents, 164, 165  
 Mallet, patent, 167  
 Mariller, recovery of solvents, 182

- Martini and Huneke, patent, 167  
 Meikle, patent, 164  
 Merz, extraction of oils, 172  
   patent, 164  
 Metzger, patent, 164  
 Meurs-Gerken, patent, 168  
 Miguet, patent, 172  
 Minekishi and Tochiku, patent, 176  
 Mixed gases, adsorption of, 41  
 Mixed vapors, adsorption from air, 45  
 Mixtures of two volatile liquids, 19  
 Mixtures of vapors and gases, 27  
 Moritz, patent, 173  
 Morron, patent, 178  
 Moscicki, gas absorption, 177  
   patent, 171
- Natural circulation, 97  
 Nikolsky, patent, 168  
 Nitrogen Products Co., patent, 174
- Oates, patent, 175
- Papling, patent, 176  
 Parent Syndicate Oil Extractor Co.,  
   patent, 164  
 Paris, patent, 178  
 Partial pressure, mixture of vapors, 11  
 Partially miscible liquids, 20  
 Partington and Parker, absorption  
   towers, 177  
 Patrick, patent, 179  
 Patrick's equation, 38  
 Percentage by volume, calculation of,  
   12  
   weight, calculation of, 12  
 Perks, patent, 169  
 Persch, patent, 176  
 Plumbridge, patent, 178  
 Ponchon, recovery of solvents, 176  
 Ponds, cooling, 85  
 Pooley and Scott, patents, 175, 178  
 Pressure drop due to contraction, 111  
   enlargement of pipe, 111  
   in circular pipes, 112  
   through coolers, 110
- Raschig, patents, 174, 175  
 Raoult's law, 18  
 Rate of adsorption, 47  
   drying, laboratory experiments, 101  
   reaction, 29  
 Razons, recovery of solvents, 177  
 Refrigeration, cooling with, 89  
 Revaporization, gases used in, 55  
 Rhoades, patent, 175  
 Rohrmann and Hiller, patent, 163  
 Rowland, patent, 173
- Saatman, patent, 164, 165  
 Saturated vapor, 70  
 Schad, patent, 176  
 Schausche, patent, 166  
 Schmidt, patent, 179  
 Schon, patents, 170, 172, and 173  
 Schunert, patent, 175  
 Scott oil extraction system, 160  
 Scrubbing apparatus, 147  
   solvent recovery by, 132  
   towers, calculation of size of, 141  
     heat transfer in, 137  
     temperature of liquid, 144  
 Sestini, recovery of solvents, 176  
 Silica-gel, adsorption plant, 62  
   rate of adsorption by, 50  
 Smith, patents, 170, 171, 172, and 173  
 Soc, J., Jean and Co., patent, 166  
 Soc, "L'Air Liquide" (Claude), patent,  
   169  
 Solvents, properties of, 180  
 Special Absorbents, 153  
 Specific heat of gases, 93  
 Spenle, patent, 168  
 Spray chambers, 60  
   cooling ponds, 85  
 Steinmuller, patent, 163  
 Stokes vacuum apparatus, 73  
 Sulphur dioxide, adsorption by silica-  
   gel, 37  
   vaporization of, 53  
 Superheated vapor, 70
- Thiesen, patent, 172; 173  
 Thomas, Henry's law, 179  
 Torrance, patent, 178  
 Trouton's rule, 15  
 Tubize, patents, 169, 170  
 Tubular coolers, 61  
 Turner, patent, 174
- Van Arsdel, Scrubbing towers, 182  
 Vapors, compression of, 124  
   effect of pressure on, 10  
   temperature on, 9  
   partial pressure of mixtures, 11  
   pressure, 14  
 Viscosity, relative, for various liquids,  
   107
- Walter, patent, 170  
 Water vapor and air, adsorption of, 44  
 Weissenberger, Cresol as an absorbing  
   medium, 182  
   tunnel drying of powder, 182  
   solvent recovery in powder plants,  
   179  
 Weldon, patent, 163  
 Whiting and Lawrence, patent, 163  
 Wilhelm, patent, 169  
 Wilson's adsorption apparatus, 68

- |  |                              |
|--|------------------------------|
| Wilson and Lamb's adsorption apparatus, 67 | Zackendorf, patent, 171      |
| Wohl, patent, 171, 172                     | Zeisberg, tower packing, 177 |
| Work of compressing gases, 120, 122        | Zipser, patent, 172          |
|  | Zöhe, patent, 175            |













UNIVERSITY OF CALIFORNIA LIBRARY  
BERKELEY

Return to desk from which borrowed.  
This book is DUE on the last date stamped below.

DEC 18 1947

25 Mar 49

LD 21-100m-9;47(A5702s16)476



YC 18718

524604

UNIVERSITY OF CALIFORNIA LIBRARY

