

LIBRARY  
OF THE  
UNIVERSITY  
OF ILLINOIS

630.7

126b

no. 676-700

AGRICULTURE

**NOTICE: Return or renew all Library Materials! The Minimum Fee for each Lost Book is \$50.00.**

The person charging this material is responsible for its return to the library from which it was withdrawn on or before the **Latest Date** stamped below.

Theft, mutilation, and underlining of books are reasons for disciplinary action and may result in dismissal from the University.  
To renew call Telephone Center, 333-8400

UNIVERSITY OF ILLINOIS LIBRARY AT URBANA-CHAMPAIGN

--	--	--







30.7  
E 16b

Ag Lib

B

Ill. B. 690

# Remodeling the BUNGALOW FARMHOUSE



BEFORE

UNIVERSITY OF ILLINOIS  
FEB 26 1963  
LIBRARY



AFTER





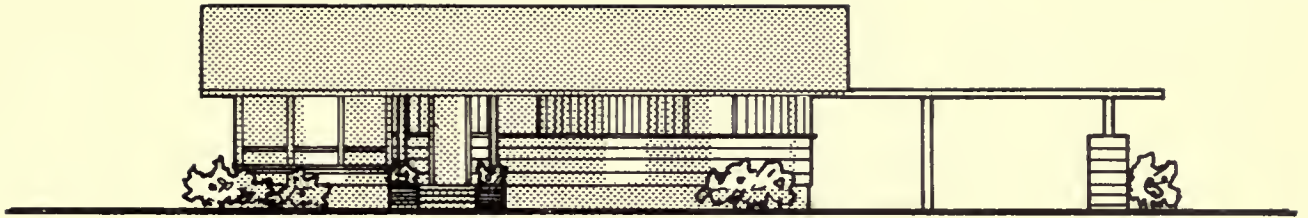

# Remodeling The Bungalow Farmhouse

Prepared by K. H. Hinchcliff, E. L. Hansen, and D. G. Jedele



NORTH CENTRAL REGIONAL PUBLICATION 137; ILLINOIS AGRICULTURAL EXPERIMENT STATION BULLETIN 690; Agricultural Experiment Stations of Alaska, Illinois, Indiana, Iowa, Kansas, Michigan, Minnesota, Missouri, Nebraska, North Dakota, Ohio, South Dakota, and Wisconsin, and the U. S. Department of Agriculture, cooperating.

February, 1963

## THE MOST COMMON TYPES OF FARMHOUSES IN THE MIDWEST

are the T-shaped, the square, and the bungalow. Many of these are in need of remodeling to improve their function and appearance. This bulletin presents remodeling possibilities for the bungalow. A similar publication featuring the model-T is also available (North Central Regional Publication 96; Illinois Bulletin 644).

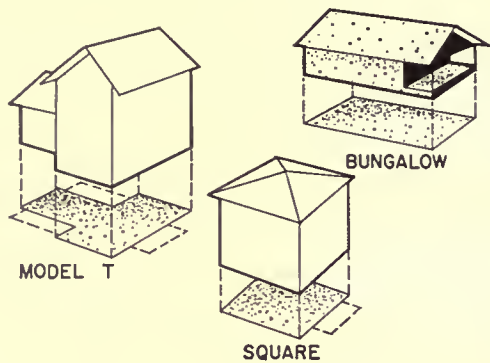

The recommendations and suggestions in this publication were developed through cooperative work of the agricultural experiment stations of the North Central states.

The preparation of this bulletin was a contribution from the Illinois Agricultural Experiment Station to the cooperative regional project NC-9 of the North Central region and was supported by funds provided under the Research and Marketing Act. The publication was prepared by K. H. Hinchcliff,

E. L. Hansen, and D. G. Jedele of the Illinois Station, working in cooperation with the regional Farmhouse Technical Committee. The committee included the following persons:

Alaska: C. Ivan Branton  
Illinois: K. H. Hinchcliff\*  
          Helen E. McCullough  
Indiana: Kathleen Johnston  
Iowa: Margaret Liston  
Kansas: Tessie Agan  
Michigan: Merle L. Esmay  
Minnesota: C. N. Christopherson

Missouri: Milton D. Shanklin  
Nebraska: Florence McKinney  
North Dakota: G. L. Pratt  
Ohio: Elaine K. Weaver\*  
          Doris Elliot  
South Dakota: H. H. Delong  
Administrative adviser: A. G. Hazen

U. S. Department of Agriculture: Avis M. Woolrich, Lenore S. Thye, Clothing and Housing Research Division, Agricultural Research Service; Georgian Adams, Cooperative State Experiment Service

\* Deceased.

## REMODELING PRESENTS BOTH OPPORTUNITIES AND PROBLEMS

Successful remodeling of a home often calls for more ingenuity than building a new house, since what you can do is always more or less restricted by the existing structure. Overcoming such difficulties offers some satisfaction in itself, but the best reason for remodeling is to gain adequate housing for less money than would be needed to build new.

The bungalow farmhouse has both deficiencies and virtues. The deficiencies often make remodeling desirable, and the virtues offer ways to make it work.

Some typical deficiencies include: front entrances that are rarely used, kitchen work areas from which there is no view of the driveway and service yard, almost no built-in storage, no bathroom or wash-up facilities for men coming in from work, usually no

farm-business area convenient for regular use, no place for the family to relax in their everyday clothes, and no car shelter.

Many of these houses, on the other hand, have the virtues of simple architecture, sound structure, and large rooms that respond well to reshaping.

The first part of this publication describes many of the considerations you need to look into before you make your decision about remodeling. In the last part a representative farmhouse with two orientations is shown. After you have decided which orientation comes closer to your own situation, you can study the accompanying transparent overlays, which give suggestions as to how such a house might be remodeled.

## THINGS TO CONSIDER BEFORE MAKING YOUR DECISION

Many farm homes are definitely not worth the cost of remodeling, others are borderline cases, and some are in such good shape structurally that to abandon them and build a new house would mean a real economic loss. The problem is to evaluate clearly the pros and cons for a particular situation.

Location, structural condition, and size and shape of the enclosed space are some basic points to examine.

### Location

If the farmhouse is located within 40 feet of a public road, as many houses are, it is usually a poor risk for remodeling — unless it has several extra-good points that will offset the cost and inconvenience of moving it farther from the road. Similarly, if a house is located where drainage is poor or where prevailing winds bring livestock odors, it

should be moved to a better location before it is remodeled. Here, again, the investment usually is not justified.

Less serious objections to the location may be cured without moving the house. For example, if the driveway is on the wrong side

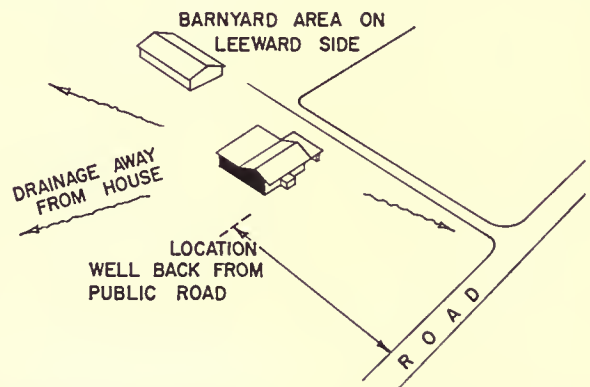

*A house should have a good location to justify remodeling.*

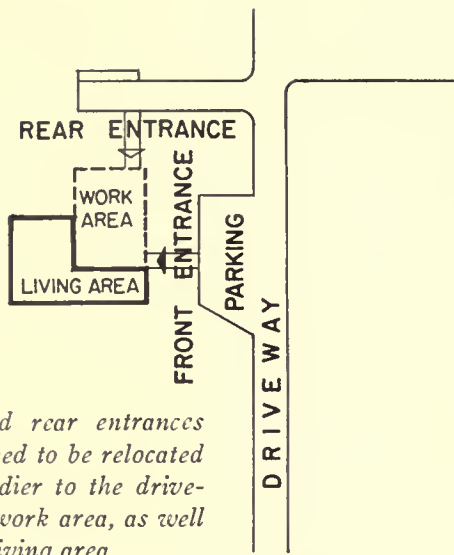

*Front and rear entrances usually need to be relocated to be handier to the driveway and work area, as well as to the living area.*

of the house to be protected from winter exposure, you can usually move it easier than you can move the house.

### Structure

The structural condition of your house is often difficult to appraise, particularly if it is borderline. One part of the house may be in reasonably good condition while another part has deteriorated.

In making an evaluation, it is important to give most weight to the more serious considerations. The most noticeable defects frequently are not the most decisive. The condition of siding and roofing, for example, is not as critical in the decision as the condition of the foundation and framing. Your decision may be influenced by the difficulty of getting to the place where repairs need to be made.

**Foundations.** Remodeling is often a poor risk if foundations have settled out of alignment, open cracks have developed, masonry surfaces are chipped or broken, or mortar is crumbly. Even sound foundations may be troublesome if they project only a few inches above grade; the situation encourages problems of decay and termites that are not

easily corrected. Porous walls admit much cold air, thus making the house uncomfortable and difficult to heat.

If both the location and foundation are poor, but the framework is unusually good, you might consider moving the house to a better location. The foundation can then be built without the interference of the superstructure. Otherwise, be sure to include any needed foundation, pier, sill, and sash work in your remodeling plans.

**Framing.** While some serious framing defects are obvious, others can be determined only after close inspection. Some defects are less serious than others because they are easier to correct.

A sagging roof or off-plumb or bulging walls usually mean that remodeling is not justified. A floor that shakes noticeably when you walk across it, however, can often be strengthened without too much difficulty. The shaking indicates that the joists are too small or too widely spaced or have deteriorated. Extra joists or an intermediate supporting girder will correct the situation. Poorly braced walls, which creak and strain with gusts of wind, are more difficult to improve, because wall surfaces have to be removed before bracing can be added to the wall or structurally strong wall sheathing can be applied to studs.

If the framing is heavily infested with termites, carpenter ants, or lyctus powder post beetles, remodeling is seldom justified.

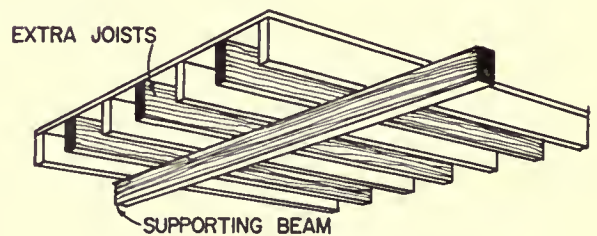

*A beam or extra joists can strengthen weak floors.*

If the infestation is limited to a spot that you can get to easily, such as a porch-stairs stringer, replacing the infested parts with termite-resistant material may control it. Sometimes adding ventilation for crawl spaces and putting metal termite shields between masonry and wood parts will give enough protection. You may need the help of a competent inspector to determine how extensive an infestation is. A good source of information on this problem is the Forest Products Laboratory, Madison, Wisconsin.

Stairways that are too steep, lack headroom, or have irregularly shaped steps usually justify remodeling for improved safety and convenience. If you decide to remodel a stairway, consider whether you want to locate it in a different place to improve the traffic through the house.

If at all practicable, you will want to remove any unused chimneys, particularly those that are supported by brackets on wall frames. Such work, however, is not usually a major problem and will probably not greatly

influence your decision as to whether to remodel or not. Often a new, safe chimney will be needed for a central heating plant.

You may want to replace your windows if they are loose, poorly located, or disquietingly out of style. Replacing windows is often more expensive than installing them in a new house because modern windows are usually a different size than the old ones, and wall framing has to be altered.

Kitchen windows are most likely to require changing because the old-style ones usually extend too low for base cabinets to be built under them. This is one reason why, if you are adding a room, it may be better to make it a kitchen rather than a bedroom. Long windows are not objectionable in bedrooms, but high "strip" windows make it easier to arrange the furniture. At the same time they improve the outside appearance of the house by emphasizing horizontal lines.

You may want to replace the windows in your living room. Large glass areas for living rooms have been growing in popularity.

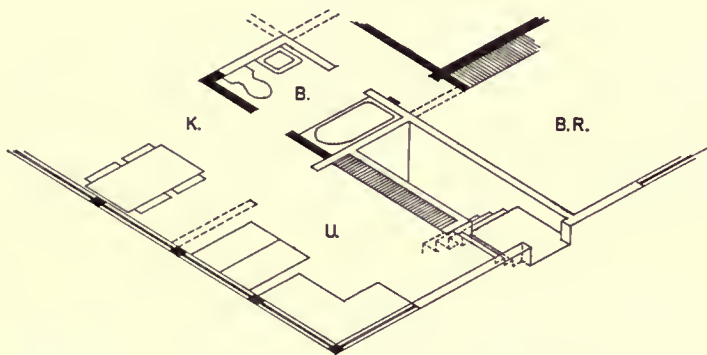

*Consider the possibility of changing the stairway location to improve traffic.*

*Replacing old windows with modern ones can result in better light and appearance.*

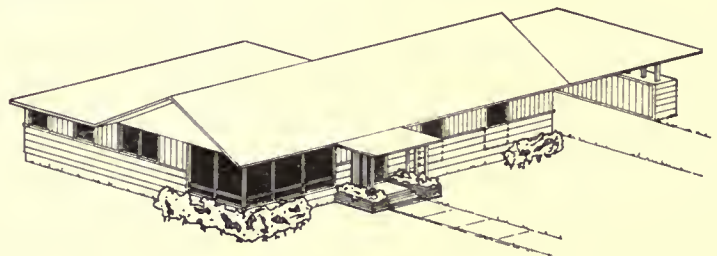

These are usually best when installed as a bank of windows, preferably toward a pleasant view, and located on the south or east side of the house to admit light and heat from the sun in the winter. Canopies or overhangs, three to four feet wide, can shade these rooms from too much summer sun. The long shades also improve the appearance of the house by emphasizing horizontal lines. Sometimes the long shades should extend around corners to break up dominating vertical lines that make the house look higher than it is. In this publication, canopies and wide overhangs have been used extensively for shading and for appearance.

### Space

Remodeling includes changing the shape of the living space as well as the structural parts. The space in many bungalow farmhouses is not well organized. Many rooms, however, remodel well because they are large enough to give up some space for closets, halls, and even bathrooms without reducing their area below today's standards.

Two small rooms can often be combined into one larger one. If the partition separating the two rooms is not load-bearing, it can usually be removed without difficulty. But even a bearing wall should be removed if the improvement in space will justify the cost of installing a beam to replace it. Com-

binning two rooms in this way gives an "open" effect suitable for living-dining areas, for kitchen-work room areas, and sometimes for family living and farm business centers. If the enlarged areas need to be separated occasionally, a modern folding partition can be used to advantage.

### Does the house justify remodeling?

Seeing a summary of the pros and cons of remodeling your home can help you make a clearer decision. It will also help to prevent any one aspect from assuming more than its share of influence. The checklist on page 7 will help you make an objective decision.

Circle the rating you think each of the items should receive. The answers will make a pattern suggesting whether remodeling is justified.

You may want to add other considerations. The more points you list and the more carefully you consider them, the more confidence you can have in your decision. Be sure, however, that the points you list are reasonably important. Evaluating trivial items will throw your list out of balance.

Even though the checklist indicates that conditions are favorable for remodeling, you may want to talk with a contractor or similar person to see whether you can do what you want to do. Of course, you also need to decide if the expense of remodeling is justified.

*More storage space (dark areas), distributed throughout the house, is a common need.*

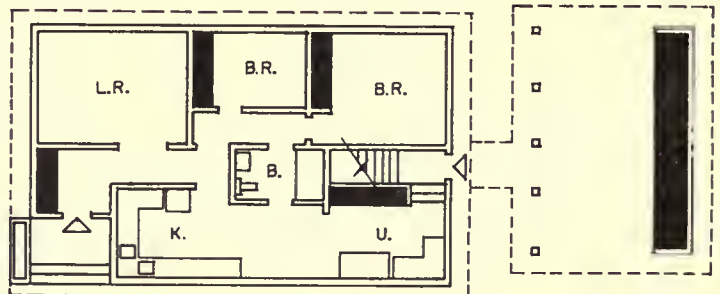

## A Checklist for Your House

<b>LOCATION</b>	Distance from public road (rate poor if close enough for annoyance from dust and noise; rate good if more than 85 feet away).....	poor	fair	good
	Barnlot odors (of primary concern on livestock farms where hogs are fed in the lot; house should be out of the path of prevailing winds from such lots).....	poor	fair	good
	Driveway (a location on the side of house which is protected from winter exposure would rate highest).....	poor	fair	good
<b>FOUNDATION</b>	Alignment (rate good if all foundations are straight and true).....	poor	fair	good
	Condition (masonry units should be sound and mortar firm; concrete not deteriorated).....	poor	fair	good
	Height above grade (8 inches on the outside from soil to wood framing and 18 inches inside are desirable to avoid wood damage).....	poor	fair	good
<b>FRAMING</b>	Roof (rate poor if roof frame shows a sagging ridge or bowed surfaces) .....	poor	fair	good
	Walls (good or even fair walls should appear straight and true and should not be noticeably affected by light winds).....	poor	fair	good
	Floors (rate poor if shaky or uneven, since joists are likely to be undersized and weakened by decay or termites)..	poor	fair	good
	Windows and frames (loose sash and window sash joints are seldom worth repairing, especially if there is extensive decay) .....	poor	fair	good
	Stairways (rate poor if stairs are steep, have risers of irregular size, or have pie-shaped treads).....	poor	fair	good
<b>SPACE USE POSSIBILITIES</b>	Room sizes (should be large enough to allow reduction for desired halls and added storage).....	poor	fair	good
	Space location (rate unneeded space low, especially if it is remote, as on an upper floor; rate well space that can be substantially improved by removing non-load bearing partitions).....	poor	fair	good
<b>APPEARANCE</b>	Architectural lines (consider how attractiveness of house after remodeling would compare with that of a new house).....	poor	fair	good

## HOW MUCH SHOULD YOU INVEST IN REMODELING?

No specific figure can be set as the upper limit for remodeling costs. Some recommend that remodeling investment should be no more than half the cost of an equivalent new home. However, it may sometimes be desirable to go above this amount. There may be a sentimental attachment to the family home, for example. Or perhaps a new home cannot be financed, and remodeling is the only home-improvement course open.

An advantage favoring remodeling is that you can often distribute the work and expense over an extended period—you might improve the kitchen this year, the bathroom

next, and the bedrooms or living area later. Irregular farm income sometimes forces such installment steps. But if you do the work over an extended period, it is extremely important to have an over-all plan so that an improvement made later will not conflict with what you do now.

Exposed items such as new roofing or siding will not cost much more for remodeling than for a new house. Adding central heating, rough-in plumbing, and vapor-protected insulation, however, can be expected to cost more because of obstructions imposed by the house structure.

## USING THE REMODELING SUGGESTIONS THAT FOLLOW

On the following pages, a typical bungalow arrangement is shown, along with several suggestions for remodeling. These suggestions are on transparent paper so that you can compare the suggested changes with the original arrangement.

Since driveways occur about as frequently on one side of the house as on the other, a reversed arrangement is shown.

Some bungalows have lower porch roofs than the one for which these remodeling plans are given. In such cases the porch roof should be removed and the house roof extended.

The following common improvements are featured throughout the remodeling arrangements.

**Front entrance** is made more accessible from the driveway and, where possible, is located between the living and work areas of the house.

**Kitchen or work area** is placed where it

permits a clear view of the driveway and the farm service area.

**Kitchen** is arranged so that its work space is not crossed by traffic.

**Storage** is added throughout the house, including wraps closets near front and back doors.

**Farm business center**, or at least desk space, is located near the rear or “business” entrance.

**Access to bathrooms** is possible without going through bedrooms or living areas.

**Bathroom windows** are suggested where the room is on an outside wall, unless they would have to be over the bathtub. While high fixed windows can be successfully used in such a situation, using artificial light and ventilation is a recommended alternative. Modern ventilating and lighting equipment has made bathrooms without windows increasingly acceptable.



**Family living areas** are combined with work areas in most arrangements and are located so they are accessible to the back door.

**Garages and carports** are placed where they will not obstruct the view of the service

yard from the kitchen. They face the driveway rather than the road.

**Roofs** for additions are predominantly low pitch or flat to avoid complicated intersections with existing roofs and to make the house appear less tall.

---

The primary aim of this guidebook is to help you visualize some of the remodeling possibilities for your farm home. You may be able to proceed directly from the plan layouts shown here, but it is likely that some adjustments will be necessary to satisfy personal needs and desires. If extensive adjustments are needed, special plans, details, and specifications are recommended, particularly if the work is to be done by contract. For such modifications and details, it is advisable to get as competent professional help as you can. Your county Extension agents may be able to direct you to professional counsel experienced in farm home planning. A good source of details is "Home Improvement Plans," available from your Extension Service or from Midwest Plan Service, Iowa State University, Ames, Iowa.



FRONT ENTRANCE CONSTRUCTION

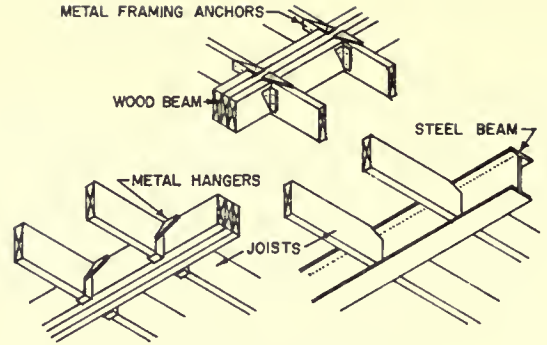

CONCEALED BEAMS

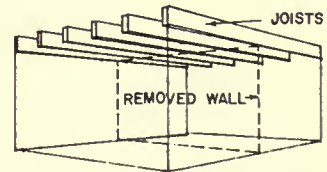
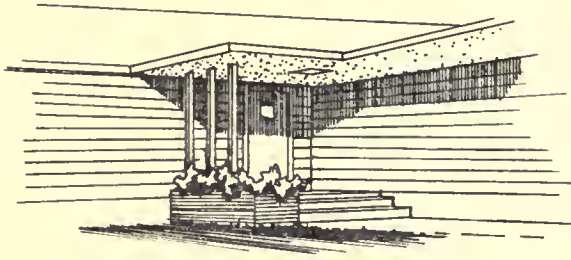

BEAMS TO REPLACE BEARING WALLS

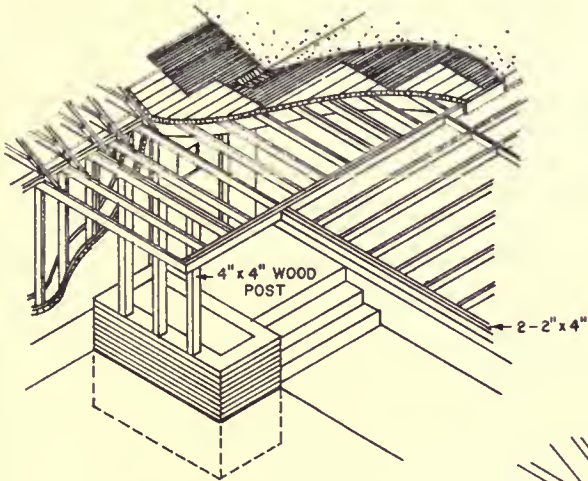

ROOF FRAMING

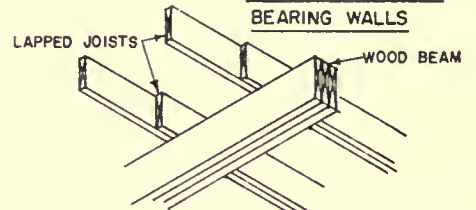

BEAMS VISIBLE BELOW CEILING

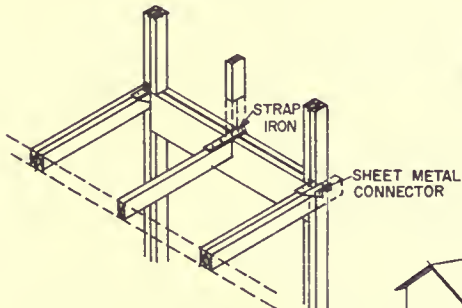
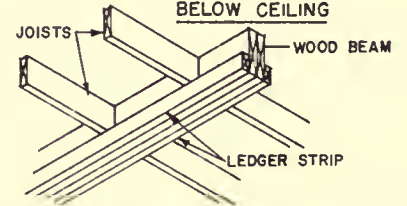

ATTACHED OVER WINDOW

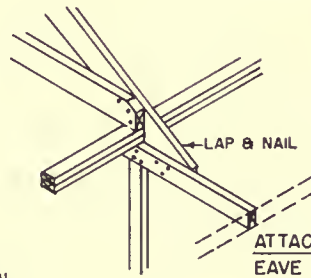

ATTACHED AT EAVE OVERHANG

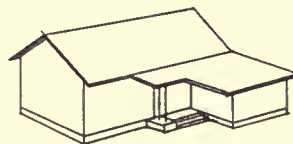

PROJECTED ROOF CONST.

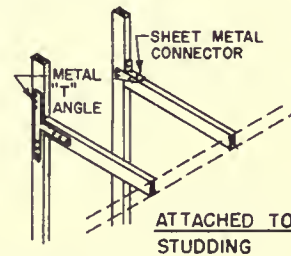

ATTACHED TO STUDING

**CONSTRUCTION DETAILS FOR REMODELING**

USE 5/8" EXTERIOR GRADE PLYWOOD GUSSET PLATES ON EACH SIDE OF THE BUTT JOINTS. GLUE WITH CASEIN OR RESORCINOL RESIN GLUE. USE 7d NAILS TO PROVIDE PRESSURE AS THE GLUE SETS.

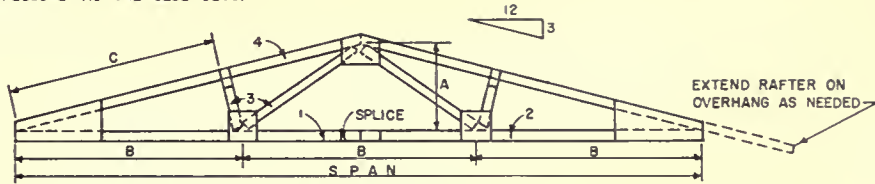

**GLUED AND NAILED TRUSS**

DIMENSIONS FOR JIG LAYOUT, GLUED AND NAILED TRUSS

SPAN (FEET)	LENGTH OF DIMENSION LINES MARKED:		
	A (FEET-INCHES)	B (FEET-INCHES)	C (FEET-INCHES)
20	2-7	6-8	6-4
24	3-0	8-0	7-4
28	3-6	9-4	8-8
32	4-0	10-8	10-4

LUMBER SIZE AND LENGTH FROM WHICH MEMBERS ARE CUT FOR GLUED AND NAILED TRUSS

SPAN (FEET)	SIZE AND LENGTH OF PIECES NUMBERED:							
	1 (INCHES-FEET)	2 (INCHES-FEET)	3 (INCHES-FEET)	4 (INCHES-FEET)				
20	2 x 4 12	2 x 4 10	2 x 4 8	2 x 4 14				
24	2 x 4 12	2 x 4 12	2 x 4 8	2 x 4 16				
28	2 x 4 14	2 x 4 14	2 x 4 10	2 x 4 18				
32	2 x 6 16	2 x 6 16	2 x 4 10	2 x 6 20				

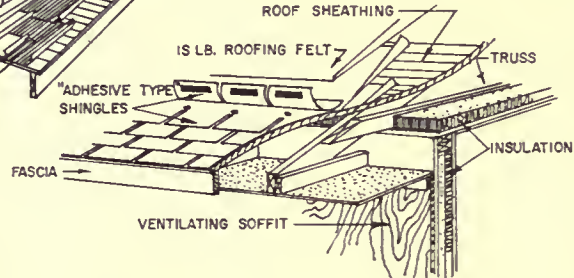
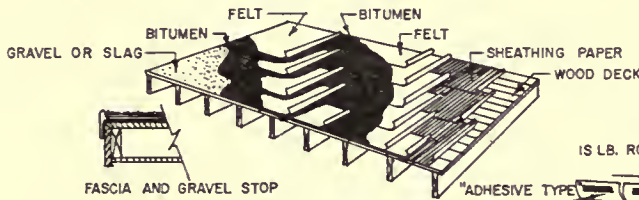

**ROOF TRUSS**

THE TRUSS IS A RELATIVELY NEW TREND IN HOUSE ROOF FRAMING. IT SUPPORTS THE ROOF FROM WALL TO WALL, PERMITTING MAXIMUM FLEXIBILITY OF SPACE PLANNING SINCE INTERIOR POSTS OR BEARING WALLS ARE NOT NEEDED; THE DESIGN LENDS ITSELF TO STANDARDIZATION, MASS PRODUCTION, OR PREASSEMBLY AT THE BUILDING SITE.

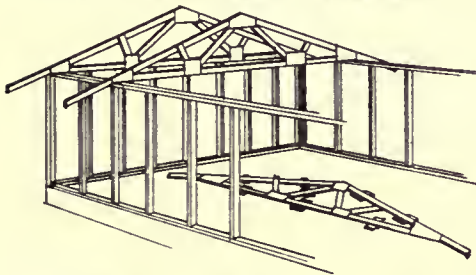

A SIMPLE JIG, FORMED BY NAILING GUIDE BLOCKS TO A LEVEL SURFACE, CAN OFFER A FAST, UNIFORM METHOD OF TRUSS ASSEMBLY.

**ROOF COVERING**

MOST FREQUENT ROOFING FAILURES ARE DUE TO USE OF COVERING THAT IS INTENDED FOR A STEEPER PITCH. THE FOLLOWING IS RECOMMENDED MINIMUM PITCHES FOR COVERING MATERIAL INDICATED.

MATERIAL	MINIMUM PITCH
ADHESIVE TYPE SHINGLES	3" TO 12"
DOUBLE COVERAGE	1" TO 12"
ROLL ROOFING	1/8" TO 12"
BUILT-UP ROOF	1/8" TO 12"

**POST AND BEAM FRAMING**

THIS METHOD IS MORE COMMONLY USED FOR FLAT OR LOW-PITCHED ROOFS THAN FOR THE STEEPER SLOPES. THE SYSTEM IS AN ADAPTATION OF OLD-TIME TIMBER FRAMING, USED INCREASINGLY IN MODERN DESIGN TO DO AWAY WITH CONTINUOUS LOAD-BEARING WALLS AND TO GAIN UNIQUE EFFECTS.

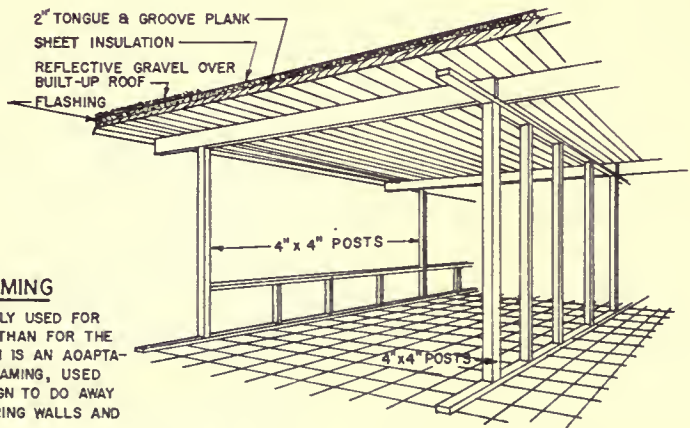

**CONSTRUCTION DETAILS FOR REMODELING**



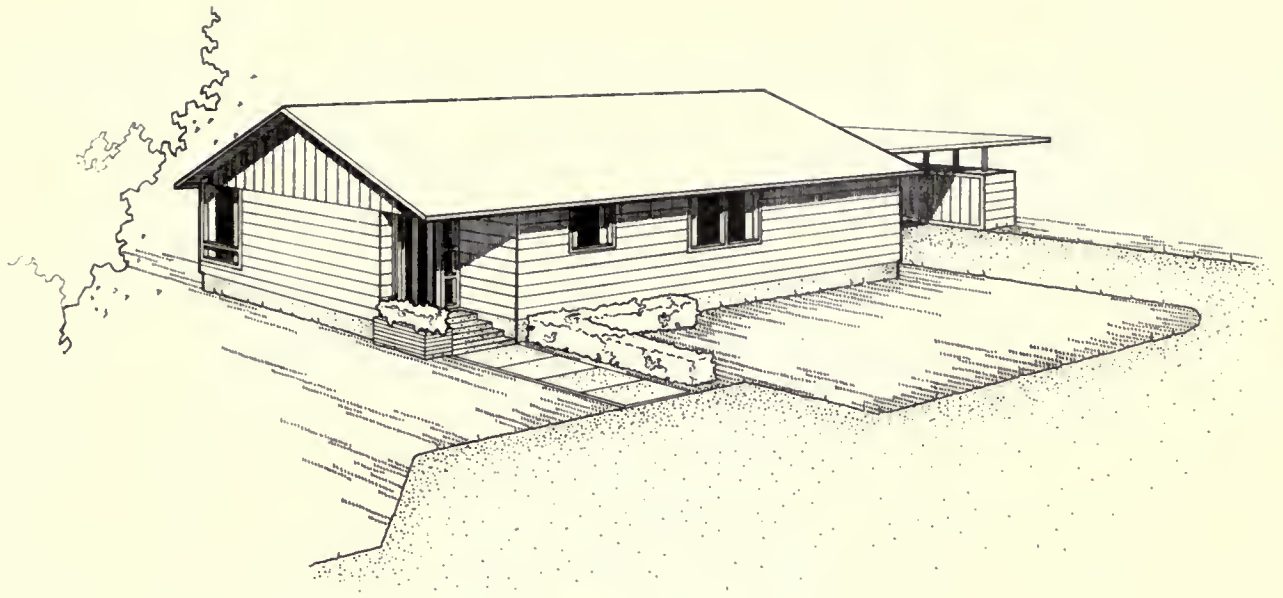

FLOOR PLAN  
NO. 1

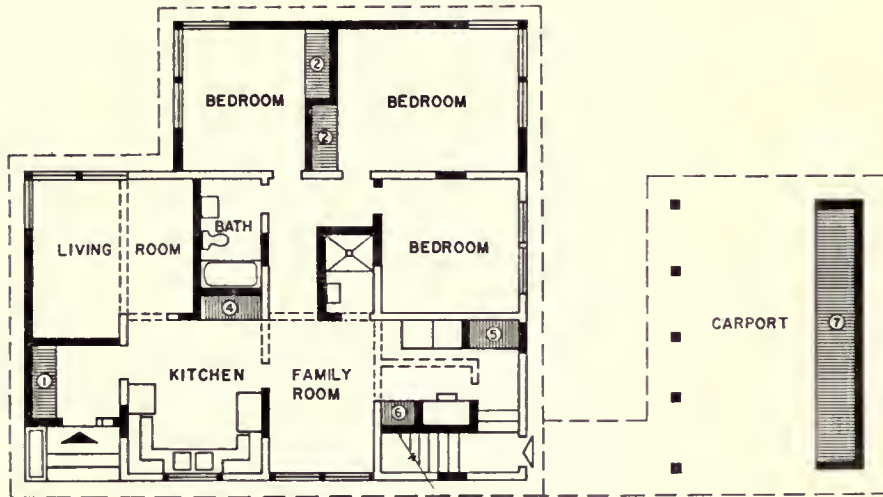

SITE PLAN

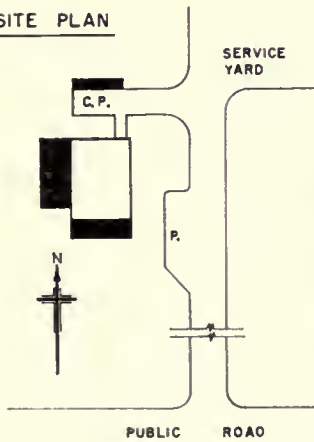

REVERSED FLOOR PLAN

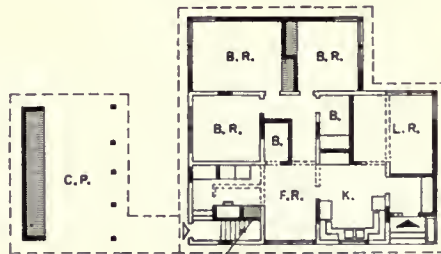

LEGEND

-  EXISTING WALL
-  NEW WALL
-  REMOVED WALL
-  ROOF OVERHANG
-  STORAGE OR CLOSET
- ① GUEST
- ② BEDROOM
- ③ LINEN
- ④ UTILITY
- ⑤ WORK CLOTHES
- ⑥ MISCELLANEOUS
- ⑦ EXTERIOR
-  SHOWER
-  GUEST ENTRANCE
-  FARM SERVICE ENTRANCE
-  WASHER AND DRYER
- LAV LAVATORY

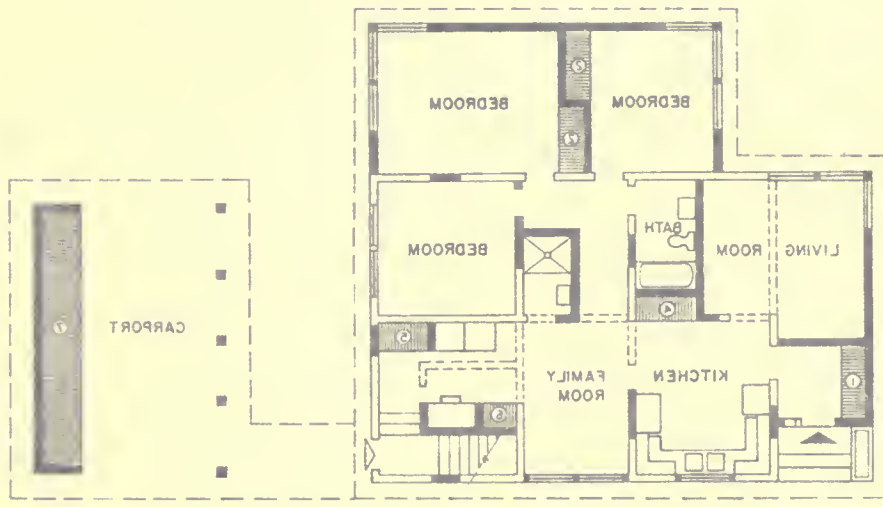
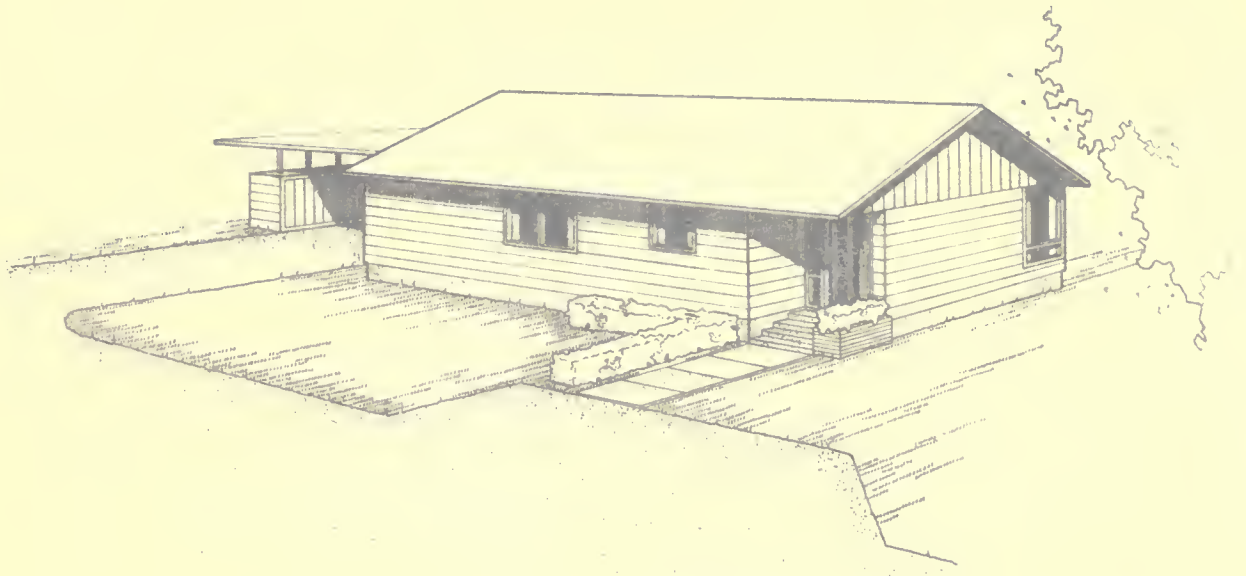

- LEGEND**
- EXISTING WALL
  - NEW WALL
  - REMOVED WALL
  - ROOF OVERHANG
  - STORAGE OR CLOSET
  - GUEST
  - BEDROOM
  - LINEN
  - UTILITY
  - WORK CLOTHES
  - MISCELLANEOUS
  - EXTERIOR
  - SHOWER
  - GUEST ENTRANCE
  - FARM SERVICE ENTRANCE
  - WASHER AND DRYER
  - LAVATORY

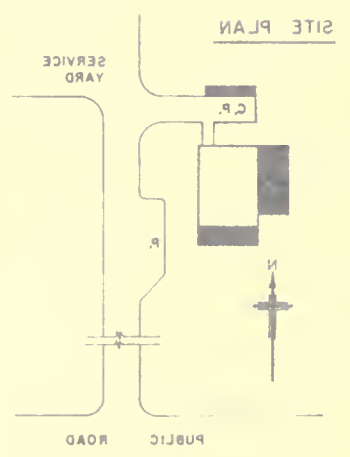
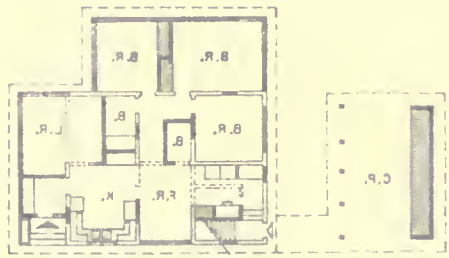

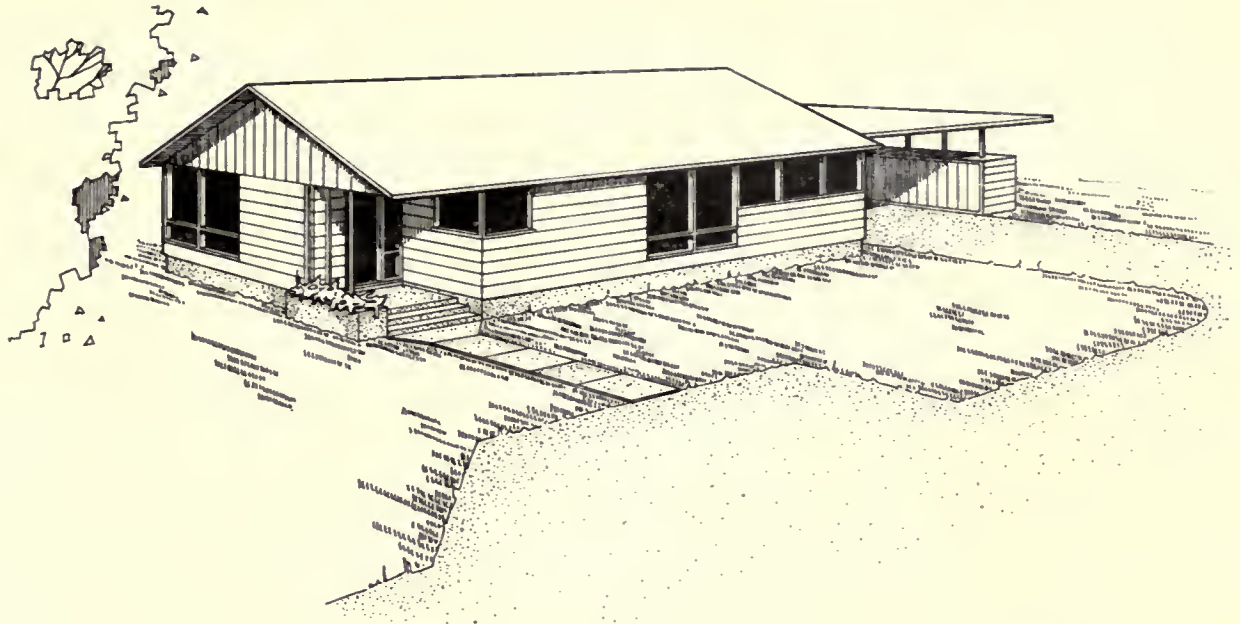

**FLOOR PLAN**  
NO. 2

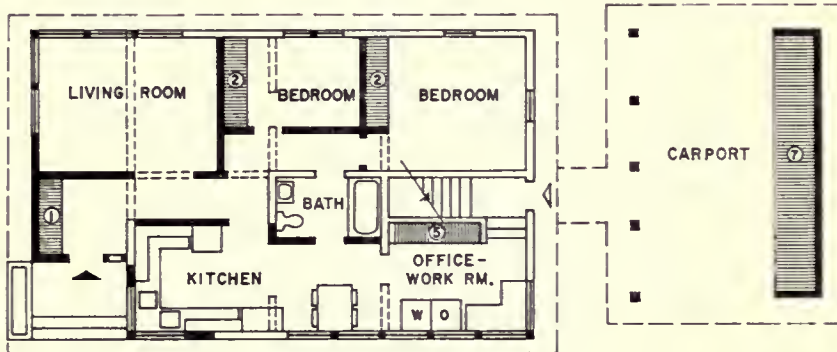

**SITE PLAN**

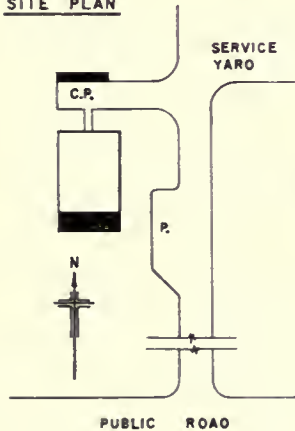

**REVERSED FLOOR PLAN**

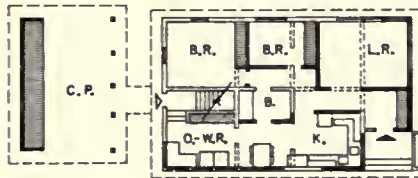

**LEGEND**

- EXISTING WALL
- NEW WALL
- - - REMOVED WALL
- - - ROOF OVERHANG
- STORAGE OR CLOSET
- ① GUEST
- ② BEOROOM
- ③ LINEN
- ④ UTILITY
- ⑤ WORK CLOTHES
- ⑥ MISCELLANEOUS
- ⑦ EXTERIOR
- ⊠ SHOWER
- ▲ GUEST ENTRANCE
- ▲ FARM SERVICE ENTRANCE
- W D WASHER AND ORYER
- LAV. LAVATORY

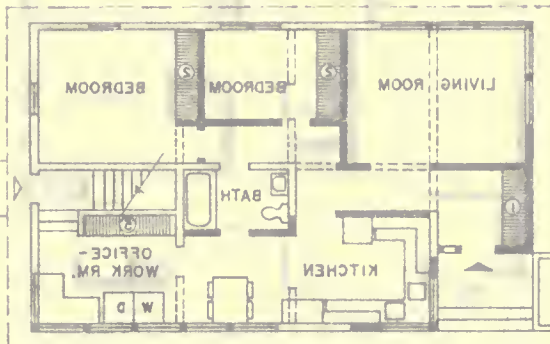
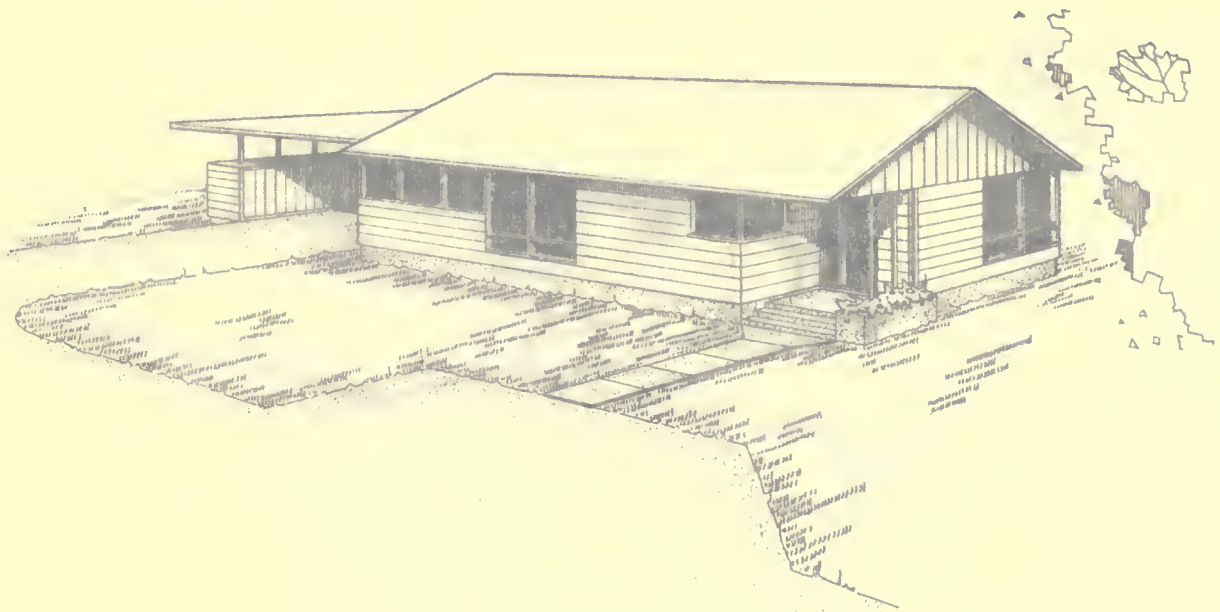

FLOOR PLAN  
NO. 5

- LEGEND**
- EXISTING WALL
  - NEW WALL
  - REMOVED WALL
  - ROOF OVERHANG
  - STORAGE OR CLOSET
  - GUEST
  - BEDROOM
  - LINEN
  - UTILITY
  - WORK CLOTHES
  - MISCELLANEOUS
  - EXTERIOR
  - SHOWER
  - GUEST ENTRANCE
  - FARM SERVICE ENTRANCE
  - WASHER AND DRYER
  - LAVATORY

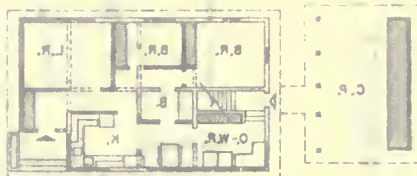

REVERSED FLOOR PLAN

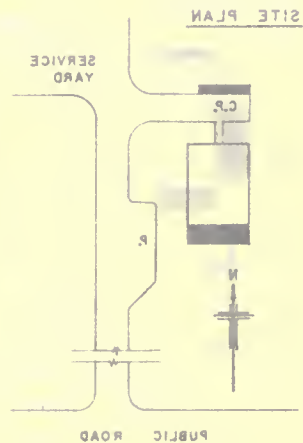

SITE PLAN



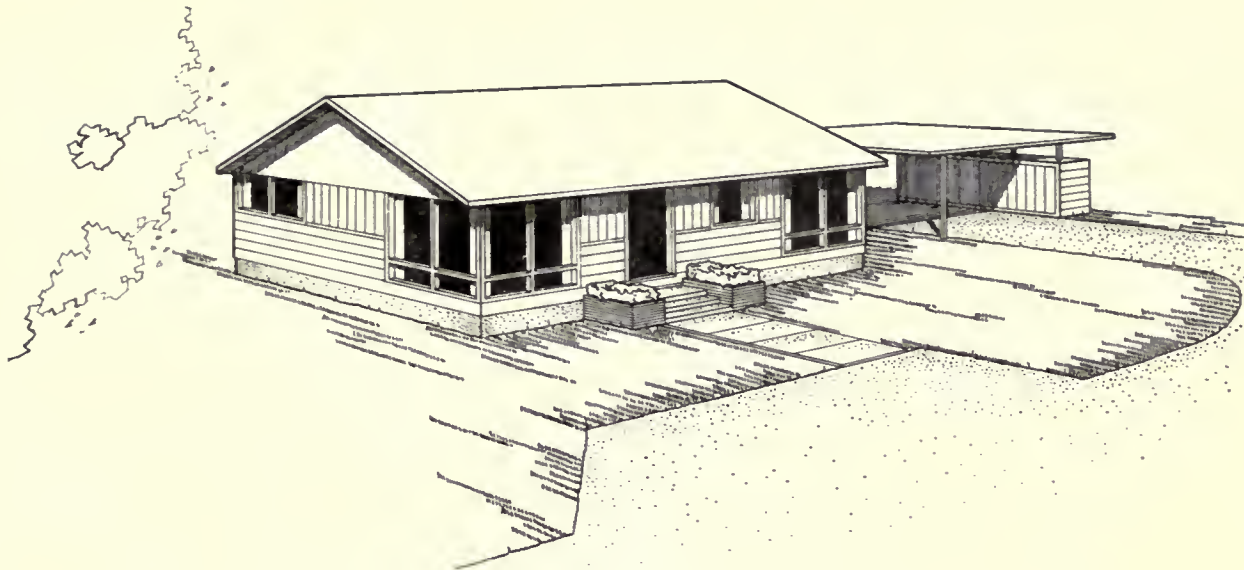

FLOOR PLAN  
NO. 3

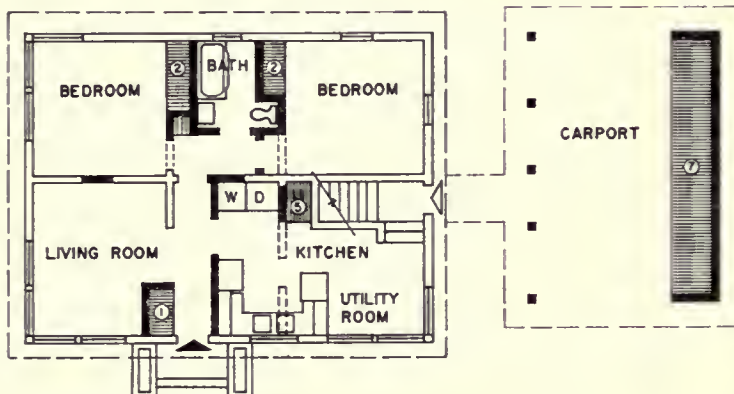

SITE PLAN

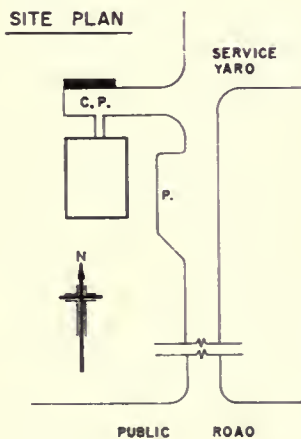

REVERSED FLOOR PLAN

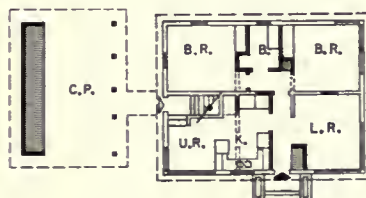

LEGEND

- EXISTING WALL
- NEW WALL
- - - REMOVED WALL
- - - ROOF OVERHANG
- STORAGE OR CLOSET
- ① GUEST
- ② BEDROOM
- ③ LINEN
- ④ UTILITY
- ⑤ WORK CLOTHES
- ⑥ MISCELLANEOUS
- ⑦ EXTERIOR
- ☒ SHOWER
- ▲ GUEST ENTRANCE
- ▲ FARM SERVICE ENTRANCE
- W D WASHER AND DRYER
- LAV LAVATORY

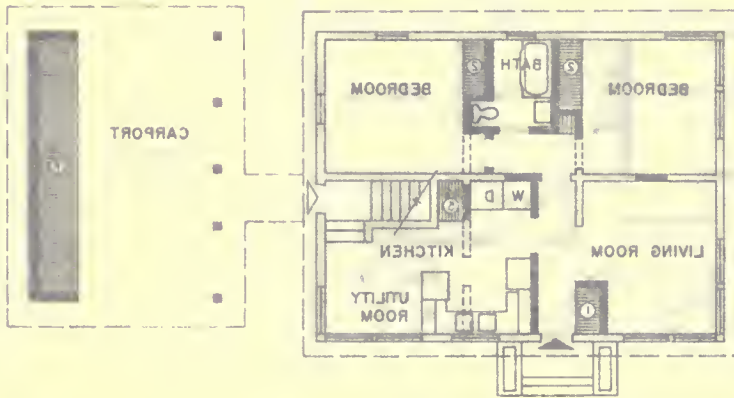
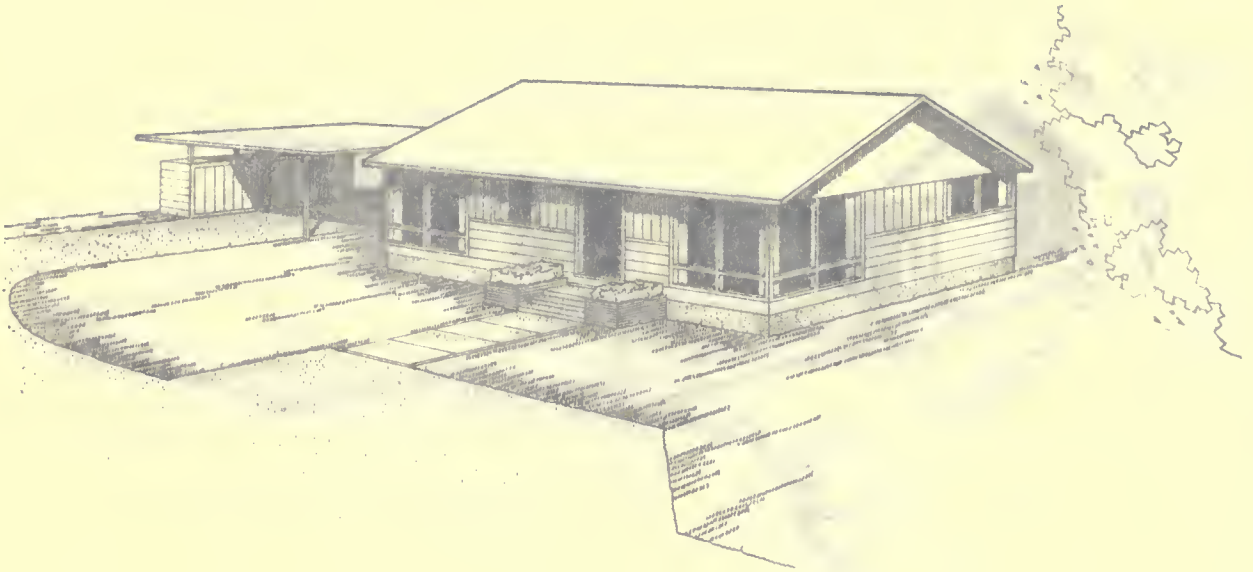

FLOOR PLAN  
NO. 3

- LEGEND**
- EXISTING WALL
  - NEW WALL
  - REMOVED WALL
  - ROOF OVERHANG
  - STORAGE OR CLOSET
  - GUEST
  - BEDROOM
  - LINEN
  - UTILITY
  - WORK CLOTHES
  - MISCELLANEOUS
  - EXTERIOR
  - SHOWER
  - GUEST ENTRANCE
  - FARM SERVICE ENTRANCE
  - WASHER AND DRYER
  - LAVATORY

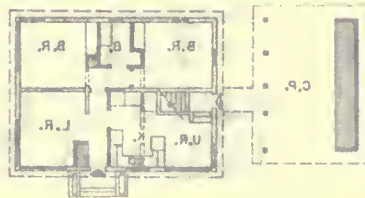

REVERSED FLOOR PLAN

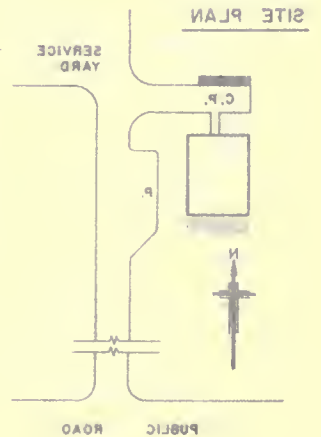

SITE PLAN

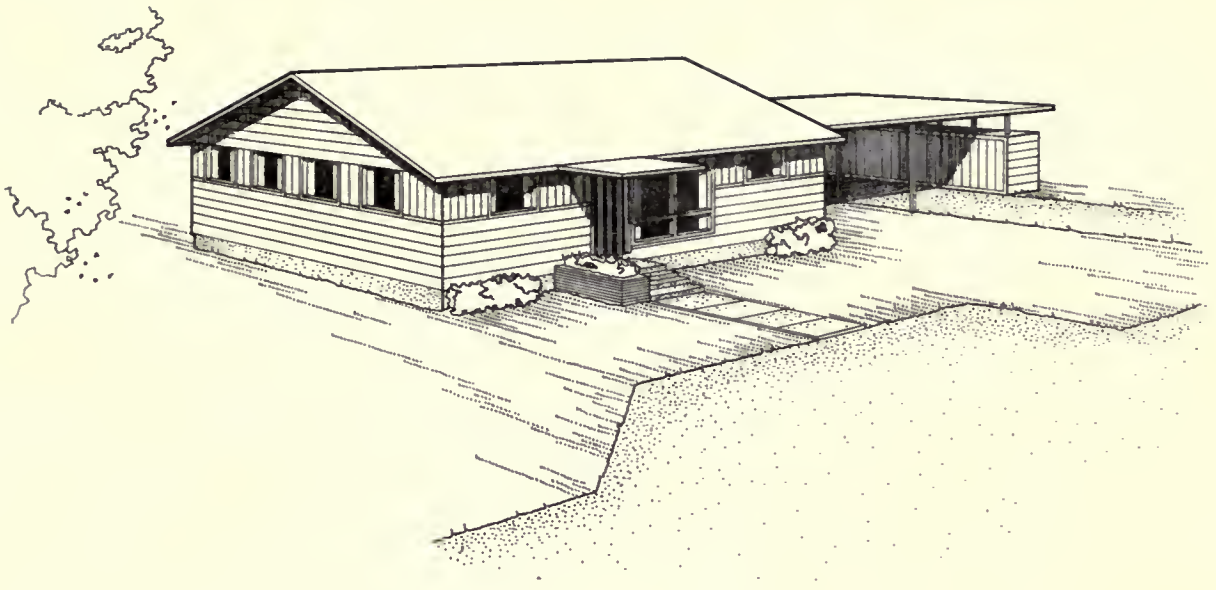

FLOOR PLAN  
NO. 4

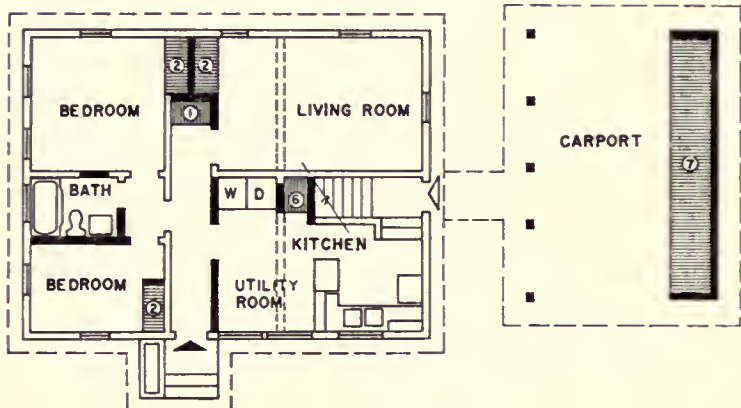

SITE PLAN

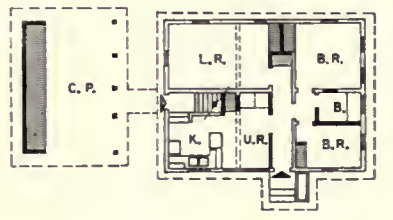
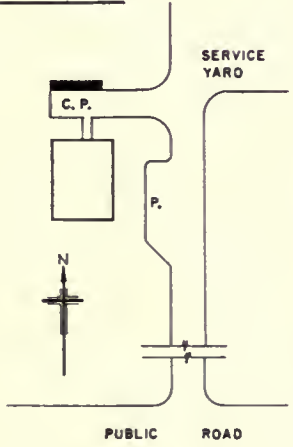

REVERSED FLOOR PLAN

LEGEND

- EXISTING WALL
- NEW WALL
- - - REMOVED WALL
- - - ROOF OVERHANG
- ▨ STORAGE OR CLOSET
- ① GUEST
- ② BEDROOM
- ③ LINEN
- ④ UTILITY
- ⑤ WORK CLOTHES
- ⑥ MISCELLANEOUS
- ⑦ EXTERIOR
- ☒ SHOWER
- ▲ GUEST ENTRANCE
- ▲ FARM SERVICE ENTRANCE
- W D WASHER AND DRYER
- LAV LAVATORY

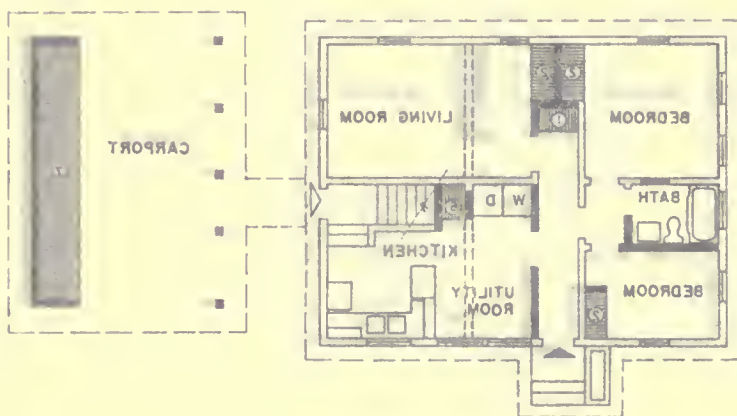
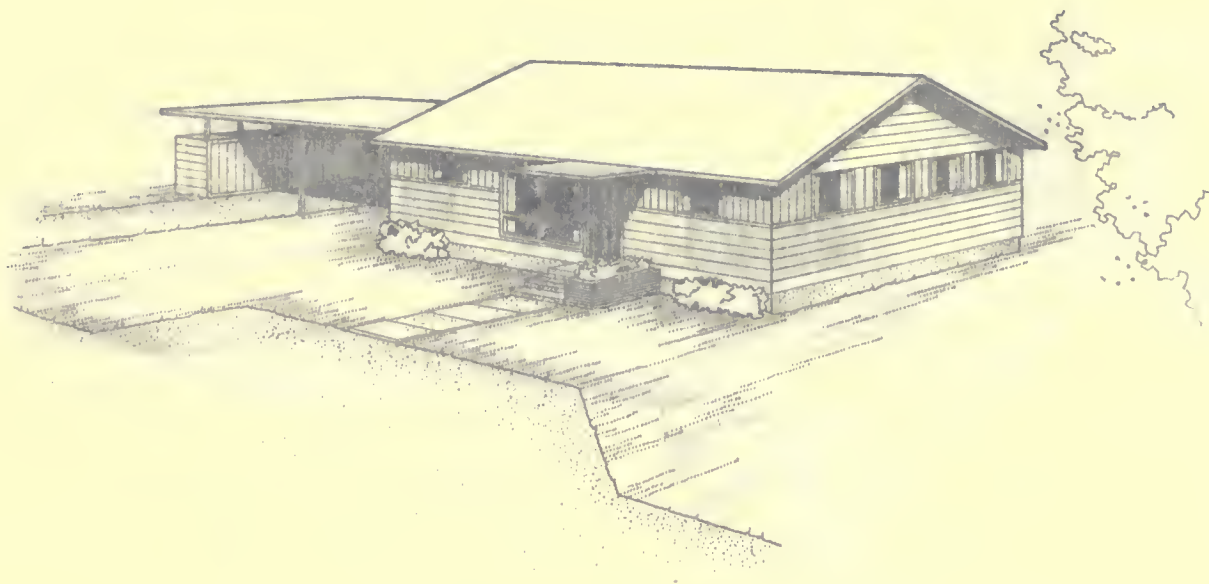

FLOOR PLAN  
NO. 4

- LEGEND**
- EXISTING WALL
  - NEW WALL
  - REMOVED WALL
  - ROOF OVERHANG
  - STORAGE OR CLOSET
  - GUEST
  - BEDROOM
  - LINEN
  - UTILITY
  - WORK CLOTHES
  - MISCELLANEOUS
  - EXTERIOR
  - SHOWER
  - GUEST ENTRANCE
  - FARM SERVICE ENTRANCE
  - WASHER AND DRYER
  - LAVATORY

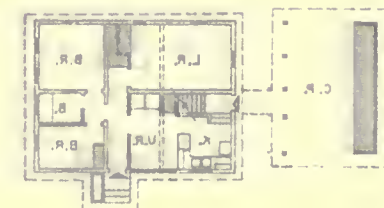

REVERSED FLOOR PLAN

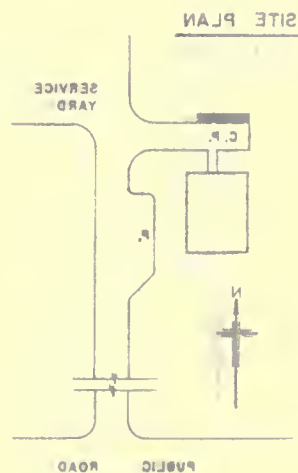

SITE PLAN

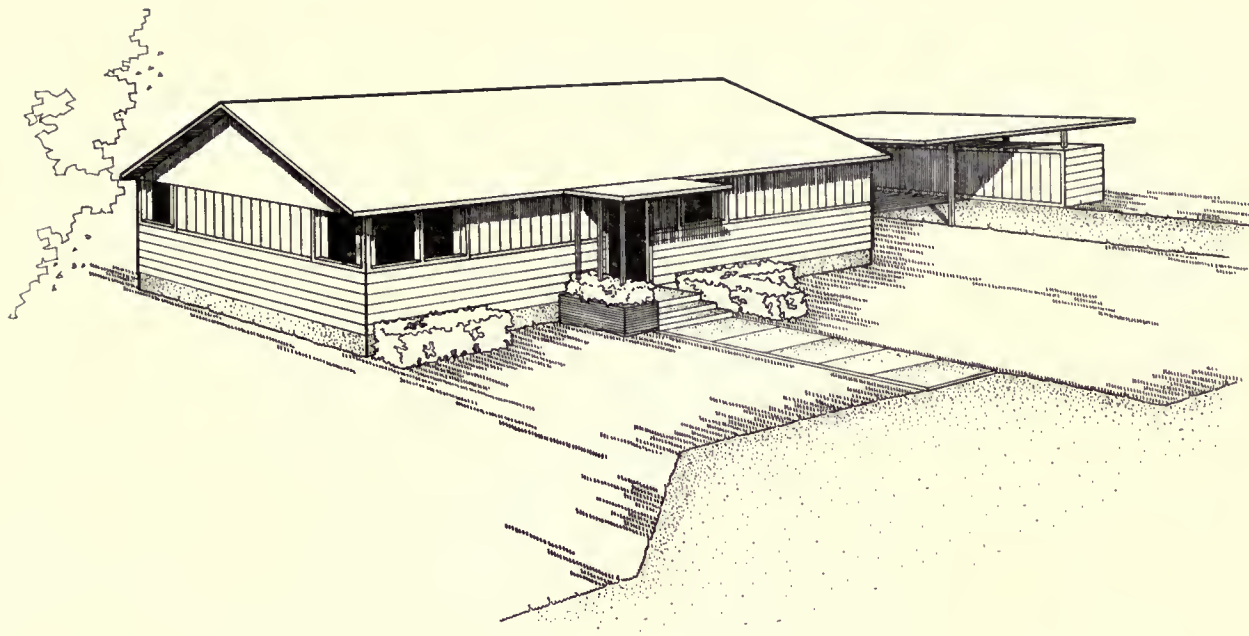

FLOOR PLAN  
NO. 5

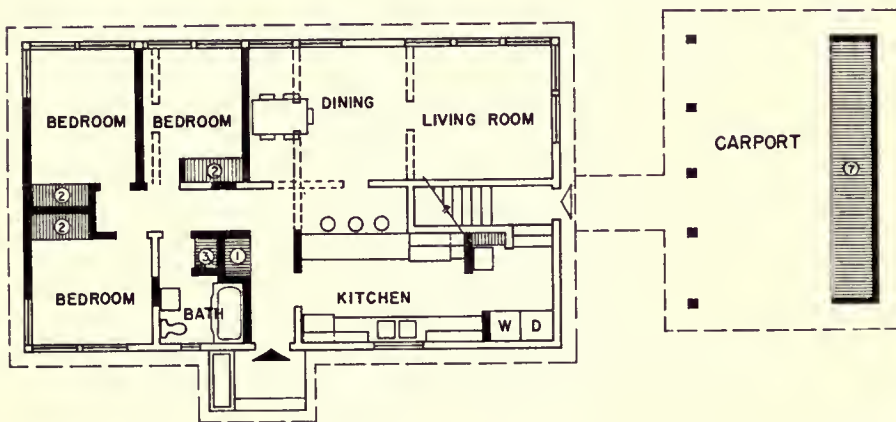

SITE PLAN

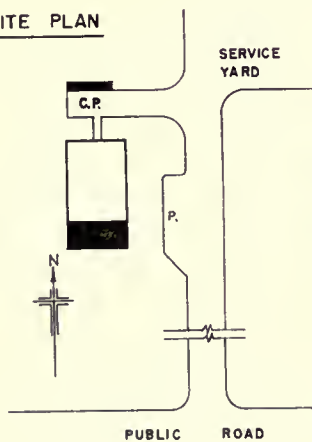

REVERSED FLOOR PLAN

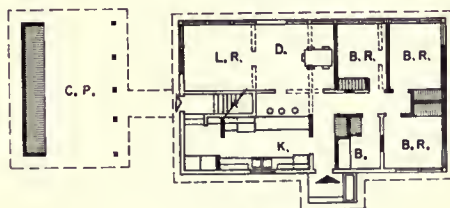

LEGEND

- EXISTING WALL
- NEW WALL
- - - REMOVED WALL
- ROOF OVERHANG
- STORAGE OR CLOSET
- ① GUEST
- ② BEDROOM
- ③ LINEN
- ④ UTILITY
- ⑤ WORK CLOTHES
- ⑥ MISCELLANEOUS
- ⑦ EXTERIOR
- ☒ SHOWER
- ▲ GUEST ENTRANCE
- ▲ FARM SERVICE ENTRANCE
- W D WASHER AND DRYER
- LAV LAVATORY

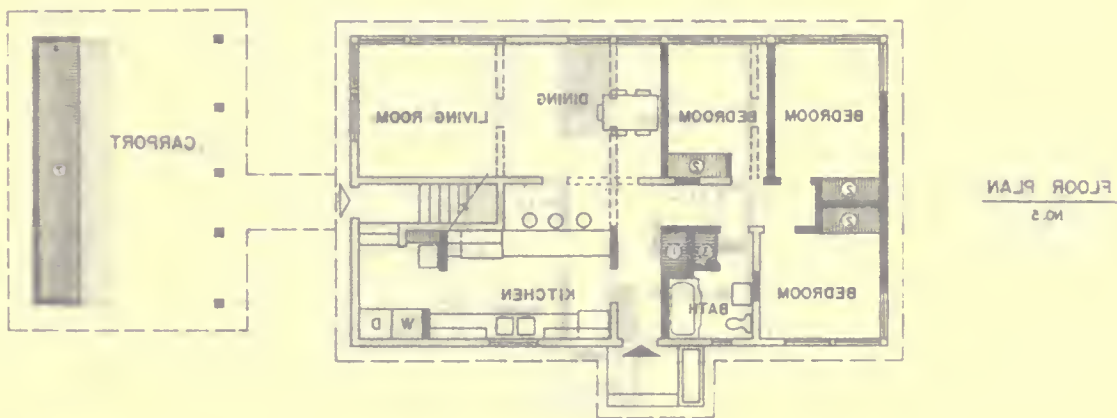
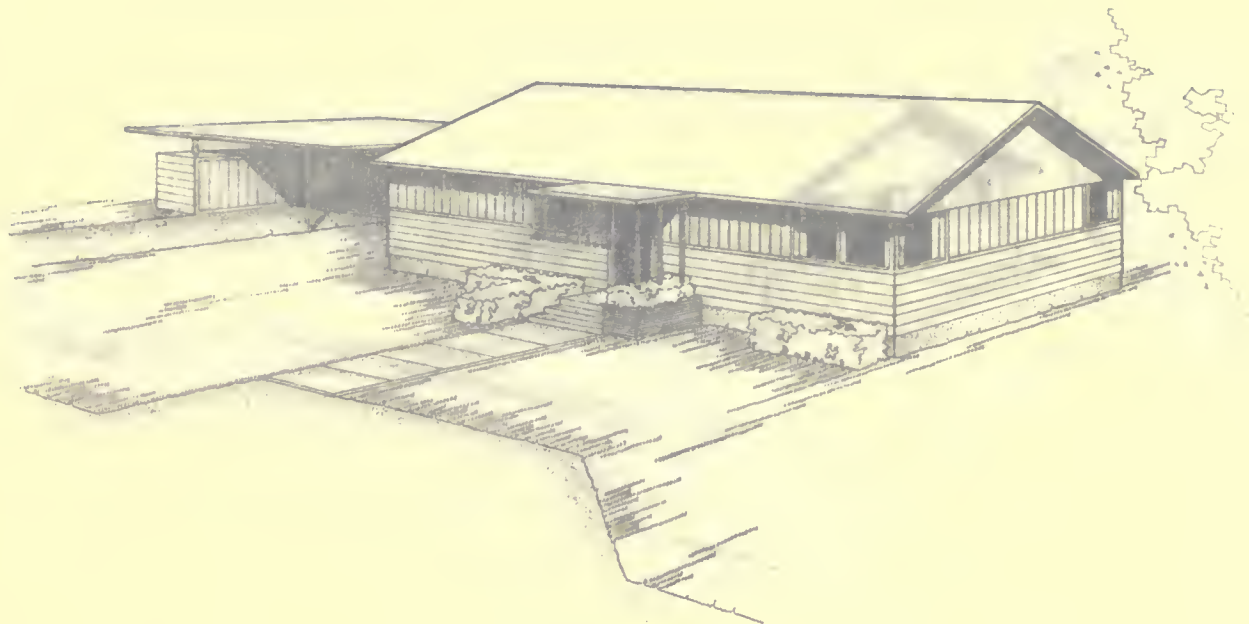

- LEGEND**
- EXISTING WALL
  - NEW WALL
  - REMOVED WALL
  - ROOF OVERHANG
  - STORAGE OR CLOSET
  - GUEST
  - BEDROOM
  - LINEN
  - UTILITY
  - WORK CLOTHES
  - MISCELLANEOUS
  - EXTERIOR
  - SHOWER
  - GUEST ENTRANCE
  - FARM SERVICE ENTRANCE
  - WASHER AND DRYER
  - LAVATORY

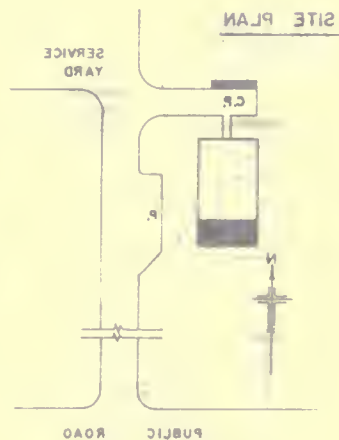
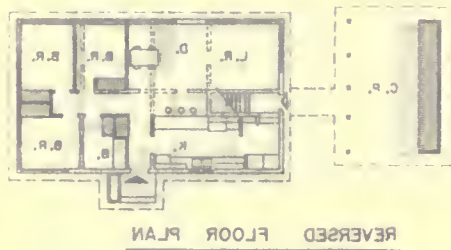

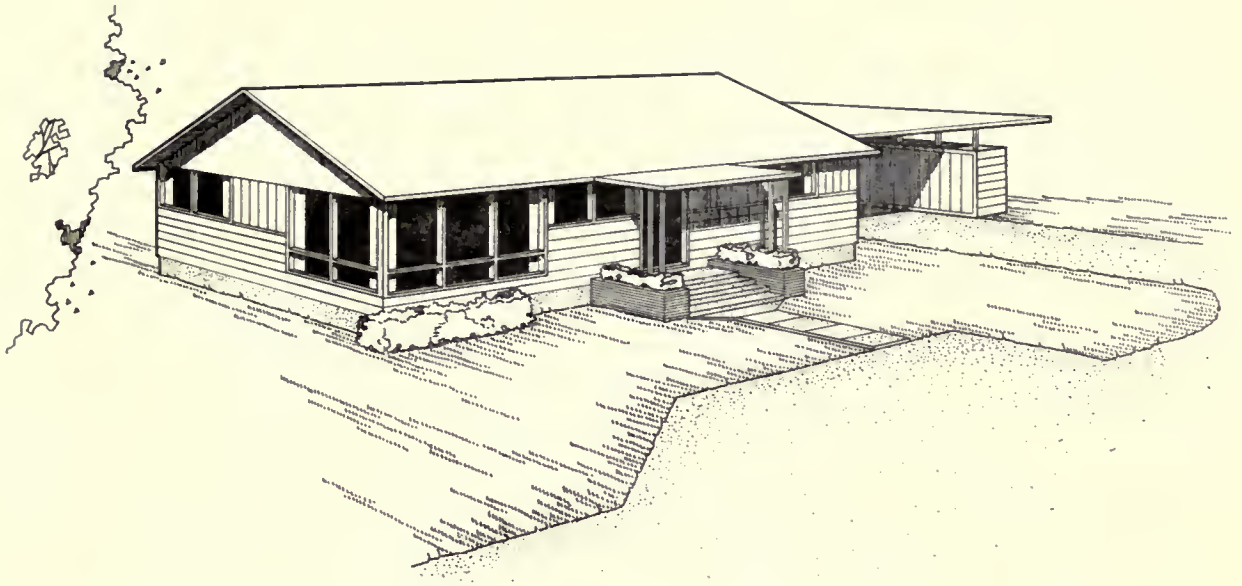

FLOOR PLAN  
NO. 6

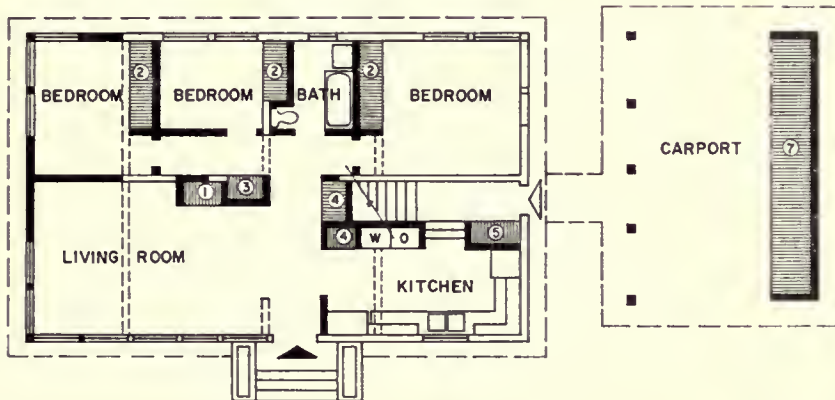

SITE PLAN

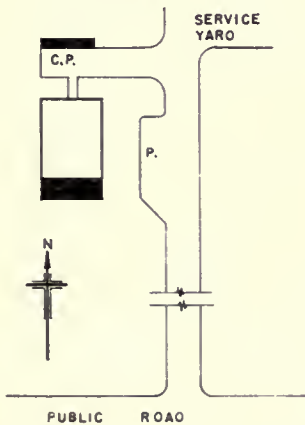

REVERSED FLOOR PLAN

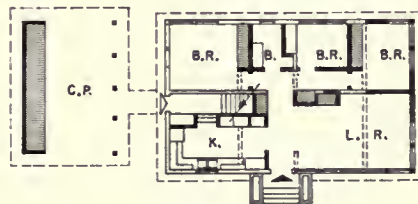

LEGEND

- EXISTING WALL
- NEW WALL
- - - REMOVED WALL
- ROOF OVERHANG
- STORAGE OR CLOSET
- ① GUEST
- ② BEOROOM
- ③ LINEN
- ④ UTILITY
- ⑤ WORK CLOTHES
- ⑥ MISCELLANEOUS
- ⑦ EXTERIOR
- ☒ SHOWER
- ▲ GUEST ENTRANCE
- ▲ FARM SERVICE ENTRANCE
- W O WASHER AND ORYER
- LAV LAVATORY

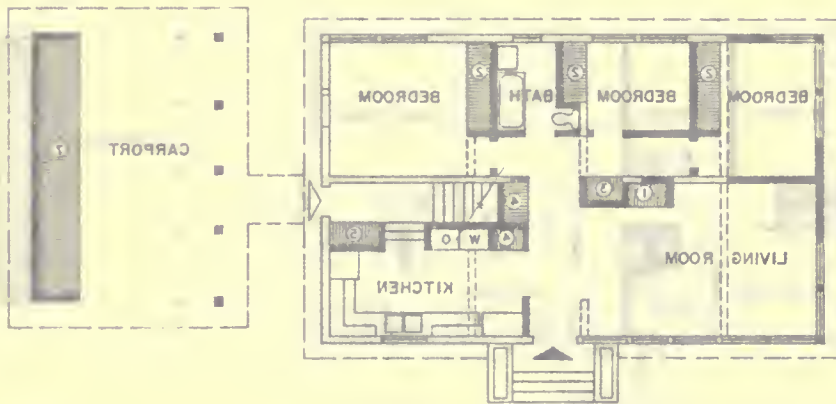
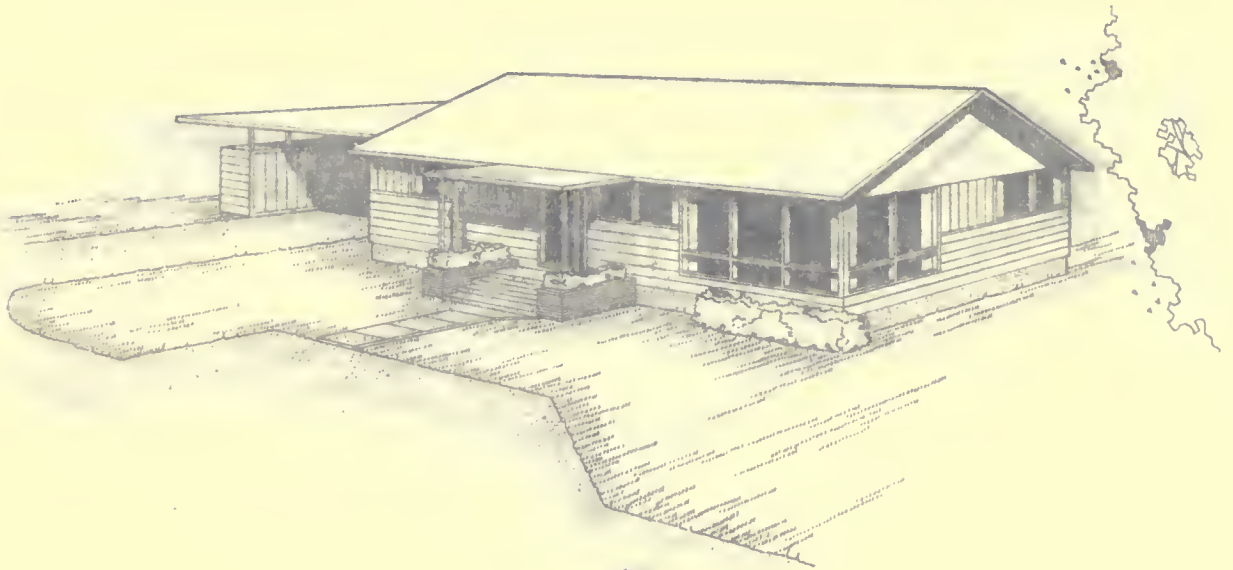

FLOOR PLAN  
NO. 6

- LEGEND**
- EXISTING WALL
  - NEW WALL
  - REMOVED WALL
  - ROOF OVERHANG
  - STORAGE OR CLOSET
  - GUEST
  - BEDROOM
  - LINEN
  - UTILITY
  - WORK CLOTHES
  - MISCELLANEOUS
  - EXTERIOR
  - SHOWER
  - GUEST ENTRANCE
  - FARM SERVICE ENTRANCE
  - WASHER AND DRYER
  - LAVATORY

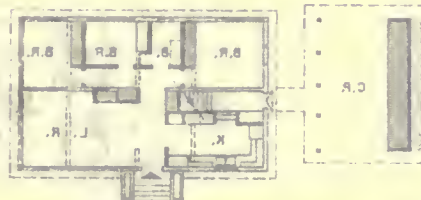

REVERSED FLOOR PLAN

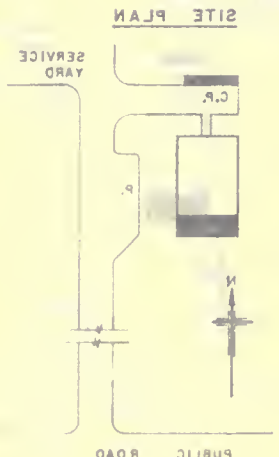

SITE PLAN



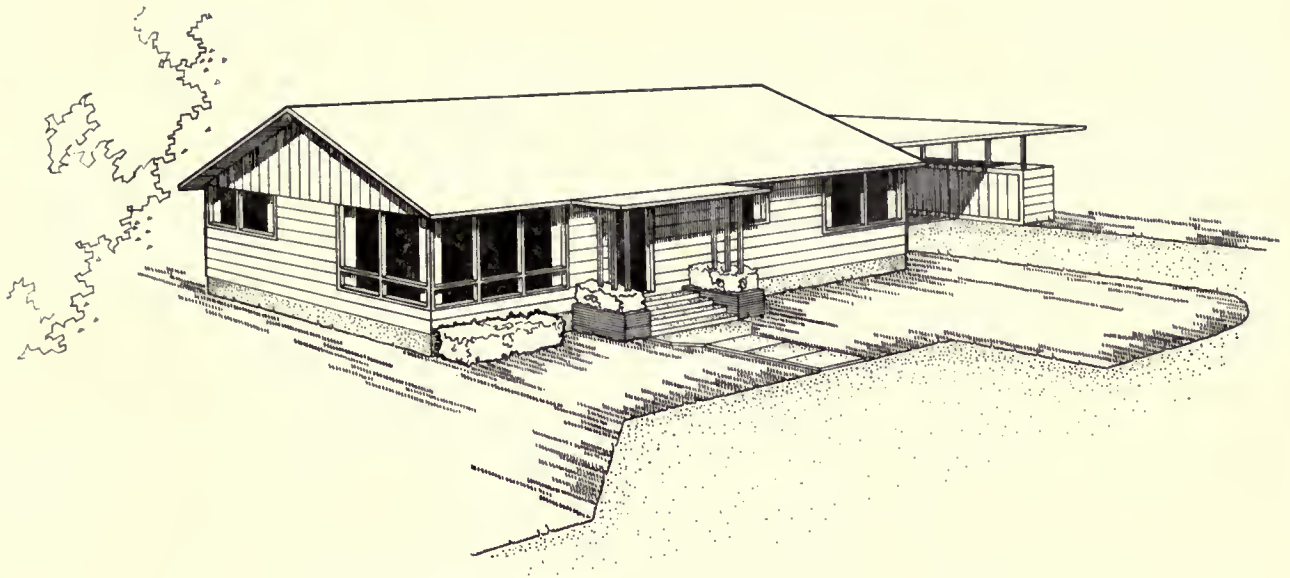

FLOOR PLAN  
NO. 7

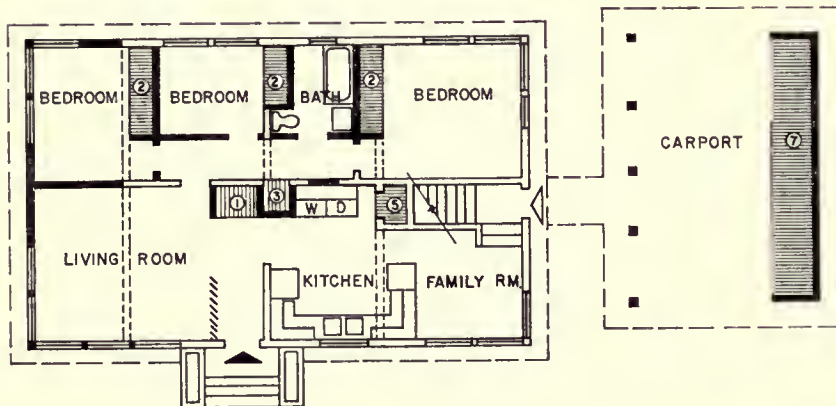

SITE PLAN

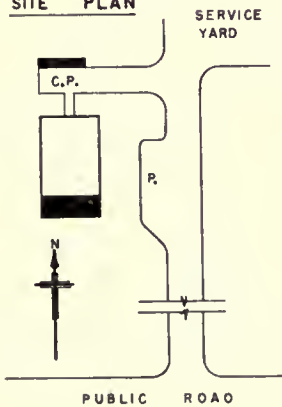

REVERSED FLOOR PLAN

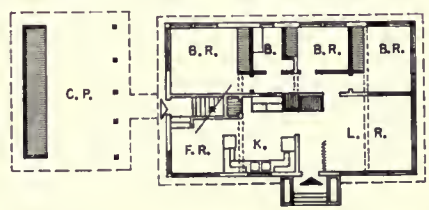

LEGEND

- EXISTING WALL
- NEW WALL
- - - REMOVED WALL
- - - ROOF OVERHANG
- ▨ STORAGE OR CLOSET
- ① GUEST
- ② BEDROOM
- ③ LINEN
- ④ UTILITY
- ⑤ WORK CLOTHES
- ⑥ MISCELLANEOUS
- ⑦ EXTERIOR
- ☒ SHOWER
- ▲ GUEST ENTRANCE
- ▲ FARM SERVICE ENTRANCE
- W O WASHER AND DRYER
- LAV LAVATORY

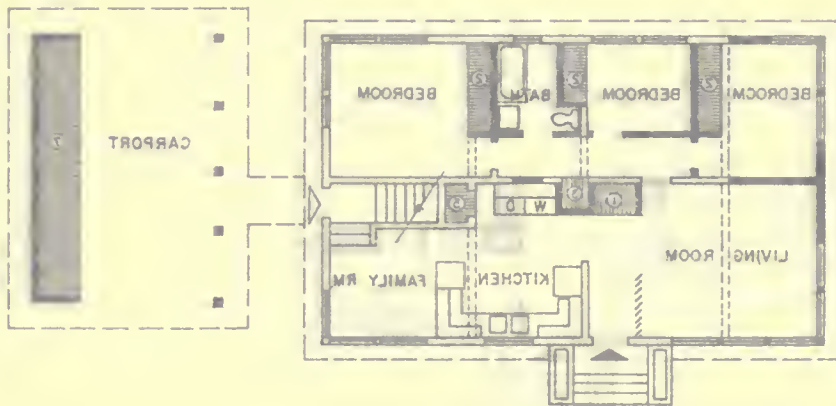
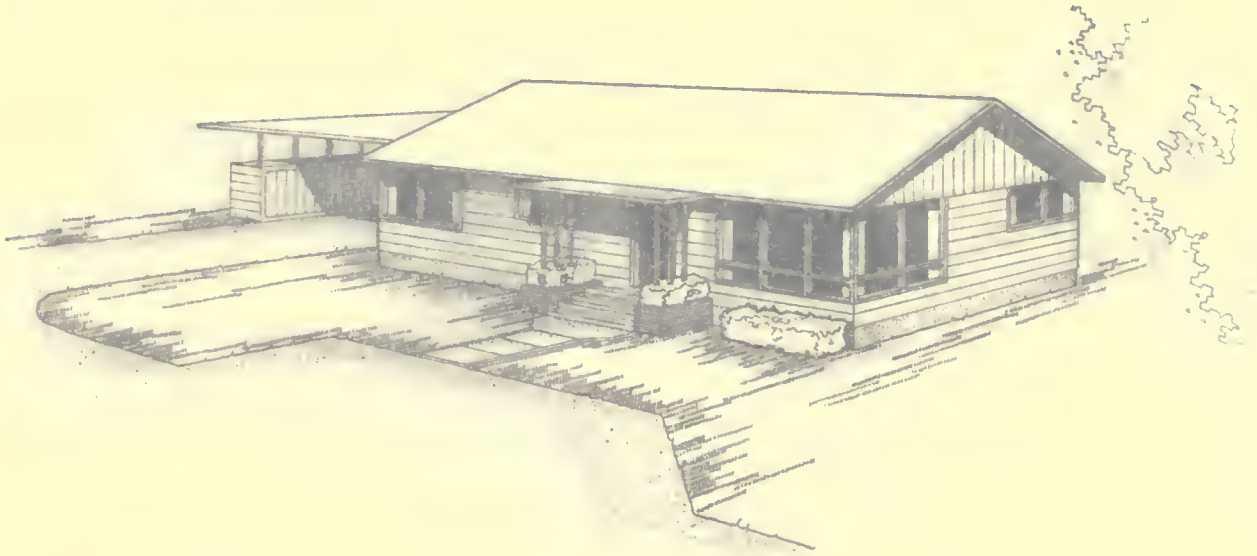

FLOOR PLAN  
NO. 7

- LEGEND**
- EXISTING WALL
  - NEW WALL
  - REMOVED WALL
  - ROOF OVERHANG
  - STORAGE OR CLOSET
  - GUEST
  - BEDROOM
  - LINEN
  - UTILITY
  - WORK CLOTHES
  - MISCELLANEOUS
  - EXTERIOR
  - SHOWER
  - GUEST ENTRANCE
  - FARM SERVICE ENTRANCE
  - WASHER AND DRYER
  - LAVATORY



REVERSED FLOOR PLAN

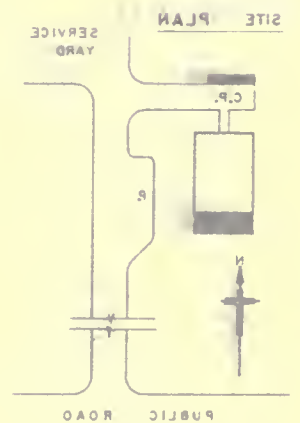

SITE PLAN

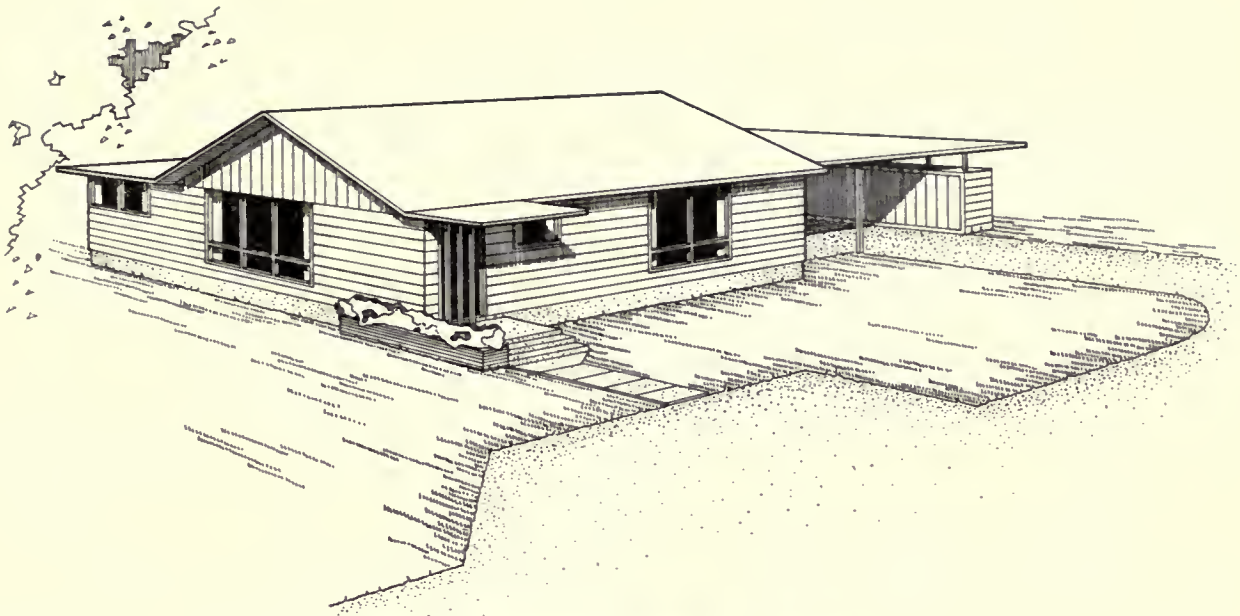

**FLOOR PLAN**  
NO. 8

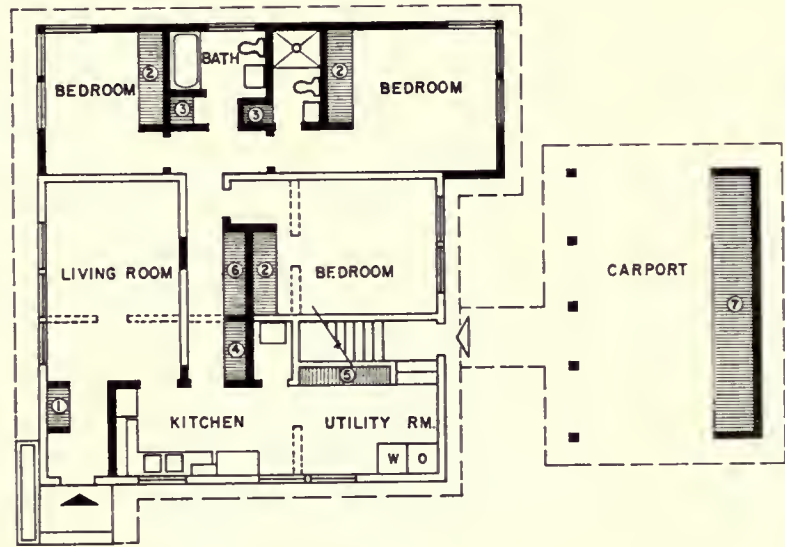

**SITE PLAN**

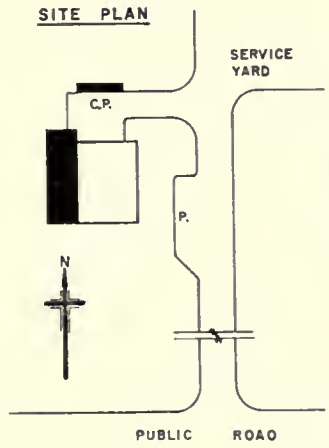

**REVERSED FLOOR PLAN**

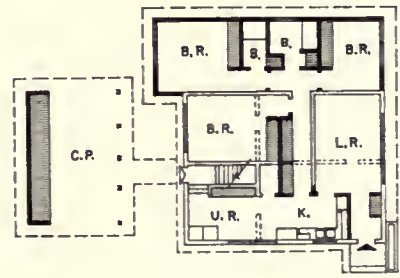

**LEGEND**

- EXISTING WALL
- NEW WALL
- - - REMOVED WALL
- - - ROOF OVERHANG
- STORAGE OR CLOSET
- ① GUEST
- ② BEDROOM
- ③ LINEN
- ④ UTILITY
- ⑤ WORK CLOTHES
- ⑥ MISCELLANEOUS
- ⑦ EXTERIOR
- ⊠ SHOWER
- ▲ GUEST ENTRANCE
- ▲ FARM SERVICE ENTRANCE
- W D WASHER AND DRYER
- LAV LAVATORY

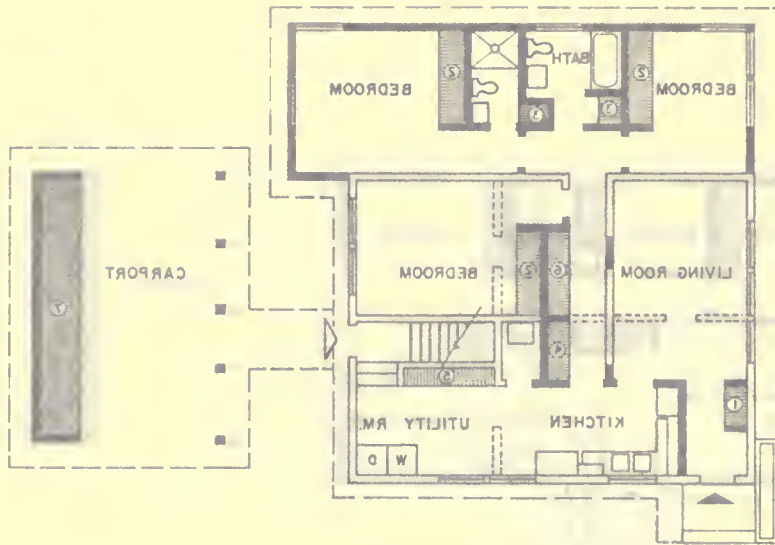
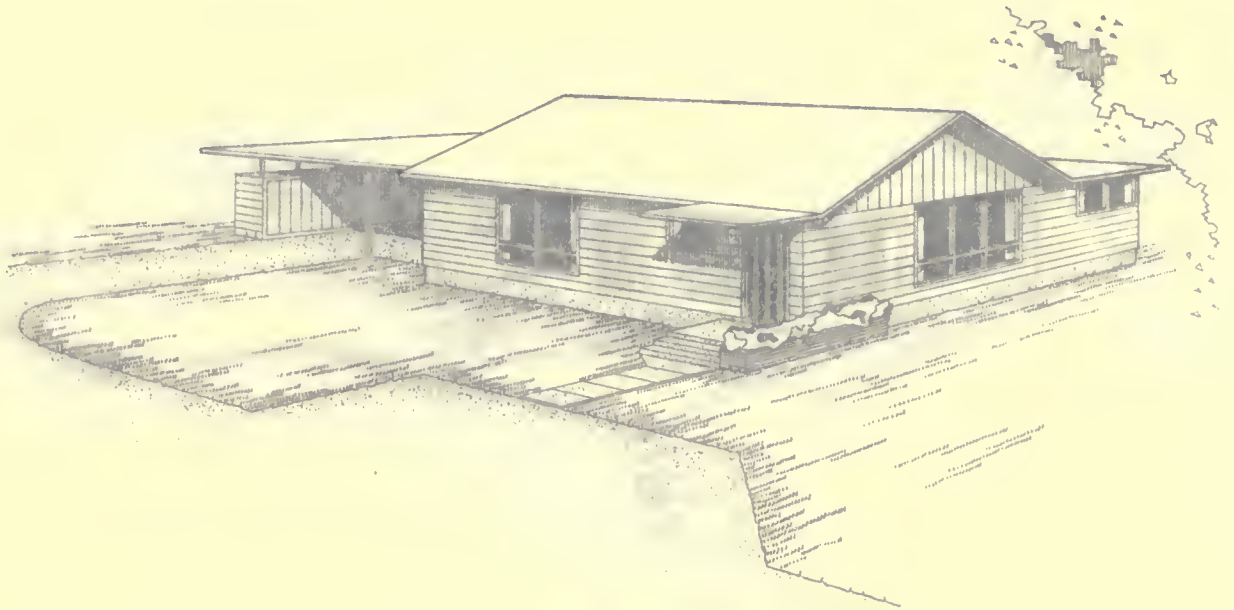

FLOOR PLAN  
NO. 8

- LEGEND**
- EXISTING WALL
  - NEW WALL
  - REMOVED WALL
  - ROOF OVERHANG
  - STORAGE OR CLOSET
  - GUEST
  - BEDROOM
  - LINEN
  - UTILITY
  - WORK CLOTHES
  - MISCELLANEOUS
  - EXTERIOR
  - SHOWER
  - GUEST ENTRANCE
  - FARM SERVICE ENTRANCE
  - WASHER AND DRYER
  - LAVATORY

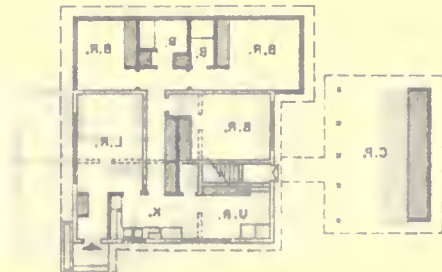

REVERSED FLOOR PLAN

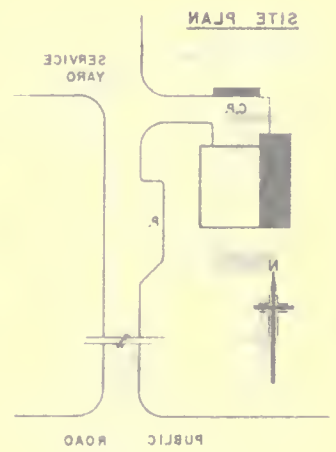

SITE PLAN

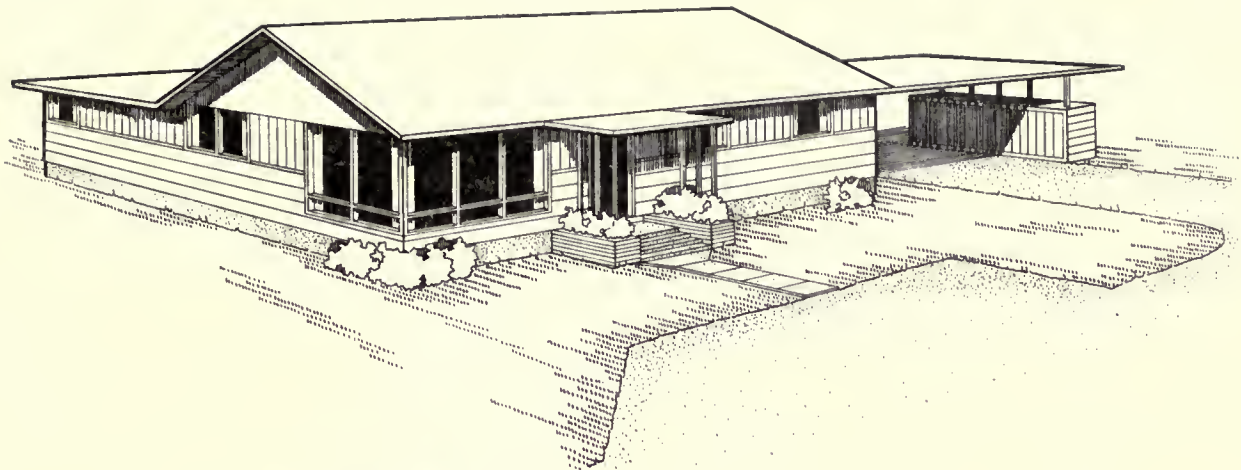

FLOOR PLAN  
NO. 9

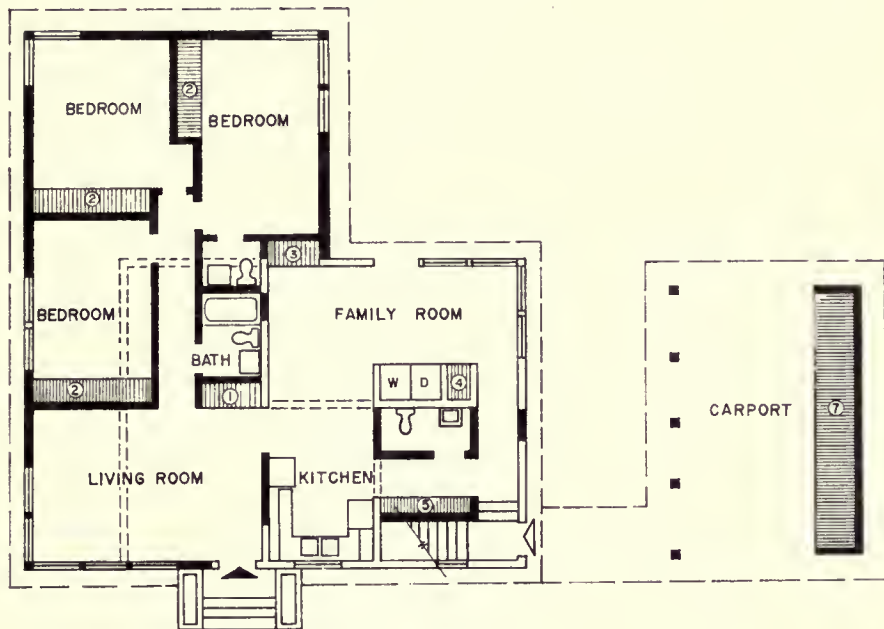

SITE PLAN

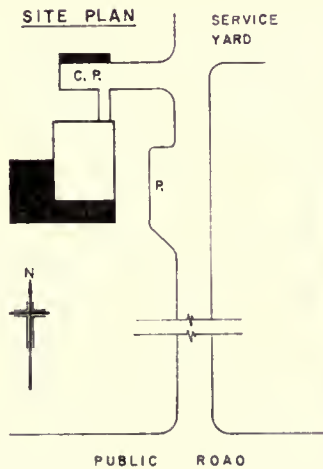

REVERSED FLOOR PLAN

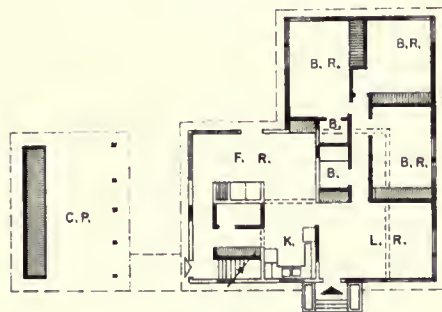

LEGEND

- EXISTING WALL
- NEW WALL
- REMOVED WALL
- ROOF OVERHANG
- STORAGE OR CLOSET
- ① GUEST
- ② BEDROOM
- ③ LINEN
- ④ UTILITY
- ⑤ WORK CLOTHES
- ⑥ MISCELLANEOUS
- ⑦ EXTERIOR
- SHOWER
- GUEST ENTRANCE
- FARM SERVICE ENTRANCE
- WASHER AND DRYER
- LAVATORY

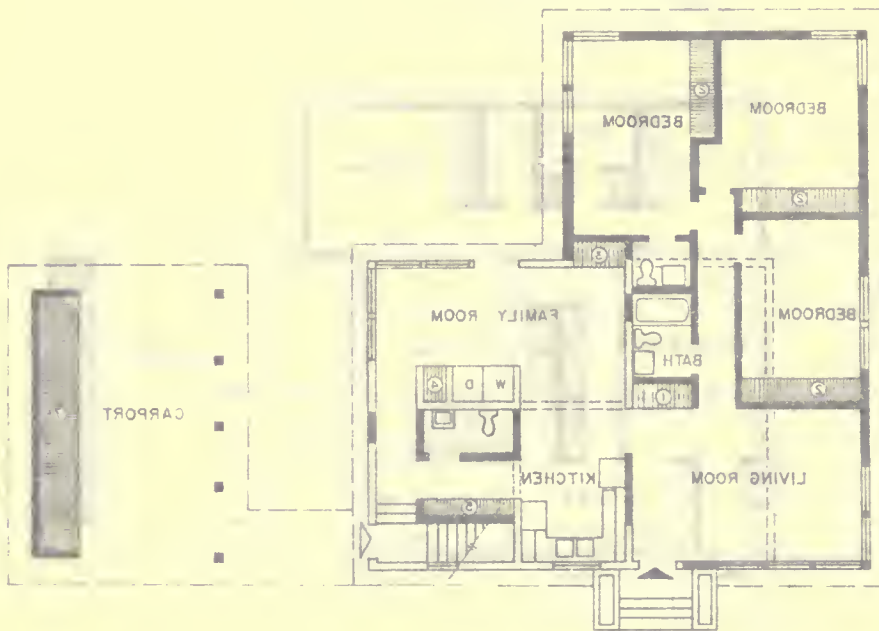
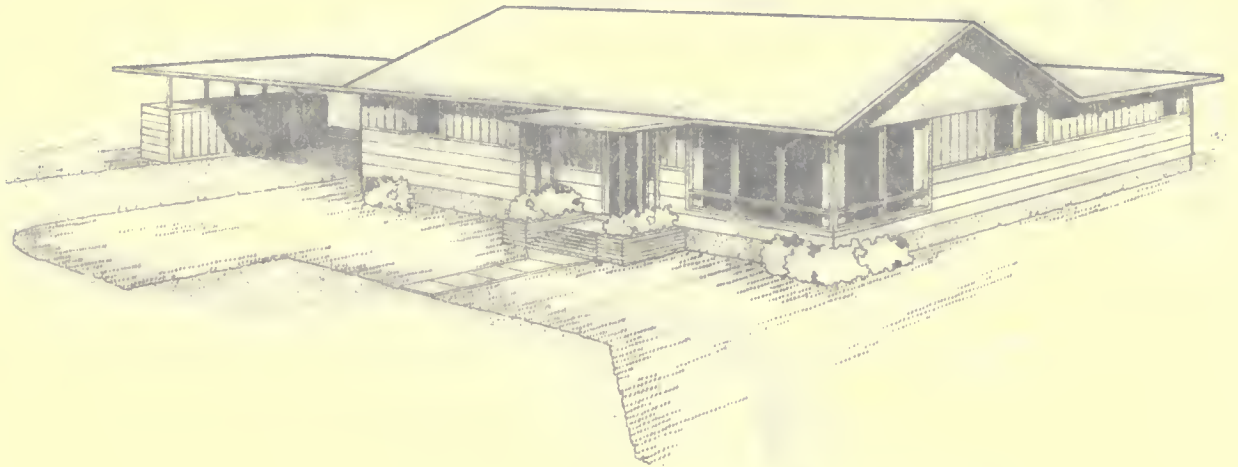

FLOOR PLAN  
NO. 3

- LEGEND**
- EXISTING WALL
  - NEW WALL
  - REMOVED WALL
  - ROOF OVERHANG
  - STORAGE OR CLOSET
  - GUEST
  - BEDROOM
  - LINE
  - UTILITY
  - WORK CLOTHES
  - MISCELLANEOUS
  - EXTERIOR
  - SHOWER
  - GUEST ENTRANCE
  - FARM SERVICE ENTRANCE
  - WASHER AND DRYER
  - LAVATORY



REVERSED FLOOR PLAN

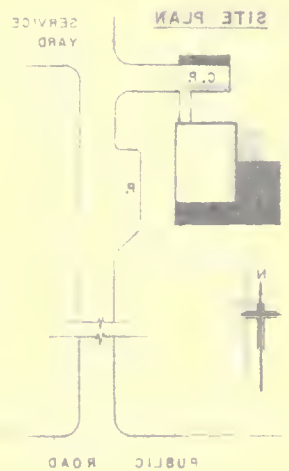

SITE PLAN

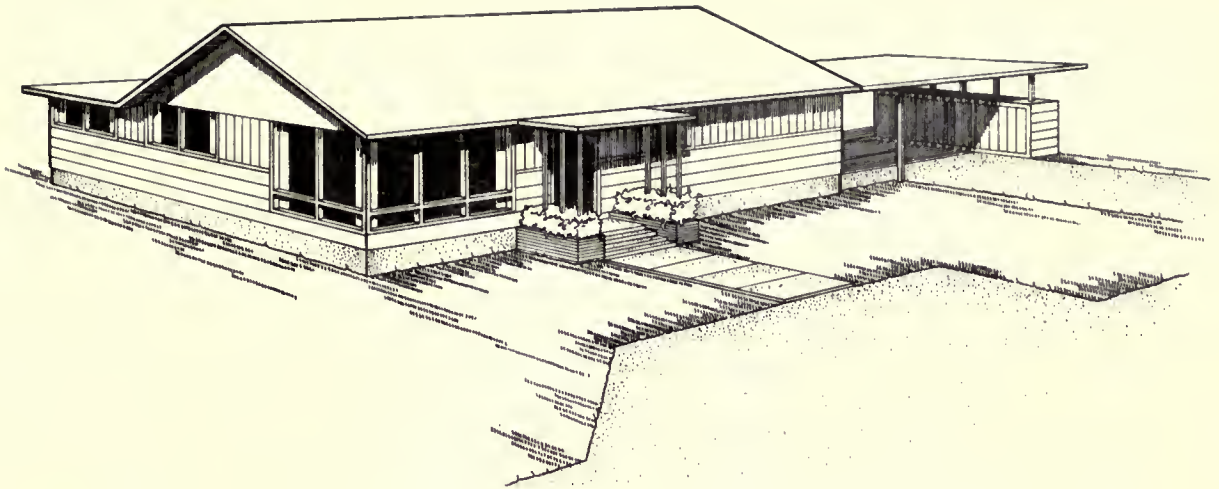

FLOOR PLAN  
NO. 10

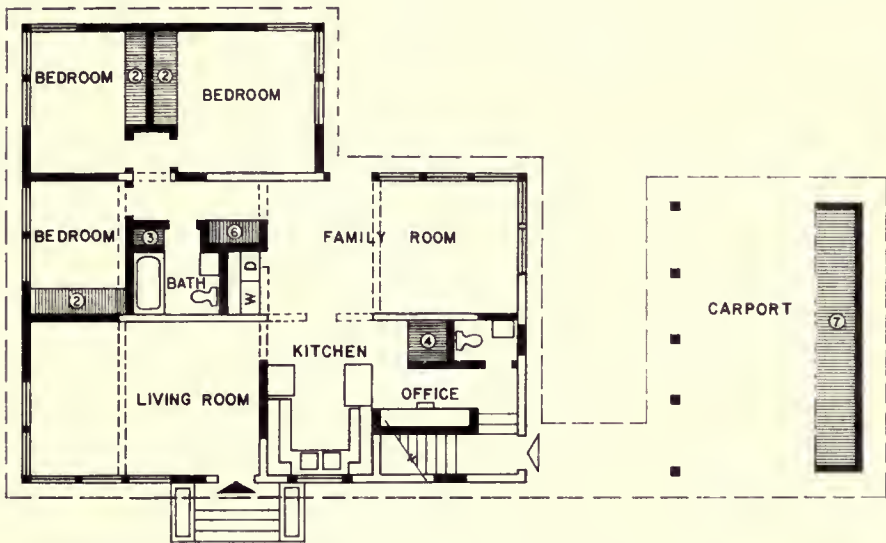

SITE PLAN

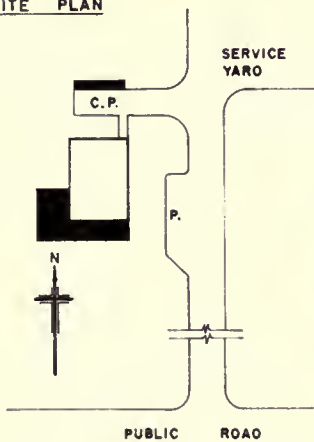

REVERSED FLOOR PLAN

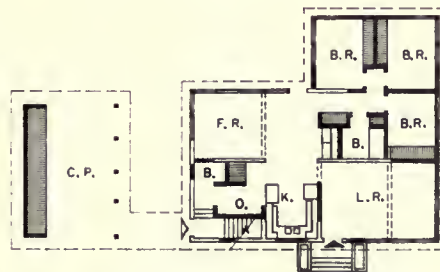

LEGEND

- EXISTING WALL
- NEW WALL
- - - REMOVED WALL
- ROOF OVERHANG
- STORAGE OR CLOSET
- ① GUEST
- ② BEDROOM
- ③ LINEN
- ④ UTILITY
- ⑤ WORK CLOTHES
- ⑥ MISCELLANEOUS
- ⑦ EXTERIOR
- ☒ SHOWER
- ▲ GUEST ENTRANCE
- ▲ FARM SERVICE ENTRANCE
- W O WASHER AND DRYER
- LAV LAVATORY

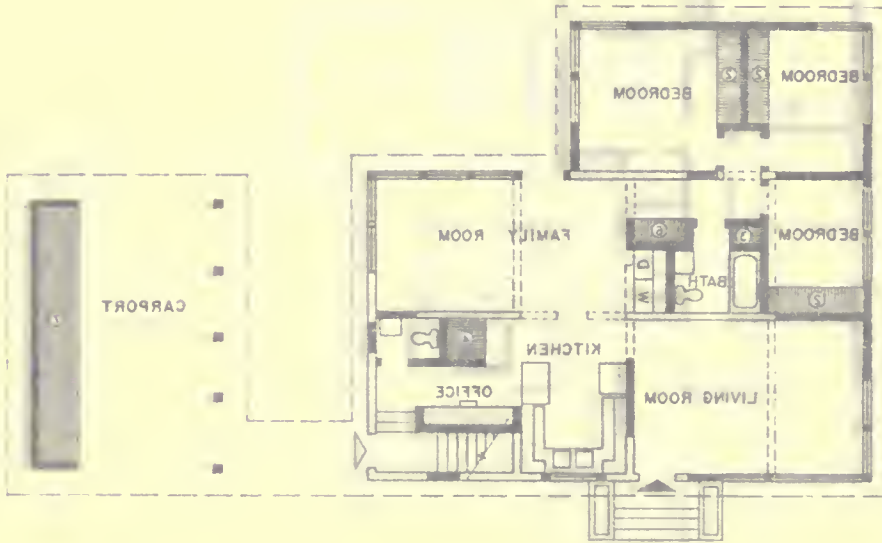
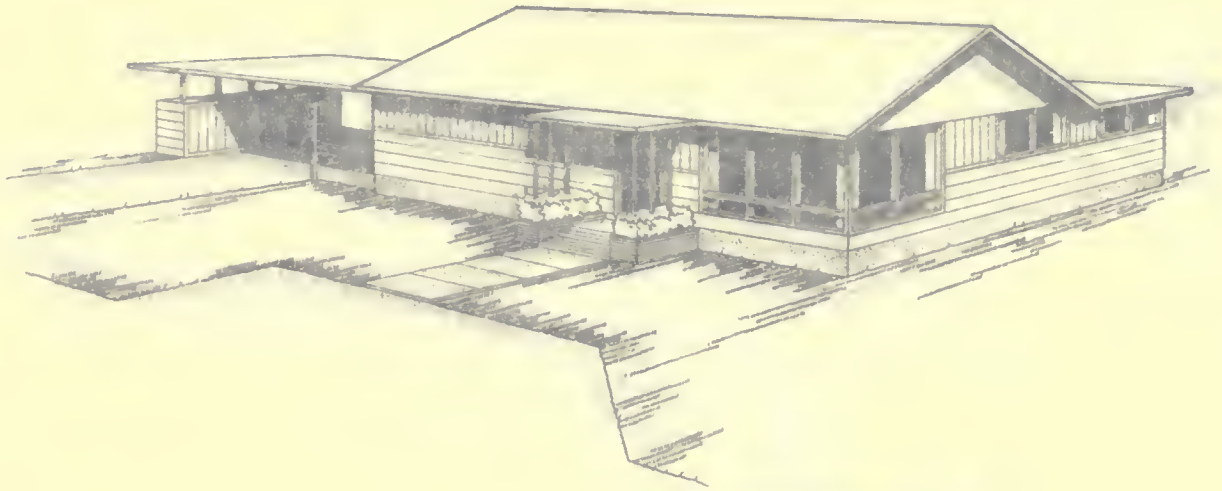

FLOOR PLAN  
NO. 10

- LEGEND**
- EXISTING WALL
  - NEW WALL
  - REMOVED WALL
  - ROOF OVERHANG
  - STORAGE OR CLOSET
  - GUEST
  - BEDROOM
  - LINEN
  - UTILITY
  - WORK CLOTHES
  - MISCELLANEOUS
  - EXTERIOR
  - SHOWER
  - GUEST ENTRANCE
  - FARM SERVICE ENTRANCE
  - WASHER AND DRYER
  - LAVATORY



REVERSED FLOOR PLAN

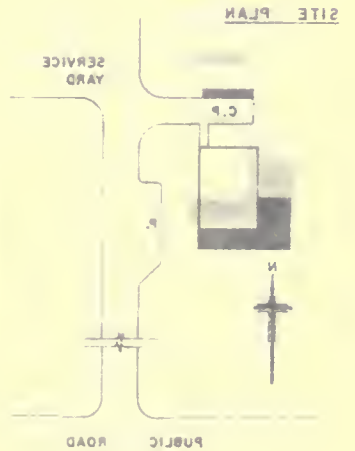

SITE PLAN



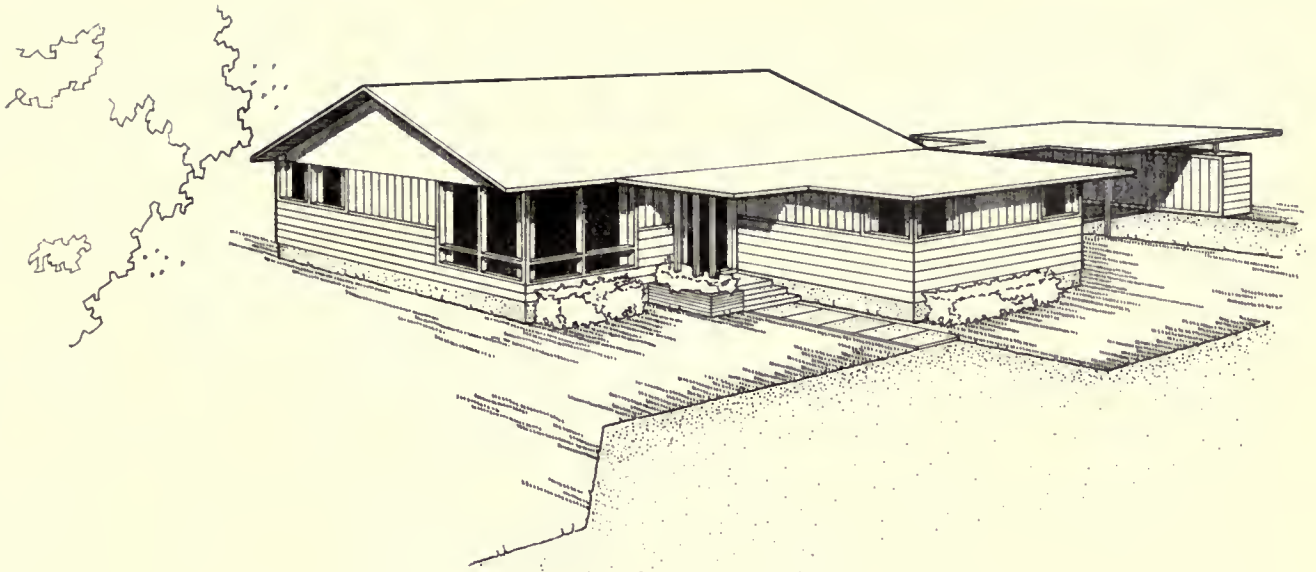

FLOOR PLAN  
NO. 11

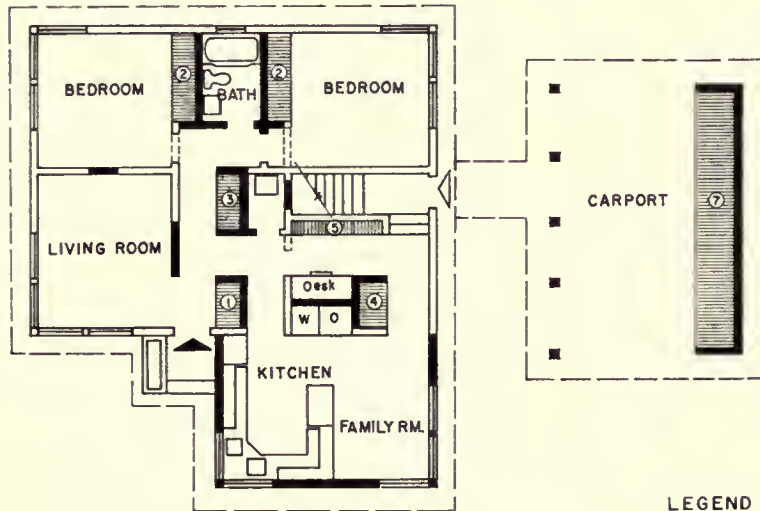

SITE PLAN

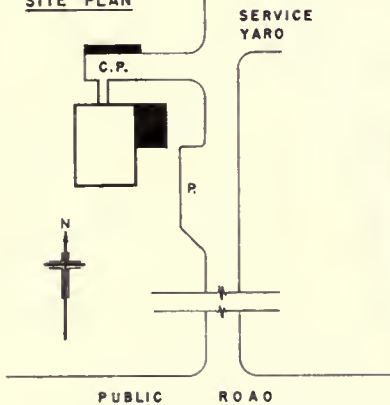

REVERSED FLOOR PLAN

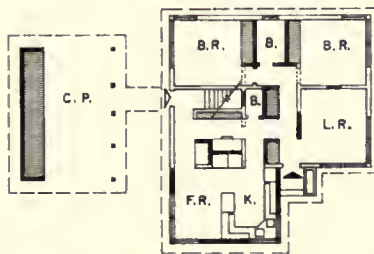

LEGEND

- EXISTING WALL
- NEW WALL
- - - REMOVED WALL
- ROOF OVERHANG
- STORAGE OR CLOSET
- ① GUEST
- ② BEDROOM
- ③ LINEN
- ④ UTILITY
- ⑤ WORK CLOTHES
- ⑥ MISCELLANEOUS
- ⑦ EXTERIOR
- ⊠ SHOWER
- ⊡ GUEST ENTRANCE
- ⊢ FARM SERVICE ENTRANCE
- W O WASHER AND DRYER
- LAV LAVATORY

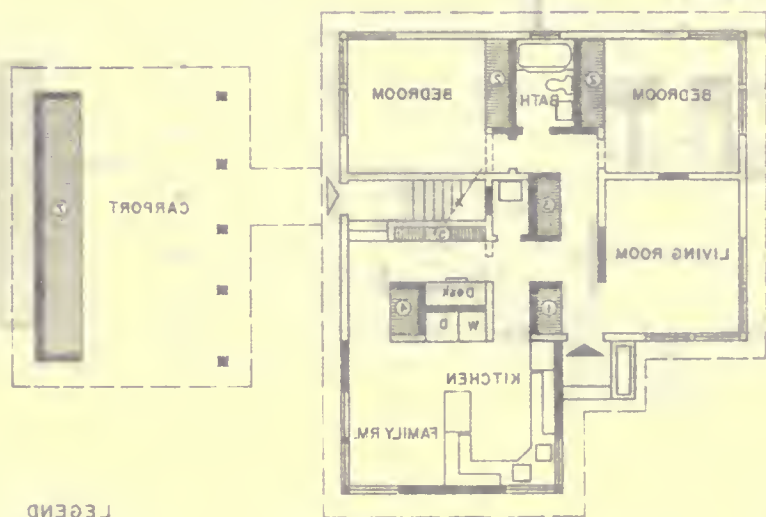
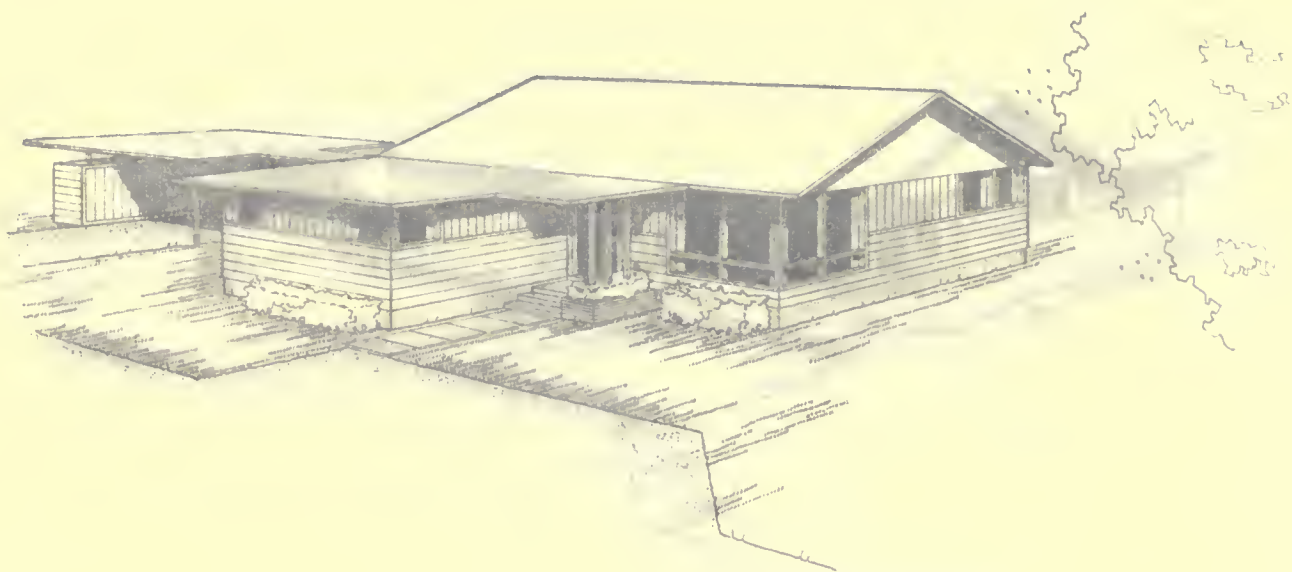

FLOOR PLAN  
NO. 11

- LEGEND**
- EXISTING WALL
  - NEW WALL
  - REMOVED WALL
  - ROOF OVERHANG
  - STORAGE OR CLOSET
  - GUEST
  - BEDROOM
  - LINEN
  - UTILITY
  - WORK CLOTHES
  - MISCELLANEOUS
  - EXTERIOR
  - SHOWER
  - GUEST ENTRANCE
  - FARM SERVICE ENTRANCE
  - WASHER AND DRYER
  - LAVATORY



REVERSED FLOOR PLAN

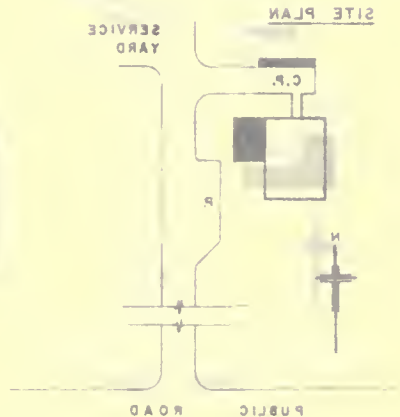

SITE PLAN

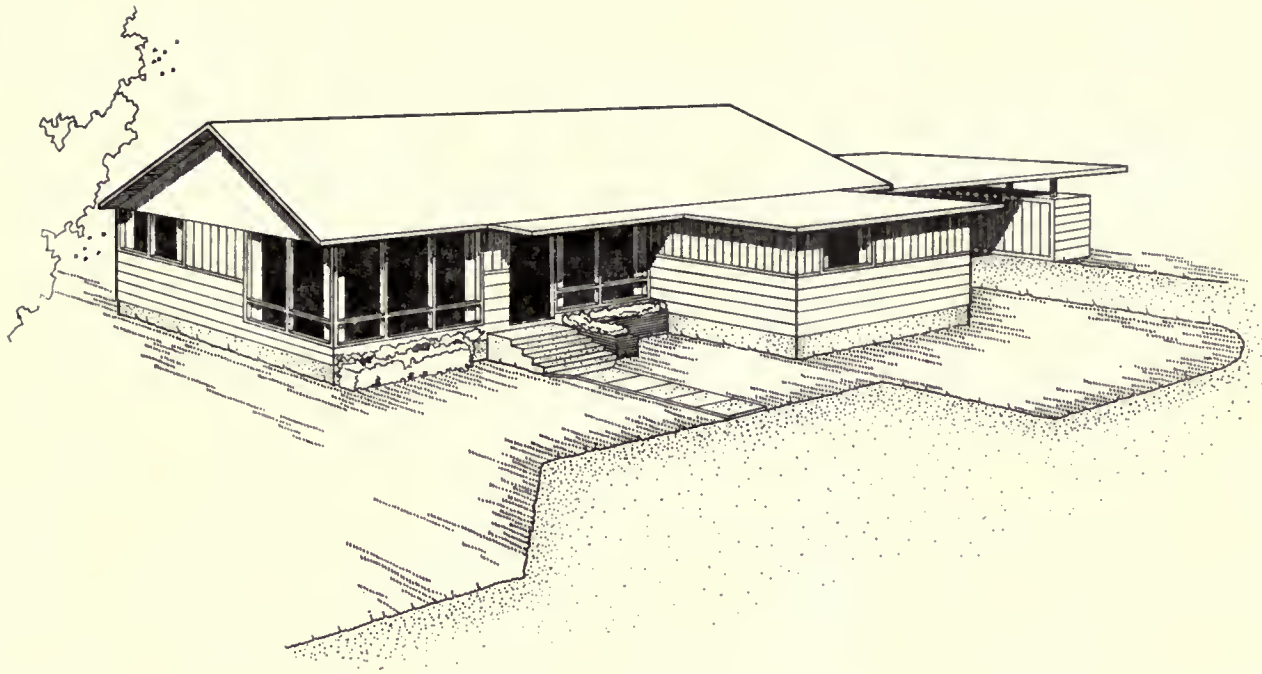

FLOOR PLAN  
NO. 12

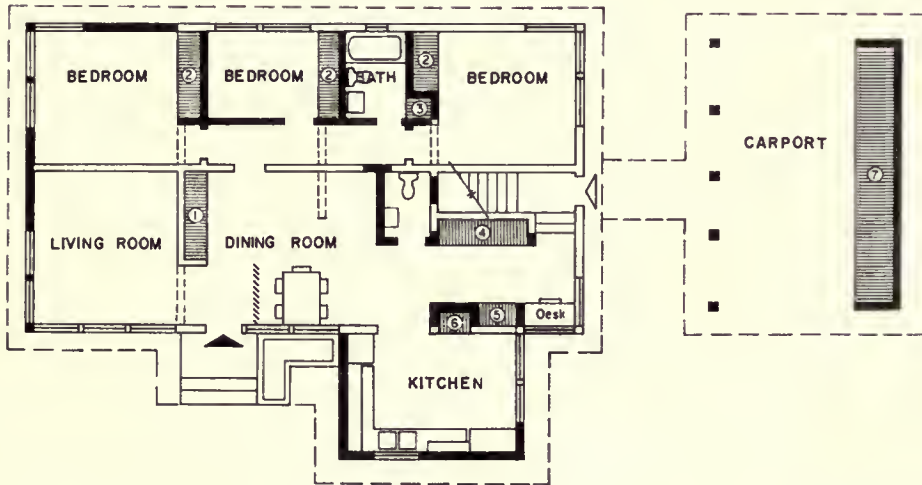

SITE PLAN

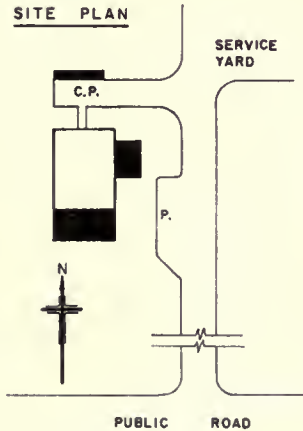

REVERSED FLOOR PLAN

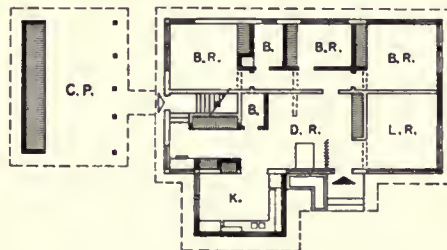

LEGEND

- EXISTING WALL
- NEW WALL
- - - REMOVED WALL
- ROOF OVERHANG
- STORAGE OR CLOSET
- ① GUEST BEOROOM
- ② BEOROOM
- ③ LINEN
- ④ UTILITY
- ⑤ WORK CLOTHES
- ⑥ MISCELLANEOUS
- ⑦ EXTERIOR
- ⊠ SHOWER
- ▲ GUEST ENTRANCE
- ▲ FARM SERVICE ENTRANCE
- W O WASHER AND DRYER
- LAV LAVATORY

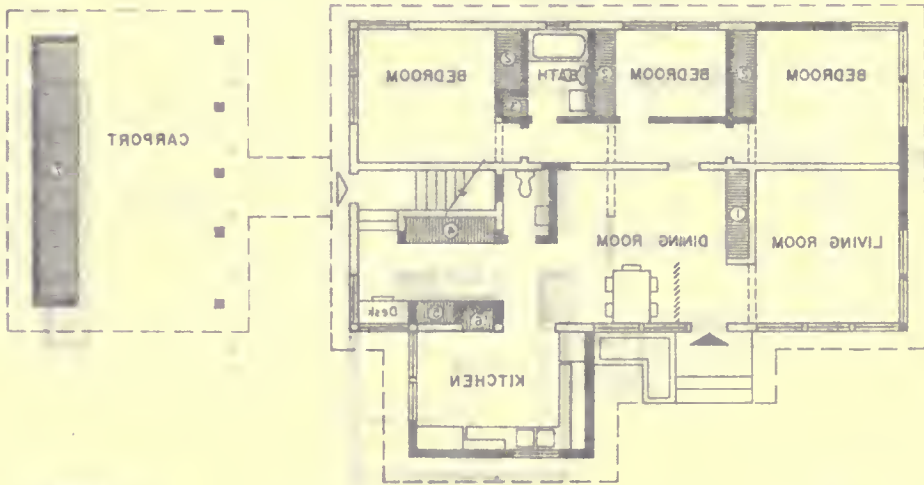
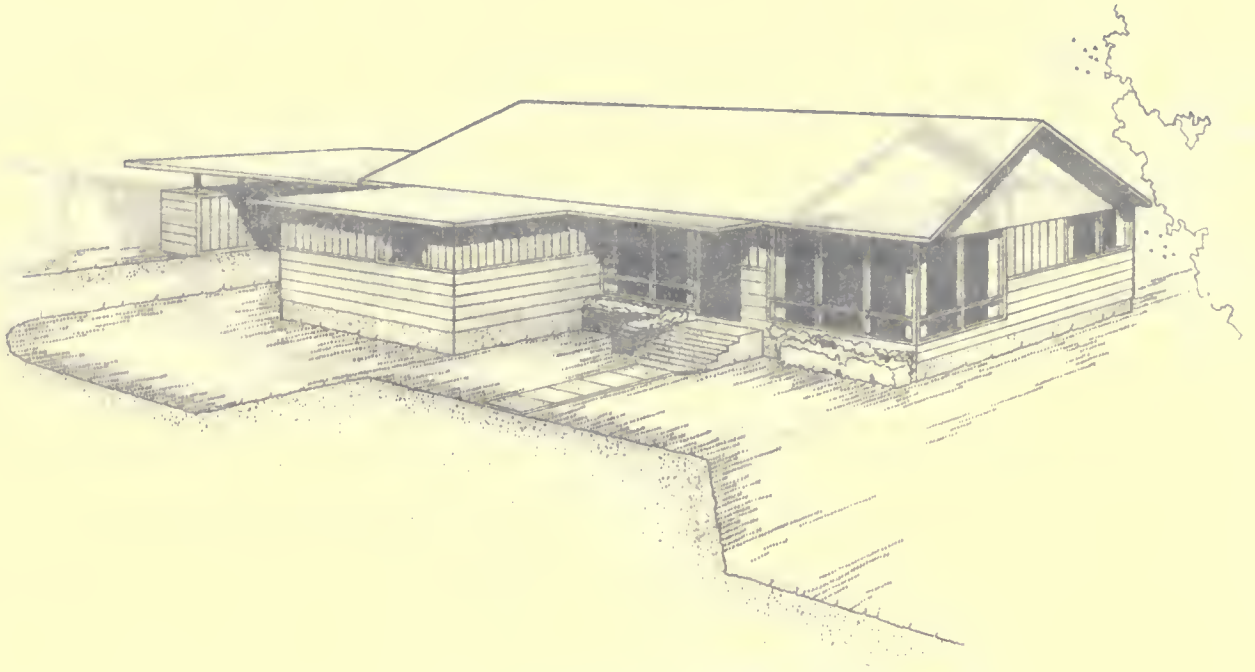

FLOOR PLAN  
NO. 12

- LEGEND**
- EXISTING WALL
  - NEW WALL
  - REMOVED WALL
  - ROOF OVERHANG
  - STORAGE OR CLOSET
  - GUEST
  - BEDROOM
  - LINEN
  - UTILITY
  - WORK CLOTHES
  - MISCELLANEOUS
  - EXTERIOR
  - SHOWER
  - GUEST ENTRANCE
  - FARM SERVICE ENTRANCE
  - WASHER AND DRYER
  - LAVATORY

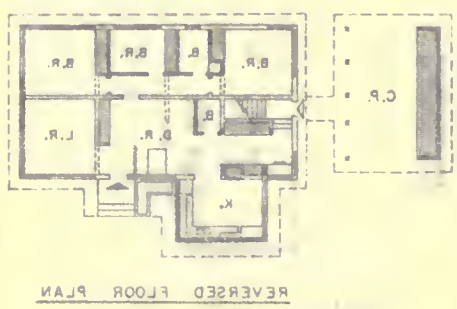

REVERSED FLOOR PLAN

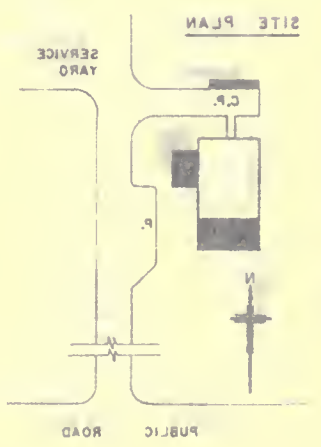

SITE PLAN

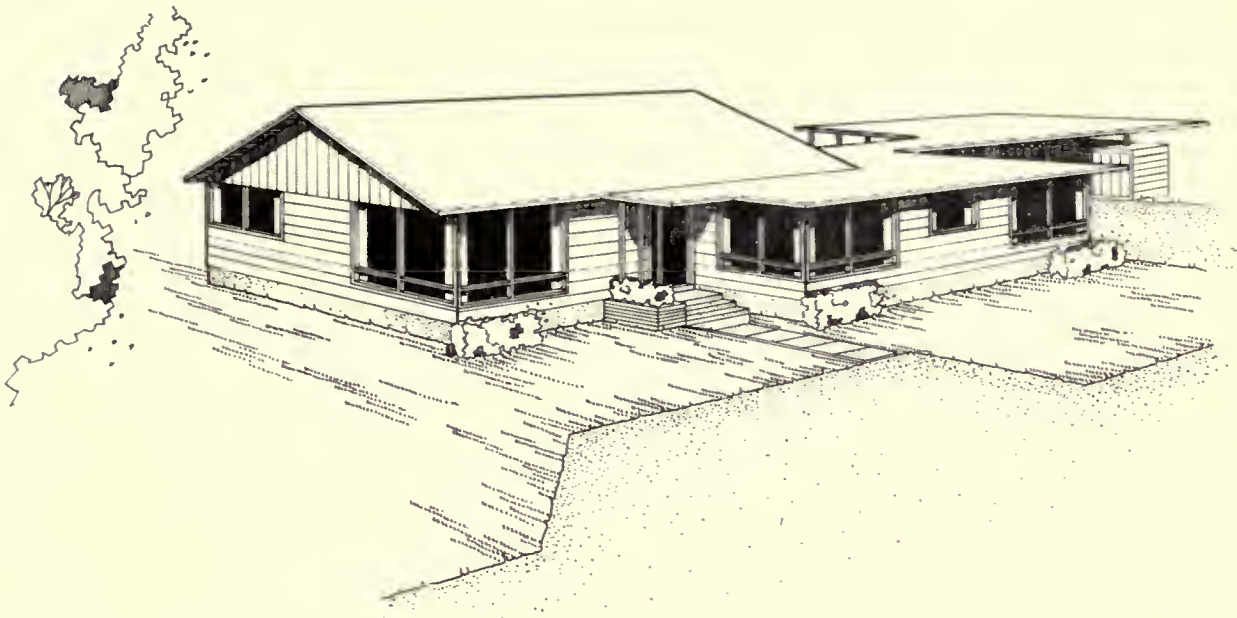

FLOOR PLAN  
NO. 13

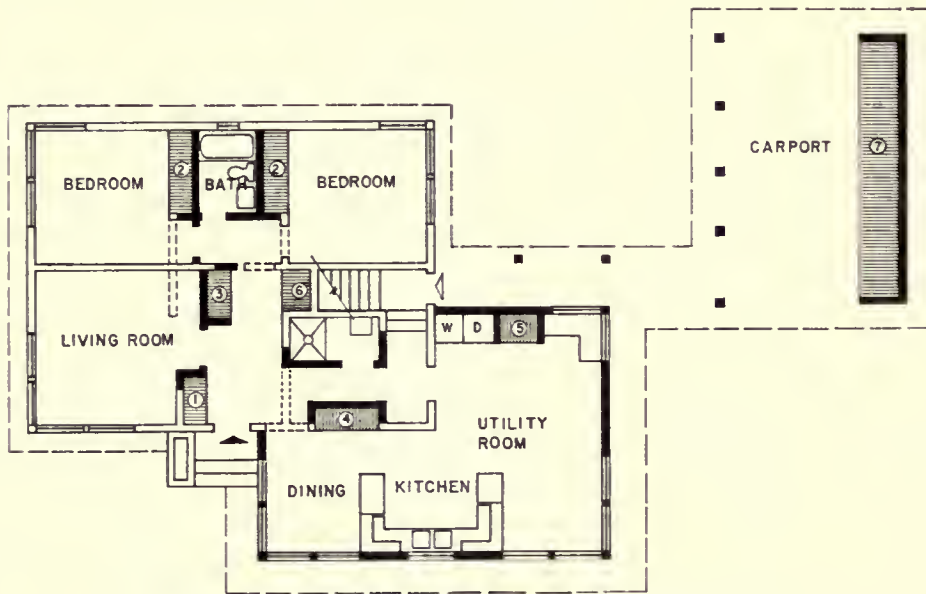

SITE PLAN

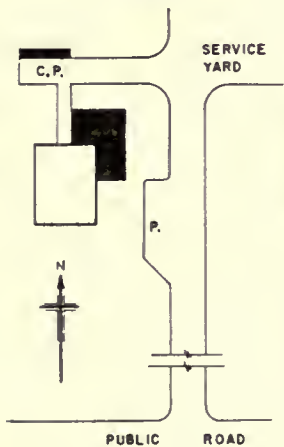

REVERSED FLOOR PLAN

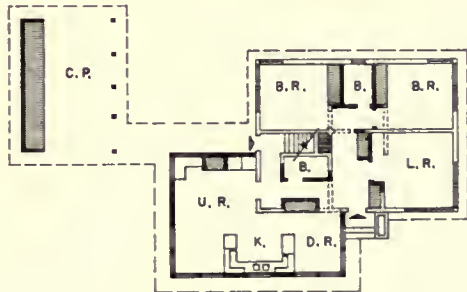

LEGEND

- EXISTING WALL
- NEW WALL
- - - REMOVED WALL
- - - ROOF OVERHANG
- STORAGE OR CLOSET
- ① GUEST
- ② BEDROOM
- ③ LINEN
- ④ UTILITY
- ⑤ WORK CLOTHES
- ⑥ MISCELLANEOUS
- ⑦ EXTERIOR
- ☒ SHOWER
- ▲ GUEST ENTRANCE
- ▲ FARM SERVICE ENTRANCE
- W D WASHER AND DRYER
- LAV LAVATORY

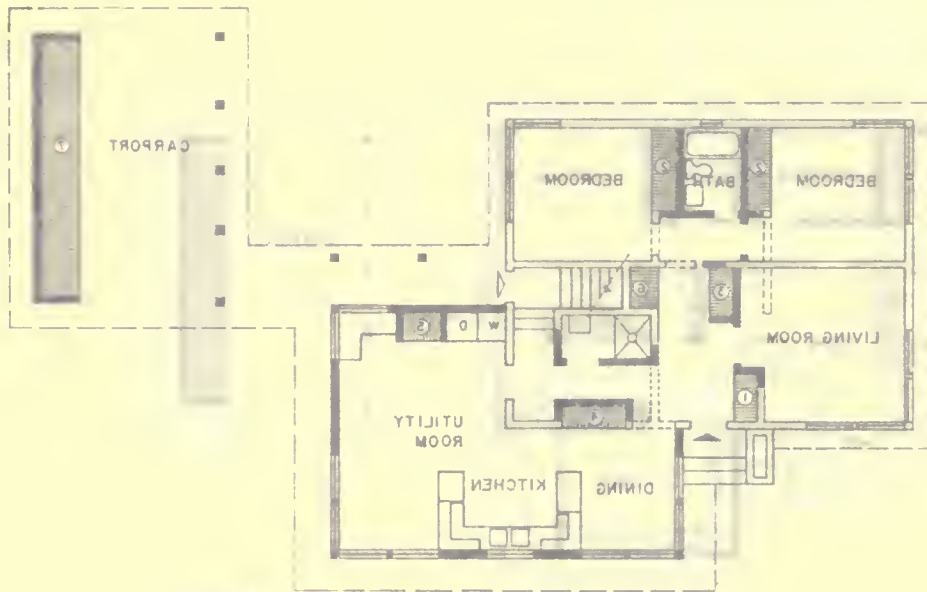
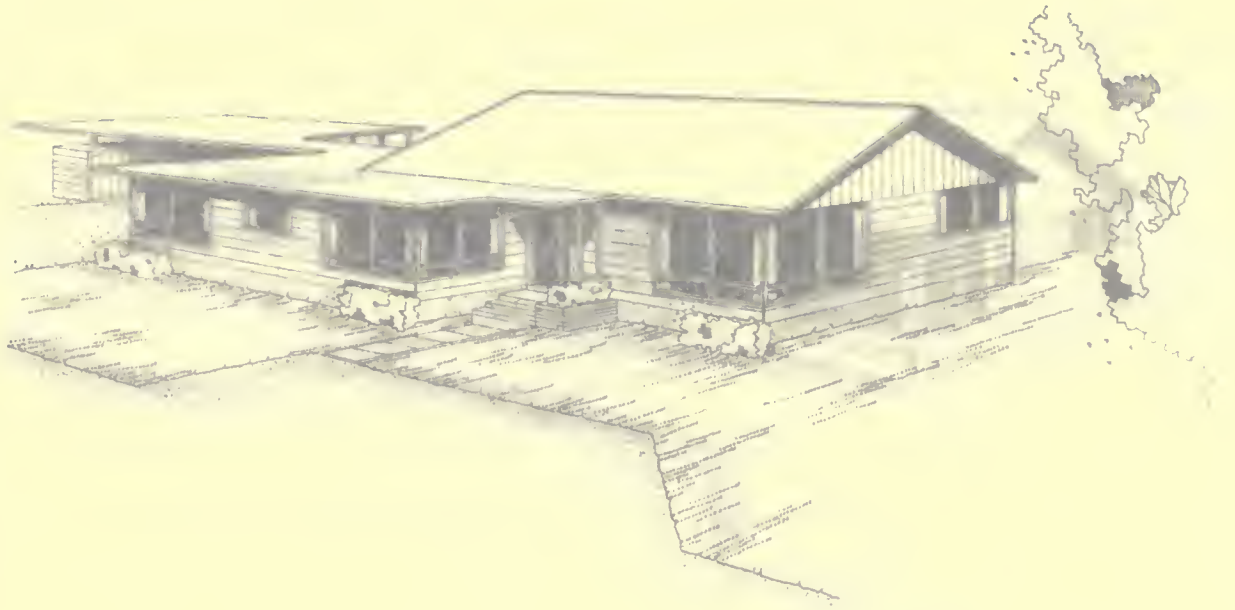

FLOOR PLAN  
NO. 12

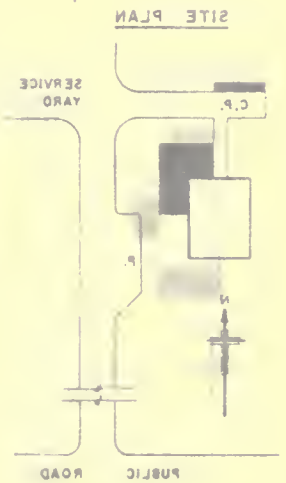

SITE PLAN

- LEGEND**
- EXISTING WALL
  - NEW WALL
  - REMOVED WALL
  - ROOF OVERHANG
  - STORAGE OR CLOSET
  - GUEST
  - BEDROOM
  - LINEN
  - UTILITY
  - WORK CLOTHES
  - MISCELLANEOUS
  - EXTERIOR
  - SHOWER
  - GUEST ENTRANCE
  - FARM SERVICE ENTRANCE
  - WASHER AND DRYER
  - LAVATORY



REVERSED FLOOR PLAN

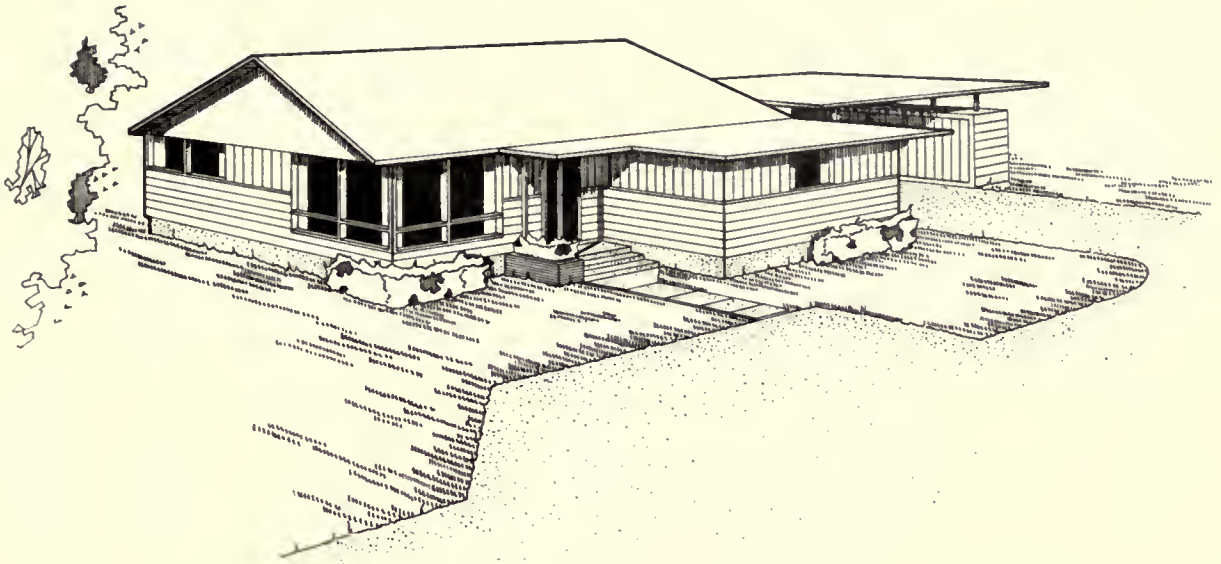

FLOOR PLAN  
NO. 14

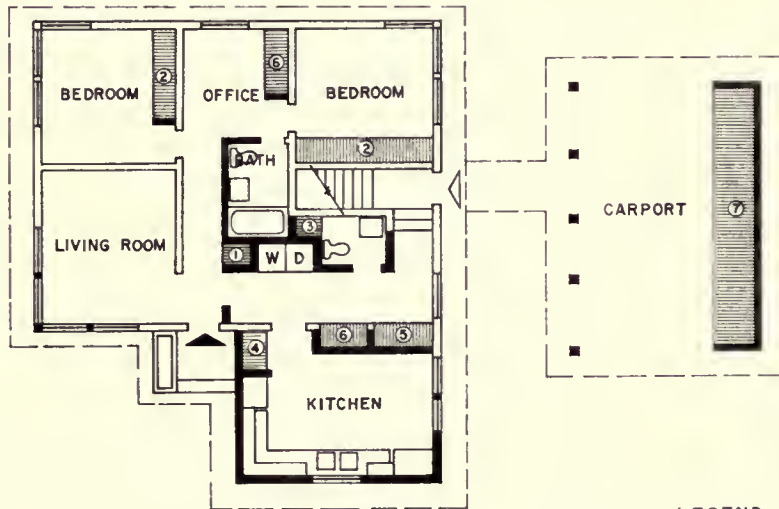

SITE PLAN

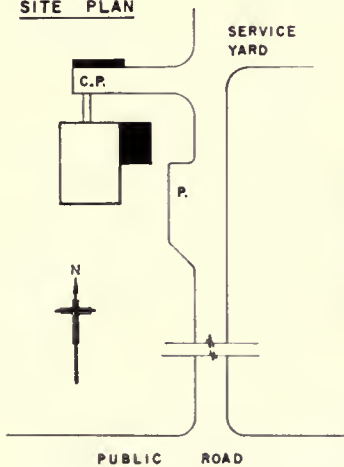

REVERSED FLOOR PLAN

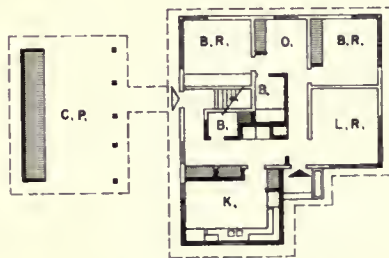

LEGEND

- EXISTING WALL
- NEW WALL
- REMOVED WALL
- ROOF OVERHANG
- STORAGE OR CLOSET
- ① GUEST
- ② BEDROOM
- ③ LINEN
- ④ UTILITY
- ⑤ WORK CLOTHES
- ⑥ MISCELLANEOUS
- ⑦ EXTERIOR
- SHOWER
- GUEST ENTRANCE
- FARM SERVICE ENTRANCE
- WASHER AND DRYER
- LAVATORY

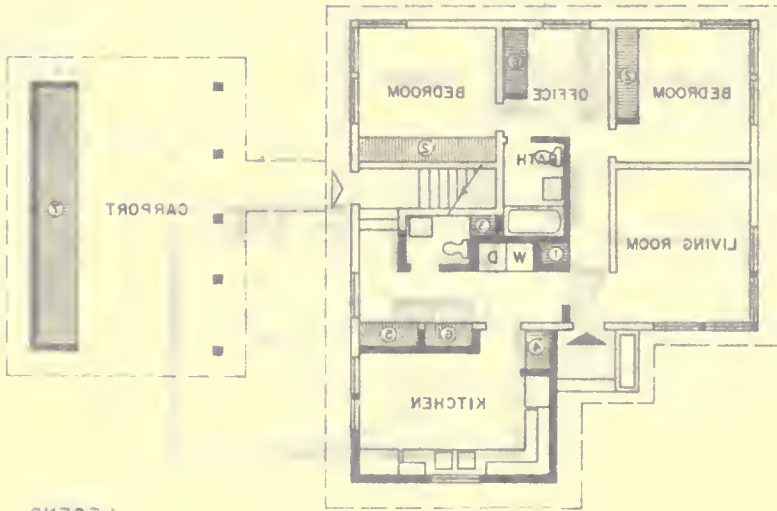
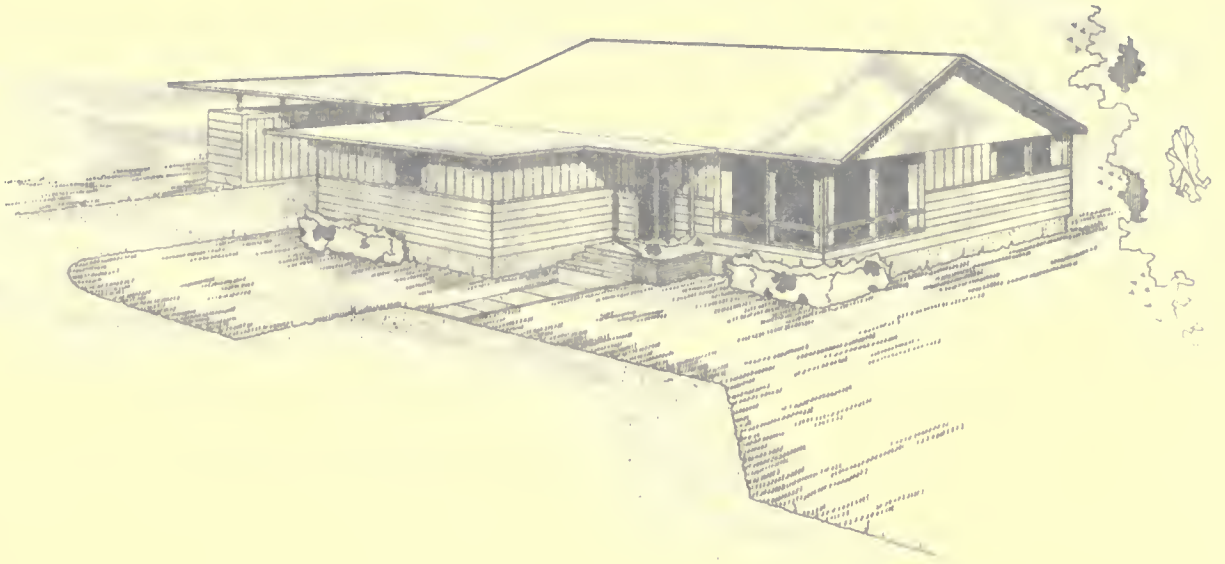

FLOOR PLAN  
NO. 14

**LEGEND**

- EXISTING WALL
- NEW WALL
- REMOVED WALL
- ROOF OVERHANG
- STORAGE OR CLOSET
- GUEST
- BEDROOM
- LINEN
- UTILITY
- WORK CLOTHES
- MISCELLANEOUS
- EXTERIOR
- SHOWER
- GUEST ENTRANCE
- FARM SERVICE ENTRANCE
- WASHER AND DRYER
- LAVATORY

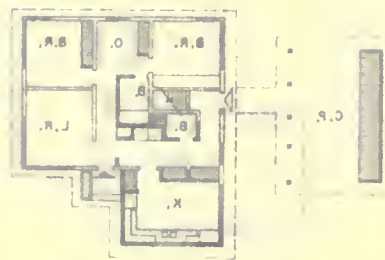

REVERSED FLOOR PLAN

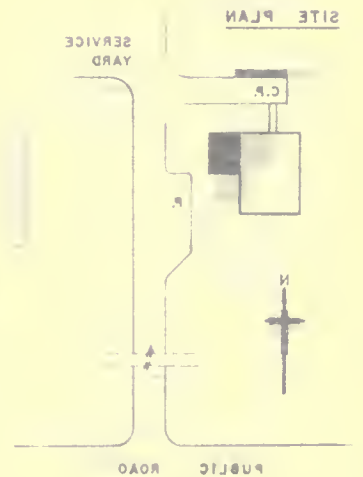

SITE PLAN



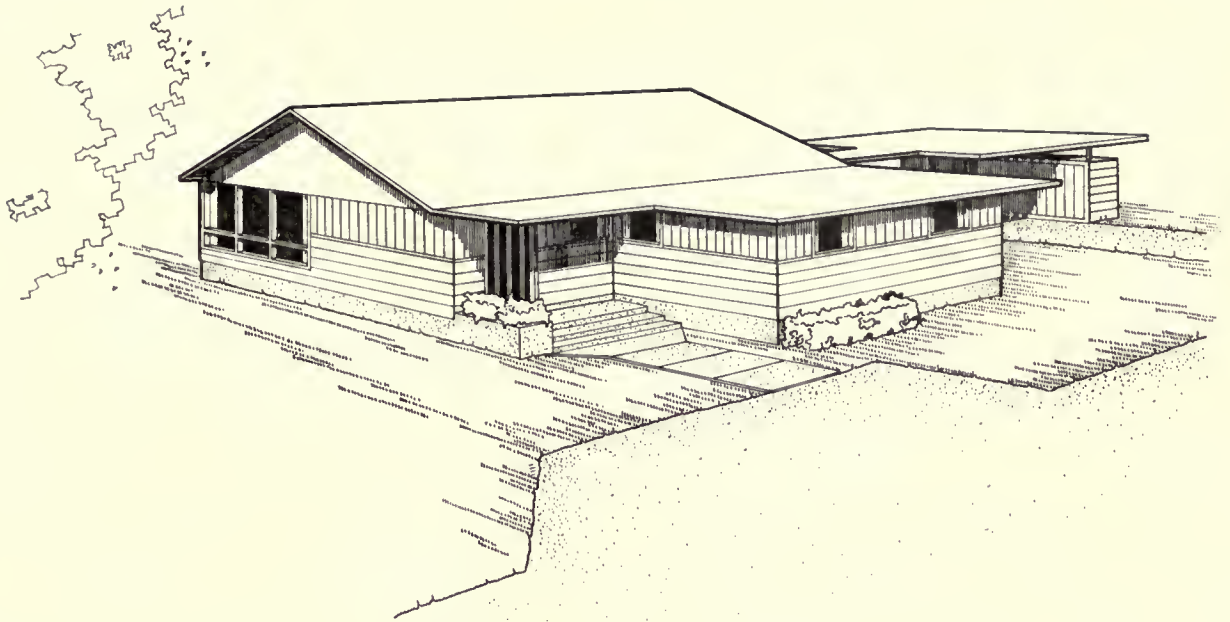

FLOOR PLAN  
NO. 15

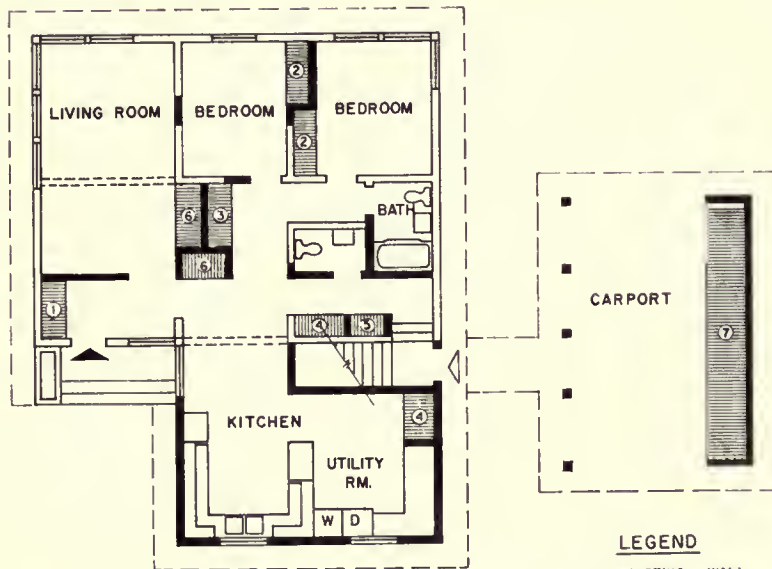

SITE PLAN

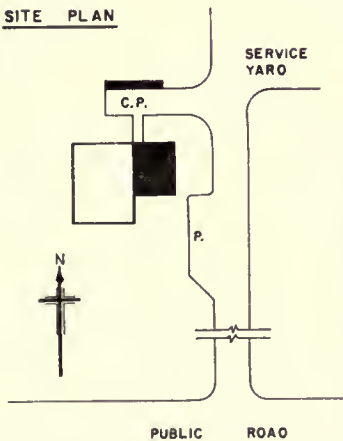

REVERSED FLOOR PLAN

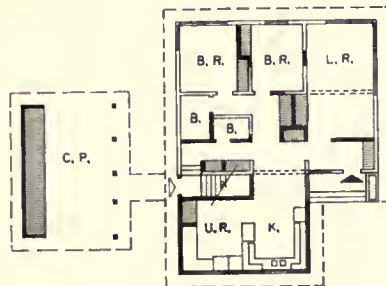

LEGEND

-  EXISTING WALL
-  NEW WALL
-  REMOVED WALL
-  ROOF OVERHANG
-  STORAGE OR CLOSET
- ① GUEST
- ② BEDROOM
- ③ LINEN
- ④ UTILITY
- ⑤ WORK CLOTHES
- ⑥ MISCELLANEOUS
- ⑦ EXTERIOR
-  SHOWER
-  GUEST ENTRANCE
-  FARM SERVICE ENTRANCE
-  WASHER AND DRYER
-  LAVATORY

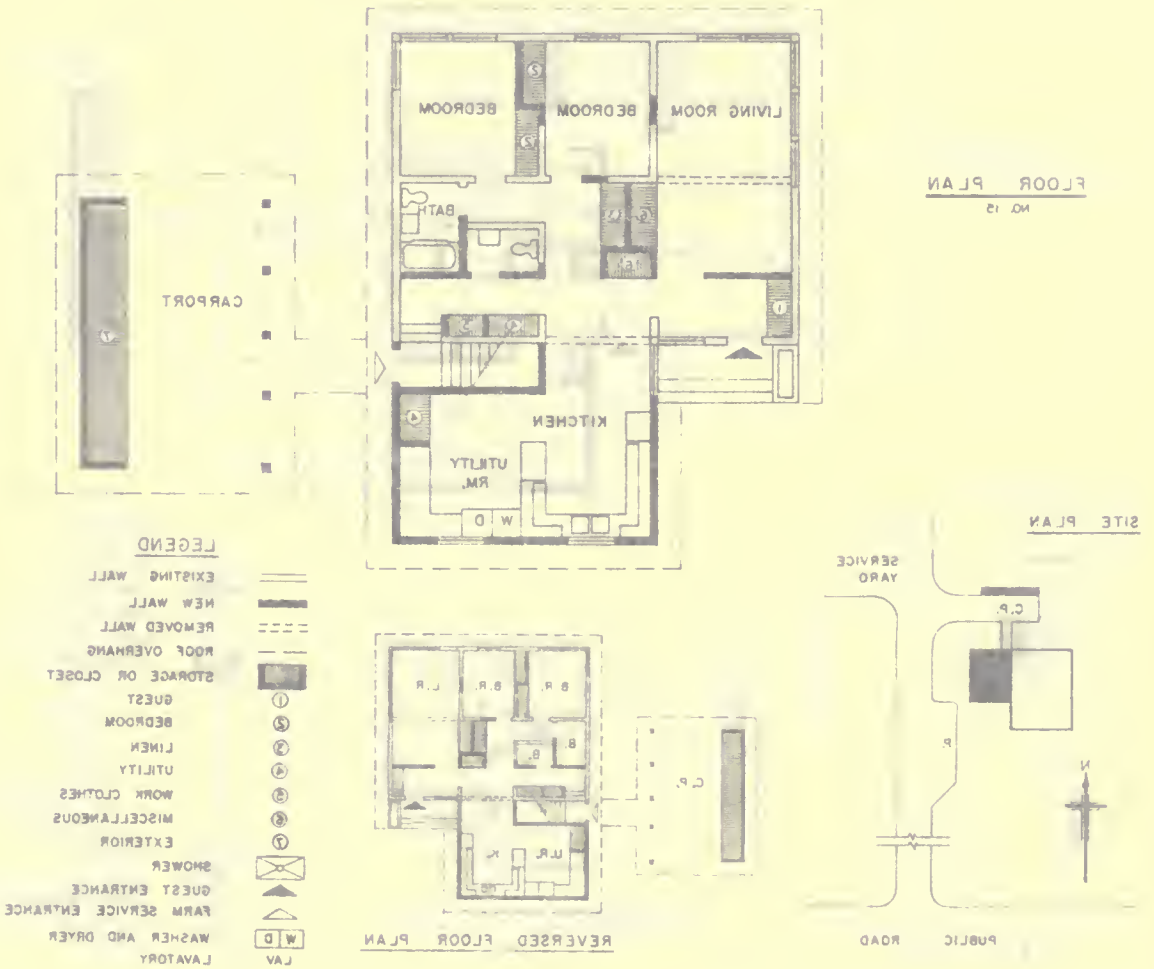
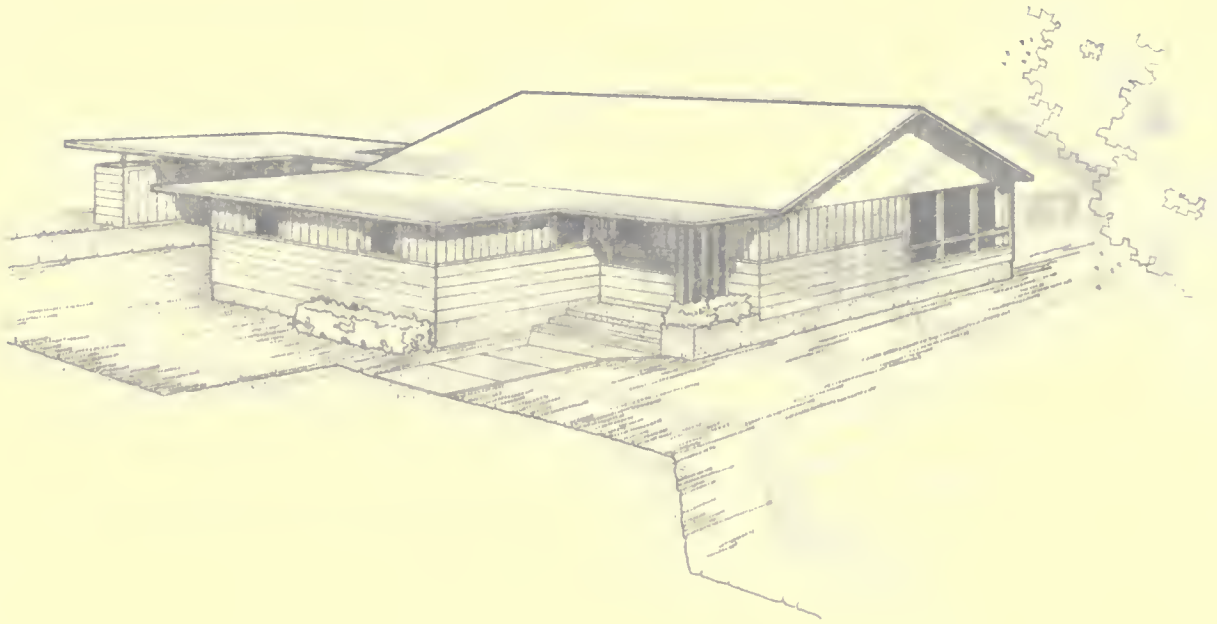

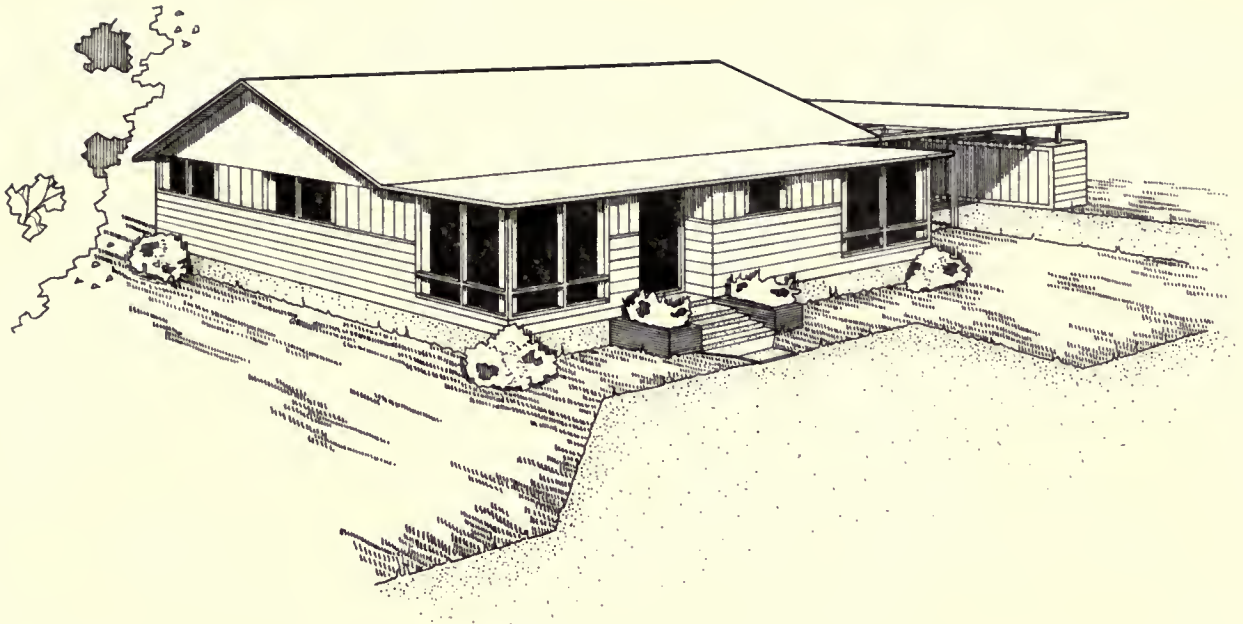

FLOOR PLAN  
NO. 16

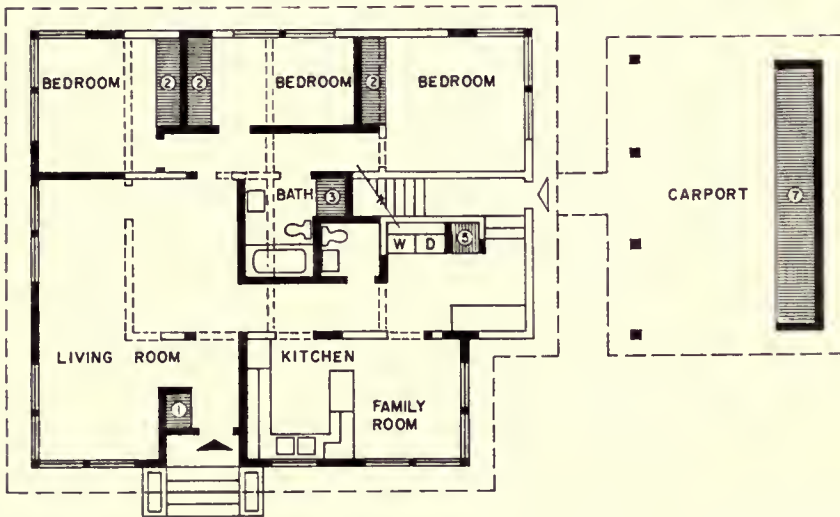

SITE PLAN

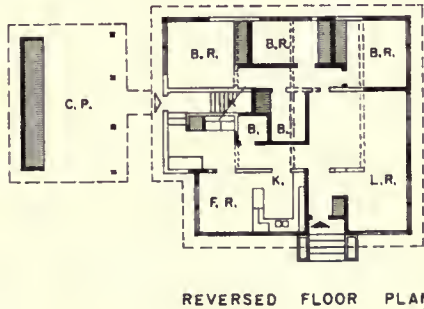
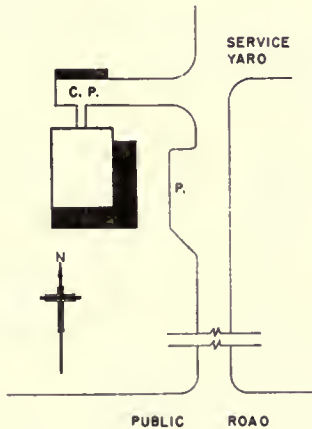

REVERSED FLOOR PLAN

LEGEND

- EXISTING WALL
- NEW WALL
- - - REMOVED WALL
- ROOF OVERHANG
- STORAGE OR CLOSET
- ① GUEST
- ② BEOROOM
- ③ LINEN
- ④ UTILITY
- ⑤ WORK CLOTHES
- ⑥ MISCELLANEOUS
- ⑦ EXTERIOR
- ☒ SHOWER
- ▲ GUEST ENTRANCE
- ▲ FARM SERVICE ENTRANCE
- W O WASHER AND DRYER
- LAV LAVATORY

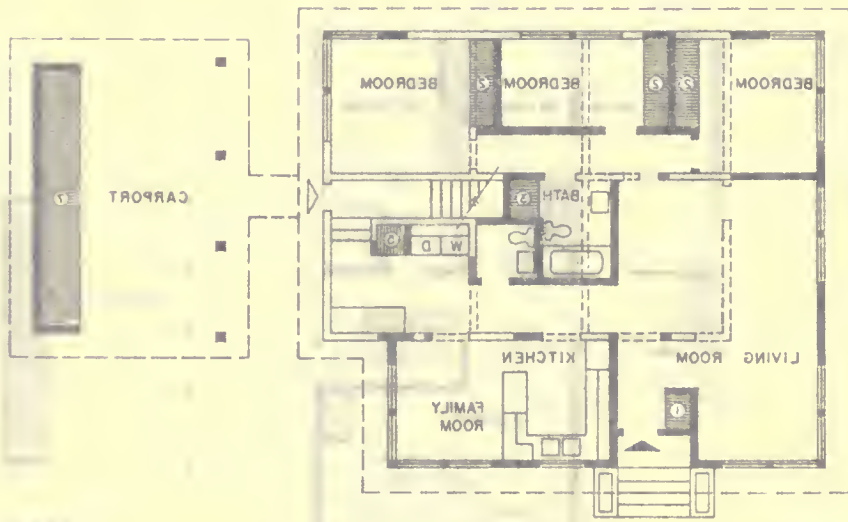
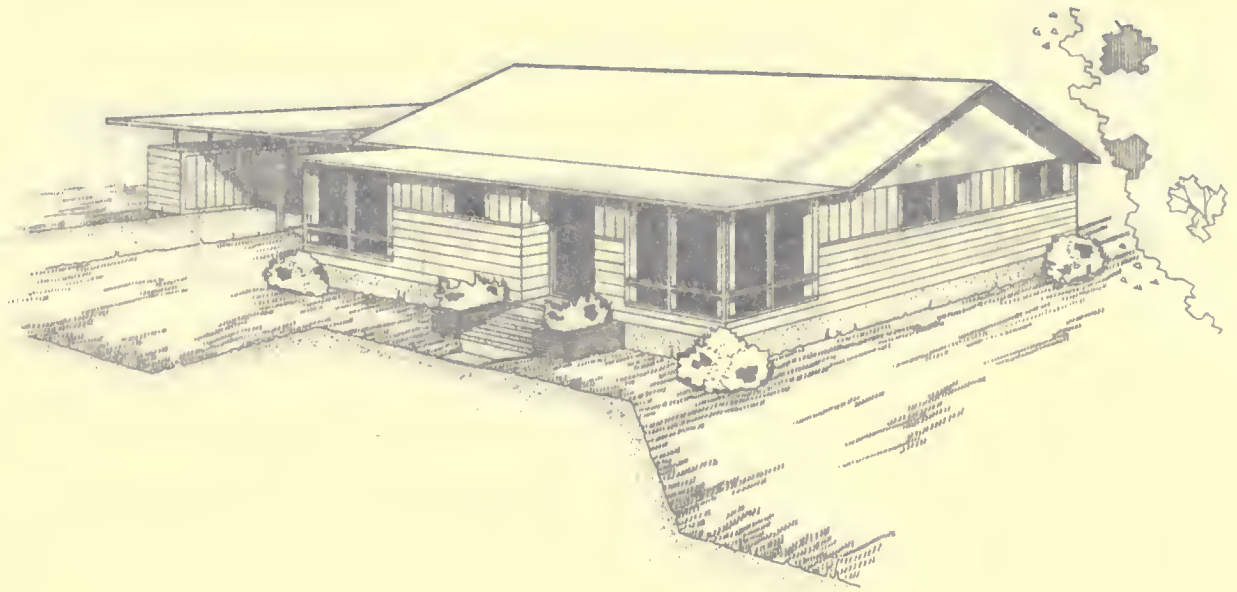

FLOOR PLAN  
NO. 18

SITE PLAN

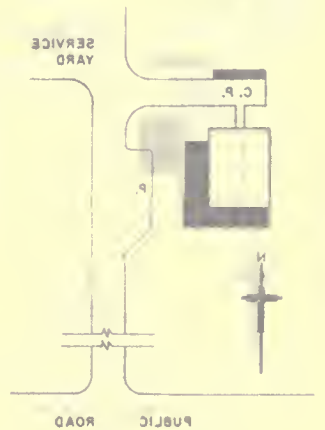

LEGEND

- EXISTING WALL
- NEW WALL
- REMOVE WALL
- ROOF OVERHANG
- STORAGE OR CLOSET
- GUEST
- BEDROOM
- LINEN
- UTILITY
- WORK CLOTHES
- MISCELLANEOUS
- EXTERIOR
- SHOWER
- GUEST ENTRANCE
- FARM SERVICE ENTRANCE
- WASHER AND DRYER
- LAVATORY

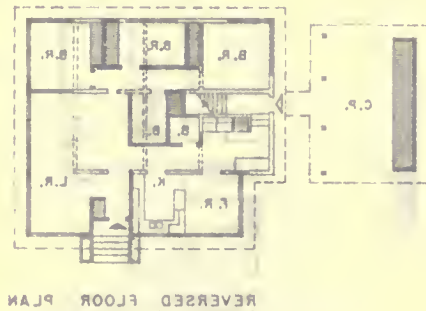

REVERSED FLOOR PLAN

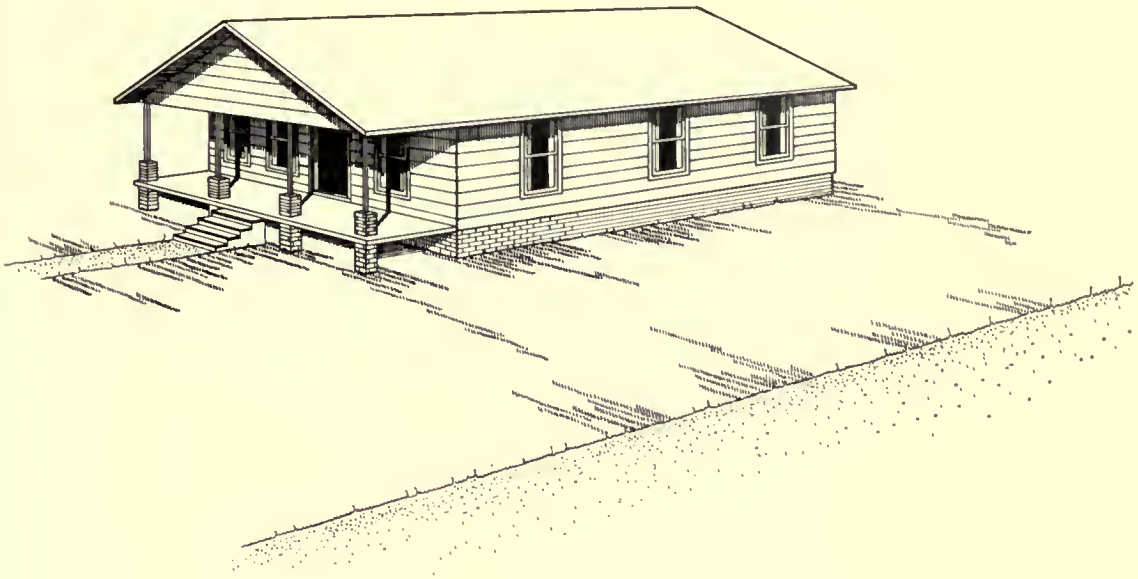

FLOOR PLAN

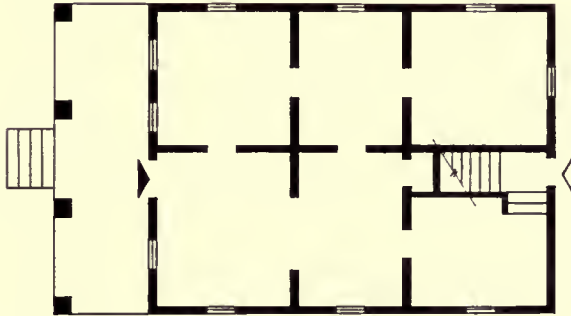

SITE PLAN

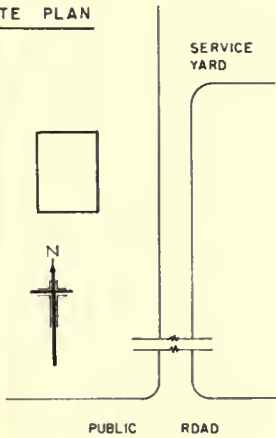

REVERSED FLOOR PLAN















UNIVERSITY OF ILLINOIS-URBANA

Q. 630.71L68  
BULLETIN, URBANA  
676-700 1961-1964

C001



3 0112 019528824