



This is a digital copy of a book that was preserved for generations on library shelves before it was carefully scanned by Google as part of a project to make the world's books discoverable online.

It has survived long enough for the copyright to expire and the book to enter the public domain. A public domain book is one that was never subject to copyright or whose legal copyright term has expired. Whether a book is in the public domain may vary country to country. Public domain books are our gateways to the past, representing a wealth of history, culture and knowledge that's often difficult to discover.

Marks, notations and other marginalia present in the original volume will appear in this file - a reminder of this book's long journey from the publisher to a library and finally to you.

Usage guidelines

Google is proud to partner with libraries to digitize public domain materials and make them widely accessible. Public domain books belong to the public and we are merely their custodians. Nevertheless, this work is expensive, so in order to keep providing this resource, we have taken steps to prevent abuse by commercial parties, including placing technical restrictions on automated querying.

We also ask that you:

- + *Make non-commercial use of the files* We designed Google Book Search for use by individuals, and we request that you use these files for personal, non-commercial purposes.
- + *Refrain from automated querying* Do not send automated queries of any sort to Google's system: If you are conducting research on machine translation, optical character recognition or other areas where access to a large amount of text is helpful, please contact us. We encourage the use of public domain materials for these purposes and may be able to help.
- + *Maintain attribution* The Google "watermark" you see on each file is essential for informing people about this project and helping them find additional materials through Google Book Search. Please do not remove it.
- + *Keep it legal* Whatever your use, remember that you are responsible for ensuring that what you are doing is legal. Do not assume that just because we believe a book is in the public domain for users in the United States, that the work is also in the public domain for users in other countries. Whether a book is still in copyright varies from country to country, and we can't offer guidance on whether any specific use of any specific book is allowed. Please do not assume that a book's appearance in Google Book Search means it can be used in any manner anywhere in the world. Copyright infringement liability can be quite severe.

About Google Book Search

Google's mission is to organize the world's information and to make it universally accessible and useful. Google Book Search helps readers discover the world's books while helping authors and publishers reach new audiences. You can search through the full text of this book on the web at <http://books.google.com/>

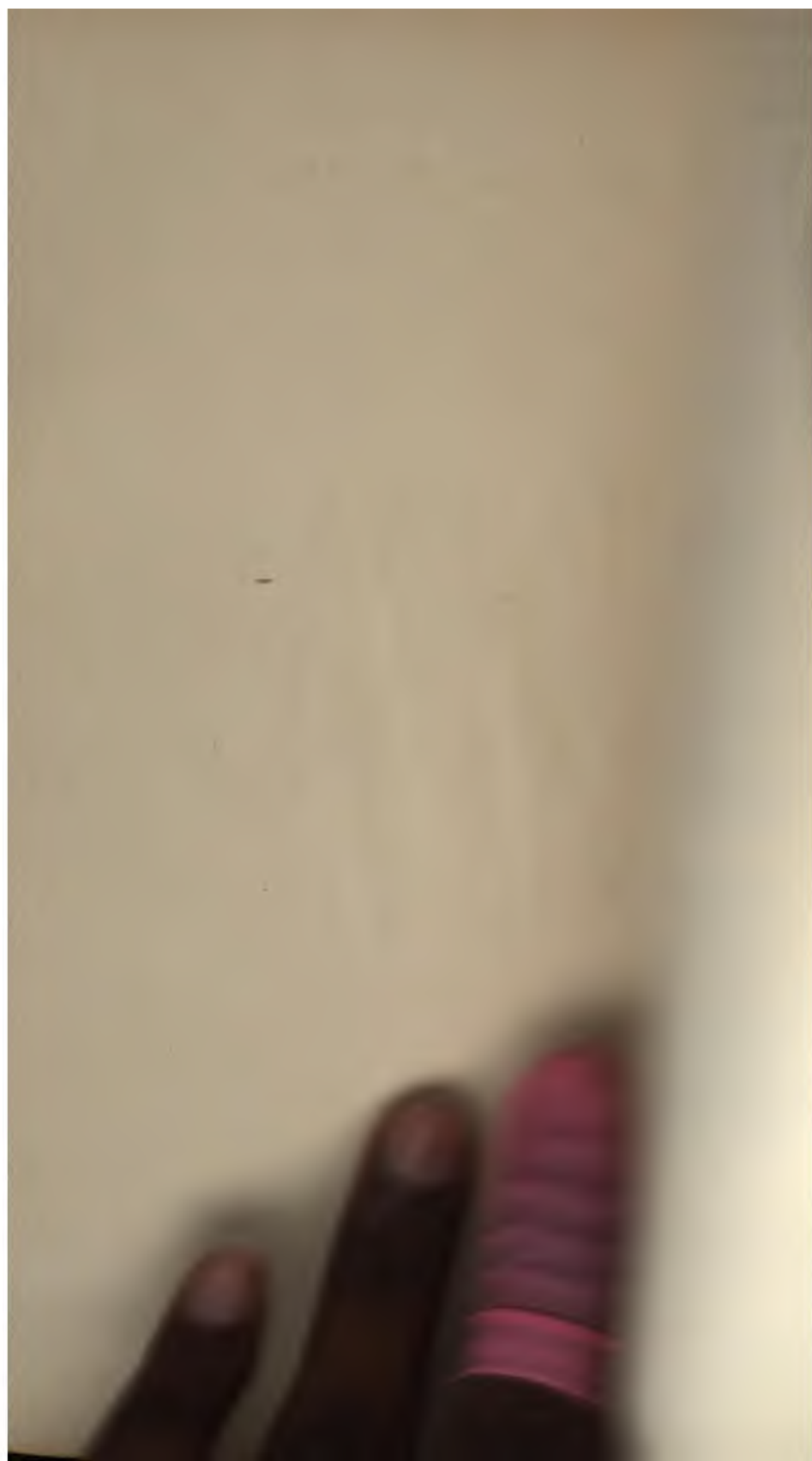

mission

EXPOSITION

**ELAND
GUS**



OMPANY



THE ELECTRIC RAILWAY TEST COMMISSION AND EXECUTIVE COMMITTEE.

W. E. Goldsborough
Jas. H. McGraw.
H. H. Norris.

W. J. Wilgus.
J. G. White.
Geo. F. McCulloch.

H. T. Plumb.
H. H. Vreeland
B. V. Swenson.



REPORT

OF THE

Electric Railway Test Commission

TO THE

PRESIDENT OF THE LOUISIANA PURCHASE EXPOSITION

MEMBERS OF THE COMMISSION :

J. G. WHITE, CHAIRMAN

GEO. F. McCULLOCH

H. H. VREELAND

JAMES H. McGRAW

W. J. WILGUS



NEW YORK
McGRAW PUBLISHING COMPANY

1908

REPORT EDITED BY
HENRY H. NORRIS, M.E. AND BERNARD V. SWENSON, E.E., M.E.

COPYRIGHTED, 1906,
BY THE
MCGRAW PUBLISHING COMPANY
NEW YORK



MS. 7. 4. 5. 2. 1. 0

HON. DAVID R. FRANCIS,

President, Louisiana Purchase Exposition.

DEAR SIR: The Electric Railway Test Commission has the honor to submit herewith an historical and chronological review of the work confided to its care.

The Commission wishes to express its appreciation of the hearty co-operation of the Chief of Electricity during all the stages of the work, and to heartily commend the efforts which have been put forth by its superintendents in successfully overcoming the many obstacles which arose during the conduct of the tests, and in the editing and arrangement of this Report.

The Commission also wishes to express its appreciation of the assistance rendered by the committees of engineers who helped to plan the scope of the work undertaken; of the results accomplished by the test corps, the United States Bureau of Standards, and others who aided directly in the tests; of the kindness of the manufacturing and other companies who contributed to the work by the loan of instruments, machinery, or otherwise; and of the financial assistance of those whose contributions made the work possible.

Very respectfully submitted,

THE ELECTRIC RAILWAY TEST COMMISSION.

J. G. WHITE, *Chairman.*

H. H. VREELAND, *Treasurer.*

JAMES H. MCGRAW, *Secretary.*

W. J. WILGUS.

GEO. F. McCULLOCH.

MEMBERS OF THE COMMISSION.

J. G. WHITE, President, J. G. White & Company, *Chairman*.
H. H. VREELAND, President, Metropolitan Railway Company, *Treasurer*.
JAMES H. MCGRAW, President, The McGraw Publishing Co., *Secretary*.
W. J. WILGUS, Vice-President, New York Central and Hudson River Railroad.
GEO. F. MCCULLOCH, President, Indiana Union Traction Co.

MEMBERS OF THE EXECUTIVE COMMITTEE.

W. E. GOLDSBOROUGH, Chief of the Department of Electricity, Louisiana Purchase Exposition, *Chairman*.
H. H. NORRIS, Assistant Professor of Electrical Engineering, Cornell University, *Superintendent*.
B. V. SWENSON, Assistant Professor of Electrical Engineering, University of Wisconsin, *Assistant Superintendent*.
H. T. PLUMB, Assistant Professor of Electrical Engineering, Purdue University, *Assistant Superintendent*.

MEMBERS OF THE ADVISORY COMMITTEE.

A. H. ARMSTRONG, General Electric Company.
CLARENCE RENSHAW, Westinghouse Electric and Manufacturing Company.
W. S. ARNOLD, Bullock Electric Manufacturing Company
W. N. SMITH, Westinghouse, Church, Kerr & Company.

MEMBERS OF THE ENGINEERING COMMITTEE ON TEST OF CITY AND SUBURBAN EQUIPMENTS.

M. G. STARRETT, Chief Engineer, New York City Railway Co.
D. F. CARVER, Chief Engineer, Public Service Corporation of New Jersey.
W. S. TWINING, Chief Engineer, Philadelphia Rapid Transit Company.

MEMBERS OF THE ENGINEERING COMMITTEE ON TEST OF INTERURBAN EQUIPMENTS.

A. L. DRUM, Assistant General Manager, Indiana Union Traction Co.
C. J. JONES, Chief Engineer, Elgin, Aurora & Chicago Railway.
C. A. ALDERMAN, Chief Engineer, Appleyard System, Springfield, Ohio.

MEMBERS OF THE ENGINEERING COMMITTEE ON TEST OF HEAVY TRACTION EQUIPMENTS.

F. J. SPRAGUE, Consulting Engineer, New York City.
B. J. ARNOLD, Consulting Engineer, New York City.
W. J. WILGUS, Vice-President, New York Central and Hudson River Railroad, New York City.
F. R. SLATER, Assistant Engineer to L. B. Stillwell, New York City.

MEMBERS OF THE ENGINEERING COMMITTEE ON NEW ELECTRIC RAILWAY SYSTEMS.

B. J. ARNOLD, Consulting Engineer, New York City.
P. M. LINCOLN, Electrical Engineer, with Westinghouse Electric and Manufacturing Company, Pittsburg, Pa.
W. B. POTTER, Electrical Engineer, with General Electric Company, Schenectady, N.Y.

CONTENTS.

PART I.

	PAGE
INTRODUCTION	1

PART II.

CHAPTER I.

SERVICE TESTS OF ELECTRIC CARS	35
--	----

CHAPTER II.

SERVICE TESTS OF A SINGLE-TRUCK CITY CAR	76
--	----

CHAPTER III.

SERVICE TESTS OF A DOUBLE-TRUCK CITY CAR	116
--	-----

CHAPTER IV.

SERVICE TESTS OF AN INTERURBAN CAR	145
--	-----

PART III.

CHAPTER V.

ACCELERATION TESTS OF A SINGLE-TRUCK CITY CAR	199
---	-----

CHAPTER VI.

ACCELERATION TESTS OF AN INTERURBAN CAR	227
---	-----

PART IV.

CHAPTER VII.

COMPRESSOR STATION TESTS OF A STORAGE AIR SYSTEM OF BRAKING	255
---	-----

CHAPTER VIII.

BRAKING TESTS ON A DOUBLE-TRUCK CITY CAR EQUIPPED WITH AIR BRAKES	292
--	-----

CHAPTER IX.

BRAKING TESTS ON AN INTERURBAN CAR EQUIPPED WITH AIR BRAKES	324
---	-----

CHAPTER X.

BRAKING TESTS ON A SINGLE-TRUCK CITY CAR EQUIPPED WITH MAG- NETIC BRAKES	338
---	-----

CONTENTS**PART V.****CHAPTER XI.**

	PAGE
TESTS OF A STORAGE BATTERY INDUSTRIAL LOCOMOTIVE	369

PART VI.**CHAPTER XII.**

ALTERNATING CURRENT LOSSES IN STEEL RAILS AND IN OTHER STEEL AND IRON SECTIONS.	389
--	------------

CHAPTER XIII.

ALTERNATING CURRENT LOSSES IN TRACK	432
--	------------

PART VII.**CHAPTER XIV.**

TRAIN RESISTANCE TESTS OF INTERURBAN CARS.	463
---	------------

CHAPTER XV.

THE TEST CAR "LOUISIANA"	488
---	------------

CHAPTER XVI.

AIR RESISTANCE TESTS	534
---------------------------------------	------------

APPENDIX A.

GENERAL DATA RELATING TO ELECTRIC CARS	577
---	------------

APPENDIX B.

ACKNOWLEDGMENTS	593
----------------------------------	------------

TESTS.

TEST

1. SERVICE TESTS ON A SINGLE-TRUCK CITY CAR.
Hand Brake.
2. SERVICE TESTS ON A SINGLE-TRUCK CITY CAR.
Magnetic Brake.
3. SERVICE TESTS ON A SINGLE-TRUCK CITY CAR.
Magnetic Brake.
4. SERVICE TESTS ON A SINGLE-TRUCK CITY CAR.
Hand Brake.
5. SERVICE TESTS ON A SINGLE-TRUCK CITY CAR.
Magnetic Brake.
6. SERVICE TESTS ON A DOUBLE-TRUCK CITY CAR.
Independent Motor Compressor. Wet Track.
7. SERVICE TESTS ON A DOUBLE-TRUCK CITY CAR.
Independent Motor Compressor. Dry Track.
8. SERVICE TESTS ON A DOUBLE-TRUCK CITY CAR.
Storage Air System. Dry Track.
9. SERVICE TESTS ON AN INTERURBAN CAR.
Run from Muncie City Limits to Indianapolis: Indianapolis to Anderson. Dry Track. No Trailer.
10. SERVICE TESTS ON AN INTERURBAN CAR.
Run from Anderson to Muncie: Muncie to Indianapolis: Indianapolis to Anderson. Dry Track. No Trailer.
11. SERVICE TESTS ON AN INTERURBAN CAR.
Run from Muncie to Indianapolis and return to Muncie. Dry Track. One Trailer.
12. SERVICE TESTS ON AN INTERURBAN CAR.
Run from Muncie to Indianapolis and return to Muncie. Dry Track. No Trailer.
13. ACCELERATION TESTS ON A SINGLE-TRUCK CITY CAR.
Controller Turned to Full Parallel in 40 feet.
14. ACCELERATION TESTS ON A SINGLE-TRUCK CITY CAR.
Controller Turned to Full Parallel in 70 feet.
15. ACCELERATION TESTS ON A SINGLE-TRUCK CITY CAR.
Controller Turned to Full Parallel in 100 feet.
16. ACCELERATION TESTS ON A SINGLE-TRUCK CITY CAR.
Controller Turned to Full Parallel in 150 feet.
17. ACCELERATION TESTS ON A SINGLE-TRUCK CITY CAR.
Controller Turned to Full Parallel in 200 feet.

TEST

18. **ACCELERATION TESTS ON AN INTERURBAN CAR.**
Controller to Series Position at once. Car at Rest. Final Contact in 9.1 Seconds.
19. **ACCELERATION TESTS ON AN INTERURBAN CAR.**
Controller to Parallel Position at once. Car at Rest. Final Contact in 20.26 Seconds.
20. **COMPRESSOR STATION TESTS OF A STORAGE AIR SYSTEM OF BRAKING.**
Length of Test, 24 hours.
21. **COMPRESSOR STATION TESTS OF A STORAGE AIR SYSTEM OF BRAKING.**
Length of Test, 2 hours, 35 minutes.
22. **BRAKING TESTS ON DOUBLE-TRUCK CITY CARS EQUIPPED WITH AIR BRAKES.**
Storage System, 51 Cars.
23. **BRAKING TESTS ON A DOUBLE-TRUCK CITY CAR EQUIPPED WITH AIR BRAKES.**
Storage System.
24. **BRAKING TESTS ON A DOUBLE-TRUCK CITY CAR EQUIPPED WITH AIR BRAKES.**
Motor. Compressor System. Wet Track.
25. **BRAKING TESTS ON A DOUBLE-TRUCK CITY CAR EQUIPPED WITH AIR BRAKES.**
Motor. Compressor System. Dry Track.
26. **STAND TESTS OF MOTOR-COMPRESSOR.**
Against Constant Pressure, 93 lbs.
27. **STAND TESTS OF MOTOR-COMPRESSOR.**
Against Pressure from 43.5 to 50.8 pounds.
28. **STAND TESTS OF MOTOR-COMPRESSOR.**
Against Pressure from 43.5 to 60.6 pounds.
29. **BRAKING TESTS ON AN INTERURBAN CAR EQUIPPED WITH AIR BRAKES.**
Air Pressure, 20 pounds to square inch.
30. **BRAKING TESTS ON AN INTERURBAN CAR EQUIPPED WITH AIR BRAKES.**
Air Pressure, 20 pounds to square inch.
31. **BRAKING TESTS ON AN INTERURBAN CAR EQUIPPED WITH AIR BRAKES.**
Air Pressure, 30 pounds to square inch.
32. **BRAKING TESTS ON AN INTERURBAN CAR EQUIPPED WITH AIR BRAKES.**
Air Pressure, 40 pounds to square inch.
33. **BRAKING TESTS ON AN INTERURBAN CAR EQUIPPED WITH AIR BRAKES.**
Air Pressure, 40 pounds to square inch.
34. **BRAKING TESTS ON A SINGLE-TRUCK CITY CAR EQUIPPED WITH MAGNETIC BRAKES.**
35. **TESTS OF A STORAGE-BATTERY INDUSTRIAL LOCOMOTIVE.**
Pulling Against Fixed Anchor.
36. **TESTS OF A STORAGE-BATTERY INDUSTRIAL LOCOMOTIVE.**
Running Without Trailers.
37. **TESTS OF A STORAGE-BATTERY INDUSTRIAL LOCOMOTIVE.**
Locomotive Hauling Trailers.

- TEST**
38. ALTERNATING CURRENT LOSSES IN STEEL RAILS AND IN OTHER STEEL AND IRON SECTIONS.
Section of A.S.C.E. Standard T-Rail, 26.07 feet long, 56 pounds per yard.
 39. ALTERNATING CURRENT LOSSES IN STEEL RAILS AND IN OTHER STEEL AND IRON SECTIONS.
Section of A.S.C.E. Standard T-Rail, 27.83 feet long, 80 pounds per yard.
 40. ALTERNATING CURRENT LOSSES IN STEEL RAILS AND IN OTHER STEEL AND IRON SECTIONS.
Square Steel Section, 8.56 feet long, 64.15 pounds per yard.
 41. ALTERNATING CURRENT LOSSES IN STEEL RAILS AND IN OTHER STEEL AND IRON SECTIONS.
Round Section, 3 inches in diameter, 8.16 feet long, 72 pounds per yard.
 42. ALTERNATING CURRENT LOSSES IN STEEL RAILS AND IN OTHER STEEL AND IRON SECTIONS.
Round Steel Section, 2.5 inches in diameter, 7.63 feet long, 50.6 pounds per yard.
 43. ALTERNATING CURRENT LOSSES IN STEEL RAILS AND IN OTHER STEEL AND IRON SECTIONS.
Tool Steel, Square Section, diameter 2.02 inches, 6.95 feet long, 41.3 pounds per yard.
 44. ALTERNATING CURRENT LOSSES IN STEEL RAILS AND IN OTHER STEEL AND IRON SECTIONS.
Wrought Iron Gas Pipe, inside diameter, 3.01 inches, outside diameter, 3.51 inches, 18.43 feet long, 22.72 pounds per yard.
 45. ALTERNATING CURRENT LOSSES IN TRACK.
Direct Current Resistance.
 46. ALTERNATING CURRENT LOSSES IN TRACK.
Double Track and Double Trolley.
 47. ALTERNATING CURRENT LOSSES IN TRACK.
Double Track Alone.
 48. ALTERNATING CURRENT LOSSES IN TRACK.
Single Track and Single Trolley.
 49. ALTERNATING CURRENT LOSSES IN TRACK.
Single Track Alone.
 50. ALTERNATING CURRENT LOSSES IN TRACK.
Single Rail and Single Trolley.
 51. ALTERNATING CURRENT LOSSES IN TRACK.
Single Rail Alone.
 52. TRAIN RESISTANCE TESTS OF INTERURBAN CARS.
Resistance Tests with Car No. 284, between Carmel and Noblesville, Ind.
 53. TRAIN RESISTANCE TESTS OF INTERURBAN CARS.
Resistance Data Selected from Service Tests of Chapter IV.
 54. TRAIN RESISTANCE TESTS OF INTERURBAN CARS.
Resistance Runs with Car "Louisiana" with Parabolic-Wedge Shaped Movable Vestibule, Standard Fixed Vestibule in Position.

TEST

55. **TRAIN RESISTANCE TESTS OF INTERURBAN CARS.**
Resistance Runs with Car "Louisiana" with Parabolic Shaped Movable Vestibule, Standard Fixed Vestibule in Position.
56. **TRAIN RESISTANCE TESTS OF INTERURBAN CARS.**
Resistance Runs with Car "Louisiana" with Flat Movable Vestibule, Standard Fixed Vestibule in Position.
57. **TRAIN RESISTANCE TESTS OF INTERURBAN CARS.**
Resistance Runs with Car "Louisiana," Standard Movable Vestibule in Position. No Rear Vestibule.
58. **AIR RESISTANCE TESTS.**
Car "Louisiana" with Parabolic-Wedge Vestibule.
59. **AIR RESISTANCE TESTS.**
Car "Louisiana" with Parabola Vestibule.
60. **AIR RESISTANCE TESTS.**
Car "Louisiana" with Flat Vestibule.
61. **AIR RESISTANCE TESTS.**
Car "Louisiana" with Standard Vestibule.

TABLES.

TABLE	PAGE
I. Synopsis of Results of Service Tests on Single-Truck City Car	77
II. Air and Motor Temperature in Single-Truck Car, Test No. 1	111
III. Air and Motor Temperature in Single-Truck Car, Test No. 2	112
IV. Air and Motor Temperature in Single-Truck Car, Test No. 3	113
V. Air and Motor Temperature in Single-Truck Car, Test No. 4	114
VI. Air and Motor Temperature in Single-Truck Car, Test No. 5	115
VII. Synopsis of Results, Tests 6-8	116
VIII. Results of Test No. 6	134
IX. Results of Test No. 7	136
X. Results of Test No. 8	138
XI. Synopsis of Results, Tests 9-12	145
XII. Running Schedule Muncie-Indianapolis Division	154
XIII. Air Temperature and Wind Data	155
XIV. Intermediate Results of Test No. 9	168
XV. Intermediate Results of Test No. 9	168
XVI. Intermediate Results of Test No. 9, Summary of Tables XIV and XV	168
XVII. Intermediate Results of Test No. 10	169
XVIII. Intermediate Results of Test No. 10	169
XIX. Intermediate Results of Test No. 10, Summary of Tables XVII and XVIII	169
XX. Intermediate Results of Test No. 11	170
XXI. Intermediate Results of Test No. 11	170
XXII. Intermediate Results of Test No. 11, Summary of Tables XX and XXI	170
XXIII. Intermediate Results of Test No. 12	171
XXIV. Intermediate Results of Test No. 12	171
XXV. Intermediate Results of Test No. 12, Summary of Tables XXIII and XXIV	171
XXVI. Result of Test No. 9	177
XXVII. Result of Test No. 10	180
XXVIII. Result of Test No. 11	182
XXIX. Result of Test No. 12	184
XXX. Synopsis of Results, Acceleration	199
XXXI. Synopsis of Results, Tests 18 and 19	228
XXXII. Synopsis of Results, Tests 20 and 21	256
XXXIII. Average Air Temperatures by Three-hour Periods	280
XXXIV. Average Temperatures of Cooling Water by Three-hour Periods	280

TABLE	PAGE
XXXV. General Summary by Three-hour Periods	281
XXXVI. General Results of Twenty-four-hour Run	281
XXXVII. Showing Average Temperatures for Test No. 21 Com- pared with those for a Similar Period in Test No. 20	282
XXXVIII. General Summary of 2.35-Hour Run with City Water, Arranged for Comparison with Twenty-four-hour Run,	283
XXXIX. General Comparison to Show Relative Merits of the two Systems of Cooling the Air During Compression	283
XL. Synopsis of Results, Tests 22-25	293
XLI. Synopsis of Results, Tests 26-28	294
XLII. Test No. 22, General Summary of Results	298
XLIII. Results of Test No. 22, Compression Data	299
XLIV. Results of Test No. 22, Stop Data	300
XLV. Air Taken by Cars	300
XLVI. Test No. 23, General Summary of Results	303
XLVII. Air Consumption of Car 2600	304
XLVIII. Tests Nos. 24 and 25, General Summary of Results	312
XLIX. Air Consumption of Car 2600	313
L. Air Consumption of Car 2600	313
LI. Tests Nos. 26, 27, and 28, General Summary of Results	318
LII. Synopsis of Results, Tests Nos. 29, 30, 31, 32, 33	324
LIII. Synopsis of Results	338
LIV. Braking Tests of Single Truck City Car Time, Speed and Distance Data	352
LV. Braking Tests of Single-Truck City Car Electrical Data	353
LVI. Synopsis of Results, Industrial Locomotive Tests	369
LVII. Test No. 38	402
LVIII. Test No. 39	408
LIX. A. C. Losses in Square Section	416
LX. A. C. Losses in Round Section	418
LXI. A. C. Losses in Round Section	420
LXII. A. C. Losses in Square Section	422
LXIII. A. C. Losses in Pipe Section	424
LXIV. Direct Current Resistance of Track	446
LXV. Synopsis of Results of Train Resistance Tests	464
LXVI. Test No. 52, Resistance Runs with Car "284" (on Test Track)	477
LXVII. Test No. 53, Resistance Runs with Car "284"	478
LXVIII. Test No. 54, Parabolic-Wedge Front Vestibule, Standard Rear Vestibule	481
LXIX. Test No. 55, Parabolic Front Vestibule, Standard Rear Vestibule	482
LXX. Test No. 56, Flat Front Vestibule, Standard Rear Ves- tibule	483
LXXI. Test No. 57, Standard Front Vestibule, No Rear Vesti- bule	484

TABLES

xiii

TABLE	PAGE
LXXII. Table of Grades between Siding 105 and Siding 109 . . .	495
LXXIII. Synopsis of Results of Air Resistance Tests	534
LXXIV. Data Showing Direction and Velocity of Wind	535
LXXV. Schedule of Runs for Preliminary Tests	537
LXXVI. Schedule of Runs with Parabolic-Wedge Vestibule . . .	538
LXXVII. Schedule of Runs, with Parabolic Vestibule	542
LXXVIII. Schedule of Runs with Flat Vestibule	543
LXXIX. Schedule of Runs with Standard Vestibule	545
LXXX. Test No. 58, Air Pressure on Car "Louisiana" on Test Track	558
LXXXI. Test No. 59, Air Pressure Tests on Car "Louisiana" on Test Track	559
LXXXII. Test No. 60, Air Pressure on Car "Louisiana" on Test Track	560
LXXXIII. Test No. 61, Air Pressure Tests on Car "Louisiana" on Test Track	561
LXXXIV. Car Body Resistance Data	562
LXXXV. Power Absorbed by Vestibules	563
LXXXVI. General Results of Air Resistance Tests	569
LXXXVII. Power Absorbed by Vestibules, Expressed in Horse Power	569
LXXXVIII. Power Absorbed by Front and Rear Vestibules in Kilowatts	570
LXXXIX. Relative Power Required to Force Front Vestibules only, through the Air, at Various Speeds	570
XC. Power Absorbed by Parabolic-Wedge Front Vestibule and Parabolic Rear Vestibule in Overcoming Air Resistance, as Compared with that Absorbed by Standard Front and Rear Vestibules	571
XCI. Power Absorbed by Front and Rear Vestibules and Car Body, Kilowatts	571
XCII. Total Estimated Power Absorbed in Overcoming Air Resistance by an Interurban Car Equipped with Various Vestibules	572
XCIII. Classification of Electric Cars	578
XCIV. Data for Light City Service (Single Truck)	582
XCV. Data for Heavy City Service (Double Truck)	582
XCVI. Data for Heavy City Service, Continued. (Double Truck)	584
XCVII. Data for Light Interurban Service (Double Truck) . . .	585
XCVIII. Data for Heavy Interurban Service (Double Truck, 4 Motors)	586
XCIX. Average Data for Light City Service	587
C. Average Data for Heavy City Service	588
CI. Average Data for Light Interurban Service	588
CII. Average Data for Heavy Interurban Service	589



PART I.
INTRODUCTION.

MEMORANDUM BY PROFESSOR GOLDSBOROUGH.

At a meeting of the Commission held on December 17, 1903, Professor Goldsborough presented the following draft of suggested plans for tests which might be satisfactorily taken up by the Commission.

MEMORANDUM FOR THE ELECTRIC RAILWAY TEST COMMISSION, UNIVERSAL EXPOSITION, ST. LOUIS, 1904.

I HAVE the honor to present, for the consideration of the Commission, a statement of the provision which has thus far been made for the test of electric railway apparatus at the Louisiana Purchase Exposition, and I have taken the liberty to suggest certain topics which, I hope, will be found worthy of consideration by the Commission.

It is the desire of the Exposition Management that, if possible, adequate arrangements be perfected for the conduct at the Exposition of a most comprehensive series of tests upon electric railway equipment, in order that, thereby, a large amount of important scientific and engineering information may be compiled for the benefit and use of designers and engineers in meeting the great engineering problems now arising, which involve enormous expenditures and deal almost exclusively with the problem of electric railway construction.

The Exposition Company has found it possible to provide adequate space in the Electricity Building for the installation of all systems which will show modern methods for the operation and control of electric cars and trains. Exhibitors of such sets will be requested to so arrange their installations as to make them available for test in position in the building.

On the grounds the Exposition Company has provided special tracks having an almost level grade and well ballasted, for the operation and test of such complete electric railway car and locomotive equipments as shall be offered. These special tracks consist of one section, fourteen hundred feet in length, and a second section, two thousand feet in length, the two sections being parallel. In addition, terminal facilities have been arranged in a prominent location, capable of holding from twenty to twenty-five fully equipped cars.

The site of the special tracks is parallel with the Transportation and Varied Industries buildings, and between these buildings and Lindell Boulevard, which is the southern boundary of the Pike. The terminal tracks lie between the Varied Industries and Transportation buildings,

and at right angles to the test tracks. It is believed that these outdoor tracks will afford ample space for very comprehensive tests upon all present types of electrically equipped cars and locomotives, including the following classes:

Equipments Operated from a Central Station.

- (a) Cars equipped for city service.
- (b) Cars equipped for interurban service.
- (c) Industrial electric locomotives.
- (d) Mining locomotives.
- (e) Locomotives for steam railway service conditions.

Equipments Operated by Stored Power.

- (a) Cars equipped for city service.
- (b) Industrial locomotives.
- (c) Mining locomotives.
- (d) Locomotives for steam railway service conditions.
- (e) Heavy tram service, electric automobiles.
- (f) Heavy electric trucks.

The character to be given the tests made upon the various electrical equipments submitted may, it is thought, be divided as follows:

Tests on Apparatus in Electricity Building.

- (a) Tests on electric railway motor equipments under constant load to determine rate of heating during continuous operation.
- (b) Tests on electric railway motor equipments to determine efficiency of such motors under different fixed conditions of operation.
- (c) Tests on electric railway motor equipment for the purpose of determining their torque curves and accelerating power.
- (d) Tests of hand, automatic, and multiple control systems to determine, by repeated tests, the relative economy, certainty, and regularity of starting motor car equipments under fixed loads.

Tests of Electrical Railway Equipments on Experimental Track.

- (a) Acceleration tests on single cars and multiple equipped trains.
- (b) Braking tests on single cars and multiple equipped trains.
- (c) Coasting tests on single cars and multiple equipped trains.
- (d) Motor heating tests on single cars and multiple equipped trains.
- (e) Acceleration tests on locomotives and locomotive trains.
- (f) Braking tests on locomotives and locomotive trains.
- (g) Coasting tests on locomotives and locomotive trains.
- (h) Motor heating tests on locomotives and locomotive trains.
- (i) Tests to determine car and train friction.

The great value of accumulating comprehensive information covering all types of standard railway apparatus at this time cannot be overestimated, and eminent authorities can be cited to show that the information at present in the hands of electrical engineers is, to a great extent, incomplete and unequal to the present demands of our profession.

That the test tracks are adequate for the tests outlined above is assured when it is remembered that, for a given temperature rise, the capacity in tons per motor is practically a fixed amount and independent of the number of stops per mile. The number of stops made by an electric car will vary from a maximum of fifteen stops per mile in city practice to a minimum of about one stop in five miles in local interurban practice. Five stops per mile is a very frequent figure even in interurban work, whereas the test track facilities admit of a rate of operating equivalent to five stops in two miles.

The tests for determining the heating of electric railway motors in service under different conditions of gearing and schedule can be made by operating the car continually over a given length of track as a shuttle-train first in one direction and then in the reverse direction. In this way conditions can be kept perfectly uniform and wind resistance to a great extent eliminated. The effect of passengers can be obtained by a dead-weight load upon the car, and variation in the behavior of the car under light and heavy loading investigated.

The importance of these tests will be better appreciated when it is remembered that only by an elaborate series of temperature runs made upon an experimental track can the degrees rise per watt lost in different parts of a motor be accurately determined. Service capacity curves for different conditions of service are, therefore, not absolutely correct unless the thermal capacity curves be obtained from actual tests giving the same train cycle as that over which the equipment is designed to be operated.

These tests are of special importance in relation to the light which they will throw upon the problem of determining the standard factory tests to be applied in the rating of electric railway motors. The relation between the commercial one-hour rating of a railway motor and its service capacity performance is very difficult to express. In fact it is almost impossible to compare two motors differing essentially in their mechanical design under present conditions, as the stand test of a motor has no direct bearing on its service performance with its different distribution of losses and better facilities for ventilation.

By carrying on a series of exhaustive tests on many individual motor equipments, it becomes possible to generalize with a fair degree of accuracy, and to evolve curves of real value to operating engineers.

The matter of the importance of wind resistance tests should not be

overlooked. Data now at hand have been developed largely through tests made upon steam railroads. No conclusive data are at hand regarding the effect of differently shaped car-ends on single or multiple car operation. When such data become available, it will be possible to much more accurately adapt railway car and train equipments to economic service on the roads for which they are designed.

If the general matter of tests on electric railway equipments has an importance sufficient to warrant such action, it may prove advisable for the Commission to enlist the co-operation of the American Street Railway Association and the American Railway Mechanical and Electrical Association, and the appointment by these associations of suitable expert committees to investigate and report upon a definite schedule of tests for all the electric railway equipments that may be submitted. To such committee or committees of experts, the matter of the introduction of alternating-current power in the operation of electric railways can, with advantage, be commended for special consideration, in order that this important and now developing branch of electric railway service shall not be overlooked, and an early opportunity of securing important information relative thereto be permitted to pass.

In carrying out these tests, the Exposition Company, and particularly the Department of Electricity, will provide every facility possible. In regard to the matter of appliances for the standardization of instruments used in connection with the tests, I desire to make the announcement that the National Bureau of Standards will erect in the Palace of Electricity a laboratory fully equipped with every modern appliance needed for the most accurate and scientific standardization of all types and classes of electrical instruments.

The importance of this work would seem to warrant the inference that important operating and manufacturing companies engaged in electrical railroading will find it worth while to co-operate to the extent of defraying expenses thereof not otherwise provided for.

Respectfully submitted,

W. E. GOLDSBOROUGH.

CO-OPERATION WITH THE AMERICAN STREET RAILWAY ASSOCIATION.

At the second meeting of the Commission, held January 27, 1904, a committee was appointed to draft a communication to the American Street Railway Association. The following letter

was prepared in order to acquaint the Association with the purposes of the Commission and to obtain its co-operation. This letter was accompanied by an abstract of Professor Goldsborough's memorandum.

NEW YORK, *February 1, 1904.*

EXECUTIVE COMMITTEE,

AMERICAN STREET RAILWAY ASSOCIATION.

GENTLEMEN:—By unanimous vote of the Electric Railway Test Commission of the Universal Exposition, St. Louis, 1904, I have been requested to submit to you the enclosed memorandum which details in brief the series of tests which the Commission hope will be successfully carried out on electric railway appliances and equipments.

That this work may be made as valuable as possible to electric railway interests the Commission invites the co-operation of the American Street Railway Association in carrying the work to a successful conclusion.

It has been suggested that the membership of the American Street Railway Association may profitably see fit to delegate certain engineers to be in attendance upon the tests and to co-operate in the making of records and supervising of experimental details. It is proposed that the tests shall be inaugurated on or about the first of July, 1904, to continue during the remainder of the Exposition term.

The way seems open to make the work now in hand of permanent and far-reaching value in its effect upon economic operation of electric railway properties.

Very respectfully,

J. G. WHITE, *Chairman.*

JAMES H. MCGRAW, *Secretary.*

The matter was presented to the Executive Committee of the Association on February 29, by Mr. Vreeland, who reported that his suggestions were heartily received. The following quotation from the minutes of the Executive Committee indicates the cordial feeling which has existed between the Association and the Commission.

The following communication in relation to tests of street railway equipment and appliances, and other electrical apparatus, to be made during the World's Fair at St. Louis, was read.

(Then follows Professor Goldsborough's memorandum as on page 2.)

Mr. Vreeland then outlined the work which it is proposed to perform in St. Louis in connection with the tests in question, and suggested that

the members of the Association should appoint engineers to co-operate with those in charge of the tests so as to secure results which will be valuable both from a theoretical and a practical standpoint.

Mr. Hutchins moved that the President and Secretary be authorized to communicate with the members of the Association urging them to co-operate as far as practicable in the tests above referred to; it being the desire of the Executive Committee that one or more engineers representing members of the Association should be present during the tests to lend such assistance as may be possible; that the attendance of the engineers be arranged for, so that two of them will be present at all times, arrangements being made in advance to this effect, it being the desire of the Executive Committee that the members shall co-operate in this matter to the fullest possible extent.

Motion carried.

ANNOUNCEMENT OF PLANS OF THE COMMISSION.

THE following outline of the plans of the Commission was prepared and printed in circular form for distribution among the individuals and companies interested in electric railway work.

OUTLINE OF THE PLANS OF THE ELECTRIC RAILWAY TEST COMMISSION, UNIVERSAL EXPOSITION, ST. LOUIS, 1904.

One of the most important features of the Louisiana Purchase Exposition to railway men, and certainly one of great permanent value, will be the results secured by the Electric Railway Test Commission.

The street railway industry of the United States comprises over one thousand companies owning and operating over 26,000 miles of single track, upon which are transported over five billion passengers per year by the use of over 71,000 cars. The aggregate mileage-run by cars exceeds one billion miles. More than one and one-quarter million horse power are involved, and in money nearly three billion dollars.

The authorities of the World's Fair, realizing the importance of this industry to our civilization and future development, have provided for the bringing together of all the types of machinery and appliances that enter into the construction and equipment of electric railroads, and, in addition to this, have offered facilities for the testing of this class of apparatus that have never before been available for such a purpose in the history of the development of electric traction.

The authorities of the Exposition thereupon appointed an Electric Railway Test Commission for the purpose of making elaborate and

accurate tests on electric railway apparatus, and to take every advantage of the facilities thus placed at their disposal. It is the intention of the Commission to test not only the electric railway equipments of standard types, but systems and apparatus now being developed, and to have demonstrated the utility of electric railway signal apparatus and safety devices of every form.

The exhibits in the Palace of Electricity will comprise principally motors, controllers, switchboard and auxiliary apparatus. Outside of this building, there are two parallel tracks 1,400 feet in length, and two parallel tracks 2,000 feet in length, upon which speed, acceleration, braking, and efficiency tests can be conducted. All the electric railway features, even if located in or about the Transportation Building, are to be, as is eminently proper, under the direction of the electrical department, and not under the steam railroad department of transportation as has been the case in previous expositions.

Through the liberality of the Indiana Union Traction Company, the Commission has obtained unusual opportunities for making high speed and heavy traction tests. The track placed at their disposal by the Indiana Company is eight miles in length, well ballasted, straight, and practically level throughout its entire length.

The Executive Committee of the American Street Railway Association, at a meeting held in New York on February 29, 1904, promised the Commission their hearty co-operation in the execution of their work. The interest and co-operation of the leading manufacturers of electric railway apparatus have also been secured. As an illustration of this, three new single-phase, alternating-current motors have been offered the Commission for testing purposes. Special tests will be arranged for them, on account of alternating-current railway apparatus being one of the newest developments in railway engineering practice, and therefore of unusual interest.

In order that the plans of the Commission might be executed under the most favorable conditions, the work has been divided into four main branches, and special committees of engineers, who are specialists in the several branches of electric railway work, have prepared schedules of the tests which will be made of the equipment offered in each class. These special committees on the scope of the tests are:

Engineering Committee on Test of City and Suburban Equipments.

M. G. Starrett, Chief Engineer, New York City Railway Company.

D. F. Carver, Chief Engineer, Public Service Corporation of New Jersey.

W. S. Twining, Chief Engineer, Philadelphia Rapid Transit Company.



THE ADVISORY AND ENGINEERING COMMITTEES.

A. H. Armstrong.
D. F. Carver.
B. J. Arnold.
Charles Jones.
Clarence Renshaw.

M. G. Starrett.
P. M. Lincoln.
Frank J. Sprague.
A. L. Drum.
W. S. Twining.

W. S. Arnold.
C. A. Alderman.
W. B. Potter.
F. R. Slater.
W. N. Smith.

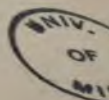



Engineering Committee on Test of Interurban Equipments.

- A. L. Drum, Assistant General Manager, Indiana Union Traction Company.
Charles Jones, Chief Engineer, Elgin, Aurora & Chicago Railway.
C. A. Alderman, Chief Engineer, Appleyard System, Springfield, Ohio.

Engineering Committee on Test of Heavy Traction Equipments.

- F. J. Sprague, Consulting Engineer, New York City.
B. J. Arnold, Consulting Engineer, New York City.
W. J. Wilgus, Vice-president, New York Central & Hudson River Railroad, New York City.
F. R. Slater, Assistant Engineer to L. B. Stillwell, New York City.

Engineering Committee on New Electric Railway Systems.

- B. J. Arnold, Consulting Engineer, New York City.
Paul M. Lincoln, Electrical Engineer with Westinghouse Electric & Manufacturing Company, Pittsburg, Pa.
W. B. Potter, Electrical Engineer with General Electric Company, Schenectady, N. Y.

The information available at the present time for those interested in the construction and operation of electric railways is the result of numerous laboratory and shop tests that have been made both by manufacturing and operating companies, and, while these data are of value within the limits of precision of measurement, the tests do not afford a proper basis of comparison as between apparatus and equipments from various manufacturers, owing to the widely differing conditions under which the tests have been made.

It is therefore the belief of engineers and railway operators that the results of a properly conducted series of tests, under absolutely uniform conditions, will be invaluable. These results will be systematically arranged and published in book form, and the volume will undoubtedly be a valuable contribution, not only to the electric railway profession, but to engineering literature as well.

Electric Railway Test Commission.

- J. G. White, *Chairman.*
H. H. Vreeland.
W. J. Wilgus.
James H. McGraw.
George F. McCulloch.

Commission Headquarters, 43-49 Exchange Place, New York.

REPORTS OF THE ENGINEERING COMMITTEES

The four engineering committees submitted reports, which, taken collectively, form an outline of the present status of the electric railway and also indicate the various directions in which the art is progressing.

REPORT OF COMMITTEE ON TEST OF CITY AND SUBURBAN
ELECTRIC RAILWAY EQUIPMENTS.

March 9, 1904.

ELECTRIC RAILWAY TEST COMMISSION,
MR. J. G. WHITE, *Chairman*,
Nos. 43-49 Exchange, New York.

GENTLEMEN: Your Engineering Committee on Tests of City and Suburban Equipment, realizing that the field of research assigned to it is somewhat limited and has been covered time and again by engineers, manufacturers of equipments, and users of equipments, nevertheless believes that such tests as have been made do not afford a proper basis of comparison as between motor equipments from different manufacturers, owing to the widely differing conditions under which such tests have been made.

We believe that the results of a proper series of tests conducted under the authority of your Commission and under absolutely uniform conditions will be of great value to engineers and users of motor equipments generally, as furnishing a reliable basis of comparison between the equipments tested.

We, therefore, wish to recommend in a general way that all tests undertaken be made as complete as possible, and that particular attention be given to details to the end that the greatest possible uniformity of conditions may be obtained, insuring the absolute reliability of results of the tests.

Specifically we would recommend that as far as possible tests be conducted along the following lines:

Tests on Apparatus in Electricity Building.

1. Tests of various kinds of electric railway motor equipments under constant load, regulated by brake, to determine rate of heating —
 - (a) Of the armatures.
 - (b) Of the field coils.
2. Tests of electric railway motor equipments, of the various kinds, to determine the motor efficiency under different fixed conditions of operation, including varying number of stops per mile.

3. Tests on motor equipments to determine their torque curves and accelerating power.
4. Tests on electric railway motor equipments under constant loads to determine the rheostatic losses corresponding to various lengths of time consumed in application of full current strength.
5. Tests on electric railway motor equipments to determine at what loads, speeds, and frequency of stops it becomes economical to adopt automatic control in place of hand control for single cars.
6. Tests on hand, automatic, and multiple control systems to determine their relative economy, certainty, and regularity of starting motor car equipments under fixed conditions of load and track.
7. Tests of electric railway motor equipments to determine *safe* load during continuous operation, as compared with *rated capacity* of motors.

Tests of Electric Railway Equipments on Experimental Track.

8. Tests to determine the relative value of two-motor and four-motor car equipments:
 - (a) As to power consumption:
 - 1st — With fixed load.
 - 2d — With varying load.
 - (b) As to acceleration:
 - 1st — With fixed load.
 - 2d — With varying load.
9. Tests to determine the proper method of mounting a *two*-motor equipment on an eight-wheel two-truck car, viz.: On which two of the four axles shall the motors be mounted?
10. Acceleration tests on single cars and on motor car and trailer, showing:
 - (a) Rate of acceleration:
 - 1st — Hand control.
 - 2d — Automatic control.
 - (b) Power used:
 - 1st — Hand control.
 - 2d — Automatic control.
11. Comparative tests on different types of power brakes, both electrical and mechanical, in respect to:
 - (a) Efficiency.
 - (b) Economy.
12. Braking tests on single car, and on motor car with trailer, under varying conditions:
 - (a) With hand brakes.
 - (b) With power brakes.

13. Tests on single car equipments to determine motor and truck friction at different speeds.

In the matter of equipments operated by stored power, your Committee understands that it is limited in its considerations to such equipments as are electrically operated. This excludes all systems of stored power, excepting those operated from storage batteries.

The tests heretofore recommended for electric motors are all applicable to electric motor equipments operated from storage batteries, as also are the controller tests.

As to the batteries themselves we would recommend the following tests:

14. Tests to determine the efficiency of batteries under —

- (a) Maximum load.
- (b) Average load.
- (c) Varying load.

15. Tests to determine life of batteries under —

- (a) Average conditions of service.
- (b) Adverse conditions of service.

Your Committee believes that the tests above recommended cover the more important phases of the subject, and that the results obtained, if the tests are carried out, will be of undoubted value to the engineers and all users of electric railway apparatus.

Respectfully submitted,

M. G. STARRETT,
D. F. CARVER,
WM. S. TWINING.

Committee on City and Suburban Electric Railway Equipments.

REPORT OF COMMITTEE ON TEST OF INTERURBAN EQUIPMENTS.

ANDERSON, IND., *March 14, 1904.*

ELECTRIC RAILWAY TEST COMMISSION,
UNIVERSAL EXPOSITION, ST. LOUIS, 1904,
43 Exchange Place, New York City.

GENTLEMEN: Complying with your request, we submit herewith a report outlining the tests which we believe it would be desirable to conduct at the Exposition on high speed and moderately heavy interurban equipments, bearing in mind the facilities which you will have at your command, as outlined in your letter.

The Committee is well aware of the fact that numerous laboratory and shop tests have been made, both by the manufacturing companies and the operating companies, and valuable data with respect to the characteristics of interurban equipment of all classes is available for the

use of any engineer or company. We believe that this data is accurate within the limits of the precision of measurements, and it will therefore be unnecessary for the Commission to take the time to duplicate tests of this character, which cover the following points set forth in the memorandum accompanying your letter of February 1, 1904:

Tests on Apparatus in Electricity Building.

- (a) Tests on electric railway motor equipments under constant load to determine rate of heating during continuous operation.
- (b) Tests on electric railway motor equipments to determine efficiency of such motors under different fixed conditions of operation.
- (c) Tests on electric railway motor equipments to determine their torque curves and accelerating power.

With reference to your section "d" as follows:

- (d) Tests of hand, automatic, and multiple control systems to determine their relative economy, certainty, and regularity of starting motor car equipments under fixed loads.

We wish to recommend that the tests of systems of control be made in conjunction with outdoor tests of railway equipments on the experimental track, with the possible exception of tests made to determine the electrical energy required for operating multiple control systems, and that shop tests be made on the different systems of multiple control to determine the electrical energy required to bring the control to the "full on" position in different lengths of time, and also the energy required to hold the control at "full on" position. With this data, it will then be possible to determine the relative economy of the different types of control, as well as the total power consumption of any type under any given conditions of train operation.

Tests on Electrical Railway Equipments on Experimental Track.

We have considered the various classes of cars and equipments which seem to come within the field allotted to this Committee, and, realizing that the Commission will probably have time to conduct a series of tests on only one type of this equipment, we recommend that the experimental equipment consist of the following:

Standard interurban car body, weight sixteen to twenty tons, exclusive of trucks and motors.

Standard pair of interurban trucks, weight eight to twelve tons per pair.

Standard direct current railway motor equipment, consisting of four seventy-five horse-power motors, with such different types of hand and train controlling apparatus as are available.

The above type of car will weigh complete (including car body, trucks, equipment, and average live load) from thirty-five to forty tons.

We note that the experimental tracks at the Exposition will consist of two parallel tracks 1,400 feet in length, and two parallel tracks 2,000 feet in length, and there is a possibility of obtaining a track three miles in length. We feel that the first two lengths of track mentioned are not long enough to permit tests that will be found to be desirable, and recommend that the Commission endeavor to secure the use of the three-mile track, as this length of track will make it possible to obtain test conditions furnishing data of greater value than may be secured on the shorter tracks.

In general, the three points in regard to which the least accurate information is available are:

- (1) The relation between the average electrical losses in the motors and the rise in temperature attained under various conditions of high speed service.
- (2) The train resistance (or power required to propel a car or train at uniform speed) at very high speeds.
- (3) The performance of cars equipped with controller so arranged that the acceleration is automatic as compared with the performance under similar conditions, where the rate of acceleration depends upon the handling of the controller by the motorman.

All information which can be obtained on these three points will be exceedingly valuable. The use of the track three miles in length will enable the cars to be run at speeds reaching sixty to seventy miles per hour as a maximum, and making a schedule speed of thirty-five to forty miles per hour.

Tests of Motor Performance and Rise in Temperature.

In general, the performance of a car in service can best be represented by speed time and current curves, as shown in Fig. 1.

These curves show at once such items as rate of acceleration, maximum speed, rate of coasting, and rate of braking.

The power input to the car at any instant is shown by the line voltage and the current at that instant. The average power used by the car can be deduced by averaging the instantaneous power, and may be verified by a recording wattmeter. The schedule speed can also be deduced from the curve showing instantaneous speeds and can be verified by the time and distance.

The power input when the car is running at any uniform speed gives at once the train resistance for that speed. From the current input to any motor of the equipment and the voltage at its terminals, the electric

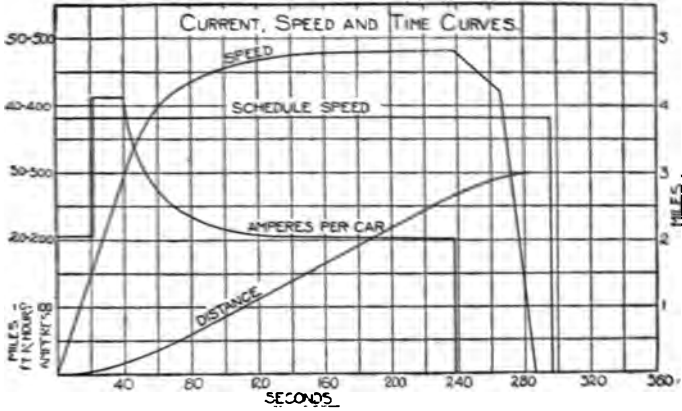

Fig. 1. — Currents, Speed and Time Curves.

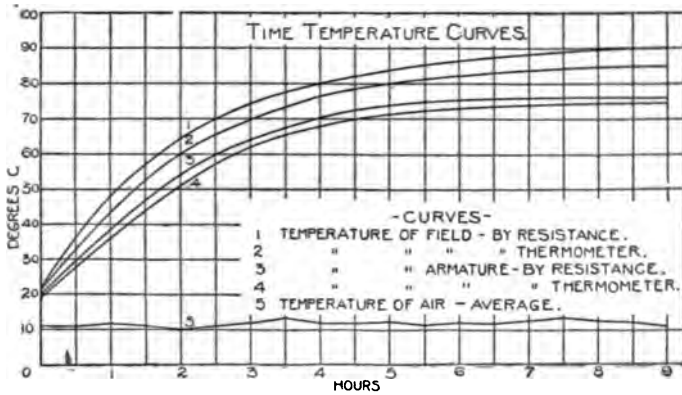

Fig. 2. — Time Temperature Curves.

losses which take place in this motor can be readily found. These instantaneous losses, averaged for the time of the entire cycle, give the average losses which determine the heat input.

By running the car backwards and forwards, over a given track, repeating as nearly as possible each time a given cycle of acceleration, maximum speed, coasting, braking, and duration of stop, a condition similar to actual service is obtained. The temperature of the various parts of the various motors can then be measured at intervals until these temperatures become constant, which indicates that the heating effect of the current introduced into the motors is just balanced by the cooling effect due to the speed of the car. A time and temperature curve can then be plotted showing the rise in temperature of the motors during the run until they reach a constant temperature. Such a curve is shown in Fig. 2.

Since the rise in temperature with given average losses in the motors will be largely influenced by the ventilation which will depend largely upon the speed at which the cars run, the above operation should be carried out at several different schedule speeds with their corresponding cycles of acceleration, maximum speed, coasting, braking, and duration of stop. Such results will then show for the equipment under test the following:

(1) With a rise in temperature of 55 degrees centigrade above the temperature of atmosphere, what average losses (square root of mean square current and equivalent voltage) are permissible at schedule speeds of 25, 30, 35, and 40 miles per hour, respectively?

(2) With maximum average losses allowable in motors at schedule speed of twenty-five miles per hour (*i.e.*, such as to give temperature rise of 55 degrees) what will be the rise in temperature with schedule speeds of 30, 35, and 40 miles per hour, respectively?

Such data will enable the probable performance of an equipment under a given service to be more closely estimated in advance than is now possible.

In the above series of tests, the condition which we have in mind is one in which the car is kept constantly moving with the exception of the comparatively short service stops, and with the exception of the time necessary to measure at intervals the temperature of the motors.

The condition on many interurban roads is such that a layover may be had at the end of each run. For instance, the car may lay over half an hour at the end of a run of two and a half hours. A second series of tests in which the car is run in the same way with such a layover will show the effect of this layover on the ultimate temperature attained, and will show the increase in average losses which may be allowed and still give

the same ultimate temperature as was attained when the car was running without layover. It is evident that if no heat is added during the half-hour layover, the consequent cooling of the motors will permit them to withstand greater average losses during the time they are running, than they could withstand if running continuously.

From a series of tests on one size of equipment, as suggested above, the performance of other sizes of equipment can be estimated with a fair degree of accuracy; but if the equipment and the time are available, we believe that it would be desirable to conduct tests as outlined in this report on cars equipped with both double and quadruple equipments of a total capacity of from 200 to 500 horse-power. However, we would recommend a complete series of tests and curves, illustrating them, to be made with one size of equipment, and the results of these tests analyzed, before making tests of other sizes of equipment, as it may be found that the average losses which the motors may safely withstand at different scheduled speeds, do not vary sufficiently to make necessary further investigation on the subject.

Tests of Train Resistance.

Tests should be made to determine the train resistance with single cars and with different numbers of cars at various speeds from forty miles per hour, upwards, as the train resistance at speeds lower than forty miles per hour is fairly well understood.

Train resistance should be measured in two ways: first, by direct measurement of instantaneous power input when running at uniform speed, and second, by allowing a car or cars to coast and determining the rate of decrease of speed. The effect of different shapes of car front should be investigated if possible. The tests should be made if possible with one, two, three, and four cars.

Tests on Hand and Automatic Control Systems.

Where the object is to compare the relative economy of hand and automatic control, it will be sufficient to make tests of single cars. Where the object is to compare different systems of multiple control, more than one car should be used.

The effect of the use of automatic acceleration on the power consumption and the general performance of a car can best be studied by plotting complete curves, showing the instantaneous values of speed, current, etc., as in Fig. 1. Such curves should be plotted from tests on the same car under conditions similar, as nearly as possible, with the car equipped at one time with automatic acceleration and at another time without automatic acceleration.

A test should also be made to determine the saving of power, if any, made by using a mechanical device on hand controllers, to limit the rate at which the controller is thrown on. The data derived from such tests should show the average as well as the maximum power consumption at any instant during the cycle, and also the fluctuation of power during the cycle, when the resistance in the circuit is varied. From this data a comparison of the relative values of this type of control and unrestricted hand control may be made.

Knowing full well the vast amount of experimental work to be done at the Exposition, we have confined ourselves to a few suggestions as to tests on railway equipments which would furnish data of value from a practical standpoint, which data, as far as we know, has not heretofore been obtained from careful investigation and experiment.

Respectfully submitted, A. L. DRUM,
 CHARLES JONES,
 C. A. ALDERMAN.
Committee on Interurban Electric Railway Equipments.

REPORT OF COMMITTEE ON TESTS OF HEAVY TRACTION
 EQUIPMENTS.

NEW YORK, U. S. A., April 1, 1904.

ELECTRIC RAILWAY TEST COMMISSION,
 UNIVERSAL EXPOSITION, ST. LOUIS,
 MR. J. G. WHITE, *Chairman*,
 43 Exchange Place, New York City.

GENTLEMEN: Complying with your request for the submission of a program to be followed in the conducting of tests upon heavy traction electric railway equipments at the St. Louis Exposition, your Committee begs to suggest as follows:

(1) Each party submitting apparatus for test shall furnish a complete written description thereof, setting forth clearly the special features of the design and calling attention to any points that are considered new. The description shall also explain the controlling mechanism, designating its applicability to direct or alternating current, with proposed working voltage, and if for alternating current, stating the frequency and phase desired for most successful operation.

(2) All tests shall be conducted upon the track designated by the Electric Railway Test Commission and conducted under actual operating conditions.

(3) No tests shall be made upon electric locomotives or other apparatus of less than 500 normal horse-power unless especially permitted by the Commission. It is assumed that the term "Heavy

Traction" applies to locomotives or motor cars of a total capacity rated on an hourly basis of 500 horse-power or more.

(4) The tests will be conducted with the locomotive or motor cars running light and also when pulling trains, with the purpose of studying the following features:

- (a) Motor capacity under various conditions of operation.
- (b) Acceleration.
- (c) Coasting.
- (d) Braking.
- (e) Heating.

The following curves and diagrams shall be prepared:

- (f) Speed time curves.
- (g) Distance time curves.
- (h) Voltage and ampere time curves.
- (i) Kilowatt input and distance curves.
- (j) Draw-bar pull diagrams made when attached to a fixed anchor and also with dynamometer coupled between locomotive and trains operated under running conditions.

If alternating current motors are used, the following additional curves shall be prepared:

- (k) Real kilowatt time curves.
- (l) Apparent kilowatt time curves.

(5) The tests shall include the determination of heating and the distribution of the same in the field, armature, and commutator, under various loads at different rates of speed. The heating of the bearings shall also receive consideration.

(6) The tests of the methods of control and comparison of hand and automatic acceleration shall be made as bearing upon the elements of:

- (a) Safety.
- (b) Convenience.
- (c) Economy.
- (d) Smoothness of operation.
- (e) Ability to group into two or more units.

(7) The tests of the methods of control shall also be considered as bearing on:

- (a) Smoothness of acceleration.
- (b) Variation of economical speeds.
- (c) Reversibility.
- (d) Action with one or more motors cut out.
- (e) Relation of starting to running current under different rates of acceleration.

- (8) The equipment will be considered as to:
- (a) General construction.
 - (b) Weight and distribution of same on drivers under static and hauling conditions.
 - (c) Relative weights of electrical and mechanical parts.
 - (d) Number and size of drivers.
 - (e) Acceleration of working parts.
 - (f) Influence on track.
- (9) Tests will be made upon each locomotive or motor car submitted, to ascertain:
- (a) Watt hours per ton mile with locomotive running light at various speeds.
 - (b) Watt hours per train ton mile exclusive of locomotive.
 - (c) Watt hours per ton mile with locomotive load and with train under various weights and acceleration.
- (10) Methods and detail conditions for conducting the tests shall be agreed upon by those who have immediate charge of the tests, before the commencement of the trials. These conditions shall be satisfactory to the representatives of those furnishing the apparatus. It is understood that all tests shall be made under similar conditions when possible. When these conditions are necessarily dissimilar, due allowance shall be made in compiling the results, so as to place all apparatus upon the same plane of comparison.

FRANK G. SPRAGUE,
 F. R. SLATER,
 W. J. WILGUS,
 BION J. ARNOLD.

Committee on Heavy Electric Traction.

REPORT OF COMMITTEE ON TESTS OF NEW ELECTRIC
 RAILWAY SYSTEMS.

CHICAGO, *March 8, 1904.*

J. G. WHITE,
*Chairman, Electric Railway Test Commission,
 Universal Exposition,
 43 Exchange Place, New York.*

DEAR SIR: Complying with your request to submit an outline of tests to be conducted upon new electric railway systems at the St. Louis Exposition, your Committee begs to submit the following:

In general each party furnishing apparatus to be tested shall submit a written or printed description setting forth clearly and fully the salient points in the system, and the principal advantages claimed for

it. He will also completely describe the motors and controlling apparatus, stating whether the system is designed for direct current or alternating current, or both, and if for alternating current whether for single phase, multiphase, series, repulsion, induction, synchronous, or other type of motor, and state in any case the most desirable voltage to use in the motor, and if alternating the preferred frequency.

In testing any new system we have assumed that the tests should be divided into principal parts, as follows:

1st. Motors, including car equipment.

2d. Line, including all substation apparatus and other translating devices interposed between the power house bus-bars, and the trolley wheel or contact shoe of the locomotive or car.

Schedule of Motor Tests to be made with Apparatus Running Stationary upon Testing Blocks :

(a) Test motors to determine efficiency, power factor (if alternating), torque, speed, horse-power, output under various conditions as to voltage, frequency (if alternating) and current, to be met in the service for which the system tested is intended.

(b) The one-hour rating of motors to be determined according to the standards outlined by the American Institute of Electrical Engineers.

(c) Test motors under constant loads to determine rate of heating during continuous operation.

Schedule of Tests to be made on Equipment when Operating upon Experimental Track :

(a) Acceleration tests of single cars and multiple equipped trains.

(b) Braking tests of single cars and multiple equipped trains.

(c) Coasting tests of single cars and multiple equipped trains.

(d) Motor heating tests of single cars and multiple equipped trains.

Prepare the following curves:

(e) Speed time curves.

(f) Ampere time curves.

(g) Volt time curves.

(h) Real kilowatt time curves.

(i) Apparent kilowatt time curves (if alternating).

(j) Distance time curves.

(k) Tests and curves to determine car and train friction.

Schedule of Tests to be made upon Line and Auxiliaries :

Determine:

(a) Ohmic resistance.

(b) Inductive reactance.

(c) Power factor.

(d) Efficiency of copper and iron portions of line, separately and jointly, under the following conditions:

1st. When the electrical energy is delivered from the power house bus bars to the working conductor without translating devices.

2d. When electrical energy is delivered from the power house bus bars to the working conductor through supplemental transmission lines or translating devices.

If supplementary transmission lines or devices are used in case No. 2, each element shall be tested separately as well as in conjunction with the line as a whole as outlined above.

Tests upon each system shall be made to determine the following:

(a) Watt hours per ton mile at car.

(b) Watt hours per ton mile at substation bus bars (in case substations are used).

(c) Watt hours per ton mile at power house bus bars.

All tests to be under like conditions, and when conditions are necessarily unlike, due allowance shall be made to reduce the apparatus tested to a fair basis for comparison.

The watt hours per ton-mile, as stated above, to be determined from the summation of the specific tests hereinbefore outlined, and checked by integrating wattmeters placed on the power house bus bars, substation buss bars (if substations are used), and the car.

Respectfully submitted,

BION J. ARNOLD,
PAUL M. LINCOLN,
W. B. POTTER.

Committee on New Electric Railway Systems.

THE EXECUTIVE COMMITTEE.

The preliminary work being well in hand and the field having been carefully surveyed by the Engineering Committees, the next step was the appointment of the Executive Committee. The duties of this committee were to decide upon and to carry out such tests as appeared practicable for the Electric Railway Test Commission to accomplish. For the purpose of personally directing the work, superintendents were selected from the instructional forces of technical colleges; their positions giving them a neutral attitude toward the product of the manufacturer. With Professor Goldsborough as chairman, these

superintendents formed the Executive Committee, which was constituted as follows:

Professor W. E. Goldsborough, Chief, Department of Electricity, Universal Exposition, *Chairman*.

Professor H. H. Norris, Cornell University, *Superintendent*, Electric Railway Tests.

Professor B. V. Swenson, University of Wisconsin, *Assistant Superintendent*, Electric Railway Tests.

Professor H. T. Plumb, Purdue University, *Assistant Superintendent*, Electric Railway Tests.

Professor Goldsborough took great interest in the work from its inception. It was largely due to the active part he assumed in furthering the interests of the Commission that the project was carried to a successful completion. Professor Goldsborough directed the work in general and was consulted on all matters of importance.

Professor Norris began his active duties as superintendent of tests on June 15, 1904, and continued his direct supervision until February 1, 1905, when it became necessary for him to again assume his duties at Cornell University. However, he continued to act as superintendent and devoted a very considerable portion of his time from February to October, 1905, to the preparation of the report.

Professor Swenson became associated with Professor Norris in the work of the Commission on June 15, 1904, and continued to be actively engaged in the testing work of the Commission until its completion on March 22, 1905. From that time until October, 1905, he devoted his entire time to the preparation of the report.

Professor Plumb began his active duties on June 15, 1904, and continued his direct connection with the work of the Commission until September 1, 1904, when it became necessary for him to resume his duties at Purdue University. However, he later devoted a considerable portion of his time to preparing for and conducting the tests upon car No. 284 of the Indiana Union Traction Company, and to the working up of the data then recorded.

THE ADVISORY COMMITTEE.

In order that the plans of the Executive Committee might have the benefit of the criticisms of engineers of the large companies engaged in the manufacture of electric railway apparatus and the construction of electric railways, the following advisory committee was appointed by the Commission.

A. H. Armstrong, General Electric Company.

Clarence Renshaw, Westinghouse Electric and Manufacturing Company.

W. S. Arnold, Bullock Electric Manufacturing Company.

W. N. Smith, Westinghouse, Church, Kerr & Company.

These gentlemen were consulted during the progress of the work and their suggestions were given careful consideration by the Executive Committee.

THE TEST CORPS.

All of the experimental work of the Commission, as well as the major part of the preparatory and construction work incident to these various tests, was performed by the Executive Committee with the assistance of a number of young men who had graduated from some of the leading technical institutions of the country. This working organization of superintendents and assistants has been designated The Test Corps of the Electric Railway Test Commission.

As these assistants entered upon the work at different times, and as, moreover, their terms of service were not at all uniform, it has been thought advisable to state the duration of service in each case.

NAME.	UNIVERSITY.	TERM OF SERVICE.
William Bradford	Wisconsin	June 22, 1904—June 29, 1904
C. E. Carter	Wisconsin	Aug. 1, 1904—Nov. 1, 1904
W. J. Crumpton	Wisconsin	Aug. 8, 1904—Dec. 4, 1904
R. N. Davidson	Purdue	June 15, 1904—Aug. 5, 1904
W. E. Dickinson	Cornell	Aug. 1, 1904—Sept. 24, 1904



THE TEST CORPS.

C. C. Myers,	R. J. McNitt,	H. B. Foote,	A. A. Post,	Will Spaulding,	C. J. Feehelmer
W. J. Crumpton,	C. E. Carter,	B. V. Swenson,	H. T. Plant,	L. J. Kirby,	W. T. Small,
O. A. Kenyon,	W. E. Dickinson,	H. H. Norris,	W. E. Goldsborough,	R. N. Davidson,	Robert Rankin.
	O. H. West,	C. A. Heron,			

NAME.	UNIVERSITY.	TERM OF SERVICE.
C. J. Fechheimer	Purdue	{ June 15, 1904–June 29, 1904 Aug. 7, 1904–Sept. 10, 1904
H. B. Foote	Cornell	Aug. 1, 1904–Oct. 3, 1904
R. W. Harris	Purdue	June 15, 1904–June 29, 1904
C. A. Heron	Purdue	Aug. 1, 1904–Sept. 9, 1904
O. A. Kenyon	Cornell	Aug. 1, 1904–Nov. 23, 1904
L. J. Kirby	Purdue	Aug. 1, 1904–Feb. 10, 1905
R. J. McNitt	Cornell	Aug. 1, 1904–Nov. 28, 1904
C. C. Myers	Cornell	Aug. 1, 1904–Sept. 10, 1904
G. G. Post	Wisconsin	June 15, 1904–Sept. 23, 1904
Robert Rankin	Cornell	Aug. 1, 1904–Oct. 3, 1904
Hartley Rowe	Purdue	June 15, 1904–July 16, 1904
W. A. Rowe	Wisconsin	June 15, 1904–June 29, 1904
W. F. Sloan	Wisconsin	June 15, 1904–July 1, 1904
W. T. Small	Purdue	Aug. 1, 1904–Mar. 11, 1905
Will Spalding	Wisconsin	June 15, 1904–Feb. 18, 1905
J. W. Watson	Wisconsin	Aug. 1, 1904–Sept. 22, 1904
O. H. West	Purdue	{ July 1, 1904–July 11, 1904 Aug. 21, 1904–Mar. 1, 1905

W. T. Giles, of Anderson, Ind., served the Commission throughout the construction work and the tests on the car "Louisiana," from November 20, 1904, to March 22, 1905. In February and March, 1905, the corps was further supplemented by the services of three members of the senior class of Cornell University. Their names follow:

- R. A. Wright, Feb. 11, 1905–Mar. 11, 1905.
- C. T. Anderson, Feb. 20, 1905–Mar. 11, 1905.
- R. L. Kingsland, Mar. 4, 1905–Mar. 25, 1905.

The single exception to the general method of conducting tests occurred in those upon interurban Car No. 284 of the Indiana Union Traction Company. These tests were made in February, 1905, at a time when the regular test corps was fully occupied with the special car "Louisiana."

While the tests on Car No. 284 were carefully outlined by Professor Plumb and the other superintendents in consultation, the former made all detailed plans and preparations, including the construction of all special apparatus, and arranged for eight members of the senior class of Purdue University to

assist in this work and in the taking of data, the latter to be used by them in thesis work. The tests were conducted under the direct supervision of Professors Plumb and Swenson. Due recognition should be given Professors Plumb and his students, not only for the work done in preparation, but also for the very considerable labor involved in putting the records of these tests into permanent form and in working up many of the results. The eight Purdue students associated with the Commission in the work done on Car No. 284 were the following

C. L. Bartholome.	M. E. Robbins.	W. V. White.
P. W. Gerhardt.	F. M. Tripp.	G. R. Zipfel.
J. J. Neilson.	J. E. Ulrich.	

PRELIMINARY REPORT OF THE EXECUTIVE COMMITTEE.

The first meeting of the Executive Committee was held at the Palace of Electricity, St. Louis, on May 6 and 7, 1904, and resulted in the following report.

PRELIMINARY REPORT OF THE EXECUTIVE COMMITTEE OF THE ELECTRIC RAILWAY TEST COMMISSION.

St. Louis, Mo., May 8, 1904.

ELECTRIC RAILWAY TEST COMMISSION,
UNIVERSAL EXPOSITION, ST. LOUIS, 1904,
43 Exchange Place, New York City.

GENTLEMEN: After careful study of the reports of the Engineering Committees, of the suggestions of the Advisory Committee, and of the excellent facilities afforded by the Exposition officials, the Executive Committee has decided to undertake the following series of tests:

(a) *Tests of the Service Capacities of Electric Railway Motors.*

Equipments will be operated upon the special tracks at different rates and durations of acceleration, coasting and braking, with different durations of stop, in order to determine the heating of the motors under conditions approaching as nearly as possible those of commercial practice. The motors will also be tested separately for heating and for the determination of their torque curves and accelerating power. This will render possible the comparison of the performance of the same equipment upon the track and upon the test stand.

(b) *Acceleration Tests.*

Acceleration tests upon single cars and upon multiple equipped trains will be made to determine the ability of the equipment to bring the cars up to speed quickly and economically.

(c) *Braking Tests.*

Braking tests upon single cars and multiple equipped trains will be conducted in order to determine the quickness of action, the shapes of the braking curves, the relation between the braking forces and the applied pressures, and the best methods of application of the braking forces.

(d) *Tests upon Train Resistance.*

Determinations of the resistances due to the rails, to the journals and gearing, and to the air will be made by systematic and complete series of runs. The effect of the shape of the car body will be carefully investigated. The methods to be used in measuring train resistance comprise the use of calibrated motors as the source of power, the hauling of the car under test by calibrated dynamometers, and by noting the falling off in speed while the cars are coasting. The pressure of the air upon different parts of the car will be recorded by means of self-registering pressure gages.

In addition to these definite series, a number of other tests will be conducted upon various exhibits in the Palace of Electricity in order to determine their efficiency and reliability.

Sections (a), (b), and (c) of the tests will be carried on upon the tracks which have been built for the purpose by the Exposition. These are of substantial construction, conveniently located, and of a total length of about 4,500 feet. For the tests described under section (d) the Indiana Union Traction Company has provided a stretch of eight miles of straight and heavily ballasted track. The resistance tests will be made after the completion of the St. Louis program.

In all the above work, graphical records of the measurements will be obtained by the use of autographic instruments which will be either built for the purpose or supplied through the co-operation of the manufacturing companies and the technical colleges. The National Bureau of Standards will materially aid in the work by providing facilities for the calibration of all of the instruments.

For the purpose of comparison, the various railway equipments will be divided into several classes including car weights up to forty-five tons, as follows:

- (a) Light city service equipments.
- (b) Heavy city service equipments.
- (c) Light interurban service equipments.
- (d) Heavy interurban service equipments.

The actual work of observation and calculation will be carried on under the personal supervision of the superintendents, assisted by a corps of young men carefully selected from among the graduates of leading technical schools, the total number of observers being between thirty and forty. The Exposition management is co-operating enthusiastically with the Railway Test Commission in providing ample facilities for the tests, and substantial results of permanent value to the profession are confidently expected.

At the present time a large part of the equipment is already at St. Louis, the organization is complete, and the ranks of the testing corps have been filled with young men who are already fitting themselves especially for the tasks before them.

Respectfully submitted,

W. E. GOLDSBOROUGH,
H. H. NORRIS,
B. V. SWENSON,
H. T. PLUMB.

FINANCIAL FEATURES OF THE WORK.

While the work of the Electric Railway Test Commission was done under the auspices of the Universal Exposition, the Exposition authorities did not provide any funds for carrying out the project. The Exposition Company did, however, aid in a number of ways, such as providing equipments and facilities for testing.

In order to defray the cost of maintaining the test corps, as well as to meet the many expenses incident to the conduction of experimental investigations, a considerable sum of money was necessary. This will be very readily understood when it is remembered that the experimental work began June 15, 1904, and was not completed until March 22, 1905, and that considerably more than a year elapsed from the time the experimental work began until the work on the Report was finished.

The funds for carrying on the work of the Commission were obtained by means of subscriptions from the various individuals and companies interested in the tests. These funds were secured by the members of the Commission and the list of subscribers and subscriptions is given in Appendix B.

CO-OPERATING COMPANIES.

Various manufacturing companies responded most cordially to requests for apparatus and instruments to be used in connection with the tests. The Standardization Laboratory of the United States Bureau of Standards proved of very great value in connection with the calibration of instruments. Technical schools also assisted by the loan of instruments.

A complete list of the co-operating companies and institutions is set forth in Appendix B.

THE TESTS.

Although the superintendents and a portion of the testing corps assembled for the work at St. Louis on June 15, 1904, it necessarily took some time to organize and prepare for the actual testing work.

The Report shows that the tests actually performed by the Executive Committee in several instances departed widely from those outlined in the suggestions of the Engineering Committees. The Executive Committee would have been more than pleased to have carried out the wishes of the Engineering Committees, but in the instances mentioned it was found impracticable to do so, either because of the hesitancy of manufacturers to permit certain apparatus to be tested or to a lack of facilities for testing, and in some instances to both of these conditions.

In outlining the tests it is to be remembered that a large amount of preliminary work was necessary in all cases and that in many instances this consumed considerably more time than did the actual tests.

The first tests attempted were those relating to the effects of alternating currents upon steel rails. These were begun in July and continued until September. All of this work was carried on in the space of the Bullock Electric Manufacturing Company in the Palace of Electricity.

The next series of tests were those on the compressor station of the St. Louis Transit Company at Tower Grove Park, St. Louis. These began on the first of August and extended over a period of about one week. Following these were the tests on the industrial locomotive, which began during the second week in August and continued about ten days. They were conducted in the court of the Palace of Electricity.

Following these tests were the service tests on Car No. 2600 of the St. Louis Transit Company, operating on the Park Avenue Line, St. Louis. These tests began about the middle of August and were completed during the latter part of the month.

Next in order came the stand tests of motor compressors, which were carried on during the latter part of August, and the first part of September. These tests were made at the Vandeventer shops of the St. Louis Transit Company.

During the progress of the foregoing tests, preliminary work was undertaken incident to car tests on the test track just north of the Transportation Building.

The first tests on these tracks were those on the Westinghouse single-truck car. These tests covered temperature runs with magnetic brake, temperature runs with hand brake, acceleration tests, and braking tests. They began about the first of September and continued until the first part of October.

After the car tests were finished, a number of tests were made on the test tracks to determine their electrical conductivity and their resistance to alternating currents of various frequencies. These tests began in October and were completed in the early part of November.

The final tests at St. Louis consisted of some additional motor-compressor stand tests which were made at the Vandeventer shops of the St. Louis Transit Company, during the first part of November.

During the summer considerable attention had been given to the problem of measuring the effect of air resistance on car bodies when running at various speeds, and the general design of a specially constructed car for these measure-

ments had been completed. In addition, various manufacturing companies had shown their interest in the matter by loaning equipment to be used in the construction of this car. The Indiana Union Traction Company had agreed to permit the work of construction to be carried on in its yards at Anderson, Indiana.

As soon, therefore, as the track tests at St. Louis were completed, the test corps and general equipment were transferred to Anderson, and active work on the construction of the "Louisiana" was begun about the middle of November, 1904. This work occupied over two months, and the preliminary tests were made the latter part of January, 1905. After some changes and adjustments, the final tests on this car were begun on February 6, 1905, and completed March 22, 1905.

During the months of December and January the preparations for the tests of Car No. 284 of the Indiana Union Traction Company had been under way. These tests were made during the first part of February, 1905, and they occurred between the preliminary and final tests on the car "Louisiana."

THE REPORT.

It was the original intention of the Executive Committee to work up each test as it was completed. By this method the Report would have been practically finished as soon as the last test had been made. Unfortunately, the reduction in the test corps necessitated by financial reasons prevented the accomplishment of this aim. However, a considerable amount of work was done during the testing period in working up data and putting them into permanent form for filing and future reference.

While it became necessary for Professor Norris to resume his duties at Cornell University on February 1, he immediately became engaged in making arrangements for the working up of the Report. Upon the completion of the air resistance tests, Professor Swenson proceeded to Ithaca, N. Y., and active

work on the preparation of the Report began the latter part of March, 1905.

It will be noted that the arrangement of the tests in the Report is not that of the order in which they actually occurred in the experimental work. The progress of the tests was governed largely by local conditions, and it has been considered desirable to arrange the material in a more logical order in the final Report.

PART II.
SERVICE TESTS OF ELECTRIC CARS.

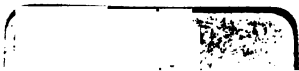

CHAPTER I.

SERVICE TESTS OF ELECTRIC CARS.

OBJECTS OF THESE INVESTIGATIONS.

THE service tests of electric cars were undertaken with a number of objects in view. Principal among these were the study of the general performance of cars and the making of comparative tests of single-truck city cars, double-truck city cars, and interurban cars.

GENERAL PERFORMANCE.

In the general performance tests the cars were operated, as nearly as possible, in accordance with practical schedules. Necessarily these schedules had to be repeated in regular routine, but they were made under fixed rulings which permitted, to all intents and purposes, of the same strain upon the motors and the equipments as is ordinarily experienced in the service for which the equipments were designed.

SPECIAL TESTS ON A SINGLE-TRUCK CITY CAR.

Special tests were made upon a selected single-truck city car for the purpose of obtaining a specific comparison of the consumption of power and the heating of the motors, (1) when hand brakes were employed, and (2) when magnetic brakes were employed.

SPECIAL TESTS ON A DOUBLE-TRUCK CITY CAR.

It was possible, in connection with the tests upon a double-truck city car, to make a special study of the performance of the car equipment when operated: (1) on a dry track on a clear

day; and, (2) on a wet track on a rainy day. Comprehensive data illustrative of the energy consumption and the heating of the motors under these conditions are included elsewhere in full.

SPECIAL TESTS ON AN INTERURBAN CAR.

In the special tests made upon an interurban car, the intent of comparing the performance of the car, when operated alone and when hauling a trailer, was successfully carried out. A variety of data on this subject has been secured, and is presented elsewhere in the Report.

TEST CONDITIONS.

In all of the tests, great care was taken to make accurate records of the starting and running currents, line pressure, power consumption, motor heating, maximum and average speeds, number of stops, brake applications, and number of passengers carried; and other important quantities, such as average current, average line pressure, kilowatt-hours per car-mile and watt-hours per ton-mile, have been derived.

GENERAL DESCRIPTION OF THE VARIOUS EQUIPMENTS.

In Part II are included only the results of the car tests which are general in character. The tests dealing specifically with acceleration and braking are treated of in Parts III and IV. In Part II only such reference is made to acceleration and braking as is necessary to explain the performance of a car when operated in accordance with a given schedule.

“Service Tests” have been primarily considered to be those furnishing data on the general performance of a car operated continuously upon a given schedule. The subject-matter descriptive of these tests includes a complete description of the cars tested. The schedule under which each car is operated is given in each case, as is also a detailed description of the events of each test.

THE SINGLE-TRUCK CITY CAR.

The car body, truck and general equipment, exclusive of motors, controllers, magnetic brakes and car wiring, were furnished by the St. Louis Car Company. The motors, controllers, magnetic brakes and car wiring were the product of the Westinghouse companies. A general view of this type of car is shown in Fig. 3. The body is of the semi-convertible type. Some of the general dimensions and data are the following:—

Length over corner posts	21 feet.
Length over bumpers	32 feet 11 inches.
Length of platforms inside of dash	5 feet 0 inches.
Height of car floor from rails	2 feet 11 inches.
Height of car roof from rails	11 feet 10½ inches.
Width over all	8 feet 8¼ inches.
Weight of car body	9,600 pounds.
Weight of truck	6,500 pounds.
Weight of two motors	6,000 pounds.
Weight of general equipment	2,565 pounds.
Weight of car complete	24,665 pounds.
Wheel base of truck	7 feet.
Diameter of wheels	33 inches.
Number of motors	2
Horse-power rating of each	55
Seating capacity	32
Capacity (crowded)	60

The electrical equipment consists of two No. 56 motors and two Type B 23 controllers. The braking equipment was supplemented by the standard hand brake apparatus of the St. Louis Car Company.

This car was exhibited at the St. Louis Exposition jointly by the St. Louis Car Company and by the Westinghouse companies, the principal features for exhibition from the standpoint of the Westinghouse companies being the magnetic brake equipment.

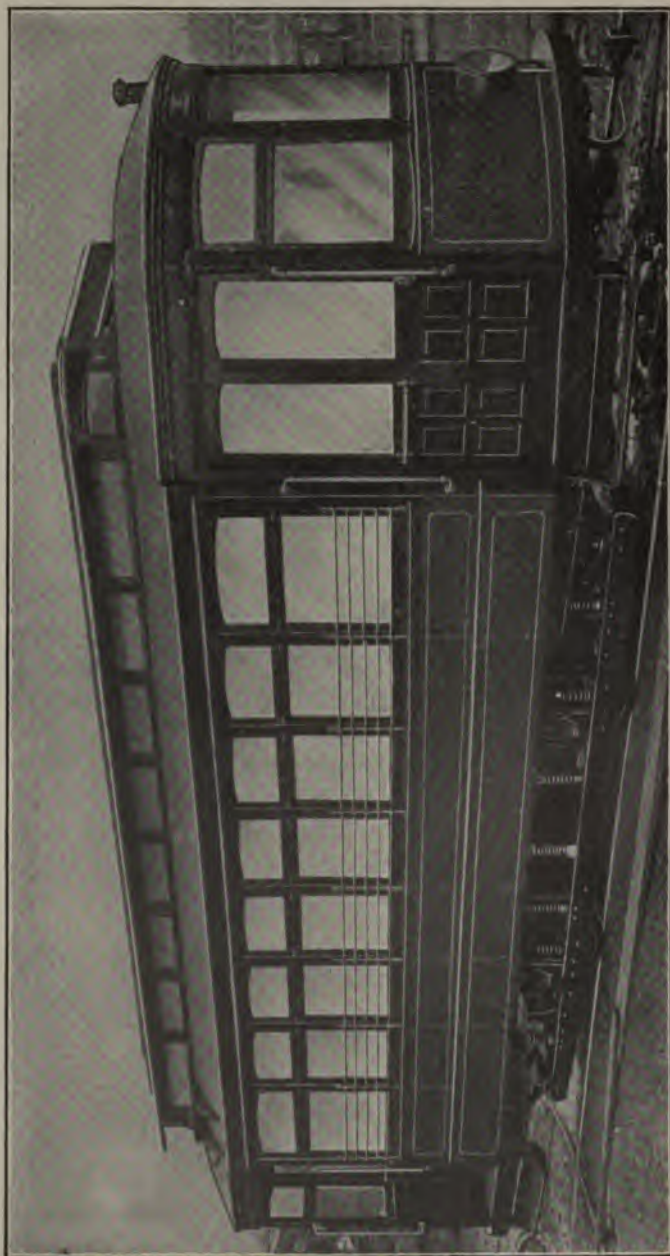

Fig. 3. — Photograph of the Single-Track Car.

The Car Body.

The car body is one of the standard 21 foot semi-convertible type of the St. Louis Car Company. Fig. 4 shows the general detail features of the car.

The side sills are in two parts of yellow pine, the outer sills $2\frac{1}{4}$ inches by 7 inches and the inner sills $5\frac{3}{4}$ inches by 7 inches. The inside side sills are made in two parts with a 7-inch "I" beam securely bolted between them. All posts and rails are of white oak. The corner posts are $3\frac{3}{4}$ inches by 6 inches, and the side posts are $2\frac{1}{2}$ inches.

The platform sills are of $2\frac{1}{4}$ -inch white oak, and the middle sills are plated with steel plate $\frac{1}{2}$ -inch by 5 inches. The bumpers are $2\frac{3}{4}$ -inch white oak faced with $\frac{1}{2}$ -inch by 5-inch steel plates. The platforms are constructed with entrances on both sides. Each end is equipped with a permanent vestibule with double folding doors on each side. The steps are malleable iron hanger with wood tread covered with safety treads. The hand brake consists of $1\frac{3}{4}$ -inch brake staffs of Norway iron, provided with St. Louis Car Company's ratchet bronze brake handles at the top and twist brake chains at the bottom.

The roof is monitor type for the full length of the car body, with eight ventilator sashes on each side. The doors are of the double automatic sliding type with drop sash. The windows are so constructed that both sashes may be dropped. The sides of the car have straight paneling of 1-inch poplar, dressed to $\frac{7}{8}$ -inch, to come over the sill plate. The inside paneling extends to the floor. The sides of the car are fitted with five window guards. The flooring is yellow pine, and the inside paneling is mahogany. The car is fitted with the usual motorman's gongs, conductor's signal bells, and passengers' push-button signals. There are eight St. Louis Car Company's latest type of seats on each side, rattan finish. The car is provided with curtains on spring rollers, and is thoroughly up to date in all appointments.

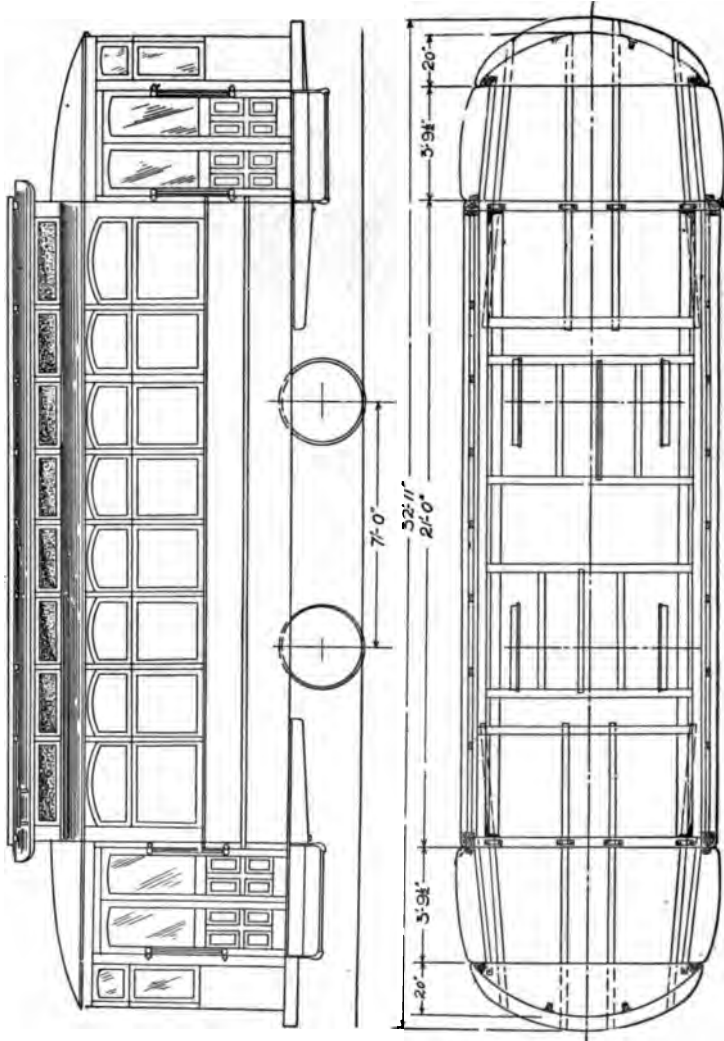

Fig. 4. — General Drawing of the Sing'e-Truck Car.

Truck and Running Gear.

The truck of this car was also built by the St. Louis Car Company and is of the No. 9 type of the LaClede works. A photographic view of this type of truck is given in Fig. 5, and it is



Fig. 5.—Photograph of Truck of the Single-Truck Car.

further illustrated by the sketches shown in Fig. 6. Some of the general dimensions and data are the following:

Gage of wheels	4 feet 8.5 inches.
Height of side sills above rail without car body .	28.25 inches
Wheel base	7 feet.
Weight of truck	6,500 pounds.
Axles, diameter at center.	4 inches.
Axles, diameter at wheel seat	3.5 inches.
Type of motor suspension,	nose.
Wheels, cast iron, diameter	33 inches.
Journals	3.5 inches by 5.5 inches.

Motors.

The driving equipment consisted of two Westinghouse No. 56 motors. The Westinghouse Company recommends this equipment for city service for the operation of either single or double-truck cars of any size up to 35 or 40 feet over all, and weighing, without equipment or load, from 23,000 to 30,000 pounds. As previously stated, the car under consideration had a gross weight, without load, of 24,665 pounds. The manufacturers further state that in city service, with runs averaging

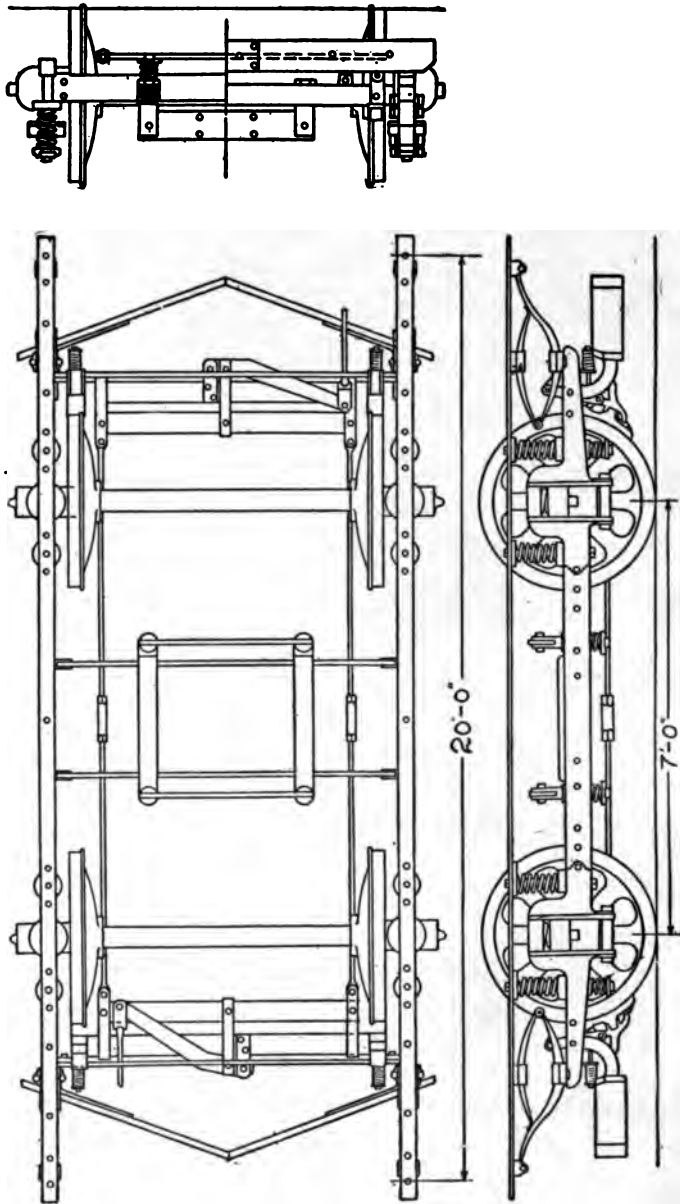

Fig. 6. — Drawing of Truck of the Single-Track Car.

from one eighth to one quarter of a mile in length, the equipment with a gear ratio of from 14, to 68 or 16 to 66, will produce an ultimate speed of from 18 to 20 miles per hour approximately, on a straight level track with a line pressure of 500 volts.

The gear ratio on the car tested was 18 to 64, and the length of run averaged 790 feet, or about 0.15 of a mile. The ultimate speed reached in the tests was approximately 21 miles per hour. A general view of this type of motor is shown in Fig. 7.



Fig. 7. — General View of Westinghouse No. 58 Motor.

GENERAL DESCRIPTION. — Fig. 8 shows a view with the motor open, the armature being contained in the lower field casting. The field frame of the motor is made of cast steel and is approximately cylindrical in shape. It is divided into two parts in a plane through the center of the armature shaft and the center of the car axle. All the working parts of the motor are inclosed by the field castings and thus protected. The poles are built up of sheet steel punchings riveted together between wrought iron end-plates, the completed pole pieces being bolted to the frame. The field coils are wound with asbestos covered round wire, and are treated with a special compound to render them moisture proof. The armature is of the ventilated slotted drum type, 14 inches in diameter. It is built up of sheet steel punchings

assembled and keyed on a steel shaft and clamped between malleable iron end-plates. There are 39 slots and 117 coils, *i.e.*, three coils per slot. At the pinion end the winding is made entirely open, for purposes of ventilation. The commutator is $10\frac{1}{2}$ inches in diameter and $4\frac{1}{8}$ inches long, and has 117 bars.

The motors have a nose suspension, and are so constructed that the armature may be either dropped with the lower half of the field or the latter may be swung down alone for inspection. The pinion is of forged steel with machine-cut teeth. The axle gear is made of cast steel in two parts which are bolted together

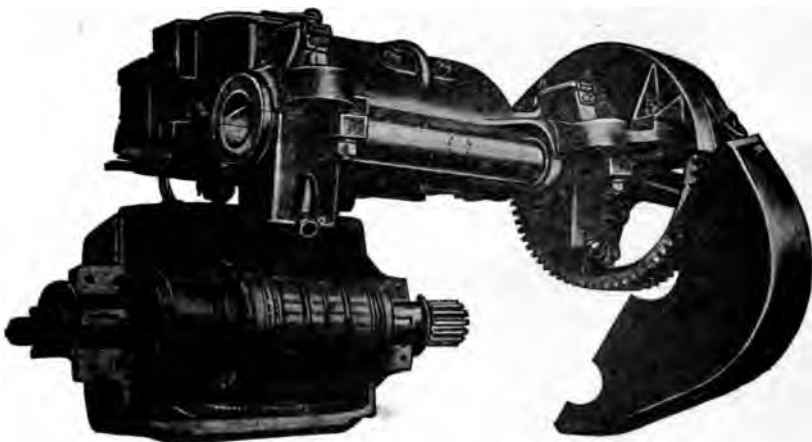

Fig. 8.—Westinghouse No. 56 Motor. (Motor open.)

and keyed to the axle. The diametral pitch is three per inch, and the face is five inches. The pinion has 18 teeth, and the gear has 64 teeth. The gear case is of malleable iron and is cast in two parts, the upper half being bolted to the upper half of the field frame, and the lower half is attached to the upper half. The weight, complete with gears and gear case, is 3,000 pounds. Without gears and gear case, the weight is 2,685 pounds. The weight of the armature, complete with commutator and winding, is 720 pounds. The weight of a double equipment, including motors, controllers, diverters, circuit breakers, wiring, and other details, is approximately 7,200 pounds.

The Magnetic Brake.

The power brake, which forms a part of the equipment of the car, consists of the magnetic-brake equipment of the Westinghouse Traction Brake Company. It consists essentially of an ingenious combination of a magnetic brake with a wheel brake. In braking, the car motors are used as generators, and the heaters form the necessary rheostats for controlling the braking current. In warm weather rheostats placed under the car are used instead of the car heaters.

The brake proper is illustrated in Fig. 9 and consists essentially of (a) a double track-shoe of peculiar construction, combined with an electro-magnet which, when energized by the car motors



Fig. 9.— Westinghouse Magnetic Brake. (Side View.)

acting as generators, is strongly attracted to the rail; (b) brake heads and shoes of the ordinary kind which act directly upon the wheels; and (c) a link mechanism for transmitting the downward pull and resultant drag of the magnetic brake into a lateral pressure upon the wheels. This arrangement of braking apparatus is in duplicate, so that all four wheels are acted upon in the braking.

The illustration shows the method of attaching the brake rigging to the truck, and of suspending the track shoes and magnet frames directly over the track. When the brake is not in operation, the suspension springs carry the track magnets and shoes clear of the rails, and, by means of their flexibility, permit the shoes to ride over or clear any obstruction not sufficient to cause the car to be stopped.

When the brake is applied, there are produced four effects, all of which assist in bringing the car to rest : (a) The motors become generators and receive their energy from the momentum of the car, thus the rotative energy of the motors is quickly absorbed; (b) The magnets in the track shoes are energized, producing a powerful magnetic drag; (c) The drag of these shoes, through a system of links and levers, is utilized in pressing the ordinary brake shoes against the wheels; (d) The pull on the track shoes also increases the pressure of the wheels upon the rails, *i.e.*, it has the effect of increasing the weight of the car.

Further details concerning the magnetic brake, together with the results of the special braking tests in which this brake was employed, will be found in Part IV.

Controllers and Car Wiring.

The controllers were the B 23 type as manufactured for the Westinghouse Company. This type of controller is designed to meet the requirements of the magnetic brake. It is intended for two 60 horse-power motors, and is provided with sixteen notches, five of which are for the series operation of the motors and four for their parallel operation, while the remaining seven notches are for the control of the magnetic brake. The general connections of the motors and resistances at the various positions of the controller, are shown in Fig. 54, Chapter V.

THE DOUBLE-TRUCK CITY CAR.

This was Car No. 2600 of the St. Louis Transit Company (now The United Railways of St. Louis). It was practically new at the time the tests were made, having been placed in service only for the purpose of limbering up preparatory to the tests. A general view of the car is shown in Fig. 10.

The car body was built by the St. Louis Car Company, and is similar to a number of others supplied to the St. Louis Transit Company. It is a single-ended, semi-convertible car, with rear platform extra long, Detroit style, without vestibule.

The trucks were Type No. 25, built by the St. Louis Transit Company, which constructs its own trucks. They were somewhat similar to the Type No. 24 trucks of the St. Louis Car Company.

The electrical equipment consists of four General Electric Company No. 54 motors and one General Electric Company Type K 28 controller. The loop system is in use in St. Louis, and the cars have single-ended equipments.

The air-brake apparatus was not the same in all service tests. In the first and second tests the Christensen individual motor-compressor system was installed, while in the third test this was replaced by the Westinghouse equipment for operation on the storage-air system. The braking equipment was supplemented in all tests by the standard hand brake of the St. Louis Car Company. Some of the general dimensions and data are the following:—

Length over corner posts	33 feet 4½ inches.
Length over bumpers	44 feet 8 inches.
Length of front vestibule	3 feet 8 inches.
Length of rear platform	9 feet.
Length (center to center of king bolts)	19 feet 10 inches.
Height of car floor from rails	3 feet 2¼ inches.
Height of car roof from rails	12 feet 3 inches.
Width over all	9 feet.
Weight of car body	15,000 pounds.
Weight of two trucks	13,000 pounds.
Weight of four motors	7,324 pounds.
Weight of general equipment	4,676 pounds.
Weight of car complete	40,000 pounds.
Wheel base of trucks	4 feet 6 inches.
Diameter of wheels	33 inches.
Number of motors	4
Horse-power rating of each	25
Seating capacity	48
Capacity (crowded)	120

The Car Body.

These cars were built specially for the St. Louis Transit Company. As seen from Fig. 10, the car body has the channel steel side sills peculiar to the St. Louis Car Company's

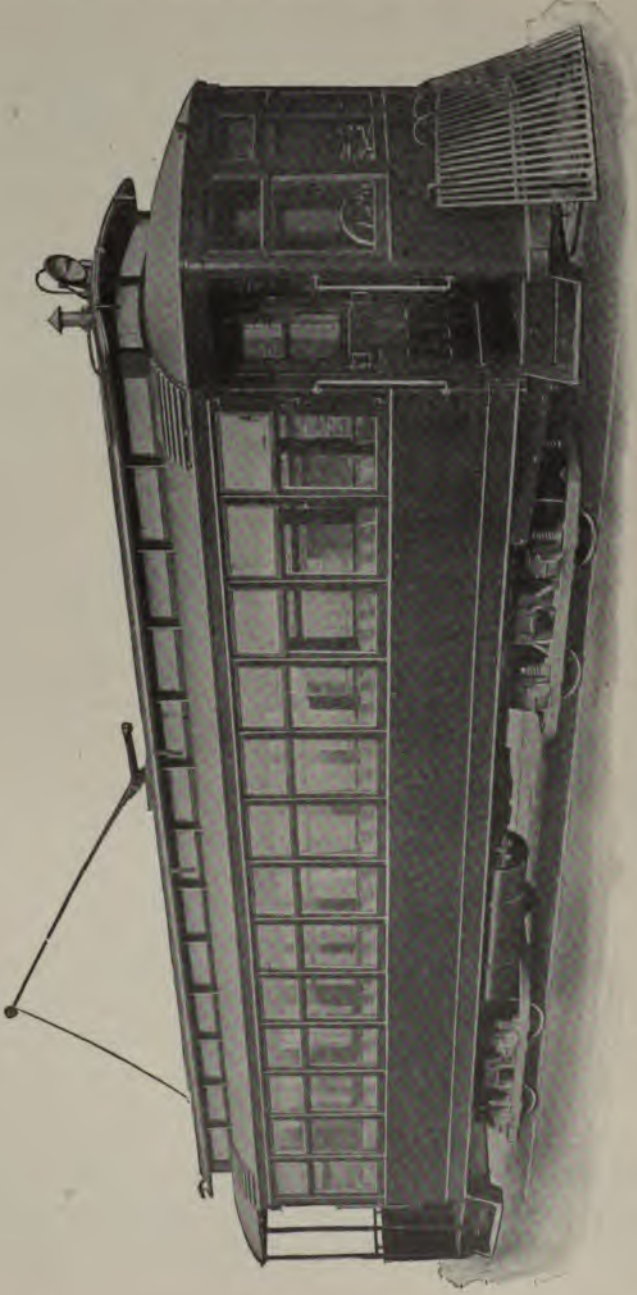

Fig. 10. — Photograph of St. Louis Transit Company Car.

patented construction which allow the windows to be lowered between the channels, thus permitting of a lower window sill construction than usual.

The front platform is very short, as it is intended to be occupied by the motorman only, although used as an entrance and exit. The car body is unusually wide, being nine feet over all, which is the widest car body in use in any of the large cities of the country.

Fig. 11 shows views of the rear platform and of the interior. The rear platform is seven feet long and represents the extreme



Fig. 11. — *St. Louis Transit Company Double-Truck Car.*

development of the Dupont type. It is divided into three parts by two iron-pipe hand rails built up for the support of the passengers. These hand rails do not extend clear across the car, but permit of the passengers moving around the ends from one part of the platform to another. Fig. 12 shows the general detail features of the car.

The bottom sills are of steel channels with narrow siding. The side and end sills are of the standard channel construction of the St. Louis Car Company. All flooring is tongued and grooved, and the platform floors are laid with square joints screwed to the platform knees with flat head counter-sunk steel screws.

In the body all framing members are mortised to each other. All parts are tenoned and draw-pinned into the bottom sills and top rails with hickory pins, and the posts are also secured to the bottom sills by hack strap bolts.

The roof framing is constructed in the same general manner as is the body framing. Steel carlines are bolted to each rafter opposite the side post, and are attached to the top sill plates by screws. The bonnet framing also is made up in the same manner, and the bonnets are built on formers, the hood bow being of green ash, steam bent to shape. The roof is monitor type for the full length of the car body, with thirteen ventilator sashes on each side.

The doors are of the single sliding type with drop sash, the front doorway being $31\frac{1}{2}$ inches wide while that at the rear is $36\frac{1}{4}$ inches wide. The windows (thirteen in number on each side) are made in two sections, and are so constructed that both parts may be dropped below the arm rail. The car is provided with curtains on Burrowes fixtures. All inside paneling is of mahogany.

The car is fitted with the usual motorman's gages, conductor's signal bells, and passengers' push-button signals. There are eleven of the St. Louis Car Company's latest type of cross-seats on the left-hand side and ten on the right-hand side. There are also two seats at the rear of the car to fill the remaining space, making twenty-three seats in all. The two rear seats hold three passengers each, and the total seating capacity is forty-eight passengers.

There are two sand boxes, also of the St. Louis Car Company's pattern. The sand-operating device consists of a vertical lever mounted on the platform, the same fixture also carrying a second lever for use in operating the fenders. These levers have an angle iron stop which also carries the fender lifting lever. The hand brake staff is made of $1\frac{3}{4}$ -inch round Norway iron, and is provided with a ratchet brake wheel at the top, and a twist brake chain at the bottom.

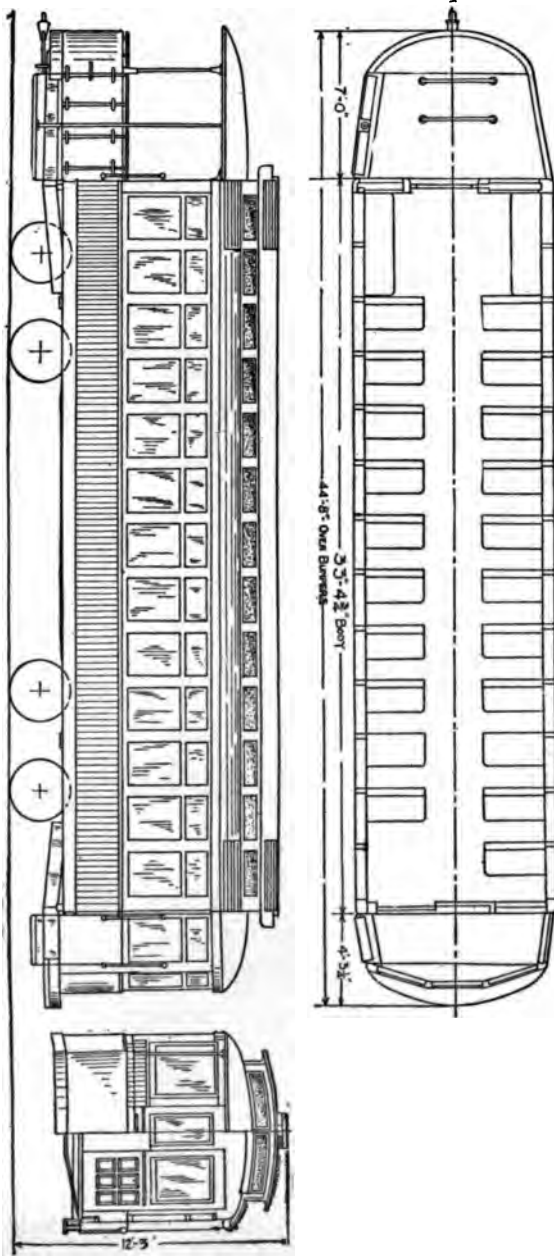

Fig. 12. — General Drawing of Double-Track City Car.

Trucks and Running Gear.

The trucks of this car are of the No. 25 double-truck type, built in the shops of the St. Louis Transit Company for its own cars. A photographic view of a truck, such as those under



Fig. 13. — Truck of St. Louis Transit Company, Car No. 2600.

Car No. 2600, is shown in Fig. 13, while Fig. 14 gives a diagrammatic view of its general construction.

Some of the general dimensions and data for each truck are the following:—

Gage of wheels	4 feet 10 inches.
Height of center plate above rail without car body . .	2 feet 2½ inches.
Height of side bearings above rail, car body loaded . . .	2 feet 2½ inches.
Wheel base	4 feet 6 inches.
Weight of truck	6,500 pounds.
Axles, diameter at center . .	4 inches.
Axles, diameter at wheel seat	4 inches.
Type of motor suspension . .	yoke.
Brakes	outside hung.
Wheels, cast iron, plate center, chilled tread, diameter . .	33 inches.
Journals	3½ inches by 8½ inches.

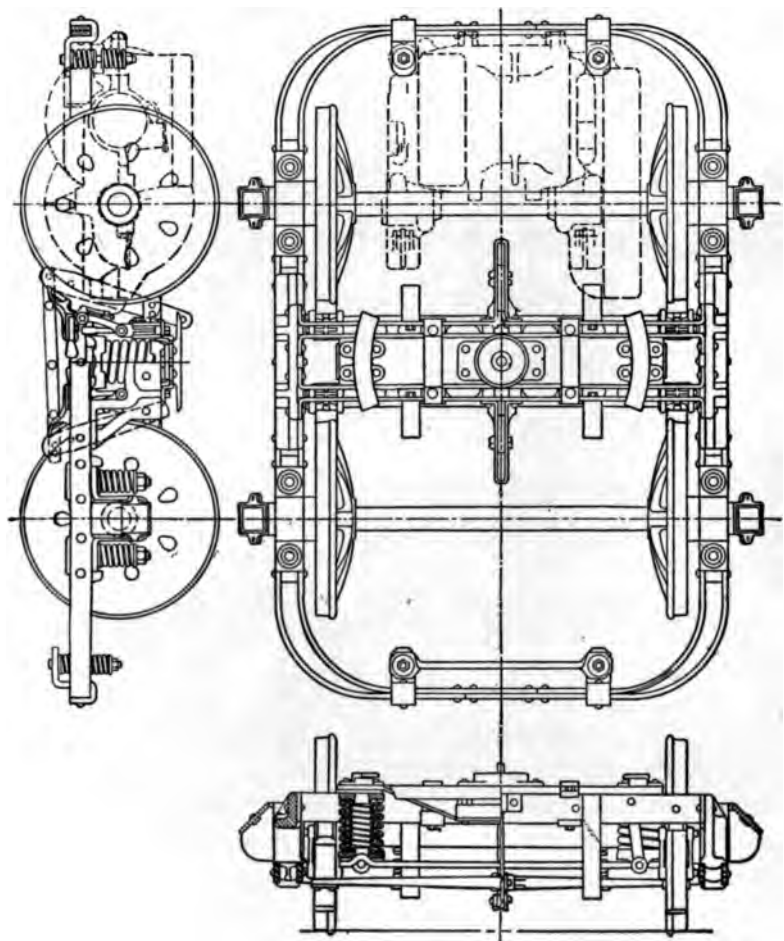

Fig. 14.— General Drawing of St. Louis Transit Company Car Truck.

Motors.

The driving equipment consisted of four General Electric No. 54 motors. This equipment is one recommended by the manufacturer for heavy city service. These motors have a rating of 25 horse-power with 45 amperes input and 500 volts at the motor terminals. The output is based upon the standard rating according to the rules of the American Institute of Electrical Engineers; that is, the horse-power output giving 75° C. rise of temperature, above a room temperature of 25° C. after



Fig. 15.—General Electric Company, Type 54, Motor.

one hour's continuous run at 500 volts terminal pressure, on a stand, with the motor covers removed.

The gear ratio of Car No. 2600 was 14 to 67, and in the tests the average length of run between stops was 1,097 feet, or about 0.21 of a mile. The average speed was 10.27 miles per hour. A general view of the motor is shown in Fig. 15.

GENERAL DESCRIPTION.—Fig. 16 shows a view with the motor open, the armature being contained in the lower field casting. The steel field frame is in the form of a hexagon with rounded corners, and is cast in two pieces. It is so arranged that the

lower frame may be swung down so as to permit inspection or repairs of the field or armature. The pieces are built up from soft iron laminations, riveted together and bolted to the frame through bolts with nuts on the outside. The field coils are placed at an angle of 45° from the horizontal, and are held in place by pressed steel flanges clamped to the pole pieces. The coils are made of asbestos, cotton-covered wire, and further insulated with wrappings of varnished cloth and tape. The armature is of the iron-clad type and is 11.5 inches in diameter. The core is built up of soft iron laminations keyed to the shaft and clamped at each end by cast iron heads, which are also keyed to the shaft. The core is hollow, and is ventilated by the air which enters the pinion end of the core and passes out through the air ducts placed at regular intervals among the laminations. The armature winding is of the series drum type, and has 115 coils of 3 turns each, and 115 commutator bars. The commutator has a diameter of $8\frac{1}{2}$ inches with a wearing length of $3\frac{1}{8}$ inches.

The motors have a yoke suspension, and are so constructed that the armature may be either dropped with the lower half of the field, or the latter may be swung down alone for inspection. The gear ratio is 14 to 67, the pinion and gear both being of steel. The latter is made of cast steel in two parts which are bolted together. Both gear and pinion have a face of $4\frac{1}{2}$ inches, and the diametral pitch is three per inch. The gear case is of malleable iron and is cast in two parts, the upper half being bolted to the upper half of the field frame, and the lower half attached to the upper half.

The weight of a General Electric 54 motor complete with gears and gear case is 1,831 pounds. Without axle gear and gear case the weight is 1,536 pounds. The weight of the armature and pinion complete is 395 pounds. The weight of the motive power equipment, including four motors, one controller, and the necessary car wiring, starting resistance, circuit breaker and other details, is approximately 8,250 pounds.

Controller and Car Wiring.

The controller was of the K 28 type manufactured by the General Electric Company. This form of controller is designed

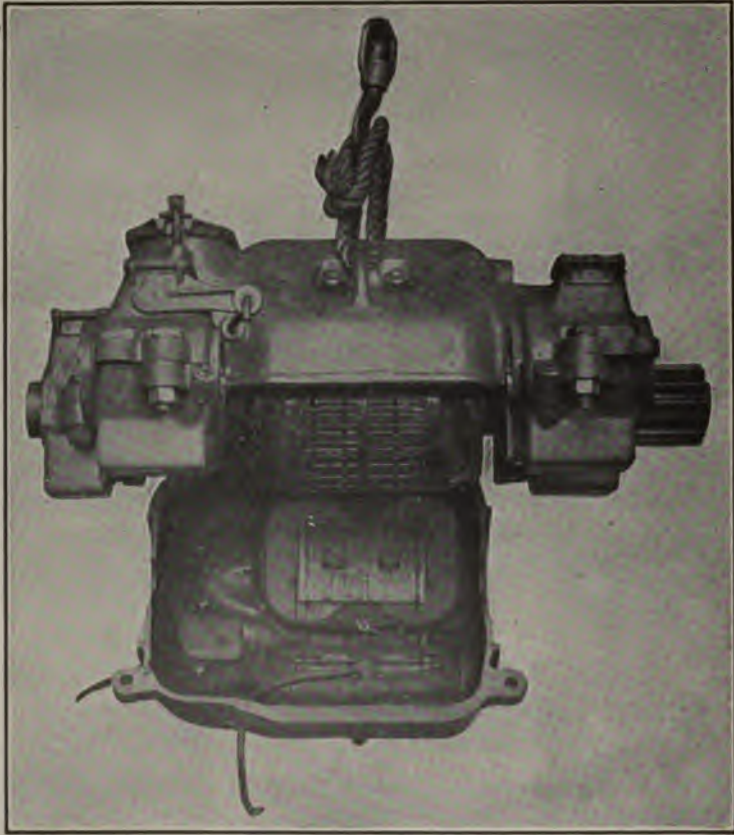

Fig. 16. — General Electric Company, Type 54, Motor.

to meet the requirements of a four-motor equipment of 25 horsepower each. It is provided with ten notches, five of which are for the series parallel operation of the motors, while the remaining five notches are for the parallel operation of the motors.

The Air Brake Equipment.

In the service tests of August 19 and August 24, the Christensen individual motor-compressor system of air braking was installed upon Car No. 2600, while in the test of August 29 the Westinghouse storage-air system of air braking was employed. The braking tests on Car No. 2600, which are considered in Part IV, were made at the same time as were the service tests on this car, and it was for the purpose of comparing the two braking systems that the braking equipment employed in the tests of August 19 and August 24 was replaced by a different system in the tests of August 29.

In the Christensen individual motor-compressor system of air braking a combination air compressor and electric motor is carried on the car. This motor compressor consists essentially of a series wound motor and a duplex single-acting compressor with two pistons which are connected by wrist pins to the connecting rods engaging with the crank shaft. This crank shaft is mounted in bearings provided in the case, the extended end of the crank shaft

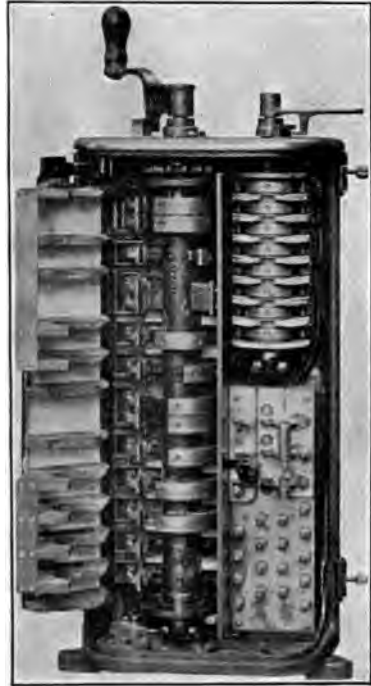

Fig. 16A.—General Electric Company, K. 28, Controller.

carrying a helical gear which engages with a helical pinion mounted in the extended end of the armature shaft of the motor. The latter is mounted directly above the compressor, the motor base forming a top cover for the compressor. This arrangement enables all the working parts to be run in oil.

The armature bearings are specially designed to prevent the oil from getting into the armature.

The Christensen governor consists essentially of an ordinary Bourdon pressure gage mechanism with a special hand, which, upon coming in contact with a conducting stud at the position of minimum pressure, allows current to flow through a solenoid magnet which actuates a switch closing the motor circuit. In like manner, when the high pressure is reached, the hand comes in contact with a second contact stud which operates a second magnet coil which causes the switch to be opened. The high and low pressure points are adjustable.

In the test of August 29 when the Westinghouse storage system of air braking was employed, the braking equipment in general was not disturbed. The Christensen motor-compressor and its accompanying reservoir were removed and the storage tanks of the Westinghouse system substituted. The piping, engineer's valves and gages, and other auxiliary appliances were necessarily different in the two systems.

The Westinghouse storage system of air braking is described in detail in Part IV, as is also the individual motor-compressor system. In this part the braking equipment is considered in detail, so that it will be unnecessary to consider these matters further at this point. So far as the service tests on Car No. 2600 are concerned, it is sufficient to have a knowledge of the braking equipment in general and to be familiar with the conditions under which this equipment was operated in each test.

THE DOUBLE-TRUCK INTERURBAN CAR.

The car tested was No. 284 of the Indiana Union Traction Company. The car body and its equipment were furnished by the Cincinnati Car Company, the trucks and running gear were built by the Baldwin Locomotive Company, while the motive power and braking equipments were the product of the Westinghouse companies. This car was exhibited at the St. Louis Exposition by the Cincinnati Car Company and at the close of the

Exposition it was turned over to the Indiana Union Traction Company. It was built for limited service on the lines of the Indiana Union Traction Company. It has a large passenger compartment in the rear and a smoking compartment in the front, and is supplied with buffet, heater-room, and toilet-room. The car was equipped with four No. 85 Westinghouse motors controlled by the Westinghouse pneumatic system of train control. The air brakes are also of the Westinghouse type.

A photographic view of the exterior of this car is shown in Fig. 17, and the interior is shown in Fig. 18.

Some of the general dimensions and data are the following:

Length over corner posts	41 feet 6½ inches.
Length over bumpers	53 feet 5½ inches.
Length over vestibules	51 feet 3 inches.
Length (center to center of king- bolts)	29 feet 6½ inches.
Height of car floor from rails	4 feet 1 inch.
Height of car roof from rails	13 feet 6 inches.
Width over all	9 feet 1½ inches.
Weight of car body (equipped)	37,400 pounds.
Weight of two trucks	19,130 pounds.
Weight of four motors	18,000 pounds.
Weight of car complete	74,530 pounds.
Wheel base of truck	6 feet.
Diameter of wheels	37¼ inches.
Number of motors	4
Horse-power rating of each	75
Seating capacity	48
Capacity (crowded)	150

The Car Body.

Car No. 284 is one of twenty which were constructed for the Indiana Union Traction Company by the Cincinnati Car Company, in accordance with the general designs of Mr. John L. Matson, superintendent of motive power of the former company. Their construction is quite a departure from the usual design, and they

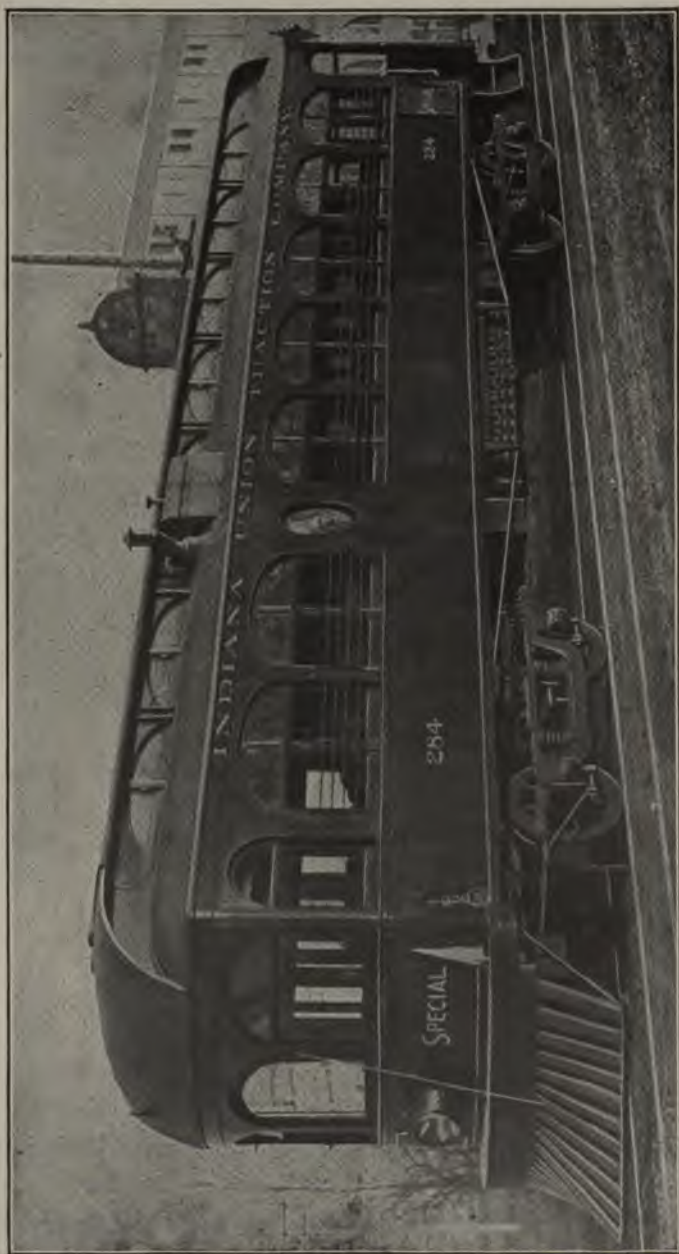

Fig. 17. — Car 284 of the Indiana Union Traction Company.

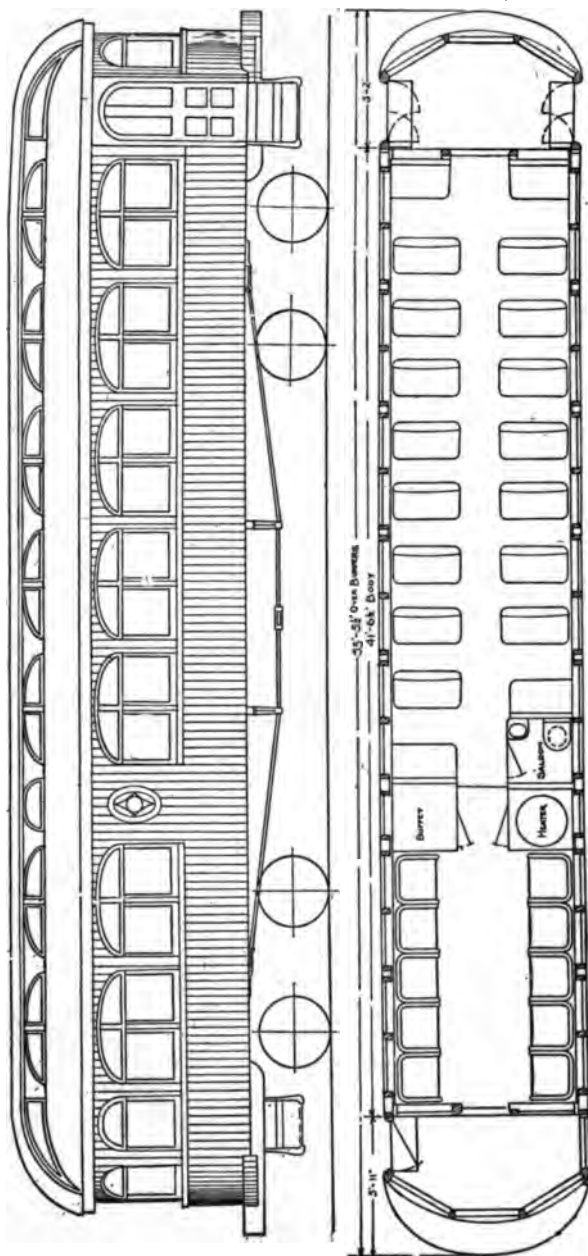

Fig. 19. — General Drawing of Car 284, Indiana Union Traction Company.

by $7\frac{1}{2}$ inches. The side sills are made in three parts; one piece of yellow pine $5\frac{1}{2}$ inches by 8 inches, and one piece 2 inches by $7\frac{1}{2}$ inches, with a $\frac{3}{4}$ -inch by 7-inch steel plate bolted between and running the full length of the sill. Tie rods $\frac{3}{4}$ -inch in diameter are placed along the side of each bridging.

The single side posts are of ash measuring 2 inches by 4 inches, every other post being a pier post consisting of two $1\frac{1}{4}$ -inch by 4-inch posts placed $3\frac{1}{2}$ inches apart.

One of the chief defects of electric cars as usually constructed is the tendency to give down in the center and for the platform to drop. In the construction of these cars an endeavor has been made to overcome this difficulty. In addition to the steel plate alongside of the sills, "I" beams of bottom framing and the customary plank measuring $1\frac{1}{4}$ inches by $10\frac{1}{2}$ inches, the center of the car is supported by two trusses. One of these consists of $\frac{3}{8}$ -inch by $2\frac{1}{2}$ inch flat refined iron and is gained into the inside of the posts under the belt rail, running the steel strut immediately over the bolsters, and from this point it slopes downward to enter the side sills terminating in 1 inch round refined iron, anchored in a suitable casting. The other body truss consists of $1\frac{1}{4}$ -inch by 8-inch ash, gained $1\frac{1}{4}$ -inch into the outside of the posts and runs for a distance under the belt rail, then descends and is mortised into the side sill over the bolster. From this point, braces of the same size ascend and are gained into the corner posts under the belt rail.

Each platform timber is supported by steel plates $\frac{3}{8}$ of an inch by 6 inches, bolted securely to the timbers and to the center and intermediate sills. In addition to these, there are bolted to the outside platform timbers 4-inch by 6-inch angle irons, which upon passing under the end sills bend outward and upward to run along the side sills to a point beyond the bolsters. The length of the front platform from the outside of the end sill to the outside of the sheathing is 4 feet 3 inches, and the rear platform is 5 feet. Both the car floor and those of the platforms are made of Georgia pine, the car floor being laid lengthwise of the car. Each end is provided with a bumper of 5-inch oak capped with bumper

irons, those on the side measuring $\frac{1}{2}$ -inch by 8 inches, and extended to follow the curve of the door posts. The front bumper iron is $\frac{5}{8}$ of an inch by 10 inches, and extends so as to lap over the side bumper irons. The front end is supplied with a pilot which is fitted to the car. The rear end of the car is supplied with a Van Dorn No. 11 radiating draw bar, fastened to the platform of the car with the necessary supports. The height from the top of the rail to the center of the draw bar is 24 inches, and the distance from the face of the bumper to the face of the draw is 8 inches.

The interior of the car is in dull finished Honduras mahogany. There is a large rear compartment, a smoking compartment, a buffet, a heater-room, and a toilet-room. The rear compartment is provided with Hale & Kilburn reversible seats upholstered with deep blue plush; the smoking compartment contains ten comfortable wicker chairs. The cars are carpeted throughout with Wilton carpet.

The roof is of the monitor deck pattern, and extends the full length of the car, with steam coach type hoods. Steel carlines are placed at every double post, and are made in one continuous piece from post plate to post plate. The upper deck ceiling is made of three-ply bird's-eye maple, in four sections, screwed in position every 4 inches. One section is in the forward compartment and the other three in the rear compartment.

The upper deck, finished in light blue, is of the Pullman style, and its vaulted appearance adds greatly to the lofty effect desired. The upper deck sash as well as the upper side sash are glazed with opalescent glass, which not only presents a pleasing appearance from the outside, but harmonizes well with the interior finish.

All side and end windows are provided with curtains mounted on spring rollers. The front doors and windows have curtains in the motorman's cab, arranged so as to unroll from the top and reaching to the bottom of the glass, thus preventing the reflection of light in the vestibule windows at night.

The buffet is ample in size for the purpose for which it was

It contains a buffet urn, an ice box, cupboards and drawers for silverware and dishes. The heater is inclosed in a neat compartment. Space for a coal box is provided by raising the heater 12 inches from the floor, thus permitting the coal box to be placed underneath the heater.

The car is provided with a sand box of 3 cubic feet capacity, placed immediately in front of the leading wheels. The Nicholas Lintern air feed is employed, the control valve being in the motorman's cab and connected to the storage line by $\frac{1}{2}$ -inch pipe.

The hand brake is operated by means of a bevel gear pattern 20-inch bronze wheel, placed in a perpendicular position. The



Fig. 20. — Baldwin Locomotive Type Truck for Car 284.

brake staff is $1\frac{3}{4}$ -inch Norway iron, tapered in proportion, and is fitted with $\frac{3}{8}$ -inch twist link chain.

The air whistle is placed in the roof over the front of the car, and is connected to the air pipe system by a $\frac{1}{2}$ -inch pipe and controlled by a valve in the motorman's cab. The car is provided with the usual motorman's gong and conductor's signal bells. The basket racks are continuous for the full length of the car. A water cooler is situated in the forward end of the rear compartment.

The car is equipped with a Mosher headlight, and is also supplied with an oil and tool box hung under the car and containing two oil cans, one waste can, one coupling bar, two packing irons, one wreck rope, two pick-ups, and three flags. A cabinet, con-

taining emergency tools and provided with a glass front, is placed inside the car. A Babcock fire extinguisher is also a part of the equipment.

Trucks and Running Gear.

The trucks of this car were built at the Baldwin Locomotive works. They are of the Baldwin heavy type M. C. B. inter-urban trucks with the Gibbs cradle suspension. This is a loco-

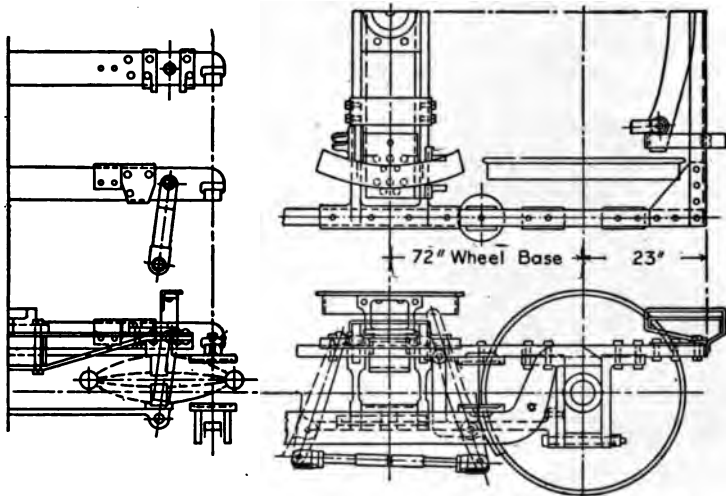

Fig. 21.—General Drawing of Baldwin Truck for Car 284.

motive type of truck, and is becoming quite commonly used on high speed electric railways. A photographic view of the truck is shown in Fig. 20, while Fig. 21 gives a diagrammatic view of its general construction.

Some of the general dimensions and data are the following:

Gage of wheels	4 feet 8½ inches.
Height of center plate above rail, car body loaded . . .	33 inches.
Height of side bearings above rail, car body loaded . . .	36½ inches.
Wheel base	6 feet.
Weight of truck.	9,565 pounds.

Designed to carry on center	
pin	20,000 pounds.
Axles, diameter at center . . .	6.5 inches.
Axles, diameter at wheel seat . .	7.5 inches.
Type of motor suspension . . .	Gibbs' cradle.
Side frames, wrought iron . . .	2 inches by 3 inches.
End frames, angle iron	3 inches by 3 inches.
Pedestals	wrought iron.
Center transom	wrought iron.
Truck bolster, steel plates . . .	9 inches wide.
Center plate	cast iron.
Equalizing bars	wrought iron.
Spring plank	wrought iron.
Brakes	inside hung.
Bolster springs, double elliptic, .	28 inches long.
Equalizing springs, single coil, .	7½ inches diameter.
Wheels, cast steel spoke center,	
steel tired	37½ inches diameter.
Journals	4½ inches by 8 inches.
Journal boxes	cast iron.
Brake leverages	4 to 1.
Extreme length of axles	85½ inches.

Motors.

The driving equipment consisted of four Westinghouse No. 85 motors. This type of motor is similar in capacity and general performance to No. 76 motor of the same company, differing from the latter in its mechanical details.

The manufacturers recommend this equipment for interurban service, and state that under reasonable conditions of grade and alignment a quadruple equipment of No. 85 motors with 33-inch wheels will operate a car weighing from 20 to 25 tons without equipment or load at schedule speeds of approximately 25 miles per hour, with stops at intervals of 1½ to 2 miles. With 36-inch wheels and gears of standard ratio a maximum speed of 45 miles an hour may be maintained.

Car No. 284 had 37½-inch wheels with a gear ratio of 27 to 47, and speeds of over 60 miles an hour were obtained during the tests. The average length of run during the service tests was

3.44 miles, which would correspond to 10.29 stops per mile. A general view of this type of motor is shown in Fig. 22, while Fig. 23 shows the various parts ready for assembling.

GENERAL DESCRIPTION. — The field frame of the motor is made of cast steel and is approximately cylindrical in shape. It is divided into two parts in a plane through the center of the armature shaft and the center of the car axle. It is so designed that when the motor is in position on the truck the holding bolts may be taken out and the upper field lifted off. In order to make this possible, the suspension lugs and projection for the support



Fig. 22. — Westinghouse No. 85 Motor. (General View.)

of the gear case are cast with the lower field. All working parts of the motor are inclosed by the field casting.

The pole pieces are built up of steel punchings, riveted together between end plates of wrought iron and are held to the motor frame by bolts. The poles project radially inward at an angle of 45° with the horizontal. They are made with projecting tips which distribute the magnetism, and also serve to retain the field coils which are held in place by spring washers.

The armature is of the ventilated slotted drum type, and is $15\frac{1}{4}$ inches in diameter. The core is made of sheet steel punchings built up on a cast iron spider, which is pressed on and keyed to the shaft. The commutator is also mounted upon the same spider, and the shaft may be removed without disturbing any

other part. There are 39 slots and 117 coils, *i.e.*, three coils per slot. The end plate at the pinion end is provided with a bell-shaped flange, upon which the windings rest and to which they are securely fastened, so as to prevent any difficulty in this direction when the motor is running at high speeds. The commutator is 12 inches in diameter and is $4\frac{1}{2}$ inches long, and has 117 bars.

The motors have the Gibbs cradle method of suspension, and are so constructed that the upper half of the field frame is readily



Fig. 23. — Westinghouse No. 85 Motor. (Showing Parts.)

removable. Repairs are made by jacking up the car body, running the truck out, and doing all work from above.

The pinion is made of forged steel with machine cut teeth. The gear is made of steel, in one piece, and is pressed on the axle. The gear and pinions have a diametral pitch of $2\frac{1}{2}$ per inch and faces 5 inches wide. The gear case is malleable iron and is in two parts bolted together.

The weight of the No. 85 motor, complete with gears and gear case, is 4,500 pounds. The motor alone without gears and gear case weighs, approximately, 4,000 pounds. The weight of the armature complete with commutator is, approximately, 995 pounds. The weight of a complete four-motor equipment, including motors, one controller, car wiring and usual accessories, is, approximately, 21,140 pounds.

Controller and Car Wiring.

The control equipment consisted of the Westinghouse pneumatic system of train control. In this system the control is accomplished by the combined use of electricity and compressed air. It consists essentially of a master controller and a turret controller. The master controller is operated by hand, and it in turn acts on the turret controller. The latter makes the contacts for the main current, the master controller using a small current only, which is supplied by a storage battery. The master controller is so arranged that there are but two positions in which it can be placed for either forward or backward operation of the car. These positions correspond to the series and the parallel notches on the ordinary controller.

If the controller is placed at the series position the master controller will cause the turret controller to make all of the contacts in their order up to the full series position. If the master controller is placed at the full parallel position the turret controller goes through all of the positions in consecutive order up to the full parallel position of the ordinary controller. The various contacts are made entirely automatically, and the speed at which they are made is regulated by the current which the car takes. A governing solenoid permits a new contact to be made only after the current has been reduced to a certain value which may be determined in advance. This method of train control is described in detail in Part III, Acceleration Tests. The general connections of the motors, resistances and brakes at the various positions of the controller, are shown in Chapter IV.

The Air Brake Equipment.

The air brake equipment consists essentially of the individual motor-compressor straight air brake system as furnished by the Westinghouse Air Brake Company. It is similar in general principle and arrangement to the Christensen air brake equipment used in Car No. 2600 of the St. Louis Transit Company's lines.

RECORDING DEVICES.

Various devices for graphically recording current, speed, pressure, and distance traveled, were employed in the different tests made upon electric cars. As the method used in obtaining these records, as well as the apparatus employed, differed in the several tests, it has been considered advisable in general to place the descriptions of these devices and methods with the matter relating to the specific test where they were first used. The single exception to this procedure is in the case of the recording ammeter made by the General Electric Company. As this instrument was employed upon all of the tests upon electric cars (except that of the industrial locomotive), and as, furthermore, the records obtained from it have been used so extensively in working up the results of the tests, it has been considered advisable to insert the general description of this instrument here.

GENERAL ELECTRIC RECORDING AMMETER.

For the purpose of making records of current which would show all of the fluctuations accurately, the recording ammeter made by the General Electric Company was selected. This instrument (as shown in Fig. 24) consists of the following essential parts:

- An ammeter with powerful torque;
- A recording device;
- A time-marking device.

The ammeter has for its essential feature a strong magnetic field produced by the current to be measured and proportional thereto. The current flows through a few rectangular turns of copper bar, and the range of the instrument may be changed by connecting these turns in series or in parallel. When in series, the range is 600 amperes, and when in parallel, 1,200 amperes. In this magnetic field is supported a movable coil consisting of about eighty turns of fine wire and carrying a direct current which is maintained at a constant value of one ampere. The

current for the movable coil is supplied by a storage battery. In the same circuit are an adjustable resistance and a sensitive indicating ammeter. By means of the resistance the current is adjusted by an attendant. The moving coil is suspended by a controlling spring at the top, and it is guided at the bottom by a small shaft which hangs freely in a bearing when the instrument is in use. The coil is protected from excessive vibration by

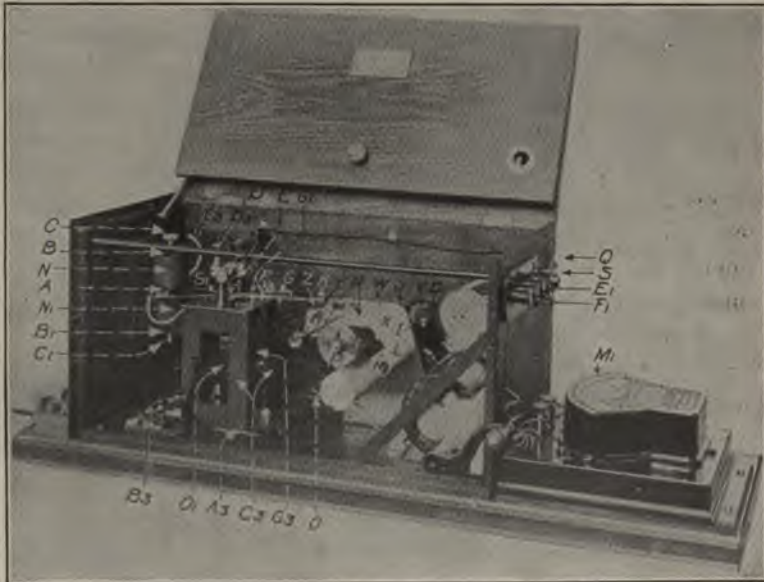

Fig. 24.—General Electric Company's Recording Ammeter.

flexible guides, and it is rendered "dead beat" in its motion by means of an eddy-current brake consisting of a copper arm carried by the moving coil and swinging in the field of a pair of auxiliary electro-magnets. Current is carried to and from the moving coil through spiral conductors which exert no appreciable controlling effect upon the coil. The movement of the coil is controlled by a spiral spring, by the adjustment of which the pointer of the instrument may be restored to its proper zero position.

The movable coil carries an aluminum pointer, approximately 10 inches in length, which is hinged horizontally near its center in order to give it the necessary flexibility. The two parts of the pointer are connected by means of a delicate adjustable spring which may be made to support the entire weight of the outer end of the pointer.

The recording apparatus of this instrument consists essentially of a paper-driving mechanism, a pen carried by the ammeter needle, and a time-marking device.

A powerful spring motor equipment with a sensitive governor drives a drum over which passes a roll of paper. The paper is unrolled from one spool and wound up upon another by the same driving force. Slipping of the paper upon the drum is prevented by means of pins upon the edge of the drum which engage in perforations made along one edge of the paper. The speed of this drum is variable over a wide range. The paper, which is in rolls about 65 feet long, is 3 inches in width, and it is ruled into spaces which indicate readings of 50 amperes and 100 amperes, with the low and the high range of the instrument respectively.

The current record is produced upon the paper by a delicate pen carried at the extreme tip of the ammeter needle. The pen consists of a capillary metal tube, one end of which is bent down to meet the paper, while the other is carried back along the aluminum needle, and dips into a metal ink reservoir located a few inches back from the tip. By siphon action the tube draws its supply of ink from the reservoir and makes a very satisfactory record upon the paper.

The time-marking device employs a second capillary pen which is vibrated by a small electro-magnet. The current for operating this magnet comes from a dry battery, and passes through a contact maker operated by a clock mechanism. The marking magnet operates a small auxiliary pen at set intervals, usually once every five seconds, producing a small mark near the base line of the record. The distance between these marks is altered by changing the speed of the paper-driving mechanism. In these

tests the spaces were generally from $\frac{1}{8}$ -inch to $\frac{1}{4}$ -inch in width. A sample record is shown in Fig. 25.

The main part of the instrument is mounted in a substantial case with a glass cover through which its operation may be inspected, and the time-marking clock and relay with the dry battery occupy a separate case. The delicate indicating ammeter



Fig. 25. — Sample Record from General Electric Company's Recording Ammeter.

which is used in maintaining the current in the movable coil at its proper value, is carried upon a projection at one end of the main case, while the adjusting rheostat is on the rear of the same. All parts are arranged for convenient operation, and throughout the tests the instrument demonstrated its adaptability to all kinds of traction testing.

It will be noted from the above description that the pointer

of the instrument moves in the arc of a circle of approximately 10 inches radius. The record produced is therefore one of curved ordinates. It would be very desirable if the instrument produced records with straight line ordinates, but for all practical purposes this is not essential, and in these tests the records, where necessary, have been transferred to straight line ordinates.

CHAPTER II.

SERVICE TESTS OF A SINGLE-TRUCK CITY CAR.

OBJECTS OF THE TEST.

THE principal object of these tests was to study the general performance of a typical single-truck city car when operated under normal conditions of service, including such measurements as those of speed, current, pressure, power, energy, and motor heating. The car tested had both hand and magnetic brake equipment, so that an opportunity was also afforded to study the general performance when operated upon a given schedule and employing: (a) *hand brake control*, and (b) *magnetic brake control*.

GENERAL DESCRIPTION OF THE TESTS.

The car selected for these tests was a single-truck car, built by the St. Louis Car Company, and equipped by the Westinghouse Electric and Manufacturing Company. It has been described and illustrated in Chapter I.

All of the service tests upon this car were carried out on the tracks provided for the Electric Railway Test Commission by the Louisiana Purchase Exposition Company, the car being operated forward and backward on the shuttle system. As previously stated in the Introduction, these tracks were each about 1,200 feet in length, and were located parallel to and directly north of the Transportation Building at the St. Louis Exposition, and are more fully described in Part VI. All tests were conducted on the north one of these tracks, which was tangent and level for the entire stretch used in the service tests.

SERVICE TESTS OF A SINGLE-TRUCK CITY CAR 77

SYNOPSIS OF RESULTS.

TABLE I. — Synopsis of Results of Service Tests on Single-Truck City Car.

	TEST No. 1.	TEST No. 2.	TEST No. 3.	TEST No. 4.	TEST No. 5.	AV. OF THE 5 TESTS.
Average line pressure (volts) ¹ . . .	525.8	520.0	511.2	514.0	527.2	519.6
Average current (amperes) ¹ . . .	117.0	115.5	116.0	121.0	116.8	117.3
Maximum current (amperes) ¹ . . .	204.0	198.0	199.0	204.0	200.0	201.0
Square root mean square current (amperes) ¹	124.1	121.5	122.0	124.0	123.2	123.0
Average power (watts) ¹	61520	60060	59299	62194	61577	60930
Maximum power (watts)	107300	102000	101000	105000	108400	103740
Length of run (feet)	792	792	792	789	789	791
Time of run (start to stop, seconds),	39.0	37.0	36.8	39.0	37.0	37.7
Time of stop (seconds) ²	15.0	15.5	14.9	11.0	13.0	13.9
Time of run (start to start, seconds).	54.0	52.5	51.7	50.0	50.0	51.6
Average speed (miles per hour) ² . .	13.9	14.6	14.7	13.8	14.5	14.3
Maximum speed (miles per hour) . .	20.8	20.7	20.6	20.8	20.9	20.7
Schedule speed (miles per hour) ² . .	10.0	10.3	10.5	10.8	10.8	10.5
Stops per mile	6.7	6.7	6.7	6.7	6.7	6.7
Average watt-hours per run	359	350	343	338	334	345
Average K.W.-hours per car mile . .	2.39	2.35	2.30	2.27	2.24	2.31
Average watt-hours per ton mile . . .	167	164	161	159	157	162
Average braking current (amperes) ³	...	50.6	58.0	...	50.5	53.0
Maximum braking current (am- peres) ³	90.0	112.0	...	130.0	110.7
Square root mean square braking current (amperes) ³	60.3	71.3	...	69.2	66.9
Average power per run (start to stop, watts) ²	33200	34100	33600	31200	32500	32920
Average power per run (start to start, watts) ²	23950	24000	23884	24336	24100	24054
Average time of run for day (all stops, seconds) ⁴	59.3	61.6	62.3	64.1	66.6	62.8
Average power for day (all stops watts) ⁴	21800	20455	19820	19000	18054	19826
Total time of day's run (hours) ⁴ . .	8.6	5.7	7.6	6.8	6.8	7.1
Temperature rise of motors (°C above 25°) ⁵	36.9	35.1	33.4	33.2	33.1	34.34

- Test No. 1. Sept. 23, 1904, hand brake, dry track.
- Test No. 2. Sept. 24, 1904, magnetic brake, wet track.
- Test No. 3. Sept. 26, 1904, magnetic brake, dry track.
- Test No. 4. Oct. 6, 1904, hand brake, dry track.
- Test No. 5. Oct. 7, 1904, magnetic brake, dry track.

- ¹ For time power was taken.
- ² For regular schedule.
- ³ For time of braking.
- ⁴ Including stops for temperature readings.
- ⁵ Average of fields and armatures by resistance.

It was originally planned to make two service tests of the single-truck car, each test continuing throughout a day, or until the temperatures of the motors had attained constant values. One of these tests was to be with the hand brake control and the other with the magnetic brake control. Five tests of this nature were finally made as shown in the following schedule.

SCHEDULE OF SERVICE TESTS ON SINGLE-TRUCK CITY CAR.

TEST.	DATE.	BRAKE USED.
No. 1 . . .	Friday, September 23d, 1904	Hand Brake
No. 2 . . .	Saturday, September 24th, 1904	Magnetic Brake
No. 3 . . .	Monday, September 26th, 1904	Magnetic Brake
No. 4 . . .	Thursday, October 6th, 1904	Hand Brake
No. 5 . . .	Friday, October 7th, 1904	Magnetic Brake

TEST No. 1. — This was more or less of a preliminary run. The data were not as complete as in subsequent runs, and considerable trouble was experienced in the heating of the axle journals of the car.

TEST No. 2. — This run was not entirely satisfactory, because the axle journals still gave considerable trouble, and because furthermore it began to rain after the test was well under way, and as a consequence the track was wet during a considerable portion of the test.

TEST No. 3. — On Sunday, September 25th, the axle journals were overhauled by the St. Louis Car people, and the test of the 24th was repeated on the 26th.

TESTS NOS. 3 AND 4. — Between September 26th and October 6th a number of acceleration and braking tests were made upon this car, the results of which are shown in Parts III and IV. When this work was completed, it was thought advisable to make two additional service tests before closing the work on the single-truck car. This decision was based upon the fact that the data taken in the test on September 23d (using the hand brake control) were not as complete as desired, and the

further fact that the running condition of the car had improved since the completion of the first service tests. Consequently on Thursday, October 6th, a service test with hand brakes was made, and this was followed on Friday, October 7th, with a service test using the magnetic brake control.

THE TOTAL WEIGHT OF CAR.

The weight of the car equipped and ready for service was 24,665 lb., as stated in Chapter I. The car had a seating capacity of 32 passengers, and it was estimated that 25 passengers would be an average load, exclusive of motorman and conductor. The total load, on the basis of 150 pounds for each person, would be 4,050 pounds. As there were on an average, five persons on the car throughout the tests, a dead load of 3,300 pounds was carried to compensate for the weight of the other 22 passengers. The main dead load consisted of 20 steel billets, weighing 150 pounds apiece, which were placed under the seats of the car. The additional weight of instruments and other appliances amounted to another 300 pounds, making up the necessary total weight, which, under the conditions of test, may be summed up as follows:

	POUNDS.
Weight of car equipped and ready for service	24,665
Weight of total dead load	3,300
Total average live load	750
Total	28,715

This total weight is approximately 14.3 tons.

MOTIVE POWER EQUIPMENT.

The motive power equipment of this car has already been described in a general way in Chapter I. As the service capacity of the motors has an important bearing upon the tests considered in the present chapter, their characteristic features of operation are here briefly discussed.

GENERAL PERFORMANCE. — The general performance of these motors with a gear ratio of 18 to 64 is shown in Figure 26. The

curves are taken from data furnished by the manufacturer, and show the speed, tractive effort, and brake horse-power, which they will develop with currents at from 25 to 200 amperes. The total electrical power input and the efficiency are also shown. The manufacturers made the following statements regarding the service capacity of these motors:

"The motor has a continuous capacity of 50 amperes at 300 volts, or 46 amperes at 400 volts. Under the usual conditions

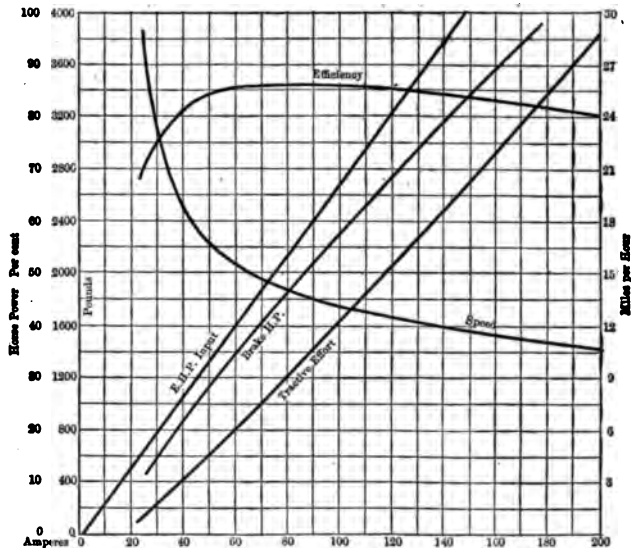

Fig. 26.—Curves Showing the General Performance of the Westinghouse, No. 58 Motor with Gear Ratio 18 to 64.

of railway service, the motor will carry safely any loads within the range shown on the curve, provided the integral heating effect does not exceed the heating effect which is caused by the continuous application of either of these currents at the corresponding voltage.

"In a shop test with either of these loads, the rise in temperature of the windings of the motor, during an all-day run, will not exceed 75° C. as measured by the thermometers. Owing to the improved ventilation which is obtained when the motor

is under a moving car, the temperature rise in service with the equivalent of these loads will usually not exceed 55° C. For short periods, such as the rush hours, the motor may be operated at loads in excess of its continuous capacity. Under these circumstances, however, a corresponding increase of temperature will result."

METHOD OF CONDUCTING THE TESTS.

The first step in planning the tests was to select a schedule of operation which would represent average city conditions, as it was obviously impossible to cover a wide range of such conditions within the available time. The number of stops per mile selected was 6.7, making a distance between stops of 790 feet. The cycle of operation performed during each run was as follows:

1. Power turned full on while the car traveled a given distance. This averaged 123 feet in Tests Nos. 1, 2, and 3, while it was 100 feet in Tests Nos. 4 and 5.

2. Power remained on full up to a certain point. This averaged 472 feet in Tests Nos. 1, 2, and 3, while it was 390 feet in Tests Nos. 4 and 5.

3. Car drifted with power off, and brakes were applied over a distance necessary to bring the car to rest at the proper point.

In further explanation of these items, it should be stated that the power was turned on in a manner such as to produce a uniform acceleration while the allotted distance was being covered, this operation requiring an average of 8.5 seconds.

The power was allowed to remain on until a speed of approximately 20.75 miles per hour was reached, this being the normal speed of the equipment. After a few trials it was found preferable to allow acceleration over a given distance, which was selected as that in which the car reached the speed mentioned.

Power was then turned off, and the car was allowed to drift to a point at which it could be stopped in the allotted distance with a normal brake application. Naturally this differed in the tests, as it was much easier to stop the car with the power brake and it was allowed to drift farther with this than with the hand brake.

The average data corresponding to these test schedules were as follows:

Maximum speed attained (miles per hour) .	20.75
Length of run (feet) .	790
Time of run from start to stop (seconds) .	38
Time of stop (seconds) .	13
Time of run from start to start (seconds) .	51
Average schedule speed (miles per hour) .	10.6

In making the tests, accurate measurements of all quantities were taken over a period of about one hour at the beginning, one hour at the middle, and one hour at the close of each test. These measurements were taken to ascertain the exact conditions under which the run was being made. At other times during the tests, the car was operated systematically in accordance with the fixed schedule, the time of start and stop being recorded for each run. Measurements of motor temperatures were made at intervals throughout the test, which was continued until the motors had reached a practically constant temperature.

ORIGINAL MEASUREMENTS.

The original data may be divided into three general classes: (a) Those relating to speed and distance; (b) those relating to the electrical input; (c) those relating to the temperatures of the motors.

Speed and Distance Data.

Two general methods of measuring and recording speed were employed as follows:

1. A direct-current dynamo with constant field strength, belted to the car axle and producing an e.m.f. proportional to the speed. A recording device was used with this apparatus.

2. A Boyer speed recorder belted to the car axle.

In the first method mentioned, the source of e.m.f. was an "Apple" generator. This is a small generator made for igniting purposes,¹ and it produced an e.m.f. of about ten volts at the highest speed which was attained in these tests. It has per-

¹ By the Dayton Electrical Manufacturing Company, of Dayton, Ohio.

manently magnetized poles and a supplementary field winding. This field winding was connected in series with the moving coil of the recording ammeter, the current of which was maintained constant at one ampere. By this means an absolutely constant field was produced in the small generator used as a speed indicating device. The generator was mounted on the truck and was belted¹ to the car axle.

The e.m.f. produced by the generator was read upon a Weston voltmeter, which indicated an e.m.f. exactly proportional to the speed. Frequent calibrations showed that this method was perfectly reliable for the purpose of indicating speed within the range of the tests.

As shown in Fig. 27, the voltmeter was mounted in a case at one end of a large chronograph, over the cylinder of which was passed a wide strip of paper. The paper was unrolled from a large spool on one side of the chronograph drum and was rolled up on another spool on the other side of the drum. Above the chronograph cylinder and parallel with its axis was a pair of guides upon which traveled a small pencil carriage. From this carriage a cord passed to a small drum mounted upon an auxiliary pointer of the voltmeter. This auxiliary pointer was mounted directly over the needle of the voltmeter, and the movement of the latter was followed by an attendant, who manipulated the pointer. By this means there was traced on the paper carried by the chronograph drum, a line which was at a distance from the base line proportional to the voltage indicated upon the voltmeter, and therefore, to the speed at which the car was moving. The exact ordinates for the various scale divisions were obtained by direct calibration. In connection with the chronograph was a time-marking device, consisting of a pen operated by an electro-magnet. The current which passed through this magnet received an impulse every five seconds from the time-marking device used in connection with the recording ammeter. In connection with the indica-

¹ In subsequent tests it was found more satisfactory to gear the speed generator to the car axle by means of sprocket gears and chain.

tions of the time marker an accurate stop-watch was used for the purpose of calibration.

The Boyer speed recorder consists of a rotary oil pump, the speed of which is proportional to that to be measured. This pump delivers the oil to a cylinder in which it produces pressure upon a piston, the motion of which is recorded upon a strip of paper by a pencil mechanism. The oil passes out of the cylinder through a port, the area of which is increased as the piston rises, so that a definite position of the piston corresponds to each speed. From the cylinder the oil passes back to the pump.

The strip of paper upon which the record is made passes over a drum driven from the car axle giving, therefore, a base line which is proportional in length to the distance traveled.

Electrical Measurements.

The electrical measurements made and the instruments employed were as follows:

QUANTITY MEASURED.	INSTRUMENT EMPLOYED.	METHOD OF MAKING MEASUREMENTS.
Line Pressure.	Weston Indicating Voltmeter.	Every five seconds.
Total Current.	G. E. Recording Ammeter.	Continuous records for certain sections of tests.
Total Current.	Weston Milli-voltmeter with shunt.	Read occasionally to check recording ammeter.
Motor Currents.	Weston Milli-voltmeter with shunt.	Separate tests to determine the division of current between the two motors.
Motor Pressures.	Weston Indicating Voltmeters.	Separate tests to determine division of E. M. F.
Total Energy.	Thomson Integrating Wattmeter.	Operated continuously.
Motor Temperature.	Weston Ammeter and Milli-voltmeter.	Resistance measured periodically and rise in temperature deduced therefrom.

(Temperatures were checked by numerous thermometer measurements.)

The connections and arrangement of instruments to facilitate the measurements were as shown in Fig. 28 and Fig. 29. The controller diagram and the connections of the motors for the power notches of the controller, are shown in Part III on Ac-

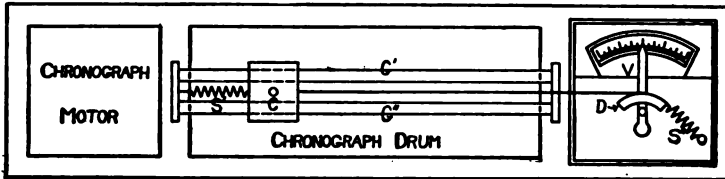

Fig. 27.—Speed Recording Mechanism.

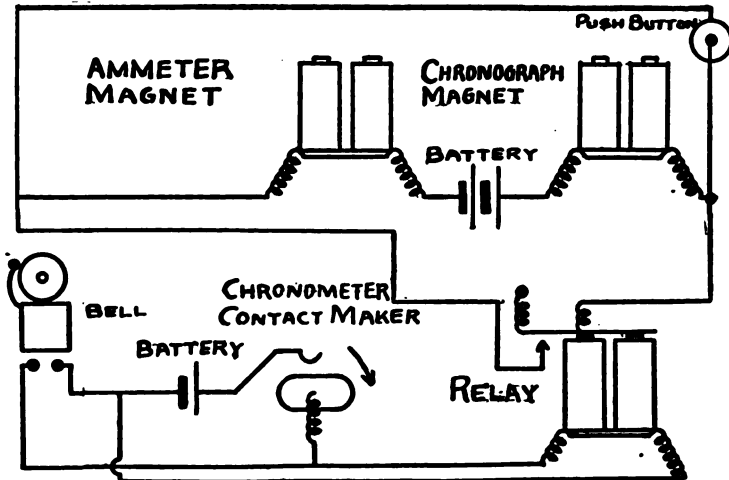

Fig. 28.—Diagram of Connections of Recording Instruments Including Bell Signal and Time Recording Devices.

celeration Tests. The connections for the braking notches of the controller are shown in Part IV on Braking Tests.

WORKING UP THE RESULTS.

The results of the tests have been briefly set forth in the synopsis. The arrangement of apparatus, diagrams of connections, instruments used, and data taken have been discussed

above. The method used in working up the results will now be considered.

It was not only important to take certain data simultaneously, but it was also necessary that these data be taken at certain time intervals, and that the time of the start and stop of the car should be accurately known with respect to these time intervals. It was only by proceeding in this way that the exact relation of all data could be obtained.

With the stop-watch was obtained the total time of run,

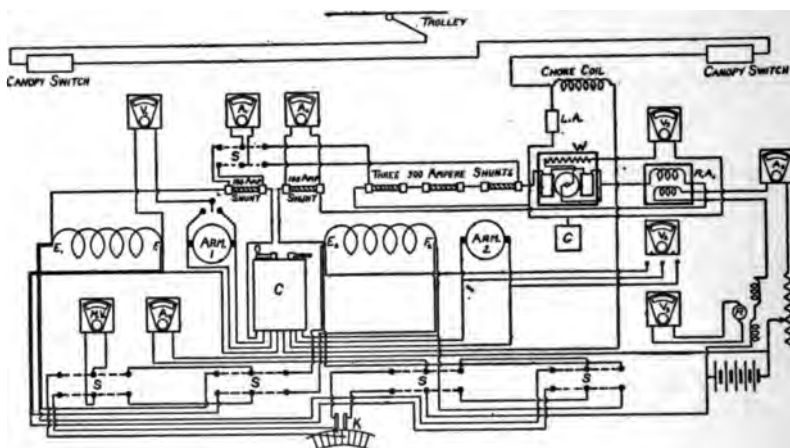

Fig. 29. — Diagram of Connections of Instruments. (Single-Truck Car.)

from the instant that the controller was placed at the first notch until the car came to a standstill. Stop-watch readings were also taken for the period of turning the controller on, total time of power on, period of drifting, and period of braking.

From the current record was obtained not only the actual value of the current at every instant at which current was being taken, but also the actual instant at which the current was applied and the instant at which it was cut off.

Accurate records, with reference to the five second readings of the indicating instruments were made on the ammeter and speed records, at the instant the five second bell rang. It is

evident that all of these readings may be accurately correlated with the records of current and speed.

In working up the final results, it was often necessary to go from one to another of these various sources of information, in order to obtain a complete knowledge of the conditions existing at any given instant.

The Time-Speed Curves.

In working up the time-speed curve for a given run of a test, it was necessary to first locate the actual time of start of each run. This was done by finding the exact instant of start with reference to the five second scores on the recording ammeter record for the particular run, and transferring these data to the speed curve by means of the five second score mark on the latter curve. The second intervals from the start were then carefully measured off and ordinates erected. A number of speed curves for a particular test were worked up in this manner. A table was then compiled showing the speed of each of these runs at the various second intervals. From this table the average speed of all the selected runs was obtained for each second interval from the start. The final speed curve was then plotted.

Since all tests did not have the same time interval, it was necessary to obtain the average time of run from start to stop for a given test. This was done by taking the average time for all runs throughout the day, the time of start and stop having been carefully recorded at the time the test was made. This average time of run was used in plotting the time-speed curve. Upon working up the time-distance curves (which are described below) it was found that the average time-speed curve as obtained in this manner, did not in all cases permit of the exact distances actually traveled from the start to the point at which the controller was placed at the full parallel position, and to the point at which the power was turned off. As these points were fixed by the schedule in each case, they served as a check on the time-speed curves.

Time-Distance Curves.

Since the distance traveled is the summation of the speed and the time at any instant, it is evident that the time distance curve may be obtained by summing up or integrating the areas under the speed time curves for any given interval from the start. The time distance curve was obtained in this manner and was transferred to the curve sheet.

The Current Curves.

The various current curves of a given run were all integrated and the final average value of current obtained, as well as the actual time which the current was on. The average time the current was on and the average current were obtained for all the current curves for the total days run. Twelve or thirteen curves were then selected which conformed most nearly to average conditions as to the shape of the curve, the total time the current was on, and the average current.

The curves were superimposed upon each other and an average curve was obtained. The final curve was reintegrated and was formed to correspond in general outline, area, and time with average conditions. The final curve was enlarged and placed upon the curve sheet.

The Squared Current Curves.

The curves of squared current were obtained by squaring the ordinates of the average current curve and plotting the results. The area of this curve was taken and the average squared value of the current obtained. Finally, the square root of the mean square value of the current was obtained for the entire day's conditions. The heating of the motors depends upon the virtual or square root of the mean square value of the current. This curve is not represented graphically on the charts.

The Pressure Curves.

Line pressure readings were taken at the stroke of the five second bell in each case. The start was intentionally made at

different time intervals with respect to the five second bell on the various runs, so that the values of pressure might be obtained for different points between the five second intervals. The five second bell period was located with reference to the start in the case of each run of a given test. In this way a number of readings would be obtained for each second period of the voltage curves, and these were recorded upon a data sheet. The average value of the pressure at each of the second point intervals was then obtained and this average was placed upon the curve sheet.

The Power Curves.

The curve of total power was obtained by multiplying together simultaneous readings of the instantaneous values of pressure and current taken from the average curve. The curve obtained from these points was plotted and integrated, and the average value of power was thus obtained.

The Division of Current.

In making the tests, an ammeter was placed in each of the motor circuits. It was thus found that the division of current between the two motors was practically equal.

This conclusion was reached by getting the results of a large number of observations. Knowing this general relation between the motors, it was a simple matter to construct a curve, showing the individual current in each case. The various notches of the controller are clearly indicated on the current curves. Knowing the connections between the motors for each position of the controller, it is possible to tell whether the motors are in series or in parallel at a given controller notch. The individual motor current curves are therefore plotted from these data and general information, as shown on the curve sheet. For the controller notches in which the motors are in series operation, the total current is also the individual motor current. For the parallel controller notches, however, the total current is double that of the individual motor currents. This

part of the current curve for a single motor is consequently obtained by taking half of the total current during this period.

The Division of Pressure.

The pressure of each of the individual motors was taken at certain intervals during the tests. From these data it was clearly shown that the motors divided pressure practically equally during the period when they were in series. When the motors were in parallel, the pressure across each of the motors was directly obtained. The method of obtaining the individual motor pressure data was the same as that employed in taking the line pressure data. That is, these data were taken at the sounding of the five second bell in each case, and the five second bell interval was not the same for all runs of a given test relative to the time of start, so that a number of readings might be obtained from the general runs of a given test which would show the pressure on the individual motor at the various seconds, starting from the time at which the current was impressed upon the motors. By correlating these data with reference to the five second score mark and the time of start of the tests in each case, it was possible to obtain a number of data for each second from the time of start. By averaging these data, a curve showing the pressure of the individual motors in each case from one second to the next could be obtained. This curve was plotted on the curve sheet.

The Division of Power.

Curves showing the division of power between the motors and the starting resistances were obtained by multiplying together the instantaneous values of pressure and current as obtained above for the individual motors and for the starting resistance.

RESULTS OF THE TESTS.

The numerical results of the various service tests made upon the single-truck car are shown in tabular form in the synopsis at the beginning of the chapter. It will be noted that the

data relating to the test of September 23d are not as complete as are those for the other tests. This test was the first of the series, and must be considered more or less as a preliminary run.

The results of tests Nos. 2, 3, 4, and 5 are shown in graphical form on the following pages of the chapter. These graphical representations have been divided into three parts for each test. One shows the general results of the test, while the other two show some of the more detailed results.

THE GENERAL DATA.

The plates showing the graphical representation of the general data are plotted on a time base, and curves have been drawn, showing the speed, distance traveled, pressure, total current, and power at each instant from the start to the stop. These diagrams are accompanied in each case by a general log, which gives all detailed information concerning the conditions existing at the time the test was made and also the general numerical results of the test.

THE DETAILED DATA.

In addition to the general diagrams there will be found two detailed diagrams for each of the tests Nos. 2, 3, 4, and 5, in which are shown the division of current, pressure, and power between motors and resistance. The first of these diagrams in each case shows the division of current and power between the two motors and the starting resistances. The second diagram in each case shows the total power, power taken by the motors, and that lost in the starting resistance. The detailed diagrams follow immediately after the general diagrams for a given test.

TEMPERATURE MEASUREMENTS.

The final average temperature rise of the motors at the end of each test has been recorded in the synopsis and also in the general data accompanying the graphical representation of results in each case. Temperature measurements were made at

intervals throughout the day in each case. These readings were taken both by means of thermometers and by means of resistance measurements of armatures and fields. The various temperature measurements are shown in the tables at the end of the chapter.

GENERAL LOG SHEET OF TEST NO. 2.

(Magnetic brake employed in this test.)

(Illustrated by Figs. 30, 31, and 32.)

Date, Saturday, September 24, 1904. *Place*, test tracks north of Transportation Building, World's Fair, St. Louis. *Weather*, unsettled, dry first part of day's run, rain at 11.50 A.M. *Condition of track*, dry at first, but wet during the latter part of run. *Average line pressure*, 520 volts.

Distance Measurements. — Length of a single run, 792 feet or 0.15 of a mile. Stops per mile, 6.7. Distance traveled, from start to the point where the controller was at the full parallel position, 123 feet. Distance traveled from start to the point where the power was shut off, 472 feet. Distance traveled to the point where the brakes were first applied, 641 feet.

Time Measurements. — Time of run (start to stop), 37 seconds. Time of stop, 15.5 seconds. Time of run (start to stop), 52.5 seconds. Average time of run for day (including stops for temperature readings), 61.6 seconds. Total time of day's run, 5.7 hours. Time in turning controller to full parallel position, 8.7 seconds. Time during which power was supplied for each run, 21 seconds. Time from start to the point of applying brakes, 27 seconds. Time from point of application of brakes to stop, 10 seconds.

Speed Measurements. — Average speed (start to stop), 14.6 miles per hour. Maximum speed during run, 20.7 miles per hour. Schedule speed (start to start), 10.3 miles per hour.

Acceleration Measurements. — Average acceleration from the start to the point where the power was cut off, 0.98 miles per hour per second. Maximum acceleration, 2.19 miles per hour per second.

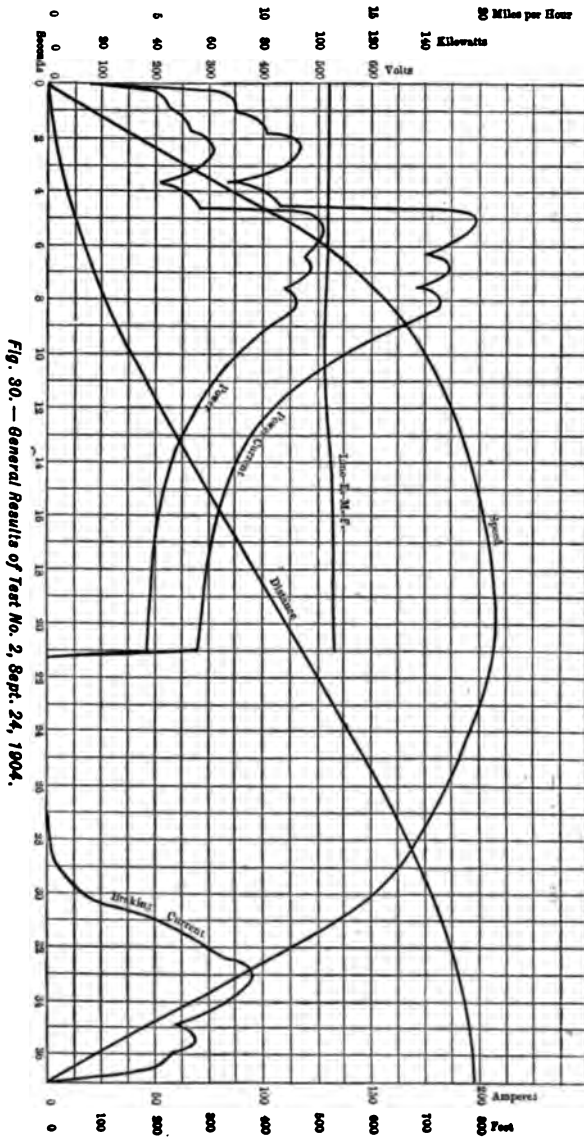

Fig. 30. — General Results of Test No. 2, Sept. 24, 1904.

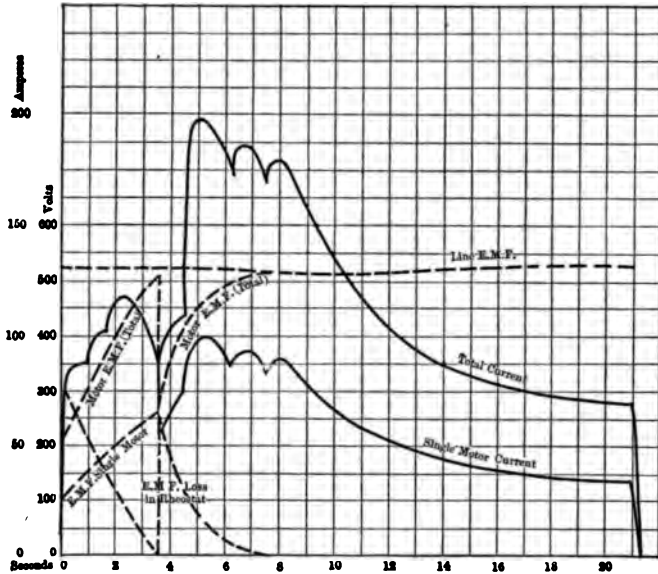

Fig. 31. — Division of Current and Pressure, Test No. 2, Sept. 24, 1904.

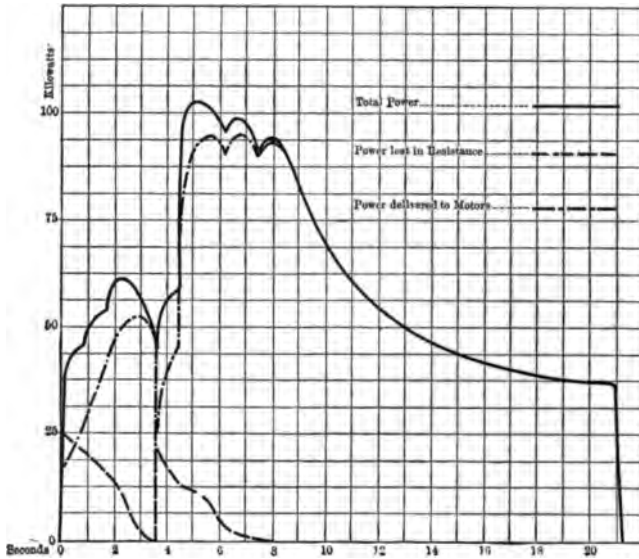

Fig. 32. — Division of Power, Test No. 2, Sept. 24, 1904.

Deceleration Measurements. — Average deceleration from the point where the brakes were first applied to the end of the run, 1.8 miles per hour per second. Maximum deceleration, 2.28 miles per hour per second.

Current Measurements. — Average current (during time power was on), 115.5 amperes. Maximum current during run, 198 amperes. Square root of mean square current, 121.5 amperes. Form factor (square root of mean square current, divided by average current), 1.05. Average braking current (during braking period), 50.6 amperes. Maximum braking current, 90 amperes. Square root of mean square braking current, 60.3 amperes. Form factor of braking current, 1.19.

Power Measurements. — Average power (during time power was on), 60,600 watts. Maximum power, 102,000 watts. Average power per run (start to stop), 34,000 watts. Average power per run (start to start), 24,000 watts. Average power for day (including stops for temperature readings), 20,455 watts.

Energy Measurements. — Average energy per run, 350 watt-hours. Average energy per car mile, 2.35 kilowatt hours. Average energy per ton mile, 164 watt-hours. Average energy per run (obtained from the readings of the integrating wattmeter), watt-hours.

GENERAL LOG SHEET OF TEST NO. 3.

(Magnetic brake used in this test.)

(Illustrated by Figs. 33, 34, and 35.)

Date, Monday, September 26, 1904. *Place*, test track north of Transportation Building, World's Fair, St. Louis. *Weather*, clear, no rain. *Condition of track*, dry and clean. *Average line pressure*, 511.2 volts.

Distance Measurements. — Length of a single run, 792 feet, or 0.15 of a mile. Stops per mile, 6.7. Distance traveled from start to the point where the controller was at the full parallel position, 123 feet. Distance traveled from start to the point where the power was shut off, 472 feet. Distance traveled to the point where the brakes were first applied, 641 feet.

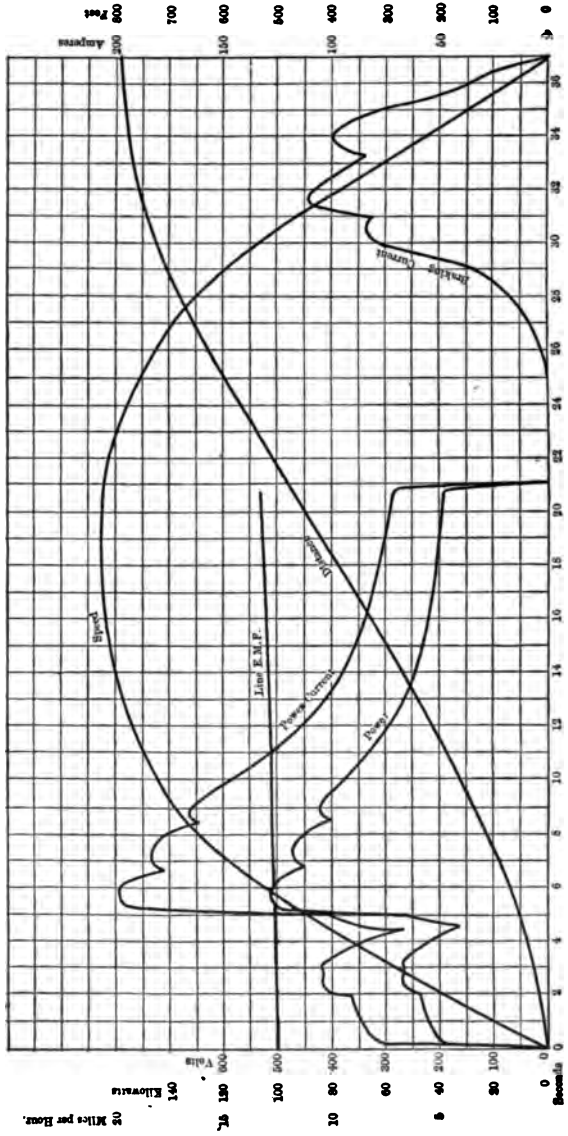

Fig. 33.— General Results of Test No. 3, Sept. 26, 1904.

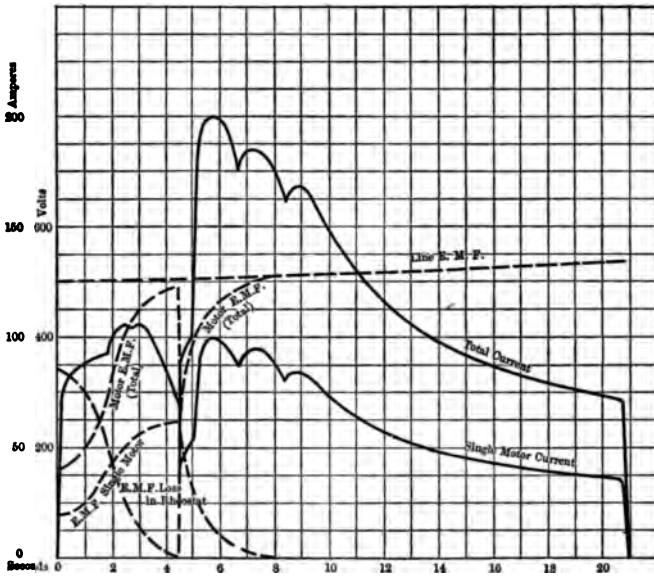

Fig. 34. — Division of Current and Pressure in Test No. 3, Sept. 26, 1904.

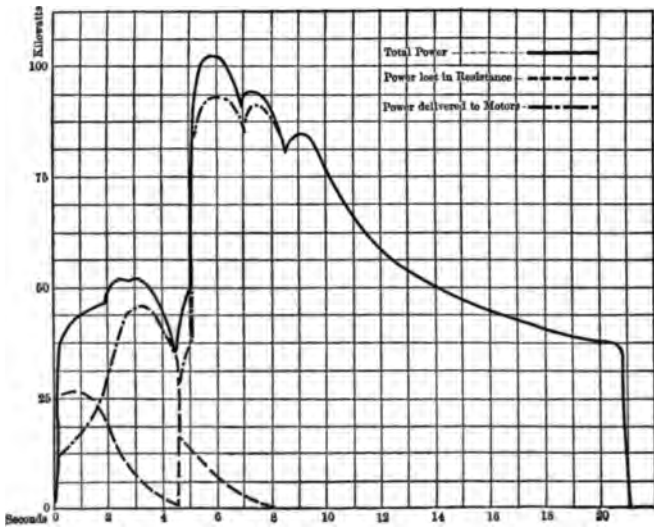

Fig. 35. — Division of Power in Test No. 3, Sept. 26, 1904.

Time Measurements. — Time of run (start to stop), 36.8 seconds. Time of stop, 14.9 seconds. Time of run (start to start), 51.7 seconds. Average time of run for day (including stops for temperature readings), 62.3 seconds. Total time of day's run, 7.6 hours. Time in turning controller to full parallel position, 8.5 seconds. Time during which power was supplied for each run, 20.8 seconds. Time from start to point of applying brakes, 25 seconds. Time from point of application of brakes to stop, 11.8 seconds.

Speed Measurements. — Average speed (start to stop), 14.7 miles per hour. Maximum speed during run, 20.6 miles per hour. Schedule speed (start to start), 10.5 miles per hour.

Acceleration Measurements. — Average acceleration from the start to the point where the power was cut off, 0.99 miles per hour per second. Maximum acceleration, 2.5 miles per hour per second.

Deceleration Measurements. — Average deceleration from the point where the brakes were first applied to the end of run, 1.51 miles per hour per second. Maximum deceleration, 1.95 miles per hour per second.

Current Measurements. — Average current (during time power was on), 116 amperes. Maximum current during run, 199 amperes. Square root of mean square current, 122 amperes. Form factor (square root of mean square current divided by average current), 1.05. Average braking current (during braking period), 58 amperes. Maximum braking current, 112 amperes. Square root of mean square braking current, 71.3 amperes. Form factor of braking current, 1.23.

Power Measurements. — Average power (during time power was on), 59,299 watts. Maximum power, 101,000 watts. Average power per run (start to stop), 33,600 watts. Average power per run (start to start), 23,884 watts. Average power for day (including stops for temperature readings), 19,820 watts.

Energy Measurements. — Average energy per run, 343 watt-hours. Average energy per car mile, 2.3 kilowatt hours. Average energy per ton mile, 161 watt-hours.

GENERAL LOG SHEET OF TEST NO. 4.

(Hand brake employed in this test.)

(Illustrated by Figs. 36, 37, and 38.)

Date, Thursday, October 6, 1904. *Place*, test tracks north of Transportation Building, World's Fair, St. Louis. *Weather*, clear, no rain. *Condition of track*, dry and clean. *Average line pressure*, 514 volts.

Distance Measurements. — Length of a single run, 789 feet or 0.15 of a mile. Stops per mile, 6.7. Distance traveled from start to the point where the controller was at full parallel position, 100 feet. Distance travelled from start to the point where the power was shut off, 390 feet. Distance travelled to the point where the brakes were first applied, 612 feet.

Time Measurements. — Time of run (start to stop), 39 seconds. Time of stop, 11 seconds. Time of run (start to start), 50 seconds. Average time of run for day (including stops for temperature readings), 64.1 seconds. Total time of days's run, 6.8 hours. Time in turning controller to full parallel position, 8.7 seconds. Time during which power was supplied for each run, 19.5 seconds. Time from start to the point of applying brakes, 22.5 seconds. Time from point of application of brakes to stop, 16.5 seconds.

Speed Measurements. — Average speed (start to stop), 13.8 miles per hour. Maximum speed during run, 20.8 miles per hour. Schedule speed (start to start), 10.8 miles per hour.

Acceleration Measurements. — Average acceleration from start to the point where the power was cut off, 1.07 miles per hour per second. Maximum acceleration, 2.14 miles per hour per second.

Deceleration Measurements. — Average deceleration from the point where the brakes were first applied to the end of run, 1.21 miles per hour per second. Maximum deceleration, 4.3 miles per hour per second.

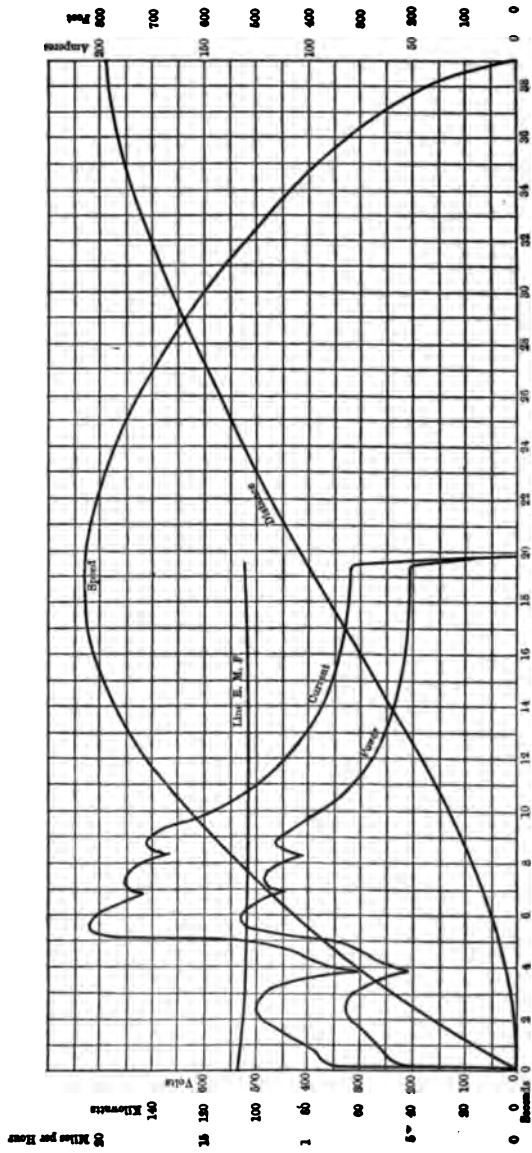

Fig. 36. — General Results of Test No. 4, Oct. 6, 1904.



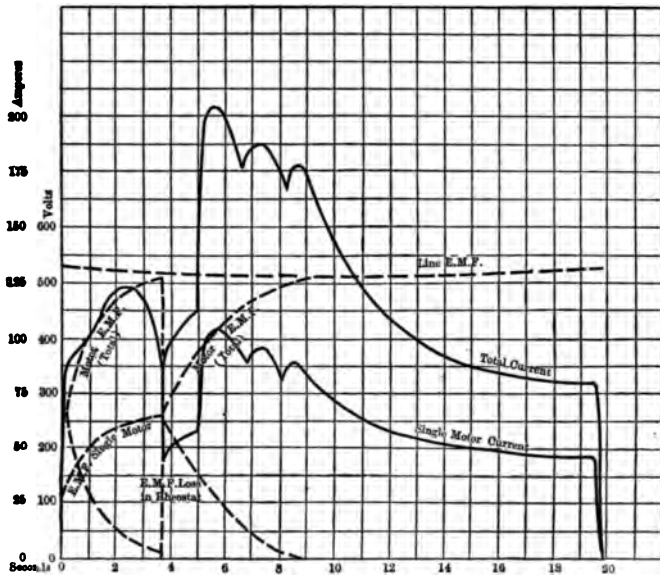

Fig. 37. — Division of Current and Pressure in Test No. 4, Oct. 6, 1904.

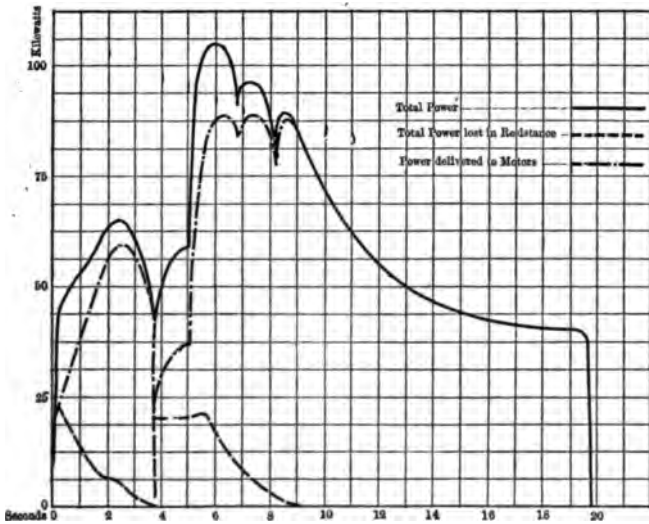

Fig. 38. — Division of Power in Test No. 4, Oct. 6, 1904.

Current Measurements. — Average current (during time power was on), 121 amperes. Maximum current during run, 204 amperes. Square root of mean square current, 124 amperes. Form factor (square root of mean square current divided by average current), 1.03.

Power Measurements. — Average power (during time power was on), 62,194 watts. Maximum power, 105,000 watts. Average power per run (start to stop), 31,200 watts. Average power per run (start to start), 24,336 watts. Average power for day (including stops for temperature readings), 19,000 watts.

Energy Measurements. — Average energy per run, 338 watt-hours. Average energy per car mile, 227 watt-hours. Average energy per ton mile 159 watt-hours.

GENERAL LOG SHEET OF TEST NO. 5.

(Magnetic brake employed in this test.)

(Illustrated by Figs. 39, 40, and 41.)

Date, Friday, October 7, 1904. *Place*, test track north of Transportation Building, World's Fair, St. Louis. *Weather*, clear, no rain. *Condition of track*, dry and clean. *Average line pressure*, 527.2 volts.

Distance Measurements. — Length of a single run, 789 feet, or 0.15 of a mile. Stops per mile, 6.7. Distance traveled from start to the point where the controller was at the full parallel position, 100 feet. Distance travelled from start to the point where the power was shut off, 390 feet. Distance travelled to the point where the brakes were first applied, 612 feet. Time of run (start to stop), 37 seconds. Time of stop, 13 seconds. Time of run (start to start), 50 seconds. Average time of run for day (including stops for temperature readings), 66.6 seconds. Total time of day's run, 6.8 hours. Time of turning controller to full parallel position, 9 seconds. Time during which power was supplied for each run, 19.5 seconds. Time from start to

the point of applying brakes, 25.3 seconds. Time from point of application of brakes to stop, 11.7 seconds.

Speed Measurements. — Average speed (start to stop), 14.5 miles per hour. Maximum speed during run, 20.9 miles per hour. Schedule speed (start to start), 10.8 miles per hour.

Acceleration Measurements. — Average acceleration from the start to the point where the power was cut off, 1.07 miles per hour per second. Maximum acceleration, 1.66 miles per hour per second.

Deceleration Measurements. — Average deceleration from the point where the brakes were first applied to the end of run, 1.71 miles per hour per second. Maximum deceleration, 3.0 miles per hour per second.

Current Measurements. — Average current (during time power was on), 116 amperes. Maximum current during run, 200 amperes. Square root of mean square current, 123.2 amperes. Form factor (square root of mean square current divided by average current), 1.05. Average braking current (during braking period), 50.5 amperes. Maximum braking current, 130 amperes. Square root of mean square braking current, 692 amperes. Form factor of braking current, 1.36.

Power Measurements. — Average power (during time power was on), 61,577 watts. Maximum power, 103,400 watts. Average power per run (start to stop), 32,500 watts. Energy per run (start to start), 24,100 watts. Average power for day (including stops for temperature readings), 18,054 watts.

Energy Measurements. — Average energy per run, 334 watt-hours. Average energy per car mile, 2.24 kilowatt hours. Average energy per ton mile, 157 watt-hours.

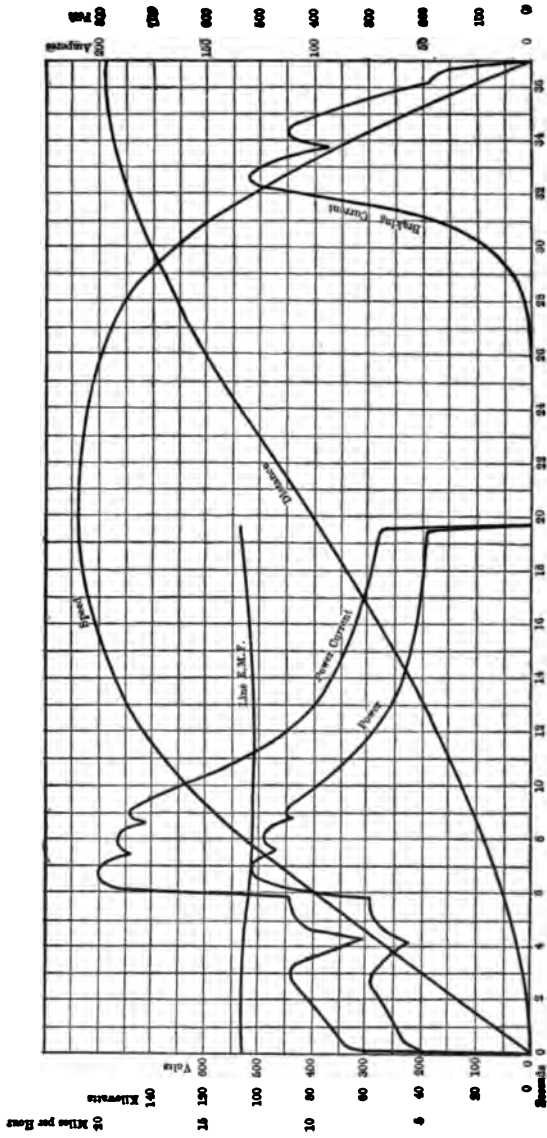

Fig. 30. — General Results of Test No. 5, Oct. 7, 1904.

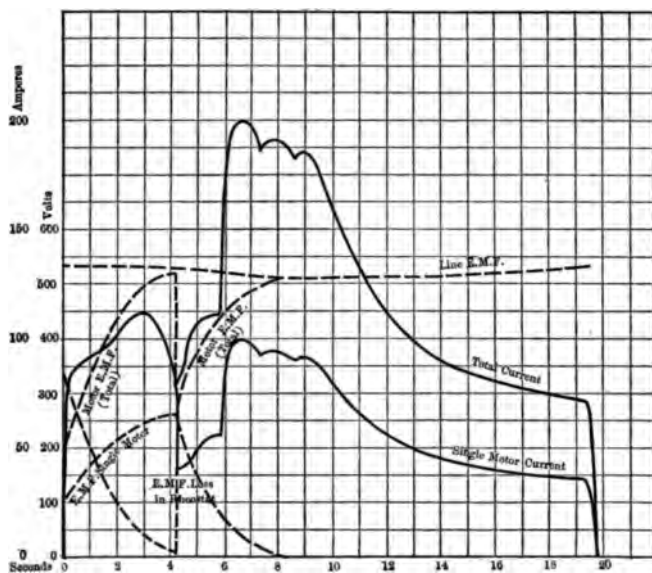

Fig. 40. — Division of Current and Pressure in Test No. 5, Oct. 7, 1904.

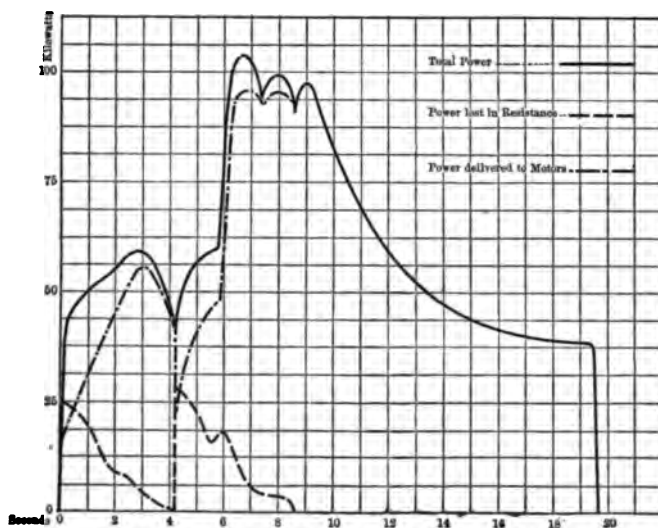

Fig. 41. — Division of Power in Test No. 5, Oct. 7, 1904.

DISCUSSION OF RESULTS.

The service tests on the single-truck city car give data which may be studied in two different ways. In the first place, they afford information as to the performance of a car under a schedule which is frequently met with in service in large cities, the car tested being of ample size and power capacity for such service. In the second place, the data allow of a comparative study of the action of hand and power brakes upon the same car. In this particular case, the power brake used was of the magnetic type, but, aside from the effect that this system produces upon the motors, substantially the same results are secured with any other power brake.

Taking up a consideration of the comparative speed performance in the several tests, it is noted that in all of the tests with the power brake the ratio of the maximum to the average speed is much lower than in the tests with the hand brake, the difference amounting to about 7 per cent. This shows that with the power brake and with the same maximum speed, it is possible to secure a greater average speed. Moreover, this increase of average speed is secured without additional expenditure of power, as it results from the additional time during which the car may be allowed to drift after the shutting off of the power and before the application of the brakes. The efficiency of each run is therefore greater with the power brakes than with the hand brakes. In these tests the rates of acceleration were as nearly uniform as possible, and no significance is to be attached to the slight variations in the maximum and average accelerations.

The variations in acceleration which are noted are due to the employment of a slightly different schedule of operation in Tests Nos. 4 and 5 from that of Tests Nos. 2 and 3. It will be remembered that Tests Nos. 4 and 5 were made some time after the others, and during the interval between considerable study had been put upon improving the schedule, with the result that Tests Nos. 4 and 5 may be considered as somewhat superior to the

others. In the later tests, also, the operators had become more skilled in the manipulation of the apparatus, and they were thus able to secure more uniform results. This is illustrated by the fact that they were able to produce in Tests Nos. 4 and 5, substantially the same maximum speed and schedule speed, with the average rates of acceleration on the two days almost exactly alike. The maximum accelerations differed somewhat, but it was found very difficult to obtain exactly equal maximum rates of acceleration, and this matter affects the results to a negligible extent. The speed recording devices did not possess such a degree of sensitiveness that much reliance can be placed upon the measurements of maximum acceleration, and as the maximum currents were in all cases substantially the same, it is evident that the values of maximum acceleration were closer together than the figures indicate.

The measurements of average deceleration show in marked manner the increase in braking ability of the car equipped with the power brakes. The average time from the point of the application of brakes in the case of the power brake is slightly over eleven seconds, while with the hand brakes this value is above sixteen seconds.

No attempt was made in the service tests to operate the power brakes at abnormal rates, but a smooth, easy stop was made in each case. The increase in the braking rate due to the use of the power brake was from 30 to 40 per cent, and the form of the braking curve was much better. A peculiar fact is noted in regard to the maximum deceleration in Test No. 4. It will be noted that this was over four miles per hour per second, and very much higher than any of the results with the power brakes. This great deceleration occurs just at the instant of stop and it is due to the increase in friction between brake shoes and car wheels as the car approaches rest. Naturally, the motorman tightens his brake as far as his strength will allow toward the end of the braking period, thereby increasing the pressure of the brake shoes more or less gradually as the deceleration progresses. In addition to this, the increase in the

coefficient of friction between shoes and wheel with the diminishing relative velocity between them, results in the final seizure of the wheels by the shoes, and the car is brought to an abrupt stop. It is thus noted that with the hand brake the maximum deceleration is over three times the average, while in the case of the power brakes it is never as much as twice the average. In this particular form of power brake, the braking force automatically decreases as the speed lowers, and thus a more uniform speed is produced, the pressure on the brake shoes being lowest when the coefficient of friction is greatest. The tests show a more uniform deceleration with the power brake than with the hand brake.

In all of the tests the energy consumption is practically the same, the difference being due to minor causes so that there is no material saving in this item obtained by the use of the power brakes. It is interesting to note that in each successive test the number of kw. hours per car-mile was slightly reduced. As this decrease is very regular, it is probably due to the more skilful operation of the car by which the pre-determined cycle of operations was more accurately adhered to. This decrease amounts to not over 5 per cent during the series of tests. There is no significance in the fact that with the hand brake a slightly greater current was used than in the other tests, as the variation is not sufficient to allow any conclusions to be drawn. Both the average and maximum currents are quite uniform throughout the tests and show very careful handling on the part of the motorman, who operated the controller under the direction of an observer provided with an accurate stop watch. It will be noted that the form factor, or ratio of the square root of the mean square current to the average current, is remarkably uniform, being substantially the same throughout the tests, that is 105 per cent. This shows that the cycle of operations, as far as the electrical part was concerned, was reasonably uniform.

A most important feature of this test was the determination of the effect of the current supplied to the brakes by the motors,

upon the heating of the motors. This extra duty upon the motors interferes with the natural cooling which would otherwise occur at times when the power is shut off. Heating of the motors by the braking current is due to two causes, the core losses and the armature and field copper losses. The details of this matter will be found in Chapter X, in which the tests on this brake are especially discussed. For the present purpose it is sufficient to note that a certain current was supplied in each case to the brakes by the motors. The current averaged a little less than 55 amperes in Tests Nos. 2, 3, and 5, and the time during which this current flowed was somewhat over eleven seconds. The form factor of this current is high on account of the peculiar peaked form of the current curve. An average value of the form factor is 128 per cent. The average comparative heating effect of the braking current and the power current can therefore be readily determined in the two cases from the values of the products of the squares of the current and the corresponding intervals of time in seconds. The averages of these products for Tests Nos. 2, 3, and 5 are 751 for the braking period, and 2497 for the power period.

While the core losses have some effect in heating the motors, this effect is not large compared with the heating due to the current in this case, partly because the average e.m.f. during the braking period is low and because the core loss is not a large percentage of the total heating in any case. Attention should be called to the fact that the shunt around the motor field deflected a considerable part of the current from this circuit and reduced the field heating to a corresponding extent.

The temperature measurements show that a somewhat greater rise of temperature is produced by the additional duty imposed upon the motors by the magnetic brake. In ordinary work this would necessitate the employment of slightly larger motors where the power brakes are used. The difference in temperature, however, is not very great, and it corresponds to that which would be expected in view of the amount of current supplied to the brakes, and the duration of the same. In

this test the car was equipped with motors of ample size for both the regular and braking service. The car weighed without passengers twelve and one-fourth tons, and the motors were rated at 50 nominal horse power, giving a power allowance of nearly 8.2 horse power per ton. The results of this test show that the car could have been easily operated on the schedule used with a smaller power equipment, but as the magnetic brake is particularly well adapted to a hilly road where a large motor equipment is necessary, it was appropriate that motors of ample capacity should be placed on the car. It can be stated, therefore, that the car was well adapted for operation in accordance with the schedule used without undue heating of the motors.

SERVICE TESTS OF A SINGLE-TRUCK CITY CAR 111

MOTOR TEMPERATURE DATA.

TABLE II. — Air and Motor Temperature in Degrees Centigrade Single-Truck Car, Test No. 1, Sept. 23, 1904.

	TIME.			
	8.30 A.M.	11.20 A.M.	2.15 P.M.	5.40 P.M.
Hours from the Start	0.0	2.8	5.7	9.2

TEMPERATURE READINGS BY THERMOMETER.

Outside Air	19.5	28.5	28.0	26.5
Field, Motor No. 1	19.5	45.0	66.5	66.0
Field, Motor No. 2	19.0	42.0	57.0	64.0
Frame, Motor No. 1	19.0	36.5	41.0	47.0
Frame, Motor No. 2	19.0	35.5	44.0	47.5
Air Gap, Motor No. 1	20.5	51.0	64.5	70.0
Air Gap, Motor No. 2	20.0	48.5	64.0	75.0
Commutator, Motor No. 1 ..	20.5	65.0	66.0	66.0
Commutator, Motor No. 2...	20.5	58.0	73.0	74.0

TEMPERATURE RISE ABOVE THE AIR TEMPERATURE.

Field, Motor No. 1	0.0	16.5	38.5	39.5
Field, Motor No. 2	-0.5	13.5	29.0	37.5
Frame, Motor No. 1	-0.5	8.0	13.0	20.5
Frame, Motor No. 2	-0.5	7.0	16.0	21.0
Air Gap, Motor No. 1	1.0	22.5	36.5	43.5
Air Gap, Motor No. 2	0.5	20.0	36.0	48.5
Commutator, Motor No. 1...	1.0	36.5	38.0	39.5
Commutator, Motor No. 2...	1.0	29.5	45.0	47.5

TEMPERATURE RISE ABOVE AN AIR TEMPERATURE OF 25° CENTIGRADE.

Field, Motor No. 1	0.0	16.2	37.9	39.2
Field, Motor No. 2	-5.1	13.3	28.6	37.2
Frame, Motor No. 1	-5.1	7.9	12.8	20.4
Frame, Motor No. 2	-5.1	6.9	15.8	20.8
Air Gap, Motor No. 1	1.0	22.1	35.9	43.2
Air Gap, Motor No. 2	0.5	19.7	35.4	48.2
Commutator, Motor No. 1...	1.0	35.9	37.4	39.2
Commutator, Motor No. 2...	1.0	29.0	44.3	47.2

TABLE III. — *Air and Motor Temperature in Degrees Centigrade Single-Truck Car, Test No. 2, September 24, 1904.*

	TIME.		
	9.45 A.M.	1.25 P.M.	3.50 P.M.
Hours from the Start	0.0	3.7	6.1

TEMPERATURE READINGS BY THERMOMETER.

Outside Air	28.5	21.3	22.2
Field, Motor No. 1	27.0	45.0	52.0
Field, Motor No. 2	27.0	48.0	57.0
Frame, Motor No. 1	27.0	36.5	39.5
Frame, Motor No. 2	26.0	36.5	42.0
Air Gap, Motor No. 1	28.5	54.0	64.0
Air Gap, Motor No. 2	27.5	60.0	68.0
Commutator, Motor No. 1	29.5	51.5	63.5
Commutator, Motor No. 2	28.5	57.0	68.0

TEMPERATURE RISE ABOVE THE AIR TEMPERATURE.

Field, Motor No. 1	-1.5	23.7	29.8
Field, Motor No. 2	-1.5	26.7	34.8
Frame, Motor No. 1	-1.5	15.2	17.3
Frame, Motor No. 2	-2.5	15.2	19.8
Air Gap, Motor No. 1	0.0	32.7	41.8
Air Gap, Motor No. 2	-1.0	38.7	45.8
Commutator, Motor No. 1	1.0	30.2	41.3
Commutator, Motor No. 2	0.0	35.7	45.8

TEMPERATURE RISE ABOVE AN AIR TEMPERATURE OF 25° CENTIGRADE.

Field, Motor No. 1	-1.47	24.1	30.2
Field, Motor No. 2	-1.47	27.2	35.3
Frame, Motor No. 1	-1.47	15.5	17.6
Frame, Motor No. 2	-2.46	15.5	20.1
Air Gap, Motor No. 1	0.0	33.3	42.4
Air Gap, Motor No. 2	1.0	39.4	46.5
Commutator, Motor No. 1	1.0	30.7	41.9
Commutator, Motor No. 2	0.0	36.3	46.5

SERVICE TESTS OF A SINGLE-TRUCK CITY CAR 113

TABLE IV.—Air and Motor Temperature in Degrees Centigrade Single-Truck Car, Test No. 3, September 26, 1904.

	TIME.				
	8.30 A.M.	11.00 A.M.	12.35 P.M.	4.10 P.M.	5.30 P.M.
Hours from the Start	0.0	2.5	4.1	7.7	9.0

TEMPERATURE READINGS BY THERMOMETER.

Outside Air	25.0	29.0	30.7	33.7	32.8
Field, Motor No. 1.....	24.0	36.0	48.0	64.5	65.5
Field, Motor No. 2.....	24.0	38.0	52.0	69.0	70.0
Frame, Motor No. 1.....	24.0	31.0	37.0	49.2	50.0
Frame, Motor No. 2.....	24.0	31.0	38.5	51.0	52.0
Air Gap, Motor No. 1.....	23.5	44.0	57.2	73.0	71.5
Air Gap, Motor No. 2.....	23.5	58.0	78.0	77.5
Commutator, Motor No. 1..	24.0	52.0	59.8	75.5	76.0
Commutator, Motor No. 2..	24.0	57.0	68.0	83.2	78.0

TEMPERATURE RISE ABOVE THE AIR TEMPERATURE.

Field, Motor No. 1.....	-1.0	7.0	17.3	30.8	32.7
Field, Motor No. 2.....	-1.0	9.0	21.3	35.3	37.2
Frame, Motor No. 1.....	-1.0	2.0	6.3	15.5	17.2
Frame, Motor No. 2.....	-1.0	2.0	7.8	17.3	19.2
Air Gap, Motor No. 1.....	-1.5	15.0	26.5	39.3	38.7
Air Gap, Motor No. 2.....	-1.5	27.3	44.3	44.7
Commutator, Motor No. 1..	-1.0	23.0	29.1	41.8	43.2
Commutator, Motor No. 2..	-1.0	28.0	37.3	49.5	45.2

TEMPERATURE RISE ABOVE ON AIR TEMPERATURE OF 25° CENTIGRADE.

Field, Motor No. 1.....	-1.0	6.9	16.8	29.3	31.4
Field, Motor No. 2.....	-1.0	8.8	20.7	33.6	35.7
Frame, Motor No. 1.....	-1.0	2.0	6.1	14.8	16.5
Frame, Motor No. 2.....	-1.0	2.0	7.6	16.5	18.5
Air Gap, Motor No. 1.....	-1.5	14.7	25.7	37.6	37.2
Air Gap, Motor No. 2.....	-1.5	26.5	42.2	42.9
Commutator, Motor No. 1..	-1.0	22.6	28.2	39.8	41.5
Commutator, Motor No. 2..	-1.0	27.4	36.2	47.1	43.4

TABLE V. — Air and Motor Temperature in Degrees Centigrade Single-Truck Car, Test No. 4, October 6, 1904.

	TIME.				
	10.10 A.M.	1.10 P.M.	2.30 P.M.	4.15 P.M.	5.40 P.M.
Hours from the Start	0.0	3.0	4.3	6.1	7.5

TEMPERATURE READINGS BY THERMOMETER.

Outside Air	14.0	18.5	19.6	17.0	17.3
Field, Motor No. 1.....	14.0	38.0	42.0	39.0	50.0
Field, Motor No. 2.....	14.0	34.0	50.0	43.0	51.0
Frame, Motor No. 1.....	13.5	26.0	28.8	32.5	32.5
Frame, Motor No. 2.....	14.0	21.2	27.0	31.5	30.0
Air Gap, Motor No. 1	15.0	42.0	47.1	54.0	56.5
Air Gap, Motor No. 2	15.0	44.0	53.5	51.5	59.0
Commutator, Motor No. 1 ..	15.0	47.0	52.0	53.2	58.5
Commutator, Motor No. 2 ..	15.0	50.0	58.0	60.0	57.0

TEMPERATURE RISE ABOVE THE AIR TEMPERATURE.

Field, Motor No. 1.....	0.0	19.5	22.4	22.0	32.7
Field, Motor No. 2.....	0.0	15.5	30.4	26.0	33.7
Frame, Motor No. 1.....	-0.5	7.5	9.2	15.5	15.2
Frame, Motor No. 2.....	0.0	2.7	7.4	14.5	12.7
Air Gap, Motor No. 1	1.0	23.5	27.5	37.0	39.2
Air Gap, Motor No. 2	1.0	25.5	33.9	34.5	41.7
Commutator, Motor No. 1 ..	1.0	28.5	32.4	36.2	41.2
Commutator, Motor No. 2 ..	1.0	31.5	38.4	43.0	39.7

TEMPERATURE RISE ABOVE AN AIR TEMPERATURE OF 25° CENTIGRADE.

Field, Motor No. 1.....	0.0	20.1	23.0	22.9	34.0
Field, Motor No. 2.....	0.0	16.0	31.2	27.0	35.0
Frame, Motor No. 1.....	-0.5	7.8	9.5	16.1	15.8
Frame, Motor No. 2.....	0.0	2.8	7.6	15.1	13.2
Air Gap, Motor No. 1	1.1	24.3	28.2	38.5	40.7
Air Gap, Motor No. 2	1.1	26.4	34.8	35.9	43.3
Commutator, Motor No. 1 ..	1.1	29.4	33.2	37.6	42.7
Commutator, Motor No. 2 ..	1.1	32.5	39.4	44.7	41.2

SERVICE TESTS OF A SINGLE-TRUCK CITY CAR 115

TABLE VI. — Air and Motor Temperature in Degrees Centigrade Single-Truck Car, Test No. 5, Oct. 7, 1904.

	TIME.					
	8.45 A.M.	9.20 A.M.	11.35 A.M.	1.05 P.M.	2.35 P.M.	4.10 P.M.
Hours from the Start	0.0	0.6	2.8	4.3	5.8	7.4

TEMPERATURE READINGS BY THERMOMETER.

Outside Air	12.0	17.0	19.5	22.5	22.1	21.8
Field, Motor No. 1	14.0	24.0	35.0	42.0	50.0	51.0
Field, Motor No. 2	14.0	25.5	39.5	45.0	47.0	54.0
Frame, Motor No. 1	13.5	18.0	32.0	29.0	33.5	37.5
Frame, Motor No. 2	11.7	18.1	24.8	31.7	36.0	37.0
Air Gap, Motor No. 1	15.2	29.0	36.5	46.0	55.5	59.0
Air Gap, Motor No. 2	16.0	28.7	38.5	51.0	59.5	64.8
Commutator, Motor No. 1	15.0	39.5	47.0	58.0	63.0	64.0
Commutator, Motor No. 2	15.0	38.7	52.0	58.7	64.5	68.0

TEMPERATURE RISE ABOVE THE AIR TEMPERATURE.

Field, Motor No. 1	2.0	7.0	15.5	19.5	27.9	29.2
Field, Motor No. 2	2.0	8.5	20.0	22.5	24.9	32.2
Frame, Motor No. 1	1.5	1.0	12.5	6.5	11.4	15.7
Frame, Motor No. 2	-0.3	1.1	5.3	9.2	13.9	15.2
Air Gap, Motor No. 1	3.2	12.0	17.0	23.5	33.4	37.2
Air Gap, Motor No. 2	4.0	11.7	19.0	28.5	37.4	43.0
Commutator, Motor No. 1	3.0	22.5	27.5	35.5	40.9	42.2
Commutator, Motor No. 2	3.0	21.7	32.5	36.2	42.4	46.2

TEMPERATURE RISE ABOVE AN AIR TEMPERATURE OF 25° CENTIGRADE.

Field, Motor No. 1	2.1	7.3	15.9	19.7	28.3	29.6
Field, Motor No. 2	2.1	8.8	20.6	22.8	25.3	32.7
Frame, Motor No. 1	1.6	1.0	12.8	6.6	11.6	15.9
Frame, Motor No. 2	-0.3	1.1	5.4	9.3	14.1	15.4
Air Gap, Motor No. 1	3.4	12.5	17.5	23.8	33.9	37.8
Air Gap, Motor No. 2	4.3	12.2	19.5	28.9	38.0	43.7
Commutator, Motor No. 1	3.2	23.4	28.3	36.0	41.6	42.9
Commutator, Motor No. 2	3.2	22.6	33.4	36.7	43.0	47.0

CHAPTER III.

SERVICE TESTS ON A DOUBLE-TRUCK CITY CAR.

OBJECTS OF THE TESTS.

THE principal object of these tests was to study the general performance of a typical double-truck city car when operated under normal conditions of service in a large city. The car was tested both when the weather was clear and the track dry, and when the weather was bad and the track wet. Consequently, comparative data was obtained of the performance of the car when operated under different weather conditions.

SYNOPSIS OF RESULTS

TABLE VII. — *Synopsis of Results. Service Test on Double-Truck City Car.*

	TEST No. 6.	TEST No. 7.	TEST No. 8.
Weather Conditions	Rainy	Clear	Clear
Total Duration of Test (Hours)	12.05	12.20	11.45
Length of Round Trip (Miles)	10.53	10.53	10.53
Interval of Round Trip Start to Stop (Minutes)	66.5	67.8	69.3
No. of Passengers per round trip (Total)	141	131	130
No. of Passengers (Ave.)	35	32	32
Ave. Line Pressure (Volts)	488.4	471.8	475.6
Ave. Current (Amperes)	53.3	53.3	53.2
Ave. Power (for Round Trip) Watts	26,032	25,147	25,292
Ave. Length of Run (Feet)	1,264	1,158	869
Stops per Mile	4.1	4.5	5.9
Ave. Interval of Stop (Sec.)	8.6	8.6	5.9
Ave. Interval of Run Start to Stop (Sec.)	82.2	76.4	59.1
Ave. Interval of Run Start to Start (Sec.)	90.8	85.0	65.0
Schedule Speed (Inc. Stops) M.P.H.	9.50	9.32	9.12
Average Speed Actual Running Time M.P.H.	10.47	10.34	10.01
Ave. Watt-Hours Per Trip	28,852	28,416	29,212
Ave. kw. Hours per Car-Mile	2.74	2.70	2.77
Ave. Watt-Hours Per Ton-Mile	122	120	123
Ave. Watt-Hours Per Passenger (Total)	203	217	225
Temp. Rise of Motors Above an Air Temperature of 25° C. ¹	44.8° C.	60°	59°

Test No. 6, Aug. 18, 1904, Wet Track, Independent Motor-Compressor.

Test No. 7, Aug. 24, 1904, Dry Track, Independent Motor-Compressor.

Test No. 8, Aug. 29, 1904, Dry Track, Storage Air System.

¹ Average of all Motor Temperatures at the end of the run.

GENERAL CONDITIONS OF THE TESTS.

The service tests upon the double-truck city car were made on the lines of the St. Louis Transit Company, now the United Railways Company of St. Louis. This company is the largest transit company in St. Louis, and operates over 350 miles of single track on over 175 miles of streets.

The company placed every facility at the disposal of the commission during the tests, and endeavored in every way to expedite the work. The tests were not made upon the test tracks on the Exposition Grounds for the reason that the city cars are not adjusted to the standard gage. The test track was also rather short for the size of the car tested, while the conditions existing on the city lines were excellent for securing data showing the performance of a car in regular city service.

The car selected for test is fully described in Chapter I. It was numbered "2600" and was a new car of the most recent type employed by the St. Louis Transit Company.

THE PARK AVENUE LINE.

The Park Avenue line was selected for the tests in preference to other lines of the Transit Company's systems, because its traffic was affected but slightly by the St. Louis Exposition, and it consequently conformed more nearly to ordinary conditions of service. As this line did not run to the Fair Grounds, the excess travel over ordinary conditions was due principally to passengers from and to the Union Depot at 18th Street.

The Park Avenue line is a double-track line running from Tower Grove Park to Third Street and Washington Avenue, a total distance of 5.26 miles. At the time the tests were made an average of 50 cars were in daily service upon this route, with a headway of from one to one and one-half minutes. A map of the route giving the location of the principal streets, is shown in Fig. 42.

The track gage on the lines of the Transit Company is 4 ft. 10 in., instead of the standard gage, 4 ft. 8½ in. This track gage

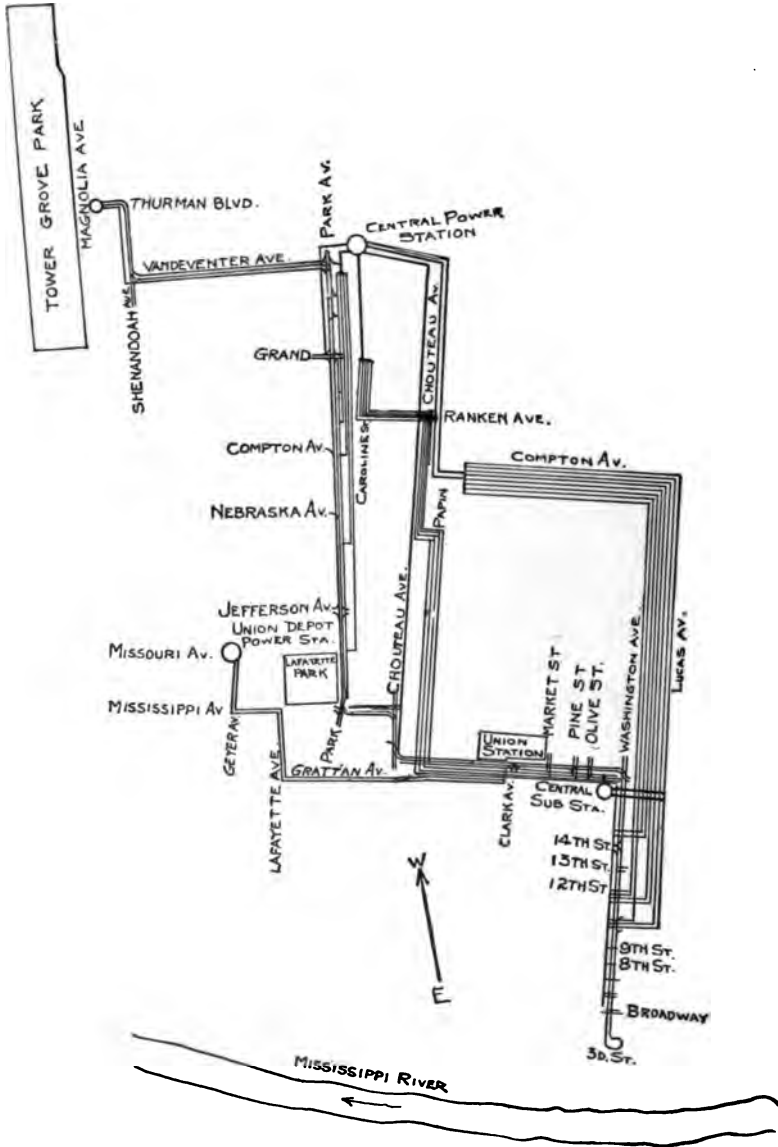

Fig. 42. - Map of Park Avenue Line, St. Louis.

has been used in St. Louis for a number of years, and is required by the city authorities. The track is all laid with girder rails, a portion being 78 lbs. per yard, another portion 80 lbs. per yard, while still a third portion weighs 107 lbs. per yard. The height of rail and weight per yard for the various sections of track are shown in the following table:

Location.	Height of Rail in Inches.	Type of Rail.	Weight per Yard in Pounds.
From Tower Grove Park to Grand Ave. and from Jefferson Ave. to Chouteau Ave.	6	Girder	78
From Mississippi Ave. to 18th St. on Chouteau Ave.	7	Girder	80
From Grand Ave. to Jefferson Ave. and from 18th St. and Chouteau Ave. to 3d St. and Washington Ave.	9	Girder	107

The track is laid upon white oak ties, standard size, spaced two-foot centers. From Third Street to Mississippi and Chouteau Avenues the track is paved with granite. From Mississippi and Chouteau Avenues to the end of the line, at Tower Grove Park, the track is macadamized. In both sections the track pavement corresponds to the street pavement.

From the Third Street loop to Grand Avenue the rails are double bonded with No. 0000 *B* and *S* gage wire, riveted to the rail. No cross bonding occurs in this section. From Grand Avenue to Tower Grove Park the line has cast-welded joints. Where these joints have been found to be defective they have been bonded with copper bonds similar to those in the section from Third Street to Grand Avenue.

The line construction is of the span wire type with poles built up of iron tubing. The average distance between spans is 105 ft. The trolley wire is of No. 00 *B* and *S* gage, and is round in section. The feeder system is shown in Fig. 42. The number of feeders and the points where the feeders tap into the trolley wire are shown on this diagram.

The power was furnished from the central power station. During the morning and evening peaks of the load, the Union Depot station was connected in parallel with the central station feeders supplying the 18th Street Bridge section, and during the evening peak the Washington Avenue station was connected

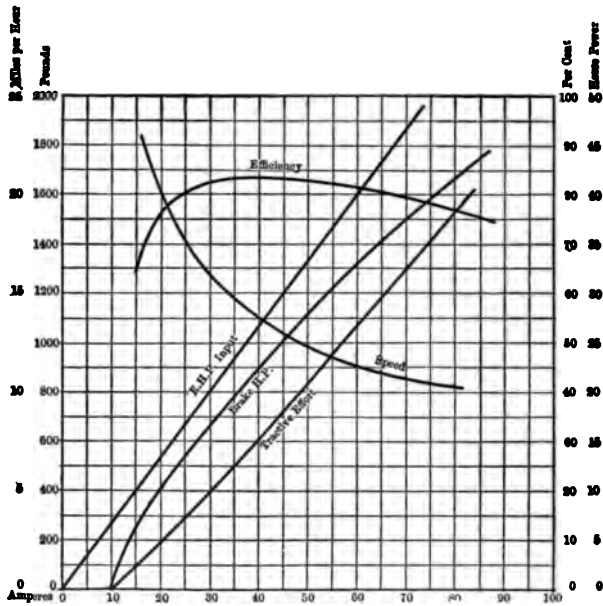

Fig. 43. — Curves Showing the General Performance of General Electric Co. No. 54 Motor.

in parallel with the feeders from the central station supplying the Washington Avenue section.

MOTIVE POWER EQUIPMENT.

The motive power equipment of this car has already been described in a general way in Chapter I. As the service capacity of the motors has an important bearing upon the tests described in the present chapter, their characteristics in operation are here briefly discussed.

The performance of these motors with a gear ratio of 14 to 67 is shown in Fig. 43. The curves are drawn from data furnished

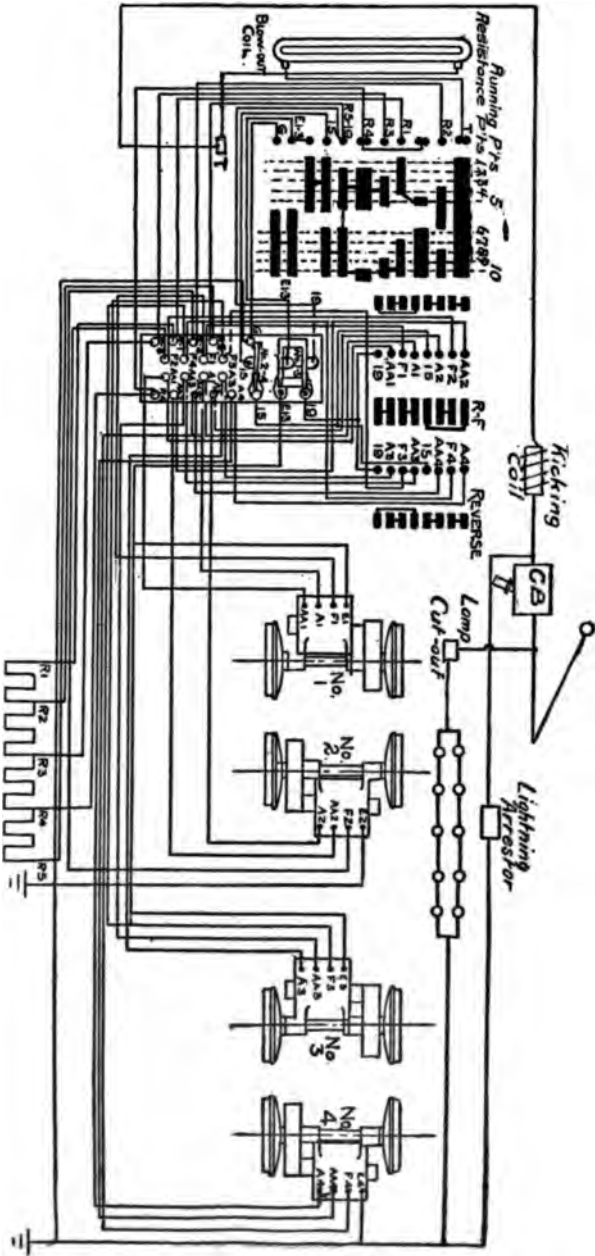

FIG. 43A. — Wiring Diagram of the Controllers and Motors of the Double-Track City Car.

by the manufacturer, and show the speed, tractive effort, and brake horse power which the motors develop when taking from 10 to 80 amperes, and with a pressure of 500 volts at their terminals. The curves also show the total electrical power input and efficiency of the motors under the same loads.

The manufacturers give the rating of these motors at 25 horse power with 45 amperes input and 500 volts at the motor terminals. This output is based upon the standard rating of the American Institute of Electrical Engineers. Its rules state that the commercial rating of a railway motor shall be the horsepower output developed in a stand test producing 75° C. rise of temperature above an air temperature of 25° C., after one hour's continuous run at 500 volts terminal pressure, with the motor covers removed.

GENERAL DESCRIPTION OF THE TESTS.

Service tests were made on this car on August 18th, August 24th, and August 29th, 1904. While the car was operated on the same schedule and over the same line in all three service tests, the conditions were somewhat different in each.

TEST No. 6. — Upon August 18th the car was operated with the individual motor-compressor system of air braking. The day proved to be rainy with an accompanying wet track and muddy street. Consequently, it was deemed advisable to make another series of runs upon a day when the weather conditions would permit of a more representative test from the standpoint of average operating conditions.

TEST No. 7. — The service tests of August 24th were made under conditions of a clear day and a dry track. A comparison of the results of this test with test No. 6 shows many interesting features relating to the service conditions under differing weather conditions.

TEST No. 8. — On August 29th the storage system of air braking was used. The day was clear, and the track dry. From the standpoint of service tests, Test No. 8 is similar to Test No. 6.

SERVICE TESTS OF A DOUBLE-TRUCK CITY CAR 123

In making the car tests upon August 18th, 24th, and 29th, the object was not only to investigate service conditions, but also to study braking conditions. Braking tests under similar conditions, using an individual motor-compressor, were obtained both on a dry track on a clear day, and on a wet track on a rainy day, the data being recorded as a part of the general tests of August 18th and 24th. By the tests of August 24th and 29th a comparison is also afforded of air braking where an individual motor-compressor system is employed as against the storage system of air braking.

Part IV of this report contains the results and deductions relating to the braking data obtained in these and other tests upon the braking of electric cars.

Tests Nos. 6, 7, and 8 were made while the car was running in ordinary service, four of the seats being given up to the accommodation of the test corps and the necessary instruments.

The schedule of the car under test was as follows :

Running Schedule of Car 2600 in the Service Tests conducted on the Park Avenue Line, August 18th, 24th, and 29th, 1904.

Tower Grove Loop.	Park and Vandeventer.	Third and Washington.
	6.31 A.M.	7.00 A.M.
7.38 A.M.	7.42	8.14
8.50	8.56	9.24
10.02	10.06	10.36
11.09	11.15	11.42
12.15 P.M.	12.21 P.M.	12.48 P.M.
1.21	1.27	1.54
2.27	2.33	3.00
3.33	3.39	4.06
4.44	4.50	5.18
5.56	6.02	6.30

ORIGINAL MEASUREMENTS.

For the purpose of making the measurements necessary for determining the car performance, the electrical input, and the motor heating, the following groups of measurements were made:

Electrical Measurements.

These included readings of line pressure at five-second intervals throughout the test and the car current as recorded by a general electric recording ammeter.

The following table gives in compact form the details of the electrical measurements:

Quantity Measured.	Instruments Employed.	Method of Making Measurements.
Line Pressure.....	Weston Indicating Voltmeter.	Readings taken every 5 seconds.
Total Current	G. E. Recording Ammeter.	Continuous record for entire tests.
Total Current	Weston Milli-voltmeter with shunt.	Read occasionally to check recording ammeter.
Motor Armature resistances.	Weston Ammeter and Milli-voltmeter.	Resistance measured periodically and rise in temperature deduced therefrom.

Speed and Distance Records.

These included a graphical speed record on the Boyer recorder ; frequent and regular readings of speed by means of a magneto-generator driven by the car axle; readings of the time and duration of each stop, of the time and duration of each run, and of the time of passing the farther crossings of the street intersections.

Temperature Measurements.

These included the determination of the electrical resistance of the motor armatures at reasonably frequent intervals; and readings of the air temperature. Thermometer readings of motor temperatures were also taken.

Sundry Measurements.

Other data recorded cover the number of passengers carried at any time, and the weather and track conditions.

In addition to these measurements all quantities relating to the braking equipment were carefully measured, and the results of this work will be found in Part IV.

Diagram of Connections.

The general arrangement of instruments and a diagram of the connections for the service tests are given in Fig. 44. The instruments used were similar to those already described in Chapter II, and the general method of conducting the tests was also similar to that outlined in Chapter II.

Data Sheets.

In collecting the original data a blank form was used somewhat similar to that shown in Fig. 118. Each observer recorded his observations on forms of this kind, and which were collected together from time to time during the tests. The forms were later bound together, and arranged in book form.

Weight of Equipment.

The weight of the car equipped, but without load, was 20 tons or 40,000 lbs. In addition to this the instrument equipment weighed 300 lbs., and there was an average number of eight observers. The total weight of the car with test equipment and observers (the latter estimated at 150 lbs. each) was 41,500 lbs. The average passenger load during the tests was 21, making a weight of 3,150 lbs. The total average weight was therefore :

Car equipped for regular service	40,000 lbs.
Motorman and conductor	300 lbs.
Test corps	1,200 lbs.
Instruments	300 lbs.
Average passenger load	3,150 lbs.
Total	44,950 lbs.

or practically 22½ tons.

WORKING UP THE RESULTS.

The results of the tests have been briefly set forth in the synopsis. The arrangement of the apparatus, the diagram of connections, the instruments used, and the data taken have been discussed above. The methods used in working up the results will now be considered.

As in the service tests on the single-truck city car, it was not only important to take certain data simultaneously, but it

was also necessary that these data be taken at certain time intervals, and that the time of the start and stop of the car should be accurately known with respect to these time intervals. It was only by proceeding in this way that the exact relation of all data could be obtained.

In working up the data each test was divided into a number of round trips, over the Park Avenue line, with the Tower Grove Park loop as the starting point. These round trips were numbered consecutively, and the times of leaving and arriving at the

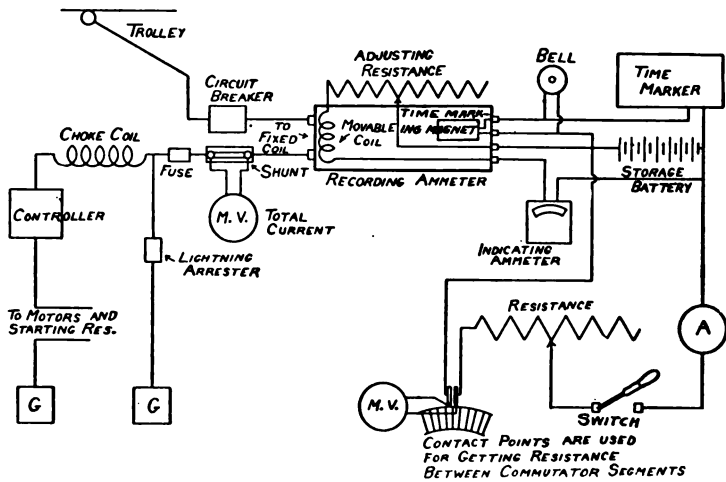

Fig. 44. — Diagram of Connections, Service Tests of Double-Track City Car.

Tower Grove Park loop were accurately obtained. The distance traversed in each of these round trips was 10.53 miles, and each test included an average of 10 of these trips. The time required for the round trip in each case was obtained from the start and stop data, as was also the time of lay-over at the Tower Grove Park loop. According to the established schedule upon which the car was operated, a lay-over of four minutes was fixed for certain trips of the day's run. This lay-over permitted of the reestablishment of the schedule in case of blockades and other delays which arise under ordinary

conditions of service, and of the taking of temperature readings at intervals throughout the tests.

The line pressure readings, which were taken every five seconds, were averaged for each round trip. The average current for each round trip was obtained by integrating the current curves for a particular trip. In obtaining both the average volts and the average amperes, the total time from start to stop of a round trip was considered in each case.

The average power was obtained by multiplying together the average line pressure and the average current for a given trip. Here also the average has been taken for the total period of time of a given trip from the start to the stop at the Tower Grove Park loop. In a similar manner, the energy for a round trip in kilowatt hours has been obtained by multiplying together the average watts by the total time in hours elapsing from the start to the stop of a round trip.

A careful record was made throughout the test of the actual number of passengers getting on and off of the car at each stop. These data permitted of obtaining the total number of passengers carried for each round trip, as well as the average number of passengers per trip.

The energy per car-mile in kilowatt hours was obtained by dividing the total energy in kilowatt hours per round trip by 10.53, which is the actual length of a round trip in miles.

The energy per ton mile in kilowatt-hours was obtained by dividing the energy per car-mile by the total weight of the car, including the observers and the average number of passengers for the trip. The total weight was approximately $22\frac{1}{2}$ tons, as previously stated. The energy required per round trip per passenger carried was obtained by dividing the total energy taken in a round trip in watt-hours by the total number of passengers and observers carried during the trip.

The average length of run in feet from start to stop was obtained for each trip by dividing the total distance traversed by the number of stops, these data having been carefully recorded in each case. The average interval of run from start to stop,

was obtained by dividing the actual running time of a round trip by the total number of stops for the trip. The stops per mile were obtained for each trip by dividing the total number of stops by 10.53, which was the total distance in miles. The average interval of stop in seconds was obtained by dividing the total number of seconds for stops during the round trip by the number of stops. The schedule speed in miles per hour was calculated by dividing the total distance traversed in miles for a round trip by the actual time in hours elapsing from the start to the stop for each trip.

The average running speed (not including stops) in miles per hour was obtained by dividing the total length of a round trip in miles by the actual running time (deducting all stops) for the given round trip.

As previously stated, temperature measurements were made at intervals throughout the day. These measurements consisted of readings of the resistances of the armatures of each of the four motors by the "fall of potential" method. This consisted essentially in sending a known current through the armature of the motor by means of a storage battery, the trolley circuit being cut off during the time the measurements were taken. The pressure drop across the commutator bars was read on a millivoltmeter, the current in the armature being recorded at the same time. Measurements of this kind were taken each day before the car left the barns, and at the close of the test, as well as at intervals throughout the tests.

The temperature of the outside air was also recorded whenever armature resistance measurements were made. From these data the resistances of the armatures were computed, and the rise in temperature at a given time of the day was determined. The final average rise of temperature for the four armatures at the close of each test was computed in accordance with the rules of the American Institute of Electrical Engineers, and is recorded on the log sheet accompanying the detailed data of each test.

RESULTS OF THE TESTS.

Some of the more important numerical results of the various service tests made of the double-truck city car are shown in tabular form in the synopsis at the beginning of the chapter.

It has been found impossible to represent the results of all the tests graphically. The more detailed data for each of these service runs are here shown in tables, which are supplemented by log sheets similar to those accompanying the graphical representations of the results of the service tests of the single-truck city car given in Chapter II. In these tables will be found the detailed data for each trip of the various tests. The average data for the day, together with other general items showing the conditions under which a test was run, will be found in the log sheets accompanying the tables.

THE GRAPHICAL LOG.

While it has not been considered possible to represent graphically the results of the various service tests made upon the double-truck city car, it has been thought desirable to show in this manner the results of a single trip which has been taken as typical of the conditions existing throughout the entire series of runs. The trip chosen for this purpose (which was selected more or less at random) is one-half of trip No. 7 of August 24th, and it covers the distance from the Third Street loop in the center of the city of St. Louis, to the Tower Grove Park loop at the end of the Park Avenue line.

Time has been taken as a base in making up this graphical log. The profile is consequently not shown at this point, but will be found in Part IV, where the braking results of these tests are graphically shown on a distance base.

The Speed Curve.

In taking the original data a Boyer railway speed recorder was employed for speed measurements. In addition to this a small magneto-generator was driven by the car axle, and the pressure generated was read by means of a milli-voltmeter. The

was obtained by dividing the actual running time of a round trip by the total number of stops for the trip. The stops per mile were obtained for each trip by dividing the total number of stops by 10.53, which was the total distance in miles. The average interval of stop in seconds was obtained by dividing the total number of seconds for stops during the round trip by the number of stops. The schedule speed in miles per hour was calculated by dividing the total distance traversed in miles for a round trip by the actual time in hours elapsing from the start to the stop for each trip.

The average running speed (not including stops) in miles per hour was obtained by dividing the total length of a round trip in miles by the actual running time (deducting all stops) for the given round trip.

As previously stated, temperature measurements were made at intervals throughout the day. These measurements consisted of readings of the resistances of the armatures of each of the four motors by the "fall of potential" method. This consisted essentially in sending a known current through the armature of the motor by means of a storage battery, the trolley circuit being cut off during the time the measurements were taken. The pressure drop across the commutator bars was read on a millivoltmeter, the current in the armature being recorded at the same time. Measurements of this kind were taken each day before the car left the barns, and at the close of the test, as well as at intervals throughout the tests.

The temperature of the outside air was also recorded whenever armature resistance measurements were made. From these data the resistances of the armatures were computed, and the rise in temperature at a given time of the day was determined. The final average rise of temperature for the four armatures at the close of each test was computed in accordance with the rules of the American Institute of Electrical Engineers, and is recorded on the log sheet accompanying the detailed data of each test.

RESULTS OF THE TESTS.

Some of the more important numerical results of the various service tests made of the double-truck city car are shown in tabular form in the synopsis at the beginning of the chapter.

It has been found impossible to represent the results of all the tests graphically. The more detailed data for each of these service runs are here shown in tables, which are supplemented by log sheets similar to those accompanying the graphical representations of the results of the service tests of the single-truck city car given in Chapter II. In these tables will be found the detailed data for each trip of the various tests. The average data for the day, together with other general items showing the conditions under which a test was run, will be found in the log sheets accompanying the tables.

THE GRAPHICAL LOG.

While it has not been considered possible to represent graphically the results of the various service tests made upon the double-truck city car, it has been thought desirable to show in this manner the results of a single trip which has been taken as typical of the conditions existing throughout the entire series of runs. The trip chosen for this purpose (which was selected more or less at random) is one-half of trip No. 7 of August 24th, and it covers the distance from the Third Street loop in the center of the city of St. Louis, to the Tower Grove Park loop at the end of the Park Avenue line.

Time has been taken as a base in making up this graphical log. The profile is consequently not shown at this point, but will be found in Part IV, where the braking results of these tests are graphically shown on a distance base.

The Speed Curve.

In taking the original data a Boyer railway speed recorder was employed for speed measurements. In addition to this a small magneto-generator was driven by the car axle, and the pressure generated was read by means of a milli-voltmeter. The

Boyer railway speed recorder gave a record of the speed on a distance base. The pressure readings of the magneto-generator were taken at the stroke of the five-second bell, and therefore would give the speed on a time base. In addition to these speed data, the actual time of passing the farther crossings of the street intersections was accurately recorded.

In working up the results it was found that no dependence could be placed upon the data obtained from the magneto-generator. This was due to the particular apparatus used, and not to this general method of obtaining speed data. The service tests upon the double-truck city car were the first tests of this nature undertaken by the Commission, and the magneto-generator used in these tests was in later tests replaced by an "Apple" generator, which gave very satisfactory results.

Because of the fact that the data obtained from the magneto-generator could not be depended upon, it was necessary to fall back on the Boyer railway speed recorder and the data showing the time of passing the farther crossings of the street intersections, for speed measurements. The Boyer railway speed recorder was calibrated in position by jacking up the car with the truck in position, and running the wheels at different speeds, simultaneous readings being taken of the revolutions of the wheels, and of the indicating gage of the recorder. At the same time a record was taken on the tape of the recording instrument. In working up the speed curve the Boyer record was plotted to a larger scale and integrated between street intersections. The average speed thus obtained was checked by the distance traversed, and by the elapsed time, as shown by the other data.

After having made certain that the distance-speed curve was correct, it became necessary to change this over to a time-speed curve. This was done by first laying off on a time base the actual time at which the car passed the farther crossings of street intersections, and also the actual time of start and stop where stops were made. The various loops of the distance-speed curve were then divided into a number of sections, and these sections

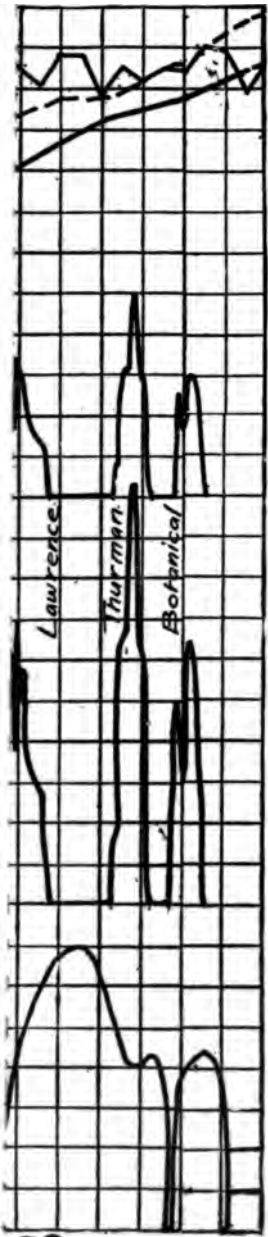

30

(To face page 130)



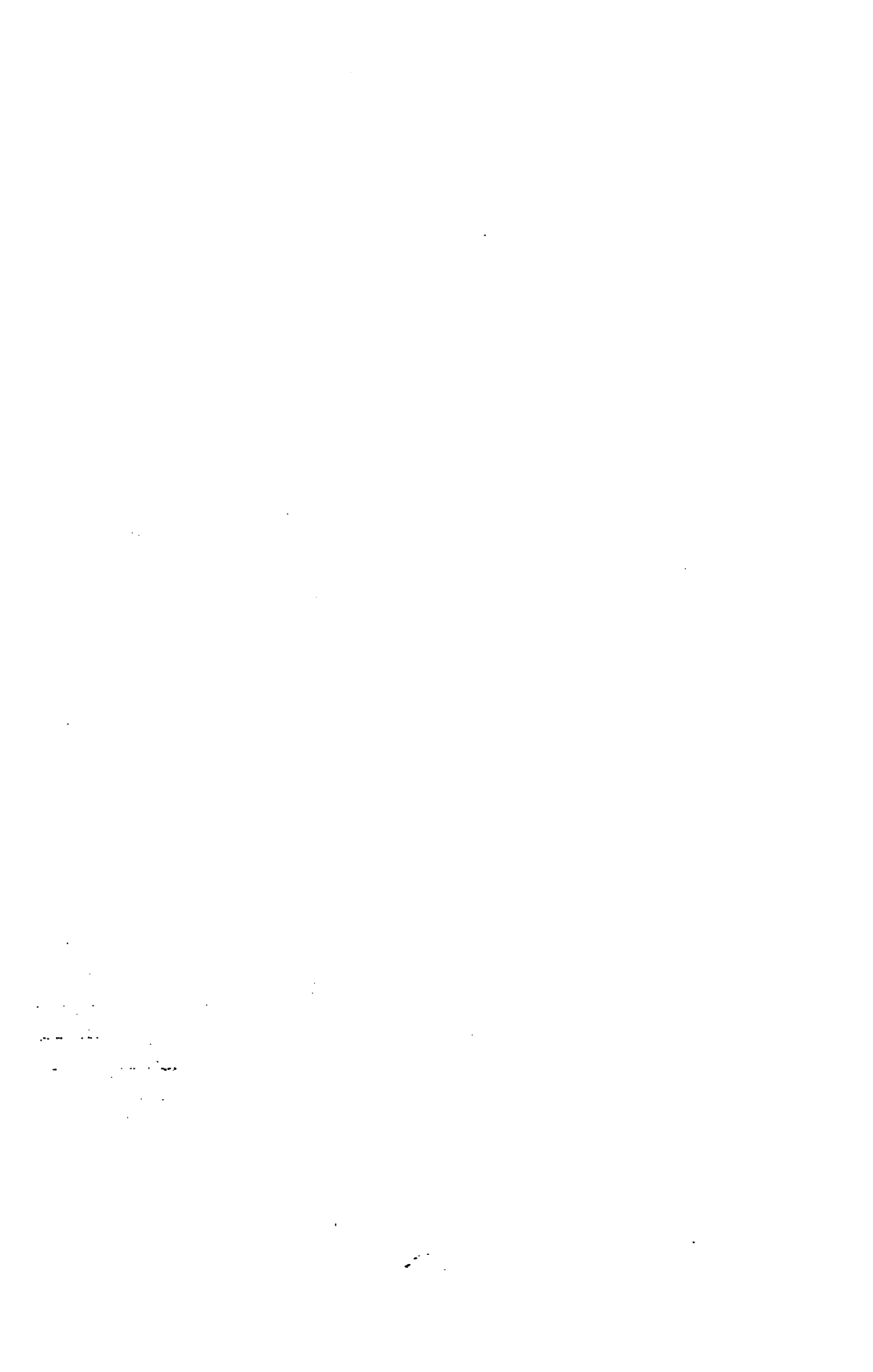

were each integrated independently and the average speed obtained for each section. As the base of the loop up to the ordinate considered, showed the distance traversed to this point, this distance was obtained and was divided by the average speed. This gave the time which had elapsed up to the point considered. This period of time was laid off on the time-speed curve, and the average speed for the period was assumed to occur at one-half the elapsed time. This speed value was then plotted on the time-speed curve. By proceeding in this manner, step by step, the various points on the time-speed curve were obtained from the distance-speed curve. Where the curve was not shown sufficiently in this way, additional data were obtained to show intermediate points. The time-speed curve was then plotted.

The Pressure Curve.

The pressure curve was obtained by plotting the five-second readings for the entire run, and straight lines were drawn between the consecutive points.

The Current Curve.

The current curve was replotted directly from the current record produced by the recording ammeter, which record was already on a time base.

The Power Curve.

The power curve was obtained by multiplying together the instantaneous values of the line pressure and the current as shown by the recording ammeter, for each five-second interval throughout the run. These points were plotted, and the intermediate points filled in according to the general shape of the current curve, due consideration being given to any variations in pressure during the interval.

The Distance Curve.

The distance curve was obtained directly from the data showing the time of passing the farther crossings of the street intersections. Where a stop was made, the time of stop is shown by a line parallel to the base on the distance curve.

The Energy Curve.

The curve showing the total energy consumed up to a certain point on the trip was obtained by integrating the ammeter curve up to this point, and multiplying the ampere-hours thus obtained by the average pressure up to the point considered. Where a stop occurs, the energy curve shows a line parallel to the base for the time of stop. No attempt was made to show the instantaneous variations in the form of the energy curve between the street intersections. The increase in energy taken is shown by a straight line from one street to the next in each case.

This graphical log is shown opposite page 138 and is Plate I, Fig. 45. The general log for this particular run is given in considerable detail. This general log shows the general conditions under which this particular run was made, in a manner similar to the explanatory logs accompanying the tabulated general results of the various tests. In this log, for a specific run will be found additional data concerning maximum values of speed, current, and power.

In order to show the relations of the maximum values of speed, current, and power to the average values, the following plan was employed. From the time-speed, time-current, and time-power curves, the maximum values of all loops were obtained, and these were averaged. This gave the average maximum values of the various quantities. Finally, the highest value which each of these attained during the tests was obtained in order to indicate the extreme maximum values and their relations to the average maximum values.

GENERAL LOG SHEET OF TEST NO. 6.

(Independent Motor-Compressor Air Brake System.)

Date, Thursday, August 18th, 1904 ; *Place*, St. Louis, Mo.; *Route*, Park Avenue line of St. Louis Transit Company, running from Tower Grove Park to Third Street and Washington Avenue ; *Weather*, unsettled, rainfall of 0.16 inch between 6.27 A.M. and 6.20 P.M. The average air temperature during the run was 22.6° C. or 72.7° F. *Condition of track*, dry at first but

wet during the greater part of the test. *Test started*, 7.02 A.M. *Test stopped*, 7.05 P.M. *Total duration of test*, 12.05 hours.

Average Data for Day.

Passengers. — Total number of passengers per round trip, 141; average number of passengers on car, 35.

Pressure Measurements. — Line pressure, 488.4 volts.

Distance Measurements. — Length of a round trip, 55,600 ft. or 10.53 miles; stops per mile, 4.1; stops per round trip, 43; length of a single run (start to stop), 1264 ft.

Time Measurements. — Interval of round trip (start to stop), 66.5 minutes; interval of lay-over at the Tower Grove Park loop, 2.0 minutes; interval for total stops for trip, 6.2 minutes; running time for trip, 60.3 minutes; interval of round trip (start to start), 68.5 minutes; interval of a single run (start to stop), 82.2 seconds; interval of stop, 8.6 seconds; interval of a single run (start to start) 90.8 seconds; interval of a run (start to start and including all stops for temperature readings and lay-over at the Tower Grove Park loop), 93.4 seconds.

Speed Measurements. — Average speed (actual running time), 10.47 miles per hour; schedule speed (including stops during trip), 9.50 miles per hour.

Current Measurements. — Average current (for round trip), 53.3 amperes; average current (actual running time), 58.8 amperes; average current for the day, 51.7 amperes.

Power Measurements. — Average power (for round trip), 26,032 watts; average power (actual running time), 28,708 watts; average power for the day, 25,272 watts.

Energy Measurements. — Average energy per round trip, 28,852 watt-hours; average energy per run (start to stop), 656 watt-hours; average energy per car-mile, 2740 watt-hours; average energy per ton-mile, 122 watt-hours; average energy per passenger carried (total for trip), 203 watt-hours.

Temperature Measurements. — (Degrees centigrade), (Conditions at the end of the run), temperature of outside air, 23.5°; average temperature of motor armatures, 68.0°; average temperature rise above an air temperature of 25.° C., 44.8°.

TABLE VIII. — Results of Tests No. 6, Aug. 18, 1904. Arranged by Trips.

Trip Number.....	1 ¹ A.M.	2 A.M.	3 A.M.	4 A.M.	5 A.M. P.M.	6 P.M.	7 P.M.	8 P.M.	9 P.M.	10 P.M.	11 P.M.
Time of Start	7:02	7:39	8:51	10:02	11:11	12:19	1:25	2:32	3:34	4:44	6:00
Time of Stop	7:32	8:47	9:57	11:11	12:19	1:25	2:32	3:34	4:38	6:00	7:05
Interval of Round Trip, Min.....	60	68	66	69	68	66	67	62	64	76	65
Lay-over at Tower Grove Park Loop, Min.	7	4	5	0	0	0	0	0	6	0
Ave. Line E.M.F., Volts	487.0	488.5	464.5	491.5	492.0	497.0	494.0	497.5	495.5	478.0	486.5
Ave. Current, Amperes	48.4	45.2	53.6	52.9	58.4	67.7	60.2	55.3	53.5	44.9	45.8
Ave. Power, Watts	23,550	22,100	24,900	26,000	28,700	33,600	29,700	27,500	26,500	21,450	22,300
Energy, K.W. Hours	23.55	25.00	27.35	29.90	32.60	36.90	33.20	28.45	28.30	27.45	24.15
No. of Passengers (Total)	100	136	179	143	191	138	205	134	109	141	79
No. of Passengers (Ave.)	28	43	36	37	43	33	51	31	33	31	17
Energy Per Car-Mile, K. W. Hours	2.24	2.37	2.59	2.84	3.09	3.50	3.15	2.70	2.68	2.60	2.29
Energy Per Ton-Mile, Watt-Hours	99.5	105.2	115.0	126.1	137.2	155.4	139.9	119.8	119.0	115.4	101.7
Energy Per Passenger (Total) Watt-Hours.	224	174	145	199	162	254	154	202	246	184	290
Ave. Length of Run (Start to Stop) Ft.	1,048	959	1,321	2,140	1,069	1,589
Ave. Interval of Run (Start to Stop) Sec.	64.9	60.5	81.3	139.1	80.8	102.8
Ave. Interval of Run (Start to Start) Sec.	74.8	69.3	88.6	147.8	87.6	111.3
Stops Per Mile	4.9	5.4	3.9	2.4	4.8	3.2
Ave. Interval of Stop, Sec.	10.2	9.0	7.5	8.8	7.2	8.9
Schedule Speed (Including Stops) M.P.H.	10.53	9.31	9.59	9.17	9.31	9.59	9.45	10.20	9.89	8.33	9.73
Ave. Speed (Excluding Stops) M.P.H.	11.07	10.82	11.00	10.38	8.96	10.42

¹ Left 3d St. Loop — half trip.

SERVICE TESTS OF A DOUBLE-TRUCK CITY CAR 135

GENERAL LOG SHEET OF TEST NO. 7.

(Air Brake System with Independent Motor-Compressor.)

Date, Wednesday, August 24th, 1904; *Place*, St. Louis, Mo.; *Route*, Park Avenue line of St. Louis Transit Company, running from Tower Grove Park to Third Street and Washington Avenue; *Weather*, clear, no rain. The average air temperature for the day was 27.5° C. or 81.5° F. *Condition of track*, dry and clean. *Test started*, 6.59 A.M. *Test stopped*, 7.11 P.M. *Total duration of test*, 12.2 hours.

Average Data for Day.

Passengers Carried. — Total number per round trip, 131; average number on car, 32.

Pressure Measurements. — Line pressure, 471.8 volts.

Distance Measurements. — Length of a round trip, 55,600 ft. or 10.53 miles; stops per mile, 4.5; stops per round trip, 47; length of a single run (start to stop), 1158 ft.

Time Measurements. — Interval of round trip (start to stop), 67.8 minutes; interval of lay-over at the Tower Grove Park loop, 2.8 minutes; interval for total stops for trip, 6.7 minutes; running time for trip, 61.1 minutes; interval of round trip (start to start), 70.6 minutes; interval of run (start to stop), 76.4 seconds; interval of stop, 8.6 seconds; interval of a single run (start to start), 85.0 seconds; interval of run (start to start, and including all stops for temperature readings and lay-over at Tower Grove Park loop), 88.3 seconds.

Speed Measurements. — Average speed (actual running time), 10.34 miles per hour; schedule speed (including stops during trip), 9.32 miles per hour.

Current Measurements. — Average current for round trip, 53.3 amperes; average current (actual running time), 59.1 amperes; average current for the day, 51.2 amperes.

Power Measurements. — Average power (for round trip), 25,147 watts; average power (actual running time), 27,883 watts; average power for the day, 24,156 watts.

Energy Measurements. — Average energy per round trip

TABLE IX. — Results of Test No. 7. Aug. 24, 1904. Arranged by Trips.

Trip Number	1 ¹	2	3	4	5	6	7 ²	8	9	10
	A.M.	A.M.	A.M.	A.M.	A.M.	P.M.	P.M.	P.M.	P.M.	P.M.
Time of Start	6:59	7:38	8:49	10:03	11:09	12:16	1:22	3:36	4:44	5:57
Time of Stop	7:33	8:49	9:59	11:05	12:16	1:18	3:32	4:39	5:55	7:11
Interval of Round Trip, Minutes	68	71	70	62	67	62	70	63	71	74
Lay-Over at Tower Grove Park Loop, Min.	5	0	4	4	0	4	4	5	2	0
Average Line E.M.F., Volts	476.5	449.0	473.5	483.0	461.5	477.0	470.0	468.5	475.0	484.0
Average Current, Amperes	43.7	45.7	56.1	55.8	59.5	58.7	51.5	57.6	55.2	49.1
Average Power, Watts	20,850	20,500	26,550	26,960	27,450	27,950	24,200	26,950	26,250	23,750
Energy, K. W. Hours	23.65	25.25	31.00	27.85	30.65	28.45	28.25	28.35	31.05	29.35
Number of Passengers (Total)	132	108	214	112	124	93	129	120	96	185
Number of Passengers (Average)	29	30	35	31	34	25	27	32	34	39
Energy Per Car-Mile, K. W. Hours	2.24	2.39	2.94	2.64	2.91	2.70	2.66	2.67	2.94	2.78
Energy Per Ton-Mile, Watt-Hours	99.6	106.2	130.7	117.3	129.3	120.0	118.2	118.6	130.7	123.6
Energy Per Passenger (Total) Watt-Hours	179	234	145	249	247	306	219	236	324	159
Ave. Length of Run (Start to Stop) Feet	942	1,292	1,208	1,425	1,030	1,030	1,292	1,158
Ave. Interval of Run (Start to Stop) Sec.	60.2	80.0	79.0	88.3	69.2	63.8	91.8	80.3
Ave. Interval of Run (Start to Start) Sec.	71.3	86.5	87.5	95.4	77.8	70.0	99.0	92.5
Stops Per Mile	5.5	4.0	4.3	3.6	5.0	5.0	4.0	4.5
Ave. Interval of Stop, Sec.	11.2	6.6	8.6	7.3	8.7	6.5	7.6	12.5
Schedule Speed (including stops) M.P.H.	9.31	8.91	9.05	10.20	9.45	10.20	9.05	10.05	8.91	8.56
Average Speed (excluding stops) M.P.H.	10.70	11.05	10.48	11.05	10.18	11.05	9.65	9.90

¹ Left 3d St. Loop — half trip.

² One hour out on account of broken brake rod.

SERVICE TESTS OF A DOUBLE-TRUCK CITY CAR 137

28,416 watt-hours; average energy per run (start to stop), 592 watt-hours; average energy per car-mile, 2698 watt-hours; average energy per ton-mile, 120 watt-hours; average energy per passenger carried (total for trip), 217 watt-hours.

GENERAL LOG SHEET OF TEST NO. 8.

(Air Brake System Employing Storage Air.)

Date, Monday, August 29th, 1904; *Place*, St. Louis, Mo.; *Route*, Park Avenue line of St. Louis Transit Company, running from Tower Grove Park to Third Street and Washington Avenue; *Weather*, clear, no rain. The average air temperature for the day was, 25.5° C. or 77.8° F. *Condition of track*, dry and clean. *Test started*, 7.38 A.M. *Test stopped*, 7.05 P.M. *Total duration of test*, 11.45 hours.

Average Data for Day.

Passengers Carried. — Total number per round trip, 130; average number on car, 32.

Pressure Measurements. — Line pressure, 475.6 volts.

Distance Measurements. — Length of a round trip, 55,600 ft. or 10.53 miles; stops per mile, 5.9; stops per round trip, 63; length of a single run (start to stop), 869 ft.

Time Measurements. — Interval of round trip (start to stop), 69.3 minutes; interval of lay-over at Tower Grove Park loop 2.0 minutes; interval of total stops for round trip 6.2 minutes; running time for trip, 63.1 minutes; interval of round trip (start to start), 71.3 minutes; interval of a single run (start to stop), 59.1 seconds; interval of stop, 5.9 seconds; interval of a single run (start to start), 65.0 seconds; interval of run (start to start, and including all stops for temperature readings and lay-over at the Tower Grove Park loop), 66.8 seconds.

Speed Measurements. — Average speed (actual running time), 10.01 miles per hour; schedule speed (including stops during run), 9.12 miles per hour.

Current Measurements. — Average current for round trip, 53.2

TABLE X. — Results of Test No. 8. Aug. 29, 1904. Arranged by Trips.

Trip Number	1	2	3	4	5 ¹	6	7 ²	8	9
Time of Start	A.M. 7:38	A.M. 8:52	A.M. 10:03	A.M. 11:11 P.M. 12:16	P.M. 12:16	P.M. 1:30	P.M. 2:48	P.M. 4:44	P.M. 5:57
Time of Stop	8:52	10:03	11:10	12:16	1:18	2:48	4:39	5:57	7:05
Interval of Round Trip (Minutes)	74	71	67	65	62	78	66	73	68
Lay-Over Tower Grove Park Loop (Min.)	0	0	1	0	12	0	5	0
Average Line E.M.F. Volts	470	451	465.5	495.5	482	470	478	464	504.5
Average Current Amperes	53.8	56.3	56.3	58.6	66.2	46.6	51.2	46.1	43.4
Average Power, Watts	25,280	25,400	26,250	29,100	31,900	21,920	24,460	21,400	21,900
Energy, K.W. Hours	31.25	30.05	29.30	30.25	34.60	28.50	26.95	26.05	24.85
No. of Passengers (Total)	113	216	192	163	123	55	120	116	72
No. of Passengers (Average)	40	52	38	33	32	19	25	30	18
Energy Per Car-Mile, K.W. Hours	2.96	2.85	2.78	2.87	3.28	2.70	2.56	2.47	2.36
Energy Per Ton-Mile, Watt-Hours	131.3	126.6	123.5	127.4	145.8	119.9	113.7	109.7	104.8
Energy Per Passenger (Total) Watt-Hours	2.76	139	153	185	282	518	224	224	345
Average Length of Run (start to stop) Feet	818	913	1,012	884	732	818	1,012	783	976
Average Interval of Run (start to stop) Sec.	60.4	61.3	66.8	56.3	44.5	62.0	67.8	58.0	65.5
Average Interval of Run (start to start) Sec.	65.3	70.0	73.1	62.0	48.9	68.9	71.9	61.7	71.7
Stops Per Mile	6.4	5.7	5.1	5.9	7.1	6.4	5.1	6.6	5.3
Average Interval of Stop, Sec.	5.1	8.7	7.4	5.6	4.5	7.1	4.4	3.8	6.2
Schedule Speed (including stops) M.P.H.	8.56	8.91	9.45	9.73	10.2	8.12	9.59	8.67	9.31
Average Speed (excluding stops) M.P.H.	9.26	10.15	10.48	10.7	11.23	8.93	10.09	9.12	10.07

¹ Nine minutes lost due to broken fender. ² Forty-five minutes lost in barn for repairs.

SERVICE TESTS OF A DOUBLE-TRUCK CITY CAR 139

amperes; average current (actual running time), 58.4 amperes; average current for the day, 51.7 amperes.

Power Measurements. — Average power for round trip, 25,292 watts; average power (actual running time), 27,775 watts; average power for the day, 24,589 watts.

Energy Measurements. — Average energy per round trip, 29,212 watt-hours; average energy per run (start to stop), 457 watt-hours; average energy per car-mile, 2774 watt-hours; average energy per ton-mile, 123 watt-hours; average energy per round trip for each passenger carried (total for trip), 225 watt-hours.

GENERAL LOG SHEET FOR GRAPHICAL LOG OF
TEST NO. 7.

(Second Half of Trip No. 7.)

Date, Wednesday, August 24th, 1904; *Place*, St. Louis, Mo.; *Route*, from Third Street and Washington Avenue to the Tower Grove Park loop, on the Park Avenue line of the St. Louis Transit Company; *Time of run*, 3.00 P.M. to 3.32 P.M.; *Weather*, clear, no rain; *Condition of track*, dry and clean.

Data for Trip.

Passengers Carried. — Total number for trip, 62; average number on the car, 26.

Pressure Measurements. — Line pressure, 501 volts; maximum line pressure, 505 volts; minimum line pressure, 440 volts.

Distance Measurements. — Length of trip, 27,800 ft. or 5.26 miles; stops per mile, 4.2; stops for the trip, 22; length of a single run (start to stop), 1202 ft.

Time Measurements. — Interval of trip (start to start), 32.0 minutes; interval for total stops for the trip, 122 seconds; running time for the trip, 29 minutes, 58 seconds; average interval of run (start to stop), 78.2 seconds; average interval of run (start to start), 83.0 seconds; average interval of stop, 5.55 seconds.

Speed Measurements. — Average speed (actual running time), 10.05 miles per hour; schedule speed including stops 9.87 miles per hour; maximum speed 17.5 miles per hour; total number of runs, 23.

Current Measurements. — Average current for the trip, 54.85 amperes; average current (actual running time), 58.5 amperes; average maximum current, 130 amperes; maximum current, 245 amperes; place where maximum current occurred, between Clark Avenue and Austin Street.

Power Measurements. — Average power for trip, 27,790 watts; average power actual running time, 29,650 watts; average maximum power, 64,800 watts; maximum power, 120,000 watts; place where maximum power occurred, between California and Ewing and between Theresa and Grand.

Energy Measurements. — Total energy for the trip, 14.792 kilowatt-hours; energy per run (start to stop), 643 watt-hours; energy per car-mile, 2.81 kilowatt hours; energy per ton-mile, 125 watt-hours; energy per passenger carried (total for trip), 283 watt-hours.

DISCUSSION OF RESULTS.

The service tests on the double-truck city car give data which may be studied from several different standpoints. In the first place, they afford information as to the performance of a car run upon a schedule in practical operation in one of the large cities of the country, the car tested being one of 1500 similar cars run in regular service. In the second place, the data allow of a comparative study of the performance of the car when operated over the same route and on the same schedule, under conditions of a dry track and a clear day, as against those of a wet track and a rainy day. A comparison of the general data of this chapter with those of Chapter II, also leads to some interesting deductions.

Tests Nos. 6, 7, and 8 were performed on three different days, with several days intervening between tests in each case. While the data for the individual runs of the various tests differ very

uniformity both in average current and in average pressure, it is to be expected that the average power during a round trip will be nearly the same for all tests, and this is seen to be the case.

The average interval of run from start to stop is seen to vary from 82 seconds in Test No. 6, to 59 seconds in Test No. 8. This follows from the fact that the number of stops per mile was considerably greater in Test No. 8 than in Test No. 6. This fact also explains the similar discrepancy in the average interval of run from start to start in the three tests. It is interesting to note, also, the uniformity of the schedule speed in the three tests, as well as that of the average speed during actual running time.

From the fact that both the duration of a round trip and the average power expended during the trip are very uniform in the three tests, it is to be expected that such data as average watt-hours per trip and average kilowatt-hours per car-mile will agree closely in the three tests, and this is seen to be the case. Furthermore, as the average number of passengers carried does not vary appreciably in these tests, it is also to be expected that the average watt-hours per ton-mile and the average watt-hours per passenger (total), will agree closely. The data of the tests fully corroborate these deductions.

While considerable time was spent in the construction of apparatus for the electrical measurement of the temperatures of the motors, and while the data relating to these temperatures were carefully taken, these data have not been found to be thoroughly consistent and reliable in the series of tests under consideration. As the time intervals available for taking temperature data were very short, no thermometer readings were made, and for this reason there is no check on the temperature data as calculated from the electrical readings. Although the results are not very consistent, they have nevertheless been introduced into the Report.

Another thing to be observed in connection with the general data of the three tests, is that there is very little difference in the conditions of operation on a clear day and on a wet day. Δ

few more passengers are carried on a wet day and they are carried for a greater average distance. In other respects, the three tests show very similar results.

A brief discussion showing a comparison of the performances of the double-truck and the single-truck city cars, is of interest. In this connection, it is well to note that the total distance traversed in a single run averages 1097 ft. in the tests with the double-truck car, as against 791 ft. with the single-truck car.

A comparison of the general data obtained for the double-truck city car with the results given in Chapter II for the single-truck city car, shows that the duration of the tests for the double-truck car averaged 11.9 hours, as against 7.1 hours for the single-truck car. While the latter was run on a uniform schedule, the length of single run being 791 ft. and the schedule speed being 10.5 miles per hour, it is interesting to note that the double-truck car averaged 1097 ft. per single run and the schedule speed averaged 9.3 miles per hour for the three tests. The general conditions of service were therefore in favor of the double-truck car, as the length of a single run was greater and the schedule speed less, than for the single-truck car.

An inspection of the pressure values shows that the line pressure was the higher in the tests with the single-truck car. The current values cannot be compared directly for the two cars, since these data are shown for the time the power was actually taken from the line in the tests on the single-truck car, whereas they have been averaged throughout the run in the tests with the double-truck car. The power, however, is given both for the time the power was actually taken, and also for the total period of the regular schedule in the data for the single-truck car. It is seen from this latter data, that the average power is approximately 24,000 watts as against approximately 25,500 watts for the double-truck car. A comparison of the kilowatt-hours per car-mile shows an average of 2.31 for the single-truck car, as against 2.74 for the double-truck car. This result is to be expected, from the fact that the average power is somewhat

greater and the schedule speed somewhat less for the double-truck car than for the single-truck car.

The average watt-hours per ton-mile is 162 for the single-truck car, as against 122 for the double-truck car. This results from the fact that, while the energy per car-mile was not greatly less for the single-truck car, the weight of this car was but little more than two-thirds that of the double-truck car.

The comparison of the two cars on the basis of average watt-hours per passenger carried (total), can only be obtained by making some assumptions as to the schedule of operation of the single-truck car. These assumptions would have to include the total number of passengers carried, as well as the total length of a round-trip. Both of these factors might vary widely in different cases.

CHAPTER IV.

SERVICE TESTS OF AN INTERURBAN CAR.

OBJECTS OF THE TESTS.

THE principal object of these tests was to study the general performance of a typical interurban car when operated under normal conditions in a locality where interurban railways have been in successful operation for a considerable period of time. The tests included such measurements as those of speed, current, pressure, power, energy, and motor heating. The car was tested only on clear days and on a dry track, both when operated alone, and when hauling a trailer. Consequently, comparative data was obtained as to the performance of the car under these conditions.

SYNOPSIS OF RESULTS.

TABLE XI. — *Synopsis of Results. Service Tests on Interurban Car.*

	TEST No. 9.	TEST No. 10.	TEST No. 11.	TEST No. 12.
Weather Conditions	Clear	Clear	Clear	Clear
Total Duration of Test (Minutes)	317.25	236.50	288.33	284.33
Total Time of Lay-over (Minutes) ...	132.00	38.58	35.06	57.91
Total Running Time Including Ordinary Stops (Min.)	185.25	197.92	253.26	226.42
Total Distance Traversed (Miles).....	93.90	95.02	113.10	113.10
Equivalent Passenger Load	30	30	70	30
Ave. Line Pressure (Volts) ¹	451.4	471.5	472.5	449.0
Ave. Current (Amperes) ¹	220.5	216.6	265.0	213.5
Ave. Power (Watts) ¹	103,300	96,100	122,700	97,300
Ave. Length of Run in Cities (Miles) ²	0.68	1.02	1.09	1.52
Ave. Length of Run between Cities (Miles) ²	5.84	5.10	5.15	5.75

¹ Average taken for actual running time, including ordinary stops, but not lay-over.

² Indianapolis, Anderson, and Muncie.

³ Average of all motors taken at the end of the test.

TABLE XI.—*Continued.*

	TEST No. 9.	TEST No. 10.	TEST No. 11.	TEST No. 12.
Ave. Stops Per Mile in Cities	1.48	0.97	0.92	0.66
Ave. Stops Per Mile between Cities ..	0.17	0.20	0.19	0.17
Ave. Speed (Miles per Hour) ¹	30.41	28.84	26.80	29.95
Ave. Speed in Cities (Miles per Hour) ^{1 2}	12.55	12.58	11.45	12.33
Ave. Speed between Cities (Miles per Hour) ^{1 2}	38.63	36.50	33.80	38.55
Kilowatt-Hours Per Car-Mile	3.40	3.34	4.58	3.24
Watt-Hours Per Ton-Mile	85.6	84.4	73.8	81.8
Watt-Hours Per Equivalent Through Passenger	10,632	10,558	7,407	12,243
Temp. Rise of Motors above an Air Temp. of 25° C. ³	46.1	59.9	78.8	69.7

Test No. 9. Feb. 2, 1905. Dry Track. No Trailer. Four Hot Boxes. Run from Muncie city limits to Indianapolis; Indianapolis to Anderson.

Test No. 10. Feb. 3, 1905. Dry Track. No Trailer. Two Hot Boxes. Run from Anderson to Muncie; Muncie to Indianapolis; Indianapolis to Anderson.

Test No. 11. Feb. 4, 1905. Dry Track. One Trailer. Run from Muncie to Indianapolis and return to Muncie.

Test No. 12. Feb. 4, 1905. Dry Track. No Trailer. Run from Muncie to Indianapolis and return to Muncie.

¹ Average taken for actual running time, including ordinary stops, but not lay-over.

² Indianapolis, Anderson, and Muncie.

³ Average of all motors taken at the end of the test.

GENERAL CONDITIONS OF THE TESTS.

The service tests upon the interurban car were made upon the lines of the Indiana Union Traction Company, which, considered from the standpoint of the number of miles of track in operation, constitute what is probably the largest interurban railway system in the country at the present time. The principal cities connected by the system are Indianapolis, Anderson, Muncie, Marion, Alexandria, Tipton, Kokomo, Peru, Logansport, and Noblesville. The offices of the company are at Anderson, as are also the main power house and the principal car shops. A map of the system is given in Fig. 46. It comprises in all approximately 262 miles of track, of which 211 miles are

interurban lines, and the remaining 51 miles are city lines. The lengths of the lines between the various cities are as follows :

Indianapolis to Anderson	39 miles
Anderson to Muncie	18 miles
Anderson to Marion	34 miles
Alexandria to Tipton	20 miles
Indianapolis to Kokomo	57 miles
Kokomo to Logansport	24 miles
Kokomo to Peru	19 miles
Total	<u>211 miles</u>

The track mileage is divided between the various cities as follows:

Anderson	11.6 miles
Marion	14.8 miles
Muncie	15.4 miles
Elwood	6.4 miles
Alexandria	1.0 miles
Jonesborough	1.8 miles
Total	<u>51.0 miles</u>

The system consists largely of single track and is built upon a private right-of-way between the cities, the right-of-way being from 60 to 100 ft. in width. The road-bed is of the most substantial type, the ballast being 14 in. deep, and laid upon a bank 16 ft. in width. Oak ties, 6 in. by 8 in. by 8 ft. in size are spaced with 24 in. between centers, and upon these are laid 80-lb. rails connected by 250,000 c.m. protected rail bonds, and in addition the rails are cross-bonded near all the special work.

The power is supplied to the system from the power station at Anderson at 15,000 volts over the Eastern division, and at 30,000 volts over the Northern division. The power is received at substations suitably distributed along the lines, which contain transformers and rotary converters for reducing the pressure to 600 volts and converting the power to direct current. The general plan of the distribution is shown in Fig. 46.

THE MUNCIE-ANDERSON-INDIANAPOLIS DIVISION.

The service tests upon the interurban car were conducted upon the Muncie division of the lines of the Indiana Union Trac-

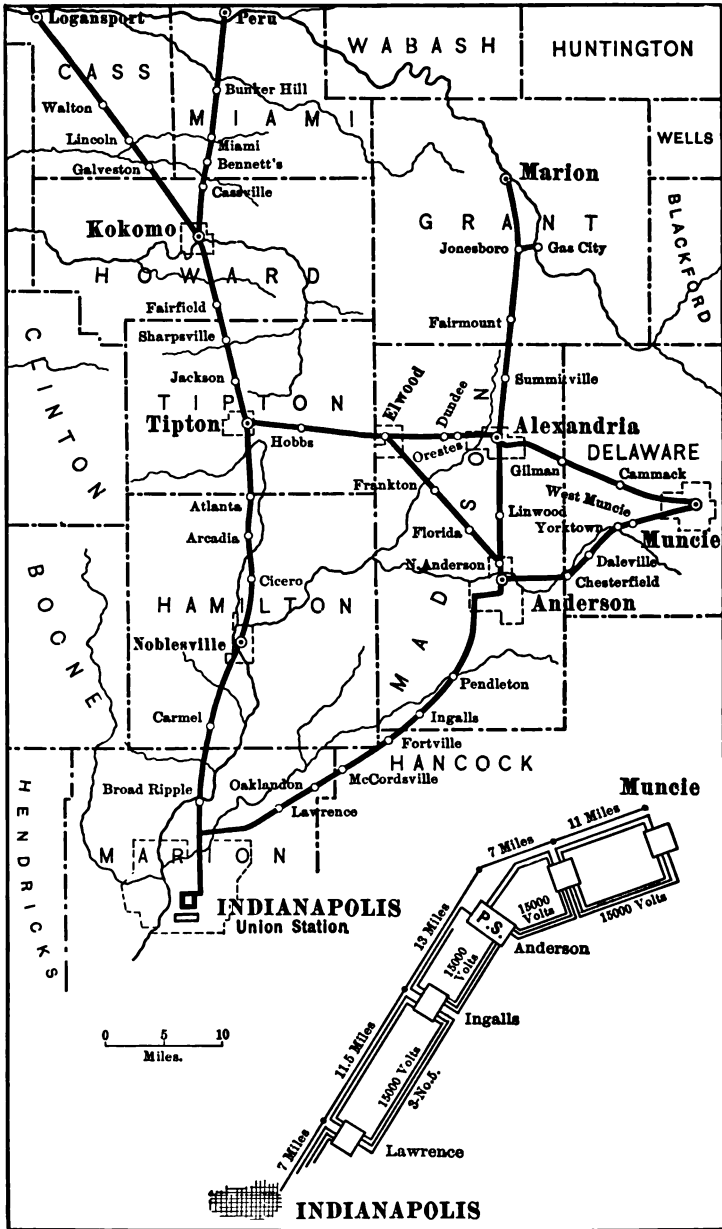

Fig. 46. — Map of System of Indiana Union Traction Company.

tion Company. This division, as shown in Fig. 46, connects the cities of Muncie, Anderson, and Indianapolis. Indianapolis has a population of approximately 200,000, while the other two cities have a population of about 30,000 each. The division, which is the original line of the system, runs through a rich farming country, and besides connecting the cities above mentioned, passes through a number of towns and villages, varying in size from 5,000 to 2,500 inhabitants.¹ It is supplied with power from the following substations, which have the equipments specified.

LOCATION OF SUBSTATIONS AND EQUIPMENTS.

SUB-STATION.	MILES FROM ANDERSON.	TRANSMISSION VOLTAGE.	NUMBER OF STEP-DOWN TRANSFORMERS.	CAPACITY OF EACH IN KILOWATTS.	NUMBER OF 250 K.W. ROTARIES.	CAPACITY OF STORAGE BATTERY IN AMP. ON 8 HR. RATE OF DISCHARGE.
Anderson .	0	375	0	87½	3	100
Daleville ..	7.1	15,000	4	87½	1	40
Muncie ...	17.1	15,000	4	175	2	80
Ingalls ...	14.5	15,000	4	87½	1	40
Lawrence .	28.9	15,000	7	87½	2	40

THE CAR TESTED.

The car selected for test was fully described in Chapter I. It was numbered "284" and was a new car of the most recent type employed by the company for its limited service.

THE CONTROL AND BRAKE EQUIPMENT.

As stated in Chapter I, the Westinghouse Pneumatic System of train control was used on car "284" when these tests were made. A complete description of this system of control is given in Part III, in connection with the acceleration tests made on this car.

¹ More detailed descriptions of the lines of the Indiana Union Traction Company will be found in the *Street Railway Journal*, Vol. 24, 1904, page 1064, and Vol. 18, 1901, page 821.

The car was equipped with the Westinghouse "straight air" system of braking which is more completely described in Part IV, in connection with the braking tests of car "284."

The average power taken and the total energy consumed per trip in operating the controller, are considered in Part III, while the corresponding values relating to the operation of the air brake are shown in Part IV.

MOTIVE POWER EQUIPMENT.

The motive power equipment of car "284" has already been described in a general way in Chapter I. As the service capa-

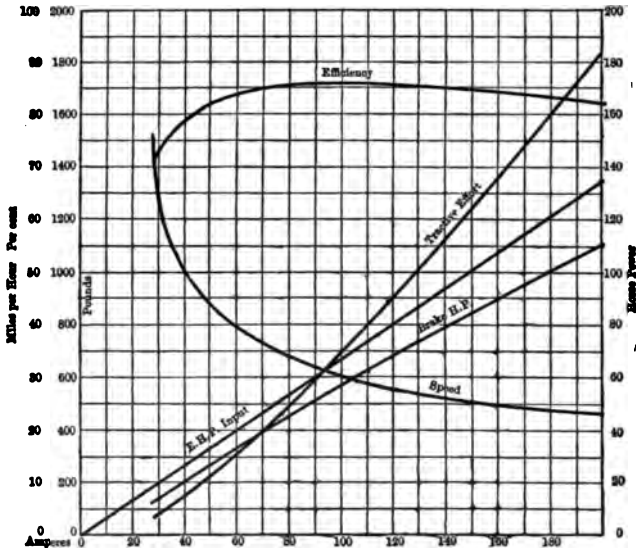

Fig. 47. — General Performance Curves of Westinghouse No. 8 Motors.

city of the motors has a very important bearing upon the test considered in the present chapter, their characteristic features of operation are here briefly discussed.

The general performance of the Westinghouse No. 85 motors with a gear ratio of 27 to 47, is shown in Fig. 47. The curves are taken from data furnished by the manufacturers and show the speed, tractive effort, and brake horse power with current at

from 30 amperes to 240 amperes at 500 volts. The total electrical power input and the efficiency are also shown. The manufacturers make the following statements regarding the service capacity of these motors :

“ The motor has a continuous capacity of 60 amperes at 300 volts or of 55 amperes at 400 volts. Under the usual condition of railway service, it will carry any load within the range shown on the performance curves, provided the integrated heating effect does not exceed that caused by the continuous application of either of these currents at the corresponding potential.

“ With a load of 60 amperes at 300 volts or 55 amperes at 400 volts carried continuously during a shop test, the rise in temperature of the motor windings, as measured by thermometer after ten or twelve hours, or after a constant temperature has been reached, will not exceed 75° C. With equivalent load under a moving car the temperature rise should not exceed 55 C.

“ Heavier loads may be carried for shorter periods as indicated by the time temperature curve. If, for example, the motor has been working at a load equivalent to 60 amperes at 300 volts, and has reached a temperature of 75° C., it may then, as shown by the curve, carry a load equivalent to the 72 amperes at 300 volts for 1½ hours, with additional rise in temperature not exceeding 20° C.”

TOTAL WEIGHT OF CAR “284.”

The weight of the car equipped and ready for service was 74,530 lbs., as stated in Chapter I. The car had a seating capacity of 48 passengers, and it was estimated that 30 passengers would be an average load, exclusive of motorman and conductor. The total passenger load on the basis of 150 lbs. for each person would then be 4500 lbs. As there was an average of 10 observers on the car throughout the tests, a dead load of 3000 lbs. was carried to compensate for the weight of 20 additional passengers. The main dead load consisted of a number of bags of sand, which were placed under the seats of the car. The weight of instruments and other appliances amounted to another 450 lbs. The

total load, under the conditions of test, may be summed up as follows:

Weight of car equipped and ready for service	74,530 lbs.
Weight of total dead load	3,000 lbs.
Weight of total live load (including motorman and conductor)	1,800 lbs.
Total weight	79,330 lbs.

This total weight is approximately 39 $\frac{1}{2}$ tons.

THE TRAIL CAR.

Car "284" was still further loaded by car "302" being used as a trailer to it in Test No. 3. This car was one of the standard interurban trailers used by the Indiana Union Traction Company, and its general construction was somewhat similar to that of car "284," excepting that it had no vestibules and was considerably lighter.

The total weight of the trailer car "302," equipped and ready for service, was 39,000 lbs. The seating capacity of this car was 50 passengers, and a load equivalent to 40 passengers at 150 lbs. each was placed on the car. This load consisted of a number of bags of sand placed under the seats, and weighing 6,000 lbs. The total weight of car "302" was, therefore, 45,000 lbs. or 22 $\frac{1}{2}$ tons.

GENERAL DESCRIPTION OF THE TESTS.

The four service tests on this car were made on Thursday, February 2d, Friday, February 3d, and Saturday, February 4th, 1905, two tests being made upon the latter day. While the car was operated on the same general schedule and over the same line in all four runs, the conditions were somewhat different.

All four tests were made upon the line between Muncie and Indianapolis, a distance of 56.55 miles. The car barns and shops are at Anderson, which is between Indianapolis and Muncie, and 18.8 miles from the latter city. The schedule time between Muncie and Indianapolis for the limited cars is 2 hours and 5 minutes going to Indianapolis, and 2 hours and 10 minutes returning to Muncie. The round trip, therefore, consumes 4

hours and 10 minutes, in addition to the lay-over at Indianapolis. The running time of trains on the division at the time the tests were made, is shown in Table XII.

The company operates what are termed first-class or limited cars, and second-class or local cars. The limited cars make stops only at the various towns along the right-of-way and carry no baggage, while the local cars make additional stops at the road intersections and carry baggage. The schedule time of the local cars between Muncie and Indianapolis is 2 hours and 20 minutes, which is 15 minutes longer than the time of the limited cars.

While the tests made with car "284" were run on the same schedule as that of any one of the regular limited cars, it was necessary to so arrange the schedule as not to interfere with the regular passenger service. It was considered advisable to load the car with a dead weight rather than attempt to substitute it in place of one of the regular limited cars carrying a passenger load. The car consequently ran between cars operated on the regular schedule, and the running time, relative to the regular cars, was so adjusted as to give, as far as possible, a good average line pressure throughout each run.

WEATHER CONDITIONS.

In the consideration of service tests on interurban cars, it is important to know the general weather conditions at the time of the tests. Not only should the condition of track be noted, but the direction and velocity of the wind and the temperature of the air should also be recorded, as these have an important bearing upon the power consumption and the heating of the motors. On all three days, February 2d, 3d, and 4th, the weather was clear and cold, and the track was in good condition and free from snow. The direction and velocity of the wind and the temperature of the air are given at hourly intervals for each of these tests in Table XIII.

TEST No. 9. — This was the first of the service tests on car "284," and must be considered more or less as a preliminary run, since four of the axle journals became overheated, even though

TABLE XII. — Running Schedule Muncie-Indianapolis Div. Indiana Union Traction Company.

MUNCIE TO INDIANAPOLIS.

	A.M.	A.M. ¹	A.M. ¹	A.M. ¹	A.M. ¹	A.M. ¹	A.M. ¹	A.M. ¹	A.M. ¹	A.M. ¹	P.M. ¹	P.M. ¹	P.M. ¹	P.M. ¹	P.M. ¹	P.M. ¹	P.M. ¹	P.M.	P.M.	P.M.	P.M.	
Muncie.....	4:40	5:20	6:40	7:20	8:40	9:20	10:40	11:20	12:40	1:20	2:40	3:20	4:40	5:20	6:40	8:40	10:40	11:20				
Yorktown.....	4:53	5:35	6:53	7:35	8:53	9:35	10:53	11:35	12:53	1:35	2:53	3:35	4:53	5:35	6:53	8:53	10:53	11:33				
Daleville.....	5:01	5:45	7:01	7:45	9:01	9:45	11:01	11:45	1:01	1:45	3:01	3:45	5:01	5:45	7:05	9:05	11:01	11:41				
Chesterfield.....	5:05	5:50	7:05	7:50	9:05	9:50	11:05	11:50	1:05	1:50	3:05	3:50	5:05	5:50	7:05	9:05	11:05	11:45				
Anderson.....	5:15	6:05	7:15	8:05	9:15	10:05	11:15	12:05	1:15	2:05	3:15	4:05	5:15	6:05	7:15	9:15	11:15	11:55				
Pendleton.....	5:35	6:25	7:35	8:25	9:35	10:25	11:35	12:25	1:35	2:25	3:35	4:25	5:35	6:25	7:35	9:35	11:35	12:15				
Ingalls.....	5:42	6:34	7:42	8:34	9:42	10:34	11:42	12:34	1:42	2:34	3:42	4:34	5:42	6:34	7:42	9:42	11:42	12:22				
Fortville.....	5:48	6:40	7:48	8:40	9:48	10:40	11:48	12:40	1:48	2:40	3:48	4:40	5:48	6:40	7:48	9:48	11:48	12:28				
McCordsville.....	5:58	6:50	7:58	8:50	9:58	10:50	11:58	12:50	1:58	2:50	3:58	4:50	5:58	6:50	7:58	9:58	11:58	12:38				
Oaklandon.....	6:02	6:56	8:02	8:56	10:02	10:56	12:02	12:56	2:02	2:56	4:02	4:56	6:02	6:56	8:02	10:02	12:02	12:42				
Lawrence.....	6:09	7:04	8:09	9:04	10:09	11:04	12:09	1:04	2:09	3:04	4:09	5:04	6:09	7:04	8:09	10:09	12:09	12:49				
Indianapolis.....	6:45	7:45	8:45	9:45	10:45	11:45	12:45	1:45	2:45	3:45	4:45	5:45	6:45	7:45	8:45	10:45	12:45	1:25				

INDIANAPOLIS TO MUNCIE.

	A.M.	A.M. ¹	A.M. ¹	A.M. ¹	A.M. ¹	A.M. ¹	A.M. ¹	A.M. ¹	A.M. ¹	A.M. ¹	P.M. ¹	P.M. ¹	P.M. ¹	P.M. ¹	P.M. ¹	P.M. ¹	P.M. ¹	P.M. ¹	P.M.	P.M.	P.M.	P.M.	
Indianapolis.....	4:00	5:00	6:00	7:00	8:00	9:00	10:00	11:00	12:00	1:00	2:00	3:00	4:00	5:00	6:00	7:00	8:00	9:00	11:00				
Lawrence.....	4:38	5:37	6:38	7:37	8:38	9:37	10:38	11:37	12:38	1:37	2:38	3:37	4:38	5:37	6:38	7:37	8:37	9:37	11:37				
Oaklandon.....	4:45	5:44	6:45	7:44	8:45	9:44	10:45	11:44	12:45	1:44	2:45	3:44	4:45	5:44	6:45	7:44	8:44	9:44	11:44				
McCordsville.....	4:50	5:48	6:50	7:48	8:50	9:48	10:50	11:48	12:50	1:48	2:50	3:48	4:50	5:48	6:50	7:48	8:48	9:48	11:48				
Fortville.....	5:00	5:56	7:00	7:56	9:00	9:56	11:00	11:56	1:00	1:56	3:00	3:56	5:00	5:56	7:00	7:56	8:56	9:56	11:56				
Ingalls.....	5:06	6:02	7:06	8:02	9:06	10:02	11:06	12:02	1:06	2:02	3:06	4:02	5:06	6:02	7:06	8:02	9:02	10:02	12:02				
Pendleton.....	5:15	6:09	7:15	8:09	9:15	10:09	11:15	12:09	1:15	2:09	3:15	4:09	5:15	6:09	7:15	8:09	9:09	10:09	12:09				
Anderson.....	5:45	6:30	7:45	8:30	9:45	10:30	11:45	12:30	1:45	2:30	3:45	4:30	5:45	6:30	7:45	8:30	9:30	10:30	12:30				
Chesterfield.....	6:01	6:42	8:01	8:42	10:01	10:42	12:01	12:42	2:01	2:42	4:01	4:42	6:01	6:42	8:01	8:42	10:42	12:42					
Daleville.....	6:05	6:46	8:05	8:46	10:05	10:46	12:05	12:46	2:05	2:46	4:05	4:46	6:05	6:46	8:05	8:46	10:46	12:46					
Yorktown.....	6:13	6:55	8:13	8:55	10:13	10:55	12:13	12:55	2:13	2:55	4:13	4:55	6:13	6:55	8:13	8:55	10:55	12:55					
Muncie.....	6:30	7:10	8:30	9:10	10:30	11:10	12:30	1:10	2:30	3:10	4:30	5:10	6:30	7:10	8:30	9:10	11:10	1:10					

¹ Limited trains.

TABLE XIII.—Air Temperature and Wind Data. Service Tests of Interurban Car.

Time	8 A.M.	9 A.M.	10 A.M.	11 A.M.	12 M.	1 P.M.	2 P.M.	3 P.M.	4 P.M.	5 P.M.	6 P.M.	7 P.M.	8 P.M.
------------	--------	--------	---------	---------	-------	--------	--------	--------	--------	--------	--------	--------	--------

TEMPERATURE OF AIR IN DEGREES FAHRENHEIT.

Thursday, Feb. 2, 1905	-11	-9	-6	-4	-1	3	4	6	5	4	3	2	1
Friday, Feb. 3, 1905	1	2	5	7	11	11	12	14	14	13	13	12	12
Saturday, Feb. 4, 1905	7	9	13	15	18	20	22	23	23	21	19	18	15

TEMPERATURE OF AIR IN DEGREES CENTIGRADE.

Thursday, Feb. 2, 1905	-24	-23	-21	-20	-18	-16	-16	-14	-15	-16	-16	-17	-17
Friday, Feb. 3, 1905	-17	-17	-15	-14	-12	-12	-11	-10	-10	-11	-11	-11	-11
Saturday, Feb. 4, 1905	-14	-13	-11	-9	-8	-7	-6	-5	-5	-6	-7	-8	-9

DIRECTION OF THE WIND.

Thursday, Feb. 2, 1905	N.W.	N.W.	N.W.	N.W.	N.W.	N.W.	N.W.	N.W.	N.W.	N.W.	N.W.	N.W.	N.W.
Friday, Feb. 3, 1905	N.	N.	N.	N.E.	N.E.	N.E.	N.E.	N.E.	N.E.	N.E.	N.E.	N.E.	N.E.
Saturday, Feb. 4, 1905	N.E.	N.E.	N.E.	N.E.	N.E.	N.E.	N.E.	N.E.	N.E.	N.E.	N.E.	N.E.	N.E.

VELOCITY OF THE WIND IN MILES PER HOUR.

Thursday, Feb. 2, 1905	10	9	9	7	10	11	10	9	10	10	10	9	9
Friday, Feb. 3, 1905	5	6	5	5	6	9	9	9	10	9	8	8	6
Saturday, Feb. 4, 1905	8	12	11	11	11	11	11	12	13	14	11	11	14

the temperature of the air was one degree below zero, and a lay-over in Indianapolis was imperative. In this test, a run was first made from Anderson to Muncie, and this was followed by a run from Muncie to Indianapolis. The intention was to make the return trip to Muncie and to run from Muncie back to the shops at Anderson. Because of the hot boxes above mentioned, however, the return trip was not made to Muncie but the car was run into the shops upon reaching Anderson. As a complete record was not taken of the run from Anderson to Muncie, it is impossible to give data for the complete round trip from Muncie to Indianapolis and return for this test. The running schedule of this test is shown in Table XXVI.

TEST No. 10. — The axle journals of car "284" were overhauled after the test of Thursday, February 2d, and on Friday, February 3d, Test No. 10 was run over the same route and schedule as Test No. 9. In this run it was found that two of the journals still gave considerable trouble, and consequently the car was again run into the Anderson shops instead of returning to Muncie, in order that the troublesome journals might be put in shape for the next day's test. In working up the final results, a round trip has been considered to have been made from Muncie to Indianapolis and return; the first portion of the run, from Anderson to Muncie, being considered as having occurred after the car had reached Anderson on the return trip. The running schedule of this test is given in Table XXVII.

TEST No. 11. — This test was made on Saturday, February 4th, and a trailer (car No. "302') was hauled by car "284" from Muncie to Indianapolis and return. The start from the Anderson shops for Muncie was made at 7.25 A.M., and the start on the round trip from Muncie to Indianapolis and return was made at 9.03 A.M. The running schedule for this trip is shown in Table XXVIII.

TEST No. 12. — Upon arriving at the Muncie car shop on the return trip of Test No. 11, the trailer was dropped. Car "284" was then run into Muncie and Test No. 12 was made without the trailer. The car left Muncie on this test at 3.05 P.M. The running schedule is given in Table XXIX.

Upon returning to Anderson from Muncie at the end of Test No. 12, the trailer was again attached to car "284" at the Muncie shops. The cars were then taken to the Anderson shops where they arrived at 9.30 P.M.

It will be seen from the above outline of the tests that besides showing the general condition of operation of interurban cars in service, they make possible a comparison of the performance of an interurban car when operated alone and when hauling a trailer over the same route and on the same schedule.

ORIGINAL MEASUREMENTS.

The original data obtained in the service tests on car "284" may be divided into three classes:

- (a) Data relating to electrical input.
- (b) Data relating to speed and distance.
- (c) Data relating to the temperature of the motors.

In preparing for the tests upon the interurban car it was decided to record all of the measurements graphically, the experience gained in the early tests being utilized in perfecting the recording apparatus. In view of the time and expense involved, it was considered impracticable to secure additional instruments similar to the General Electric Company's recording ammeter, which is entirely automatic in its action. It was necessary, therefore, to design simple but effective recording devices which could be quickly and cheaply constructed.

Recording Apparatus.

The experience with the automatic speed recording device used at St. Louis, was so satisfactory that it was decided to use the same principle in the construction of a more elaborate apparatus, correcting such defects as the operation of the instrument had brought to light. The original suggestion for this manual recording device came from Prof. H. J. Ryan, of Cornell University, who had worked out the details of the plan some years ago, and had used it in connection with thesis work. The general principle is similar to that employed by Mr. J. D. Keiley in tests made

for the New York Central Railroad.¹ The same idea has been employed on a much more elaborate scale on the car test recorder of the Boston Elevated Railway Company.²

The total current in conjunction with other values was manually recorded on the general graphical record, and as the recording ammeter of the General Electrical Company was also employed in these tests, as in all the other service tests, to record the total current taken by the car, a check upon the accuracy and delicacy of the manually operated recorder was obtained.

A general view of the apparatus is shown in Fig. 48, while in Fig. 49 is given a detailed drawing of it. In general, the apparatus consists of a strip of paper drawn over a table by means of a motor. Across this paper move recording pens which are operated by cords passing around drums mounted over the centers of the various instruments.

The record paper, which was a strip of manila paper of good quality and about 24 in. in width, was contained upon a reel placed at one end of a table. This table was 6 ft. in length and 3½ ft. in width, outside dimensions. The paper was drawn from one end of the table to the other over an elevated section, and coiled upon a reel at the other end after the records had been made. The driving force was a spring motor, *S*, by which was driven a pair of rubber covered wooden rollers. The paper was drawn over the table by these rollers, and was guided by raised strips along the edge of the center portion of the table. The paper was kept taut by being drawn through a pair of friction rollers near the supply reel. The reel for the complete record was operated by hand, which plan was found very satisfactory. It was originally intended to drive this reel by a small motor, allowing the driving belt to slip when the slack had been taken up, but the plan mentioned above was found to be simpler and more effective.

¹ See article on "Train Testing," by Sydney W. Ashe, *Street Railway Journal*, Volume XXIII, page 768.

² See article on "Car Test Recording," of Boston Elevated Railway Company. J. M. Ayer and H. S. Knowlson, *Street Railway Journal*, Volume XXVI, page 68.

Over the paper was mounted, at right angles to its direction of motion, six round brass rods, *R, R, etc.* To these were clamped the time marking devices, *M, M, etc.* These magnets were provided with armatures mounted upon hinged arms and carrying recording pens made of glass tubing drawn out to points. It was convenient for this purpose to use the relays manufactured by the Electric Tabulating Machine Company,

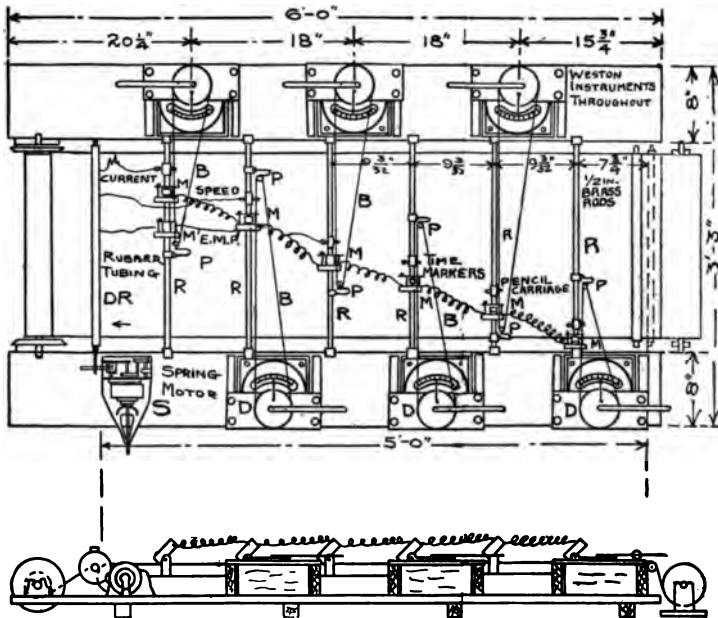

Fig. 49.—Diagram of Recording Apparatus used in Interurban Car Test.

for use in their electric tabulating machines. These pens marked the base lines for the various records. They were all connected in series and in series also with the time marking device of the General Electric recording ammeter, and all of the magnets were thus energized once every five seconds. When energized in this manner, each pen made a mark upon the base line corresponding to the impulse received. Upon the record sheet were synchronized all of the records made by this means.

Upon the rods, *R, R*, were also mounted sliding pen carriages for making the various records. These pen carriages were attached to points on the endless cords, *B, B*, which passed over drums, *D, D*, carried upon the instrument cases and over tension pulleys, *P, P*, clamped to the rods. For the cords, well-stretched fish lines of good quality were found to be entirely satisfactory. The tension pulleys consisted of small brass pulleys mounted upon springs, which were in turn attached to brass clamps. A wooden drum with grooved circumference, 3 inches in diameter, was mounted with its center over the case of each electrical instrument. From this drum projected a pointer so that the movements of the needle of the instrument could be followed by rotating the drum. A handle attached to each drum increased the convenience of operation. Operators, seated three on each side of the table, followed with the pointers of the several instruments the deflections of the needles, transmitting the motion of the pointer to the sliding pen carriage by means of the drum belt. The extra magnet, *M*, was a marking device used for the purpose of recording the time of passing certain poles. The apparatus as described was self-contained and portable, so that it could readily be set up in the car, or moved from car to car if necessary.

As stated in Chapter I, the car tested had two general compartments. The recording apparatus was placed transversely in this compartment, one end being opposite to the third window from the front of the car on the left-hand side. The recording table was separated from its supporting table by thick felt blocks, and the table legs were cushioned by means of felt pads. These precautions were taken in order to reduce as much as possible the shock and jar incident to the movement of the car. A second table was placed in the forward end of the compartment, and upon this table were placed the General Electric recording ammeter, and two watt-hour meters, which latter were placed in the main line circuit and in the motor-compressor circuit respectively. The method of cushioning used for the general recording table was also employed here.

Diagram of Connections.

The general diagram of connections for the service tests Nos. 9, 10, 11, and 12 is given in Fig. 50.

As seen from this diagram, the main current ran through the General Electric recording ammeter and the watt-hour meter, showing the total energy. Other current data, such as the total car current and the current in the various motors, was obtained by means of Weston milli-voltmeters connected to shunts placed in the car wiring circuits. The shunt for the total car current was placed on the table with the recording ammeter and watt-

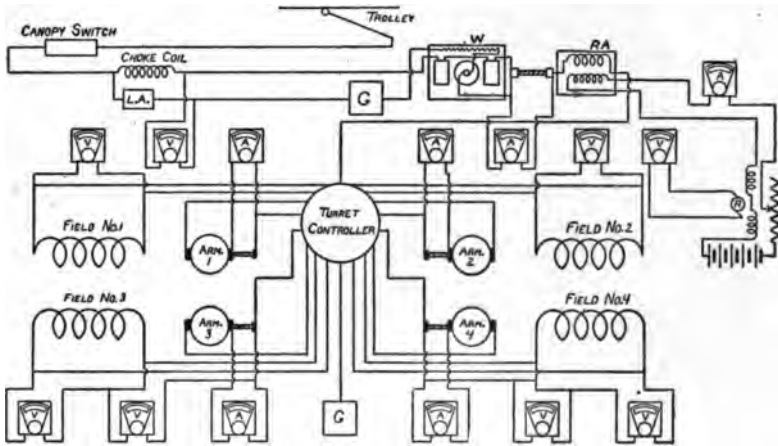

Fig. 50.—Diagram of Connections, Interurban Car Service Tests.

hour meters. The shunts for the various motors were connected directly in series in the car wiring circuits at the motor terminal. This was done by disconnecting the bayonet connections and inserting the shunts, which latter had been previously provided with short leads with bayonet terminals.

Pressure wires, consisting of No. 14 *B & S* gage rubber-covered copper wire, were run from the shunts to a terminal board which was placed directly under the recording apparatus. The pressure wires ended at binding posts on the terminal board, from which connections were made directly to the instruments

which produced the general record. Pressure wires from the motor terminals were also brought to this terminal board and connected with the instruments as desired.

All wiring from the motors to the terminal board was run on porcelain insulators on the underside of the car body to a point directly below the third window on the left-hand side of the car. From this point it was run up on porcelain insulators mounted on wooden strips fastened to the side of the car, passed through the car window and then down to the terminal board. By this arrangement, it was not necessary to bore any holes through the car floor, which would have been objectionable.

Because of the weather conditions, it was necessary to keep all windows closed. A false sash was put in at the lower edge of the window and the window raised slightly, the wiring running through porcelain tubes inserted in the false sash.

As it was impossible to take more than six records on the general apparatus at any one time, it became necessary to arrange connections so that additional records could be taken at different times on certain of these instruments. One voltmeter was arranged with four sets of mercury cups so that the pressure across the brushes of any one of the four motors could be read. In a similar manner two ammeters were arranged with double pole, double throw switches so that the current in any two motors could be obtained at the same time.

Speed and Distance Measurements.

A graphical record of the speed throughout the entire test was obtained by means of an "Apple" ignition generator driven by the car axle, the speed of which was shown by the reading on the milli-voltmeter, which reading was recorded by means of the general recording apparatus. As in the tests on the single-truck city car, the field current for this small generator was supplied from a storage battery which also supplied the current for the movable coil of the recording ammeter. A constant current of one ampere was sent through both of these devices in series. Instead of using a belt to connect the speed generator to the car

axle, a sprocket chain and gears were employed for this purpose. This method of connecting was the natural outgrowth of the experience obtained in the service tests on the other two cars. Difficulty was experienced at first in keeping the sprocket chain on the gears, but this difficulty was overcome by the use of flanges on both sprockets. The sprockets of an ordinary bicycle were used in this connection with the corresponding bicycle chain. The

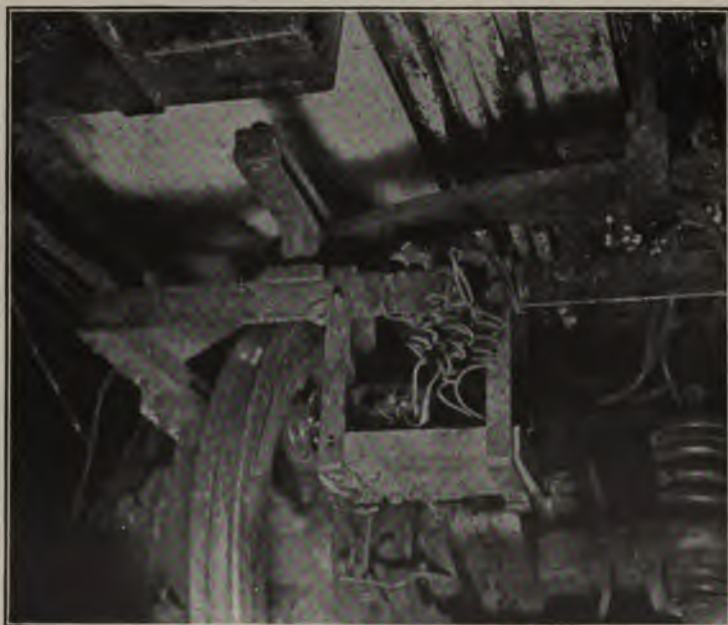

Fig. 51. — "Apple" Generator Attached to the Car Axle.

arrangement of the small magneto-generator relative to the truck is shown in Fig. 51.

In addition to the general speed record as made by means of the small generator, an electro-magnet was placed on the recording apparatus and connected to a battery circuit through a push button. This push button was operated by an observer seated in the front vestibule, and a record was made in this way at the instant the front vestibule of the car passed every fifth pole.

Every fifth pole has its number painted on the pole, and these numbers were placed on the general record sheet. By this means an absolute record of the position of the car at a given time was obtained on the general record sheet. In addition to these records, an observer seated in the front vestibule recorded on a separate log sheet the time of passing street intersections in cities, sidings, and towns, and also the pole number at frequent intervals.

Electrical Measurements.

QUANTITY MEASURED.	INSTRUMENT EMPLOYED.	METHOD OF MAKING MEASUREMENTS.
Line pressure	Weston indicating volt-meter.	Continuous record on general record apparatus.
Total current	General Electric recording ammeter.	Continuous record for entire tests.
Total current	Weston milli-voltmeter with shunt.	Continuous record by general recording apparatus.
Total energy	General Electric watt-hour meter.	Readings recorded at ends of runs and at intervals of approximately 30 minutes.
Energy taken by motor compressor.	Duncan watt-hour meter.	Readings recorded at ends of runs and at intervals of approximately 30 minutes.
Individual motor currents.	Weston milli-voltmeters with shunts.	Readings recorded at intervals throughout the test.
Individual motor pressures.	Weston voltmeters.	Readings recorded at intervals throughout the tests.
Resistances of motor fields.	Weston ammeter and milli-voltmeter.	Resistances measured periodically throughout the tests and the temperatures deduced therefrom.
Resistances of motor armatures.	Weston ammeter and milli-voltmeter.	Resistances measured at the beginning of the test and at Muncie, Anderson, and Indianapolis. The rise in temperature of the motor armatures was deduced from these measurements.

Temperature Measurements.

The temperature measurements included the determination of the electrical resistances of the armatures of the motors at the beginning and end of each test, and at Muncie and Indianapolis. These readings were obtained by means of Weston ammeters and milli-voltmeters in conjunction with a storage battery. The general method was similar to that employed in the other service tests on electric cars. Besides these measurements the resistances of the fields of the motors were taken at frequent intervals throughout the tests by means of Weston ammeters and milli-voltmeters, as explained above. From these various electrical readings of resistances, the temperature of the armatures and of the fields of the various motors was obtained for various periods of the day.

In addition to these electrical measurements of temperature, readings were made by means of thermometers of the temperature of the air throughout the tests and the temperatures of the commutator, and of the air gap surfaces of the motors at the beginning and end of the tests and at Indianapolis and Muncie stops.

Sundry Measurements.

Other data taken in connection with the service tests of the interurban car, relate to the condition of the weather, the number and duration of the applications of compressed air in braking, the number and duration of the applications of the controller, the number of times the whistle was used, the time of passing sidings, and other similar data. The various measurements recorded and covering the acceleration and braking of the car will be considered more fully in connection with Parts III and IV, which relate specifically to these operations.

WORKING UP THE RESULTS.

The methods used in working up the results will now be considered.

The records were carefully worked over, and the various stops were indicated and synchronized between the different sources

of information. The city limits of Muncie, Anderson, and Indianapolis were recorded as were also the various towns and sidings between cities. This was done both for the recording ammeter record and the general record. The recording ammeter record was then integrated, and the average current obtained between various points throughout the tests. These points in general have been taken at the terminal stations in Muncie, Anderson, and Indianapolis, at the limits of these cities, and at the towns along the way. The average current and the time taken in traversing the distance were obtained in each case.

The ammeter record on the general record sheet was next worked up, and the average current found as in the preceding case. The various stops were checked with those on the recording ammeter record. In a similar manner, the pressure record was averaged between the various stops. From these data the average power, the duration of run, and the watt-hours were obtained for the various portions of the trip. These data are shown in Tables XIV to XXV inclusive.

From the following recorded data, it will be seen that the current record, as obtained by means of the indicating ammeter and general recording device, agrees very fairly well with the record made by the General Electric recording ammeter, which is entirely automatic in its action. That a personal error does exist in the manipulation of this instrument, however, is shown by the fact that it is sometimes high and sometimes low in comparison with the General Electric recording ammeter, while in general it is low.

The distances between the various stops were accurately determined from the general operating train schedule sheet of the company, and from pole data obtained during the tests. The time of run between the various stops was obtained directly from the general records, as was also the time of stop, and the lay-over at cities and sidings. Knowing the distances traversed and the time of run, the average speeds between the turning points were obtained. The stops per mile were obtained from the general records. Between cities, these stops were in general

TABLE XIV. — *Intermediate Results of Test No. 9. Feb. 2, 1905. Muncie City Limits to Indianapolis.*

FROM	TO	TIME, MIN- UTES.	VOLTS, AVER- AGE	RECORDING AMMETER.			WESTON AMMETER.		
				AM- PERES AVER- AGE.	WATTS AVER- AGE.	WATT- HOURS.	AM- PERES AVER- AGE.	WATTS AVER- AGE.	WATT- HOURS.
Muncie ¹	Yorktown	7.33	516	265	136,700	16,700	248	112,800	13,780
Yorktown	Daleville	8.42	436	292	127,300	17,880	268	116,800	16,400
Daleville	Chesterfield	3.25	518	319	165,300	8,940	296	153,500	8,310
Chesterfield	Anderson ¹	5.75	490	273	133,800	12,720	252	123,500	11,740
Anderson ¹	Anderson ¹	4.25	457	187	85,500	6,050	175	80,000	5,660
Anderson ¹	Anderson ¹	5.92	511	292	149,000	14,700	291	148,500	14,640
Anderson ¹	Pendleton	9.75	427	222	94,850	15,400	221	94,500	15,370
Pendleton	Ingalls	7.92	412	269	111,000	14,650	256	105,500	13,925
Ingalls	Fortville	3.83	510	248	126,500	8,070	220	112,300	7,170
Fortville	McCordsville	6.33	440	276	121,500	12,820	264	116,200	12,250
McCordsville	Oaklandon	3.08	450	254	114,300	5,880	237	106,700	5,480
Oaklandon	Lawrence	5.83	519	283	147,000	14,280	285	148,000	14,370
Lawrence	Indianapolis ¹	9.5	505	260	131,300	20,800	244	123,250	19,500
Indianapolis ¹	Indianapolis	20.67	422	100	42,000	14,490	85	35,830	12,370

¹ City limits.TABLE XV. — *Intermediate Results of Test No. 9. Feb. 2, 1905. Indianapolis to Anderson.*

FROM	TO	TIME, MIN- UTES.	VOLTS, AVER- AGE.	RECORDING AMMETER.			WESTON AMMETER.		
				AM- PERES AVER- AGE.	WATTS AVER- AGE.	WATT- HOURS.	AM- PERES AVER- AGE.	WATTS AVER- AGE.	WATT- HOURS.
Indianapolis	Indianapolis ¹	19.0	411	126	51,800	16,400	126	51,800	16,400
Indianapolis	Lawrence	13.5	435	268	116,500	26,220	270	117,500	28,400
Lawrence	Oaklandon	6.75	511	328	167,500	18,850	311	159,000	17,900
Oaklandon	McCordsville	3.083	460	273	125,500	6,460	280	124,200	6,385
McCordsville	Fortville	6.5	452	284	128,400	13,910	248	112,000	12,130
Fortville	Ingalls	4.67	494	258	127,500	9,950	256	126,500	9,870
Ingalls	Pendleton	7.83	489	212	103,700	13,530	214	104,600	13,660
Pendleton	Anderson ¹	13.59	365	250	92,000	20,820	253	93,100	21,085
Anderson ¹	Anderson	8.50	474	140	70,300	9,425	170	85,000	11,400

¹ City limits.TABLE XVI. — *Intermediate Results of Test No. 9. Feb. 2, 1905. Summary of Tables XIV and XV.*

FROM	TO	TIME, MIN- UTES.	VOLTS, AVER- AGE.	RECORDING AMMETER.			WESTON AMMETER.		
				AM- PERES AVER- AGE.	WATTS AVER- AGE.	WATT- HOURS.	AM- PERES AVER- AGE.	WATTS AVER- AGE.	WATT- HOURS.
Muncie ¹	Indianapolis	101.83	462	231	106,700	183,380	217	100,250	170,965
Indianapolis	Anderson	83.42	439	220	85,689	135,565	224	85,478	135,230

¹ City limits.

SERVICE TESTS OF AN INTERURBAN CAR 169

TABLE XVII. — Intermediate Results of Test No. 10. Feb. 3, 1905. Muncie to Indianapolis.

FROM	TO	TIME, MINUTES.	VOLTS, AVERAGE.	RECORDING AMMETER.			WESTON AMMETER.		
				AMPERES AVERAGE.	WATTS AVERAGE.	WATT-HOURS.	AMPERES AVERAGE.	WATTS AVERAGE.	WATT-HOURS.
Muncie	Muncie ¹	10 25	490	121	59,300	10,120	153	75,000	12,810
Muncie ¹	Yorktown	7 25	487	272	132,500	16,020	269	131,000	15,830
Yorktown	Daleville	7 25	471	276	130,000	15,700	279	131,250	15,870
Daleville	Chesterfield	2 83	521	252	131,100	6,180	253	131,800	6,225
Chesterfield	Anderson ¹	5 67	480	248	119,000	11,230	239	114,700	10,825
Anderson ¹	Anderson ¹	2 83	480	226	108,480	5,117	226	108,480	5,117
Anderson ¹	Anderson ¹	7 17	486	266	129,270	15,448	259	125,870	15,051
Anderson ¹	Pendleton	9 83	443	237	105,000	17,220	241	106,700	17,500
Pendleton	Ingalls	11 97	406	212	86,000	17,070	195	79,100	15,690
Ingalls	Fortville	5 33	545	210	114,500	10,170	198	108,000	9,590
Fortville	McCordsville	6 83	478	280	133,800	15,240	250	119,500	13,620
McCordsville	Oaklandon	3 33	458	289	132,300	7,340	279	127,700	7,085
Oaklandon	Lawrence	5 5	518	226	117,000	10,670	230	119,000	10,850
Lawrence	Indianapolis ¹	12.08	491	193	94,800	19,100	204	100,150	20,170
Indianapolis ¹	Indianapolis	17.42	431	83	35,700	10,370	84	36,200	10,520

¹ City limits.

TABLE XVIII. — Intermediate Results of Test No. 10. Feb. 3, 1905. Indianapolis to Muncie.

FROM	TO	TIME, MINUTES.	VOLTS, AVERAGE.	RECORDING AMMETER.			WESTON AMMETER.		
				AMPERES AVERAGE.	WATTS AVERAGE.	WATT-HOURS.	AMPERES AVERAGE.	WATTS AVERAGE.	WATT-HOURS.
Indianapolis	Indianapolis ¹	16 42	406	105	42,650	11,620	94	38,100	10,400
Indianapolis ¹	Lawrence	13 50	464	294	136,500	30,720	270	125,400	28,210
Lawrence	Oaklandon	5 75	547	210	114,800	11,020	250	136,500	13,110
Oaklandon	McCordsville	4 25	491	241	118,200	8,370	239	117,300	8,300
McCordsville	Fortville	7 58	470	264	124,000	15,670	249	47,000	14,800
Fortville	Ingalls	5 17	520	212	112,500	9,690	217	112,800	9,715
Ingalls	Pendleton	8 67	498	190	94,600	13,650	210	104,500	15,100
Pendleton	Anderson ¹	11 58	405	243	98,400	19,000	234	94,700	18,280
Anderson ¹	Anderson	9 50	374	167	62,500	10,000	168	62,800	10,050

¹ City limits.

TABLE XIX. — Intermediate Results of Test No. 10. Feb. 3, 1905. Summary of Tables XVII and XVIII.

FROM	TO	TIME, MINUTES.	VOLTS, AVERAGE.	RECORDING AMMETER.			WESTON AMMETER.		
				AMPERES AVERAGE.	WATTS AVERAGE.	WATT-HOURS.	AMPERES AVERAGE.	WATTS AVERAGE.	WATT-HOURS.
Muncie	Indianapolis	115 5	470	207	94,470	187,000	214	94,000	186,745
Indianapolis	Anderson	82 42	449	291	94,600	129,700	203	93,100	127,970

TABLE XX. — *Intermediate Results of Test No. 11. Feb. 4, 1905. Muncie to Indianapolis.*

FROM	TO	TIME, MINUTES.	VOLTS, AVERAGE.	RECORDING AMMETER.			WESTON AMMETER.		
				AMPERES AVERAGE.	WATTS AVERAGE.	WATT-HOURS.	AMPERES AVERAGE.	WATTS AVERAGE.	WATT-HOURS.
Muncie	Muncie ¹	13.67	456	153	69,800	15,900	143	65,200	14,850
Muncie ¹	Yorktown	7.58	503	316	159,000	20,100	312	156,900	19,800
Yorktown	Daleville	8.25	483	321	155,000	21,300	333	160,800	22,100
Daleville	Chesterfield	4.00	532	305	162,300	10,830	311	165,400	11,000
Chesterfield	Anderson ¹	6.17	507	287	144,500	14,860	290	14,690	15,100
Anderson ¹	Anderson	4.17	542	170	92,100	6,400	161	87,250	6,070
Anderson	Anderson ¹	8.00	496	256	127,000	16,940	266	127,200	16,990
Anderson ¹	Pendleton	10.83	443	285	126,300	22,800	287	131,900	23,800
Pendleton	Ingalls	10.58	350	273	95,500	16,820	257	90,000	15,850
Ingalls	Fortville	4.58	547	306	167,000	12,800	290	158,600	12,150
Fortville	McCordsville	7.41	453	296	134,000	16,550	295	133,600	16,500
McCordsville	Oaklandon	3.00	478	223	106,500	5,320	221	105,600	5,280
Oaklandon	Lawrence	6.91	498	285	142,000	16,320	286	142,400	16,375
Lawrence	Indianapolis ¹	14.1	497	255	126,700	29,800	251	124,700	29,300
Indianapolis ¹	Indianapolis	16.75	415	153	63,500	17,700	151	62,700	17,500

¹ City limits.TABLE XXI. — *Intermediate Results of Test No. 11. Feb. 4, 1905. Indianapolis to Muncie.*

FROM	TO	TIME, MINUTES.	VOLTS, AVERAGE.	RECORDING AMMETER.			WESTON AMMETER.		
				AMPERES AVERAGE.	WATTS AVERAGE.	WATT-HOURS.	AMPERES AVERAGE.	WATTS AVERAGE.	WATT-HOURS.
Indianapolis	Indianapolis ¹	17.17	425	188	79,900	22,850	171	72,700	20,800
Indianapolis ¹	Lawrence	14.92	453	337	152,600	37,900	340	154,000	38,300
Lawrence	Oaklandon	7.91	518	268	137,200	18,090	263	134,600	17,740
Oaklandon	McCordsville	4.0	445	311	138,300	9,200	312	138,800	9,250
McCordsville	Fortville	7.6	432	317	137,000	17,350	302	130,450	16,500
Fortville	Ingalls	5.83	497	290	144,000	14,000	280	139,150	13,500
Ingalls	Pendleton	8.75	465	237	110,200	16,000	254	118,100	17,200
Pendleton	Anderson ¹	11.33	405	306	124,000	23,400	305	123,500	23,350
Anderson ¹	Anderson	7.83	490	288	141,000	18,400	277	135,700	17,700
Anderson	Anderson ¹	3.83	507	160	81,000	5,200	151	76,550	4,900
Anderson ¹	Chesterfield	7.92	478	342	163,500	21,600	340	162,500	21,450
Chesterfield	Daleville	3.91	503	347	174,500	11,350	330	166,000	10,800
Daleville	Yorktown	8.42	481	316	152,000	21,300	308	148,150	20,800
Yorktown	Muncie ¹	9.67	440	320	140,800	22,700	314	138,150	22,250
Muncie ¹	Muncie	8.17	490	220	107,800	14,700	212	103,900	14,150

¹ City limits.TABLE XXII. — *Intermediate Results of Test No. 11. Feb. 4, 1905. Summary of Tables XX and XXI.*

FROM	TO	TIME, MINUTES.	VOLTS, AVERAGE.	RECORDING AMMETER.			WESTON AMMETER.		
				AMPERES AVERAGE.	WATTS AVERAGE.	WATT-HOURS.	AMPERES AVERAGE.	WATTS AVERAGE.	WATT-HOURS.
Muncie	Indianapolis	126.01	466	249	113,500	245,340	244	113,700	240,855
Indianapolis	Muncie	127.26	462	281	129,700	274,040	275	127,000	268,690

SERVICE TESTS OF AN INTERURBAN CAR 171

TABLE XXIII. — Intermediate Results of Test No. 12. Feb. 4, 1905. Muncie to Indianapolis.

FROM	TO	TIME, MINUTES.	VOLTS, AVERAGE.	RECORDING AMMETER.			WESTON AMMETER.		
				AMPERES AVERAGE.	WATTS AVERAGE.	WATT-HOURS.	AMPERES AVERAGE.	WATTS AVERAGE.	WATT-HOURS.
Muncie	Muncie ¹	8.00	454	145	65,920	8,790	132	59,850	7,970
Muncie	Yorktown	7.08	494	249	123,000	14,550	237	117,070	13,850
Yorktown	Daleville	7.00	460	278	128,000	14,980	263	121,000	14,150
Daleville	Chesterfield	3.17	487	300	146,100	8,110	274	133,400	7,400
Chesterfield	Anderson ¹	5.25	468	232	108,500	9,500	239	112,000	9,800
Anderson	Anderson	4.75	501	107	53,600	4,230	102	51,100	4,040
Anderson	Anderson ¹	6.75	450	233	105,000	12,780	221	99,600	12,080
Anderson	Pendleton	10.08	467	190	88,730	14,900	189	88,250	14,820
Pendleton	Ingalls	8.67	412	227	92,500	13,480	224	92,200	13,300
Ingalls	Fortville	4.50	492	221	108,900	8,160	224	110,000	8,260
Fortville	McCordsville	6.58	447	240	107,200	11,750	230	102,800	11,250
McCordsville	Oaklandon	3.42	431	299	129,000	7,350	283	122,000	6,950
Oaklandon	Lawrence	5.17	512	208	106,500	9,180	191	97,800	8,420
Lawrence	Indianapolis ¹	10.58	474	290	137,800	24,300	255	120,800	21,300
Indianapolis	Indianapolis	16.00	357	112	39,980	10,670	109	38,900	10,380

¹ City limits.

TABLE XXIV. — Intermediate Results of Test No. 12. Feb. 4, 1905. Indianapolis to Muncie.

FROM	TO	TIME, MINUTES.	VOLTS, AVERAGE.	RECORDING AMMETER.			WESTON AMMETER.		
				AMPERES AVERAGE.	WATTS AVERAGE.	WATT-HOURS.	AMPERES AVERAGE.	WATTS AVERAGE.	WATT-HOURS.
Indianapolis	Indianapolis ¹	17.33	395	107	42,300	12,230	105	41,500	12,000
Indianapolis	Lawrence	13.58	425	301	128,100	29,000	270	114,900	26,000
Lawrence	Oaklandon	5.17	497	246	122,250	10,525	208	103,370	8,900
Oaklandon	McCordsville	3.42	434	279	121,000	6,900	217	94,200	5,360
McCordsville	Fortville	7.66	444	241	107,000	13,650	221	98,300	12,530
Fortville	Ingalls	6.42	484	219	106,000	11,350	191	92,400	9,890
Ingalls	Pendleton	10.75	418	179	74,800	13,400	158	66,200	11,850
Pendleton	Anderson ¹	10.25	393	254	99,800	16,900	237	93,100	15,830
Anderson	Anderson	8.67	490	189	92,600	13,400	189	92,600	13,400
Anderson	Anderson ¹	4.17	502	143	71,700	4,980	133	67,000	4,660
Anderson	Chesterfield	6.00	496	309	153,260	15,325	290	143,840	14,380
Chesterfield	Daleville	3.25	434	280	121,500	6,570	275	119,500	6,460
Daleville	Yorktown	6.92	498	263	130,950	15,050	243	121,000	13,900
Yorktown	Muncie ¹	7.33	470	282	132,500	16,150	260	122,200	14,900
Muncie	Muncie	8.5	487	132	64,300	9,130	132	64,300	9,130

¹ City limits.

TABLE XXV. — Intermediate Results of Test No. 12. Feb. 4, 1905. Summary of Tables XXIII and XXIV.

FROM	TO	TIME, MINUTES.	VOLTS, AVERAGE.	RECORDING AMMETER.			WESTON AMMETER.		
				AMPERES AVERAGE.	WATTS AVERAGE.	WATT-HOURS.	AMPERES AVERAGE.	WATTS AVERAGE.	WATT-HOURS.
Muncie	Indianapolis	107.00	480	210	97,000	172,730	195	92,000	163,970
Indianapolis	Muncie	119.42	447	217	97,600	194,560	199	90,100	179,190

only at towns or at sidings where trains were passed. In the cities of Muncie, Anderson, and Indianapolis, however, it was necessary to make a number of stops. These stops were recorded on the general record sheet, and it will be noted that the stops per mile in cities is considerably greater than between cities. The equivalent passenger load has been taken as thirty passengers, as explained above under the general heading "Total Weight of the Car."

The total watt-hours between stops was obtained, as stated above, by multiplying together the average pressure, the average current (as obtained from the recording ammeter data), and the time of run. This method of obtaining the average power is not as accurate as would be that of plotting a watt curve from the instantaneous values of the current and pressure, and integrating this curve. However, it was considered to be impracticable to go to this additional refinement, as the limited time available would not permit of doing so.

The watt-hours per car-mile were obtained by dividing the total watt-hours in each case by the number of miles between the points considered. The energy in watt-hours per ton-mile was obtained by dividing the energy in watt-hours per car-mile by the total weight of the car, which was 39.33 tons. In Test No. 9, when the trailer was hauled by Car No. "284," the weight of the loaded trailer was added, making the total weight 62.16 tons. The energy in watt-hours per average through passenger carried, was obtained by dividing the total energy in watt-hours in each case by the equivalent passenger load. In Tests Nos. 9, 10, and 12 this number was 30, while in Test No. 11, it was increased to 70, because of the trailer load.

RESULTS OF THE TESTS.

Some of the more important numerical results of the various tests made on the interurban car are shown in tabular form in the synopsis at the beginning of the chapter.

It has been found impossible to represent the results of all of the tests graphically, and the more detailed data for each of

these tests are shown below in Tables XXVI to XXIX inclusive, which are supplemented by log sheets similar to those accompanying the tables of results of the service tests of the double-truck city car shown in Chapter III. In these tables will be found the detailed data showing the general results between the various stops for each test as well as general summaries of these results between cities. The average data for the tests, together with other items showing the conditions under which each test was run and the final rise in temperature of the motors, will be found in the log sheets accompanying the tables.

THE GRAPHICAL LOG.

While it has not been considered possible to represent graphically the results of the various service tests made upon the interurban car, it has been thought desirable to show in such a manner the results of a portion of one test, which portion has been taken as typical of the conditions existing throughout the entire series of the tests. This graphical representation is shown in Plate II, Fig. 52. The section chosen for this purpose, which was selected more or less at random, is the run from the station in Anderson to the town of McCordsville, which lies 21.02 miles southeast of Anderson, and is somewhat more than half way to Indianapolis from that city.

Time has been taken as a base in making up this graphical log. The profile is consequently not shown, but will be found in Fig. 53. The per cent grade at various points along the line is shown, however, on the graphical log.

The Speed Curve.

The speed curve was transferred from the general speed record in the following manner. Various sections of the original speed curve were integrated, and the average ordinates obtained for known intervals of time. From the pole record the actual distance traversed during this interval was accurately obtained. From the distance and time data the average speed was obtained, and consequently the speed for a given ordinate could then be

calculated. By proceeding in this way, and taking portions of the speed curve, which shows different ordinates, the speed calibration curve was obtained. The speed curve was directly transferred to the graphical log by erecting ordinates at the five-second intervals and finding the exact speed at these ordinates by means of the calibration curve.

The Pressure Curve.

The pressure curve was obtained by transferring the original record to the graphical log. In order to do this it was necessary to obtain a calibration curve showing the relation between the ordinates and the actual voltage values at periods throughout the tests. Ordinates were then erected at the five-second points on the original curve, and their values obtained by means of the calibration curve. These points were then transferred to the graphical log and the pressure curve was drawn, the general form being taken from the original record.

The Current Curve.

The current curve was re-plotted directly from the current curve produced by the General Electric recording ammeter, which record was already on a time base. The same method of procedure was employed in making this transfer as in the case of the pressure curve. The General Electric recording ammeter ordinates have a value of 200 amperes to the inch in this test. The ordinates at the five-second points were therefore measured and transferred to the graphical log.

The Power Curve.

The power curve was obtained by multiplying together the instantaneous values of the line pressure and current curves, for each five-second interval throughout the run. These points were plotted and intermediate points filled in according to the general shape of the current curve, due consideration being given to the variations in the pressure curve during the interval.

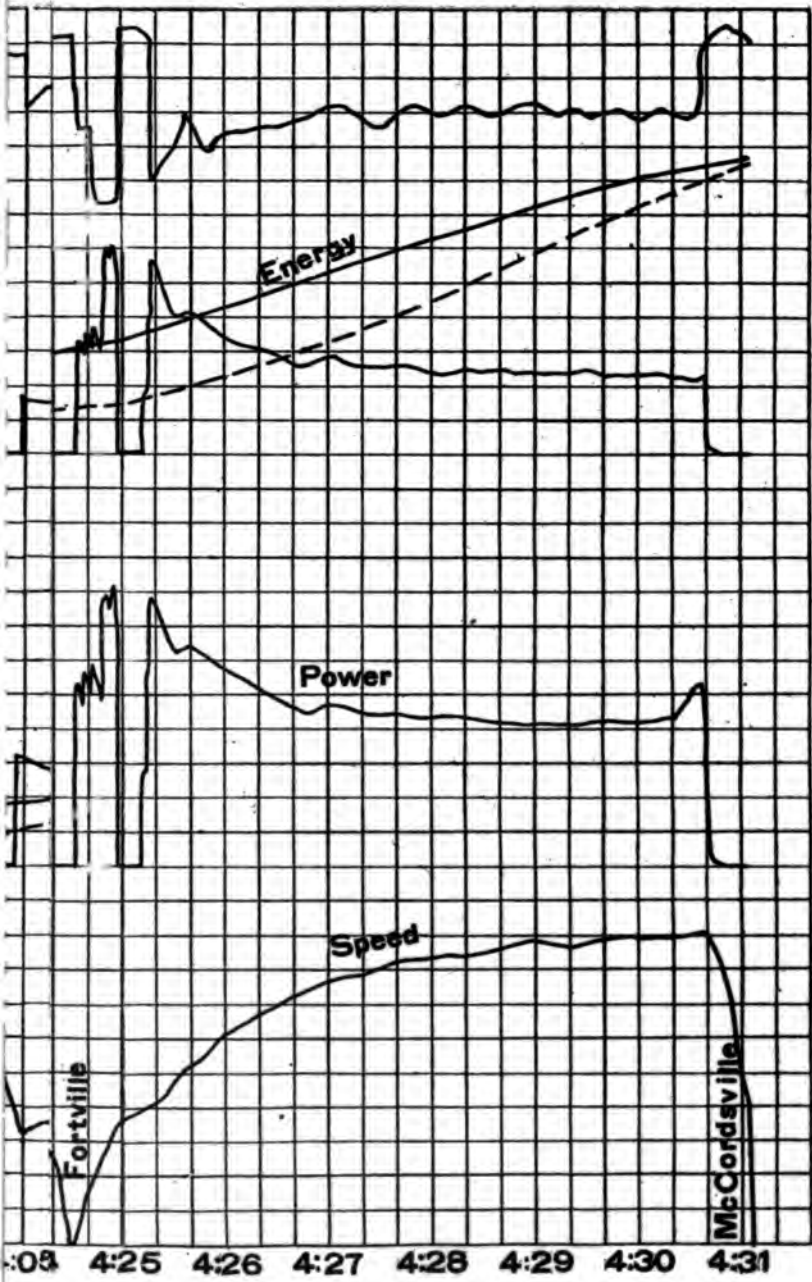

(To face page 174)





Vertical text on the right side of the page, possibly a page number or header.

)

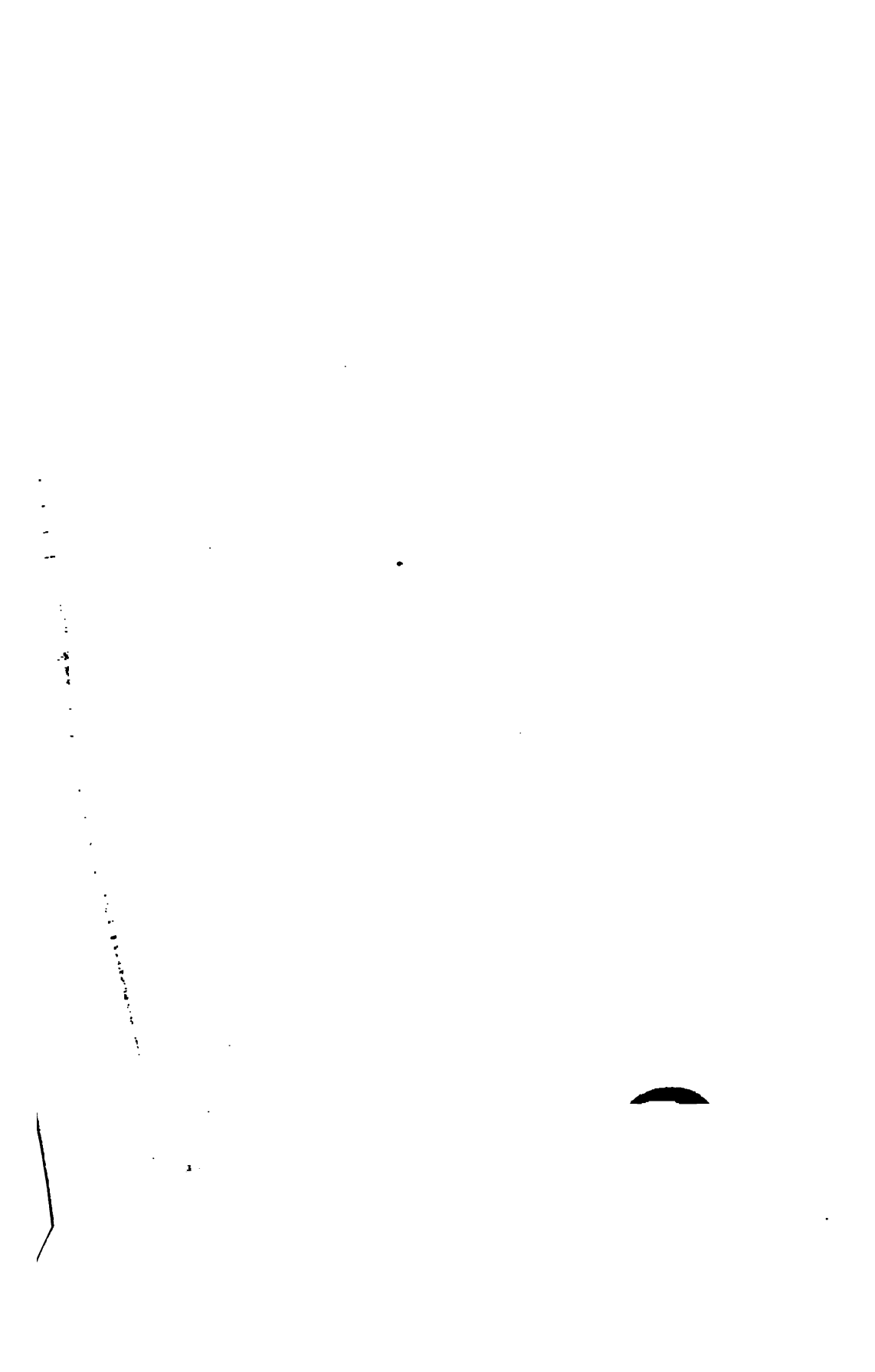

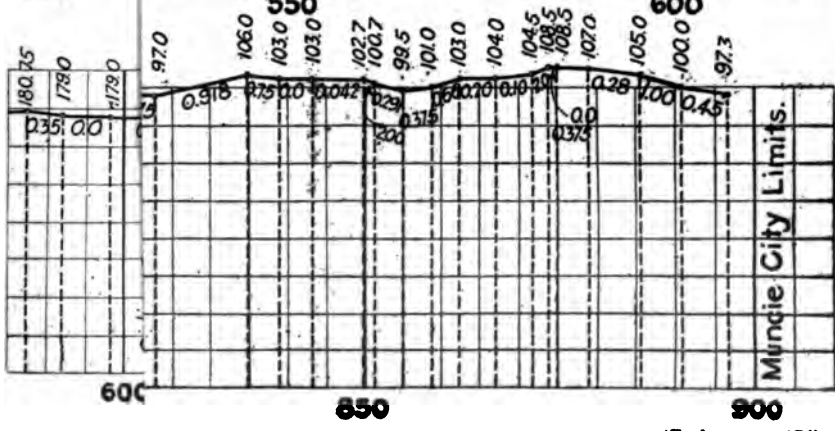
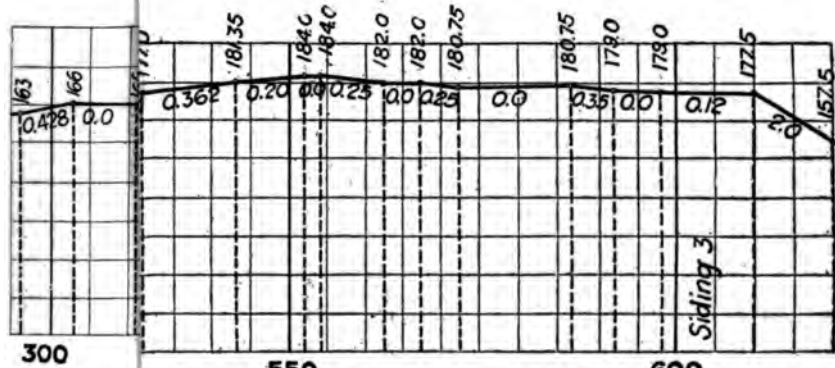
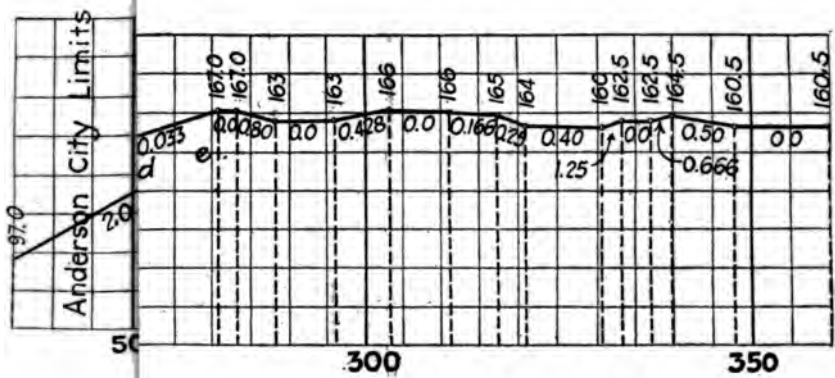

(To face page 174)



1. The first part of the document discusses the importance of maintaining accurate records of all transactions and activities. It emphasizes that proper record-keeping is essential for transparency and accountability, particularly in financial matters. The text notes that without clear documentation, it becomes difficult to track expenses, revenues, and other critical data points. This section also touches upon the legal implications of record-keeping, suggesting that organizations must adhere to specific regulations and standards to avoid penalties or legal challenges.

2. The second part of the document focuses on the role of technology in modern record-keeping. It highlights how digital tools and software solutions can significantly improve the efficiency and accuracy of data management. The text describes various types of record-keeping systems, including cloud-based storage, automated data entry, and secure digital archiving. It also discusses the importance of data security and privacy, noting that organizations must implement robust measures to protect sensitive information from unauthorized access or breaches.

3. The third part of the document addresses the challenges of record-keeping in a rapidly changing business environment. It identifies several key issues, such as data integration, scalability, and compliance with evolving regulations. The text suggests that organizations should adopt a proactive approach to record-keeping, regularly reviewing and updating their systems to ensure they remain effective and compliant. It also emphasizes the need for clear policies and procedures to guide record-keeping practices across the organization.

4. The final part of the document provides a summary of the key points discussed and offers some practical recommendations for implementing a successful record-keeping strategy. It stresses the importance of leadership support, employee training, and ongoing monitoring and evaluation. The text concludes by noting that while record-keeping may seem like a mundane task, it is a critical component of any organization's success, providing a solid foundation for decision-making and long-term growth.

The Energy Curve.

The curve showing the total energy consumed up to a certain point on the run was obtained by integrating the power curve up to this point. No attempt was made to show the variations in the form of the energy curve between the points considered, and the increase in energy taken is shown by a straight line from one point to the next in each case.

The Distance Curve.

The distance curve was obtained directly from the data showing the time of passing various known points throughout the run.

THE GENERAL LOG ACCOMPANYING THE GRAPHICAL LOG.

The general log for this particular portion of the line is given in considerable detail. It shows the general conditions under which this particular portion of the run was made, in a manner similar to the explanatory logs accompanying the tabulated general results of the various tests. In this log will be found additional data concerning the maximum values of speed and power for the specific portion of the run considered.

In order to show the relations of the maximum values of speed, current, and power to the average values, the following plan was employed. From the time-speed, time-current, and time-power curves, the maximum values of all loops were obtained and these maximum values were averaged in each case. This gave the average maximum values of the quantities. The highest value which each quantity attained during the test was also obtained, in order to show the extreme maximum values and their relation to the average maximum values.

GENERAL LOG SHEET OF TEST NO. 9.

Date, Thursday, February 2d, 1905; *Place*, Central Indiana; *Route*, Muncie-Anderson-Indianapolis section of the Indiana Union Traction Company's system. This test included the run from Muncie city limits to Indianapolis, and from Indianapolis

to Anderson. In addition, the car was run from the Anderson shops to Muncie before the test was started, and from Anderson to the Anderson shops after the test was completed.

Weather, clear, no snow. The average air temperature during the run was -16.4° C. or $+2.5^{\circ}$ F. *Condition of the track*, dry and clean. *Test started*, 11:23 A.M. *Test stopped*, 4:40 P.M. *Total duration of test*, 5.29 hours. *Equivalent load*, 30 passengers.

Average Data for the Day.

Pressure Measurements. — (Including all ordinary stops but no lay-over.) Line pressure for the test, 451.4 volts; line pressure in cities, 438.0 volts; line pressure between cities, 457.6 volts.

Distance Measurements. — Total length of run during test, 93.90 miles; total length of run in cities,¹ 12.20 miles; total length of run between cities, 81.70 miles; stops for total run during test, 32; stops for the total run in cities, 18; stops for total run between cities, 14; stops per mile for the test, 0.34; stops per mile in cities, 1.48; stops per mile between cities, 0.17; average length of run in cities, 0.68 miles; average length of run between cities, 5.84 miles.

Time Measurements. — Total interval of test (including all lay-overs), 317.25 minutes; lay-over at Anderson, 5.83 minutes; lay-over at Indianapolis, 95.83 minutes; lay-over at Lawrence, 5 minutes; lay-over at Siding No. 12, 22.59 minutes; lay-over at Madison Ave. (Anderson), 2.75 minutes; total interval of lay-over, 132.00 minutes; running time for the test (including ordinary stops but no lay-over), 185.25 minutes; total running time in cities, 58.34 minutes; total running time between cities, 126.91 minutes; average interval of a single run for the test (start to stop), 5.79 minutes; average interval of a single run in cities (start to stop), 3.24 minutes; average interval of a single run between cities (start to stop), 9.07 minutes.

Speed Measurements. — (Including all ordinary stops but no lay-over). Average speed for the test, 30.41 miles per hour;

¹ Anderson and Indianapolis.

SERVICE TESTS OF AN INTERURBAN CAR

TABLE No. XXVI. — Result of Test No. 9. Feb. 2, 1905.

FROM	TO	DIST. MILES.	DIST. FROM START MILES.	LEFT AT	ARRIVED AT	INTER-VAL OF RUN MIN. 1	EMBARSED FROM START MIN.	AVE. SPEED (RUNNING TIME) M.P.H.	AVE. SPEED FROM START M.P.H.	TOTAL K.W. HOURS.	K.W.H. PER CAR-MILE.	WATT-HOURS PER TON-MILE.	WATT-HOURS PER PASSENGER.
Muncie City Lim.	Yorktown	4.88	4.88	11:23:00	11:30:20	7.33	7.33	40.0	40.0	16.70	3.43	86.5	567
Yorktown	Daleville	5.00	9.88	11:30:20	11:38:45	8.42	7.33	37.7	37.7	17.88	3.58	90.3	596
Daleville	Chesterfield	2.24	12.12	11:38:45	11:42:00	3.25	19.00	38.3	38.3	8.94	3.99	100.6	298
Chesterfield	Anderson City Lim.	4.10	16.22	11:42:00	11:47:45	5.75	24.75	42.7	39.3	12.72	3.11	78.4	424
Anderson C. L.	Anderson	0.74	16.96	11:47:45	11:52:00	4.25	29.00	40.4	35.1	6.05	8.17	206.0	202
Anderson C. L.	Anderson C. L.	2.04	19.00	11:57:50	12:03:45	5.92	40.75	28.0	28.0	14.70	2.30	182.5	490
Anderson C. L.	Pendleton	6.62	25.62	12:03:45	12:13:30	9.79	50.50	20.7	30.8	15.40	2.33	158.8	513
Pendleton	Ingalls	3.16	28.99	12:13:30	12:21:25	7.92	58.42	30.8	30.8	14.65	3.36	84.4	488
Ingalls	Fortville	4.82	37.98	12:21:25	12:25:15	3.83	62.25	49.5	32.0	8.07	2.55	64.4	269
Fortville	McCordsville	2.10	40.07	12:31:35	12:34:40	3.08	68.58	45.6	33.1	12.82	2.67	67.3	427
McCordsville	Oaklandon	2.10	44.60	12:34:40	12:40:30	5.83	71.66	40.9	34.1	5.84	2.80	70.5	196
Oaklandon	Lawrence	4.53	51.72	12:40:30	12:50:00	9.50	86.99	46.6	35.5	20.80	3.15	79.4	476
Lawrence	Indianapolis C. L.	3.71	55.43	12:50:00	1:10:40	20.67	107.66	10.8	30.9	14.49	2.92	73.6	693
Indianapolis C. L.	Indianapolis C. L.	3.71	3.71	2:46:30	3:05:30	19.00	19.00	11.7	11.7	16.40	4.42	111.4	547
Indianapolis C. L.	Lawrence	7.12	10.83	3:05:30	3:15:30	13.50	32.50	20.0	20.0	26.22	3.69	93.0	874
Lawrence	Oaklandon	4.53	15.36	3:24:00	3:30:45	6.75	44.25	20.8	18.85	18.85	4.15	104.6	628
Oaklandon	McCordsville	2.10	17.46	3:30:45	3:33:50	3.08	54.17	21.9	21.9	6.46	3.08	72.6	215
McCordsville	Fortville	4.82	22.28	3:33:50	3:40:20	6.50	61.17	13.91	13.91	9.91	2.89	72.8	464
Fortville	Ingalls	3.16	25.44	3:40:20	3:45:50	4.67	58.50	26.2	26.2	9.95	3.15	79.4	332
Ingalls	Pendleton	4.37	29.81	3:45:50	3:52:50	7.83	66.33	27.0	27.0	13.53	3.11	78.5	451
Pendleton	Anderson C. L.	6.62	36.43	3:52:50	4:29:00	13.59	102.50	21.3	21.3	20.82	3.15	79.4	694
Anderson C. L.	Anderson	2.04	38.47	4:29:00	4:40:15	8.50	113.75	14.4	20.3	9.43	4.62	116.5	314

SUMMARY.

Lay-over at Anderson
Lay-over at Indianapolis
Lay-over at Lawrence

5.83 Minutes.
95.83 Minutes.
5.00 Minutes.

Lay-over at Sidling No. 12
Lay-over at Madison Ave. (Anderson)

22.50 Minutes.
2.75 Minutes.

1 Including ordinary stops, but not lay-overs.

Muncie C. L.	Anderson	16.96	11:23:00	11:52:00	29.00	35.1	62.29	3.67	92.5	2,076
Anderson	Indianapolis	38.47	11:57:50	1:10:40	72.83	31.7	121.09	3.15	79.5	4,036
Muncie C. L.	Indianapolis	55.43	11:23:00	1:10:40	101.83	32.7	183.38	3.31	83.5	6,113
Indianapolis	Anderson	38.47	2:46:30	4:40:15	83.42	27.7	136.09	3.54	89.3	4,536

average speed in cities, 12.55 miles per hour; average speed between cities, 38.63 miles per hour.

Current Measurements. — (Including all ordinary stops but no lay-over.) Average current for the test, 220.5 amperes; average current in cities, 140.3 amperes; average current between cities, 257.5 amperes.

Power Measurements. — (Including all ordinary stops but no lay-over.) Average power for the test, 103,302 watts; average power in cities, 62,805 watts; average power between cities, 12,180 watts.

Energy Measurements. — (Including all ordinary stops but no lay-over.) Total energy for the test, 318,945 watt-hours; total energy in cities, 61,065 watt-hours; total energy between cities, 257,880 watt-hours; energy per car-mile for the test, 3397 watt-hours; energy per car-mile in cities, 5005 watt-hours; energy per car-mile between cities, 3156 watt-hours; energy per ton-mile for the test, 85.6 watt-hours; energy per ton-mile in cities, 126.2 watt-hours; energy per ton-mile between cities, 79.6 watt-hours; energy per average through passenger carried for the test, 10,632 watt-hours; energy per average through passenger carried in cities, 2036 watt-hours; energy per average through passenger carried between cities, 8596 watt-hours.

GENERAL LOG SHEET OF SERVICE TEST NO. 10.

Date, Friday, February 3d, 1905; *Place*, Central Indiana; *Route*, Muncie-Anderson-Indianapolis section of the Indiana Union Traction Company's system. This test includes the run from Muncie to Indianapolis and from Indianapolis to Anderson. In addition, the car was run from the Anderson shops to Muncie before the test was started, and from Anderson to the Anderson shops after the test was completed.

Weather, clear, no snow. The average air temperature during the run was -11.4° C. or 11.5° F. *Condition of the track*, dry and clean. *Test started*, 11:12 A.M. *Test stopped*, 3:08 P.M. *Total duration of test*, 3.94 hours. *Equivalent passenger load*, 30 passengers.

Average Data for the Day.

Pressure Measurements. — (Including all ordinary stops but no lay-over.) Line pressure for the test, 471.5 volts; line pressure in cities, 459.0 volts; line pressure between cities, 434.0 volts.

Distance Measurements. — Total length of run during test, 95.02 miles; total length of run in cities, 13.36 miles; total length of run between cities, 81.70 miles; stops for total run during test, 29; stops for total run in cities, 13; stops for total run between cities, 16; stops per mile for test, 0.31; stops per mile in cities, 0.97; stops per mile between cities, 0.20; average length of run for the test, 3.28 miles; average length of run in cities, 1.02 miles; average length of run between cities, 5.10.

Time Measurements. — Total interval of test (including all stops but no lay-over), 236.5 minutes; lay-over at Anderson, 2.75 minutes; lay-over at Indianapolis, 35.83 minutes; total interval of lay-over, 38.58 minutes; running time for the test (including all ordinary stops but no lay-over), 197.92 minutes; total running time in cities, 63.59 minutes; total running time between cities, 134.33 minutes; average interval of a single run for the test (start to stop), 6.83 minutes; average interval of a single run in cities (start to stop), 4.88 minutes; average interval of a single run between cities (start to stop), 8.40 minutes.

Speed Measurements. — (Including all ordinary stops but no lay-over.) Average speed for the test, 28.84 miles per hour; average speed in cities, 12.58 miles per hour; average speed between cities, 36.50 miles per hour.

Current Measurements. — (Including all ordinary stops but no lay-over.) Average current for the test, 216.6 amperes; average current in cities, 134.3 amperes; average current between cities, 255.2 amperes.

Power Measurements. — (Including all ordinary stops but no lay-over.) Average power for the test, 96,100 watts; average power in cities, 59,200 watts; average power between cities, 113,400 watts.

Energy Measurements. — (Including all ordinary stops but no lay-over.) Total energy for the test, 316,740 watt-hours; total

TABLE No. XXXVII. — Results of Test No. 10. Feb. 3, 1905.

FROM	TO	DIST. MILES.	DIST. FROM START MILES.	LEFT AT	ARRIVED AT	INTERVAL OF RUN. MIN.¹	ELAPSED TIME FROM START MIN.	AVE. SPEED (RUNNING TIME) M.P.H.	AVE. SPEED FROM START M.P.H.	TOTAL K.W. HOURS.	K.W.H. PER TON-MILE.	WATT-HOURS PER TON-MILE.	WATT-HOURS THROUGH PASSENGER.
Muncie	Muncie City Lim.	1.12	1.12	11:11:45	11:22:00	10.25	10.25	6.5	6.5	10.1	9.00	227.0	337
Muncie	Yorktown	4.88	6.00	11:22:00	11:29:15	7.25	17.50	40.5	20.6	16.0	3.25	82.7	533
Muncie	Daleville	5.00	11.00	11:29:15	11:36:30	7.25	24.75	41.3	20.6	15.7	3.14	79.1	523
Muncie	Chesterfield	2.24	13.24	11:36:30	11:39:20	2.83	27.58	49.5	27.5	6.2	2.77	69.8	207
Muncie	Anderson C. L.	4.10	17.34	11:39:20	11:45:00	5.67	33.25	46.5	31.3	11.2	2.71	68.3	373
Muncie	Anderson C. L.	0.74	18.08	11:45:00	11:47:50	2.83	36.08	19.7	30.0	5.1	5.89	173.5	170
Muncie	Anderson C. L.	2.04	20.12	11:50:35	11:57:45	7.17	46.00	17.1	28.7	15.4	7.35	190.0	513
Muncie	Pendleton	6.62	26.74	11:57:45	12:07:35	9.83	55.83	40.3	28.7	17.2	2.60	65.5	573
Muncie	Ingalls	4.37	31.11	12:07:35	12:19:30	11.92	67.75	21.9	27.6	17.1	3.91	98.6	570
Muncie	Fortville	3.16	34.27	12:19:30	12:24:50	5.33	73.08	35.5	28.1	10.2	3.23	81.3	340
Muncie	McCordsville	4.82	39.09	12:24:50	12:31:40	6.84	79.92	42.2	29.4	15.2	3.16	79.7	507
Muncie	Oaklandon	2.10	41.19	12:31:40	12:35:00	3.33	83.25	37.8	29.7	7.3	3.48	87.8	243
Muncie	Lawrence	4.53	45.72	12:35:00	12:40:30	5.50	88.75	49.7	30.9	10.7	2.36	59.5	357
Muncie	Anderson C. L.	7.12	52.84	12:40:30	12:52:35	12.08	100.83	35.4	31.4	19.1	2.68	67.5	637
Muncie	Indianapolis C. L.	3.71	56.55	12:52:35	1:10:00	17.42	118.25	12.8	28.7	10.4	2.81	70.9	347
Indianapolis	Indianapolis C. L.	3.71	3.71	1:45:50	2:12:15	16.42	16.42	13.5	13.5	11.6	3.13	78.8	387
Indianapolis	Lawrence	7.12	10.83	2:02:15	2:15:45	13.50	29.92	31.6	21.7	30.7	4.31	108.8	1,023
Indianapolis	Oaklandon	4.53	15.36	2:15:45	2:21:30	5.75	35.67	47.3	25.9	11.0	2.43	61.3	367
Indianapolis	McCordsville	2.10	17.46	2:21:30	2:25:45	4.25	39.92	29.6	26.2	8.4	4.00	100.9	280
Indianapolis	Fortville	4.82	22.28	2:25:45	2:33:20	7.58	47.50	38.1	28.2	16.7	3.26	82.2	523
Indianapolis	Ingalls	3.16	25.44	2:33:20	2:38:30	5.17	52.67	36.7	29.0	9.7	3.07	77.4	323
Indianapolis	Fortville	4.37	29.81	2:38:30	2:47:10	8.67	61.34	30.2	29.2	13.6	3.12	79.1	453
Indianapolis	Pendleton	6.62	36.43	2:47:10	2:58:45	11.58	72.92	34.3	30.0	19.0	2.87	72.3	633
Indianapolis	Anderson C. L.	2.04	38.47	2:58:45	3:08:15	9.50	82.42	12.9	28.0	10.0	4.90	123.5	333

SUMMARY.

FROM	TO	DIST. MILES.	DIST. FROM START MILES.	LEFT AT	ARRIVED AT	INTERVAL OF RUN. MIN.¹	ELAPSED TIME FROM START MIN.	AVE. SPEED (RUNNING TIME) M.P.H.	AVE. SPEED FROM START M.P.H.	TOTAL K.W. HOURS.	K.W.H. PER TON-MILE.	WATT-HOURS PER TON-MILE.	WATT-HOURS THROUGH PASSENGER.
Muncie	Anderson	18.08	18.08	11:11:45	11:47:50	36.08	36.08	30.0	30.0	64.3	3.58	89.7	2,143
Muncie	Indianapolis	38.47	38.47	11:11:45	1:10:00	79.42	79.42	29.0	29.0	122.6	3.16	80.2	4,087
Muncie	Indianapolis	56.55	56.55	11:11:45	1:10:00	115.50	115.50	26.4	26.4	186.9	3.31	83.4	6,280
Muncie	Anderson	38.47	38.47	1:45:50	3:08:15	82.42	82.42	28.0	28.0	129.7	3.63	91.5	4,323

Lay-over at Anderson — 2.75 Min.

Lay-over at Indianapolis — 35.83 Min.

¹ Including ordinary stops, but not lay-overs.

energy in cities, 62,680 watt-hours; total energy between cities, 254,060 watt-hours; energy per car-mile for the test, 3340 watt-hours; energy per car-mile in cities, 4700 watt-hours; energy per car-mile between cities, 3210 watt-hours; energy per ton-mile for the test, 841.4 watt-hours; energy per ton-mile in cities, 118.5 watt-hours; energy per ton-mile between cities, 80.9 watt-hours; energy per average through passenger carried for the test, 10,558 watt-hours; energy per average through passenger carried in cities, 2089 watt-hours; energy per average through passenger carried between cities, 8469 watt-hours.

GENERAL LOG SHEET OF SERVICE TEST NO. 11.

Date, Saturday, February 4th, 1905; *Place*, Central Indiana; *Route*, Muncie-Anderson-Indianapolis section of the Indiana Union Traction Company's system. This test included the run from Muncie to Indianapolis and return, trailer No. "302" being hauled throughout the test. Car "284" hauling trailer No. "302," was run from the Anderson shops to Muncie before this was started.

Weather, clear and cold, no rain. The average air temperature during the run was -8.8° C. or 16.2° F. *Condition of the track*, dry and clean. *Test started*, 9:03 A.M. *Test stopped*, 1:52 P.M. *Total duration of test*, 4.81 hours. *Equivalent passenger load*, 70 passengers.

Average Data for the Day.

Pressure Measurements. — (Including all ordinary stops but no lay-over.) Line pressure for the test, 472.5 volts; line pressure in cities, 460.0 volts; line pressure between cities, 478.5 volts.

Distance Measurements.—Total length of run during test, 113.10 miles; total length of run in cities, 15.22 miles; total length of run between cities, 97.88 miles; stops for total run during test, 33; stops for total run in cities, 14; stops for total run between cities, 19; stops per mile for test, 0.29; stops per mile in cities, 0.92; stops per mile between cities, 0.19; average length of run for the test, 3.43 miles; average length of run in

TABLE No. XXVIII. — Results of Test No. 11. Feb. 4, 1905.

FROM	TO	DIST. MILES.	DIST. MILES.	LEFT AT	ARRIVED AT	INTERVAL OF RUN MIN. ¹	ELAPSED TIME FROM START MIN.	AVE. SPEED (RUNNING TIME) M.P.H.	AVE. SPEED FROM START M.P.H.	TOTAL K.W. HOURS.	K.W.H. PER CAR-TON-MILE.	WATT-HOURS PER TON-PASSENGER.
Muncie	Muncie City Lim.	1.12	1.12	9:03:20	9:17:00	13.67	13.67	4.9	4.9	15.90	15.59	227
Muncie	Yorktown	4.88	6.00	9:17:00	9:24:35	7.58	21.25	38.6	16.9	20.10	4.12	287
Yorktown	Daleville	5.00	11.00	9:24:35	9:32:50	8.25	29.50	36.4	23.4	21.30	4.26	304
Daleville	Chesterfield	2.24	13.24	9:32:50	9:36:50	4.00	33.50	33.6	22.7	10.83	5.10	155
Anderson	Anderson C. L.	4.10	17.34	9:36:50	9:43:00	6.17	39.67	39.8	25.2	14.86	3.62	212
Anderson C. L.	Anderson C.	0.74	18.08	9:43:00	9:47:10	4.17	43.83	40.6	24.7	6.40	8.65	242
Anderson C.	Anderson C. L.	2.04	20.12	9:49:00	9:57:00	8.00	53.07	43.0	22.9	16.94	8.30	326
Anderson C. L.	Pendleton	6.62	26.74	10:07:50	10:50:00	10.83	64.90	45.3	24.5	22.80	3.44	260
Pendleton	Ingalls	4.37	31.11	10:09:50	10:20:25	10.58	77.08	41.3	24.1	16.82	4.05	240
Ingalls	Fortville	3.16	34.27	10:20:25	10:25:00	4.58	81.67	39.0	26.1	12.80	3.85	183
Fortville	McCordsville	4.82	39.09	10:25:00	10:32:25	7.41	89.08	39.0	26.1	16.55	3.42	222
McCordsville	Oaklandon	2.10	41.19	10:32:25	10:35:25	3.00	92.08	42.0	26.6	5.32	2.52	79
Oaklandon	Lawrence	4.53	45.72	10:35:25	10:42:20	6.91	99.00	39.3	27.7	16.32	3.60	232
Lawrence	Indianapolis C. L.	7.12	52.84	10:42:20	10:56:25	14.10	113.00	30.3	28.0	29.80	4.19	426
Indianapolis C. L.	Indianapolis C. L.	3.71	56.55	10:56:25	11:13:10	16.75	129.83	13.3	26.1	17.70	4.77	253
Indianapolis	Indianapolis C. L.	3.71	11:35:50	11:53:00	12:07:00	17.17	17.17	13.0	13.0	22.85	6.16	326
Indianapolis	Lawrence	7.12	10.83	11:53:00	12:07:55	14.92	32.09	28.6	20.2	37.90	5.33	85.9
Lawrence	Oaklandon	4.53	15.36	12:07:55	12:15:50	7.91	40.00	34.4	23.0	18.09	3.98	64.1
Oaklandon	McCordsville	2.10	17.46	12:15:50	12:19:50	4.00	44.00	31.5	23.8	9.20	4.38	70.5
McCordsville	Fortville	4.82	22.28	12:19:50	12:33:15	7.60	51.60	38.1	25.9	17.35	3.60	247
Fortville	Ingalls	3.16	25.44	12:33:15	12:37:25	5.83	57.43	32.5	26.6	14.00	4.43	200
Ingalls	Pendleton	4.37	29.81	12:37:25	12:45:50	8.75	70.00	30.0	25.6	16.00	3.66	229
Pendleton	Anderson C. L.	6.62	36.43	12:45:50	12:57:10	11.33	81.33	35.6	26.9	23.40	3.38	334
Anderson C. L.	Anderson C. L.	2.04	38.47	12:57:10	1:05:00	7.83	89.17	15.6	26.0	18.40	9.03	263
Anderson C. L.	Anderson C. L.	0.74	39.21	1:07:05	1:10:55	3.83	93.08	11.6	24.8	5.20	7.03	74
Anderson C. L.	Chesterfield	4.10	43.31	1:13:35	1:21:30	7.92	105.67	31.0	24.6	21.30	5.27	309
Chesterfield	Daleville	2.24	45.55	1:21:30	1:25:25	3.91	109.58	34.0	24.9	11.35	5.07	179
Daleville	Yorktown	5.00	50.55	1:25:25	1:33:50	8.42	118.00	35.6	25.7	21.30	4.03	304
Yorktown	Muncie C. L.	4.88	55.43	1:33:50	1:43:30	9.67	127.67	30.3	26.0	23.70	4.65	324
Muncie C. L.	Muncie	1.12	56.55	1:43:30	1:51:40	8.17	135.83	8.2	25.0	14.70	1.31	210
Muncie	Anderson	18.08	9:03:20	9:47:10	43.84	43.84	89.39	24.7	89.39	4.94	79.4	1,277
Anderson	Indianapolis	38.4	9:49:00	11:13:10	82.16	82.16	155.05	28.1	155.05	4.03	65.0	2,215
Indianapolis	Indianapolis	56.55	9:03:20	11:13:10	126.00	126.00	244.44	26.9	244.44	4.33	69.6	5,492
Indianapolis	Anderson	38.47	11:35:50	1:05:00	85.34	89.17	177.19	27.1	177.19	4.61	74.1	2,431
Anderson	Muncie	18.08	1:07:05	1:51:40	41.92	44.58	96.85	25.0	96.85	5.35	86.1	1,884
Anderson	Indianapolis	56.55	11:35:50	1:51:40	127.26	139.83	274.04	26.6	274.04	4.85	78.0	1,915
Indianapolis	Muncie	113.10	9:03:20	1:51:40	253.26	288.33	518.48	26.8	518.48	4.58	73.7	7,407

Lay-over at Anderson 1.83 Min.
 Lay-over at Pendleton 2.00 Min.
 Lay-over at Indianapolis 22.66 Min.
 1 Including ordinary stops, but not lay-overs.
 Lay-over at Anderson, 2.08 Min.
 Lay-over at Ingalls, 3.83 Min.
 Lay-over at Siding 11A, 2.66 Min.

cities, 1.09 miles; average length of run between cities, 5.15 miles.

Time Measurements. — Total interval of test (including all ordinary stops but no lay-over), 288.33 minutes; lay-over at Anderson, 1.83 minutes; lay-over at Pendleton, 2.00 minutes; lay-over at Indianapolis, 22.66 minutes; lay-over at Ingalls, 3.83 minutes; lay-over at Anderson, 2.08 minutes; lay-over at Siding, 11a, 2.66 minutes; total interval of lay-over, 35.06 minutes; running time for the test (including all ordinary stops but no lay-over), 253.26 minutes; running time in cities, 79.59 minutes; running time between cities, 173.67 minutes; average interval of a single run for the test (start to stop), 7.68 minutes; average interval of a single run in cities (start to stop), 5.68 minutes; average interval of a single run between cities (start to stop), 9.14 minutes.

Speed Measurements. — (Including all ordinary stops but no lay-over.) Average speed for the test, 26.80 miles per hour; average speed in cities, 11.45 miles per hour; average speed between cities, 33.80 miles per hour.

Current Measurements. — (Including all ordinary stops but no lay-over.) Average current for the test, 265.0 amperes; average current in cities, 192.0 amperes; average current between cities, 299.0 amperes.

Power Measurements. — (Including all ordinary stops but no lay-over.) Average power for the test, 122,700 watts; average power in cities, 89,200 watts; average power between cities, 138,200 watts.

Energy Measurements. — (Including all ordinary stops but no lay-over.) Total energy for the test, 518,480 watt-hours; total energy in cities, 118,090 watt-hours; total energy between cities, 400,390 watt-hours; energy per car-mile for the test, 4580 watt-hours; energy per car-mile in cities, 7770 watt-hours; energy per car-mile between cities, 4090 watt-hours; energy per ton-mile for the test, 73.8 watt-hours; energy per ton-mile in cities, 125.0 watt-hours; energy per ton-mile between cities, 65.9 watt-hours; energy per average through pas-

TABLE No. XXIX. — Results of Test No. 12. Feb. 4, 1905.

FROM	TO	DIST. MILES.	DIST. FROM START MILES.	LEFT AT	ARRIVED AT	INTERVAL OF RUN MIN. ¹	ELAPSED TIME FROM START MIN.	AVE. SPEED (RUNNING TIME) M.P.H.	AVE. SPEED FROM START M.P.H.	TOTAL K.W. HOURS.	K.W.H. PER CAR-MILE.	WATT-HOURS PER TON-PASSENGER.
Muncie	Muncie City Lim.	1.12	1.12	3:05:40	3:19:00	8.00	13.33	8.40	5.05	8.79	7.86	293
Muncie	Yorktown	4.88	6.00	3:19:00	3:26:05	7.08	20.42	41.40	17.62	14.55	3.97	483
Yorktown	Daleville	5.00	11.00	3:26:05	3:33:05	7.00	27.42	42.90	24.05	14.98	3.00	500
Daleville	Chesterfield	2.24	13.24	3:33:05	3:36:15	3.17	30.58	40.35	29.95	8.11	3.62	270
Anderson C. L.	Anderson C. L.	4.10	17.34	3:36:15	3:41:30	5.25	35.83	46.90	29.05	9.50	3.32	317
Anderson C. L.	Anderson C. L.	0.74	18.08	3:41:30	3:46:15	4.75	40.58	9.35	26.05	4.23	5.68	140
Anderson C. L.	Anderson C. L.	2.04	20.12	3:46:15	3:55:40	6.75	50.00	18.13	24.15	12.78	6.27	427
Anderson C. L.	Pendleton	6.62	26.74	3:55:40	4:05:45	10.08	60.08	39.41	26.70	14.90	2.25	51.8
Anderson C. L.	Ingalls	4.37	31.11	4:05:45	4:20:00	8.67	74.33	30.20	25.15	13.48	3.09	450
Anderson C. L.	Fortville	3.16	34.27	4:20:00	4:24:30	4.50	78.83	42.10	26.10	8.16	2.59	65.3
Anderson C. L.	McCordsville	4.82	39.09	4:24:30	4:31:05	6.58	85.41	43.90	27.55	11.75	2.42	61.1
Anderson C. L.	Oaklandon	2.10	41.19	4:31:05	4:34:30	3.42	88.83	36.85	29.20	7.35	3.48	243
Anderson C. L.	Lawrence	4.53	45.72	4:34:30	4:39:40	5.17	94.00	52.85	29.20	9.18	2.02	51.0
Anderson C. L.	Indianapolis C. L.	7.12	52.84	4:45:25	4:56:00	10.58	110.33	43.90	28.80	24.30	3.42	810
Indianapolis C. L.	Indianapolis C. L.	3.71	56.55	4:56:00	5:12:00	16.00	126.33	13.52	26.93	10.67	3.38	357
Indianapolis C. L.	Indianapolis C. L.	3.71	60.26	5:39:05	5:56:25	17.33	143.66	12.87	12.87	12.23	3.29	407
Indianapolis C. L.	Lawrence	7.12	67.38	5:56:25	6:13:20	15.58	159.24	31.45	19.29	26.00	4.07	967
Indianapolis C. L.	Oaklandon	4.53	71.91	6:13:20	6:18:30	5.17	164.41	52.70	23.35	10.52	2.42	61.1
Indianapolis C. L.	McCordsville	2.10	74.01	6:18:30	6:21:55	3.42	167.83	36.85	24.45	6.90	3.28	230
Indianapolis C. L.	Fortville	4.82	78.83	6:21:55	6:29:35	7.66	175.49	37.75	26.50	13.65	2.82	71.2
Indianapolis C. L.	Ingalls	3.16	81.99	6:29:35	6:36:00	6.45	181.94	29.55	26.85	11.35	3.56	373
Indianapolis C. L.	Fortville	4.37	86.36	6:36:00	6:46:45	10.75	192.69	24.41	26.42	13.40	3.07	77.5
Indianapolis C. L.	Pendleton	6.62	92.98	6:46:45	6:57:00	10.25	202.94	38.70	28.10	16.90	2.56	563
Indianapolis C. L.	Anderson C. L.	2.04	95.02	6:57:00	7:05:40	8.76	211.70	44.12	25.95	13.40	6.57	165.8
Anderson C. L.	Anderson C. L.	0.74	95.76	7:05:40	7:18:00	4.17	215.87	10.68	23.85	4.98	6.76	170.1
Anderson C. L.	Chesterfield	4.10	99.86	7:18:00	7:24:00	6.00	221.87	41.00	24.80	15.32	3.73	94.1
Anderson C. L.	Daleville	2.24	102.10	7:24:00	7:27:15	3.25	225.12	43.35	25.25	6.57	2.94	73.2
Chesterfield	Yerktown	5.00	107.10	7:27:15	7:34:10	6.92	232.04	43.35	26.40	15.05	3.00	75.7
Yerktown	Muncie C. L.	4.88	111.98	7:34:10	7:41:30	7.20	240.24	40.00	27.20	16.15	3.30	83.2
Yerktown	Muncie C. L.	1.12	113.10	7:41:30	7:50:00	8.50	248.74	7.90	25.95	9.13	8.12	204.2
Muncie	Anderson	18.08	131.18	3:05:40	3:46:15	35.25	40.58	30.75	60.1	3.32	83.6
Muncie	Indianapolis	38.47	169.65	3:46:15	5:12:00	75.00	83.17	32.15	112.6	2.92	376.9
Muncie	Indianapolis	56.55	226.20	3:05:40	5:12:00	107.00	126.33	39.15	172.7	3.05	76.9
Indianapolis	Anderson	38.47	264.67	5:39:05	7:05:40	86.58	143.66	31.70	172.7	3.31	83.5
Anderson	Muncie	18.08	282.75	7:05:40	7:50:00	36.17	181.94	37.00	167.1	3.71	93.5
Indianapolis	Muncie	56.55	339.30	5:39:05	7:50:00	118.42	248.74	24.41	194.3	3.43	86.4
Muncie	Muncie	113.10	452.40	3:05:40	7:50:00	226.42	284.33	29.95	367.0	3.24	12,280

Lay-over at Muncie, 5.33 Min.
 Lay-over at Anderson, 2.67 Min.
 Lay-over at Siding No. 14, 5.58 Min.
 Lay-over at Lawrence, 5.75 Min.
 Lay-over at Muncie, 5.33 Min.
 Lay-over at Anderson, 3.17 Min.
 Lay-over at Siding No. 11a, 5.00 Min.
 Lay-over at Indianapolis, 27.08 Min.
 Including ordinary stops, but not lay-overs.

senger carried for the test, 7407 watt-hours; energy per average through passenger carried in cities, 1687 watt-hours; energy per average through passenger carried between cities, 5720 watt-hours.

GENERAL LOG SHEET OF SERVICE TEST NO. 12.

Date, Saturday, February 4th, 1905; *Place*, Central Indiana; *Route*, Muncie-Anderson-Indianapolis section of the Indiana Union Traction Company's system. This test included the run from Muncie to Indianapolis and return to Muncie without trailer. Test No. 11 immediately preceded this test, and car "284" was run back to the Anderson shops, hauling trailer "302," immediately after the close of the test.

Weather, clear and cold, no snow. The average air temperature during the run was — 6.8° C. or 19.8° F. *Condition of the track*, dry and clean. *Test started*, 3:06 P. M. *Test stopped*, 7:50 P. M. *Total duration of test*, 4.74 hours. *Equivalent passenger load*, 30 passengers.

Average Data for the Day.

Pressure Measurements. — (Including all ordinary stops but no lay-over.) Line pressure for the test, 449.0 volts; line pressure in cities, 434.0 volts; line pressure between cities, 473.0 volts.

Distance Measurements. — Total length of run during test, 113.10 miles; total length of run in cities, 15.22 miles; total length of run between cities, 97.88 miles; stops for total run during test, 27; stops for total run in cities, 10; stops for total run between cities, 17; stops per mile for the test, 0.24; stops per mile in cities, 0.66; stops per mile between cities, 0.17; average length of run for the test, 4.20 miles; average length of run in cities, 1.52 miles; average length of run between cities, 5.75 miles.

Time Measurements. — Total interval of test (including all stops but no lay-over), 284.33 minutes; lay-over at Muncie, 5.33 minutes; lay-over at Anderson, 2.67 minutes; lay-over at Siding No. 14, 5.58 minutes; lay-over at Lawrence, 5.75 min-

utes; lay-over at Indianapolis, 27.08 minutes; lay-over at Siding No. 27, 3.33 minutes; lay-over at Anderson, 3.17 minutes; lay-over at Siding No. 11a, 5.00 minutes; total interval of lay-over, 57.91 minutes; running time for the test (including all ordinary stops but no lay-over), 226.42 minutes; total running time in cities, 74.17 minutes; total running time between cities, 152.25 minutes; average interval of a single run for the test (start to stop), 8.39 minutes; average interval of a single run in cities (start to stop), 7.41 minutes; average interval of a single run between cities (start to stop), 8.79 minutes.

Speed Measurements. — (Including all ordinary stops but no lay-over.) Average speed for the test, 29.95 miles per hour; average speed in cities, 12.33 miles per hour; average speed between cities, 38.55 miles per hour.

Current Measurements. — (Including all ordinary stops but no lay-over.) Average current for the test, 213.5 amperes; average current in cities, 138.5 amperes; average current between cities, 250.5 amperes.

Power Measurements. — (Including all ordinary stops but no lay-over.) Average power for the test, 97,300 watts; average power in cities, 61,650 watts; average power between cities, 114,600 watts.

Energy Measurements. — (Including all ordinary stops but no lay-over.) Total energy for the test, 367,290 watt-hours; total energy in cities, 76,210 watt-hours; total energy between cities, 291,080 watt-hours; energy per car-mile for the test, 3242 watt-hours; energy per car-mile in cities, 5007 watt-hours; energy per car-mile between cities, 2975 watt-hours; energy per ton-mile for the test, 81.8 watt-hours; energy per ton-mile in cities, 126.1 watt-hours; energy per ton-mile between cities, 75.0 watt-hours; energy per average through passenger carried for the test, 12,240 watt-hours; energy per average through passenger carried in cities, 25,400 watt-hours; energy per average through passenger carried between cities, 97,030 watt-hours.

GENERAL LOG SHEET FOR GRAPHICAL LOG. PART OF
SERVICE TEST NO. 12.

(From Anderson to McCordsville.)

Date, Saturday, February 4th, 1905; *Place*, Central Indiana; *Route*, Muncie-Indianapolis section of the Indiana Union Traction Company's lines. The graphical log shows approximately one-third of the run from Muncie to Indianapolis, and the part selected is that from Anderson to McCordsville, a town between Anderson and Indianapolis.

Weather, clear and cold, no rain. The average air temperature during the run was — 5.0° C. or 23.0° F. *Condition of track*, dry and clean. *Graphical log begins* at 3:49 P.M. *Graphical log ends* at 4:31 P.M. *Total interval* shown by graphical log, 0.7 hours. *Equivalent load*, 30 passengers.

Data for the Run.

Pressure Measurements. — Average line pressure, 435.9 volts; maximum line pressure, 575.0 volts; place where maximum line pressure occurred at city limits, Anderson; minimum line pressure, 245 volts; place where minimum line pressure occurred, leaving Siding No. 14.

Distance Measurements. — Total length of run, 21.02 miles; length of run in Anderson, 2.04 miles; length of run from Anderson city limits to McCordsville, 18.98 miles; stops for the total run, 7; stops in Anderson, 3; stops between Anderson city limits and McCordsville, 4; stops per mile for total run, 0.31; stops per mile in Anderson, 1.47; stops per mile between Anderson city limits and McCordsville, 0.21; length of a single run in Anderson (start to stop), 0.68 miles; length of a single run between Anderson city limits and McCordsville (start to stop), 3.80 miles.

Time Measurements. — Interval for total run (start to stop), 42.20 minutes; lay-over at Siding No. 14, 5.59 minutes; total running time (including ordinary stops), 36.01 minutes; running time in Anderson, 6.91 minutes; running time between Anderson city limits and McCordsville, 29.5 minutes; average

interval of run in Anderson (start to stop), 2.30 minutes; average interval of run between Anderson city limits and McCordsville, 5.87 minutes.

Speed Measurements. — Average speed between Anderson city limits and McCordsville (including all stops), 32.0 miles per hour; average speed (including all ordinary stops but no lay-over), 34.7 miles per hour; average speed in Anderson (including all ordinary stops but no lay-over), 17.8 miles per hour; average speed between Anderson city limits and McCordsville (including all ordinary stops but no lay-over), 38.2 miles per hour; maximum speed, 56 miles per hour; place where maximum speed occurred, north of Fortville.

Current Measurements. — Average current for the total run (including all stops), 205.8 amperes; average current for the total run (including all ordinary stops but no lay-over), 237.5 amperes; average current in Anderson (including all ordinary stops but no lay-over), 231.9 amperes; average current between Anderson city limits and McCordsville (including all ordinary stops but no lay-over), 232.0 amperes; average maximum current in Anderson, 603.0 amperes; maximum current in Anderson, 670 amperes; place and time at which maximum current occurred in Anderson, after stop at Madison Ave., at 4:20:27 P. M.; average maximum current between Anderson city limits and McCordsville, 465 amperes; place where maximum current occurred, pole No. 1763.

Power Measurements. — Average power for the entire run (including all stops), 88,250 watts; average power for the entire run (including all stops but no lay-over), 101,700 watts; average power in Anderson (including all ordinary stops but no lay-over), 111,500 watts; average power between Anderson and McCordsville (including all ordinary stops but no lay-over), 103,200 watts; average maximum power in Anderson, 251,000 watts; maximum power in Anderson, 320,000 watts; place where maximum power occurred, after stop at Madison Ave.; average maximum power between Anderson city limits and McCordsville, 179,500 watts; maximum power between Anderson city

limits and McCordsville, 300,000 watts; place and time at which maximum current occurred, pole No. 1765, at 4:20:30 P. M.

Energy Measurements. — Total energy for the entire run, 61.04 kw. hours; total energy in Anderson, 10.48 K.W. hours; total energy between Anderson city limits and McCordsville, 50.56 kw. hours; energy per car-mile for entire run, 2.90 K.W. hours; energy per car-mile in Anderson, 5.13 K.W. hours; energy per car-mile between Anderson city limits and McCordsville, 2.66 kw. hours; energy per ton-mile for entire run, 73.2 watt-hours; energy per ton-mile in Anderson, 129.3 watt-hours; energy per ton-mile between Anderson city limits and McCordsville, 67.1 watt-hours; energy per average through passenger carried for entire run, 2035 watt-hours; energy per passenger carried in Anderson, 349 watt-hours; energy per passenger between Anderson city limits and McCordsville, 1685 watt-hours.

DISCUSSION OF RESULTS.

The service tests on the interurban car give data which may be studied from several different standpoints. In the first place, they offer information as to the performance of a car when run upon a schedule in practical operation on one of the larger interurban roads in the Central West, the car being one of a number of similar cars used in regular service. In the second place, the data allow of the comparative study of the performance of the car when operated over a given route and upon a given schedule, both with and without a trailer. A comparison of the general data of this chapter with those of Chapters II and III also leads to some interesting deductions.

Tests Nos. 9, 10, 11, and 12 were performed on three consecutive days, Feb. 2d, 3d, and 4th, 1905, Tests Nos. 11 and 12 being performed on the latter date. While the data for individual portions of the various tests differ very materially, it is interesting to note that the general data for the tests agree very closely for the four tests. In this connection, it is to be remembered that while the same general schedule was adhered to throughout all four tests, it was found impracticable to make

Tests Nos. 9 and 10 as complete as were Tests Nos. 11 and 12. While it was the intention to run from Muncie to Indianapolis and return in all four tests, it was necessary to cut off Tests Nos. 9 and 10 at Anderson on the return trip. These two tests, therefore, show a run of but 95 miles as against 113 miles for Tests Nos. 11 and 12.

It will be seen that the total duration of the test differed materially in Tests Nos. 9 and 10, while Tests Nos. 11 and 12 correspond very closely in this particular. An inspection of the data showing the running time, including all ordinary stops, shows a great uniformity in the results obtained for the various tests. The discrepancy in the results for the total duration of test is accounted for in the time of lay-over, which differed in the various tests, although it was nearly the same in Tests Nos. 10 and 11. The lay-over of more than two hours shown in Test No. 9, was caused principally by the great trouble experienced with the heating of the journal boxes.

While it was not considered advisable to run the car under test in regular service, it was run upon the same schedule as were the limited cars, and the schedule was so adjusted as not to interfere with the operation of the cars in regular service. Car No. 284 was loaded with an equivalent passenger load of 30 passengers and trailer No. 302 with an equivalent passenger load of 40 passengers. These loads were considered by the officials of the road as representing ordinary practical conditions. Tests No. 9, 10, and 12 were with Car No. 284 alone, while in Test No. 11 the trailer was hauled by this car.

An inspection of the data showing the line pressure indicates a very considerable variation in this pressure at different periods of the test and at certain points on the system. The average line pressure for the various tests, however, shows a very fair uniformity, the lowest value being 449 volts in Test No. 12, and the highest 472 volts in Test No. 11. A noticeable feature in this connection is the fact that the average pressure appears to be much lower than would be found desirable for this class of service, particularly when it is remembered that the line pres-

sure often rises to 550 volts or more when no power is taken from the system. This not only indicates a considerable loss of power in the transmission system, but it also means a reduced efficiency of the motors and a decreased speed at the low prevailing pressures. All of these objections could be remedied by the addition of more copper in the feeding system.

While the current varies largely at different periods of the test, and is constantly being turned on and off during the run, it is interesting to note how very uniform are the results obtained for the average current in the various tests. This average value is 221 amperes for Test No. 9, 217 for Test No. 10, 265 for Test No. 11, and 214 for Test No. 12. It is to be observed that the average current of Test No. 9 is approximately 3.5 per cent higher than that of Test No. 12. This increase in average current was undoubtedly due to the increase in friction caused by the heating of the journal boxes while Test No. 9 was being made. Some difficulty was also experienced in the heating of the journal boxes in Test No. 10, and the increase of 3 amperes in the average current of this test over that of Test No. 12 may be explained in the same way. The average current of Test No. 11 is approximately 50 amperes more than that for Tests Nos. 10 and 12. This shows the increase in current necessary for hauling the trailer, which was used in Test No. 11.

As the average line pressure does not differ very materially in the four tests, it is to be expected that the average power taken will, in general, follow the relative values of the average current. This is seen to be the case, the average power for Tests Nos. 10 and 12 being almost identical, that for Test No. 9 being approximately 6 per cent above the power in Tests Nos. 10 and 12, and that for Test No. 11 (where the trailer was used) being approximately 25 per cent greater than for Tests Nos. 10 and 12.

The average interval of run in cities differed considerably in the four tests, being 0.68 of a mile in Test No. 9, 1.02 miles in Test No. 10, 1.09 miles in Test No. 11, and 1.52 miles in Test No. 12. This difference is due largely to the difference in operat-

ing conditions in passing through the city of Indianapolis. In some runs, it was necessary to make many more stops between the city limits and the terminal station than was the case in others. The average length of run between cities shows considerable uniformity, being between 5 and 6 miles in all four tests.

The average speed for the entire test varies between 26.8 miles an hour in Test No. 11 and 30.4 miles an hour in Test No. 9. It is to be observed in this connection that Tests Nos. 9, 10, and 12 show average speeds which are very close together, while Test No. 11 shows an average speed of approximately 3 miles per hour less than that of Test No. 12. This is due to the fact that Car No. 284 was hauling a trailer in Test No. 11, and it was impossible to obtain as high speeds with this added load as when running alone. The average speed in cities is found to be nearly the same for all tests, that of Test No. 11 being approximately one mile per hour less than for the other three tests. The average speed between cities is seen to be 38.5 miles an hour for Test No. 12, as against 33.8 miles an hour for Test No. 11. This shows a loss in speed of 4.7 miles an hour in Test No. 11, due to the hauling of the trailer.

The values showing the kilowatt-hours per car-mile follow in general the results giving the average power. Tests Nos. 9, 10, and 12 show practically uniform results, Tests Nos. 9 and 10 having slightly larger values than Test No. 12, due to the fact that an increased frictional effect, caused by the heating of the journal boxes, was produced in these two tests. The kilowatt-hours per car-mile for Test No. 11 are over 40 per cent greater than the value shown for Test No. 12. This increase is due to the increase in power necessary to haul the trailer.

The watt-hours per ton-mile were 85.6, 84.4, 73.8, and 81.8 for Tests Nos. 9, 10, 11, and 12, respectively. The higher values of Tests Nos. 9 and 10 were due in part to the increased journal friction, especially the value shown in Test No. 9. The value shown for Test No. 12, which is 81.8, may be taken as fairly representative of the watt-hours per ton-mile for the interurban

car alone. Test No. 11, which was with the trailer, shows the corresponding value to be 73.8. This gives 8 watt-hours per ton-mile as the added energy necessary in hauling the trailer.

The watt-hours per equivalent through passenger carried are approximately 10,500 in Tests Nos. 9 and 10, 7400 in Test No. 11, and 12,250 in Test No. 12. It is to be observed that while the watt-hours per ton-mile are greater in Tests Nos. 9 and 10 than in Test No. 12, the watt-hours per equivalent through passenger carried are considerably less. The reason for this is that Tests Nos. 9 and 10 cover a total distance of approximately 95 miles, whereas Test No. 12 covers a total distance of 113 miles. The data showing the watt-hours per equivalent through passenger for Test No. 11, are to be compared directly with Test No. 12, and not with Tests Nos. 9 and 10, as Tests Nos. 11 and 12 cover the same total distance traversed. It is seen that the value showing the watt-hours per equivalent through passenger carried is nearly 80 per cent higher for Test No. 12 than for Test No. 11. This is for the reason that but 30 passengers were carried in Test No. 12, as against 70 passengers in Test No. 11, due to the fact that a trailer was hauled in the latter test.

A comparison of the general data obtained for the interurban car with the results given in Chapters II and III for the city cars, can only be made in a general way. The duration of the run was very different in the three tests, as were also the schedule speed and the stops per mile. While the two city cars had an average schedule speed of approximately 10 miles per hour, the interurban car had an average schedule speed of nearly 30 miles an hour, while the maximum speed of the single-truck city car was approximately 20 miles an hour and that of the double-truck city car was somewhat less than 20 miles an hour, and the maximum speed of the interurban car was over 60 miles an hour.

It is seen from these general considerations, that the average power taken by the interurban car would naturally be much larger than that taken in the other two cases. This is found to be the case, as the average power taken by the interurban

car was nearly four times that used by the other two cars, while it was nearly five times as much when the interurban car was hauling a trailer. With this large increase in power would necessarily come a corresponding increase in the current drawn from the line, if the pressure were the same in the three cases. The increase in the current is found to be more than in proportion, since the average line pressure is less in the interurban tests than it is in either of the other two tests.

The kilowatt-hours per car-mile are approximately 3.3 for the interurban car alone, as against 2.7 for the double-truck city car, and 2.3 for the single-truck city car. It is seen that these results are more nearly comparable than are those relating to power and current. The reason for this is that the largely increased speed of the interurban car very materially reduces the time required to traverse a given distance.

The watt-hours per ton-mile are approximately 83 for the interurban car, as against 122 for the double-truck city car, and 162 for the single-truck city car. It is seen from these data that the energy required per ton-mile for the interurban car is considerably less than for either the double-truck city car or the single-truck city car, being but 68 per cent of the former and but 51 per cent of the latter. This is due to the largely increased weight of the interurban car over the weights of the city cars.

Data showing the watt-hours per total passenger carried, were given in the test on the double-truck city car, whereas the watt-hours per equivalent through passenger carried are given in the tests on the interurban car. No comparison can be made on the basis of passenger carried, for the reason that the conditions of service are very different in interurban and in city work. In an interurban service such as that existing on the line between Muncie and Indianapolis, the fare charged depends upon the distance traversed, whereas in a city service the fare is five cents irrespective of the distance traversed. This being the case, a comparison on the basis of passengers transported can only be made by considering the total number of passengers carried on an existing line in a city service, as against the average number

of through passengers carried on an interurban service. Knowing the rates of tariff for the latter service, it is a comparatively simple matter to draw deductions as to the cost of energy supplied to the car in comparison with the revenue obtained from the car.

The power taken by the air-compressor, incident to the operation of the air-brakes and the pneumatic system of control, is considered more fully in Chapters VI and IX, where the acceleration and braking tests on the interurban car are considered. The control energy was found to be very small indeed, being considerably less than one-tenth of one per cent of the total energy supplied to the car.

PART III.
ACCELERATION TESTS OF ELECTRIC CARS.

CHAPTER V

ACCELERATION TESTS OF A SINGLE-TRUCK CITY CAR.

OBJECT OF THE TESTS.

THE principal object of these tests was to bring out the salient features of the various factors effecting the acceleration of a single-truck city car when the power is turned on by means of a manually operated controller, and the car is brought up to a given speed in a given distance. It was intended to study primarily the maximum current, the maximum power, and the energy consumption during the acceleration tests, but the tests also included the measurement of such other variables as time, current, pressure, speed, and the distances traversed. Five different rates of acceleration were employed, the maximum speed attained being the same in each case, and comparisons are made in the report of the results obtained under the various conditions.

SYNOPSIS OF RESULTS.

TABLE No. XXX. — *Synopsis of Results. Acceleration. Tests of Single-Truck Car.*

	CONTROLLER TURNED TO FULL PARALLEL.				
	40 Ft.	70 Ft.	100 Ft.	150 Ft.	200 Ft.
Maximum Speed M.P.H.	20.0	20.0	20.0	20.0	20.0
Speed at Full Parallel M.P.H. ...	11.0	12.4	13.8	14.3	15.3
Time to Attain Maximum Speed (Seconds).	14.5	16.1	17.9	19.1	21.1
Time to Attain Full Parallel (Sec- onds).	4.52	6.63	8.88	11.33	13.90
Total Distance Traversed (Feet) ..	286.6	305.5	322.5	339.1	377.2
Distance Traversed to Full Paral- lel (Feet)	40.0	70.0	100.0	150.0	200.0

TABLE No. XXX.—Continued

This value should be increased in order, and 146.7 for 40 ft. etc

	CONTROLLER TURNED TO FULL PARALLEL.				
	40 Ft.	70 Ft.	100 Ft.	150 Ft.	200 Ft.
Average Current (Amperes)	99.7	115.0	122.1	132.2	146.7
Maximum Current at Series Position (Amperes).	172.0	139.6	139.3	135.3	115.2
Maximum Current at Parallel Position (Amperes).	298.5	220.4	191.2	158.2	127.2
Average Power (Kilowatts)	74.60	64.60	62.05	59.75	50.60
Maximum Power at Series Position (Watts).	89.4	71.6	71.2	70.0	59.8
Maximum Power at Parallel Position (Watts).	149.7	111.0	94.2	80.0	65.1
Total Energy (Watt-Hours)	301.0	289.2	308.3	317.1	297.0
Average Acceleration $\left(\frac{\text{M.P.H.}}{\text{Sec.}}\right)$.	1.33	1.25	1.12	1.05	0.95
Maximum Acceleration $\left(\frac{\text{M.H.P.}}{\text{Sec.}}\right)$.	2.50	2.32	2.32	2.32	2.32

GENERAL CONDITIONS OF THE TESTS.

All of the acceleration tests upon the single-truck car, were carried out on the tracks provided for the Electric Railway Test Commission by the Louisiana Purchase Exposition Company. These tracks were about 1200 feet in length, and were located parallel to and directly north of the Transportation Building at the St. Louis Exposition. The tests were conducted on the north one of these tracks, which was tangent and level throughout the entire length used.

The car selected for the acceleration tests was the same single-truck car which was used in making the service tests considered in Chapter II, and is fully described and illustrated in Chapter I. The car equipped and ready for service weighed 24,665 lbs. and the total weight under the conditions of test was 28,715 lbs., or approximately 14.3 tons. The load was the same as in the service tests of Chapter II.

As previously stated, the motive power equipment consisted of two Westinghouse No. 56 motors, which have a rating of 55

horse-power each. The controllers were type *B* 23, and especially adapted to the Westinghouse magnet brake apparatus, with which the car was equipped. Fig. 54 shows a diagram of the connections of the controller and motors for the various power notches of the controller. There are sixteen notches on a controller of the type used, nine of which are power notches, and of these nine, five are for the series connection of the motors and four for the parallel connection. The effective utilization of the braking notches of the controller is considered in Part IV, which treats of the braking tests on this car.

GENERAL DESCRIPTION OF THE TESTS.

The tests consisted in starting the car from a given point, in turning the controller to full parallel in traversing a given distance, and in shutting off the power when the car had attained a speed of exactly 20 miles an hour. This latter speed was approximately the maximum speed which the car would attain under the conditions of the tests. The service tests of Chapter II show a speed of about 21 miles an hour, but it was considered desirable, in making the acceleration tests, to cut off the power at a slightly lower speed than this in order to insure a uniform maximum velocity in all runs.

Five different values of acceleration were employed, the various tests differing only in the manner in which the power was turned on. In the five tests the controller was turned to the full parallel position in the time interval necessary for the car to traverse a distance of 40, 70, 100, 150, and 200 feet respectively. Twenty runs were taken for each of the five different accelerating conditions. Uniform acceleration was obtained in each case by practicing starts before any records were taken. The criterion for uniform acceleration was freedom from jerks in passing from one notch of the controller to the next. The motorman was an experienced operator in the employ of the Westinghouse Company and, after a few trials, he was able to obtain a fairly uniform acceleration under the desired conditions.

TEST No. 13. — In this test the controller was turned to full parallel in 40 ft. The average time taken to cover this distance was 4.52 seconds, and a constant speed of 20 miles an hour was reached in 14.51 seconds.

TEST No. 14. — In this test the controller was turned to full parallel in 70 ft. The average time taken to cover this dis-

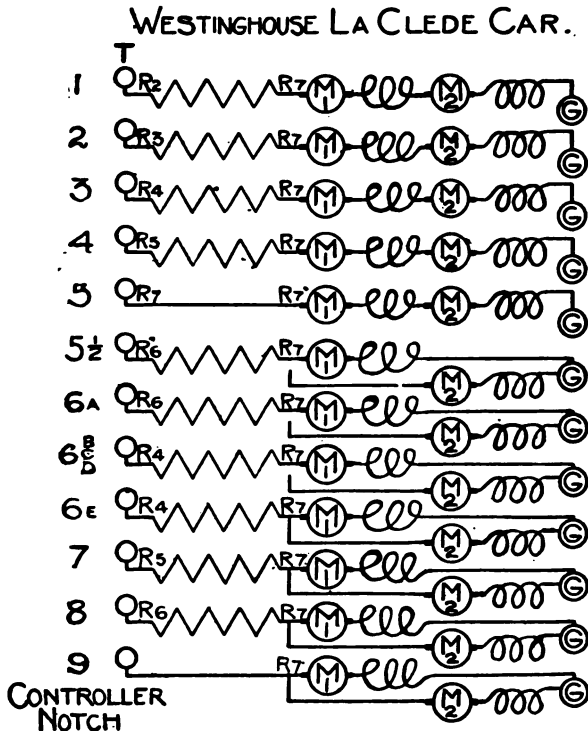

Fig. 54. — Connections of Power Notches of Controller, Single-Truck City Car.

tance was 6.63 seconds, and a constant speed of 20 miles an hour was reached in 16.1 seconds.

TEST No. 15. — In this test the controller was turned to full parallel in 100 ft. The average time taken to cover this distance was 8.88 seconds, and a constant speed of 20 miles an hour was reached in 17.9 seconds.

TEST No. 16. — In this test the controller was turned to full parallel in 150 feet. The average time taken to cover this distance was 11.33 seconds, and a constant speed of 20 miles an hour was reached in 19.09 seconds.

TEST No. 17. — In this test the controller was turned to full parallel in 200 ft. The average time taken to cover this distance was 13.90 seconds, and a constant speed of 20 miles an hour was reached in 21.09 seconds.

ORIGINAL MEASUREMENTS.

The original data obtained in the acceleration tests on the single-truck car may be divided into four general classes: (a) data relating to electrical input; (b) data relating to time; (c) data relating to speed; (d) data relating to distance traversed.

Electrical Measurements.

The general method of taking electrical measurements was the same as that employed in conducting the service tests on the single-truck car, excepting that the readings of the indicating instruments were taken at one-second or at two-second intervals instead of at five-second intervals. It was found by trial that one-second intervals were almost too short to take readings, and the majority of the data was obtained at two-second intervals. The general method of procedure was for one person to count the seconds aloud, making use of a stop watch, the readings being taken upon the signal. The first count was taken as a signal for the start, and all readings were recorded for this count. The time marker and relay system employed in registering the five-second scores on the recording instruments were also used in these tests. The connections of the instruments were in this case made the same as in the service tests on this car, and are shown in Fig. 29, Chapter II.

The various electrical measurements are recorded in the following table :

QUANTITY MEASURED.	INSTRUMENT EMPLOYED.	METHOD OF MAKING MEASUREMENTS.
Line Pressure	Weston indicating voltmeter.	Readings taken at one-second or two-second intervals.
Total Current	General Electric recording ammeter.	Continuous record.
Total Current	Weston milli-voltmeter with shunt.	Read occasionally to check recording ammeter.
Motor Currents . . .	Weston milli-voltmeters with shunts.	Separate tests to determine the division of current between the two motors. Readings at one-second or two-second intervals.
Motor Pressures . .	Weston voltmeters.	Separate tests to determine the division of pressure between the two motors. Readings at one-second or two-second intervals.
Total Energy	Thomson watt-hour meter.	Readings at beginning and end of runs, number of revolutions of the disk being noted for the interval. Readings were also taken at the beginning of the run and at the instant the controller was placed at the full parallel position.

Time Measurements.

In addition to the stop-watch readings mentioned above, the total time taken to reach the constant speed of 20 miles an hour was noted in each case. Besides these time measurements, the time-marking device and relay system employed in the service tests were used here, and upon the base lines of the current and speed records the five-second intervals were indicated. The star wheel on the controller was equipped with a circuit-breaking device which was connected to the time-marking device of the recording ammeter. By means of a finger, which followed the indentations of the star wheel, the time-marker circuit was

completed at the instant at which the controller cylinder passed from one position to another. By this means, the actual instant at which the controller was turning to a notch was accurately recorded with reference to the five-second marks on the recording ammeter record.

Speed Measurements.

The speed was measured by means of an "Apple" ignition generator, driven by the car axle in a manner similar to that described in the service tests of Chapter II, a chronograph being employed to give a graphical record of the armature pressure readings. The time and distance measurements were used as a check on the speed curve.

Distance Measurements.

The car was started from a given point in all tests. The distance in which it was desired to turn on the controller to full parallel was carefully measured off in each case, and a stake was placed alongside the track at this point. In addition, the time of passing fixed points on the track was recorded on the base line of the speed record in a manner similar to that by which the controller notches were recorded on the current curve. These distance records were produced by means of a circuit-breaker carried on the bottom of the car body, and operated by wire trippers fastened to the track. The general arrangement of this apparatus is shown in Fig. 55.

Contact Device. — The contact device, Fig. 55, was securely fastened to the running board of the car, and in such a position as to bring the contact breaker arm *P* just outside the rail, and its extremity about one-fourth inch below the head of the rail.

The mechanism was mounted upon a block *A* made of one-inch white pine. It consisted essentially of a hickory arm *P*, pivoted at *D*, on a one-fourth inch bolt, and held in its normal position by the spiral springs *S S*, and the wooden guide *G*.

The arm *P* was partially covered with sheet brass *B*, which served to conduct the current. This brass covering was connected to one side of the relay circuit through the bolt *D*, and

through a strip of brass fastened to the inner side of the guide *G*. The connection to the other side of the circuit was made by means of the contact *C*, which consisted of a sheet of brass sprung into grooves cut in the block *A*.

The guide *G* was held in place by two bolts *b b*, provided with thick felt washers *F F*, and sheet brass washers *d d*. The felt

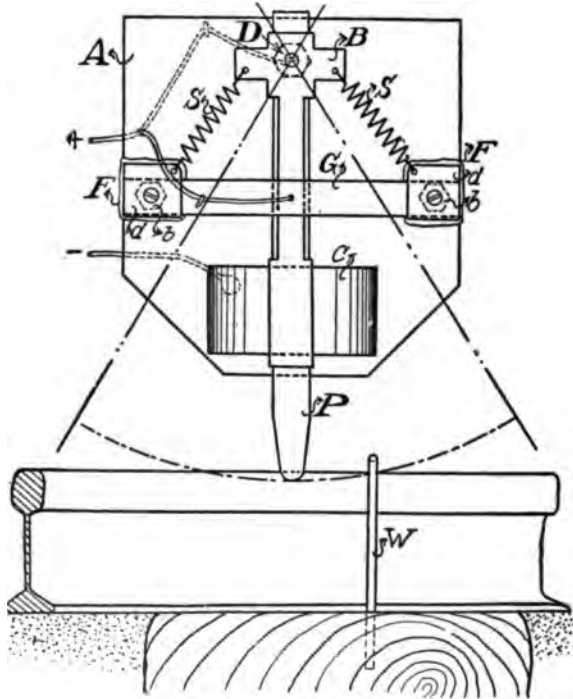

Fig. 55. — Contact Device for Distance Measurements. Acceleration Tests.

washers served the double purpose of holding the guide at the proper distance from the block and of deadening the blow of the arm *P*. They also aided the springs *S S* in restoring the arm to its normal position. The brass washers protected the wood and served as a fastening for the springs *S S*.

The device was operated by wickets made of steel wire, and driven into the ties at certain intervals along the track. One of these wickets is shown at *W*. These wickets or "trippers" were

placed close together at the end of the track from which the starts were made, in order to give fairly uniform time intervals, thus insuring accuracy throughout the entire distance.

Fig. 56 shows in detail the connections used with this apparatus, the circuit breaker being indicated at K . When the circuit is opened by the operation of the switch arm, the armature of the relay r_1 is released, and a contact is made which completes the circuit through the battery B , and the electro-magnet r_1 ,

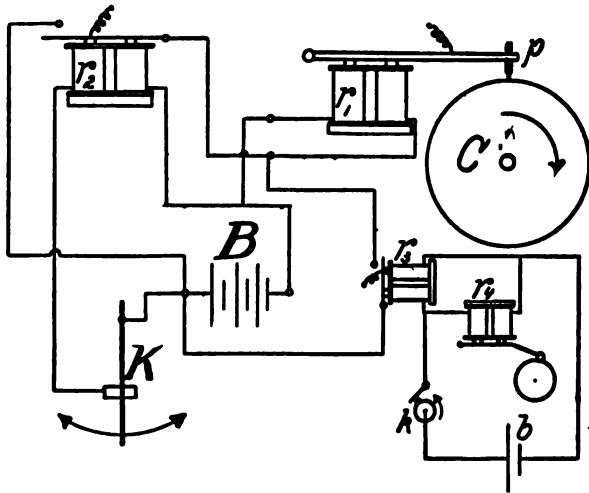

Fig. 56. — Relay Circuits for Time and Distance Measurements. Acceleration Tests.

which latter, by means of the pen-point p , makes a record on the chronograph cylinder, C .

This diagram also shows the circuit of the time-marking device. Five-second impulses of current are produced in this circuit by the periodical closing of the circuit by means of the rotating switch k , which is a part of the chronometer. The circuit is completed through the relay r_3 and the dry cell battery b , so that, when the circuit is completed at each five-second interval, a record is produced as before upon the chronograph cylinder. A vibrating bell r_4 is connected in parallel with the relay r_3 , and this gives the signal for all five-second readings, which are made on other instruments.

WORKING UP THE RESULTS.

It was not only important to take certain data simultaneously, but it was also necessary that these data be taken at certain time intervals, and that the time of start and stop of the car should be accurately known with respect to these time intervals. It was only by proceeding in this way that the exact relation of all data could be fixed. With the stop watch, the total time of run from the instant the controller was turned to the first notch until the car attained a fixed speed of 20 miles an hour, was obtained. From the current record were obtained not only the actual value of the current at every instant at which current was being taken, but also the actual instant at which the current was applied and the instant at which it was cut off. Accurate records, with reference to the five-second readings of the indicating instruments, were made on the ammeter and speed records at five-second intervals.

It is evident that all of these readings may be accurately correlated with the records of the current and speed. In addition, the instant of passing each individual notch of the controller was indicated on the current record, and the time of passing given points on the track was shown on the speed record.

In working up the final results, it was often necessary to go from one to another of the various sources of information in order to obtain a complete knowledge of the conditions existing at any given instant. The records were all carefully worked over, and the various data were synchronized between the different sources of information.

The Current Curves.

The twenty current curves, for each of the five conditions of acceleration considered, were averaged by superimposing the various individual records one upon the other. Each individual record was also integrated, and the average curve was made to correspond in area as well as in shape to the average of

the current curves. The exact elapsed time from the start to the passage of each of the controller notches was next obtained for each of the individual twenty curves, and the average time for each notch was found. In a similar manner the maximum current at each of the controller notches for each of the twenty individual curves of a run was found, and the average maximum value at each notch was obtained for each of the tests.

The average current curve was checked by means of these data, and it was also made to conform in its characteristic features to the general shape of the individual curves for the given test.

The Pressure Curves.

The pressure readings were taken at either one-second or at two-second intervals in each test. The readings at corresponding time intervals were averaged for the twenty runs in a given test. The average pressure curve was then drawn from the data thus obtained.

The Power Curves.

The power data were obtained directly from the current and pressure data, values being found for each second interval. The power curves were then plotted, due consideration being given to variations in current and pressures between the points obtained. The average power over a given interval of time was obtained by dividing the total energy for the interval by the elapsed time.

The Energy Curves.

The energy curves were obtained by integrating the power curves over one-second intervals, the energy at each second point being thus obtained. A straight line has been drawn from point to point, no attempt being made to show the variations in energy consumption between these points. These total energy readings were checked up with the data, as shown by the watt-hour meter.

WORKING UP THE RESULTS.

It was not only important to take certain data simultaneously, but it was also necessary that these data be taken at certain time intervals, and that the time of start and stop of the car should be accurately known with respect to these time intervals. It was only by proceeding in this way that the exact relation of all data could be fixed. With the stop watch, the total time of run from the instant the controller was turned to the first notch until the car attained a fixed speed of 20 miles an hour, was obtained. From the current record were obtained not only the actual value of the current at every instant at which current was being taken, but also the actual instant at which the current was applied and the instant at which it was cut off. Accurate records, with reference to the five-second readings of the indicating instruments, were made on the ammeter and speed records at five-second intervals.

It is evident that all of these readings may be accurately correlated with the records of the current and speed. In addition, the instant of passing each individual notch of the controller was indicated on the current record, and the time of passing given points on the track was shown on the speed record.

In working up the final results, it was often necessary to go from one to another of the various sources of information in order to obtain a complete knowledge of the conditions existing at any given instant. The records were all carefully worked over, and the various data were synchronized between the different sources of information.

The Current Curves.

The twenty current curves, for each of the five conditions of acceleration considered, were averaged by superimposing the various individual records one upon the other. Each individual record was also integrated, and the average curve was made to correspond in area as well as in shape to the average of

the current curves. The exact elapsed time from the start to the passage of each of the controller notches was next obtained for each of the individual twenty curves, and the average time for each notch was found. In a similar manner the maximum current at each of the controller notches for each of the twenty individual curves of a run was found, and the average maximum value at each notch was obtained for each of the tests.

The average current curve was checked by means of these data, and it was also made to conform in its characteristic features to the general shape of the individual curves for the given test.

The Pressure Curves.

The pressure readings were taken at either one-second or at two-second intervals in each test. The readings at corresponding time intervals were averaged for the twenty runs in a given test. The average pressure curve was then drawn from the data thus obtained.

The Power Curves.

The power data were obtained directly from the current and pressure data, values being found for each second interval. The power curves were then plotted, due consideration being given to variations in current and pressures between the points obtained. The average power over a given interval of time was obtained by dividing the total energy for the interval by the elapsed time.

The Energy Curves.

The energy curves were obtained by integrating the power curves over one-second intervals, the energy at each second point being thus obtained. A straight line has been drawn from point to point, no attempt being made to show the variations in energy consumption between these points. These total energy readings were checked up with the data, as shown by the watt-hour meter.

The Speed Curves.

As in previous tests, the data for the speed curves were obtained directly from the speed record made by means of the "Apple" ignition generator, driven by the car axle, the pressure of which was recorded by means of a Weston voltmeter and the chronograph record. In working up the speed curve it was necessary to first obtain the actual time of start of each run. This was done by finding the exact instant of start with reference to the five-second scores on the recording ammeter record for the particular run, and transferring these data to the speed curve by means of the five-second scores on the latter curve. The "second" intervals from the start were then carefully measured and ordinates erected. The various speed curves for each condition of acceleration were worked up in this manner, and a table was compiled showing the speed for each of these runs at the "second" intervals. From these data the average speed of all runs for a given condition of acceleration was obtained for each "second" interval from the start. From these data the speed curves were plotted. Since all runs for a given condition of acceleration did not have the same total time interval, it was necessary to obtain the average time of running, in each case, from the start to the point at which the fixed speed of 20 miles an hour was reached. This was done by taking the average time of each run, as shown by the stop watch.

The Distance Curves.

As previously stated, the times of passing certain fixed points on the track were indicated on the speed record by means of an electro-magnet, which was operated by the circuit-breaking device on the car coming in contact with the wire trippers on the track. These data were used in obtaining the distance curve. The wire trippers were set close together at the beginning, and the distance between trippers became greater and greater toward the end of the test-track limits. This arrangement of trippers was necessary because of the slow speed at the start, and the gradual increase of the speed to a maximum value

at the end of a test. Nineteen trippers in all were used and the distances in feet, at which these trippers were placed from the starting points were as follows : 0, 5, 10, 15, 20, 25, 35, 50, 65, 80, 100, 120, 140, 165, 190, 240, 290, 340, and 390.

A number of runs were selected for each condition of acceleration, and the exact instant of passing each tripper was ascertained and recorded for each of these runs. The average time of passing each tripper was then found for each condition of acceleration, and the distance curve was plotted from these values.

Since the distance traveled is the summation of the speed and time from the start to the point considered, it is evident that the distance curve may be obtained by summing up or integrating the area under the speed curve for any interval from the start. Such integrations were made for each of the curves, and the distances thus determined were then checked against the actual distances traversed, as shown by the distance measurements.

Division of Current and Pressure.

Readings were taken of the individual currents and pressures of the motors at various instants throughout each run. These data show that the motors were very evenly matched, the pressure being practically the same on each motor for the series position of the controller, and the current dividing practically equally between the motors for the parallel position of the controller. As the division of current and pressure between the motors have been shown in the Service Tests in Chapter II, they will not be discussed here.

RESULTS OF THE TESTS.

Some of the more important numerical results of the various acceleration tests made upon the single-truck city car are shown in tabular form in the synopsis at the beginning of the chapter. The results are shown more completely in graphical form in Figs. 57 to 66, inclusive. These graphical representations have been divided into two sets of curves for each test. One set

shows the electrical data, while the other shows the speed and distance data. The graphical results for each condition of acceleration are accompanied by a general log sheet.

The plates showing the electrical data are plotted on a time base, and the curves show the variations in the pressure, current, power, and energy in each case. The acceleration curve is also placed on this sheet. The plates showing the speed and distance data are also plotted on a time base, and give the speed, in miles per hour, and the distance traveled in feet. Figs. 57, 59, 61, 63, and 65 are plotted from the electrical data, while Figs. 58, 60, 62, 64, and 66 are plotted from the speed and distance data.

GENERAL LOG SHEET OF TEST NO. 13.

Pressure. — Average line pressure, 521.0 volts.

Distance. — Distance traversed from the start to the point at which the controller was at the full parallel position, 40 ft.; distance traversed from the start to the point at which the speed reached 20 miles an hour, 286.6 ft.

Time. — Interval from the start to the point at which the controller was at the full parallel position, 4.52 seconds; interval from the start to the point at which the speed became 20 miles an hour, 14.51 seconds.

Acceleration. — Average acceleration for the test run, 1.33 miles per hour per second; maximum acceleration, 2.50 miles per hour per second.

Current. — Average current for the test, 146.7 amperes; maximum current for the series position of controller, 172.0 amperes; maximum current for the parallel position of controller, 298.5 amperes; the square root of the mean square value of the current for the run, 160.9 amperes; the form factor (square root of the mean square of the current divided by the average current), 1.097.

Power. — Average power for the test, 74.6 kilowatts; maximum power at the series position of the controller, 89.4 kilowatts; maximum power at the parallel position of the controller, 149.7 kilowatts.

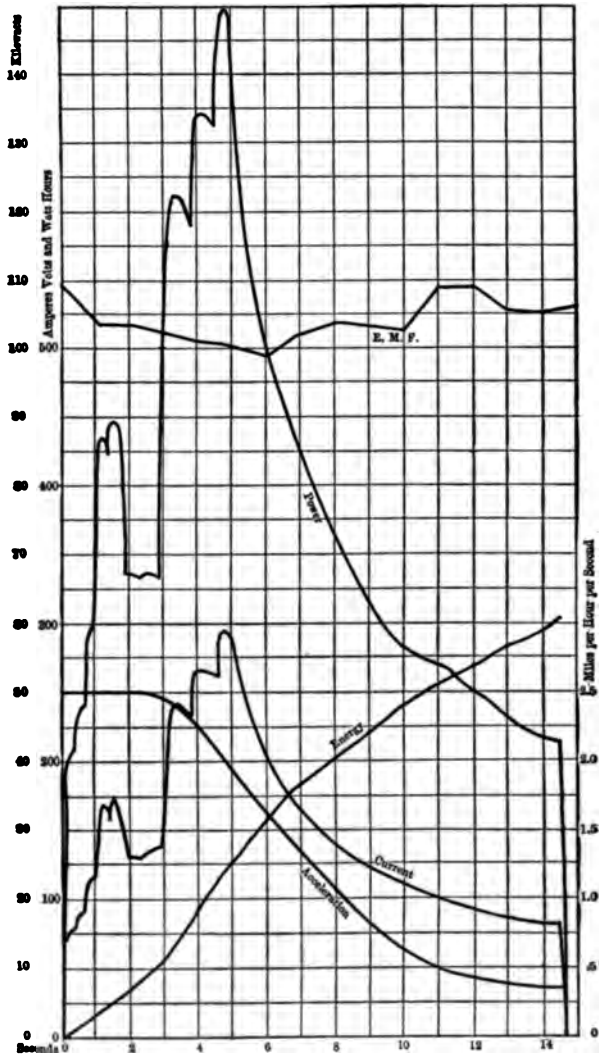

Fig. 57. — Electrical Data of Test No. 12.

Energy. — Energy required for the test, 301.0 watt-hours; energy used from the start to the point at which the controller was at the full parallel position, 108.1 watt-hours.

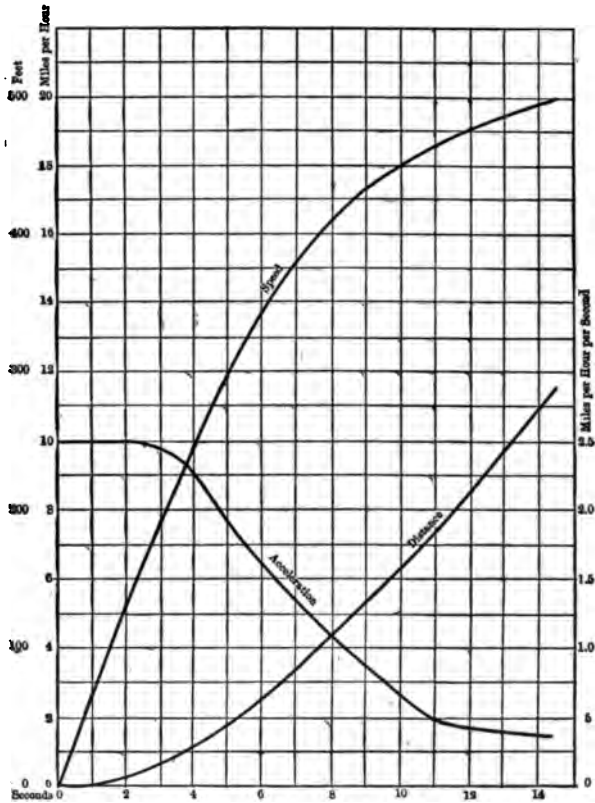

Fig. 58. — Speed and Distance Data, Test No. 13.

GENERAL LOG SHEET OF TEST NO. 14.

Pressure. — Average line pressure, 516 volts.

Distance. — Distance traversed from the start to the point at which the controller was at the full parallel position, 70 ft.; distance traversed from the start to the point at which the speed reached 20 miles an hour, 305.5 ft.

Time. — Interval of run from the start to the point at which the controller was at the full parallel position, 6.63 seconds; in-

terval of run from the start to the point at which the speed became 20 miles an hour, 16.10 seconds.

Acceleration. — Average acceleration for the test, 1.25 miles per hour per second; maximum acceleration, 2.32 miles per hour per second.

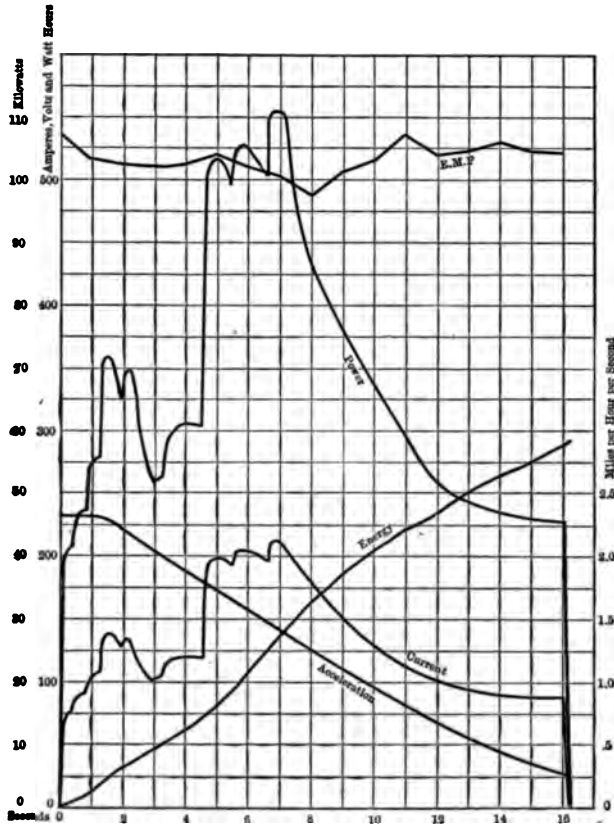

Fig. 59. — Electrical Data of Test No. 14.

Current. — Average current for the test, 132.2 amperes; maximum current for the series position of controller, 139.6 amperes; maximum current for the parallel position of controller, 220.4 amperes; the square root of the mean square value of the current for the run, 142.8 amperes; the form factor

(square root of the mean square of the current divided by the average current), 1.08.

Power. — Average power for the test, 64.6 kilowatts; maximum power at the series position of the controller, 71.6 kilowatts; maximum power at the parallel position of the controller, 111.0 kilowatts.

Energy. — Energy required for the test, 289.2 watt-hours;

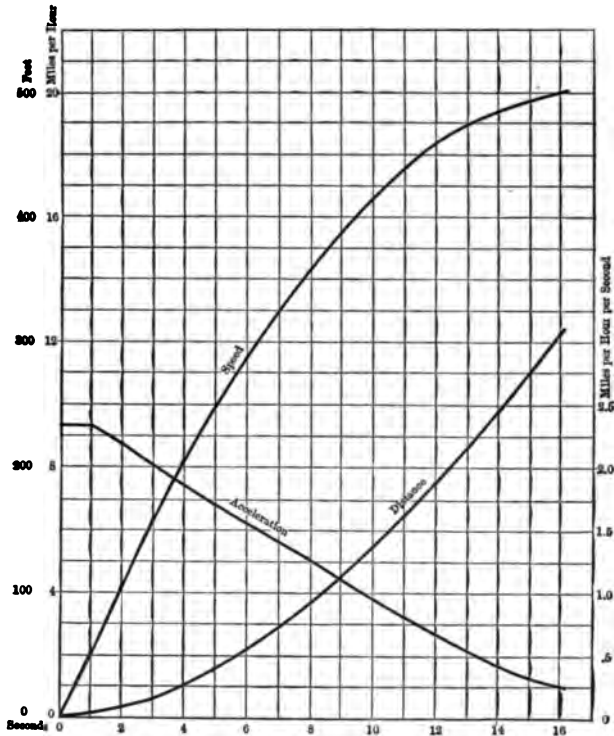

Fig. 60.—Speed and Distance Data, Test No. 14.

energy used from the start to the point at which the controller was at the full parallel position, 122.7 watt-hours.

GENERAL LOG SHEET OF TEST NO. 15.

Pressure. — Average line pressure, 513 volts.

Distance. — Distance traversed from the start to the point

root of the mean square of the current divided by the average current), 1.041.

Power. — Average power for the test, 62.1 kilowatts; maximum power at the series position of the controller, 71.2 kilo-

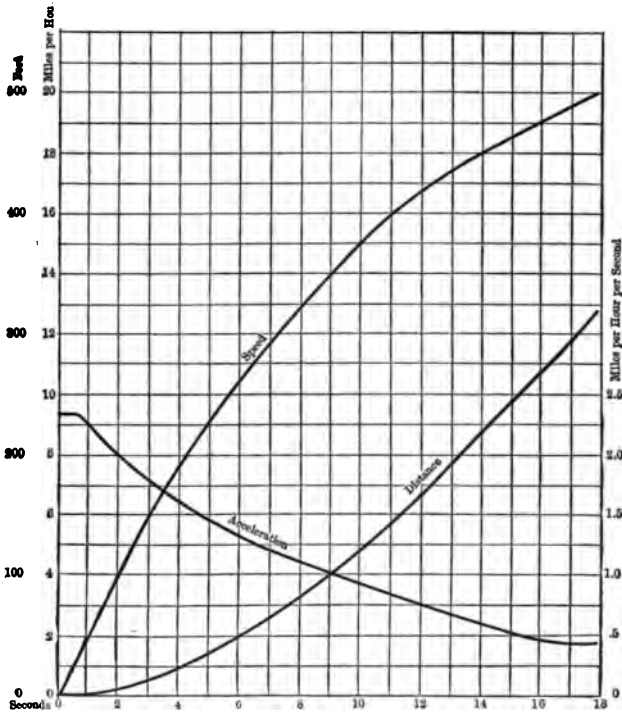

Fig. 62.—Speed and Distance Data, Test No. 15.

watts; maximum power at the parallel position of the controller, 94.2 kilowatts.

Energy. — Energy required for the test, 308.3 watts-hours; energy used from the start to the point at which the controller was at the full parallel position, 158.6 watt-hours.

GENERAL LOG SHEET OF TEST NO. 16.

Pressure. — Average line pressure, 517 volts.

Distance. — Distance traversed from the start to the point at which the controller was at the full parallel position, 150 ft.;

Power. — Average power for the test, 59.8 kilowatts; maximum power at the series position of the controller, 70.0 kilowatts; maximum power at the parallel position of the controller, 80.0 kilowatts.

Energy. — Energy required for the test, 317.1 watt-hours;

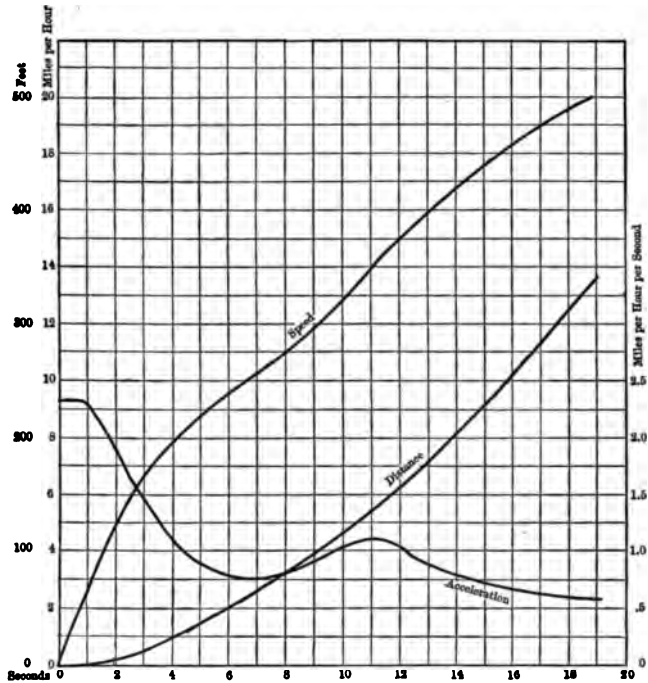

Fig. 64. — Speed and Distance Data, Test No. 16.

energy used from the start to the point at which the controller was at the full parallel position, 182.9 watt-hours.

GENERAL LOG SHEET OF TEST NO. 17.

Pressure. — Average line pressure, 517 volts.

Distance. — Distance traversed from the start to the point at which the controller was at the full parallel position, 200 ft.; distance traversed from the start to the point at which the speed reached 20 miles an hour, 377.2 ft.

Time. — Interval of run from the start to the point at which the controller was at the full parallel position, 13.90 seconds ; interval of run from the start to the point at which the speed became 20 miles an hour, 21.09 seconds.

Acceleration. — Average acceleration for the test, 0.95 miles per hour per second ; maximum acceleration, 2.32 miles per hour per second.

Current. — Average current for the test, 99.7 amperes ; maxi-

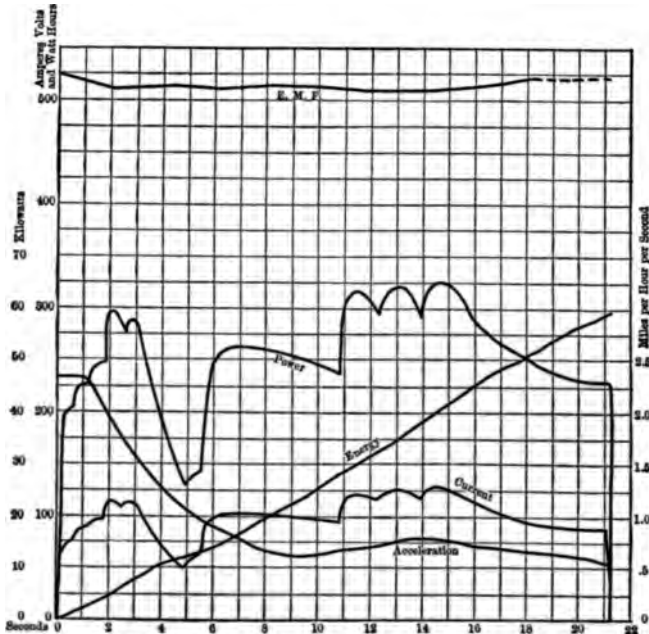

Fig. 65. — Electrical Data of Test No. 17.

imum current for the series position of controller, 115.2 amperes ; maximum current for the parallel position of controller, 127.2 amperes ; the square root of the mean square value of the current for the run, 101.7 amperes ; the form factor (square root of the mean square value of the current divided by the average current), 1.01.

Power. — Average power for the test, 50.6 kilowatts ; maximum power at the series position of the controller, 59.8 kilo-

watts; maximum power at the parallel position of the controller, 65.1 kilowatts.

Energy. — Energy required for the test, 297.0 watt-hours; energy used from the start to the point at which the controller was at the full parallel position, 189.4 watt-hours.

DISCUSSION OF RESULTS.

A study of the curves given in Figs. 57 to 66, inclusive, brings out some very interesting results.

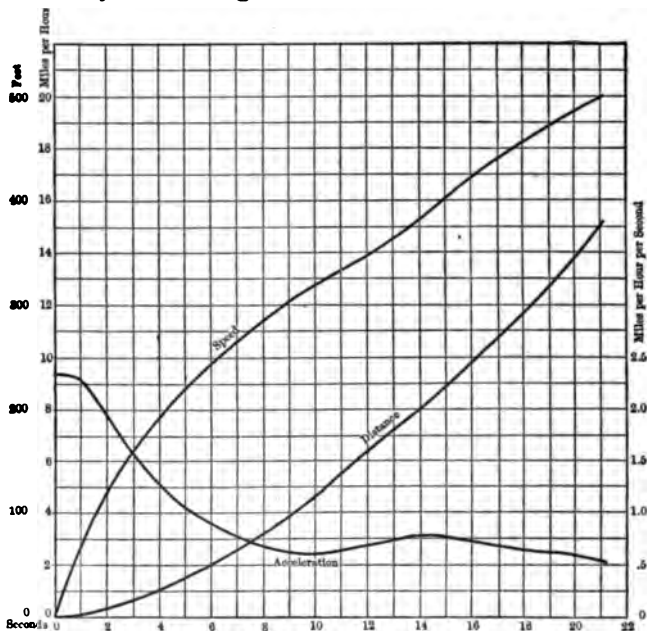

Fig. 66. — Speed and Distance Data, Test No. 17.

THE PRESSURE CURVES. — The pressure curves all show more or less fluctuation. This is due to the variations in the current taken by the car. However, these variations are negligible, in so far as their bearing on the acceleration tests is concerned. The reasons for this are : first, that the acceleration tests were started between the times of passing of the Intramural cars, which were supplied with power from the same source; second, the maximum duration of any one run was not greater than 21

seconds; and, third, twenty runs were taken for each test, and the results averaged. An inspection of the pressure curves shows a general tendency for a fall in pressure as soon as the controller is turned on, and a rise in pressure as the current decreases toward the end of test. A depression is found at the point where the maximum current is taken for the series position, and again at the corresponding point for the parallel posi-

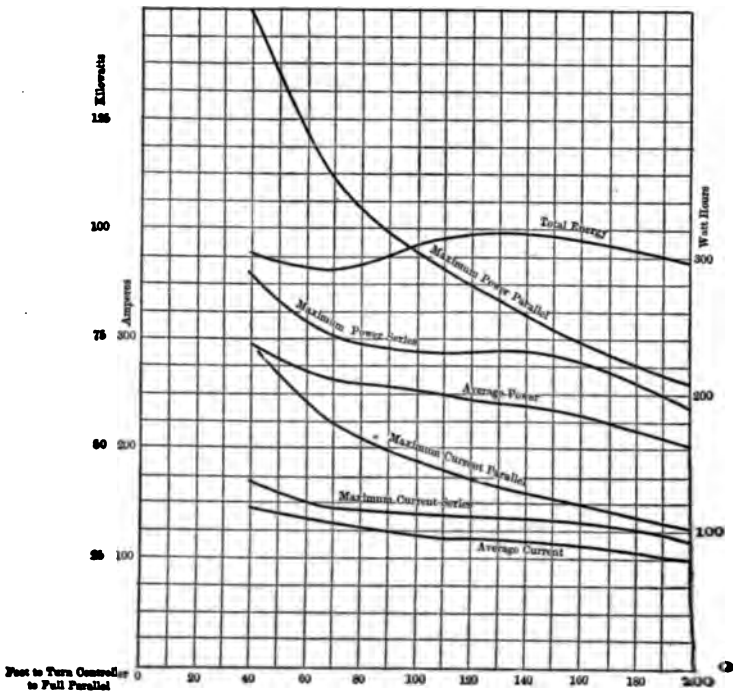

Fig. 67.—Summary of Electrical Data, Acceleration Tests of Single-Truck Car.

tion. It will also be noticed that the pressure remains more nearly uniform with the slower accelerations, there being very little change in the pressure with the slowest acceleration, beyond the characteristic drop at the points of maximum acceleration for the series and parallel positions of the controller.

THE CURRENT CURVES. — While the current curves all have the same characteristic shape, it is seen that the maximum cur-

rent both for the series and parallel positions of the controller, is very much greater for the rapid acceleration than for the slower ones. It will also be noted that while the maximum current at both the series and parallel positions decreased as the acceleration became slower, the maximum current at the parallel position decreased much faster than did the maximum current at the series position. This is very clearly brought out in the curves shown in Fig. 67. The average current for the test is somewhat lower than the maximum current for the series position of the controller.

THE POWER CURVES. — The power curves necessarily have the general characteristic shape of the current curves, since the variations in pressure are not marked. The same general results that occur in the case of the current curves are noted here. While the maximum power in both the series and parallel positions of the controller decreased very materially with the slower accelerations, it is seen by an inspection of Fig. 67 that the decrease in the maximum power at full parallel is very much greater than that for full series. The average power for the test is less than the maximum power for the series position of the controller.

THE ENERGY CURVES. — While the energy curves have the same characteristic form for each of the five conditions of acceleration, they vary somewhat because of the fact that the power curves are considerably different in form in the various tests. While the time required to reach a speed of 20 miles an hour was considerably shorter for the more rapid accelerations, the average power for the test was much greater. The consequence is that, in the tests under consideration, the total energy taken by the car in reaching this speed was very nearly the same for all tests made. An inspection of the total energy curve in Fig. 67, shows a tendency for the total energy to become a maximum at the more rapid accelerations, and again at the intermediate accelerations. The data at hand, however, hardly warrants the drawing of conclusive deductions.

THE SPEED CURVES. — The speed curves show a general

appears to be no particular reason for this. The controller was turned to the first notch under practically the same conditions in all tests, and in each case the acceleration was a maximum at the start. It will be noted, however, that this maximum acceleration continues throughout a greater portion of the run with the more rapid accelerations. The acceleration curves have the same general shape in all tests, starting with a maximum and gradually falling off to a minimum value at the end of the test. In the curves for the slower accelerations a rise will be noted toward the middle of the run. This is due to the falling off in speed during this portion of the run, as above mentioned.

The variations in maximum acceleration, and also in average acceleration for the various tests, are shown in Fig. 68. While the maximum acceleration remained practically constant for all tests, the average acceleration decreased with the slower accelerations.

THE DISTANCE CURVES. — The distance curves all have the same characteristic shape, as slight variations in speed have but little effect upon their general form. The total distance traversed, however, is quite different for the various tests. The distance curve in Fig. 68 shows the variation in distance traveled, as the acceleration is changed.

TABLE NO. XXXI. — *Synopsis of Results. Acceleration Tests of an Inter-urban Car.*

	TEST No. 18.	TEST No. 19.
Running Position of Controller	Series	Parallel
Maximum Speed (M.P.H.)	25.0	38.0
Speed at Full Series (M.P.H.)	11.6	12.4
Speed at Full Parallel (M.P.H.)		22.3
Elapsed Time for the Test (Seconds)	55.5	65.5
Elapsed Time to Full Series (Seconds)	9.10	9.35
Elapsed Time to Full Parallel (Seconds)		20.26
Distance for the Test (feet)	1,510	2,540
Distance to Full Series (Feet)	83.0	87.0
Distance to Full Parallel (Feet)		345.0
Average Current (Amperes)	204.0	414.5
Maximum Current (Amperes)	490.0	623.0
Average Pressure (Volts)	519.1	440.3
Average Power (Kilowatts)	106.9	178.7
Maximum Power (Kilowatts)	240.1	236.8
Total Energy (Watt-hours)	1,648	3,252
Average Acceleration $\frac{\text{(Miles per hour)}}{\text{Seconds}}$	0.45	0.58
Maximum Acceleration $\frac{\text{(Miles per hour)}}{\text{Seconds}}$	1.52	1.55

pany's system. Its exact location was between poles Nos. 10,909 and 10,883. The spacing of the poles was 100 ft. and the stretch of track used, therefore, was 2600 ft. in length. It was tangent and level throughout the entire distance.

The car used for the acceleration tests was the one also used for the service tests considered in Chapter IV. This inter-urban car is fully described and illustrated in Chapter I. The car equipped and ready for service weighed 74,530 lbs., and the total weight under the conditions of test was 79,320 lbs., or approximately 39.66 tons. The load was the same as in the service tests described in Chapter IV. As previously stated, the motive power equipment consisted of four Westinghouse No. 85 motors, which have a rating capacity of 75 horse power each.

THE CONTROL SYSTEM.

The car was equipped with the latest type of the electro-pneumatic, multiple-unit control system of the Westinghouse

Electric and Manufacturing Company. The essential features of this system are:

(1) The Switch Group or turret controller for each car in the train consists of a number of switches suitably arranged for making the necessary connections of the motor circuits. The switches are operated by air-driven pistons, working in small cylinders, the supply of air to which is controlled by valves operated by electro-magnets.

(2) A Train Line, connecting all of the cars in the train, and containing a suitable number of circuits for operating the electro-pneumatic valves in the switch groups. The train line is supplied with current from storage batteries placed in each car.

(3) A Master Controller in each car arranged to make connections through the train line to all of the switch group operating magnets.

(4) A Reverse Switch, electro-pneumatically operated, for reversing the relative connection of motor armatures and fields, and hence the direction of motion of the car.

(5) A Limit Switch, for controlling the rate at which current can be drawn by the motors, and which thus limits the acceleration of the train to a pre-determined value.

THE SWITCH GROUP. — Fig. 69 shows in cross-section the switch group, consisting of thirteen radially arranged switches or contactors, surrounding a powerful coil which magnetically blows out the arcs. Each switch unit consists of three essential parts: a contactor, an air cylinder for operating the same, and an electro-pneumatic valve which controls the admission of air to the cylinder. Air is drawn from an auxiliary reservoir, which in turn receives it from the main air brake reservoir. The air is received at the switch group in the chamber *C*, Fig. 69. The pressure in this chamber is 70 lbs. per square inch. From this chamber the air passes to the electro-pneumatic valve, *M*. As previously stated, the electro-magnet operating the valve receives its current from the train line, and when energized the core of the solenoid is lowered, and air is admitted to the upper end of the cylinder *A*. The air presses

the piston downward against the resistance of a strong spiral spring, thereby forcing together the copper-faced jaws of the contactor *K*, and closing the motor circuit. When the current is cut off from the electro-pneumatic valve *M*, the core rises, closing the inlet valve and opening the exhaust to the atmosphere. The piston is then forced upward by the spiral spring, and the contactor circuit is opened. The unit switches, comprising the switch group, are covered with a sheet-iron case to protect the mechanism from dirt and moisture.

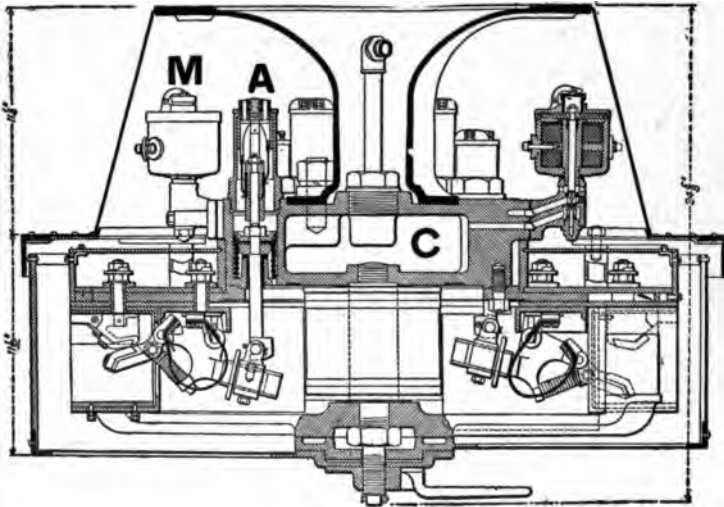

Fig. 69.—Switch group of the Westinghouse Electro-Pneumatic System of Control.

The plan for connecting the motors is known as the bridging system. The arrangement of the motor circuits is shown in Fig. 70. The contactors or unit switches are numbered from one to thirteen, and these are closed in succession in such a way as to produce the several connections of the series-parallel arrangement. The starting resistances are short circuited by switches 1, 2, 3, 9, 10, and 11.

THE TRAIN LINE. — The train line consists of seven small wires, which run from end to end of each car, terminating in

couplers into which plug jumpers are inserted for the purpose of connecting the several cars of the train. These wires are connected to the master controller, and they are also led to the switch group located near the center of the car. They are supplied with storage battery current at about fourteen volts.

THE MASTER CONTROLLER. — The master controller consists of a small rotating cylinder, upon which are mounted copper segments which make connection between contact fingers in which branch leads from the train line terminate, there being one contact finger for each train line wire. As this cylinder is

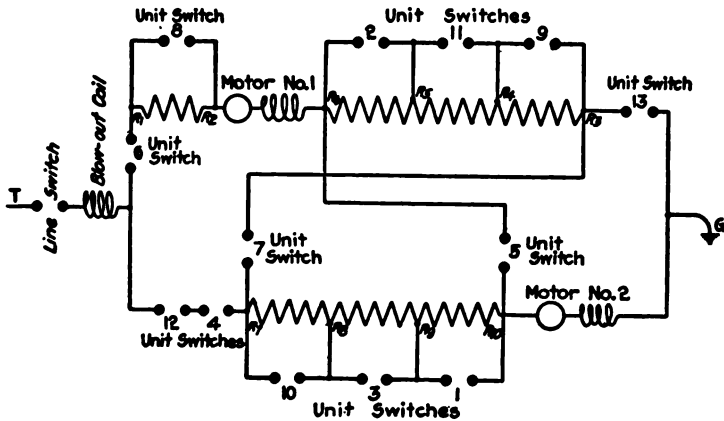

Fig. 70. — Diagram of Connections, Westinghouse Electro-Pneumatic System of Control.

rotated by means of a handle, the various contactors of the train line are supplied with current, and the corresponding electro-pneumatic valves in the switch groups are energized. The master controller is arranged for three running conditions. The first running notch is known as the switching notch, at which the motors are in series-parallel with all of the resistances in circuit. The series running notch is the same, but with the resistances cut out. On the parallel running notch the motors are connected in parallel with the resistances cut out. The intermediate positions are as usual in the series-parallel

control system. The master controller handle is automatically brought to the "off" position if released.

THE REVERSE SWITCH. — The reverse switch consists of a rotating cylinder placed under the car, and operated by an air cylinder mechanism. The cylinder carries copper segments, which connect the armatures and fields of the various motors in one relative direction or another, depending upon the position of the cylinder. The position of the reverse switch is controlled by the master controller by means of an electro-pneumatic valve.

THE LIMIT SWITCH. — The function of the limit switch is to prevent excessive draft of motor current by limiting the rate at which the electro-pneumatic valves in the switch groups can be operated. It consists of a solenoid and plunger, the former being connected in one of the motor circuits. To the plunger is attached a copper disc, which normally bridges across two contacts in the control circuit. When the motor current is excessive the core of the solenoid is raised, breaking the control circuit. All of the pneumatic valves, which have been previously energized will remain so, but no new valves can be operated until the solenoid core falls again. The operation of the limit switch is susceptible of adjustment, but it is generally set for a given maximum current, according to the equipment used and the acceleration desired.

In addition to the essential devices described above, the system includes a number of auxiliary features which tend to increase the reliability of operation. Complete descriptions of the entire equipment may be found in the *Street Railway Journal*, Volume XXII, 1903, page 617, and Volume XXV, 1905, page 809. A description is also given in the *Electric Club Journal*, Volume II, 1905, page 207.

GENERAL DESCRIPTION OF THE TESTS.

The tests consisted primarily in starting the car from rest at a given point, by turning the master controller immediately to a pre-determined position, and taking continuous measure-

ments of all of the quantities involved until a certain speed was reached. This speed was taken at 25 miles an hour for the series position of the controller, and at 38 miles an hour for the parallel position.

The maximum speeds attained do not represent the highest values of speed which would be reached by the car if it were permitted to continue running under the conditions of the tests on a tangent level track. In the case of the test with the master controller in the parallel position, the speed of 38 miles an hour was recorded practically the limit of speed to be obtained in the 2600 ft. of level tangent track available. A one per cent grade was encountered immediately after the 2600 ft. had been traversed, and it was not considered advisable to continue the acceleration tests beyond the distance indicated. In the case of the acceleration tests with the master controller in the series position, a limiting speed of 25 miles an hour was taken in order to insure a distinct point at which to consider the test ended. Beyond this point the speed variations are small and not very clearly defined, although the speed continues to increase slowly.

Because of the fact that it was necessary for the company to make use of the car on a certain day, it was impossible to make the acceleration tests as comprehensive as had been planned, as but one-half day was available for actually conducting this series of tests.

Two runs only were made with the master controller in the series position at the start. These two runs were made under exactly the same conditions, except for the variations in line pressure, and the data obtained in them has been averaged in working up the results designated as Test No. 18.

Eight runs were made with the master controller in the parallel position at the start. All of these runs were under the same conditions, excepting that it was attempted to vary the conditions by changing the adjustment of the limit switch of the control apparatus by means of small weights. The eight runs were made in pairs, four different adjustments of the limit switch being considered. These four conditions were with the

limit switch weighted as follows: (a) zero ounces, (b) 0.286 ounces, (c) 0.859 ounces, (d) 1.430 ounces.

It was found that the weights employed were not sufficient to cause any very considerable difference in the operation of the controller as the car was accelerated. Lack of time prevented further investigation with heavier weights. In working up the results these eight runs have been averaged together, and the average values used in plotting curves. This practically amounts to the same thing as the average of a series of eight runs, with the limit switch adjusted for a current slightly heavier than allowed by the normal adjustment of the apparatus. As the data for the four conditions of adjustment of the limit switch show some variations which appear to follow certain laws, these data are considered in more detail in the discussion of results. As the controller was entirely automatic in its action, there was no practicing of starts necessary in order to obtain uniform acceleration. At the time the tests were made the car appeared to start smoothly, and no objectionable jerks were experienced, as succeeding contacts were made on the group switch.

The arrangements for the acceleration tests on this car may be briefly set forth as follows:

TEST No. 18. — In this test the master controller was turned at once to the series position, the car being at rest at the instant of start. The final contact for the series position of the motors was made in 9.1 seconds from the start, when the car had traversed 83 ft. The fixed speed of 25 miles an hour was reached in 55.5 seconds, when the car had traversed 1510 ft.

TEST No. 19. — In this test the master controller was turned at once to the parallel position, the car being at rest. The final contact for the series position of the motors was made in 9.35 seconds, when the car had traversed 87 ft. The final contact for the parallel position of the motors was made in 20.26 seconds, when the car had traversed 345 ft. The fixed speed of 38 miles per hour was reached in 65.5 seconds, when the car had traversed 2540 ft.

ORIGINAL MEASUREMENTS.

In taking the original data for the acceleration tests on the interurban car, the recording devices were used which were employed in the service tests on this car. They have been described and illustrated in Chapter IV.

The original data obtained for the acceleration tests, may be divided into four general classes as follows: (a) those relating to electrical input, (b) those relating to time, (c) those relating to speed, and (d) those relating to distance traversed.

Electrical Measurements.

The general method of taking the electrical measurements was the same as that employed in conducting the service tests on the interurban car, a record being made of the total current, line pressure, speed, and control current. The General Electric recording ammeter gave an additional graphical record of the current taken by the car. The method of procedure was for one person to give the signal for the turning on of the controller, which was the starting signal for all the readings.

In working up the results, the actual instant at which the current was turned on, as shown by the General Electric recording ammeter record, was taken as the starting point. The connections of the instruments were the same as in the service tests on this car, and are shown in Fig. 50. As seen from this diagram, the main current passed through the General Electric recording ammeter and the watt-hour meter, the latter instrument recording the total energy. Other electrical data obtained was the total car current as measured on the general recording apparatus, the line pressure, and the control current, all of which were recorded by means of the general apparatus. The shunt for the Weston milli-voltmeter giving the total current, was connected in the main circuit. The energy taken by the motor compressor was also obtained by means of a Duncan watt-hour meter.

The various electrical measurements which were made are shown in the following table:

QUANTITY MEASURED.	INSTRUMENT EMPLOYED.	METHOD OF MAKING MEASUREMENTS.
Line Pressure . . .	Weston indicating volt-meter.	Continuous record by general recording apparatus.
Total Current . . .	General Electric recording ammeter.	Continuous record by general recording apparatus.
Total Current . . .	Weston milli-voltmeter with shunt.	Continuous record by general recording apparatus.
Control Current . .	Weston ammeter.	Continuous record by general recording apparatus.
Total Energy . . .	Thomson watt-hour meter.	Readings at beginning and end of runs, number of revolutions of the disk being noted for the interval.
Control Energy . .	Duncan watt-hour meter.	Readings at beginning and end of runs, number of revolutions of the disk being noted for the interval.

Time Measurements.

The time of the beginning and end of each run was noted with a stop-watch. Besides these time measurements, the time-marking device and relay system employed in the service tests on the car were used. The five-second intervals were indicated upon the base lines of the records of the General Electric recording ammeter, and upon the general recording apparatus.

Speed Measurements.

The speed was measured by means of an "Apple" ignition generator, driven by the car axle in a manner similar to that described in the service tests of Chapter IV; the armature pressure of this generator being recorded graphically by means of the general record apparatus. The time and distance data were used as a check on the speed curve.

Distance Measurements.

The car was started from a given point in all tests, pole 10,909 being directly opposite the center of the window in the front vestibule. At the instant of starting a record of this pole was made on the general recording apparatus, in a manner already described. In a similar way the observer made corresponding records, showing the instant at which each successive pole passed the center of the vestibule. As these poles were spaced exactly 100 ft. apart, the record gives an accurate determination of the time-distance curve.

The Control Measurements.

In addition to the control current data as shown on the general record, and the control energy data as measured by the watt-hour meter, measurements were made after the completion of the tests to determine the amount of energy taken by the motor compressor in compressing air between the limits used in the test. Data were also obtained showing the leakage of air from the piping system. In addition, a number of tests were made to determine the amount of air used in making applications of the controller to the series position, and also to the parallel position.

WORKING UP THE RESULTS.

As in previous tests, instrument readings were synchronized at certain intervals, and the time of the "start" and the "stop" of a test were accurately registered with respect to these time intervals. The exact instant at which the current was applied and the instant at which it was cut off, as well as the exact value of the current throughout a test were obtained from the current record. The data showing the line pressure, speed, and the instant of passing each pole were obtained from the general record.

The records were carefully worked over, and the various data correlated among the different sources of information. By proceeding in this manner, it was possible to obtain a complete knowledge of the conditions existing at any instant.

The Current Curve.

The exact time of "start" in each case was obtained from the current curves, as shown by the General Electric recording ammeter, the start of a run being assumed at the instant when the current was turned on. The current curves of the recording ammeter were worked up in the following manner. Ordinates were erected at the starting point, and at each five-second point thereafter, up to the end of the test. The exact ordinate corresponding to each of these points was obtained by correcting for the curvature inherent in the record, as explained in Chapter I of the Report. The average of the current records, for the two runs made with the master controller at the series position, was taken for each similarly situated five-second point, and a current curve adjudged to be typical of the "series" position was plotted from these averages. In a similar manner, the average current, for the eight runs made with the master controller at the parallel position, was taken for each of the five-second points from the "start." The typical current curve for the "parallel position" in acceleration was plotted from these results.

The exact elapsed time from the start to the passage of each of the controller notches was obtained for each individual curve, and the average time for each notch was found. In a similar manner the maximum current at each of the controller notches for each individual curve was obtained, and the average maximum current at each of the notches found. This was done both for the condition of "series" acceleration, and for that of "parallel" acceleration.

The average current curve for each of the two conditions was checked by means of these data, and it was also made to conform in its characteristic features to the general shape of the individual curves for the given condition of acceleration.

The Pressure Curves.

The exact instant of start was found for each pressure curve by ascertaining the relation between the five-second score

marks and the instant of start on the current curve as shown by the General Electric recording ammeter, and transferring these data to the pressure curve on the general record. The "typical" pressure curves were then worked up in a manner similar to that employed in working up the current curves. The average ordinate of all runs for each condition of acceleration was obtained for each five-second interval from the start. These data were then used in plotting the typical pressure curves, which were also made to conform in their characteristic features to the general form of the individual curves for a given test.

The Power Curves.

The power data were obtained directly from the current and pressure data, values being found for each five-second interval. The power curves were then plotted, due consideration being given to the variations in current and pressure between the points used. The average power for a given interval of time was obtained by dividing the total energy for the interval by the elapsed time.

The Energy Curves.

The energy curves were obtained by integrating the power curves over five-second intervals, the total energy up to each five-second point being found in this manner. A straight line was then drawn from point to point, no attempt being made to show the variation in the energy consumption between the five-second intervals. The total energy readings were checked up with the energy data as shown by the watt-hour meter.

The Speed Curves.

The data for the speed curves were obtained directly from the speed record made by means of the "Apple" ignition generator driven by the car axle, the pressure of which was recorded on the general record by means of a Weston voltmeter. In working up the speed curve it was necessary to first obtain the actual time of start of each run. This was done by finding the exact instant of start with reference to the five-second score

marks on the recording ammeter for the particular run, and transferring these data to the speed curve by means of the five-second scores on the latter curve. The five-second intervals from the start were then carefully measured, and ordinates erected. The various curves for each condition of acceleration were worked up in this manner, and tables compiled showing the speed for each of these runs at the various five-second intervals from the start. From these data, the average speed of all runs for a given condition of acceleration was obtained for each five-second interval from the start, and the typical speed curves were plotted.

The Distance Curves.

As previously stated, the instant at which the center of the window in the front vestibule of the car passed each pole was recorded on the general record. This was accomplished by means of an electro-magnet operating a pen. The circuit through the electro-magnet was closed by means of a push button, operated by an observer stationed in the front vestibule of the car. As the pole spacing was exactly 100 ft., and as the total distance traversed in the tests with the controller in the series position was approximately 1500 ft. and in the parallel position 2500 ft., from fifteen to twenty-five observations of the distance traversed with respect to the time from the start were accurately recorded for each run by this means.

The exact time of start for each run was found by means of the five-second score marks on the record, and the exact instant at which the car passed each successive pole was determined. The average of these time intervals for each condition of acceleration, was found by taking the average time interval of passing each pole for all runs of the test. The distance curves were then plotted from the data obtained in this manner. Since the summation of the speed and time for a given time interval from the start shows the distance traversed, it is seen that the distance curve may be obtained by summing up or integrating the area under the speed curve for any time interval from the

start. Such integrations were made for each of the speed curves, and they were checked to correspond with the actual distance traversed up to a given instant, as shown by the distance measurements.

The Control Data.

The current used by the control mechanism during the period of acceleration was recorded on the general record. During the period of control this current was irregular, varying between 2 and 3.5 amperes. When the controller reached the full parallel position, the control current became constant at approximately 3.5 amperes. The average control current during the test was obtained by integrating the current curves, and finding the average ordinate. As previously stated, this control current is supplied from a storage battery at a pressure of 14 volts. The electrical power was determined from the current and pressure data. From the measurements of time and power, the electrical energy dissipated in the control system could be obtained for a given interval. No attempt has been made to present the control data in graphical form, as they have no particular bearing on the results of the tests, excepting in so far as the energy consumed by the control system is concerned. From the air pump calibrations of the control system were obtained data showing the energy per application of air for both the series, and the parallel operation of the controller.

RESULTS OF THE TESTS.

In the synopsis at the beginning of the chapter are shown in tabular form some of the more important numerical results of the acceleration tests made upon the interurban car. The results are shown more completely in graphical form in Figs. 71 to 74, inclusive. These graphical representations are shown on a time base, and have been divided into two sets of curves for each test, one set showing the electrical data, while the other gives the speed and distance data. The graphical records are accompanied by general log sheets.

On the plates showing the electrical data have been plotted curves of pressure, current, power, and energy. The acceleration curve is also placed on this sheet. On the plates showing the speed and distance, the speed is plotted in miles per hour and the distance traversed in feet, while the acceleration is plotted in miles per hour per second. Figs. 71 and 73 show the electrical data, while the speed and distance data are shown in Figs. 72 and 74.

GENERAL LOG SHEET OF TEST NO. 18.

Pressure. — Average line pressure, 519.1 volts.

Distance. — Distance traversed from the start to the point at which the controller was at full series position, 83 ft.; distance traversed from the start to the point at which the speed reached 25 miles an hour, 1510 ft.

Time. — Interval of run from the start to the point at which the controller was at full series position, 9.10 seconds; interval of run from start to the point at which the speed reached 25 miles an hour, 55.5 seconds.

Acceleration. — Average acceleration for the test, 0.45 miles per hour per second; maximum acceleration, 1.52 miles per hour per second.

Current. — Average current for the test, 204.0 amperes; maximum current for the series position of the controller, 490.0 amperes; square root of mean square current for the run, 219.7 amperes; form factor (square root of the mean square current divided by the average current), 1.075.

Power. — Average power for the test, 106.9 kilowatts; maximum power at series position of the controller, 240.1 kilowatts.

Energy. — Energy for the test, 1648 watt-hours; energy from the start to the point at which the controller was at the series position, 489 watt-hours.

Controller. — Average control current for the test, 3.2 amperes; average control pressure for the test, 14 volts; average control electrical power for the test, 44.8 watts; average time control current was on (2.34 seconds more than the average

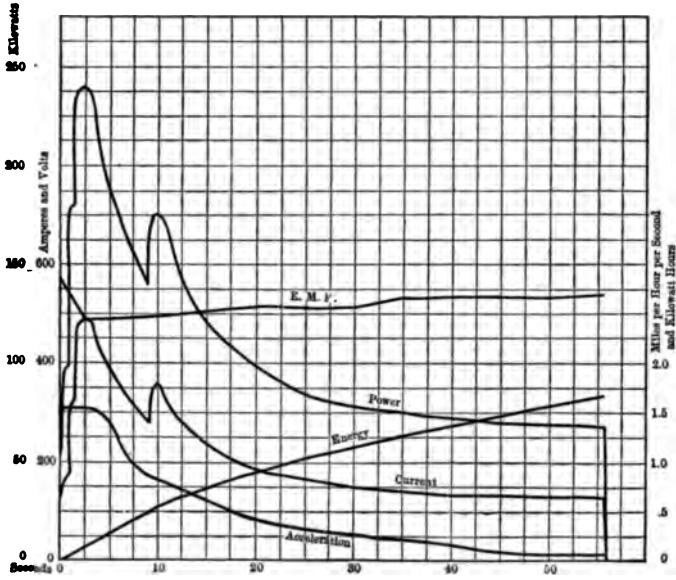

Fig. 71.—Electrical Data of Test No. 18.

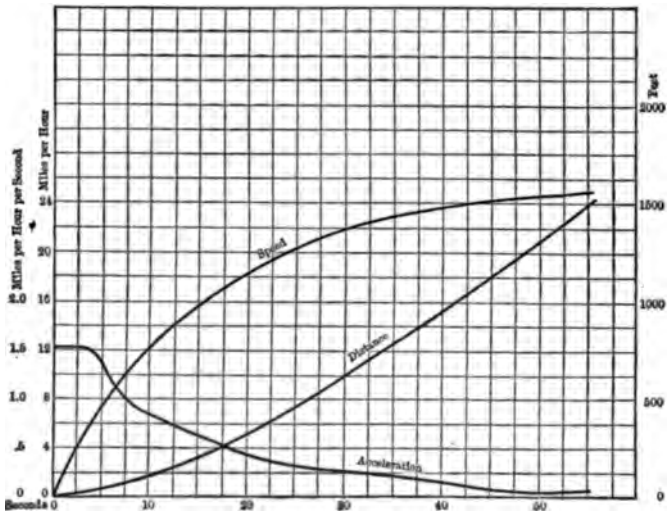

Fig. 72.—Speed and Distance Data, Test No. 18.

time of run), 57.34 seconds; electrical energy per run to operate the master controller, 71 watt-hours; electrical energy per run taken from the line by the control circuit (based on an efficiency of 65 per cent for the battery and control system), 1.10 watt-hours; total energy per run consumed in the electro-pneumatic operation of the controller, 6.03 watt-hours; proportion of total energy taken by the car for the test, which is consumed in the operation of the control system, 0.37 per cent.

Motor-compressor. — Electrical energy consumed per run by the motor-compressor in operating the controller (average for the test assuming no leakage), 0.55 watt-hour; electrical energy consumed per run by the motor compressor in operating the controller (average for the test including leakage from the air system), 4.93 watt-hours.

GENERAL LOG SHEET OF TEST NO. 19.

Pressure. — Average line pressure, 440.3 volts.

Distance. — Distance traversed from the start to the point at which the controller was at full series position, 87 ft.; distance traversed from the start to the point at which the speed reached 38.0 miles an hour, 2540 ft.

Time. — Interval of run from start to the point at which the controller was at the series position, 9.35 seconds; interval of run from start to the point at which the controller was at the parallel position, 20.26 seconds; interval of run from start to the point at which the speed reached 38 miles an hour, 65.50 seconds.

Acceleration. — Average acceleration for the test, 0.58 miles per hour per second; maximum acceleration, 1.55 miles per hour per second.

Current. — Average current for the test, 414.5 amperes; maximum current for the series position of the controller, 467.0 amperes; maximum current for the parallel position of the controller, 623.0 amperes; square root of mean square current for the run, 426.3 amperes; form factor (square root of mean square current divided by average current), 1.03.

Power. — Average power for the test, 178.7 kilowatts; maximum power at series position of the controller, 210.2 kilowatts;

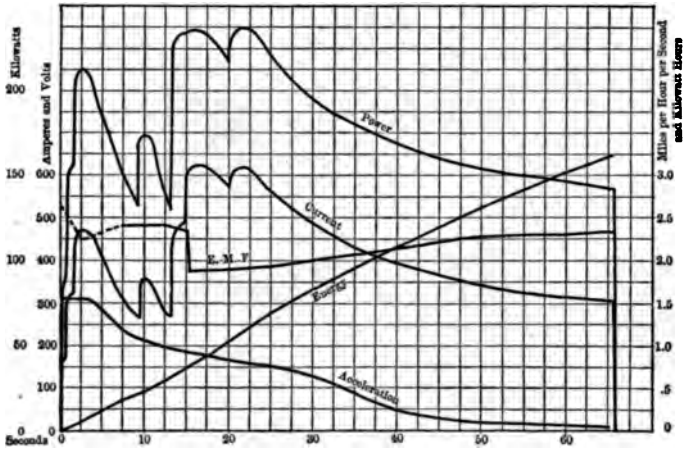

Fig. 73. — Electrical Data of Test No. 19.

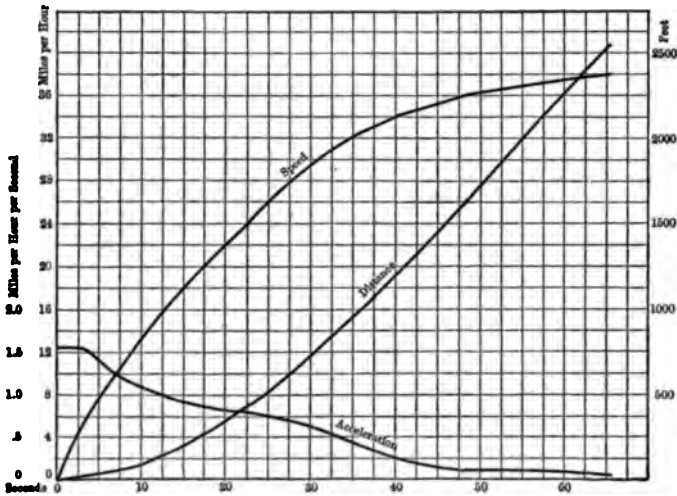

Fig. 74. — Speed and Distance Data of Test No. 19.

maximum power at parallel position of the controller, 236.8 kilowatts.

Energy. — Energy for the test, 3252 watt-hours; energy from the start to the point at which the controller was at the series

position, 442.6 watt-hours; energy from the start to the point at which the controller was at the parallel position, 1050 watt-hours.

Controller. — Average control current for the test, 3.0 amperes; average control pressure for the test, 14.0 volts; average control electrical power for the test, 42.0 watts; average time control current was on (2.34 seconds more than the average time of run), 67.34 seconds; electrical energy per run to operate the master controller, 0.79 watt-hours; electrical energy per run taken from the line by the control circuit (based on an efficiency of 65 per cent for the battery and control system), 1.21 watt-hours.

Motor compressor. — Electrical energy per run consumed by the motor compressor in operating the controller (average for the test assuming no leakage), 0.55 watt-hour; electrical energy per run consumed by the motor-compressor in operating the controller (average for the test including leakage from the air system), 6.09 watt-hours; total energy per run consumed in the electro-pneumatic operation of the controller, 7.30 watt-hours; proportion of total energy taken by the car for the test, which is consumed in the operation of the controller system, 0.37 per cent.

DISCUSSION OF RESULTS.

While circumstances did not permit of as extensive a series of acceleration tests on the interurban car as was contemplated, a study of the curves given in Figs. 71 to 74 show some interesting results.

THE PRESSURE CURVE. — As in the case of the acceleration tests of the single-truck car, the pressure curves show more or less fluctuation, due to the variation in the current taken by the car. In Test No. 18, where the master controller was kept at the series position, it will be noted that the line pressure decreased considerably as soon as current was taken by the car, and that it became higher and higher as the current decreased toward the end of the run. An inspection of the pressure curve

of Test No. 19, where the master controller was maintained at the parallel position, shows a fall in the line pressure as soon as the controller was turned on, an increase after the point of maximum current was passed for the series position, a second depression during the time when a large current was drawn for the parallel position of the controller, and a gradual rise as the current falls off toward the end of the run. It will also be noted that the line pressure is considerably more uniform for Test No. 18 than for Test No. 19. It should be noted in this connection that the pressure curve of Test No. 19 is shown dotted for the first few seconds of the test. The reason for this is that the original data were not complete in this particular.

The tests were all performed during the interval between the passage of the cars running in regular service. Because of the relatively small amount of copper in the line, the proximity of other cars produced considerable variations in line pressure. The acceleration runs were so timed, however, that these variations were reduced to a minimum during the actual time of test.

THE CURRENT CURVES. — It will be observed that the current curve for the series position of the master controller shows two very characteristic notches, while two others, somewhat less pronounced, are also indicated. An inspection of the current curves for the parallel position of the master controller (Test No. 19), shows this characteristic form of the current curve for the series position reproduced, and, in addition, there are clearly shown three distinct notches for the parallel points on the controller. The diagram of connections for this system of control shows nine different conditions in going from an "off" position of the controller to the full parallel position. The additional notches are not in evidence, and the probable reason for this is that the limit switch and the resistances have been so adjusted that practically no change in current occurs in passing over the missing contacts.

It will be observed that the maximum current for the series connection of the motors is practically the same for both tests, being approximately 475 amperes. It will also be observed

that the maximum current for the parallel connection of the motors is considerably greater than the maximum current for their series connection. This is in accordance with the acceleration tests of Chapter V, and is what might be expected, since the currents in the individual motors did not differ greatly for the two conditions of connection. It will also be noted that the maximum current for the series connection of the motors, is somewhat greater for Test No. 19 than for Test No. 18. It would be reasonable to expect that this current should be the same in both cases, since the controller was entirely automatic and the same operations were performed in each case, and in the same order. However, it is to be remembered that Test No. 19 is the result of the average of eight runs which were made under slightly different conditions. As previously stated, an attempt was made to ascertain the effect of weighing down the limit switch. The eight runs consisted of four different sets, in one of which the limit switch operated under normal conditions, while in the other three weights of 0.286, 0.859, 1.430 ounces, respectively, were placed on the limit switch. As these weights had such a slight effect on the controlling mechanism, the average of the eight runs was taken for the test. The general effect of this is the same as setting the limit switch for a slightly heavier current, and this is shown nicely by the fact that the maximum current for the series position of Test No. 19 is somewhat larger than that shown for the same position of Test No. 18.

THE POWER CURVES. — Since the variations in pressure are not nearly so great as the changes in current, the power curves have the general characteristic shape of the current curves. While the maximum power is practically the same for the series position of the controller in each test, it is seen that the maximum power at the parallel position is considerably greater than at the series position, as shown by Test No. 19. It will also be observed that the average power for the test is considerably less than the maximum power at the series position of the controller in each case. The average power for Test No. 18

is considerably less than that for Test No. 19, as would be expected. Another interesting feature is shown in the comparatively large fall in line pressure, due to the small amount of copper in the line in proportion to the large current taken by the car. The effect here is a relatively lower increase in the power taken by the car, with a given increase in the current. It is to be observed that, while this decrease in line pressure may have a tendency to prevent excessive currents being taken by the car during acceleration, the efficiency of the transmission system is considerably decreased by the large drop in the line.

THE ENERGY CURVES. — The energy curves for the two tests differ somewhat in general form, and considerably in their final values. The energy curve for Test No. 18 shows the most rapid rise at the start, and a more gradual increase after the controller has reached the full series position. The curve for Test No. 19 again shows a rapid rise during the period of time in which the controller is brought to the full series position, followed by a still more rapid rise as the contacts for the parallel position are made, and a more gradual increase from this point on to the end of the test. It will be noted that the total energy for Test No. 19 is practically twice that for Test No. 18. While the time is nearly the same in the two cases, the distance traversed in Test No. 19 is approximately 66 per cent greater than in Test No. 18, while the speed is more than 50 per cent greater.

THE SPEED CURVES. — The speed curves show a rapid increase in speed at the start, which increase gradually falls off as the maximum speed is reached. The speed curves for both conditions of acceleration show smoothness and uniformity. No abrupt variations in speed are noticed, and from the standpoint of comfort to passengers, the accelerating effect is all that can be desired. It is to be noted that the speed rose more nearly to its full value for the conditions of Test No. 18 than it did for those of Test No. 19. The latter test would have been prolonged had it not been for the fact that a one per cent grade was encountered at a distance of 2600 ft. from the start. As it would have been impossible to properly interpret the various

factors after the car had passed from the level stretch of track, it was necessary to cut off the test before the end of this level portion was reached.

• THE ACCELERATION CURVES. — The acceleration curves show a maximum acceleration at the start, this maximum being practically the same for both tests, and having a value of approximately 1.5 miles per hour per second. This is what might be looked for, as there is no apparent reason for any variation in the acceleration at the start in the two tests, since the automatic action of the controller at the start was the same for both conditions of acceleration. The acceleration curves have the same general shape in the two tests, although it will be noted that the acceleration decreases much more rapidly in Test No. 18 than is the case in Test No. 19. An inspection of the acceleration curves with respect to the current curves will show that the acceleration began to fall off quite rapidly after the point of maximum current at the series position in Test No. 18, while in Test No. 19 the acceleration remained relatively high for a considerable interval of time after the parallel position of the controller was reached.

THE DISTANCE CURVES. — The distance curves all have the same characteristic shape, as there is comparatively little effect upon their general form due to slight variations in speed. The total distance traversed, however, is very different for the two tests, being 1510 ft. in Test No. 18, and 2540 ft. in Test No. 19.

VARYING THE LIMIT SWITCH.

As previously stated, it was the original intention to vary the maximum current taken by the car by so adjusting the limit switch that the contacts would be made under different conditions of maximum current. It was attempted to accomplish this by means of small weights placed on the limit switch in such a manner as to cause greater currents to flow before the successive contacts were made. It was soon discovered that the weights used were altogether too small to accomplish the desired result. However, because of existing conditions,

time did not permit of extending the acceleration tests, and it was consequently impossible to obtain the results desired in this connection.

While the weights used on the limit switch did not produce any marked effects, it was observed that there was a general tendency toward an increase in the current and a decrease in the interval during the accelerating period.

THE CONTROL DATA.

As shown in the data in the general logs of Tests Nos. 18 and 19, it is seen that the energy taken in operating the control system is entirely negligible in comparison with the total energy taken by the car, it being but a fraction of one per cent of the latter. An inspection of the data shows that for both tests the energy consumed by the motor compressor due to leakage amounts to over seventy per cent of the total energy taken by the control system. It is thus seen that the amount of energy used in the control system, is not much greater than that which would be used if the air brakes and the ordinary hand controller were employed.

Another feature of the electro-pneumatic system of control is that which concerns the time-lag between the instant at which the control circuit is closed, and the instant at which the motor circuit is closed. Measurements were made from twenty-seven different observations taken from the original records. The average of these observations showed a time-lag of 2.34 seconds from the instant the controller current was set up until current was drawn from the line. In a similar manner, the average of twenty-seven different observations, recording power cut off, taken from the original records, show no difference in the time intervals elapsed from the instants the control and current circuits were set to the instants they were cut off in the two circuits. This demonstrates the fact that the same time-lag that is present in turning on the power also exists when the master controller is turned off.

PART IV.
BRAKING TESTS OF ELECTRIC CARS.

CHAPTER VII.

COMPRESSOR-STATION TESTS OF A STORAGE AIR SYSTEM OF BRAKING.

OBJECTS OF THE TESTS.

THE principal objects of the tests were to study the characteristic features of the operation of a compressor station for the compressing of air for the storage system of air braking, and to obtain the relation between the amount of energy consumed and the volume of air compressed. The calculations included not only the computation of the cubic feet of free air compressed per kilowatt, but also computations based upon the actual number of cubic feet of free air delivered to the storage tanks on the car.

In addition, the thermodynamic losses of the system were investigated, and tests were made to determine the relative economy of cooling by different methods. Calculations were also made of the energy consumed per cubic foot of free air.

GENERAL CONDITIONS OF THE TESTS.

The entire fifteen hundred cars operated by the St. Louis Transit Company during the summer of 1904 were equipped with the storage air system of braking. To supply this number of cars, eighteen compressor stations, located at various points in the city, were necessary.

THE COMPRESSOR STATION TESTED.

The station selected for the test is located at the Tower Grove Park loop of the Park Avenue and Compton Avenue lines, operated by the St. Louis Transit Company. The general

SYNOPSIS OF RESULTS.

TABLE XXXII. — *Synopsis of Results. Station Compressor Tests. August 3 and 4, 1904.*

	TEST No. 20.	TEST No. 21.
Duration of test, hours	24.00	2.35
Total running time of compressor, hours	9.80	1.57
Total number of compressor runs	108	18
Average interval of compressor runs, minutes	5.44	5.24
Average reservoir pressure, lbs. per sq. in.	280.8	276.2
Average max. reservoir pressure, lbs. per sq. in.	296.9	283.2
Average min. reservoir pressure, lbs. per sq. in.	271.8	256.4
Average range of reservoir pressure, lbs. per sq. in.	25.1	26.8
Average reservoir temperature, degrees, C.	39.2	40.8
Total volume of free air compressed, cu. ft.	40,402	7,250
Total volume of free air delivered to cars, cu. ft.	38,515	6,889
Total weight of air compressed, lbs.	3205.0	574.0
Total weight of air delivered to cars, lbs.	3055.0	545.5
Total weight of air lost by leakage, lbs.	150.0	28.5
Total weight of cooling water circulated, lbs.	10,400	4125
Total heat absorbed by cooling water, B. T. U.	259,295	6,9052
Average line pressure, volts	491.5	488.0
Average current during runs, amperes	46.5	45.5
Average current for test, amperes	9.78	29.0
Average power during runs, kilowatts	22.85	22.45
Average power for test, kilowatts	9.23	15.0
Maximum power for test, kilowatts	26.8	23.6
Total electrical energy for test, K. W. hours	221.9	35.3
Average energy per compressor run, watt-hours	2,052	1,960
Energy per lb. of free air compressed, watt-hours	69.2	61.5
Energy per lb. of free air delivered to cars, watt-hours ..	12.6	64.8
Energy per cu. ft. of free air compressed, watt-hours	5.49	4.87
Energy per cu. ft. of free air delivered to cars, watt-hours	5.76	5.13
Average number of cars in operation during test	22	42
Average power taken by each car, kilowatts	25.3	25.3
Ratio of $\frac{\text{power taken by compressor plant}}{\text{power taken by cars}}$, per cent	1.7	1.4

plan of this station is shown in Fig. 75. It contains two compressor units delivering air into two large tanks, which are connected by a suitable header. The compressors are chain-driven by 500 volt, 50 ampere, d.c. motors, compound wound for constant speed, and running at 500 revolutions per minute. Fig. 76 shows the compressor and motor with the gear case removed, while another view, showing the controller, is given in Fig. 77. The pinion on the armature shaft carries 24 teeth,

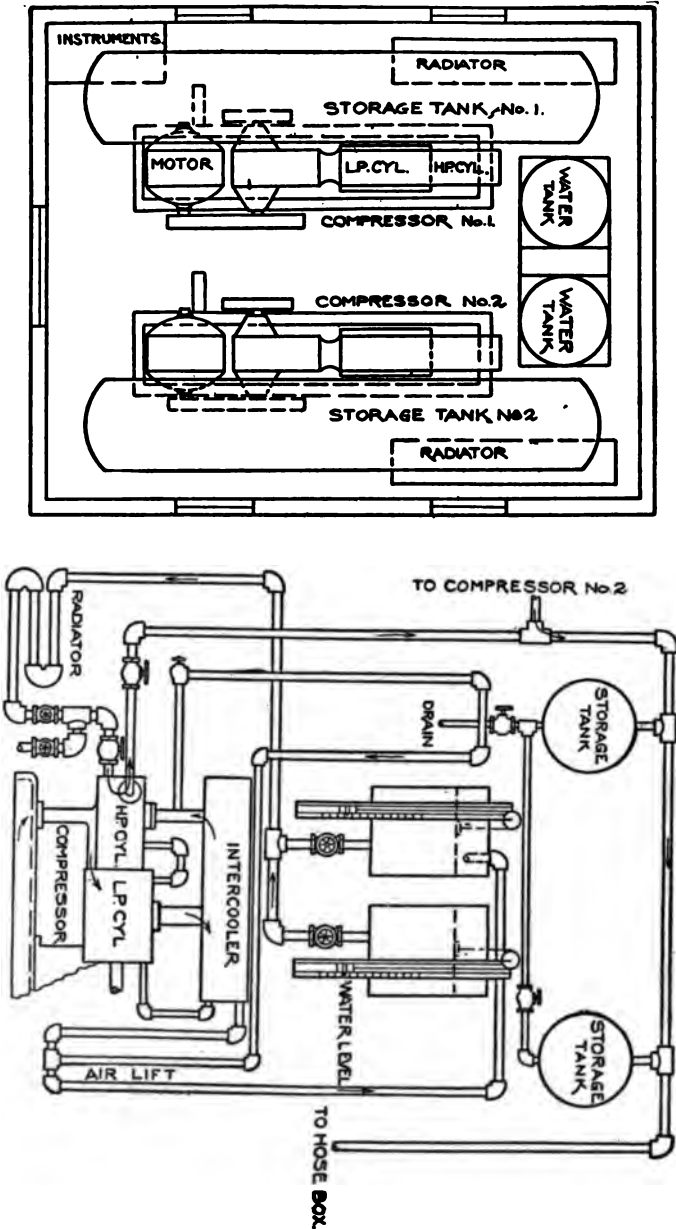

Fig. 75.—Tower Grove Park Station of the St. Louis Transit Company.

while the compressor gear has 99 teeth. The running parts of the machine are self-oiling, and the valves are all of brass and of poppet style. Automatic starting and stopping of the

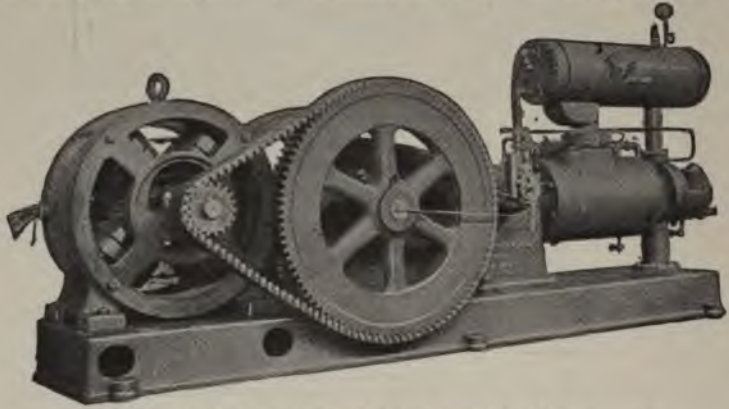

Fig. 76.—Station Compressor and Motor, Showing Gear Case Removed.

compressor are accomplished by solenoid devices in the motor circuit, these devices being controlled by an automatic governor, operated by variations in the air pressure.

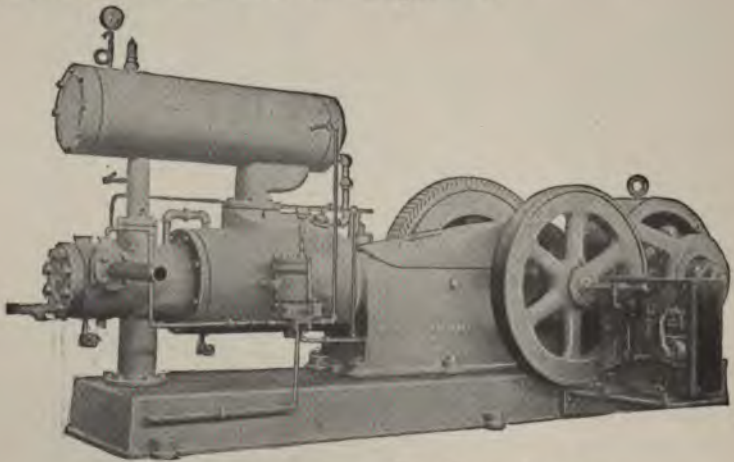

Fig. 77.—Station Compressor and Motor, Showing Controller.

The general scheme of station piping is also shown in Fig. 75. From the base of the governor, air is drawn into the low-pres-

sure cylinder, compressed to about 70 lbs. per square inch, forced through the intercooler, and then into the high-pressure cylinder, where it is compressed to 300 lbs. per square inch. The cylinders are arranged in tandem. As the compressor is single acting, a free air space is obtained between the two pistons, hence no packing is used between them. As the high-pressure cylinder is in the end of the machine and a part of it, there is no packing subjected to a high pressure except the piston rings and the gasket under the head. A pipe from the high-pressure cylinder leads to a safety valve, and to a globe valve from which a 2-in. riser is run into a $2 \times 1\frac{1}{2}$ -in. header, and into one of the tanks. The two air tanks are connected at one end by a $2\frac{1}{2}$ -in. header. From the other end of the second, a pipe leads to a globe valve, and thence under the floor and underground to three hose-box valves and connections for charging cars.

The cylinders are kept cool by circulating water through their water jackets, the water being supplied from a storage tank, one tank sufficing for two compressors. The tank is made of galvanized iron, about 4 ft. deep and 3 ft. in diameter, supported with the bottom about $7\frac{1}{2}$ ft. above the floor. The water flows from the bottom of the tank, through a pipe into the high-pressure cylinder jacket, through this into the intercooler, where it passes back and forth up through baffle plates, out and down to a pipe coil radiator exposed to the air. An air lift raises the water back to the tank again. This is a $\frac{3}{4}$ -in. pipe connection from the intercooler to the bottom of the pipe, leading vertically from the radiator to the storage tank. The air entering the bottom of this riser acts to lift the water above it, causing a fairly rapid circulation. With a small valve near the intercooler connection, the flow of air through the lift can be regulated. Interconnections are made for the two machines so that they may both be supplied with cooling water from the tank and radiator. Valves and connections are all placed so that the tank and radiator may be cut off and water received from the city water supply and drained to the sewer, after circulating through the jackets. The storage air system, as

installed in St. Louis, is fully described in the *Street Railway Journal*, Vol. XXIII, 1904, pp. 208 and 628.

THE CAR EQUIPMENT.

The compressor station above described supplied air for all cars operating on the Compton Avenue and Park Avenue lines. It was not practicable to make complete tests of all of these cars, but the gage readings were taken on all cars, and a complete test was made upon one of the cars, which was numbered 2600. This is the double-truck city car described in Chapter I. Its equipment is similar to that of 1500 other cars in service in the city of St. Louis. A diagram of the car piping will be found in Fig. 78.

The storage reservoirs have a total capacity of about 20 cu. ft., and the service tank a capacity of about 2.5 cu. ft. Air from the storage tanks passes through the reduction valve, thence to the service reservoir, in which a constant gage pressure of 45 lbs. per square inch is maintained, regardless of pressure in the storage reservoir. The air passes from the service tank through a $\frac{3}{4}$ -in. pipe to the engineer's valve, thence back again through a $\frac{3}{4}$ -in. pipe to the brake cylinder, and the brakes are supplied through the usual rigging. The cars are equipped also with a hand brake for emergency use. The charging pipe for the storage tanks terminates near the middle of the car in a coupling head, which is denoted in the figure as "sleeve coupling." In charging the main tanks a length of flexible hose is used to connect the terminals of the pipe from the compressing station with the sleeve coupling. This pipe terminates in a hose-box, located close to the side of the track, and containing a valve for controlling the supply of air to the car.

The packing in the brake cylinder is the ordinary leather packing instead of the piston rings used in steam piston packing. The maximum travel of the piston is about 6 inches.

GENERAL DESCRIPTION OF THE TESTS.

The station equipment was disturbed as little as possible during the tests, in order that the measurements might be

representative of the usual running conditions. The primary objects of the tests being to obtain the relation between the amount of energy consumed and the volume of air compressed,

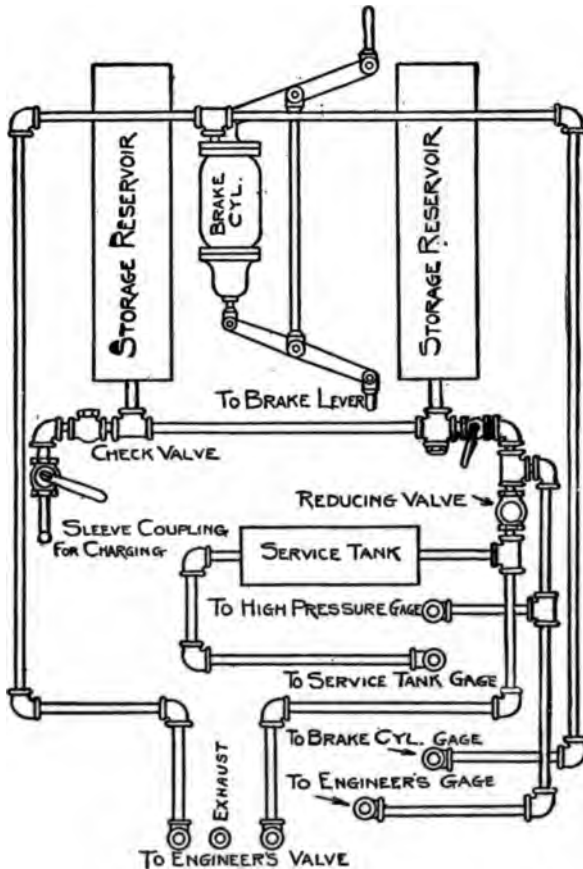

Fig. 78. — Diagram of Car Piping for Storage Air System of Braking.

the principal measurements were: (a) those relating to the electrical energy taken by the motor in operating the compressor; (b) those relating to the volume and weight of air compressed, as deduced from measurements of pressures and temperatures taken before and after motor-compressor runs.

The measurements relating to volume and weight of air com-

pressed, were checked by measurements which were made upon the consumption of air by individual cars, as deduced from the measurements of the pressures and temperatures of the air in the tanks upon the cars before and after charging.

The first of the compressor station tests was conducted between 2.00 P.M. on August 3d and 2.00 P.M. on August 4th, 1904, measurements being made continuously over a period of twenty-four hours. Only one of the two compressors in the station was used during the tests, as it was found that the required pressure in the storage tanks could be readily maintained with one compressor, and the measurements were greatly simplified by making the tests under these conditions. This test was performed with the apparatus operating under ordinary conditions as to the circulation of cooling water, that is, with cylinder cooling water circulating by means of the air lift.

The second test was made late in the afternoon of August 4th, after the completion of the first test. The purpose of this test was to determine the net saving, if any, which would result from a rapid circulation of cooling water directly taken from the city mains. The test covered a period of 2.35 hours, beginning at 5.10 P.M., and ending at 7.31 P.M. This part of the day was selected as the twenty-four-hour test showed it to be one of the busiest periods, considered from the standpoint of air taken from the compressor station by the cars. The test was conducted under precisely the same conditions as existed in the preceding test, with the exception of the manner of circulating the cooling water.

As the volume of air compressed was measured by the rise in pressure in the storage tanks, it was essential that the compressor should not be in operation while the air tanks of the cars were being charged. To insure against such a contingency, a switch was placed in the electric control circuit, in place of the minimum contact point on the governor, and this switch was closed by one of the observers when it was desired to start the compressor. The compressor was run during intervals when cars were not drawing air from the station, and the start of each

run was made when the pressure in the storage tank had decreased to a value near the lower limit of normal operation of the compressor.

The tests consisted essentially in operating the compressor as frequently as was necessary to maintain the desired pressure. The cars were supplied with air as it was required, observations being made of the indications of the car gages both before and after each charge, in order that the amount of air taken in each case might be determined. The gages of all of the cars on the line were subsequently calibrated, in order to insure accuracy in the results. Blank forms were used by the observers in recording the readings of the various instruments.

Between the twenty-four-hour test and the shorter test to determine the effect of a rapid circulation of cooling water direct from the city mains, tests were made to determine the efficiency of the electric motor, and also that of the compressor. The resistances of the armature and fields of the motor were taken, and a "stray power" test was made to determine the losses due to friction, hysteresis, and eddy currents. From these measurements, the efficiency of the electric motor was obtained. The electrical efficiency of the air-compressor was obtained by first removing the valves and then driving the compressor by means of the motor, the power required to drive the compressor being measured.

A short test was also made covering a period of one and one-half hours, to determine the fluctuations of the various quantities involved in the compressing of air by means of the apparatus tested. The air compressor was run a number of times during this test, and observations were taken at very frequent intervals during each run. While the results of this test have been worked up in considerable detail, it has been found that the limitations of the printed report will not permit of their being shown graphically. The data resulting from this test show that the power fluctuates from a high value at the start through a low value, and increases toward a maximum as the air pressure in the storage tank rises. The total fluctuation

of the power during a run amounts to approximately 25 per cent after the pressure in the compressor has risen high enough to open the valves. Until air actually begins to enter the storage tank, the consumption of power averages less than 50

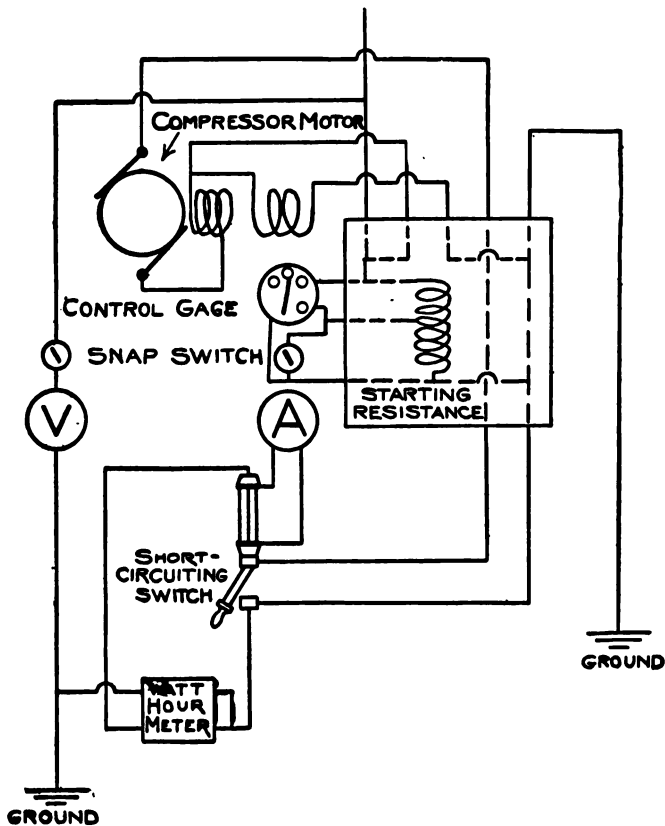

Fig. 79. — Electrical Connections for Tests of Compression Stations.

per cent of the maximum. Less than one minute is required for this operation.

ORIGINAL MEASUREMENTS.

The principal original data obtained for the compressor station tests may be divided into five general classes as follows: (a) those relating to the electrical input; (b) those relating to

time; (c) those relating to the speed of the motor-driven compressor, and the number of double strokes of the air compressor piston; (d) those relating to the pressure of air at various points in the system; and (e) those relating to the temperatures of air and water.

In addition, tests were made to determine the efficiency of the motor-compressor, and many other data were obtained, which either relate to the general conditions existing during the tests or which were necessary in the working up of the results.

Electrical Measurements.

The electrical measurements consisted essentially in taking readings of the current and pressure supplied to the motor during the interval of run, and in reading the watt-hour meter at the end of each run, to obtain the total energy delivered to the motor during the interval. The ammeter and voltmeter were read at the start and at one-minute intervals throughout the run in each case.

The arrangement of instruments for the test was as shown in Fig. 79. A snap switch was connected in the motor governor circuit, so that the observer who took the electrical measurements, could prevent the compressor from starting when a car was taking air. The method employed in measuring the quantity of air made this necessary.

The various electrical measurements which were made are shown in the following table:

QUANTITY MEASURED.	INSTRUMENT EMPLOYED.	METHOD OF MAKING MEASUREMENTS.
Terminal pressure.	Weston indicating voltmeter.	Readings at one-minute intervals throughout run.
Total current.	Weston milli-voltmeter with shunt.	Readings at one-minute intervals throughout run.
Total energy	Thomson watt-hour meter.	Readings at the end of each run, actual dial readings being recorded.

Time Measurements.

The time of start and stop of each run was accurately recorded from observations made from a watch. From these data, the time interval of each run was found.

Speed Measurements.

The speed of the motor was obtained by means of a speed counter and watch. From these measurements the number of revolutions of the motor armature per minute was obtained, and from this value the number of strokes of the compressor piston was deduced.

Pressure Measurements.

In order to determine the volume of air delivered to the storage tanks, it was necessary to make accurate determinations of the pressures and temperatures at various points in the system. The air pressures in the main tanks, in the intercooler, in the main pipe line, and in the cars were measured upon reliable gages which were checked from time to time. These readings were taken before and after each run, or before and after a car received a charge of air.

Temperature Measurements.

Calibrated quick reading thermometers were placed so as to obtain the various temperatures as follows:

- (1) Air intake;
- (2) Intercooler;
- (3) Discharge pipe;
- (4) Interior of tanks;
- (5) Exterior of tanks, both near the top and near the bottom;
- (6) Hose-box pipe;
- (7) Room temperature, both near the ceiling and near the floor;
- (8) Temperature of the outside air.

To obtain temperatures 2, 3, and 6 it was necessary to insert thermometers in specially constructed oil wells. It was found impracticable to use a built-up oil well, because of the exces-

twenty-four-hour run. Since a record of each car throughout this time had been accurately kept, it was a simple matter to enter the corrected readings without the laborious task of plotting calibration curves. The results of the calibration showed that enough gages were in error to have materially affected the results, had not this precaution been observed.

Determination of Losses.

The losses occurring in the system may be classified as follows: (1) motor losses, both electrical and mechanical; (2) compressor losses, mechanical; (3) heat losses to the air both during

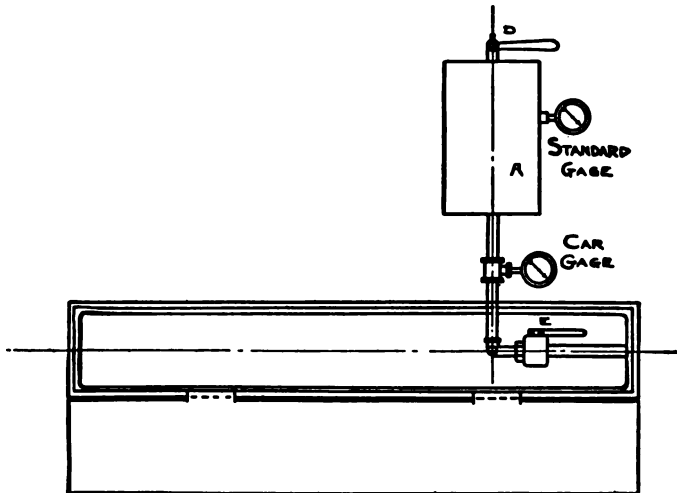

Fig. 80. — Connection for Calibrating Car Gages.

and after compression; and (4) actual losses of air, both by leakage and in the "air-lift," which was used for circulating the cooling water. These losses all affect the efficiency of the system, and for the purposes of this test they were separated as far as practicable.

Methods Employed for Determining Losses.

MOTOR EFFICIENCY. — In order to secure the necessary data for determining the motor efficiency at various loads, measurements of the resistance of the series and shunt fields were made

HEAT LOSSES FROM THE AIR. — In order to ascertain the manner in which the heat energy was liberated from the air during and after compression, the system was divided up into a number of sections, and the temperature of the air was measured as it entered and as it left each section. In addition, the amount of water circulated about the cylinders and the intercooler, and the temperatures of the same were carefully determined so that the amount of heat removed could be calculated. A special test was conducted to determine the effect, upon the system, of a more rapid carrying away of the heat from the compressor than that which was in ordinary use in the station.

MEASUREMENTS OF AIR LIFT. — A separate test was necessary for this purpose. The plan used was to deliver the air from the lift into an inverted measuring vessel in one of the large tanks, the vessel being first filled with water. The time necessary for the air from the lift to fill this vessel was determined.

In determining the actual amount of air compressed it is necessary to know the pressures and temperatures before and after compression, and also the volume of the receiver into which the air is pumped. Having obtained these quantities, it remains to reduce them to standard conditions in order that the results obtained may be comparable with those of other tests. The measurements are changed in accordance with the laws of perfect gases, to correspond with a temperature of zero degrees centigrade and an absolute pressure of fifteen pounds per square inch. The results show, therefore, the amount of electrical energy required to compress a cubic foot of free air at a barometer pressure of fifteen pounds per square inch, to a given gage pressure at 0° C.

The following convenient formulæ have been used in these calculations:

SYMBOLS.

P_1 = Absolute pressure in storage tanks before a compressor run.

P_2 = Absolute pressure in storage tanks after a compressor run.

T_1 = Absolute temperature in storage tanks before a compressor run.

T_2 = Absolute temperature in storage tanks after a compressor run.

V_1 = Volume of free air in storage tanks before a compressor run.

V_2 = Volume of free air in storage tanks after a compressor run.

K, K_1 = Reduction constants.

t_1 = Temperature by thermometer before a compressor run.

t_2 = Temperature by thermometer after a compressor run.

All of the above symbols relate to the several quantities as actually measured. To represent the same quantities reduced to standard conditions, that is, 0° C., and fifteen pounds per square inch absolute pressure, the following corresponding symbols are employed:

$$P'_1, P'_2, T'_1, T'_2, V'_1, V'_2, t'_1, \text{ and } t'_2.$$

0° C. is taken as 273° C. absolute temperature.

$V_1 = V_2$ = cubic feet in tanks and piping. Then, according to the thermodynamic law of perfect gases,

$$\begin{aligned} P'_1 V'_1 &= K_1 T'_1. \\ P_1 V_1 &= K_1 T_1. \end{aligned}$$

Dividing and solving for volume under standard conditions,

$$\begin{aligned} V'_1 &= \frac{P_1}{P'_1} \times \frac{T'_1}{T_1} \times V_1 \\ &= \frac{P_1}{15} \times \frac{273}{273 + t_1} \times V_1 = K \times \frac{P_1}{273 + t} \end{aligned}$$

Likewise,

$$V'_2 = K \times \frac{P_2}{273 + t_2}.$$

Then the standard volume delivered to the storage tanks during the run under consideration will be

$$V' = V'_2 - V'_1.$$

WORKING UP THE RESULTS.

The data sheets were first bound into books, and such corrections as the calibrations showed to be necessary were entered therein. The next step consisted in assembling the data for the test on one large sheet, called for convenience the "combined log sheet." This large sheet contained spaces for all calculations, and as it formed an essential part of the work, and also because it shows in condensed form the nature of the calculations, the headings of the many columns of this sheet are inserted in this report. None of the actual readings are included, as they number many thousands and as they are incorporated into the diagrams which show graphically all of the results of the tests. The readings of the combined log sheets, with explanatory notes, are as follows:

TIME.				POWER.					SPEED.		
1	2	3	4	5	6	7	8	9	10	11	12
Number of Run.	Time of Starting Compressor.	Time of Stopping Compressor.	Actual Running Time.	Average Amperes (Corrected).	Average Volts (Corrected).	Average Watts, Av. E. \times Av. I.	Watt-hours, Av. E. \times Av. I \times time.	Watt-hours from Integrating W. M.	Revolutions of Motor per Run.	Double Strokes of Piston per Run.	Double Strokes of Piston per Minute.
No. of Instrument.											

Notes on the Various Items.

COLUMN 1. — A run was covered between the time at which the compressor was allowed to start and that at which it was stopped by the controller, operated by the tank pressure.

COLUMN 2. — The compressor was started by hand when the tank pressure had fallen through the normal range and when

AIR.												
TEMPERATURES, DEGREES CENTIGRADE.												
13	14	15	16	17	18	19	20	21	22	23	24	25
Intake, Hole in Base of Machine.	Intercooler, Thermometer Well, in Place of Pop-Valve.	On Outside of Discharge Pipe.	Tank No. 1 (Well on top).	Outside of Tank No. 1 (on top).	Outside of Tank No. 1 (near bottom).	Tank No. 2 (Well on top).	Outside of Tank No. 2 (on top).	Outside of Tank No. 2 (near bottom).	Hose-Box Pipe (Thermometer Well in Plug) Car Charging.	In Station.	In Station.	Outside Station.
No. of Instrument.												
		Before After	Before After	Before After	Before After	Before After	Before After	Before After	Before During After	Down	Up	

Notes.

These temperature readings were made for two purposes; to use in connecting the volume of the compressed air for temperature, and to show the losses in heat in different parts of the system.

COLUMN 13. — This item shows the temperature of the air entering the compressor.

COLUMN 14. — The compression was in two stages, and this temperature was taken in the cooling receiver between the two cylinders.

COLUMN 15. — The discharge pipe connects the compressor with the storage tanks.

COLUMNS 16, 17, AND 18. — These temperatures were taken in order to obtain an average temperature in the storage tank. In Column 16 the readings are obtained by placing the thermometer in an oil well tapped into the tank wall. The other temperatures were obtained by laying thermometers against the tank wall, and covering them with non-conducting material.

COLUMNS 19, 20, AND 21. — These show the same items for the second tank. The air passed first into tank No. 1, and then into tank No. 2.

volumes of the tanks and piping were accurately obtained, and correction was made for the water condensed in the tanks. In referring to the amount of air it is to be understood that this is free air at 0° C and 14.7 lbs. barometric pressure.

COLUMN 31. — This quantity is the difference between those in the preceding two columns.

COLUMN 32. — The theoretical amount of air compressed is that corresponding to the piston displacement.

COLUMN 33. — This volume was drawn by the cars and lost by leakage, and it was measured by the reduction in pressure.

COLUMN 34. — A careful count of the cars which were charged was kept, and their individual numbers were recorded.

COLUMN 35. — This volume was measured by noting the rise in pressure in the car tanks. The individual car gages were all calibrated.

WATER.

TEMPERATURE IN DEG. CENT.							TEMPERATURE DIFFERENCES, DEG. CENT.				
36	37	38	39	40	41	42	43	44	45	46	47
Tank No. 1.	Tank No. 2.	Leaving Radiator.	Entering High-Pressure Cylinder.	Between High- and Low-Pressure Cylinders.	Entering Intercooler.	Leaving Intercooler.	Entering and Leaving High-Pressure Cylinder.	Entering and Leaving Low-Pressure Cylinder.	Entering and Leaving Intercooler.	Entering and Leaving Water Tank.	Entering and Leaving Radiator.

No. of Instrument.

Before	After	Before	After	Before	After	Before	After	Before	After	Before	After	Before	After	Before	After	Before	After
--------	-------	--------	-------	--------	-------	--------	-------	--------	-------	--------	-------	--------	-------	--------	-------	--------	-------

Notes.

The measurement of the heat losses in the cooling water was made in order to allow a separation of the various heat losses in the system. Oil wells were inserted in the piping at the proper points, in order to obtain the exact temperature of the water.

COLUMN 54. — These items were obtained by dividing those of Column 53 by the time of each run.

COLUMN 55. — In order to compare this plan of cooling with others, the total amount of heat conveyed from the air by the water makes a satisfactory quantity for measurement. The heat per run is therefore tabulated.

RESULTS OF THE TESTS.

It was the original intention to represent all of the results

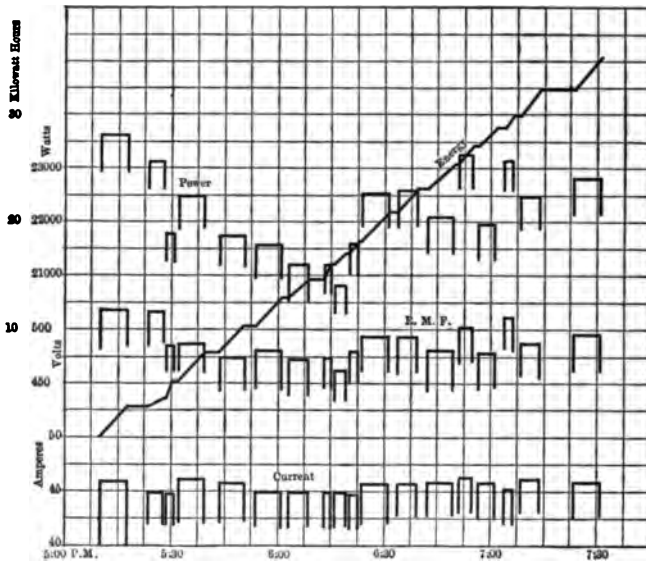

Fig. 82. — General Electrical Data of Test No. 21.

of the compressor station tests in graphical form. It was found, however, that the limitations of the report would not permit of such a large number of curve sheets for a single chapter. The general and detailed results have, therefore, been put into the form of tables.

Although it has been found impracticable to insert, in the final report, curve sheets showing the various data in graphical form, such graphical logs were prepared from the original data and were used in working up the results shown in the various

mary of the two tests arranged for comparison by considering a 2.35 hour period in the twenty-four-hour test. In Table XXXIX are given the more general data for the two tests, similar 2.35-hour periods being chosen.

TABLE XXXIII. — Average Air Temperatures by Three-Hour Periods.¹

TWENTY-FOUR-HOUR RUN.

PERIOD.	2-5	5-8	8-11	11-2	2-5	5-8	8-11	11-2	AVERAGE FOR EN- TIRE RUN
	P.M.	P.M.	P.M.	A.M.	A.M.	A.M.	P.M.		
Temp. at intake	29.5	29.5	27.6	27.4	26.5	25.7	27.9	30.2	28.4
	85	85	82	81	80	78	82	86	83
Temp. in intercooler	47.1	54.5	52.5	47.8	42.6	46.6	54.8	53.8	50.6
	117	130	127	118	109	116	131	129	123
Temp. in discharge pipe of compressor.	102.0	119.7	110.5	91.5	56.5	102.6	116.9	108.5	101.1
	216	247	231	147	134	216	242	227	214
Temp. in storage tank No. 1.	46.9	51.1	47.3	40.7	31.6	36.0	46.6	45.4	43.2
	116	124	117	105	89	97	116	114	110
Temp. in storage tank No. 2.	39.0	39.9	38.2	34.5	30.1	29.1	34.1	36.3	35.2
	102	104	101	94	86	84	93	97	95
Room temp. near ceiling ...	37.5	36.8	34.0	30.6	27.3	27.9	33.2	36.3	33.0
	99	98	93	87	81	82	92	97	91
Room temp. near floor	31.9	30.7	27.2	25.0	22.7	24.5	24.7	32.8	27.4
	89	87	81	77	73	75	76	91	81
Temp. at hose-box	26.6	26.8	24.9	22.8	19.7	22.3	24.1	28.0	24.4
	80	80	77	73	67	72	75	82	76
Temp. of outdoor air	28.8	25.0	19.3	17.3	15.8	20.6	26.7	31.1	23
	84	77	67	63	60	69	80	88	74

NOTE. — Each temperature is shown in both Centigrade and Fahrenheit degrees, the Centigrade values being given first.

TABLE XXXIV. — Average Temperatures of Cooling Water by Three-Hour Periods.

TWENTY-FOUR-HOUR RUN.¹

PERIOD.	2-5	5-8	8-11	11-2	2-5	5-8	8-11	11-2	AVERAGE FOR EN- TIRE RUN.
	P.M.	P.M.	P.M.	A.M.	A.M.	A.M.	P.M.		
Temp. in water tank No. 1	37.8	43.9	44.6	42.2	38.6	38.5	43.7	46.1	41.9
	100	111	112	108	102	101	111	115	107
Temp. in water tank No. 2	39.0	45.6	45.5	43.3	40.2	37.9	44.8	46.2	42.8
	102	114	114	110	104	100	113	115	109
Temp. water entering high- pressure cylinder jacket.	33.4	37.1	34.7	33.6	26.6	31.1	37.3	39.4	34.1
	92	99	94	93	80	88	99	103	93
Temp. water between cylin- ders.	37.6	40.6	41.2	39.0	32.4	34.2	41.4	22.8	38.9
	100	105	106	102	90	94	107	113	102
Temp. water entering inter- cooler.	41.7	46.8	45.7	44.2	36.2	39.0	47.5	49.3	43.8
	107	116	114	112	97	102	118	121	111
Temp. water leaving inter- cooler.	45.5	51.2	49.8	48.2	40.3	43.2	52.2	53.0	47.9
	114	124	122	119	105	110	126	127	118
Temp. water leaving radi- ator.	38.3	44.3	44.2	39.4	33.4	36.8	43.4	45.2	40.7
	101	112	112	103	92	98	110	113	105

¹ Each temperature is shown in Fahrenheit and in Centigrade degrees, the Centigrade values being given first.

TABLE XXXV. — General Summary by Three-Hour Periods.

TWENTY-FOUR-HOUR RUN.

PERIOD.	2-5	5-8	8-11	11-2	2-5	5-8	8-11	11-2	TOTALS FOR EN- TIRE RUN.
	P.M.	P.M.	P.M.	A.M.	A.M.	A.M.	P.M.		
Item No. 1, total vol. of free air compressed in cu. ft.	5,870	7,470	6,170	2,730	896	6,880	6,400	3,987	40,402
Item No. 2, total vol. of free air used by cars in cu. ft.	5,750	6,910	5,120	2,100	415	7,210	6,280	4,730	38,515
Item No. 3, total vol. of cooling water circulated in cu. ft.	17.0	3.50	18.0	11.5	6.0	32.0	25.5	23.56	168.36
Item No. 4, B. T. U. absorbed by cooling water in the H. P. cylinder.	7,920	13,740	8,220	7,030	3,950	11,200	11,800	9,940	73,800
Item No. 5, B. T. U. absorbed by cooling water in the L. P. cylinder.	8,020	24,160	9,120	6,645	2,580	17,400	17,530	11,820	97,275
Item No. 6, B. T. U. absorbed by cooling water in the intercooler.	7,150	17,300	13,020	5,240	2,740	15,070	13,500	14,200	88,220
Item No. 7, B. T. U. absorbed by cooling water (total).	23,090	55,200	30,360	18,915	9,270	43,670	42,830	35,960	259,295
Item No. 8, kilowatt-hours furnished motor (total).	32.3	39.6	27.9	15.1	5.7	37.5	35.6	28.2	221.9
Item No. 9, actual running time of motor-hours.	M S	M S	M S	M S	M S	M S	M S	M S	M S
	88 15	110 32	77 10	42 0	13 15	97 15	90 0	69 40	588 7
	1.47	1.84	1.28	0.70	.22	1.62	1.50	1.16	9.80
	21.9	21.4	21.6	21.4	25.3	23.1	23.6	24.8	22.8
Item No. 10, average kilowatts furnished motor.	285	270	276	289	286	284	288	288	280.8
Item No. 11, average tank pressure in lbs. per sq. in. tank No. 2.									

TABLE XXXVI. — General Results of Twenty-Four-Hour Run.

Total volume of free air compressed to 280.8 lbs. gage pressure.	40,403 cu. ft.
Total electrical energy absorbed.....	221.9 k. w. hours.
Electrical energy absorbed per 1,000 cu. ft. of free air compressed.	5.49 k. w. hours.
Volume of free air compressed per k. w. hour absorbed	182.0 cu. ft.
Electrical energy absorbed per pound of free air compressed.	69.2 watt-hours.
Weight of free air compressed per k. w. hour absorbed	14.5 lbs.

TABLE XXXVII. — Showing Average Temperatures for Test No. 21 compared with those for a Similar Period in Test No. 20.

AIR TEMPERATURES.		
SYSTEM OF COOLING EMPLOYED.	TEST No. 20. WATER CIRCULATED BY AIR LIFT.	TEST No. 21. CITY WATER.
Temperature at intake	29.5 85	26.7 80
Temperature in intercooler.....	54.5 130	42.8 109
Temperature in compressor discharge pipe	119.7 247	107.4 225
Temperature in storage tank No. 1	51.1 124	45.3 114
Temperature in storage tank No. 2	39.9 104	36.3 97
Room temperature near ceiling	36.8 98	33 92
Room temperature near floor	30.7 87	27.2 81
WATER TEMPERATURES.		
Temperature in water tank No. 1	43.9 111	32.1 90
Temperature in water tank No. 2.....	45.6 114	31.8 89
Temperature of water entering h. p. cylinder jacket.	37.1 99	22.7 73
Temperature of water between cylinders	40.6 105	24.6 76
Temperature of water entering intercooler	46.8 116	22.8 83
Temperature of water leaving intercooler	51.2 124	32.0 90

DISCUSSION OF RESULTS.

In the discussion, the more general results will be first considered, and this will be followed by a discussion of the results in detail. While a number of tables are given showing the results in detail, the more general data have been assembled in the synopsis at the beginning of the chapter.

GENERAL RESULTS. — In Table XXXII the general results of Tests Nos. 20 and 21 are presented, not by way of comparison, but to give in compact form the most important data for reference. A correct comparison of the results of the runs made with different methods of cylinder cooling, requires the study of similar periods in the two tests. Such a comparison is made in Table XXXVIII.

The primary object of these tests was not to compare the two systems of cooling, but to determine the energy needed to supply compressed air for operating electric car brakes. Table XXXII, therefore, should be viewed from this standpoint.

The first test shows the average conditions of operation for an entire day and night, while the conditions during the heaviest part of the day are shown in the second test. The compressor under test supplied the entire quantity of air needed for braking on the Park Avenue line, as many as fifty-four double truck cars being operated at one time during the rush hours. These cars averaged twenty tons in weight, including passengers. The number of car miles run in Test No. 20 was 4608, and in Test No. 21, 863. During the period covered by Test No. 21, the compressor was working nearly up to its capacity, which latter would have been reached when continuous operation became necessary. Obviously, however, it is essential that a reserve be provided, and the results show that one compressor has sufficient capacity to supply the entire line. The station contains an additional compressor as an extra precaution against breakdown. It will be noted that during the entire day the running time was 9.80 hours, or 41 per cent of

the time. During the period of heavy load covered by Test No. 21, the actual running time was 67 per cent of the total time.

This difference is further indicated by the number of compressor runs. During the entire day 108 runs were made, the average hourly number being 4.5 runs. The short run included 18 runs, the average duration of each being practically the same as in the preceding case, somewhat over five minutes. This is at the rate of 7.6 runs per hour. The strain upon the capacity of the compressor is further shown by the somewhat lower gage pressure in the storage tanks, indicating that at times it was necessary for cars to draw air before the maximum pressure had been reached. No great disadvantage could result from this, however, as the storage tanks were of such large capacity that, in case of a congestion of cars at the compressor station, the air could be drawn off more rapidly than it was being compressed, without a serious lowering of the pressure.

The automatic controller was adjusted to start the motor when a minimum pressure of 275 lbs. had been reached, and to stop it when the air pressure reached 300 lbs. The average of all "starts" for the range of pressure allowed by the governor was slightly over 25 lbs., and, when the call on the compressor was not unduly severe, the pressure was maintained substantially as desired. The average value is somewhat below the average of maximum and minimum values in Test No. 20 and above this average in Test No. 21. There is not necessarily any fixed relation between these pressures, as the maximum and minimum averages each cover a number of values equal to the number of runs, and distributed at irregular intervals, while the average pressure is obtained for the entire test.

The temperature of the stored air is about 40° Centigrade or 104° Fahrenheit, being substantially the same for the two tests. It might be expected that the temperature would be lower in the second than in the first test on account of the more rapid circulation of compressor cooling water. This is the case

if similar periods in the two days are compared, but the average temperature is lowered in Test No. 20 by the cool period during the night and early morning.

The data relating to the volume of air compressed show that the compressor delivered to the storage tanks 68.7 cu. ft. of free air per minute, compressed to a pressure of 280.8 lbs. in Test No. 20. The corresponding value for Test No. 21 shows 76.9 cu. ft. per minute at 276.2 lbs. pressure. Of the total quantity of air compressed, 95 per cent reaches the cars, the remaining 5 per cent being lost in the leakage at valves and joints.

In Test No. 20, 10,400 lbs. of water circulated around the cylinders and intercooler and absorbed the greater part of the heat produced by the compressor. That this circulation was sufficient to maintain the cylinders at a safe working temperature, is evident from a study of the tables showing the variations in temperature. A more rapid circulation of cooler water, however, should improve the conditions of operation, as with the resultant increase in density more air is compressed, without increasing the friction in the compressor. In Test No. 21, the water was more rapidly circulated and was lower in temperature than in Test No. 20, and hence an improvement in economy of operation would be expected. That this is the case is brought out in the latter part of the discussion. It will be noted that the amount of heat absorbed per pound of cooling water circulated, is 24.6 B.T.U. in Test No. 20 and 16.7 B.T.U. in Test No. 21. This naturally follows from the more rapid circulation of the cooling water in the second test.

The general data are summed up in the values showing the energy per pound of air compressed and per cubic feet of free air compressed. These data render possible the calculation of the cost of compressing the air for any particular case.

THE ELECTRICAL DATA. — The electrical readings show that the motor provided for the purpose of driving the compressor was of ample capacity. It was rated at 50 horse power, while the average electrical input was but slightly over 30 horse power

in each test. In Table XXXII are given, for each test, both the average power for the individual runs and the average power for the entire test.

As there were forty compressors situated in different stations located in various sections of the city, it is evident that the power drawn from the central station to supply these air compressors did not fluctuate over very wide limits, since the compressors at the various stations would be starting and stopping at irregular intervals, and the fluctuations in load at the several stations would be practically neutralized as far as the load on the central station is concerned.

From Table XXXII it will be seen that the number of cars in operation during the twenty-four-hour test was twenty-two, as against an average of forty-two cars in operation during the 2.35-hour test. The increase in the average number of cars in operation during the latter test is due to the fact that it covered a very busy period in the day. From the results of the service test shown in Chapter III, it is found that the average power taken by a single car during a twelve-hour run was approximately 25.3 kilowatts. Data as to the average power taken by such a car over a twenty-four-hour period are not available, but it is probable that the average power would not differ greatly from this amount. Considering the average power taken by a car as 25.3 kilowatts in each test, it is found that the average total power taken by cars during the twenty-four-hour test is 556.6 kilowatts, while that taken during the 2.35-hour test is 1062.6 kilowatts. The average power taken by the compressor station is shown to be 9.23 kilowatts during the twenty-four-hour test as against 15.0 kilowatts in the 2.35-hour test. From these data may be calculated the relation between the power taken by the compressor plant, in comparison with that taken by the cars which are supplied with compressed air from this plant. The data show that in the twenty-four-hour test the power taken by the compressor plant is 1.7 per cent of that taken by the cars supplied with air from this plant, while in the 2.35-hour test this value is 1.4 per cent.

TEMPERATURE DATA. — For the purpose of studying the variations of the several temperatures (both of the air and of the cooling water) during the different periods of the day, the twenty-four-hour run was divided up into eight three-hour periods, all of the temperatures being averaged for each period. In order to appreciate these data, it will be necessary to remember that the heavy loads occurred between 4.00 P.M. and 8.00 P.M., and between 5.00 A.M. and 9.00 A.M., with a smaller congestion of load at about the noon hour. The variation in temperature of the room was not very great, being about 10° C. or 18° F. between midnight and noon. At the point where the air entered the compressor, the variation was even less than this amount, being less than 40° C. during the entire test. It may be assumed for comparison, that the air is received at a constant temperature by the compressor. The temperature in the intercooler, where the air passes after the first stage of compression, shows a fluctuation following very closely the congestion of load upon the station, but lagging slightly in time behind the periods of heaviest load. This is true also, and to a much greater extent, in the case of the temperature at the discharge pipe of the compressor, at which point the air reaches its maximum temperature. Between the hours of 5.00 P.M. and 8.00 P.M., this temperature rose to a value of 119.7° C. or 247° F. After this period, the temperature decreased until the period in which none but "owl" cars were running, that is, from 2.00 A.M. to 5.00 A.M., when a minimum value of 56.50 is reached. The temperature then rises, reaching another high value between 8.00 A.M. and 11.00 A.M., when the load is again very heavy.

The temperature in the storage tanks does not show much variation. This is to be expected, as the tanks are large and exposing a considerable surface for radiation. The air enters the tanks slowly as compared with the total volume contained by them, and ample time is afforded for radiation. In addition, as these storage tanks are located high in the room where the air temperature has a high value, they are in a region where the

stantially the same, being greatest in the low-pressure cylinder, and least in the high-pressure cylinder. The total heat absorbed, considered by three-hour periods, shows a close relation to the load upon the station; varying from 18,400 B.T.U. per hour to 3090 B.T.U. per hour, between the time of heaviest and of lightest load.

The electrical energy absorbed during the different periods is nearly proportional to the quantity of air compressed in each case. This is due to the fact that the motor worked at a high efficiency while actually in operation, being automatically shut down when the pressure reached its upper limit. This relation is further indicated by the manner in which the running time of the motor, in each period, follows the quantity of air compressed during that period. As a matter of fact, the motor received somewhat less power from the line when the load was heaviest, on account of the lower pressure on the trolley circuit.

It is seen that the storage reservoir pressure was maintained at a high average value, except at the periods of heavy loads.

The data resulting from Test No. 20, having been condensed into a few items in Table XXXVII, give a detailed comparison of the relative temperatures for Tests Nos. 20 and 21, covering two similar periods on successive days, but with different methods of cooling the compressor cylinders. The room temperature, and consequently the temperature at the compressor intake, was 2.8° C. lower in Test No. 21 than in Test No. 20, so that the differences in air temperatures in the two tests must be reduced by this amount for an accurate comparison. After making this correction, the data show that the intercooler temperature has been lowered by 8.9° C. (16.0° F.), while for the discharge pipe, the hottest point in the air circuit, the reduction has been 9.5° C. (17.1° F.).

The reduction in the water temperatures is even greater than that in the air temperatures. The water was received from the city mains at 22.7° C. (73° F.), which was 14.4° C. (25.9° F.) lower than that delivered from the storage tanks.

CHAPTER VIII.

BRAKING TESTS ON A DOUBLE-TRUCK CITY CAR EQUIPPED WITH AIR BRAKES.

OBJECTS OF THE TESTS.

THE primary object of these tests was to determine the amount of air necessary to make an average stop under normal conditions in city service and to ascertain the amount of electrical energy required to compress air for making such a stop. Further, it was desired to compare the amount of electrical energy used for braking by the storage system, and by that employing a car motor compressor. Finally, the plan comprised a series of tests to determine the comparative performance of a car motor compressor when operating upon a car under ordinary service conditions, and again when operating under stand test conditions.

SYNOPSIS OF RESULTS.

The following tables give in condensed form the general results of the tests. Table XL shows the general results of service braking tests Nos. 26, 27, and 28. Table XLI gives similar data for the stand tests. Detailed tables are shown in the several parts of the chapter.

SECTION A. TESTS UPON THE CARS.

GENERAL CONDITIONS OF THE TESTS.

The storage-air tests comprised air measurements of the entire number of cars on the Park Avenue and Compton Avenue lines of the St. Louis Transit Company, which were normally operated by the storage system. In connection with the tests

TABLE XLI. — *Synopsis of Results. Stand Tests of Motor Compressor.*
NOVEMBER, 1904.

	TEST No. 26	TEST No. 27	TEST No. 28
Duration of test, hours	6.95	4.95	7.11
Actual running time, hours.....	1.93	.44	.68
Total number of runs.....	116	141	95
Average temperature of air in room, degrees C ...	13.40	13.40	17.60
Average current, amperes	3.42	3.12	3.19
Average pressure, volts	537.2	546.1	548.0
Average power, watts	1,840	1,705	1,750
Average power, E. H. P.	2.47	2.29	2.34
Total energy supplied, watt-hours	3,552	754	1,187
Average temperature in reservoir	17.40	15.10	19.90
Speed of compressor axle, R. P. M.....	219	242	250
Average gage pressure before runs, lbs. per sq. in.	44.70	43.52	43.48
Average gage pressure after runs, lbs. per sq. in...	72.00	50.78	60.59
Average rise in gage pressure, lbs. per sq. in.	27.30	7.26	17.11
Average pressure pumped against, lbs. per sq. in.	93.00	47.15	52.03
Total volume free air compressed at 0°C. and 14.4 lbs. barometer, cu. ft.	970	328	488
Energy per cu. ft. free air compressed, watt-hours	3.66	2.30	2.43
Weight of air delivered by compressor per H. P. minute, lbs.	.243	383	.363
Power to compress to above pressure, one cu. ft. free air per minute, E. H. P.	.295	.185	.195

Test No. 26. — Against constant pressure, 93 lbs.

Test No. 27. — Against pressure from 43.5 to 50.8 lbs.

Test No. 28. — Against pressure from 43.5 to 60.6 lbs.

upon the entire system special tests of individual cars were made, these cars all being equipped with the storage-air apparatus; and in addition tests were made on Car No. 2600 equipped with a motor compressor, in addition to the same kind of brake cylinders and rigging used in all the tests.

The line selected for the car braking tests was the same as that supplied with air from the compressor station, the tests of which were described in Chapter VII. Upon this line were operated double-truck cars of two types. One of these was like Car No. 2600, upon which service tests were also made as is fully described in Chapter III. At the times of congested traffic, additional cars of an older and lighter style were placed

upon the line. These cars, however, had approximately the same passenger capacity and maintained the same schedule as the heavier ones. The average number of cars upon the line during an entire day was 22, and the average number during the time of heaviest traffic was 42. Each car required an average power input of 25.3 kilowatts. The total number operated upon a single day was 51. The newer type of cars weighed 20 tons, fully equipped, while the older cars averaged approximately 16 tons.

Braking Equipment of the Cars.

CARS EQUIPPED FOR THE STORAGE SYSTEM. — All cars operated by the St. Louis Transit Company were equipped with storage reservoirs, designed to carry sufficient air at 300 lbs. pressure to operate the brakes for thirty or more miles of car travel. The arrangement of tank and brake cylinder with piping and brake rigging is shown in Fig. 78. The storage reservoirs, two in number, were located under, and at about the center of the car, one being on each side. The reservoirs were 18 in. in diameter and 6 ft. long, and each had a capacity of about 9.62 cu. ft., giving at 300 lbs. pressure a total capacity equivalent to 420 cu. ft. of free air at 14.4 lbs. absolute pressure. The storage reservoirs were charged from the compressing station, and the pipe leading from the coupling to the reservoirs contained an ordinary valve and a check valve to prevent loss of air. From the storage tanks air was supplied, through a reducing valve, to a service reservoir 14 in. in diameter and 33 in. long, which contained approximately 4400 cu. in. The reducing valve was arranged to maintain a pressure of 45 lbs. on the service reservoir side, regardless of the pressure on the other side.

From the service tank, the air was conducted to the engineer's valve at the front of the car, and from there it passed to the air brake cylinder, which was 10 in. in diameter, with a 12 in. stroke. The brake rigging was similar to that used in other systems of braking, a hand brake being supplied for

emergency use. The engineer's valve was of the standard O.V.J. type of the Westinghouse Traction Brake Company. This was a three-way valve, in one position connecting the service tank to the brake cylinder, and in the other position connecting the air brake cylinder to the exhaust. In an intermediate position the air supply was cut off without opening the exhaust, and the cylinder pressure was maintained at its previous value except as reduced by leakage. Each car was equipped with a gage connected to the high pressure reservoir, and located in the front vestibule.

Car No. 2600 was selected for the special tests upon an individual car. The power end control equipment of this car is fully described in Chapter II.

CAR EQUIPPED WITH MOTOR-COMPRESSOR. — Car No. 2600 was employed for the motor-compressor tests, the brake cylinder and rigging being identical with those previously used.

The compressor equipment, manufactured by the National Electric Company, was installed beneath the floor of the car on a frame suspended from the sills, and delivered air at from 45 to 60 lbs. pressure into a storage tank through a flexible hose section and such piping as would allow the tanks and compressor to be placed in the best relative position. The compressor was of the type known as AA-1, consisting of a 500-volt, 4-pole, series wound motor connected through a spiral tooth reduction gear to a pair of $5 \times 2\frac{1}{2}$ -in. cylinders, mounted side by side in a horizontal position, with cranks 180° apart. The motor was rated at 2.2 horse-power, which amount of power was expected to deliver 11 cu. ft. of air per minute when pumping against 90 lbs. pressure, and with the compressor making 195 revolutions per minute. The motor was started and stopped automatically at the lower and upper limits of pressure respectively, by a governor operated by a solenoid plunger which opened and closed a contact in the main compressor circuit. The motor was entirely enclosed, and its base formed the top cover for the compressor, the outside dimensions being $21\frac{1}{8}$ in. long, $18\frac{1}{8}$ in. wide, and $16\frac{3}{8}$ in. deep.

DESCRIPTION AND RESULTS OF THE TESTS

TEST NO. 22. AVERAGE CONSUMPTION OF AIR BY CARS
EQUIPPED WITH STORAGE TANKS.

The general method followed in determining the average amount of air used by the different cars on the line consisted in taking readings of the car gages, each time a car took air at the compressor station. This operation was continued during the entire period of the station tests, as described in Chapter VII.

A special test was made in more detail to determine the amount of air used on each trip by a few selected cars, and to ascertain the number of miles which could be run with one charge of air.

The number of cubic feet of free air used by each car, was determined from the reduction in the gage pressure in a manner similar to that employed in the compressor station tests. In order to secure accuracy in this measurement, it was necessary to compare every car gage on the line with a standard gage, suitable corrections being made in the readings.

Incidentally, an opportunity was afforded to study the characteristics of individual motormen in the matter of handling the air brakes, as it is generally understood that by careful handling a motorman can produce a considerable saving in air consumption.

Measurements Made.

Observers were stationed at the hose-box from which the cars took air, and they recorded the following data as each car took a charge.

Time of charge.

Number of car taking charge.

Air temperature at hose-box, before, during, and after each charge.

Pressure at hose-box at end of each charge.

Pressure on car storage reservoir gage, before and after each charge and its maximum value.

Pressure on service reservoir before and after each charge.

Numbers of cars passing without charging.

No special preparation was necessary for this test, as the apparatus was installed in connection with the compressor station test.

WORKING UP THE RESULTS.

The readings were first corrected in accordance with the calibrations, and they were then entered on a "combined log sheet," as in the preceding tests. The measurements made upon each car were arranged together so that the air record of the car would show the total amount of air taken during the day, and at what times air was taken. No attempt has been made to put these data into graphical form, but the general results are shown in Table XLII, and in the synopsis given at the beginning of the chapter. In addition to the data obtained from the test, the trip sheet records kept by the St. Louis Transit Company, were employed in the determination of the total number of round trips made during the test.

RESULTS OF THE TESTS.

The following tables show in condensed form the results obtained from Test No. 22.

TABLE XLII. — *Test No. 22. General Summary of Results.*

Total number of cars in operation	51
Total number of car-miles run during test	4,608
Total number of car charges	211
Average number of car charges, per hour	8.8
Maximum number of car charges, per hour	17.0
Maximum distance run per charge, miles	21.8
Total volume of air supplied by station, cu. ft.	38,515
Average volume of free air taken, per charge, cu. ft.	183
Average temperature of air at start, degrees C.	25.1
Average temperature of air during charge, degrees C.	25.1
Average temperature of air at end of charge, degrees C.	25.1
Average temperature of atmosphere, degrees C.	24.4
Average gage pressure in hose-box, at end of charge, lbs. per sq. in.	267
Average car storage reservoir pressure, before charging, lbs. per sq. in.	122.5

BRAKING TESTS ON A DOUBLE-TRUCK CITY CAR 299

TABLE XLII. — *Continued.*

Average maximum car storage reservoir pressure, lbs. per sq. in.	276
Average final car storage reservoir pressure, lbs. per sq. in.	269
Average rise in pressure during charge, lbs. per sq. in.	146.5
Average car service reservoir pressure before charging, lbs. per sq. in.	44.8
Average car service reservoir pressure, after charging, lbs. per sq. in.	47.7
Average number of round trips (10.53 miles) per charge	2.08

From the above data and the results of the compressor station tests, in which it was found that the electrical energy used per 1000 cu. ft. of air delivered was 5.75 kilowatt-hours, a number of deductions were made as follows:

TABLE XLIII. — *Results of Test No. 22. Compression Data.*

Electrical energy to deliver 1,000 cu. ft. of free air, k. w. hours	5.75
Total car-miles for test	4,608
Total car-hours for test	477
Total ton-miles for test ¹	98,400
Total volume of free air received, cu. ft.	38,515
Volume of free air used per car-mile, cu. ft.	8.35
Volume of free air used per car-hour	80.7
Volume of free air used per ton-mile39
Electrical energy used for compressing air per car-mile, watt-hours	48.1
Electrical energy used for compressing air per car-hour, watt-hours	465
Electrical energy used for compressing air per ton-mile, watt-hours	2.25

¹ Fifteen of the cars weighed with average load, 18.5 tons each ; 36 of the cars weighed with average load, 22.5 tons each.

As it was impossible to measure the number of stops made by all of the cars on the line during Test No. 22, it was necessary to estimate these from the results of Tests Nos. 23, 24, and 25, which covered a total of nearly 30 round trips, or over 325 miles. These tests covered the time between daylight and dark, and the average number of stops per mile was 4.8. This may be reduced to 4.5 to cover the few cars which operate during the night, and upon this basis an additional number of items may be calculated.

TABLE XLIV. — *Results of Test No. 22, Stop Data.*

Stops per mile (estimated)	4.5
Total miles run	4,608
Total stops (estimated)	20,736
Volume of free air used per stop, cu. ft.	1.85
Electrical energy used for compressing air per stop, watt-hours .	10.7

In order to show the rate at which the cars took air during the entire 24 hours, Table XLV has been prepared.

TABLE XLV. — *Air Taken by Cars.*

TIME.	NO. OF CARS CHARGED.	TOTAL VOLUME OF AIR TAKEN.	AVERAGE VOLUME of AIR TAKEN PER CAR.
		CU. FT.	CU. FT.
2-3 P.M.	8		
3-4 P.M.	12	5,750	169
4-5 P.M.	14		
5-6 P.M.	12		
6-7 P.M.	13	6,910	192
7-8 P.M.	11		
8-9 P.M.	10		
9-10 P.M.	7	5,120	197
10-11 P.M.	9		
11-5 A.M.	13	2,515	193
5-6 A.M.	11		
6-7 A.M.	15	7,210	168
7-8 A.M.	17		
8-9 A.M.	14		
9-10 A.M.	14	6,280	174
10-11 A.M.	8		
11-12 A.M.	9		
12-1 P.M.	7	4,730	203
1-2 P.M.	7		
Total	211	38,515	Average 183

BRAKING TESTS ON A DOUBLE-TRUCK CITY CAR 301

TEST NO. 23. PERFORMANCE OF A CAR EQUIPPED WITH STORAGE-AIR SYSTEM OF BRAKING.

For the purpose of studying in detail the performance of a typical city car equipped with a standard outfit as used at St. Louis, Car No. 2600 was provided with instruments for measuring all quantities affecting the braking. Special piping was installed in order to bring the instruments into convenient position for reading as shown in Fig. 84.

The measurements arranged for were as follows:

Storage reservoir pressure.

Service reservoir pressure.

Air brake cylinder pressure.

Brake applications.

Speed of car.

Distance traversed.

Number and duration of stops.

These data were sufficient to permit of the calculation of the volume of air received from the compressing station, and the relation between the consumption of this air and the number of stops made.

In determining the various pressures, American indicating gages were employed, and these were read at five-second intervals throughout the tests. A Crosby recording gage was connected to the brake cylinder during a part of the tests, but it was found that a more reliable method of determining this pressure was to read it from an indicating gage each time a brake application was made, noting also the time of each application. Thus, one observer obtained data for determining the number of brake applications in a given time, the pressure of each of such applications, and the time at which each occurred. The recording gage was afterward connected to the service reservoir, in which the pressure did not vary greatly. The speed of the car was obtained by means of a Boyer railway speed recorder which was checked by noting the time of passing certain points in the route, and thus the distance traveled

in a given time was also determined directly. An observer noted the time of making each stop and its duration, thus giving data permitting of a comparison of the number of stops and the number of brake applications.

WORKING UP THE RESULTS.

The data were first arranged in tabular form after correction of the instrument readings by calibration, and from these values

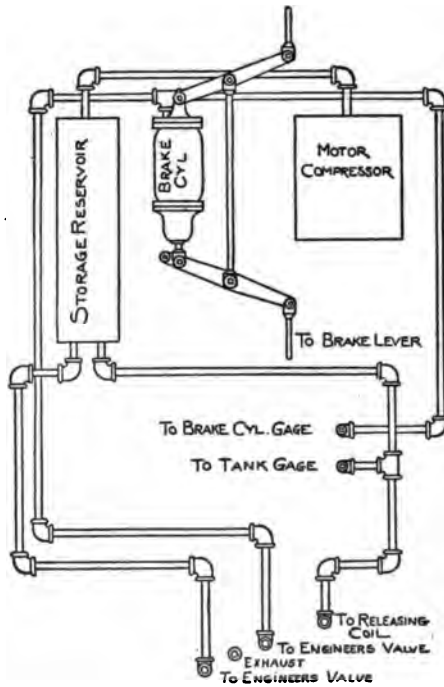

Fig. 84. — Piping of Car 2600, Equipment with Motor Compressor.

the deductions were made. No attempt was made to put the data into graphical form.

RESULTS OF THE TESTS.

The general results of the tests have already been given in the synopsis in convenient form for comparison. The more detailed results are given in Table XLVI.

BRAKING TESTS ON A DOUBLE-TRUCK CITY CAR 303

TABLE XLVI. — Test No. 23. General Summary of Results.

Weather conditions	clear
Weight of car with average load, tons	22.5
Total duration of tests, hours	11.75
Total number of round trips	9.2
Total distance covered, miles	97.0
Total number of stops	572
Average number of stops per mile	5.9
Total number of brake applications	1,220
Average number of brake applications, per mile	12.6
Average number of brake applications, per stop	2.14
Average storage reservoir pressure, lbs. per sq. in.	164.6
Maximum storage reservoir pressure, lbs. per sq. in.	265.0
Minimum storage reservoir pressure, lbs. per sq. in.	50.0
Average service reservoir pressure, lbs. per sq. in.	43.7
Average brake cylinder pressure during brake applications, lbs. per sq. in.	22.2
Schedule speed of car (including stops), M. P. H.	9.12
Maximum speed of car (approximate), M. P. H.	17.5
Number of times storage tank was charged from compressing station.	5
Average storage reservoir gage pressure before charging, lbs. per sq. in.	248.2
Total volume of free air received from compressing station, cu. ft.	819
Average volume of free air received per charge, cu. ft.	164
Average distance of run per charge of air, miles	24.2 ¹
Average number of stops made per charge of air	143 ¹
Average number of brake applications per charge of air	284
Average volume of free air used per stop, cu. ft.	1.43
Average volume of free air used per brake application67
Average volume of free air used per car mile, cu. ft.	8.44
Average volume of free air used per car hour, cu. ft.	69.5
Average volume of free air used per ton mile, cu. ft.375
Electrical energy equivalent of air used, kilowatt-hours	4.71
Electrical energy per stop, watt-hours	8.25
Electrical energy per brake application, watt-hours	4.15
Electrical energy per car mile, watt-hours	48.6
Electrical energy per car hour, watt-hours	400
Electrical energy per ton mile, watt-hours	2.16
Ratio of electrical energy used in braking to that taken by motors, per cent.	1.75
Weight of air delivered by compressor to car per H. P. minute, lbs.155
Power to compress to above pressure 1 cu. ft. free air per minute, E. H. P.463

¹ Calculated on the basis of four charges as car went to barn with full charge of air at end of test.

TABLE XLVII. — Air Consumption of Car 2600. Arranged by Round Trips.

STORAGE AIR SYSTEM, DRY TRACK. AUG. 29, 1904. TEST No. 23.

TRIP.	TIME.	DIS-TANCE MILES.	BRAKE AP-Plications.	Cu. Ft. Air. 0° C. 15 lbs. TOTAL.	Cu. Ft. PER CAR MILE.	Cu. Ft. PER BRAKE AP-Plication.	Cu. Ft. PER CAR HOUR.	TANK PRESSURES.		BRAKE Cyl-INDER PRESSURES.
								At Be-ginning of Run.	At End of Run.	
	A.M.									
1	7:38- 8:50	10.30	121	77.0	7.48	0.683	64.1	256	192	19.1
2	8:52-10:00	9.64	108	70.3	7.29	0.651	62.0	190	132	23.4
3	10:05-11:00	10.23	95	66.7	6.51	0.702	61.7	129	74	22.7
4	11:11-12:10	10.63	107	105.5	10.40	0.984	96.6	251	164	24.7
	P.M.									
5	12:16- 1:10	8.89	145	105.0	11.80	0.723	118.9	164	77	29.5
6	1:20- 2:45	10.22	180	131.3	13.00	0.736	93.8	231	121	24.3
7	2:50- 4:39	10.53	122	84.9	8.12	0.702	80.8	117	46	23.6
8	4:42- 5:55	10.63	141	79.1	7.44	0.569	64.8	262	196	21.1
9	5:55- 7:05	10.63	126	67.5	6.35	0.536	58.2	196	140	21.0

TESTS NOS. 24 AND 25. PERFORMANCE OF A CAR EQUIPPED WITH THE MOTOR-COMPRESSOR SYSTEM OF BRAKING.

Car No. 2600 was supplied with a motor-compressor equipment as described earlier in the chapter, and instruments were obtained for making all measurements necessary to determine the efficiency of this system as compared with the storage system of braking. The particular purpose of the test was to study the operation of a motor-compressor equipment under actual working conditions. To this end the motor compressor was allowed to operate normally, and the quantity of air was determined by the rise in pressure in the tanks. It was realized that this plan is open to certain objections in that it is difficult to determine accurately, by means of pressure gages, the actual pressure existing, and this is particularly the case when it is a difference of pressure that is to be measured. Here the errors in reading the gages are multiplied in effect when two pressures differing only a few pounds are to be used for comparison. However, as this was the only practicable means of performing the desired test, a satisfactory degree of accuracy was obtained by extreme care in the reading of instruments and by careful calibration. The measurements made in connection with this

BRAKING TESTS ON A DOUBLE-TRUCK CITY CAR 305

test included: (1) service reservoir pressure before and after the operation of the compressor; (2) strokes of the compressor; (3) air brake cylinder pressure; (4) brake applications; (5) speed of car; (6) distance traversed; (7) number and duration of stops.

The arrangement of piping and of instruments for making the various measurements were as shown in Fig. 85. It will

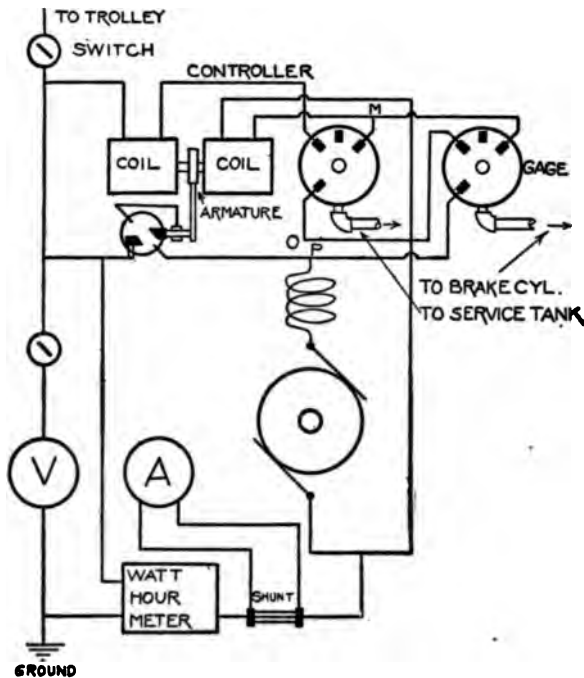

Fig. 85. — Diagram of Connections, Independent Motor, Compressor System.

be noted in this figure that there was a connection from the brake cylinder piping to a special controller in the motor circuit. The function of this switch was to prevent air being used by the motorman while it was being compressed. The pneumatically operated switch was closed whenever the brake was in operation. This arrangement was essential because the volume of air compressed by the motor-compressor was determined

from the rise in pressure in the storage reservoir, hence any air drawn while the motor was in operation would not have been included in the measurements.

ORIGINAL MEASUREMENTS.

The original measurements may be divided into general classes as follows: (a) Those relating to electrical input; (b) those relating to reservoir and brake cylinder pressures; (c) those relating to temperatures; (d) those relating to stops, distance, and speed; (e) those relating to brake applications; (f) those relating to motor-compressor speed.

Electrical Measurements.

The electrical measurements comprise those of current, e.m.f., and energy. The current was read on two instruments, starting current being noted on a higher-reading ammeter than the normal current. The maximum value of the starting current was read on the first-mentioned instrument, and immediately after obtaining this reading a switch which short-circuited the low-reading ammeter was opened, and thereafter readings were taken of the steady current, the average value of this current being recorded. It was impossible to obtain the exact duration of the starting current, but this was afterward estimated from a large number of measurements covering the entire series of tests. The compressor volts were read every ten seconds. The energy for each run was determined by means of a Thomson watt-hour meter, and readings were taken at the start and stop of each compressor run.

Pressure Measurements.

The brake cylinder pressure was read on an indicating gage connected by special piping directly to the head of the brake cylinder, while special piping was also connected to the storage reservoir. The brake cylinder pressure measurements were made whenever the brakes were applied, and the time of such application was also noted. In this test a Crosby recording

gage was used on the brake cylinder as well as the indicating gage. The storage reservoir pressure was read at each start and stop of the motor compressor, the times of such starts and stops being also recorded.

Temperature Measurements.

The temperature of the air was noted at regular intervals throughout the day, and the average temperature of the atmosphere for the test was thus obtained. An attempt was also made to determine the temperature of the air in the storage reservoir by means of an electric thermometer. A fine iron wire was wrapped spirally around a wooden rod one foot in length, and this was inserted in the end of a steel plug which was screwed into the head of the storage reservoir. The terminals were brought out through the center of the rod, and through the wire was sent a small battery current, not sufficient in amount to raise the temperature of the wire to an appreciable extent. By means of sensitive Weston instruments the resistance of this wire was determined by finding the fall in pressure in the wire with a given current. The electric thermometer gave fairly consistent results, but it was found that the temperature variation of the air in the storage reservoir was so slight that it was unnecessary to make temperature measurements for the purpose of correcting the calculations of volumes of air compressed. In fact, the corrections which would have to be made for variation in temperature were very small compared with the errors of observations which would be expected in reading the indicating gages, so that the use of the thermometer was discontinued after it had been thoroughly tested. The temperature of the air in the storage reservoir was assumed to be the same as that of the outside air, which assumption was substantially correct, from the fact that the air passed through a considerable length of piping between the compressor and the storage reservoir, this piping acting very effectively as a radiator.

The Distance and Speed Data.

The time and duration of each stop and its location were carefully recorded. These data also furnished a means for determining the average speed between stops, thus checking the record on the Boyer instrument, which was used for producing the distance-speed curve. In addition to the Boyer instrument, there was operated a small generator driven by the car axle, which gave a record of speed on a time base. The indicating gage of the Boyer recorder was read from time to time, and the readings were recorded upon the paper tape of the instrument, thus checking the two measurements of speed made by this instrument. As an additional check upon the distance and speed measurements, the times of passing all street intersections were also recorded.

Brake Application Data.

From the indications of the brake cylinder pressure gage, the number and times of the brake applications were determined, in connection with the pressure measurements already referred to.

Motor-Compressor Speed Data.

The number of strokes which the motor-compressor made during each compressor run was recorded on an engine counter. This was a Shaefer and Budenberg six-figure, counter-electrically operated by means of an electro-magnet. A contact device, attached to the pump, was closed once during each revolution. This contact device was connected in series with a battery and the electro-magnet of the counter. The revolution counter was read before and after each run. As the motor was spirally geared to the compressor, the average speed of the motor during the run was calculated directly from the time of the compressor run and the number of strokes made by the compressor pistons.

WORKING UP THE RESULTS.

After the various data had been corrected by calibration, they were assembled on a "Combined Log Sheet" for reference



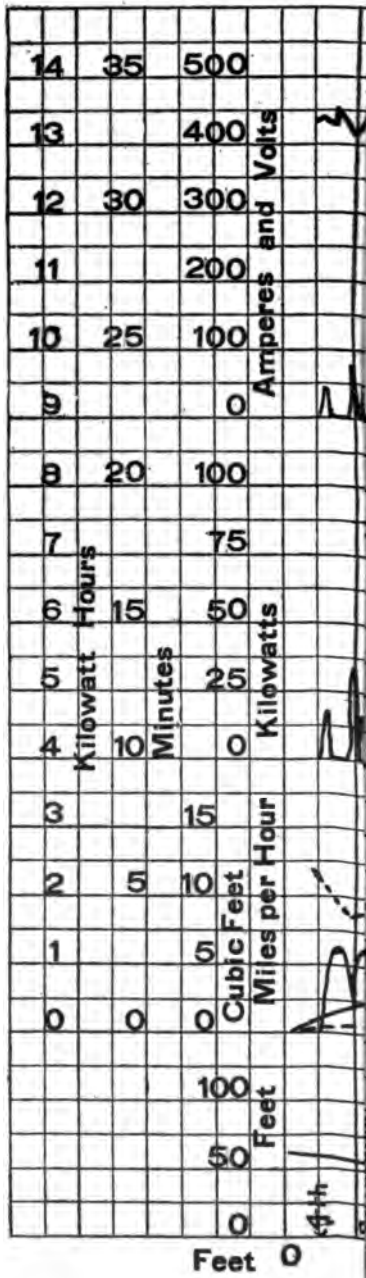

BRAKING TESTS ON A DOUBLE-TRUCK CITY CAR 309

in working up the final results. Fig. 86 shows a portion of the headings placed upon the "Combined Log Sheet." The explanation, which has already been made, will render unnecessary a further discussion of this part of the work.

No.		TIME.		POWER.					AIR DATA.						
									GAGE PRESSURES.			TEM.	VOLUME.		
1	2	3	4	5	6	7	8	9	10	11	12	13	14	15	16
No. of Run.	At Beginning of Run.	At End of Run.	Duration of Run in Seconds = T.	Average Amp. = A.	Average Volts = E.	Average Watts = A × E.	Watt-hours = A × E × T.	Watt-hours by Integrating W. M.	In Brake Cylinder.	In Tank at Beginning of Run.	In Tank at End of Run.	Increase of Pressure in Tank.	Air in Car.	Revolutions of Compressor Shaft.	Cu. Ft. Free Air.
No. of Instrument.															

Fig. 86. — Log Sheet Headings, Tests Nos. 24 and 26.

It was found impracticable to put all of the data resulting from Tests Nos. 24 and 25 into graphical form, but the material has been put into tables, and such deductions have been made as will be found most useful. For the purpose of illustration and to indicate the manner in which the variables are related, the results of a single trip have been put into graphical form in Fig. 87. The results of this part of the test have been arranged upon a distance base. In this connection it is interesting to note that the same run has been illustrated on a time base in the service tests on this car, which will be found in Chapter II, Part II.

Electrical Measurements.

In working up the electrical readings for the purpose of determining the total amount of electrical energy used per compressor run, the two sources of information were both used.

From the average current and volts and time, the total energy was determined, and the readings of the watt-hour meter were compared with the amount of energy thus derived. In obtaining the average current, some difficulty was experienced in deciding upon the duration of the sudden impulse in the current at the start. While almost instantaneous, this starting impulse was between two and three times the normal value of the current. A reasonable assumption for the duration of the starting current was made, and a satisfactory determination of the total energy was obtained by comparing the data calculated from the readings of pressure, current, and time with the readings of energy as shown by the watt-hour meter.

Air Volume Measurements.

The volume of air delivered to the storage reservoir by the compressor during each run was determined from the difference in pressure before and after the run, from the average temperature during the run, and from the time interval of the run. From these data the volume of air compressed in terms of barometric pressure and at a temperature of zero degrees Centigrade was calculated by the plan employed in the station tests and described in Chapter VII.

Speed and Distance Data.

The speed data were taken from the Boyer speed recorder after calibration, which calibration was performed by jacking up the car and driving the car axle at various speeds. The speed of the car axle was determined by means of a watch and revolution counter. The record of the Boyer speed recorder was checked by means of the time measurements made between known points on the line. In fact, the time and distance between each two successive stops were used to determine the average speed of each car run. The Boyer records were integrated, and the average value of the speed was made to correspond with the actual value obtained above. The record produced by the generator geared to the axle was not

entirely satisfactory, owing to the fact that a rubber-faced metal wheel was used to transmit the motion from the car axle to the generator. It was found that the contact between the rubber wheel and the car axle was not continuous, so that the jars due to passing over irregularities in the track rendered the readings unsatisfactory.

RESULTS OF THE TESTS.

The results of the tests have already been arranged in convenient form for comparison with those of the other tests in the synopsis at the beginning of the chapter. It will be found convenient to refer to a somewhat more elaborate table showing the results of two similar tests, both with the motor-compressor, and these data are given in Table XLVIII. As far as possible the two tests were kept exactly alike except in regard to the condition of the track, the first test being made on a wet track, the other being on a dry track. While the primary purpose of the test was to obtain the comparative energy consumption of the motor-compressor and storage systems, advantage was taken of the opportunity to compare the performance of the same car on different days with the same equipment. The advantage of this duplication of the work was not only to show the difference due to the condition of the track, but it doubled the number of readings taken, and thus increased the value of the results of the test by increasing the accuracy of the deductions.

TABLE XLVIII. — Tests Nos. 24 and 25. General Summary of Results.

	TEST 24.	TEST 25.
Condition of track.....	wet	dry
Total duration of test, hours.....	12.6	12.75
Total number of round trips (10.53 miles).....	11.15	10.60
Total distance covered, miles.....	117.8	111.9
Total number of compressor runs.....	419	351
Total running time of compressor, hours.....	1.91	1.63
Average line pressure, volts.....	488.4	471.8
Average compressor current, amperes.....	3.5	3.84
Average maximum value of compressor current, amperes.....	8.4	8.4
Average compressor power (running time), watts.....	1,710	1,810
Total electrical energy used, k.w. hours.....	3.26	2.95
Average electrical energy per run, watt-hours.....	7.8	8.4
Average reservoir pressure before compressor run, lbs. per sq. in.....	46.2	43.5
Average reservoir pressure after compressor run, lbs. per sq. in.....	52.5	50.5
Average rise in pressure during compressor run, lbs. per sq. in.....	6.3	7.0
Average air temperature during test, degrees C.....	24.0	22.4
Average number of compressor revolutions per run.....	57.5	69.0
Total volume of air compressed, cu. ft.....	812	761
Average volume of air compressed per run, cu. ft.....	1.94	2.17
Electrical energy per cu. ft. of free air compressed, watt-hours.....	4.02	3.96
Average cu. ft. of free air compressed per kilowatt-hour.....	248	259
Total number of stops.....	483	503
Average number of stops per mile.....	4.1	4.5
Total number of brake applications.....	1,730	1,276
Total number of brake applications per mile.....	14.45	11.40
Average brake cylinder pressure during brake applications.....	16.0	21.6
Schedule speed of car, mile per hour.....	9.5	9.3
Average maximum speed of car, miles per hour (approximate).....	16	16
Average volume of free air used per stop, cu. ft.....	1.68	1.51
Average volume of free air used per brake application.....	.47	.60
Average volume of free air used per car-mile.....	6.9	6.8
Average volume of free air used per car-hour.....	64.4	59.7
Average volume of free air used per ton-mile.....	.31	.30
Electrical energy used for braking per stop, watt-hours.....	6.74	5.86
Electrical energy per brake application, watt-hours.....	1.9	2.3
Electrical energy used for braking per car-mile, watt-hours.....	27.7	26.4
Electrical energy per car-hour, watt-hours.....	259	231
Electrical energy per ton-mile, watt-hours.....	1.27	1.17
Ratio of energy used for braking to that used in motors, per cent.....	1.01	.98
Weight of air delivered by compressor per H. P. minute.....	.223	.232
Average pressure pumped against lbs. per sq. in.....	49.3	47.0
Power to compress to above pressure, 1 cu. ft. free air per minute, E. H. P.....	.322	.312

BRAKING TESTS ON A DOUBLE-TRUCK CITY CAR 313

TABLE XLIX. — Air Consumption of Car 2600. Arranged by Round Trips.

MOTOR COMPRESSOR SYSTEM. WET TRACK. AUGUST 18, 1904.

TEST No. 24.

TRIP.	TIME.	DIS-TANCE. MILES.	BRAKE APPLI- CATIONS.	CU. FT. AIR 0° C. 15 LBS. TOTAL.	CU. FT. PER CAR- MILE.	CU. FT. PER BRAKE APPLI- CATION.	CU. FT. PER CAR- HOUR.
	A.M.						
1	7:06- 8:13	10.63	149	56.9	5.35	.383	56.9
2	8:14- 9:24	10.63	133	71.6	6.73	.538	65.2
3	9:26-10:36	10.63	132	71.2	6.72	.542	65.0
4	10:36-11:45	10.63	228	75.5	7.09	.346	65.7
5	11:45-12:52	10.63	160	86.2	8.10	.332	77.2
	P.M.						
6	12:52- 1:58	10.63	185	98.1	9.21	.530	89.1
7	1:58- 3:03	10.63	149	77.2	7.24	.518	71.2
8	3:03- 4:04	10.63	130	75.8	7.02	.583	74.5
9	4:04- 5:19	10.63	133	51.3	5.17	.414	44.0
10	5:19- 6:33	10.63	139	65.2	6.13	.470	54.0

TABLE L. — Air Consumption of Car 2600. Arranged by Round Trips.

MOTOR COMPRESSOR SYSTEM. DRY TRACK. AUGUST 24, 1904.

TEST No. 25.

TRIP.	TIME.	DIS-TANCE. MILES.	BRAKE APPLI- CATIONS.	CU. FT. AIR 0° C. 15 LBS. TOTAL.	CU. FT. PER CAR- MILE.	CU. FT. PER BRAKE APPLI- CATION.	CU. FT. PER CAR- HOUR.
	A.M.						
1	6:30- 7:35	9.40	94	49.0	5.20	.520	44.5
2	7:35- 8:49	10.63	100	72.4	6.82	.724	68.2
3	8:49- 9:59	10.63	108	84.8	7.96	.785	73.4
4	10:03-11:05	10.63	96	67.8	6.29	.697	64.8
5	11:09-12:20	10.63	132	79.2	7.47	.600	68.2
	P.M.						
6	12:21- 1:18	10.63	124	66.5	6.24	.536	69.9
7	2:33- 3:31	9.40	146	58.6	6.23	.402	61.0
8	3:35- 4:39	10.63	152	68.8	6.48	.452	65.2
9	4:43- 5:55	10.63	126	67.7	6.35	.538	56.3
10	5:55- 7:11	10.63	105	65.7	6.17	.636	52.0

SECTION B. STAND TESTS OF A MOTOR COMPRESSOR.

Tests Nos. 26, 27, and 28.

OBJECTS OF THE TESTS.

The primary object of this series of tests was to obtain data relating to the performance of a motor-compressor when operated in the test room upon a pre-arranged schedule. Further, it was desired to study the relative results of different schedules of operation, and to compare the information thus gained with that already obtained from the service braking tests.

GENERAL CONDITIONS OF THE TESTS.

In the service tests of the motor-compressor, already described, the effort was made to determine the energy consumption for braking purposes under normal working conditions. These tests were carried on for a sufficient time and under a variety of conditions sufficient to yield data which are applicable to similar conditions elsewhere and to other conditions by means of suitable modifications. It was realized, however, that tests of this kind, being tedious and expensive to make, could only be performed under exceptional conditions. Hence, a most important part of the plan of the braking tests consisted in determining the relation between stand tests and service tests of motor-compressors. After the elaborate service tests had been completed, a series of stand tests was made, which rendered possible a comparison between the rather artificial tests on the stand and the actual tests in service. These stand tests were made at the shops of the St. Louis Transit Company during November, 1904. The stand tests were divided into two parts:

- (1.) One in which the compressor was allowed to pump against a fixed pressure.
- (2.) One in which service conditions were imitated as closely as possible.

WORKING UP THE RESULTS.

The data resulting from the tests were entered on a "Combined Log Sheet," as in the preceding tests. The electrical

data were checked by comparison of the readings of the watt-hour meter and the voltmeter and ammeter. The watt-hour meter was calibrated for these tests.

The measuring reservoir pressures for all runs were averaged before and after the operation of the compressor, giving data from which, with due allowance for temperature and barometric pressure, the volume of air corresponding to each run was calculated. The temperatures of motor armatures and fields were obtained by means of thermometers and by measurements of the resistances of the circuits. By this means it was possible to secure an accurate check upon the temperature measurements. From the change in resistances of the armatures and fields, the average temperature throughout the machine was secured. From the thermometers, the surface temperatures were obtained.

The results of the entire number of runs, comprising the series, were averaged, and from these averages the summary, as given in Table LI, was made.

DESCRIPTIONS AND RESULTS OF THE STAND TESTS.

Test No. 26. Compressor Pumping against Ninety Pounds Pressure.

The plan employed in Test No. 26, in which the compressor was allowed to pump against a constant pressure, was that suggested by Mr. E. H. Dewson in the *Street Railway Journal*, Vol. XXIII, No. 9, page 320, February 27, 1904. The electrical apparatus was arranged as in the car test, except that the circuits were connected as in Fig. 88, for resistance measurements. The compressor was allowed to pump into a small receiving reservoir of approximately three cubic feet capacity, the air entering at the side of the reservoir. This was equipped with a pressure gage reading above 90 lbs. A similar reservoir, with a capacity of 4.742 cu. ft., was connected to the smaller one by means of a pipe containing a three-way valve and a needle valve. The function of the needle valve was to adjust the pressure against which the compressor was allowed to

pump, while that of the three-way valve was to alternately connect the small or measuring reservoir with the receiving or supply reservoir and with the exhaust. In other words, with the three-way valve in one position, air was delivered from the supply to the measuring reservoir. In the other position the measuring reservoir was disconnected from the supply reservoir and was open to the air, thus reducing the measuring reservoir pressure. The large reservoir was also equipped with a pressure gage.

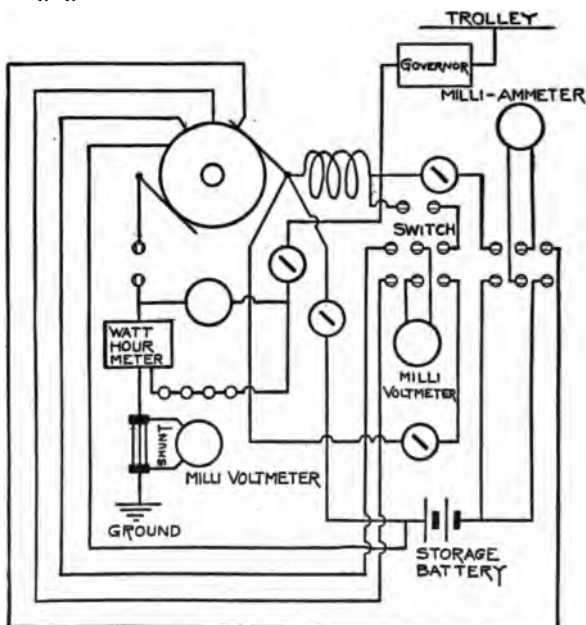

Fig. 86. — Connections for Resistance Measurements, Stand Test of Motor-Compressor.

In the compressor circuit were an indicating ammeter and voltmeter, and a recording watt-hour meter. A revolution counter was also connected to the compressor so that the total number of double strokes was recorded. Thermometers were placed at various parts of the motor and compressor, and were read from time to time to determine the rise in temperature. Measurements of the resistances of the armatures and fields were also made periodically.

BRAKING TESTS ON A DOUBLE-TRUCK CITY CAR 317

The operation of the tests consisted in maintaining a uniform pressure of 90 lbs. per square inch in the large reservoir by manipulation of the needle valve, the measuring reservoir pressure being reduced periodically. At a given signal the compressor motor was started and a uniform pressure was maintained in the large reservoir as described above, the three-way valve being open so as to connect the two reservoirs. The air was allowed to flow at this constant pressure for a period of one minute, the pressure in the measuring reservoir increasing about 27 lbs. during this time. The motor compressor was then stopped, and the air pressure in the measuring reservoir was reduced. After three minutes had elapsed from the time of start, the operation was repeated. This was kept up for several hours, until the temperature of the motor had attained a steady value.

The measuring reservoir pressures varied between values of 44.70 and 72.01 lbs. per square inch, a range of 27.31 lbs.

The results of Test No. 26 are shown in Table LI.

Tests Nos. 27 and 28. Compressor Pumping from 45 lbs. to 52½ and 62½ lbs., Respectively.

These tests were designed to imitate as closely as possible the service tests made upon the cars. In order to determine the effect of setting the governor at different upper limits the latter was placed at 52½ lbs., representing the minimum in ordinary service, and at 62½ lbs. representing the high service reservoir pressure. These two tests, therefore, gave data corresponding very closely to the conditions of the service tests.

The apparatus used was set up in the shops of the St. Louis Transit Company, and the various parts were connected substantially as when located upon the car. The duration of the runs and the interval between starts were chosen to correspond with those of the service tests as nearly as possible. In Test No. 27 the runs were 11.4 seconds in length, and the average interval from start to start was 126 seconds. The corresponding intervals for Test No. 28 were 25.8 seconds and 269 seconds

respectively. As in the preceding case, the tests were continued until the motor had attained a stationary temperature. The arrangement of electric circuits and of electrical instruments, as well as of pressure gages and revolution counter, were exactly similar to the tests made upon the car, and a standard car reservoir was used to receive the air from the compressor. As in the other case, the volume compressed was calculated from the rise in pressure of the air in the measuring reservoir.

The results of these tests are given in detail in Table LI.

TABLE LI. — Tests Nos. 26, 27, and 28. General Summary of Results.

	TEST 26.	TEST 27.	TEST 28.
Total interval of test, hours	6.95	4.95	7.11
Total running time, hours	1.93	.442	.68
Total number of compressor runs	116	141	95
Interval of compressor run, start to start, min	5.15	2.10	4.49
Interval of compressor run, start to stop, min	1.00	.190	.43
Average temperature of outside air, degrees C.	13.4	13.4	17.6
Average temperature of air in tank, degrees C.	17.4	15.1	19.9
Average temperature compressor exhaust . . .	55.0	26.7	31.2
Average current, amperes	3.42	3.12	3.19
Average e. m. f., volts	537.2	546.1	548.0
Average power, watts	1,840	1,705	1,750
Average power, e. h. p.	2.47	2.29	2.34
Total energy supplied, watt-hours	3,552	754	1,187
Average speed of compressor shaft, r. p. m. .	219	242	250
Reservoir pressure before runs, lbs. per sq. in.	44.70	43.52	43.48
Average measuring reservoir pressure after runs, lbs. per sq. in.	72.00	50.78	60.59
Average rise in pressure in measuring reser- voir during runs, lbs. per sq. in.	27.30	7.26	17.11
Average service reservoir pressure, lbs. per sq. in.	93.00	47.15	52.05
Temperature motor case (bolt hole) at be- ginning of test, degrees C.	13.5	12.8	14.5
Average temperature motor case (bolt hole) at end of test, degrees C.	24.0	17.4	22.7
Average rise in temperature motor case (bolt hole) above air temperature, degrees C. . . .	12.0	2.8	4.3
Average temperature of gear case at begin- ning of test, degrees C.	11.0	10.2	14.5
Average temperature of gear case at end of test, degrees C.	41.0	22.0	28.7
Average rise in temperature above air tem- perature gear case, degrees C.	29.0	7.4	10.3

TABLE LI. — *Continued.*

	TEST 26.	TEST 27.	TEST 28.
Average temperature motor field at beginning of test, degrees C.....	12.0	10.9	14.3
Average temperature by resistance of motor field at end of test, degrees C.....	58.0	34.0	32.0
Average rise in temperature by resistance, of motor field above air temperature, degrees C.	46.0	19.4	13.6
Average temperature of motor armature at beginning of test, degrees C.....	13.5	11.1	14.7
Average temperature by resistance of motor armature at end of test, degrees C.	55.0	38.0	74.0
Rise in temperature above air temperature, of motor armature, degrees C.....	43.0	23.4	55.6
Average temperature of motor commutator at beginning of test, degrees C.	14.0	10.0	15.0
Average temperature of motor commutator at end of test, degrees C.....	46.0	25.0	30.0
Average rise in temperature of motor commutator above air temperature, degrees C.	34.0	10.4	11.6
Total volume of free air compressed, cu. ft.	970	328	488
Average volume of air compressed per run, cu. ft.	8.36	2.32	5.14
Energy per cu. ft. of free air compressed, watt-hours.....	3.66	2.30	2.43
Weight of air delivered by compressor per H. P. minute.....	.243	.383	.363
Power to compress to above pressure, one cu. ft. free air per minute, E. H. P.....	.295	.185	.195

Discussion of the Results of the Air Braking Tests Nos. 22 to 29.

The tests described in this chapter of the Report covered a wide range of operating conditions, and they were numerous enough to assure accuracy in the results. The tests were continued over periods of time sufficient to include braking service in all parts of the day. Every quantity which could have any bearing on the test was measured, and its effect on the results was allowed for in working up the data. It is therefore safe to draw certain general conclusions from the data obtained.

Comparison of the Storage and Motor-Compressor Systems.

Table XL shows that the two storage tests, Nos. 22 and 23, and the two motor-compressor tests, Nos. 24 and 25, are in substantial agreement with each other, but that a number of

marked differences appear between the results of the two groups of tests. The electrical energy required to compress a cubic foot of air is 5.49 watt-hours in the storage system and 3.99 watt-hours in the motor-compressor system, a difference in favor of the latter of 37.5 per cent. This results from the greater efficiency of the process of compressing the air directly to the pressure at which it is to be used. In compressing first to a high pressure, which is afterward to be reduced by expansion without useful return, a certain amount of work is done on the air which is absolutely lost. Further, in compressing the air to a high pressure a great deal of heat is generated which is abstracted by the cooling water and is wasted. The efficiency of the large motors used in the storage system is much higher than that of the small motors, but this is an item of minor importance compared with the losses in the air. This difference in the amount of energy absorbed by the air might easily have been greater than shown, as is evident from an inspection of the performance of the same motor-compressor when on the car and on the stand. The efficiency of compression, as indicated by the number of watt-hours per cubic foot of air compressed, is much higher in the latter case, showing that it would have been possible to still further improve the performance of the motor when mounted under the car. The results may, therefore, be considered as entirely conservative.

The difference between the electrical energy used for braking in the two cases shows practically the same advantage in favor of the motor-compressor system. In the comparison based on brake applications, a still more marked difference exists, but as the relation of the number of brake applications to the number of stops is largely a personal matter with the motorman and is not a fixed quantity, no general conclusion can be based upon this relation.

A more marked advantage to the motor-compressor system appears from an examination of the figures for energy consumption in braking per car-mile, per car-hour, and per ton-mile. In these cases the difference is from 50 per cent to 70 per cent.

This follows from two causes: (1) the air is more economically compressed, and (2) the air is delivered more economically to the brake cylinders. The first of these items has already been discussed. The second is evident from the figures given for the volumes of free air used per car-hour, per car-mile, and per ton-mile. In the storage system more air is required from the fact that it is carried on the car at a high pressure, and leakage is difficult to avoid. This leakage occurs not only in the joints upon the car, but at the time of charging the amount of air in the charging hose is wasted.

The results of these tests are summed up in the figures for the ratios found at the bottom of Table XL. It is there shown that while a horse-power minute of electrical energy will deliver 0.155 lb. of air in the storage system, this same energy will compress 0.228 lb. in the motor-compressor system, this saving resulting from the saving in the work done on the air in compression and not restored to it in expansion. Similarly it requires 0.463 horse-power to compress one cubic foot of air per minute to the higher pressure, and 0.317 horse-power to the lower pressure.

Finally, 1.72 per cent of the energy supplied to the car motors must be used for braking when the storage system is used and 0.99 per cent with the motor-compressor, the former being 74 per cent greater than the latter. In deciding upon the system to be used in any case, therefore, the question at issue is whether or not there is a saving in interest and maintenance in the use of the storage system which will offset the greater efficiency following from the use of the other equipment.

Comparison of the Two Storage System Tests, Nos. 22 and 23.

While Test No. 22 was conducted upon the entire number of cars in operation during 24 hours and Test No. 23 covered but one car for a shorter period, there is substantial agreement in the results of the two tests. The important difference from the operating standpoint in the conduct of the two tests was that a number of the cars lay in the barn during a considerable

part of the day, being used as "extras" for a few trips each. The leakage during this period is charged against the cars. That this caused no serious discrepancy in the results is evident from the fact that while somewhat more air was used per car-hour in Test No. 22, slightly less was used per car-mile. On the whole, somewhat more air was used in Test No. 22, but this is accounted for by the leakage mentioned, which was not an important item. The ratio of braking energy to car-motor energy was practically unity.

Comparison of the Several Stand Tests.

As has been previously described, the three stand tests were intended to yield data as to performance under standard test conditions as suggested by Mr. Dewson, and under conditions approximately those of ordinary service. The results show, in all cases, a consistent increase in the energy consumption with increase in the pressure pumped against. From these figures it is possible to predict the amount of energy that will be used under other circumstances.

Comparison of Stand and Service Tests of Motor-Compressor.

As would be expected, the motor-compressor exhibited a somewhat better performance upon the stand than when under the car. While every precaution was taken to insure conditions as nearly similar as possible, the fact still remains that, with all leakage eliminated, with dirt and jar absent, and with regular and careful handling of apparatus, better results should be secured. It will be remembered that upon the car it was necessary to cut off the current whenever the motorman used air, in order to prevent a quantity of air from being used unmeasured. This frequently necessitated abnormally short compressor runs with consequent lowering in efficiency of operation. In addition, it was possible to read instruments more accurately in the shop. These features, in addition to the principal one of the difference in operating conditions, explains the better performance of the motor-compressor upon the stand.

The stand test may be taken as the ideal performance of the equipment which would be reached upon the car if all conditions were perfect.

Comparison of Air Consumption by Trips in Tests Nos. 23, 24, and 25.

Tables XLVII, XLIX, and L show in an interesting manner the effect of density of traffic upon the air consumption. These tables do not cover the entire test in any case, but the trips at the beginning and end of the day have been omitted, and round trips from and to the Tower Grove Park loop have been arranged for comparison. In general there is a greater consumption of air in the middle of the day on account of the large number of stops.

CHAPTER IX.

BRAKING TESTS ON AN INTERURBAN CAR EQUIPPED WITH AIR BRAKES.

OBJECTS OF THE TESTS.

THE primary object of these tests was to determine the rates of deceleration which can be employed in braking a heavy interurban car from various speeds, and with different air pressures in the brake cylinder.

SYNOPSIS OF RESULTS.

TABLE LII. — *Synopsis of Results. Braking Tests of Interurban Car.*

	TEST NUMBERS.				
	29	30	31	32	33
Air pressure applied to brakes, lbs. per sq. in.	20	20	30	40	40
Speed at application of brakes, m.p.h. ...	44.2	53.5	47.2	48.8	55.5
Duration of braking period, seconds ...	28.7	38.7	25.0	17.5	23.4
Distance covered during braking period, feet ...	955	1,540	932	655	985
Average deceleration, m.p.h. per sec. ...	1.54	1.38	1.89	2.79	2.37
Maximum deceleration, m.p.h. per sec. ...	2.20	2.70	3.20	4.80	3.10
Average pressure of brake shoes on wheels, pounds ...	25,125	25,125	37,687	50,250	50,250
Limit of braking force, at 25 per cent adhesion, pounds ...	19,883	19,883	19,883	19,883	19,883
Average braking force from actual deceleration, pounds ...	5,560	4,980	6,830	10,080	8,550
Average braking force per ton from actual deceleration, pounds ...	140.3	125.7	172.2	254.2	216.0
Average deceleration per 1000 lbs. pressure applied by brake shoes, m.p.h. per seconds ...	0.0613	0.0550	0.0502	0.0555	0.0471
Electrical energy equivalent of air used in making stops, watt-hours ...	5.5	7.6	9.7	10.3	11.6

Weight of car 79,330 lbs., 39.67 tons.

GENERAL CONDITIONS OF THE TESTS.

The braking tests upon the interurban car were made upon the stretch of tangent track between Noblesville and Carmel, Indiana, on the Northern Division of the Indiana Union Traction Company's lines. This was the track used in the acceleration tests upon the same car, and the tests were conducted between poles Nos. 10,909 and 10,850, the section covered during the braking period being absolutely level and tangent.

The car employed in these tests was the one used in the service and acceleration tests already described. The details of the car are given fully in Chapter I. The car equipped and ready for service weighed 74,530 lbs., and the total weight under the conditions of test was 79,330 lbs., or approximately 39.66 tons. The load was the same as in the service tests described in Chapter IV. As previously stated, the braking equipment consisted of a motor-driven compressor of the Westinghouse Traction Brake Company, supplying air to a 10-in. brake cylinder through the "straight air" system of control. The brake lever ratio was four to one, and the brakes were inside hung.

GENERAL DESCRIPTION OF THE TESTS.

The tests consisted essentially in bringing the car to the desired speed, in allowing it to drift a distance of 500 ft., and in applying the brakes with a pre-determined air pressure which was maintained constant until the car came to rest. The time available for this test was not sufficient to permit of a great range of speed, and it was therefore deemed advisable to study braking conditions from the ordinary speeds at which this car would be normally operated. Speeds were selected ranging between 45 miles an hour and 56 miles an hour. The brake cylinder pressures employed in the tests ranged from 20 to 40 lbs.; these limits being chosen as covering the requirements of ordinary practice, and giving data from which the effect of employing other pressures could be readily predicted.

In connection with the braking tests, readings were made to

determine the electrical energy equivalent to the air used. The pressure in the storage reservoir was noted at the beginning and at the end of each application. By means of an auxiliary test, made to determine the relation between the electrical energy used and the volume of air compressed, it was possible to ascertain the relation desired.

ORIGINAL MEASUREMENTS.

The recording apparatus installed upon the car for the purpose of making the service tests already described, was also employed in the present series of tests.

Speed and Distance Measurements.

The speed of the car was accurately determined by means of an "Apple" generator connected with the car axle by a sprocket chain, a voltmeter being connected to the armature of the generator. The indications of the voltmeter were checked by the pole record made on the recording mechanism, the instant of passing each pole being shown on a time base. The distance from the last pole to the actual point of stop was measured by means of a steel tape.

Air Pressure Measurements.

Accurate gages were connected to the piping leading to the air brake cylinder and to that connected with the storage reservoir, and from these gages the corresponding pressures were determined.

Electrical Measurements.

In order to determine the electrical energy expended in braking under various conditions, an independent series of tests was made on the motor-compressor. The calibration consisted essentially in the determination of the quantity of electrical energy expended in applying the brake under the same conditions of brake cylinder pressure and time interval of the braking period, as occurred in the braking tests. A series of observations was made for each condition, readings being obtained

showing the initial and final pressures in the reservoir, the brake cylinder pressure, and the duration of the application in seconds. The electrical energy required to restore the reservoir pressure was ascertained by inserting a watt-hour meter in the motor-compressor circuit and making a series of runs of the motor-compressor, pumping within the desired limits. The results showed an energy consumption of 2.1 watt-hours per pounds variation of pressure in the reservoir. Investigations were made at braking pressures of 20, 30, 40 and 50 lbs. The duration of the application of the braking pressure varied from 15 to 44 seconds, and covered all of the conditions employed in the braking tests. The governor controlling the pressure was set for a lower limit of 58, and an upper limit of 71 lbs. The general results of this calibration have been arranged, for convenience, in tabular form as follows:

CALIBRATION DATA OF MOTOR-COMPRESSOR AND AIR BRAKES.

Brake cylinder pressure, pounds.....	20	30	40	50
Average duration of brake application, seconds	35	25	23	15
Average fall in reservoir pressure, pounds.....	3.3	4.6	4.9	6.3
Electrical energy per pound variation in reservoir pressure, watt-hours.	2.1	2.1	2.1	2.1
Electrical energy per brake application, watt-hours.	6.9	9.7	10.3	13.2
Upper limit of reservoir pressure, pounds.....	71	71	71	71
Lower limit of reservoir pressure.....	58	58	58	58
Average number brake applications for one pumping.	5.0	3.5	2.5	2.0

The data showing the electrical energy equivalent to the air used in making stops, under various conditions of braking, are given in Table LII. The calculations are based upon the original data showing the actual fall in reservoir pressure during each test, the results given above in tabular form being employed in the proper interpretation of the original data. In this connection it should be observed that leakage tests were also made at the same time that the calibration tests were performed. These investigations show a fall of approximately one pound per minute in the reservoir pressure, due to leakage, within the limits of pressure employed in the braking tests.

WORKING UP THE RESULTS.

As the results of these tests were very largely obtained graphically, the form used has been adhered to in working up the results. After correction of the various quantities measured, the first step was to produce accurate time-speed and time-distance curves for each case, by combining the results furnished by the speed recorder and the time-distance data. By means of integration of the speed curves up to various points, the distance data obtained from the pole record were checked point by point. The curves represent the average values from two tests in most cases, which were as many as it was practicable to make in the available time. From the time-speed and time-distance curves a number of deductions were made, including average and maximum deceleration. By combining with these results the air pressure data, other deductions were made showing the relation of the brake-shoe pressures to the deceleration produced thereby.

The general results of the tests have been arranged in tabular form in Table LII. In preparing the table the tests were arranged in order of air pressure. Tests Nos. 29 and 30 and Tests Nos. 32 and 33 form two groups, the first named in each case being at the lower speed. Test No. 31 stands alone, as time did not permit a test at higher speed and at this air pressure.

The average deceleration was obtained by dividing the speed at the instant of application of the brakes by the time interval of the braking period. The maximum deceleration was determined by the approximate method of drawing tangents to the braking curve (time-speed curve), and from the slope of this tangent obtaining the ratio of the speed to the time. The accuracy of this method depends upon the correctness of the shape of the curve during the last few seconds of the run, and, as this shape is very difficult to obtain, the accuracy of the results of these calculations is not as great as that of the average deceleration, but they are as close to the correct values as could be obtained with the apparatus employed.

The average brake shoe pressure was obtained from the piston area, the air pressure, and the brake leverage. The figures given represent the total pressure on eight brake shoes. In order to determine how near these results approach to the ordinarily accepted limit of braking force, this limiting value, 25 per cent of the weight of the car, has been placed in the table for comparison with the results of the tests. Under these figures are placed the actual braking forces as calculated from the weight of the car and the deceleration produced. This braking force is simply the product of the weight of the car in pounds divided by 32.2, the acceleration of gravity, and multiplied by the acceleration in feet per second per second. The values were calculated both for the total weight and per ton. The average deceleration per thousand pounds pressure upon the brake shoes was also calculated, in order to permit of a comparison of the braking effect from the various speeds and with the several brake-cylinder pressures.

Finally, the electrical energy equivalent to the air used in making stops was determined by means of an auxiliary test, as already described. From the amount of electrical energy used in the compressor to produce a certain rise of reservoir pressure, a constant was deduced, which gave the electrical energy corresponding to that of ordinary operation, and a sufficient number of tests were made to insure reasonable accuracy in this deduction.

RESULTS OF THE TESTS.

The calibration runs of the motor-compressor comprised a sufficient variation in duration and range of pressure to secure an accurate average. From these tests the constant derived was 2.1 watt-hours as the electrical energy required to produce a change in reservoir pressure of one pound per square inch. The general results of the tests are given in the synopsis, Table LII, at the beginning of the chapter. For the purpose of enabling a detailed study to be made, the data showing the action of the car throughout the deceleration period have been placed

in graphical form, and are shown in Figs. 89 to 93, inclusive. The accompanying "logs" give the general data of each test, arranged conveniently for comparison between the numerical and the graphical representations.

GENERAL LOG SHEET OF BRAKING TEST NO. 29.

Air pressure applied to brakes20 lbs. per sq. in.
 Speed at application of brakes44.2 miles per hour.
 Duration of braking period28.7 seconds.
 Distance covered during braking period955 ft.
 Average deceleration1.54 miles per hour per second.
 Maximum deceleration2.20 miles per hour per second.
 Average pressure of brake shoes on wheels25,125 lbs.
 Limit of braking force, 25 per cent adhesion19,883 lbs.
 Average braking force from actual deceleration.....5,560 lbs.
 Average braking force per ton from actual deceleration 140.3 lbs.
 Average deceleration per 1000 lbs. pressure applied by
 brake shoes......0613 miles per hour per second.
 Electrical energy equivalent of air used in making stop 5.5 watt-hours.

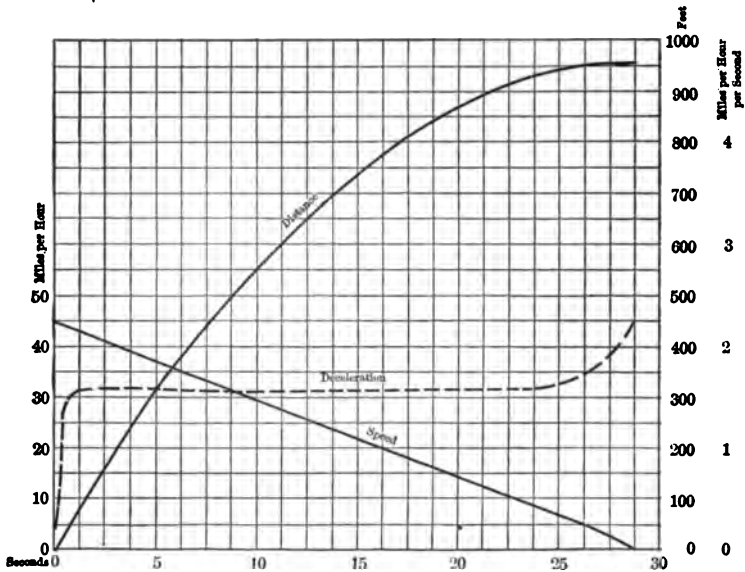

Fig. 89. — Speed and Distance Data. Test No. 29.

GENERAL LOG SHEET OF BRAKING TEST NO. 30.

Air pressure applied to brakes 20 lbs. per sq. in.
 Speed at application of brakes 53.5 miles per hour.
 Duration of braking period 38.7 seconds.
 Distance covered during braking period 1,540 ft.
 Average deceleration 1.38 miles per hour per second.
 Maximum deceleration 2.70 miles per hour per second.
 Average pressure of brake shoes on wheels 25,125 lbs.
 Limit of braking force, 25 per cent adhesion 19,883 lbs.
 Average braking for actual deceleration 4,980 lbs.
 Average braking force per ton, from actual deceleration 125.7 lbs.
 Average deceleration per 1000 lbs. pressure applied by
 brake shoes0550 miles per hour per second.
 Electrical energy equivalent of air used in making stop 7.6 watt-hours.

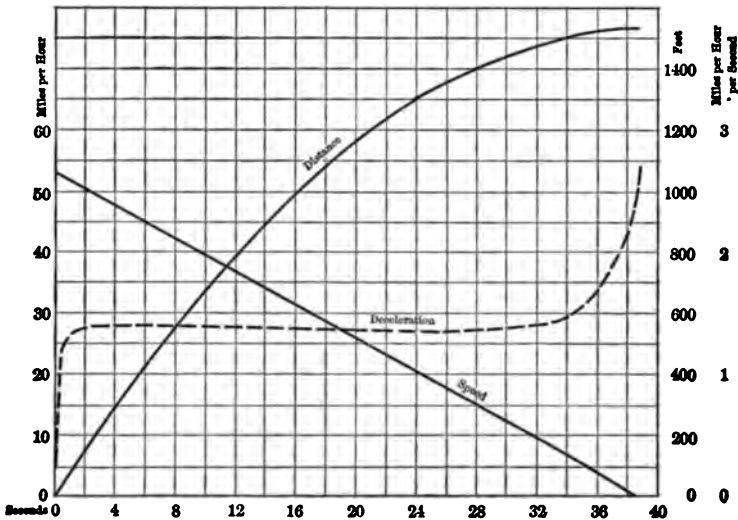

Fig. 90. — Speed and Distance Data. Test No. 30.

GENERAL LOG SHEET OF BRAKING TEST NO. 31.

Air pressure applied to brakes 30 lbs. per sq. in.
 Speed at application of brakes 47.2 miles per hour.
 Duration of braking period 25.0 seconds.
 Distance covered during braking period 932 ft.
 Average deceleration 1.89 miles per hour per second.
 Maximum deceleration 3.2 miles per hour per second.

Average pressure of brake shoes on wheels 37,687 lbs.
 Limit of braking, force 25 per cent adhesion 19,883 lbs.
 Average braking force from actual deceleration 6,830 lbs.
 Average braking force per ton, from actual deceleration 172.2 lbs.
 Average deceleration per 1000 lbs. pressure applied by
 brake shoes0502 miles per hour per second.
 Electrical energy equivalent of air used in making stop 9.7 watt-hours.

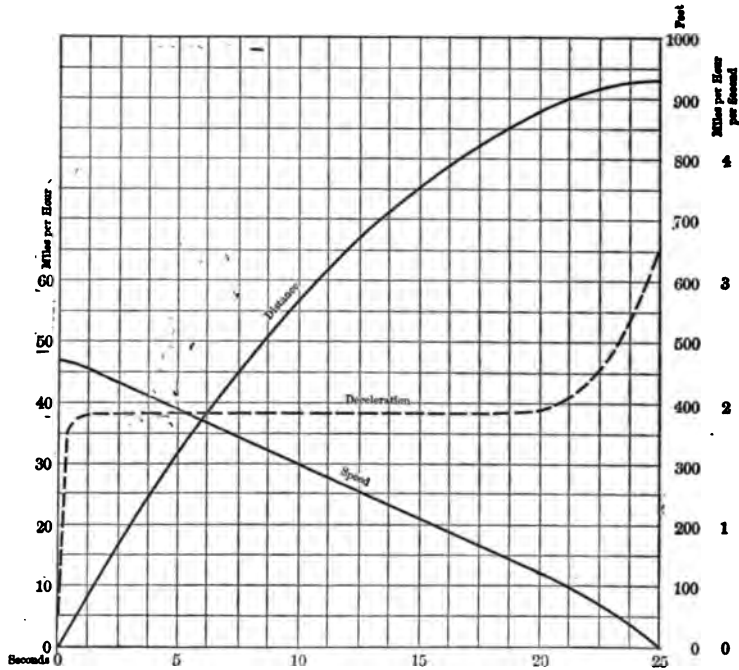

Fig. 91. — Speed and Distance Data. Test No. 31.

GENERAL LOG SHEET OF BRAKING TEST NO. 32.

Air pressure applied to brakes 40 lbs. per sq. in.
 Speed at application of brakes 48.8 miles per hour.
 Duration of braking period 17.5 seconds.
 Distance covered during braking period 655 ft.
 Average deceleration 2.79 miles per hour per second.
 Maximum deceleration 4.80 miles per hour per second.
 Average pressure of brake shoes on wheels 50,250 lbs.
 Limit of braking force, 25 per cent adhesion 19,883 lbs.
 Average braking force from actual deceleration 10,082 lbs.
 Average braking force per ton, from actual deceleration 254.2 lbs.

Average deceleration per 1000 lbs. pressure applied by
 brake shoes..... .0555 miles per hour per second.
 Electrical energy equivalent of air used in making stop 10.3 watt-hours.

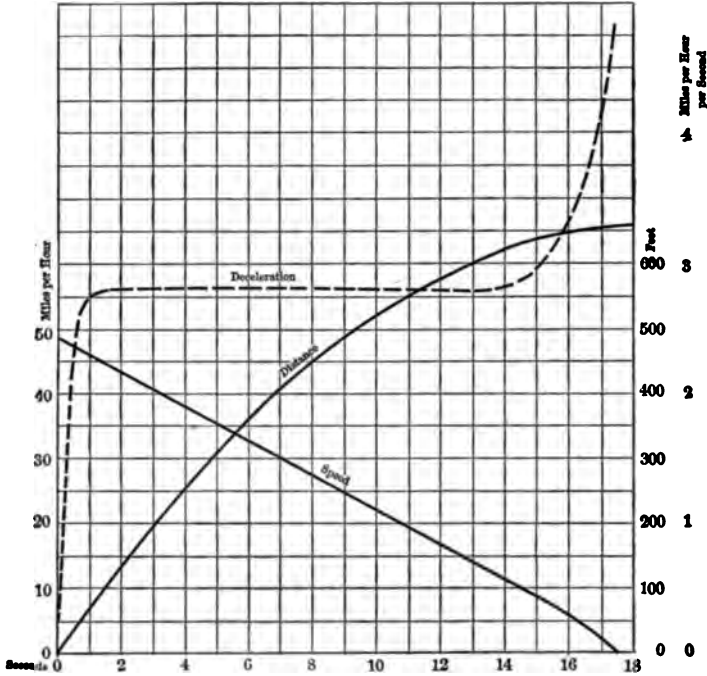

Fig. 92. — Speed and Distance Data. Test No. 32.

GENERAL LOG SHEET OF BRAKING TEST NO. 33.

Air pressure applied to brakes40 lbs. per sq. in.
 Speed at application of brakes......55.5 miles per hour.
 Duration of braking period......23.4 seconds.
 Distance covered during braking period985 ft.
 Average deceleration2.37 miles per hour per second.
 Maximum deceleration3.10 miles per hour per second.
 Average pressure of brake shoes on wheels50,250 lbs.
 Limit of braking force, 25 per cent adhesion19,883 lbs.
 Average braking force from actual deceleration8,550 lbs.
 Average braking force per ton, from actual deceleration 216.0 lbs.
 Average deceleration per 1000 lbs. pressure applied by
 brake shoes......0471 miles per hour
 Electrical energy equivalent of air used in making stop 11.6 watt-hours.

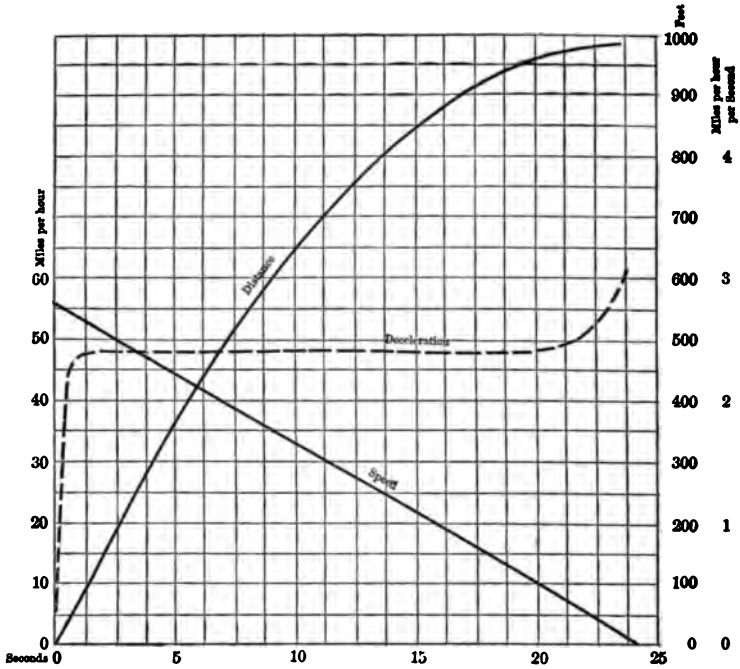

Fig. 93. — Speed and Distance Data. Test No. 33.

DISCUSSION OF RESULTS.

The results as shown in Table LII, cover braking from the ordinary speeds at which the particular type of car would be operated in ordinary service. The tests show that with an average pressure of from 20 to 40 lbs. in the brake cylinder it is possible to secure decelerations of between 1.5 and 2.5 miles per hour per second, while the corresponding average length of stop will be somewhat under 1000 ft. In all cases the average rate of deceleration is smaller at the higher speeds than it is at the lower values of speed. This indicates that at the high speeds the brake shoes do not take hold of the wheels as quickly as they do at the lower speeds. As would be expected, the maximum deceleration, which occurs during the last few seconds of the braking period, is considerably greater than the average, and while the figures for these values do not warrant

any sweeping deductions, they show that the maximum exceeds the average value by from 50 to 75 or more per cent. This increase in deceleration toward the end of the braking period is due to the increase in friction between the brake shoes and the wheels at the low speeds.

Assuming that the wheels would "skid" when the braking force is about 25 per cent of the weight of the car, the table shows that in no case in these tests did the actual braking force approach this limit. In fact in the extreme case shown, Test 32, the braking force is only slightly more than 50 per cent of the theoretical limit. This means that it would have been possible in an emergency, to have stopped the car with a braking force twice that actually employed in this case. The braking force in pounds per ton varies in the tests from 125.7 lbs. to 254.2 lbs., which forces produced rates of deceleration closely corresponding to those which would be expected from the pressure applied to the brake shoes. In order to study this relation somewhat more closely, the values of deceleration produced by each thousand pounds applied to the brake shoes have been entered in the table. These figures show that the deceleration produced per unit of brake-shoe pressure is greater at the lower cylinder pressures, although the results of Test No. 31 do not accord with the general rule. However, the fact that the value shown in Test No. 29 is considerably higher than in Test No. 32, while in Test No. 30 it is higher than in Test No. 33, fully warrants the deductions drawn.

The data showing the amount of electrical energy required to compress a volume of air sufficient to bring the car to rest from the various speeds, may be compared with the results obtained in the city car tests, as given in Table XL. In Tests Nos. 32 and 33, which correspond most nearly with the conditions of the preceding tests, approximately 10.9 watt-hours are used per stop. Comparing these figures with those for the motor-compressor given above, it is noted that the amount of air, while greater in the interurban tests, is not in proportion to the speed from which the stop is made. As a matter of fact, it should

not be so, as after the brakes have been once applied, only enough air is needed to make up for the leakage. As the duration of the braking period is greater with the interurban car, the possibility of leakage is correspondingly increased.

The Graphical Results.

Figs. 89 to 93, inclusive, show curves of speed, deceleration, and distance traversed during the braking period, for Tests Nos. 29 to 33, inclusive.

As previously stated, the data shown represent the average of two runs for each test. The speed curves were obtained graphically in taking the original data, in a manner similar to that employed in obtaining the speed data for the service runs on the interurban car. The general method employed and the apparatus used were described in Chapter II. It will be noted that all of the diagrams are represented on a time base. While the interval of deceleration varied considerably in the five tests, the limiting values were between 17.5 and 38.7 seconds. This large variation in the time necessary to bring the car to a stop is due to two reasons: first, the speed at the instant of the application of the brakes was not the same in all tests; and, second, the braking pressure was varied in the different tests.

THE SPEED CURVES. — The speed curves have the same general form in all of the tests, although the speed at the instant the brakes were applied varied from 44.2 miles per hour to 55 miles per hour. The speed fell off at practically a uniform rate throughout the entire braking period, excepting during the very last portion of this interval. In all of the tests the car was permitted to drift 500 ft. before the brakes were applied. This resulted in a slight deceleration during the interval just previous to the application of the brakes.

THE DECELERATION CURVES. — The deceleration curves show an abrupt increase from a deceleration of approximately 0.25 of a mile per hour per second at the instant of the application of the brakes, to a practically constant deceleration which lasted throughout the greater portion of the braking period,

again rising somewhat abruptly during the last few seconds of the interval. It was impossible to accurately determine the exact value of the deceleration due to the period of drifting immediately preceding the application of the brakes, but it was approximately 0.25 of a mile per hour per second. This value has been taken as the deceleration at the instant of the application of the brakes. The average deceleration varied from 1.38 miles per hour per second in Fig. 90, to 2.79 miles per hour per second in Fig. 92. This difference is due to the variation in the air pressure applied to the brakes. This pressure was 40 lbs. per square inch in Fig. 92, as against 20 lbs. per square inch in Fig. 90.

THE DISTANCE CURVES. — While the distance curves have the same general shape in all of the diagrams, it is seen that the distance traversed varies considerably in the several tests, ranging from 655 ft. in Fig. 92, to 1540 ft. in Fig. 90. This variation in the distance traversed during the braking interval is due to differences both in the air pressure during the braking interval, and in the speed of the car at the instant the brakes were applied. The results, while differing considerably in the various tests, are within the limits shown in Figs. 90 and 92.

CHAPTER X.

BRAKING TESTS ON A SINGLE-TRUCK CITY CAR EQUIPPED WITH MAGNETIC BRAKES.

OBJECTS OF THE TESTS.

THESE tests were made to determine the braking curves of a car equipped with magnetic brakes when the brake controller was operated in various ways. It was desired to determine the most effective method of handling this brake, the object being to produce a quick and smooth stop without undue heating of the motors.

SYNOPSIS OF RESULTS.

TABLE LIII. — *Synopsis of Results. Braking Tests of a Single-Truck City Car Equipped with Magnetic Brake.*

(Each datum is the average of fifty runs.)

Average duration of braking period, seconds	7.13
Average distance covered during braking period, feet	114.67
Average speed at application of brakes, M.P.H.	18.15
Average speed during braking period, M.P.H.	10.91
Average deceleration during braking period, M.P.H. per second	2.57
Average deceleration during last second, M.P.H. per second	3.49
Average total braking force calculated from actual deceleration, lbs. .	3,356
Average braking force per ton, from actual deceleration, lbs.	233.9
Average current during braking, amperes	135.6
Average maximum current during braking, amperes	241.6
Average time to maximum current during braking, seconds	1.61
Average square root of mean square current during braking, amperes	154.3
Average ratio of average current to square root of mean square current	1.16
Average E.M.F. during braking, volts	155.8
Average maximum E.M.F. during braking, volts	345.4
Average quantity of electricity passing through brake circuits, ampere-seconds.	945.5
Average electrical energy delivered by motors acting as generators, watt-hours	39.5
Average ampere-seconds per M.P.H. per second of average deceleration	372

GENERAL CONDITIONS OF THE TESTS.

All of the braking tests upon the single-truck car were carried out on the tracks provided for the Electric Railway Test Commission by the Louisiana Purchase Exposition Company. These tracks were approximately 1200 ft. in length, and were located parallel to and directly north of the Transportation Building at the St. Louis Exposition. The braking tests were conducted on the north one of these tracks, which was tangent and level throughout the entire length used.

The car selected for these tests was the same single-truck car used in making the service tests considered in Chapter II, and is fully described and illustrated in Chapter I. The car equipped and ready for service weighed 24,665 lbs., and the total weight under the conditions of test was 28,715 lbs., or approximately 14.3 tons. The load was the same as in the service tests of Chapter II.

The car was equipped with a magnetic brake of the Westinghouse Traction Brake Company, manufactured under the Newell patents. In this system the brake comprises a track shoe combined with an electro-magnet which, when energized by current produced by the motors acting as generators, is magnetically attracted to the track, producing four effects:

- (1) An increase in the pressure of the wheels upon the track.
- (2) A retardation due to the friction between the track shoes and rails.
- (3) A braking effect on the wheels due to the transmission of the resultant drag of the track shoes to the brake shoes by means of suitable levers.
- (4) A back torque in the motors which act as generators, supplying current to the magnets.

These effects combine to produce a braking effort which is not only a powerful one, but which has certain peculiar characteristics not common to hand or air brakes.

The magnetic track brake consists of three essential parts:
(1) An electro-magnet equipped with steel track shoes which

form the poles; (2) a system of levers for transmitting the braking force to the wheel brake shoes; and (3) an electrical regulative device for controlling the electromotive force, which can be furnished by the car motors acting as generators.

The construction of the brake and rigging is shown in Figs. 94, 95, and 96. Fig. 94 shows a view of the braking equipment taken from under the car, at a point midway between the trucks. Fig. 95 represents a transparent view, showing the

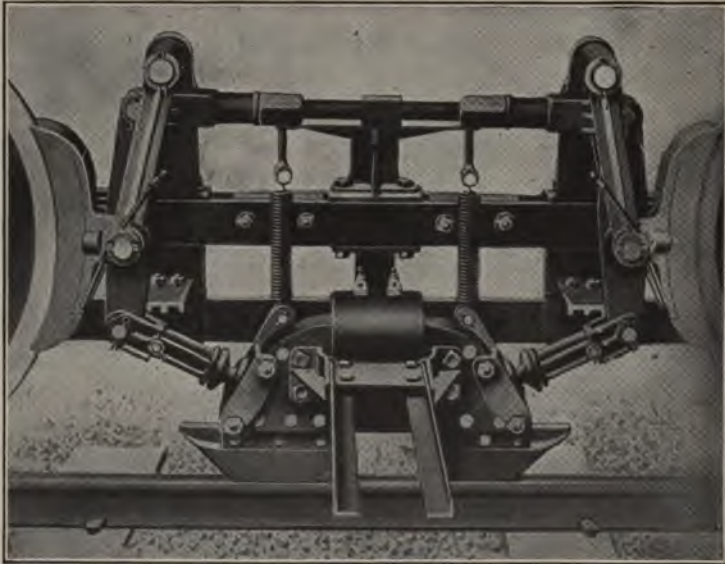

Fig. 94.—General View of Braking Equipment Taken from under the Car.

method of attaching the brake to the car frame and trucks; while Fig. 96 shows the truck frame for the magnetic brake. Two track brakes are employed in a single-truck car, one being located at the center of each side of the truck frame, and each is made in three parts. The magnetic circuit proper is composed of steel, and the poles are shod with replaceable soft steel blocks. These steel shoes are beveled off at a sharp angle in order to enable them to throw obstructions from the rails, and to ride easily over such slight irregularities in the rails as are

not sufficient to derail the car. The shoes are brought as near together as possible without short circuiting the magnetic flux. The magnetomotive force for the track brake is furnished by a magnet winding of sufficient cross-sectional area and radiating

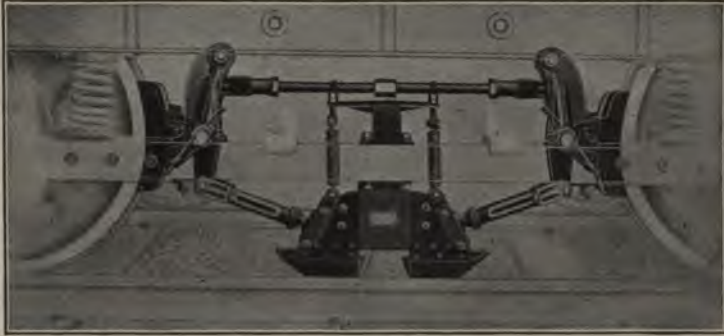

Fig. 95. — Transparent View of Braking Equipment, Showing Method of Attaching the Brakes.

surface to carry a current of one hundred amperes or more, for a short period of time. The coil is inclosed in a water-proof cover of substantial construction, and the winding terminates in two insulated binding posts at the top of the coil. The coil is located



Fig. 96. — View of Track Frame for Magnetic Brake.

midway between the poles on a reduced section of the magnet core and is rigidly held in position. The bottom of the coil is carried several inches above the track, and is protected from injury by the core and pole shoes.

The track brake is flexibly suspended by adjustable steel springs through a bracket secured to and projecting upward and inward from the side frame of the truck. It clears the rail by a short distance when the coil is not energized. The two track brakes, located opposite each other, are cross-connected by a light steel frame so that the distance between them is rigidly maintained, and the desired stiffness is secured. Each side of the track brake is attached by means of an adjustable link, to the end of a lever through which the braking force is trans-

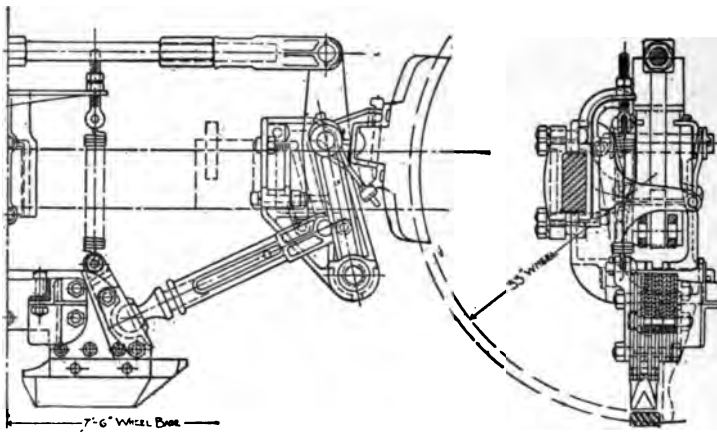

Fig. 96a. — Sketch Showing General Construction of Magnetic Brake.

mitted to the regular wheel brake shoes. This brake rigging is clearly shown in the figures already referred to.

THE CONTROLLER DEVICES.

The general connections of the motor and resistances for the various power positions of the controller are shown in Fig. 54, Chapter V, of Part IV, under the description of the acceleration tests on this car. The controller is provided with sixteen notches, five of which are for the series operation of the motors and four for their parallel position, while the remaining seven notches are for the control of the magnetic brake.

Fig. 97 is a diagram of connections showing the method of

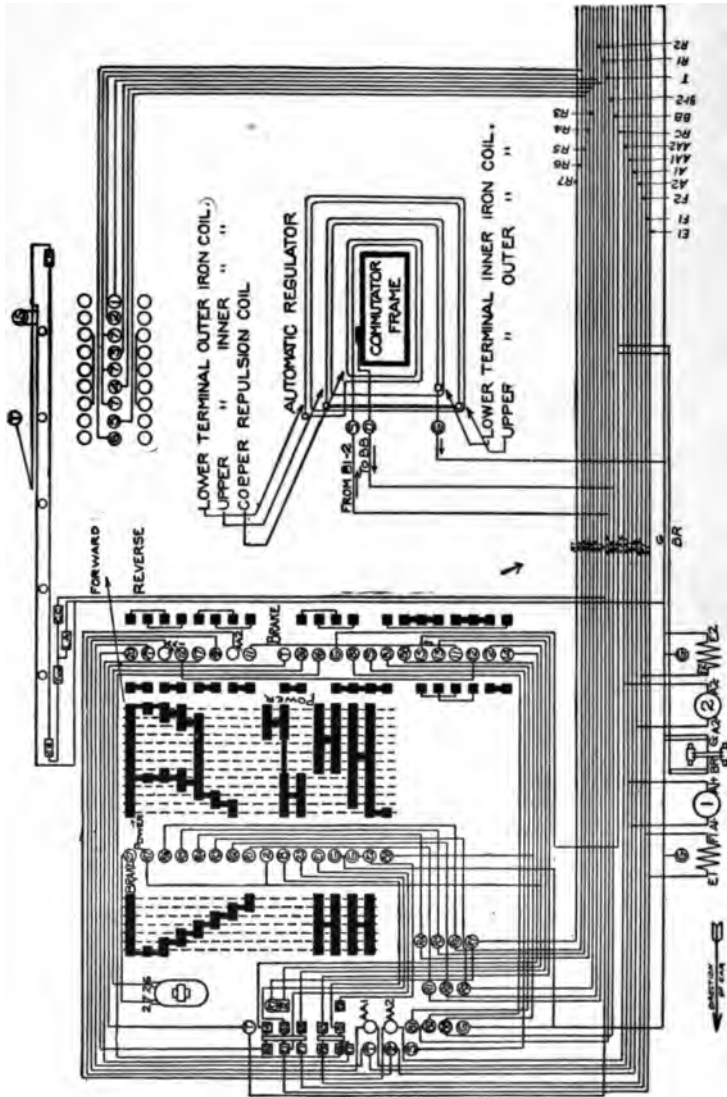

Fig. 97a. — Wiring Diagram Showing General Connections for Serafoc.

to a given schedule, the time of passing from notch to notch of the controller being accurately determined by means of a stop watch, and in accordance with a predetermined schedule. Each run was repeated and the average of the two tests used, in order that the data obtained might be substantially correct. The automatic regulator was adjusted by representatives of the Westinghouse Traction Brake Company before these tests were performed, to conform to service conditions on a level track. The adjustment of the regulator remained unchanged throughout the braking tests.

As the automatic regulator was not varied, there remained but two other general conditions which entered into the method of conducting the tests. These may be classified as Running Conditions and Method of Applying Brake.

RUNNING CONDITIONS. — All runs were made from west to east, the start being made at a certain point near the west end of the upper test track. Five running conditions were employed as follows:

(1) Turn power on in 100 ft., run 400 ft. with full power on, turn off power, drift 100 ft., and apply brake.

(2) Same as (1), but drift only 90 ft., then turn power full on and instantly off, and apply brake. This charges the field immediately before the application of the brake.

(3) Turn power on in 100 ft., run 400 ft. with full power on, turn off power, and apply brake.

(4) Same as (1), but run with full power on 300 ft., turn off power, drift 200 ft., and apply brake.

(5) Same as (4), but drift 190 ft., and charge field by turning power on and instantly off before applying brake.

METHOD OF APPLYING BRAKE. — Five methods of applying the brake were employed, as follows:

(1) Turn to braking notch 3, pause two seconds, and then advance at the rate of one notch per second.

(2) Turn to braking notch 4, and advance as fast as practicable.

(3) Turn at once to braking notch 6 until car has almost stopped, and then advance to the 7th notch.

(4) Turn at once to braking notch 5 until car has almost stopped, and then advance to the 6th and 7th braking notches.

SCHEDULE OF RUNS.

As there were five different running conditions and five conditions governing the method of applying the brake, a series of twenty-five runs in all was made. These runs are shown in the following schedule.

RUN.	RUNNING CONDITIONS.	METHOD OF APPLYING BRAKE.
A . . .	Turn power on in 100 ft., run with full power 400 ft., drift 100 ft., and apply brake.	Turn to notch 3, pause two sec. and then advance at rate of one notch per sec.
B . . .	Turn power on in 100 ft., run with full power 400 ft., drift 100 ft., and apply brake.	Turn to notch 4, and advance as fast as practicable.
C . . .	Turn power on in 100 ft., run with full power 400 ft., drift 100 ft., and apply brake.	Turn at once to 7th notch.
D . . .	Turn power on in 100 ft., run with full power 400 ft., drift 100 ft., and apply brake.	Turn at once to 6th notch until almost to stop, then to 7th.
E . . .	Turn power on in 100 ft., run with full power 400 ft., drift 100 ft., and apply brake.	Turn at once to 5th notch until almost to stop, then to 6th and 7th.
F . . .	Turn power on in 100 ft., run 400 ft., drift 90 ft., turn power full on and instantly off and apply brake.	Turn to notch 3, pause two sec., and then advance at rate of one notch per sec.
G . . .	Turn power on in 100 ft., run with full power 400 ft., drift 90 ft., turn power full on and instantly off, and apply brake.	Turn to notch 4 and advance as fast as practicable.
H . . .	Turn power on in 100 ft., run with full power 400 ft., drift 90 ft., turn power full on and instantly off, and apply brake.	Turn at once to 7th notch.
I . . .	Turn power on in 100 ft., run with full power 400 ft., drift 90 ft., turn power full on and instantly off, and apply brake.	Turn at once to 6th notch until almost to stop, then to 7th.
J . . .	Turn power on in 100 ft., run with full power 400 ft., drift 90 ft., turn power full on and instantly off, and apply brake.	Turn at once to 5th notch until almost to stop, then to 6th and 7th.
K . . .	Turn power on in 100 ft., run with full power 400 ft., and apply brake.	Turn to notch 3, pause two sec., and then advance at the rate of one notch per sec.

BRAKING TESTS ON A SINGLE-TRUCK CITY CAR 347

RUN.	RUNNING CONDITIONS.	METHOD OF APPLYING BRAKE.
L ...	Turn power on in 100 ft., run with full power 400 ft., and apply brake.	Turn to notch 4, and advance as fast as practicable.
M ..	Turn power on in 100 ft., run with full power 400 ft., and apply brake.	Turn at once to 7th notch.
N ...	Turn power on in 100 ft., run with full power 400 ft., and apply brake.	Turn at once to 6th notch until almost to stop, then to 7th.
O ...	Turn power on in 100 ft., run with full power 400 ft., and apply brake.	Turn at once to 5th notch until almost to stop, then to 6th and 7th.
P ...	Turn power on in 100 ft., run with full power 300 ft., drift 200 ft., and apply brake.	Turn to notch 3, pause two sec., and then advance at rate of one notch per sec.
Q ...	Turn power on in 100 ft., run with full power 300 ft., drift 200 ft., and apply brake.	Turn to notch 4 and advance as fast as practicable.
R ...	Turn power on in 100 ft., run with full power 300 ft., drift 200 ft., and apply brake.	Turn at once to 7th notch.
S ...	Turn power on in 100 ft., run with full power 300 ft., drift 200 ft., and apply brake.	Turn at once to 6th notch until almost to stop, then to 7th.
T ...	Turn power on in 100 ft., run with full power 300 ft., drift 200 ft., and apply brake.	Turn at once to 5th notch until almost to stop, then to 6th and 7th.
U ...	Turn power on in 100 ft., run with full power 300 ft., drift 190 ft., charge field full power, and apply brake.	Turn to notch 3, pause two sec., and then advance at rate of one notch per sec.
V ...	Turn power on in 100 ft., run with full power 300 ft., drift 190 ft., charge field full power and apply brake.	Turn to notch 4, and advance as fast as practicable.
W ...	Turn power on in 100 ft., run with full power 300 ft., drift 190 ft., charge field full power, and apply brake.	Turn at once to 7th notch.
X ..	Turn power on in 100 ft., run with full power 300 ft., drift 190 ft., charge field full power, and apply brake.	Turn at once to 6th notch until almost to stop, then to 7th.
Y ...	Turn power on in 100 ft., run with full power 300 ft., drift 190 ft., charge field full power, and apply brake.	Turn at once to 5th notch until almost to stop, then to 6th and 7th.

ORIGINAL MEASUREMENTS.

The original data may be divided into four general classes: those relating to (a) electrical input; (b) time; (c) speed; and (d) distance traversed.

Electrical Measurements.

The general method of taking electrical measurements was the same as that employed in conducting the service tests on

the single-truck car, excepting that the readings of the indicating instruments were taken at one-second intervals instead of five-second intervals. The general method of procedure was for one person to count the seconds aloud, making use of the stop watch, the readings being taken upon the signal. The first count was taken as the signal for start, and all readings were begun at this point. The counting started at the instant the controller was turned to the first braking position. The time marker and relay system employed in the service tests to show the five-second scores on the recording instrument, were also used in these tests. The connections of the magnetic brake circuits are shown in Fig. 97. It will be seen that the General Electric Company recording ammeter was placed between the motor fields and the magnet coils of the brakes. The total braking current was thus obtained on the current record.

The principal electrical measurements made in connection with the braking tests were those of the total braking current, and the electrical pressure generated by the motors. The first-mentioned measurement was made by means of the General Electric Company recording ammeter, as described above. The pressure generated by the motors was obtained directly across the armatures of the two machines, the latter being connected in parallel. Voltmeter readings were taken at one-second intervals throughout the braking period.

Time Measurements.

In addition to the stop watch readings mentioned above, the total time interval elapsing from the instant the brake was applied until the car came to a standstill was noted in each case. Besides these time measurements, the time-marking device and relay system employed in the service tests considered in Chapter II were also used, the five-second intervals being indicated upon the base lines of the speed and current records. The star wheel of the controller was equipped with a circuit-braking device which was connected to the time-marking device of the recording ammeter, as in the acceleration tests of Chapter V, Part III.

By this means the actual instant at which the controller was turned to a given braking notch was accurately recorded with reference to the five-second score marks on the recording ammeter record.

Speed Measurements.

The speed was measured by means of an "Apple" ignition generator, driven by the car axle in a manner similar to that described in the service tests of Chapter II, the chronograph being employed to give a graphical record of the armature pressure reading. The time and distance measurements were used as a check on the speed curves.

Distance Measurements.

While the point at which the braking began was in general fixed by the conditions of the test in each case, the exact position of the car at the instant the brake was applied was determined by means of a piece of waste thrown from the car by an observer, at the instant the signal was given. The distance traversed during the period of braking was then obtained by measurements with a steel tape.

In addition, the time of passing fixed points on the track was recorded on the base line of the speed record by means of a circuit-breaker carried on the bottom of the car and operated by wire trippers fastened to the track. The general arrangement of this apparatus is described and illustrated in Chapter V, Part III.

WORKING UP THE RESULTS.

The records of amperes passing through the motor armatures for the two runs of each test were first averaged so as to secure accurate graphical records of this current. These records were then transferred to rectangular coördinates on an enlarged scale. The maximum values of current and the time intervals from the point of application of the brakes to those at which the maximum current occurred, were obtained from the current diagrams. The average value of each record was obtained by integration.

The ordinates of the current diagrams were then squared, and a diagram of squared current was produced for each test. From these diagrams the effective values of the currents were determined.

Pressure Measurements.

As no automatic pressure-measuring instrument was available, readings of the indicating voltmeter were taken at one-second intervals. In plotting the results, allowance was made for inaccuracies in the measurements by checking them with the current and resistance of the circuit at the different controller positions.

Speed and Distance Records.

The average of the two graphical records for each test was obtained. These average values were carefully checked by means of the distance and time data which have been obtained independently. The distance records were obtained by actual tape-line measurements on the track and the durations of the braking periods were determined by actual measurements with a stop watch. The final speed and distance curves, therefore, are the result of the combination of several independent measurements.

The average deceleration during the last second of braking was obtained graphically from the speed and distance curves. The average deceleration during the entire braking period, produced by the different methods of braking, was found by dividing the speed at the instant of application of the brakes by the time required for the stop, as determined by the stop watch.

The results of all of the tests were put into graphical form for office use, but the number is so large that they cannot all be presented in this report. A typical set of five diagrams has been selected, which shows a considerable variation in operating conditions. The most important data have been selected from the entire series of diagrams and have been arranged in tabular form.

In preparing the tables of results the above-mentioned graphical data formed the basis for the deductions. The average speed was obtained by the integration of the original time-speed curves, and by afterward correcting by comparison the time and distance data. Similar corrections were applied to the records of maximum speed. From the maximum speed the average deceleration was obtained by dividing by the duration of the braking period. As the determination of the maximum deceleration was very difficult, it was found more satisfactory to obtain the average deceleration for the last second. This was done by obtaining from the diagrams the speed one second before the actual stop, and dividing this value by the interval of one second.

The actual braking force acting to bring the car to rest was calculated from the average deceleration. As in the preceding chapter, this was done by dividing the weight of the car in pounds by 32.2 (the acceleration due to gravity) and by the deceleration in feet per second per second. Then, by dividing these results by the weight of the car in tons, the braking force per ton was obtained.

From the electrical data resulting from the tests, it was possible to obtain a relation between the strain on the motors and the braking effect produced. The former is indicated by the product of the average current and the time giving the quantity of electricity passing through the motors, in ampere-seconds. The total amount of energy developed by the motors in braking, was obtained by multiplying the quantity of electricity by the average pressure, which gives an approximate measure of this energy.

Finally, as a basis upon which to compare the results of the various tests, the ampere-seconds per mile per hour per second of deceleration were calculated and tabulated.

From these detailed deductions the average values for all of the tests were obtained, and these have been placed in the synopsis at the beginning of the chapter.

RESULTS OF THE TESTS.

The average of the results of all runs have been placed, for convenience, in the synopsis at the beginning of the chapter. The detailed time, speed, and distance data for the various runs are shown in Table LIV, while the corresponding electrical data are to be found in Table LV.

The various data in these tables show the effects produced by operating the controller in different ways. The results have been arranged for convenient comparison with the schedule of operation which has been given earlier in the chapter.

TABLE LIV. — *Braking Tests of Single-Truck City Car. — Time, Speed, and Distance Data.*

RUN NUMBER.	TIME, SEC-ONDS.	DIS-TANCE, FEET.	MAXI-MUM SPEED, M.P.H.	AVERAGE SPEED, M. P. H.	AVERAGE DE-CELERATION DURING LAST SECOND, M.P.H. PER SEC.	AVERAGE DECELERATION, M.P.H. PER SEC.	BRAKING FORCE FROM DECELERATION, LBS.	BRAKING FORCE PER TON, LBS.
A	8.6	164.4	19.8	13.1	3.2	2.32	3,034	211.3
B	8.0	139.2	20.7	11.9	2.9	2.59	3,385	236.0
C	7.6	117.9	18.7	10.6	2.8	2.48	3,241	225.8
D	7.5	125.2	19.4	11.4	3.4	2.59	3,382	236.0
E	7.6	123.0	18.6	11.0	3.4	2.44	3,190	222.2
F	7.4	132.6	19.4	12.2	4.0	2.62	3,425	238.5
G	7.5	120.9	18.2	11.0	3.7	2.43	3,175	221.2
H	6.9	109.6	19.1	10.8	3.0	2.77	3,620	252.1
I	7.0	109.5	18.1	10.7	3.4	2.59	3,382	236.0
J	7.0	110.4	17.8	10.8	3.8	2.54	3,320	231.4
K	6.7	112.8	20.8	11.5	3.8	3.10	4,050	282.4
L	7.1	108.1	17.6	10.4	3.6	2.48	3,241	225.8
M	6.3	92.9	17.6	10.1	3.2	2.80	3,655	251.0
N	6.6	99.3	17.8	10.4	3.4	2.72	3,555	247.5
O	6.8	104.3	20.1	10.5	3.5	2.96	3,870	269.6
P	8.5	163.9	18.4	13.2	4.1	2.16	2,824	196.6
Q	7.7	134.4	18.0	11.9	3.5	2.34	3,058	213.0
R	6.7	99.7	16.9	10.2	3.8	2.52	3,292	229.5
S	7.3	105.3	16.0	9.8	2.9	2.19	2,862	199.5
T	7.0	107.9	17.3	10.5	3.2	2.48	3,241	225.8
U	6.9	112.4	17.9	11.1	3.3	2.51	3,280	228.5
V	6.7	96.6	16.0	9.8	3.6	2.67	3,485	243.0
W	6.2	93.1	17.0	10.2	3.8	2.74	3,580	249.5
X	6.4	93.4	17.0	10.0	3.8	2.66	3,476	242.0
Y	6.3	90.0	15.8	9.7	4.2	2.51	3,280	228.5
Average	7.13	114.67	18.15	10.91	3.49	2.57	3,356	233.9

BRAKING TESTS ON A SINGLE-TRUCK CITY CAR 353

TABLE LV. — Braking Tests of Single-Truck City Car. — Electrical Data.

RUN NUMBER.	AVERAGE DECELERATION, M.P.H. PER SEC.	AVERAGE CURRENT, AMPERES.	MAXIMUM CURRENT, AMPERES.	TIME TO MAXIMUM CURRENT, SECONDS.	SQ. ROOT MEAN SQ. CURRENT, AMPERES.	FORM FACTOR.*	AVERAGE E.M.F., VOLTS.	MAXIMUM E.M.F., VOLTS.	QUANTITY OF ELECTRICITY, AMP. SECONDS.	ELECT. ENERGY IN BRAKING, WATT HOURS.	AMP. SEC. PER AVERAGE M.P.H. PER SEC.
A	2.32	112	245	2.8	142	1.265	164	375	957	43.0	413
B	2.59	129	240	1.8	154	1.184	148	310	1035	42.6	400
C	2.48	156	280	0.5	172	1.104	138	295	1177	44.6	474
D	2.59	132	230	1.0	152	1.145	153	290	991	41.0	383
E	2.44	138	235	1.6	154	1.118	163	350	1030	47.3	422
F	2.62	127	200	2.7	143	1.137	221	405	937	53.6	384
G	2.43	139	218	0.8	157	1.131	151	420	1042	42.6	429
H	2.77	167	316	0.4	190	1.169	139	320	1152	42.2	416
I	2.59	151	243	0.9	167	1.109	152	340	1055	41.6	407
J	2.54	149	220	0.7	161	1.088	139	300	1040	28.9	409
K	3.10	112	190	2.8	129	1.146	218	450	748	44.7	241
L	2.48	143	215	1.7	139	1.153	183	455	852	47.0	344
M	2.80	162	335	0.5	179	1.110	164	385	1019	46.4	364
N	2.72	148	248	0.7	166	1.122	152	300	967	40.0	356
O	2.96	127	230	1.5	159	1.252	155	360	865	37.2	292
P	2.16	93	205	4.7	133	1.441	117	290	787	24.7	364
Q	2.34	143	245	3.8	144	1.228	130	305	898	31.5	384
R	2.52	129	250	0.9	149	1.150	148	305	866	35.7	344
S	2.19	125	245	1.6	153	1.188	139	310	916	34.3	418
T	2.48	127	235	1.5	149	1.174	171	315	886	42.0	357
U	2.51	112	205	3.1	125	1.116	172	420	772	34.8	308
V	2.67	126	220	1.8	138	1.096	164	440	848	38.6	318
W	2.74	154	300	0.7	164	1.167	134	280	958	33.4	350
X	2.66	142	250	0.6	175	1.120	144	305	910	35.2	342
Y	2.51	148	240	1.4	163	1.113	136	310	930	35.1	370
Average	2.57	135.6	241.6	1.61	154.3	1.160	155.8	345.4	945.5	39.5	372

* Ratio of square root of mean square current to average current.

While it has not been found practicable to represent the data for all of the tests in graphical form, the current, e.m.f., speed, and distance data for five runs have been represented graphically in Figs. 98 to 102, inclusive. These have been selected as typical diagrams for illustrating the performance of the car. The most important general data of these runs are as follows:

Fig. 98 shows the general data of run F, which was a good average stop.

Fig. 99 shows the performance for run M, where a sudden

application of the brake was made after a heavy charging of the field, resulting in a very quick stop.

Fig. 100 shows the data of run P, where the current and pressure were very low in "building up," with a resultant very slow stop.

Fig. 101 shows the data of run Q, where a heavy draft of current occurred with a low value of maximum pressure. A slow stop was the result in this case.

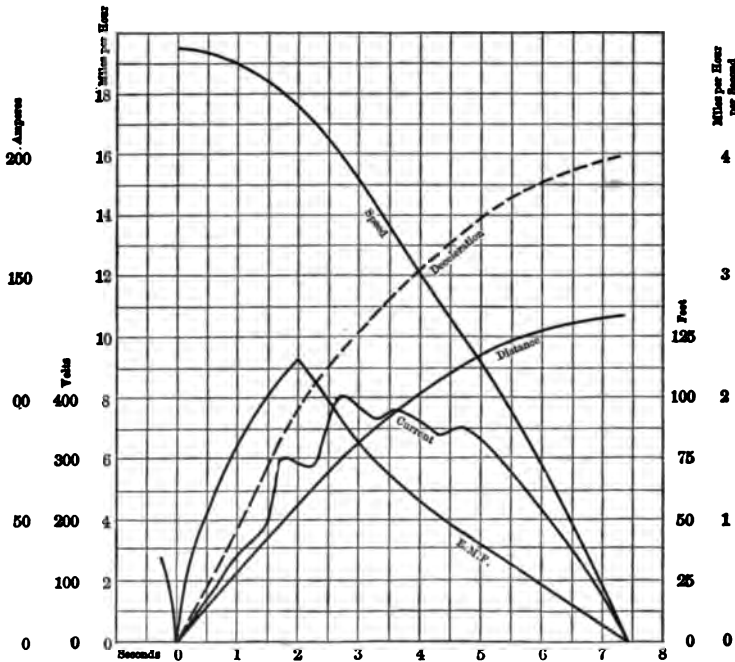

Fig. 98.—Braking Tests of Single-Truck City Car. General Braking Data of Run F.

Fig. 102 shows the performance for run T, which was somewhat similar to run Q, but with the current more suddenly applied, thereby reducing the duration of the braking period.

DISCUSSION OF RESULTS.

In studying the results of these tests, it was necessary to have in mind the various factors which enter into the operation of the magnetic brake.

BRAKING TESTS ON A SINGLE-TRUCK CITY CAR 355

The track brake itself is a simple electro-magnet, and after it has come into contact with the track, the pull or attractive force exerted is proportioned to the square of the magnetic induction.

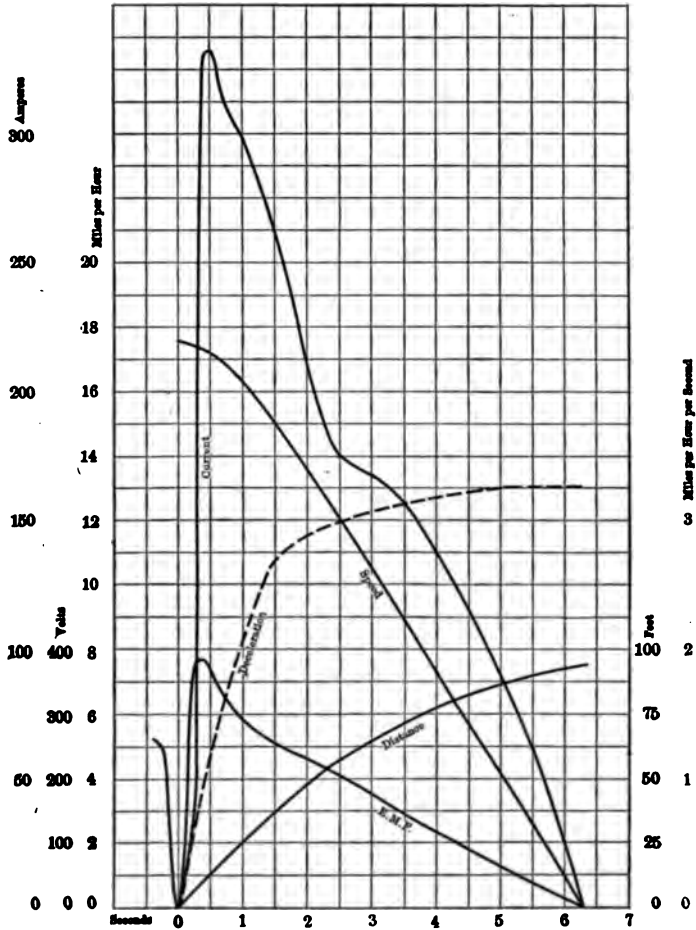

Fig. 99.—Braking Tests of Single-Truck City Car. General Braking Data of Run M.

For low values of the magnetizing current, the magnetic induction is practically proportional to the current so that the tractive effort would vary as the square of the current increases.

The average deceleration produced was more than 2.5 miles per hour per second, a value considerably above the average results of tests made on the interurban car with an air pressure in the brake cylinder of 40 lbs. per square inch. The detailed tests on the double-truck city car showed that in regular city

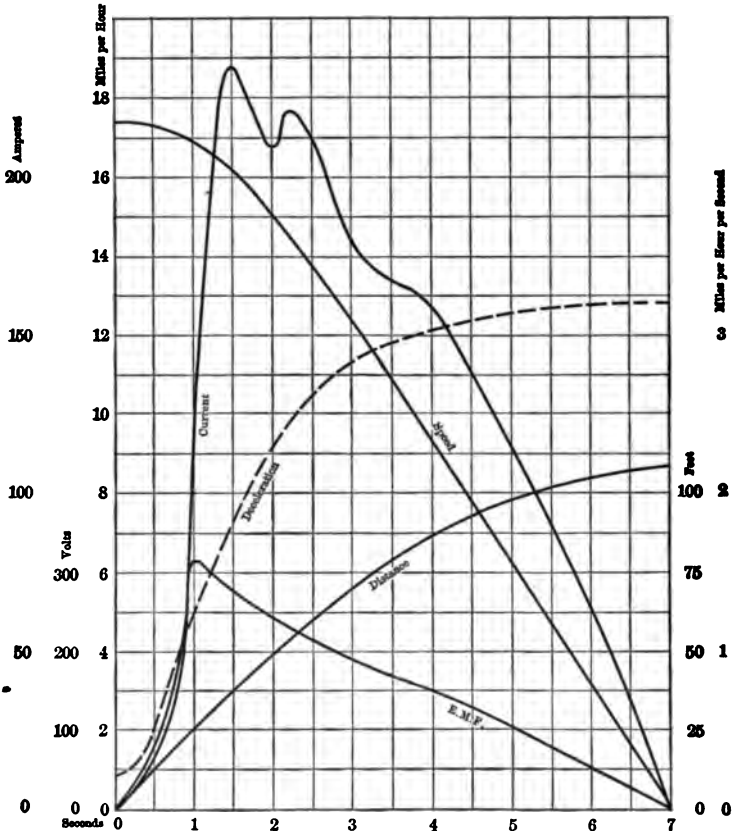

Fig. 102.—Braking Tests of Single-Truck City Car. General Braking Data Run T.

service, the brake cylinder pressure was about 20 lbs. per square inch, with 45 lbs. in the storage reservoir. These facts lead to the conclusion that the average results of the tests covered in the present chapter, show a deceleration more rapid than is ordinarily produced by the air brake in regular city service.

This information in itself would not be sufficient, as the comfort of the passengers is also an element of prime importance. As a matter of fact, even the most rapid stop made during the tests was smooth and uniform, although deceleration was somewhat greater than would conduce to the comfort of the passengers.

It was found impracticable to calculate from the curves an exact value of the maximum deceleration. Instead of this the deceleration for the last second was calculated, and the results show this to be somewhat more than 50 per cent in excess of the average value. This increases toward the end of the braking period, and is due to the increase in friction between the brake shoes and wheels. This increase in friction is apparently offset to a considerable extent by the increase in the braking current. In other words, after the brakes have once been set, they grip the wheels firmly, and with an undiminished pressure, practically until the car comes to rest, provided it is on a level track. The brake shoes are, of course, released when the current ceases, but the diagrams show clearly that the current disappears only at a very low speed. As far as the results show, the stop is similar to that made by the air brake, with the possible exception of a slightly lower ratio of maximum to average deceleration.

The total braking force acting on the car and the braking force per ton are considerably in excess of the average of these values in the tests upon the interurban car. The value of 234 lbs. per ton corresponds to an average cylinder pressure of at least 40 lbs. per square inch in the interurban tests already referred to. The effect of this large braking force is clearly seen in the short time interval (7.113 seconds) during which the average stop was made, and the average distance (114.7 ft.) covered during the period.

The general form of the braking curve is indicated by the ratio of the maximum to the average speed during the braking period. If the deceleration were absolutely uniform from the point of application of the brakes to the stop, the average would

be just one-half of the maximum. As a matter of fact, it is considerably larger than this value, indicating that the speed did not begin to drop off immediately after the brakes were applied. This is readily seen from an inspection of the diagrams. It is to be noticed that, in the use of this particular type of brake, the deceleration begins somewhat slowly and increases to a steady value within a few seconds. It holds this value until within one second of the stop, when it increases slightly, as shown above. The rapidity with which the brakes operate depends very largely upon the manner of handling the controller on the braking notches.

The data given in the synopsis showing the average of the maximum values of the current during braking, is an indication of the back torque produced in the motors. The average time elapsing before this maximum value is reached shows the quickness with which the motors assume their duty as generators. This item is also effected to a considerable extent by the manner of handling the controller. The average current gives no indication of the heating effect upon the motors, as this is proportionate at all times to the square of the current. For this reason the square root of the mean square current was calculated, as this is the true measure of the heat produced in the motors by the braking. The service tests considered in Chapter II, with and without the magnetic brake, show that the heating effect upon the motors, due to the magnetic brakes, is negligible in the equipment under test. The ratio of the square root of the mean square current to the average current, commonly known as the form factor, shows the effect of the shape of the braking curve upon the heating.

Measurements of the e.m.f. have an important bearing upon the results of the tests in that they show that the average maximum pressure was considerably below the normal working pressures of the motors when in regular service. The core losses were, therefore, small, and no injurious sparking occurred at the brushes on account of the braking current.

As a final summation of the entire results of the tests, the last

item in the synopsis is important. This shows the ampere-seconds required to produce a deceleration of one mile per hour per second, the value being 372 ampere-seconds. From this value the ampere-seconds required to produce greater or less deceleration can be calculated. Tables LIV and LV contain the general data of all of the runs and contain considerable information of interest. These tables show a range of duration of the braking period from 8.6 seconds to 6.2 seconds. This seems a small range, when considered in the light of the great variety of methods employed in applying the brakes. Similarly, the braking distances vary from a maximum of 164.4 ft. to a minimum of 90 ft. After allowing for the differences in maximum speed in the various tests, it is evident that the magnetic brake produces a stop which is remarkably uniform for duration and distance. The average deceleration during the braking period is remarkably uniform in its value, departing only a few per cent from the average value in any instance, and having a total range of between 3.10 and 2.16 miles per hour per second, with an average value of 2.57 miles per hour per second. This emphasizes the facts already stated. It is unnecessary here to point out the causes of the variations which are shown by these tables. A comparison of the results of any one run with the schedule makes the cause of these variations perfectly clear. For example, in run K a large average deceleration is noted, with a corresponding very quick stop. The schedule shows the method of operating the brake in this case. An excessive current was not used at the start, but the current was increased to a maximum in about three seconds, and then gradually reduced, giving a current curve somewhat like that shown in Fig. 98. This is evidently an effective way of handling the brake.

As an example of an extreme case in the other direction, run P may be cited. This is illustrated in Fig. 100. From this diagram it will be noted that the current was built up very slowly at the start, due to the car drifting a considerable distance between the time of shutting off the power and that of

the application of the brakes. During this interval the field magnetism in the motors was reduced by the vibration, and considerable time was necessary to enable the machines "to build" again after being short-circuited through the brake shoes.

The Graphical Results.

A study of the curves shown in Figs. 98 to 102, inclusive, brings out some very interesting results. The curves show the current, e.m.f., speed, deceleration, and distance data during the braking period, and are plotted on a time base. It is to be noted in this connection that while the time involved in the braking period varied considerably in the different tests, it was between six and nine seconds in all cases.

THE CURRENT CURVES. — The current shows a general tendency to increase rather slowly at the start, with an abrupt increase to a maximum value after the motors begin to generate e.m.f. As the brakes operate and the car decelerates, the current falls off, decreasing to a zero value when the car comes to a standstill. Fig. 98 shows a very low maximum current, but one which is fairly uniform throughout the entire braking period. Fig. 99 shows a condition where the current rises abruptly to an excessive maximum value. This maximum is 335 amperes, while the average value of the current is only 162 amperes, or less than half of the maximum. The abrupt rise of current in this case was due to the fact that the controller was turned to the 7th notch immediately after the power was cut off. The residual magnetism in the motors was high, and the resistance in the braking circuit was low, resulting in a rapid building up of the e.m.f. The result was a very quick stop. Fig. 100 shows a very small current during the first three seconds of the braking period. However, as soon as the current began to increase, it rose abruptly to its maximum value and remained at a high value for several seconds before it finally began to decrease. In this test the car drifted 200 ft. before the brakes were applied. The controller was first turned to the third braking notch and then advanced at the rate of

one notch per second, producing a very slow stop. Fig. 101 shows a braking current which is intermediate between that of 99 and 100. It comes on more rapidly than that in Fig. 99, but rises somewhat higher than in Fig. 100. This results from the method of applying the brake. While the drifting distance was the same in Figs. 100 and 101, the braking was done at a more rapid rate in Fig. 101, with the result that the time interval of the braking period was decreased. Fig. 102 shows a current curve which is more nearly like that of Fig. 98, in that the maximum value is not so large in proportion to the average value of the current. However, the current is considerably greater than that of Fig. 98 and the braking effect is not as good in proportion, although the time interval of the braking period is slightly less than that of Fig. 98.

THE PRESSURE CURVES.—In general, the pressure curves have the same general form as the current curves in the various runs. It is to be noted that where the current is slow in rising, this sluggish action is due to the fact that the motors have not "built up" their e.m.f. rapidly. This is especially noticeable in Fig. 100, where the car drifted 200 ft. before the brakes were applied. Where the controller was turned on gradually during the interval of braking, it will be seen that, in general the maximum value of the e.m.f. occurs just previous to the point of maximum current. Another point of interest in connection with the pressure curves is that the maximum pressure did not rise above 500 volts, and, in general, varies between 300 and 450 volts. The average maximum e.m.f. for the 25 tests was but 345 volts, while the average value of the pressure throughout the entire period of braking was 155 volts.

THE SPEED CURVES.—The speed curves have the same general form in all of the tests which have been graphically represented. The speed falls off gradually at first, then at a more rapid rate, which remains nearly constant during the greater portion of the braking interval. During the first second, however, a still more rapid decrease in the speed occurs, due probably to the increased frictional effect as the speed is de-

creased. It will be noted that Fig. 100 shows a very slight decrease in speed over the first three seconds of the braking interval, while the speed falls off abruptly during the remaining time. This corresponds with the slow "building up" of the current in the braking circuit, as brought out in the discussion of the current curves. The other extreme is found in the speed curve of Fig. 99, where the speed falls off abruptly, almost from the start of the braking period. This is due to the fact that the current almost immediately rises to its maximum value, a fact which was brought out in the discussion of the current curves. The other speed curves show characteristics which are between these extreme conditions. It will be noticed in this connection that the speed at the instant the brakes were applied did not vary greatly in the different tests, being between 17 and 19 miles per hour.

THE DECELERATION CURVES. — While the deceleration curves have the same general characteristics for all tests, it will be seen that they, too, are considerably affected by the general conditions of braking. The most rapid rise at the beginning of the deceleration curve is noted in Fig. 99, while the most gradual increase in deceleration at the beginning of the braking period occurs in Fig. 100. These conditions are due to the rapid building up of the current in Fig. 99 and to the sluggish action of the motors in Fig. 100. A matter of interest in this connection is the fact that, while the brakes did not take hold during the first three seconds in Fig. 100, with a consequent low value of deceleration during this interval of time, the deceleration during the remaining portion of the braking interval is greater than that obtained in Fig. 99. That is, while the brakes did not take hold for several seconds after the brake was applied in Fig. 100, when the current did build up, it attained a higher average value throughout the remaining portion of the braking period, than was attained in Fig. 99. The deceleration curves of the other tests represent graphically values which lie between the extreme cases just considered.

It is to be observed that the deceleration is zero at the be-

ginning of the braking period in Figs. 98 and 99, while it has a value between 0.20 and 0.25 of a mile per hour per second in Figs. 100, 101, and 102.

In the test shown by Fig. 98, the brake was applied immediately upon shutting off the power, when the car was running at a constant speed. In the run shown in Fig. 99 the power was turned on and immediately off just before the brakes were applied, the result being a practically uniform speed at the beginning of the braking period. In both of these tests, therefore, the deceleration is zero at the instant the brakes are applied.

In the tests shown by Figs. 100, 101, and 102, the car drifted a distance of 200 ft. in each case before the brake was applied. In these three tests the car had begun to decelerate before the application of the brakes. This deceleration was comparatively slight, and was found to be approximately 0.23 of a mile per hour per second in all three tests.

THE DISTANCE CURVES. — While the distance curves have the same general shape in all the tests considered, it will be seen that the distance traversed varies considerably in the several tests. As would be expected, the shortest distance traversed during the braking period occurs in Fig. 99, where the deceleration is most rapid, due to the abrupt rise of the braking current upon the application of the brakes. The distance was only 93 ft. The greatest distance traversed was 164 ft., which occurs in Fig. 100. This would be expected, as the car ran with a slightly diminishing speed during the first three seconds of the braking period. After the brakes began to act, however, the distance curve rose much more gradually. The distance curves shown in the other three tests graphically represented, have the same general characteristics as those of the two tests already discussed. Where the speed curve falls off but slightly at the start, it will be noticed that the distance curve rises most abruptly. In all cases the maximum slope of the distance curve occurs at the start, and it becomes parallel to the base at the point of stop.

GENERAL DEDUCTIONS. — A general study of the graphical results shows a most interesting interrelation between the curves for a given test. Where the current rises abruptly at the beginning of the braking period, it will be found that the e.m.f. also rises suddenly; whereas, if the current is slow in increasing, this is due to a sluggishness in the action of the motors as shown by the e.m.f. curve. It will be found that, in general, the current rises rapidly to a maximum value as soon as the motors begin to "build up," but that the time at which this action occurs depends largely upon the manner in which the braking is performed. The current increases most rapidly at the start when the brake is applied immediately after the power is turned off. On the other hand, the brakes are most sluggish in their action when the car has been permitted to drift with the power off for a considerable distance, before the brakes are applied. In this connection it is interesting to note that good braking results may be obtained even after a considerable period of drifting, if the power is turned on and instantly off before applying the brakes. This operation charges the fields of the motors and restores the residual magnetism, which may otherwise be considerably decreased, due to the vibration of the motors. This condition of affairs is brought out very clearly in Fig. 98. In this case the car drifted for a distance of 90 ft., after which the power was turned on and instantly off, before applying the brake. The result was that both the e.m.f. and current curves increased to a fair value immediately upon the application of the brake. The speed and deceleration curves show that the brakes acted very promptly after the controller was turned to the braking position, while the distance curve shows that the stop was made in a distance of 133 ft. This was a good average stop, as the speed at the beginning of the braking period was between 19 and 20 miles an hour.

PART V.
TESTS OF A STORAGE BATTERY
INDUSTRIAL LOCOMOTIVE.

CHAPTER XI.

TESTS OF A STORAGE BATTERY INDUSTRIAL LOCOMOTIVE.

OBJECTS OF THE TESTS.

THE tests were made in order to determine the relation between the horizontal tractive effort produced by an industrial locomotive, and the current drawn by the motors, and also to find the general efficiency of the equipment when hauling loads under normal conditions of speed. The condition of the track, as affecting the results, was also carefully investigated.

SYNOPSIS OF RESULTS.

The general results of the tests are shown in the synopsis given in Table LVI.

TABLE LVI. — *Synopsis of Results. Industrial Locomotive Tests.*

PART I. LOCOMOTIVE PULLING AGAINST FIXED ANCHOR.

Run number	1	2	3	4	5	6
Kind of track	Straight	Curved	Straight	Curved	Straight	Curved
Controller notch number	1	1	2	2	3	3
Maximum horizontal effort, lbs.	2400	2080	3500	3400	1680	1160
Maximum current, amperes.	80	80	110	120	120	130
Horizontal effort per ampere, lbs.	30.0	26.0	31.8	28.3	14.0	8.9

In runs 1, 2, 5, and 6 the horizontal effort was limited by the limit of discharge rate of the batteries, while in runs 3 and 4 the limit was set by the slipping of the wheels. These runs cover the best conditions of track.

PART II. LOCOMOTIVE RUNNING WITHOUT TRAILERS.

Run number	7	8	9	10	11	12
Kind of track	Straight	Curved	Straight	Curved	Straight	Curved
Condition of track	Dry	Dry	Dry	Dry	Dry	Dry
Controller notch number	1	1	2	2	3	3
Speed, miles per hour	0.70	0.51	1.44	1.20	2.61	2.29
Electromotive force, volts	48.7	48.4	95.8	94.7	92.6	89.6
Current, amperes	13.5	21.6	14.6	23.4	33.9	48.1
Power, watts	660	1047	1397	2213	3133	4301

PART III. LOCOMOTIVE HAULING TRAILERS.

Run number	13	14	15	16	17	18
Kind of track	Straight	Curved	Curved	Straight	Curved	Curved
Condition of track	Dry	Dry	Oily	Dry	Dry	Oily
Controller notch number	1	1	1	2	2	2
Speed, miles per hour	.68	.48	.5	1.36	1.21	1.30
Horizontal effort, lbs.	116	183	164	113	195	194
Electromotive force, volts	48.3	48.0	48.0	94.8	95.7	95.7
Power, watts	656	975	820	1460	1915	1770

Run number	19	20	21			
Kind of track	Straight	Curved	Curved			
Condition of track	Dry	Dry	Oily			
Controller notch number	3	3	3			
Speed, miles per hour	2.61	2.33	2.49			
Horizontal effort, lbs.	95	217	172			
Electromotive force, volts	95.2	91.2	91.3			
Power, watts	3312	4090	4025			

Load consisted of two light trail cars, weighing with load 6300 lbs.

Since two cars and locomotive could not be accommodated on a curve at the same time, the pull was read with the two cars on the curve.

GENERAL CONDITIONS OF THE TESTS.

The tests were conducted in the court of the Palace of Electricity on a special track installed for the purpose of operating this locomotive. Fig. 103 shows the general arrangement of this track, with the dimensions of the various curves and straight portions. The track gage was 21.5 inches, and the total length was 663 ft. All curves were laid out with a radius of 12 ft. to

approximately 5 tons and it was designed to haul loads up to a maximum of 5 tons, at speeds varying between 0.5 and 2.5 miles per hour on straight and level track, with a 25 per cent reduction on curves.

THE LOCOMOTIVE EQUIPMENT.

The locomotive was so designed that the driving motors, with their speed reducing gear cases, were located above the platform carried on the trucks, suitable supports being provided for this purpose. Two trucks were pivoted on the body of the locomotive in such a way as to enable it to easily pass curves of a 12 ft. radius. The wheels were provided with outside flanges and in turning curves the outer wheels ran on flanges, over a specially constructed rail. The increased circumference compensated for the difference in length of the two rails of the curves, and slipping and friction were greatly reduced. As the uses to which these locomotives are put require a large horizontal effort on curves, the desirability of this feature is evident.

The motive power was supplied by two series motors with a rated capacity of two horse power each, and designed for a normal e.m.f. of 75 volts. The motors were four-pole, and the armatures were of the two-circuit or series type.

The motors were covered by dust and water-proof cylindrical cases. The power was transmitted to the axles through a reduction gear and a chain drive. The reduction gear consisted of a train of gear wheels conveniently arranged for inclosure in a cylindrical oil-tight case. By means of an intermediate pinion the driving chain was carried over spur gears on both driving axles, thus giving a large tractive effort. The reduction ratio from the motor axles to the car wheels is 20.65 to 1.

A small controller was arranged so that it could be operated from either end of the platform. There were four controller positions, the first being the charging point on which all cells of the storage battery were connected in series directly to the charging leads and with the motors cut out. In the second position the motors were thrown in series, the two sets of the storage battery being in parallel. In the third position both the

manufactured by the Electric Storage Battery Company. These cells were arranged in two groups of 24 each, which groups could be arranged in series or in parallel. The following data relate to these cells:

Type	E-9
E.m.f. per cell, when charging with 20 amperes, volts	2.16
E.m.f. per cell on open circuit, volts	2.08
Capacity, in amperes when discharged in 8 hours	160
Number of positive grids per cell	4
Number of negative grids per cell	5
Weight per cell with acid, pounds	52
Total weight of battery, pounds	2500
Weight of acid per cell, pounds	101.5

GENERAL DESCRIPTION OF THE TESTS.

The tests comprised two general classes: (a), those made with the locomotive pulling against a fixed anchor; and (b) those in which the locomotive operated upon the track under normal conditions of speed.

In order that the tests might be comprehensive and systematic, they were carried out in accordance with the following schedule:

SERIES A. Locomotive pulling against an anchor; straight track, rusty, wet, and muddy.

SERIES B. Locomotive pulling against anchor; straight track, rusty, and dry.

SERIES C. Locomotive pulling against anchor; curved track, clean, dry, and rusty.

SERIES D. Locomotive pulling against anchor, curved track, muddy, and rusty.

SERIES E. Tests of starting currents for various conditions.

SERIES F. Locomotive running light on controller notch No. 1.

SERIES G. Locomotive running light on controller notch No. 2.

SERIES H. Locomotive running light on controller notch No. 3.

SERIES I. Locomotive hauling trailers loaded with 6300 lbs. and operating on controller notch No. 1.

SERIES J. Locomotive hauling trailers loaded with 6300 lbs. and operating on controller notch No. 2.

SERIES K. Locomotive hauling trailers loaded with 6300 lbs. and operating on controller notch No. 3.

From the results of these tests the data for the runs made on the different controller notches were arranged so as to permit of convenient comparison as follows:

Part 1. — Locomotive Pulling Against Anchor.

- RUN 1. Straight track, notch No. 1.
- RUN 2. Curved track, notch No. 1.
- RUN 3. Straight track, notch No. 2.
- RUN 4. Curved track, notch No. 2.
- RUN 5. Straight track, notch No. 3.
- RUN 6. Curved track, notch No. 3.

Part 2. — Locomotive Running Without Trailers.

- RUN 7. Straight track, notch No. 1.
- RUN 8. Curved track, notch No. 1.
- RUN 9. Straight track, notch No. 2.
- RUN 10. Curved track, notch No. 2.
- RUN 11. Straight track, notch No. 3.
- RUN 12. Curved track, notch No. 3.

Part 3. — Locomotive Hauling Trailers.

- RUN 13. Straight, dry track, notch No. 1.
- RUN 14. Curved, dry track, notch No. 1.
- RUN 15. Curved, oily track, notch No. 1.
- RUN 16. Straight, dry track, notch No. 2.
- RUN 17. Curved, dry track, notch No. 2.
- RUN 18. Curved, oily track, notch No. 2.
- RUN 19. Straight, dry track, notch No. 3.
- RUN 20. Curved, dry track, notch No. 3.
- RUN 21. Curved, oily track, notch No. 3.

ORIGINAL MEASUREMENTS.

Measurements of Horizontal Effort.

In the horizontal effort tests, the locomotive pulled against a Stormbaugh guy anchor screwed in the ground to the eye and at a sharp angle with its surface. A stranded guy wire served to connect the anchor with the draw-bar of the locomotive.

In the trailer hauling tests, it was found to be impracticable to secure sufficient loading to reach the capacity of the locomotive, partly because there were not enough trailers available to carry such a load, and partly because conditions at the Fair

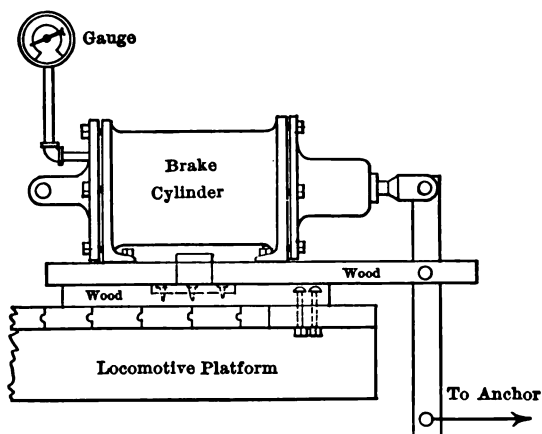

Fig. 105.—Oil Dynamometer. Industrial Locomotive.

Grounds did not permit of securing 50 tons of compact material at the time of the tests. It was not considered necessary, however, to so load the locomotive, because the static tests gave all of the necessary data for determining the general relation of current and horizontal effort, and a sufficient load was hauled to show the relation between the speed when hauling no trailers and the speed when hauling a reasonable load.

For the purpose of measuring the horizontal effort, a special oil dynamometer was constructed as shown in Fig. 105. An eight-inch Christensen air-brake cylinder, A, was mounted on a two-inch plank, which was arranged to rotate on a cast-iron

pin, *P*, securely fastened to the car platform. A flat steel lever *B*, with its fulcrum at *M*, transmitted the resisting force from the anchor cable to the piston rod. In order to reduce the internal friction of the cylinder, the packing rings of the piston were removed. The space behind the piston was filled with oil and a pressure gage was connected to this oil chamber for the purpose of reading the pressure produced on the oil by the piston. The oil lost by leakage was replaced by pumping additional oil behind the piston from time to time. The total ratio of the lever system was so arranged that the push upon the piston was 1.855 times that at the draw-bar. The area of the piston was 50.27 sq. in., so that for every one thousand pounds horizontal effort the pressure registered by the gage was 36.9 lbs. per square inch. In the actual operation of this apparatus, it was found necessary to clamp the dynamometer platform to the car platform when a large horizontal effort was to be measured, as there was a considerable tilting effect. The dynamometer was first allowed to take its natural position and it was then clamped securely in this position. When hauling the trailers this was not found to be necessary and the dynamometer was allowed to rotate about the pin *P*.

Electrical Measurements.

As the larger part of the tests comprised a study of the static pull of the locomotive, it would have been necessary to waste in resistance a large amount of the energy stored in the batteries, if the full battery pressure had been used. In order to save battery energy the batteries were tapped at such points as to give the desired current without the insertion of resistances, the variation in the current being produced by changing the number of cells furnishing the current. For the controller positions in which the batteries were normally connected in parallel, the separate batteries were similarly connected. While this operation made the tests somewhat tedious, the results amply justified the effort made, as it was possible to make many more tests with one battery charge than would otherwise have been the case.

The current was allowed to attain a steady value for each condition of the tests, and a series of measurements of e.m.f. and current were then made, corresponding to the several controller notches, Weston instruments being used. No attempt was made to determine the efficiency of the battery, as this was beyond the purpose of these tests. Furthermore, the conditions of operation were not the same as those of the ordinary application of the locomotive.

Speed Measurements.

The speed during the tests when the locomotive was running light or hauling trailers, was determined by noting the time of passing fixed points on the track.

WORKING UP THE RESULTS.

The results were first corrected for inaccuracies in the instruments and the data were then assembled on summary sheets, one of these being prepared for each test. The calculated results of the tests covering the performance of the car when pulling against an anchor, were finally transferred to curve sheets and represented in graphical form. It was found impracticable to represent graphically the results of the tests showing the performance of the locomotive under running conditions. These calculations were, therefore, worked up in tabular form.

RESULTS OF THE TESTS.

The general results of the tests have already been summarized in the synopsis, Table LVI. As this table shows all of the principal results obtained, for the running tests, these data will not be repeated here. However, additional data concerning the static tests will be found graphically represented in Figs. 106 to 111, inclusive. This series of six sets of curves shows the variations in the several quantities involved, such as horizontal effort, e.m.f., and power, with change of current.

the locomotive when hauling various loads. It was possible to carry the first series far beyond the limit of the ordinary demand upon the locomotive. In the second part of the tests, owing to the impracticability of obtaining sufficient load, it

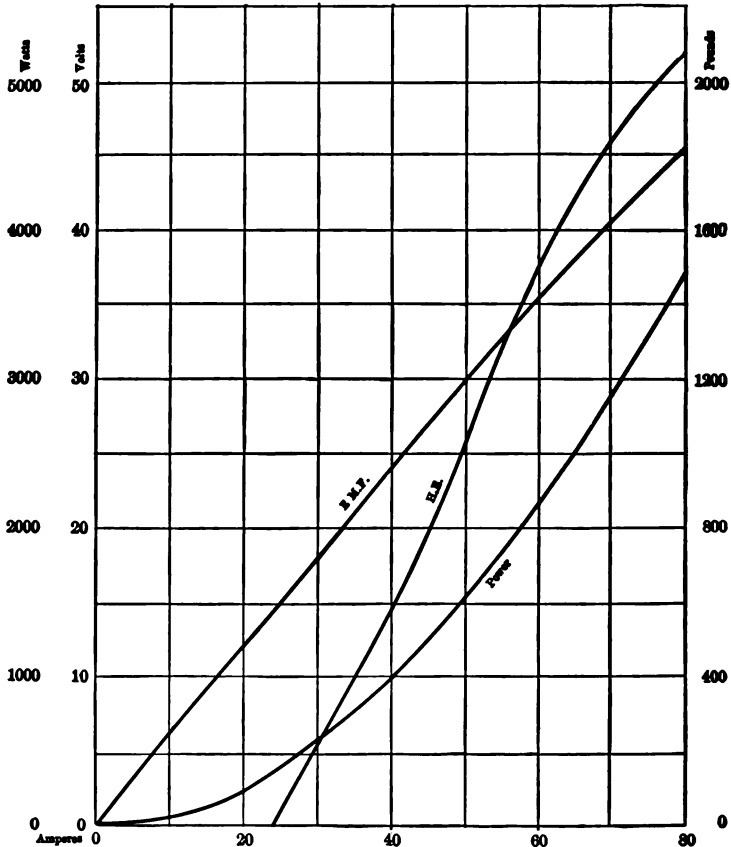

Fig. 107.—General Data, Industrial Locomotive Tests. Run No. 2.

was not possible to show the performance of the locomotive hauling heavily loaded trailers. However, a sufficient load was applied to obtain useful and interesting information regarding the efficiency of the equipment when hauling light loads. This efficiency would be considerably higher when hauling heavy

the locomotive pulls at a great disadvantage on a curve, even with the compensating flange already described. The tests show, however, that it developed a large horizontal effort, even on a curve, with a reasonable expenditure of current. As far

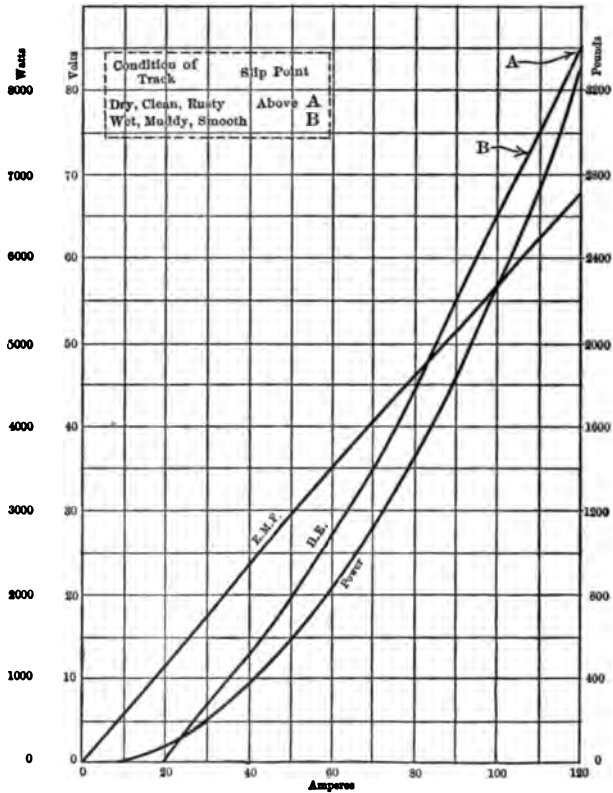

Fig. 109.—General Data, Industrial Locomotive Tests. Run No. 4.

as the production of horizontal effort is concerned, there is no choice between the first notch and the second notch. The reason for this is that the motors are connected in series in both cases. On the second notch, the horizontal effort was carried up to a point at which the wheels slipped. Naturally, the third notch gave less horizontal effort against the anchor, for a given

current, than the others, as in this position the motors were in parallel. As this is the high speed notch, it would not be used in starting the locomotive.

The second part of Table LVI shows the performance of the locomotive running light at various controller notches and on a dry track, and on both straight and curved portions of the track. This test shows approximately the amount of power which would be consumed in the locomotive itself when hauling trailers, although the electrical losses would be somewhat more

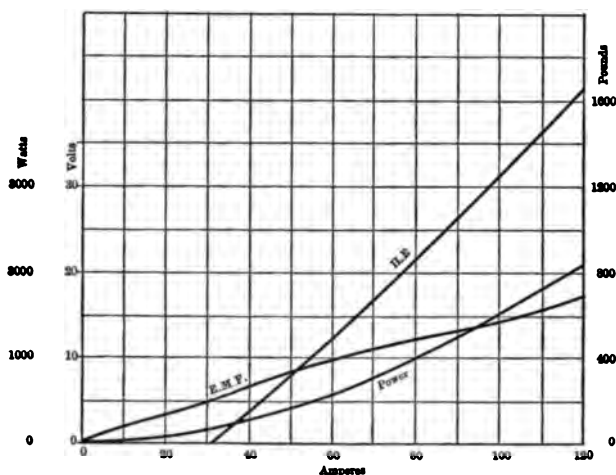

Fig. 110.—General Data, Industrial Locomotive Tests. Run No. 5.

under these conditions. The effect of the increased friction on curves is evidenced both by the reduction in speed and by the increased consumption of power. On notch No. 1, the speed is reduced to 74 per cent; on notch No. 2, to 84 per cent; and on notch No. 3, to 88 per cent, of the corresponding values on straight track. The respective increases in power amount to 59 per cent, 58 per cent, and 37 per cent.

Part 3 of Table LVI gives data showing the performance of the locomotive when hauling a light load. A comparison of the data with those appearing in other parts shows that the effect of this load upon the speed, as well as the effect on the

power consumption, is entirely negligible. The latter will be greater at notches Nos. 2 and 3 on the straight track, and less on all notches on the curved track. The table also shows the horizontal effort necessary to haul the given load at various speeds and on different kinds of track. The friction on the curved track was considerably reduced by oiling. This is shown by the decrease in power absorbed, by the increased speed, and by the diminished horizontal effort necessary to haul the trailers. Average values of the tractive effort per ton, calculated from these data are 34.3 lbs. per ton for the straight track; 62.9 lbs. per ton for the curved track, dry; and 56.7 lbs. per ton for the curved track, oiled.

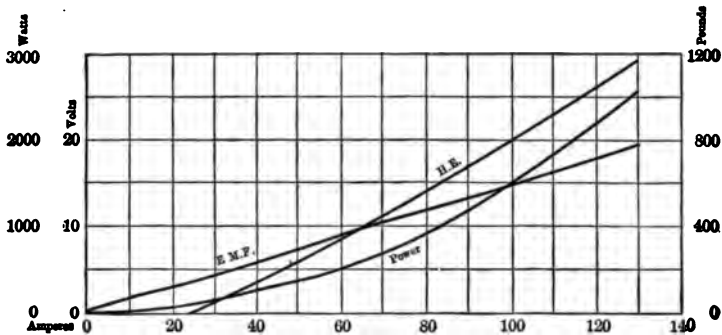

Fig. 111.—General Data, Industrial Locomotive Tests. Run No. 6.

Figs. 106 to 111, inclusive, show the general performance of the locomotive when pulling against an anchor. Fig. 106 shows that 16.5 amperes were required before any pull was observed upon the dynamometer. This much current was used in overcoming friction. The horizontal effort then increased at a uniform rate to a value of 2400 lbs., beyond which it was not considered advisable to go, on account of the current capacity of the battery, although no slip was observed at this point. The horizontal effort was about 24 per cent of the weight of the locomotive at the final value of current used.

Fig. 107, which represents the results of a test similar to that shown in Fig. 106 except that the locomotive was located on a

steel rails, due to the flow of alternating currents, are much larger than those which occur with direct currents.

The work done upon this subject up to the present time, both experimentally and by mathematical deduction, indicates that the current is driven to the surface of the conductor by means of a counter electromotive force generated in the conductor by the reversal of the magnetic flux. The electromotive force produced by the flux is greatest at the center, diminishing to the periphery of the rail, where it is a minimum. The consequence is an uneven distribution of the current in the rail, with a consequent increase of the actual resistance met by the current flowing. This result is known as "skin" effect in conductors, the name indicating that the current is conducted along the surface of the conductor. This "skin" effect is not very serious in the case of copper conductors, but with materials having a high magnetic permeability the magnetic flux produced by the current assumes a deflecting value which causes a considerable increase in apparent resistance.

In order to obtain information and data on this subject, a series of tests was undertaken by the Commission on single lengths of steel rails and on short lengths of steel of other sections. These tests covered a range of current of from 50 to 600 amperes per rail, and a range of frequency of from 10 to 60 cycles per second.

A rational mathematical expression of the loss due to the flow of an alternating current in a steel rail, is quite complex and is not of such form as to be readily used in calculation; and, therefore, in the obtaining of data, useful in constructing a simple empirical formula, tests undertaken on variously shaped sections, including rectangular, square, and round steel forms, and wrought-iron gas pipe, are most important.

The above indoor tests were later supplemented by a series of outdoor tests made upon the stretch of track lying north of the Transportation Building at the St. Louis Exposition. This has been called the "Test Track," and it is the track upon which the tests of the single-truck car, described in earlier

The direct current motor and generator were designed for a 220 volt circuit, and 220 volt mains were available at the testing table. The connections were so arranged that this set could be started on the 220 volt circuit, and, by throwing a switch, the generator and the 220 volt mains could be placed in series, producing a combined pressure of approximately 450 volts.

The rotary converter was usually started from the direct current side, power being furnished by the 450 volt circuit just mentioned. After the machine had been brought up to speed, it was synchronized with the alternating current-power circuit, and then switched over to this circuit.

It is seen from the above description of the equipment and of the circuits available in this exhibit, that an opportunity was presented for doing a large amount of experimental work involving wide ranges of current and frequency. A 50 k.w., 6600 to 110 volt transformer of the General Electric Company make, was loaned to the Commission by the Mechanical and Electrical Department of the Louisiana Purchase Exposition. With the addition of the necessary instruments and auxiliary devices, this completed the equipment used in the experimental determination of the alternating current losses in rails and track, which are discussed in this chapter, and in Chapter XIII.

GENERAL DESCRIPTION OF THE TESTS.

Tests were made upon two single-rail lengths of different cross-sectional areas. These rails were tested one at a time, the three-voltmeter method of making power measurements being employed. In addition, a series of similar investigations was carried out on steel bars of variously shaped sections, and of different cross-sectional areas. Tests were also conducted upon a wrought-iron gas pipe.

The tests were made at frequencies of 10, 15, 20, 25, 30, 40, 50, and 60 cycles per second. For each frequency, measurements were made at currents of approximately 50, 100, 200, 300, 400, 500, and 600 amperes. Both electrical and temperature measurements were taken for all conditions.

TEST No. 40. — This series was made upon a square steel section having an area of 6.29 sq. in., and a weight per yard of 64.15 lbs. The length tested was 8.56 ft.

TEST No. 41. — This series comprised tests on a round section having a diameter of .3 in. and an area of 7.1 sq. in. The weight per yard was 72 lbs. and the length tested was 8.16 ft.

TEST No. 42. — This test was on a round steel section, having a diameter of 2.5 in. and an area of 4.97 sq. in. The weight per yard was 50.6 lbs. and the length tested was 7.63 ft.

TEST No. 43. — This comprised tests on a piece of tool steel having a square cross-section with a diameter of 2.02 in., and an area of 4.05 sq. in. The weight per yard was 41.3 lbs. and the length tested was 6.95 ft.

TEST No. 44. — This comprised tests on a wrought-iron gas pipe, having an inside diameter of 3.07 in., and an outside diameter of 3.51 in. The cross-sectional area of the iron was 2.27 sq. in., the weight per yard 22.72 lbs., and the length tested, 18.43 ft.

It will be seen from the above description of the various tests, that the lengths of the different steel sections were not nearly as great as those of the rails tested. It was found impracticable to obtain either greater lengths or larger sections, at the time the tests were made.

ORIGINAL MEASUREMENTS.

In making the tests at frequencies of 60, 50, and 40 cycles per second, the electrical connections were at first as shown in Fig. 112. The rotary converter supplied power to the motor side of the motor-generator set and the frequency of the generator was adjusted by varying the speed of this motor by means of its field rheostat. The alternating current was taken from the generator side of the motor-generator set, connection being made to the high pressure winding of the General Electric transformer through an oil switch. The low pressure side of this transformer was short-circuited directly through the rail

ments of the amount of power absorbed in the rail with an alternating current flowing. All standard wattmeters are wound for a pressure of 110 volts or more, whereas the pressures involved in these measurements were in many cases less than one volt. There was little time for experimentation in

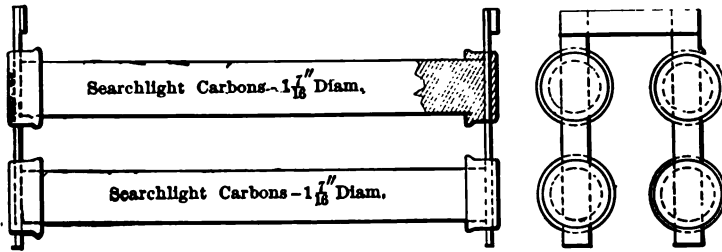

Fig. 115. — Carbon Resistance for A. C. Rail Tests.

the construction of a special type of wattmeter for this purpose, nor did it seem wise to attempt to employ such an instrument. It was finally decided that the "three voltmeter method" was the simplest, most straightforward, and most reliable one, and therefore best adapted to the purposes of the investigation. The question which next arose was that of a suitable non-

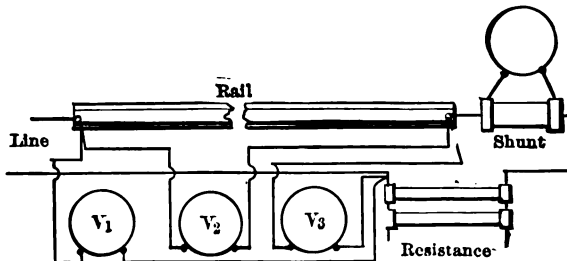

Fig. 116. — Diagram of Connections for A. C. Rail Tests.

inductive resistance to be used in connection with this method of testing. It was necessary that this resistance should have a low value, that it should be capable of carrying a maximum current of 600 amperes, and that it should be fairly constant. A water rheostat was found to be out of the question, undesirable from the standpoint of exhibitors. The

as it was
resistance

It is seen from this brief description that the object of inserting the non-inductive resistance into the circuit is to obtain three interrelated voltmeter readings, one of which is in phase with the current.

If the value of the current and pressure across the rail and their phase relation are known, the power lost in the rail is expressed by the equation,

$$P = E_2 I \cos \alpha.$$

The value of the cosine of the angle α is readily obtained if the three pressures which form the triangle are known. The final expression for the power lost in the inductive part of the circuit is,

$$P = \frac{E_1^2 - E_2^2 - E_3^2}{2R}.$$

Temperature Measurements.

Thermometers were placed at different points along the rail, both above and below, and the bulbs were inclosed in small pasteboard boxes filled with waste to prevent radiation of the heat. Readings both of these thermometers and of thermometers suspended in the air near the rail, were taken at frequent intervals.

Data Sheets.

In recording the measurements of all quantities connected with the tests a blank form, similar to that shown in Fig. 118, was used.

Calibration of Instruments.

While it would be inferred that proper calibration of instruments was made, it is considered desirable to make special mention of this matter in connection with the present series of tests for the reason that the methods of measurement employed required the most careful calibration. The National Bureau of Standards rendered great assistance in this connection. In addition to calibrating the various electrical instruments, it also obtained for the Executive Committee the ratios of trans-

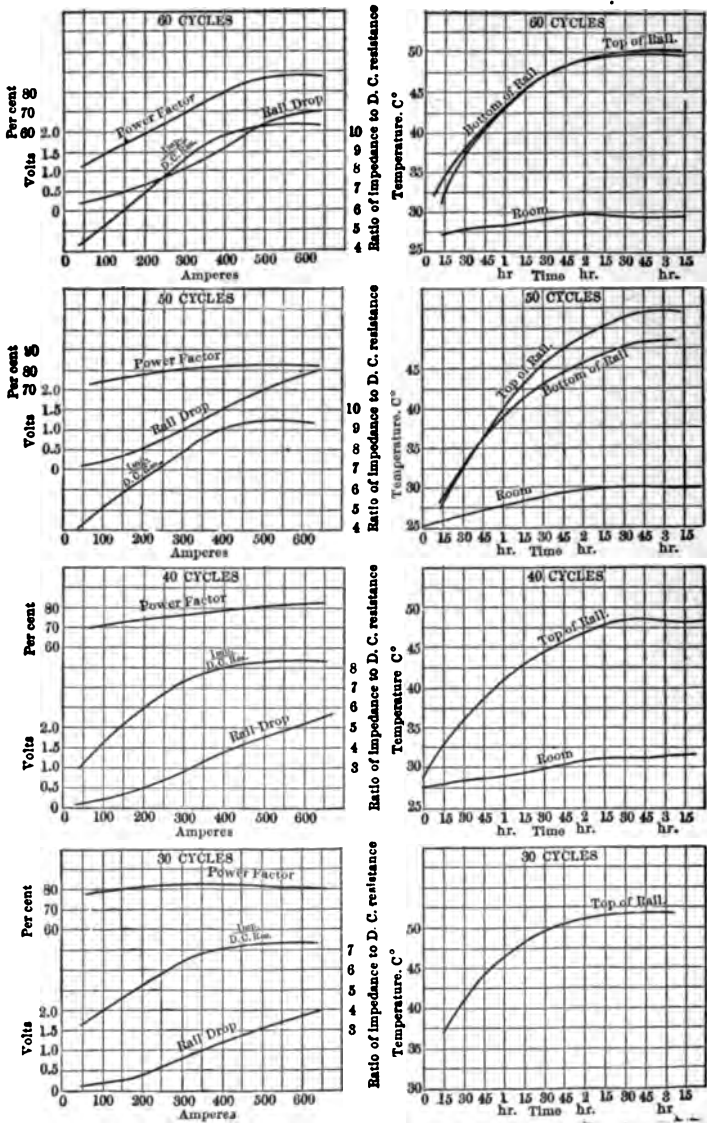

Fig. 120.—General Data Runs, 1 to 4, 56 lb. Rail, A. C. Rail Tests.

tains the same data as the preceding one, except that the frequency has been given prominence instead of the current.

Fig. 124 shows the ratio of (A.C.) impedance to (D.C.) resistance, plotted against frequency. While these data do not yield as smooth curves as those shown in the preceding sheet, the

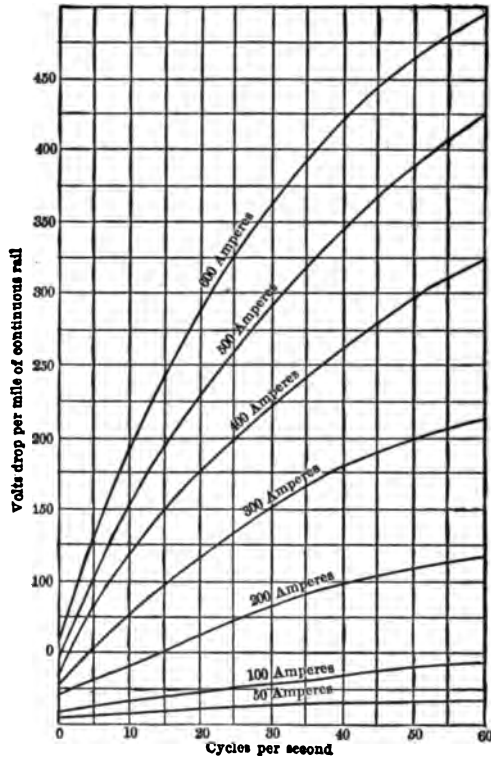

Fig. 122.—Frequency Drop Curves, 56 lb. Rail, A. C. Rail Tests.

curves illustrate the general tendency of this ratio to increase with the frequency.

Fig. 125 shows the same ratio plotted against amperes per rail, the frequency remaining constant for a given curve.

Fig. 126 shows the relation of the power losses and the frequency with given currents, while Fig. 127 shows the relation of the power losses and the current for fixed frequencies.

TABLE LVIII. — Test No. 39. — Magnetic Properties of Eighty-Pound Tee-Rail.

B.	H.	μ .
2,000	4.03	496
4,000	6.00	667
6,000	7.78	773
8,000	10.15	788
10,000	13.95	717
11,000	16.75	657
12,000	20.00	600
13,000	24.30	542
14,000	29.15	478
15,000	37.80	497
16,000	53.00	308
16,500	62.00	266

The results of these tests are shown in Figs. 129 to 135.

Fig. 129 shows the general electrical data for the entire series of runs, no special temperature runs having been made with

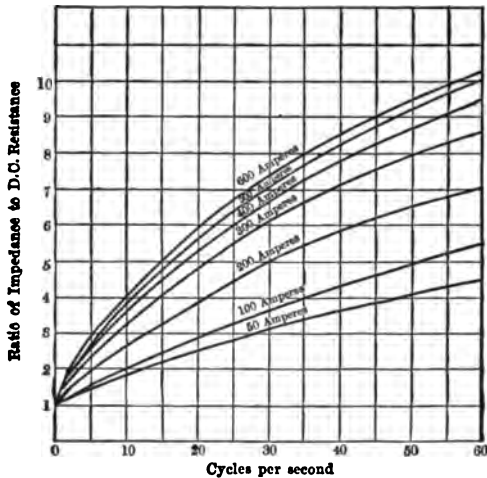

Fig. 124. — Frequency Ratio Curves, 56 lb. Rail, A. C. Rail Tests.

this section. The relations of the several variables have been placed in the form of "cross" curves, as in the preceding tests, and these are shown in Figs. 130 to 135.

Fig. 130 shows the relation between volts drop per mile of continuous rail and the frequency, for the various given values of the current.

Fig. 131 shows the same data in reverse form; that is, the variation of volts drop per mile of continuous rail with the

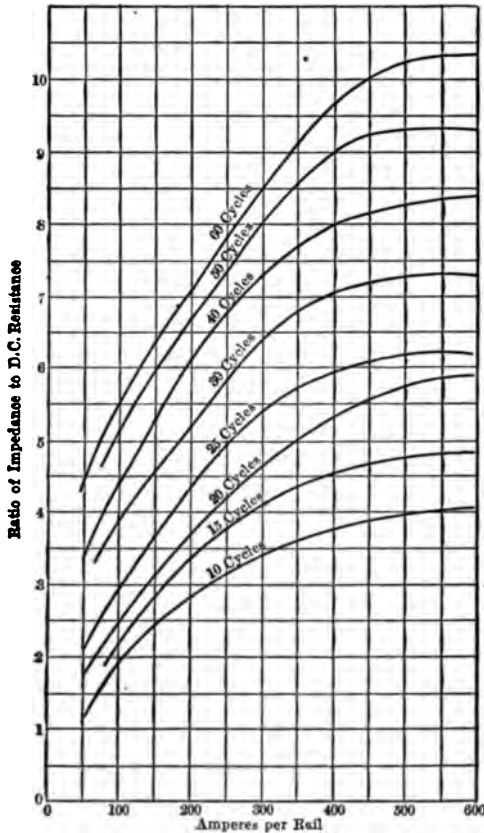

Fig. 125.—Current Ratio Curves, 55 lb. Rail, A. C. Rail Tests.

amperes per rail, for the several given frequencies, including zero frequency or continuous current.

Fig. 132 shows the relation of the ratio of impedance to D.C. resistance and the frequency, for given values of current; while Fig. 133 shows the same ratio compared with the current,

for several given values of frequency. The data shown are somewhat inconclusive as far as high current densities are

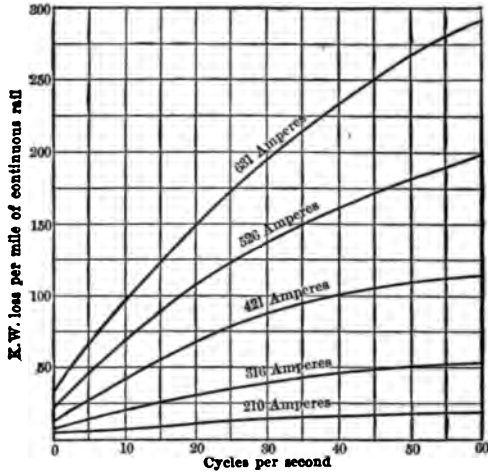

Fig. 126.— Frequency Power Curves, 56 lb. rail, A. C. Rail Tests.

concerned, but they serve to show the general relation of the variables.

Figs. 134 and 135 give the power loss data for the several currents and frequencies per mile of continuous rail.

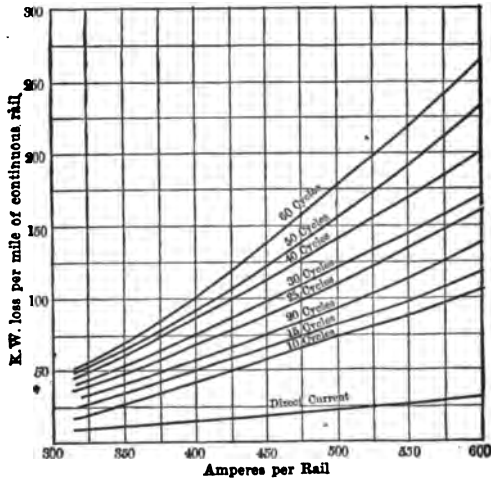

Fig. 127.— Current Power Curves, 56 lb. Rails, A. C. Rail Tests.

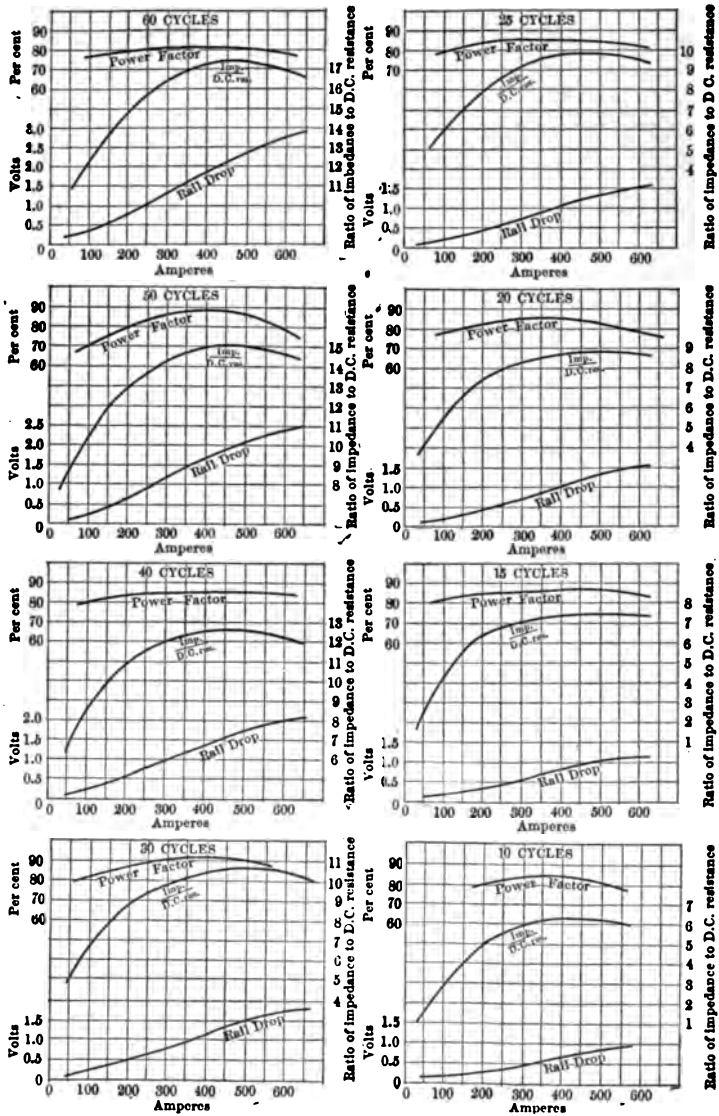

Fig. 129. — General Data, 80 lb. Rail, A. C. Rail Tests.

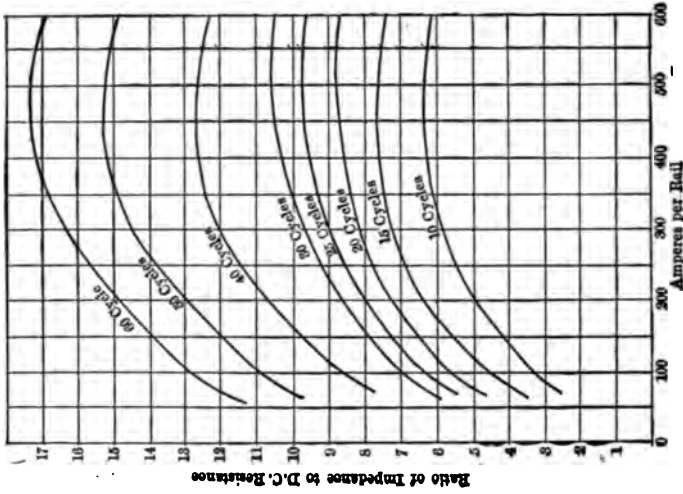

Fig. 132. — Frequency Ratio Curves, 80 lb. Rail, A. C. Tests.

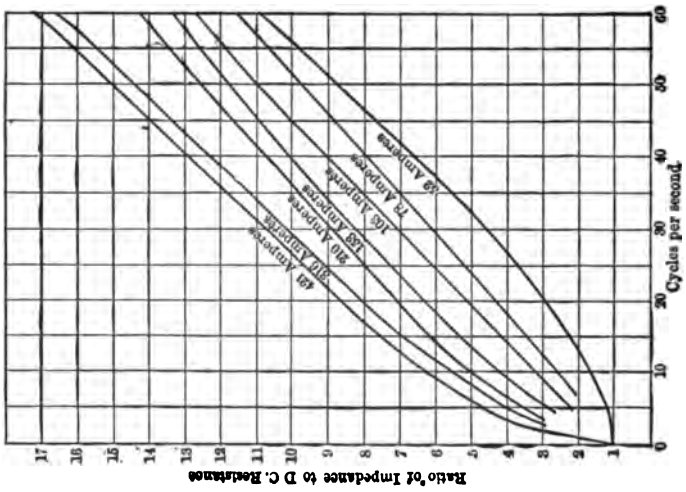

Fig. 133. — Current Ratio Curves, 80 lb. Rail, A. C. Rail Tests.

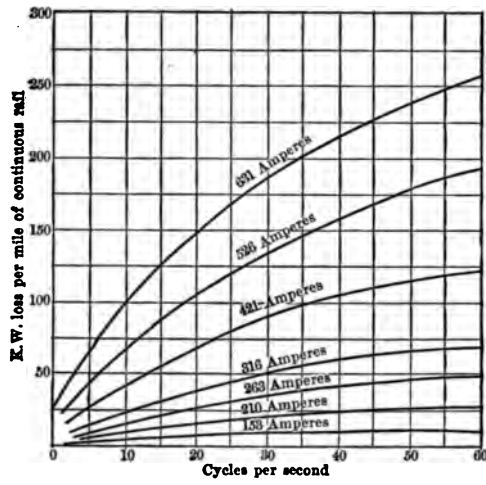

Fig. 134. — Frequency Power Curves, 80 lb. Rail, A. C. Tests.

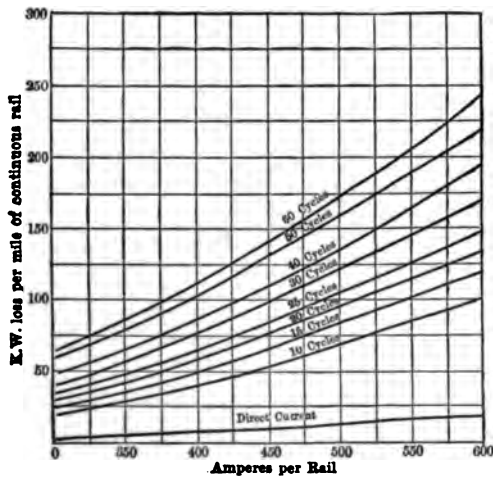

Fig. 135. — Current Power Curves, 80 lb. Rail, A. C. Tests.

TEST No. 40.

TABLE LIX. — A.C. Losses in Square Section.

DIAM. 2.51 IN. AREA 6.295 SQ. IN. LENGTH 8.562 FT.

Frequency, 10 Cycles per Second.

CURRENT.	VOLTS.	WATTS.	IMPEDANCE.	RATIO IMPEDANCE TO A.C. RESISTANCE.
526	0.491	108	0.00094	7.9
421	0.393	141	0.00094	7.9
316	0.292	74	0.00092	7.8
263	0.233	50	0.00089	7.5
210	0.189	31	0.00090	7.6
153	0.132	15	0.00086	7.3
103	0.069	6	0.00067	5.7
78	0.048	2	0.00062	5.2

Frequency, 15 Cycles per Second.

621	0.693	322	0.00110	9.3
526	0.578	258	0.00110	9.3
421	0.497	158	0.00118	10.0
316	0.317	99	0.00100	8.5
263	0.314	64	0.00119	10.1
210	0.243	38	0.00116	9.8
153	0.181	20	0.00118	10.0
103	0.099	8	0.00096	8.1
78	0.063	3	0.00080	6.7
52	0.042	0.8	0.00081	6.9

Frequency, 20 Cycles per Second.

621	0.796	404	0.00126	8.6
526	0.704	289	0.00134	8.8
421	0.572	220	0.00136	11.5
316	0.452	119	0.00143	11.2
263	0.376	82	0.00143	12.1
210	0.297	46	0.00141	12.0
153	0.211	24	0.00138	11.7
103	0.122	10	0.00118	10.0
78	0.066	5	0.00085	7.2
52	0.046	1	0.00089	7.5

Frequency, 25 Cycles per Second.

621	0.926	446	0.00147	12.4
526	0.825	314	0.00157	13.2
421	0.680	202	0.00161	13.6
316	0.516	142	0.00163	13.8
263	0.428	101	0.00163	13.8
210	0.336	55	0.00160	13.5
153	0.168	23	0.00109	7.9

ALTERNATING CURRENT LOSSES

Frequency, 30 Cycles per Second.

CURRENT.	VOLTS.	WATTS.	IMPEDANCE.	RATIO IM- PEDANCE. TO A.C. RESISTANCE.
621	1.007	573	0.00160	13.5
526	0.870	362	0.00165	14.0
421	0.727	239	0.00173	14.6
316	0.558	156	0.00177	14.9
263	0.478	120	0.00182	15.4
153	0.271	38	0.00177	14.9
103	0.160	13	0.00156	13.2
78	0.103	6	0.00132	11.1
52	0.049	2	0.00099	8.0

Frequency, 40 Cycles per Second.

621	1.325	588	0.00210	17.8
526	1.162	420	0.00221	18.7
421	0.960	278	0.00228	19.3
316	0.707	188	0.00225	19.0
263	0.590	120	0.00224	18.9
210	0.465	72	0.00221	18.7
153	0.348	40	0.00227	19.2
103	0.208	15	0.00202	17.1
78	0.130	8	0.00167	14.1
52	0.073	3	0.00140	11.8

Frequency, 50 Cycles per Second.

526	1.260	474	0.00239	20.2
421	1.053	310	0.00250	21.2
316	0.780	166	0.00247	20.8
263	0.642	125	0.00243	20.7
210	0.521	86	0.00248	20.0
153	0.406	47	0.00265	22.4
103	0.247	19	0.00239	20.2
78	0.167	11	0.00214.	18.1
52	0.089	4	0.00172	14.5

Frequency, 60 Cycles per Second.

621	1.560	715	0.00251	21.2
526	1.380	509	0.00262	22.2
421	1.175	347	0.00279	23.6
316	0.843	221	0.00266	22.5
263	0.730	149	0.00278	23.5
210	0.589	78	0.00280	23.7
153	0.475	61	0.00310	22.1
103	0.296	25	0.00287	24.3
78	0.196	12	0.00252	21.3
52	0.101	5	0.00194	16.4

TEST No. 41.

TABLE LX. — A.C. Losses in Round Section.

DIAM. 1.5 IN. AREA 7.068 Sq. IN. LENGTH 8.16 Ft.

Frequency, 10 Cycles per Second.

CURRENT.	VOLTS.	WATTS.	IMPEDANCE.	RATIO IM- PEDANCE TO D.C. RESISTANCE.
526	0.506	154	0.00096	9.0
421	0.420	171	0.00100	9.4
316	0.352	75	0.00111	10.5
263	0.286	55	0.00109	10.3
210	0.204	35	0.00097	9.1
153	0.153	19	0.00100	9.4
103	0.096	7	0.00094	8.8
78	0.061	4	0.00078	7.3

Frequency, 15 Cycles per Second.

631	0.720	318	0.00114	10.7
526	0.637	201	0.00121	11.4
421	0.543	147	0.00127	11.9
316	0.436	89	0.00138	13.0
263	0.371	62	0.00141	13.3
210	0.203	45	0.00130	12.2
103	0.132	10	0.00128	12.1
78	0.083	5	0.00106	10.0
52	0.051	1	0.00099	9.3

Frequency, 20 Cycles per Second.

631	0.820	354	0.00130	12.2
526	0.725	247	0.00138	13.0
421	0.596	199	0.00141	13.3
316	0.482	101	0.00152	14.3
263	0.384	70	0.00146	13.7
210	0.308	52	0.00146	13.7
153	0.241	26	0.00158	14.9
103	0.145	11	0.00140	13.2
78	0.087	5	0.00112	10.5
52	0.056	2	0.00108	10.2

Frequency, 25 Cycles per Second.

631	0.958	412	0.00152	14.3
526	0.843	295	0.00160	15.1
421	0.712	188	0.00169	15.9
316	0.553	128	0.00175	16.5
263	0.464	97	0.00176	16.6
210	0.364	57	0.00173	16.3
153	0.275	31	0.00180	16.9
103	0.170	13	0.00165	15.5
78	0.116	7	0.00149	14.0
52	0.057	2	0.00110	10.4

TEST NO. 42.

TABLE LXI. — A.C. Losses in Round Section.

DIAM. 1.25 IN. AREA 4.97 SQ. FT. LENGTH 4.97 FT.

Frequency, 10 Cycles per Second.

CURRENT.	VOLTS.	WATTS.	IMPEDANCE.	RATIO IM- PEDANCE. TO D.C. RESISTANCE.
526	0.575	176	0.00109	7.9
421	0.461	123	0.00109	7.9
316	0.383	75	0.00121	8.8
263	0.328	64	0.00125	9.1
210	0.240	42	0.00114	8.3
153	0.176	17	0.00115	8.3
103	0.099	7	0.00096	6.9
78	0.069	4	0.00088	6.4
52	0.058	0.8	0.00110	8.0

Frequency, 15 Cycles per Second.

631	0.780	292	0.00124	9.1
526	0.695	214	0.00132	9.7
421	0.582	134	0.00138	10.1
316	0.486	96	0.00154	11.3
263	0.435	64	0.00165	12.1
210	0.314	49	0.00150	11.0
103	0.139	8	0.00135	9.9
78	0.095	4	0.00122	9.0
52	0.052	1	0.00100	7.4

Frequency, 20 Cycles per Second.

631	0.908	344	0.00144	10.7
526	0.797	232	0.00151	11.2
421	0.658	213	0.00156	11.6
316	0.545	110	0.00172	12.8
263	0.398	87	0.00151	11.2
210	0.356	37	0.00170	12.6
103	0.162	11	0.00157	11.6
78	0.110	5	0.00141	11.5
52	0.060	2	0.00115	8.5

Frequency, 25 Cycles per Second.

631	1.033	410	0.00164	12.1
526	0.920	299	0.00175	12.9
421	0.778	203	0.00185	13.7
316	0.613	137	0.00194	14.3
263	0.519	90	0.00197	14.5
210	0.412	73	0.00196	14.5
153	0.304	31	0.00199	14.7
103	0.189	13	0.00183	13.5
78	0.128	6	0.00164	12.1
52	0.071	2	0.00136	10.0

ALTERNATING CURRENT LOSSES

421

Frequency, 30 Cycles per Second.

CURRENT.	VOLTS.	WATTS.	IMPEDANCE.	RATIO IMPEDANCE TO D.C. RESISTANCE.
631	1.153	461	0.00183	13.4
526	1.023	335	0.00195	14.3
421	0.870	243	0.00206	15.1
316	0.696	151	0.00220	16.1
263	0.585	107	0.00222	16.3
210	0.476	72	0.00227	16.7
153	0.343	38	0.00224	16.4
103	0.211	14	0.00205	15.0
78	0.147	6	0.00187	13.7
52	0.076	2	0.00146	10.7

Frequency, 40 Cycles per Second.

631	1.390	560	0.00220	16.1
526	1.550	381	0.00234	17.1
421	1.030	272	0.00245	18.0
316	0.800	167	0.00253	18.5
263	0.655	133	0.00249	18.2
210	0.543	85	0.00259	19.0
153	0.400	49	0.00261	19.1
103	0.255	16	0.00248	17.6
78	0.172	7	0.00220	16.1

Frequency, 50 Cycles per Second.

631	1.530	605	0.00244	17.8
526	1.360	441	0.00258	18.8
421	1.150	300	0.00273	19.9
316	0.870	199	0.00275	20.1
263	0.735	139	0.00280	20.4
153	0.463	55	0.00302	20.0
103	0.298	20	0.00289	21.1
78	0.198	11	0.00254	18.5
52	0.098	3	0.00189	13.8

Frequency, 60 Cycles per Second.

631	1.710	673	0.00271	20.0
526	1.500	500	0.00285	20.9
421	1.260	359	0.00301	22.1
316	0.940	207	0.00298	21.9
263	0.800	163	0.00304	22.4
210	0.695	101	0.00330	24.3
153	0.520	63	0.00340	25.0
103	0.347	22	0.00336	24.7
78	0.236	13	0.00298	21.9
52	0.118	4	0.00227	16.7

TEST No. 43.

TABLE LXII. — A.C. Losses in Square Section.

DIAM. 2.01 IN. AREA 4.05 Sq. IN. LENGTH 6.948 FT.

Frequency, 10 Cycles per Second.

CURRENT.	VOLTS.	WATTS.	IMPEDANCE.	RATIO IMPEDANCE TO D.C. RESISTANCE.
526	0.575	249	0.00109	8.9
421	0.490	172	0.00116	9.5
316	0.326	102	0.00103	8.5
263	0.302	78	0.00115	9.4
210	0.243	52	0.00116	9.5
153	0.176	24	0.00115	9.4
103	0.117	13	0.00114	9.4
78	0.085	7	0.00109	8.9
52	0.052	3	0.00101	8.3

Frequency, 15 Cycles per Second.

631	0.776	471	0.00123	10.1
526	0.655	358	0.00124	10.2
421	0.583	225	0.00138	11.3
316	0.422	137	0.00133	10.9
263	0.359	102	0.00137	11.3
210	0.253	57	0.00121	9.9
153	0.181	29	0.00118	9.7
103	0.121	13	0.00117	9.6
78	0.083	10	0.00106	8.7
52	0.051	3	0.00099	8.1

Frequency, 20 Cycles per Second.

631	0.852	512	0.00135	11.1
526	0.526	198	0.00100	8.3
421	0.570	240	0.00135	11.1
316	0.427	135	0.00135	11.1
263	0.371	94	0.00141	11.7
210	0.273	59	0.00130	10.7
153	0.198	29	0.00129	10.7
103	0.130	15	0.00126	10.4
78	0.096	8	0.00124	10.2
52	0.061	3	0.00118	9.8

Frequency, 25 Cycles per Second.

526	0.767	366	0.00146	12.0
421	0.615	245	0.00146	12.0
316	0.457	134	0.00144	11.8
263	0.383	74	0.00146	12.0
210	0.282	59	0.00135	11.1
153	0.209	33	0.00136	11.2
103	0.135	15	0.00131	10.8
78	0.102	9	0.00131	10.8
52	0.066	3	0.00127	10.4

TEST NO. 44.

TABLE LXIII. — A.C. Losses in Pipe Section.

AREA 2.27 SQ. IN. LENGTH 18.427 FT. INSIDE DIAMETER 3.07 IN.
OUTSIDE DIAMETER 3.51 IN.

Frequency, 10 Cycles per Second.

CURRENT.	VOLTS.	WATTS.	IMPEDANCE.	RATIO IM- PEDANCE TO D.C. RESISTANCE.
474	1.150	424	0.00524	7.4
421	1.068	305	0.00254	3.6
316	0.845	183	0.00267	3.8
263	0.725	129	0.00275	3.9
210	0.598	87	0.00285	4.0
153	0.492	55	0.00322	4.5
103	0.382	25	0.00371	5.2
78	0.258	19	0.00331	4.7
52	0.141	7	0.00272	3.8

Frequency, 15 Cycles per Second.

631	1.615	766	0.00256	3.6
526	1.483	572	0.00282	4.0
421	1.283	343	0.00305	4.3
263	0.897	186	0.00341	4.8
210	0.760	123	0.00362	5.1
103	0.461	34	0.00448	6.3
78	0.344	20	0.00428	6.0

Frequency, 20 Cycles per Second.

631	1.900	883	0.00310	4.3
526	1.670	670	0.00318	4.4
421	1.510	470	0.00358	5.0
316	1.220	298	0.00386	5.4
263	1.080	214	0.00410	5.7
210	0.880	144	0.00420	5.8
153	0.725	88	0.00474	6.6
103	0.518	40	0.00503	7.0
78	0.387	25	0.00496	6.9

Frequency, 25 Cycles per Second.

631	2.080	982	0.00330	4.6
526	1.880	764	0.00358	5.0
421	1.650	512	0.00393	5.5
316	1.373	307	0.00434	6.1
263	1.175	240	0.00447	6.3
210	0.941	157	0.00448	6.3
153	0.781	96	0.00510	7.2
103	0.572	49	0.00555	7.8
78	0.438	27	0.00561	7.9
52	0.272	12	0.00522	7.3

ALTERNATING CURRENT LOSSES

425

Frequency, 30 Cycles per Second.

CURRENT.	VOLTS.	WATTS.	IMPEDANCE.	RATIO IM- PEDANCE TO D.C. RESISTANCE.
631	2.310	1258	0.00366	5.0
526	2.080	811	0.00396	5.5
421	1.830	581	0.00435	6.0
316	1.500	342	0.00474	6.5
263	1.292	275	0.00491	6.8
210	1.058	175	0.00504	7.0
153	0.853	106	0.00557	7.7
103	0.621	51	0.00603	8.3
78	0.467	29	0.00599	8.3
52	0.282	16	0.00542	7.5

Frequency, 40 Cycles per Second.

631	2.620	1595	0.00416	5.9
526	2.360	865	0.00449	6.4
421	2.023	647	0.00486	6.9
316	1.674	402	0.00529	7.5
263	1.420	308	0.00540	7.7
210	1.190	213	0.00567	8.1
153	0.950	117	0.00621	8.9
103	0.681	55	0.00661	9.4
78	0.509	34	0.00652	9.3
52	0.291	14	0.00560	8.6

Frequency, 50 Cycles per Second.

631	2.030	1850	0.00480	6.5
526	2.720	1382	0.00516	7.0
421	2.660	980	0.00561	7.6
316	1.896	493	0.00600	8.1
263	1.667	298	0.00634	8.5
210	1.372	225	0.00654	8.8
153	1.100	146	0.00719	9.7
103	0.770	69	0.00747	10.1
78	0.613	42	0.00785	10.6
52	0.369	16	0.00710	9.6

Frequency, 60 Cycles per Second.

631	3.280	1960	0.00520	7.3
526	2.960	1510	0.00562	7.9
421	2.540	845	0.00603	8.5
316	2.040	508	0.00645	9.1
263	1.790	374	0.00680	9.6
210	1.560	221	0.00743	10.5
153	1.170	151	0.00765	10.8
103	0.890	79	0.00860	12.1
78	0.666	43	0.00853	12.0
52	0.518	16	0.00765	10.8

DISCUSSION OF RESULTS.

Data on Light Rail Section, Test No. 38.

RAIL DROP DATA. — An inspection of the rail drop curves shows that the drop increases almost proportionately with the current at all frequencies. A slight tendency toward curvature is noticed both at the lower and the upper parts of the curve. The same characteristic form is preserved for the various frequencies. The curves show the variations over a wide range of frequency and current. The results illustrate, therefore, what may be expected under average conditions of operation. As is to be anticipated, the drop is very much greater at the high frequencies, and the curves show that with a current of 300 amperes per rail, a frequency of 50 cycles produces approximately twice the drop which is caused by a frequency at 15 cycles. This is due to the fact that, at the high frequencies, the current is driven to the surface of the rail, and the actual electric resistance is thereby greatly increased. The fact that this drop is largely due to an increase of resistance is evident from a study of the power-factor curves, which show that, roughly speaking, the power factor in the rail is not far from 80 per cent. The inductive effect in the rail is, therefore, small, compared with the "skin effect" produced by the driving of the current to the surface of the rail.

THE IMPEDANCE-RESISTANCE CURVES. — The curves showing the ratio of alternating current impedance to the D.C. resistance have a characteristic form, which is preserved throughout the entire range of the tests. At very low values of the current, the ratio approaches unity, especially in the low frequency tests. It will be noted that at the low values of current, the power factor corresponding to the drop, is somewhat reduced, showing that this drop contains a larger inductive component than at the high values of current. This is due to the fact that at low current densities, the current is more uniformly distributed over the section of the rail, and, therefore, more magnetic flux surrounds the current, in proportion to the

rail, and hence, especially at the higher frequencies, there is a proportionally less counter e.m.f. produced in the rail with a large current than with a small.

TEMPERATURE DATA. — The importance of the temperature data in corroborating the deductions drawn from the other tests, lies in the fact that since the increased pressure drop is accompanied by an increase in the energy loss (resistance, eddy current, and hysteresis) in the rail, the pressure drop is due in a great part to a loss in the energy which is being transmitted through the rail, and all such energy losses are directly proportional in alternating current working, in their effect upon the power factor to the apparent non-inductive resistance of the circuit. This is clearly the case, as shown by the temperature curves. In the temperature tests, the current was maintained constant at 631 amperes. The curves show that at the end of two hours, the temperature had risen as follows: 60 cycles, 49°; 50 cycles, 47°; 40 cycles, 47° (top of rail only); 30 cycles, 46°; 25 cycles, 44°; 20 cycles, 42°; 15 cycles, 42°. These data were in practically all cases the average of readings taken at the top and at the bottom of the rail, the former being in most cases considerably greater than the latter.

THE POWER DATA. — The power curves show in a conclusive manner, the considerable losses which are to be expected in transmitting currents of any considerable value through a steel rail. These losses are greatest at high frequencies, but they are large even at low frequencies. In alternating current practice, it will be undoubtedly the case that the currents in the rails will be smaller than is customary at the present time in direct current practice, owing to the higher pressures which will be employed; however, even with this decrease in current, the loss in the rails is certain to assume considerable proportions.

Data on Heavy Rail Section. Test No. 39.

RAIL DROP DATA. — In comparing the drop produced in the heavy rail with the corresponding value in the light rail, for any given current, the surprising fact is noted that with the

the runs on the heavy rail were those necessary to determine the direct current resistance with various currents, and to determine the temperature coefficient with which to correct for the differences in temperature. No special temperature runs were made, as it was considered that the data secured for the light rail yielded all the necessary information in regard to the heating effect of the current. From the data there obtained, it is evident that the increased surface of the rail is not sufficient to radiate the extra heat generated without an increase in the temperature.

THE POWER DATA. — As would naturally follow from the higher resistance and power factor in the large rail, the loss per mile with a given current and frequency are correspondingly greater.

Data on Square Sections. Tests Nos. 40 and 43.

While of less importance than the sections previously discussed, the square section is sometimes important in case it is ever desired to use a third rail conductor for alternating currents.

The square section has a large area compared with its periphery, and it should therefore give a fairly large ratio of impedance to D.C. resistance. Tables LIX and LXII show this to be the case, as the ratio varies between a moderate value for the very low frequencies to a very high value at 60 cycles. As in the case of the large and small rails, the ratio of impedance to D.C. resistance is greater with the large section than with the small section. The power loss, however, appears to be greater with the smaller section in this case, although the difference is not very great. This difference is quite marked at the low frequencies, while at the high frequencies the power consumption is more nearly the same in the two samples tested. As has been previously explained, the samples were of very hard steel, and, as it was impracticable to make any magnetic measurements, the difference may easily be due to either or both the magnetic and electrical qualities of the steel. It would be safer, therefore, to accept these data as

CHAPTER XIII.

ALTERNATING CURRENT LOSSES IN TRACK.

OBJECTS OF THE TESTS.

THE principal object of these tests was to ascertain the energy losses in an actual stretch of track when subjected to alternating current, to observe the effects of varying the strength of these currents and their frequency, and to compare the losses with those resulting from equivalent direct currents.

Another object was to determine and compare the losses resulting when the current flowed in a single rail, in both rails of a single track, and in the four rails of a double track. Another important matter was the separation of the energy losses due to the current flowing in the track rails from the energy losses in the overhead construction.

SYNOPSIS OF RESULTS.

On account of the nature of the results of these tests, it has been found very impracticable to summarize the general results in a single table. The synopsis at the beginning of this chapter is therefore omitted, and the curves found later on in the chapter are depended upon to show the scope of the work and the results obtained.

GENERAL CONDITIONS OF THE TESTS.

Chapter XII contains the results of a large number of investigations relating to the alternating current losses in steel rails and in other steel and iron sections, under different conditions of frequency and current density. While it is believed that the data and results set forth in that chapter, truly represent the

losses occurring in single lengths of the various sections tested, it has not been considered that tests of this nature necessarily represent the losses which would actually occur in the case of a constructed track.

In order to compare the results obtained on individual rail lengths with those which might be expected in a constructed track, and to furnish additional data of this nature for use in alternating current railway installations, a series of investigations was carried out on the test tracks lying directly north of and parallel to the Palace of Transportation at the St. Louis Exposition.

THE TEST TRACK.

Fig. 136 gives a plan of the tracks, and shows their position relative to the Palace of Transportation and to the tracks of the Intramural Railway. It is seen that the test tracks were two in number, and were situated between the Intramural Railway and the north side of the Palace of Transportation, and that they ran directly east and west, paralleling the Intramural tracks. Both test tracks were connected to the Intramural tracks at the west end, and the north one of the two test tracks was connected to the Intramural tracks at the east end. The south test track was "dead-ended" at the east end of the Palace of Transportation. The stretch of double track was about 1200 ft. in length.

Fig. 136 also shows a cross-sectional sketch giving the general grade levels. It is seen that both of the test tracks were somewhat lower than the Intramural tracks, and that the north test track level was higher than that of the south test track. The difference in level between the two test tracks was approximately three feet. The switching and crossing connections between the various tracks are also shown in Fig. 136.

The tracks were laid with 56-lb. Tee rails, A. S. C. E. standard, 30 ft. lengths, 4 ft. 8½ in. gage, and 15 ft. centers, on oak ties of standard size, twelve to a rail length, which were set in cinder ballast. There were several short stretches of metal ties of different makes in the south track.

For the sixty frequency tests, the power supply was as shown in Fig. 112, Chapter XII. The motor-generator set was driven from the 500 k.w., 500 volt, 25 cycle, three-phase rotary converter, which in turn was supplied with power from the 6600 volt, three-phase power mains of the Exposition Company; the pressure of these mains being reduced to the proper value by means of three Bullock transformers of the oil cooled type.

For the forty frequency tests, connections were similar to those of Fig. 113 of Chapter XII. The motor-generator set was driven from a composite circuit made up of the 240 volt, direct current power mains in series with the 240 volt, 150 k.w. direct current generator; the latter being driven by the 150 horse power, 240 volt direct current motor. This driving motor was supplied with power from the 240 volt direct current power mains. The frequency of the alternating current used in the tests was adjusted by means of the rheostats in the fields of the direct current machines.

For the fifteen and twenty-five frequency tests the power supply connections were similar to those shown in Fig. 113, except that the field of the direct current motor, driving the supply alternator, was connected directly across the 240 volt power mains and the 240 volt direct current generator in series, while the armature of this motor was supplied directly from the 240 volt power mains. By this means, the driving motor was supplied with a strong magnetic field, while its speed could be adjusted readily by means of varying the pressure across its armature terminal. Power for the direct current measurements was furnished from the 100 k.w., 240 volt generator, and was transmitted to the test track by the No. 00 *B & S* gage, duplex cable above mentioned.

The transmission cable ended at the middle of the test track. From this point, the power was transmitted to the east end of the test tracks by means of two No. 12 *B & S* gage rubber-covered wires, hung loosely from the pole brackets. In the direct current tests, the terminals of these wires were connected directly to the test track circuit through the necessary instruments.

Weather Bulletin and Test Record.

1904.	TESTS.		
Sat., Oct. 22 . .	1- 7 inclusive 8- 17 "	Fair, cold, windy. About 45° F.	Outside mea- surements.
	TESTS.		
Mon., Oct. 24 .	20- 31 inclusive 36- 39 "	A.M. fair and rather warm. P.M. cold and windy. About 55° F.	Outside mea- surements.
	TESTS.		
Tues., Oct. 25 .	32- 35 inclusive 40- 59 "	A.M. wet from rain night before. Fair and windy all day. About 50° F.	Measurements taken in car.
	TESTS.		
Wed., Oct. 26 .	60- 75 inclusive 80- 83 " 92- 99 "	Fair day, dry weather. Temp. about 60° F.	Measurements taken in car.
	TESTS.		
Thurs., Oct. 27	100-105 inclusive 108-111 " 114-181 "	Fair day, dry weather. Temp. about 60° F.	Measurements taken in car.
	TESTS.		
Fri., Oct. 28 . .	132-149 inclusive	Fair day, dry weather. Temp. about 60°. Ran till noon only.	Measurements taken in car.
	TESTS.		
Sat., Oct. 29 . .	150-173 inclusive 176-181 "	Fair day, dry weather. Temp. about 65-70°.	Measurements taken in car.
	TESTS.		
Mon., Oct. 31 .	174-175 inclusive 182-211 "	Fair day, dry weather. Temp. about 65°.	Measurements taken in car.
	TESTS.		
Tues., Nov. 1 .	211-261 inclusive	Fair day, dry, smoky, Temp. 60°.	Measurements taken in car.
	TESTS.		
Wed., Nov. 2 .	261-282 inclusive	Fair day, dry. Temp. 65°	Measurements taken in car.

across the voltmeter and the pressure coil of the wattmeter was the pressure drop of the track alone, instead of that of the track and trolley wire combined, which was the condition in Series A. This connection was made by means of a No. 12 *B. & S.* gage copper pressure wire, which was connected to the track at the west end of the section under test. This pressure lead was 930 ft. long, and was 3 ft. above the ground.

SERIES C. — These tests comprised those on the single track and trolley combined. The connections were the same as those in Fig. 137, except that one trolley wire was disconnected and

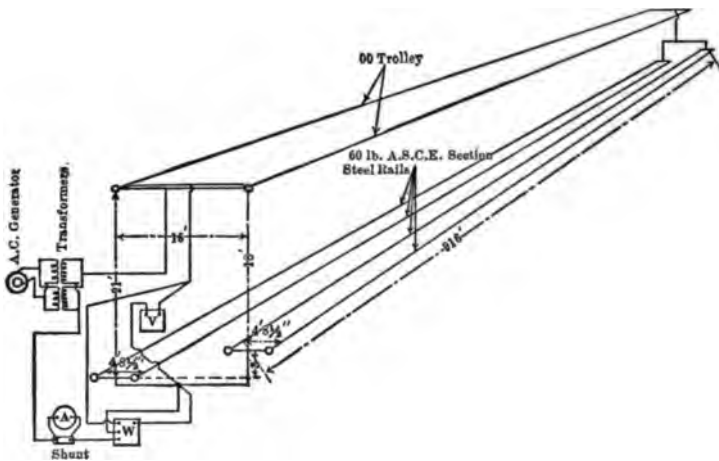

Fig. 137. — Connections Used in Making the Alternating Current Tests with Double Track and Double Trolley.

one track was isolated by cutting the cross-bonds between the two tracks. The tests were made on the north or upper track of the two. This track was selected because there were no steel cross-ties used in its construction, as was the case in the south test track.

SERIES D. — This series of tests comprised those showing the pressure drop and power losses existing in the single track alone. The connections were the same as in Series B, except that the south track and trolley wire were disconnected as in Series C.

SERIES E. — These tests comprised those showing the pressure drop and power losses occurring in the single trolley with

described in Chapter XII. This instrument was provided with two shunts, one for a full scale reading of 200 amperes, and the other for a full scale reading of 1000 amperes. The currents between 200 and 600 amperes were obtained by means of the 1000 ampere shunt. The alternating current pressure was measured by means of a Weston alternating current voltmeter, with a scale reading of 0 to 75 and 150, for the higher values; while a similar Weston instrument reading 0 to $7\frac{1}{2}$ and 15 was used for the lower values of pressure.

The alternating current power was obtained by means of a 0 to 300 Thomson wattmeter and a 0 to 150 Weston wattmeter. The current coils of these instruments were supplied from the secondary of a Westinghouse current transformer with a reduction ratio from 120 to 1. The primary or heavy coil of this transformer was connected directly into the track circuit. An attempt was made to use pressure transformers on the voltmeter and on the pressure coil of the wattmeter, but this was abandoned because it was found to be unreliable, on account of the extremely low pressures encountered.

A telephone connected between the test tracks and the exhibit space of the Bullock Company, was employed in taking the readings. The operator in the Palace of Electricity regulated the current and frequency as directed by those in charge of the tests at the track. Although this method was slow, it was possible to obtain exact values of the current and frequency, within the limits of error in the observations. Three sets of readings were taken for each current and frequency, the average being used in the final results.

WORKING UP THE RESULTS.

All data were carefully recorded, in preliminary tabular form, at the time the tests were made; the general conditions of the tests, the connections existing at the time the tests were made, and the instruments used in each case being carefully observed.

It was of especial importance that the calibration of the instruments be conducted in such a manner as to include all of

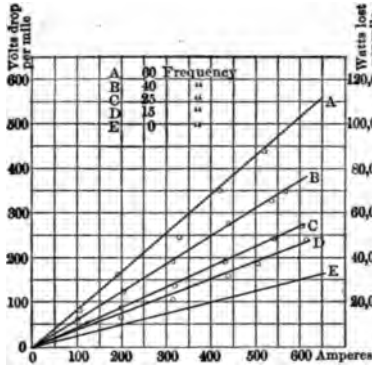

Fig. 138.—Variation of Pressure Drop per Mile with Total Amperes. Double Track and Trolley.

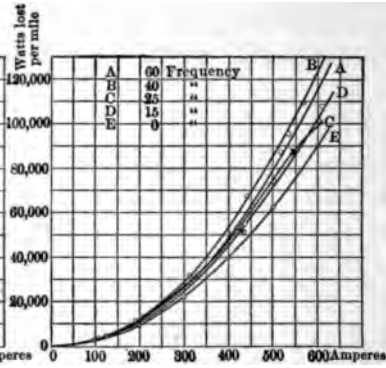

Fig. 139.—Variation of Watts Lost per Mile with Total Amperes. Double Track and Trolley.

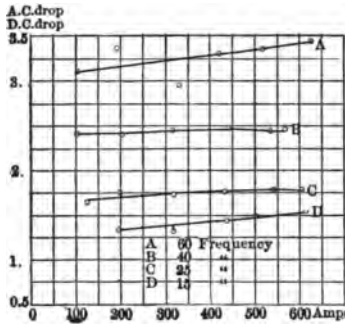

Fig. 140.—Variation of Rates A.C. Drop with D.C. Drop Total Amperes. Double Track and Trolley.

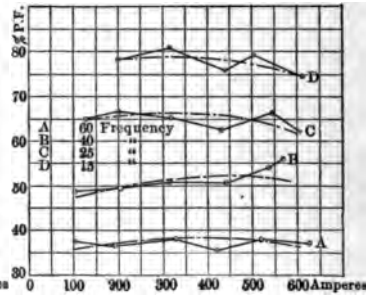

Fig. 141.—Variation of Power Factor with Total Amperes. Double Track and Trolley.

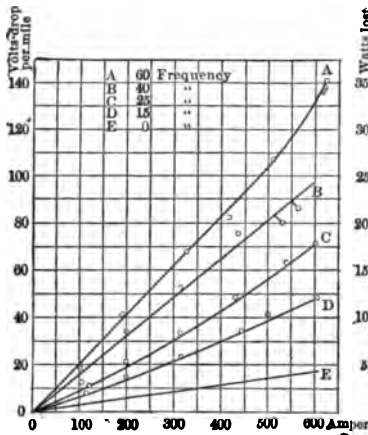

Fig. 142.—Variation of Power Drop per Mile with Total Amperes. Double Track.

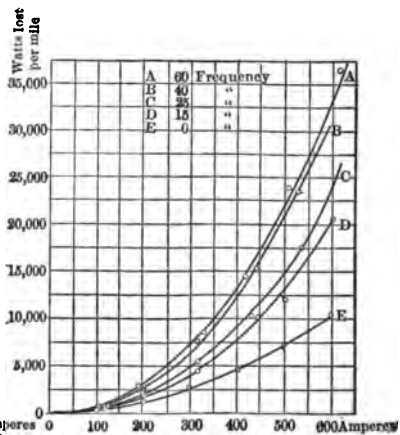

Fig. 143.—Variation of Watts Lost per Mile with Total Amperes. Double Track.

nating current conditions. However, as these data are of considerable interest in themselves, they have been summarized and are contained in Table LXIV. While the length of track tested was but 916 ft. the results have been reduced to a basis of resistance per 1000 ft. of track in each case, as this is a more convenient figure for comparison.

TABLE LXIV. — *Direct Current Resistance of Track. — Data in Ohms Per 1000 Feet of Track.*

Double track and double trolley	0.04749
Double track alone	0.00545
Single track and single trolley	0.06275
Single track alone	0.01078
Single rail and single trolley	0.06965
Single rail alone	0.01885

The Alternating Current Tests.

TEST NO. 46. DOUBLE TRACK AND DOUBLE TROLLEY. — This test includes all of the results of the measurements made on the double track and double trolley. The graphical representation of these results will be found in Figs. 138, 139, 140, and 141. The pressure drop for various currents at given frequencies is shown in Fig. 138 and the power lost is shown in Fig. 139, the data for each frequency being plotted in a single curve. Fig. 140 shows the ratios of the A.C. to the D.C. pressure drop for various currents at given frequencies, while Fig. 141 shows the variation of power-factor; the data for each frequency being plotted in a single curve.

TEST NO. 47. DOUBLE TRACK ALONE. — The data calculated from the results of the investigations on the double track alone, are shown graphically in Figs. 142, 143, 144, and 145. These curves have been plotted in the same general manner as were those of Figs. 138, 139, 140, and 141. In all cases the current values have been taken as abscissas. Fig. 142 shows the pressure drop per mile of track for various currents at given frequencies. Fig. 143 shows the power losses per mile, Fig. 144 shows the ratio of A.C. to D.C. pressure drop, and Fig. 145 shows the power factor.

TEST NO. 49. SINGLE TRACK ALONE. — Figs. 150, 151, 152, and 153 show the results of the investigations on a single track alone. These curves have been constructed in the same

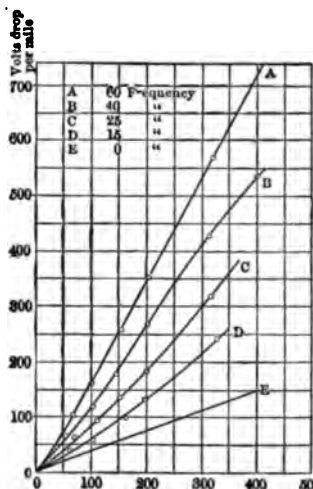

Fig. 154. — Variation of Pressure Drop with Total Current. Single Rail and Single Trolley.

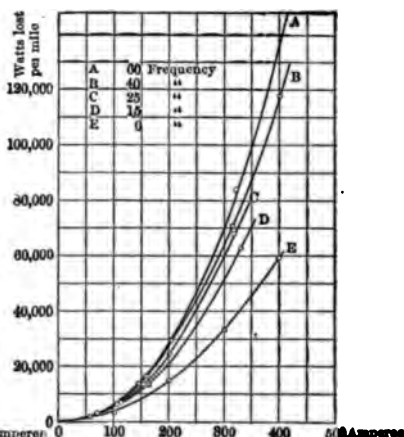

Fig. 155. — Variation of Power Lost with Total Current. Single Rail and Single Trolley.

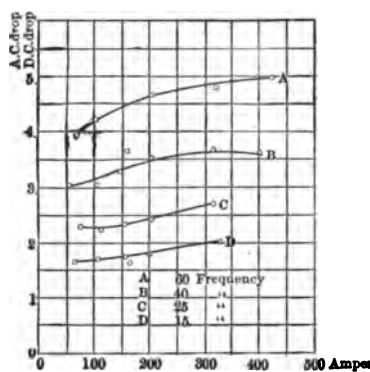

Fig. 156. — Variation of Ratio $\frac{A.C. \text{ Drop}}{D.C. \text{ Drop}}$ Single Rail and Single Track.

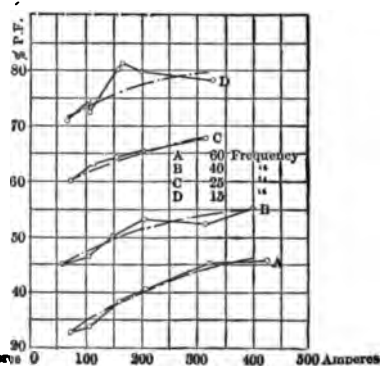

Fig. 157. — Variation of Power Factor. Single Rail and Single Track.

general manner as were the preceding ones, the data for a given frequency being plotted in a single curve in each case. Fig. 150 shows the pressure drop per mile of track, Fig. 151 shows the

tests. Fig. 154 shows the pressure drop per mile, Fig. 155 shows the power losses per mile, Fig. 156 shows the ratios of the A.C. to the D.C. pressure drop, and Fig. 157 shows the power factor.

TEST NO. 51. SINGLE RAIL ALONE. — The results of the investigations on a single rail alone are shown in Figs. 158, 159, 160, and 161. These curves have been constructed in the same general manner as those showing the results of the preceding tests. Fig. 158 shows the pressure drop per mile, Fig. 159 shows the power losses per mile, Fig. 160 shows the ratios of the A.C. to D.C. pressure drop, and Fig. 161 shows the power factor.

DISCUSSION OF RESULTS.

The Direct Current Tests.

It was the desire of the Executive Committee to make an elaborate series of tests on the rail-bonding, which had been installed by the American Steel and Wire Company, under the direct supervision of their representative. While the time available for making the direct and alternating current tests on the track did not warrant detailed tests covering the individual rail bonds, a sufficient number of data was obtained to form a very fair opinion of the value of the bonds of this track.

TEST NO. 45. DIRECT CURRENTS. — The length of track tested was 916 ft., and the results obtained reduced to a length of track of 1000 ft. for the purpose of comparison, were as follows:

OHMS PER 1000 FT.

Single rail	0.01885
Single track.	0.01078
Double track	0.00545

The rails of the track tested were 56-lb. rails of the A. S. C. E. standard, and were similar to the smaller rail used in the special rail tests, the results of which are shown in Chapter XII. This rail shows a resistance of 0.08333 ohm per mile of continuous rail. Reducing this value to a continuous rail length of 1000 ft.

The power loss curves rise rapidly with increasing current, and the curves for alternating currents, especially at the higher frequencies, are much steeper than are those for direct currents.

The curves giving the ratios of A.C. to D.C. pressure drop show a large increase in this ratio for the higher frequencies, while the power-factor curves show a decrease in the power factor as the frequency rises.

In general, the magnetic properties of the steel in the rails determine the effects produced to a considerable extent. While a large part of the power loss in the rails is undoubtedly due to the "skin effect," hysteresis and eddy-currents have an important bearing on the results obtained.

TEST No. 46. DOUBLE TRACK AND DOUBLE TROLLEY. — These tests are shown in Figs. 138, 139, 140, and 141. The pressure drop per mile for various currents and frequencies is shown in Fig. 183. It is seen that the pressure drop increases rapidly with increased frequency, and that it is considerably greater with a frequency of 25 cycles per second than it is with a direct current; while at 60 frequency the pressure drop is over three times that which occurs when a direct current of an equivalent value is flowing.

Fig. 139 shows the power losses for various frequencies and currents. It is seen that while these losses become larger with increasing current and frequency, the increase in loss with an increase in frequency is not as great as the increase in pressure drop shown in Fig. 138. This indicates a higher inductive effect, and a consequent increase of the inductive component of the pressure drop as the frequency is increased. This is verified by the power-factor curves shown in Fig. 141, which represent the variation of power factor with current and frequency.

The curves showing the ratios of the A.C. to the D.C. pressure drop are given in Fig. 140. This ratio is above three for 60 frequency, while it is less than one and one-half for the 15 frequency tests. Another fact to be observed in connection with these curves is that they all have a tendency to rise with

rent and frequency, it is to be observed that they do not increase as rapidly in proportion to the frequency as do the pressure drops under the same conditions. This is due to the fact that the inductive effect becomes greater with the increasing frequencies, and the inductive component of the pressure drop increases rapidly as the frequency rises. These facts are corroborated by the power factor curves which are shown in Fig. 145.

A study of the curves of A.C. to D.C. pressure drop, Fig. 144, shows an increase of this ratio with increasing frequency, and also the fact that this ratio is considerably higher than is the case with the double track and trolley combined, being fully twice as great for the 60 frequency tests.

Curves showing the variation of the impedance for different currents and frequencies were also plotted in working up the results, but these have not been included in the Report. The impedance in general rises rapidly with increasing frequency, and tends to rise slightly with increasing currents. The impedance for the double track is approximately one-fourth of that for the double track and double trolley, and the power factor in general is ten per cent lower for the double track than it is for the double track and trolley.

TEST NO. 48. SINGLE TRACK AND SINGLE TROLLEY. — The results of these investigations are shown in Figs. 146, 147, 148, and 149. The volts drop per mile are given in Fig. 146, and show clearly the large increase in pressure drop with increasing frequency. At 500 amperes the pressure drop with a direct current is 155 volts; whereas it is 615 when the frequency is 60 cycles per second. This shows an increase of 300 per cent in the pressure drop.

The watts lost per mile are indicated in Fig. 147. It is seen that while the power losses rise rapidly with increasing current, there is not a very large increase in the loss with increasing frequency. This indicates that a considerable portion of the increase in pressure drop at the higher frequencies is due to an inductive effect; although a part of this increase is caused

cycles. This is an increase of approximately 900 per cent. These data show that while the power lost increases rapidly with the frequency, it does not increase as rapidly as does the pressure drop. This shows an increased inductive effect in the rails, as the frequency rises, which fact is shown clearly in the power-factor curves of Fig. 153.

A comparison of the power lost in the single track with that lost in the single track and single trolley combined shows that, for 500 amperes and 60 cycles, the loss in the track alone is 50 per cent of the loss in the track and the trolley combined. A comparison of the pressure drop in these two cases at 500 amperes and 60 cycles, shows that the pressure drop in the single track alone is 258 volts as against 610 volts for the track and trolley combined, the former being approximately 40 per cent of the latter. These results show that the power lost for the track alone is greater in proportion than is the pressure drop, indicating that the increase in power lost with increase in frequency occurs in the track itself.

Fig. 152 shows the ratios of the A.C. to the D.C. pressure drop for the track alone. A comparison of these results with those given in Fig. 148 shows that this ratio is considerably higher for the track alone than it is for the track and trolley combined; the values of the ratio for the track alone being on an average twice as high as those for the track and trolley combined. These data bear out the statement made concerning the relative amount of power lost under the two conditions.

The power-factor curves for the rail alone are given in Fig. 153, and show the large decrease in power factor as the frequency rises. A comparison of these curves with those of Fig. 149 shows that, in general, the power factor for the track alone is lower than for the track and trolley combined, especially at the higher frequencies.

Curves showing the variation of impedance for different currents at given frequencies were also plotted in working up the results, but these have not been included in the Report. The

TEST No. 51. SINGLE RAIL ALONE. — The results of this test are shown graphically in Figs. 158, 159, 160, and 161. The pressure drop per mile, Fig. 158, shows a considerable increase with increasing frequency. The pressure drop at 400 amperes is 38 volts with direct current and 412 volts with alternating current at 60 cycles. This is an increase in the pressure drop of approximately 1000 per cent. A comparison of this curve with Fig. 154 shows that practically 60 per cent of the pressure drop for the single rail and trolley occurs in the rail alone at 60 cycles and 400 amperes, whereas approximately 25 per cent of the pressure drop for the single rail and trolley occurs in the rail alone, for direct currents. An inspection of Fig. 159 shows that the power lost for the single rail and trolley, due to direct current, is 14,000 watts; while, at a frequency of 60 cycles per second, it is 89,000 watts at the same current, the increase being over 500 per cent. A comparison of this increase in the power lost with the corresponding increase in pressure drop, shows that a considerable portion of the increase in pressure drop was due to an inductive action in the rail itself; the power lost not increasing as rapidly as did the corresponding pressure drop.

A comparison of the power lost in the single rail with that lost in the single rail and trolley combined, shows that, for 400 amperes and 60 cycles, the loss in the track alone is 66 per cent of the loss in the track and trolley combined. A comparison of the pressure drop in these two cases, at 400 amperes and 60 cycles, shows that the pressure drop in the single rail alone is approximately 57 per cent of the latter. These results show that the power lost for the rail alone is greater in proportion than is the pressure drop. This would indicate that the inductive effect of the rail and trolley combined is greater in this case than for the rail alone.

This is seen to be the case from a comparison of the power factors for 400 amperes and 60 cycles, as shown in Figs. 157 and 161. It is seen that the power factor is just over 45 per cent for the rail and trolley combined, whereas it is 54 per cent for the rail alone.

PART VII.
TRAIN AND AIR RESISTANCE TESTS.

TABLE LXV. — *Synopsis of Results of Train Resistance Tests.*

CAR TESTED AND VESTIBULE ARRANGEMENT.	RESISTANCE IN LBS. PER TON AT VARIOUS SPEEDS.*						REMARKS.
	20 m.p.h.	30 m.p.h.	40 m.p.h.	50 m.p.h.	60 m.p.h.	70 m.p.h.	
Car 284 on Test Track running forward.	12.0	15.0	20.0	26.8	35.0†	
Car 284 on Test Track running backward.	12.0	15.0	20.0	26.8	35.0†	
Car 284 in Service Tests, without trailer.	20.0	26.0	
Car 284 in Service Tests, with trailer.	19.0	25.0	
Louisiana with parabolic wedge front vestibule.	16.8	18.2	21.0	24.8	30.0	37.0†	Standard Rear Vestibule.
Louisiana with standard front vestibule.	17.5	19.4	22.5	27.5	33.8	41.0†	Parabolic wedge rear vestibule.
Louisiana with parabolic front vestibule.	15.0	16.2	19.0	23.5	30.0	37.0†	Standard rear vestibule.
Louisiana with standard front vestibule.	16.5	17.9	21.0	26.2	32.6	40.0†	Parabolic rear vestibule.
Louisiana with flat front vestibule.	17.0	20.2	26.0	33.8	43.0†	Standard rear vestibule.
Louisiana with standard front vestibule.	14.0	16.7	21.8	28.7	36.5	Flat rear vestibule.
Louisiana with standard front vestibule.	15.0	17.8	22.2	28.2	35.0	No rear vestibule.
Louisiana with no front vestibule.	18.0	21.4	26.0	32.6	41.0†	Standard rear vestibule.

* These values are taken from the Resistance Curves.

† Estimated.

electrical input and the speed was employed. To do this required correction for acceleration and grade, allowance being made also for the velocity and direction of the wind. Before beginning the tests a study was made of a number of the empirical formulas mentioned above, and curves for the special dynamometer car were constructed in accordance with the conditions of the various formulas. The results of the application of these formulas are given in Figs. 162, 163, and 164.

GENERAL DESCRIPTION OF THE TESTS.

For the purpose of these tests a section of tangent track was selected on the "Northern" division of the Indiana Union Traction Company's system. This track was not quite level, but a careful survey of the grades was made so that corrections could be made for the changes in speed and resistance, due to such grades.

The section of the track selected for the tests was slightly less than five miles in length, and extended from Noblesville southwesterly toward the town of Carmel. The direction of the track departed approximately 24 degrees from the east and west line. The profile is shown in Fig. 171. This track was of the most recent type of construction employed by the Indiana Union Traction Company. It consisted of 70-pound Tee rails laid on

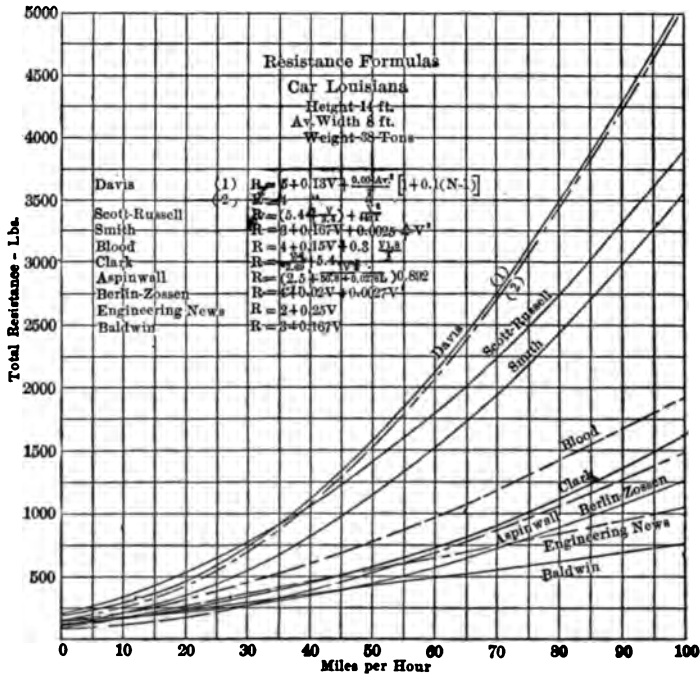

Fig. 162.—Application of Train Resistance Formulas to Car Louisiana (Results Shown in Pounds Pressure at Various Speeds).

standard oak ties. It was gravel ballasted and in first-class condition at the time the tests were made. Certain runs were also selected from the data of the service tests described in Chapter IV.

THE CARS TESTED.

The cars selected for test were Car No. 284 of the Indiana Union Traction Company's system, fully described in Chapter

I, and the special dynamometer car "Louisiana," described in Chapter XV. The trailer, used in some of the tests on Car No. 284, was the one employed in the service tests described in Chapter IV, and was equipped and loaded as in those tests.

SCHEDULES OF THE TESTS.

The tests included in the present chapter comprise a series of thirty runs with Car No. 284, and a series of sixty-four runs with the car "Louisiana."

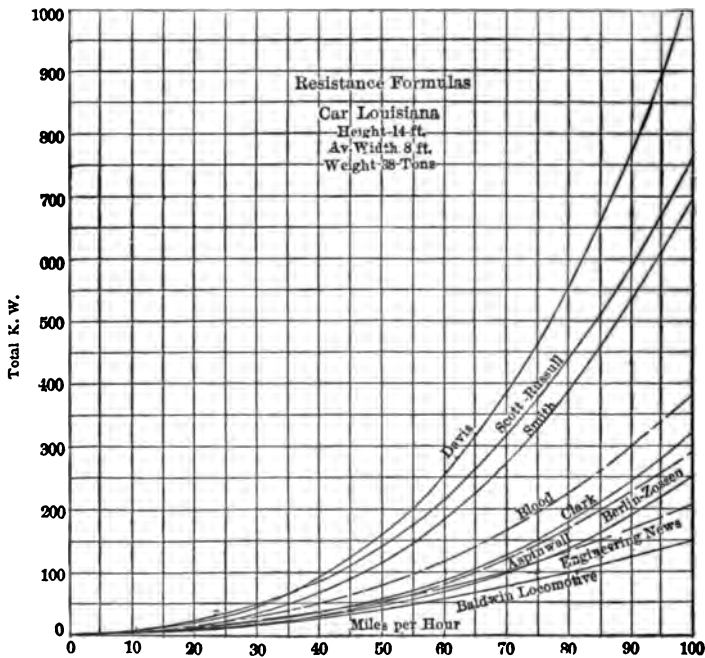

Fig. 163.—Application of Train Resistance Formulas to Car Louisiana (Results Shown in Kilowatts Lost at Various Speeds).

The data relating to Car No. 284 are subdivided into two general classes, and are considered under the headings Test No. 52 and Test No. 53. These data were selected from a number of runs made on the test section of track near Noblesville, and also from the service runs between Muncie and Indianapolis.

The data relating to the car "Louisiana" are subdivided into four general classes, and are considered under the headings Test No. 54, Test No. 55, Test No. 56, and Test No. 57. These data have been selected from among several hundred runs made

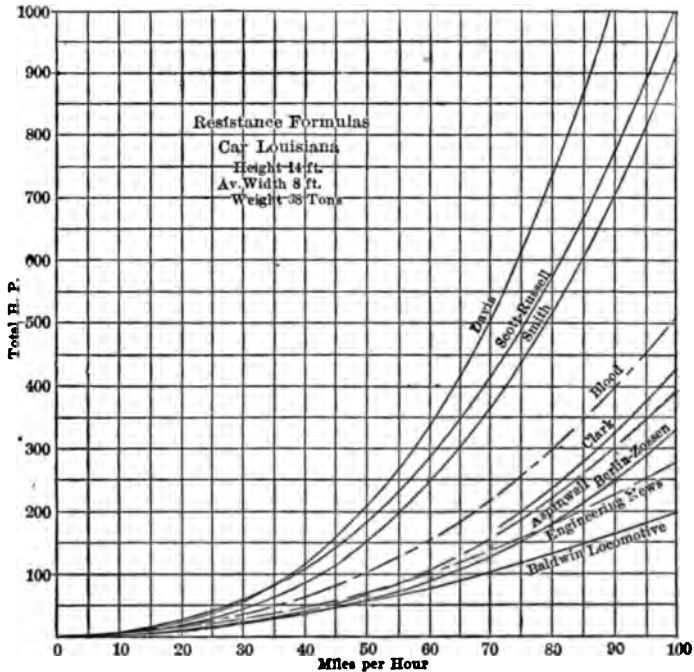

Fig. 164. — Application of Train Resistance Formulas to Car Louisiana (Results Shown in Horse-power Lost at Various Speeds).

under various conditions of speed, direction, and arrangement of vestibules and car body. The results are used both for the study of car resistance as a whole in the present chapter, and for the independent study of air resistance on vestibules and car bodies in Chapter XVI.

TESTS NO 52, CAR NO. 284. — The following twenty runs made with Car No. 284 include those carried out on the special test track between Carmel and Noblesville.

ELECTRIC RAILWAY TEST COMMISSION

*Schedule of Runs for Test No. 52. Resistance Runs with Car
No. 284, on Test Track.*

RUN.	DATE, 1905.	CAR GOING.	CAR POINTED.	MOTOR CONNECTIONS.
A	Feb. 6	East	East	4 motors in parallel
B	Feb. 6	East	East	2 motors in parallel
C	Feb. 6	West	West	4 motors in parallel
D	Feb. 6	East	East	2 motors in parallel
E	Feb. 6	East	East	4 motors in series-parallel
F	Feb. 6	West	West	2 motors in parallel
G	Feb. 6	West	West	2 motors in parallel
H	Feb. 6	East	East	2 motors in series
I	Feb. 6	West	West	4 motors in series-parallel
J	Feb. 6	West	West	2 motors in series
K	Feb. 6	West	East	4 motors in parallel
L	Feb. 6	West	East	2 motors in parallel
M	Feb. 6	West	East	2 motors in parallel
N	Feb. 6	East	West	4 motors in parallel
O	Feb. 6	East	West	2 motors in parallel
P	Feb. 6	East	West	2 motors in parallel
Q	Feb. 6	West	East	4 motors in series-parallel
R	Feb. 6	West	East	2 motors in series
S	Feb. 6	East	West	4 motors in series-parallel
T	Feb. 6	East	West	2 motors in series

TEST NO. 53, CAR NO. 284. — The following ten runs are taken from the service runs of Car No. 284 described in Chapter IV, and were specially selected for a study of train resistance.

*Schedule of Runs for Test No. 53. Resistance Runs Selected
From Service Tests.*

RUN.	DATE, 1905.	FROM POLE No.	TO POLE No.	REMARKS.
A	Feb. 4	820	670	Without trailer
B	Feb. 3	820	670	Without trailer
C	Feb. 3	500	595	Without trailer
D	Feb. 3	1260	1465	Without trailer
E	Feb. 3	2100	1950	Without trailer
F	Feb. 3	1465	1260	Without trailer
G	Feb. 4	820	675	With trailer
H	Feb. 4	1260	1465	With trailer
I	Feb. 4	2100	1950	With trailer
J	Feb. 4	1465	1265	With trailer

TEST NO. 54, CAR "LOUISIANA." — The following sixteen runs were selected from over one hundred runs made with the "parabolic-wedge" shaped movable vestibule and the standard fixed vestibule in position.

TRAIN RESISTANCE TESTS

Schedule of Runs for Test No. 54. Resistance Runs with Parabolic-Wedge Vestibule.

RUN.	DATE, 1905.	CAR GOING.	CAR POINTED.	MOTOR CONNECTIONS.
A	Feb. 20	East	East	4 motors in parallel
B	Feb. 20	West	West	4 motors in parallel, 4 grids on motors
C	Feb. 16	East	East	2 motors in parallel
D	Feb. 18	West	West	4 motors in parallel
E	Feb. 16	East	East	4 motors in series-parallel
F	Feb. 11	East	East	2 motors in series
G	Feb. 17	West	West	4 motors in series-parallel
H	Feb. 17	West	West	2 motors in series
I	Feb. 20	East	West	4 motors in parallel, 16 sec- tions of grids on motors
J	Feb. 20	West	East	4 motors in parallel
K	Feb. 17	East	West	4 motors in parallel
L	Feb. 17	East	West	4 motors in series-parallel
M	Feb. 16	West	East	2 motors in parallel
N	Feb. 17	East	West	2 motors in series
O	Feb. 16	West	East	2 motors in series
P	Feb. 16	West	East	2 motors in series.

TEST NO. 55, CAR "LOUISIANA."—The following sixteen runs were selected from forty runs made with the "parabolic" shaped movable vestibule and the standard fixed vestibule in position.

Schedule of Runs for Test No. 55. Runs With Parabolic Vestibule.

RUN.	DATE, 1905.	CAR GOING.	CAR POINTED.	MOTOR CONNECTIONS.
A	Feb. 21	East	East	4 motors in parallel, 4 sec- tions of grids on motors
B	Feb. 21	West	West	4 motors in parallel, 4 sec- tions of grids on motors
C	Feb. 22	West	East	2 motors in parallel, no grids on motors
D	Feb. 22	East	East	4 motors in series
E	Feb. 22	West	West	2 motors in parallel
F	Feb. 22	East	East	2 motors in series
G	Feb. 22	West	West	4 motors in series
H	Feb. 22	West	West	2 motors in series

Schedule of Runs for Test No. 55—Continued.

RUN.	DATE, 1905.	CAR GOING.	CAR POINTED.	MOTOR CONNECTIONS.
I	Feb. 21	East	West	4 motors in parallel, 4 sections of grids on motors
J	Feb. 21	West	East	4 motors in parallel, 4 sections of grids on motors
K	Feb. 22	East	West	2 motors in parallel
L	Feb. 22	West	East	2 motors in parallel, no grids on motors
M	Feb. 22	East	West	4 motors in series
N	Feb. 22	East	West	2 motors in series
O	Feb. 22	West	East	4 motors in series-parallel
P	Feb. 22	West	East	2 motors in series

TEST NO. 56, CAR "LOUISIANA."—The following sixteen runs were selected from thirty-six runs made with the "flat" movable vestibule and the standard fixed vestibule in position.

Schedule of Runs for Test No. 56. Runs With Flat Vestibule.

RUN.	DATE, 1905.	CAR GOING.	CAR POINTED.	MOTOR CONNECTIONS.
A	Feb. 28	East	East	4 motors in parallel, 4 sections of grids on motors
B	Feb. 28	West	West	4 motors in parallel, 24 sections of grids on motors
C	Feb. 25	East	East	4 motors in parallel
D	Feb. 27	East	East	4 motors in series-parallel
E	Feb. 27	West	West	2 motors in parallel
F	Feb. 27	West	West	4 motors in series-parallel
G	Feb. 27	East	East	2 motors in series
H	Feb. 27	West	West	2 motors in series
I	Feb. 28	East	West	4 motors in parallel, 4 sections of grids on motors
J	Feb. 28	West	East	4 motors in parallel, 4 sections of grids on motors
K	Feb. 27	East	West	2 motors in parallel
L	Feb. 27	East	West	4 motors in series-parallel
M	Feb. 25	West	East	2 motors in parallel
N	Feb. 27	East	West	2 motors in series
O	Feb. 27	West	East	4 motors in series-parallel
P	Feb. 27	West	East	2 motors in series

TEST No. 57, CAR "LOUISIANA." — The following sixteen runs were selected from thirty-eight runs made with the "standard" movable vestibule in position, no vestibule being attached to the other end of the car body.

Schedule of Runs for Test No. 57. Runs With Standard Vestibule.

RUN.	DATE, 1905.	CAR GOING.	CAR POINTED.	MOTOR CONNECTIONS.
A	Mar. 10	East	East	4 motors in parallel, 20 sections of grids on motors
B	Mar. 10	West	West	4 motors in parallel, 12 sections of grids on motors
C	Mar. 7	East	East	2 motors in parallel
D	Mar. 7	East	East	4 motors in series-parallel
E	Mar. 7	West	West	2 motors in parallel
F	Mar. 7	East	East	2 motors in series
G	Mar. 7	West	West	4 motors in series-parallel
H	Mar. 7	West	West	2 motors in series
I	Mar. 10	East	West	4 motors in parallel, 8 sections of grids on motors.
J.....	Mar. 10	West	East	4 motors in parallel, 16 sections of grids on motors
K	Mar. 7	East	West	2 motors in parallel
L	Mar. 7	West	East	2 motors in parallel
M	Mar. 7	West	East	4 motors in series-parallel
N	Mar. 7	East	West	4 motors in series-parallel
O	Mar. 7	East	West	2 motors in series
P	Mar. 7	West	East	2 motors in series

GENERAL METHOD EMPLOYED.

The general plan followed in making all of these tests was to allow the car to attain a practically constant speed before beginning to record data. All the readings were then taken over the desired section of track and the observations were stopped before the brakes were applied. Finally, in working up the results, a section from each run was selected in which the conditions were as nearly uniform as possible.

ORIGINAL MEASUREMENTS.

The measurements made during the tests consisted simply of accurate speed determinations and electrical input measure-

ments. Wind and temperature data were also included, in order to allow for the effect of atmospheric conditions.

Speed Measurements.

Both cars were equipped with a simple speed generator geared by means of sprockets and chain to the car axle, as already described and illustrated in Chapter IV. Car No. 284 was equipped with the elaborate recording apparatus, also described and illustrated in Chapter IV, and which included a device for tracing a speed curve on the record strip. The speed was checked by recording on the chronograph record the time of passing particular poles, each ten poles or less being marked on the record. At high speeds every ten poles were marked, at lower speeds every five poles, and at very low speeds the position of each pole was indicated.

On the "Louisiana" no graphical record of speed was made, but the indications of the speed voltmeter were recorded every five seconds. A chronograph pole record was also kept, similar to that in the tests of Car No. 284.

Electrical Measurements.

The electrical measurements comprised those of current and e.m.f. The current records from the tests of Car 284 were made by the automatic apparatus already described, and by the recording ammeter of the General Electric Company. These two devices formed an accurate check upon each other. E.m.f. was recorded graphically as in all other tests. On the "Louisiana," only the General Electric recording ammeter was employed, but a Weston indicating ammeter was read frequently in order to check the graphical record. The e.m.f. was recorded at five-second intervals. No attempt was made to measure directly the power in these tests, as it was considered to be more advisable to make the tests of current and e.m.f. with the greatest accuracy and to depend upon the product of the averages of these quantities for the power readings. As the current and e.m.f. were substantially constant in the tests, their product accurately gave the average power.

WORKING UP THE RESULTS.

Electrical Data.

In all of the tests the readings of e.m.f. were averaged from the graphical records, or from the records made periodically, and corrected for errors in the instruments. The current records were integrated for the period selected for the tests, these results being compared with the periodical measurements.

From these data the power was obtained by multiplying together the average e.m.f. and the average current for the period of the test. The electrical power delivered by the motors to the car axles was obtained by reference to the efficiency curves of the motors.

Speed Data.

The first step in preparing the speed data was to obtain accurate calibrations of the speed indicating device. This was done by running the car both forward and backward at various speeds and by checking the indications of the speed device by the actual speed as shown by the distance traversed in a given time. The results of these calibrations were plotted in the form of curves. The readings obtained during the tests were then averaged and corrected by reference to these curves.

The next step was to obtain, from the graphical record, the exact location by poles of the start and the stop of each test and the time interval corresponding thereto. The average speed was then calculated from the time-distance data thus obtained. These data were considered to be more reliable than those furnished by the speed voltmeter, and where they differed the voltmeter readings were corrected to correspond with the distance and time. As distance and time measurements are the simplest of all measurements to make, and as they were made with great accuracy in these tests, they were considered to be the final data of reference for average speed. It would not have been possible, however, to have conducted the tests satisfactorily without the speed generator, for the reason that

the latter gave direct and quick indications of the variation of the speed and therefore data for calculating the acceleration. It should be said, however, that the two methods of measuring speed gave nearly similar results; in some cases being absolutely the same, and in others differing by but a few per cent.

Acceleration and Grade Data.

While the attempt was made in every test to maintain the speed at a uniform value, it was not always possible to do this because of the grades, especially in the runs at the high speeds. As the acceleration diminishes with increasing speed, the tests at 60 miles an hour and upward required several miles of running before a uniform speed was reached.

In correcting for acceleration, the records obtained by the speed indicating device were considered to give accurately the relative speed at start and stop. The average speed from these records was compared with the average speed from the time-distance measurements, and the former were corrected to conform to the latter. The speed at the start of the tests was subtracted from that at the stop, and this was divided by the total time interval in seconds, the result giving the acceleration in miles per hour per second.

In allowing for the grades, the elevations of the poles at the start and the stop of the test were determined from the profile. The net grade for the runs was then obtained by dividing the difference in elevation by the distance between these poles. In working up the results, the algebraic sum of the errors due to grade and acceleration was obtained, and this correction was made in the results obtained from the electrical measurements.

Determination of the Horizontal Effort.

In all cases, the horizontal effort was determined directly from the electrical power input. The loss in the motors was determined from their efficiency curves, due allowance being made for the variation of efficiency with the e.m.f. at the motor terminals. The power output of the motors was then reduced

The results show the comparative performance of two inter-urban cars similarly equipped, the one being a standard car and the other a special car constructed for measurements of air resistance. These cars were of nearly the same weight, the standard car, however, exposing somewhat less surface to the action of the air.

TEST NO. 52, CAR NO. 284. — Table LXVI and Fig. 166 cover the results of a series of 20 special runs made with the inter-urban car No. 284 on the tangent test track.

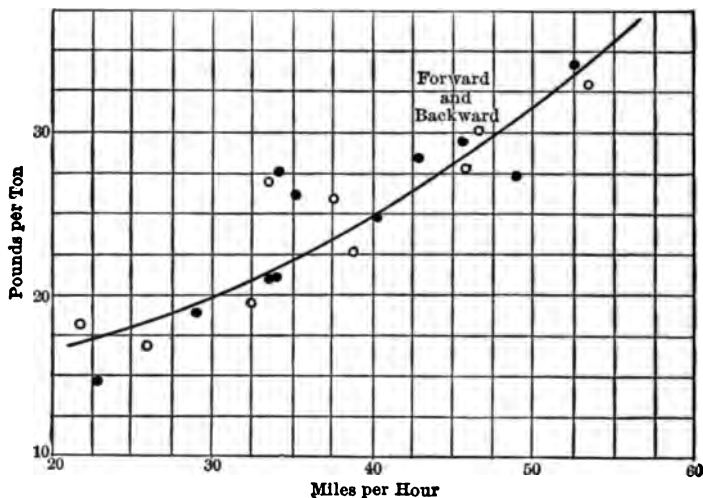

Fig. 166. — Resistance Curves, Test No. 52. Car No. 284.

TEST NO. 53, CAR NO. 284. — Table LXVII shows similar data for the same car operating under regular service conditions with and without a trailer. No curves have been plotted from the results shown in this table, as the data do not cover a sufficiently wide range of variation.

TEST NO. 54, CAR "LOUISIANA." — Table LXVIII and Fig. 167 give the data resulting from tests on the Car "Louisiana" when equipped with the parabolic wedge-shaped vestibule, the first half of the Table (runs A to H) giving the results with the car running forward in both directions on the track, while runs I to P show the results with the car running backward.

TRAIN RESISTANCE TESTS

TABLE LXVI. — Test No. 52. Resistance Runs with Car "284" (on Test Track).

Run.	Direction of Motion of Car*.	Direction of Vestibule*.	Number of Motors.	Motor Connec-	Average Speed	Average Cur-	Average E.M.F.	Average Power	Total Hor't. Effort.	Gross H.T. Lbs. per Ton.	Acceleration M.P.H. P.S.	Acceleration Correc-tion.	Average Grade	Grade Correc-tion.	TON. CORREC-TION.	TON. PER HOR'T. EFFORT.	Direction of Wind.	Velocity of Wind M.P.H.	Temperature.	Weather.	Remarks.
A	East	East	4	Parallel	53.3	213	525	111.7	864	22.5	0.0321	+2.8	+0.41	—	8.4	27.9	N.W.	7	13.	Clear	In runs from A to J inclusive, the vestibule is pointed in the direction of the motion of the car.
B	East	West	4	Parallel	46.5	149	544	81.0	744	19.5	0.0412	+3.8	+0.47	—	9.4	25.1	N.W.	12	17.	Clear	
C	West	West	4	Parallel	45.8	254	506	128.5	1158	30.3	0.0000	+1.3	+0.37	—	7.4	22.9	N.W.	14	20.	Clear	
D	East	East	4	Parallel	45.6	133	527	70.1	664	17.4	0.0142	+1.3	+0.41	—	8.2	24.3	N.W.	10	14.	Clear	
E	East	East	4	Ser.-par.	38.7	67	552	37.0	347	9.1	0.0000	+0.000	+0.43	—	8.6	17.7	N.W.	8	13.	Clear	
F	West	West	4	Parallel	37.6	165	525	97.1	1119	29.3	0.0055	+0.50	+0.40	—	8.0	20.8	N.W.	14	20.	Clear	
G	West	West	4	Parallel	33.7	168	473	79.6	1021	26.8	0.0028	+2.6	+0.37	—	7.4	22.0	N.W.	13	20.	Clear	
H	East	East	4	Series	32.4	42	561	23.6	275	7.2	0.0196	+1.8	+0.45	—	9.0	14.4	N.W.	11	18.	Clear	
I	West	West	4	Ser.-par.	25.8	97	501	48.6	729	19.1	0.0000	0.0	+0.36	—	7.0	11.9	N.W.	16	21.	Clear	
J	West	West	4	Series	21.7	81	527	42.7	802	21.0	0.0000	0.0	+0.40	—	8.0	13.0	N.W.	9	20.	Clear	In runs from K to T inclusive, the vestibule is pointed in the direction of the motion of the car.
K	East	West	4	Parallel	52.5	208	513	106.8	837	21.9	0.0000	0.0	+0.40	—	8.0	29.0	N.W.	15	20.	Clear	
L	East	West	4	Parallel	48.5	133	570	75.8	657	17.2	0.0451	+4.1	+0.37	—	9.8	22.3	N.W.	12	20.	Clear	
M	East	West	4	Parallel	43.0	142	502	71.3	709	18.6	0.0300	+2.7	+0.37	—	7.4	23.3	N.W.	14	20.	Clear	
N	West	East	4	Parallel	40.2	232	434	100.8	1048	27.4	0.0000	+0.6	+0.38	—	7.6	21.1	N.W.	11	16.	Clear	
O	West	East	4	Parallel	35.2	182	480	87.4	1072	30.8	0.0065	+0.6	+0.36	—	7.2	22.7	N.W.	10	13.	Clear	
P	West	East	4	Parallel	34.2	194	480	93.2	1178	30.8	0.0000	+1.8	+0.33	—	6.6	16.1	N.W.	18	21.	Clear	
Q	East	West	4	Ser.-par.	34.0	76	532	40.4	430	11.2	0.0198	+1.8	+0.37	—	7.4	16.0	N.W.	9	20.	Clear	Opposed to that of the motion of the car.
R	East	West	4	Series	33.4	46	596	27.4	314	8.2	0.0041	+3.8	+0.39	—	7.8	13.9	N.W.	8	13.	Clear	
S	West	East	4	Ser.-par.	28.8	96	567	54.3	720	18.9	0.0420	+3.8	+0.39	—	7.8	13.9	N.W.	8	13.	Clear	
T	West	East	4	Series	22.8	71	588	41.5	740	19.4	0.0000	+0.00	+0.50	—	10.0	9.4	N.W.	11	17.6	Clear	

* The words East and West are used to designate the general direction only. The test track lies N.E. and S.W., 24 degrees from an East and West line.

TABLE LXVII. — Test No. 53. Resistance Runs with Car "284." Selected Sections from Service Test Runs.

Run.	Direction of Motion of Car.*	Direction of Vestibule.*	Number of Motors.	Motor Connection.	Average Speed M.P.H.	Average Current Amp.	Average E.M.F. Volts.	Average Power K.W.	Total Horse Power Effort, Lbs.	Gross H.P.E. Lbs. per Ton.	Net Acceleration M.P.H.P.S. per Ton.	Acceleration Correction Lbs. per Ton.	Average Grade Per Cent.	Grade Correction Ton. Lbs. per Ton.	Net Horse Power Effort, Lbs. per Ton.	Direction of Wind.	Velocity of Wind, M.P.H.	Temperature, Degrees F.	Weather.	Remarks.
A	West	West	4	Parallel	54.6	203	505	102.9	778	20.4	0.0148	1.4	0.0	0.0	19.0	N.E.	21	23	Clear	284 alone
B	West	West	4	Parallel	49.9	216	507	109.	828	21.7	0.0026	0.0	0.0	0.0	21.5	N.E.	7	11	Clear	284 alone
C	N. East	N. East	4	Parallel	46.5	254	507	129.	1173	30.8	0.0078	0.0	0.0	0.0	30.1	N.E.	5	11	Clear	284 alone
D	S. West	S. West	4	Parallel	46.1	217	460	99.6	898	23.5	0.0053	0.0	0.0	0.0	24.0	N.E.	9	12	Clear	284 alone
E	N. East	N. East	4	Parallel	45.3	224	492	110.	1017	26.6	0.0237	0.0	0.0	0.0	24.4	N.E.	9	13	Clear	284 alone
F	N. East	N. East	4	Parallel	41.9	224	447	100.	997	26.1	0.0240	0.0	0.0	0.0	23.9	N.E.	9	14	Clear	284 alone
G	N. East	N. East	4	Parallel	46.3	253	530	134.	1228	20.2	0.0075	0.0	0.0	0.0	19.5	N.E.	12	11	Clear	284 and trailer
H	S. West	S. West	4	Parallel	40.5	246	452	110.5	1252	20.7	0.0140	0.0	0.0	0.0	19.4	N.E.	11	13	Clear	284 and trailer
I	N. East	N. East	4	Parallel	39.8	269	468	126.	1354	22.4	0.0104	0.0	0.0	0.0	21.5	N.E.	11	18	Clear	284 and trailer
J	N. East	N. East	4	Parallel	38.0	258	430	110.5	1239	20.4	0.0194	0.0	0.0	0.0	18.6	N.E.	11	18	Clear	284 and trailer

Note. — No curves are plotted from this table, as the data do not cover a sufficiently wide range of variation.

Average resistance without trailer, 23.8 lbs. per ton.

Average resistance with trailer, 19.8 lbs. per ton.

Average speed without trailer, 47.4 M.P.H.

Average speed with trailer, 41.1 M.P.H.

* These are actual directions.

TEST NO. 57, CAR "LOUISIANA." — Table LXXI and Fig. 170 give the results of the tests on the "Louisiana" equipped with the standard vestibule. Runs A to H are for the car running forward, while runs I to P are for backward operation.

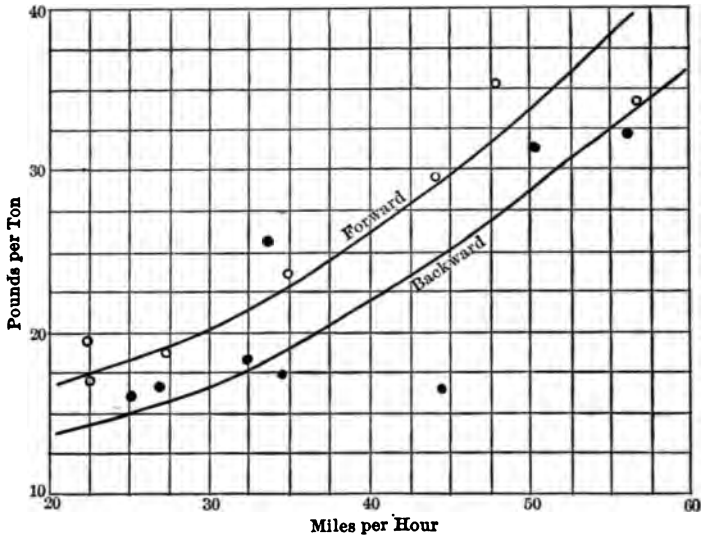

Fig. 169. — Resistance Curves, Test No. 56. Car Louisiana with Flat and Standard Vestibule.

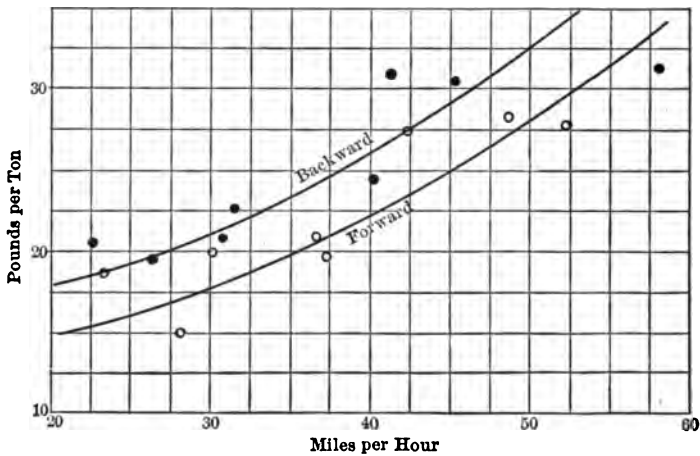

Fig. 170. — Resistance Curves, Test No. 57. Car Louisiana with Standard Front and no Rear Vestibule.

TRAIN RESISTANCE TESTS

TABLE LXVIII. — Test No. 54. Parabolic Wedge Front Vestibule, Standard Rear Vestibule. Train Resistance Tests on Car "Louisiana" on Test Track.

Run.	Direction of Motion of Car*	Direction of Vestibule*	Number of Motors	Motor Connec.	Average Speed M.P.H.	Average Cur.	Average E.M.F. Volts.	Average Power K.W.	Total H.P. Effort Lbs.	Gross H.E. Lbs. per Ton.	Net Acceleration TON M.P.H.P.S.	Acceleration Lbs. per Ton.	Average Grade Per Cent.	Grade Correc- TON LBS. PER TON.	Net H.P. Effort Lbs. per Ton.	Direction of Wind.	Velocity of Wind M.P.H.	Temperature Degrees F.	Weather.	Remarks.
A	East	East	4	Parallel	60.9	368.8	8431.8	159.2	1130	20.8	+0.117	+10.7	-0.338	-6.7	25	W...	7	35	Clear	From runs A to H inclusive, the vestibule is pointed in the direction of motion of the car.
B	West	West	4	Parallel	52.1	390.8	8418.5	163.5	1360	35.3	-0.022	-9.0	+0.342	-6.8	25	W.	7	35	Clear	
C	East	East	4	Parallel	49.0	411.0	8718.5	173.1	973	35.3	-0.017	-9.1	+0.388	-7.2	25	W.	7	30	Clear	
D	West	West	4	Parallel	47.5	332.2	7458.5	152.2	1280	35.3	-0.008	-7.7	+0.311	-6.5	25	W.	13	15	Clear	
E	East	East	4	Parallel	38.2	100.5	2455.1	52.0	573	14.9	-0.008	-0.7	+0.340	-6.2	21.5	W.	16	10	Snowy	
F	East	East	4	Series	38.2	100.5	2455.1	52.0	573	14.9	-0.008	-0.7	+0.340	-6.2	21.5	W.	16	10	Snowy	
G	West	West	4	Series	38.2	100.5	2455.1	52.0	573	14.9	-0.008	-0.7	+0.340	-6.2	21.5	W.	16	10	Snowy	
H	West	West	4	Ser.-par.	34.8	159.2	3227.9	85.0	1240	32.2	-0.019	-1.1	+0.266	-5.5	17.1	W...	21	25	Snowy	
I	East	East	4	Series	34.8	159.2	3227.9	85.0	1240	32.2	-0.019	-1.1	+0.266	-5.5	17.1	W...	21	25	Snowy	
J	West	West	4	Series	34.8	159.2	3227.9	85.0	1240	32.2	-0.019	-1.1	+0.266	-5.5	17.1	W...	21	25	Snowy	
K	East	East	4	Parallel	56.5	265.5	4859.8	130.0	993	25.8	-0.072	-6.6	+0.341	-6.8	26.0	W.	10	30	Clear	From runs I to P inclusive, the vestibule is pointed in a direction opposed to that of the motion of the car.
L	West	West	4	Parallel	49.3	365.8	3965.5	156.9	1360	35.3	-0.027	-2.5	+0.326	-5.5	20.3	W.	9	35	Clear	
M	East	East	4	Parallel	47.5	222.2	4995.3	110.9	973	25.3	-0.027	-2.5	+0.382	-7.6	30.4	W.	21	24	Clear	
N	West	West	4	Parallel	37.3	94.8	400.7	47.5	478	12.4	-0.019	-1.1	+0.344	-6.8	17.5	W.	22	24	Snowy	
O	East	East	4	Ser.-par.	34.1	217.0	470.0	102.0	1280	33.3	-0.001	-0.1	+0.428	-8.5	24.9	W.	18	20	Clear	
P	West	West	4	Series	33.3	72.3	524.4	37.9	460	11.9	-0.020	-1.8	+0.336	-6.5	16.9	W.	16	24	Clear	
Q	East	East	2	Ser.-par.	25.1	127.8	499.9	64.4	1020	26.5	-0.001	-0.1	+0.320	-6.4	20.0	E.	15	10	Snowy	
R	West	West	2	Series	19.1	112.7	531.2	59.9	1130	29.7	-0.008	-0.7	+0.319	-6.4	22.6	E.	15	4	Snowy	

* The words East and West are used to designate the general direction only. The test track lies N. East and S. West 24 degrees from an east and west line.

TABLE LXIX. — Test No. 55. Parabolic Front Vestibule, Standard Rear Vestibule, Resistance Tests on Car "Louisiana" on Test Track.

Run.	Direction of Motion of Car*	Direction of Vestibule	Number of Motors	Motor Connec-	Average Speed M.P.H.	Average Ctr. RENT Amp.	Average E.M.F. Volts	Average Power K.W.	Total Effort Lbs.	Gross H.P. Lbs. per Ton.	Net Acceleration TON M.P.H.P.S.	Acceleration (Correction Lbs. per Ton.	Average Grade Per Cent.	Grade Correc- tion Lbs. per Ton.	Net Hor't. Effort Lbs. per Ton.	Direction of Wind.	Velocity of Wind.	Temperature Degrees F.	Weather.	Remarks.	
A	East	East	4	Parallel	58.3	383.9	431.1	1165.5	1225.0	0.31	8	10.5	-0.288	-5.8	27.1	N.	11	35	Clear	From runs A to H inclusive, the vestibule pointed in the direction of the motion of the car.	
B	West	West	4	Parallel	40.8	417.2	402.6	1188.0	1440.0	0.27	8	4.4	-0.309	5.2	26.8	N.W.	10	35	Clear		
C	East	East	4	Parallel	45.7	156.0	480.1	770.3	731.0	0.18	7	5.4	0.354	7.0	25.5	N.W.	8	32	Lt rain		
D	East	East	4	Par.-par.	37.2	101.2	535.4	51.1	552.0	0.14	6	3.7	0.329	6.5	17.4	N.W.	6	35	Clear		
E	West	West	4	Parallel	35.2	188.2	439.2	33.0	1020.0	0.25	5	0.018	0.315	5.3	16.6	N.W.	8	35	Clear		
F	West	West	4	Series	33.4	74.2	461.5	11.7	802.5	0.13	2	0.023	0.209	5.3	16.4	N.W.	6	35	Clear		
G	West	West	4	Series	26.4	126.2	408.2	52.9	645.0	0.24	0	0.002	0.2	0.417	16.0	N.W.	7	36	Clear		
H	West	West	4	Series	27.1	104.7	571.9	59.9	1020.0	0.26	5	1.0	0.307	6.1	19.4	N.W.	7	36	Clear	From runs I to P inclusive, the vestibule pointed in a direction opposed to that of the motion of the car.	
I	West	West	4	Parallel	54.4	356.8	433.2	154.6	1165.0	0.30	0	0.012	0.351	7.2	28.6	N.W.	10	35	Clear		
J	West	West	4	Parallel	31.8	403.3	422.2	170.4	1420.0	0.36	9	1.1	0.362	7.4	28.6	N.W.	11	35	Clear		
K	West	West	4	Parallel	30.2	149.2	421.1	62.8	855.0	0.17	8	5.2	0.372	7.4	18.7	N.W.	6	35	Clear		
L	West	West	4	Parallel	37.8	198.9	483.9	96.2	1100.0	0.28	6	0.008	0.7	0.311	6.2	21.7	N.W.	6	35	Lt rain	
M	West	West	4	Par.-par.	36.7	93.2	526.1	49.0	511.0	0.13	3	1.7	0.360	7.0	20.3	N.W.	7	36	Clear		
N	West	West	4	Series	33.4	81.2	571.8	46.4	566.0	0.14	7	0.019	0.301	6.0	19.0	N.W.	7	36	Clear		
O	West	West	4	Series	24.7	128.0	506.0	66.0	1060.0	0.27	5	0.009	0.4	0.437	8.9	18.2	N.W.	8	35	Clear	
P	West	West	4	Series	23.9	101.4	547.2	55.5	955.0	0.24	8	1.7	0.241	4.9	18.2	N.W.	8	38	Clear		

* The words East and West are used to designate the general direction only. The test track lies N.E. and S.W., 24 degrees from an east and west line.

TRAIN RESISTANCE TESTS

TABLE LXX.— Test No. 56. Flat Front Vestibule, Standard Rear Vestibule. Resistance Tests on Car "Louisiana" on Test Track.

Run	Direction of Car*	Direction of Vestibule*	Number of Motors	Motor Connec- tion	Average Speed M.P.H.	Average Cur- rent Amp.	Average E.M.F. Volts	Average Power K.W.	Total Hor't. Effort, Lbs.	Gross Hor't. Effort, Lbs.	Net Acceler- ation M.P.H. ² /S.	Acc'n Corn'n Lbs. per Ton.	Average Grade Per Cent.	Grade Corn'n Lbs. per Ton.	Net Hor't. Effort, Lbs.	Direction of Wind.	Velocity of Wind M.P.H.	Temperature, Degrees F.	Weather.	Remarks.
A	East	East	4	Parallel	56.7	402	1430	9.173	21330	35.3	-0.088	+8.0	-0.346	-6.9	34.2	S.W.	8	42	Clear	From runs A to H inclusive, the vestibule is pointed in the direction of the motion of the car.
B	West	West	4	Parallel	47.8	459	1419	7.192	1720	45.6	-0.087	+1.7	+0.287	+5.7	35.2	S.W.	9	40	Clear	
C	East	East	2	Parallel	44.0	177	1527	9.93	920	24.4	-0.021	+1.9	-0.341	-8.8	29.3	N.W.	22	33	Raw	
D	East	East	4	Ser-par.	34.9	123	1555	5.68	4778	90.7	-0.033	+3.0	-0.30	-6.0	23.7	N.E.	6	34	Windy	
E	West	West	2	Parallel	32.1	210	1523	0.80	1168	31.7	-0.068	+0.5	-0.312	-8.3	24.0	N.W.	8	33	Clear	
F	West	West	4	Ser-par.	37.9	132	1532	2.70	1028	21.5	-0.063	+0.3	-0.315	-8.3	18.7	N.E.	8	33	Clear	
G	East	East	2	Series	22.5	153	1494	0.24	1028	47.5	-0.009	+0.0	-0.303	-6.1	17.0	N.E.	6	34	Clear	
H	West	West	2	Series	22.1	104	1540	5.56	1940	51.9	-0.063	+0.3	-0.330	-8.6	19.3	N.E.	7	33	Clear	
I	East	East	4	Parallel	58.5	391	1494	3.169	8125	33.9	-0.088	+8.0	-0.346	-6.9	32.2	S.W.	9	40	Clear	
J	West	West	4	Parallel	50.2	415	1417	3.173	3190	39.5	-0.027	+2.5	-0.287	-5.7	31.3	S.W.	8	42	Clear	From runs I to P inclusive, the vestibule is pointed in a direction op- posed to that of the motion of the car.
K	East	East	4	Parallel	44.3	124	1452	7.56	536	14.2	-0.047	+3.0	-0.334	-6.7	16.0	N.W.	8	35	Clear	
L	West	West	2	Ser-par.	34.1	97	1499	7.48	631	14.0	-0.040	+3.6	-0.321	-6.4	17.4	N.W.	6	33	Raw	
M	East	East	2	Parallel	33.7	219	1458	8.100	61286	34.1	-0.021	+1.9	-0.325	-6.5	25.7	N.W.	22	33	Windy	
N	West	West	2	Series	32.4	73	1535	9.39	498	13.2	+0.021	+1.9	-0.345	-6.9	18.2	N.E.	7	33	Clear	
O	West	West	2	Ser-par.	26.9	121	1508	6.62	918	24.4	-0.015	+1.4	-0.319	-6.4	16.0	N.E.	6	34	Clear	
P	East	East	2	Series	25.1	107	1498	0.53	861	22.8	+0.009	+0.8	-0.297	-5.9	16.1	N.E.	6	34	Clear	

* The words East and West are used to designate the general direction only. The test track lies N.E. and S.W., 24 degrees from an east and west line.

TABLE LXXI. — Test No. 57. Standard Front Vestibule. No Rear Vestibule. Resistance Tests on Car "Louisiana," on Test Track.

Run.	Direction of Motion of Car.*	Direction of Vestibule.*	Number of Motors.	Motor Connections.	Average Speed, M.P.H.	Average Current, Amps.	Average E.M.F., Volts.	Average Power, K.W.	Total Horsepower.	Gross H.P., Lbs. per Ton.	Net Acceleration, Tons M.P.H.P.S.	Acceleration, Lbs. per Ton.	Average Grade, Per Cent.	Grade Correction, Tons.	Net Horsepower, Lbs. per Ton.	Direction of Wind.	Velocity of Wind, M.P.H.	Temperature, Degrees F.	Weather.	Remarks.
A	East	East	4	Parallel	52.3	277.5	474.7	131.7	1038	27.7	+0.076	-0.9	+0.350	7.0	27.8	W.	11	38	Clear	From runs A to H inclusive, the vestibule is pointed in the direction of motion of the car.
B	West	West	4	Parallel	48.7	354.1	443.5	157.0	1390	36.1	-0.022	2.0	0.296	5.9	28.2	W.	11	38	Clear	
C	East	East	4	Parallel	42.2	109.7	497.9	84.5	865	23.1	-0.031	2.8	0.356	7.1	27.4	N.E.	4	41	L't rain	
D	East	East	4	Series-par.	37.3	97.7	534.4	52.2	541	14.4	-0.019	1.7	0.340	6.8	19.5	N.E.	3	40	L't rain	
E	West	West	4	Parallel	36.4	290.3	489.4	98.0	1165	31.1	-0.015	1.4	0.390	7.8	20.9	N.E.	3	39	L't rain	
F	East	East	2	Series	30.1	75.8	536.6	40.7	544	14.5	-0.017	1.5	0.407	6.9	19.9	N.E.	4	40	L't rain	
G	West	West	4	Series-par.	28.0	126.1	543.4	68.5	972	25.9	-0.031	2.8	0.407	8.1	15.0	N.E.	4	40	L't rain	
H	East	East	4	Series	23.2	100.3	553.4	55.5	979	25.9	-0.044	0.4	0.357	7.1	18.4	N.E.	4	40	L't rain	
I	West	West	2	Parallel	58.0	288.5	461.0	133.0	979	26.1	-0.020	1.8	0.344	6.9	31.2	W.	11	38	Clear	From runs I to P inclusive, the vestibule is pointed in a direction opposed to that of the motion of the car.
J	East	East	4	Parallel	45.4	331.4	460.9	152.7	1461	39.0	-0.031	2.8	0.387	5.9	30.5	N.W.	6	37	Clear	
K	West	West	2	Parallel	41.1	182.8	519.2	94.9	996	26.6	-0.026	3.7	0.344	6.9	31.1	N.E.	3	40	L't rain	
L	West	West	2	Parallel	40.3	256.8	476.7	122.4	1295	34.5	-0.042	3.8	0.306	6.1	24.6	N.E.	4	41	L't rain	
M	East	East	4	Series-par.	31.6	100.2	518.9	52.0	637	17.0	-0.015	1.4	0.348	7.0	20.9	N.E.	4	40	L't rain	
N	West	West	2	Series	30.8	79.5	558.4	44.4	855	15.6	-0.019	1.4	0.349	7.0	20.9	N.E.	3	40	L't rain	
O	East	East	4	Series-par.	26.3	123.6	504.6	62.4	938	25.0	-0.000	0.0	0.279	5.6	19.4	N.E.	5	39	L't rain	
P	West	West	4	Series	22.6	103.3	553.6	57.2	1025	27.4	-0.012	1.1	0.288	5.8	20.5	N.E.	5	39	L't rain	

* The words East and West are used to designate the general direction only. The test track lies N.E. and S.W., 24 degrees from an east and west line.

In all of the tests on the "Louisiana," excepting Test No. 57, the standard vestibule is on the rear, and in Test No. 57 there was no rear vestibule.

DISCUSSION OF RESULTS.

The effect of variation in the speed of an interurban car on the resistance is clearly brought out in the tables and curves comprised in this chapter. A comparison of these data with the curves of Figs. 162, 163, and 164 given at the beginning of the chapter, shows that both Car No. 284 and the "Louisiana" exhibited a train resistance intermediate between the extremes of the theoretical curves.

Car No. 284 shows an average resistance between 30 and 60 miles an hour of 25 lbs. per ton, varying between the extreme of 15 lbs. at 30 miles an hour and 35 lbs. per ton at 60 miles per hour. These figures conform closely with the average results of tests given by previous experimenters in this line of work. The data show what resistance may be expected on a level track and under ordinary conditions of service. Taken together with the tests on the "Louisiana," a sufficient variety of weather conditions was encountered to permit of the elimination of the effect of wind upon the car resistance.

The data furnished by the "Louisiana" tests are the most important, in that they show the effect of a change of form of the vestibule upon the resistance, and hence exhibit in a marked manner the extent of the influence of the air resistance upon the total resistance. In most of the formulas covering train resistance, the air component is assumed to vary with the square of the speed. The fact that there is a considerable variation in the resistance with the speed, is evidence of the increasing influence of this resistance at high speeds; for the mechanical resistance, aside from the resistance of the air, does not vary greatly with the speed.

While it is not to be expected that the points from which resistance curves are plotted will all lie on smooth curves, on account of the difficulty of making exact determinations, never-

theless, all of the curves show a consistent tendency toward well defined curves. The irregularity of the points is due also to the fact that a car does not exhibit the same resistance on two successive runs under exactly the same general conditions, as there are variables affecting the result which are not measurable, and which are not under the control of the experimenter.

Such variables are the resistance between the wheel flange and the rails, the instantaneous variation in direction and velocity of the wind, instantaneous variations in grade and acceleration, and changes in lubrication of the various bearings and gears forming parts of the equipment. It is well known that the losses in bearings and in gears can be determined only approximately, and variations of several per cent in these losses may be expected in the same equipment. With these indeterminate variables, should be included the change in the efficiency of the motors due to fluctuations in the line pressure. The line pressure is constantly varying in a test, and the resultant changes in motor efficiency can only be accounted for in a general way in calculating the train resistance.

These facts are clearly borne out in the tests discussed in this chapter from the fact that, while each measurement was made with extreme care and with substantial accuracy, there is a variation in the results which can only be accounted for through the uncertain elements mentioned. However, the curves of resistance which have been determined are sufficiently numerous, and the resistance constants are so consistent, especially at the higher speeds, that it is safe to make a number of deductions therefrom.

As would be expected, the greatest resistance at speeds of from 40 to 60 miles an hour, is obtained when a flat vestibule is used. The increase of resistance of the flat vestibule over other forms is from 20 to 40 per cent at a speed of 60 miles an hour. At speeds below 40 miles an hour, the flat vestibule does not show any great increase in resistance over other forms. The tests with the car equipped with the flat vestibule show also, as would be expected, that the train resistance is considerably

greater when the car is running forward than it is when the car is running backward. This difference is practically the same when the car is equipped with the standard vestibule in front. In both of these cases, there is a considerable suction in the rear when the car is running forward. That this is true is further evidenced by a study of runs I to P in Table LXXI, in which tests the standard vestibule was on the front and no vestibule on the rear; that is, the rear was perfectly flat. In this case, the resistance with the car running backward was very much greater than with the same car running forward, and the figures conform very closely with the corresponding data of Table LXX, in which tests the car was equipped with the flat vestibule. This shows clearly that it is not sufficient to have a well-formed front vestibule, but that the rear vestibule also requires attention.

A comparison of Tables LXVIII, LXIX, and LXX, in which the car is equipped with the parabolic wedge, parabolic and standard vestibules, respectively, shows several interesting and practical features. In the first place, as would be expected, the total resistance does not vary greatly with the form of the vestibule. The reason for this is that the variation of vestibule form does not produce a sufficient effect on the total resistance to be very noticeable, excepting in cases where there is great divergence in form. It would be expected that the parabolic wedge would offer a much smaller resistance, but the difference between this and the parabolic form is not great enough to produce any marked effect on the total resistance. It must be left to the special tests, considered in Chapter XVI, to determine the exact effect of each of these forms upon the total resistance.

CHAPTER XV.
THE TEST CAR "LOUISIANA."

INTRODUCTION.

THE "Louisiana" is an especially designed dynamometer car which was constructed for the purpose of determining the effect of the air pressure upon the front, the sides, and the rear of a car when running on a tangent level track at various speeds up to 70 miles an hour.

Various forms of movable vestibules were designed and constructed so that the investigations not only permitted of a determination of the effect of the shape of vestibule, but also a complete separation of the vestibule pressure from the total car body pressure. As the total power required to drive the car was obtained from the electrical input data, a separation of the total power into its various component parts was also possible.

The results of the air resistance tests are given in Chapter XVI, the present chapter being devoted to a more or less detailed description of the car itself.

GENERAL CONSIDERATIONS INVOLVED.

The particular purpose of the air resistance tests was to measure the air components of the car resistance independently of the total resistance. Apparently, the only direct method of accomplishing this was to suspend the car body above the trucks in such a way that the air pressure upon the car body could be measured by suitable dynamometers. Further, as it was desired to separate the head resistance and the rear resistance from the total air resistance, the natural plan was to suspend the ves-

tibule separate from the body and to provide a suitable dynamometer for measuring the force exerted against the body by the vestibule. While this involved numerous difficulties, they were finally overcome by practical and safe expedients.

It was essential that the car body be entirely free from the driving trucks, except for the contacts through the supports, which contacts were made as free from friction as possible. It became necessary, therefore, to mount the controllers, braking apparatus, and trolley base entirely independent of the car body. The details of the mechanism for securing these results are given later in the chapter.

In choosing a frictionless support for the car body a number of plans were given careful consideration. Among these were various knife-edged supports and various forms of ball and roller bearings. In view of all the circumstances, the double-ball bearings manufactured by the Chapman Ball Bearing Company were selected as the most practical for the purpose of the Commission. While the actual plan employed combined a number of most important features for safety and convenience, it is probable that a spring hinge would have been devised, if time had permitted.

The difficult problem in connection with the designing of the car was that of the dynamometer for measuring the tractive effort exerted by the driving trucks on the car body, as well as that of the vestibule. An oil dynamometer with a piston rotating to eliminate friction, would probably have been found to be the ideal arrangement. However, the time at the disposal of the Commission did not permit of the construction of such a dynamometer, and of making the experiments necessary to perfect it. It was decided, therefore, that the simplest and most direct means must be employed, and for that reason a plan involving the use of levers and weighing beams was adopted. The firm of Fairbanks, Morse & Company manifested great interest in the experiments and cooperated with the Executive Committee in the construction of the necessary apparatus.

GENERAL CONDITIONS OF THE TEST.

Soon after the Executive Committee of the Electric Railway Test Commission began its investigations, the Indiana Union Traction Company placed at the disposal of the Commission, a section of track on the "Northern Division," which is for several miles perfectly straight and well adapted to the purposes of making car resistance tests. This stretch of track has already been described in connection with the car resistance tests covered in Chapter XIV.

The section employed in the present series of tests was located between poles numbers 10,670 and 10,920, a total length of 25,000 ft. or nearly five miles. The section was supplied with power from the Noblesville substation, which was located a short distance from the northern end of the section. This substation is located 42.1 miles from the power house at Anderson, from which it receives power over a three-phase transmission line at 30,000 volts. The station contains four 175 kilowatt "step down" transformers and two 250 kilowatt rotary converters. It also contains a storage battery which has a rated capacity of 80 amperes discharge for eight hours. In making the very high speed runs, the pressure on the line was increased by raising the pressure on the generators at Anderson by means of an increase in their field excitation. The battery was disconnected from the line during the runs made at abnormally high pressure.

The profile showing the original grades is given in Fig. 171. As the proposed tests required an accurate knowledge of the profile of the track, a special survey was made to determine the exact grade for each one hundred feet throughout the test section. A portion of the track showing the original grades, as well as those obtained from the special survey, is given in Fig. 171A, while Table LXXII shows the results of the special survey for the entire test section. Although the poles were found to be spaced with great uniformity, the distances between the poles along the line were carefully checked, as the

location of the car with reference to the poles was used in checking the calculations of the speed. The test track was divided into 500 ft. sections, each of which was plainly marked by a white sign-board approximately one foot by three, with the section number plainly marked on both sides with figures 5 in. in height. These signs were placed at a height of 5 ft. above the car floor, so that they were on the eye level of the observer, whose duty it was to record the time of passing each sign-board.

GENERAL DESCRIPTION OF THE DYNAMOMETER CAR.

Before entering upon the details relating to the design of construction of the "Louisiana," the following general items will serve as an introduction to this description:

The essential feature was a car body specially constructed by the J. G. Brill Company. This was an interurban car body 32 ft. long, exclusive of vestibules, arranged to roll freely upon rails secured to the floor of a "Pressed Steel" flat car of 100,000 lbs. capacity. In addition to this car body, a special steel vestibule and a standard vestibule were also designed and supplied by the J. G. Brill Company for the use of the Commission.

Under the side sills of the dynamometer car body were mounted eight Chapman double-ball bearings, and these carried four axles $3\frac{7}{8}$ in. in diameter and 9 ft. long. Upon the axles were pressed specially chilled wheels, 12 in. in diameter, with ground treads. The rails were also ground perfectly smooth where they came in contact with the wheels. By this method of mounting, there was comparatively little friction between the body and the flat car. The body was restrained from excessive motion by various effective safety devices.

The pressure of the air upon the body was measured by means of scale beams constructed for the tests by Fairbanks, Morse & Company, and loaned by them to the Executive Committee. The beams were supplied with dash-pots, and the weighing mechanism consisted of the regular beam, with weights and poise; and, in addition, a spring balance with a dial was attached to

ELECTRIC RAILWAY TEST COMMISSION

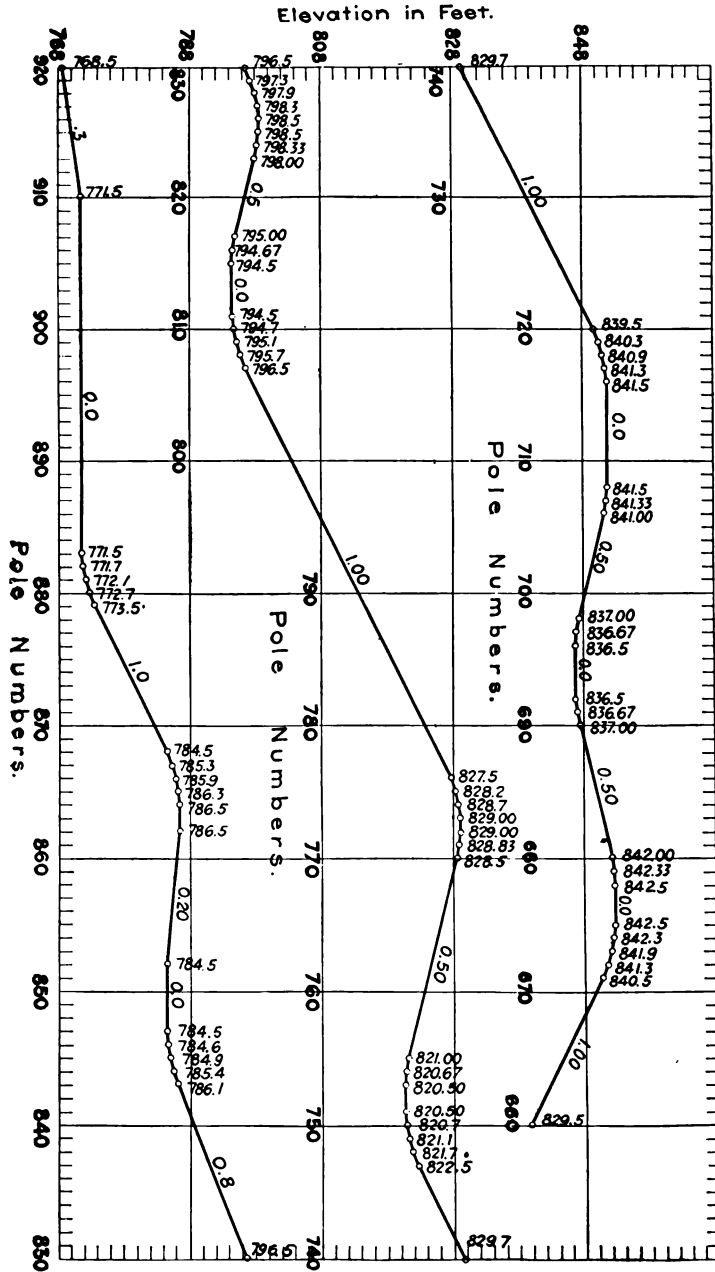

Fig. 171. — Section of Test Track between Noblesville and Carmel, Showing both the Original Grades and the Actual Grades as Obtained from the Special Survey,

the end of the beam to render easier the manipulation of the weighing mechanism.

As safety was a most important element in these tests, two safety locks were constructed for the purpose of rigidly clamping the car body to the flat car floor at all times when measurements were not being made. These locks also served to restrain the motion of the car body to the few inches necessary to permit of taking readings during the time the pressure measurements were being made. One of these locks also served as the point of attachment to the flat car of the dynamometer employed in measuring the air pressure on the car body.

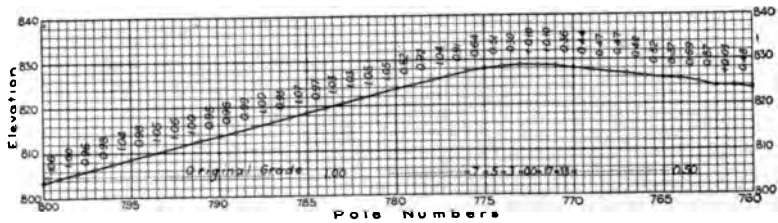

Fig. 171A.—Profile of Test Tracks between Noblesville and Carmel. Indiana Union Traction Co.

A heavy counterweight mounted on a steel lever was used to hold the car body against the knife edges of the lever system at all times, so that the dynamometer equipment (which read in one direction only) could be used for making measurements with the car going in either direction.

In order to absorb the vibrations between the car body and the flat car upon which it rolled, a pair of air brake cylinders was mounted on the car body floor, one just forward and the other just back of the center of the car, the arrangement being such that their pistons pressed against the trolley post which was a part of the flat car. The cylinders were filled with oil, and were connected by means of a by-pass containing a valve so that the rate of flow of oil between the cylinders could be regulated, and the vibration absorbed to any desired extent.



Fig. 172. — Test Car "Louisiana" Equipped with Parabolic Vestibule.

THE TEST CAR "LOUISIANA"

TABLE LXXII. — Table of Grades between Siding 105 and Siding 109.
Indiana Union Traction Co.

NOTE. — Plus sign (+) indicates up grade going east.

Pole No.	Per Cent Grade	Pole No.	Per Cent Grade	Pole No.	Per Cent Grade	Pole No.	Per Cent Grade	Pole No.	Per Cent Grade	Pole No.	Per Cent Grade
660		4	0	8	1.04	2	.45	6	1.01	830	.74
	+1.07		0		-1.06		+ .87		-.98		-.76
1	1.01	5	.03	9	1.07	3	.78	7	.97	1	.77
	+ .95		+ .06		-1.08		+ .69		-.96		-.79
2	.95	6	0	730	1.01	4	.53	8	.98	2	.80
	+ .95		+ .14		-.95		+ .37		-1.00		-.81
3	1.02	7	.15	1	.99	5	.44	9	1.03	3	.82
	+1.09		+ .17		-1.03		+ .52		-1.06		-.84
4	1.07	8	.22	2	1.01	6	.47	800	1.03	4	.82
	+1.06		+ .28		-.99		+ .42		-1.00		-.80
5	1.05	9	.33	3	1.01	7	.44		1.95	5	.81
	+1.04		+ .39		-1.04		+ .47		-.89		-.82
6	.93	700	.38	4	1.02	8	.47	2	.99	6	.85
	+ .93		+ .37		-1.00		+ .47		-1.09		-.88
7	.98	1	.39	5	.97	9	.45	3	1.00	7	.86
	+1.04		+ .42		-.94		+ .44		-.92		-.84
8	1.01	2	.39	6	.96	770	.40	4	.97	8	.80
	+ .98		+ .37		-.99		+ .36		-1.03		-.77
9	.98	3	.41	7	1.01	1	.23	5	.96	9	.82
	+ .99		+ .45		-1.02		+ .10		-.89		-.88
670	.88	4	.40	8	1.04	2	.10	6	.94	840	.85
	+ .78		+ .35		-1.07		+ .10		-.99		-.83
1	.77	5	.40	9	1.03	3	-.10	7	.80	1	.87
	+ .77		+ .44		-.99		+ .30		-.61		-.90
2	.73	6	.35	740	1.01	4	-.40	8	.56	2	.87
	+ .69		+ .27		-1.02		+ .51		-.52		-.84
3	.61	7	.35	1	1.00	5	.57	9	.44	3	.77
	+ .52		+ .44		-.98		+ .64		-.36		-.70
4	.41	8	.35	2	1.01	6	.77	810	.34	4	.61
	+ .31		+ .25		-1.05		+ .91		-.32		-.53
5	.26	9	.20	3	1.02	7	.97	1	.29	5	.42
	+ .22		+ .16		-1.00		+ .04		-.26		-.32
6	.11	710	.15	4	1.04	8	.98	2	.21	6	.21
	0		+ .14		-1.08		+ .92		-.17		-.11
7	-.08	1	.07	5	1.07	9	.87	3	-.09	7	.14
	+ .16		+ .01		-1.07		+ .82		+ .01		-.17
8	.23	2	.03	6	.88	780	.94	4	.04	8	.17
	+ .31		+ .05		-.69		-1.05		+ .07		-.18
9	.32	3	.06	7	.69	1	-.69	5	.18	9	-.05
	+ .33		+ .07		-.69		-1.05		+ .29		+ .08
680	.38	4	.02	8	.69	2	1.04	6	.31	850	.05
	+ .43		+ .04		-.69		-1.03		+ .34		+ .03
1	.49	5	.02	9	.55	3	-.41	7	.40	1	.06
	+ .55		+ .01		-.41		-1.03		+ .45		+ .10
2	.51	6	-.08	750	.29	4	1.00	8	.44	2	.19
	+ .48		+ .17		-.17		-.97		+ .44		+ .28
3	.53	7	.29	1	.12	5	1.02	9	.50	3	.24
	+ .64		+ .41		-.08		-1.07		+ .55		+ .21
4	.61	8	.50	2	+.08	6	1.00	820	.56	4	.33
	+ .58		+ .58		+ .24		-.93		+ .58		+ .46
5	.55	9	.72	3	.14	7	.96	1	.60	5	.34
	+ .53		+ .87		+ .04		-1.00		+ .61		+ .22
6	.59	720	.83	4	.15	8	1.00	2	.52	6	.23
	+ .65		+ .79		+ .26		-.99		+ .43		+ .24
7	.59	1	.92	5	.37	9	.97	3	.37	7	.41
	+ .53		+ .05		+ .49		-.96		+ .31		+ .58
8	.48	2	1.04	6	.48	790	.95	4	.22	8	.40
	+ .43		+ .03		+ .48		-.95		+ .13		+ .22
9	.31	3	1.04	7	.49	1	.97	5	.10	9	.22
	+ .19		+ .05		+ .50		-1.00		+ .07		+ .23
690	.20	4	.98	8	.56	2	1.03	6	-.08	860	.15
	+ .21		+ .92		+ .62		-1.06		-.22		+ .09
1	.15	5	.96	9	.56	3	1.05	7	.30	1	.15
	+ .10		+ .01		+ .50		-1.05		-.39		+ .20
2	-.03	6	1.01	760	.49	4	1.01	8	.50	2	+.10
	+ .03		+ .01		+ .48		-.98		-.61		+ .01
3	.01	7	1.01	1	.25	5	1.01	9	.67	3	-.04
	0		-1.02		+ .03		-1.04		-.73		-.07

TABLE LXXII. — *Continued.*

NOTE. — Plus sign (+) indicates up grade going east.

Pole No.	Per Cent Grade	Pole No.	Per Cent Grade	Pole No.	Per Cent Grade	Pole No.	Per Cent Grade	Pole No.	Per Cent Grade	Pole No.	Per Cent Grade	Pole No.	Per Cent Grade					
8	.04	+	.20	5	.0	—	.09	—	.25	5	—	.27	—	.31				
—	.01	2	+	.14	+	.02	9	—	.12	2	—	.26	5	—	.25			
9	.06	+	.08	6	—	.04	—	.15	—	.23	6	—	.24	8	—	.30		
—	.11	3	+	.06	—	.10	910	—	.20	3	—	.19	6	—	.26	9	—	.38
900	.14	+	.04	7	—	.06	—	.24	—	.10	7	—	.28	9	—	.47		
—	.27	4	+	.0	—	.02	1	—	.24	4	—	.18	7	—	.30	920		
1	.03	—	.03	8	—	.06												

NOTE. — Large figures show grades *between* poles, and small figures show grades *at* poles.

The movable vestibule was hung from the front of the car body by means of two links. The vestibule was attached to the front of a steel and oak guide frame, which was restrained in its motion on all sides by small Chapman bearings specially constructed for this purpose. These bearings were mounted on rubber seats to relieve them from shock. The frame and vestibule were approximately balanced on the links, so that the guide frame exerted little force against the restraining bearings. The force exerted by the vestibule on the body was transmitted from a central point on the guide frame through a system of knife-edged levers to a dynamometer similar to that used for the car body pressure measurements.

In order to eliminate all possible resistance between the movable car body and the supporting flat car, the controllers were mounted on iron stands projecting upward from the flat car floor. As the cables were very heavy and stiff, this feature was absolutely necessary.

The trolley stand was supported on the top of a heavy oak post projecting upward through the car body floor from the flat car floor to a point about 6 ft. above the floor. The trolley base was, therefore, inside the car body, the trolley pole projecting through the roof and being bent at such an angle as to enable it to hold to the trolley wire.

The air brake equipment was supported entirely from the flat car. The piping for the motorman's valve, the pneumatic track sanding device and the whistle, projected through the car body

floor to a height convenient for the motorman, who was stationed inside the car body, and not in the vestibule.

A set of twenty extra heavy resistance frames, supplied by the Westinghouse Electric and Manufacturing Company, was connected in the main trolley circuit for the purpose of controlling the current and therefore the speed of the car. These resistances were manipulated by means of a specially designed switchboard, so arranged as to enable the operator to short circuit any or all grids, and to connect the frames either in series or in parallel in any desired combination.

EXTERIOR VIEWS OF THE CAR.

Fig. 172 shows the car as it was arranged for the preliminary tests, and also for Test No. 59. The movable car body has a

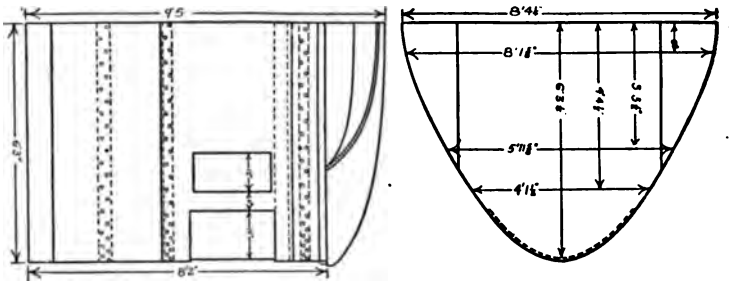

Fig. 173. — Sketch of "Parabolic" Movable Vestibule.

standard vestibule attached at the rear, while the movable vestibule at the front is that of the "parabolic" form, a sketch of which is shown in Fig. 173. This constituted the original car body and vestibule which were built for the Commission by the J. G. Brill Company. While the car body and rear vestibule were of standard construction, the parabolic vestibule was specially designed and constructed by the Brill Company, in accordance with preliminary sketches furnished by the Executive Committee. The vestibule proper was of sheet steel mounted on a steel framework, the hood being similar to the standard form of construction, excepting that it had to be spe-

cially designed to fit the parabolic vestibule. The hood formed a part of the movable vestibule, the latter being swung on supports projecting from the front of the car body, as described elsewhere in this chapter.

The sign shown in the photograph of the car gives a list of the principal coöperating companies and reads as follows:

PRINCIPAL COÖPERATING COMPANIES

INDIANA UNION TRACTION COMPANY

J. G. Brill Company
 Pressed Steel Car Company
 National Electric Company
 Fairbanks, Morse & Company
 Westinghouse E. and M. Company

Baldwin Locomotive Works
 Weston Electrical Instrument Company
 Chapin Double-Ball Bearing Company

Fig. 174 shows the car equipped with the "parabolic wedge" vestibule used in Test No. 58. The general construction does not differ from that shown in Fig. 172, excepting in the form of

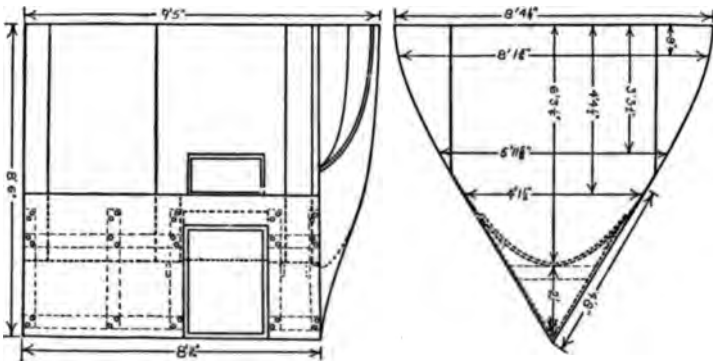

Fig. 175. — Sketch of "Parabolic Wedge" Movable Vestibule.

the vestibule, a sketch of which is shown in Fig. 175. The wedge shape was obtained by building out a wooden framework attached to the parabolic vestibule, and by covering this framework with a galvanized iron sheathing. As seen from the photograph, the flat surface of the wedge began at a point just forward of the small side windows of the parabolic vestibule. Two large windows were placed in the wedge so as to enable the motorman

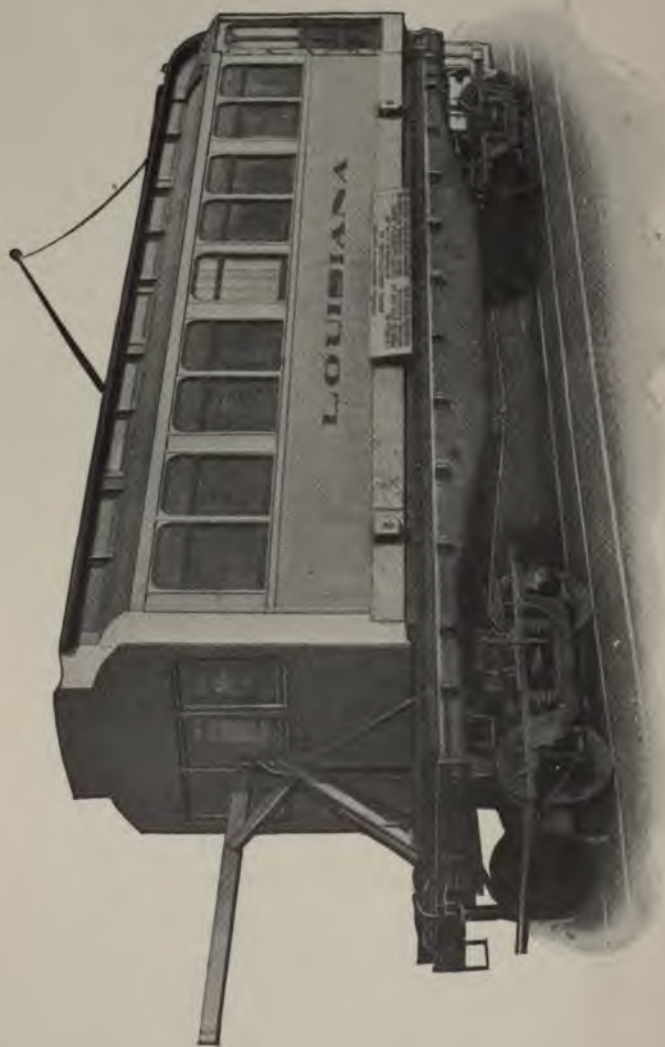

Fig. 176.—Car "Louisiana" Equipped with Fiat Vestibule and with Calibrating Lever in Position.

to have a good view of the right of way. Some little difficulty was experienced in building out the hood of the parabolic vestibule to conform to the parabolic wedge conditions, but this was finally accomplished in a satisfactory manner. The standard form of vestibule was attached to the rear of the movable car body during the tests in which the parabolic wedge vestibule was employed.

The "flat" form of movable vestibule is shown in Fig. 176, and was the one employed in Test No. 60. The standard form of vestibule was attached at the rear of the movable car body during these tests. The movable vestibule in this case consisted essentially of a flat surface, which conformed to the general contour of the cross-section of the car body. It was built up with light matched lumber mounted on a steel and iron framework, three large windows being included in the construction for purposes of observation. The large bell crank lever shown in the photograph was not in position at the time Test No. 60 was made. As stated elsewhere, this lever was constructed for the purpose of obtaining a calibration of the dynamometers by means of direct pressure and tension measurements.

DETAILED DESCRIPTION OF THE CAR.

The Driving Equipment.

The Flat Car. — The foundation of the dynamometer car was a pressed steel flat car of 100,000 lbs. capacity, loaned to the Commission by the Pressed Steel Car Company of Pittsburgh, Pa. The construction of this car is illustrated in Fig. 177.

It consists essentially of a pair of extra heavy center sills, connected above by a steel plate firmly riveted to the sills. The sills are braced by means of angles riveted to the bottom edge, and they are cross-connected by Tee bars. The side sills are of the dished pattern, and these were also stiffened by means of angles riveted at the top and bottom. All of the sills were connected by cross angle-bars spaced about 3 ft. apart. The bolsters were extra heavy, and were located about 5 ft. from

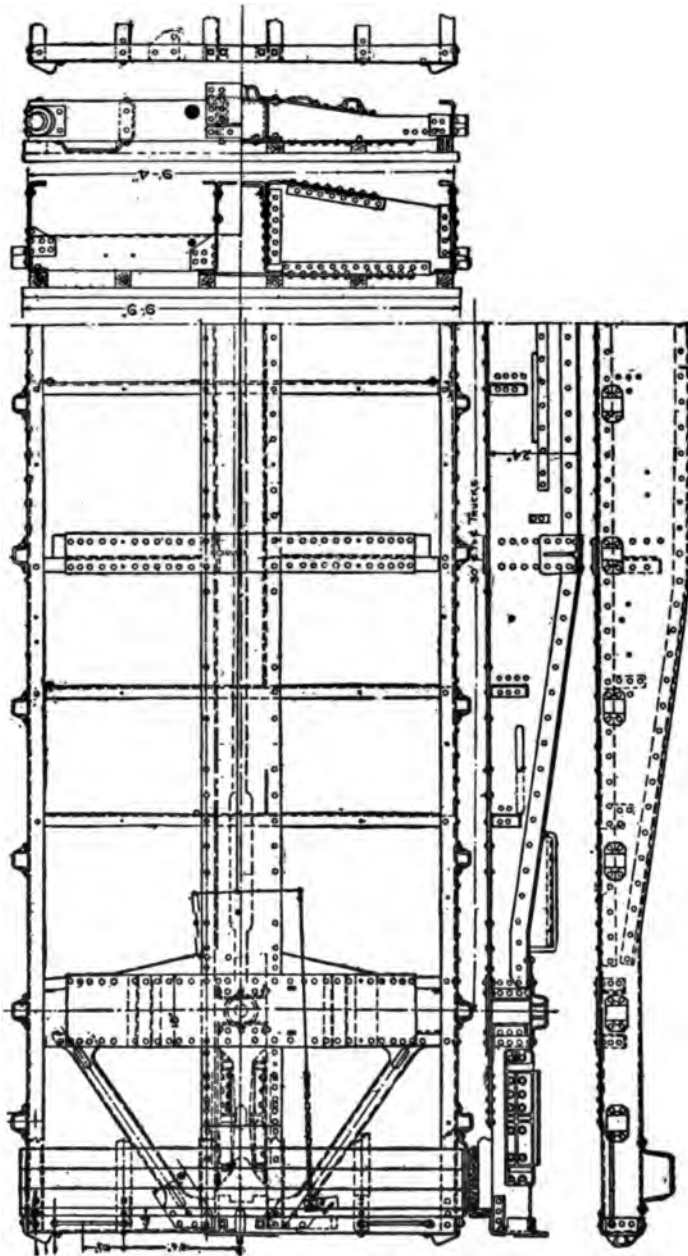

Fig. 177. — Sketch Showing General Construction of Pressed Steel Flat Car.

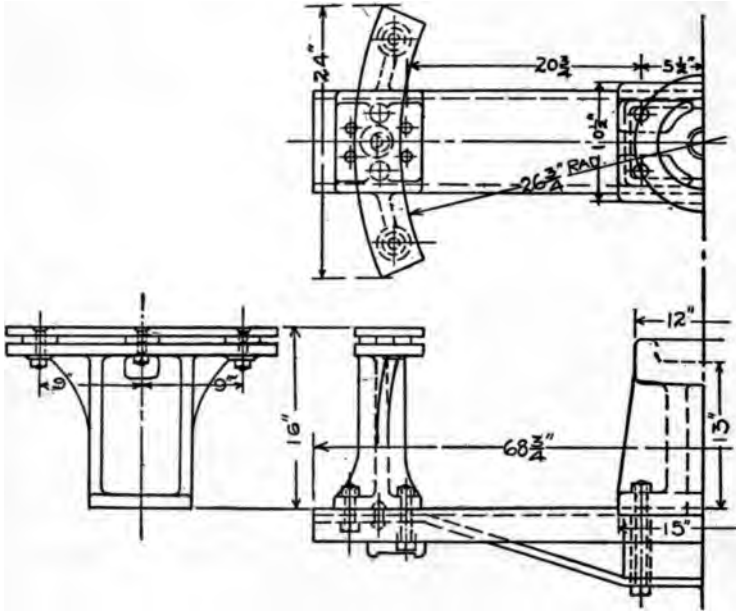

Fig. 178.—Sketch Showing Details of Changes Made in Center Plates and Side Bearings of Baldwin Trucks.

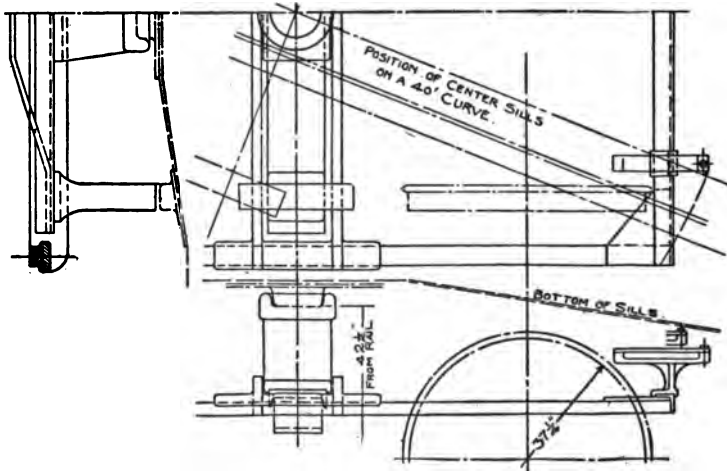

Fig. 179.—Sketch Showing Changes in the Baldwin Trucks to Accommodate the Flat Car.

air brake in connection with the flat car. The entire brake equipment, with the exception of the parts constructed by the Executive Committee, was supplied by the National Electric Company.

The brake cylinder was mounted on steel strips hung from the bottom of the cross-bars at the middle of the flat car. The bars which connected the ends of the levers to the transoms were one inch by five inches, and were bent in such a form as to enable them to clear the various parts of the flat car frame. The ends of these bars were forged into a U-shape, so as to span the transoms and support a pair of rollers, which served to deliver the force to the transoms without undue friction. The tension bars were prevented from side motion by a guide hung from the center sills. In order to provide against any possible accident to the air braking equipment, a hand brake equipment was installed. This was equipped with drums of the Peacock type, supplied by the National Brake Company. These drums have a spiral form, which brings the chain nearer to the spindle as the chain is wound up. The drums are largest at the end to which the brake chain is attached, so that the slack is quickly taken up and the tension on the chain increases as the drum is rotated. The hand brake rigging, as well as the piping for the air brake equipment, was mounted on the flat car floor and projected through openings in the car body floor.

The motor-compressor was mounted near the center of the car, under the floor, and suspended from two adjacent cross-angles by steel straps which were hung from the tops of the angles, and which passed under the base of the compressor. The compressor was entirely inclosed, but it was so located that there was sufficient space between the box and the side sills to permit of the removal of the sides of the box. This made it possible to inspect the commutator and to oil the machine. The reservoir was located above the floor of the flat car near the compressor.

The governor was also located on the flat car floor, and was accessible from above by means of a trap door in the car body floor.

Motor Equipment. — Upon the trucks were mounted four No. 85 Westinghouse motors geared for a speed of 60 miles an hour, the gear ratio being 27 to 47. These motors were similar to the standard equipment of the Indiana Union Traction Company, by which the motors were loaned to the Commission.

For the purpose of these tests the motor fields were shunted through iron grid resistance frames, furnished by the Westinghouse Electric & Manufacturing Company. These grids were mounted beneath the floor of the flat car, and were so arranged that the shunt resistance could be increased or decreased with little trouble by means of suitable switches.

Controller and Wiring. — While the standard cars of the Indiana Union Traction Company are supplied with but one controller, it was quite essential to provide a double-ended equipment for these tests. The Traction Company loaned one Type L-4 Westinghouse Controller, and the Westinghouse Electric & Manufacturing Company loaned a duplicate one. The Traction Company also supplied a set of cables for a single-ended equipment. It was necessary, therefore, for the Executive Committee to rearrange this wiring to fit it to a double-ended controller equipment.

As the wiring had to be done on as economical a basis as possible, it was decided to make up the new cables of weather-proof wire. No. 0 *B & S* gage wire was used for all of the motor and resistance connections, and No. 000 *B & S* gage rubber covered cable was used for the trolley and ground connections. The starting resistance grid frames were mounted upon the flat car floor. They were thirteen in number, and were connected in accordance with the standard practice of the Traction Company, as shown in Fig. 180. This diagram also gives details of the wiring and of the controller connections. The wiring cables were covered with canvas cable hose, which was laid directly upon the flat car floor.

In order to prevent any unnecessary connection between the upper part of the car and the driving equipment, the controllers were mounted upon bent steel frames which projected upward

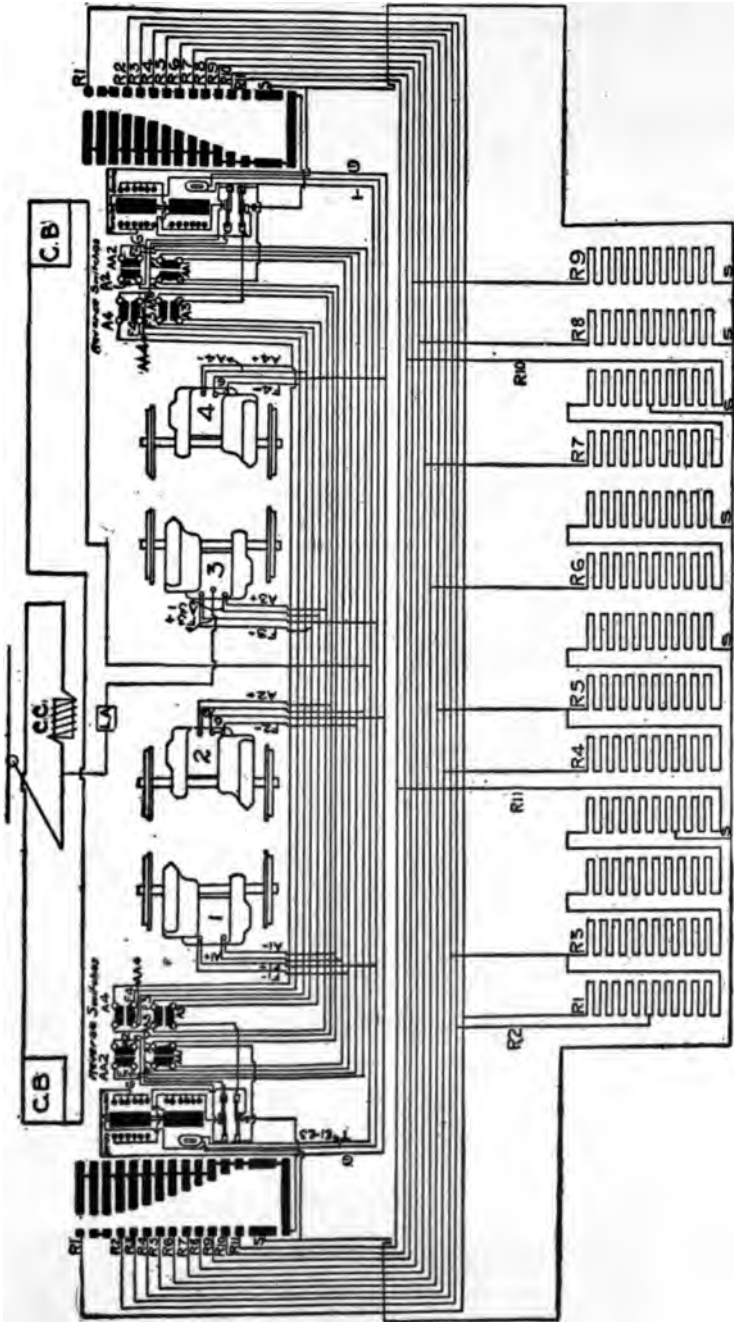

Fig. 180. — Car Wiring Diagram of "Louisiana."

from the flat car floor through the car body floor without touching the latter. All cables were brought up inside these frames, and were thus kept entirely free from the car body. The controller and controller-supporting frames also served as the support for the air brake and whistle piping.

Other Driving Mechanisms. — Each truck was provided with pneumatic sanders consisting of iron boxes mounted upon the truck frames, with openings which delivered sand directly in front of the wheels. The sand valves were operated by means of compressed air, the air valve being placed close to the air brake valve.

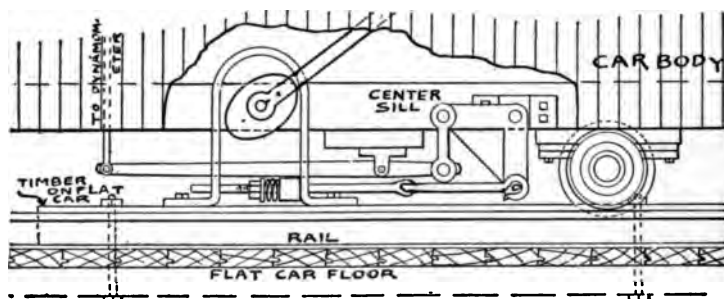

Fig. 181. — Sketch Showing General Arrangement of Safety-Locking Device and Car Body Dynamometer.

The car was supplied with a chime whistle for use in the open country, and with a large foot gong for use in cities. A Mosher head-light for use on night runs was a part of the equipment, as were also the usual trolley retrievers and other sundry equipment necessary for the operation of a high speed car.

Car Body Equipment. — Lengthwise upon the flat car floor, and 6 ft. 4 in. between the insides of the heads, were mounted two steel rails weighing 45 lbs. per yard. These were secured to the floor by means of lag screws. These rails were straight, carefully leveled, and were polished at those places where the car body wheels rolled.

To the center of the flat car floor was secured a 6-inch by 8-inch Georgia pine timber 20 ft. in length, which was bolted

at several places to the steel plates of the center sill of the flat car. This timber was used to support the driving and safety mechanisms of the movable car body. One of the two safety locking devices used is shown in Fig. 181, while a more detailed view is given in Fig. 182.

The Movable Car Body. — A special interurban car body was supplied for these tests by the J. G. Brill Company. In order to

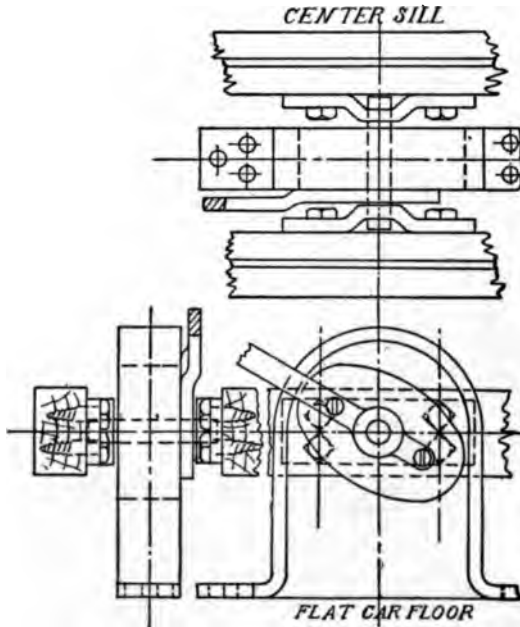

Fig. 182. — Detailed Sketch of Safety-Locking Device.

render it as light as possible, and to provide the necessary room inside the car body, it was not lined, and all unnecessary parts were omitted. The body was 32 ft. in length over corner posts, 8 ft. 4 in. in width outside, and the height from the bottom of the side sills to the top of the roof was 9 ft. 4 in. A sketch of the cross-section is shown in Fig. 183.

The body was mounted upon eight 12-inch wheels specially chilled for the purpose by the American Car & Foundry Com-

pany. They were pressed upon four $3\frac{1}{8}$ -inch steel axles, 9 ft. in length. Fig. 183A shows a general sketch of the wheels and axle. The treads of these wheels were ground, after they were in

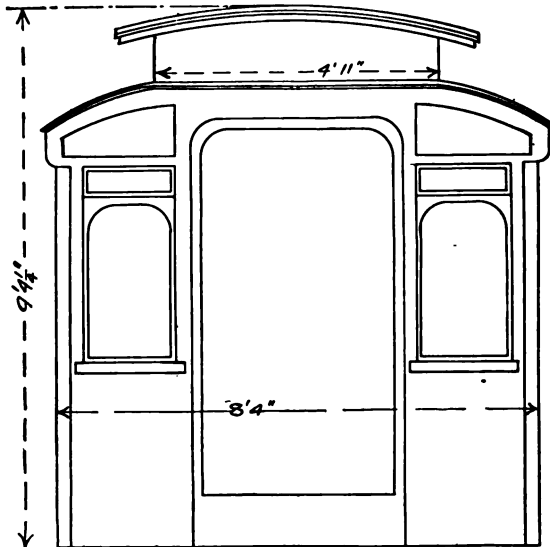

Fig. 183. — Cross Section of Car Body of "Louisiana." This Sketch Also Shows the General Dimensions of the "Flat" Movable Vestibule.

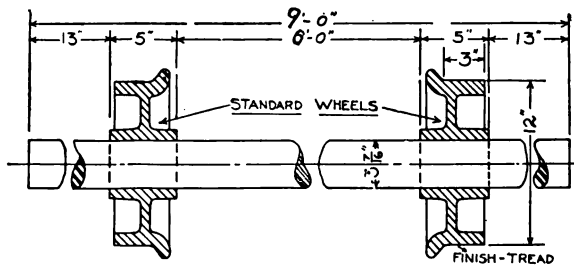

Fig. 183A. — General Sketch of Wheels and Axle for Mounting Car Body, Showing Dimensions.

position, by means of curved blocks formed to fit the surface of the wheel; emery powder mixed with oil being used as an abrasive. The blocks were held against the wheels by means of springs, and the wheels were driven by an electric motor belted to a pulley mounted on the axle. The wheels were so hard

that a week or more was consumed in grinding the surfaces of the treads perfectly smooth.

The axles were carried by Chapman double-ball bearings, which are illustrated in Figs. 184 and 185. The general method of mounting the bearings is shown in Fig. 186, while Fig. 187 gives the mounting more in detail. As the success of the experiments depended to a considerable extent upon the character of the bearings employed, a brief description of the bearings selected will be of interest. As is evident from the illustra-

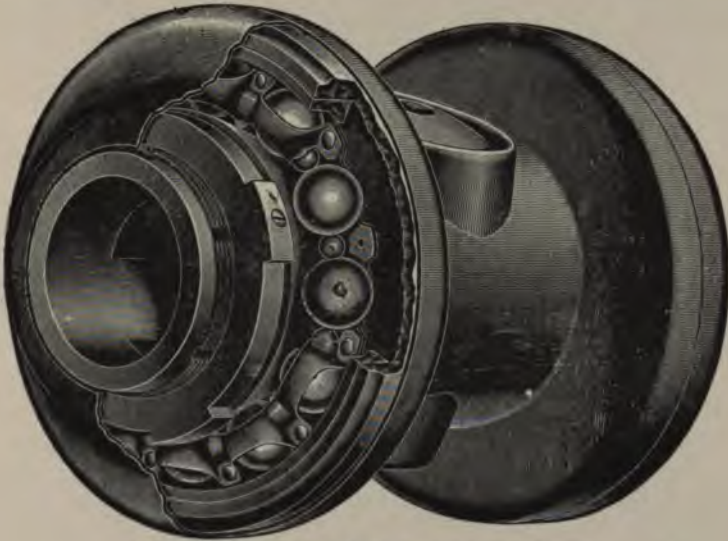

Fig. 184. — General View Chapman Double-Ball Bearing.

tion, the bearings consist of two rings of large balls carried between cones, one on each of the hubs. The cones are of hard tool steel, and are adjusted by means of screw threads. A feature peculiar to the Chapman bearing is the fact that the balls are spaced by means of small intermediate balls, each of which is carried in a small cage. The spacing balls are so arranged that there is no slipping between any pair of adjacent large balls. The hub of the bearing slips loosely over the shaft to be driven, which is free to revolve inside the hub in case the friction in the

ball rings becomes excessive for any reason. The hub is covered at each end by a pressed steel dust proof case. In the test, tin hoods were built over the ends of the bearings to protect them from the weather.

The four supporting axles were placed under the car body in such a way as to distribute the strain uniformly along the rails. When thus mounted, the body rolled freely upon the rails, a force of a few pounds being sufficient to start it.

The Vestibules. — Four types of vestibule were employed in connection with the tests: (1) a vestibule with a parabolic sec-

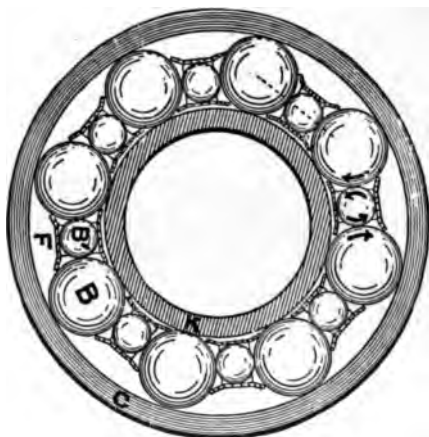

Fig. 185.—Pressed Steel Duct-Ring of Chapman Double-Ball Bearing.

tion; (2) a vestibule with a wedge-shaped section; (3) a standard interurban vestibule; and (4) a flat surface, representing the front of a perfectly square-ended car.

The parabolic vestibule was constructed of light sheet steel built upon a steel angle iron framework. This vestibule was constructed for the tests by the J. G. Brill Company. Figs. 172 and 173 show the general construction of this vestibule and its dimensions. It conformed in outline to the front of the car, and was provided with a hood of the Pullman type. The weight of this vestibule was approximately 1900 lbs., including the guide frame.

As the general construction did not permit of a motorman standing in the vestibule, a special bent glass front was constructed by the Executive Committee in order to give the motorman as good a view of the track as possible. A plate of double thick window-glass was bent by a local firm to conform to the exact curvature of the front. An aperture was cut in the steel sheathing and around the edge of this was placed a strip of thick felt. A wooden frame was sprung against the inside of the sheathing to support the glass, and, after the glass was placed against the felt strip, a second felt strip was placed over it, and strips of thin steel were screwed firmly against this felt. This

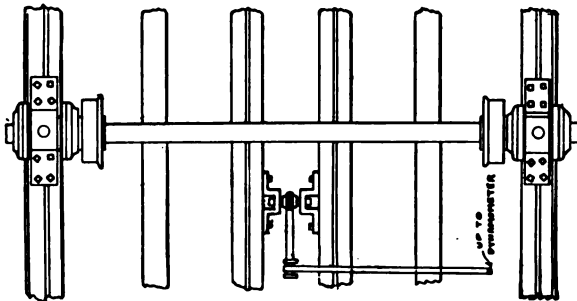

Fig. 186.—Sketch Showing General Method of Mounting Chapman Double-Ball Bearings. This Sketch Also Shows General Arrangement of the Car Body Dynamometer Lever.

construction served to hold the glass in position without having it come in contact with any hard surface. The glass was specially annealed to protect it from the strains which would be caused by constant changes in temperature.

After the vestibule was placed in position in the car, the contour of its surface was continued downward with sheets of thin steel to the top of the flat car floor, to prevent currents of air from circulating underneath it and introducing errors into the measurements.

The "parabolic wedge" vestibule was produced by building a wooden framework out from the parabolic vestibule and covering it with sheet steel, as shown in Figs. 174 and 175. The roof was molded to conform with the general contour of the

cross-section of the car, and when this was equipped, the vestibule weighed approximately 2150 lbs. including the guide frame. Flat windows were provided on the sides of the wedge in front of the curved glass of the parabolic vestibule.

The standard interurban vestibule was one such as is usually constructed for use with this type of car body, and was also supplied by the J. G. Brill Company. This vestibule had a section as shown in Figs. 188 and 189, and it weighed 1230 pounds

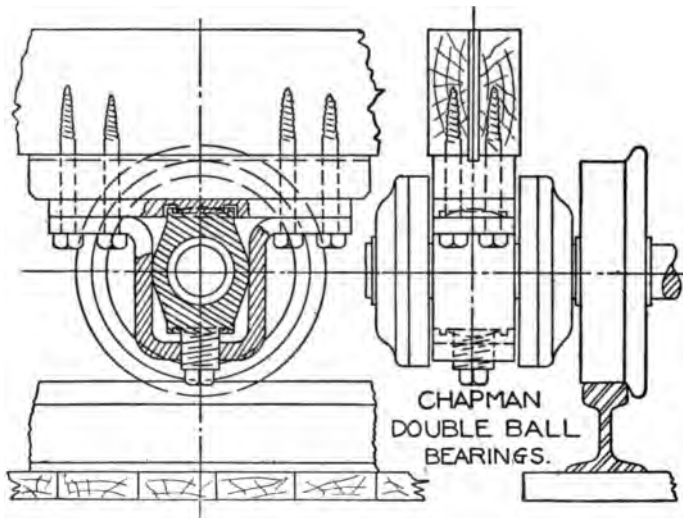

Fig. 187.—Sketch Showing Details of Mounting Chapman Double-Ball Bearings.

when complete and hanging on the dynamometer frame. This vestibule had a curved front with a radius of curvature of $5\frac{1}{2}$ ft., and the front was equipped with the usual sashes. Double doors, 2 ft. 10 in. in width, closed the openings at the sides. The roof of this vestibule conformed in outline to the contour of the car body, and was supplied with a standard hood of the Pullman type.

The flat vestibule consisted of a light framework covered with planking, and having a form corresponding to the cross-section of the car as shown in Fig. 183. It weighed 730 lbs. when

equipped with window-sashes and the devices for hanging it from the dynamometer frame.

All of the vestibules, when hanging upon the dynamometer frame, were connected with the car body by a strip of light cloth, which served to prevent eddies of air between the vestibule and the front or rear of the car body.

Vestibule Mounting. — In order to support the vestibule by

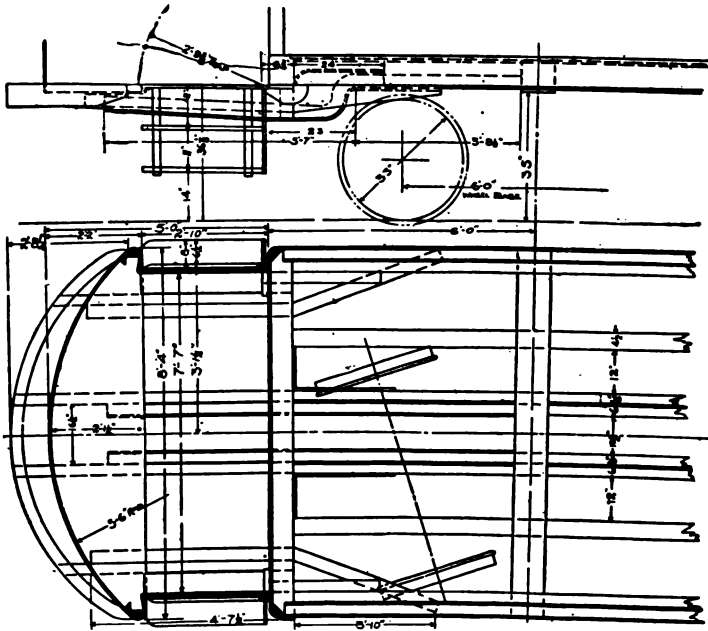

Fig. 188.—General Sketch of "Standard" Vestibule, Showing Method of Attachment to Car Body.

a mechanism involving as little friction as possible, it was decided to hang the vestibule from a pair of links carried over two heavy oak timbers projecting through the front of the car. To the ends of these timbers were attached eye bolts, from which hung a pair of links connected at their lower ends to eye bolts carried by steel brackets, attached to vertical steel strips forming part of the vestibule. These links were of such a length that the vestibule could swing a short distance without serious friction. To the rear of the vestibule was attached a guide frame

constructed of light oak timbers with diagonal truss rods of steel on all sides. The method of mounting is shown in Fig. 190, which is a general sketch showing the elevation and plan of the car. Each truss rod contained a turn buckle so that the shape of the frame could be altered to a certain extent to insure its being absolutely square. This frame was approximately four feet by six feet outside, and it had a total length of eight feet. In addition to the truss rods, there were also two cross braces at the rear of the frame, built of flat steel three-fourths inch by three inches in section. These cross braces served to render the

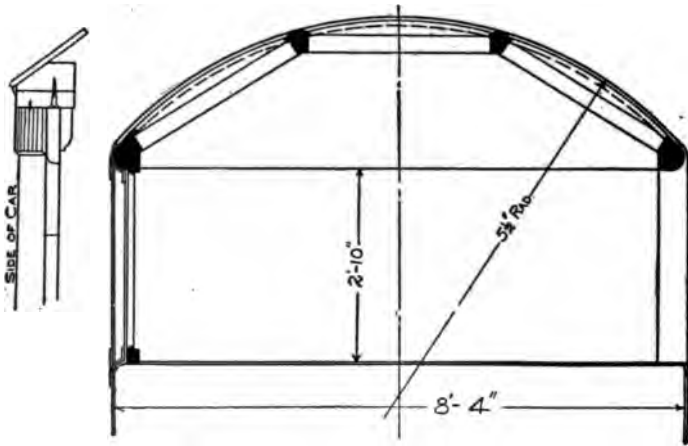

Fig. 189. — Detailed Sketch of "Standard" Vestibule.

guide frame absolutely rigid. Its main purpose, however, was to form (at its center) a point of attachment for the pressure measuring dynamometer. The four longitudinal timbers of the guide frame were shod at their front ends with steel straps which projected through holes cut in the front of the car body, and which were bolted to the vertical steel strips attached to the back of the vestibule. The guide frame thus formed an integral part of the vestibule equipment.

The guide frame served two general purposes: first, it moved between guide bearings on all sides so that it held the vestibule in its proper position, and second, it counterbalanced the weight

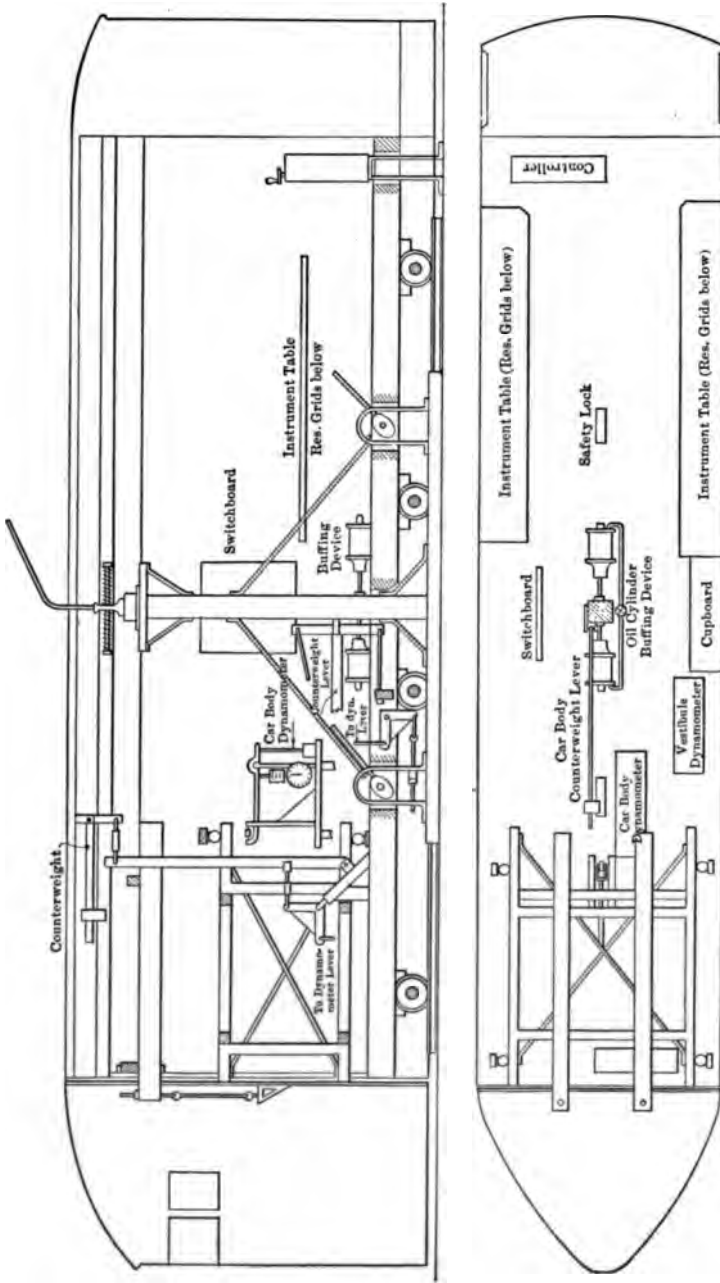

Fig. 190.—Sketch of Car "Louisiana," Showing Plan and Elevation Views of General Mechanism.

of the vestibule. The guide bearings (twelve in number) were one inch Chapman double-ball bearings, similar in general form to the larger bearings used in mounting the car body. They were carried in cast-iron forms upon small pieces of one-inch shafting. The bearings required special fitting for this work, as it was desired to have them bear upon the sides of the guide frame. The flanges at the ends of the hubs were turned off perfectly smooth, and the dust caps were removed. In order to take up the shock which might be transmitted to the bearings from the guide frame, the bolt holes in the bearing frames were countersunk, both above and below, and rubber washers were fitted into the recesses thus formed. The heads of the bolts used to clamp the bearing frames to the support did not, therefore, at any point come in contact with iron. This provision was effective in taking the sudden jars off the bearings themselves. Flat steel plates were screwed to the sides of the oak frame at the places where the guide bearings were located.

THE PRESSURE-MEASURING EQUIPMENT.

The Dynamometers. — One of the most difficult problems in connection with the tests was that of obtaining a pressure measuring device which would weigh accurately the pressure upon the vestibule. The Executive Committee would have preferred to have constructed a rotating piston oil dynamometer with various diameters of piston for use at different pressures. This was found to be out of the question, on account of lack of time, and for that reason it was decided to adopt some form of scale beam which could be obtained upon the market. The scale finally selected was one constructed by Fairbanks, Morse & Company, and called an automatic, self-indicating, quick-weighing beam. The essential features of this beam are shown in Fig. 191.

The beam is 30 in. in length, and it is supported approximately 4 in. from one end by a knife-edged link suspension. The link hangs upon a hook carried by a vertical stand which is mounted upon a low table. The force is transmitted to the

beam through a knife-edged link, $3\frac{3}{8}$ in. from the suspension knife edge. The weights are carried on a platform hung from a link suspension $16\frac{1}{2}$ in. from the supporting link, this platform being large enough to carry weights equivalent to 1500 lbs. A spring balance with a large dial was connected between the bottom of the scale pan and the table, with a screw adjustment for setting the zero. The dial of the balance was divided into 200 parts, a complete revolution of the pointer

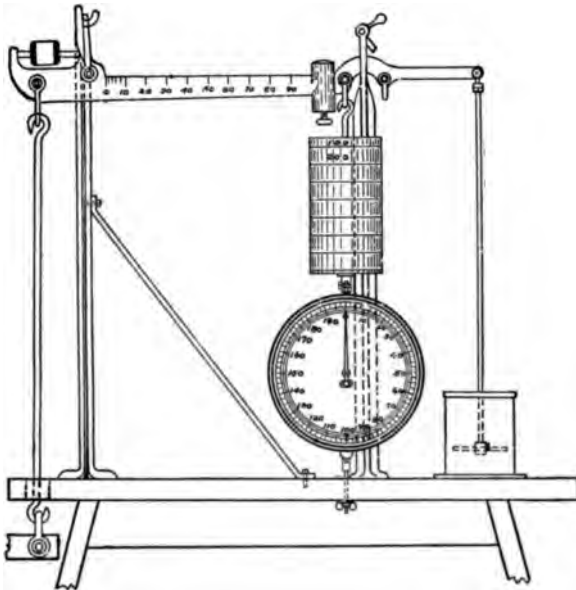

Fig. 101. — General Sketch of Scale Mechanism Used with Dynamometers.

being nominally equivalent to 200 lbs. In addition to the weights carried by the scale pan, a movable poise with set screw and having a maximum value of 100 lbs., was carried on the beam.

To the end of the beam was attached a rod, at the lower end of which was a metal disk, submerged in oil in a cast-iron receptacle. This formed a dash-pot for absorbing the vibrations of the beam. The dash-pot ordinarily used with the beam was of sufficient size in the case of the vestibule dynamometer,

but for the car body dynamometer, a larger dash-pot was constructed, as the vibrations in this case were very great. The beam was supplied with a counterbalance and with a lock for holding the beam securely in place when not in use.

The Lever Systems. — The point of attachment for the measurement of the vestibule pressure was at the center of the diagonal cross brace at the rear of the vestibule guide frame. A steel plate was bolted to the brace at this point and in this plate were bored holes, the edges of which were rounded for the knife-edge link attachments. At the front of the frame the pressure measuring lever was attached, while at the rear the counterweight lever was connected by means of a suitable link.

The pressure was transmitted from the guide frame through a link in a knife-edge bell-crank lever which latter served to turn the force from a horizontal to a vertical direction. From this bell-crank, a link transmitted the force to the end of a horizontal lever carried in a floor stand. The other end of this lever was attached directly to the tension rod of the weighing beam. All knife edges were of hardened tool steel, and they were mounted in round holes in steel straps, the holes being bored somewhat larger than the diameter of the steel on which the knife edges were ground, so that in no case would there be any contact, except through the knife edges.

As it was necessary to take the readings of the dynamometer with the car going in both directions, and as the dynamometer would only read in one direction, a constant pressure was maintained between the guide frame and the lever system by means of a counterweight applied to the guide frame through a system of levers. This counterweight pressure was maintained at approximately 350 lbs. This counterweight served also to steady the vestibule, especially at high speeds.

The car body dynamometer was similar to that employed for the vestibule except for the larger dash-pot, as already mentioned. Pressure was transmitted from the flat car to the car body through a system of levers somewhat similar to that already described. The point of attachment in this case was the steel

frame forming a part of one of the safety locks. Figs. 181, 186, and 190 show the details of this attachment. A rod turned perfectly smooth was carried through two holes bored in the large wrought-iron strap of the safety lock frame. The rod was threaded for a length of 4 in. inside the frame, and this thread carried a tension nut which was screwed against a stiff spring mounted over the rod. The purpose of this spring was to take up lost motion in the lever system. When the tension was on the rod, the tension nut was drawn down against an iron tube which was slipped loosely over the spring. The tension rod was connected through links to a double hook which was

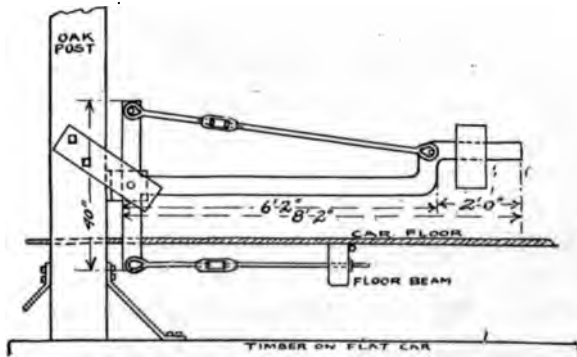

Fig. 192.—Sketch Showing General Arrangement of Car Body Counterweight.

connected to one arm of a bell-crank lever carried in a bearing between the center of the sills of the car body. The other arm of this bell-crank lever transmitted the force through a link to the short arm of a second lever, which was supported by bearings mounted beneath the sill. The long arm of this lever was connected directly to the tension rod of the dynamometer. The general arrangement of the dynamometer lever below the car floor is shown in Figs. 181 and 186.

The matter of counterweighting the car body in such a manner as to produce a steady pressure upon its dynamometer was found to be a most important matter. The counterweight lever shown in Fig. 192 was constructed to produce a pressure of approximately a thousand pounds against the dynamometer

at all times. The tension rod for this counterweight lever was attached to one of the beams beneath the car body, and this tension rod was supplied with a turn-buckle for the purpose of adjusting the position of the lever. The lever was made in the shape of a large T in order to provide a convenient method of stiffening it, which was done by means of a truss rod. The tension rod was attached to the lower end of one of the short arms of the "T" and the whole lever was carried in a bearing supported by the trolley post. Cast-iron weights were carried at the end of the lever.

THE TROLLEY SUPPORT AND STAND.

One of the essentials in obtaining the pressure on the car body, was to have it perfectly free from all fixed connections with the flat car. It was also necessary that the trolley connection be made in the ordinary way, by means of a trolley pole projecting from the roof of the car.

In order to accomplish the desired results an oak tie was used as a trolley support. This tie was dressed to a cross-sectional area of 5 by 7 inches, the length being 8 ft. It was placed on end at a point near the center of the car, and secured to the center beam fastened to the floor of the flat car. It was braced to the flat car by means of tension rods and turn-buckles. This support projected through the floor of the movable car body, passing between the two center sills. In order to have no contact between the car body and the trolley support, the floor of the former was cut away so as to leave an opening of approximately $1\frac{1}{2}$ inches between it and the support. This permitted of the free movement of the car body on the dynamometer. In like manner, the flooring of the car body was cut around the tension rods which braced the trolley support. The general arrangement is shown in the sketch given in Fig. 190.

On top of this support was securely fastened an oak slab 2 inches thick, the dimensions of which were approximately 12 by 20 inches. Upon this slab was mounted a ball-bearing trolley stand. This trolley stand was remodeled to suit the

would react upon the flat car. The method employed is illustrated in Fig. 190. Two Christensen air brake cylinders 10 inches in diameter were securely lagged to the floor of the movable car body, after the springs had been removed from the interior of the cylinders. These cylinders were placed one in front of and the other behind the trolley support, described above, and which was built up from the flat car. Suitable bearings were constructed and placed on the trolley support, in such a position as to take the thrust of the plungers operated by the pistons in the cylinders. Holes were bored in the back cylinder heads, and a 1½-inch pipe was connected to the cylinders so as to provide a passage between them and back of the piston in each case. Oil was pumped into the cylinders, and the plungers were forced out against the bearings on the trolley support.

By this arrangement a cushioning effect was produced as soon as the car body commenced to vibrate with reference to the flat car. One piston would be forced further back in its cylinder, and oil would be forced around from that cylinder into the other one. The flow of the oil between the two cylinders could be regulated by means of a gate valve, which formed a part of the piping connecting the two cylinders. Some little leakage occurred, but this did not prove to be of any considerable moment. It was found necessary to pump oil into the cylinders at intervals, in order that the plungers might be kept pressing against the trolley support on both sides.

Various kinds of oil were used in these cylinders, and the apparatus was tried under many different conditions of operation. Kerosene oil was first used, but this was found to be too light and, furthermore, it was decidedly objectionable from the standpoint of fire, as it leaked past the pistons very readily, and ran down on the floor of the flat car. Cylinder oil was tried, but was found to be too heavy for the purpose. The oil which was most successful was a motor oil, such as was used by the Indiana Union Traction Company on its interurban motor cars.

Experiments were also made to determine the effect of having

the cylinders pumped up so that the plungers pressed tightly against the trolley support, and, again, of permitting some considerable lost motion in this buffing device. The best results were obtained with the plungers pressed tightly against the trolley support.

WEIGHTS OF CAR BODY VESTIBULES FOR THE VARIOUS TESTS.

In order to make the proper corrections for grade and acceleration, it was necessary to know the weight of the movable vestibule, and also that of the movable car body, for each series of tests.

A complete inventory was made, covering all of the component parts of the various equipment which entered into the general assembly of the movable car body and vestibule. The actual weights of the major portion of the equipment were already available, and where the weights were lacking in any given place, the particular piece of apparatus or component part of the construction was carefully measured, and its weight estimated from the volumes of the various materials contained. There were on an average, eight observers (including motorman and conductor), and the total live weight was estimated at 1200 lbs., or 150 lbs. per man.

The total weights are summarized in the following table, which shows the fixed vestibule, the car body, the movable vestibule, and the total weight for each of the various tests.

Weights of Car Body and Vestibule (in pounds) for the Various Tests.

	TEST NUMBER.			
	58	59	60	61
Fixed Vestibule	970	970	970	0
Car Body Alone	17,930	17,930	17,930	17,930
Movable Vestibule	2,250	2,100	730	1,430
Total Weight	21,150	21,000	19,630	19,360

The various tests referred to in this table are those considered in Chapter XVI. The vestibules employed were as follows:

TEST No. 58. — "Parabolic-wedge" movable vestibule, standard fixed vestibule.

TEST No. 59. — "Parabolic" movable vestibule, standard fixed vestibule.

TEST No. 60. — "Flat" movable vestibule, standard fixed vestibule.

TEST No. 61. — "Standard" movable vestibule, no fixed vestibule.

ELECTRICAL CONNECTIONS.

As has already been stated, the controllers were placed inside the car body, being mounted on iron shoes fastened to the floor of the flat car, and brought up through openings in the floor of the movable car body, the flooring being cut away so as to permit of the free movement of the car body. The trolley pole was supported on an oak post built up from the floor of the flat car. The general construction necessitated that the motorman should operate the car while standing on the floor of the movable car body. A controller was placed at each end of the car, as was also a circuit-breaker.

It was necessary that arrangements be made whereby additional resistances could be readily inserted in the trolley circuit, in order that the speed of the car might be governed by the observers. This was done by means of sixteen frames of starting grids, loaned by the Westinghouse Electric & Manufacturing Company, which were connected to a special switchboard in such a manner that they could be introduced into the circuit in various combinations. The general wiring scheme was essentially as follows:

A No. 0 *B* & *S* gage rubber covered cable was connected to the trolley stand, and was brought to the roof of the car body in a loop which was approximately 6 ft. in length. This loop permitted of a flexible connection between the trolley support and the movable car body. The cable was carried along the

roof of the car body to the circuit-breaker at the rear of the car.

After passing through this circuit-breaker, the trolley circuit was run direct to the switchboard, and from there to the circuit-breaker at the front of the car. From this circuit-breaker the line was brought back to the center of the car, and looped down to the trolley support by means of a flexible No. 0 rubber covered cable, in a manner similar to that employed in passing from the trolley support to the roof of the car body. The circuit was then continued down the trolley support, and connected to the trolley lead in the car wiring cable. From this point, connections were such as would ordinarily be used in an equipment with two Type L-4 controllers and four Westinghouse No. 85 motors. The car wiring cables were placed on the floor of the flat car, as were also the regular starting grids used in connection with this equipment.

The switchboard consisted essentially of an oak panel, upon which were mounted sixteen single-pole single-throw knife switches, and the connection board below, by means of which the resistance grids could be connected in various combinations relative to the switchboard. The resistance grids were placed on either side of the car underneath the benches at the rear. Taps were brought out from various panels of these grid frames and connected either to the distributing board or to the main switchboard. By this arrangement, the grids could be connected in various combinations on the distributing board in a manner similar to that ordinarily employed in making the connections between the coils of transformers. With a given combination on the distributing board, the main switchboard could be employed to short circuit this extra resistance altogether, or to vary it between the limits of the combination.

INTERIOR VIEWS OF THE CAR.

The interior of the car, looking toward the front from the rear vestibule, is shown in Fig. 193. Benches were constructed on either side of the car at the rear for the purpose of placing

instruments in positions convenient for observation and for general use in the testing work. Under these benches were located the extra resistance grids connected to the switchboard. The general construction of the trolley support is shown very clearly in the center of the picture, as is also the oil cylinder



Fig. 193.—Interior View of Car "Louisiana," Looking Toward the Front from the Rear Vestibule.

buffing device. The switchboard is shown on the right at the center of the car, and the dynamometers are on the left, in front of the trolley support.

Fig. 194 shows a view of the interior of the car looking toward the rear from the front or movable vestibule. The general construction of the vestibule and guide frame, the supporting timbers for its suspension, and the general mechanism of the

sisted essentially of a "T" shaped lever extending from the trolley support toward the front of the car. At the end of this lever are seen cast-iron weights for producing the proper amount of counterweighting.



Fig. 195.—Interior View of Car "Louisiana," Looking from the Center of the Car and Looking Forward.

THE CALIBRATION OF THE DYNAMOMETERS.

A very considerable amount of time and attention was given to the general question of the calibration of the weighing mechanism. Various schemes for calibration were considered, and the one finally adopted is described below.

It was decided that the most direct and reliable calibration would be obtained by means of known pressures exerted directly

upon the vestibule and car body. The most convenient method of obtaining variable direct pressures of this nature was by means of a large bell-crank lever. Fig. 176 shows this lever in position for calibration with the "Flat" vestibule, which was used in Test No. 60. This lever had a short arm of 18 in. and a long arm of 9 ft. Three weights were employed in the calibration. These weights consisted of pinion wheels taken from motor armatures, and weighing approximately 50 lbs. apiece. The exact weight of each of these pinions was carefully determined, and the pressure exerted upon the vestibule was varied by using 1, 2, or 3 weights, and by varying the point of suspensions on the long lever arm. Knowing the weight suspended and the length of the lever arms, the actual pressure exerted upon the vestibule could be readily determined. As the vestibule re-acted against the car body, and as the support for the bell-crank lever was fixed relative to the flat car, the calibration of the car body dynamometer was carried on simultaneously with that of the vestibule.

As half of the dynamometer readings taken during the tests were tension readings, it was necessary to calibrate the dynamometer for tension as well as for pressure. This was done by reversing the bell-crank lever and lowering the supporting framework, changing some of the necessary supports, and by connecting the short arm of the bell-crank lever to the vestibule by means of a light steel cable. The tension readings were made by weighing the long lever arm as in taking the pressure measurements. In all cases the compression or tension was exerted at a point close to the center of the movable vestibule. Both high and low values of the readings were obtained, and the average used so that frictional effects were eliminated.

Calibration data were obtained for the flat movable vestibule, and also for the standard movable vestibule, when hanging in position. This was done in order to determine any difference in the reading of the dynamometer in the two cases, with a given pressure exerted by the calibrating lever. It was thought that some difference might exist in the two cases, due

to the fact that one of the vestibules was very much heavier than the other, and that, consequently, more frictional effects might enter. This difference was found to be slight, and an average of the two calibrations was used in working up the results of the various tests.

In the above calibrations a perfectly level track was selected, an engineer's level being used in placing the car in position. The level of the flat car floor was carefully determined, measurements being made at each of the four corners of the car.

As a slight difference in the level of the flat car floor was observed even under these conditions, the car was turned around after the calibration data were obtained, and the calibration was repeated with the car in a reverse position.

THE CALIBRATIONS OF THE DYNAMOMETER DIALS.

Very shortly after the dynamometer was first placed in position, it was observed that a given change of reading on the dial did not correspond with the change of weight on the scale-pan. While this difference was not very much in the dynamometer used with the movable vestibule, it was quite different, especially for large dial readings, in the case of the car body dynamometer. In general, for a given reading, the dial indication was considerably less than that of the corresponding weight on the scale-pan. This effect was probably due in a large measure to the fact that some considerable friction and loss of motion was incident to the operation of the dynamometers, especially that showing the car body readings.

In order to find the weight on the scale-pan equivalent to a given dial reading, a large number of observations was made on both dynamometers throughout the entire series of tests. These readings were made at the time when the zero readings were taken, and the general method employed follows.

As already stated, both the vestibule and the car body dynamometers were counterweighted. By changing the weights on the scale-pan, the dial readings could be adjusted to any desired value. By proceeding in this way, the actual weight on the

scale-pan for a given change in the dial reading at a given part of the scale, was obtained. A curve was then plotted for the dynamometer, showing the actual weight on the scale-pan corresponding to a given dial reading. These curves were employed in the reduction of the dynamometer dial data to the corresponding weight on the scale-pan.

THE CALIBRATION CURVES.

From the calibration data obtained in the manner described above, a large number of data was obtained showing the relation between the weight on the scale-pan of each dynamometer and the pressure (or tension), in pounds, exerted upon the weighing mechanism. In obtaining this data it was necessary to reduce the dial readings to data showing the equivalent weight on the scale-pan. Curves were constructed from the calibration data, showing the relation between the equivalent scale-pan readings of the dynamometer in each case, and the actual pressure exerted. These curves were used in interpreting the results of the various tests. A difference was found between the compression and the tension data. Different curves were used for the two general conditions.

CHAPTER XVI.

AIR RESISTANCE TESTS.

OBJECTS OF THE TESTS.

WHILE the primary object of the tests of Chapter XIV, was to determine the total train resistance of interurban cars when running at various speeds, the principal object of the tests of the present chapter was to separate the head resistance, the rear suction and the side and roof resistance, due to air pressure from the total train resistance. Another important object was the determination of the effect of varying the forms of the front and rear vestibules, upon the various air resistance factors.

SYNOPSIS OF RESULTS.

Table LXXIII gives briefly the general results of the air resistance tests which are discussed in this chapter.

TABLE LXXIII. — *Synopsis of Results of Air Resistance Tests. Vestibule Data.*

TYPE OF MOVABLE VESTIBULE.	AIR RESISTANCE IN LBS. PER SQ. FT. AT VARIOUS SPEEDS IN MILES PER HOUR.					REMARKS.
	20	30	40	50	60	
Parabolic Wedge . . .	0.39	0.48	0.73	1.37	2.10	Head Pressure
Parabola	0.50	0.63	0.90	1.60	2.50	Head Pressure
Standard	0.33	0.90	1.98	3.18	4.53	Head Pressure
Flat	1.40	2.20	3.56	5.60	8.20	Head Pressure
Parabola	0.08	0.09	0.11	0.15	0.24	Rear Suction
Parabolic Wedge . . .	0.19	0.20	0.23	0.28	0.45	Rear Suction
Flat	0.14	0.17	0.20	0.37	0.50	Rear Suction
Standard	0.13	0.22	0.40	0.70	1.04	Rear Suction

NOTE.—The above values are taken from the curves of Figs. 199, 200, 201, and 202. The power data corresponding to these conditions are given in Table LXXXV.

CAR BODY DATA.

The results of all tests show an average speed of 36.4 miles per hour and a total pressure of 97.6 pounds.

GENERAL CONDITIONS OF THE TESTS.

The tests were conducted between Noblesville and Carmel, Indiana, upon the stretch of tangent track described in Chapter XIV, in connection with the car resistance tests. As the direction of the car, with reference to the direction of the wind, is a

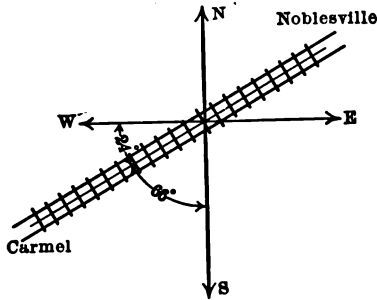

Fig. 196. — Direction of Test Track between Noblesville and Carmel, Indiana.

matter of considerable importance in these tests, the direction of the track with reference to the four points of the compass, was accurately determined and is shown in Fig. 196. The data giving the direction and velocity of the wind at 8 A.M., 12 o'clock noon, and 4 P.M., are shown in Table LXXIV.

TABLE LXXIV. — Data Showing Direction and Velocity of Wind. For Air Resistance Tests.

DATE.	HOURS ENDING AT					
	8 A.M.	12 M.	4. P.M.	8 A.M.	12 M.	4 P.M.
	WIND VELOCITY.			WIND DIRECTION.		
Feb. 15	8	5	10	N.W.	W.	W.
16	13	18	18	S.E.	S	S.
17	13	22	20	S.W.	W.	W.
18	9	5	11	S.W.	S.W.	S.W.
19	6	12	9	S.W.	S.	S.E.
20	6	7	6	S.	S.W.	S.W.
21	6	10	11	S.W.	S.	S.
22	8	8	6	N.W.	N.W.	W.

TABLE LXXIV.—Continued.

DATE.	HOURS ENDING AT					
	8 A.M.	12 M.	4 P.M.	8 A.M.	12 M.	4 P.M.
	WIND VELOCITY.			WIND DIRECTION.		
Feb. 23	3	10	7	N.W.	S.	S.E.
24	12	12	12	S.E.	S.E.	S.E.
25	22	20	13	N.W.	N.W.	N.W.
26	6	7	6	N.W.	N.W.	N.W.
27	12	6	8	N.E.	N.E.	N.W.
28	6	9	8	W.	S.W.	S.
Mar. 1	10	10	10	N.W.	N.	N.
2	7	6	7	E.	S.	S.E.
3	5	9	15	S.	S.E.	S.
4	14	9	8	N.	N.	N.E.
5	7	6	6	S.E.	S.W.	N.W.
6	12	15	14	N.E.	E.	E.
7	6	4	3	N.E.	N.E.	N.E.
8	10	10	8	N.	N.	N.
9	7	4	3	N.E.	N.E.	N.
10	10	6	11	N.	N.W.	W.
11	3	4	7	N.	N.W.	N.W.
12	8	10	8	N.E.	N.	N.
13	5	5	4	N.	N.	N.
14	11	11	12	N.E.	N.E.	N.E.
15	7	5	5	E.	S.E.	S.E.
16	4	13	11	S.E.	E.	S.W.
17	8	18	17	S.	S.	S.
18	16	26	22	S.	S.W.	S.
19	18	24	19	S.	S.	W.
20	4	8	11	N.W.	N.E.	N.E.

The tests continued from January 15, to March 16, 1905, and included, in all, several hundred separate and independent runs. There were four general series of tests, in addition to the preliminary or trial tests. The general conditions of each series, together with the schedule of runs, are given below.

TEST NO. 58, PARABOLIC WEDGE VESTIBULE.

After the preliminary investigations, the car was run back to Anderson, where the car body counterweight was constructed and installed. The parabolic shaped vestibule was also built out in the parabolic wedge form at this time, as shown in Fig. 174. Considerable difficulty was experienced in this series of tests, with the dynamometer, especially that used in connection with the car body readings. The oil cylinder buffing device was experimented with under various conditions of operation before satisfactory dynamometer readings were obtained. One hundred and two independent runs were made in this series of tests but many of them were repetitions under slightly different conditions. Many of the runs were made in an endeavor to obtain higher speeds by means of the use of resistance grids connected across the motor fields. The schedule of these runs is given in Table LXXVI.

TABLE LXXVI. — *Schedule of Runs with Parabolic Wedge Vestibule.*

RUN No.	DATE, 1905.	CAR GOING.	VESTIBULE POINTED.	MOTOR CONNECTIONS.
1	Feb. 11	West	East	4 motors in series-parallel.
2	Feb. 11	East	East	4 motors in series-parallel.
3	Feb. 11	West	East	Motors 1 and 2 in series.
4	Feb. 11	East	East	Motors 1 and 2 in series.
5	Feb. 11	West	East	4 motors in series. Grids on motors.
6	Feb. 11	East	East	4 motors in series-parallel. Grids on motors.
7	Feb. 11	West	West	4 motors in series-parallel.
8	Feb. 11	East	West	4 motors, series-parallel.
9	Feb. 11	West	West	Nos. 1 and 2 in series.
10	Feb. 11	East	West	Motors 1 and 2 in full series.
11	Feb. 11	West	West	4 motors full series-parallel, grids on motors.
12	Feb. 11	East	West	4 motors full series-parallel, grids on motors.
13	Feb. 11	West	West	4 motors full parallel.
14	Feb. 11	East	West	4 motors full parallel.
15	Feb. 11	West	West	4 motors parallel, grids on motors.
16	Feb. 11	East	West	4 motors full parallel, grids on motors.
17	Feb. 11	West	West	4 motors, full parallel, grids on motors.

AIR RESISTANCE TESTS

539

TABLE LXXVI. — *Continued.*

RUN No.	DATE, 1905.	CAR GOING.	VESTIBULE POINTED.	MOTOR CONNECTIONS.
18	Feb. 11	East	West	4 motors, full parallel, grids on motors.
19	Feb. 14	West	West	4 motors, full parallel.
20	Feb. 14	East	West	4 motors, full parallel.
21	Feb. 14	West	West	4 motors, full parallel.
22	Feb. 14	East	West	4 motors, full parallel.
23	Feb. 14	West	West	4 motors, full parallel.
24	Feb. 14	East	West	4 motors, full parallel.
25	Feb. 14	West	West	4 motors, full parallel.
26	Feb. 14	East	West	4 motors, full parallel.
27	Feb. 14	West	West	4 motors, parallel.
28	Feb. 14	East	West	4 motors, full parallel.
29	Feb. 15	West	East	4 motors, full parallel.
30	Feb. 15	East	East	4 motors, full parallel.
31	Feb. 15	West	East	4 motors, full parallel, grids on motors.
32	Feb. 15	East	East	4 motors, full parallel, grids on motors.
33	Feb. 15	West	East	4 motors, full parallel, grids on motors.
34	Feb. 15	East	East	4 motors, full parallel, grids on motors.
35	Feb. 15	West	East	2 motors, 1 and 4 in series, run made at a slow speed down line to determine zeros at various points. Wind pressure slight.
36	Feb. 15	East	East	4 motors, parallel, grids on motors.
37	Feb. 15	West	East	4 motors, parallel, grids on motors.
38	Feb. 15	East	East	4 motors, parallel, grids on motors.
39	Feb. 15	West	East	4 motors, full parallel, grids on motors.
40	Feb. 15	East	East	4 motors, parallel, grids on motors.
41	Feb. 16	West	East	1 and 4 full series, motor oil in cylinder pumped up full.
42	Feb. 16	East	East	2 motors (1 and 4) full series.
43	Feb. 16	West	East	4 motors, full series-parallel.
44	Feb. 16	East	East	4 motors, full series-parallel.
45	Feb. 16	West	East	1 and 4 motors in series, slow run to test dynamometer.
46	Feb. 16	East	East	1 and 4 series, slow run to test dynamometer.
47	Feb. 16	West	East	4 motors, full parallel.
48	Feb. 16	East	East	4 motors, full parallel.
49	Feb. 16	West	East	Motors 1 and 4, full parallel.
50	Feb. 16	East	East	2 motors, 1 and 4, full parallel.
51	Feb. 16	West	East	4 motors, full parallel.

TABLE LXXVI. — *Continued.*

RUN No.	DATE, 1905.	CAR GOING.	VESTIBULE POINTED.	MOTOR CONNECTIONS.
52	Feb. 16	East	East	4 motors, full parallel, grids on 8 sections.
53	Feb. 16	West	East	4 motors, full parallel.
54	Feb. 16	East	East	4 motors, full parallel, grids on motors, 16 sections instead of 18.
55	Feb. 16	West	East	4 motors, full parallel, 14 sections of grids on motors.
56	Feb. 16	East	East	4 motors, full parallel, 14 sections of grids on motors.
57	Feb. 16	West	East	4 motors, full parallel, 12 sections of grids on motors.
58	Feb. 16	East	East	4 motors, full parallel, 12 sections of grids on motors.
59	Feb. 16	West	East	4 motors, full parallel, 10 sections of grids on motors.
60	Feb. 16	East	East	4 motors, full parallel, 10 sections grids on motors.
61	Feb. 17	West	West	1 and 4, full series.
62	Feb. 17	East	West	1 and 4 in full series.
63	Feb. 17	West	West	1 and 4 in series.
64	Feb. 17	East	West	1 and 4 motors in series.
65	Feb. 17	West	West	4 motors, full series-parallel.
66	Feb. 17	East	West	4 motors, full series-parallel.
67	Feb. 17	West	West	4 motors, full parallel.
68	Feb. 17	East	West	4 motors, full parallel.
69	Feb. 17	West	West	4 motors, full parallel.
70	Feb. 17	East	West	4 motors, full parallel, 20 sections grids on motors.
71	Feb. 18	West	West	4 motors, full parallel, 16 sections grids on motors.
72	Feb. 18	East	West	4 motors, full parallel, 16 sections grids on motors.
73	Feb. 18	West	West	4 motors, full parallel.
74	Feb. 18	East	West	4 motors, full parallel, 12 sections grids on motors.
75	Feb. 18	West	West	4 motors, full parallel, 8 sections grids on motors.
76	Feb. 18	East	West	4 motors, full parallel, 8 sections grids on motors.
77	Feb. 18	West	West	4 motors, full parallel, 6 sections grids on motors.
78	Feb. 18	East	West	4 motors, full parallel, 6 sections grids on motors.
79	Feb. 18	West	West	4 motors, full parallel, 4 sections grids on motors.
80	Feb. 18	East	West	4 motors, full parallel, 4 section grids on motors.
81	Feb. 18	West	East	4 motors, full parallel, 4 sections grids on motors.
82	Feb. 18	East	East	4 motors, full parallel, 4 sections grids on motors.

TABLE LXXVI. — *Concluded.*

RUN No.	DATE, 1905.	CAR GOING.	VESTIBULE POINTED.	MOTOR CONNECTIONS.
83	Feb. 18	West	East	4 motors, full parallel, 6 grids on motors.
84	Feb. 18	East	East	4 motors, full parallel, 6 sections grids on motors.
85	Feb. 18	West	East	4 motors, full parallel, 8 section grids on motors.
86	Feb. 18	East	East	4 motors, full parallel, 8 sections grids on motors.
87	Feb. 20	West	East	4 motors, full parallel. No grids on motors.
88	Feb. 20	East	East	4 motors full parallel. No grids on motors.
89	Feb. 20	West	East	4 motors, full parallel, 16 section grids on motors.
90	Feb. 20	East	East	4 motors, full parallel, 16 section grids on motors.
91	Feb. 20	West	East	4 motors, full parallel, 10 grids on motors.
92	Feb. 20	East	East	4 motors, full parallel, 4 sections grids on motors.
93	Feb. 20	West	East	4 motors, full parallel.
94	Feb. 20	East	East	4 motors, full parallel.
95	Feb. 20	West	West	4 motors, full parallel. No grids on motors.
96	Feb. 20	East	West	4 motors, full parallel. No grids on motors.
97	Feb. 20	West	West	4 motors, full parallel, 4 grids on motors.
98	Feb. 20	East	West	4 motors, full parallel, 4 grids on motors.
99	Feb. 20	West	West	4 motors, full parallel, 10 section grids on motors.
100	Feb. 20	East	West	4 motors, full parallel, 10 section grids on motors.
101	Feb. 20	West	West	4 motors, full parallel, 16 section grids on motors.
102	Feb. 20	East	West	4 motors, full parallel, 16 section of grids on motors.

TEST NO. 59, PARABOLA VESTIBULE.

After the tests with the parabolic wedge movable vestibule were completed, the car was run back to the substation at Noblesville and the wedge structure was taken down, leaving the movable vestibule in its original parabolic form, as shown in Fig. 172. Thirty-eight runs were then made, the schedule of tests being as shown in Table LXXVII.

TABLE LXXVII. — *Schedule of Runs. With Parabolic Vestibule.*

RUN No.	DATE, 1905.	CAR GOING.	VESTIBULE POINTED.	MOTOR CONNECTIONS.
1	Feb. 21	West	East	4 motors in parallel. No grids on motors.
2	Feb. 21	East	West	4 motors in parallel. No grids on motors.
3	Feb. 21	West	West	4 motors in parallel, 16 sections of grids on motors.
4	Feb. 21	East	West	4 motors in parallel, 16 sections of grids on motors.
5	Feb. 21	West	West	4 motors in parallel, 16 sections of grids on motors.
6	Feb. 21	East	West	4 motors in parallel, 16 sections of grids on motors.
7	Feb. 21	West	West	4 motors in parallel, 16 sections of grids on motors.
8	Feb. 21	East	West	4 motors in parallel, 10 sections of grids on motors.
9	Feb. 21	West	West	4 motors in parallel, 4 sections of grids on motors.
10	Feb. 21	East	West	4 motors in parallel, 4 sections of grids on motors.
11	Feb. 21	West	East	4 motors in parallel. No grids on motors.
12	Feb. 21	East	East	4 motors in parallel. No grids on motors.
13	Feb. 21	West	East	4 motors in parallel, 4 sections of grids on motors.
14	Feb. 21	East	East	4 motors in parallel, 4 sections of grids on motors.
15	Feb. 21	West	East	4 motors in parallel, 16 sections of grids on motors.
16	Feb. 21	East	East	4 motors in parallel, 16 sections of grids on motors.
17	Feb. 21	West	East	4 motors in parallel, 4 sections of grids on motors.
18	Feb. 21	East	East	4 motors in parallel, 10 sections of grids on motors.
19	Feb. 21	West	East	4 motors in parallel, 20 sections of grids on motors.
20	Feb. 21	East	East	4 motors in parallel, 20 sections of grids on motors.
21	Feb. 21	West	East	4 motors.
22	Feb. 21	East	East	4 motors.
23	Feb. 22	West	East	2 motors in parallel. No grids on motors.
24	Feb. 22	East	East	2 motors in parallel. No grids on motors.
25	Feb. 22	West	East	2 motors in series.
26	Feb. 22	East	East	2 motors in series.
27	Feb. 22	West	East	4 motors in series-parallel.
28	Feb. 22	East	East	4 motors in series.
29	Feb. 22	West	East	2 motors in series.

TABLE LXXVII. — *Continued.*

RUN No.	DATE, 1905.	CAR GOING.	VESTIBULE POINTED.	MOTOR CONNECTIONS.
30	Feb. 22	East	East	2 motors in series.
31	Feb. 22	West	West	2 motors in series.
32	Feb. 22	East	West	2 motors in series.
33	Feb. 22	West	West	4 motors in series.
34	Feb. 22	East	West	4 motors in series.
35	Feb. 22	West	West	2 motors in parallel.
36	Feb. 22	East	West	2 motors in parallel.
37	Feb. 22	West	West	2 motors in series.
38	Feb. 22	East	West	2 motors in series.

TEST NO. 60, FLAT VESTIBULE.

Upon the completion of the tests with the parabolic vestibule, the car was run back to Anderson and the parabolic movable vestibule was taken off, the "flat" vestibule being put in its place. The car was then equipped as shown in Fig. 176, except that the calibrating lever was not in position at the time the tests were made. The flat vestibule tests included forty runs, as shown in Table LXXVIII.

TABLE LXXVIII. — *Schedule of Runs. With Flat Vestibule.*

RUN No.	DATE, 1905.	CAR GOING.	VESTIBULE POINTED.	MOTOR CONNECTIONS.
1	Feb. 25	West	East	2 motors in parallel.
2	Feb. 25	East	East	2 motors in parallel.
3	Feb. 25	West	East	4 motors in series-parallel.
4	Feb. 25	East	East	4 motors in series-parallel.
5	Feb. 25	West	East	4 motors in parallel.
6	Feb. 25	East	East	4 motors in parallel.
7	Feb. 25	West	East	4 motors in parallel.
8	Feb. 25	East	East	4 motors in parallel.
9	Feb. 27	West	East	2 motors in parallel.
10	Feb. 27	East	East	2 motors in parallel.
11	Feb. 27	West	East	2 motors in series.
12	Feb. 27	East	East	2 motors in series.
13	Feb. 27	West	East	4 motors in series-parallel.
14	Feb. 27	East	East	4 motors in series-parallel.
15	Feb. 27	West	West	4 motors in series-parallel.
16	Feb. 27	East	West	4 motors in series-parallel.
17	Feb. 27	West	West	2 motors in series.

TABLE LXXVIII.—Continued.

RUN No.	DATE, 1905.	CAR GOING.	VESTIBULE POINTED.	MOTOR CONNECTIONS.
18	Feb. 27	East	West	2 motors in series.
19	Feb. 27	West	West	2 motors in series.
20	Feb. 27	East	West	2 motors in series.
21	Feb. 27	West	West	2 motors in parallel.
22	Feb. 27	East	West	2 motors in parallel.
23	Feb. 28	West	West	4 motors in parallel.
24	Feb. 28	East	West	4 motors in parallel.
25	Feb. 28	West	West	4 motors in parallel.
26	Feb. 28	East	West	4 motors in parallel.
27	Feb. 28	West	West	4 motors in parallel, 20 sections of grids on motors.
28	Feb. 28	East	West	4 motors in parallel.
29	Feb. 28	West	West	4 motors in parallel, 4 sections of grids on motors.
30	Feb. 28	East	West	4 motors in parallel, 4 sections of grids on motors.
31	Feb. 28	West	West	4 motors in parallel, 16 sections of grids on motors.
32	Feb. 28	East	West	4 motors in parallel, 16 sections of grids on motors.
33	Feb. 28	West	East	4 motors in parallel, 16 sections of grids on motors.
34	Feb. 28	East	East	4 motors in parallel, 16 sections of grids on motors.
35	Feb. 28	West	East	4 motors in parallel, 12 sections of grids on motors.
36	Feb. 28	East	East	4 motors in parallel, 12 sections of grids on motors.
37	Feb. 28	West	East	4 motors in parallel, 4 sections of grids on motors.
38	Feb. 28	East	East	4 motors in parallel, 4 sections of grids on motors.
39	Feb. 28	West	East	4 motors in parallel, no grids on motors.
40	Feb. 28	East	East	4 motors in parallel, no grids on motors.

TEST NO. 61, STANDARD VESTIBULE.

The car was run back to the Anderson yards when Test No. 60 was completed and a series of calibration experiments was made, as discussed in Chapter XV. The "flat" vestibule was then taken off and the standard vestibule was removed from the rear of the car and mounted as the movable vestibule on the front, there being no rear vestibule in these tests. The experiments with the standard movable vestibule included thirty-six runs, as shown in Table LXXIX.

TABLE LXXIX. — *Schedule of Runs. With Standard Vestibule.*

RUN NO.	DATE, 1905.	CAR GOING.	VESTIBULE POINTED.	MOTOR CONNECTIONS.
1	Mar. 7	West	East	2 motors in series.
2	Mar. 7	East	East	2 motors in series.
3	Mar. 7	West	East	4 motors in series-parallel.
4	Mar. 7	East	East	4 motors in series-parallel.
5	Mar. 7	West	East	2 motors in series.
6	Mar. 7	East	East	2 motors in series.
7	Mar. 7	West	East	2 motors in parallel.
8	Mar. 7	East	East	2 motors in parallel.
9	Mar. 7	West	West	4 motors in series-parallel.
10	Mar. 7	East	West	4 motors in series-parallel.
11	Mar. 7	West	West	2 motors in series.
12	Mar. 7	East	West	2 motors in series.
13	Mar. 7	West	West	2 motors in parallel.
14	Mar. 7	East	West	2 motors in parallel.
15	Mar. 7	West	West	2 motors in series.
16	Mar. 7	East	West	2 motors in series.
17	Mar. 8	West	West	4 motors in parallel.
18	Mar. 8	East	West	4 motors in parallel.
19	Mar. 8	West	West	4 motors in parallel, 20 sections of grids on motors.
20	Mar. 8	East	West	4 motors in parallel, 20 sections of grids on motors.
21	Mar. 8	West	West	4 motors in parallel, 20 sections of grids on motors.
22	Mar. 8	East	West	4 motors in parallel, 20 sections of grids on motors.
23	Mar. 8	West	East	4 motors in parallel, 20 sections of grids on motors.
24	Mar. 8	East	East	4 motors in parallel, 20 sections of grids on motors.
25	Mar. 8	West	East	4 motors in parallel. No grids on motors.
26	Mar. 8	East	East	4 motors in parallel. No grids on motors.
27	Mar. 10	West	East	4 motors in parallel, 20 sections of grids on motors.
28	Mar. 10	East	East	4 motors in parallel, 20 sections of grids on motors.
29	Mar. 10	West	East	4 motors in parallel, 16 sections of grids on motors.
30	Mar. 10	East	East	4 motors in parallel, 16 sections of grids on motors.
31	Mar. 10	West	West	4 motors in parallel, 16 sections of grids on motors.
32	Mar. 10	East	West	4 motors in parallel, 16 sections of grids on motors.
33	Mar. 10	West	West	4 motors in parallel, 12 sections of grids on motors.
34	Mar. 10	East	West	4 motors in parallel, 12 sections of grids on motors.
35	Mar. 10	West	West	4 motors in parallel, 8 sections of grids on motors.
36	Mar. 10	East	West	4 motors in parallel, 8 sections of grids on motors.

GENERAL DESCRIPTION OF THE TESTS.

The general plan of the tests consisted in careful determinations of the speed, the pressure upon the vestibule, and the pressure upon the car body as a whole. As the mechanical devices for making these measurements have already been described in Chapter XV, in the present chapter it will be unnecessary to discuss more than the plan of conducting the tests. Before starting a run, the general speed conditions were decided upon and the car was operated under such conditions of motor connections as to produce the desired results. The highest speeds were obtained by connecting the four motors in parallel and shunting their fields. In running the car at the slowest speeds, two motors were used, connected in series, with the extra resistance grids also inserted in the circuit. The General Electric Company's ammeter was used to graphically record the current, and its accompanying time marking device, the five-second intervals.

The time a certain part of the car passed a given pole was also recorded on the graphical ammeter record. The method used to accomplish this was somewhat similar to that used, and described in Chapters IV and XIV.

In addition to the time and distance records mentioned above, the speed was obtained directly by taking readings every five seconds of the indications of a low reading voltmeter attached to the magneto generator driven from the car axle, as described in Chapter IV. This device was calibrated by direct comparisons with the time and distance data.

The line pressure was obtained by means of voltmeter readings taken every five seconds and the graphical record of current was checked by similar readings taken on an indicating ammeter. The vestibule and car-body air pressure measurements were made by means of readings of the dynamometers, these readings being also taken at five-second intervals.

In order to secure uniformity and accuracy in recording the results of the various measurements, a "Data Sheet" of stan-

AIR RESISTANCE TESTS

547

Sheet No.

ELECTRIC RAILWAY TEST COMMISSION.

AIR RESISTANCE TESTS.

Test..... Run No.....

.....Data

Date..... Time of start.....

Car going Vestibule pointed.....

1		26		51		76
2		27		52		77
3		28		53		78
4		29		54		79
5		30		55		80
6		31		56		81
7		32		57		82
8		33		58		83
9		34		59		84
10		35		60		85
11		36		61		86
12		37		62		87
13		38		63		88
14		39		64		89
15		40		65		90
16		41		66		91
17		42		67		92
18		43		68		93
19		44		69		94
20		45		70		95
21		46		71		96
22		47		72		97
23		48		73		98
24		49		74		99
25		50		75		100

Observer.

Remarks.....

Fig. 197.—Data Sheet for Air Resistance Tests.

dard letter size, was prepared, as shown in Fig. 197. Each observer in the car was provided with a supply of these sheets which contained blank spaces opposite numbers from 1 to 100.

The Director of the test determined at what part of a run the measurements should be recorded and he called out the number opposite which each reading should be set down. A bell signal was given every five seconds by the chronometer used in connection with the recording ammeter and pole record, and this signal was used to determine the exact instant at which to call off the reading number. The Director was stationed opposite a clock equipped with a second hand, so that, in case of the failure of the bell to ring at the proper time, he could give his signal from the clock. Immediately after the close of each run the record sheets for that run were assembled and bound together into a book, with a cover similar to that shown in Fig. 198. By thus binding together the data sheets for each run, it was possible to avoid any confusion in the records and any danger of losing or mislaying the sheets was eliminated.

ORIGINAL MEASUREMENTS.

Speed Measurements.

As in the preceding tests, two separate methods of determining the speed were employed. The small generator belted to the car axle, with its field magnet excited from a storage battery in circuit with the field of the recording ammeter, was used to indicate the relative speed at different parts of a run. In order to determine the average speed with great exactness, the instants of passing certain poles were accurately recorded on the chronograph record. As a check on this determination, the average reading of the speed generator was determined and corrected by calibration. The readings of the speed generator voltmeter, as well as those of all other instruments, were made every five seconds.

Sheet No.....

ELECTRIC RAILWAY TEST COMMISSION.

AIR RESISTANCE TESTS.

General Data.

Date.....190....

Test..... Run No.....

Car Going..... Vestibule Pointed.....

Time of Start..... Time of Stop.....

Type of Movable Vestibule.....

Line Pressure at Start (Controller off)..... Volts

Motor Connections.....

Switchboard Connections.....

Switches Open.....

Weather..... Temperature..... °C.

Condition of Track.....

East Anemometer.....miles West Anemometer.....miles

East Weather Vane..... West Weather Vane.....

Run between Pole No.....and Pole No.....

Total Distance Run.....miles

Duration of Run.....minutes.....seconds

Averages.

Velocity of Wind.....miles per hour

Speed.....miles per hour Direction of Wind.....

Total Motor Current.....Amperes Total Motor Pressure..... Volts

Vestibule Pressure.....lbs. Car Body Pressure..... lbs.

Vestibule Power.....K. W. Car Body Power..... K. W.

Total Power Consumed.....K. W.

Ratio of Power Consumed by Car Body to Total Power.....Per cent

Fig. 198.—General Data Sheet for Air Resistance Tests.

Air Pressure Measurements.

Records were made of the indications of the car body and vestibule dynamometers, the observers noting the weight on the scale pan and the reading on the dial for each case. In order to determine the zero values of the readings of each of the dynamometers, the car was placed on a level stretch of track and a series of zero readings was taken with various weights on the scale-pan, the corresponding readings on the dials being noted.

Occasionally, a series of zero readings was taken on several stretches of track, either level or of known grade, but generally the zeros were taken at one point on the test track, and wherever possible they were taken every two runs.

Electrical Measurements.

The graphical record of current was made on the General Electric recording ammeter which was checked from time to time by readings of a Weston indicating ammeter. The electrical pressure was read every five seconds and the power was determined from the readings of e.m.f. and current.

Other Measurements.

An anemometer was placed at each end of the test track, mounted at the top of a post as nearly as possible on a level with the center of the vestibule. A wind vane was mounted under each anemometer. The anemometers were loaned for this purpose by Messrs. Queen and Co. Readings of the wind vanes and of the anemometers were made at the end of each trip, and these data were later checked by the records of the United States Weather Bureau at Indianapolis.

A spirit level was constructed for the purpose of determining the exact level of the car. This level consisted of two vertical glass tubes three feet in height, provided with verniers and scales, one being located near the front corner post of the car and the other near the rear. They were connected by a small steel tube and, at the points of contact between the glass and the steel tubes, small diaphragms were inserted with apertures

The dynamometer readings showing the air pressure on the front vestibules were quite large in numerical value, especially at the higher speeds, and good results were obtained. The suction data for the rear vestibules were much lower in value and the results, while fairly consistent, are not as accurate as are those for the pressures on the front vestibules at various speeds. It is to be remembered in this connection, however, that, because of their greater numerical value, the latter data are of much greater importance than the former.

The Car Body Data.

The car body dynamometer indicated the total air resistance, including the pressure on the front vestibule and the suction on the rear vestibule. For the purpose of obtaining an average value of the surface friction on the sides and roof, the following plan was adopted. The head pressure and the suction for the particular form of vestibule used in a given run, were determined for any given speed from the air pressure curves for the vestibule. These air resistance data were added together and subtracted from the total car body air resistance readings, the net air resistance data for the car body itself being thus obtained.

These determinations were then arranged in groups for the purpose of averaging the values over certain ranges of speed. Naturally these values varied considerably, owing to the fact that in the first place, the measurement itself was an extremely difficult one to make, and in the second place the effect of wind and of the currents of air caused by the different forms of vestibule introduced variables and indeterminate factors. The average data for the groups, therefore, represent approximate values of the skin resistance for the average speeds of the groups.

RESULTS OF THE TESTS.

The final results of the tests are given in the synopsis and in Tables LXXX to LXXXV inclusive. They are also represented

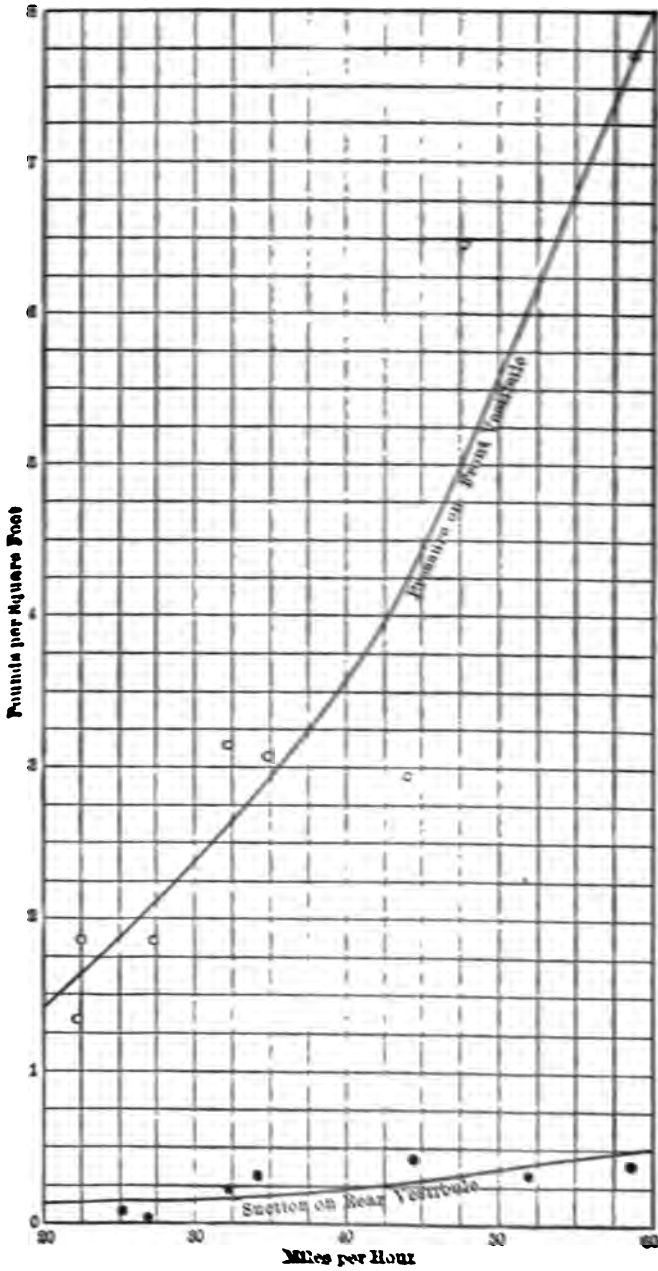

Fig. 201. — Air Resistance Curves for Flat Vestibule.

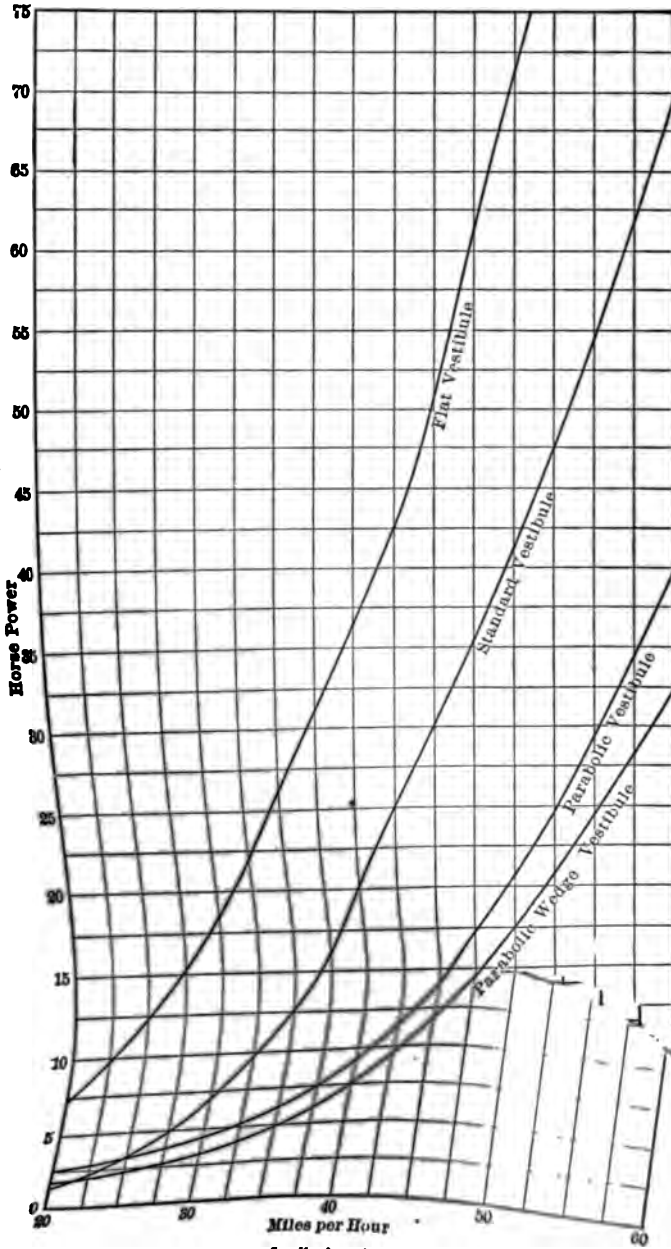

Fig. 298. — Pressure Power Curves for Various Vestibules — Air Resistance Tests.

Figs. 199, 200, 201, and 202 show graphically the vestibule data given in Tables LXXX to LXXXIII inclusive. The pressure on the front vestibule is shown by the upper curve, while

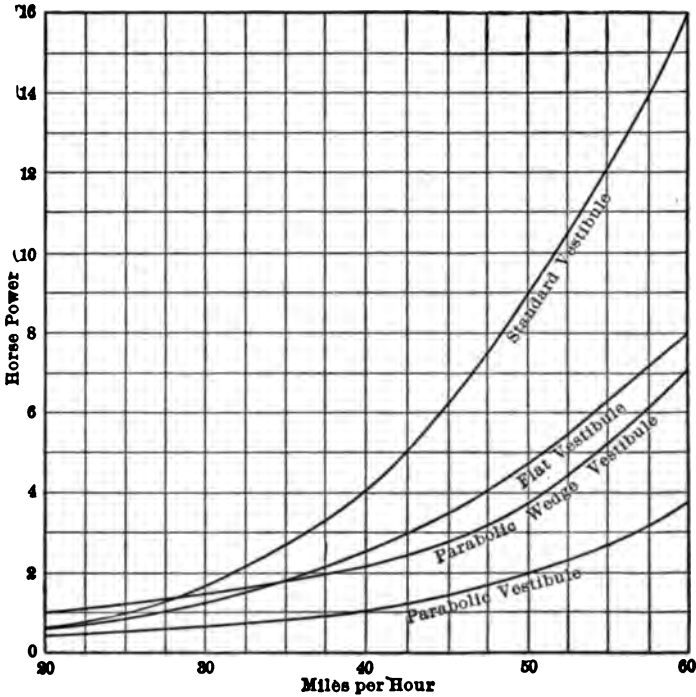

Fig. 204.—Suctions—Power Curves for Various Vestibules—Air Resistance Tests.

the lower curve in each case shows the suction on the rear vestibule, for various speeds.

The horse power absorbed, due to the air resistance on the front vestibule when the car is running at various speeds, is shown graphically for the different vestibules in Fig. 203. In a similar manner, the horse power absorbed, due to the suction on the rear vestibule, is shown in Fig. 204.



The Test Track lies N.E. and S.W. 24 deg. from an E.W. line
 Force is opposed to direction of travel.
 Projected area, 96 sq. ft.

AIR RESISTANCE TESTS

TABLE LXXXI. — Test No. 59. Air Pressure Tests on Car "Louisiana" on Test Track. Parabolic Vestibule.

Run.	Direction of Motion of Car.*	Direction of Vestibule.*	Average Speed M.P.H.	Total Pressure †	Average Acceleration M.P.H.P.S.	Correction for Acceleration †	Average Grade Per Cent.	Correction for Grade †	Total Net Pressure †	Net Pressure per Sq. Ft. Lbs.	Direction of Wind.	Velocity of Wind M.P.H.	Temperature Degrees F.	Weather.	Remarks.
A	East	East	58.3	212.0	+0.115	+11.0	-0.288	-6.1	P 207	2.16	S.	11	35	Clear	From run A to run
B	West	West	49.8	213.0	-0.048	+4.6	+0.309	+6.5	P 201	2.10	N.W.	10	35	Clear	H inclusive, the
C	East	East	45.7	76.8	-0.057	+5.5	-0.354	+7.4	P 79	0.82	N.W.	8	32	1" rain	vestibule is
D	East	East	37.2	80.0	-0.041	+3.9	-0.326	+6.8	P 83	0.87	N.W.	8	35	Clear	pointed in the
E	West	West	35.2	103.5	-0.069	+1.7	-0.315	+6.6	P 96	1.00	N.W.	6	35	Clear	direction of mo-
F	East	East	33.4	66.3	-0.023	+2.2	-0.266	+5.6	P 70	0.73	N.W.	8	38	Clear	tion of the car.
G	West	West	26.4	58.0	-0.002	+0.2	-0.417	+8.8	P 49	0.51	N.W.	7	35	Clear	
H	West	West	24.1	58.5	-0.011	+1.0	-0.307	+6.4	P 52	0.54	N.W.	7	36	Clear	
I	East	East	57.4	16.2	-0.079	+7.6	-0.331	+7.0	P 15	0.16	S.	10	35	Clear	From run I to run
J	West	West	51.8	26.0	-0.012	+1.2	-0.362	+7.8	P 17	0.18	S.	11	35	Clear	P inclusive, the
K	East	East	39.2	13.0	-0.068	+5.8	-0.372	+7.8	P 15	0.16	W.	6	35	Clear	vestibule is
L	West	West	37.8	17.6	-0.008	+0.7	-0.311	+7.8	P 11	0.11	N.W.	8	32	1" rain	pointed in a di-
M	East	East	36.7	15.0	-0.002	+0.2	-0.340	+6.5	P 20	0.21	N.W.	7	36	Clear	rection opposed
N	West	West	33.4	13.0	-0.019	+1.3	-0.301	+6.3	P 6	0.06	N.W.	7	36	Clear	to the direction
O	East	East	23.7	20.6	-0.009	+1.3	-0.301	+9.2	P 11	0.11	N.W.	7	35	Clear	of motion of the
P	West	West	23.9	11.3	-0.019	+1.0	-0.241	+5.1	P 4	0.04	N.W.	8	33	Clear	car.

* East and West indicate the general direction only. The Test Track lies N.E. and S.W., 24 deg. from an E. W. line.
 † P indicates the pressure, S, suction.
 ‡ Positive (+) force is opposed to direction of motion.
 Weight of Vestibule, 2,100 lbs. Projected area, 96 sq. ft.

TABLE LXXXII. — Test No. 60. Air Pressure Tests on Car "Louisiana" on Test Track. Flat Vestibule Data.

Run.	Direction of Motion of Car.*	Direction of Vestibule.*	Average Speed M.P.H.	Total Pressure Lbs.†	Average Acceleration M.P.H.P.S.	Correction for Acceleration Lbs.‡	Average Grade Per Cent.	Correction for Grade Lbs.‡	Total Net Pressure Lbs.†	Net Pressure Per Sq. Ft. Lbs.	Direction of Wind.	Velocity of Wind M.P.H.	Temperature Degrees F.	Weather.	Remarks.
A	East	East	56.7	P 744.0	+0.088	+2.9	-0.346	-2.5	P 743	7.74	S.W.	8	42	Clear	From run A to run H inclusive, the vestibule is pointed in the direction of motion of the car. From run I to run P inclusive, the vestibule is pointed in a direction opposed to the direction of motion of the car.
B	West	West	47.8	P 630.0	+0.052	+1.7	+0.287	+2.1	P 620	6.46	S.W.	9	40	Clear	
C	East	East	44.0	P 275.0	+0.021	+0.7	-0.341	-2.5	P 280	2.92	N.W.	22	33	Raw, windy	
D	East	East	34.9	P 283.0	+0.033	+1.1	-0.300	-2.2	P 296	3.09	N.E.	6	34	Clear	
E	West	West	32.1	P 309.0	+0.006	+0.2	+0.313	+2.3	P 302	3.15	N.W.	8	33	Clear	
F	West	West	27.2	P 184.0	+0.003	+0.1	+0.415	+3.0	P 175	1.83	N.E.	6	34	Clear	
G	East	East	22.5	P 171.0	+0.000	+0.0	-0.303	-2.2	P 177	1.85	N.E.	6	34	Clear	
H	West	West	22.1	P 135.0	+0.003	+0.1	+0.430	+3.1	P 127	1.33	N.E.	7	33	Clear	
I	East	East	58.5	P 39.0	+0.088	+2.9	+0.346	+2.5	S 38	0.40	S.W.	9	40	Clear	
J	West	West	50.2	P 39.0	+0.027	+0.9	+0.287	+2.1	S 31	0.32	S.	8	42	Clear	
K	East	East	44.3	P 39.0	+0.047	+1.6	-0.334	-2.4	S 31	0.43	N.W.	8	33	Clear	
L	West	West	34.1	P 28.0	+0.040	+1.3	-0.321	-2.3	S 31	0.32	N.E.	6	34	Clear	
M	East	East	33.7	S 66.0	+0.021	+0.7	+0.325	+2.4	S 58	0.60	N.W.	22	33	Raw, windy	
N	East	West	32.2	S 18.0	+0.021	+0.7	-0.345	-2.5	S 23	0.24	N.	7	33	Clear	
O	West	East	26.9	S 8.0	+0.015	+0.5	+0.319	+2.3	S 5	0.05	N.E.	6	34	Clear	
P	West	East	25.1	S 12.5	+0.009	+0.3	+0.247	+2.2	S 10	0.10	N.E.	6	34	Clear	

* East and West indicate the general direction only. The Test Track lies N.E. and S.W., 24 deg. from an E.W. line.
 † P indicates pressure. S suction.
 ‡ Positive (+) force is opposed to direction of motion.
 Weight of Vestibule, 730 lbs. Projected area, 96 sq. ft.

TABLE LXXXIV. — Car Body Resistance Data.

GROUP A — 19 TO 30 M.P.H.

DIRECTION OF MOTION OF CAR.	SPEED M.P.H.	TOTAL SKIN RESISTANCE OF CAR BODY. LBS.	DIRECTION OF WIND.	VELOCITY OF WIND M.P.H.
West	19.1	154.2	S.E.	15.0
West	25.1	57.3	S.	15.0
West	24.8	20.2	W.	21.0
West	24.7	14.5	N.W.	8.0
West	23.9	17.4	N.W.	8.0
West	24.1	83.4	N.W.	7.0
West	26.4	21.2	N.W.	7.0
West	22.1	35.4	N.	7.0
West	22.6	5.0	N.E.	5.0
West	28.0	163.8	N.E.	4.0
West	23.2	162.6	N.E.	3.0
East	28.4	47.6	7.0
West	19.4	107.9	S.W.	16.0
Average	23.9	68.5

GROUP B — 30 TO 40 M.P.H.

East	38.2	51.2	S.	16.0
West	37.8	87.4	N.W.	8.0
East	37.2	335.7	N.W.	8.0
East	36.7	214.4	N.W.	7.0
West	35.2	135.3	W.	6.0
East	39.2	40.8	W.	6.0
West	33.7	102.8	N.W.	22.0
West	32.1	59.1	N.W.	8.0
East	30.1	42.4	N.E.	5.0
East	37.3	132.9	N.E.	5.0
East	31.6	24.1	N.E.	4.0
West	36.4	181.8	N.E.	3.0
East	34.1	67.8	S.	18.0
Average	35.4	113.5

GROUP C — 40 TO 50 M.P.H.

East	49.0	34.5	S.	18.0
East	47.5	74.2	W.	21.0
West	49.3	25.0	S.	7.0
East	44.0	85.1	N.W.	22.0
West	47.8	52.5	S.W.	9.0
East	42.2	229.1	N.E.	4.0
East	41.1	330.9	N.E.	3.0
West	45.4	72.2	N.W.	6.0
West	48.7	173.0	W.	11.0
Average	46.1	119.6

AIR RESISTANCE TESTS

563

TABLE LXXXIV.—Continued.

GROUP D — 50 TO 60 M.P.H.

DIRECTION OF MOTION OF CAR.	SPEED M.P.H.	TOTAL SKIN RESISTANCE OF CAR BODY. LBS.	DIRECTION OF WIND.	VELOCITY OF WIND M.P.H.
West	52.1	67.8	S.W.	7.0
East	57.4	116.9	S.	10.0
West	51.8	88.5	S.	11.0
East	58.3	78.2	S.	11.0
West	50.2	118.6	S.	8.0
Average	53.9	92.0

Average Speed — 36.4 M.P.H.
 Average Resistance — 97.6 Lbs.

TABLE LXXXV.—Power Absorbed by Vestibules.

TYPE OF VESTIBULE.	HORSE-POWER TAKEN BY HEAD PRESSURE AND REAR SUCTION AT VARIOUS SPEEDS IN MILES PER HOUR.					REMARKS.
	20	30	40	50	60	
Parabolic Wedge	2.00	3.69	7.48	17.6	32.2	Head Pressure
Parabola	2.56	4.84	9.23	20.5	36.9	Head Pressure
Standard	1.69	6.92	20.3	40.7	69.6	Head Pressure
Flat	7.18	16.9	36.5	71.7	126.0	Head Pressure
Parabola	0.41	0.69	1.13	1.92	3.68	Rear Suction
Parabolic Wedge	0.97	1.54	2.36	3.59	6.91	Rear Suction
Flat	0.72	1.31	2.05	4.74	7.68	Rear Suction
Standard	0.67	1.69	4.10	8.96	16.0	Rear Suction

NOTE.—These data are taken from the curves of Figs. 203 and 204.

DISCUSSION OF RESULTS.

The curves and tables given in this chapter furnish data for showing the pressure exerted on the front of a car and the suction on the rear when the car is running at various speeds. Some information is also obtained in regard to the side and roof friction. While the latter data must be considered as approximate only,

the tests show that the side and roof resistance are small compared with the head resistance. The determinations of the values of the side and roof resistance are made by subtracting the combined head and rear resistance from the total air resistance of the car at given speeds. As the results show, this difference is small and therefore the accuracy of this part of the tests is not as great as that of the head and rear resistance, which latter data are reasonably close to the actual values, especially those relating to the air resistance of the front vestibule.

THE FRONT VESTIBULE AIR RESISTANCE.

The head resistances were measured for four different types, the parabolic-wedge, the parabola, the flat and the standard vestibules respectively. The curves and tables show, as would be expected, that the flat form gives by far the highest resistance, the standard form being next in order. The standard form of vestibule was at a slight disadvantage in comparison with the other forms, owing to the fact that it was equipped with side doors. While the parabolic wedge and the parabola both had a greater longitudinal length than did the standard form, the flat vestibule was practically a surface only. Undoubtedly this latter vestibule would have shown a considerably increased air resistance if it had been provided with side doors such as the standard vestibule was equipped with, or if it had been provided with extended smooth side surfaces equivalent to those of the parabolic wedge and parabola vestibule.

THE REAR VESTIBULE AIR RESISTANCE.

In all cases the rear vestibule air resistance proved to be a suction, the effect of which is to retard the motion of the car. While the flat form showed the greatest front pressure, an inspection of the data and curves shows that the standard form gives the greatest rear suction. This is accounted for by the fact that the flat vestibule was a surface only, whereas the standard form was equipped with side doors which offered con-

the front vestibule upon the sides and roof of the car. It is probable that the air is thrown away from the sides at very high speeds and this would seem to be indicated by the results given in the tables.

THE EFFECT OF AIR RESISTANCE ON TRAIN RESISTANCE.

While the effect of the shape of the vestibule upon the train resistance is discussed in Chapter XIV, a more specific investiga-

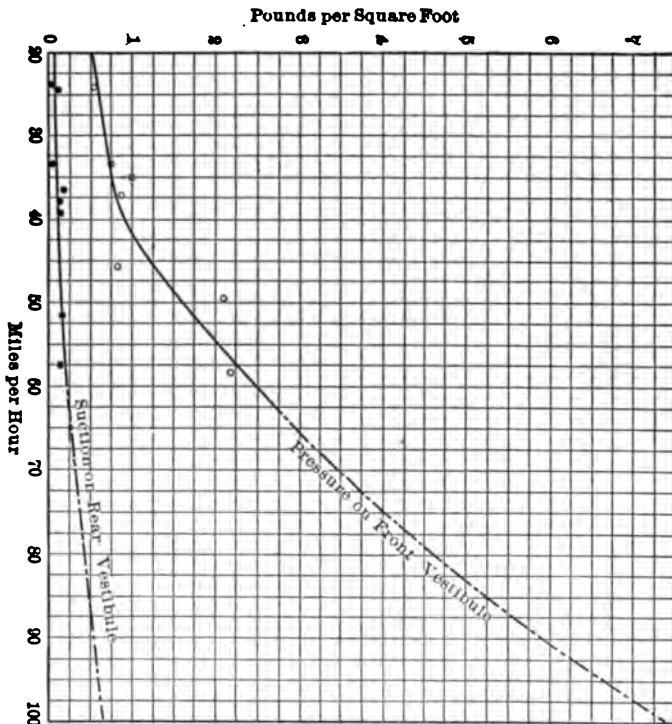

Fig. 206. — Air Resistance Curves for Parabolic Vestibule Extended to 100 M.P.H.

tion, based upon the data of the present chapter, leads to some interesting deductions.

Figures 205, 206, 207, and 208 show the curves of Figures 199, 200, 201, and 202, extended to a speed of one hundred miles per hour. These curves were extended in accordance with the

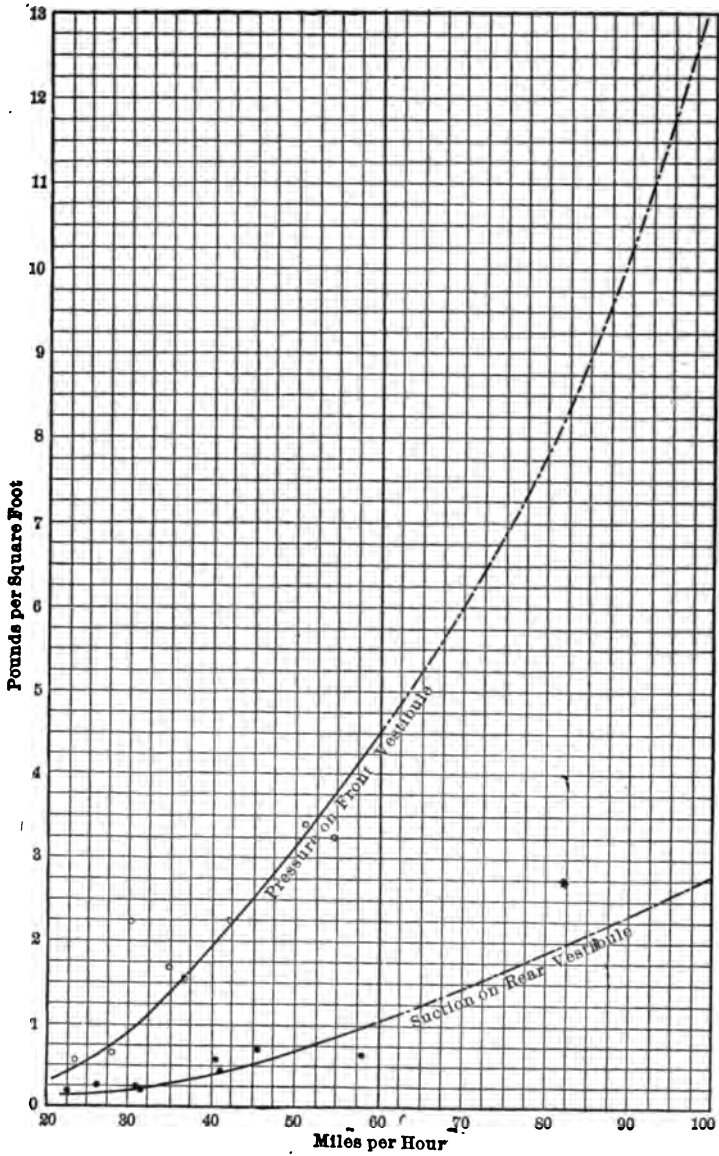

Fig. 208.— Air Resistance Curves for Standard Vestibule Extended to 100 M.P.H.

If the car were equipped with the same style of vestibule at both ends, the data giving the total power in kilowatts, absorbed in forcing the two vestibules through the air at various speeds, from 20 to 100 miles per hour, would be as shown in Table LXXXVIII. In this table the values above 60 miles an hour have been obtained by projecting the curves in accordance with the same general law underlying the form of all of the curves of the series.

TABLE LXXXVIII. — *Power Absorbed by Front and Rear Vestibules in Kilowatts.*

TYPE OF VESTIBULE.	KILOWATTS AT VARIOUS SPEEDS IN MILES PER HOUR.								
	20	30	40	50	60	70	80	90	100
Parabolic wedge.....	2.2	3.9	7.5	15.8	29.2	48.7	75.7	111.7	157.0
Parabola.....	2.2	4.1	7.7	16.7	30.3	51.5	76.7	110.8	153.8
Flat.....	5.9	13.6	28.7	57.0	99.8	155.7	202.7	321.0	448.0
Standard.....	1.8	6.4	18.2	37.1	63.9	99.3	148.0	215.5	327.0

In order to bring out somewhat more perfectly what these figures mean, Table LXXXIX has been computed by assuming the amount of power required to force a standard front vestibule through the air at the various speeds to be 100 per cent, the relative amount of power for the other forms of front vestibule being expressed comparatively.

TABLE LXXXIX. — *Relative Power Required to Force Front Vestibules Only, Through the Air, at Various Speeds.*

TYPE OF VESTIBULE.	PER CENT AT VARIOUS SPEEDS. MILES PER HOUR.								
	20	30	40	50	60	70	80	90	100
Parabolic wedge.....	118.0	53.5	36.9	43.3	46.3	49.6	51.2	50.8	49.6
Parabola.....	151.0	70.0	45.5	50.5	53.1	58.0	58.8	57.8	55.5
Standard.....	100.0	100.0	100.0	100.0	100.0	100.0	100.0	100.0	100.0
Flat.....	425.0	245.0	180.0	176.3	181.2	183.2	179.2	171.0	165.0

While the experiments are not entirely conclusive, they tend to show that a parabolic-wedge front vestibule and a parabolic

¹ Same type of vestibule front and rear.

TABLE XCII. — *Total Estimated Power Absorbed in Overcoming Air Resistance by an Interurban Car Equipped with Various Vestibules.*¹

TYPE OF VESTIBULES.	TOTAL POWER ABSORBED, KILOWATTS. MILES PER HOUR.								
	20	30	40	50	60	70	80	90	100
Parabolic wedge	6.6	11.2	18.4	32.2	5.9	81.3	119.0	168.5	231.4
Parabola	6.6	11.4	18.8	33.1	54.0	84.1	120.0	167.6	228.2
Flat	10.3	20.9	39.8	73.4	123.5	188.3	246.0	377.8	522.4
Standard	6.2	13.7	29.3	53.5	87.6	131.9	191.3	272.3	401.4

In the above table the bottom of the car body is assumed to be three feet above the track and the under-body resistance is calculated on the basis of a flat surface equal to one-half of the under-body cross-sectional area, which in this case is 8.5 times 3 or 25.5 square feet.

As the arrangement of apparatus beneath the car is different in the several types of car, only an average value can be estimated. It would appear to be a safe assumption to say that the resistance below the car would be approximately one-half that of a plain surface extending from the car floor to the rails. As it is physically impossible to measure this quantity, some such assumption as this must be made, and this assumption can be checked by comparison with the total car resistance as given in Chapter XIV. By making this allowance and combining with the data already determined the assumed under-body resistance, the figures given in Table XCII have been obtained.

It will be noted that the actual experimental data for the flat front vestibule did not exceed 50 miles per hour, and the reason for this is that it was impossible with the power at hand to force the flat-ended car above this speed. This power was sufficient to easily permit a speed of 75 miles an hour with the parabolic wedge-front vestibule, and this fact gives force to the statements already made. Assume for purpose of comparison that of two cars one car is equipped with the flat front and one with the wedge-shaped front, and that each operates 30,000 car miles per year, at an average speed of 50 miles per hour, the annual saving in energy of the latter over the former car would be 24,200 kilowatt hours. Nothing more forcibly calls attention to these

¹ Same type of vestibule front and rear.

facts than to observe the reading of the instruments on the dynamometer car when it is equipped with the several forms of vestibule. The sensations in this case are somewhat startling.

In addition to the conclusions based upon the form of the vestibule the results also emphasize the importance of reducing the number and area of projections from the car surface, as such projections act in a manner very similar to the increase of the area of a flat front. Hence for high speed cars window casings should be kept as nearly flush with the body surface as possible and all other unnecessary projections should be eliminated.

The results of these tests are not only applicable in connection with electric cars but they also yield many suggestions regarding the construction of steam locomotives and trains. From the standpoint of wind resistance nothing worse than the standard type of locomotive can be imagined, with its multitude of irregular projections. The experience of engineers and firemen in putting their heads out of cab windows is such as to demonstrate the great resistance met by such obstacles. The resistance offered to all high speed steam trains by the air would be materially diminished if the locomotive were housed in a shell and if pains were taken to remove all unnecessary projections from the coaches and, further, if the outline of the tender were made to conform to the general cross-sectional shape of the train.

While something has been accomplished in the present series of tests, there is much more to be done, both in the way of working up more thoroughly the data already secured and in continuing the series of tests. The experience gained with the present form of dynamometer car can be utilized so as to render further tests much more accurate. It is highly desirable that other forms of vestibule be tested and that the resistance of the car body proper be more thoroughly investigated. The experiments should be made with several cars in a train and the effect of the wind in all directions should be very carefully studied. Fig. 209 shows a sketch of a car modelled in accordance with the principles discussed in the present chapter.

APPENDIX A.

TABLE XCIII. — Classification of Electric Cars.
Light City Service

	Company							Ave.
		A*	B	C	D	E	F	
Range of Car Body Weights in Lbs.	min.	8 000	8 000	6 500	10 700	7 000	5 000	7 530
	max.	12 000	10 000	8 000	12 500	8 000	10 000	10 080
	ave.	10 000	10 000	7 250	11 600	6 500	7 500	8 810
Range of Truck Weights (Total) in Lbs.	min.	4 700	5 000	4 500	17 300	4 500	4 000	6 670
	max.	9 000	7 500	5 000	19 500	5 000	5 000	8 500
	ave.	6 850	6 250	4 750	18 400	4 750	4 500	7 580
Range of Total Weights of Equipped Cars in Lbs.	min.	17 700	16 300	...	28 000	15 000	18 000†	19 000
	max.	31 000	21 100	...	32 000	16 000	30 000†	26 020
	ave.	24 350	18 700	...	30 000	15 500	24 000†	22 510
Usual Number of Motors	min.	1	2	2	2	2	2	2
	max.	4	4
	ave.	2	2	2	2	2	2	2
Range of Total H.P. of Motors	min.	25	35	...	60	50	50	45
	max.	50	80	...	80	80	80	75
	ave.	37.5	57.5	...	70	65	65	60

Heavy City Service

Range of Car Body Weights in Lbs.	min.	12 000	16 000	12 000	14 500	12 000	13 000	13 250
	max.	20 000	23 000	16 000	16 000	12 000	18 000	17 500
	ave.	16 000	19 500	14 000	15 250	12 000	15 500	16 380
Range of Truck Weights (Total) in Lbs.	min.	9 000	10 000	7 000	19 500	8 000	10 000	10 580
	max.	16 000	12 000	12 000	20 900	8 000	15 000	13 980
	ave.	12 500	11 000	9 500	20 200	8 000	12 500	12 280
Range of Total Weights of Equipped Cars in Lbs.	min.	35 000	32 000	...	34 000	30 000	35 000†	33 200
	max.	50 000	45 000	...	36 900	30 000	50 000†	42 380
	ave.	42 500	38 500	...	35 450	30 000	42 500†	37 790
Usual Number of Motors	min.	4	4	2	4	4	2	4
	max.	4	4	4
	ave.	4	4	4	4	4	4	4
Range of Total H.P. of Motors	min.	35	100	100	...	140	100	85
	max.	60	160	140	...	140	150	130
	ave.	47.5	130	120	...	140	125	115

Light Interurban Service

Range of Car Body Weights in Lbs.	min.	16 000	20 000	16 000	16 800	16 000	14 000	16 470
	max.	25 000	24 000	22 000	20 000	18 000	20 000	21 170
	ave.	20 500	22 000	19 000	18 400	16 000	17 000	18 820
Range of Truck Weights (Total) in Lbs.	min.	10 000	11 000	10 000	22 000	10 000	10 000	12 170
	max.	18 000	13 000	12 500	23 500	10 000	15 000	15 330
	ave.	14 000	12 000	11 250	22 750	10 000	12 500	13 750
Range of Total Weights of Equipped Cars in Lbs.	min.	35 000	42 000	...	38 800	42 000	40 000†	39 580
	max.	55 000	48 000	...	43 500	42 000	60 000†	49 700
	ave.	45 000	45 000	...	41 150	42 000	50 000†	44 630
Usual Number of Motors	min.	4	4	4	4	4	2	4
	max.	4	4
	ave.	4	4	4	4	4	4	4
Range of Total H.P. of Motors	min.	40	160	...	200	200	150	150
	max.	70	200	...	250	200	200	185
	ave.	55	180	...	225	200	175	170

Heavy Interurban Service

Range of Car Body Weights in Lbs.	min.	25 000	25 000	25 000	35 000	30 000	25 000	27 500
	max.	36 000	40 000	35 000	45 000	30 000	40 000	37 670
	ave.	30 500	32 500	30 000	40 000	30 000	32 500	32 580
Range of Truck Weights (Total) in Lbs.	min.	20 000	14 000	18 000	25 000	13 000	16 000	17 670
	max.	36 000	16 000	25 000	40 000	13 000	22 000	25 330
	ave.	28 000	15 000	21 500	32 500	13 000	19 000	21 500
Range of Total Weights of Equipped Cars in Lbs.	min.	50 000	50 000	...	60 000	67 000	65 000†	58 400
	max.	80 000	75 000	...	85 000	67 000	85 000†	78 400
	ave.	65 000	62 500	...	72 500	67 000	75 000†	63 200
Usual Number of Motors	min.	4	4	4	4	4	2	4
	max.	4	4
	ave.	4	4	4	4	4	4	4
Range of Total H.P. of Motors	min.	60	200	...	240	500	300	250
	max.	200	700	...	320	500	500	450
	ave.	130	450	...	280	500	400	350

* Calculated on use of single and maximum traction truck.
 † With seated load. § Are usually equipped with power brakes.
 ‡ With and without vestibule. ¶ Speed up to 80 miles per hour.

ELECTRIC RAILWAY TEST COMMISSION.

DATA SHEET.

Number..... Date.....
 Source of Information.....

CAR BODY. DATA.

REMARKS.

Make		
Type		
Length — over corner posts		
Length — over corner posts		
Length — front platform		
Length — rear platform		
Width — over all		
Weight		
Weight — equipped		
Number of seats		
Kind of seats		
Capacity — seating		
Capacity — standing *		
Shape of front		

* Allowing.....square feet per passenger.

TRUCKS.

Make		
Type		
Weight		
Carrying capacity		
Speed rating		
Wheel base		
Distance between truck centers		
Diameter of wheels		
Diameter of axles		
Size of journals		
System of springs		
Kind of tires		

MOTORS.

Make		
Type		
Number per car		
Voltage		
Capacity (one hour rating)		
Gear ratio		
Weight (total)		
Weight (armature)		
Diameter of armature		
Size of bearings		
Arrangement on trucks		
Method of suspension		
Maximum speed		

GENERAL EQUIPMENT.

Hand brake		
Power brake		
System of control		
Type of controller		
Method of heating		
Trolley stand		
Trolley wheel		
Circuit breakers		
Number of lamps		
Kind and position of headlight		

Height of car floor from track

Height of car roof from track

Weight of car complete

Fig. 211. — Information Blank Used in Obtaining General Data Concerning Electric Cars

21. Philadelphia Rapid Transit Company, Philadelphia, Pa.
22. Pittsburg Railways Company, Pittsburg, Pa.
23. Public Service Corporation of New Jersey, Jersey City and Newark, N. J.
24. The Rhode Island Company, Providence, R. I.
25. Schenectady Railway Company, Schenectady, N. Y.
26. St. Louis Transit Company, St. Louis, Mo.
27. Tri-City Railway Company, Davenport, Ia.
28. Twin City Rapid Transit Company, Minneapolis, Minn.
29. United Railroads of San Francisco, San Francisco, Cal.
30. United Railways & Electric Company of Baltimore, Baltimore, Md.
31. Virginia Passenger & Power Company Richmond, Va.
32. Worcester Consolidated Street Railway Company, Worcester, Mass.

After this information had been carefully studied and tabulated, it was found that the data were defective in certain particulars. During the winter and spring of 1904-1905, a second attempt was made to fill in the missing items, and after this second canvass had been completed, there were sufficient data at hand to enable the committee to tabulate a number of data relating to the present American practice in the use of electric cars for street and interurban purposes.

THE TABULATED RESULTS.

Tables XCVIV to XCVIII, inclusive, show the results of this investigation as they were obtained from the principal coöperating companies previously mentioned. Table XCIV refers to light city service, Tables XCV and XCVI show the data obtained for heavy city service conditions, Table XCVII gives the results for light interurban conditions, while Table XCVIII the data relating to heavy interurban service.

TABLE XCV. — Data for Heavy City Service. (Double Truck.)

COMPANY NO.	3	4	4	5	6	6	7	8	8
Type of car.....	Closed	Closed	Open	Semi-con- vertible*	Closed*	Con- vertible	Semi-con- vertible	Closed	Closed
Length over bumpers.....	38' 29" 8"	38' 41"	34' 2"	37' 3"	34' 8"	29' 4"	49' 8"	38' 4"	38' 6"
Length over corner posts.....	29' 8"	29' 51"	25' 10"	28' 0"	42' 7"	29' 4"	34' 8"	28' 28"	28' 28"
Length — front platform.....	4' 6"	5' 3"	2' 6"	4' 61"	4' 7"	4' 6"	7' 3"	5' 4"	5' 4"
Length — rear platform.....	4' 6"	5' 3"	2' 6"	4' 61"	4' 7"	4' 6"	7' 3"	5' 4"	5' 4"
Width over all.....	8' 8"	7' 10½"	7' 10"	8' 8"	7' 5"	8' 3"	8' 8"	7' 10"	7' 10"
Weight of body (lbs.).....	18000	11375	8490	16250	8900	14500	22300	13460	13460
Weight of body equipped (lbs.).....	17000	15940	9070	16250	10120	15100	24830	2 longit.	2 longit.
Number of seats.....	20	20	12	2 longit.	2 longit.	22	26	2 longit.	2 longit.
Capacity standing.....	40	38	60	38	40	40	52	54	54
Number of motors per car.....	2 50-h.p.	2 40-h.p.	2 25-h.p.	2	2 25-h.p.	2 40-h.p.	4 37-h.p.	2 35-h.p.	2 40-h.p.

COMPANY NO.	8	8	8	11	13	13	14	16	16
Type of car.....	Closed	Closed	Closed	Closed	Closed	Closed	Closed	Closed	Semi-con- vertible
Length over bumpers.....	38' 11½"	38' 11½"	43'	41' 4"	47' 1"	51' 2"	39' 4"	39' 0"	43' 3"
Length over corner posts.....	30'	34'	34'	29'	39' 8"	42' 7"	28' 0"	30' 0"	30' 7"
Length — front platform.....	4' 0"	4' 6"	4' 6"	6' 8"	3' 8"	4' 3½"	5' 0"	3' 7"	5' 3"
Length — rear platform.....	4' 6"	4' 6"	4' 6"	6' 8"	3' 8"	4' 3½"	5' 0"	3' 7"	5' 3"
Width over all.....	7' 10"	8' 6"	8' 6"	8' 4"	8' 9"	8' 11½"	8' 4"	8' 44"	8' 6"
Weight of body (lbs.).....	14900	26100	26100	19100	20400	34300	15200	15000	24162
Weight of body equipped (lbs.).....	14900	11 cross, 1 longit.	11 cross, 1 longit.	12 cross, 4 longit.	8 double cross, 32 single sides	8 double cross, 36 side, 1½" parting piece be- tween each side seat	20 cross	16 cross	22 cross
Number of seats.....	2 longit.	2 longit.	1 longit.	4 longit.	8 double cross, 32 single sides	8 double cross, 36 side, 1½" parting piece be- tween each side seat	17000	17860	17860
Capacity seating.....	40	44	44	41	48	52	40	38	44
Capacity standing.....	57	57	65	40	46	50	60	34	48
Number of motors per car.....	2 & 4 35-h.p.	2 & 4 35-h.p.	2 & 4 35-h.p.	2 50-h.p.	2 125-h.p.	2 200-h.p.	4 40-h.p.	4 37-h.p.	4 60-h.p.

* Single Truck 1.

ELECTRIC RAILWAY TEST COMMISSION

TABLE XCVI. — Data for Heavy City Service. Continued. (Double Track.)

COMPANY No.	17	17	18	18	20	21	23	24	24	25	26
Type of car.....	Closed	Closed	Closed	Open	Closed	Semi-con-vertible	Closed	Closed	Open	Convert-ible	Closed
Length over bumpers.....	46' 0"	49' 0"	37' 3"	37' 4"	47' 0"	38' 8"	35' 0"	35' 8"	37' 9"	33' 6"	39' 0"
Length over corner posts.....	34' 0"	40' 0"	28' 0"	28' 7 1/2"	40' 0"	28' 0"	25' 0"	25' 7"	23' 3"	24' 5"	28' 0"
Length — front platform.....	5' 5"	4' 1"	4' 0"	4' 6 1/2"	3' 6"	4' 6"	4' 0"	4' 0"	3' 10"	3' 8 1/2"	5' 0"
Length — rear platform.....	5' 5"	4' 1"	4' 0"	4' 6 1/2"	3' 6"	4' 6"	4' 0"	4' 0"	3' 10"	3' 8 1/2"	5' 0"
Width over all.....	8' 6"	8' 6 1/2"	7' 9"	8' 0"	8' 8 1/2"	8' 2"	8' 0"	8' 4"	8' 11"	8' 4"	8' 9"
Weight of body (lbs.).....		10500	10500	12550	27000	12900	15000	14680	14080	10050	16750
Weight of body equipped (lbs.)		22300	11500	13250	32000	12 cross, 4 longit.	2 longit.	17650	17080	10800	18058
Number of seats.....	26 cross	30 cross	2 longit.	12 cross				2 longit.	13 cross	16 cross	20 cross
Capacity seating.....	52	60	34	60	56	40	36	34	78	32	40
Capacity standing.....	44	50	53	50	44	85	54	46	55	18	38
Number of motors per car.....	2 50-h.p.	4 25-h.p.	2 50-h.p.	2 50-h.p.	2 100-h.p.	4 25-h.p.	2 50-h.p.	4 40-h.p.	4 40-h.p.	4 27-h.p.	2 50-h.p.
COMPANY No.	26	26	26	27	28	30	30	30	32	32	33
Type of car.....	Closed	Semi-con-vertible	Combination	Semi-con-vertible	Closed	Closed	Open	California	Closed	Closed	Open
Length over bumpers.....	44' 8"	45' 8"	39' 6"	40' 11"	45' 2 1/2"	39' 2"	40' 5"	40' 3"	40' 3"	38' 4 1/2"	37' 9"
Length over corner posts.....	32' 0"	33' 4 1/2"	30' 6"	30' 11"	33' 1"	28' 0"	31' 9"	14' 8"	30' 1"	28' 1 1/2"	31' 7"
Length — front platform.....	7' 0"	5' 0"	4' 0"	4' 2 1/2"	5' 3"	5' 0"	3' 6"	12' 8"	4' 3 1/2"	4' 3"	3' 7"
Length — rear platform.....	7' 0"	5' 0"	4' 0"	4' 2 1/2"	5' 3"	5' 0"	3' 6"	12' 8"	4' 3 1/2"	4' 3"	3' 7"
Width over all.....	8' 11"	8' 6 1/2"	8' 8"	8' 6 1/2"	8' 8 1/2"	8' 1 1/2"	8' 1 1/2"	9' 4"	8' 1 1/2"	8' 1 1/2"	8' 5 1/2"
Weight of body (lbs.).....	15000	13700	14556	17800	29300	14480	17250	14700	18050	16000	18000
Weight of body equipped (lbs.)	16300	15000	15856	20000	24000	14480	14750	17700	19680	16945	17975
Number of seats.....	20 cross, 2 longit.	20 cross, 3 longit.	24 cross	22 cross	14 cross, 2 longit.	2 longit.	12 cross- bench	12 cross, 2 longit.	2 longit.	2 longit.	13 cross
Capacity seating.....	48	48	48	44	66	40	60	42	44	36	65
Capacity standing.....	45	50	30	81	66	60	40	60	56	40	48
Number of motors per car.....	4 25-h.p.	4 25-h.p.	2 50-h.p.	4 25-h.p.	4 40-h.p.	2 50-h.p.	2 50-h.p.	4 35-h.p.	4 38-h.p.	2 38-h.p.	2 38-h.p.

TABLES OF AVERAGE DATA.

While the general data are given in each instance in Tables XCIV to XCVIII inclusive, it has been considered advisable to place the average values by themselves in separate tables, so that they may be more conveniently compared. These data are contained in Tables XCIX to CII inclusive.

TABLE XCIX. — *Average Data for Light City Service.*

CAR BODY.	
Length over bumpers	29 feet, 6 inches.
Length over corner posts	21 feet, 0 inches.
Length of platforms	3 feet, 11 inches.
Width over all	7 feet, 11 inches.
Weight	7,570 lbs.
Weight equipped	8,400 lbs.
Capacity seating	33
Capacity standing	32

TRUCKS.	
Weight	5,090 lbs.
Carrying capacity	23,200 lbs.
Speed rating	18 5 m.p.h.
Wheel base	6 feet, 6 inches.
Diameter of wheels	33 inches.
Diameter of axles	4 inches.
Size of journals	3½ inches × 7¼ inches.

MOTORS.	
Number per car	2
Voltage	550
Capacity (one hour rating)	37 h.p. per motor
Gear ratio	4.455
Weight total	2,194 lbs. per motor.
Weight of armature	549 lbs.
Diameter of armature	14 inches.
Size of bearings	C. E. 2½ inches × 6½ inches. P. E. 3 inches × 7¼ inches.

GENERAL DATA.	
Height of car floor from track	34 inches.
Height of car roof from track	11 feet, 0 inches.
Weight of car complete	18,800 lbs.

TABLE C. — Average Data for Heavy City Service.

CAR BODY.	
Length over bumpers	40 feet, 9 $\frac{1}{4}$ inches.
Length over corner posts	31 feet, 7 $\frac{1}{4}$ inches.
Length of platforms	4 feet, 6 $\frac{1}{4}$ inches.
Width over all	8 feet, 4 $\frac{1}{2}$ inches.
Weight	16,600 lbs.
Weight equipped	18,730 lbs.
Capacity seating	46
Capacity standing	50
TRUCKS.	
Weight	5,790 lbs.
Carrying capacity	25,400 lbs.
Speed rating	26 m.p.h.
Distance between truck centers	19 feet, 2 inches.
Wheel base	4 feet, 8 inches.
Diameter of wheels	33 inches.
Diameter of axles	4 $\frac{3}{8}$ inches.
Size of journals	3 $\frac{1}{4}$ inches \times 7 $\frac{1}{4}$ inches.
MOTORS.	
Number per car	2 or 4.
Voltage	500 and 550.
Capacity (one hour rating)	43 h.p. and 35 h.p.
Gear ratio	4.15 and 4.26.
Weight (total)	2,760 lbs. and 2,376 lbs.
Weight (armature)	704 lbs. and 552 lbs.
Diameter of armature	14 $\frac{1}{2}$ inches and 14 inches.
Size of bearings	C.E. 2 $\frac{1}{4}$ inches \times 6 $\frac{1}{4}$ inches. P.E. 3 $\frac{1}{4}$ inches \times 8 $\frac{3}{8}$ inches.
GENERAL DATA.	
Height of car floor from track	38 $\frac{1}{4}$ inches.
Height of car roof from track	11 feet, 9 $\frac{1}{4}$ inches.
Weight of car complete	37,100 lbs.

TABLE CI. — Average Data for Light Interurban Service.

CAR BODY.	
Length over bumpers	41 feet, 2 inches.
Length over corner posts	31 feet, 2 $\frac{1}{2}$ inches.
Length of platforms	4 feet, 10 $\frac{3}{4}$ inches.
Width over all	8 feet, 6 inches.
Weight	16,410 lbs.
Weight equipped	19,230 lbs.
Capacity seating	51.
Capacity standing	36.

TABLE CII. — *Continued.*

MOTORS.

Number per car	4.
Voltage	550.
Capacity (one hour rating)	70 h.p.
Gear ratio	2.395.
Weight (total)	3,660 lbs.
Weight (armature)	1,000 lbs.
Diameter of armature	16 inches.
Size of bearings	C. E. $3\frac{1}{4}$ inches \times $7\frac{1}{4}$ inches. P. E. $3\frac{1}{8}$ inches \times 9 inches.

GENERAL DATA.

Height of car floor from track	$45\frac{1}{4}$ inches.
Height of car roof from track	12 feet, $7\frac{1}{4}$ inches.
Weight of car complete	62,800 lbs.

were contributed from various sources, and a statement of the contributors and the amounts contributed will be found in the Treasurer's Report.

REPORT OF THE TREASURER.

RECEIPTS.

Individual subscriptions of Commissioners. (See exhibit "A" for detail)	\$2,250.00
Subscriptions of railway companies, bankers, engineering firms and companies, etc., less exchange on out of town checks. (See exhibit "B" for detail)	7,529.02
Cash contribution by Superintendents. (See exhibit "C" for detail)	73.93
Total net cash receipts	\$9,852.95

DISBURSEMENTS.

Stationery, printing, and postage expenses at New York City.	\$ 54.35
Miscellaneous expenses ¹ at	
St. Louis, Mo.	4,623.75
Anderson, Ind.	3,639.52
Ithaca, N. Y.	1,535.33
Total Disbursements	\$9,852.95

(Signed) H. H. VREELAND, *Treasurer.*

EXHIBIT "A."

Individual Subscriptions of Commission.

	ORIGINAL SUBSCRIPTION	ADDITIONAL SUBSCRIPTION	TOTAL
J. G. White	\$200.00	\$500.00 ²	\$700.00
James H. McGraw	200.00	250.00 ²	450.00
W. J. Wilgus	200.00		200.00
G. F. McCullough	200.00	250.00	450.00
H. H. Vreeland	200.00	250.00	450.00
Total			\$2,250.00

¹ See exhibit "D" for details.

² Mr. White's check for \$500.00 and Mr. McGraw's check for \$250.00, were sent direct to the Executive Committee without passing through the treasurer's hands.

EXHIBIT "B" (continued).

Conn. Ry. & Lighting Co.	\$100.00
Ft. Wayne & Wabash Valley Trac. Co.	25.00
California Gas & Electric Corporation	25.00
Interborough R. T. Co.	250.00
The Mexico Electric Tramways Co. Ltd.	50.00
Manila Electric R. R. Co. & Lighting Corporation	25.00
Birmingham Ry Lighting & Power Co.	25.00
The United Railways & Electric Co. of Baltimore	150.00
Louisville & S. Ind. Trac. Co.	25.00
Lack. & Wyoming Valley R. R. Co.	25.00
Tucker Anthony & Co., Boston	100.00
Rochester Ry Co.	50.00
The Rhode Island Company	150.00
International Ry Co., Buffalo	150.00
Detroit United Ry. Co.	150.00
Rapid Ry. System, Detroit	100.00
St. Louis Transit Co.	200.00
Pennsylvania, N Y. & L. I. R. R. Co.	100.00
Ford, Bacon & Davis	200.00
Boston Elevated Ry. Co.	250.00
Washington Ry. & Electric Co.	100.00
Richmond Lt. & R. R. Co., Staten Island	75.00
Boston & Worcester Street Ry. Co.	200.00
Met. St. Ry Co., Kansas City Mo.	25.00
Westinghouse, Church, Kerr & Co.	200.00
North Shore R. R. Co. (John Martin), San Francisco	25.00
New York Central & Hudson River R. R. Co.	300.00
Binghamton Ry Co.	50.00
Nashville Ry & Light Co.	50.00
Milwaukee Elec. Ry. & Light Co.	200.00
Chicago City Ry Co.	250.00
City & Suburban Ry. Co., Portland, Ore.	50.00
Sanderson & Porter	50.00
Pittsburgh Railways Co.	250.00
Cleveland Electric Ry. Co.	150.00
W E. Baker & Co.	100.00
Portland R. R. Co., Portland, Me.	50.00
New York & Queens Co., Ry. Co.	50.00
Elmira Water, Light & R. R. Co.	50.00
Arnold Electric Power Station Co.	50.00
Bion J. Arnold	50.00
The Ottawa Electric Ry. Co.	50.00
Total	\$7,535.00
Less exchange on out of town checks	5.98
Total	\$7,529.02

AMERICAN GAGE COMPANY.

The American Gage Company supplied special pressure gages for use in several of the tests. This company had an extensive exhibit of their various gages and appliances in the Palace of Machinery at the St. Louis Exposition. The members of the Executive Committee and the Test Corps were shown great courtesy by those in charge of the exhibit.

AMERICAN STEEL AND WIRE COMPANY.

This company, through its district manager, Mr. O. B. Barrows, contributed in no small degree to the success of the tests upon the grounds of the Exposition. It furnished the trolley wire for the test tracks and placed the services of one of its superintendents at the disposal of the Commission to supervise the erection of the line and to oversee the installation of the rail bonds, which were also furnished by the company. The American Steel and Wire Company supplied several thousand feet of No. 0. *B. & S.* gage duplex lead covered cable for use in connecting the exhibit of the Bullock Electric Manufacturing Company with the test tracks. This cable was in continual use during the investigations of the effects of alternating current in a constructed track, the results of which tests comprise the material contained in Chapter XIII.

THE AMERICAN STREET AND INTERURBAN RAILWAY
ASSOCIATION.

The American Street and Interurban Railway Association rendered important service to the Commission by permitting Prof. Bernard V. Swenson, Secretary of the Association, to devote a considerable portion of his time for several months after his election to the work of the preparation of the Report. This service was especially appreciated by the Commission from the fact that the duties required of Professor Swenson by the Association were most urgent. However, through the cour-

alternating current losses in rails and in track, which tests are fully described in Chapters XII and XIII. This exhibit was admirably adapted for the purpose and comprised a number of machines of large size and of various types which, through the courtesy of the company, were operated under the most severe conditions in order that the series of measurements made might be both complete and comprehensive. The officials of the company and their local representative, Mr. Dunfield, aided the Commission in this series of tests in every possible way. Mr. Ward S. Arnold, of this company, was a member of the Advisory Committee.

CHAPMAN DOUBLE-BALL BEARING COMPANY.

This company provided a set of eight large double-ball bearings for the support of the car body of the "Louisiana." It also prepared twelve special small bearings for use in connection with the vestibule guide frame of the same car. Through its local representative, Mr. E. C. Fisher, and its President, Mr. Herbert E. Dickson, the company was at all times ready to assist the Commission.

CINCINNATI CAR COMPANY.

The Cincinnati Car Company placed at the disposal of the Commission a modern double-truck city car which it had constructed for the Indiana Union Traction Company. This car was a joint exhibit at the Exposition of the Cincinnati Car Company and the Westinghouse Companies. It was tested under various conditions of operation on the lines of the Indiana Union Traction Company. These tests are fully considered in Chapters IV, VI, and IX, while the car is fully described and illustrated in Chapter I.

The Commission also wishes to acknowledge the personal courtesies and assistance tendered by the President of the company, Mr. W. Kelsey Schoepf, who was not only instrumental in placing the interurban car at the disposal of the

"Apple" generators, ordinarily used for ignition purposes in connection with gas engines, particularly those used for automobiles and motor boats. These generators were found to serve their purpose most admirably.

THE ELECTRIC RAILWAY AND EQUIPMENT COMPANY.

This company through the Wesco Company, supplied the tubular iron poles of its manufacture for the equipment of the testing tracks and also the brackets for supporting the trolley wires. These brackets were specially constructed for the purpose and were made ornamental to conform with the exhibit character of the installation.

ELECTRIC STORAGE BATTERY COMPANY.

This company, through its Chicago office, furnished portable storage batteries for supplying the current for the speed generator, the General Electric recording ammeter, and the signalling devices, furnishing whatever batteries were requested for this purpose without expense to the Commission.

FAIRBANKS, MORSE AND COMPANY.

This company, through its Chicago office, constructed for the Commission and loaned to them without charge, a pair of special quick weighing beams for use on the car "Louisiana." This courtesy was especially appreciated as the company is neither directly nor indirectly interested in electric railway work.

FELT AND TARRANT COMPANY.

This company very materially aided the Executive Committee in the working up of the great mass of data by the loan of one of its well-known comptometers, which was used for several months without charge to the Commission.

GENERAL ELECTRIC COMPANY

The General Electric Company through its representative on the Advisory Committee, Mr. A. H. Armstrong, made most valuable suggestions in regard to the work of the Commission. The local representative in charge of the exhibit at the St. Louis Exposition, Mr. F. H. Gale, was always ready to assist in the work in every way possible. The company loaned to the Commission one of its recording ammeters during the entire series of tests both at St. Louis and in Central Indiana. The Company furnished without cost to the Commission, the necessary supplies for operating this instrument, which latter proved to be invaluable in the work of the Commission.

ROBERT W. HUNT COMPANY.

The Hunt Company furnished the industrial locomotive and its equipment, the tests on which are given in Chapter XI. This company also furnished all electrical energy consumed in the tests on the locomotive, entirely free of charge to the Commission. The local representative of the company also assisted materially in these tests.

THE INDIANA UNION TRACTION COMPANY.

Early in the development of the work of the Commission, this company, through Mr. Geo. F. McCulloch, its president at the time, placed at the disposal of the Commission a stretch of track on the northern division of the system. As soon as the work at St. Louis was completed, the test corps was transferred to Anderson, Indiana, where the company furnished excellent office and drawing room facilities free to the Commission.

Mr. A. L. Drum, general manager, Mr. A. S. Richey, electrical engineer, and Mr. C. A. Baldwin, superintendent of transportation, cooperated with the Executive Committee in arranging the details of the tests on the car "Louisiana," as well as those on the interurban car. Mr. Drum also arranged through

Mr. J. L. Matson, superintendent of motive power, to place at the disposal of the Executive Committee the shop and yard facilities of the company, without expense to the Commission, the company charging merely the actual cost of such material and labor as it was called upon to furnish. Mr. Matson also made many valuable suggestions in regard to the mechanical and electrical equipment.

The company loaned a pair of Baldwin trucks, a Westinghouse type L4 controller, and four Westinghouse No. 85 motors, all of which were greatly needed for regular service. It also loaned car-wiring cables, resistance grids, and many other parts of the equipment of the "Louisiana." The company furthermore supplied all electrical energy consumed in making the tests on the interurban car and on the "Louisiana," and, through its transportation department, arranged schedules for the operation of these cars, which, while not interfering with the regular service, would provide all the conditions necessary for the successful carrying out of the desired tests. The present president, Mr. A. L. Brady, instructed the officers of the company to aid the Executive Committee in every possible way.

INGERSOLL-SARGENT DRILL COMPANY.

This company which supplied the compressors for the storage air brake system of the St. Louis Transit Company, manifested great interest in the air-braking tests. The representative of the company, Mr. L. I. Wightman, assisted materially in the air compression station tests described in Chapter VII.

E. H. LINLEY SUPPLY COMPANY.

Mr. E. H. Linley, president of the company, showed much interest in the tests on the effect of alternating current in steel rails. He supplied, without expense to the Commission, a number of pieces of steel of various kinds, and of different lengths and cross-sections. The tests on these steel sections are given in Chapter XIII.

LOUISIANA PURCHASE EXPOSITION COMPANY.

The President of the Exposition, Hon. David R. Francis, made the work possible by the official appointment of the members of the Electric Railway Test Commission. The Exposition Company, by placing at the disposal of the Commission the facilities afforded by the presence of apparatus arranged primarily for exhibit purposes, made possible the testing of this apparatus for the securing of scientific information. The Exposition Company constructed for test purposes two special test tracks located north of the Palace of Transportation, and supplied the electrical energy used in all the tests made on the Exposition grounds.

Through the civil engineering department and the mechanical and electrical department of the Division of Works, the testing tracks were installed and equipped for the work, the power for operating the car being obtained from the lines of the Intramural Railway. Through the coöperation of the mechanical and electrical department, the cable used for the purpose of connecting the exhibit space of the Bullock Electric Manufacturing Company with the test tracks, was installed. This department also erected the poles and trolley wire and installed the bonds on the test track, and loaned a 100-kilowatt General Electric transformer for use in the alternating current rail and track tests. Through its chief, Mr. Ellicott, and its superintendent of construction, Mr. Dixon, the mechanical and electrical department aided the Commission in many ways.

The Test Corps was accorded the privileges of employes of the Exposition, being given unlimited free admission to the grounds and buildings by day or night. The Exposition Company, through the chief of the department of electricity, Professor W. E. Goldsborough, afforded ample office facilities in the Palace of Electricity. Professor Goldsborough, in the capacity of Chairman of the Executive Committee, gave his time and energies freely to the work at all times and by his perseverance, determination, and patience, carried through what

was apparently an almost impossible task. The Commission is also indebted to the several superintendents of the department of electricity, Messrs. Cloyd Marshall, P. F. Williams, Frank Welyand, and P. E. Fansler, for many courtesies extended to the Test Corps.

The department of transportation, through its chief, Mr. Willard A. Smith, also placed its facilities at the disposal of the Commission. During the convention of the American Street Railway Association, Mr. Smith provided quarters in the convention hall so that the work of the Commission might be properly recognized.

THE MCGRAW PUBLISHING COMPANY.

In addition to his personal subscription as a member of the Commission, Mr. James H. McGraw, in his capacity as president of the McGraw Publishing Company, undertook the entire financial responsibility of publishing the Report. Mr. Edward Caldwell, manager of the book department, was also greatly interested in the matter. He assisted the editors in many ways and arranged to have Mr. O. A. Kenyon, of his department, aid in the work; this being peculiarly fitting, as he had served the Commission as a member of the Test Corps, and was, therefore, personally interested.

NATIONAL ELECTRIC COMPANY.

The National Electric Company supplied a motor-compressor equipment for use in connection with the tests upon the lines of the St. Louis Transit Company, in order that a comparison might be made between the storage-air system and the motor-compressor system. It supplied a second equipment for installation upon the "Louisiana," including a five horse power motor-compressor with reservoir, governor, valves, brake cylinder, and accessories. The chief engineer, Mr. C. P. Tolman, offered many valuable suggestions in regard to the air-brake tests, as

well as personal assistance when this was requested. The company was ready at all times to loan apparatus or in any other way to assist in the work of the Commission.

NORTHERN ELECTRICAL MANUFACTURING COMPANY.

This Company had a very complete motor-driven machine tool exhibit in the Palace of Electricity at the St. Louis Exposition. This exhibit was placed at the disposal of the Executive Committee on several occasions during the progress of the work at St. Louis.

OHIO STATE UNIVERSITY.

Ohio State University, through Professor F. C. Caldwell, assisted in the work by loaning to the Commission apparatus for determining the speed of the cars, as well as a number of electrical instruments which were used in the tests at St. Louis.

PRESSED STEEL CAR COMPANY.

The Pressed Steel Car Company, through its president, Mr. J. W. Friend, and its representative at the St. Louis Exposition, Mr. C. M. Mendenhall, furnished to the Commission a steel flat car of 100,000 pounds capacity complete with trucks for use in connection with the air-resistance tests. The company also prepaid the freight on this car to Anderson, Indiana. The value of this contribution to the work is apparent from the description of the "Louisiana," of which the flat car was an important part.

PURDUE UNIVERSITY.

Purdue University, through the head of the electrical engineering department, Prof. W. E. Goldsborough, and Assistant Professors H. T. Plumb and J. W. Esterline, contributed largely to the success of the tests, placing at the disposal of the Commission a considerable number of electrical instruments. At the close of the work, through its president, Dr. W. E. Stone,

the broad coöperative policy of the University was shown in the agreement between the Commission, the American Street and Interurban Railway Association, and Purdue University, whereby the University agreed to coöperate with the Association in further tests by housing and caring for the "Louisiana" without cost to the Association. The University further permitted Professor Plumb and eight of its students to coöperate with the Executive Committee in making the tests on Car No. 284, to which work Professor Plumb devoted much time and attention after returning to his University work.

QUEEN AND COMPANY.

This company loaned to the Commission for use in the air resistance tests, a pair of cup anemometers which were stationed at the ends of the test track on the Indianapolis and Logansport line of the Indiana Union Traction Company. This apparatus was employed in the determination of the velocity of the wind, which was a matter of considerable importance in the tests described in Chapter XVI.

ST. LOUIS CAR COMPANY.

In conjunction with the Westinghouse Traction Brake Company and the Westinghouse Electric Manufacturing Company, the St. Louis Car Company placed at the disposal of the Commission a single-truck city car which was exhibited on the test tracks north of the Palace of Transportation at the World's Fair. Through the officers of the company, every courtesy was extended to the members of the Executive Committee. This car is the one considered in Chapters II, V, and X, and is fully described in Chapter I.

STANDARD UNDERGROUND CABLE COMPANY.

The Standard Underground Cable Company, through its Chicago manager, Mr. Wylie, offered to supply, free of cost to

the Commission, the cable for connecting the space of the Bullock Electric Manufacturing Company with the test tracks on the Exposition Grounds. This proposition would have been gladly accepted were it not for the fact that another company's courtesy in this connection had been previously accepted. The kindness in making this offer was duly appreciated by the members of the Commission.

THE TEST CORPS.

While the Commission is under obligation to the various members of the Test Corps, as stated in the letter of transmittal at the beginning of the Report, it is felt that additional recognition should be given to Messrs. R. J. McNitt, Will Spalding, and C. C. Myers for the great interest which they showed in the work after they had severed their connection with the Test Corps, by aiding very materially in working up the final data contained in the Report.

WASHINGTON UNIVERSITY.

The authorities of Washington University, at St. Louis, accorded the Executive Committee most courteous treatment upon every possible occasion. The University dormitory was placed at the disposal of the Test Corps at a nominal charge for a period of several weeks. Professor Nipher and Langsdorf also assisted the Executive Committee upon several occasions.

WESTINGHOUSE ELECTRIC AND MANUFACTURING COMPANY.

Through Mr. Clarence Renshaw, a member of the Advisory Committee, this company made many valuable suggestions in regard to the work of the Commission. Throughout the entire series of tests, the company showed itself ready to loan the Commission whatever materials and supplies were needed. In con-

junction with the Westinghouse Traction Brake Company it placed at the disposal of the Executive Committee the single-truck city car exhibited on the test tracks north of the Palace of Transportation at the St. Louis Exposition. In conjunction with the Cincinnati Car Company, it submitted for test the double-truck interurban car, which was also exhibited at the Exposition. This car was equipped with the latest type electro-pneumatic control, and was of the latest design in all particulars. In connection with the special air resistance tests made in central Indiana, the company further manifested its cooperation by the loan of twenty extra heavy gird resistance frames for controlling the speed of the "Louisiana," an L4 controller, and two 600-ampere circuit-breakers. The manager of the Westinghouse exhibit at the Louisiana Purchase Exposition, Mr. W. K. Dunlap, was at all times ready to aid in the work of the Commission, and his cooperation was greatly appreciated.

WESTINGHOUSE TRACTION BRAKE COMPANY.

The Westinghouse Traction Brake Company, which has always been much interested in tests of railway apparatus, did everything in its power to promote the work of the Commission. By cooperation with the St. Louis Car Company, the St. Louis Transit Company, and Cincinnati Car Company, and the Westinghouse Electric Manufacturing Company, it placed at the disposal of the Commission several braking equipments for testing purposes. Among these were the magnetic brake placed on the St. Louis Car Company's interurban car, and the Storage System of air-braking, such as is employed by the St. Louis Transit Company. The company also supplied a considerable amount of apparatus for use, including a special recording pressure gage. It furnished a competent operator for the tests on a single-truck city car, this operator working under the direction of the Executive Committee. The local representative in charge of the exhibit at the St. Louis Exposition, Mr. Townsend, was

indefatigable in his efforts to further the work of the Commission. The chief mechanical engineer of the company, Mr. E. H. Dewson, contributed largely, both by suggestions and by personal assistance, to the success of the tests on the single-truck car. Mr. Ellicott, general manager of the company, also manifested a practical interest in the tests on this car.

WESTON ELECTRICAL INSTRUMENT COMPANY.

A large number of the instruments used, especially in the tests on Car No. 284 and on the "Louisiana," were supplied by the Weston Electrical Instrument Company, which company offered to furnish as many instruments as might be required for all parts of the work. These were all new instruments supplied either from its large exhibit in the Palace of Electricity or directly from the factory. They were given to the Commission on very short notice and without restriction. Furthermore, the company refused to accept compensation for damage to instruments, which, while slight in any one case, amounted in the aggregate to a considerable sum, as a number of instruments were used. These instruments, of both direct and alternating current types, comprised ammeters, voltmeters, and wattmeters of various types and ranges.

UNITED RAILWAYS OF ST. LOUIS.

(FORMERLY THE ST. LOUIS TRANSIT COMPANY.)

A short time before the opening of the Exposition, the St. Louis Transit Company installed upon its lines the Westinghouse Traction Brake Company's system of braking by means of storage air. The Transit Company placed at the disposal of the Commission, for the purpose of testing, such parts of this system as were deemed necessary. The company also placed at the disposal of the Commission one of its latest types of double-truck cars for a considerable period of time. The facilities of the repair shops were also placed at the disposal of

the Executive Committee in the work incident to rearranging and constructing apparatus for the car tests as well as for the compressor station tests. The company supplied the necessary power for all of these tests, and furnished transportation to the Test Corps while it was engaged in this work.

Special mention should also be made of the courtesies extended by the general manager, Captain Robert McCulloch, by the assistant general manager, Mr. Richard McCulloch, and by the master mechanic, Mr. Michael O'Brien.

UNITED STATES GOVERNMENT.

The Department of Commerce and Labor, through the National Bureau of Standards, rendered invaluable service by placing at the disposal of the Commission its standardization laboratory installed in the Palace of Electricity at the Exposition. Through the chief of the Bureau, Dr. S. W. Stratton, and his chief assistants, Prof. E. B. Rosa, Dr. Wolf, Dr. M. G. Lloyd, and other members of the staff, the exceptional facilities afforded by this laboratory were made available to the Commission. In the laboratory were installed many types of apparatus for making calibrations of electrical instruments, and the instruments used in the tests were frequently standardized without expense to the Commission. The various members of the corps of the National Bureau of Standards also contributed to the success of the work by suggestions and practical assistance.

The Coast and Geodetic Survey Department loaned to the Commission, during the time of the St. Louis tests, a powerful and accurate chronograph which was used in connection with the speed measurements in the tests upon the single-truck city car.

The Weather Bureau also furnished much information and data relating to temperature, moisture, and the velocity and direction of the wind, both at St. Louis and at Indianapolis.

UNIVERSITY OF ILLINOIS.

Through Professor Morgan Brooks and Assistant Professor Williams, the University of Illinois assisted in the work by loaning to the Commission a number of electrical instruments which were used in the tests at St. Louis.

UNIVERSITY OF WISCONSIN.

Through the head of the electrical department, Prof. D. C. Jackson, the University of Wisconsin contributed to the work of the Commission by the loan of numerous instruments. The University authorities, through President C. R. Van Hise, Dean F. E. Turneaure, and Professor Jackson, also aided the Commission by granting a leave of absence to Prof. B. V. Swenson, assistant superintendent of tests, for the purpose of enabling him to take up the work of the Commission. Through Prof. J. W. Shuster, the University assisted in the work on the rail tests, by making magnetic measurements on samples of rail submitted to it.

INDEX.

- Acceleration, corrections for, 474.**
power consumption during, 200.
tests, 197.
with Westinghouse multiple unit control, 229.
- Acknowledgments, 593.**
- Air brake, individual motor-compressor (see brake), 57, 296.**
straight (see brake), 150.
- Air pressure dynamometers, 488.**
resistance, car body, 565.
car body data, 562-563.
curves, flat vestibule, 554.
parabolic vestibule, 553.
parabolic wedge vestibule, 553.
standard vestibule, 555.
up to 100 miles per hour, 565-568.
for different speeds, 534.
its effect upon train resistance, 566.
power absorbed by vestibules, 569-572.
front vestibule, 564.
rear vestibule, 564.
table up to 100 miles per hour, 569.
vestibule data, 558-561.
tests, 534.
arrangement of apparatus, 529.
description, 546.
direction and velocity of wind, 535.
discussion, 563.
profile of track, 490.
- Air resistance tests. — Continued.**
results, 552.
schedule of runs with parabolic vestibule, 537, 542.
schedule of runs with parabolic wedge vestibule, 538.
schedule of runs with flat vestibule, 543.
schedule of runs with standard vestibule, 545.
speed measurement, 546.
- Alternating current losses in pipe sections, 424.**
in rails (see rail).
in rails and other steel and iron sections, 389.
in round sections, 418, 420.
in square sections, 416, 422.
in track, 432.
description of tests, 439.
description of track, 433.
- American Gage Co., 598.**
- American Street and Interurban Railway Association, 598.**
- American Street Railway Association, cooperation with Commission, 5.**
- American Steel and Wire Co., 598.**
- Ammeter, General Electric recording, 71.**
- Anchor tests, 381.**
- Apparatus for making complete graphical record of car test, 157.**
- Baldwin Locomotive Works, 599.**
trucks, construction of, 504.
- Ball bearings, 511.**

- Brakes, Individual motor-compressor system, National Electric Co., 57, 296.**
 electrical connections for, 305.
 piping for, 302.
 storage air system, 47, 58, 296.
 braking equipment, 261.
 Westinghouse straight air system, 150.
 with motor-compressor, 70.
 Westinghouse magnetic, 45
 braking current, 77.
 description of, 3, 39.
 diagram of connections, 343.
 heating of motors, 109.
 regulating devices, 342.
 tractive effort, 356.
- Braking, air, braking distances, 324.**
 braking force, 324.
 braking period, 324.
 comparison of stand test, with service test, 322.
 discussion of results, 319.
 energy consumption, 324.
 energy consumption per cubic foot air, 294.
 leakage tests, 327.
 maximum deceleration, 324.
 motor-compressor vs. storage systems, 319.
 stand test, connections for resistance measurements, 316.
 stand tests of motor-compressor, 314.
 storage system, 255.
 stand test of motor-compressor, 294.
 brake shoe pressure, 329.
 city car, air per stop, 293.
 curve, 359.
 force, 335.
 force, method of finding, 351.
 magnetic, current consumption, 338.
 distance, 338
 force, 338.
- Braking, magnetic. — Continued.**
 period, 338.
 storage air, city car, average pressure in high pressure reservoir, 293.
 power consumption per stop, 293
 tests, 253.
 city car, results, 311.
 magnetic brakes, 338.
- Brill, G. J., Co., 599.
 Buffers to take up vibration, 523.
 Bullock Electric Mfg. Co., 599.
 Bureau of standards, 29.
- Carbon resistance, 398.**
- Car body used by United Railways of St. Louis, 47, 48.**
 data, heavy city service, 583, 588.
 heavy interurban, 586, 589.
 light city service, 582, 587.
 light interurban, 585, 588.
 double-truck city, 46.
 brakes, 57.
 braking tests of, 292.
 compared with single-truck city, 143.
 controller and wiring of, 56.
 discussion of results of braking tests, 319.
 discussion of results of service tests, 140.
 energy consumption, 116.
 general dimensions and data, 47, 52.
 general results of service tests, 132, 135, 137, 139.
 motors, 47.
 passengers carried, 116, 141.
 power consumption, 142.
 results of braking tests, 311.
 schedule speed, 116.
 service tests of, 116.
 stops per mile, 116, 141.
 temperature measurement, 142.

- Car, single-truck city. — *Continued.*
 power consumption during acceleration, 200.
 power *vs.* hand brake, 107.
 results of acceleration tests, 211.
 results of braking tests, 338.
 retardation, 107.
 service tests of, 76
 speed average, 77.
 speed maximum, 77.
 speed performance, 106.
 speed schedule, 77.
 temperature data, 111.
 total weight, 79.
 truck and running gear, 41, 42.
 working up results of service tests, 85.
 trailer, 152.
 wiring diagram "Louisiana," 507.
 Chapman Double-Ball Bearing Co., 600.
 construction of, 511.
 Christensen motor-compressor braking apparatus, 57, 296.
 Cincinnati Car Co., 600.
 City car (see car), 338.
 City car data (see car).
 Energy and power consumption of
 double-truck city car, 116.
 of interurban car, 145, 189, 191, 192.
 multiple unit control apparatus, 237.
 single-truck city car, 77, 108.
 Committees, various, *iv.*
 Control, detailed description of Westinghouse multiple unit system, 229.
 energy consumed by multiple unit control apparatus, 237.
 Westinghouse multiple unit, adjustment of limit switch, 232.
 time lag in, 251.
 effect of adjustment of time limit switch, 250.
- Control, Westinghouse multiple unit.
 — *Continued*
 Westinghouse pneumatic system, 59, 229.
 Controllers, diagram of wiring B 23 Westinghouse, 344.
 G. E. Type K 28, 47, 56.
 master for Westinghouse multiple unit control, 231.
 power connections of Westinghouse B 23, 202.
 storage battery locomotive, 372.
 Westinghouse B 23, 344.
 Westinghouse multiple unit, 59, 149.
 Coöperators, 597.
 Cornell University, 601.
 Counter E.M.F. in rails, 390.
 Crosby Steam Gate Co., 601.
 Current density effect on rail drop, 407.
- Dayton Electrical Manufacturing Company, 601.**
 Deceleration average in braking tests of city car, 358.
 methods of finding, 328, 350.
 Distance recorder, 206.
 Double-truck car (see car).
 Dynamometer car, description of, 491.
 safety locking device, construction of, 508, 509.
 sketch of, a, 517.
 Dynamometers, calibration of, 530.
 for measurement of air pressure, 488, 518.
 Dynamometer, oil, 376.
- Electric Railway and Equipment Co., 602.**
 Electric Railway Test Commission, Organization, 1.
 Electric Storage Battery Co., 602.
 Engineering committee, on test of city and suburban equipments, 8.

Ohio State University, 607.

Oil dynamometer, 376.

Parabolic vestibule construction of, 499.

Pipe sections a.c. losses in, 424.

Plans of commission, Outline of, 7.

Power consumption during acceleration, 200.

measurement by three volt-meter method, 399.

taken at different speeds by different head vestibules, 556.

by different rear vestibules, 557.

Pressed Steel Car Co., 607.

Purdue University, 607.

Queen & Co., 608.

Rails, alternating current losses in, 389.

counter E.M.F. in, 390.

drop in, 426, 428.

impedance-resistance ratios, 426, 429.

power-factors, 427, 429.

used by United Railways of St. Louis, 119.

tests of, 56 pounds per yard, 393.

80 pounds per yard, 393.

carbon resistance, 398.

diagram of electrical connections, 395, 396, 397, 398.

discussion of, 426.

gas pipe, 394.

graphical data, 404, 412.

power measurements, 399.

results of, 401.

round sections, 394.

square sections, 394.

temperature measurements, 400.

Report, General description of, 31.

of various committees, 10.

Resistance carbon, 398.

measurements, connections for, 316.

Resistance. — Continued.

of rails, 45.

of double-track, 450.

of single-track, 450.

Retardation (see Deceleration), 328.

St. Louis Car Co., 608.

Sand box, capacity of, for interurban service, 65.

Scales, quick weighing, 519.

Service tests, 33.

definition of, 36.

Single-truck car (see car), 338.

Skin effect, 390.

Speed measurement, Apple generator, 82, 163.

Apple generator, 349.

Boyer recorder, 82, 84, 130.

chronograph, 83.

contact device, 206.

magneto generator, 130.

tests of single-truck city car, 43.

Stand test of air compressor compared with actual performance on car, 322.

Standard Underground Cable Co., 608.

Stops, duration of, 116.

per mile city service, 116, 141.

interurban service, 146.

Storage air system, air lost by leakage, 256.

automatic controller, 285.

braking equipment, 261.

capacity of station, 295.

compared with motor-compressor systems, 319.

compressor efficiency, 269.

compressor-station tests, 255.

connections for calibrating car gages, 268.

discussion of results of compressor station test, 284.

electrical connections for test, 264.

- Storage air system. — *Continued.*
 heat absorbed by cooling water, 256.
 connections for charging cars, 259.
 interval of compressor runs, 256.
 loss in air lift, 268.
 measurement of volume of air compressed, 262.
 motor-compressor, 258.
 plan of station, 257.
 power consumption, 256.
 reservoir pressure, 256.
 results of station tests, 277.
 summary of compressor station tests, 289.
 tank capacity, 260.
 battery locomotive, Test of, 369.
- Test car, Louisiana, 488.
 corps, 24, 609.
 general description of, 29.
 Three voltmeter method, 399.
 Tool box for interurban cars, 65.
- Track, alternating and continuous current losses in, 390.
 gage used by United Railways of St. Louis, 117.
 impedance tests, connections, 440.
 discussion of results, 450.
 results of tests, 443.
 power factor for different frequencies and currents, 444-449.
 power loss for different frequencies and currents, 444-449.
 pressure drop for different frequencies and currents, 444-449.
 rails used by United Railways of St. Louis, 119.
 tests, power supply, 435.
- Tracks used by Commission at Exposition, 2.
- Trailer, 152.
- Train resistance, air component, 485.
 as affected by air resistance, 566.
 effect of form of vestibule, 485.
 formulas, 465.
 tests, 463.
 discussion of, 485.
 for different speeds, 464.
- Treasurer's report, 594.
- Trucks, Baldwin, Construction of, 504.
 heavy interurban, 66.
 general dimensions of single truck, 41, 42.
 used by United Railways of St. Louis, 52.
- United Railways, 611.
 of St. Louis Park Ave. line (map), 118.
- United States Government, 612.
- University of Illinois, 613.
- University of Wisconsin, 613.
- Vestibule, parabolic, construction of, 499.
 standard, Construction of, 515, 516.
- Washington University, 609.
- Westinghouse Electric and Mfg. Co., 609.
- Westinghouse Traction Brake Co., 610.
- Weston Electrical Instrument Co., 611.
- Wind direction and velocity, air resistance tests, 535.
- Wiring, double-truck city car, 56.
 interurban car, 70.
 dynamometer car, "Louisiana," 507.
 single-truck city car, 46.

