

S. 1. A

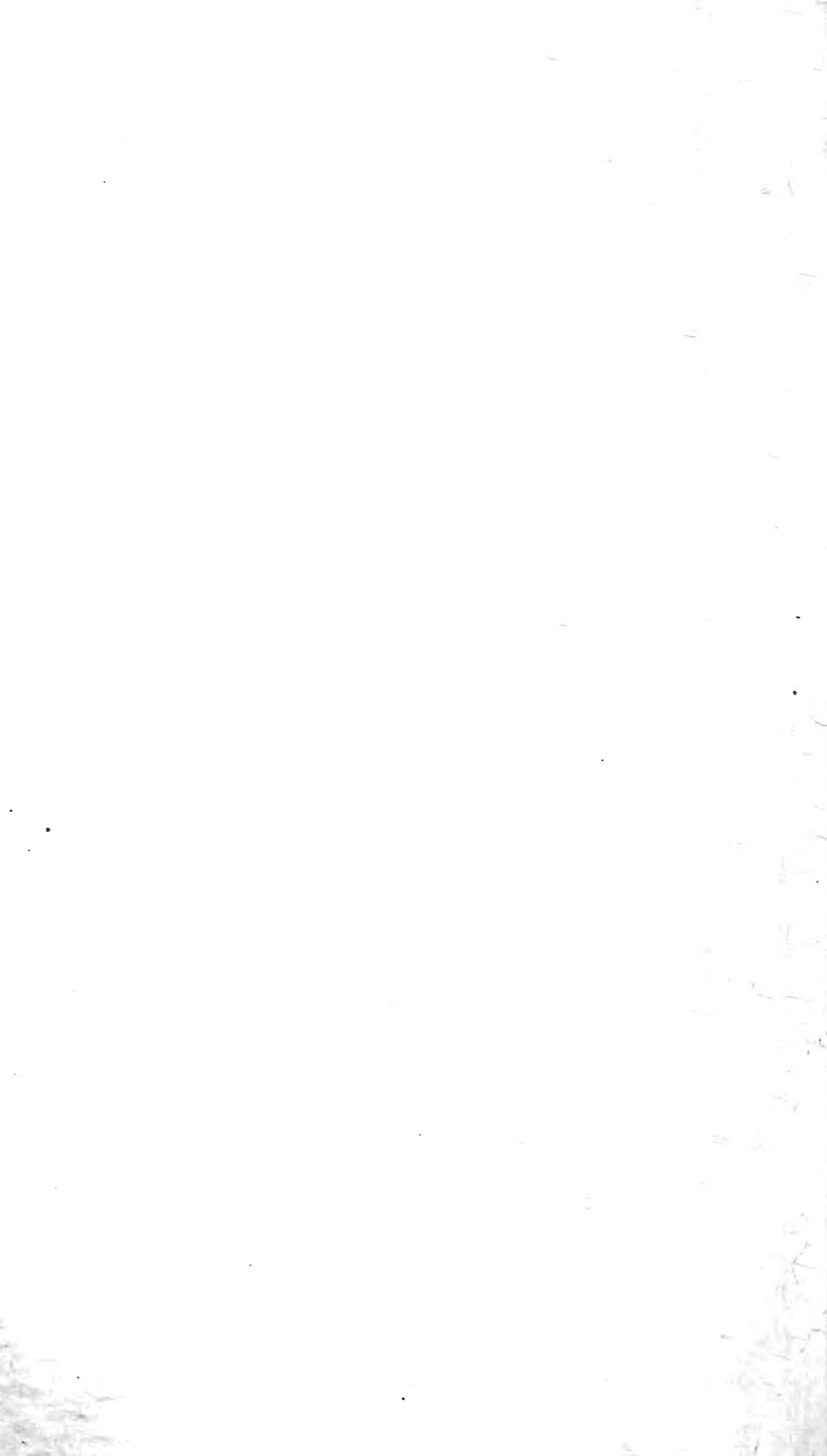





REPORT

OF THE

FIFTY-EIGHTH MEETING

OF THE

BRITISH ASSOCIATION

FOR THE

ADVANCEMENT OF SCIENCE

HELD AT

BATH IN SEPTEMBER 1888.



LONDON:

JOHN MURRAY, ALBEMARLE STREET.

1889.

Office of the Association: 22 ALBEMARLE STREET, LONDON, W.

S. I. A. 57.

PRINTED BY
SPOTTISWOODE AND CO., NEW-STREET SQUARE
LONDON

CONTENTS.

	Page
OBJECTS and Rules of the Association	xxvi
Places and Times of Meeting and Officers from commencement	xxxvi
Presidents and Secretaries of the Sections of the Association from commencement	xliv
List of Evening Lectures	lix
Lectures to the Operative Classes	lxii
Officers of Sectional Committees present at the Bath Meeting.....	lxiii
Officers and Council, 1888-89	lxv
Treasurer's Account	lxvi
Table showing the Attendance and Receipts at the Annual Meetings	lxviii
Report of the Council to the General Committee	lxx
Committees appointed by the General Committee at the Bath Meeting in September 1888	lxxiii
Synopsis of Grants of Money	lxxxii
Places of Meeting in 1889 and 1890	lxxxiii
General Statement of Sums which have been paid on account of Grants for Scientific Purposes	lxxxiv
Arrangement of the General Meetings	xcvi
Address by the President, Sir FREDERICK BRAMWELL, D.C.L., F.R.S., M.Inst.C.E.	1

REPORTS ON THE STATE OF SCIENCE.

Fourth Report of the Committee, consisting of Professors A. JOHNSON (Secretary), J. G. MACGREGOR, J. B. CHERRIMAN, and H. T. BOVEY and Mr. C. CARPMAEL, appointed for the purpose of promoting Tidal Observations in Canada	27
Report of the Committee, consisting of Sir R. S. BALL, Dr. G. JOHNSTONE STONEY, Professors EVERETT, FITZGERALD, HICKS, CAREY FOSTER, O. J. LODGE, POYNTING, MACGREGOR, GENESE, W. G. ADAMS, and LAMB, Messrs. BAYNES, A. LODGE, FLEMING, W. N. SHAW, GLAZE BROOK, HAYWARD, LANT CARPENTER, CULVERWELL (Secretary), and GREENHILL, Dr. MUIR, and Messrs. G. GRIFFITH and J. LARMOR, appointed for the purpose of considering the desirability of introducing a Uniform Nomenclature for the Fundamental Units of Mechanics, and of co-operating with other bodies engaged in similar work.....	27

	Page
Fourth Report of the Committee, consisting of Professor BALFOUR STEWART (Secretary), Professor W. GRYLLS ADAMS, Mr. W. LANT CARPENTER, Mr. C. H. CARPMAEL, Mr. W. H. CHRISTIE (Astronomer Royal), Professor G. CHRYSAL, Captain CREAK, Professor G. H. DARWIN, Mr. WILLIAM ELLIS, Sir J. H. LEFROY, Professor S. J. PERRY, Professor SCHUSTER, Professor Sir W. THOMSON, and Mr. G. M. WHIPPLE, appointed for the purpose of considering the best means of Comparing and Reducing Magnetic Observations	28
Fourth Report of the Committee, consisting of Professor G. FORBES (Secretary), Captain ABNEY, Dr. J. HOPKINSON, Professor W. G. ADAMS, Professor G. C. FOSTER, Lord RAYLEIGH, Mr. PREECE, Professor SCHUSTER, Professor DEWAR, Mr. A. VERNON HARCOURT, Mr. H. TRUEMAN WOOD, Sir JAMES DOUGLASS, Professor H. B. DIXON, and Mr. DIBDIN, appointed for the purpose of reporting on Standards of Light	39
Report of the Committee, consisting of Professor CRUM BROWN (Secretary), Mr. MILNE-HOME, Dr. JOHN MURRAY, Lord McLAREN, and Dr. BUCHAN, appointed for the purpose of co-operating with the Scottish Meteorological Society in making Meteorological Observations on Ben Nevis	49
Second Report of the Committee, consisting of Professors TILDEN, McLEOD, PICKERING, RAMSAY, and YOUNG and Drs. A. R. LEEDS and NICOL (Secretary), appointed for the purpose of reporting on the Bibliography of Solution	54
Report of the Committee, consisting of Professor G. CAREY FOSTER, Sir WILLIAM THOMSON, Professor AYRTON, Professor J. PERRY, Professor W. G. ADAMS, Lord RAYLEIGH, Dr. O. J. LODGE, Dr. JOHN HOPKINSON, Dr. A. MUIRHEAD, Mr. W. H. PREECE, Mr. HERBERT TAYLOR, Professor EVERETT, Professor SCHUSTER, Dr. J. A. FLEMING, Professor G. F. FITZGERALD, Mr. R. T. GLAZEBROOK (Secretary), Professor CHRYSAL, Mr. H. TOMLINSON, Professor W. GARNETT, Professor J. J. THOMSON, Mr. W. N. SHAW, Mr. J. T. BOTTOMLEY, and Mr. T. GRAY, appointed for the purpose of constructing and issuing Practical Standards for use in Electrical Measurements	55
Second Report of the Committee, consisting of Professors TILDEN and W. CHANDLER ROBERTS-AUSTEN and Mr. T. TURNER (Secretary), appointed for the purpose of investigating the Influence of Silicon on the properties of Steel. (Drawn up by Mr. T. TURNER)	69
Third Report of the Committee, consisting of General J. T. WALKER, Sir WILLIAM THOMSON, Sir J. H. LEFROY, General R. STRACHEY, Professors A. S. HERSCHEL, G. CHRYSAL, C. NIVEN, J. H. POYNTING (Secretary), and A. SCHUSTER, and Mr. C. V. BOYS, appointed for the purpose of inviting designs for a good Differential Gravity Meter in supersession of the pendulum, whereby satisfactory results may be obtained at each station of observation in a few hours instead of the many days over which it is necessary to extend pendulum observations.....	72
Report of the Committee, consisting of Professor H. E. ARMSTRONG, Mr. J. T. DUNN, Professor W. R. DUNSTAN (Secretary), Dr. J. H. GLADSTONE, Mr. A. G. VERNON HARCOURT, Mr. FRANCIS JONES, Professor H. McLEOD, Professor MELDOLA, Mr. PATTISON MUIR, Dr. W. J. RUSSELL, Mr. W. A. SHENSTONE, Professor SMITHELLS, and Mr. STALLARD, appointed for the purpose of inquiring into and reporting on the present methods of teaching Chemistry. (Drawn up by Professor DUNSTAN)	73
Report of the Committee, consisting of Dr. RUSSELL, Captain ABNEY, Professor HARTLEY, and Dr. A. RICHARDSON (Secretary), appointed for the investigation of the action of Light on the Hydracids of Halogens in presence of Oxygen. (Drawn up by Dr. A. RICHARDSON)	89
Second Report of the Committee, consisting of Professors TILDEN and	

	Page
RAMSAY and Dr. NICOL (Secretary), appointed for the purpose of investigating the Nature of Solution.....	93
Report of the Committee, consisting of Professor RAY LANKESTER, Mr. P. L. SCLATER, Professor M. FOSTER, Mr. A. SEDGWICK, Mr. WALTER HEAPE, Professor A. C. HADDON, Professor MOSELEY, and Mr. PERCY SLADEN (Secretary), appointed for the purpose of making arrangements for assisting the Marine Biological Association Laboratory at Plymouth.....	94
Third Report of the Committee, consisting of Professors TILDEN and ARMSTRONG (Secretary), appointed for the purpose of investigating Isomeric Naphthalene Derivatives. (Drawn up by Professor ARMSTRONG)	96
Third Report of the Committee, consisting of Dr. GARSON, Mr. PENGELLY, Mr. F. W. RUDLER, Mr. G. W. BLOXAM (Secretary), Mr. J. THEODORE BENT, and Mr. J. STUART GLENNIE, appointed for the purpose of investigating the Prehistoric Race in the Greek Islands	99
Report of the Committee, consisting of Sir RAWSON RAWSON, General PITT-RIVERS, Dr. MUIRHEAD, Mr. C. ROBERTS, Dr. J. BEDDOE, Mr. H. H. HOWORTH, Mr. F. W. RUDLER, Dr. G. W. HAMBLETON, Mr. HORACE DARWIN, Mr. G. W. BLOXAM, Dr. GARSON, and Dr. A. M. PATERSON, appointed for the purpose of investigating the effects of different occupations and employments on the Physical Development of the Human Body .	100
Sixteenth Report of the Committee, consisting of Professors J. PRESTWICH, W. BOYD DAWKINS, T. MCK. HUGHES, and T. G. BONNEY, Dr. H. W. CROSSKEY (Secretary), and Messrs. C. E. DE RANCE, H. G. FORDHAM, D. MACKINTOSH, W. PENGELLY, J. PLANT, and R. H. TIDDEMAN, appointed for the purpose of recording the position, height above the sea, lithological characters, size, and origin of the Erratic Blocks of England, Wales, and Ireland, reporting other matters of interest connected with the same, and taking measures for their preservation. (Drawn up by Dr. CROSSKEY, Secretary)	101
Report of the Committee, consisting of Professor VALENTINE BALL, Mr. H. G. FORDHAM, Professor HADDON, Professor HILLHOUSE, Mr. JOHN HOPKINSON, Dr. MACFARLANE, Professor MILNES MARSHALL, Mr. F. T. MOTT (Secretary), Dr. TRAQUAIR, and Dr. H. WOODWARD, reappointed at Manchester for the purpose of preparing a further Report upon the Provincial Museums of the United Kingdom.....	124
Second Report of the Committee, consisting of Mr. R. ETHERIDGE, Dr. H. WOODWARD, and Mr. A. BELL (Secretary), appointed for the purpose of reporting upon the 'Manure' Gravels of Wexford. (Drawn up by Mr. A. BELL)	133
Report of the Committee, consisting of Professors MCINTOSH (Secretary), ALLMAN, LANKESTER, BURDON SANDERSON, CLELAND, EWART, STIRLING, and MCKENDRICK, Drs. CLEGHORN and TRAQUAIR, for continuing the Researches on Food-Fishes at the St. Andrews Marine Laboratory	141
Fourteenth Report of the Committee, consisting of Drs. E. HULL and H. W. CROSSKEY, Sir DOUGLAS GALTON, Professor G. A. LEBOUR, and Messrs. JAMES GLAISHER, E. B. MARTEN, G. H. MORTON, W. PENGELLY, JAMES PLANT, J. PRESTWICH, I. ROBERTS, T. S. STOOKE, G. J. SYMONS, W. TOPLEY, TYLDEN-WRIGHT, E. WETHERED, W. WHITAKER, and C. E. DE RANCE (Secretary), appointed for the purpose of investigating the Circulation of Underground Waters in the Permeable Formations of England and Wales, and the Quantity and Character of the Water supplied to various Towns and Districts from these Formations. (Drawn up by C. E. DE RANCE, Reporter)	145
Report of the Committee, consisting of Mr. JOHN CORDEAUX (Secretary), Professor A. NEWTON, Mr. J. A. HARVIE-BROWN, Mr. WILLIAM EAGLE CLARKE, Mr. R. M. BARRINGTON, and Mr. A. G. MORE, reappointed at Man-	

	Page
chester for the purpose of obtaining (with the consent of the Master and Brethren of the Trinity House and the Commissioners of Northern and Irish Lights) observations on the Migration of Birds at Lighthouses and Lightvessels, and of reporting on the same.....	146
Report of the Committee, consisting of Professor W. C. WILLIAMSON and Mr. W. CASH, appointed for the purpose of investigating the Flora of the Carboniferous Rocks of Lancashire and West Yorkshire. (Drawn up by Professor W. C. WILLIAMSON)	150
Report of the Committee, consisting of Professor RAY LANKESTER, Mr. P. L. SCLATER, Professor M. FOSTER, Mr. A. SEDGWICK, Professor A. M. MARSHALL, Professor A. C. HADDON, Professor MOSELEY, and Mr. PERCY SLADEN (Secretary), appointed for the purpose of arranging for the occupation of a Table at the Zoological Station at Naples	150
Report of the Committee, consisting of Dr. J. H. GLADSTONE (Secretary), Professor ARMSTRONG, Mr. STEPHEN BOURNE, Miss LYDIA BECKER, Sir JOHN LUBBOCK, Bart., Dr. H. W. CROSSKEY, Sir RICHARD TEMPLE, Bart., Sir HENRY E. ROSCOE, Mr. JAMES HEYWOOD, and Professor N. STORY MASKELYNE, appointed for the purpose of continuing the inquiries relating to the teaching of Science in Elementary Schools	164
Sixth Report of the Committee, consisting of Mr. R. ETHERIDGE, Dr. H. WOODWARD, and Professor T. RUPERT JONES (Secretary), on the Fossil Phyllopora of the Palæozoic Rocks	173
Second Report of the Committee, consisting of Mr. S. BOURNE, Professor F. Y. EDGEWORTH (Secretary), Professor H. S. FOXWELL, Mr. ROBERT GIFFEN, Professor ALFRED MARSHALL, Mr. J. B. MARTIN, Professor J. S. NICHOLSON, Mr. R. H. INGLIS PALGRAVE, and Professor H. SIDGWICK, appointed for the purpose of investigating the best method of ascertaining and measuring Variations in the Value of the Monetary Standard. (Drawn up by Mr. GIFFEN)	181
Report of the Committee, consisting of Mr. S. BOURNE, Professor F. Y. EDGEWORTH (Secretary), Professor H. S. FOXWELL, Mr. ROBERT GIFFEN, Professor ALFRED MARSHALL, Mr. J. B. MARTIN, Professor J. S. NICHOLSON, and Mr. R. H. INGLIS PALGRAVE, appointed for the purpose of inquiring and reporting as to the Statistical Data available for determining the amount of the Precious Metals in use as Money in the principal Countries, the chief forms in which the Money is employed, and the amount annually-used in the Arts. (Drawn up by the Secretary)	219
Fourth Report of the Committee, consisting of Dr. E. B. TYLOR, Dr. G. M. DAWSON, General Sir J. H. LEFROY, Dr. DANIEL WILSON, Mr. R. G. HALIBURTON, and Mr. GEORGE W. BLOXAM (Secretary), appointed for the purpose of investigating and publishing reports on the physical characters, languages, and industrial and social condition of the North-Western Tribes of the Dominion of Canada	233
Report of the Corresponding Societies Committee, consisting of Mr. FRANCIS GALTON (Chairman), Professor A. W. WILLIAMSON, Sir DOUGLAS GALTON, Professor BOYD DAWKINS, Sir RAWSON RAWSON, Dr. J. G. GARSON, Dr. J. EVANS, Mr. J. HOPKINSON, Professor R. MELDOLA (Secretary), Mr. W. WHITAKER, Mr. G. J. SYMONS, General PITT-RIVERS, Mr. W. TOPLEY, Mr. H. G. FORDHAM, and Mr. WILLIAM WHITE	255
Second Report of the Committee, consisting of Sir JOHN LUBBOCK, Dr. JOHN EVANS, Professor BOYD DAWKINS, Dr. ROBERT MUNRO, Mr. PENGELLY, Dr. HENRY HICKS, Professor MELDOLA, Dr. MUIRHEAD, and Mr. JAMES W. DAVIS, appointed for the purpose of ascertaining and recording the localities in the British Islands in which evidences of the existence of Prehistoric Inhabitants of the country are found. (Drawn up by JAMES W. DAVIS) ...	289

Third Report of the Committee, consisting of Sir JOSEPH D. HOOKER, Sir JOHN LUBBOCK, Sir GEORGE NARES, General J. T. WALKER, Sir LEOPOLD MCCLINTOCK, Admiral Sir GEORGE H. RICHARDS, Professor FLOWER, Professor HUXLEY, Dr. SCLATER, Professor MOSELEY, Mr. JOHN MURRAY, General STRACHEY, Sir WILLIAM THOMSON, and Admiral Sir ERASMUS OMMANNEY (Secretary), appointed for the purpose of drawing attention to the desirability of prosecuting further research in the Antarctic Regions ...	316
Report of the Committee, consisting of Dr. ALEX. BUCHAN, Professor MCKENDRICK, Professor CHRYSAL, and Dr. JOHN MURRAY (Secretary), appointed for the purpose of aiding in the maintenance of the establishment of a Marine Biological Station at Granton, Scotland	319
Report of the Committee, consisting of Mr. H. BAUERMAN, Mr. F. W. RUDLER, Mr. J. J. H. TEALL, and Dr. H. J. JOHNSTON-LAVIS, appointed for the investigation of the Volcanic Phenomena of Vesuvius and its neighbourhood. (Drawn up by Dr. H. J. JOHNSTON-LAVIS, M.D., F.G.S., Secretary)	320
Report of the Committee, consisting of Mr. JOHN MURRAY (Secretary), Professor CHRYSAL, Dr. A. BUCHAN, Rev. C. J. STEWARD, the Hon. R. ABERCROMBY, Mr. J. Y. BUCHANAN, Mr. DAVID CUNNINGHAM, Mr. ISAAC ROBERTS, Dr. H. R. MILL, and Professor FITZGERALD, appointed to arrange an investigation of the Seasonal Variations of Temperature in Lakes, Rivers, and Estuaries in various parts of the United Kingdom in co-operation with the local societies represented on the Association	326
Report of the Committee, consisting of Mr. J. W. DAVIS, Mr. W. CASH, Dr. H. HICKS, Mr. G. W. LAMPLUGH, Mr. CLEMENT REID, Dr. H. WOODWARD, and Mr. T. BOYNTON, appointed for the purpose of investigating an ancient Sea-beach near Bridlington Quay. (Drawn up by G. W. LAMPLUGH, Secretary)	328
Report of the Committee, consisting of Professor LANKESTER, Professor MILNES MARSHALL, Mr. SEDGWICK, and Mr. G. H. FOWLER (Secretary), appointed for the purpose of investigating the Development of the Oviduct and connected structures in certain fresh-water Teleostei	338
Third Report of the Committee, consisting of Professors ARMSTRONG, LODGE, Sir WILLIAM THOMSON, Lord RAYLEIGH, FITZGERALD, J. J. THOMSON, SCHUSTER, POYNTING, CRUM BROWN, RAMSAY, FRANKLAND, TILDEN, HARTLEY, S. P. THOMPSON, MCLEOD, ROBERTS-AUSTEN, RÜCKER, REINOLD, CAREY FOSTER, and H. B. DIXON, Captain ABNEY, Drs. GLADSTONE, HOPKINSON, and FLEMING, and Messrs. CROOKES, SHELFORD BIDWELL, W. N. SHAW, J. LARMOR, J. T. BOTTOMLEY, R. T. GLAZEBROOK, J. BROWN, E. J. LOVE, and JOHN M. THOMSON, appointed for the purpose of considering the subject of Electrolysis in its Physical and Chemical Bearings	339
Report of the Committee, consisting of Messrs. W. CARRUTHERS, W. F. R. WELDON, J. G. BAKER, G. M. MURRAY, and W. T. THISELTON-DYER (Secretary), appointed for the purpose of exploring the Flora of the Bahamas.....	361
Second Report of the Committee, consisting of Professors SCHÄFER (Secretary), MICHAEL FOSTER, and LANKESTER and Dr. W. D. HALLIBURTON, appointed for the purpose of investigating the Physiology of the Lymphatic System. (Drawn up by Dr. W. D. HALLIBURTON)	363
Report of the Committee, consisting of Professor T. G. BONNEY, Mr. J. J. H. TEALL, and Professor J. F. BLAKE (Secretary), appointed to investigate the Microscopic Structure of the Older Rocks of Anglesey. (Drawn up by the Secretary)	367
Report of the Committee, consisting of Mr. THISELTON-DYER (Secretary), Mr. CARRUTHERS, Mr. BALL, Professor OLIVER, and Mr. FORBES, appointed for the purpose of continuing the preparation of a Report on our present knowledge of the Flora of China	420
Second Report of the Committee, consisting of Professor FOSTER, Professor	

	Page
BAYLEY BALFOUR, Mr. THISELTON-DYER, Dr. TRIMEN, Professor MARSHALL WARD, Mr. CARRUTHERS, Professor HARTOG, and Professor BOWER (Secretary), appointed for the purpose of taking steps for the establishment of a Botanical Station at Peradeniya, Ceylon.....	421
Eighth Report of the Committee, consisting of Mr. R. ETHERIDGE, Mr. THOMAS GRAY, and Professor JOHN MILNE (Secretary), appointed for the purpose of investigating the Earthquake and Volcanic Phenomena of Japan. (Drawn up by the Secretary)	422
Report of the Committee, consisting of Mr. THISELTON-DYER (Secretary), Professor NEWTON, Professor FLOWER, Mr. CARRUTHERS, and Mr. SCLATER, appointed for the purpose of reporting on the present state of our knowledge of the Zoology and Botany of the West India Islands, and taking steps to investigate ascertained deficiencies in the Fauna and Flora	437
Second Report on our Experimental Knowledge of the Properties of Matter with respect to Volume, Pressure, Temperature, and Specific Heat. By P. T. MAIN, M.A.	465
Report of the Committee, consisting of Sir F. J. BRAMWELL, Mr. E. A. COWPER, Mr. G. J. SYMONS, Professors G. H. DARWIN and EWING, Mr. ISAAC ROBERTS, Mr. THOMAS GRAY, Dr. JOHN EVANS, Professors LEBOUR, PRESTWICH, HULL, MELDOLA, and JUDD, and Mr. J. GLAISHER, appointed for the purpose of considering the advisability and possibility of establishing in other parts of the country observations upon the prevalence of Earth Tremors similar to those now being made in Durham	522
The Relations between Sliding Scales and Economic Theory. By L. L. PRICE, M.A.	523
Index-numbers as illustrating the Progressive Exports of British Produce and Manufactures. By STEPHEN BOURNE, F.S.S.	536
The Friction of Metal Coils. By Professor HELE SHAW and EDWARD SHAW	540
Sur l'application de l'analyse spectrale à la mécanique moléculaire et sur les spectres de l'oxygène. Par Dr. J. JANSSEN	547

TRANSACTIONS OF THE SECTIONS.

SECTION A.--MATHEMATICAL AND PHYSICAL SCIENCE.

THURSDAY, SEPTEMBER 6.

	Page
Address by Professor G. F. FITZGERALD, M.A., F.R.S., President of the Section.....	557
1. Fourth Report of the Committee for promoting Tidal Observations in Canada	562
2. On the Behaviour of Water under great Provocation from Heat. By Professor W. RAMSAY, F.R.S.	562
3. On the Proof of the Logarithmic Law of Atomic Weights. By Dr. G. JOHNSTONE STONEY, F.R.S.	562
4. On the Oscillations of a Rotating Liquid Spheroid and the Genesis of the Moon. By A. E. H. LOVE, B.A.	562
5. Waves in a Viscous Liquid. By A. B. BASSET, M.A.	563
6. On a Hydrostatic Balance. By J. JOLY, M.A., B.E.	564
7. On the Meldometer. By J. JOLY, M.A., B.E.	564
8. Electro-calorimetry. By Professor WILLIAM STROUD, B.A., D.Sc., and W. W. HALDANE GEE, B.Sc.	565
9. On Figures produced by Electric Action on Photographic Dry Plates. By J. BROWN.	565
10. Comparison of Gassner's Dry Cells with Leclanché's. By WM. LANT CARPENTER.	566
11. On the Intensity of Magnetisation of soft Iron Bars of various lengths in a uniform Magnetic Field. By A. TANAKADATÉ.	566

FRIDAY, SEPTEMBER 7.

1. Recent Progress in the Use of Concave Gratings for Spectrum Analysis. By Professor H. A. ROWLAND	566
2. Is the Velocity of Light in an Electrolytic Liquid influenced by an Electric Current in the direction of propagation? By Lord RAYLEIGH, LL.D., Sec. R.S.	566
3. On the Measurement of the Length of Electro-magnetic Waves. By Professor OLIVER J. LODGE, F.R.S.	567
4. On the Impedance of Conductors to Leyden-jar Discharges. By Professor OLIVER J. LODGE, F.R.S.	567

	Page
5. A simple hypothesis for Electro-magnetic Induction of incomplete circuits, with consequent equations of Electric Motion in fixed homogeneous or heterogeneous solid matter. By Professor Sir WILLIAM THOMSON, LL.D., F.R.S.	567
6. On the Transference of Electricity within a Homogeneous Solid Conductor. By Professor Sir WILLIAM THOMSON, LL.D., F.R.S.	570
7. Five Applications of Fourier's Law of Diffusion, illustrated by a Diagram of Curves with Absolute Numerical Values. By Professor Sir WILLIAM THOMSON, LL.D., F.R.S.	571
8. On Flux and Reflux of Water in Open Channels or in Pipes or other Ducts. By Professor JAMES THOMSON, LL.D., F.R.S.	574

SATURDAY, SEPTEMBER 8.

DEPARTMENT FOR LIGHT AND ELECTRICITY.

1. Sur l'application de l'analyse spectrale à la mécanique moléculaire et sur les spectres de l'oxygène. By Dr. J. JANSSEN	576
2. On the Absorption Spectrum of Oxygen. By Professors LIVEING, F.R.S., and DEWAR, F.R.S.....	576
3. The Spectra of Meteorites compared with the Solar Spectrum. By J. NORMAN LOCKYER, F.R.S.	576
4. On the Harmonic Series of Lines in the Spectra of the Elements. By Professor CARL RUNGE	576
5. A Vortex Analogue of Static Electricity. By Professor W. M. HICKS, M.A., F.R.S.	577
6. On a Diffusion Photometer. By J. JOLY, M.A., B.E.	578
7. Third Report of the Committee on Electrolysis.....	578

DEPARTMENT FOR MATHEMATICS AND GENERAL PHYSICS.

1. On Centres of Finite Twist and Stretch. By Professor R. W. GENESE, M.A.	579
2. On Recurring Decimals and Fermat's Theorem. By Professor R. W. GENESE, M.A.	580
3. On the Relations between Orbits, Catenaries, and Curved Rays. By Professor J. D. EVERETT, F.R.S.	581
4. On the Stretching of Liquids. By Professor A. M. WORTHINGTON, M.A., F.R.A.S.	583
5. A new Sphere Planimeter. By Professor HELE SHAW, M.Inst.C.E.	584
6. On Composition of Sensation and Notion of Space. By L. DE LA RIVE... ..	585

MONDAY, SEPTEMBER 10.

1. Third Report of the Committee for inviting Designs for a good Differential Gravity Meter.....	586
2. Fourth Report of the Committee for considering the best means of Comparing and Reducing Magnetic Observations.	586
3. Third Report of the Committee appointed to co-operate with the Scottish Meteorological Society in making Meteorological Observations on Ben Nevis	586

	Page
4. Modern Views about Hurricanes, as compared with the Older Theories. By Hon. RALPH ABERGROMBY, F.R.Met.Soc.	586
5. Report of the Committee appointed to arrange an investigation of the Seasonal Variations of Temperature in Lakes, Rivers, and Estuaries in various parts of the United Kingdom.....	587
6. On the Temperature of some Scottish Rivers. By HUGH ROBERT MILL, D.Sc., F.R.S.E.	588
7. On the recent Magnetic Survey of Japan. By Professor CARGILL G. KNOTT, D.Sc., F.R.S.E.	588
8. On Reading Electrically Meteorological Instruments distant from the Observer. By J. JOLY, M.A., B.E.....	589
9. On the Mechanical Conditions of a Swarm of Meteorites, and on Theories of Cosmogony. By Professor G. H. DARWIN, F.R.S.	590
10. On some accurate Charts of Kew Corrections for Mercury Thermometers. By W. N. SHAW, M.A.	590
11. On an Apparatus for determining Temperature by the Variation of Electrical Resistance. By W. N. SHAW, M.A.....	590
12. Fourth Report of the Committee on Standards of Light.	591

TUESDAY, SEPTEMBER 11.

1. Joint Discussion with Section G on Lightning-conductors	591
2. On the Burning by Lightning of a Magnet on a Generating Dynamo at the Waterfall on the Bush River, County Antrim, belonging to the Giant's Causeway and Portrush Electric Railway and Tramway Company. By ANTHONY TRAILL, LL.D., M.D.	615
3. Analyse chronométrique des Phénomènes électriques lumineux. Par Dr. J. JANSSEN	615
4. Report of the Committee for constructing and issuing Practical Standards for use in Electrical Measurements	616
5. On Standards of Electrical Resistance. By R. T. GLAZEBROOK, F.R.S. ...	616
6. On the C.G.S. Units of Measurement. By W. H. PREECE, F.R.S.	616
7. Electrometric Determination of 'v.' By Professors Sir W. THOMSON, F.R.S., AYRTON, F.R.S., and PERRY, F.R.S.	616

WEDNESDAY, SEPTEMBER 12.

1. Report of the Committee for considering the desirability of introducing a Uniform Nomenclature for the Fundamental Units of Mechanics	616
2. Second Report on our Experimental Knowledge of the Properties of Matter. By P. T. MAIN, M.A.	616
3. On the Mechanical Arrangements of the Analytical Engine of the late Charles Babbage, F.R.S. By Major-General H. P. BABBAGE.....	616
4. On a Modification of Maxwell's Equations of Electromagnetic Waves. By Professor H. A. ROWLAND	617
5. On a Photographic Image of an Electric Arc Lamp, probably due to Phosphorescence in the Eye, and on some Photographs of an Eclipse of the Moon. By FRIESE GREENE	617
6. On the Errors of the Argument of Statistical Tables. By JOSEPH KLEIBER	618

	Page
7. On Geometry of Four Dimensions. By EDWARD T. DIXON	618
8. A Suggestion from the Bologna Academy of Science towards an agreement on the Initial Meridian for the Universal Hour. By Dr. CES. TONDINI DE QUARENGHI	618

SECTION B.—CHEMICAL SCIENCE.

THURSDAY, SEPTEMBER 6.

Address by Professor W. A. TILDEN, D.Sc., F.R.S., F.C.S., President of the Section.....	620
1. Report of the Committee for the investigation of the action of Light on the Hydracids of Halogens in presence of Oxygen	627
2. Second Report of the Committee on the Bibliography of Solution	627
3. Second Report of the Committee for investigating the Nature of Solution	627
4. Second Report of the Committee for investigating the Influence of Silicon on the properties of Steel	627
5. On the Study of Mineralogy. By T. STERRY HUNT, LL.D., F.R.S.	627
6. On the Logarithmic Law and its connection with the Atomic Weights. By Dr. G. JOHNSTONE STONEY, F.R.S.....	630
7. On Dissociation. By the Rev. A. IRVING, D.Sc., B.A.....	630
8. On Closed-chain Formulæ. By J. E. MARSH, B.A.	631
9. On Van't Hoff's Hypothesis and the Constitution of Benzene. By J. E. MARSH, B.A.	631

FRIDAY, SEPTEMBER 7.

1. Discussion on the Chemical Problems presented by Living Bodies, opened by Professor MICHAEL FOSTER, Sec.R.S.....	631
2. On the Atomic Weight of Oxygen. By ALEXANDER SCOTT, M.A., D.Sc., F.R.S.E.	631
3. The Incompleteness of Combustion in Explosions. By Professor H. B. DIXON, F.R.S., and H. W. SMITH, B.Sc.	632
4. A new Gas Analysis Apparatus. By W. W. J. NICOL, M.A., D.Sc.	632
5. The Determination of Vapour-densities at High Temperatures and under Reduced Pressure. By Dr. WILLIAM BOTT, F.C.S.	632
6. On Photographing Hydrogen and Chlorine Bulbs by aid of the Flash of Light which caused their Explosion. By Professor P. PHILLIPS BEDSON, D.Sc.	633
7. On the Formation of Crystals of Calcium Oxide and Magnesium Oxide in the Oxyhydrogen Flame. By J. JOLY, M.A., B.E.	634

SATURDAY, SEPTEMBER 8.

1. Report of the Committee on the present methods of teaching Chemistry...	634
2. Chemistry as a School Subject. By the Rev. A. IRVING, D.Sc., B.A. ...	634

MONDAY, SEPTEMBER 10.

1. Discussion on Valency, opened by Professor H. E. ARMSTRONG, F.R.S. ...	635
2. Evidence of the Tetravalency of Oxygen derived from the Constitution of the Azonaphthol-Compounds. By Professor R. MELDOLA, F.R.S., F.C.S., F.I.C.	635

	Page
3. The Theory of Solution. By T. STERRY HUNT, LL.D., F.R.S.	636
4. The Composition of Copper-Tin Alloys. By A. P. LAURIE.....	637
5. The Composition of the ancient Roman Mortar from the London Wall. By JOHN SPILLER, F.C.S.	637
6. On the Rate of Solution of Copper in Acids. By V. H. VELEY, M.A. ...	638
7. Recovery of the Ammonia and Chlorine in the Ammonia-soda Process. By F. BALE	638

TUESDAY, SEPTEMBER 11.

1. Third Report of the Committee for investigating Isomeric Naphthalene Derivatives	640
2. Note on the Molecular Weight of Caoutchouc and other Colloids. By Dr. J. H. GLADSTONE, F.R.S., and W. HIBBERT, F.I.C.	640
3. On some new Silicon Compounds. By Professor J. EMERSON REYNOLDS, M.D., F.R.S.	640
4. On some new Thiocarbamide Compounds. By Professor J. EMERSON REYNOLDS, M.D., F.R.S.	640
5. Proposed International Standards to control the Analysis of Iron and Steel. By Professor J. W. LANGLEY	640
6. On the Action of Light on Water Colours. By ARTHUR RICHARD- SON, Ph.D.	641
7. Further Researches on the Pyrocresols. By Dr. WILLIAM BOTT, F.C.S., and J. BRUCE MILLER, F.I.C.	642

SECTION C.—GEOLOGY.

THURSDAY, SEPTEMBER 6.

Address by Professor W. BOYD DAWKINS, M.A., F.R.S., F.G.S., F.S.A., President of the Section.....	644
1. Further Note on the Midford Sands. By HORACE B. WOODWARD, F.G.S.	650
2. The Relations of the Great Oolite to the Forest Marble and Fuller's-earth in the South-west of England. By HORACE B. WOODWARD, F.G.S.	651
3. Note on the Portland Sands of Swindon and elsewhere. By HORACE B. WOODWARD, F.G.S.	652
4. On Local Geological Photography. By OSMUND W. JEFFS.....	653
5. Further Notes on the Origin of the Crystalline Schists of Malvern and Anglesey. By CHARLES CALLAWAY, D.Sc., M.A., F.G.S.	653
6. Sketch of the Geology of the Crystalline Axis of the Malvern Hills. By CHARLES CALLAWAY, D.Sc., M.A., F.G.S.	654
7. Archean Characters of the Rocks of the Nucleal Ranges of the Antilles. By Dr. PERSIFOR FRAZER.....	654
8. On a Specimen of Quartz from Australia and Three Specimens of Oligo- clase from North Carolina exhibiting curious Optical Properties. By Dr. PERSIFOR FRAZER	655

FRIDAY, SEPTEMBER 7.

1. Sixteenth Report on the Erratic Blocks of England, Wales, and Ireland...	656
2. On a High Level Boulder-clay in the Midlands. By Dr. H. W. CROSS- KEY, F.G.S.	656

	Page
3. On the Extension of the Bath Oolite under London, as shown by a Deep Boring at Streatham. By W. WHITAKER, B.A., F.R.S.....	656
4. On the Lower Carboniferous Rocks of Gloucestershire. By E. WETHERED, F.G.S., F.C.S., F.R.M.S.	657
5. On the Tytherington and Thornbury Section. By the Rev. H. H. WINWOOD, F.G.S.	658
6. The Northern Section of the Bristol Coal-field. By HANDEL COSSHAM, M.P., F.G.S.	659
7. Some Points of Interest in the Geology of Somerset. By W. A. E. USSHER, F.G.S.	659

SATURDAY, SEPTEMBER 8.

1. Comparison of the principal Forms of Dinosauria of Europe and America. By Professor O. C. MARSH	660
2. The Evolution of the Mammalian Molar Teeth to and from the Tritubercular Type. By HENRY FAIRFIELD OSBORN	660
3. On the Gigantic Size of some extinct Tertiary Mammalia. By Professor A. GAUDRY	660
4. Note on the Relation of the Percentage of Carbonic Acid in the Atmosphere to the Life and Growth of Plants. By the Rev. A. IRVING, D.Sc., B.A., F.G.S.	661
5. On the Occurrence of a Boulder of Granitoid Gneiss or Gneissoid Granite in the Halifax Hard-bed Coal. By JAMES SPENCER. With a Note by Professor T. G. BONNEY.....	661
6. The Caverns of Luray. By the Chevalier R. E. REYNOLDS	662
7. Report on the Rate of Erosion of the Sea-coasts of England and Wales ...	663

MONDAY, SEPTEMBER 10.

1. The Volcanoes of the Two Sicilies. By TEMPEST ANDERSON, M.D., B.Sc.	663
2. Notes on the late Eruption in the island of Vulcano. By TEMPEST ANDERSON, M.D., B.Sc., and H. J. JOHNSTON-LAVIS, M.D., F.G.S.	664
3. Report on the Volcanic Phenomena of Vesuvius and its neighbourhood ...	666
4. On the Conservation of Heat in Volcanic Chimneys. By H. J. JOHNSTON-LAVIS, M.D., F.G.S.	666
5. Note on a Mass containing Metallic Iron found on Vesuvius. By H. J. JOHNSTON-LAVIS, M.D., F.G.S.....	667
6. Note on the Occurrence of Leucite at Etna. By H. J. JOHNSTON-LAVIS, M.D., F.G.S.	669
7. Note on some recent Investigations into the Condition of the Interior of the Earth. By Professor E. W. CLAYPOLE, B.A., D.Sc., F.G.S.	669
8. On the Causes of Volcanic Action. By J. LOGAN LOBLEY, F.G.S.	670
9. Eighth Report on the Earthquake and Volcanic Phenomena of Japan.....	671
10. On the recent Volcanic Structure of the Azorean Archipelago. By OSBERT H. HOWARTH.....	671
11. Report of the Earth Tremor Committee	671

SUB-SECTION C.

	Page
1. The Watcombe Terra-Cotta Clay. By W. A. E. USSHER, F.G.S.	672
2. Second Report on the 'Manure' Gravels of Wexford	672
3. Beds exposed in the Southampton New Dock Excavation. By T. W. SHORE, F.G.S., F.C.S.	672
4. Fossil Arctic Plants from the Lacustrine Deposit at Hoxne, in Suffolk. By CLEMENT REID, F.G.S., and H. N. RIDLEY, M.A., F.L.S.	674
5. Report on an ancient Sea Beach near Bridlington Quay	674
6. On the Origin of Oolitic Texture in Limestone Rocks. By Professor H. G. SEELEY, F.R.S.	674

TUESDAY, SEPTEMBER 11.

1. Notes of some Researches on the Fossil Fishes of Chiavòn, Vicentino (Stratum of Sotzka, Lower Miocene). By Professor FRANCESCO BASSANI	675
2. Sixth Report on the Fossil Phyllopora of the Palæozoic Rocks	677
3. Report of the Committee for investigating the Flora of the Carboniferous Rocks of Lancashire and West Yorkshire	677
4. On an <i>Ichthyosaurus</i> from Mombasa, East Africa, with Observations on the Vertebral Characters of the Genus. By Professor H. G. SEELEY, F.R.S.	677
5. A Comparison of the Cretaceous Fish-fauna of Mount Lebanon with that of the English Chalk. By A. SMITH WOODWARD, F.G.S., F.Z.S.	678
6. On <i>Bucklandium diluvii</i> , König, a Siluroid Fish from the London Clay of Sheppey. By A. SMITH WOODWARD, F.G.S., F.Z.S.	679
7. On the Origin of Graphite in the Archæan Rocks, with a Review of the alleged Evidence of Life on the Earth in Archæan Time. By the Rev. A. IRVING, D.Sc., B.A., F.G.S.	679
8. On some Devonian Cephalopods and Gasteropods. By the Rev. G. F. WHIDBORNE, M.A., F.G.S.	680
9. On some Devonian Crustaceans. By the Rev. G. F. WHIDBORNE, M.A., F.G.S.	681
10. On some Fossils of the Limestones of South Devon. By the Rev. G. F. WHIDBORNE, M.A., F.G.S.	681

SUB-SECTION C.

1. Mineralogical Evolution. By T. STERRY HUNT, LL.D., F.R.S.	682
2. Report on the Microscopic Structure of the Older Rocks of Anglesey.....	684
3. On a probable Cause of Contortions of Strata. By CHARLES RICKETTS, M.D., F.G.S.	684
4. On the Temperature at which Beryl is decolorised. By J. JOLY, M.A., B.E.	684
5. On the Occurrence of Iolite in the Granite of County Dublin. By J. JOLY, M.A., B.E.	685
6. An Igneous Succession in Shropshire. By W. W. WATTS, M.A., F.G.S.	685
7. Fourteenth Report on the Circulation of Underground Waters.....	685
8. A List of Works referring to British Mineral and Thermal Waters. By W. H. DALTON.	685

SECTION D.—BIOLOGY.

THURSDAY, SEPTEMBER 6.

	Page
Address by W. T. THISELTON-DYER, C.M.G., M.A., B.Sc., F.R.S., F.L.S., President of the Section.....	686
1. Report of the Committee for exploring the Flora of the Bahamas	701
2. Second Report of the Committee for taking steps for the establishment of a Botanical Station at Peradeniya, Ceylon.....	701
3. Report of the Committee for continuing the preparation of a Report on our present knowledge of the Flora of China	701
4. A Lily Disease. By Professor H. MARSHALL WARD, F.R.S.	702
5. On the Morphology of the Pitcher of <i>Nepenthes</i> . By Professor BOWER, F.L.S.	702
6. On <i>Adelphotaxy</i> : an undescribed Form of Irritability. By Professor MARCUS M. HARTOG, D.Sc., M.A.....	702

ZOOLOGICAL DEPARTMENT.

1. Report of the Committee for reporting on the present state of our know- ledge of the Zoology and Botany of the West India Islands, and taking steps to investigate ascertained deficiencies in the Fauna and Flora	702
2. Report of the Committee to arrange for the occupation of a Table at the Zoological Station at Naples	703
3. Report of the Committee for making arrangements for assisting the Marine Biological Association Laboratory at Plymouth.....	703
4. Report of the Committee for continuing the Researches on Food-Fishes at the St. Andrews Marine Laboratory	703
5. Report of the Committee on the Migration of Birds	703
6. On the Irruption of <i>Syrrhaptes paradoxus</i> . By Professor NEWTON, M.A., F.R.S.	703
7. Remarks on some Teleostean Ova, and their Development. By J. T. CUNNINGHAM, B.A., F.R.S.E.	703

FRIDAY, SEPTEMBER 7.

PHYSIOLOGICAL DEPARTMENT.

1. On the Physiological Bearing of Waist-belts and Stays. By Professor ROY, M.D., F.R.S., and J. G. ADAMI, M.A.	704
---	-----

ZOOLOGICAL DEPARTMENT.

1. Some Remarks on the Instincts of Solitary Wasps and Bees. By Sir JOHN LUBBOCK, Bart., F.R.S.	706
2. Restoration of <i>Brontops Robustus</i> , from the Miocene of America. By Professor O. C. MARSH, Ph.D., LL.D.	706
3. Heredity in Cats with an extra Number of Toes. By E. B. POULTON, M.A.	707
4. On the Nature of the Geological Terrain as an important factor in the Geographical Distribution of Animals. By HANS GADOW, M.A., Ph.D....	707
5. On the Natural History of Christmas Island. By J. J. LISTER, M.A., F.Z.S.	708

MONDAY, SEPTEMBER 10.

	Page
1. Report of the Committee for aiding in the maintenance of the establishment of a Marine Biological Station at Granton, Scotland	710
2. Report of the Committee on the Development of the Oviduct in certain fresh-water Teleostei	710
3. On certain Adaptations for the Nutrition of Embryos. By F. W. OLIVER.....	710
4. On the Development of the Bulb in <i>Laminaria bulbosa</i> . By C. A. BARBER	710
5. On <i>Pachytheca</i> , a Silurian Alga of doubtful Affinities. By C. A. BARBER	711
6. On the Plant-remains discovered by Mr. W. M. Flinders Petrie in the Cemetery of Hawara, Lower Egypt. By PERCY E. NEWBERRY.....	712
7. Abnormal Ferns, Hybrids, and their Parents. By E. J. LOWE, F.R.S., and Colonel JONES	713
8. Preliminary Note on the Functions and Homologies of the Contractile Vacuole in Plants and Animals. By Professor MARCUS M. HARTOG, D.Sc., M.A.	714
9. On the Contrivances for the Seed Protection and Distribution in <i>Blumenbachia Hieronymi</i> , Urban. By W. GARDINER	716

ZOOLOGICAL DEPARTMENT.

1. On Locusts in Cyprus. By S. BROWN	716
2. On the Fauna of the Firth of Clyde. By W. E. HOYLE, M.A.	717
3. On a Deep-sea Tow Net. By W. E. HOYLE, M.A.	717
4. On some Points in the Natural History of the Coral Fungia. By J. J. LISTER, M.A., F.Z.S.	717
5. On the Echinodermata of the Sea of Bengal. By Professor F. JEFFREY BELL, M.A., Sec. R.M.S.	718

TUESDAY, SEPTEMBER 11.

1. Discussion on Coral Reefs	718
2. Second Report of the Committee on the Physiology of the Lymphatic System.....	723
3. Contributions to the Anatomy of the Tubificidæ. By F. E. BEDDARD, M.A., F.Z.S.	723
4. On the Flora of Madagascar. By the Rev. R. BARON	724
5. On the Effects of the Weather of 1888 on the Animal and Vegetable Kingdoms. By E. J. LOWE, F.R.S.	726
6. The Odoriferous Apparatus of the <i>Blaps mortisaga</i> (Coleoptera). By Professor GUSTAVE GILSON	727
7. Report of the Committee on Provincial Museums	728
8. The effect of various substances (chiefly members of the aromatic series of organic compounds) upon the rate of secretion and constitution of the Bile. By W. J. COLLINS, M.D., M.S., B.Sc. (Lond.), F.R.C.S.	728

SECTION E.—GEOGRAPHY.

THURSDAY, SEPTEMBER 6.

	Page
Address by Colonel Sir C. W. WILSON, R.E., K.C.B., K.C.M.G., D.C.L., F.R.S., F.R.G.S., President of the Section	729
1. Le Canal de Panama. Par F. DE LESSEPS	738
2. Meteorological Conditions of the Red Sea. By Lieut.-General STRACHEY, F.R.S.	738
3. Sea Temperatures in the neighbourhood of Cape Guardafui. By Lieut.- General STRACHEY, F.R.S.	738
4. The Salinity of the Clyde Sea Area. By HUGH ROBERT MILL, D.Sc., F.R.S.E.	738
5. Sea Temperatures on the Continental Shelf. By HUGH ROBERT MILL, D.Sc., F.R.S.E.	739
6. Perspective Maps and Common Maps. By ARTHUR W. CLAYDEN, M.A., F.G.S.	740
7. 'Little Russia.' By E. DELMAR MORGAN, F.R.G.S.	740
8. Third Report of the Committee appointed for the purpose of drawing attention to the desirability of prosecuting further research in the Ant- arctic Regions.....	741

FRIDAY, SEPTEMBER 7.

1. Explorations on the Chindwin River, Upper Burmah, in 1886-87. By Colonel WOODTHORPE, R.E.	741
2. A new Route from India to Tibet. By Captain W. J. ELWES	741
3. Russian Topographical Surveys. By E. DELMAR MORGAN, F.R.G.S.....	741
4. Notes on the Geography of the Region from the Nile to the Euphrates as known to the ancient Egyptians. By the Rev. HENRY GEORGE TOMKINS	741
5. Remarks on Mr. Tomkins's Paper. By Major CONDER, R.E.	743
6. Recent Explorations East of the Jordan. By Captain A. M. MANTELL, R.E.....	743
7. Jerusalem: Nehemiah's Wall and the Royal Sepulchres. By GEORGE ST. CLAIR, F.G.S.	744

MONDAY, SEPTEMBER 10.

1. Tunis since the French Protectorate. By Colonel Sir LAMBERT PLAYFAIR, K.C.M.G.....	745
2. The Commercial Future of Central Africa. By Colonel Sir FRANCIS DE WINTON	745
3. Bechuanaland and the Land of Ophir. By the Rev. JOHN MACKENZIE ...	745
4. The Transvaal, or South African Republic. By P. H. FORD	745
5. The Cameroons. By H. H. JOHNSTON	745
6. Dr. Livingstone and Lake Bangweolo. By E. G. RAVENSTEIN	745
7. Notes from the Atlas Mountains. By Jos. THOMSON	745
8. Akkas and Dwarfs in Southern Morocco. By R. G. HALIBURTON	745
9. Through Kakongo. By Q. E. DENNETT	745

TUESDAY, SEPTEMBER 11.

	Page
1. Photographic and Photozincographic Processes employed in the Ordnance Survey. By Colonel J. H. BOLLAND, R.E.	746
2. Note on Geographical Terminology. By H. J. MACKINDER, M.A.	746
3. The River of Joseph, the Fayum and Raian Basins. By COPE WHITEHOUSE, M.A.	746
4. Mission to El-Wedj. By Captain CONYERS SURTEES	747
5. Notes on Topographic Maps produced by the United States Geological Survey. By G. K. GILBERT.	747
6. On Pahang, an Independent State in the Malayan Peninsula. By W. BARRINGTON D'ALMEIDA	747
7. Formosa: Characteristic Traits of the Island and its Aboriginal Inhabitants. By GEORGE TAYLOR	747
8. On the general adoption of the Gregorian Calendar in relation with that of the universal hour. By Dr. C.ES. TONDI NI DE QUARENGHI	747

SECTION F.—ECONOMIC SCIENCE AND STATISTICS.

THURSDAY, SEPTEMBER 6.

Address by The Right Hon. Lord BRAMWELL, LL.D., F.R.S., F.S.S., President of the Section.	749
1. On Mining Royalties and their effect on the Iron and Coal Industries. By Professor W. R. SORLEY.	755
2. The Relations between Sliding Scales and Economic Theory. By L. L. PRICE, M.A.	757
3. On Wage Statistics and Theories. By JAMES MAJOR	757
4. The Growth of American Industries and Wealth. By MICHAEL GEORGE MULHALL, F.S.S.	757
5. Somersetshire Cider. By JOHN HIGGINS	759
6. Agricultural, Commercial, Industrial, and Banking Statistics. By WM. BOTLY, M.R.A.S.E.	760

FRIDAY, SEPTEMBER 7.

1. An Analysis of the Current Conception of State Socialism. By Professor HENRY SIDGWICK, M.A.	760
2. The Transition to Social Democracy. By G. BERNARD SHAW.	761
3. The Tendency of Competition to result in Monopoly. By Professor FOXWELL	762
4. Associative Economics applied to Colonisation. By W. L. REES	762
5. On the Statistics of Examination. By Professor F. Y. EDGEWORTH, M.A., F.S.S.	763

SATURDAY, SEPTEMBER 8.

1. The Revenue System of the United States. By ALBERT SHAW, Ph.D. ...	763
2. On the Distribution of the Licences proposed to be transferred in aid of Local Expenditure. By R. H. INGLIS PALGRAVE, F.R.S., F.S.S.	764

	Page
3. The Standard, or Basis, of Taxation. By CLAIR J. GRECE, LL.D.....	765
4. The Suitability of Small Towns for Factory Industries. By RUSSELL R. TANNER	767

MONDAY, SEPTEMBER 10.

1. Second Report of the Committee on the method of ascertaining and measuring Variations in the Value of the Monetary Standard	767
2. Index-numbers as illustrating the Progressive Exports of British Produce and Manufactures. By STEPHEN BOURNE, F.S.S.....	767
3. Report of the Committee on the Statistical Data available for determining the amount of the Precious Metals in use as Money in the principal Countries, the chief forms in which the Money is employed, and the amount annually used in the Arts	767
4. An Examination into the Reasons of the Price of Wheat rising or falling contemporaneously with the Variation in the Value of Foreign Currencies. By W. J. HARRIS, F.S.S.	767
5. The Effects on Indian Exports of the Fall in the Gold Price of Silver. By L. C. PROBYN	768
6. On Stigigrams, with some suggestions for Greater Uniformity in Comparative Graphics. By the Rev. J. F. HEYES, M.A., F.C.S., F.R.G.S. ...	769
7. Reasons for a Quinquennial Census. By G. B. LONGSTAFF, M.A., M.B., F.R.C.P.	769

TUESDAY, SEPTEMBER 11.

1. Leasehold Enfranchisement. By CHARLES HARRISON	770
2. Report of the Committee for continuing the inquiries relating to the teaching of Science in Elementary Schools	771
3. The Industrial Education of Women abroad and at home. By E. J. WATHERSTON	771
4. Irishwomen's Industries. By Miss HELEN BLACKBURN	772
5. Education: a Chapter of Economics. By T. W. DUNN, M.A.	773
6. L'organisation et la statistique de l'enseignement technique secondaire en Italie. By Signor BONGHI	774
7. Agricultural Education. By Professor JAMES LONG	776
8. Economy in Education and in Writing. By EIZAK PITMAN	776

WEDNESDAY, SEPTEMBER 12.

1. The Malthusian Theory. By EDWIN CHADWICK, C.B.	777
2. Dairy Industry. By GEORGE GIBBONS	778
3. Amendments founded on Experiences submitted for the Local Government Bill. By EDWIN CHADWICK, C.B.	779
4. The Vital and Commercial Statistics of Bath. By F. NORFOLK	780
5. Old Age and Sickness Assurance for the Mercantile and Professional Classes. By F. NORFOLK	780

SECTION G.—MECHANICAL SCIENCE.

THURSDAY, SEPTEMBER 6.

	Page
Address by W. H. PREECE, F.R.S., M.Inst.C.E., President of the Section.....	781
1. The Phonograph. By Colonel G. E. GOUBAUD	792
2. The Graphophone. By HENRY EDMUNDS	792
3. Mechanical Pathology considered in its relation to Bridge Design. By G. H. THOMSON, M.Am.S.E.....	793
4. A few Arguments in favour of Light or Road Railways. By THOS. STEPHEN P. W. D'ALTE SELLON, Assoc.M.Inst.C.E.....	794

FRIDAY, SEPTEMBER 7.

1. The Barry Docks. By JOHN WOLFE BARRY, M.Inst.C.E.	795
2. Plant and Machinery in use on the Manchester Ship Canal. By LIONEL B. WELLS, M.Inst.C.E.	796
3. On an improved Canal Lift. By S. LLOYD.....	797
4. On the Replenishment of the Underground Waters of the Permeable Formations of England. By J. BAILEY DENTON, M.Inst.C.E., F.G.S. ...	797
5. The Raiyān Project for the Storage of Nile Flood. By COPE WHITEHOUSE, M.A.	799
6. The Severn Watershed. By J. W. WILLIS BUND	799

SATURDAY, SEPTEMBER 8.

1. On Rolling Seamless Tubes from Solid Bars or Ingots, by the Mannesmann Process. By FREDERICK SIEMENS	804
2. Gaseous Fuel. By J. EMERSON DOWSON, M.Inst.C.E.	805
3. The Shipman Engine. By W. R. PIDGEON, M.A.....	806
4. On the Disengaging of Boats, &c. By E. J. HILL.....	807
5. The old Orkney Click Mill. By Professor A. JAMIESON, M.Inst.C.E.....	807

MONDAY, SEPTEMBER 10.

1. On the application of Electricity to the working of a 20-ton Travelling Crane. By W. ANDERSON, M.Inst.C.E.	808
2. On recent Developments of the Cowles Aluminium Process. By R. E. CROMPTON	809
3. Electric Lighting in America. By Professor GEORGE FORBES, F.R.S. ...	813
4. On a System of Electrical Distribution. By HENRY EDMUNDS	813
5. The Measurement of Electricity in a House to House Supply. By W. LOWRIE	814
6. Electric Light applied to Night Navigation upon the Suez Canal. By R. PERCY SELLON	814
7. Electricity as applied to Mining. By FRANK BRAIN	815
8. Miners' Electric Safety Lamps. By NICHOLAS WATTS, Assoc.M.Inst.C.E.	816
9. On an Automatic Fire-damp Detector. By JOSEPH WILSON SWAN, M.A.	817

TUESDAY, SEPTEMBER 11.

	Page
1. An improved Seismograph. By E. A. COWPER, M.Inst.C.E.	818
2. The Friction of Metal Coils. By Professor H. S. HELE SHAW and E. SHAW	819
3. Steam Engine Diagrams. By M. F. FITZGERALD	819
4. The Efficiency of Steam at High Pressures and the Carnot Theorem. By W. WORBY BEAUMONT, M.Inst.C.E.	820
5. Revolving Sails, or Air-propellers. By H. C. VOGT	820
6. A new Sphere Planimeter. By Professor H. S. HELE SHAW	821

WEDNESDAY, SEPTEMBER 12.

1. Underground Railway Communication in great Cities. By Colonel ROWLAND R. HAZARD	821
2. Transmission of Motion and Power. By J. WALTER PEARSE.....	823
3. An Annual Winding Clock, with Torsion Pendulum. By W. H. DOUGLAS	823
4. A new form of Air-compressor for Variable Pressures. By H. DAVEY, M.Inst.C.E.	824
5. On controlling the direction of Rotation of a Dynamo. By A. WINTER...	824

SECTION H.—ANTHROPOLOGY.

THURSDAY, SEPTEMBER 6.

Address by Lieut.-General PITT-RIVERS, D.C.L., F.R.S., F.G.S., F.S.A., President of the Section	825
1. Report of the Committee for investigating the effects of different occupations and employments on the Physical Development of the Human Body	836
2. Second Report of the Committee for ascertaining and recording the localities in the British Islands in which evidences of the existence of Pre-historic Inhabitants of the country are found	836
3. The Constitutional Characteristics of those who dwell in large Towns, as relating to Degeneracy of Race. By G. B. BARRON, M.D., L.R.C.S.E., M.R.C.S., Hon. Surgeon-Major.....	836
4. The Physique of the Swiss as influenced by Race and by Media. By Dr. BEDDOE, F.R.S., V.P.A.I.	837
5. On Colour-blindness. By KARL GROSSMANN, M.D.....	838

FRIDAY, SEPTEMBER 7.

1. On Human Bones discovered by General Pitt-Rivers at Woodcuts, Rotherley, &c. By Dr. BEDDOE, F.R.S.....	839
2. Human Remains from Wiltshire. By J. G. GARSON, M.D., V.P.A.I.....	839
3. On a Method of investigating the Development of Institutions; applied to Laws of Marriage and Descent. By EDWARD B. TYLOR, F.R.S.	840
4. Australian Message-sticks and Messengers. By A. W. HOWITT, F.G.S ...	842
5. Social Regulations in Melanesia. By the Rev. R. H. CODRINGTON, D.D.	843

Page

6. On the Funeral Rites and Ceremonies of the Nicobar Islanders. By E. H. MAN 844
7. Notes on the Shell-Mounds and Ossuaries of the Choptank River, Maryland, U.S.A. By the Chevalier R. ELMER REYNOLDS 845

SATURDAY, SEPTEMBER 8.

1. Marriage Customs of the New Britain Group. By the Rev. BENJAMIN DANKS 847
2. Totem Clans and Star Worship. By GEORGE ST. CLAIR, F.G.S. 848
3. The Survival of Corporal Penance. By OSBERT H. HOWARTH..... 849
4. Notes on Chest-types. By Dr. G. W. HAMBLETON 849
5. Third Report of the Committee for investigating the Prehistoric Race in the Greek Islands 849
6. Fourth Report of the Committee for investigating and publishing reports on the physical characters, languages, and industrial and social condition of the North-Western Tribes of the Dominion of Canada..... 849

MONDAY, SEPTEMBER 10.

1. Necklaces in relation to Prehistoric Commerce. By Miss A. W. BUCKLAND 849
2. The Definition of a Nation. By J. PARK HARRISON, M.A. 850
3. Sun-myths in Modern Hellas. By J. THEODORE BENT..... 850
4. The Ancient Inhabitants of the Canary Islands. By J. HARRIS STONE, M.A., F.L.S., F.C.S. 851
5. Some Account of the Ancient (præ-Roman) Stronghold of Worlebury, near Weston-super-Mare. By the Rev. HENRY GEORGE TOMKINS 851
6. Celtic Earthworks in Hampshire, in reference to the Density of the Celtic Population. By T. W. SHORE, F.G.S., F.C.S. 852

TUESDAY, SEPTEMBER 11.

1. The Monument known as 'King Orry's Grave' compared with Tumuli in Gloucestershire. By Miss A. W. BUCKLAND..... 854
2. Observations made in the Anthropometric Laboratory at Manchester. By GEORGE W. BLOXAM, M.A., and J. G. GARSON, M.D. 854
3. On the Early Races of Western Asia. By Major C. R. CONDER, R.E. ... 855
4. Discoveries in Asia Minor. By J. THEODORE BENT 856
5. Notes on the Hyksôs or Shepherd-Kings of Egypt. By the Rev. HENRY GEORGE TOMKINS 856
6. Pelasgians, Etruscans, and Iberians; their relations to the Founders of the Chaldean and Egyptian Civilisations. By J. S. STUART GLENNIE, M.A..... 857

APPENDIX.

	Page
A List of Works referring to British Mineral and Thermal Waters. By W. H. DALTON, F.G.S.	859
Report of the Committee, consisting of Mr. R. B. GRANTHAM, Major- General Sir A. CLARKE, Sir J. N. DOUGLASS, Capt. Sir G. NARES, Admiral Sir E. OMMANNEY, Capt. J. PARSONS, Capt. W. J. L. WHARTON, Professor J. PRESTWICH, Messrs. C. E. DE RANCE, E. EASTON, J. B. REDMAN, W. TOPLEY, J. S. VALENTINE, L. F. VERNON-HARCOURT, W. WHITAKER, and J. W. WOODALL, appointed for the purpose of inquiring into the Rate of Erosion of the Sea-coasts of England and Wales, and the Influ- ence of the Artificial Abstraction of Shingle or other material in that Action. C. E. DE RANCE and W. TOPLEY, Secretaries. (The Report edited by W. TOPLEY)	898
INDEX	935

LIST OF PLATES.

PLATE I.

Illustrating the Report of the Committee for constructing and issuing Practical Standards for use in Electrical Measurements.

PLATES II., III., IV., AND V.

Illustrating the Report of the Committee for investigating the Microscopical Structure of the Older Rocks of Anglesey.

OBJECTS AND RULES

OF

THE ASSOCIATION.



OBJECTS.

THE ASSOCIATION contemplates no interference with the ground occupied by other institutions. Its objects are:—To give a stronger impulse and a more systematic direction to scientific inquiry,—to promote the intercourse of those who cultivate Science in different parts of the British Empire, with one another and with foreign philosophers,—to obtain a more general attention to the objects of Science, and a removal of any disadvantages of a public kind which impede its progress.

RULES.

Admission of Members and Associates.

All persons who have attended the first Meeting shall be entitled to become Members of the Association, upon subscribing an obligation to conform to its Rules.

The Fellows and Members of Chartered Literary and Philosophical Societies publishing Transactions, in the British Empire, shall be entitled, in like manner, to become Members of the Association.

The Officers and Members of the Councils, or Managing Committees, of Philosophical Institutions shall be entitled, in like manner, to become Members of the Association.

All Members of a Philosophical Institution recommended by its Council or Managing Committee shall be entitled, in like manner, to become Members of the Association.

Persons not belonging to such Institutions shall be elected by the General Committee or Council, to become Life Members of the Association, Annual Subscribers, or Associates for the year, subject to the approval of a General Meeting.

Compositions, Subscriptions, and Privileges.

LIFE MEMBERS shall pay, on admission, the sum of Ten Pounds. They shall receive *gratuitously* the Reports of the Association which may be published after the date of such payment. They are eligible to all the offices of the Association.

ANNUAL SUBSCRIBERS shall pay, on admission, the sum of Two Pounds, and in each following year the sum of One Pound. They shall receive

gratuitously the Reports of the Association for the year of their admission and for the years in which they continue to pay *without intermission* their Annual Subscription. By omitting to pay this subscription in any particular year, Members of this class (Annual Subscribers) *lose for that and all future years* the privilege of receiving the volumes of the Association *gratis*: but they may resume their Membership and other privileges at any subsequent Meeting of the Association, paying on each such occasion the sum of One Pound. They are eligible to all the Offices of the Association.

ASSOCIATES for the year shall pay on admission the sum of One Pound. They shall not receive *gratuitously* the Reports of the Association, nor be eligible to serve on Committees, or to hold any office.

The Association consists of the following classes:—

1. Life Members admitted from 1831 to 1845 inclusive, who have paid on admission Five Pounds as a composition.

2. Life Members who in 1846, or in subsequent years, have paid on admission Ten Pounds as a composition.

3. Annual Members admitted from 1831 to 1839 inclusive, subject to the payment of One Pound annually. [May resume their Membership after intermission of Annual Payment.]

4. Annual Members admitted in any year since 1839, subject to the payment of Two Pounds for the first year, and One Pound in each following year. [May resume their Membership after intermission of Annual Payment.]

5. Associates for the year, subject to the payment of One Pound.

6. Corresponding Members nominated by the Council.

And the Members and Associates will be entitled to receive the annual volume of Reports, *gratis*, or to *purchase* it at reduced (or Members') price, according to the following specification, viz.:—

1. *Gratis*.—Old Life Members who have paid Five Pounds as a composition for Annual Payments, and previous to 1845 a further sum of Two Pounds as a Book Subscription, or, since 1845, a further sum of Five Pounds.

New Life Members who have paid Ten Pounds as a composition.
Annual Members *who have not intermitted* their Annual Subscription.

2. *At reduced or Members' Price*, viz., two-thirds of the Publication Price.—Old Life Members who have paid Five Pounds as a composition for Annual Payments, but no further sum as a Book Subscription.

Annual Members who have intermitted their Annual Subscription.
Associates for the year. [Privilege confined to the volume for that year only.]

3. Members may purchase (for the purpose of completing their sets) any of the volumes of the Reports of the Association up to 1874, of which more than 15 copies remain, at 2s. 6d. per volume.¹

Application to be made at the Office of the Association, 22 Albemarle Street, London, W.

Volumes not claimed within two years of the date of publication can only be issued by direction of the Council.

Subscriptions shall be received by the Treasurer or Secretaries.

¹ A few complete sets, 1831 to 1874, are on sale, at £10 the set.

Meetings.

The Association shall meet annually, for one week, or longer. The place of each Meeting shall be appointed by the General Committee two years in advance; and the arrangements for it shall be entrusted to the Officers of the Association.

General Committee.

The General Committee shall sit during the week of the Meeting, or longer, to transact the business of the Association. It shall consist of the following persons:—

CLASS A. PERMANENT MEMBERS.

1. Members of the Council, Presidents of the Association, and Presidents of Sections for the present and preceding years, with Authors of Reports in the Transactions of the Association.

2. Members who by the publication of Works or Papers have furthered the advancement of those subjects which are taken into consideration at the Sectional Meetings of the Association. *With a view of submitting new claims under this Rule to the decision of the Council, they must be sent to the Secretary at least one month before the Meeting of the Association. The decision of the Council on the claims of any Member of the Association to be placed on the list of the General Committee to be final.*

CLASS B. TEMPORARY MEMBERS.¹

1. Delegates nominated by the Corresponding Societies under the conditions hereinafter explained. *Claims under this Rule to be sent to the Secretary before the opening of the Meeting.*

2. Office-bearers for the time being, or delegates, altogether not exceeding three, from Scientific Institutions established in the place of Meeting. *Claims under this Rule to be approved by the Local Secretaries before the opening of the Meeting.*

3. Foreigners and other individuals whose assistance is desired, and who are specially nominated in writing, for the Meeting of the year, by the President and General Secretaries.

4. Vice-Presidents and Secretaries of Sections.

*Organizing Sectional Committees.*²

The Presidents, Vice-Presidents, and Secretaries of the several Sections are nominated by the Council, and have power to act until their names are submitted to the General Committee for election.

From the time of their nomination they constitute Organizing Committees for the purpose of obtaining information upon the Memoirs and Reports likely to be submitted to the Sections,³ and of preparing Reports

¹ Revised by the General Committee, 1884.

² Passed by the General Committee, Edinburgh, 1871.

³ *Notice to Contributors of Memoirs.*—Authors are reminded that, under an arrangement dating from 1871, the acceptance of Memoirs, and the days on which they are to be read, are now as far as possible determined by Organizing Committees for the several Sections *before the beginning of the Meeting.* It has therefore become necessary, in order to give an opportunity to the Committees of doing justice to the

thereon, and on the order in which it is desirable that they should be read, to be presented to the Committees of the Sections at their first meeting. The Sectional Presidents of former years are *ex officio* members of the Organizing Sectional Committees.¹

An Organizing Committee may also hold such preliminary meetings as the President of the Committee thinks expedient, but shall, under any circumstances, meet on the first Wednesday of the Annual Meeting, at 11 A.M., to nominate the first members of the Sectional Committee, if they shall consider it expedient to do so, and to settle the terms of their report to the General Committee, after which their functions as an Organizing Committee shall cease.²

*Constitution of the Sectional Committees.*³

On the first day of the Annual Meeting, the President, Vice-Presidents, and Secretaries of each Section having been appointed by the General Committee, these Officers, and those previous Presidents and Vice-Presidents of the Section who may desire to attend, are to meet, at 2 P.M., in their Committee Rooms, and enlarge the Sectional Committees by selecting individuals from among the Members (not Associates) present at the Meeting whose assistance they may particularly desire. The Sectional Committees thus constituted shall have power to add to their number from day to day.

The List thus formed is to be entered daily in the Sectional Minute-Book, and a copy forwarded without delay to the Printer, who is charged with publishing the same before 8 A.M. on the next day in the Journal of the Sectional Proceedings.

Business of the Sectional Committees.

Committee Meetings are to be held on the Wednesday at 2 P.M., on the following Thursday, Friday, Saturday,⁴ Monday, and Tuesday, from 10 to 11 A.M., punctually, for the objects stated in the Rules of the Association, and specified below.

The business is to be conducted in the following manner:—

1. The President shall call on the Secretary to read the minutes of the previous Meeting of the Committee.
- 2 No paper shall be read until it has been formally accepted by the

several Communications, that each Author should prepare an Abstract of his Memoir, of a length suitable for insertion in the published Transactions of the Association, and that he should send it, together with the original Memoir, by book-post, on or before....., addressed thus—'General Secretaries, British Association, 22 Albemarle Street, London, W. For Section'. If it should be inconvenient to the Author that his paper should be read on any particular days, he is requested to send information thereof to the Secretaries in a separate note. Authors who send in their MSS. three complete weeks before the Meeting, and whose papers are accepted, will be furnished, before the Meeting, with printed copies of their Reports and Abstracts. No Report, Paper, or Abstract can be inserted in the Annual Volume unless it is handed either to the Recorder of the Section or to the Secretary, before the conclusion of the Meeting.

¹ Added by the General Committee, Sheffield, 1879.

² Revised by the General Committee, Swansea, 1880.

³ Passed by the General Committee, Edinburgh, 1871.

⁴ The meeting on Saturday was made optional by the General Committee at Southport, 1883.

Committee of the Section, and entered on the minutes accordingly.

3. Papers which have been reported on unfavourably by the Organizing Committees shall not be brought before the Sectional Committees.¹

At the first meeting, one of the Secretaries will read the Minutes of last year's proceedings, as recorded in the Minute-Book, and the Synopsis of Recommendations adopted at the last Meeting of the Association and printed in the last volume of the Transactions. He will next proceed to read the Report of the Organizing Committee.² The list of Communications to be read on Thursday shall be then arranged, and the general distribution of business throughout the week shall be provisionally appointed. At the close of the Committee Meeting the Secretaries shall forward to the Printer a List of the Papers appointed to be read. The Printer is charged with publishing the same before 8 A.M. on Thursday in the Journal.

On the second day of the Annual Meeting, and the following days, the Secretaries are to correct, on a copy of the Journal, the list of papers which have been read on that day, to add to it a list of those appointed to be read on the next day, and to send this copy of the Journal as early in the day as possible to the Printer, who is charged with printing the same before 8 A.M. next morning in the Journal. It is necessary that one of the Secretaries of each Section (generally the Recorder) should call at the Printing Office and revise the proof each evening.

Minutes of the proceedings of every Committee are to be entered daily in the Minute-Book, which should be confirmed at the next meeting of the Committee.

Lists of the Reports and Memoirs read in the Sections are to be entered in the Minute-Book daily, which, with *all Memoirs and Copies or Abstracts of Memoirs furnished by Authors, are to be forwarded, at the close of the Sectional Meetings, to the Secretary.*

The Vice-Presidents and Secretaries of Sections become *ex officio* temporary Members of the General Committee (*vide p. xxxiii*), and will receive, on application to the Treasurer in the Reception Room, Tickets entitling them to attend its Meetings.

The Committees will take into consideration any suggestions which may be offered by their Members for the advancement of Science. They are specially requested to review the recommendations adopted at preceding Meetings, as published in the volumes of the Association and the communications made to the Sections at this Meeting, for the purposes of selecting definite points of research to which individual or combined exertion may be usefully directed, and branches of knowledge on the state and progress of which Reports are wanted; to name individuals or Committees for the execution of such Reports or researches; and to state whether, and to what degree, these objects may be usefully advanced by the appropriation of the funds of the Association, by application to Government, Philosophical Institutions, or Local Authorities.

In case of appointment of Committees for special objects of Science, it is expedient that *all Members of the Committee should be named, and one of them appointed to act as Chairman, who shall have notified personally*

¹ These rules were adopted by the General Committee, Plymouth, 1877.

² This and the following sentence were added by the General Committee, Edinburgh, 1871.

or in writing his willingness to accept the office, the Chairman to have the responsibility of receiving and disbursing the grant (if any has been made) and securing the presentation of the Report in due time; and, further, it is expedient that one of the members should be appointed to act as Secretary, for insuring attention to business.

That it is desirable that the number of Members appointed to serve on a Committee should be as small as is consistent with its efficient working.

That a tabular list of the Committees appointed on the recommendation of each Section should be sent each year to the Recorders of the several Sections, to enable them to fill in the statement whether the several Committees appointed on the recommendation of their respective Sections had presented their reports.

That on the proposal to recommend the appointment of a Committee for a special object of science having been adopted by the Sectional Committee, the number of Members of such Committee be then fixed, but that the Members to serve on such Committee be nominated and selected by the Sectional Committee at a subsequent meeting.¹

Committees have power to add to their number persons whose assistance they may require.

The recommendations adopted by the Committees of Sections are to be registered in the Forms furnished to their Secretaries, and one Copy of each is to be forwarded, without delay, to the Secretary for presentation to the Committee of Recommendations. *Unless this be done, the Recommendations cannot receive the sanction of the Association.*

N.B.—Recommendations which may originate in any one of the Sections must first be sanctioned by the Committee of that Section before they can be referred to the Committee of Recommendations or confirmed by the General Committee.

The Committees of the Sections shall ascertain whether a Report has been made by every Committee appointed at the previous Meeting to whom a sum of money has been granted, and shall report to the Committee of Recommendations in every case where no such Report has been received.²

Notices regarding Grants of Money.

Committees and individuals, to whom grants of money have been entrusted by the Association for the prosecution of particular researches in science, are required to present to each following Meeting of the Association a Report of the progress which has been made; and the Chairman of a Committee to whom a money grant has been made must (previously to the next Meeting of the Association) forward to the General Secretaries or Treasurer a statement of the sums which have been expended, and the balance which remains disposable on each grant.

Grants of money sanctioned at any one Meeting of the Association expire *a week before* the opening of the ensuing Meeting; nor is the Treasurer authorized, after that date, to allow any claims on account of such grants, unless they be renewed in the original or a modified form by the General Committee.

No Committee shall raise money in the name or under the auspices

¹ Revised by the General Committee, Bath, 1888.

² Passed by the General Committee at Sheffield, 1879.

of the British Association without special permission from the General Committee to do so; and no money so raised shall be expended except in accordance with the rules of the Association.

In each Committee, the Chairman is the only person entitled to call on the Treasurer, Professor A. W. Williamson, 17 Buckingham Street, London, W.C., for such portion of the sums granted as may from time to time be required.

In grants of money to Committees, the Association does not contemplate the payment of personal expenses to the members.

In all cases where additional grants of money are made for the continuation of Researches at the cost of the Association, the sum named is deemed to include, as a part of the amount, whatever balance may remain unpaid on the former grant for the same object.

All Instruments, Papers, Drawings, and other property of the Association are to be deposited at the Office of the Association, 22 Albemarle Street, Piccadilly, London, W., when not employed in carrying on scientific inquiries for the Association.

Business of the Sections.

The Meeting Room of each Section is opened for conversation from 10 to 11 daily. *The Section Rooms and approaches thereto can be used for no notices, exhibitions, or other purposes than those of the Association.*

At 11 precisely the Chair will be taken,¹ and the reading of communications, in the order previously made public, commenced. At 3 P.M. the Sections will close.

Sections may, by the desire of the Committees, divide themselves into Departments, as often as the number and nature of the communications delivered in may render such divisions desirable.

A Report presented to the Association, and read to the Section which originally called for it, may be read in another Section, at the request of the Officers of that Section, with the consent of the Author.

Duties of the Doorkeepers.

- 1.—To remain constantly at the Doors of the Rooms to which they are appointed during the whole time for which they are engaged.
- 2.—To require of every person desirous of entering the Rooms the exhibition of a Member's, Associate's, or Lady's Ticket, or Reporter's Ticket, signed by the Treasurer, or a Special Ticket signed by the Secretary.
- 3.—Persons unprovided with any of these Tickets can only be admitted to any particular Room by order of the Secretary in that Room.

No person is exempt from these Rules, except those Officers of the Association whose names are printed in the programme, p. 1.

Duties of the Messengers.

To remain constantly at the Rooms to which they are appointed during the whole time for which they are engaged, except when employed on messages by one of the Officers directing these Rooms.

¹ The sectional meetings on Saturday and on Wednesday may begin at any time which may be fixed by the Committee, not earlier than 10 or later than 11. Passed by the General Committee at Bath, 1888.

Committee of Recommendations.

The General Committee shall appoint at each Meeting a Committee, which shall receive and consider the Recommendations of the Sectional Committees, and report to the General Committee the measures which they would advise to be adopted for the advancement of Science.

All Recommendations of Grants of Money, Requests for Special Researches, and Reports on Scientific Subjects shall be submitted to the Committee of Recommendations, and not taken into consideration by the General Committee unless previously recommended by the Committee of Recommendations.

Corresponding Societies.¹

(1.) Any Society is eligible to be placed on the List of Corresponding Societies of the Association which undertakes local scientific investigations, and publishes notices of the results.

(2.) Applications may be made by any Society to be placed on the List of Corresponding Societies. Application must be addressed to the Secretary on or before the 1st of June preceding the Annual Meeting at which it is intended they should be considered, and must be accompanied by specimens of the publications of the results of the local scientific investigations recently undertaken by the Society.

(3.) A Corresponding Societies Committee shall be annually nominated by the Council and appointed by the General Committee for the purpose of considering these applications, as well as for that of keeping themselves generally informed of the annual work of the Corresponding Societies, and of superintending the preparation of a list of the papers published by them. This Committee shall make an annual report to the General Committee, and shall suggest such additions or changes in the List of Corresponding Societies as they may think desirable.

(4.) Every Corresponding Society shall return each year, on or before the 1st of June, to the Secretary of the Association, a schedule, properly filled up, which will be issued by the Secretary of the Association, and which will contain a request for such particulars with regard to the Society as may be required for the information of the Corresponding Societies Committee.

(5.) There shall be inserted in the Annual Report of the Association a list, in an abbreviated form, of the papers published by the Corresponding Societies during the past twelve months which contain the results of the local scientific work conducted by them; those papers only being included which refer to subjects coming under the cognisance of one or other of the various Sections of the Association.

(6.) A Corresponding Society shall have the right to nominate any one of its members, who is also a Member of the Association, as its delegate to the Annual Meeting of the Association, who shall be for the time a Member of the General Committee.

Conference of Delegates of Corresponding Societies.

(7.) That the Conference of Delegates of Corresponding Societies be empowered to send recommendations to the Committee of Recommendations for their consideration, and for report to the General Committee.²

¹ Passed by the General Committee, 1884.

(8.) The Delegates of the various Corresponding Societies shall constitute a Conference, of which the Chairman, Vice-Chairmen, and Secretaries shall be annually nominated by the Council, and appointed by the General Committee, and of which the members of the Corresponding Societies Committee shall be *ex officio* members.

(9.) The Conference of Delegates shall be summoned by the Secretaries to hold one or more meetings during each Annual Meeting of the Association, and shall be empowered to invite any Member or Associate to take part in the meetings.

(10.) The Secretaries of each Section shall be instructed to transmit to the Secretaries of the Conference of Delegates copies of any recommendations forwarded by the Presidents of Sections to the Committee of Recommendations bearing upon matters in which the co-operation of Corresponding Societies is desired; and the Secretaries of the Conference of Delegates shall invite the authors of these recommendations to attend the meetings of the Conference and give verbal explanations of their objects and of the precise way in which they would desire to have them carried into effect.

(11.) It will be the duty of the Delegates to make themselves familiar with the purport of the several recommendations brought before the Conference, in order that they and others who take part in the meetings may be able to bring those recommendations clearly and favourably before their respective Societies. The Conference may also discuss propositions bearing on the promotion of more systematic observation and plans of operation, and of greater uniformity in the mode of publishing results.

Local Committees.

Local Committees shall be formed by the Officers of the Association to assist in making arrangements for the Meetings.

Local Committees shall have the power of adding to their numbers those Members of the Association whose assistance they may desire.

Officers.

A President, two or more Vice-Presidents, one or more Secretaries, and a Treasurer shall be annually appointed by the General Committee.

Council.

In the intervals of the Meetings, the affairs of the Association shall be managed by a Council appointed by the General Committee. The Council may also assemble for the despatch of business during the week of the Meeting.

(1) The Council shall consist of¹

1. The Trustees.
2. The past Presidents.
3. The President and Vice-Presidents for the time being.
4. The President and Vice-Presidents elect.
5. The past and present General Treasurers, General and Assistant General Secretaries.

¹ Passed by the General Committee, Belfast, 1874.

6. The Local Treasurer and Secretaries for the ensuing Meeting.
7. Ordinary Members.
- (2) The Ordinary Members shall be elected annually from the General Committee.
- (3) There shall be not more than twenty-five Ordinary Members, of whom not more than twenty shall have served on the Council, as Ordinary Members, in the previous year.
- (4) In order to carry out the foregoing rule, the following Ordinary Members of the outgoing Council shall at each annual election be ineligible for nomination :—1st, those who have served on the Council for the greatest number of consecutive years ; and, 2nd, those who, being resident in or near London, have attended the fewest number of Meetings during the year—observing (as nearly as possible) the proportion of three by seniority to two by least attendance.
- (5) The Council shall submit to the General Committee in their Annual Report the names of the Members of General Committee whom they recommend for election as Members of Council.
- (6) The Election shall take place at the same time as that of the Officers of the Association.

Papers and Communications.

The Author of any paper or communication shall be at liberty to reserve his right of property therein.

Accounts.

The Accounts of the Association shall be audited annually, by Auditors appointed by the General Committee.

Table showing the Places and Times of Meeting of the British Association, with Presidents, Vice-Presidents, and Local Secretaries, from its Commencement.

PRESIDENTS.		VICE-PRESIDENTS.		LOCAL SECRETARIES.	
The EARL FITZWILLIAM, D.C.L., F.R.S., F.G.S., &c.	York, September 27, 1831.	Rev. W. Vernon Harcourt, M.A., F.R.S., F.G.S.	William Gray, jun., Esq., F.G.S.	Professor Phillips, M.A., F.R.S., F.G.S.	Professor Daubeny, M.D., F.R.S., &c.
The REV. W. BUCKLAND, D.D., F.R.S., F.G.S., &c.	Oxford, June 19, 1832.	Rev. W. Whewell, F.R.S., Pres. Geol. Soc.	Rev. W. Whewell, F.R.S., L. & E., &c.	Rev. Professor Powell, M.A., F.R.S., &c.	Rev. Professor Henslow, M.A., F.L.S., F.G.S.
The REV. ADAM SEDGWICK, M.A., V.P.R.S., V.P.G.S.	CAMBRIDGE, June 23, 1833.	G. B. Airy, Esq., F.R.S., Astronomer Royal, &c.	John Dalton, Esq., D.C.L., F.R.S.	Rev. W. Whewell, F.R.S.	Professor Forbes, F.R.S., L. & E., &c.
SIR T. MACDOUGALL BRISBANE, K.C.B., D.C.L., F.R.S., L. & E.	EDNBURGH, September 8, 1834.	Sir David Brewster, F.R.S., &c.	Rev. T. R. Robinson, D.D.	Sir John Robinson, Sec. R.S.E.	Sir W. R. Hamilton, Astron. Royal of Ireland, &c.
The REV. PROVOST LLOYD, LL.D.	DUBLIN, August 10, 1835.	Viscount Oxmantown, F.R.S., F.R.A.S.	Rev. W. Whewell, F.R.S., &c.	Rev. Professor Lloyd, F.R.S.	Professor Daubeny, M.D., F.R.S., &c.
The MARQUIS OF LANSDOWNE, D.C.L., F.R.S., &c.	BRISTOL, August 29, 1836.	The Marquis of Northampton, F.R.S.	Rev. W. D. Conybeare, F.R.S., F.G.S., J. C. Pritchard, Esq., M.D., F.R.S.	V. F. Hovenden, Esq.	Professor Traill, M.D. Wm. Wallace Currie, Esq.
The EARL OF BURLINGTON, F.R.S., F.G.S., Chancellor of the University of London	LIVERPOOL, September 11, 1837.	The Bishop of Norwich, P.L.S., F.G.S., John Dalton, Esq., D.C.L., F.R.S.	Sir Philip de Grey Egerton, Bart., F.R.S., F.G.S.	John Adamson, Esq., F.L.S., &c.	Wm. Hutton, Esq., F.G.S.
The DUKE OF NORTHUMBERLAND, F.R.S., F.G.S., &c.	NEWCASTLE-ON-TYNE, August 20, 1838.	The Rev. W. Vernon Harcourt, F.R.S., &c.	Pridcaux John Selby, Esq., F.R.S.E.	Professor Johnston, M.A., F.R.S.	George Barker, Esq., F.R.S.
The REV. W. VERNON HARCOURT, M.A., F.R.S., &c.	BIRMINGHAM, August 26, 1839.	The Marquis of Northampton.	The Earl of Dartmouth.	Peyton Blakiston, Esq., M.D.	Joseph Hodgson, Esq., F.R.S.
The MARQUIS OF BREADALBANE, F.R.S.	GLASGOW, September 17, 1840.	The Rev. T. R. Robinson, D.D.	John Corrie, Esq., F.R.S.	Andrew Liddell, Esq.	Rev. J. P. Nicol, LL.D.
The REV. PROFESSOR WHEWELL, F.R.S., &c.	PLYMOUTH, July 29, 1841.	The Very Rev. Principal Macfarlane	Sir David Brewster, F.R.S.	John Strang, Esq.	W. Snow Harris, Esq., F.R.S.
The LORD FRANCIS EGERTON, F.G.S.	MANCHESTER, June 23, 1842.	Major-General Lord Greenock, F.R.S.E.	Sir T. M. Brisbane, Bart., F.R.S.	Col. Hamilton Smith, F.L.S.	Robert Vere Fox, Esq., F.R.A.S.
The EARL OF ROSSE, F.R.S.	CORK, August 17, 1843.	The Earl of Mortley.	Lord Eliot, M.P.	Peter Clate, Esq., F.R.A.S.	W. Fleming, Esq., M.D.
The REV. G. PEACOCK, D.D. (Dean of Ely), F.R.S.	YORK, September 26, 1844.	Rev. A. Sedgwick, M.A., F.R.S.	W. C. Henry, Esq., M.D., F.R.S.	James Heywood, Esq., F.R.S.	Professor John Stevelly, M.A.
SIR JOHN F. W. HERSCHEL, Bart., F.R.S., &c.	CAMBRIDGE, June 19, 1845.	The Earl of Listowel.	Viscount Adare.	Rev. Jos. Carson, F.T.C. Dublin.	William Keleher, Esq. Wm. Clear, Esq.
		Sir W. R. Hamilton, Pres. R.I.A.	Rev. T. R. Robinson, D.D.	William Hatfield, Esq., F.G.S.	Thomas Meynell, Esq., F.L.S.
		Earl Fitzwilliam, F.R.S.	Viscount Morpeth, F.G.S.	Rev. W. Scoresby, LL.D., F.R.S.	William West, Esq.
		The Hon. John Stuart Wortley, M.P.	Sir David Brewster, K.H., F.R.S.		
		Michael Faraday, Esq., D.C.L., F.R.S.	Rev. W. V. Harcourt, F.R.S.		
		Rev. W. V. Harcourt, F.R.S.	The Bishop of Norwich		
			Rev. G. Ainslie, D.D.		
			G. B. Airy, Esq., M.A., D.C.L., F.R.S.		

SIR RODERICK IMPEY MURCHISON, G.C.St.S., F.R.S.
SOUTHAMPTON, September 10, 1846.

SIR ROBERT HARRY INGLIS, Bart., D.C.L., F.R.S.,
M.P. for the University of Oxford.
OXFORD, June 23, 1847.

The MARQUIS OF NORTHAMPTON, President of the
Royal Society, &c.
SWANSEA, August 9, 1848.

The REV. T. R. ROBINSON, D.D., M.R.I.A., F.R.A.S.
BIRMINGHAM, September 12, 1849.

SIR DAVID BREWSTER, K.H., LL.D., F.R.S. L. & E.,
Principal of the United College of St. Salvador and St.
Leonard, St. Andrews.
EDINBURGH, July 21, 1850.

GEORGE BIDELELL AIRY, Esq., D.C.L., F.R.S., Astro-
nomer Royal.
IRSWICH, July 2, 1851.

COLONEL EDWARD SABINE, Royal Artillery, Treas. &
V.P. of the Royal Society.
BELFAST, September 1, 1852.

WILLIAM HOPKINS, Esq., M.A., V.P.R.S., F.G.S.,
Pres. Camb. Phil. Society.
HULL, September 7 1853.

The Marquis of Winchester. The Earl of Yarborough, D.C.L.
Lord Ashburton, D.C.L. Viscount Palmerston, M.P.
Right Hon. Charles Shaw Lefevre, M.P.
Sir George T. Staunton, Bart., M.P., D.C.L., F.R.S.
The Lord Bishop of Oxford, F.R.S.
Professor Owen, M.D., F.R.S. The Rev. Professor Powell, F.R.S.

The Earl of Rosse, F.R.S. The Lord Bishop of Oxford, F.R.S.
The Vice-Chancellor of the University
Thomas G. Bucknall Esq., D.C.L., M.P. for the University of
Oxford. The Very Rev. the Dean of Westminster, D.D., F.R.S.
Professor Daubeny, M.D., F.R.S. The Rev. Prof. Powell, M.A., F.R.S.

The Marquis of Bute, K.T. Viscount Adare, F.R.S.
Sir H. T. De la Beche, F.R.S., Pres. G.S.
The Very Rev. the Dean of Llandaf, F.R.S.
Lewis W. Dillwyn, Esq., F.R.S. W. R. Grove, Esq., F.R.S.
J. H. Vivian, Esq., M.P., F.R.S. The Lord Bishop of St. David's

The Earl of Harrowby. The Lord Wrottesley, F.R.S.
The Right Hon. Sir Robert Peel, Bart., M.P., D.C.L., F.R.S.
Charles Darwin, Esq., M.A., F.R.S., Sec. G.S.
Professor Faraday, D.C.L., F.R.S.
Sir David Brewster, K.H., LL.D., F.R.S. Rev. Prof. Willis, M.A., F.R.S.

The Right Hon. the Lord Provost of Edinburgh
The Earl of Cathcart, K.C.B., F.R.S.E.
The Earl of Rosebery, K.T., D.C.L., F.R.S.
The Right Hon. David Boyle (Lord Justice-General), F.R.S.E.
General Sir Thomas M. Brisbane, Bart., D.C.L., F.R.S., Pres. R.S.E.
The Very Rev. John Lee, D.D., V.P.R.S.E., Principal of the University
of Edinburgh. Professor W. P. Alison, M.D., V.P.R.S.E.
Professor J. D. Forbes, F.R.S., Sec. R.S.E.

The Lord Rendlesham, M.P. The Lord Bishop of Norwich.
Rev. Professor Sedgwick, M.A., F.R.S.
Rev. Professor Henslow, M.A., F.L.S.
Sir John P. Boileau, Bart., F.R.S. Sir William F. F. Middleton, Bart.
J. C. Cobbold, Esq., M.P. T. B. Western, Esq.

The Earl of Enniskillen, D.C.L., F.R.S.
The Earl of Rosse, Pres. R.S., M.R.I.A.
Sir Henry T. De la Beche, F.R.S.
Rev. Edward Hincks, D.D., M.R.I.A.
Rev. P. S. Henry, D.D., Pres. Queen's College, Belfast
Rev. T. R. Robinson, D.D., Pres. R.I.A., F.R.A.S.
Professor G. G. Stokes, F.R.S. Professor Stevelly, LL.D.

The Earl of Carlisle, F.R.S. Lord Londesborough, F.R.S.
Professor Faraday, D.C.L., F.R.S. Rev. Prof. Sedgwick, M.A., F.R.S.
Charles Frost, Esq., F.S.A., Pres. of the Hull Lit. and Phil. Society
William Spence, Esq., F.R.S. Lieut.-Col. Sykes, F.R.S.
Professor Wheatstone, F.R.S.

Henry Clark, Esq., M.D.
T. H. C. Moody, Esq.

Rev. Robert Walker, M.A., F.R.S.
H. Wentworth Acland, Esq., B.M.

Matthew Mogeridge, Esq.
D. Nicol, Esq., M.D.

Captain Tindal, R.N.
William Wills, Esq.
Bell Fletcher, Esq., M.D.
James Chance, Esq.

Rev. Professor Kelland, M.A., F.R.S. L. & E.
Professor Balfour, M.D., F.R.S.E., F.L.S.
James Tod, Esq., F.R.S.E.

Charles May, Esq., F.R.A.S.
Dillwyn Sims, Esq.
George Arthur Biddell, Esq.
George Ransome, Esq., F.L.S.

W. J. C. Allen, Esq.
William M'Gee, Esq., M.D.
Professor W. P. Wilson.

Henry Cooper, Esq., M.D., V.P. Hull Lit. & Phil.
Society.
Bethel Jacobs, Esq., Pres. Hull Mechanics' Inst.,

PRESIDENTS.

The EARL OF HARROWBY, F.R.S......
LIVERPOOL, September 20, 1854.

The DUKE OF ARGYLL, F.R.S, F.G.S......
GLASGOW, September 12, 1855.

CHARLES G. B. DAUBENY, Esq., M.D., LL.D., F.R.S.,
Professor of Botany in the University of Oxford,.....
CHELTENHAM, August 6, 1856.

The REV. HUMPHREY LLOYD, D.D., D.C.L., F.R.S.
L. & E., V.P.R.I.A.
DUBLIN, August 26, 1857.

RICHARD OWEN, Esq., M.D., D.C.L., V.P.R.S., F.L.S.,
F.G.S., Superintendent of the Natural History Depart-
ments of the British Museum.
LEEDS, September 22, 1858.

HIS ROYAL HIGHNESS THE PRINCE CONSORT..
ABERDEEN, September 14, 1859.

The LORD WROTTESELEY, M.A., V.P.R.S., F.R.A.S....
OXFORD, June 27, 1860.

VICE-PRESIDENTS.

The Lord Wrottesley, M.A., F.R.S., F.R.A.S.
Sir Philip de Malpas Grey Egerton, Bart., M.P., F.R.S., F.G.S.
Professor Owen, M.D., LL.D., F.R.S., F.L.S., F.G.S.
Rev. Professor Whewell, D.D., F.R.S., Hon. M.R.I.A., F.G.S., Master of
Trinity College, Cambridge.
William Lassell, Esq., F.R.S. L. & E., F.R.A.S.
Joseph Brooks Yates, Esq., F.S.A., F.R.G.S.

The Very Rev. Principal Macfarlane, D.D.
Sir William Jardine, Bart., F.R.S.E.
Sir Charles Lyell, M.A., LL.D., F.R.S. Walter Crum, Esq., F.R.S.
James Smith, Esq., F.R.S. L. & E.
Thomas Graham, Esq., M.A., F.R.S., Master of the Royal Mint.
Professor William Thomson, M.A., F.R.S.

The Earl of Ducie, F.R.S., F.G.S.
The Lord Bishop of Gloucester and Bristol
Sir Roderick I. Murchison, G.C.St.S., D.C.L., F.R.S.
Thomas Barwick Lloyd Baker, Esq. The Rev. Francis Close, M.A.

The Right Hon. the Lord Mayor of Dublin
The Provost of Trinity College, Dublin
The Marquis of Kildare. Lord Talbot de Malahide.
The Lord Chancellor of Ireland
The Lord Chief Baron, Dublin
Sir William R. Hamilton, LL.D., F.R.A.S., Astronomer Royal of Ireland
Lieut.-Colonel Larcom, R.E., LL.D., F.R.S.
Richard Griffith, Esq., LL.D., M.R.I.A., F.R.S.E., F.G.S.

The Lord Montagu, F.R.S.
The Lord Viscount Goderich, M.P., F.R.G.S.
The Right Hon. M. T. Baines, M.A., M.P.
Sir Philip de Malpas Grey Egerton, Bart., M.P., F.R.S., F.G.S.
The Rev. W. Whewell, D.D., F.R.S., Hon. M.R.I.A., F.G.S., F.R.A.S.,
Master of Trinity College, Cambridge.
James Garth Marshall, Esq., M.A., F.G.S.
R. Monckton Milnes, Esq., D.C.L., M.P., F.R.G.S.

The Duke of Richmond, K.G., F.R.S.
The Earl of Aberdeen, LL.D., K.G., K.T., F.R.S.
The Lord Provost of the City of Aberdeen
Sir John F. W. Herschel, Bart., M.A., D.C.L., F.R.S.
Sir David Brewster, K.H., D.C.L., F.R.S.
Sir Roderick I. Murchison, G.C.St.S., D.C.L., F.R.S.
The Rev. W. V. Harcourt, M.A., F.R.S.
The Rev. T. R. Robinson, D.D., F.R.S.
A. Thomson, Esq., LL.D., F.R.S., Convener of the County of Aberdeen

The Earl of Derby, K.G., P.C., D.C.L., Chancellor of the Univ. of Oxford
The Rev. F. Jeune, D.C.L., Vice-Chancellor of the University of Oxford
The Duke of Marlborough, D.C.L., F.G.S., Lord Lieutenant of Oxford-
shire
The Earl of Rosse, K.P., M.A., F.R.S., F.R.A.S.
The Lord Bishop of Oxford, D.D., F.R.S.
The Very Rev. H. G. Liddell, D.D., Dean of Christ Church, Oxford
Professor Daubeny, M.D., LL.D., F.R.S., F.L.S., F.G.S.
Professor Acland, M.D., F.R.S. Professor Donkin, M.A., F.R.S., F.R.A.S.,

LOCAL SECRETARIES.

Joseph Dickinson, Esq., M.D., F.R.S.
Thomas Inman, Esq., M.D.

John Strang, Esq., LL.D.
Professor Thomas Anderson, M.D.
William Gourlie, Esq.

Capt. Robinson, R.A.
Richard Beamish, Esq., F.R.S.
John West Hugell, Esq.

Lundy E. Foote, Esq.
Rev. Professor Jellett, F.T.C.D.
W. Neilson Hancock, Esq., LL.D.

Rev. Thomas Hincks, B.A.
W. Sykes Ward, Esq., F.C.S.
Thomas Wilson, Esq., M.A.

Professor J. Nicol, F.R.S.E., F.G.S.
Professor Fuller, M.A.
John F. White, Esq.

George Rolleston, Esq., M.D., F.L.S.
H. J. S. Smith, Esq., M.A., F.C.S.
George Griffith, Esq., M.A., F.C.S.

WILLIAM FAIRBAIRN, Esq., LL.D., C.E., F.R.S.
MANCHESTER, September 4, 1861.

The Earl of Ellesmere, F.R.G.S.
The Lord Stanley, M.P., D.C.L., F.R.G.S.
The Lord Bishop of Manchester, D.D., F.R.S., F.G.S.
Sir Philip de Malpas Grey Egerton, Bart., M.P., F.R.S., F.G.S.
Sir Benjamin Heywood, Bart., F.R.S.
Thomas Bazley, Esq., M.P.
James Aspinall Turner, Esq., M.P.
James Prescott Joule, Esq., LL.D., F.R.S., Pres. Lit. & Phil. Soc. Manchester
Professor E. Hodgkinson, F.R.S., M.R.I.A., M.Inst.C.E.
Joseph Whitworth, Esq., F.R.S., M.Inst.C.E.

The **REV. R. WILLIS**, M.A., F.R.S., Jacksonian Professor
of Natural and Experimental Philosophy in the University
of Cambridge
CAMBRIDGE, October 1, 1862.

The Rev. the Vice-Chancellor of the University of Cambridge
The Rev. Harvey Goodwin, D.D., Dean of Ely.
The Rev. W. Hewell, D.D., F.R.S., Master of Trinity College, Cambridge
The Rev. Professor Sedgwick, M.A., D.C.L., F.R.S.
The Rev. J. Challis, M.A., F.R.S.
G. B. Airy, Esq., M.A., D.C.L., F.R.S., Astronomer Royal
Professor G. G. Stokes, M.A., D.C.L., Sec. R.S.
Professor J. C. Adams, M.A., D.C.L., F.R.S., Pres. C.P.S.

SIR W. ARMSTRONG, C.B., LL.D., F.R.S.
NEWCASTLE-ON-TYNE, August 26, 1863.

Sir Walter C. Trevelyan, Bart., M.A.
Sir Charles Lyell, LL.D., D.C.L., F.R.S., F.G.S.
Hugh Taylor, Esq., Chairman of the Coal Trade
Isaac Lowthian Bell, Esq., Mayor of Newcastle
Nicholas Wood, Esq., President of the Northern Institute of Mining
Engineers
Rev. Temple Chevalier, B.D., F.R.A.S.
William Fairbairn, Esq., LL.D., F.R.S.

SIR CHARLES LYELL, Bart., M.A., D.C.L., F.R.S.
BATH, September 14, 1864.

The Right Hon. the Earl of Cork and Orrery, Lord-Lieutenant of Somersetshire
The Most Noble the Marquis of Bath
The Right Hon. Earl Nelson
The Right Hon. Lord Portman
The Very Rev. the Dean of Hereford
The Venerable the Archdeacon of Bath
W. Tite, Esq., M.P., F.R.S., F.G.S., F.S.A.
A. E. Way, Esq., M.P. Francis H. Dickinson, Esq.
W. Sanders, Esq., F.R.S., F.G.S.

JOHN PHILLIPS, Esq., M.A., LL.D., F.R.S., F.G.S.,
Professor of Geology in the University of Oxford
BIRMINGHAM, September 6, 1865.

The Right Hon. the Earl of Lichfield, Lord-Lieutenant of Staffordshire
The Right Hon. the Earl of Dudley
The Right Hon. Lord Leigh, Lord-Lieutenant of Warwickshire
The Right Hon. Lord Lytton, Lord-Lieutenant of Worcestershire
The Right Hon. Lord Wrottesley, M.A., D.C.L., F.R.S., F.R.A.S.
The Right Rev. the Lord Bishop of Worcester
The Right Hon. C. B. Adderley, M.P.
William Scholefield, Esq., M.P. F. Osler, Esq., F.R.S.
J. T. Chance, Esq. The Rev. Charles Evans, M.A.

R. D. Darbshire, Esq., B.A., F.G.S.
Alfred Neild, Esq.
Arthur Ransome, Esq., M.A.
Professor H. E. Roscoe, B.A.

Professor C. C. Babington, M.A., F.R.S., F.I.S.
Professor G. D. Liveing, M.A.
The Rev. N. M. Ferrers, M.A.

A. Noble, Esq.
Augustus H. Hunt, Esq.
R. C. Clapham, Esq.

C. Moore, Esq., F.G.S.
C. E. Davis, Esq.
The Rev. H. H. Winwood, M.A.

William Matheus, jun., Esq., M.A., F.G.S.
John Henry Chamberlain, Esq.
The Rev. G. D. Boyle, M.A.

PRESIDENTS.

WILLIAM R. GROVE, Esq., Q.C., M.A., F.R.S.
 NOTTINGHAM, August 22, 1866.

HIS GRACE THE DUKE OF BUCCLEUCH, K.G.,
D.C.L., F.R.S.
 DUNDEE, September 4, 1867.

JOSEPH DALTON HOOKER, Esq., M.D., D.C.L., F.R.S.,
F.L.S.
 NORWICH, August 19, 1868.

PROFESSOR GEORGE G. STOKES, D.C.L., F.R.S.
 EXETER, August 18, 1869.

PROFESSOR T. H. HUXLEY, LL.D., F.R.S. F.G.S.
 LIVERPOOL, September 14, 1870.

PROFESSOR SIR WILLIAM THOMSON, M.A., LL.D.,
F.R.S. L. & E.
 EDINBURGH, August 2, 1871.

VICE-PRESIDENTS.

His Grace the Duke of Devonshire, Lord-Lieutenant of Derbyshire
His Grace the Duke of Rutland, Lord-Lieutenant of Leicestershire
The Right Hon. Lord Belper, Lord-Lieutenant of Nottinghamshire
The Right Hon. J. E. Denison, M.P.
J. C. Webb, Esq., High-Sheriff of Nottinghamshire
Thomas Graham, Esq., F.R.S., Master of the Mint
Joseph Hooker, Esq., M.D., F.R.S., F.L.S. **T. Close, Esq.**
John Russell Hind, Esq., F.R.S., F.R.A.S.

The Right Hon. the Earl of Airlie, K.T.
The Right Hon. the Lord Kinnaird, K.T.
Sir John Ogilvy, Bart., M.P.
Sir Roderick I. Murchison, Bart., K.C.B., LL.D., F.R.S., F.G.S., &c.
Sir David Baxter, Bart.
Sir David Brewster, D.C.L., F.R.S., Principal of the University of Edinburgh
James D. Forbes, Esq., LL.D., F.R.S., Principal of the United College of St. Salvador and St. Leonard, University of St. Andrews

The Right Hon. the Earl of Leicester, Lord-Lieutenant of Norfolk
Sir John Peter Boileau, Bart., F.R.S.
The Rev. Adam Sedgwick, M.A., LL.D., F.R.S., F.G.S., &c., Woodwardian Professor of Geology in the University of Cambridge
Sir John Lubbock, Bart., F.R.S., F.L.S., F.G.S.
John Couch Adams, Esq., M.A., D.C.L., F.R.S., F.R.A.S., Lowndean Professor of Astronomy and Geometry in the University of Cambridge

Thomas Brightwell, Esq.
The Right Hon. the Earl of Devon
The Right Hon. Sir Stafford H. Northcote, Bart., C.B., M.P., &c.
Sir John Bowring, LL.D., F.R.S.
William B. Carpenter, Esq., M.D., F.R.S., F.L.S.
Robert Vere Fox, Esq., F.R.S.
W. H. Fox Talbot, Esq., M.A., LL.D., F.R.S., F.L.S.

The Right Hon. the Earl of Derby, LL.D., F.R.S.
Sir Philip de Malpas (Grey Egerton), Bart., M.P.
The Right Hon. W. E. Gladstone, D.C.L., M.P.
S. R. Graves, Esq., M.P.
Sir Joseph Whitworth, Bart., LL.D., D.C.L., F.R.S.
James P. Joule, Esq., LL.D., D.C.L., F.R.S.
Joseph Mayer, Esq., F.S.A., F.R.C.S.

His Grace the Duke of Buccleuch, K.G., D.C.L., F.R.S.
The Right Hon. the Lord Provost of Edinburgh
The Right Hon. John Inglis, LL.D., Lord Justice-General of Scotland
Sir Alexander Grant, Bart., M.A., Principal of the University of Edinburgh
Sir Roderick I. Murchison, Bart., K.C.B., G.C.St.S., D.C.L., F.R.S.
Sir Charles Lyell, Bart., D.C.L., F.R.S., F.G.S.
Dr. Lyon Playfair, C.B., M.P., F.R.S.
Professor Christison, M.D., D.C.L., Pres. R.S.E.
Professor Balfour, F.R.S. L. & E.

LOCAL SECRETARIES.

Dr. Robertson.
Edward J. Lowe, Esq., F.R.A.S., F.I.S.
The Rev. J. F. McCullin, M.A.

J. Henderson, jun., Esq.
John Austin Lake (Hoag), Esq.
Patrick Anderson, Esq.

Dr. Donald Dalrymple.
Rev. Joseph Crompton, M.A.
Rev. Canon Hinds Howell.

Henry S. Ellis, Esq., F.R.A.S.
John C. Bowring, Esq.
The Rev. R. Kirwan.

Rev. W. Banister.
Reginald Harrison, Esq.
Rev. Henry H. Higgins, M.A.
Rev. Dr. A. Ilume, F.S.A.

Professor A. Crum Brown, M.D., F.R.S.E.
J. D. Marwick, Esq., F.R.S.E.

The Right Hon. the Earl of Chichester, Lord-Lieutenant of the County of Sussex.

W. B. CARPENTER, Esq., M.D., LL.D., F.R.S., F.L.S.
BRIGHTON, August 14, 1872.

PROFESSOR ALEXANDER W. WILLIAMSON, Ph.D., F.R.S., F.C.S.
BRADFORD, September 17, 1873.

PROFESSOR J. TYNDALL, D.C.L., LL.D., F.R.S.
BELFAST, August 19, 1874.

SIR JOHN HAWKSHAW, M. Inst. C.E., F.R.S., F.G.S.
BRISTOL, August 25, 1875.

PROFESSOR THOMAS ANDREWS, M.D., LL.D., F.R.S., Hon. F.R.S.E.
GLASGOW, September 6, 1876.

PROFESSOR ALLEN THOMSON, M.D., LL.D., F.R.S. L. & E.
PLYMOUTH, August 15, 1877.

WILLIAM SPOTTISWOODE, Esq., M.A., D.C.L., LL.D., F.R.S., F.R.A.S., F.R.G.S.
DUBLIN, August 14, 1878.

PROFESSOR G. J. ALLMAN, M.D., LL.D., F.R.S. L. & E., M.R.I.A., Pres. L.S.
SHEFFIELD, August 20, 1879.

His Grace the Duke of Richmond, K.G., P.C., D.C.L.
His Grace the Duke of Devonshire, K.G., D.C.L., F.G.S.
Sir John Lubbock, Bart., M.P., F.R.S., F.L.S., F.G.S.
Dr. Sharpey, LL.D., Sec. R.S., F.L.S.
Joseph Prestwich, Esq., F.R.S., Pres. G.S.

The Right Hon. the Earl of Rosse, F.R.S., F.R.A.S.
The Right Hon. Lord Houghton, D.C.L., F.R.S.
The Right Hon. W. E. Forster, M.P.
The Mayor of Bradford.
Sir John Hawkshaw, F.R.S., F.G.S.
J. P. Gassiot, Esq., D.C.L., F.R.S., Professor Phillips, D.C.L., F.R.S.

The Right Hon. the Earl of Enniskillen, D.C.L., F.R.S.
The Right Hon. the Earl of Rosse, F.R.S.
Sir Richard Wallace, Bart., M.P.
The Rev. Dr. Henry.
Dr. Andrews, F.R.S.
The Rev. Dr. Robinson, F.R.S., Professor Stokes, D.C.L., F.R.S.

The Right Hon. the Earl of Ducie, F.R.S., F.G.S.
The Right Hon. Sir Stafford H. Northcote, Bart., C.B., M.P., F.R.S.
The Mayor of Bristol
Major-General Sir Henry C. Rawlinson, K.C.B., LL.D., F.R.S., F.R.G.S.
Dr. W. B. Carpenter, LL.D., F.R.S., F.L.S., F.G.S.
W. Sanders, Esq., F.R.S., F.G.S.

His Grace the Duke of Argyll, K.T., LL.D., F.R.S. L. & E., F.G.S.
The Hon. the Lord Provost of Glasgow
Sir William Stirling Maxwell, Bart., M.A., M.P.
Professor Sir William Thomson, M.A., LL.D., D.C.L., F.R.S. L. & E.
Professor Allen Thomson, M.D., LL.D., F.R.S. L. & E.
Professor A. C. Ramsay, LL.D., F.R.S., F.G.S.
James Young, Esq., F.R.S., F.C.S.

The Right Hon. the Earl of Mount-Edgumbe.
The Right Hon. Lord Blichford, K.C.M.G.
William Spottiswoode, Esq., M.A., LL.D., F.R.S., F.R.A.S., F.R.G.S.
William Froude, Esq., M.A., C.E., F.R.S.
Charles Spence Bate, Esq., F.R.S., F.L.S.

The Right Hon. the Lord Mayor of Dublin
The Provost of Trinity College, Dublin
His Grace the Duke of Abercorn, K.G.
The Right Hon. the Earl of Enniskillen, D.C.L., F.R.S., F.G.S.
The Right Hon. the Earl of Rosse, B.A., D.C.L., F.R.S., F.R.A.S., M.R.I.A.
The Right Hon. Lord O'Hagan, M.R.I.A.
Professor G. G. Stokes, M.A., D.C.L., LL.D., Sec. R.S.

His Grace the Duke of Devonshire, K.G., M.A., LL.D., F.R.S., F.R.G.S.
The Right Hon. the Earl Fitzwilliam, K.G., F.R.G.S.
The Right Hon. the Earl of Wharmliffe, F.R.G.S.
W. H. Brittain, Esq. (Master Cutler)
Professor T. H. Huxley, Ph.D., LL.D., Sec. R.S., F.L.S., F.G.S.
Professor W. Odling, M.B., F.R.S., F.C.S.

Charles Carpenter, Esq.
The Rev. Dr. Griffith.
Henry Willett, Esq.

The Rev. J. R. Campbell, D.D.
Richard Goddard, Esq.
Pede Thompson, Esq.

W. Quartus Ewart, Esq.
Professor G. Fuller, C.E.
T. Sinclair, Esq.

W. Lant Carpenter, Esq., B.A., B.Sc., F.C.S.
John H. Clarke, Esq.

Dr. W. G. Blackie, F.R.G.S.
James Grahame, Esq.
J. D. Marwick, Esq.

William Adams, Esq.
William Square, Esq.
Hamilton Whiteford, Esq.

Professor R. S. Ball, M.A., F.R.S.
James Goff, Esq.
John Norwood, Esq., LL.D.
Professor G. Sigerson, M.D.

H. Clifton Sorby, Esq., LL.D., F.R.S., F.G.S.
J. F. Moss, Esq.

PRESIDENTS.

ANDREW CROMBIE RAMSAY, Esq., LL.D., F.R.S., V.P.G.S., Director-General of the Geological Survey of the United Kingdom, and of the Museum of Practical Geology
 SWANSEA, August 25, 1880.

SIR JOHN LUBBOCK, Bart., M.P., D.C.L., LL.D., F.R.S.,
 Pres., L.S., F.G.S.
 YORK, August 31, 1881.

O. W. SIEMENS, Esq., D.C.L., LL.D., F.B.S., F.C.S.,
 M.Inst.C.E.
 SOUTHAMPTON, August 23, 1882.

ARTHUR CAYLEY, Esq., M.A., D.C.L., LL.D., F.R.S.,
 V.P.R.A.S., Sadlerian Professor of Pure Mathematics in the University of Cambridge
 SOUTHPORT, September 19, 1883.

The RIGHT HON. LORD RAYLEIGH, M.A., D.C.L., LL.D., F.R.S., F.R.A.S., F.R.G.S., Professor of Experimental Physics in the University of Cambridge.
 MONTREAL, August 27, 1884.

VICE-PRESIDENTS.

The Right Hon. the Earl of Jersey
 The Mayor of Swansea
 The Hon. Sir W. R. Grove, M.A., D.C.L., F.R.S.
 H. Hussey Vivian, Esq., M.P., F.G.S.
 L. La Dillwyn, Esq., M.P., F.L.S., F.G.S.
 J. Gwyn Jeffreys, Esq., LL.D., F.L.S., F.L.S., Treas. G.S., F.R.G.S.

His Grace the Archbishop of York, D.D., F.R.S.
 The Right Hon. the Lord Mayor of York
 The Right Hon. Lord Houghton, D.C.L., F.R.S., F.R.G.S.
 The Venerable Archdeacon Creyke, M.A.
 The Hon. Sir W. R. Grove, M.A., D.C.L., F.R.S.
 Professor G. G. Stokes, M.A., D.C.L., LL.D., Sec. R.S.
 Sir John Hawkshaw, C.E., F.R.S., F.G.S., F.R.G.S.
 Allen Thomson, Esq., M.D., LL.D., F.R.S. L. & E.
 Professor Allman, M.D., LL.D., F.R.S. L. & E., F.L.S.

The Right Hon. the Lord Mount-Temple.
 Captain Sir F. J. Evans, K.C.B., F.R.S., F.R.A.S., F.R.G.S., Hydrographer to the Admiralty
 F. A. Abel, Esq., C.B., F.R.S., V.P.C.S., Director of the Chemical Establishment of the War Department.
 Professor De Chaumont, M.D., F.L.S.
 Major-General A. C. Cooke, R.E., C.B., F.R.G.S., Director-General of the Ordnance Survey.
 Professor Prestwich, M.A., F.R.S., F.G.S., F.C.S., Wyndham S. Portal, Esq.
 Philip Lutley Sclater, Esq., M.A., Ph.D., F.R.S., F.L.S., F.G.S.

The Right Hon. the Earl of Derby, M.A., LL.D., F.R.S., F.R.G.S.
 The Right Hon. the Earl of Crawford and Balcarres, LL.D., F.R.S., F.R.A.S.
 The Right Hon. the Earl of Lathom
 Principal J. W. Dawson, C.M.G., M.A., LL.D., F.R.S., F.G.S.
 J. G. Greenwood, Esq., LL.D., Vice-Chancellor of the Victoria University
 Professor H. E. Roscoe, Ph.D., LL.D., F.R.S., F.C.S.

His Excellency the Governor-General of Canada, G.C.M.G., LL.D.
 The Right Hon. Sir John Alexander Macdonald, K.C.B., D.C.L., LL.D.
 The Right Hon. Sir Lyon Playfair, K.C.B., M.P., Ph.D., LL.D., F.R.S. L. & E., F.C.S.
 The Hon. Sir Alexander Tilloch Galt, G.C.M.G.
 The Hon. Sir Charles Tupper, K.C.M.G.
 Chief Justice Sir A. A. Dorton, C.M.G.
 Principal Sir William Dawson, C.M.G., M.A., LL.D., F.R.S., F.G.S.
 The Hon. Dr. Chauveau
 Professor Edward Frankland, M.D., D.C.L., Ph.D., LL.D., F.R.S., F.C.S.
 W. H. Hingston, Esq., M.D., D.C.L., L.R.C.S.E.
 Thomas Sterry Hunt, Esq., M.A., D.Sc., LL.D., F.R.S.

LOCAL SECRETARIES.

W. Morgan Esq., Ph.D., F.C.S.
 James Strick, Esq.

Rev. Thomas Adams, M.A.
 Tempest Anderson, Esq., M.D., B.Sc.

C. W. A. Jellicoe, Esq.
 John E. Le Feuvre, Esq.
 Morris Miles, Esq.

J. H. Ellis, Esq.
 Dr. Vernon.
 T. W. Willis, Esq.

S. E. Dawson, Esq.
 R. A. Ramsay, Esq.
 S. Rivard, Esq.
 S. C. Stevenson, Esq.
 Thos. White, Esq., M.P.

The RIGHT HON. SIR LYON PLAYFAIR, K.C.B., M.P.,
Ph.D., LL.D., F.R.S. L. & E., F.C.S.
ABERDEEN, September 9, 1885.

SIR J. WILLIAM DAWSON, C.M.G., M.A., LL.D., F.R.S.,
F.G.S., Principal and Vice-Chancellor of McGill Uni-
versity, Montreal, Canada
BRIMMINGHAM, September 1, 1886.

SIR H. E. ROSCOE, M.P., D.C.L., LL.D., Ph.D., F.R.S.,
V.P.O.S.
MANCHESTER, August 31, 1887.

SIR FREDERICK J. BRAMWELL, D.C.L., F.R.S.,
M.Inst.C.E.
BATH, September 5, 1888.

of the University of Aberdeen
The Right Hon. the Earl of Aberdeen, LL.D., Lord-Lieutenant of
Aberdeenshire
The Right Hon. the Earl of Crawford and Balcarres, M.A., LL.D.,
F.R.S., F.R.A.S.
James Matthews, Esq., Lord Provost of the City of Aberdeen
Professor Sir William Thomson, M.A., LL.D., F.R.S. L. & E., F.R.A.S.
Alexander Bain, Esq., M.A., LL.D., Rector of the University of
Aberdeen
The Very Rev. Principal Pirie, D.D., Vice-Chancellor of the University
of Aberdeen
Professor W. H. Flower, LL.D., F.R.S., F.L.S., Pres. Z.S., F.G.S.,
Director of the Natural History Museum, London
Professor John Struthers, M.D., LL.D.

The Right Hon. the Earl of Bradford, Lord-Lieutenant of Shropshire.
The Right Hon. Lord Leigh, D.C.L., Lord-Lieutenant of Warwickshire.
The Right Hon. Lord Norton, K.C.M.G.
The Right Hon. Lord Wrottesley, Lord-Lieutenant of Staffordshire
The Right Rev. the Lord Bishop of Worcester, D.D.
Thomas Martineau, Esq., Mayor of Birmingham
Professor G. G. Stokes, M.A., D.C.L., LL.D., Pres. R.S.
Professor W. A. Tilden, D.Sc., F.R.S., F.O.S.
Rev. A. R. Vardy, M.A.
Rev. H. W. Watson, D.Sc., F.R.S.

His Grace the Duke of Devonshire, K.G., M.A., LL.D., F.R.S., F.G.S.,
F.R.G.S.
The Right Hon. the Earl of Derby, K.G., M.A., LL.D., F.R.S., F.R.G.S.
The Right Rev. the Lord Bishop of Manchester, D.D.
The Right Rev. the Bishop of Salford
The Right Worshipful the Mayor of Manchester
The Right Worshipful the Mayor of Salford
The Vice-Chancellor of the Victoria University
The Principal of the Owens College
Sir William Roberts, B.A., M.D., F.R.S.
Thomas Ashton, Esq., J.P., D.L.
Oliver Heywood, Esq., J.P., D.L.
James Prescott Joule, Esq., D.C.L., LL.D., F.R.S., F.R.S.E., F.C.S.

The Right Hon. the Earl of Cork and Orrery, Lord Lieutenant of Somers-
set
The Most Noble the Marquis of Bath
The Right Hon. and Right Rev. the Lord Bishop of Bath and Wells, D.D.
The Right Rev. the Bishop of Clifton, D.D.
The Right Worshipful the Mayor of Bath
The Right Worshipful the Mayor of Bristol
Sir F. A. Abel, C.B., D.C.L., F.R.S., V.P.O.S.
The Venerable the Archdeacon of Bath, M.A.
The Rev. Leonard Blomfield, M.A., F.L.S., F.G.S.
Professor Michael Foster, M.A., M.D., LL.D., Sec. R.S., F.L.S., F.C.S.
W. S. Gore-Langton, Esq., J.P., D.L.
H. D. Skrine, Esq., J.P., D.L.
E. R. Wodehouse, Esq., M.P.
Colonel R. P. Laurie, C.B., M.P.
J erom Murch, Esq., J.P., D.L.

J. W. Crombie, Esq., M.A.,
Angus Fraser, Esq., M.A., M.D., F.C.S.
Professor G. Pirie, M.A.

J. Barham Carslake, Esq.,
Rev. H. W. Crosskey, LL.D., F.G.S.
Charles J. Hart, Esq.

F. J. Faraday, Esq., F.L.S., F.S.S.,
Charles Hopkinson, Esq., B.Sc.
Professor A. Milnes Marshall, M.A., M.D.,
D.Sc., F.R.S.
Professor A. H. Young, M.B., F.R.C.S.

W. Pumphrey, Esq.,
J. L. Stothert, Esq., M.Inst.C.E.
B. H. Watts, Esq.

Presidents and Secretaries of the Sections of the Association.

Date and Place	Presidents	Secretaries
MATHEMATICAL AND PHYSICAL SCIENCES.		
COMMITTEE OF SCIENCES, I.—MATHEMATICS AND GENERAL PHYSICS.		
1832. Oxford.....	Davies Gilbert, D.C.L., F.R.S.	Rev. H. Coddington.
1833. Cambridge	Sir D. Brewster, F.R.S.	Prof. Forbes.
1834. Edinburgh	Rev. W. Whewell, F.R.S.	Prof. Forbes, Prof. Lloyd.
SECTION A.—MATHEMATICS AND PHYSICS.		
1835. Dublin.....	Rev. Dr. Robinson	Prof. Sir W. R. Hamilton, Prof. Wheatstone.
1836. Bristol.....	Rev. William Whewell, F.R.S.	Prof. Forbes, W. S. Harris, F. W. Jerrard.
1837. Liverpool...	Sir D. Brewster, F.R.S.	W. S. Harris, Rev. Prof. Powell, Prof. Stevelly.
1838. Newcastle	Sir J. F. W. Herschel, Bart., F.R.S.	Rev. Prof. Chevallier, Major Sabine, Prof. Stevelly.
1839. Birmingham	Rev. Prof. Whewell, F.R.S....	J. D. Chance, W. Snow Harris, Prof. Stevelly.
1840. Glasgow ...	Prof. Forbes, F.R.S.....	Rev. Dr. Forbes, Prof. Stevelly, Arch. Smith.
1841. Plymouth	Rev. Prof. Lloyd, F.R.S.	Prof. Stevelly.
1842. Manchester	Very Rev. G. Peacock, D.D., F.R.S.	Prof. McCulloch, Prof. Stevelly, Rev. W. Scoresby.
1843. Cork.....	Prof. McCulloch, M.R.I.A. ...	J. Nott, Prof. Stevelly.
1844. York.....	The Earl of Rosse, F.R.S. ...	Rev. Wm. Hey, Prof. Stevelly.
1845. Cambridge	The Very Rev. the Dean of Ely.	Rev. H. Goodwin, Prof. Stevelly, G. G. Stokes.
1846. Southamp- ton.	Sir John F. W. Herschel, Bart., F.R.S.	John Drew, Dr. Stevelly, G. G. Stokes.
1847. Oxford.....	Rev. Prof. Powell, M.A., F.R.S.	Rev. H. Price, Prof. Stevelly, G. G. Stokes.
1848. Swansea ...	Lord Wrottesley, F.R.S.	Dr. Stevelly, G. G. Stokes.
1849. Birmingham	William Hopkins, F.R.S.....	Prof. Stevelly, G. G. Stokes, W. Ridout Wills.
1850. Edinburgh	Prof. J. D. Forbes, F.R.S., Sec. R.S.E.	W. J. Macquorn Rankine, Prof. Smyth, Prof. Stevelly, Prof. G. G. Stokes.
1851. Ipswich ...	Rev. W. Whewell, D.D., F.R.S.	S. Jackson, W. J. Macquorn Rankine, Prof. Stevelly, Prof. G. G. Stokes.
1852. Belfast.....	Prof. W. Thomson, M.A., F.R.S. L. & E.	Prof. Dixon, W. J. Macquorn Rankine, Prof. Stevelly, J. Tyndall.
1853. Hull.....	The Very Rev. the Dean of Ely, F.R.S.	B. Blaydes Haworth, J. D. Sollitt, Prof. Stevelly, J. Welsh.
1854. Liverpool...	Prof. G. G. Stokes, M.A., Sec. R.S.	J. Hartnup, H. G. Puckle, Prof. Stevelly, J. Tyndall, J. Welsh.
1855. Glasgow ...	Rev. Prof. Kelland, M.A., F.R.S. L. & E.	Rev. Dr. Forbes, Prof. D. Gray, Prof. Tyndall.
1856. Cheltenham	Rev. R. Walker, M.A., F.R.S.	C. Brooke, Rev. T. A. Southwood, Prof. Stevelly, Rev. J. C. Turnbull.
1857. Dublin.....	Rev. T. R. Robinson, D.D., F.R.S., M.R.I.A.	Prof. Curtis, Prof. Hennessy, P. A. Ninnis, W. J. Macquorn Rankine, Prof. Stevelly.
1858. Leeds	Rev. W. Whewell, D.D., V.P.R.S.	Rev. S. Earnshaw, J. P. Hennessy, Prof. Stevelly, H. J. S. Smith, Prof. Tyndall.

Date and Place	Presidents	Secretaries
1859. Aberdeen...	The Earl of Rosse, M.A., K.P., F.R.S.	J. P. Hennessy, Prof. Maxwell, H. J. S. Smith, Prof. Stevelly.
1860. Oxford.....	Rev. B. Price, M.A., F.R.S....	Rev. G. C. Bell, Rev. T. Rennison, Prof. Stevelly.
1861. Manchester	G. B. Airy, M.A., D.C.L., F.R.S.	Prof. R. B. Clifton, Prof. H. J. S. Smith, Prof. Stevelly.
1862. Cambridge	Prof. G. G. Stokes, M.A., F.R.S.	Prof. R. B. Clifton, Prof. H. J. S. Smith, Prof. Stevelly.
1863. Newcastle	Prof. W. J. Macquorn Rankine, C.E., F.R.S.	Rev. N. Ferraers, Prof. Fuller, F. Jenkin, Prof. Stevelly, Rev. C. T. Whitley.
1864. Bath.....	Prof. Cayley, M.A., F.R.S., F.R.A.S.	Prof. Fuller, F. Jenkin, Rev. G. Buckle, Prof. Stevelly.
1865. Birmingham	W. Spottiswoode, M.A., F.R.S., F.R.A.S.	Rev. T. N. Hutchinson, F. Jenkin, G. S. Mathews, Prof. H. J. S. Smith, J. M. Wilson.
1866. Nottingham	Prof. Wheatstone, D.C.L., F.R.S.	Fleeming Jenkin, Prof. H. J. S. Smith, Rev. S. N. Swann.
1867. Dundee ...	Prof. Sir W. Thomson, D.C.L., F.R.S.	Rev. G. Buckle, Prof. G. C. Foster, Prof. Fuller, Prof. Swan.
1868. Norwich ...	Prof. J. Tyndall, LL.D., F.R.S.	Prof. G. C. Foster, Rev. R. Harley, R. B. Hayward.
1869. Exeter	Prof. J. J. Sylvester, LL.D., F.R.S.	Prof. G. C. Foster, R. B. Hayward, W. K. Clifford.
1870. Liverpool...	J. Clerk Maxwell, M.A., LL.D., F.R.S.	Prof. W. G. Adams, W. K. Clifford, Prof. G. C. Foster, Rev. W. Allen Whitworth.
1871. Edinburgh	Prof. P. G. Tait, F.R.S.E. ...	Prof. W. G. Adams, J. T. Bottomley, Prof. W. K. Clifford, Prof. J. D. Everett, Rev. R. Harley.
1872. Brighton ...	W. De La Rue, D.C.L., F.R.S.	Prof. W. K. Clifford, J. W. L. Glaisher, Prof. A. S. Herschel, G. F. Rodwell.
1873. Bradford ...	Prof. H. J. S. Smith, F.R.S.	Prof. W. K. Clifford, Prof. Forbes, J. W. L. Glaisher, Prof. A. S. Herschel.
1874. Belfast.....	Rev. Prof. J. H. Jellett, M.A., M.R.I.A.	J. W. L. Glaisher, Prof. Herschel, Randal Nixon, J. Perry, G. F. Rodwell.
1875. Bristol	Prof. Balfour Stewart, M.A., LL.D., F.R.S.	Prof. W. F. Barrett, J. W. L. Glaisher, C. T. Hudson, G. F. Rodwell.
1876. Glasgow ...	Prof. Sir W. Thomson, M.A., D.C.L., F.R.S.	Prof. W. F. Barrett, J. T. Bottomley, Prof. G. Forbes, J. W. L. Glaisher, T. Muir.
1877. Plymouth...	Prof. G. C. Foster, B.A., F.R.S., Pres. Physical Soc.	Prof. W. F. Barrett, J. T. Bottomley, J. W. L. Glaisher, F. G. Landon.
1878. Dublin.....	Rev. Prof. Salmon, D.D., D.C.L., F.R.S.	Prof. J. Casey, G. F. Fitzgerald, J. W. L. Glaisher, Dr. O. J. Lodge.
1879. Sheffield ...	George Johnstone Stoney, M.A., F.R.S.	A. H. Allen, J. W. L. Glaisher, Dr. O. J. Lodge, D. MacAlister.
1880. Swansea ...	Prof. W. Grylls Adams, M.A., F.R.S.	W. E. Ayrton, J. W. L. Glaisher, Dr. O. J. Lodge, D. MacAlister.
1881. York.....	Prof. Sir W. Thomson, M.A., LL.D., D.C.L., F.R.S.	Prof. W. E. Ayrton, Prof. O. J. Lodge, D. MacAlister, Rev. W. Routh.
1882. Southamp- ton.	Rt. Hon. Prof. Lord Rayleigh, M.A., F.R.S.	W. M. Hicks, Prof. O. J. Lodge, D. MacAlister, Rev. G. Richardson.
1883. Southport	Prof. O. Henrici, Ph.D., F.R.S.,	W. M. Hicks, Prof. O. J. Lodge, D. MacAlister, Prof. R. C. Rowe.
1884. Montreal ...	Prof. Sir W. Thomson, M.A., LL.D., D.C.L. F.R.S	C. Carpmael, W. M. Hicks, Prof. A. Johnson, Prof. O. J. Lodge, Dr. D. MacAlister.

Date and Place	Presidents	Secretaries
1885. Aberdeen...	Prof. G. Chrystal, M.A., F.R.S.E.	R. E. Baynes, R. T. Glazebrook, Prof. W. M. Hicks, Prof. W. Ingram.
1886. Birmingham	Prof. G. H. Darwin, M.A., LL.D., F.R.S.	R. E. Baynes, R. T. Glazebrook, Prof. J. H. Poynting, W. N. Shaw.
1887. Manchester	Prof. Sir R. S. Ball, M.A., LL.D., F.R.S.	R. E. Baynes, R. T. Glazebrook, Prof. H. Lamb, W. N. Shaw.
1888. Bath	Prof. G. F. Fitzgerald, M.A., F.R.S.	R. E. Baynes, R. T. Glazebrook, A. Lodge, W. N. Shaw.

CHEMICAL SCIENCE.

COMMITTEE OF SCIENCES, II.—CHEMISTRY, MINERALOGY.

1832. Oxford.....	John Dalton, D.C.L., F.R.S.	James F. W. Johnston.
1833. Cambridge	John Dalton, D.C.L., F.R.S.	Prof. Miller.
1834. Edinburgh	Dr. Hope.....	Mr. Johnston, Dr Christison.

SECTION B.—CHEMISTRY AND MINERALOGY.

1835. Dublin.....	Dr. T. Thomson, F.R.S.	Dr. Apjohn, Prof. Johnston.
1836. Bristol.....	Rev. Prof. Cumming	Dr. Apjohn, Dr. C. Henry, W. Hera- path.
1837. Liverpool...	Michael Faraday, F.R.S.....	Prof. Johnston, Prof. Miller, Dr. Reynolds.
1838. Newcastle	Rev. William Whewell, F.R.S.	Prof. Miller, H. L. Pattinson, Thomas Richardson.
1839. Birmingham	Prof. T. Graham, F.R.S.	Dr. Golding Bird, Dr. J. B. Melson.
1840. Glasgow ...	Dr. Thomas Thomson, F.R.S.	Dr. R. D. Thomson, Dr. T. Clark, Dr. L. Playfair.
1841. Plymouth...	Dr. Daubeny, F.R.S.	J. Prideaux, Robert Hunt, W. M. Tweedy.
1842. Manchester	John Dalton, D.C.L., F.R.S.	Dr. L. Playfair, R. Hunt, J. Graham.
1843. Cork.....	Prof. Apjohn, M.R.I.A.....	R. Hunt, Dr. Sweeny.
1844. York.....	Prof. T. Graham, F.R.S.	Dr. L. Playfair, E. Solly, T. H. Barker.
1845. Cambridge	Rev. Prof. Cumming	R. Hunt, J. P. Joule, Prof. Miller, E. Solly.
1846. Southamp- ton	Michael Faraday, D.C.L., F.R.S.	Dr. Miller, R. Hunt, W. Randall.
1847. Oxford.....	Rev. W. V. Harcourt, M.A., F.R.S.	B. C. Brodie, R. Hunt, Prof. Solly.
1848. Swansea ...	Richard Phillips, F.R.S.	T. H. Henry, R. Hunt, T. Williams.
1849. Birmingham	John Percy, M.D., F.R.S.....	R. Hunt, G. Shaw.
1850. Edinburgh	Dr. Christison, V.P.R.S.E.	Dr. Anderson, R. Hunt, Dr. Wilson.
1851. Ipswich ...	Prof. Thomas Graham, F.R.S.	T. J. Pearsall, W. S. Ward.
1852. Belfast.....	Thomas Andrews, M.D., F.R.S.	Dr. Gladstone, Prof. Hodges, Prof. Ronalds.
1853. Hull	Prof. J. F. W. Johnston, M.A., F.R.S.	H. S. Blundell, Prof. R. Hunt, T. J. Pearsall.
1854. Liverpool	Prof. W. A. Miller, M.D., F.R.S.	Dr. Edwards, Dr. Gladstone, Dr. Price.
1855. Glasgow ...	Dr. Lyon Playfair, C.B., F.R.S.	Prof. Frankland, Dr. H. E. Roscoe.
1856. Cheltenham	Prof. B. C. Brodie, F.R.S. ...	J. Horsley, P. J. Worsley, Prof. Voelcker.
1857. Dublin.....	Prof. Apjohn, M.D., F.R.S., M.R.I.A.	Dr. Davy, Dr. Gladstone, Prof. Sul- livan.
1858. Leeds	Sir J. F. W. Herschel, Bart., D.C.L.	Dr. Gladstone, W. Odling, R. Rey- nolds.
1859. Aberdeen...	Dr. Lyon Playfair, C.B., F.R.S.	J. S. Brazier, Dr. Gladstone, G. D. Liveing, Dr. Odling.

Date and Place	Presidents	Secretaries
1860. Oxford.....	Prof. B. C. Brodie, F.R.S.....	A. Vernon Harcourt, G. D. Liveing, A. B. Northcote.
1861. Manchester	Prof. W.A. Miller, M.D., F.R.S.	A. Vernon Harcourt, G. D. Liveing.
1862. Cambridge	Prof. W.A. Miller, M.D., F.R.S.	H. W. Elphinstone, W. Odling, Prof. Roscoe.
1863. Newcastle	Dr. Alex. W. Williamson, F.R.S.	Prof. Liveing, H. L. Pattinson, J. C. Stevenson.
1864. Bath.....	W. Odling, M.B., F.R.S., F.C.S.	A. V. Harcourt, Prof. Liveing, R. Biggs.
1865. Birmingham	Prof. W. A. Miller, M.D., V.P.R.S.	A. V. Harcourt, H. Adkins, Prof. Wanklyn, A. Winkler Wills.
1866. Nottingham	H. Bence Jones, M.D., F.R.S.	J. H. Atherton, Prof. Liveing, W. J. Russell, J. White.
1867. Dundee ...	Prof. T. Anderson, M.D., F.R.S.E.	A. Crum Brown, Prof. G. D. Liveing, W. J. Russell.
1868. Norwich ...	Prof. E. Frankland, F.R.S., F.C.S.	Dr. A. Crum Brown, Dr. W. J. Russell, F. Sutton.
1869. Exeter	Dr. H. Debus, F.R.S., F.C.S.	Prof. A. Crum Brown, Dr. W. J. Russell, Dr. Atkinson.
1870. Liverpool...	Prof. H. E. Roscoe, B.A., F.R.S., F.C.S.	Prof. A. Crum Brown, A. E. Fletcher, Dr. W. J. Russell.
1871. Edinburgh	Prof. T. Andrews, M.D., F.R.S.	J. T. Buchanan, W. N. Hartley, T. E. Thorpe.
1872. Brighton ...	Dr. J. H. Gladstone, F.R.S....	Dr. Mills, W. Chandler Roberts, Dr. W. J. Russell, Dr. T. Wood.
1873. Bradford ...	Prof. W. J. Russell, F.R.S....	Dr. Armstrong, Dr. Mills, W. Chandler Roberts, Dr. Thorpe.
1874. Belfast.....	Prof. A. Crum Brown, M.D., F.R.S.E., F.C.S.	Dr. T. Cranstoun Charles, W. Chandler Roberts, Prof. Thorpe.
1875. Bristol	A. G. Vernon Harcourt, M.A., F.R.S., F.C.S.	Dr. H. E. Armstrong, W. Chandler Roberts, W. A. Tilden.
1876. Glasgow ...	W. H. Perkin, F.R.S.	W. Dittmar, W. Chandler Roberts, J. M. Thomson, W. A. Tilden.
1877. Plymouth...	F. A. Abel, F.R.S., F.C.S. ...	Dr. Oxland, W. Chandler Roberts, J. M. Thomson.
1878. Dublin	Prof. Maxwell Simpson, M.D., F.R.S., F.C.S.	W. Chandler Roberts, J. M. Thomson, Dr. C. R. Tichborne, T. Wills.
1879. Sheffield ...	Prof. Dewar, M.A., F.R.S.	H. S. Bell, W. Chandler Roberts, J. M. Thomson.
1880. Swansea ...	Joseph Henry Gilbert, Ph.D., F.R.S.	P. Phillips Bedson, H. B. Dixon, Dr. W. R. Eaton Hodgkinson, J. M. Thomson.
1881. York.....	Prof. A. W. Williamson, Ph.D., F.R.S.	P. Phillips Bedson, H. B. Dixon, T. Gough.
1882. Southamp- ton.	Prof. G. D. Liveing, M.A., F.R.S.	P. Phillips Bedson, H. B. Dixon, J. L. Notter.
1883. Southport	Dr. J. H. Gladstone, F.R.S....	Prof. P. Phillips Bedson, H. B. Dixon, H. Forster Morley.
1884. Montreal ...	Prof. Sir H. E. Roscoe, Ph.D., LL.D., F.R.S.	Prof. P. Phillips Bedson, H. B. Dixon, T. McFarlane, Prof. W. H. Pike.
1885. Aberdeen...	Prof. H. E. Armstrong, Ph.D., F.R.S., Sec. C.S.	Prof. P. Phillips Bedson, H. B. Dixon, H. Forster Morley, Dr. W. J. Simpson.
1886. Birmingham	W. Crookes, F.R.S., V.P.C.S.	Prof. P. Phillips Bedson, H. B. Dixon, H. Forster Morley, W. W. J. Nicol, C. J. Woodward.
1887. Manchester	Dr. E. Schunck, F.R.S., F.C.S.	Prof. P. Phillips Bedson, H. Forster Morley, W. Thomson.
1888. Bath.....	Prof. W. A. Tilden, D.Sc., F.R.S., V.P.C.S.	Prof. H. B. Dixon, Dr. H. Forster Morley, R. E. Moyle, Dr. W. W. J. Nicol.

Date and Place	Presidents	Secretaries
GEOLOGICAL (AND, UNTIL 1851, GEOGRAPHICAL) SCIENCE.		
COMMITTEE OF SCIENCES, III.—GEOLOGY AND GEOGRAPHY.		
1832. Oxford	R. I. Murchison, F.R.S.	John Taylor.
1833. Cambridge.	G. B. Greenough, F.R.S.	W. Lonsdale, John Phillips.
1834. Edinburgh.	Prof. Jameson	Prof. Phillips, T. Jameson Torrie, Rev. J. Yates.

SECTION C.—GEOLOGY AND GEOGRAPHY.

1835. Dublin	R. J. Griffith	Captain Portlock, T. J. Torrie.
1836. Bristol	Rev. Dr. Buckland, F.R.S.— <i>Geography</i> , R. I. Murchison, F.R.S.	William Sanders, S. Stutchbury, T. J. Torrie.
1837. Liverpool...	Rev. Prof. Sedgwick, F.R.S.— <i>Geography</i> , G.B.Greenough, F.R.S.	Captain Portlock, R. Hunter.— <i>Geography</i> , Captain H. M. Denham, R.N.
1838. Newcastle..	C. Lyell, F.R.S., V.P.G.S.— <i>Geography</i> , Lord Prudhope.	W. C. Trevelyan, Capt. Portlock.— <i>Geography</i> , Capt. Washington.
1839. Birmingham	Rev. Dr. Buckland, F.R.S.— <i>Geography</i> , G.B.Greenough, F.R.S.	George Lloyd, M.D., H. E. Strick- land, Charles Darwin.
1840. Glasgow ...	Charles Lyell, F.R.S.— <i>Geography</i> , G. B. Greenough, F.R.S.	W. J. Hamilton, D. Milne, Hugh Murray, H. E. Strickland, John Scouler, M.D.
1841. Plymouth...	H. T. De la Beche, F.R.S. ...	W. J. Hamilton, Edward Moore, M.D., R. Hutton.
1842. Manchester	R. I. Murchison, F.R.S.	E. W. Binney, R. Hutton, Dr. R. Lloyd, H. E. Strickland.
1843. Cork	Richard E. Griffith, F.R.S., M.R.I.A.	Francis M. Jennings, H. E. Strick- land.
1844. York	Henry Warburton, M.P., Pres. Geol. Soc.	Prof. Ansted, E. H. Bunbury.
1845. Cambridge.	Rev. Prof. Sedgwick, M.A., F.R.S.	Rev. J. C. Cumming, A. C. Ramsay, Rev. W. Thorp.
1846. Southamp- ton.	Leonard Horner, F.R.S.— <i>Geography</i> , G. B. Greenough, F.R.S.	Robert A. Austen, Dr. J. H. Norton, Prof. Oldham.— <i>Geography</i> , Dr. C. T. Beke.
1847. Oxford.....	Very Rev. Dr. Buckland, F.R.S.	Prof. Ansted, Prof. Oldham, A. C. Ramsay, J. Ruskin.
1848. Swansea ...	Sir H. T. De la Beche, C.B., F.R.S.	Starling Benson, Prof. Oldham, Prof. Ramsay.
1849. Birmingham	Sir Charles Lyell, F.R.S., F.G.S.	J. Beete Jukes, Prof. Oldham, Prof. A. C. Ramsay.
1850. Edinburgh ¹	Sir Roderick I. Murchison, F.R.S.	A. Keith Johnston, Hugh Miller, Prof. Nicol.

SECTION C (*continued*).—GEOLOGY.

1851. Ipswich ...	William Hopkins, M.A., F.R.S.	C. J. F. Bunbury, G. W. Ormerod, Searles Wood.
1852. Belfast.....	Lieut.-Col. Portlock, R.E., F.R.S.	James Bryce, James MacAdam, Prof. M'Coy, Prof. Nicol.

¹ At a meeting of the General Committee held in 1850, it was resolved 'That the subject of Geography be separated from Geology and combined with Ethnology, to constitute a separate Section, under the title of the "Geographical and Ethnological Section,"' for Presidents and Secretaries of which see page liv.

Date and Place	Presidents	Secretaries
1853. Hull	Prof. Sedgwick, F.R.S.....	Prof. Harkness, William Lawton.
1854. Liverpool ..	Prof. Edward Forbes, F.R.S.	John Cunningham, Prof. Harkness, G. W. Ormerod, J. W. Woodall.
1855. Glasgow ...	Sir R. I. Murchison, F.R.S....	James Bryce, Prof. Harkness, Prof. Nicol.
1856. Cheltenham	Prof. A. C. Ramsay, F.R.S....	Rev. P. B. Brodie, Rev. R. Hep- worth, Edward Hull, J. Scougall, T. Wright.
1857. Dublin	The Lord Talbot de Malahide	Prof. Harkness, Gilbert Sanders, Robert H. Scott.
1858. Leeds	William Hopkins, M.A., LL.D., F.R.S.	Prof. Nicol, H. C. Sorby, E. W. Shaw.
1859. Aberdeen...	Sir Charles Lyell, LL.D., D.C.L., F.R.S.	Prof. Harkness, Rev. J. Longmuir, H. C. Sorby.
1860. Oxford	Rev. Prof. Sedgwick, LL.D., F.R.S., F.G.S.	Prof. Harkness, Edward Hull, Capt. D. C. L. Woodall.
1861. Manchester	Sir R. I. Murchison, D.C.L., LL.D., F.R.S.	Prof. Harkness, Edward Hull, T. Rupert Jones, G. W. Ormerod.
1862. Cambridge	J. Beete Jukes, M.A., F.R.S.	Lucas Barrett, Prof. T. Rupert Jones, H. C. Sorby.
1863. Newcastle	Prof. Warrington W. Smyth, F.R.S., F.G.S.	E. F. Boyd, John Daglish, H. C. Sorby, Thomas Sopwith.
1864. Bath.....	Prof. J. Phillips, LL.D., F.R.S., F.G.S.	W. B. Dawkins, J. Johnston, H. C. Sorby, W. Pengelly.
1865. Birmingham	Sir R. I. Murchison, Bart., K.C.B.	Rev. P. B. Brodie, J. Jones, Rev. E. Myers, H. C. Sorby, W. Pengelly.
1866. Nottingham	Prof. A. C. Ramsay, LL.D., F.R.S.	R. Etheridge, W. Pengelly, T. Wil- son, G. H. Wright.
1867. Dundee ...	Archibald Geikie, F.R.S., F.G.S.	Edward Hull, W. Pengelly, Henry Woodward.
1868. Norwich ...	R. A. C. Godwin-Austen, F.R.S., F.G.S.	Rev. O. Fisher, Rev. J. Gunn, W. Pengelly, Rev. H. H. Winwood.
1869. Exeter	Prof. R. Harkness, F.R.S., F.G.S.	W. Pengelly, W. Boyd Dawkins, Rev. H. H. Winwood.
1870. Liverpool...	Sir Philip de M. Grey Egerton, Bart., M.P., F.R.S.	W. Pengelly, Rev. H. H. Winwood, W. Boyd Dawkins, G. H. Morton.
1871. Edinburgh	Prof. A. Geikie, F.R.S., F.G.S.	R. Etheridge, J. Geikie, T. McKenny Hughes, L. C. Miall.
1872. Brighton ...	R. A. C. Godwin-Austen, F.R.S., F.G.S.	L. C. Miall, George Scott, William Topley, Henry Woodward.
1873. Bradford ...	Prof. J. Phillips, D.C.L., F.R.S., F.G.S.	L. C. Miall, R. H. Tiddeman, W. Topley.
1874. Belfast.....	Prof. Hull, M.A., F.R.S., F.G.S.	F. Drew, L. C. Miall, R. G. Symes, R. H. Tiddeman.
1875. Bristol	Dr. Thomas Wright, F.R.S.E., F.G.S.	L. C. Miall, E. B. Tawney, W. Top- ley.
1876. Glasgow ...	Prof. John Young, M.D.	J. Armstrong, F. W. Rudler, W. Topley.
1877. Plymouth...	W. Pengelly, F.R.S.....	Dr. Le Neve Foster, R. H. Tidge- man, W. Topley.
1878. Dublin.....	John Evans, D.C.L., F.R.S., F.S.A., F.G.S.	E. T. Hardman, Prof. J. O'Reilly, R. H. Tiddeman.
1879. Sheffield ...	Prof. P. Martin Duncan, M.B., F.R.S., F.G.S.	W. Topley, G. Blake Walker.
1880. Swansea ...	H. C. Sorby, LL.D., F.R.S., F.G.S.	W. Topley, W. Whitaker.
1881. York.....	A. C. Ramsay, LL.D., F.R.S., F.G.S.	J. E. Clark, W. Keeping, W. Topley, W. Whitaker.
1882. Southamp- ton.	R. Etheridge, F.R.S., F.G.S.	T. W. Shore, W. Topley, E. West- lake, W. Whitaker.

Date and Place	Presidents	Secretaries
1883. Southport	Prof. W. C. Williamson, LL.D., F.R.S.	R. Betley, C. E. De Rance, W. Topley, W. Whitaker.
1884. Montreal ...	W. T. Blanford, F.R.S., Sec. G.S.	F. Adams, Prof. E. W. Claypole, W. Topley, W. Whitaker.
1885. Aberdeen ...	Prof. J. W. Judd, F.R.S., Sec. G.S.	C. E. De Rance, J. Horne, J. J. H. Teall, W. Topley.
1886. Birmingham	Prof. T. G. Bonney, D.Sc., LL.D., F.R.S., F.G.S.	W. J. Harrison, J. J. H. Teall, W. Topley, W. W. Watts.
1887. Manchester	Henry Woodward, LL.D., F.R.S., F.G.S.	J. E. Marr, J. J. H. Teall, W. Topley, W. W. Watts.
1888. Bath.....	Prof. W. Boyd Dawkins, M.A., F.R.S., F.G.S.	Prof. G. A. Lebour, W. Topley, W. W. Watts, H. B. Woodward.

BIOLOGICAL SCIENCES.

COMMITTEE OF SCIENCES, IV.—ZOOLOGY, BOTANY, PHYSIOLOGY, ANATOMY.

1832. Oxford.....	Rev. P. B. Duncan, F.G.S. ...	Rev. Prof. J. S. Henslow.
1833. Cambridge ¹	Rev. W. L. P. Garnons, F.L.S.	C. C. Babington, D. Don.
1834. Edinburgh.	Prof. Graham.....	W. Yarrell, Prof. Burnett.

SECTION D.—ZOOLOGY AND BOTANY.

1835. Dublin.....	Dr. Allman.....	J. Curtis, Dr. Litton.
1836. Bristol.....	Rev. Prof. Henslow	J. Curtis, Prof. Don, Dr. Riley, S. Rootsey.
1837. Liverpool...	W. S. MacLeay.....	C. C. Babington, Rev. L. Jenyns, W. Swainson.
1838. Newcastle	Sir W. Jardine, Bart.	J. E. Gray, Prof. Jones, R. Owen, Dr. Richardson.
1839. Birmingham	Prof. Owen, F.R.S.	E. Forbes, W. Ick, R. Patterson.
1840. Glasgow ...	Sir W. J. Hooker, LL.D.....	Prof. W. Couper, E. Forbes, R. Patterson.
1841. Plymouth...	John Richardson, M.D., F.R.S.	J. Couch, Dr. Lankester, R. Patterson.
1842. Manchester	Hon. and Very Rev. W. Herbert, LL.D., F.L.S.	Dr. Lankester, R. Patterson, J. A. Turner.
1843. Cork.....	William Thompson, F.L.S. ...	G. J. Allman, Dr. Lankester, R. Patterson.
1844. York.....	Very Rev. the Dean of Manchester.	Prof. Allman, H. Goodsir, Dr. King, Dr. Lankester.
1845. Cambridge	Rev. Prof. Henslow, F.L.S....	Dr. Lankester, T. V. Wollaston.
1846. Southampton.	Sir J. Richardson, M.D., F.R.S.	Dr. Lankester, T. V. Wollaston, H. Wooldridge.
1847. Oxford.....	H. E. Strickland, M.A., F.R.S.	Dr. Lankester, Dr. Melville, T. V. Wollaston.

SECTION D (*continued*).—ZOOLOGY AND BOTANY, INCLUDING PHYSIOLOGY.

[For the Presidents and Secretaries of the Anatomical and Physiological Subsections and the temporary Section E of Anatomy and Medicine, see p. liii.]

1848. Swansea ...	L. W. Dillwyn, F.R.S.....	Dr. R. Wilbraham Falconer, A. Henfrey, Dr. Lankester.
1849. Birmingham	William Spence, F.R.S.	Dr. Lankester, Dr. Russell.
1850. Edinburgh	Prof. Goodsir, F.R.S. L. & E.	Prof. J. H. Bennett, M.D., Dr. Lankester, Dr. Douglas MacLagan.

¹ At this Meeting Physiology and Anatomy were made a separate Committee, for Presidents and Secretaries of which see p. liii.

Date and Place	Presidents	Secretaries
1851. Ipswich ...	Rev. Prof. Henslow, M.A., F.R.S.	Prof. Allman, F. W. Johnston, Dr. E. Lankester.
1852. Belfast.....	W. Ogilby	Dr. Dickie, George C. Hyndman, Dr. Edwin Lankester.
1853. Hull	C. C. Babington, M.A., F.R.S.	Robert Harrison, Dr. E. Lankester.
1854. Liverpool...	Prof. Balfour, M.D., F.R.S....	Isaac Byerley, Dr. E. Lankester.
1855. Glasgow ...	Rev. Dr. Fleeming, F.R.S.E.	William Keddie, Dr. Lankester.
1856. Cheltenham	Thomas Bell, F.R.S., Pres.L.S.	Dr. J. Abercrombie, Prof. Buckman, Dr. Lankester.
1857. Dublin.....	Prof. W. H. Harvey, M.D., F.R.S.	Prof. J. R. Kinahan, Dr. E. Lankester, Robert Patterson, Dr. W. E. Steele.
1858. Leeds	C. C. Babington, M.A., F.R.S.	Henry Denny, Dr. Heaton, Dr. E. Lankester, Dr. E. Perceval Wright.
1859. Aberdeen...	Sir W. Jardine, Bart., F.R.S.E.	Prof. Dickie, M.D., Dr. E. Lankester, Dr. Ogilvy.
1860. Oxford.....	Rev. Prof. Henslow, F.L.S....	W. S. Church, Dr. E. Lankester, P. L. Sclater, Dr. E. Perceval Wright.
1861. Manchester	Prof. C. C. Babington, F.R.S.	Dr. T. Alcock, Dr. E. Lankester, Dr. P. L. Sclater, Dr. E. P. Wright.
1862. Cambridge	Prof. Huxley, F.R.S.	Alfred Newton, Dr. E. P. Wright.
1863. Newcastle	Prof. Balfour, M.D., F.R.S....	Dr. E. Charlton, A. Newton, Rev. H. B. Tristram, Dr. E. P. Wright.
1864. Bath	Dr. John E. Gray, F.R.S. ...	H. B. Brady, C. E. Broom, H. T. Stainton, Dr. E. P. Wright.
1865. Birmingham	T. Thomson, M.D., F.R.S. ...	Dr. J. Anthony, Rev. C. Clarke, Rev. H. B. Tristram, Dr. E. P. Wright.

SECTION D (*continued*).—BIOLOGY.¹

1866. Nottingham	Prof. Huxley, LL.D., F.R.S. — <i>Physiological Dep.</i> , Prof. Humphry, M.D., F.R.S.— <i>Anthropological Dep.</i> , Alf. R. Wallace, F.R.G.S.	Dr. J. Beddard, W. Felkin, Rev. H. B. Tristram, W. Turner, E. B. Tylor, Dr. E. P. Wright.
1867. Dundee ...	Prof. Sharpey, M.D., Sec. R.S. — <i>Dep. of Zool. and Bot.</i> , George Busk, M.D., F.R.S.	C. Spence Bate, Dr. S. Cobbold, Dr. M. Foster, H. T. Stainton, Rev. H. B. Tristram, Prof. W. Turner.
1868. Norwich ...	Rev. M. J. Berkeley, F.L.S. — <i>Dep. of Physiology</i> , W. H. Flower, F.R.S.	Dr. T. S. Cobbold, G. W. Firth, Dr. M. Foster, Prof. Lawson, H. T. Stainton, Rev. Dr. H. B. Tristram, Dr. E. P. Wright.
1869. Exeter	George Busk, F.R.S., F.L.S. — <i>Dep. of Bot. and Zool.</i> , C. Spence Bate, F.R.S.— <i>Dep. of Ethno.</i> , E. B. Tylor.	Dr. T. S. Cobbold, Prof. M. Foster, E. Ray Lankester, Prof. Lawson, H. T. Stainton, Rev. H. B. Tris- tram.
1870. Liverpool...	Prof. G. Rolleston, M.A., M.D., F.R.S., F.L.S.— <i>Dep. of</i> <i>Anat. and Physiol.</i> , Prof. M. Foster, M.D., F.L.S.— <i>Dep.</i> <i>of Ethno.</i> , J. Evans, F.R.S.	Dr. T. S. Cobbold, Sebastian Evans, Prof. Lawson, Thos. J. Moore, H. T. Stainton, Rev. H. B. Tristram, C. Staniland Wake, E. Ray Lan- kester.
1871. Edinburgh.	Prof. Allen Thomson, M.D., F.R.S.— <i>Dep. of Bot. and</i> <i>Zool.</i> , Prof. Wyville Thomson, F.R.S.— <i>Dep. of Anthropol.</i> , Prof. W. Turner, M.D.	Dr. T. R. Fraser, Dr. Arthur Gamgee, E. Ray Lankester, Prof. Lawson, H. T. Stainton, C. Staniland Wake, Dr. W. Rutherford, Dr. Kelburne King.

¹ At a meeting of the General Committee in 1865, it was resolved:—'That the title of Section D be changed to Biology;' and 'That for the word "Subsection," in the rules for conducting the business of the Sections, the word "Department" be substituted.'

Date and Place	Presidents	Secretaries
1872. Brighton ...	Sir J. Lubbock, Bart., F.R.S.— <i>Dep. of Anat. and Physiol.</i> , Dr. Burdon Sanderson, F.R.S.— <i>Dep. of Anthropol.</i> , Col. A. Lane Fox, F.G.S.	Prof. Thiselton-Dyer, H. T. Stainton, Prof. Lawson, F. W. Rudler, J. H. Lamprey, Dr. Gamgee, E. Ray Lankester, Dr. Pye-Smith.
1873. Bradford ...	Prof. Allman, F.R.S.— <i>Dep. of Anat. and Physiol.</i> , Prof. Rutherford, M.D.— <i>Dep. of Anthropol.</i> , Dr. Beddoe, F.R.S.	Prof. Thiselton-Dyer, Prof. Lawson, R. M'Lachlan, Dr. Pye-Smith, E. Ray Lankester, F. W. Rudler, J. H. Lamprey.
1874. Belfast	Prof. Redfern, M.D.— <i>Dep. of Zool. and Bot.</i> , Dr. Hooker, C.B., Pres.R.S.— <i>Dep. of Anthropol.</i> , Sir W.R. Wilde, M.D.	W. T. Thiselton-Dyer, R. O. Cunningham, Dr. J. J. Charles, Dr. P. H. Pye-Smith, J. J. Murphy, F. W. Rudler.
1875. Bristol	P. L. Sclater, F.R.S.— <i>Dep. of Anat. and Physiol.</i> , Prof. Cleland, M.D., F.R.S.— <i>Dep. of Anthropol.</i> , Prof. Rolleston, M.D., F.R.S.	E. R. Alston, Dr. McKendrick, Prof. W. R. M'Nab, Dr. Martyn, F. W. Rudler, Dr. P. H. Pye-Smith, Dr. W. Spencer.
1876. Glasgow ...	A. Russel Wallace, F.R.G.S., F.L.S.— <i>Dep. of Zool. and Bot.</i> , Prof. A. Newton, M.A., F.R.S.— <i>Dep. of Anat. and Physiol.</i> , Dr. J. G. McKendrick, F.R.S.E.	E. R. Alston, Hyde Clarke, Dr. Knox, Prof. W. R. M'Nab, Dr. Muirhead, Prof. Morrison Watson.
1877. Plymouth...	J. Gwyn Jeffreys, LL.D., F.R.S., F.L.S.— <i>Dep. of Anat. and Physiol.</i> , Prof. Macalister, M.D.— <i>Dep. of Anthropol.</i> , Francis Galton, M.A., F.R.S.	E. R. Alston, F. Brent, Dr. D. J. Cunningham, Dr. C. A. Hingston, Prof. W. R. M'Nab, J. B. Rowe, F. W. Rudler.
1878. Dublin	Prof. W. H. Flower, F.R.S.— <i>Dep. of Anthropol.</i> , Prof. Huxley, Sec. R.S.— <i>Dep. of Anat. and Physiol.</i> , R. McDonnell, M.D., F.R.S.	Dr. R. J. Harvey, Dr. T. Hayden, Prof. W. R. M'Nab, Prof. J. M. Purser, J. B. Rowe, F. W. Rudler.
1879. Sheffield ...	Prof. St. George Mivart, F.R.S.— <i>Dep. of Anthropol.</i> , E. B. Tylor, D.C.L., F.R.S.— <i>Dep. of Anat. and Physiol.</i> , Dr. Pye-Smith.	Arthur Jackson, Prof. W. R. M'Nab, J. B. Rowe, F. W. Rudler, Prof. Schäfer.
1880. Swansea ...	A. C. L. Günther, M.D., F.R.S.— <i>Dep. of Anat. and Physiol.</i> , F. M. Balfour, M.A., F.R.S.— <i>Dep. of Anthropol.</i> , F. W. Rudler, F.G.S.	G. W. Bloxam, John Priestley, Howard Saunders, Adam Sedgwick.
1881. York.....	Richard Owen, C.B., M.D., F.R.S.— <i>Dep. of Anthropol.</i> , Prof. W. H. Flower, LL.D., F.R.S.— <i>Dep. of Anat. and Physiol.</i> , Prof. J. S. Burdon Sanderson, M.D., F.R.S.	G. W. Bloxam, W. A. Forbes, Rev. W. C. Hey, Prof. W. R. M'Nab, W. North, John Priestley, Howard Saunders, H. E. Spencer.
1882. Southamp- ton.	Prof. A. Gamgee, M.D., F.R.S.— <i>Dep. of Zool. and Bot.</i> , Prof. M. A. Lawson, M.A., F.L.S.— <i>Dep. of Anthropol.</i> , Prof. W. Boyd Dawkins, M.A., F.R.S.	G. W. Bloxam, W. Heape, J. B. Nias, Howard Saunders, A. Sedgwick, T. W. Shore, jun.

Date and Place	Presidents	Secretaries
1883. Southport ¹	Prof. E. Ray Lankester, M.A., F.R.S.— <i>Dep. of Anthropol.</i> , W. Pengelly, F.R.S.	G. W. Bloxam, Dr. G. J. Haslam, W. Heape, W. Hurst, Prof. A. M. Marshall, Howard Saunders, Dr. G. A. Woods.
1884. Montreal ² ...	Prof. H. N. Moseley, M.A., F.R.S.	Prof. W. Osler, Howard Saunders, A. Sedgwick, Prof. R. R. Wright.
1885. Aberdeen ...	Prof. W. C. McIntosh, M.D., LL.D., F.R.S. L. & E.	W. Heape, J. McGregor-Robertson, J. Duncan Matthews, Howard Saunders, H. Marshall Ward.
1886. Birmingham	W. Carruthers, Pres. L.S., F.R.S., F.G.S.	Prof. T. W. Bridge, W. Heape, Prof. W. Hillhouse, W. L. Sclater, Prof. H. Marshall Ward.
1887. Manchester	Prof. A. Newton, M.A., F.R.S., F.L.S., V.P.Z.S.	C. Bailey, F. E. Beddard, S. F. Har- mer, W. Heape, W. L. Sclater, Prof. H. Marshall Ward.
1888. Bath	W. T. Thiselton-Dyer, C.M.G., F.R.S., F.L.S.	F. E. Beddard, S. F. Harmer, Prof. H. Marshall Ward, W. Gardiner, Prof. W. D. Halliburton.

ANATOMICAL AND PHYSIOLOGICAL SCIENCES.

COMMITTEE OF SCIENCES, V.—ANATOMY AND PHYSIOLOGY.

1833. Cambridge	Dr. Haviland	Dr. Bond, Mr. Paget.
1834. Edinburgh	Dr. Abercrombie	Dr. Roget, Dr. William Thomson.

SECTION E (UNTIL 1847).—ANATOMY AND MEDICINE.

1835. Dublin	Dr. Pritchard.....	Dr. Harrison, Dr. Hart.
1836. Bristol	Dr. Roget, F.R.S.	Dr. Symonds.
1837. Liverpool...	Prof. W. Clark, M.D.	Dr. J. Carson, jun., James Long, Dr. J. R. W. Vose.
1838. Newcastle	T. E. Headlam, M.D.	T. M. Greenhow, Dr. J. R. W. Vose.
1839. Birmingham	John Yelloly, M.D., F.R.S....	Dr. G. O. Rees, F. Ryland.
1840. Glasgow ...	James Watson, M.D.	Dr. J. Brown, Prof. Couper, Prof. Reid.

SECTION E.—PHYSIOLOGY.

1841. Plymouth...	P. M. Roget, M.D., Sec. R.S.	Dr. J. Butter, J. Fuge, Dr. R. S. Sargent.
1842. Manchester	Edward Holme, M.D., F.L.S.	Dr. Chaytor, Dr. R. S. Sargent.
1843. Cork	Sir James Pitcairn, M.D. ...	Dr. John Popham, Dr. R. S. Sargent.
1844. York	J. C. Pritchard, M.D.	I. Erichsen, Dr. R. S. Sargent.
1845. Cambridge	Prof. J. Haviland, M.D.	Dr. R. S. Sargent, Dr. Webster.
1846. Southamp- ton.	Prof. Owen, M.D., F.R.S. ...	C. P. Keele, Dr. Laycock, Dr. Sar- gent.
1847. Oxford* ...	Prof. Ogle, M.D., F.R.S.	Dr. Thomas K. Chambers, W. P. Ormerod.

¹ By direction of the General Committee at Southampton (1882) the Departments of Zoology and Botany and of Anatomy and Physiology were amalgamated.

² By authority of the General Committee, Anthropology was made a separate Section, for Presidents and Secretaries of which see p. lix.

³ By direction of the General Committee at Oxford, Sections D and E were incorporated under the name of 'Section D—Zoology and Botany, including Physiology' (see p. 1). The Section being then vacant was assigned in 1851 to Geography.

Date and Place	Presidents	Secretaries
PHYSIOLOGICAL SUBSECTIONS OF SECTION D.		
1850. Edinburgh	Prof. Bennett, M.D., F.R.S.E.	
1855. Glasgow ...	Prof. Allen Thomson, F.R.S.	Prof. J. H. Corbett, Dr. J. Struthers.
1857. Dublin.....	Prof. R. Harrison, M.D.	Dr. R. D. Lyons, Prof. Redfern.
1858. Leeds	Sir Benjamin Brodie, Bart., F.R.S.	C. G. Wheelhouse.
1859. Aberdeen...	Prof. Sharpey, M.D., Sec.R.S.	Prof. Bennett, Prof. Redfern.
1860. Oxford.....	Prof. G. Rolleston, M.D., F.L.S.	Dr. R. M'Donnell, Dr. Edward Smith.
1861. Manchester	Dr. John Davy, F.R.S.L. & E.	Dr. W. Roberts, Dr. Edward Smith.
1862. Cambridge	G. E. Paget, M.D.....	G. F. Helm, Dr. Edward Smith.
1863. Newcastle	Prof. Rolleston, M.D., F.R.S.	Dr. D. Embleton, Dr. W. Turner.
1864. Bath.....	Dr. Edward Smith, LL.D., F.R.S.	J. S. Bartrum, Dr. W. Turner.
1865. Birmingham, ¹	Prof. Acland, M.D., LL.D., F.R.S.	Dr. A. Fleming, Dr. P. Heslop, Oliver Pembleton, Dr. W. Turner.

GEOGRAPHICAL AND ETHNOLOGICAL SCIENCES.

[For Presidents and Secretaries for Geography previous to 1851, see Section C. p. xlviii.]

ETHNOLOGICAL SUBSECTIONS OF SECTION D.

1846. Southampton	Dr. Pritchard.....	Dr. King.
1847. Oxford	Prof. H. H. Wilson, M.A. ...	Prof. Buckley.
1848. Swansea	G. Grant Francis.
1849. Birmingham	Dr. R. G. Latham.
1850. Edinburgh	Vice-Admiral Sir A. Malcolm	Daniel Wilson.

SECTION E.—GEOGRAPHY AND ETHNOLOGY.

1851. Ipswich ...	Sir R. I. Murchison, F.R.S., Pres. R.G.S.	R. Cull, Rev. J. W. Donaldson, Dr. Norton Shaw.
1852. Belfast.....	Col. Chesney, R.A., D.C.L., F.R.S.	R. Cull, R. MacAdam, Dr. Norton Shaw.
1853. Hull	R. G. Latham, M.D., F.R.S.	R. Cull, Rev. H. W. Kemp, Dr. Norton Shaw.
1854. Liverpool...	Sir R. I. Murchison, D.C.L., F.R.S.	Richard Cull, Rev. H. Higgins, Dr. Ihne, Dr. Norton Shaw.
1855. Glasgow ...	Sir J. Richardson, M.D., F.R.S.	Dr. W. G. Blackie, R. Cull, Dr. Norton Shaw.
1856. Cheltenham	Col. Sir H. C. Rawlinson, K.C.B.	R. Cull, F. D. Hartland, W. H. Rumsey, Dr. Norton Shaw.
1857. Dublin.....	Rev. Dr. J. Henthorn Todd, Pres. R.I.A.	R. Cull, S. Ferguson, Dr. R. R. Madden, Dr. Norton Shaw.
1858. Leeds	Sir R. I. Murchison, G.C.St.S., F.R.S.	R. Cull, Francis Galton, P. O'Cal- laghan, Dr. Norton Shaw, Thomas Wright.
1859. Aberdeen...	Rear - Admiral Sir James Clerk Ross, D.C.L., F.R.S.	Richard Cull, Prof. Geddes, Dr. Nor- ton Shaw.
1860. Oxford.....	Sir R. I. Murchison, D.C.L., F.R.S.	Capt. Burrows, Dr. J. Hunt, Dr. C. Lemprière, Dr. Norton Shaw.
1861. Manchester	John Crawford, F.R.S.....	Dr. J. Hunt, J. Kingsley, Dr. Nor- ton Shaw, W. Spottiswoode.
1862. Cambridge	Francis Galton, F.R.S.....	J.W. Clarke, Rev. J. Glover, Dr. Hunt, Dr. Norton Shaw, T. Wright.

¹ Vide note on page xlviii.

Date and Place	Presidents	Secretaries
1863. Newcastle	Sir R. I. Murchison, K.C.B., F.R.S.	C. Carter Blake, Hume Greenfield, C. R. Markham, R. S. Watson.
1864. Bath.....	Sir R. I. Murchison, K.C.B., F.R.S.	H. W. Bates, C. R. Markham, Capt. R. M. Murchison, T. Wright.
1865. Birmingham	Major-General Sir H. Raw- linson, M.P., K.C.B., F.R.S.	H. W. Bates, S. Evans, G. Jabet, C. R. Markham, Thomas Wright.
1866. Nottingham	Sir Charles Nicholson, Bart., LL.D.	H. W. Bates, Rev. E. T. Cusins, R. H. Major, Clements R. Markham, D. W. Nash, T. Wright.
1867. Dundee ...	Sir Samuel Baker, F.R.G.S.	H. W. Bates, Cyril Graham, Clements R. Markham, S. J. Mackie, R. Sturrock.
1868. Norwich ...	Capt. G. H. Richards, R.N., F.R.S.	T. Baines, H. W. Bates, Clements R. Markham, T. Wright.

SECTION E (*continued*).—GEOGRAPHY.

1869. Exeter	Sir Bartle Frere, K.C.B., LL.D., F.R.G.S.	H. W. Bates, Clements R. Markham J. H. Thomas.
1870. Liverpool...	Sir R. I. Murchison, Bt., K.C.B., LL.D., D.C.L., F.R.S., F.G.S.	H. W. Bates, David Buxton, Albert J. Mott, Clements R. Markham.
1871. Edinburgh	Colonel Yule, C.B., F.R.G.S.	A. Buchan, A. Keith Johnston, Cle- ments R. Markham, J. H. Thomas.
1872. Brighton ...	Francis Galton, F.R.S.....	H. W. Bates, A. Keith Johnston, Rev. J. Newton, J. H. Thomas.
1873. Bradford ...	Sir Rutherford Alcock, K.C.B.	H. W. Bates, A. Keith Johnston, Clements R. Markham.
1874. Belfast.....	Major Wilson, R.E., F.R.S., F.R.G.S.	E. G. Ravenstein, E. C. Rye, J. H. Thomas.
1875. Bristol	Lieut. - General Strachey, R.E., C.S.I., F.R.S., F.R.G.S., F.L.S., F.G.S.	H. W. Bates, E. C. Rye, F. F. Tuckett.
1876. Glasgow ...	Capt. Evans, C.B., F.R.S.....	H. W. Bates, E. C. Rye, R. Oliphant Wood.
1877. Plymouth...	Adm. Sir E. Ommanney, C.B., F.R.S., F.R.G.S., F.R.A.S.	H. W. Bates, F. E. Fox, E. C. Rye.
1878. Dublin.....	Prof. Sir C. Wyville Thom- son, LL.D., F.R.S.L.&E.	John Coles, E. C. Rye.
1879. Sheffield ...	Clements R. Markham, C.B., F.R.S., Sec. R.G.S.	H. W. Bates, C. E. D. Black, E. C. Rye.
1880. Swansea ...	Lieut.-Gen. Sir J. H. Lefroy, C.B., K.C.M.G., R.A., F.R.S., F.R.G.S.	H. W. Bates, E. C. Rye.
1881. York.....	Sir J. D. Hooker, K.C.S.I., C.B., F.R.S.	J. W. Barry, H. W. Bates.
1882. Southamp- ton.	Sir R. Temple, Bart., G.C.S.I., F.R.G.S.	E. G. Ravenstein, E. C. Rye.
1883. Southport	Lieut.-Col. H. H. Godwin- Austen, F.R.S.	John Coles, E. G. Ravenstein, E. C. Rye.
1884. Montreal ...	Gen. Sir J. H. Lefroy, C.B., K.C.M.G., F.R.S., V.P.R.G.S.	Rev. Abbé Laflamme, J. S. O'Halloran, E. G. Ravenstein, J. F. Torrance.
1885. Aberdeen...	Gen. J. T. Walker, C.B., R.E., LL.D., F.R.S.	J. S. Keltie, J. S. O'Halloran, E. G. Ravenstein, Rev. G. A. Smith.
1886. Birmingham	Maj.-Gen. Sir F. J. Goldsmid, K.C.S.I., C.B., F.R.G.S.	F. T. S. Houghton, J. S. Keltie, E. G. Ravenstein.
1887. Manchester	Col. Sir C. Warren, R.E., G.C.M.G., F.R.S., F.R.G.S.	Rev. L. C. Casartelli, J. S. Keltie, H. J. Mackinder, E. G. Raven- stein.
1888. Bath.....	Col. Sir C. W. Wilson, R.E., K.C.B., F.R.S., F.R.G.S.	J. S. Keltie, H. J. Mackinder, E. G. Ravenstein.

Date and Place	Presidents	Secretaries
----------------	------------	-------------

STATISTICAL SCIENCE.

COMMITTEE OF SCIENCES, VI.—STATISTICS.

1833. Cambridge	Prof. Babbage, F.R.S.	J. E. Drinkwater.
1834. Edinburgh	Sir Charles Lemon, Bart.....	Dr. Cleland, C. Hope Maclean.

SECTION F.—STATISTICS.

1835. Dublin	Charles Babbage, F.R.S.	W. Greg, Prof. Longfield.
1836. Bristol	Sir Chas. Lemon, Bart., F.R.S.	Rev. J. E. Bromby, C. B. Fripp, James Heywood.
1837. Liverpool...	Rt. Hon. Lord Sandon	W. R. Greg, W. Langton, Dr. W. C. Tayler.
1838. Newcastle	Colonel Sykes, F.R.S.	W. Cargill, J. Heywood, W. R. Wood.
1839. Birmingham	Henry Hallam, F.R.S.	F. Clarke, R. W. Rawson, Dr. W. C. Tayler.
1840. Glasgow ...	Rt. Hon. Lord Sandon, M.P., F.R.S.	C. R. Baird, Prof. Ramsay, R. W. Rawson.
1841. Plymouth...	Lieut.-Col. Sykes, F.R.S.....	Rev. Dr. Byrth, Rev. R. Luney, R. W. Rawson.
1842. Manchester	G. W. Wood, M.P., F.L.S. ...	Rev. R. Luney, G. W. Ormerod, Dr. W. C. Tayler.
1843. Cork	Sir C. Lemon, Bart., M.P. ...	Dr. D. Bullen, Dr. W. Cooke Tayler.
1844. York.....	Lieut.-Col. Sykes, F.R.S., F.L.S.	J. Fletcher, J. Heywood, Dr. Lay- cock.
1845. Cambridge	Rt. Hon. the Earl Fitzwilliam	J. Fletcher, Dr. W. Cooke Tayler.
1846. Southamp- ton.	G. R. Porter, F.R.S.	J. Fletcher, F. G. P. Neison, Dr. W. C. Tayler, Rev. T. L. Shapcott.
1847. Oxford	Travers Twiss, D.C.L., F.R.S.	Rev. W. H. Cox, J. J. Danson, F. G. P. Neison.
1848. Swansea ...	J. H. Vivian, M.P., F.R.S. ...	J. Fletcher, Capt. R. Shortrede.
1849. Birmingham	Rt. Hon. Lord Lyttelton.....	Dr. Finch, Prof. Hancock, F. G. P. Neison.
1850. Edinburgh	Very Rev. Dr. John Lee, V.P.R.S.E.	Prof. Hancock, J. Fletcher, Dr. J. Stark.
1851. Ipswich ...	Sir John P. Boileau, Bart. ...	J. Fletcher, Prof. Hancock.
1852. Belfast.....	His Grace the Archbishop of Dublin.	Prof. Hancock, Prof. Ingram, James MacAdam, jun.
1853. Hull	James Heywood, M.P., F.R.S.	Edward Cheshire, W. Newmarch.
1854. Liverpool...	Thomas Tooke, F.R.S.	E. Cheshire, J. T. Danson, Dr. W. H. Duncan, W. Newmarch.
1855. Glasgow ...	R. Monckton Milnes, M.P. ...	J. A. Campbell, E. Cheshire, W. New- march, Prof. R. H. Walsh.

SECTION F (*continued*).—ECONOMIC SCIENCE AND STATISTICS.

1856. Cheltenham	Rt. Hon. Lord Stanley, M.P.	Rev. C. H. Bromby, E. Cheshire, Dr. W. N. Hancock, W. Newmarch, W. M. Tartt.
1857. Dublin	His Grace the Archbishop of Dublin, M.R.I.A.	Prof. Cairns, Dr. H. D. Hutton, W. Newmarch.
1858. Leeds	Edward Baines	T. B. Baines, Prof. Cairns, S. Brown, Capt. Fishbourne, Dr. J. Strang.
1859. Aberdeen...	Col. Sykes, M.P., F.R.S.	Prof. Cairns, Edmund Macrory, A. M. Smith, Dr. John Strang.
1860. Oxford	Nassau W. Senior, M.A.	Edmund Macrory, W. Newmarch, Rev. Prof. J. E. T. Rogers.
1861. Manchester	William Newmarch, F.R.S....	David Chadwick, Prof. R. C. Christie, E. Macrory, Rev. Prof. J. E. T. Rogers.

Date and Place	Presidents	Secretaries
1862. Cambridge	Edwin Chadwick, C.B.	H. D. Macleod, Edmund Macrory.
1863. Newcastle	William Tite, M.P., F.R.S. ...	T. Doubleday, Edmund Macrory, Frederick Purdy, James Potts.
1864. Bath	William Farr, M.D., D.C.L., F.R.S.	E. Macrory, E. T. Payne, F. Purdy.
1865. Birmingham	Rt. Hon. Lord Stanley, LL.D., M.P.	G. J. D. Goodman, G. J. Johnston, E. Macrory.
1866. Nottingham	Prof. J. E. T. Rogers.....	R. Birkin, jun., Prof. Leone Levi, E. Macrory.
1867. Dundee	M. E. Grant Duff, M.P.	Prof. Leone Levi, E. Macrory, A. J. Warden.
1868. Norwich ...	Samuel Brown, Pres. Instit. Actuaries.	Rev. W. C. Davie, Prof. Leone Levi.
1869. Exeter	Rt. Hon. Sir Stafford H. North- cote, Bart., C.B., M.P.	E. Macrory, F. Purdy, C. T. D. Acland.
1870. Liverpool...	Prof. W. Stanley Jevons, M.A.	Chas. R. Dudley Baxter, E. Macrory J. Miles Moss.
1871. Edinburgh	Rt. Hon. Lord Neaves	J. G. Fitch, James Meikle.
1872. Brighton ...	Prof. Henry Fawcett, M.P. ...	J. G. Fitch, Barclay Phillips.
1873. Bradford ...	Rt. Hon. W. E. Forster, M.P.	J. G. Fitch, Swire Smith.
1874. Belfast.....	Lord O'Hagan	Prof. Donnell, F. P. Fellows, Hans MacMordie.
1875. Bristol	James Heywood, M.A., F.R.S., Pres.S.S.	F. P. Fellows, T. G. P. Hallett, E. Macrory.
1876. Glasgow ...	Sir George Campbell, K.C.S.I., M.P.	A. McNeel Caird, T. G. P. Hallett, Dr. W. Neilson Hancock, Dr. W. Jack.
1877. Plymouth...	Rt. Hon. the Earl Fortescue	W. F. Collier, P. Hallett, J. T. Pim.
1878. Dublin	Prof. J. K. Ingram, LL.D., M.R.I.A.	W. J. Hancock, C. Molloy, J. T. Pim.
1879. Sheffield ...	G. Shaw Lefevre, M.P., Pres. S.S.	Prof. Adamson, R. E. Leader, C. Molloy.
1880. Swansea ...	G. W. Hastings, M.P.	N. A. Humphreys, C. Molloy.
1881. York.....	Rt. Hon. M. E. Grant-Duff, M.A., F.R.S.	C. Molloy, W. W. Morrell, J. F. Moss.
1882. Southamp- ton.	Rt. Hon. G. Selater-Booth, M.P., F.R.S.	G. Baden-Powell, Prof. H. S. Fox- well, A. Milnes, C. Molloy.
1883. Southport	R. H. Inglis Palgrave, F.R.S.	Rev. W. Cunningham, Prof. H. S. Foxwell, J. N. Keynes, C. Molloy.
1884. Montreal ...	Sir Richard Temple, Bart., G.C.S.I., C.I.E., F.R.G.S.	Prof. H. S. Foxwell, J. S. McLennan, Prof. J. Watson.
1885. Aberdeen...	Prof. H. Sidgwick, LL.D., Litt.D.	Rev. W. Cunningham, Prof. H. S. Foxwell, C. McCombie, J. F. Moss.
1886. Birmingham	J. B. Martin, M.A., F.S.S.	F. F. Barham, Rev. W. Cunningham, Prof. H. S. Foxwell, J. F. Moss.
1887. Manchester	Robert Giffen, LL.D., V.P.S.S.	Rev. W. Cunningham, F. Y. Edge- worth, T. H. Elliott, C. Hughes, Prof. J. E. C. Munro, G. H. Sar- gant.
1888. Bath	Rt. Hon. Lord Bramwell, LL.D., F.R.S.	Prof. F. Y. Edgeworth, T. H. Elliott, Prof. H. S. Foxwell, L. L. F. R. Price.

MECHANICAL SCIENCE.

SECTION G.—MECHANICAL SCIENCE.

1836. Bristol	Davies Gilbert, D.C.L., F.R.S.	T. G. Bunt, G. T. Clark, W. West.
1837. Liverpool...	Rev. Dr. Robinson	Charles Vignoles, Thomas Webster.
1838. Newcastle	Charles Babbage, F.R.S.	R. Hawthorn, C. Vignoles, T. Webster.

Date and Place	Presidents	Secretaries
1839. Birmingham	Prof. Willis, F.R.S., and Robt. Stephenson.	W. Carpmael, William Hawkes, T. Webster.
1840. Glasgow ...	Sir John Robinson	J. Scott Russell, J. Thomson, J. Tod, C. Vignoles.
1841. Plymouth	John Taylor, F.R.S.	Henry Chatfield, Thomas Webster.
1842. Manchester	Rev. Prof. Willis, F.R.S.	J. F. Bateman, J. Scott Russell, J. Thomson, Charles Vignoles.
1843. Cork	Prof. J. Macneill, M.R.I.A. ...	James Thomson, Robert Mallet.
1844. York	John Taylor, F.R.S.	Charles Vignoles, Thomas Webster.
1845. Cambridge	George Rennie, F.R.S.	Rev. W. T. Kingsley.
1846. Southamp- ton.	Rev. Prof. Willis, M.A., F.R.S.	William Betts, jun., Charles Manby.
1847. Oxford	Rev. Prof. Walker, M.A., F.R.S.	J. Glynn, R. A. Le Mesurier.
1848. Swansea ...	Rev. Prof. Walker, M.A., F.R.S.	R. A. Le Mesurier, W. P. Struvé.
1849. Birmingham	Robt. Stephenson, M.P., F.R.S.	Charles Manby, W. P. Marshall.
1850. Edinburgh	Rev. R. Robinson	Dr. Lees, David Stephenson.
1851. Ipswich	William Cubitt, F.R.S.	John Head, Charles Manby.
1852. Belfast	John Walker, C.E., LL.D., F.R.S.	John F. Bateman, C. B. Hancock, Charles Manby, James Thomson.
1853. Hull	William Fairbairn, C.E., F.R.S.	James Oldham, J. Thomson, W. Sykes Ward.
1854. Liverpool...	John Scott Russell, F.R.S. ...	John Grantham, J. Oldham, J. Thomson.
1855. Glasgow ...	W. J. Macquorn Rankine, C.E., F.R.S.	L. Hill, jun., William Ramsay, J. Thomson.
1856. Cheltenham	George Rennie, F.R.S.	C. Atherton, B. Jones, jun., H. M. Jeffery.
1857. Dublin	Rt. Hon. the Earl of Rosse, F.R.S.	Prof. Downing, W.T. Doyne, A. Tate, James Thomson, Henry Wright.
1858. Leeds	William Fairbairn, F.R.S. ...	J. C. Dennis, J. Dixon, H. Wright.
1859. Aberdeen...	Rev. Prof. Willis, M.A., F.R.S.	R. Abernethy, P. Le Neve Foster, H. Wright.
1860. Oxford	Prof. W. J. Macquorn Rankine, LL.D., F.R.S.	P. Le Neve Foster, Rev. F. Harrison, Henry Wright.
1861. Marchester	J. F. Bateman, C.E., F.R.S.	P. Le Neve Foster, John Robinson, H. Wright.
1862. Cambridge	Wm. Fairbairn, LL.D., F.R.S.	W. M. Fawcett, P. Le Neve Foster.
1863. Newcastle	Rev. Prof. Willis, M.A., F.R.S.	P. Le Neve Foster, P. Westmacott, J. E. Spencer.
1864. Bath	J. Hawkshaw, F.R.S.	P. Le Neve Foster, Robert Pitt.
1865. Birmingham	Sir W. G. Armstrong, LL.D., F.R.S.	P. Le Neve Foster, Henry Lea, W. P. Marshall, Walter May.
1866. Nottingham	Thomas Hawksley, V.P.Inst. C.E., F.G.S.	P. Le Neve Foster, J. F. Iselin, M. O. Tarbotton.
1867. Dundee	Prof. W. J. Macquorn Rankine, LL.D., F.R.S.	P. Le Neve Foster, John P. Smith, W. W. Urquhart.
1868. Norwich ...	G. P. Bidder, C.E., F.R.G.S.	P. Le Neve Foster, J. F. Iselin, C. Manby, W. Smith.
1869. Exeter	C. W. Siemens, F.R.S.	P. Le Neve Foster, H. Bauerman.
1870. Liverpool...	Chas. B. Vignoles, C.E., F.R.S.	H. Bauerman, P. Le Neve Foster, T. King, J. N. Shoolbred.
1871. Edinburgh	Prof. Fleeming Jenkin, F.R.S.	H. Bauerman, Alexander Leslie, J. P. Smith.
1872. Brighton ...	F. J. Bramwell, C.E.	H. M. Brunel, P. Le Neve Foster, J. G. Gamble, J. N. Shoolbred.
1873. Bradford ...	W. H. Barlow, F.R.S.	Crawford Barlow, H. Bauerman, E. H. Carbutt, J. C. Hawkshaw, J. N. Shoolbred.
1874. Belfast	Prof. James Thomson, LL.D., C.E., F.R.S.E.	A. T. Atchison, J. N. Shoolbred, John Smyth, jun.

Date and Place	Presidents	Secretaries
1875. Bristol	W. Froude, C.E., M.A., F.R.S.	W. R. Browne, H. M. Brunel, J. G. Gamble, J. N. Shoolbred.
1876. Glasgow ...	C. W. Merrifield, F.R.S.	W. Bottomley, jun., W. J. Millar, J. N. Shoolbred, J. P. Smith.
1877. Plymouth...	Edward Woods, C.E.	A. T. Atchison, Dr. Merrifield, J. N. Shoolbred.
1878. Dublin	Edward Easton, C.E.	A. T. Atchison, R. G. Symes, H. T. Wood.
1879. Sheffield ...	J. Robinson, Pres. Inst. Mech. Eng.	A. T. Atchison, Emerson Bainbridge, H. T. Wood.
1880. Swansea ...	James Abernethy, V.P. Inst. C.E., F.R.S.E.	A. T. Atchison, H. T. Wood.
1881. York.....	Sir W. G. Armstrong, C.B., LL.D., D.C.L., F.R.S.	A. T. Atchison, J. F. Stephenson, H. T. Wood.
1882. Southamp- ton.	John Fowler, C.E., F.G.S. ...	A. T. Atchison, F. Churton, H. T. Wood.
1883. Southport	James Brunlees, F.R.S.E., Pres.Inst.C.E.	A. T. Atchison, E. Rigg, H. T. Wood.
1884. Montreal ...	Sir F. J. Bramwell, F.R.S., V.P.Inst.C.E.	A. T. Atchison, W. B. Dawson, J. Kennedy, H. T. Wood.
1885. Aberdeen...	B. Baker, M.Inst.C.E.	A. T. Atchison, F. G. Ogilvie, E. Rigg, J. N. Shoolbred.
1886. Birmingham	Sir J. N. Douglass, M.Inst. C.E.	C. W. Cooke, J. Kenward, W. B. Marshall, E. Rigg.
1887. Manchester	Prof. Osborne Reynolds, M.A., LL.D., F.R.S.	C. F. Budenberg, W. B. Marshall, E. Rigg.
1888. Bath.....	W. H. Preece, F.R.S., M.Inst.C.E.	C. W. Cooke, W. B. Marshall, E. Rigg, P. K. Stothert.

ANTHROPOLOGICAL SCIENCE.

SECTION H.—ANTHROPOLOGY.

1884. Montreal ...	E. B. Tylor, D.C.L., F.R.S. ...	G. W. Bloxam, W. Hurst.
1885. Aberdeen...	Francis Galton, M.A., F.R.S.	G. W. Bloxam, Dr. J. G. Garson, W. Hurst, Dr. A. Macgregor.
1886. Birmingham	Sir G. Campbell, K.C.S.I., M.P., D.C.L., F.R.G.S.	G. W. Bloxam, Dr. J. G. Garson, W. Hurst, Dr. R. Saundby
1887. Manchester	Prof. A. H. Sayce, M.A.	G. W. Bloxam, Dr. J. G. Garson, Dr. A. M. Paterson.
1888. Bath.....	Lieut.-General Pitt-Rivers, D.C.L., F.R.S.	G. W. Bloxam, Dr. J. G. Garson, J. Harris Stone.

LIST OF EVENING LECTURES.

Date and Place	Lecturer	Subject of Discourse
1842. Manchester	Charles Vignoles, F.R.S.....	The Principles and Construction of Atmospheric Railways.
	Sir M. I. Brunel	The Thames Tunnel.
	R. I. Murchison.....	The Geology of Russia.
1843. Cork	Prof. Owen, M.D., F.R.S.....	The Dinornis of New Zealand.
	Prof. E. Forbes, F.R.S.....	The Distribution of Animal Life in the Ægean Sea.
	Dr. Robinson.....	The Earl of Rosse's Telescope.
1844. York	Charles Lyell, F.R.S.	Geology of North America.
	Dr. Falconer, F.R.S.....	The Gigantic Tortoise of the Siwalik Hills in India.

Date and Place	Lecturer	Subject of Discourse
1845. Cambridge	G.B. Airy, F.R.S., Astron. Royal	Progress of Terrestrial Magnetism.
1846. Southampton.	R. I. Murchison, F.R.S.	Geology of Russia.
	Prof. Owen, M.D., F.R.S. ...	Fossil Mammalia of the British Isles.
	Charles Lyell, F.R.S.	Valley and Delta of the Mississippi.
	W. R. Grove, F.R.S.	Properties of the Explosive substance
		discovered by Dr. Schönbein; also
		some Researches of his own on
		the Decomposition of Water by
		Heat.
1847. Oxford.....	Rev. Prof. B. Powell, F.R.S.	Shooting Stars.
	Prof. M. Faraday, F.R.S.	Magnetic and Diamagnetic Phenomena.
	Hugh E. Strickland, F.G.S.	The Dodo (<i>Didus ineptus</i>).
1848. Swansea ...	John Percy, M.D., F.R.S.	Metallurgical Operations of Swansea and its neighbourhood.
	W. Carpenter, M.D., F.R.S.	Recent Microscopical Discoveries.
1849. Birmingham	Dr. Faraday, F.R.S.	Mr. Gassiot's Battery.
	Rev. Prof. Willis, M.A., F.R.S.	Transit of different Weights with
		varying velocities on Railways.
1850. Edinburgh	Prof. J. H. Bennett, M.D.,	Passage of the Blood through the
	F.R.S.E.	minute vessels of Animals in connexion with Nutrition.
	Dr. Mantell, F.R.S.	Extinct Birds of New Zealand.
1851. Ipswich ...	Prof. R. Owen, M.D., F.R.S.	Distinction between Plants and Animals, and their changes of Form.
	G.B. Airy, F.R.S., Astron. Royal	Total Solar Eclipse of July 28, 1851.
1852. Belfast.....	Prof. G. G. Stokes, D.C.L.,	Recent discoveries in the properties
	F.R.S.	of Light.
	Colonel Portlock, R.E., F.R.S.	Recent discovery of Rock-salt at
		Carrickfergus, and geological and
		practical considerations connected
		with it.
1853. Hull	Prof. J. Phillips, LL.D., F.R.S.,	Some peculiar Phenomena in the
	F.G.S.	Geology and Physical Geography
	Robert Hunt, F.R.S.	of Yorkshire.
1854. Liverpool...	Prof. R. Owen, M.D., F.R.S.	The present state of Photography.
	Col. E. Sabine, V.P.R.S.	Anthropomorphic Apes.
		Progress of researches in Terrestrial
		Magnetism.
1855. Glasgow ...	Dr. W. B. Carpenter, F.R.S.	Characters of Species.
	Lieut.-Col. H. Rawlinson ...	Assyrian and Babylonian Antiquities
		and Ethnology.
1856. Cheltenham	Col. Sir H. Rawlinson	Recent Discoveries in Assyria and
		Babylonia, with the results of
		Cuneiform research up to the
		present time.
	W. R. Grove, F.R.S.	Correlation of Physical Forces.
1857. Dublin.....	Prof. W. Thomson, F.R.S. ...	The Atlantic Telegraph.
	Rev. Dr. Livingstone, D.C.L.	Recent Discoveries in Africa.
1858. Leeds	Prof. J. Phillips, LL.D., F.R.S.	The Ironstones of Yorkshire.
	Prof. R. Owen, M.D., F.R.S.	The Fossil Mammalia of Australia.
1859. Aberdeen...	Sir R. I. Murchison, D.C.L. ...	Geology of the Northern Highlands.
	Rev. Dr. Robinson, F.R.S. ...	Electrical Discharges in highly
		rarefied Media.
1860. Oxford.....	Rev. Prof. Walker, F.R.S. ...	Physical Constitution of the Sun.
	Captain Sherard Osborn, R.N.	Arctic Discovery.
1861. Manchester	Prof. W. A. Miller, M.A., F.R.S.	Spectrum Analysis.
	G.B. Airy, F.R.S., Astron. Royal	The late Eclipse of the Sun.
1862. Cambridge	Prof. Tyndall, LL.D., F.R.S.	The Forms and Action of Water.
	Prof. Odling, F.R.S.	Organic Chemistry.

Date and Place	Lecturer	Subject of Discourse
1863. Newcastle	Prof. Williamson, F.R.S.....	The Chemistry of the Galvanic Battery considered in relation to Dynamics.
	James Glaisher, F.R.S.....	The Balloon Ascents made for the British Association.
1864. Bath.....	Prof. Roscoe, F.R.S.....	The Chemical Action of Light.
	Dr. Livingstone, F.R.S.	Recent Travels in Africa.
1865. Birmingham	J. Beete Jukes, F.R.S.....	Probabilities as to the position and extent of the Coal-measures beneath the red rocks of the Midland Counties.
1866. Nottingham	William Huggins, F.R.S. ...	The results of Spectrum Analysis applied to Heavenly Bodies.
	Dr. J. D. Hooker, F.R.S.....	Insular Floras.
1867. Dundee.....	Archibald Geikie, F.R.S.....	The Geological Origin of the present Scenery of Scotland.
	Alexander Herschel, F.R.A.S.	The present state of knowledge regarding Meteors and Meteorites.
1868. Norwich ...	J. Fergusson, F.R.S.....	Archæology of the early Buddhist Monuments.
	Dr. W. Odling, F.R.S.	Reverse Chemical Actions.
1869. Exeter	Prof. J. Phillips, LL.D., F.R.S.	Vesuvius.
	J. Norman Lockyer, F.R.S....	The Physical Constitution of the Stars and Nebulæ.
1870. Liverpool...	Prof. J. Tyndall, LL.D., F.R.S.	Scientific Use of the Imagination.
	Prof. W. J. Macquorn Rankine, LL.D., F.R.S.	Stream-lines and Waves, in connection with Naval Architecture.
1871. Edinburgh	F. A. Abel, F.R.S.....	Some recent investigations and applications of Explosive Agents.
	E. B. Tylor, F.R.S.	The Relation of Primitive to Modern Civilization.
1872. Brighton ...	Prof. P. Martin Duncan, M.B., F.R.S.	Insect Metamorphosis.
	Prof. W. K. Clifford... ..	The Aims and Instruments of Scientific Thought.
1873. Bradford ...	Prof. W. C. Williamson, F.R.S.	Coal and Coal Plants.
	Prof. Clerk Maxwell, F.R.S.	Molecules.
1874. Belfast	Sir John Lubbock, Bart., M.P., F.R.S.	Common Wild Flowers considered in relation to Insects.
	Prof. Huxley, F.R.S.	The Hypothesis that Animals are Automata, and its History.
1875. Bristol	W. Spottiswoode, LL.D., F.R.S.	The Colours of Polarized Light.
	F. J. Bramwell, F.R.S.....	Railway Safety Appliances.
1876. Glasgow ...	Prof. Tait, F.R.S.E.	Force.
	Sir Wyville Thomson, F.R.S.	The <i>Challenger</i> Expedition.
1877. Plymouth...	W. Warington Smyth, M.A., F.R.S.	The Physical Phenomena connected with the Mines of Cornwall and Devon.
	Prof. Odling, F.R.S.....	The new Element, Gallium.
1878. Dublin	G. J. Romanes, F.L.S.	Animal Intelligence.
	Prof. Dewar, F.R.S.	Dissociation, or Modern Ideas of Chemical Action.
1879. Sheffield ...	W. Crookes, F.R.S.	Radiant Matter.
	Prof. E. Ray Lankester, F.R.S.	Degeneration.
1880. Swansea ...	Prof. W. Boyd Dawkins, F.R.S.	Primeval Man.
	Francis Galton, F.R.S.....	Mental Imagery.
1881. York.....	Prof. Huxley, Sec. R.S.	The Rise and Progress of Palæontology.
	W. Spottiswoode, Pres. R.S.	The Electric Discharge, its Forms and its Functions.

Date and Place	Lecturer	Subject of Discourse
1882. Southamp- ton.	Prof. Sir Wm. Thomson, F.R.S.	Tides.
1883. Southport	Prof. H. N. Moseley, F.R.S. Prof. R. S. Ball, F.R.S.	Pelagic Life. Recent Researches on the Distance of the Sun.
1884. Montreal ...	Prof. J. G. McKendrick, F.R.S.E. Prof. O. J. Lodge, D.Sc. Rev. W. H. Dallinger, F.R.S.	Galvani and Animal Electricity. Dust. The Modern Microscope in Re- searches on the Least and Lowest Forms of Life.
1885. Aberdeen...	Prof. W. G. Adams, F.R.S. ...	The Electric Light and Atmospheric Absorption.
1886. Birmingham	John Murray, F.R.S.E..... A. W. Rücker, M.A., F.R.S. Prof. W. Rutherford, M.D. ...	The Great Ocean Basins. Soap Bubbles. The Sense of Hearing.
1887. Manchester	Prof. H. B. Dixon, F.R.S. ... Col. Sir F. de Winton, K.C.M.G.	The Rate of Explosions in Gases. Explorations in Central Africa.
1888. Bath.....	Prof. W. E. Ayrton, F.R.S. ... Prof. T. G. Bonney, D.Sc., F.R.S.	The Electrical Transmission of Power. The Foundation Stones of the Earth's Crust.

LECTURES TO THE OPERATIVE CLASSES.

1867. Dundee.....	Prof. J. Tyndall, LL.D., F.R.S.	Matter and Force.
1868. Norwich ...	Prof. Huxley, LL.D., F.R.S.	A Piece of Chalk.
1869. Exeter	Prof. Miller, M.D., F.R.S. ...	Experimental illustrations of the modes of detecting the Composi- tion of the Sun and other Heavenly Bodies by the Spectrum.
1870. Liverpool...	Sir John Lubbock, Bart., M.P., F.R.S.	Savages.
1872. Brighton ...	W. Spottiswoode, LL.D., F.R.S.	Sunshine, Sea, and Sky.
1873. Bradford ...	C. W. Siemens, D.C.L., F.R.S.	Fuel.
1874. Belfast	Prof. Odling, F.R.S.....	The Discovery of Oxygen.
1875. Bristol	Dr. W. B. Carpenter, F.R.S.	A Piece of Limestone.
1876. Glasgow ...	Commander Cameron, C.B., R.N.	A Journey through Africa.
1877. Plymouth...	W. H. Preece	Telegraphy and the Telephone.
1879. Sheffield ...	W. E. Ayrton	Electricity as a Motive Power.
1880. Swansea ...	H. Seebohm, F.Z.S.	The North-East Passage.
1881. York	Prof. Osborne Reynolds, F.R.S.	Raindrops, Hailstones, and Snow- flakes.
1882. Southamp- ton.	John Evans, D.C.L. Treas. R.S.	Unwritten History, and how to read it.
1883. Southport	Sir F. J. Bramwell, F.R.S. ...	Talking by Electricity—Telephones.
1884. Montreal ...	Prof. R. S. Ball, F.R.S.....	Comets.
1885. Aberdeen ...	H. B. Dixon, M.A.	The Nature of Explosions.
1886. Birmingham	Prof. W. C. Roberts-Austen, F.R.S.	The Colours of Metals and their Alloys.
1887. Manchester	Prof. G. Forbes, F.R.S.	Electric Lighting.
1888. Bath.....	Sir John Lubbock, Bart., M.P., F.R.S.	The Customs of Savage Races.

OFFICERS OF SECTIONAL COMMITTEES PRESENT AT THE BATH MEETING.

SECTION A.—MATHEMATICAL AND PHYSICAL SCIENCE.

President.—Professor G. F. Fitzgerald, M.A., F.R.S.

Vice-Presidents.—Capt. W. de W. Abney, C.B., F.R.S.; William Esson, F.R.S.; Dr. Janssen, For.Memb.R.S.; Lord Rayleigh, Sec.R.S.; Professor Sir W. Thomson, F.R.S., F.R.A.S.; Professor Stokes, Pres.R.S.; Professor H. A. Rowland; Rev. R. Harley, F.R.S.

Secretaries.—Robert E. Baynes, M.A. (*Recorder*); R. T. Glazebrook, F.R.S.; Alfred Lodge, M.A.; W. N. Shaw, M.A.

SECTION B.—CHEMICAL SCIENCE.

President.—Professor W. A. Tilden, D.Sc., F.R.S., V.P.C.S.

Vice-Presidents.—Professor H. E. Armstrong, F.R.S.; Dr. J. H. Gladstone, F.R.S.; Professor T. Sterry Hunt, F.R.S.; Professor W. Odling, F.R.S.; Dr. W. H. Perkin, F.R.S.; Professor J. Emerson Reynolds, F.R.S.; Sir H. E. Roscoe, F.R.S.; Dr. W. J. Russell, F.R.S.; Professor A. W. Williamson, F.R.S.

Secretaries.—Professor H. B. Dixon, F.R.S.; H. Forster Morley, D.Sc. (*Recorder*); R. E. Moyle, B.A.; Dr. W. W. J. Nicol, M.A.

SECTION C.—GEOLOGY.

President.—Professor W. Boyd Dawkins, M.A., F.R.S., F.G.S.

Vice-Presidents.—W. Whitaker, F.R.S.; Rev. H. H. Winwood, M.A.; Professor A. Gaudry; Professor O. C. Marsh; Professor S. Nikitin; Dr. Max von Hantken; Professor G. Stefanescu; Professor Baron F. von Richthofen; Professor J. Szabó.

Secretaries.—Professor G. A. Lebour, M.A.; W. Topley, F.R.S. (*Recorder*); W. W. Watts, M.A.; H. B. Woodward, F.G.S.

SECTION D.—BIOLOGY.

President.—W. T. Thiselton-Dyer, C.M.G., M.A., B.Sc., F.R.S., F.L.S.

Vice-Presidents.—Professor Bayley Balfour, F.R.S.; Professor M. Foster, Sec.R.S.; Professor Newton, F.R.S.; Professor E. A. Schäfer, F.R.S.; P. L. Sclater, F.R.S.; Rev. Leonard Blomefield, M.A.

Secretaries.—F. E. Beddard, M.A.; S. F. Harmer, M.A.; Professor H. Marshall Ward, F.R.S. (*Recorder*); Walter Gardiner, M.A.; Professor W. D. Halliburton, M.D.

SECTION E.—GEOGRAPHY.

President.—Colonel Sir C. W. Wilson, R.E., K.C.B., K.C.M.G., D.C.L., F.R.S., F.R.G.S.

Vice-Presidents.—E. Delmar Morgan, F.R.G.S.; H. W. Bates, F.R.S.; Sir Lambert Playfair, K.C.M.G.; Lieut.-Gen. Richard Strachey, R.E., F.R.S.; General J. T. Walker, C.B., R.E., F.R.S.

Secretaries.—J. S. Keltie; H. J. Mackinder, M.A.; E. G. Ravenstein (*Recorder*).

SECTION F.—ECONOMIC SCIENCE AND STATISTICS.

President.—The Right Hon. Lord Bramwell, LL.D., F.R.S., F.S.S.

Vice-Presidents.—S. Bourne, F.S.S.; G. W. Hastings, M.P.; R. H. Inglis Palgrave, F.R.S.; Professor H. Sidgwick, Litt.D.

Secretaries.—Professor F. Y. Edgeworth, M.A., F.S.S.; T. H. Elliott, F.S.S. (*Recorder*); Professor H. S. Foxwell, M.A., F.S.S.; L. L. F. R. Price, M.A., F.S.S.

SECTION G.—MECHANICAL SCIENCE.

President.—W. H. Preece, F.R.S., M.Inst.C.E.

Vice-Presidents.—W. Anderson, M.Inst.C.E.; Benjamin Baker, M.Inst.C.E.; Sir J. N. Douglass, F.R.S., M.Inst.C.E.; William Pole, Mus.Doc., F.R.S., M.Inst.C.E.; W. Shelford, M.Inst.C.E.; J. L. Stothert, M.Inst.C.E.

Secretaries.—Conrad W. Cooke; W. Bayley Marshall, M.Inst.C.E.; E. Rigg, M.A. (*Recorder*); P. K. Stothert. †

SECTION H.—ANTHROPOLOGY.

President.—Lieut.-General Pitt-Rivers, D.C.L., F.R.S., F.G.S., F.S.A.

Vice-Presidents.—J. Beddoe, M.D., F.R.S.; J. Evans, D.C.L., LL.D., F.R.S.; Professor A. H. Sayce, M.A.; Edward B. Tylor, D.C.L., F.R.S.

Secretaries.—G. W. Bloxam, M.A. (*Recorder*); J. G. Garson, M.D.; J. Harris Stone, M.A.

OFFICERS AND COUNCIL, 1888-89.

PRESIDENT.

SIR FREDERICK J. BRAMWELL, BART., D.C.L., F.R.S., M.INST.C.E.

VICE-PRESIDENTS.

The Right Hon. the EARL OF CORK AND ORRERY,
K.P., Lord Lieutenant of Somerset.
The Most Noble the MARQUIS OF BATH.
The Right Hon. and Right Rev. the LORD BISHOP
OF BATH AND WELLS, D.D.
The Right Rev. the BISHOP OF CLIFTON.
The Worshipful the MAYOR OF BATH.
The Worshipful the MAYOR OF BRISTOL.
Sir F. A. ABEL, C.B., D.C.L., F.R.S., V.P.C.S.
The Venerable the ARCHDEACON OF BATH.

The Rev. LEONARD BLOMEFIELD, M.A.,
F.G.S.
Professor MICHAEL FOSTER, M.A., M.D., LL.D.,
Sec.R.S., F.L.S., F.C.S.
W. S. GORE-LANGTON, Esq., J.P., D.L.
H. D. SKRINE, Esq., J.P., D.L.
Colonel R. P. LAURIE, C.B., M.P.
E. R. WODEHOUSE, Esq., M.P.
JEROM MURCH, Esq., J.P., D.L.

PRESIDENT ELECT.

PROFESSOR WILLIAM HENRY FLOWER, C.B., LL.D., F.R.S., F.R.C.S., PRES.Z.S., F.L.S., F.G.S.,
Director of the Natural History Department of the British Museum.

VICE-PRESIDENTS ELECT.

His Grace the DUKE OF NORTHUMBERLAND, K.G.,
D.C.L., LL.D., Lord-Lieutenant of Northum-
berland.
The Right Hon. the EARL OF DURHAM, Lord
Lieutenant of Durham.
The Right Hon. the EARL OF RAVENSWORTH.
The Right Rev. the LORD BISHOP OF NEWCASTLE,
D.D.
The Right Hon. Lord ARMSTRONG, C.B., D.C.L.,
LL.D., F.R.S.

The Very Rev. the WARDEN of the University of
Durham, D.D.
The Worshipful the MAYOR OF NEWCASTLE.
The Worshipful the MAYOR OF GATESHEAD.
Sir I. LOWTHIAN BELL, Bart., F.R.S., F.C.S.,
M.Inst.C.E.
Sir CHARLES MARK PALMER, Bart., M.P. (*nomi-
nated by the Council*).
The Right Hon. JOHN MORLEY, LL.D., M.P.

LOCAL SECRETARIES FOR THE MEETING AT NEWCASTLE-UPON-TYNE.

Professor P. P. BEDSOX, D.Sc., F.C.S. | Professor J. H. MERVIALE, M.A. | HOWARD PEASE, Esq.

LOCAL TREASURER FOR THE MEETING AT NEWCASTLE-UPON-TYNE.

THOMAS HODGKIN, Esq.

ORDINARY MEMBERS OF THE COUNCIL.

ABNEY, Capt. W. DE W., C.B., F.R.S.
BALL, Sir R. S., F.R.S.
BARLOW, W. H., Esq., F.R.S.
BLANFORD, W. T., Esq., F.R.S.
CROOKES, W., Esq., F.R.S.
DARWIN, Professor G. H., F.R.S.
DOUGLASS, Sir J. N., F.R.S.
GAMGEE, Dr. A., F.R.S.
GEIKIE, Dr. A., F.R.S.
GODWIN-AUSTEN, Lieut.-Col. H. H., F.R.S.
HENRICH, Professor O., F.R.S.
JUDD, Professor J. W., F.R.S.
LIVINGE, Professor G. D., F.R.S.

M'LEOD, Professor H., F.R.S.
MARTIN, J. B., Esq., F.S.S.
OMMANNEY, Admiral Sir E., C.B., F.R.S.
PREECE, W. H., Esq., F.R.S.
ROBERTS-AUSTEN, Professor W. C., F.R.S.
RÜCKER, Professor A., F.R.S.
SCHÄFER, Professor E. A., F.R.S.
SCHUSTER, Professor A., F.R.S.
SIDGWICK, Professor H., M.A.
THIBELTON-DYER, W. T., Esq., C.M.G.,
F.R.S.
THORPE, Professor T. E., F.R.S.
WOODWARD, Dr. H., F.R.S.

GENERAL SECRETARIES.

Capt. Sir DOUGLAS GALTON, K.C.B., D.C.L., LL.D., F.R.S., F.G.S., 12 Chester Street, London, S.W.
A. G. VERNON HARCOURT, Esq., M.A., LL.D., F.R.S., F.C.S., Cowley Grange, Oxford.

SECRETARY.

ARTHUR T. ATCHISON, Esq., M.A., 22 Albemarle Street, London, W.

GENERAL TREASURER.

Professor A. W. WILLIAMSON, Ph.D., LL.D., F.R.S., F.C.S., 17 Buckingham Street, London, W.C.

EX-OFFICIO MEMBERS OF THE COUNCIL.

The Trustees, the President and President Elect, the Presidents of former years, the Vice-Presidents and Vice-Presidents Elect, the General and Assistant General Secretaries for the present and former years, the Secretary, the General Treasurers for the present and former years, and the Local Treasurer and Secretaries for the ensuing Meeting.

TRUSTEES (PERMANENT).

Sir JOHN LUBBOCK, Bart., M.P., D.C.L., LL.D., F.R.S., Pres. L.S.
The Right Hon. Lord RAYLEIGH, M.A., D.C.L., LL.D., Sec.R.S., F.R.A.S.
The Right Hon. Sir LYON PLAYFAIR, K.C.B., M.P., Ph.D., LL.D., F.R.S.

PRESIDENTS OF FORMER YEARS.

The Duke of Devonshire, K.G.	Prof. Stokes, D.C.L., Pres. R.S.	Sir A. C. Ramsay, LL.D., F.R.S.
Sir G. B. Airy, K.C.B., F.R.S.	Prof. Huxley, LL.D., F.R.S.	Sir John Lubbock, Bart., F.R.S.
The Duke of Argyll, K.G., K.T.	Prof. Sir Wm. Thomson, LL.D.	Prof. Cayley, LL.D., F.R.S.
Sir Richard Owen, K.C.B., F.R.S.	Prof. Williamson, Ph.D., F.R.S.	Lord Rayleigh, D.C.L., Sec.R.S.
Lord Armstrong, C.B., LL.D.	Prof. Tyndall, D.C.L., F.R.S.	Sir Lyon Playfair, K.C.B.
Sir William R. Grove, F.R.S.	Sir John Hawkshaw, F.R.S.	Sir Wm. Dawson, C.M.G., F.R.S.
Sir Joseph D. Hooker, K.C.S.I.	Prof. Allman, M.D., F.R.S.	Sir H. E. Roscoe, F.R.S.

GENERAL OFFICERS OF FORMER YEARS.

F. Galton, Esq., F.R.S.	Dr. Michael Foster, Sec.R.S.	P. L. Sclater, Esq., Ph.D., F.R.S.
Dr. T. A. Hirst, F.R.S.	George Griffith, Esq., M.A., F.C.S.	Prof. Bonney, D.Sc., F.R.S.

AUDITORS.

Dr. W. H. Perkin, F.R.S.	Dr. John Evans, F.R.S.	Dr. J. H. Gladstone, F.R.S.
--------------------------	------------------------	-----------------------------

THE BRITISH ASSOCIATION FOR

Dr.

THE GENERAL TREASURER'S ACCOUNT

1887-88.

RECEIPTS.

	£	s.	d.
Balance of account rendered at Manchester Meeting	1718	10	1
By Life Compositions	940	0	0
" New Annual Members	502	0	0
" Annual Subscriptions	730	0	0
" Associate Tickets at Manchester Meeting	1985	0	0
" Ladies' Tickets at Manchester Meeting	493	0	0
" Sale of Publications	190	5	5
" Interest on Exchequer Bills	58	4	8
" Dividends on Consols	295	8	2
" Rent received from London Mathematical Society, year ending September 29, 1887	12	15	0
" Unexpended balance of grant made to 'Sliding Scale' Committee	7	10	10
" Sale of Exchequer Bills	1509	2	4

£8441 16 6

Investment Account : September, 1887, to September, 1888.

Consols	£	s.	d.	Profit on change :	£	s.	d.	New Consols	£	s.	d.
Exchequer Bills	8500	0	0		9	2	4	Exchequer Bills	8500	0	0
Cash	2000	0	0		77	17	6	India 3 per cent.	500	0	0
Excess of receipts over expenditure	1718	10	1	To Contra.	86	19	10	Cash	3600	0	0
Per contra	534	0	6						239	10	5
	86	19	10								
	<u>12,839</u>	<u>10</u>	<u>5</u>						<u>12,839</u>	<u>10</u>	<u>5</u>

THE ADVANCEMENT OF SCIENCE.

(not including receipts at the Bath Meeting).

Cr.

1887-88.

PAYMENTS.

	£	s.	d.
To Expenses of Manchester Meeting, including Printing, Advertising, and incidental expenses	314	18	2
„ Salaries, one year (1887-88).....	538	15	0
„ Rent of Office at Albemarle Street (1887-88)	117	0	0
„ Spottiswoode & Co. printing account to July, 1887	1028	3	6
„ „ „ to February, 1888	1170	6	6
„ Purchase of India 3 per Cent. Stock	3522	2	6

GRANTS.

	£	s.	d.
Flora of Bahamas.....	100	0	0
Biological Station at Granton	50	0	0
Flora of China	75	0	0
Carboniferous Flora of Lancashire and West Yorkshire	25	0	0
Properties of Solutions	25	0	0
Isomeric Naphthalene Derivatives.....	25	0	0
Influence of Silicon on Steel.....	20	0	0
Action of Light on Hydracids	20	0	0
Marine Laboratory, Plymouth.....	100	0	0
Naples Zoological Station	100	0	0
Development of Teleostei	15	0	0
Precious Metals in Circulation.....	20	0	0
Value of Monetary Standard	10	0	0
Volcanic Phenomena of Vesuvius	20	0	0
Prehistoric Race in Greek Islands	20	0	0
Paleontological Society	50	0	0
Zoology and Botany of West Indies	100	0	0
Development of Fishes—St. Andrews	50	0	0
Pliocene Fauna of St. Erth	50	0	0
Lymphatic System	25	0	0
Ben Nevis Observatory	150	0	0
North-Western Tribes of Canada	100	0	0
Silent Discharge of Electricity.....	9	11	10
Manure Gravels of Wexford.....	10	0	0
Sea Beach near Bridlington	20	0	0
Effects of Occupations on Physical Development	25	0	0
Magnetic Observations	15	0	0
Methods of Teaching Chemistry	10	0	0
Uniform Nomenclature in Mechanics ..	10	0	0
Geological Record	50	0	0
Migration of Birds	30	0	0
Depths of Frozen Soil in Polar Regions	5	0	0
Circulation of Underground Waters	5	0	0
Standards of Light	79	2	3
Electrical Standards	2	6	4
Peradeniya Botanical Station	50	0	0
Erosion of Sea Coasts	10	0	0
Electrolysis	50	0	0
	1511	0	5
By Balance at Bank of England, Western Branch	239	10	5
	<u>£8441</u>	<u>16</u>	<u>6</u>

ALEX. W. WILLIAMSON, *General Treasurer.*

JOHN EVANS.	} <i>Auditors.</i>
J. H. GLADSTONE.	
W. H. PERKIN.	

Table showing the Attendance and Receipts

Date of Meeting	Where held	Presidents	Old Life	New Life
			Members	Members
1831, Sept. 27 ...	York	The Earl Fitzwilliam, D.C.L.
1832, June 19 ...	Oxford	The Rev. W. Buckland, F.R.S.
1833, June 25 ...	Cambridge	The Rev. A. Sedgwick, F.R.S.
1834, Sept. 8 ...	Edinburgh	Sir T. M. Brisbane, D.C.L.....
1835, Aug. 10 ...	Dublin	The Rev. Provost Lloyd, LL.D.
1836, Aug. 22 ...	Bristol	The Marquis of Lansdowne
1837, Sept. 11 ...	Liverpool	The Earl of Burlington, F.R.S.
1838, Aug. 10 ...	Newcastle-on-Tyne	The Duke of Northumberland
1839, Aug. 26 ...	Birmingham.....	The Rev. W. Vernon Harcourt
1840, Sept. 17 ...	Glasgow	The Marquis of Breadalbane...
1841, July 20 ...	Plymouth	The Rev. W. Whewell, F.R.S.	169	65
1842, June 23 ...	Manchester	The Lord Francis Egerton.....	303	169
1843, Aug. 17 ...	Cork	The Earl of Rosse, F.R.S.	109	28
1844, Sept. 26 ...	York	The Rev. G. Peacock, D.D. ...	226	150
1845, June 19 ...	Cambridge	Sir John F. W. Herschel, Bart.	313	36
1846, Sept. 10 ...	Southampton	Sir Roderick I. Murchison, Bart.	241	10
1847, June 23 ...	Oxford	Sir Robert H. Inglis, Bart.....	314	18
1848, Aug. 9 ...	Swansea	The Marquis of Northampton	149	3
1849, Sept. 12 ...	Birmingham.....	The Rev. T. R. Robinson, D.D.	227	12
1850, July 21 ...	Edinburgh	Sir David Brewster, K.H.	235	9
1851, July 2 ...	Ipswich	G. B. Airy, Astronomer Royal	172	8
1852, Sept. 1 ...	Belfast	Lieut.-General Sabine, F.R.S.	164	10
1853, Sept. 3 ...	Hull	William Hopkins, F.R.S.	141	13
1854, Sept. 20 ...	Liverpool	The Earl of Harrowby, F.R.S.	238	23
1855, Sept. 12 ...	Glasgow	The Duke of Argyll, F.R.S. ...	194	33
1856, Aug. 6 ...	Cheltenham	Prof. C. G. B. Daubeny, M.D.	182	14
1857, Aug. 26 ...	Dublin	The Rev. Humphrey Lloyd, D.D.	236	15
1858, Sept. 22 ...	Leeds.....	Richard Owen, M.D., D.C.L....	222	42
1859, Sept. 14 ...	Aberdeen	H.R.H. the Prince Consort ...	184	27
1860, June 27 ...	Oxford	The Lord Wrottesley, M.A. ...	286	21
1861, Sept. 4 ...	Manchester	William Fairbairn, LL.D., F.R.S.	321	113
1862, Oct. 1 ...	Cambridge	The Rev. Professor Willis, M.A.	239	15
1863, Aug. 26 ...	Newcastle-on-Tyne	Sir William G. Armstrong, C.B.	203	36
1864, Sept. 13 ...	Bath	Sir Charles Lyell, Bart., M.A.	287	40
1865, Sept. 6 ...	Birmingham.....	Prof. J. Phillips, M.A., LL.D.	292	44
1866, Aug. 22 ...	Nottingham	William R. Grove, Q.C., F.R.S.	207	31
1867, Sept. 4 ...	Dundee	The Duke of Buccleuch, K.C.B.	167	25
1868, Aug. 19 ...	Norwich	Dr. Joseph D. Hooker, F.R.S.	196	18
1869, Aug. 18 ...	Exeter	Prof. G. G. Stokes, D.C.L.	204	21
1870, Sept. 14 ...	Liverpool	Prof. T. H. Huxley, LL.D.....	314	39
1871, Aug. 2 ...	Edinburgh	Prof. Sir W. Thomson, LL.D.	246	28
1872, Aug. 14 ...	Brighton	Dr. W. B. Carpenter, F.R.S. ...	245	36
1873, Sept. 17 ...	Bradford	Prof. A. W. Williamson, F.R.S.	212	27
1874, Aug. 19 ...	Belfast	Prof. J. Tyndall, LL.D., F.R.S.	162	13
1875, Aug. 25 ...	Bristol	Sir John Hawkshaw, C.E., F.R.S.	239	36
1876, Sept. 6 ...	Glasgow	Prof. T. Andrews, M.D., F.R.S.	221	35
1877, Aug. 15 ...	Plymouth	Prof. A. Thomson, M.D., F.R.S.	173	19
1878, Aug. 14 ...	Dublin	W. Spottiswoode, M.A., F.R.S.	201	18
1879, Aug. 20 ...	Sheffield	Prof. G. J. Allman, M.D., F.R.S.	184	16
1880, Aug. 25 ...	Swansea	A. C. Ramsay, LL.D., F.R.S....	144	11
1881, Aug. 31 ...	York	Sir John Lubbock, Bart., F.R.S.	272	28
1882, Aug. 23 ...	Southampton	Dr. C. W. Siemens, F.R.S.....	178	17
1883, Sept. 19 ...	Southport	Prof. A. Cayley, D.C.L., F.R.S.	203	60
1884, Aug. 27 ...	Montreal	Prof. Lord Rayleigh, F.R.S. ...	235	20
1885, Sept. 9 ...	Aberdeen	Sir Lyon Playfair, K.C.B., F.R.S.	225	18
1886, Sept. 1 ...	Birmingham.....	Sir J.W. Dawson, C.M.G., F.R.S.	314	25
1887, Aug. 31 ...	Manchester	Sir H. E. Roscoe, D.C.L., F.R.S.	428	86
1888, Sept. 5 ...	Bath	Sir F. J. Bramwell, F.R.S.....	266	36

* Ladies were not admitted by purchased Tickets until 1843.

† Tickets of Admission to Sections only.

at Annual Meetings of the Association.

Attended by						Amount received during the Meeting	Sums paid on Account of Grants for Scientific Purposes	Year
Old Annual Members	New Annual Members	Associates	Ladies	Foreigners	Total			
...	353	1831
...	1832
...	900	1833
...	1298	£20 0 0	1834
...	167 0 0	1835
...	1350	435 0 0	1836
...	1840	922 12 6	1837
...	1100*	...	2400	932 2 2	1838
...	34	1438	1595 11 0	1839
...	40	1353	1546 16 4	1840
46	317	...	60*	...	891	1235 10 11	1841
75	376	33†	331*	28	1315	1449 17 8	1842
71	185	...	160	1565 10 2	1843
45	190	9†	260	981 12 8	1844
94	22	407	172	35	1079	831 9 9	1845
65	39	270	196	36	857	685 16 0	1846
197	40	495	203	53	1320	208 5 4	1847
54	25	376	197	15	819	£707 0 0	275 1 8	1848
93	33	447	237	22	1071	963 0 0	159 19 6	1849
128	42	510	273	44	1241	1085 0 0	345 18 0	1850
61	47	244	141	37	710	620 0 0	391 9 7	1851
63	60	510	292	9	1108	1085 0 0	304 6 7	1852
56	57	367	236	6	876	903 0 0	205 0 0	1853
121	121	765	524	10	1802	1882 0 0	380 19 7	1854
142	101	1094	543	26	2133	2311 0 0	480 16 4	1855
104	48	412	346	9	1115	1098 0 0	734 13 9	1856
156	120	900	569	26	2022	2015 0 0	507 15 4	1857
111	91	710	509	13	1698	1931 0 0	618 18 2	1858
125	179	1206	821	22	2564	2782 0 0	684 11 1	1859
177	59	636	463	47	1689	1604 0 0	766 19 6	1860
184	125	1589	791	15	3138	3944 0 0	1111 5 10	1861
150	57	433	242	25	1161	1089 0 0	1293 16 6	1862
154	209	1704	1004	25	3335	3640 0 0	1608 3 10	1863
182	103	1119	1058	13	2802	2965 0 0	1289 15 8	1864
215	149	766	508	23	1997	2227 0 0	1591 7 10	1865
218	105	960	771	11	2303	2469 0 0	1750 13 4	1866
193	118	1163	771	7	2444	2613 0 0	1739 4 0	1867
226	117	720	682	45†	2004	2042 0 0	1940 0 0	1868
229	107	678	600	17	1856	1931 0 0	1622 0 0	1869
303	195	1103	910	14	2878	3096 0 0	1572 0 0	1870
311	127	976	754	21	2463	2575 0 0	1472 2 6	1871
280	80	937	912	43	2533	2649 0 0	1285 0 0	1872
237	99	796	601	11	1983	2120 0 0	1685 0 0	1873
232	85	817	630	12	1951	1979 0 0	1151 16 0	1874
307	93	884	672	17	2248	2397 0 0	960 0 0	1875
331	185	1265	712	25	2774	3023 0 0	1092 4 2	1876
238	59	446	283	11	1229	1268 0 0	1128 9 7	1877
290	93	1285	674	17	2578	2615 0 0	725 16 6	1878
239	74	529	349	13	1404	1425 0 0	1080 11 11	1879
171	41	389	147	12	915	899 0 0	731 7 7	1880
313	176	1230	514	24	2557	2689 0 0	476 3 1	1881
253	79	516	189	21	1253	1286 0 0	1126 1 11	1882
330	323	952	841	5	2714	3369 0 0	1083 3 3	1883
317	219	826	74	26 & 60 H. §	1777	1538 0 0	1173 4 0	1884
332	122	1053	447	6	2203	2256 0 0	1385 0 0	1885
428	179	1067	29	11	2453	2532 0 0	995 0 6	1886
510	244	1985	493	92	3838	4336 0 0	1186 18 0	1887
399	100	639	509	35	1984	2107 0 0	1511 0 5	1888

Including Ladies.

§ Fellows of the American Association were admitted as Hon. Members for this Meeting.

REPORT OF THE COUNCIL.

Report of the Council for the year 1887-88, presented to the General Committee at Bath, on Wednesday, September 5, 1888.

The Council have received reports during the past year from the General Treasurer, and his account for the year will be laid before the General Committee this day.

Since the Meeting at Manchester the following have been elected Corresponding Members of the Association :—

Cleveland Abbe.
 Professor de Bary.
 Professor Bernthsen.
 His Excellency R. Bonghi.
 Professor Lewis Boss.
 Professor J. W. Bruhl.
 Professor G. Capellini.
 H. Caro.
 Professor J. B. Carnoy.
 F. W. Clarke.
 Professor R. Fittig.
 Dr. Anton Fritsch.
 Professor W. His.
 Fr. von Hefner-Altenneck.
 Professor C. Julin.
 Professor Krause.
 Professor A. Ladenburg.
 Professor J. W. Langley.
 Professor Count Solms von Laubach.
 Professor H. Le Chatelier.
 Professor A. Lieben.
 Professor G. Lippmann.
 Dr. Georg Lunge.
 Dr. Henry C. McCook.
 Dr. C. A. Martius.
 Professor D. Meudelcéff.

Professor N. Menschutkin.
 Professor Lothar Meyer.
 Dr. Charles Sedgwick Minot.
 E. S. Morse.
 Professor Noelting.
 Dr. Pauli.
 Professor W. Preyer.
 N. Pringsheim.
 Professor G. Quincke.
 C. V. Riley.
 M. le Marquis de Saporta.
 Ernest Solvay.
 Dr. Alfred Springer.
 Dr. T. M. Treub.
 Professor John Vilanova.
 Professor H. F. Weber.
 Professor L. Weber.
 Professor August Weismann.
 Professor R. Wiedersheim.
 Professor G. Wiedemann.
 Professor J. Wislicenus.
 Dr. Otto Witt.
 Dr. Ludwig H. Wolf.
 Professor C. A. Young.
 Professor F. Zirkel.

The Council have nominated the Venerable Archdeacon Browne a Vice-President of the meeting at Bath.

Invitations for the year 1890 will be presented from Leeds and Cardiff, and from Edinburgh for the year 1891.

The following resolution was referred by the General Committee to the Council for consideration, and action if desirable :—

‘That the Council be requested to take such action as they may think most expedient in order to bring before the Signal Office of the United States a statement of the high value which British meteorologists attach to the manuscript bibliography prepared by the Signal Office.’

The Council, after consideration of the question, are of opinion that it is inexpedient to take action in the matter.

The Council, having considered a motion of Mr. W. T. Thiselton-Dyer calling attention to the present mode of appointing Committees,

with a view to securing more responsible action, are of opinion that the following rule of the Association, 'In case of appointment of Committees for special objects of science, it is expedient that all Members of the Committee should be named, and one of them appointed to act as Secretary, for insuring attention to business,' should be amended as follows:

'In case of appointment of Committees for special objects of science it is expedient that all Members of the Committee should be named, and one of them appointed to act as Chairman, who shall have notified personally or in writing his willingness to accept the office, the Chairman to have the responsibility of receiving and disbursing the grant (if any has been made) and securing the presentation of the report in due time; and, further, it is expedient that one of the Members should be appointed to act as Secretary for insuring attention to business.

'That it is desirable that the number of Members appointed to serve on a Committee should be as small as is consistent with its efficient working.

'That a tabular list of the Committees appointed on the recommendation of each Section should be sent each year to the Recorders of the several Sections, to enable them to fill in the statement whether the several Committees appointed on the recommendation of their respective Sections had presented their reports.

'That on the proposal to recommend the appointment of a Committee for a special object of science having been adopted by the Sectional Committee, the number of Members of such Committee be then fixed, but that the Members to serve on such Committee be nominated and selected by the Sectional Committee at a subsequent meeting.'

The Council have received the following report from a Committee of Council appointed to consider the question of grants to marine biological stations in this country, together with a letter from Professor E. Ray Lankester, Secretary of the Marine Biological Association, suggesting that the British Association should complete its donations to the funds of that Association, so as to make up the sum given to the amount of 500*l.*, thereby securing certain rights.

'The British Association has up to the present time granted altogether 300*l.* to the Marine Biological Association, and by a further grant of 200*l.* the British Association would be entitled to nominate a representative on the Council of the Marine Biological Association. The Committee are of opinion that the Council should recommend the General Committee to grant the 200*l.*, and appoint a member to represent them on the Council of the Marine Biological Association.

'With reference to the grants to Marine Biological Stations generally, the Committee are of opinion that in all these cases it is desirable that grants in future should be made to individuals for specific researches rather than for the general maintenance of institutions; and with reference to the Scottish Stations they would further call the attention of the Council to the fact that the Scotch Fishery Board has a parliamentary grant of 2,000*l.* per annum for scientific investigations, the whole of which, it appears from the appropriation accounts, is not at present expended.'

The Council, having received the above Report, have forwarded it, together with the letter of Professor Lankester, to the Committee of Section D.

The report of the Corresponding Societies Committee is herewith submitted to the General Committee.

The Corresponding Societies Committee consisting of Mr. Francis Galton (Chairman), Professor A. W. Williamson, Sir Douglas Galton, Professor Boyd Dawkins, Sir Rawson Rawson, Dr. J. G. Garson, Dr. J. Evans, Mr. J. Hopkinson, Professor R. Meldola (Secretary), Mr. W. Whitaker, Mr. G. J. Symons, General Pitt-Rivers, Mr. W. Topley, Mr. H. G. Fordham, and Mr. William White, with the addition of Professor T. G. Bonney, is hereby nominated for reappointment by the General Committee.

The Council hereby nominate Dr. John Evans, Treasurer R.S., Chairman, Mr. W. Whitaker, F.R.S., Vice-Chairman, and Professor R. Meldola, F.R.S., Secretary to the Conference of Delegates of Corresponding Societies to be held during the Bath meeting.

In accordance with the regulations the five retiring Members of the Council will be:—

Prof. W. Boyd Dawkins, F.R.S.
 Prof. J. Dewar, F.R.S.
 Prof. W. H. Flower, C.B.

Dr. J. H. Gladstone.
 Prof. H. N. Moseley.

The Council recommend the re-election of the other ordinary Members of Council, with the addition of the gentlemen whose names are distinguished by an asterisk in the following list:—

Abney, Capt. W. de W., C.B., F.R.S.
 Ball, Sir R. S., F.R.S.
 Barlow, W. H., Esq., F.R.S.
 Blanford, W. T., Esq., F.R.S.
 Crookes, W., Esq., F.R.S.
 Darwin, Prof. G. H., F.R.S.
 Douglass, Sir James, F.R.S.
 *Gamgee, Dr. A., F.R.S.
 *Geikie, Dr. A., F.R.S.
 Godwin-Austen, Lieut.-Col. H. H., F.R.S.
 Henrici, Prof. O., F.R.S.
 Judd, Prof. J. W., F.R.S.
 *Liveing, Prof., F.R.S.

Martin, J. B., Esq., F.S.S.
 M'Leod, Prof. H., F.R.S.
 Ommanney, Admiral Sir E., C.B., F.R.S.
 *Preece, W. H., Esq., F.R.S.
 Roberts-Austen, Prof. W. C., F.R.S.
 *Rücker, Prof., F.R.S.
 Schuster, Prof., F.R.S.
 Sidgwick, Prof. H., M.A.
 Schäfer, Prof., F.R.S.
 Thiselton-Dyer, W. T., Esq., C.M.G.,
 F.R.S.
 Thorpe, Prof. T. E., F.R.S.
 Woodward, Dr. H., F.R.S.

COMMITTEES APPOINTED BY THE GENERAL COMMITTEE AT THE
BATH MEETING IN SEPTEMBER 1888.

1. *Receiving Grants of Money.*

Subject for Investigation or Purpose	Members of the Committee	Grants
<p>The Possibility of Calculating Tables of certain Mathematical Functions, and, if necessary, of taking steps to carry out the calculations, and to publish the results in an accessible form.</p>	<p><i>Chairman.</i>—Lord Rayleigh. <i>Secretary.</i>—Mr. A. Lodge. Sir William Thomson, Professor Cayley, Professor B. Price, and Messrs. J. W. L. Glaisher, A. G. Greenhill, and W. M. Hicks.</p>	<p>£ 10</p>
<p>Co-operating with the Scottish Meteorological Society in making Meteorological Observations on Ben Nevis.</p>	<p><i>Chairman.</i>—Hon. R. Abercromby. <i>Secretary.</i>—Professor Crum Brown. Messrs. Milne-Home, John Murray, and Buchan, and Lord McLaren.</p>	<p>50</p>
<p>Making Experiments for improving the Construction of Practical Standards for use in Electrical Measurements.</p>	<p><i>Chairman.</i>—Professor Carey Foster. <i>Secretary.</i>—Mr. R. T. Glazebrook. Sir William Thomson, Professor Ayrton, Professor J. Perry, Professor W. G. Adams, Lord Rayleigh, Dr. O. J. Lodge, Dr. John Hopkinson, Dr. A. Muirhead, Mr. W. H. Preece, Mr. Herbert Taylor, Professor Everett, Professor Schuster, Dr. J. A. Fleming, Professor G. F. Fitzgerald, Professor Chrystal, Mr. H. Tomlinson, Professor W. Garnett, Professor J. J. Thomson, Mr. W. N. Shaw, Mr. J. T. Bottomley, and Mr. T. C. Fitzpatrick.</p>	<p>100</p>
<p>Considering the subject of Electrolysis in its Physical and Chemical Bearings.</p>	<p><i>Chairman.</i>—Professor Fitzgerald. <i>Secretaries.</i>—Professors Armstrong and O. J. Lodge. Professors Sir William Thomson, Lord Rayleigh, J. J. Thomson, Schuster, Poynting, Crum Brown, Ramsay, Frankland, Tilden, Hartley, S. P. Thompson, M'Leod, Roberts-Austen, Rücker, Reinold, Carey Foster, and H. B. Dixon, Captain Abney, Drs. Gladstone, Hopkinson, and Fleming, and Messrs. Crookes, Shelford Bidwell, W. N. Shaw, J. Larmor, J. T. Bottomley, R. T. Glazebrook, J. Brown, E. J. Love, and John M. Thomson.</p>	<p>20</p>

1. *Receiving Grants of Money*—continued.

Subject for Investigation or Purpose	Members of the Committee	Grants
Considering the best Methods of Recording the Direct Intensity of Solar Radiation.	<i>Chairman.</i> —Professor Stokes. <i>Secretary.</i> —Mr. G. J. Symons. Professor Schuster, Mr. G. Johnstone Stoney, Sir H. E. Roscoe, Captain Abney, and Mr. Whipple.	£ 10
Inviting Designs for a good Differential Gravity Meter in super-session of the Pendulum, whereby satisfactory results may be obtained at each station of observation in a few hours instead of the many days over which it is necessary to extend pendulum observations.	<i>Chairman.</i> —General J. T. Walker. <i>Secretary.</i> —Professor Poynting. Sir William Thomson, Sir J. H. Lefroy, General R. Strachey, Professors A. S. Herschel, G. Chrystal, C. Niven, and A. Schuster, and Mr. C. V. Boys.	10
Seasonal Variations in the Temperatures of Lakes, Rivers, and Estuaries in Various Parts of the United Kingdom in Co-operation with the Local Societies represented on the Association.	<i>Chairman.</i> —Mr. John Murray. <i>Secretary.</i> —Dr. H. R. Mill. Professor Chrystal, Dr. A. Buchan, Rev. C. J. Steward, the Hon. R. Abercromby, Mr. J. Y. Buchanan, Mr. David Cunningham, Mr. Isaac Roberts, Professor Fitzgerald, Mr. Sorby, and Mr. Willis Bund.	30
Considering the Desirability of introducing a Uniform Nomenclature for the Fundamental Units of Mechanics and of co-operating with other bodies engaged in similar work.	<i>Chairman.</i> —Sir R. S. Ball. <i>Secretary.</i> —Mr. Culverwell. Dr. G. Johnstone Stoney, Professors Everett, Fitzgerald, Hicks, Carey Foster, O. J. Lodge, Poynting, MacGregor, Genese, W. G. Adams, and Lamb, and Messrs. Baynes, A. Lodge, Fleming, W. N. Shaw, Glazebrook, Hayward, Lant Carpenter, Greenhill, Muir, G. Griffith, and J. Larmor.	10
The Action of Light on the Hydracids of the Halogens in presence of Oxygen.	<i>Chairman.</i> —Dr. Russell. <i>Secretary.</i> —Dr. A. Richardson. Captain Abney, and Professors Noel Hartley and W. Ramsay.	10
The Influence of the Silent Discharge of Electricity on Oxygen and other gases.	<i>Chairman.</i> —Professor H. M'Leod. <i>Secretary.</i> —W. A. Shenstone. Professor Ramsay and Mr. J. T. Cundall.	10
Inquiring into and reporting on the present Methods adopted for teaching Chemistry.	<i>Chairman.</i> —Dr. W. J. Russell. <i>Secretary.</i> —Professor W. R. Dunstan. Sir H. E. Roscoe, Professor H. E. Armstrong, Professor Meldola, Professor M'Leod, Dr. J. H. Gladstone, Mr. A. G. Vernon Harcourt, Mr. M. M. Pattison Muir, Professor Smithells, Mr. W. A. Shenstone, and Mr. G. Stallard.	10

1. *Receiving Grants of Money*—continued.

Subject for Investigation or Purpose	Members of the Committee	Grants
Recording the Position, Height above the sea, Lithological Characters, Size, and Origin of the Erratic Blocks of England, Wales, and Ireland, reporting other matters of interest connected with the same, and taking measures for their preservation.	<i>Chairman.</i> —Professor J. Prestwich, <i>Secretary.</i> —Dr. H. W. Crosskey. Professors W. Boyd Dawkins, T. McK. Hughes, and T. G. Bonney and Messrs. C. E. De Rance, D. Mackintosh, W. Pengelly, J. Plant, and R. H. Tiddeman.	£ 10
The Volcanic Phenomena of Japan.	<i>Chairman.</i> —Mr. R. Etheridge. <i>Secretary.</i> —Professor J. Milne. Mr. T. Gray.	25
The Volcanic Phenomena of Vesuvius and its neighbourhood.	<i>Chairman.</i> —Mr. H. Bauerman. <i>Secretary.</i> —Dr. H. J. Johnston-Lavis. Messrs. F. W. Rudler and J. J. H. Teall.	20
Reporting on the Fossil Phyllo-poda of the Palæozoic Rocks.	<i>Chairman.</i> —Mr. R. Etheridge. <i>Secretary.</i> —Professor T. R. Jones. Dr. H. Woodward.	20
Exploring the Higher Eocene Beds of the Isle of Wight.	<i>Chairman.</i> —Dr. H. Woodward. <i>Secretary.</i> —Mr. J. S. Gardner. Mr. Clement Reid.	15
Reporting on the Fossil Plants of the Tertiary and Secondary Beds of the United Kingdom.	<i>Chairman.</i> —Dr. W. T. Blanford. <i>Secretary.</i> —Mr. J. S. Gardner. Professor J. W. Judd, Mr. W. Carruthers, and Dr. H. Woodward.	15
Carrying on the 'Geological Record.'	<i>Chairman.</i> —Dr. J. Evans. <i>Secretary.</i> —Mr. W. Topley. Dr. G. J. Hinde and Messrs. R. B. Newton, J. J. H. Teall, F. W. Rudler, and W. Whitaker.	80
To improve and experiment with a Deep-sea Tow-net for opening and closing under water.	<i>Chairman.</i> —Professor Schäfer. <i>Secretary.</i> —Mr. W. E. Hoyle. Professor W. A. Herdman.	10
The Natural History of the Friendly Islands, or other groups in the Pacific, visited by H.M.S. 'Egeria.'	<i>Chairman.</i> —Professor Newton. <i>Secretary.</i> —Mr. Harmer. Mr. W. T. Thiselton-Dyer and Professor M. Foster.	100
Continuing the Preparation of a Report on our present Knowledge of the Flora of China.	<i>Chairman.</i> —Mr. John Ball. <i>Secretary.</i> —Mr. Thiselton-Dyer. Mr. Carruthers, Professor Oliver, and Mr. Forbes.	25
The Physiology of the Lymphatic System.	<i>Chairman.</i> —Professor Schäfer. <i>Secretary.</i> —Dr. W. D. Halliburton. Professor M. Foster and Professor E. Ray Lankester.	25

1. *Receiving Grants of Money*—continued.

Subject for Investigation or Purpose	Members of the Committee	Grants
Arranging for the Occupation of a Table at the Zoological Station at Naples.	<i>Chairman.</i> —Dr. P. L. Sclater. <i>Secretary.</i> —Mr. Percy Sladen. Professor E. Ray Lankester, Professor Cossar Ewart, Professor M. Foster, Mr. A. Sedgwick, and Professor A. M. Marshall.	£ 100
Reporting on the present state of our Knowledge of the Zoology and Botany of the West India Islands, and taking steps to investigate ascertained deficiencies in the Fauna and Flora.	<i>Chairman.</i> —Professor Flower. <i>Secretary.</i> —Mr. D. Morris. Mr. Carruthers, Dr. Sclater, Mr. Thiselton-Dyer, Dr. Sharp, Mr. F. Du Cane Godman, and Professor Newton.	100
Geography and Geology of the Atlas ranges in the Empire of Morocco, by Mr. Joseph Thomson.	<i>Chairman.</i> —General J. T. Walker. <i>Secretary.</i> —Mr. H. W. Bates. General R. Strachey, Mr. W. T. Thiselton-Dyer, and Professor W. Boyd Dawkins.	100
Inquiring and reporting as to the Statistical Data available for determining the Amount of the Precious Metals in use as Money in the principal countries of the world, the chief forms in which the money is employed, and the amount annually used in the arts.	<i>Chairman.</i> —Mr. Robert Giffen. <i>Secretary.</i> —Prof. F. Y. Edgeworth. Mr. S. Bourne, Professor H. S. Foxwell, Professor Alfred Marshall, Mr. J. B. Martin, Professor J. S. Nicholson, Mr. R. H. Inglis Palgrave, and Professor H. Sidgwick.	20
The best method of ascertaining and measuring Variations in the Value of the Monetary Standard.	<i>Chairman.</i> —Mr. Robert Giffen. <i>Secretary.</i> —Prof. F. Y. Edgeworth. Mr. S. Bourne, Professor H. S. Foxwell, Professor Alfred Marshall, Mr. J. B. Martin, Professor J. S. Nicholson, Mr. R. H. Inglis Palgrave, and Professor H. Sidgwick.	10
The Action of Waves and Currents on the Beds and Foreshores of Estuaries by means of Working Models.	<i>Chairman.</i> —Sir J. N. Douglass. <i>Secretary.</i> —Professor W. C. Unwin. Professor Osborne Reynolds and Messrs. W. Topley, E. Leader Williams, W. Shelford, G. F. Deacon, A. R. Hunt, and W. H. Wheeler.	100
To report on the Development of Graphic Methods in Mechanical Science.	<i>Chairman.</i> —Mr. W. H. Preece. <i>Secretary.</i> —Professor H. S. Hele Shaw. Messrs. B. Baker, W. Anderson, and G. Kapp and Professors J. Perry and R. H. Smith.	25
Editing a new Edition of 'Anthropological Notes and Queries.'	<i>Chairman.</i> —General Pitt-Rivers. <i>Secretary.</i> —Dr. Garson. Dr. Beddoe, Professor Flower, Mr. Francis Galton, Dr. E. B. Tylor.	50

1. *Receiving Grants of Money*—continued.

Subject for Investigation or Purpose	Members of the Committee	Grants
The Habits and Customs and Physical Characteristics of the Nomad Tribes of Asia Minor, and to excavate on sites of ancient occupation.	<i>Chairman.</i> —Dr. Garson. <i>Secretary.</i> —Mr. Bent. Mr. Pengelly, Mr. Rudler, Mr. Bloxam, Mr. J. Stuart Glennie.	£ 30
The Physical Characters, Languages, and Industrial and Social Condition of the North-Western Tribes of the Dominion of Canada.	<i>Chairman.</i> —Dr. E. B. Tylor. <i>Secretary.</i> —Mr. G. W. Bloxam. Sir Daniel Wilson, Dr. G. M. Dawson, General Sir H. Lefroy, Mr. R. G. Haliburton.	150
The Effects of different Occupations and Employments on the Physical Development of the Human Body.	<i>Chairman.</i> —Sir Rawson Rawson. <i>Secretary.</i> —Mr. G. W. Bloxam. General Pitt-Rivers, Dr. J. Beddoe, Dr. H. Muirhead, Mr. C. Roberts, Dr. G. W. Hambleton, Mr. F. W. Rudler, Mr. Horace Darwin, Dr. J. G. Garson, and Dr. A. M. Paterson.	20
Calculating the Anthropological Measurements taken at Bath	<i>Chairman.</i> —General Pitt-Rivers. <i>Secretary.</i> —Dr. Garson. Mr. Bloxam.	5
Carrying on the work of the Corresponding Societies Committee.	<i>Chairman.</i> —Dr. John Evans. <i>Secretary.</i> —Professor R. Meldola. Mr. Francis Galton, Professor A. W. Williamson, Sir Douglas Galton, Professor Boyd Dawkins, Sir Rawson Rawson, Dr. J. G. Garson, Mr. J. Hopkinson, Mr. W. Whitaker, Mr. G. J. Symons, General Pitt-Rivers, Mr. W. Topley, Mr. H. G. Fordham, Mr. William White, and Professor Bonney.	20

2. *Not receiving Grants of Money.*

Subject for Investigation or Purpose	Members of the Committee
To consider the proposals of M. Tondini de Quarenghi relative to the Unification of Time, and the adoption of a Universal Prime Meridian, which have been brought before the Committee by a letter from the Academy of Sciences of Bologna.	<i>Chairman.</i> —Mr. J. Glaisher. <i>Secretary.</i> —Mr. J. Glaisher. Mr. Christie (Astronomer Royal), Sir R. S. Ball, and Dr. G. B. Longstaff.
Considering the advisability and possibility of establishing in other parts of the country Observations upon the Prevalence of Earth Tremors similar to those now being made in Durham in connection with coal-mine explosions.	<i>Chairman.</i> —Mr. G. J. Symons. <i>Secretary.</i> —Professor Lebour. Sir F. J. Bramwell, Mr. E. A. Cowper, Professor G. H. Darwin, Professor Ewing, Mr. Isaac Roberts, Mr. Thomas Gray, Dr. John Evans, Professor Prestwich, Professor Hull, Professor Meldola, Professor Judd, Mr. M. Walton Brown, and Mr. J. Glaisher.

2. *Not receiving Grants of Money*—continued.

Subject for Investigation or Purpose	Members of the Committee
The Molecular Phenomena connected with the Magnetisation of Iron.	<i>Chairman.</i> —Professor Fitzgerald. <i>Secretary.</i> —Professor Barrett. Mr. Trouton.
The Collection and Identification of Meteoric Dust.	<i>Chairman.</i> —Mr. John Murray. <i>Secretary.</i> —Mr. John Murray: Professor Schuster, Sir William Thomson, the Abbé Renard, Mr. A. Buchan, the Hon. R. Abercromby, and Dr. M. Grabham.
The Promotion of Tidal Observations in Canada.	<i>Chairman.</i> —Professor Johnson. <i>Secretary.</i> —Professor Johnson. Professors Macgregor, J. B. Cherriman, and H. J. Bovey and Mr. C. Carpmael.
Calculating certain tables in the Theory of Numbers connected with the Divisors of a Number.	<i>Chairman.</i> —Professor Cayley. <i>Secretary.</i> —Mr. J. W. L. Glaisher. Sir W. Thomson and Mr. James Glaisher.
The Harmonic Analysis of Tidal Observation.	<i>Chairman.</i> —Professor J. C. Adams. <i>Secretary.</i> —Professor G. H. Darwin.
Preparing instructions for the practical Work of Tidal Observation.	<i>Chairman.</i> —Professor Darwin. <i>Secretary.</i> —Professor Darwin. Sir W. Thomson and Major Baird.
Comparing and Reducing Magnetic Observations.	<i>Chairman.</i> —Professor W. G. Adams. <i>Secretary.</i> —Professor W. G. Adams. Sir W. Thomson, Sir J. H. Lefroy, Professors G. H. Darwin, G. Chrystal, and S. J. Perry, Mr. C. H. Carpmael, Professor Schuster, Mr. G. M. Whipple, Captain Creak, the Astronomer Royal, Mr. William Ellis, and Mr. W. Lant Carpenter.
The Rate of Increase of Underground Temperature downwards in various Localities of dry Land and under Water.	<i>Chairman.</i> —Professor Everett. <i>Secretary.</i> —Professor Everett. Professor Sir William Thomson, Mr. G. J. Symons, Sir A. C. Ramsay, Dr. A. Geikie, Mr. J. Glaisher, Mr. Pengelly, Professor Edward Hull, Professor Prestwich, Dr. C. Le Neve Foster, Professor A. S. Herschel, Professor G. A. Lebour, Mr. A. B. Wynne, Mr. Gallo-way, Mr. Joseph Dickinson, Mr. G. F. Deacon, Mr. E. Wethered, and Mr. A. Strahan.
Conferring with a Committee of the American Association with a view of forming a Uniform System of Recording the Results of Water Analysis.	<i>Chairman.</i> —Professor Dewar. <i>Secretary.</i> —Professor P. F. Frankland. Professor Odling and Mr. Crookes.

2. *Not receiving Grants of Money*—continued.

Subject for Investigation or Purpose	Members of the Committee
The Continuation of the Bibliography of Spectroscopy.	<i>Chairman.</i> —Professor H. M'Leod. <i>Secretary.</i> —Professor Roberts-Austen. Professor Reinold.
To consider the best Method of Establishing an International Standard for the Analysis of Iron and Steel.	<i>Chairman.</i> —Professor Roberts-Austen. <i>Secretary.</i> —Mr. T. Turner. Mr. J. W. Langley.
Preparing a new series of Wave-length Tables of the Spectra of the Elements.	<i>Chairman.</i> —Sir H. E. Roscoe. <i>Secretary.</i> —Dr. Marshall Watts. Mr. Lockyer, Professors Dewar, Liveing, Schuster, W. N. Hartley, and Wolcott Gibbs and Captain Abney.
Absorption Spectra of Pure Compounds.	<i>Chairman.</i> —General Festing. <i>Secretary.</i> —Dr. H. E. Armstrong. Captain Abney and Professor W. N. Hartley.
The Influence of Silicon on the Properties of Steel.	<i>Chairman.</i> —Professor W. A. Tilden. <i>Secretary.</i> —Mr. Thomas Turner. Professor Roberts-Austen.
Isomeric Naphthalene Derivatives.	<i>Chairman.</i> —Professor W. A. Tilden. <i>Secretary.</i> —Professor H. E. Armstrong.
Certain Physical Constants of Solution, especially the Expansion of Saline Solutions.	<i>Chairman.</i> —Professor W. Ramsay. <i>Secretary.</i> —Professor W. L. Goodwin. Professors Marshall and Tilden.
Reporting on the Bibliography of Solution.	<i>Chairman.</i> —Professor W. A. Tilden. <i>Secretary.</i> —Dr. W. W. J. Nicol. Professors M'Leod, Pickering, Ramsay, and Young and Dr. A. R. Leeds.
The Properties of Solutions	<i>Chairman.</i> —Professor W. A. Tilden. <i>Secretary.</i> —Dr. W. W. J. Nicol. Professor Ramsay.
The Circulation of the Underground Waters in the Permeable Formations of England, and the Quality and Quantity of the Waters supplied to various Towns and Districts from these Formations.	<i>Chairman.</i> —Professor E. Hull. <i>Secretary.</i> —Mr. C. E. De Rance. Dr. H. W. Crosskey, Sir D. Galton, Professor J. Prestwich, and Messrs. J. Glaisher, E. B. Marten, G. H. Morton, J. Parker, W. Pengelly, J. Plant, I. Roberts, C. Fox-Strangways, T. S. Stooke, G. J. Symons, W. Topley, Tylden-Wright, E. Wethered, and W. Whitaker.
Reporting upon the 'Manure Gravels' of Wexford.	<i>Chairman.</i> —Mr. R. Etheridge. <i>Secretary.</i> —Mr. A. Bell. Dr. H. Woodward.
An Ancient Sea-beach near Bridlington.	<i>Chairman.</i> —Mr. J. W. Davis. <i>Secretary.</i> —Mr. G. W. Lamplugh. Mr. W. Cash, Dr. H. Hicks, Mr. Clement Reid, Dr. H. Woodward, and Mr. T. Boynton.

2. *Not receiving Grants of Money.*—continued.

Subject for Investigation or Purpose	Members of the Committee
The Rate of Erosion of the Sea-coasts of England and Wales, and the Influence of the Artificial Abstraction of Shingle or other material in that action.	<p><i>Chairman.</i>—Mr. R. B. Grantham. <i>Secretaries.</i>—Messrs. C. E. De Rance and W. Topley. Messrs. J. B. Redman, W. Whitaker, and J. W. Woodall, Maj.-Gen. Sir A. Clarke, Admiral Sir E. Ommanney, Sir J. N. Douglass, Capt. Sir G. Nares, Capt. J. Parsons, Capt. W. J. L. Wharton, Professor J. Prestwich, and Messrs. E. Easton, J. S. Valentine, and L. F. Vernon Harcourt.</p>
The Flora of the Carboniferous Rocks of Lancashire and West Yorkshire.	<p><i>Chairman.</i>—Professor W. C. Williamson. <i>Secretary.</i>—Mr. W. Cash.</p>
The Development of the Oviduct and connected Structures in certain Fresh-water Teleostei.	<p><i>Chairman.</i>—Professor Lankester. <i>Secretary.</i>—Mr. G. H. Fowler. Professor Milnes Marshall and Mr. Sedgwick.</p>
Taking steps for the Establishment of a Botanical Station at Peradeniya, Ceylon.	<p><i>Chairman.</i>—Professor M. Foster. <i>Secretary.</i>—Professor F. O. Bower. Professor Bayley Balfour, Mr. Thiselton-Dyer, Dr. Trimen, Professor Marshall Ward, Mr. Carruthers, and Professor Hartog.</p>
To make a Digest of the Observations on Migrations of Birds at Lighthouses and Light-vessels, which have been carried on during the past nine years by the Migrations Committee of the British Association (with the consent of the Masters and Elder Brethren of the Trinity House, and the Commissioners of Northern Lights), and to report upon the same at Newcastle.	<p><i>Chairman.</i>—Professor Newton. <i>Secretary.</i>—Mr. John Cordeaux. Mr. Harvie-Brown, Mr. R. M. Barrington, Mr. W. E. Clarke, and Rev. E. P. Knubley.</p>
Collecting Information as to the Disappearance of Native Plants from their Local Habitats.	<p><i>Chairman.</i>—Mr. A. W. Wills. <i>Secretary.</i>—Professor W. Hillhouse. Mr. E. W. Badger.</p>
The Teaching of Science in Elementary Schools.	<p><i>Chairman.</i>—Dr. J. H. Gladstone. <i>Secretary.</i>—Professor Armstrong. Mr. S. Bourne, Miss Becker, Sir J. Lubbock, Dr. Crosskey, Sir R. Temple, Sir H. E. Roscoe, Mr. J. Heywood, and Professor N. Story Maskelyne.</p>

Other Resolutions adopted by the General Committee.

That it is desirable that the Association should become a Governor of the Marine Biological Association, and that a grant of 200*l.* be made to the Marine Biological Association with that view.

That the sum of 100*l.* be placed at the disposal of the Baths Committee of the Bath Corporation to assist in the prosecution of further researches in the Roman Baths.

That Mr. R. E. Baynes and Mr. J. Larmor be requested to draw up a Report on the present state of our knowledge in Thermodynamics, specially with regard to the second law.

That Mr. W. N. Shaw be requested to continue his Report on the present state of our knowledge in Electrolysis and Electro-chemistry.

That Mr. P. T. Main be requested to continue his Report on our experimental knowledge of the Properties of Matter with respect to Volume, Pressure, Temperature, and Specific Heat.

That Mr. Glazebrook be requested to continue his Report on Optics.

That Professor J. J. Thomson be requested to continue his Report on Electrical Theories.

Communications ordered to be printed in extenso in the Annual Report of the Association.

Dr. J. Janssen's paper, 'Sur l'application de l'analyse spectrale à la mécanique moléculaire et sur les spectres de l'oxygène.'

Mr. Stephen Bourne's paper, 'The Use of Index-numbers.'

Mr. L. L. F. R. Price's paper, 'The Relation between Sliding Scales and Economic Theory.'

Professor H. S. Hele Shaw and Mr. E. Shaw's paper on 'The Friction of Metal Coils,' with the necessary illustrations.

The Report of the Conference on Lightning Conductors, as far as is desirable.

Mr. Dalton's paper giving a List of British Mineral Waters.

The Bibliography of the Lesser Antilles, as an appendix to the Report of the Committee on the Zoology and Botany of the West India Islands.

Resolutions referred to the Council for consideration, and action if desirable.

That the Council be recommended to consider what measures, if any, it might be desirable to take with respect to the apparatus from time to time purchased by funds voted by the Association.

That the Council of the Association be requested to urge upon the Corporation of Bath the desirability of laying bare a further portion of the unique Roman Baths at this city, with the view to their permanent preservation; and that the part already laid bare should be protected from the weather.

That the Council be requested to memorialise her Majesty's Government in favour of establishing a permanent Census Sub-Department, and taking the census of the United Kingdom every five years.

Synopsis of Grants of Money appropriated to Scientific Purposes by the General Committee at the Bath Meeting, in September, 1888. The Names of the Members entitled to call on the General Treasurer for the respective Grants are prefixed.

Mathematics and Physics.

	£	s.	d.
*Abercromby, Hon. R.—Ben Nevis Observatory	50	0	0
*Foster, Professor G. Carey.—Electrical Standards	100	0	0
*Fitzgerald, Professor.—Electrolysis	20	0	0
*Stokes, Professor.—Solar Radiation	10	0	0
*Walker, General J. T.—Differential Gravity Meter	10	0	0
*Ball, Sir R. S.—Uniform Nomenclature in Mechanics	10	0	0
Rayleigh, Lord.—Calculating Tables of certain Mathematical Functions.....	10	0	0
*Murray, Mr. J.—Seasonal Variations in the Temperature of Lakes, Rivers, and Estuaries.....	30	0	0

Chemistry.

*McLeod, Professor H.—The Influence of the Silent Discharge of Electricity on Oxygen and other Gases	10	0	0
*Russell, Dr. W. J.—Methods of Teaching Chemistry	10	0	0
*Russell, Dr. W. J.—Oxidation of Hydracids in Sunlight ...	10	0	0

Geology.

*Evans, Dr. J.—Geological Record	80	0	0
*Prestwich, Professor J.—Erratic Blocks	10	0	0
*Etheridge, Mr. R.—Volcanic Phenomena of Japan	25	0	0
*Bauerman, Mr. H.—Volcanic Phenomena of Vesuvius	20	0	0
*Etheridge, Mr. R.—Fossil Phyllopoda of the Palæozoic Rocks	20	0	0
*Woodward, Dr. H.—Higher Eocene Beds of the Isle of Wight	15	0	0
*Blanford, Dr. W. T.—Fossil Plants of the Tertiary and Secondary Beds of the United Kingdom.....	15	0	0

Biology.

*Flower, Professor.—Zoology and Botany of the West India Islands	100	0	0
*Ball, Mr. John.—Flora of China	25	0	0
*Selater, Dr. P. L.—Naples Zoological Station	100	0	0

Carried forward..... £680 0 0

* Reappointed.

	£	s.	d.
Brought forward.....	680	0	0
*Schäfer, Professor.—Physiology of the Lymphatic System...	25	0	0
*Schäfer, Professor.—To Improve and Experiment with a Deep Sea Tow-Net, for opening and closing under water	10	0	0
Newton, Professor.—Natural History of the Friendly Islands	100	0	0

Geography.

Walker, General J. T.—Geography and Geology of the Atlas Ranges	100	0	0
--	-----	---	---

Economic Science and Statistics.

*Giffen, Mr. R.—Precious Metals in Circulation	20	0	0
*Giffen, Mr. R.—Variations in the Value of the Monetary Standard	10	0	0

Mechanical Science.

*Douglass, Sir J. W.—Investigation of Estuaries by Means of Models	100	0	0
Preece, Mr. W. H.—Development of Graphic Methods in Mechanical Science.....	25	0	0

Anthropology.

*Rawson, Sir R.—Effect of Occupations on Physical Develop- ment	20	0	0
*Tylor, Dr. E. B.—North-Western Tribes of Canada.....	150	0	0
*Pitt-Rivers, General.—Editing a New Edition of Anthropol- ogical Notes and Queries	50	0	0
Pitt-Rivers, General.—Calculating the Anthropological Mea- surements taken at Bath.....	5	0	0
Garson, Dr.—Characteristics of Nomad Tribes of Asia Minor	30	0	0
*Evans, Dr. J.—Corresponding Societies	20	0	0
Marine Biological Association	200	0	0
Exploration of Roman Baths at Bath	100	0	0
	<u>£1,645</u>	<u>0</u>	<u>0</u>

* Reappointed.

The Annual Meeting in 1889.

The Meeting at Newcastle-upon-Tyne will commence on Wednesday,
September 11.

Place of Meeting in 1890.†

The Annual Meeting of the Association will be held at Leeds.

General Statement of Sums which have been paid on account of Grants for Scientific Purposes.

	£	s.	d.		£	s.	d.
				Mechanism of Waves	144	2	0
1834.				Bristol Tides	35	18	6
Tide Discussions	20	0	0	Meteorology and Subterra- nean Temperature.....	21	11	0
				Vitrification Experiments ...	9	4	7
1835.				Cast-Iron Experiments.....	103	0	0
Tide Discussions	62	0	0	Railway Constants	28	7	2
British Fossil Ichthyology ...	105	0	0	Land and Sea Level.....	274	1	4
				Steam-vessels' Engines	100	0	0
	£167	0	0	Stars in Histoire Céleste	171	18	6
				Stars in Lacaille	11	0	0
1836.				Stars in R.A.S. Catalogue ...	166	16	6
Tide Discussions	163	0	0	Animal Secretions.....	10	10	0
British Fossil Ichthyology ...	105	0	0	Steam Engines in Cornwall...	50	0	0
Thermometric Observations, &c.	50	0	0	Atmospheric Air	16	1	0
Experiments on long-con- tinued Heat	17	1	0	Cast and Wrought Iron	40	0	0
Rain-Gauges	9	13	0	Heat on Organic Bodies	3	0	0
Refraction Experiments	15	0	0	Gases on Solar Spectrum	22	0	0
Lunar Nutation.....	60	0	0	Hourly Meteorological Ob- servations, Inverness and Kingussie	49	7	8
Thermometers	15	6	0	Fossil Reptiles	118	2	9
	£435	0	0	Mining Statistics	50	0	0
					£1595	11	0
1837.							
Tide Discussions	284	1	0	1840.			
Chemical Constants	24	13	6	Bristol Tides	100	0	0
Lunar Nutation.....	70	0	0	Subterranean Temperature ...	13	13	6
Observations on Waves	100	12	0	Heart Experiments	18	19	0
Tides at Bristol	150	0	0	Lungs Experiments	8	13	0
Meteorology and Subterra- nean Temperature.....	93	3	0	Tide Discussions	50	0	0
Vitrification Experiments ...	150	0	0	Land and Sea Level.....	6	11	1
Heart Experiments	8	4	6	Stars (Histoire Céleste)	242	10	0
Barometric Observations	30	0	0	Stars (Lacaille)	4	15	0
Barometers.....	11	18	6	Stars (Catalogue)	264	0	0
	£922	12	6	Atmospheric Air	15	15	0
				Water on Iron	10	0	0
1838.				Heat on Organic Bodies	7	0	0
Tide Discussions	29	0	0	Meteorological Observations .	52	17	6
British Fossil Fishes.....	100	0	0	Foreign Scientific Memoirs...	112	1	6
Meteorological Observations and Anemometer (construc- tion)	100	0	0	Working Population	100	0	0
Cast Iron (Strength of)	60	0	0	School Statistics	50	0	0
Animal and Vegetable Sub- stances (Preservation of) ...	19	1	10	Forms of Vessels	184	7	0
Railway Constants	41	12	10	Chemical and Electrical Phe- nomena	40	0	0
Bristol Tides	50	0	0	Meteorological Observations at Plymouth	80	0	0
Growth of Plants	75	0	0	Magnetical Observations.....	185	13	9
Mud in Rivers	3	6	6		£1546	16	4
Education Committee	50	0	0				
Heart Experiments	5	3	0	1841.			
Land and Sea Level.....	267	8	7	Observations on Waves	30	0	0
Steam-vessels.....	100	0	0	Meteorology and Subterra- nean Temperature.....	8	8	0
Meteorological Committee ...	31	9	5	Actinometers	10	0	0
	£932	2	2	Earthquake Shocks	17	7	0
				Acrid Poisons.....	6	0	0
1839.				Veins and Absorbents	3	0	0
Fossil Ichthyology	110	0	0	Mud in Rivers	5	0	0
Meteorological Observations at Plymouth, &c.	63	10	0				

	£	s.	d.
Marine Zoology	15	12	8
Skeleton Maps	20	0	0
Mountain Barometers	6	18	6
Stars (Histoire Céleste)	185	0	0
Stars (Lacaille).....	79	5	0
Stars (Nomenclature of)	17	19	6
Stars (Catalogue of)	40	0	0
Water on Iron	50	0	0
Meteorological Observations at Inverness	20	0	0
Meteorological Observations (reduction of)	25	0	0
Fossil Reptiles	50	0	0
Foreign Memoirs	62	0	6
Railway Sections	38	1	0
Forms of Vessels	193	12	0
Meteorological Observations at Plymouth	55	0	0
Magnetical Observations	61	18	8
Fishes of the Old Red Sand- stone	100	0	0
Tides at Leith	50	0	0
Anemometer at Edinburgh ...	69	1	10
Tabulating Observations	9	6	3
Races of Men.....	5	0	0
Radiate Animals	2	0	0
	<u>£1235</u>	<u>10</u>	<u>11</u>

1842.

Dynamometric Instruments..	113	11	2
Anoplura Britannicæ	52	12	0
Tides at Bristol	59	8	0
Gases on Light	30	14	7
Chronometers.....	26	17	6
Marine Zoology.....	1	5	0
British Fossil Mammalia	100	0	0
Statistics of Education.....	20	0	0
Marine Steam-vessels' En- gines	28	0	0
Stars (Histoire Céleste)	59	0	0
Stars (Brit. Assoc. Cat. of) ...	110	0	0
Railway Sections	161	10	0
British Belemnites ..	50	0	0
Fossil Reptiles (publication of Report)	210	0	0
Forms of Vessels	180	0	0
Galvanic Experiments on Rocks	5	8	6
Meteorological Experiments at Plymouth	68	0	0
Constant Indicator and Dyna- mometric Instruments	90	0	0
Force of Wind	10	0	0
Light on Growth of Seeds ...	8	0	0
Vital Statistics	50	0	0
Vegetative Power of Seeds ...	8	1	11
Questions on Human Race ...	7	9	0
	<u>£1449</u>	<u>17</u>	<u>8</u>

1843.

Revision of the Nomenclature of Stars	2	0	0
--	---	---	---

	£	s.	d.
Reduction of Stars, British Association Catalogue	25	0	0
Anomalous Tides, Frith of Forth	120	0	0
Hourly Meteorological Obser- vations at Kingussie and Inverness	77	12	8
Meteorological Observations at Plymouth	55	0	0
Whewell's Meteorological Anemometer at Plymouth .	10	0	0
Meteorological Observations, Osler's Anemometer at Ply- mouth	20	0	0
Reduction of Meteorological Observations	30	0	0
Meteorological Instruments and Gratuities	39	6	0
Construction of Anemometer at Inverness	56	12	2
Magnetic Co-operation.....	10	8	10
Meteorological Recorder for Kew Observatory	50	0	0
Action of Gases on Light.....	18	16	1
Establishment at Kew Ob- servatory, Wages, Repairs, Furniture, and Sundries ...	133	4	7
Experiments by Captive Bal- loons	81	8	0
Oxidation of the Rails of Railways.....	20	0	0
Publication of Report on Fossil Reptiles	40	0	0
Coloured Drawings of Rail- way Sections	147	18	3
Registration of Earthquake Shocks.....	30	0	0
Report on Zoological Nomen- clature.....	10	0	0
Uncovering Lower Red Sand- stone near Manchester	4	4	6
Vegetative Power of Seeds ...	5	3	8
Marine Testacea (Habits of). .	10	0	0
Marine Zoology	10	0	0
Marine Zoology	2	14	11
Preparation of Report on Bri- tish Fossil Mammalia	100	0	0
Physiological Operations of Medicinal Agents	20	0	0
Vital Statistics	36	5	8
Additional Experiments on the Forms of Vessels	70	0	0
Additional Experiments on the forms of Vessels	100	0	0
Reduction of Experiments on the Forms of Vessels	100	0	0
Morin's Instrument and Con- stant Indicator	69	14	10
Experiments on the Strength of Materials	60	0	0
	<u>£1565</u>	<u>10</u>	<u>2</u>

GENERAL STATEMENT.

lxxxvii

	£	s.	d.
1848.			
Maintaining the Establish- ment at Kew Observatory	171	15	11
Atmospheric Waves	3	10	9
Vitality of Seeds	9	15	0
Completion of Catalogue of Stars	70	0	0
On Colouring Matters	5	0	0
On Growth of Plants	15	0	0
	<u>£275</u>	<u>1</u>	<u>8</u>

1849.			
Electrical Observations at Kew Observatory	50	0	0
Maintaining the Establish- ment at ditto.....	76	2	5
Vitality of Seeds	5	8	1
On Growth of Plants	5	0	0
Registration of Periodical Phenomena.....	10	0	0
Bill on Account of Anemo- metrical Observations	13	9	0
	<u>£159</u>	<u>19</u>	<u>6</u>

1850.			
Maintaining the Establish- ment at Kew Observatory	255	18	0
Transit of Earthquake Waves	50	0	0
Periodical Phenomena.....	15	0	0
Meteorological Instruments, Azores	25	0	0
	<u>£345</u>	<u>18</u>	<u>0</u>

1851.			
Maintaining the Establish- ment at Kew Observatory (includes part of grant in 1849)	309	2	2
Theory of Heat	20	1	1
Periodical Phenomena of Ani- mals and Plants.....	5	0	0
Vitality of Seeds	5	6	4
Influence of Solar Radiation	30	0	0
Ethnological Inquiries.....	12	0	0
Researches on Annelida	10	0	0
	<u>£391</u>	<u>9</u>	<u>7</u>

1852.			
Maintaining the Establish- ment at Kew Observatory (including balance of grant for 1850).....	233	17	8
Experiments on the Conduc- tion of Heat	5	2	9
Influence of Solar Radiations	20	0	0
Geological Map of Ireland ...	15	0	0
Researches on the British An- nelida	10	0	0
Vitality of Seeds	10	6	2
Strength of Boiler Plates.....	10	0	0
	<u>£304</u>	<u>6</u>	<u>7</u>

	£	s.	d.
1853.			
Maintaining the Establish- ment at Kew Observatory	165	0	0
Experiments on the Influence of Solar Radiation	15	0	0
Researches on the British Annelida.....	10	0	0
Dredging on the East Coast of Scotland.....	10	0	0
Ethnological Queries	5	0	0
	<u>£205</u>	<u>0</u>	<u>0</u>

1854.			
Maintaining the Establish- ment at Kew Observatory (including balance of former grant).....	330	15	4
Investigations on Flax.....	11	0	0
Effects of Temperature on Wrought Iron.....	10	0	0
Registration of Periodical Phenomena.....	10	0	0
British Annelida	10	0	0
Vitality of Seeds	5	2	3
Conduction of Heat	4	2	0
	<u>£380</u>	<u>19</u>	<u>7</u>

1855.			
Maintaining the Establish- ment at Kew Observatory	425	0	0
Earthquake Movements	10	0	0
Physical Aspect of the Moon	11	8	5
Vitality of Seeds	10	7	11
Map of the World	15	0	0
Ethnological Queries	5	0	0
Dredging near Belfast.....	4	0	0
	<u>£480</u>	<u>16</u>	<u>4</u>

1856.			
Maintaining the Establish- ment at Kew Observa- tory:—			
1854.....	£ 75	0	0
1855.....	£500	0	0
		575	0
Strickland's Ornithological Synonyms	100	0	0
Dredging and Dredging Forms	9	13	0
Chemical Action of Light ...	20	0	0
Strength of Iron Plates	10	0	0
Registration of Periodical Phenomena.....	10	0	0
Propagation of Salmon.....	10	0	0
	<u>£734</u>	<u>13</u>	<u>9</u>

1857.			
Maintaining the Establish- ment at Kew Observatory	350	0	0
Earthquake Wave Experi- ments	40	0	0
Dredging near Belfast.....	10	0	0
Dredging on the West Coast of Scotland.....	10	0	0

	£	s.	d.
Investigations into the Mollusca of California	10	0	0
Experiments on Flax	5	0	0
Natural History of Madagascar	20	0	0
Researches on British Annelida	25	0	0
Report on Natural Products imported into Liverpool ...	10	0	0
Artificial Propagation of Salmon	10	0	0
Temperature of Mines.....	7	8	0
Thermometers for Subterranean Observations.....	5	7	4
Life-boats	5	0	0
	<u>£507 15 4</u>		

1858.

Maintaining the Establishment at Kew Observatory	500	0	0
Earthquake Wave Experiments	25	0	0
Dredging on the West Coast of Scotland.....	10	0	0
Dredging near Dublin.....	5	0	0
Vitality of Seeds	5	5	0
Dredging near Belfast.....	18	13	2
Report on the British Annelida	25	0	0
Experiments on the production of Heat by Motion in Fluids.....	20	0	0
Report on the Natural Products imported into Scotland.....	10	0	0
	<u>£618 18 2</u>		

1859.

Maintaining the Establishment at Kew Observatory	500	0	0
Dredging near Dublin.....	15	0	0
Osteology of Birds	50	0	0
Irish Tunicata	5	0	0
Manure Experiments	20	0	0
British Medusidæ	5	0	0
Dredging Committee	5	0	0
Steam-vessels' Performance... ..	5	0	0
Marine Fauna of South and West of Ireland.....	10	0	0
Photographic Chemistry	10	0	0
Lanarkshire Fossils	20	0	1
Balloon Ascents.....	39	11	0
	<u>£684 11 1</u>		

1860.

Maintaining the Establishment at Kew Observatory	500	0	0
Dredging near Belfast.....	16	6	0
Dredging in Dublin Bay.....	15	0	0
Inquiry into the Performance of Steam-vessels	124	0	0
Explorations in the Yellow Sandstone of Dura Den ...	20	0	0

	£	s.	d.
Chemico-mechanical Analysis of Rocks and Minerals.....	25	0	0
Researches on the Growth of Plants	10	0	0
Researches on the Solubility of Salts	30	0	0
Researches on the Constituents of Manures	25	0	0
Balance of Captive Balloon Accounts.....	1	13	6
	<u>£766 19 6</u>		

1861.

Maintaining the Establishment of Kew Observatory..	500	0	0
Earthquake Experiments.....	25	0	0
Dredging North and East Coasts of Scotland	23	0	0
Dredging Committee:—			
1860.....£50 0 0	}	72	0 0
1861.....£22 0 0			
Excavations at Dura Den.....	20	0	0
Solubility of Salts	20	0	0
Steam-vessel Performance ..	150	0	0
Fossils of Lesmahago	15	0	0
Explorations at Uriconium... ..	20	0	0
Chemical Alloys	20	0	0
Classified Index to the Transactions.....	100	0	0
Dredging in the Mersey and Dee	5	0	0
Dip Circle	30	0	0
Photoheliographic Observations	50	0	0
Prison Diet.....	20	0	0
Gauging of Water.....	10	0	0
Alpine Ascents	6	5	10
Constituents of Manures	25	0	0
	<u>£1111 5 10</u>		

1862.

Maintaining the Establishment of Kew Observatory	500	0	0
Patent Laws	21	6	0
Mollusca of N.-W. of America	10	0	0
Natural History by Mercantile Marine	5	0	0
Tidal Observations	25	0	0
Photoheliometer at Kew	40	0	0
Photographic Pictures of the Sun	150	0	0
Rocks of Donegal.....	25	0	0
Dredging Durham and Northumberland	25	0	0
Connexion of Storms	20	0	0
Dredging North-east Coast of Scotland	6	9	6
Ravages of Teredo	3	11	0
Standards of Electrical Resistance	50	0	0
Railway Accidents	10	0	0
Balloon Committee	200	0	0
Dredging Dublin Bay	10	0	0

	£	s.	d.
Dredging the Mersey	5	0	0
Prison Diet	20	0	0
Gauging of Water	12	10	0
Steamships' Performance.....	150	0	0
Thermo-Electric Currents ...	5	0	0
	<u>£1293</u>	<u>16</u>	<u>6</u>

1863.

Maintaining the Establish- ment of Kew Observatory... 600	0	0	
Balloon Committee deficiency 70	0	0	
Balloon Ascents (other ex- penses)	25	0	
Entozoa	25	0	
Coal Fossils	20	0	
Herrings	20	0	
Granites of Donegal.....	5	0	
Prison Diet	20	0	
Vertical Atmospheric Move- ments	13	0	
Dredging Shetland	50	0	
Dredging North-east coast of Scotland	25	0	
Dredging Northumberland and Durham	17	3	
Dredging Committee superin- tendence	10	0	
Steamship Performance	100	0	
Balloon Committee	200	0	
Carbon under pressure	10	0	
Volcanic Temperature	100	0	
Bromide of Ammonium	8	0	
Electrical Standards.....	100	0	
Electrical Construction and Distribution	40	0	
Luminous Meteors	17	0	
Kew Additional Buildings for Photoheliograph	100	0	
Thermo-Electricity	15	0	
Analysis of Rocks	8	0	
Hydroida.....	10	0	
	<u>£1608</u>	<u>3</u>	<u>10</u>

1864.

Maintaining the Establish- ment of Kew Observatory.. 600	0	0
Coal Fossils	20	0
Vertical Atmospheric Move- ments	20	0
Dredging Shetland	75	0
Dredging Northumberland... 25	0	0
Balloon Committee	200	0
Carbon under pressure	10	0
Standards of Electric Re- sistance	100	0
Analysis of Rocks	10	0
Hydroida	10	0
Askham's Gift	50	0
Nitrite of Amyle	10	0
Nomenclature Committee ...	5	0
Rain-Gauges	19	15
Cast-Iron Investigation	20	0

	£	s.	d.
Tidal Observations in the Humber	50	0	0
Spectral Rays.....	45	0	0
Luminous Meteors	20	0	0
	<u>£1289</u>	<u>15</u>	<u>8</u>

1865.

Maintaining the Establish- ment of Kew Observatory.. 600	0	0	
Balloon Committee	100	0	
Hydroida.....	13	0	
Rain-Gauges	30	0	
Tidal Observations in the Humber	6	8	
Hexylic Compounds	20	0	
Amyl Compounds	20	0	
Irish Flora	25	0	
American Mollusca	3	9	
Organic Acids	20	0	
Lingula Flags Excavation ...	10	0	
Eurypterus	50	0	
Electrical Standards.....	100	0	
Malta Caves Researches	30	0	
Oyster Breeding	25	0	
Gibraltar Caves Researches... 150	0	0	
Kent's Hole Excavations.....	100	0	
Moon's Surface Observations	35	0	
Marine Fauna	25	0	
Dredging Aberdeenshire	25	0	
Dredging Channel Islands ...	50	0	
Zoological Nomenclature.....	5	0	
Resistance of Floating Bodies in Water.....	100	0	
Bath Waters Analysis	8	10	
Luminous Meteors	40	0	
	<u>£1591</u>	<u>7</u>	<u>10</u>

1866.

Maintaining the Establish- ment of Kew Observatory.. 600	0	0
Lunar Committee.....	64	13
Balloon Committee	50	0
Metrical Committee.....	50	0
British Rainfall.....	50	0
Kilkenny Coal Fields	16	0
Alum Bay Fossil Leaf-Bed ...	15	0
Luminous Meteors	50	0
Lingula Flags Excavation ...	20	0
Chemical Constitution of Cast Iron	50	0
Amyl Compounds	25	0
Electrical Standards.....	100	0
Malta Caves Exploration	30	0
Kent's Hole Exploration	200	0
Marine Fauna, &c., Devon and Cornwall	25	0
Dredging Aberdeenshire Coast	25	0
Dredging Hebrides Coast ...	50	0
Dredging the Mersey	5	0
Resistance of Floating Bodies in Water.....	50	0
Polycyanides of Organic Radi- cals	29	0

	£	s.	d.
Rigor Mortis	10	0	0
Irish Annelida	15	0	0
Catalogue of Crania.....	50	0	0
Didine Birds of Mascarene Islands.....	50	0	0
Typical Crania Researches ..	30	0	0
Palestine Exploration Fund...	100	0	0
	<u>£1750</u>	<u>13</u>	<u>4</u>

1867.

Maintaining the Establish- ment of Kew Observatory..	600	0	0
Meteorological Instruments, Palestine.....	50	0	0
Lunar Committee	120	0	0
Metrical Committee	30	0	0
Kent's Hole Explorations ...	100	0	0
Palestine Explorations	50	0	0
Insect Fauna, Palestine	30	0	0
British Rainfall.....	50	0	0
Kilkenny Coal Fields	25	0	0
Alum Bay Fossil Leaf-Bed ...	25	0	0
Luminous Meteors	50	0	0
Bournemouth, &c., Leaf-Beds	30	0	0
Dredging Shetland	75	0	0
Steamship Reports Condensa- tion	100	0	0
Electrical Standards.....	100	0	0
Ethyl and Methyl series	25	0	0
Fossil Crustacea	25	0	0
Sound under Water	24	4	0
North Greenland Fauna	75	0	0
Do. Plant Beds	100	0	0
Iron and Steel Manufacture...	25	0	0
Patent Laws	30	0	0
	<u>£1739</u>	<u>4</u>	<u>0</u>

1868.

Maintaining the Establish- ment of Kew Observatory..	600	0	0
Lunar Committee	120	0	0
Metrical Committee.....	50	0	0
Zoological Record.....	100	0	0
Kent's Hole Explorations ...	150	0	0
Steamship Performances	100	0	0
British Rainfall	50	0	0
Luminous Meteors.....	50	0	0
Organic Acids	60	0	0
Fossil Crustacea.....	25	0	0
Methyl Series.....	25	0	0
Mercury and Bile	25	0	0
Organic Remains in Lime- stone Rocks	25	0	0
Scottish Earthquakes	20	0	0
Fauna, Devon and Cornwall..	30	0	0
British Fossil Corals	50	0	0
Bagshot Leaf-Beds	50	0	0
Greenland Explorations	100	0	0
Fossil Flora	25	0	0
Tidal Observations	100	0	0
Underground Temperature ...	50	0	0
Spectroscopic Investigations of Animal Substances	5	0	0

	£	s.	d.
Secondary Reptiles, &c.	30	0	0
British Marine Invertebrate Fauna	100	0	0
	<u>£1940</u>	<u>0</u>	<u>0</u>

1869.

Maintaining the Establish- ment of Kew Observatory..	600	0	0
Lunar Committee.....	50	0	0
Metrical Committee.....	25	0	0
Zoological Record.....	100	0	0
Committee on Gases in Deep- well Water	25	0	0
British Rainfall.....	50	0	0
Thermal Conductivity of Iron, &c.....	30	0	0
Kent's Hole Explorations.....	150	0	0
Steamship Performances	30	0	0
Chemical Constitution of Cast Iron.....	80	0	0
Iron and Steel Manufacture	100	0	0
Methyl Series.....	30	0	0
Organic Remains in Lime- stone Rocks.....	10	0	0
Earthquakes in Scotland.....	10	0	0
British Fossil Corals	50	0	0
Bagshot Leaf-Beds	30	0	0
Fossil Flora	25	0	0
Tidal Observations	100	0	0
Underground Temperature ...	30	0	0
Spectroscopic Investigations of Animal Substances	5	0	0
Organic Acids	12	0	0
Kiltorcan Fossils	20	0	0
Chemical Constitution and Physiological Action Rela- tions	15	0	0
Mountain Limestone Fossils	25	0	0
Utilization of Sewage	10	0	0
Products of Digestion	10	0	0
	<u>£1622</u>	<u>0</u>	<u>0</u>

1870.

Maintaining the Establish- ment of Kew Observatory	600	0	0
Metrical Committee.....	25	0	0
Zoological Record.....	100	0	0
Committee on Marine Fauna	20	0	0
Ears in Fishes	10	0	0
Chemical Nature of Cast Iron	80	0	0
Luminous Meteors	30	0	0
Heat in the Blood.....	15	0	0
British Rainfall.....	100	0	0
Thermal Conductivity of Iron, &c.	20	0	0
British Fossil Corals.....	50	0	0
Kent's Hole Explorations ...	150	0	0
Scottish Earthquakes	4	0	0
Bagshot Leaf-Beds	15	0	0
Fossil Flora	25	0	0
Tidal Observations	100	0	0
Underground Temperature ...	50	0	0
Kiltorcan Quarries Fossils ...	20	0	0

	£	s.	d.
Mountain Limestone Fossils	25	0	0
Utilization of Sewage	50	0	0
Organic Chemical Compounds	30	0	0
Onny River Sediment	3	0	0
Mechanical Equivalent of Heat.....	50	0	0
	<u>£1572</u>	<u>0</u>	<u>0</u>

1871.

Maintaining the Establishment of Kew Observatory	600	0	0
Monthly Reports of Progress in Chemistry	100	0	0
Metrical Committee	25	0	0
Zoological Record.....	100	0	0
Thermal Equivalents of the Oxides of Chlorine	10	0	0
Tidal Observations	100	0	0
Fossil Flora	25	0	0
Luminous Meteors	30	0	0
British Fossil Corals	25	0	0
Heat in the Blood.....	7	2	6
British Rainfall.....	50	0	0
Kent's Hole Explorations ...	150	0	0
Fossil Crustacea	25	0	0
Methyl Compounds	25	0	0
Lunar Objects	20	0	0
Fossil Coral Sections, for Photographing	20	0	0
Bagshot Leaf-Beds	20	0	0
Moab Explorations	100	0	0
Gaussian Constants	40	0	0
	<u>£1472</u>	<u>2</u>	<u>6</u>

1872.

Maintaining the Establishment of Kew Observatory	300	0	0
Metrical Committee	75	0	0
Zoological Record.....	100	0	0
Tidal Committee	200	0	0
Carboniferous Corals	25	0	0
Organic Chemical Compounds	25	0	0
Exploration of Moab.....	100	0	0
Terato-Embryological Inquiries	10	0	0
Kent's Cavern Exploration..	100	0	0
Luminous Meteors	20	0	0
Heat in the Blood.....	15	0	0
Fossil Crustacea	25	0	0
Fossil Elephants of Malta ...	25	0	0
Lunar Objects	20	0	0
Inverse Wave-Lengths.....	20	0	0
British Rainfall.....	100	0	0
Poisonous Substances Antagonism.....	10	0	0
Essential Oils, Chemical Constitution, &c.	40	0	0
Mathematical Tables	50	0	0
Thermal Conductivity of Metals	25	0	0
	<u>£1285</u>	<u>0</u>	<u>0</u>

1873.

Zoological Record.....	100	0	0
Chemistry Record.....	200	0	0
Tidal Committee	400	0	0
Sewage Committee	100	0	0
Kent's Cavern Exploration ...	150	0	0
Carboniferous Corals	25	0	0
Fossil Elephants	25	0	0
Wave-Lengths	150	0	0
British Rainfall.....	100	0	0
Essential Oils.....	30	0	0
Mathematical Tables	100	0	0
Gaussian Constants	10	0	0
Sub-Wealden Explorations...	25	0	0
Underground Temperature ...	150	0	0
Settle Cave Exploration	50	0	0
Fossil Flora, Ireland.....	20	0	0
Timber Denudation and Rainfall	20	0	0
Luminous Meteors.....	30	0	0
	<u>£1685</u>	<u>0</u>	<u>0</u>

1874.

Zoological Record	100	0	0
Chemistry Record.....	100	0	0
Mathematical Tables	100	0	0
Elliptic Functions.....	100	0	0
Lightning Conductors	10	0	0
Thermal Conductivity of Rocks	10	0	0
Anthropological Instructions, &c.	50	0	0
Kent's Cavern Exploration... 150	0	0	0
Luminous Meteors	30	0	0
Intestinal Secretions	15	0	0
British Rainfall.....	100	0	0
Essential Oils.....	10	0	0
Sub-Wealden Explorations... 25	0	0	0
Settle Cave Exploration	50	0	0
Mauritius Meteorological Research	100	0	0
Magnetization of Iron	20	0	0
Marine Organisms.....	30	0	0
Fossils, North-West of Scotland	2	10	0
Physiological Action of Light	20	0	0
Trades Unions	25	0	0
Mountain Limestone-Corals	25	0	0
Erratic Blocks	10	0	0
Dredging, Durham and Yorkshire Coasts	28	5	0
High Temperature of Bodies	30	0	0
Siemens's Pyrometer	3	6	0
Labyrinthodonts of Coal-Measures.....	7	15	0
	<u>£1151</u>	<u>16</u>	<u>0</u>

1875.

Elliptic Functions	100	0	0
Magnetization of Iron	20	0	0
British Rainfall.....	120	0	0
Luminous Meteors	30	0	0
Chemistry Record.....	100	0	0

	£	s.	d.
Specific Volume of Liquids...	25	0	0
Estimation of Potash and Phosphoric Acid.....	10	0	0
Isometric Cresols	20	0	0
Sub-Wealden Explorations ...	100	0	0
Kent's Cavern Exploration...	100	0	0
Settle Cave Exploration	50	0	0
Earthquakes in Scotland	15	0	0
Underground Waters	10	0	0
Development of Myxinoid Fishes	20	0	0
Zoological Record.....	100	0	0
Instructions for Travellers ...	20	0	0
Intestinal Secretions	20	0	0
Palestine Exploration	100	0	0
	<u>£960</u>	<u>0</u>	<u>0</u>

1876.

Printing Mathematical Tables	159	4	2
British Rainfall.....	100	0	0
Ohm's Law.....	9	15	0
Tide Calculating Machine ...	200	0	0
Specific Volume of Liquids...	25	0	0
Isomeric Cresols	10	0	0
Action of Ethyl Bromobutyrate on Ethyl Sodacetate.....	5	0	0
Estimation of Potash and Phosphoric Acid.....	13	0	0
Exploration of Victoria Cave, Settle	100	0	0
Geological Record.....	100	0	0
Kent's Cavern Exploration...	100	0	0
Thermal Conductivities of Rocks	10	0	0
Underground Waters	10	0	0
Earthquakes in Scotland.....	1	10	0
Zoological Record.....	100	0	0
Close Time	5	0	0
Physiological Action of Sound	25	0	0
Zoological Station.....	75	0	0
Intestinal Secretions	15	0	0
Physical Characters of Inhabitants of British Isles.....	13	15	0
Measuring Speed of Ships ...	10	0	0
Effect of Propeller on turning of Steam Vessels	5	0	0
	<u>£1092</u>	<u>4</u>	<u>2</u>

1877.

Liquid Carbonic Acids in Minerals	20	0	0
Elliptic Functions	250	0	0
Thermal Conductivity of Rocks	9	11	7
Zoological Record.....	100	0	0
Kent's Cavern	100	0	0
Zoological Station at Naples	75	0	0
Luminous Meteors	30	0	0
Elasticity of Wires	100	0	0
Dipterocarpe, Report on.....	20	0	0

	£	s.	d.
Mechanical Equivalent of Heat.....	35	0	0
Double Compounds of Cobalt and Nickel	8	0	0
Underground Temperatures	50	0	0
Settle Cave Exploration	100	0	0
Underground Waters in New Red Sandstone	10	0	0
Action of Ethyl Bromobutyrate on Ethyl Sodacetate	10	0	0
British Earthworks	25	0	0
Atmospheric Elasticity in India	15	0	0
Development of Light from Coal-gas	20	0	0
Estimation of Potash and Phosphoric Acid.....	1	18	0
Geological Record.....	100	0	0
Anthropometric Committee	34	0	0
Physiological Action of Phosphoric Acid, &c.....	15	0	0
	<u>£1128</u>	<u>9</u>	<u>7</u>

1878.

Exploration of Settle Caves	100	0	0
Geological Record.....	100	0	0
Investigation of Pulse Phenomena by means of Syphon Recorder	10	0	0
Zoological Station at Naples	75	0	0
Investigation of Underground Waters.....	15	0	0
Transmission of Electrical Impulses through Nerve Structure.....	30	0	0
Calculation of Factor Table of Fourth Million	100	0	0
Anthropometric Committee...	66	0	0
Chemical Composition and Structure of less known Alkaloids.....	25	0	0
Exploration of Kent's Cavern	50	0	0
Zoological Record	100	0	0
Fermanagh Caves Exploration	15	0	0
Thermal Conductivity of Rocks	4	16	6
Luminous Meteors.....	10	0	0
Ancient Earthworks	25	0	0
	<u>£725</u>	<u>16</u>	<u>6</u>

1879.

Table at the Zoological Station, Naples	75	0	0
Miocene Flora of the Basalt of the North of Ireland ...	20	0	0
Illustrations for a Monograph on the Mammoth	17	0	0
Record of Zoological Literature	100	0	0
Composition and Structure of less-known Alkaloids	25	0	0

	£	s.	d.
Exploration of Caves in Borneo	50	0	0
Kent's Cavern Exploration	100	0	0
Record of the Progress of Geology	100	0	0
Fermanagh Caves Exploration	5	0	0
Electrolysis of Metallic Solutions and Solutions of Compound Salts.....	25	0	0
Anthropometric Committee... ..	50	0	0
Natural History of Socotra	100	0	0
Calculation of Factor Tables for 5th and 6th Millions	150	0	0
Circulation of Underground Waters.....	10	0	0
Steering of Screw Steamers... ..	10	0	0
Improvements in Astronomical Clocks	30	0	0
Marine Zoology of South Devon	20	0	0
Determination of Mechanical Equivalent of Heat	12	15	6
Specific Inductive Capacity of Sprengel Vacuum.....	40	0	0
Tables of Sun-heat Coefficients	30	0	0
Datum Level of the Ordnance Survey	10	0	0
Tables of Fundamental Invariants of Algebraic Forms	36	14	9
Atmospheric Electricity Observations in Madeira	15	0	0
Instrument for Detecting Fire-damp in Mines	22	0	0
Instruments for Measuring the Speed of Ships	17	1	8
Tidal Observations in the English Channel	10	0	0
	<u>£1080</u>	<u>11</u>	<u>11</u>

1880.

New Form of High Insulation Key	10	0	0
Underground Temperature	10	0	0
Determination of the Mechanical Equivalent of Heat	8	5	0
Elasticity of Wires	50	0	0
Luminous Meteors	30	0	0
Lunar Disturbance of Gravity	30	0	0
Fundamental Invariants	8	5	0
Laws of Water Friction	20	0	0
Specific Inductive Capacity of Sprengel Vacuum.....	20	0	0
Completion of Tables of Sun-heat Coefficients	50	0	0
Instrument for Detection of Fire-damp in Mines	10	0	0
Inductive Capacity of Crystals and Paraffines	4	17	7
Report on Carboniferous Polyzoa	10	0	0

	£	s.	d.
Caves of South Ireland	10	0	0
Viviparous Nature of Ichthyosaurus	10	0	0
Kent's Cavern Exploration... ..	50	0	0
Geological Record.....	100	0	0
Miocene Flora of the Basalt of North Ireland	15	0	0
Underground Waters of Permian Formations	5	0	0
Record of Zoological Literature	100	0	0
Table at Zoological Station at Naples	75	0	0
Investigation of the Geology and Zoology of Mexico.....	50	0	0
Anthropometry	50	0	0
Patent Laws	5	0	0
	<u>£731</u>	<u>7</u>	<u>7</u>

1881.

Lunar Disturbance of Gravity	30	0	0
Underground Temperature	20	0	0
High Insulation Key.....	5	0	0
Tidal Observations	10	0	0
Fossil Polyzoa	10	0	0
Underground Waters	10	0	0
Earthquakes in Japan	25	0	0
Tertiary Flora	20	0	0
Scottish Zoological Station	50	0	0
Naples Zoological Station	75	0	0
Natural History of Socotra	50	0	0
Zoological Record.....	100	0	0
Weights and Heights of Human Beings	30	0	0
Electrical Standards	25	0	0
Anthropological Notes and Queries	9	0	0
Specific Refractions	7	3	1
	<u>£476</u>	<u>3</u>	<u>1</u>

1882.

Tertiary Flora of North of Ireland	20	0	0
Exploration of Caves of South of Ireland	10	0	0
Fossil Plants of Halifax	15	0	0
Fundamental Invariants of Algebraical Forms	76	1	11
Record of Zoological Literature	100	0	0
British Polyzoa	10	0	0
Naples Zoological Station	80	0	0
Natural History of Timor-laut	100	0	0
Conversion of Sedimentary Materials into Metamorphic Rocks	10	0	0
Natural History of Socotra... ..	100	0	0
Circulation of Underground Waters.....	15	0	0
Migration of Birds	15	0	0
Earthquake Phenomena of Japan	25	0	0

	£	s.	d.
Geological Map of Europe ...	25	0	0
Elimination of Nitrogen by Bodily Exercise.....	50	0	0
Anthropometric Committee...	50	0	0
Photographing Ultra-Violet Spark Spectra	25	0	0
Exploration of Raygill Fissure	20	0	0
Calibration of Mercurial Thermometers	20	0	0
Wave-length Tables of Spectra of Elements.....	50	0	0
Geological Record.....	100	0	0
Standards for Electrical Measurements	100	0	0
Exploration of Central Africa	100	0	0
Albuminoid Substances of Serum	10	0	0
	<u>£1126</u>	<u>1</u>	<u>11</u>

1883.

Natural History of Timor-laut	50	0	0
British Fossil Polyzoa	10	0	0
Circulation of Underground Waters.....	15	0	0
Zoological Literature Record	100	0	0
Exploration of Mount Kilima-njaro.....	500	0	0
Erosion of Sea-coast of England and Wales	10	0	0
Fossil Plants of Halifax	0	0	0
Elimination of Nitrogen by Bodily Exercise.....	38	3	3
Isomeric Naphthalene Derivatives.....	15	0	0
Zoological Station at Naples	80	0	0
Investigation of Loughton Camp	10	0	0
Earthquake Phenomena of Japan	50	0	0
Meteorological Observations on Ben Nevis.....	50	0	0
Fossil Phyllopoda of Palæozoic Rocks	25	0	0
Migration of Birds	20	0	0
Geological Record.....	50	0	0
Exploration of Caves in South of Ireland	10	0	0
Scottish Zoological Station...	25	0	0
Screw Gauges.....	5	0	0
	<u>£1083</u>	<u>3</u>	<u>3</u>

1884.

Zoological Literature Record	100	0	0
Fossil Polyzoa.....	10	0	0
Exploration of Mount Kilima-njaro, East Africa	500	0	0
Anthropometric Committee...	10	0	0
Fossil Plants of Halifax	15	0	0
International Geological Map	20	0	0
Erratic Blocks of England ...	10	0	0
Natural History of Timor-laut	50	0	0

	£	s.	d.
Coagulation of Blood.....	100	0	0
Naples Zoological Station ...	80	0	0
Bibliography of Groups of Invertebrata	50	0	0
Earthquake Phenomena of Japan	75	0	0
Fossil Phyllopoda of Palæozoic Rocks	15	0	0
Meteorological Observatory at Chepstow.....	25	0	0
Migration of Birds.....	20	0	0
Collecting and Investigating Meteoric Dust.....	20	0	0
Circulation of Underground Waters.....	5	0	0
Ultra-Violet Spark Spectra ...	8	4	0
Tidal Observations.....	10	0	0
Meteorological Observations on Ben Nevis	50	0	0
	<u>£1173</u>	<u>4</u>	<u>0</u>

1885.

Zoological Literature Record.	100	0	0
Vapour Pressures, &c., of Salt Solutions.....	25	0	0
Physical Constants of Solutions.....	20	0	0
Recent Polyzoa	10	0	0
Naples Zoological Station ...	100	0	0
Exploration of Mount Kilima-njaro	25	0	0
Fossil Plants of British Tertiary and Secondary Beds .	50	0	0
Calculating Tables in Theory of Numbers.....	100	0	0
Exploration of New Guinea...	200	0	0
Exploration of Mount Roraima	100	0	0
Meteorological Observations on Ben Nevis	50	0	0
Volcanic Phenomena of Vesuvius	25	0	0
Biological Stations on Coasts of United Kingdom	150	0	0
Meteoric Dust	70	0	0
Marine Biological Station at Granton	100	0	0
Fossil Phyllopoda of Palæozoic Rocks	25	0	0
Migration of Birds	30	0	0
Synoptic Chart of Indian Ocean	50	0	0
Circulation of Underground Waters.....	10	0	0
Geological Record	50	0	0
Reduction of Tidal Observations.....	10	0	0
Earthquake Phenomena of Japan	70	0	0
Raygill Fissure	15	0	0
	<u>£1385</u>	<u>0</u>	<u>0</u>

GENERAL STATEMENT.

xcv

1886.	£	s.	d.
Zoological Literature Record.	100	0	0
Exploration of New Guinea...	150	0	0
Secretion of Urine.....	10	0	0
Researches in Food-Fishes and Invertebrata at St. Andrews	75	0	0
Electrical Standards.....	40	0	0
Volcanic Phenomena of Vesu- vius	30	0	0
Naples Zoological Station.....	50	0	0
Meteorological Observations on Ben Nevis	100	0	0
Prehistoric Race in Greek Islands	20	0	0
North-Western Tribes of Ca- nada.....	50	0	0
Fossil Plants of British Ter- tiary and Secondary Beds...	20	0	0
Regulation of Wages under Sliding Scales	10	0	0
Exploration of Caves in North Wales	25	0	0
Migration of Birds	30	0	0
Geological Record.....	100	0	0
Chemical Nomenclature	5	0	0
Fossil Phyllopoda of Palæozoic Rocks	15	0	0
Solar Radiation.....	9	10	6
Magnetic Observations.....	10	10	0
Tidal Observations	50	0	0
Marine Biological Station at Granton	75	0	0
Physical and Chemical Bear- ings of Electrolysis	20	0	0
	<u>£995</u>	<u>0</u>	<u>6</u>

1887.

Volcanic Phenomena of Japan (1886 grant)	50	0	0
Standards of Light (1886 grant).....	20	0	0
Silent Discharge of Elec- tricity	20	0	0
Exploration of Cae Gwyn Cave, North Wales	20	0	0
Investigation of Lymphatic System.....	25	0	0
Granton Biological Station...	75	0	0
Zoological Record	100	0	0
Flora of China	75	0	0
Nature of Solution	20	0	0
Influence of Silicon on Steel	30	0	0
Plymouth Biological Station	50	0	0
Naples Biological Station ...	100	0	0
Volcanic Phenomena of Vesu- vius	20	0	0
Regulation of Wages	10	0	0
Microscopic Structure of the Rocks of Anglesey.....	10	0	0
Ben Nevis Observatory.....	75	0	0
Prehistoric Race of Greek Islands.....	20	0	0

	£	s.	d.
Flora and Fauna of the Cameroons	75	0	0
Provincial Museum Reports	5	0	0
Harmonic Analysis of Tidal Observations	15	0	0
Coal Plants of Halifax.....	25	0	0
Exploration of the Eocene Beds of the Isle of Wight...	20	0	0
Magnetic Observations.....	26	2	0
'Manure' Gravels of Wexford	10	0	0
Electrolysis.....	30	0	0
Fossil Phyllopoda	20	0	0
Racial Photographs, Egyptian Standards of Light (1887 grant)	10	0	0
Migration of Birds	30	0	0
Volcanic Phenomena of Japan (1887 grant)	50	0	0
Electrical Standards	50	0	0
Bathy-hypsographical Map of British Isles	7	6	0
Absorption Spectra	40	0	0
Solar Radiation	18	10	0
Circulation of Underground Waters.....	5	0	0
Erratic Blocks	10	0	0
	<u>£1186</u>	<u>18</u>	<u>0</u>

1888.

Flora of Bahamas	100	0	0
Biological Station at Granton	50	0	0
Flora of China	75	0	0
Carboniferous Flora of Lan- cashire and West Yorkshire	25	0	0
Properties of Solutions	25	0	0
Isomeric Naphthalene Deriva- tives.....	25	0	0
Influence of Silicon on Steel	20	0	0
Action of Light on Hydracids	20	0	0
Marine Laboratory, Plymouth	100	0	0
Naples Zoological Station ...	100	0	0
Development of Teleostei ...	15	0	0
Precious Metals in Circula- tion	20	0	0
Value of Monetary Standard	10	0	0
Volcanic Phenomena of Vesu- vius	20	0	0
Prehistoric Race in Greek Islands.....	20	0	0
Palæontographical Society ...	50	0	0
Zoology and Botany of West Indies	100	0	0
Development of Fishes—St. Andrews	50	0	0
Pliocene Fauna of St. Erth	50	0	0
Lymphatic System	25	0	0
Ben Nevis Observatory.....	150	0	0
North-Western Tribes of Canada	100	0	0
Silent Discharge of Elec- tricity	9	11	10
Manure Gravels of Wexford...	10	0	0

	£	s.	d.		£	s.	d.
Sea Beach near Bridlington...	20	0	0	Circulation of Underground			
Effect of Occupations on Physical Development.....	25	0	0	Waters	5	0	0
Magnetic Observations.....	15	0	0	Standards of Light	79	2	3
Methods of Teaching Chemistry	10	0	0	Electrical Standards.....	2	6	4
Uniform Nomenclature in Mechanics	10	0	0	Peradeniya Botanical Station	50	0	0
Geological Record	50	0	0	Erosion of Sea Coasts	10	0	0
Migration of Birds	30	0	0	Electrolysis	30	0	0
Depth of Frozen Soil in Polar Regions	5	0	0		<u>£1511</u>	<u>0</u>	<u>5</u>

General Meetings.

On Wednesday, September 5, at 8 P.M., in the Drill Hall, Sir H. E. Roscoe, M.P., D.C.L., LL.D., Ph.D., F.R.S., F.C.S., resigned the office of President to Sir F. J. Bramwell, D.C.L., F.R.S., M.Inst.C.E., who took the Chair, and delivered an Address, for which see page 1.

On Thursday, September 6, at 8.30 P.M., a Soirée took place in the Assembly Rooms.

On Friday, September 7, at 8.30 P.M., in the Drill Hall, Professor W. E. Ayrton, F.R.S., delivered a Discourse on 'The Electrical Transmission of Power.'

On Monday, September 10, at 8.30 P.M., in the Drill Hall, Professor T. G. Bonney, D.Sc., LL.D., F.R.S., F.S.A., F.G.S., delivered a Discourse on 'The Foundation Stones of the Earth's Crust.'

On Tuesday, September 11, at 8 P.M., a Soirée took place in the Assembly Rooms.

On Wednesday, September 12, at 2.30 P.M., in the Assembly Rooms, the concluding General Meeting took place, when the Proceedings of the General Committee and the Grants of Money for Scientific purposes were explained to the Members.

The Meeting was then adjourned to Newcastle-upon-Tyne. [The Meeting is appointed to commence on Wednesday, September 11, 1889.]

PRESIDENT'S ADDRESS.

ADDRESS

BY

SIR FREDERICK BRAMWELL,

D.C.L., F.R.S., M.INST.C.E.,

PRESIDENT.

THE late Lord Iddesleigh delighted an audience, for a whole evening, by an address on 'Nothing.' Would that I had his talents, and could discourse to you as charmingly as he did to his audience, but I dare not try to talk about 'Nothing.' I do however propose, as one of the two sections of my Address, to discourse to you on the importance of the 'Next-to-Nothing.' The other section is far removed from this microscopic quantity, as it will embrace the 'Eulogy of the Civil Engineer and will point out the value to science of his works.'

I do not intend to follow any system in dealing with these two sections. I shall not even do as Mr. Dick, in 'David Copperfield,' did—have two papers, to one of which it was suggested he should confine his Memorial and his observations as to King Charles's head. The result is, you will find, that the importance of the next-to-nothing, and the laudation of the Civil Engineer, will be mixed up in the most illogical and haphazard way, throughout my Address. I will leave to such of you as are of orderly minds, the task of rearranging the subjects as you see fit, but I trust—arrangement or no arrangement—that by the time I have brought my Address to a conclusion, I shall have convinced you that there is no man who more thoroughly appreciates the high importance of the 'next-to-nothing,' than the Civil Engineer of the present day, the object of my eulogy this evening.

If I may be allowed to express the scheme of this Address in modern musical language, I will say that the 'next-to-nothing' 'motive' will commonly usher in the 'praise-song' of the Civil Engineer; and it seems to me will do this very fitly, for in many cases it is by the patient and discriminating attention paid to the effect of the 'next-to-nothing' that

the Civil Engineer of the present day has achieved some of the labours of which I now wish to speak to you.

An Association for the Advancement of Science is necessarily one of such broad scope in its objects, and is so thoroughly catholic as regards Science, that the only possible way in which it can carry out those objects at all, is to segregate its members into various subsidiary bodies, or sections, engaged on particular branches of Science. Even when this division is resorted to, it is a hardy thing to say that every conceivable scientific subject can be dealt with by the eight Sections of the British Association. Nevertheless, as we know, for fifty-seven years the Association has carried on its labours under Sections, and has earned the right to say that it has done good service to all branches of Science.

Composed, as the Association is, of a union of separate Sections, it is only right and according to the fitness of things that, as time goes on, your Presidents should be selected, in some sort of rotation, from the various Sections. This year it was felt, by the Council and the Members, that the time had once more arrived when Section G—the Mechanical Section—might put forward its claim to be represented in the Presidency; the last time on which a purely engineering Member filled the chair having been at Bristol in 1875, when that position was occupied by Sir John Hawkshaw. It is true that at Southampton, in 1882, our lamented friend, Sir William Siemens, was President, and it is also true that he was a most thorough engineer and representative of Section G; but all who knew his great scientific attainments will probably agree that, on that occasion, it was rather the Physical Section A which was represented, than the Mechanical Section G.

I am aware, it is said, Section G does not contribute much to pure Science by original research, but that it devotes itself more to the application of Science. There may be some foundation for this assertion, but I cannot refrain from the observation, that when Engineers, such as Siemens, Rankine, Sir William Thomson, Fairbairn, or Armstrong, make a scientific discovery, Section A says it is made, not in the capacity of an Engineer, and, therefore, does not appertain to Section G, but in the capacity of a Physicist, and therefore appertains to Section A—an illustration of the danger of a man's filling two positions, of which the composite Prince-Bishop is the well-known type. But I am not careful to labour this point, or even to dispute that Section G does not do much for *original* research. I don't agree it is a fact, but, for the purposes of this evening, I will concede it to be so. But what then? This Association is for the 'Advancement of Science'—the *Advancement* be it remembered; and I wish to point out to you, and I trust I shall succeed in establishing, that for the *Advancement* of Science it is absolutely necessary there should be the *Application* of Science, and that, therefore, the Section, which as much as any other (or, to state the fact more truly, which more than any other) in the Association *applies* Science, is doing

a very large share of the work of *advancing* Science, and is fully entitled to be periodically represented in the Presidency of the whole Association.

I trust also I shall prove to you that applications of Science, and discoveries in pure Science, act and re-act the one upon the other. I hope in this to carry the bulk of my audience with me, although there are some, I know, whose feelings, from a false notion of respect for Science, would probably find vent in the 'toast' which one has heard in another place—this 'toast' being attributed to the Pure Scientist—'Here's to the latest scientific discovery: may it never do any good to anybody!'

To give an early illustration of this action and re-action, which I contend occurs: take the well-worn story of Galileo, Torricelli, and the pump-maker. It is recorded that Galileo first, and his pupil Torricelli afterwards, were led to investigate the question of atmospheric pressure, by observing the failure of a pump to raise water by 'suction,' above a certain level. Perhaps you will say the pump-maker was not applying science, but was working without science. I answer, he was unknowingly applying it, and it was from that which arose in this unconscious application that the mind of the Pure Scientist was led to investigate the subject, and thereupon to discover the primary fact, of the pressure of the atmosphere, and the subsidiary facts which attend thereon. It may appear to many of you that the question of the exercise of pressure by the atmosphere should have been so very obvious, that but little merit ought to have accrued to the discoverer; and that the statement, once made, must have been accepted almost as a mere truism. This was, however, by no means the case. Sir Kenelm Digby, in his 'Treatise on the Nature of Bodies,' printed in 1658, disputes the proposition altogether, and says, in effect, he is quite sure, the failure of the pump to raise water was due to imperfect workmanship of some kind or description, and had nothing to do with the pressure of the air; and that there is no reason why a pump should not suck up water to any height. He cites the boy's sucker, which, when applied to a smooth stone, will lift it, and he says the reason why the stone follows the sucker is this. Each body must have some other body in contact with it. Now, the stone being in contact with the sucker, there is no reason why that contact should be broken up, for the mere purpose of substituting the contact of another body, such as the air. It seems pretty clear, therefore, that even to an acute and well-trained mind, such as that of Sir Kenelm Digby, it was by no means a truism, and to be forthwith accepted when once stated, that the rise of water on the 'suction side' of a pump was due to atmospheric pressure. I hardly need point out that the pump-maker should have been a member of 'G.' Galileo and Torricelli, led to reflect by what they saw, should have been members of 'A' of the then 'Association for the Advancement of Science.'

But, passing away from the question of the value of the application

of Science of a date some two and a half centuries ago, let us come a little nearer to our own times.

Electricity—known in its simplest form to the Greeks by the results arising from the friction on amber, and named therefrom; afterwards produced from glass cylinder machines, or from plate machines; and produced a century ago by the 'Influence' machine—remained, as did the discoveries of Volta and Galvani, the pursuit of but a few, and even the brilliant experiments of Davy did not suffice to give very great impetus to this branch of physical science.

Ronalds, in 1823, constructed an electric telegraph. In 1837 the first commercial use was made of the telegraph, and from that time electrical science received an impulse such as it had never before experienced. Further scientific facts were discovered; fresh applications were made of these discoveries. These fresh applications led to renewed vigour in research, and there was the action and reaction of which I have spoken. In the year 1871 the Society of Telegraph Engineers was established. In the year 1861 our own Association had appointed a Committee to settle the question of electrical standards of resistance, which Committee, with enlarged functions, continued its labours for twenty years, and of this Committee I had the honour of being a member. The results of the labours of that Committee endure (somewhat modified, it is true), and may be pointed to as one of the evidences of the value of the work done by the British Association. Since Ronalds's time, how vast are the advances which have been made in electrical communication of intelligence, by land lines, by submarine cables all over the world, and by the telephone! Few will be prepared to deny the statement, that pure electrical science has received an enormous impulse, and has been advanced by the commercial application of electricity to the foregoing, and to purposes of lighting. Since this latter application, scores, I may say hundreds, of acute minds have been devoted to electrical science, stimulated thereto by the possibilities and probabilities of this application.

In this country, no doubt, still more would have been done if the lighting of districts from a central source of electricity had not been, since 1882, practically forbidden by the Act passed in that year. This Act had in its title the facetious statement that it was 'to facilitate Electrical Lighting'—although it is an Act which, even modified as it has been this year, is still a great discouragement of free enterprise, and a bar to progress. The other day a member of the House of Commons was saying to me: 'I think it is very much to our discredit in England that we should have allowed ourselves to be outrun in the distribution of electric lighting to houses, by the inhabitants of the United States, and by those of other countries.' Looking upon him as being one of the authors of the 'facetious' Act, I thought it pertinent to quote the case of the French parricide, who, being asked what he has to say in mitigation of punishment, pleads, 'Pity a poor orphan'—

the parricide and the legislator being both of them authors of conditions of things which they affect to deplore. I will say no more on this subject, for I feel that it would not be right to take advantage of my position here to-night to urge Political Economy views, which should be reserved for Section F. I will merely, and as illustrative of my views of the value of the application of Science to Science itself, say there is no branch of physics pursued with more zeal and with more happy results than that of electricity, with its allies, and there is no branch of Science towards which the public looks with greater hope of practical benefits; a hope that, I doubt not, will be strengthened after we have had the advantage of hearing one of the ablest followers of that science, Professor Ayrton, who, on Friday next, has been good enough to promise to discourse on 'The Electrical Transmission of Power.'

One of the subjects which, as much as (or probably more than) any other, occupies the attention of the engineer, and therefore of Section G, is that of (the so-called) Prime Movers, and I will say boldly that, since the introduction of printing by the use of movable type, nothing has done so much for civilisation as the development of these machines. Let us consider these prime movers—and, first, in the comparatively humble function of replacing that labour which might be performed by the muscular exertion of human beings, a function which at one time was looked upon by many kindly but short-sighted men as taking the bread out of the mouth of the labourer (as it was called), and as being therefore undesirable. I remember revisiting my old schoolmaster, and his saying to me, shaking his head: 'So you have gone the way I always feared you would, and are making things of iron and brass, to do the work of men's hands.'

It must be agreed that all honest and useful labour is honourable, but when that labour can be carried out without the exercise of any intelligence, one cannot help feeling that the result is likely to be intellectually lowering. Thus it is a sorry thing to see unintelligent labour, even although that labour be useful. It is but one remove from unintelligent labour which is not useful; that kind of labour generally appointed (by means of the tread-wheel or the crank) as a punishment for crime. Consider even the honourable labour (for it is useful, and it is honest) of the man who earns his livelihood by turning the handle of a crane, and compare this with the labour of a smith, who, while probably developing more energy by the use of his muscles, than is developed by the man turning the crane-handle, exercises at the same time the powers of judgment, of eye, and of hand in a manner which I never see without my admiration being excited. I say that the introduction of prime movers as a mere substitute for unintelligent manual labour is in itself a great aid to civilisation and to the raising of humanity, by rendering it very difficult, if not impossible, for a human being to obtain a livelihood by unintelligent work—the work of the horse in the mill, or of the turnspit.

But there are prime movers and prime movers—those of small dimensions, and employed for purposes where animal power or human power might be substituted, and those which attain ends that by no conceivable possibility could be attained at all by the exertion of muscular power.

Compare a galley, a vessel propelled by oars, with the modern Atlantic liner; and first let us assume that prime movers are non-existent and that this vessel is to be propelled galley-fashion. Take her length as some 600 feet, and assume that place be found for as many as 400 oars on each side, each oar worked by three men, or 2,400 men; and allow that six men under these conditions could develop work equal to one horse-power: we should have 400 horse-power. Double the number of men, and we should have 800 horse-power, with 4,800 men at work, and at least the same number in reserve, if the journey is to be carried on continuously. Contrast the puny result thus obtained with the 19,500 horse-power given forth by a large prime mover of the present day, such a power requiring, on the above mode of calculation, 117,000 men at work and 117,000 in reserve; and these to be carried in a vessel less than 600 feet in length. Even if it were possible to carry this number of men in such a vessel, by no conceivable means could their power be utilised so as to impart to it a speed of twenty knots an hour.

This illustrates how a prime mover may not only be a mere substitute for muscular work, but may afford the means of attaining an end, that could not by any possibility be attained by muscular exertion, no matter what money was expended or what galley-slave suffering was inflicted.

Take again the case of a railway locomotive: from 400 to 600 horse-power developed in an implement which, even including its tender, does not occupy an area of more than fifty square yards, and that draws us at sixty miles an hour. Here again, the prime mover succeeds in doing that which no expenditure of money or of life could enable us to obtain from muscular effort.

To what, and to whom, are these meritorious prime movers due? I answer: to the application of science, and to the labours of the civil engineer, using that term in its full and proper sense, as embracing all engineering other than military. I am, as you know, a Civil Engineer, and I desire to laud my profession and to magnify mine office; and I know of no better means of doing this than by quoting to you the definition of 'civil engineering,' given in the Charter of The Institution of Civil Engineers, namely, that it is 'the art of directing the great sources of power in Nature for the use and convenience of man.' These words are taken from a definition or description of engineering given by one of our earliest scientific writers on the subject, Thomas Tredgold, who commences that description by the words above quoted, and who, having given

various illustrations of the civil engineer's pursuits, introduces this pregnant sentence :—

‘This is, however, only a brief sketch of the objects of civil engineering; the real extent to which it may be applied is limited only by the progress of science; its scope and utility will be increased with every discovery in philosophy, and its resources with every invention in mechanical or chemical art, since its bounds are unlimited, and equally so must be the researches of its professors.’

‘The art of directing the great sources of power in Nature for the use and convenience of man.’ Among all secular pursuits, can there be imagined one more vast in its scope, more beneficent, and therefore more honourable, than this? There are those, I know—hundreds, thousands—who say that such pursuits are not to be named as on a par with those of literature; that there is nothing ennobling in them; nothing elevating; that they are of the earth, earthy; are mechanical, and are unintellectual, and that even the mere bookworm, who, content with storing his own mind, neither distributes those stores to others nor himself originates, is more worthily occupied than is the civil engineer.

I deny this altogether, and, while acknowledging, with gratitude, that, in literature, the masterpieces of master minds have afforded, and will afford, instruction, delight, and solace for all generations, so long as civilisation endures, I say that the pursuits of civil engineering are worthy of occupying the highest intelligence, and that they are elevating and ennobling in their character.

Remember the kindly words of Sir Thomas Browne, who said, when condemning the uncharitable conduct of the mere bookworm, ‘I make not, therefore, my head a grave, but a treasure of knowledge, and study not for mine own sake only, but for those who study not for themselves.’ The engineer of the present day finds that he must not make his ‘head a grave,’ but that, if he wishes to succeed, he must have, and must exercise, scientific knowledge; and he realises daily the truth that those who are to come after him must be trained in science, so that they may readily appreciate the full value of each scientific discovery as it is made. Thus the application of science by the engineer not only stimulates those who pursue science, but adds him to their number.

Holding, as I have said I do, the view that he who displaces unintelligent labour is doing good to mankind, I claim for the unknown engineer who, in Pontus, established the first water-wheel of which we have a record, and for the equally unknown engineer who first made use of wind for a motor, the title of pioneers in the raising of the dignity of labour, by compelling the change from the non-intelligent to the intelligent.

With respect to these motors—wind and water—we have two proverbs which discredit them: ‘Fickle as the wind,’ ‘Unstable as water.’

Something more trustworthy was needed—something that we were sure of having under our hands at all times. As a result, Science was

applied, and the 'fire' engine, as it was first called, the 'steam' engine, as it was re-named, a form of 'heat' engine, as we now know it to be, was invented.

Think of the early days of the steam-engine—the pre-Watt days. The days of Papin, Savory, Newcomen, Smeaton! Great effects were produced, no doubt, as compared with no fire engine at all; effects so very marked as to extort from the French writer, Belidor, the tribute of admiration he paid to the 'fire' engine erected at the Fresnes Colliery by English engineers. A similar engine worked the pumps in York Place (now the Adelphi) for the supply of water to portions of London. We have in his work one of the very clearest accounts, illustrated by the best engravings (absolute working drawings), of the engine which had excited his admiration. These drawings show the open-topped cylinder, with condensation taking place below the piston, but with the valves worked automatically.

It need hardly be said that, noteworthy as such a machine was, as compared with animal power, or with wind or water motors, it was of necessity a most wasteful instrument as regards fuel. It is difficult to conceive in these days how, for years, it could have been endured that at each stroke of the engine the chamber that was to receive the steam at the next stroke was carefully cooled down beforehand by a water injection.

Watt, as we know, was the first to perceive, or, at all events, to cure, this fundamental error which existed prior to his time in the 'fire' engine. To him we owe condensation in a separate vessel, the doing away with the open-topped cylinder, and the making the engine double-acting; the parallel motion; the governor; and the engine indicator, by which we have depicted for us the way in which the work is being performed within the cylinder. To Watt, also, we owe that great source of economic working—the knowledge of the expansive force of steam; and to his prescience we owe the steam jacket, without which expansion, beyond certain limits, is practically worthless. I have said 'prescience'—fore-knowledge—but I feel inclined to say that, in this case, prescience may be rendered 'pre-Science,' for I think that Watt *felt* the utility of the steam jacket, without being able to say on what ground that utility was based.

I have already spoken in laudatory terms of Tredgold, as being one of the earliest of our scientific engineering writers, but, as regards the question of steam jacketing, Watt's prescience was better than Tredgold's science, for the latter condemns the steam jacket, as being a means whereby the cooling surfaces are enlarged, and whereby, therefore, the condensation is increased.

I think it is not too much to say, that engineers who, since Watt's days, have produced machines of such marvellous power—and, compared with the engines of Watt's days, of so great economy—have, so far as principles are concerned, gone upon those laid down by Watt. Details

of the most necessary character—necessary to enable those principles to be carried out—have, indeed, been devised since the days of Watt. Although it is still a very sad confession to have to make, that the very best of our steam engines only utilises about one-sixth of the work which resides (if the term may be used) in the fuel that is consumed, it is, nevertheless, a satisfaction to know that great economical progress has been made, and that the 6 or 7 lbs. of fuel per horse-power per hour consumed by the very best engines of Watt's days, when working with the aid of condensation, is now brought down to about one-fourth of this consumption; and this in portable engines, for agricultural purposes, working without condensation—engines of small size, developing only 20 horse-power; in such engines the consumption has been reduced to as little as 1.85 lb. per brake horse-power per hour, equal to 1.65 lb. per indicated horse-power per hour, as was shown by the trials at the Royal Agricultural Society's meeting at Newcastle last year—trials in which I had the pleasure of participating.

In these trials, Mr. William Anderson, one of the Vice-Presidents of Section G, and I were associated, and, in making our report of the results, we adopted the balance-sheet system, which I suggested and used so long ago as 1873 (see vol. 52, pages 154 and 155, of the 'Minutes of Proceedings of the Institution of Civil Engineers'), and to which I alluded in my address as President of Section G at Montreal.

I have told you that the engineer of the present day appreciates the value of the 'next-to-nothings.' There is an old housekeeping proverb that, if you take care of the farthings and the pence, the shillings and the pounds will take care of themselves. Without the balance-sheet one knows that for the combustion of 1 lb. of coal, the turning into steam of a given quantity of water at a given pressure is obtained. It is seen, at once, that the result is much below that which should be had, but to account for the deficiency is the difficulty. The balance-sheet, dealing with the most minute sources of loss—the farthings and the pence of economic working—brings you face to face with these, and you find that improvement must be sought in paying attention to the 'next-to-nothings.'

Just one illustration. The balance-sheet will enable you at a glance to answer this among many important questions. Has the fuel been properly burnt?—with neither too much air, nor too little.

At the Newcastle trials our knowledge as to whether we had the right amount of air for perfect combustion was got by an analysis of the waste gases, taken continuously throughout the whole number of hours' run of each engine, affording, therefore, a fair average. The analysis of any required portion of gases thus obtained was made in a quarter of an hour's time by the aid of the admirable apparatus invented by Mr. Stead, and, on the occasion to which I refer, manipulated by him. In one instance an excess of air had been supplied, causing a percentage

of loss of 6·34. In the instance of another engine there was a deficiency of air, resulting in the production of carbonic oxide, involving a loss of $\frac{1}{4}$ per cent. The various percentages of loss, of which each one seems somewhat unimportant, in the aggregate amounted to 28 per cent., and this with one of the best boilers. This is an admirable instance of the need of attention to apparently small things.

I have already said that we now know the steam engine is really a heat engine. At the York Meeting of our Association I ventured to predict that, unless some substantive improvement were made in the steam engine (of which improvement, as yet, we have no notion), I believed its days, for small powers, were numbered, and that those who attended the centenary of the British Association in 1931 would see the present steam engines in museums, treated as things to be respected, and of antiquarian interest to the engineers of those days, such as are the open-topped steam cylinders of Newcomen and of Smeaton to ourselves. I must say I see no reason, after the seven years which have elapsed since the York Meeting, to regret having made that prophecy, or to desire to withdraw it.

The working of heat engines, without the intervention of the vapour of water, by the combustion of the gases arising from coal, or from coal and from water, is now not merely an established fact, but a recognised and undoubted, commercially economical, means of obtaining motive power. Such engines, developing from 1 to 40-horse-power, and worked by the ordinary gas supplied by the gas mains, are in most extensive use in printing works, hotels, clubs, theatres, and even in large private houses, for the working of dynamos to supply electric light. Such engines are also in use in factories, being sometimes driven by the gas obtained from 'culm' and steam, and are giving forth a horse-power for, it is stated, as small a consumption as one pound of fuel per hour.

It is hardly necessary to remind you—but let me do it—that, although the saving of half a pound of fuel per horse-power appears to be insignificant, when stated in that bald way, one realises that it is of the highest importance when that half-pound turns out to be 33 per cent. of the whole previous consumption of one of those economical engines to which I have referred.

The gas engine is no new thing. As long ago as 1807, a M. de Rivaz proposed its use for driving a carriage on ordinary roads. For anything I know he may not have been the first proposer. It need hardly be said that in those days he had not illuminating gas to resort to, and he proposed to employ hydrogen. A few years later, a writer in 'Nicholson's Journal,' in an article on 'flying machines,' having given the correct statement that all that is needed to make a successful machine of this description is to find a sufficiently light motor, suggests that the direction in which this may be sought is the employment of illuminating gas, to operate by its explosion on the piston of an engine. The idea of the gas engine

was revived, and formed the subject of a patent by Barnett in the year 1838. It is true this gentleman did not know very much about the subject, and that he suggested many things which, if carried out, would have resulted in the production of an engine which could not have worked ; but he had an alternative proposition which would have worked.

Again, in the year 1861, the matter was revived by Lenoir, and in the year 1865, by Hugon, both French inventors. Their engines obtained some considerable amount of success and notoriety, and many of them were made and used ; but in the majority of cases they were discarded as wasteful and uncertain. The Institution of Civil Engineers, for example, erected a Lenoir in the year 1868, to work the ventilating fan, but after a short time they were compelled to abandon it and to substitute a hydraulic engine.

At the present time, as I have said, gas engines are a great commercial success, and they have become so by the attention given to small things, in popular estimation—to important things, in fact, with which, however, I must not trouble you. Messrs. Crossley Brothers, who have done so much to make the gas engine the commercial success that it is, inform me that they are prosecuting improvements in the direction of attention to detail, from which they are obtaining greatly improved results.

But, looking at the wonderful petroleum industry, and at the multifarious products which are obtained from the crude material, is it too much to say, that there is a future for motor engines, worked by the vapour of some of the more highly volatile of these products—true vapour—not a gas, but a condensable body, capable of being worked over and over again? Numbers of such engines, some of as much as 4 horse-power, made by Mr. Yarrow, are now running, and are apparently giving good results ; certainly excellent results as regards the compactness and lightness of the machinery ; for boat purposes they possess the great advantage of being rapidly under way. I have seen one go to work within two minutes of the striking of the match to light the burner.

Again, as we know, the vapour of this material has been used as a gas in gas engines, the motive power having been obtained by direct combustion.

Having regard to these considerations, was I wrong in predicting that the heat engine of the future will probably be one independent of the vapour of water? And, further, in these days of electrical advancement, is it too much to hope for the direct production of electricity from the combustion of fuel?

As the world has become familiar with prime movers, the desire for their employment has increased. Many a householder could find useful occupation for a prime mover of $\frac{1}{4}$ or $\frac{1}{2}$ horse-power, working one or two hours a day ; but the economical establishment of a steam engine is not possible until houses of very large dimensions are reached, where

space exists for the engine, and where, having regard to the amount of work to be done, the incidental expenses can be borne. Where this cannot be, either the prime mover, with the advantages of its use, must be given up as a thing to be wished for, but not to be procured, or recourse must be had to some other contrivance—say to the laying on of power, in some form or another, from a central source.

I have already incidentally touched upon one mode of doing this, namely, the employment of illuminating gas, as the working agent in the gas engine; but there are various other modes, possessing their respective merits and demerits—all ingenious, all involving science in their application, and all more or less in practical use—such as the laying-on of special high-pressure water, as is now being extensively practised in London, in Hull, and elsewhere. Water at 700 lbs. pressure per inch is a most convenient mode of laying on a large amount of power, through comparatively small pipes. Like electricity, where, when a high electro-motive force is used, a large amount of energy may be sent through a small conductor, so with water, under high pressure, the mains may be kept of reasonable diameters, without rendering them too small to transmit the power required through them.

Power is also transmitted by means of compressed air, an agent which, on the score of its ability to ventilate, and of its cleanliness, has much to recommend it. On the other hand, it is an agent which, having regard to the probability of the deposition of moisture in the form of 'snow,' requires to be worked with judgment.

Again, there is an alternative mode for the conveyance of power by the exhaustion of air—a mode which has been in practical use for over sixty years.

We have also the curious system pursued at Schaffhausen, where quick-running ropes are driven by turbines, these being worked by the current of the river Rhine; and at New York, and in other cities of the United States, steam is laid on under the streets, so as to enable domestic steam engines to be worked, without the necessity of a boiler, a stoker, or a chimney, the steam affording also means of heating the house when needed.

Lastly, there is the system of transmitting power by electricity, to which I have already adverted. I was glad to learn, only the other day, that there was every hope of this power being applied to the working of an important subterranean tramway.

These distributions from central sources need, as a rule, statutory powers to enable the pipes or wires to be placed under the roads; and, following the deplorable example of the Electrical Facilities Act, it is now the habit of the enlightened corporation and the enterprising town clerk of most boroughs to say to capitalists who are willing to embark their capital in the plant for the distribution of power from a central source—for their own profit, no doubt, but also, no doubt, for the good of the

community—‘We will oppose you in Parliament, unless you will consent that, at the end of twenty-one years, we may acquire compulsorily your property, and may do so, if it turns out to be remunerative, without other payment than that for the mere buildings and plant at that time existing.’ This is the way English enterprise is met, and then English engineers are taunted, by Englishmen—often by the very men who have had a share in making this ‘boa-constrictor’ of a ‘Facilities Act’—that their energy is not to be compared with that which is to be found in the United States and other countries. Again, however, I must remember that I am not addressing Section F.

There is one application of science, by engineers, which is of extreme beauty and interest, and that cannot be regarded with indifference by the agriculturists of this country. I allude to the Heat-withdrawing Engines (I should like to say, ‘Cold-Producers,’ but I presume, if I did, I should be criticised), which are now so very extensively used for the importation of fresh meat, and for its storage when received here. It need hardly be said, that that which will keep cool and sweet the carcasses of sheep will equally well preserve milk, and many other perishable articles of food. We have in these machines daily instances that, if you wish to make a ship’s hold cold, you can do it by burning a certain quantity of coals—a paradox, if ever there was one.

In this climate of ours, where the summer has been said to consist of ‘three hot days and a thunderstorm,’ there is hardly need to make a provision for cooling our houses, although there is an undoubted need for making a provision to heat them. Nevertheless, those of us who have hot-water heating arrangements for use in the winter would be very glad indeed if, without much trouble or expense, they could turn these about, so as to utilise them for cooling their houses in summer. Mr. Loftus Perkins, so well known for his labours in the use of very high-pressure steam (600 to 1,000 lbs. on the inch), and also so well known for those most useful high-pressure warming arrangements which, without disfiguring our houses by the passage of large pipes, keep them in a state of warmth and comfort throughout the winter, has lately taken up the mode of, I will say it, producing ‘cold’ by the evaporation of ammonia, and, by improvements in detail, has succeeded in making an apparatus which, without engine or pumps, produces ‘cold’ for some hours in succession, and requires, to put it in action, the preliminary combustion of only a few pounds of coke or a few feet of gas.

As I have said, our climate gives us but little need to provide or employ apparatus to cool our houses, but one can well imagine that the Anglo-Indian will be glad to give up his punkah for some more certain, and less draughty, mode of cooling.

I now desire to point out how, as the work of the engineer grows, his needs increase. New material, or better material of the old kind, has to be found to enable him to carry out these works of greater mag-

nitide. At the beginning of this century, stone, brick, and timber were practically the only materials employed for that which I may call standing engineering work—*i.e.*, buildings, bridges, aqueducts, and so on—while timber, cast iron, and wrought iron were for many years the only available materials for the framing and principal parts of moving machines and engines, with the occasional use of lead for the pipes and of copper for pipes and for boilers.

As regards the cast iron, little was known of the science involved (or that ought to be involved) in its manufacture. It was judged of by results. It was judged of largely by the eye. It was 'white,' it was 'mottled,' it was 'grey.' It was known to be 'fit for refining,' fit for 'strong castings,' or fit for castings in which great fluidity in the molten metal was judged to be of more importance than strength in the finished casting. With respect to wrought iron, it was judged of by its results also. It was judged of by the place of its manufacture—but when the works of the district were unknown, the iron, on being tested, was classed as 'good fibrous,' although some of the very best was 'steel-like,' or 'bad,' 'hot-short,' or 'cold-short.' A particular district would produce one kind of iron, another district another kind of iron. The ore, the flux, and the fuel were all known to have influence, but to what extent was but little realised; and if there came in a new ore, or a new flux, it might well be that for months the turn-out of the works into which these novelties had been introduced would be prejudiced. Steel again—that luxury of the days of my youth—was judged by the eye. The wrought bars, made into 'blister' steel by 'cementation,' were broken, examined, and grouped accordingly. Steel was known, no doubt, to be a compound of iron and carbon, but the importance of exactness in the percentage was but little understood, nor was it at all understood how the presence of comparatively small quantities of foreign matter might necessitate the variation of the proportions of carbon. The consequence was that anomalous results every now and then arose to confound the person who had used the steel, and falsifying the proverb 'true as steel,' steel became an object of distrust. Is it too much to say that Bessemer's great invention of steel made by the 'converter,' and that Siemens's invention of the open-hearth process, reacted on pure science, and set scientific men to investigate the laws which regulate the union of metals and of metalloids?—and that the labours of these scientific men have improved the manufacture, so that steel is now thoroughly and entirely trusted? By its aid engineering works are accomplished which, without that aid, would have been simply impossible. The Forth Bridge, the big gun, the compound armour of the ironclad with its steel face, the projectile to pierce that steel face—all equally depend upon the 'truth' of steel as much as does the barely visible hair spring of the chronometer, which enables the longitude of the ship in which it is carried to be ascertained. Now, what makes the difference between trustworthy and untrustworthy steel

for each particular purpose? Something which, until our better sense comes to our aid, we are inclined to look upon as ridiculously insignificant—a ‘next-to-nothing.’ Setting extraneous ingredients aside, and considering only the union of iron and carbon, the question whether there shall be added or deducted one-tenth of 1 per cent. (pardon my clumsy way of using the decimal system) of carbon is a matter of great importance in the resulting quality of the steel. This is a striking practical instance of how apparently insignificant things may be of the highest importance. The variation of this fraction of a percentage may render your boiler steel untrustworthy, may make the difference between safety in a gun and danger in a gun, and may render your armour-piercing projectile unable to pierce even the thinnest wrought-iron armour.

While thus brought incidentally to the subject of guns, let me derive from it another instance of the value of small things. I have in my hand a piece of steel ribbon. It is probable that only those who are near to me can see it. Its dimensions are one-fourth by one-sixteenth of an English inch, equal to an area of one sixty-fourth of a square inch. This mode of stating the dimensions I use for the information of the ladies. To make it intelligible to my scientific friends, I must tell them that it is approximately $\cdot 00637$ of a metre, by approximately $\cdot 00159$ of a metre, and that its sectional area is $\cdot 0000101283$ (also approximately) of a square metre. This insignificant (and speaking in reference to the greater number of my audience), practically invisible piece of material—that I can bend with my hand, and even tie into knots—is, nevertheless, not to be despised. By it one reinforces the massive and important-looking A-tube of a 9·2-inch gun, so that from that tube can be projected with safety a projectile weighing 380 pounds at a velocity, when leaving the muzzle, of between one-third and one-half of a mile in a second, and competent to traverse nearly $12\frac{1}{2}$ miles before it touches the ground. It may be said, ‘What is the use of being able to fire a projectile to a distance which commonly is invisible (from some obstacle or another) to the person directing the gun?’ I will suggest to you a use. Imagine a gun of this kind placed by some enemy who, unfortunately, had invaded us, and had reached Richmond. He has the range table for his gun; he, of course, is provided with our Ordnance maps, and he lays and elevates the gun at Richmond, with the object of striking, say, the Royal Exchange. Suppose he does not succeed in his exact aim. The projectile goes 100 yards to one side or to the other; or it falls 250 yards short, or passes 250 yards over; and it would be ‘bad shooting’ indeed, in these days, if nearly every projectile which was fired did not fall somewhere within an area such as this. In this suggested parallelogram of 100,000 square yards, or some 20 acres, there is some rather valuable property; and the transactions which are carried on are not unimportant. It seems to me that business would not be conducted with that calmness and coolness which are necessary for success, if, say every five minutes, a 380-pound

shell fell within this area, vomiting fire, and scattering its walls in hundreds of pieces, with terrific violence, in all directions. Do not suppose I am saying that similar effects cannot be obtained from a gun where wire is not employed. They can be. But my point is, that they can also be obtained by the aid of the insignificant thing which I am holding up at this moment—this piece of steel ribbon, which looks more suitable for the framework of an umbrella.

I have already spoken to you, when considering steel as a mere alloy of iron and carbon, as to the value of even a fraction of 1 per cent. of the latter; but we know that in actual practice steel almost always contains other ingredients. One of the most prominent of these is manganese. It had for years been used, in quantities varying from a fraction of 1 per cent. up to 2·5 per cent., with advantage as regards ductility, and as regards its ability to withstand forging. A further increase was found not to augment the advantage: a still further increase was found to diminish it: and here the manufacturer stopped, and, so far as I know, the pure scientist stopped, on the very reasonable ground that the point of increased benefit appeared to have been well ascertained, and that there could be no advantage in pursuing an investigation which appeared only to result in decadence. But this is another instance of how the application of science reacts in the interests of pure science itself. One of our steel manufacturers, Mr. Hadfield, determined to pursue this apparently barren subject, and in doing so discovered this fact—that, while with the addition of manganese in excess of the limit before stated, and up to as much as 7 per cent., deterioration continued, after this latter percentage was passed improvement again set in.

Again, the effects of the addition of even the very smallest percentages of aluminium upon the steel with which it may be alloyed are very striking and very peculiar, giving to the steel alloy thus produced a very much greater hardness, and enabling it to take a much brighter and more silver-like polish. Further, the one-twentieth part of 1 per cent. of aluminium, when added to molten wrought iron, will reduce the fusing-point of the whole mass some 500 degrees, and will render it extremely fluid, and thus enable wrought iron (or what are commercially known as 'Mitis'—castings of the most intricate character) to be produced.

No one has worked more assiduously at the question of the effect of the presence of minute quantities, even traces, of alloys with metals than Professor Roberts-Austen, and he appears, by his experiments, to be discovering a general law, governing the effect produced by the mixture of particular metals, so that, in future, it is to be hoped, when an alloy is, for the first time, to be attempted, it will be possible to predict with reasonable certainty what the result will be, instead of that result remaining to be discovered by experiment.

I have just, incidentally, mentioned aluminium. May I say that we

engineers look forward, with much interest, to all processes tending to bring this metal, or its alloys, within possible commercial use?

One more instance of the effect of impurities in metals. The engineer engaged in electrical matters is compelled, in the course of his daily work, frequently to realise the importance of the 'next-to-nothing.' One striking instance of this is afforded by the influence which an extremely minute percentage of impurity has on the electrical conductivity of copper wire: this conductivity being in some cases reduced by as much as 50 per cent., in consequence of the admixture of that which, under other circumstances, would be looked upon as insignificant.

Reverting to the question of big guns. According to the present mode of manufacture, after we have rough-bored and turned the 'A' tube (and perhaps I ought to have mentioned that by the 'A' tube is meant the main piece of the gun, the innermost layer, if I may so call it, that portion which is the full length of the gun, and upon which the remainder of the gun is built up)—after, as I have said, we have rough-bored and turned this 'A' tube, we heat it to a temperature lying between certain specified limits, but actually determined by the behaviour of samples previously taken, and then suddenly immerse it perpendicularly into a well some 60 feet deep, full of oil, the oil in this well being kept in a state of change by the running into it, at the bottom, of cold oil conveyed by a pipe proceeding from an elevated oil tank. In this way the steel is oil-hardened, with the result of increasing its ultimate tensile strength, and also with the result of raising its so-called elastic limit. In performing this operation it is almost certain that injurious internal strains will be set up: strains tending to produce self-rupture of the material. Experiments have been carried out in England, by Captain Andrew Noble, and by General Maitland of the Royal Gun Factory, by General Kalakoutsky, in Russia, and also in the United States, to gauge what is the value, as represented by dimensions, of these strains, and we find that they have to be recorded in the most minute fractions of an inch, and yet, if the steel be of too 'high' a quality (as it is technically called), or if there has been any want of uniformity in the oil-hardening process, these strains, unless got rid of or ameliorated by annealing, may, as I have said, result in the self-rupture of the steel.

I have spoken of the getting rid of these strains by annealing, a process requiring to be conducted with great care, so as not to prejudice the effects of the oil-hardening. But take the case of a hardened steel projectile, hardened so that it will penetrate the steel face of compound armour. In that case annealing cannot be resorted to, for the extreme hardness of the projectile must not be in the least impaired. The internal strains in these projectiles are so very grave, that for months after they are made there is no security that they will not spontaneously fracture. I have here the point of an 8-inch projectile, which projectile weighs 210 lbs., this with others was received from the makers as long ago as March of

this year, and remained an apparently perfect and sound projectile until about the middle of August—some five months after delivery—and, of course, a somewhat longer time since manufacture—and between August 6th and 8th this piece which I hold in my hand, measuring $3\frac{3}{4}$ inches by $3\frac{1}{2}$ inches, spontaneously flew off from the rest of the projectile, and has done so upon a surface of separation which, whether having regard to its beautiful regularity, or to the conclusions to be drawn from it as to the nature of the strains existing, is of the very highest scientific interest. Many other cases of self-rupture of similar projectiles have been recorded.

Another instance of the effect of the 'next-to-nothing' in the hardening and tempering or annealing of steel. As we know, the iron and the carbon (leaving other matters out of consideration) are there. The carbon is (even in tool-steel) a very small proportion of the whole. The steel may be bent, and will retain the form given to it. You heat it and plunge it in cold water; you attempt to bend it and it breaks; but if, after the plunging in cold water, you temper it by carefully reheating it, you may bring it to the condition fit either for the cutting-tool for metal, or for the cutting-tool for wood, or for the watch-spring; and these important variations of condition which are thus obtained depend upon the 'next-to-nothing' in the temperature to which it is reheated, and therefore in the nature of the resulting combination of the ingredients of which the steel is composed.

Some admirable experiments were carried out on this subject by the Institution of Mechanical Engineers, with the assistance of one of our Vice-Presidents, Sir Frederick Abel, and the subject has also been dealt with by an eminent Russian writer.

There is, to my mind, another and very striking popular instance (if I may use the phrase) of the importance of attention to detail—that is, to the 'next-to-nothing.' Consider the bicycles and tricycles of the present day—machines which afford the means of healthful exercise to thousands, and which will, probably within a very short time, prove of the very greatest possible use for military purposes. The perfection to which these machines have been brought is almost entirely due to strict attention to detail; in the selection of the material of which the machines are made; in the application of pure science (in its strictest sense) to the form and to the proportioning of the parts, and also in the arrangement of these various parts in relation the one to the other. The result is that the greatest possible strength is afforded with only the least possible weight, and that friction in working has been reduced to a minimum. All of us who remember the hobby-horse of former years, and who contrast that machine with the bicycle or tricycle of the present day, realise how thoroughly satisfactory is the result of this attention to detail—this appreciation of the 'next-to-nothing.'

Let me give you another illustration of the importance of small things, drawn from gunnery practice.

At first sight one would be tempted to say that the density of the air on the underside of a shot must, notwithstanding its motion of descent, be so nearly the same as that of the air upon the upper side as to cause the difference to be unworthy of consideration; but we know that the projectiles from rifled guns tend to travel sideways as they pass through the air, and that the direction of their motion, whether to the right or to the left, depends on the 'hand' of the rifling. We know also, that the friction against liquid or against gaseous bodies varies with the densities of these bodies, and it is believed that, minute as is the difference in density to which I have referred, it is sufficient to determine the lateral movement of the projectile. This lateral tendency must be allowed for, in these days of long ranges, in the sighting and laying of guns, if we desire accuracy of aim, at those distances at which it is to be expected our naval engagements will have to be commenced, and perhaps concluded. We can no longer afford to treat the subject as Nelson is said to have treated it, in one of his letters to the Secretary of the Admiralty, who had requested that an invention for laying guns more accurately should be tried. Nelson said he would be glad to try the invention, but that, as his mode of fighting consisted in placing his ship close alongside that of the enemy, he did not think the invention, even if it were successful, would be of much use to him.

While upon the question of guns, I am tempted to remark upon that which is by no means a small thing (for it is no less than the rotation of the earth), which in long-distance firing may demand attention, and that to an extent little suspected by the civilian.

Place the gun north and south, say in the latitude of London, and fire a 12-mile round such as I have mentioned, and it will be found that, assuming the shot were passing through a vacuum, a lateral allowance of more than 200 feet must be made to compensate for the different velocity of the circumference of the earth at 12 miles north or south of the place where the gun was fired, as compared with the velocity of the circumference of the earth at that place itself—the time of flight being in round numbers one minute.

At the risk of exciting a smile, I am about to assert that engineering has even its poetical side. I will ask you to consider with me whether there may not be true poetry in the feelings of the engineer who solves a problem such as this: Consider this rock, never visible above the surface of the tide, but making its presence known by the waves which rise around it: it has been the cause of destruction to many a noble vessel which had completed, in safety, its thousands of leagues of journey, and was, within a few score miles of port; then dashed to pieces upon it? Here is this rock. On it build a lighthouse. Lay your foundations through the water, in the midst of the turmoil of the sea; make your preparations; appear to be attaining success, and find the elements are against you and that the whole of your preliminary works are ruined

or destroyed in one night ; but again commence, and then go on and go on until at last you conquer ; your works rise above ordinary tide-level ; then upon these sure foundations, obtained it may be after years of toil, erect a fair shaft, graceful as a palm and sturdy as an oak ; surmount it with a light, itself the produce of the highest application of science ; direct that light by the built-up lens, again involving the highest application of science ; apply mechanism, so arranged that the lighthouse shall from minute to minute reveal to the anxious mariner its exact name and its position on the coast. When you have done all this, will you not be entitled to say to yourself, 'It is I who have for ever rendered innocuous this rock which has been hitherto a dread source of peril' ? Is there no feeling, do you think, of a poetical nature excited in the breast of the engineer who has successfully grappled with a problem such as this ?

Another instance : the mouth of a broad river, or, more properly speaking, the inlet of the sea, has to be crossed at such a level as not to impede the passage of the largest ships. Except in one or two places the depth is profound, so that multiple foundations for supporting a bridge become commercially impossible, and the solution of the problem must be found by making, high in the air, a flight of span previously deemed unattainable. Is there no poetry here ? Again, although the results do not strike the eye in the same manner, is there nothing of poetry in the work, that has to be thought out and achieved, when a wide river or an ocean channel has to be crossed by a subterranean passage ? Works of great magnitude of this character have been performed with success, and to the benefit of those for whose use they were intended. One of the greatest and most noble of such works, encouraged, in years gone by, by the Governments of our own country and of France, has lately fallen into disfavour with an unreasoning public, who have not taken the pains to ascertain the true state of the case.

Surely it will be agreed that the promotion of ready intercourse and communication between nations constitutes the very best and most satisfactory guarantees for the preservation of peace ; when the peoples of two countries come to know each other intimately, and when they, therefore, enter into closer business relations, they are less liable to be led away by panic or by anger, and they hesitate to go to war the one with the other. It is in the interests of both that questions of difference which may arise between them should be amicably settled, and having an intimate knowledge of each other, they are less liable to misunderstand, and the mode of determination of their differences is more readily arranged. Remember, the means of ready intercourse and of communication, and the means of easy travel, are all due to the application of science by the engineer. Is not therefore his profession a beneficent one ?

Further, do you not think poetical feeling will be excited in the breast of that engineer who will in the near future solve the problem (and it certainly will be solved when a sufficiently light motor is obtained) of travel-

ling in the air—whether this solution be effected by enabling the self-suspended balloon to be propelled and directed, or perhaps, better still, by enabling not only the propulsion to be effected and the direction to be controlled, but by enabling the suspension in the air itself to be attained by mechanical means ?

Take other functions of the Civil Engineer—functions which, after all, are of the most important character, for they contribute directly to the prevention of disease, and thereby not only prolong life, but do that which is probably more important—afford to the population a healthier life while lived.

In one town, about which I have full means of knowing, the report has just been made that in the year following the completion of a comprehensive system of sewerage, the deaths from zymotic diseases had fallen from a total of 740 per annum to a total of 372—practically one half. Has the engineer no inward satisfaction who knows such results as these have accrued from his work ?

Again, consider the magnitude and completeness of the water supply of a large town, especially a town that has to depend upon the storing-up of rain water: the prevision which takes into account, not merely the variation of the different seasons of the year, but the variation of one year from another; that, having collated all the stored-up information, determines what must be the magnitude of the reservoirs to allow for at least three consecutive dry years, such as may happen; and that finds the sites where these huge reservoirs may be safely built.

All these—and many other illustrations which I could put before you if time allowed—appear to me to afford conclusive evidence that, whether it be in the erection of the lighthouse on the lonely rock at sea; whether it be in the crossing of rivers or seas, or arms of seas, by bridges or by tunnels; whether it be the cleansing of our towns from that which is foul; whether it be the supply of pure water to every dwelling, or the distribution of light or of motive power; or whether it be in the production of the mighty ocean steamer, or in the spanning of valleys, the piercing of mountains, and affording the firm, secure road for the express train; or whether it be the encircling of the world with telegraphs—the work of the Civil Engineer is not of the earth earthy, is not mechanical to the exclusion of science, is not unintellectual; but is of a most beneficent nature, is consistent with true poetical feeling, and is worthy of the highest order of intellect.

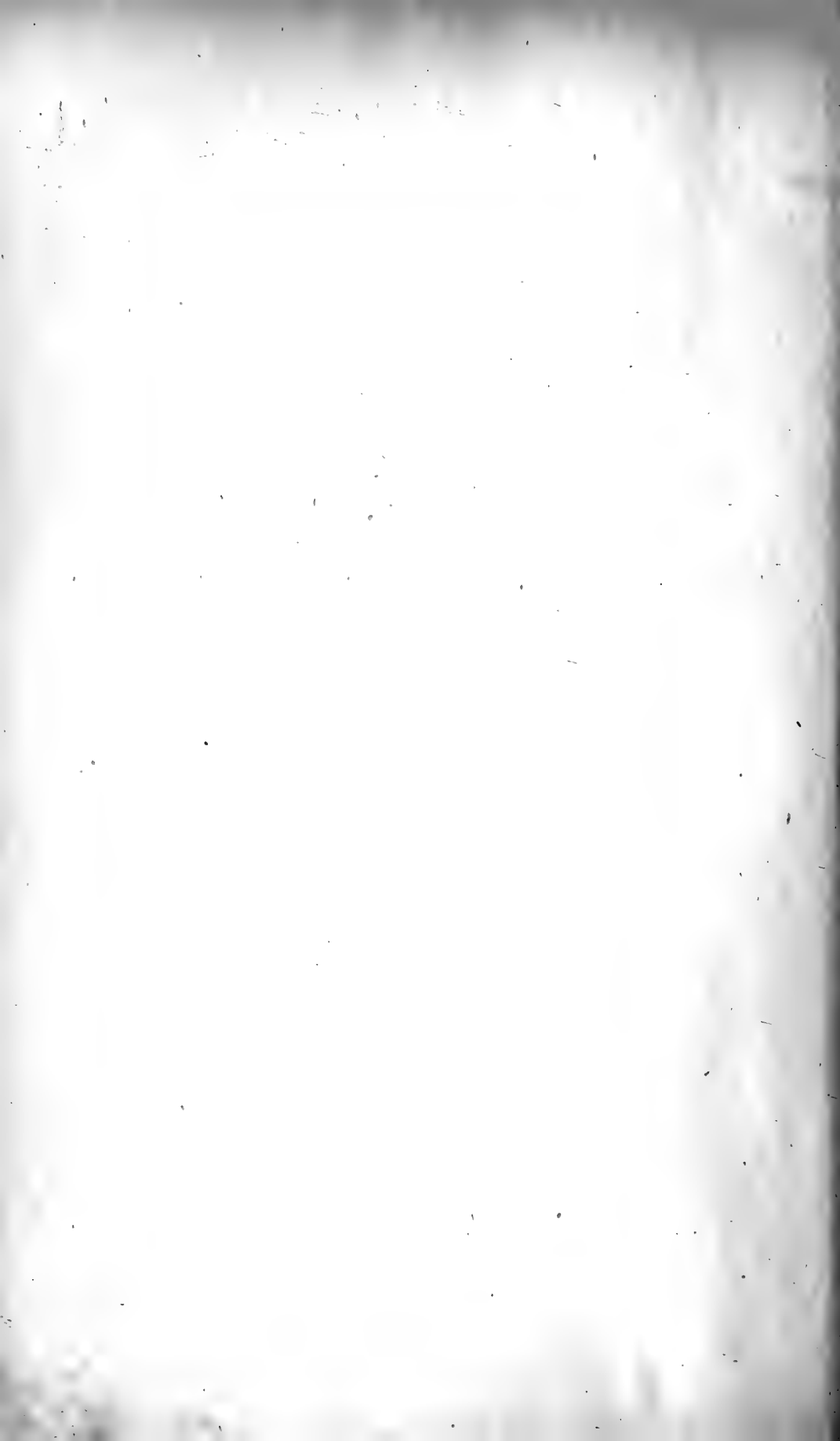

REPORTS
ON THE
STATE OF SCIENCE.

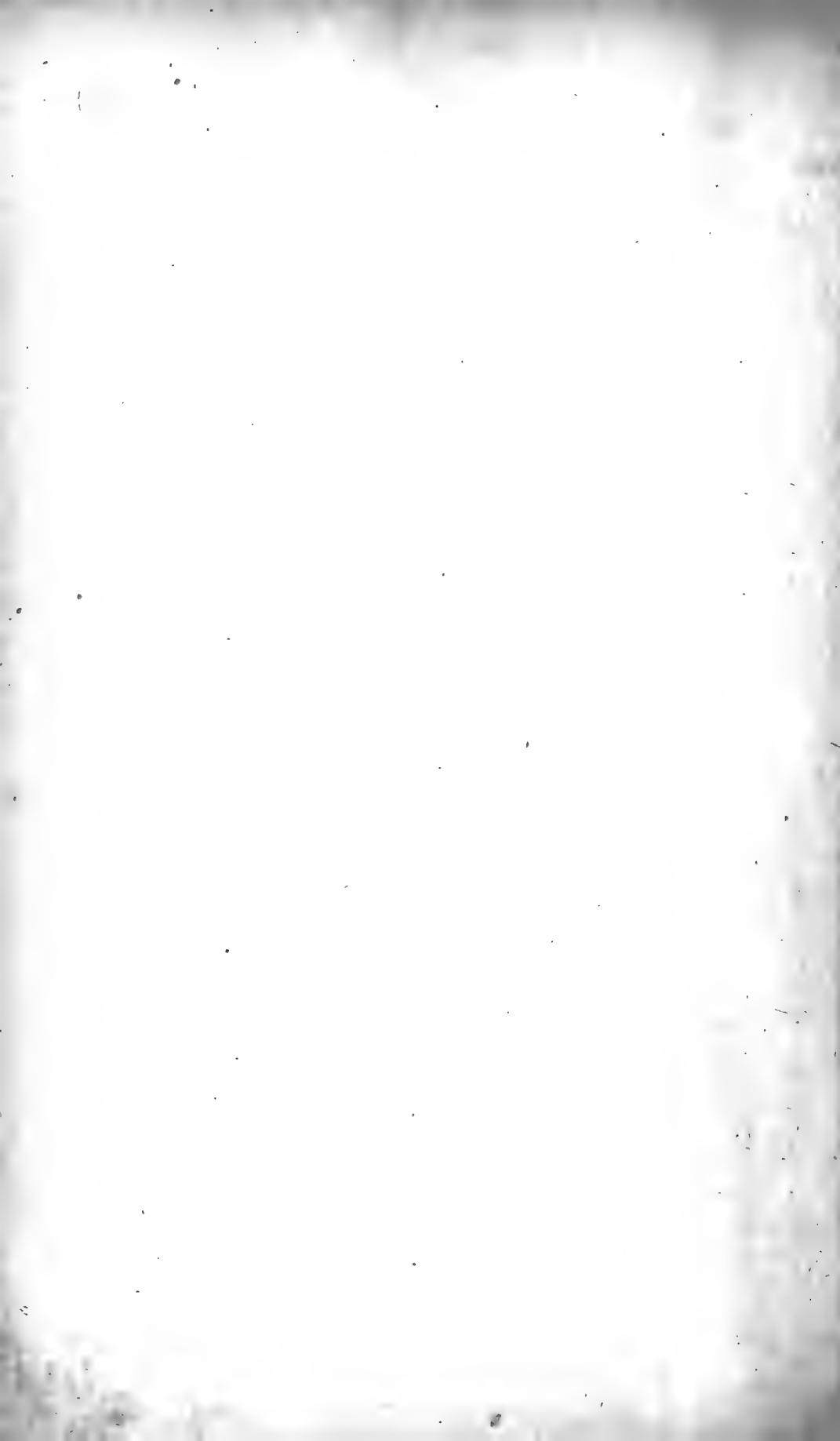

REPORTS

ON THE

STATE OF SCIENCE.

Fourth Report of the Committee, consisting of Professors A. JOHNSON (Secretary), J. G. MACGREGOR, J. B. CHERRIMAN, and H. T. BOVEY and Mr. C. CARPMAEL, for the purpose of promoting Tidal Observations in Canada.

LAST year the Committee reported that Lieut. Gordon, R.N., commander of one of the Dominion cruisers, had been authorised to make some preliminary observations and to spend some small sums of money in getting assistance for this purpose; and also that he had been directed to put himself in communication with Prof. Darwin with the expectation that next year a special grant would be made for systematic tidal observations. It was understood that no more could be done in the interval. The Committee, therefore, have taken no action during the past year. It is considered, however, desirable that they should be reappointed in order to keep the matter before the Government during the next session of Parliament. The Board of Trade of Montreal is still earnestly pressing this as well as other questions connected with a hydrographic survey on the attention of ministers.

Report of the Committee, consisting of Sir R. S. BALL, Dr. G. JOHNSTONE STONEY, Professors EVERETT, FITZGERALD, HICKS, CAREY FOSTER, O. J. LODGE, POYNTING, MACGREGOR, GENESE, W. G. ADAMS, and LAMB, Messrs. BAYNES, A. LODGE, FLEMING, W. N. SHAW, GLAZEBROOK, HAYWARD, LANT CARPENTER, CULVERWELL (Secretary), and GREENHILL, Dr. MUIR, and Messrs. G. GRIFFITH and J. LARMOR, appointed for the purpose of considering the desirability of introducing a Uniform Nomenclature for the Fundamental Units of Mechanics, and of cooperating with other bodies engaged in similar work.

THE Committee recommend the use of the following names:—

The unit of velocity on the C.G.S. system of units, *i.e.*, the velocity of one centimetre per second, to be called one Kine.

The unit of momentum on the C.G.S. system of units, *i.e.*, the momentum of one gramme moving at one kine, to be called one Bole.

The unit of pressure on the C.G.S. system of units, *i.e.*, the pressure of one dyne per square centimetre, to be called one Barad.

The Committee do not recommend that any additional names be given to English units.

They ask to be reappointed, as they think that there are some other units upon which there is prospect of agreement as to the names to be recommended.

Fourth Report of the Committee, consisting of Professor BALFOUR STEWART (Secretary), Professor W. GRYLLS ADAMS, Mr. W. LANT CARPENTER, Mr. C. H. CARPMAEL, Mr. W. H. M. CHRISTIE (Astronomer Royal), Professor G. CHRYSAL, Captain CREAK, Professor G. H. DARWIN, Mr. WILLIAM ELLIS, Sir J. H. LEFROY, Professor S. J. PERRY, Professor SCHUSTER, Professor Sir W. THOMSON, and Mr. G. M. WHIPPLE, appointed for the purpose of considering the best means of Comparing and Reducing Magnetic Observations.

SINCE their last report the Committee have to record the death of their Secretary, Professor Balfour Stewart, whose loss will be deeply felt in the scientific world, especially by those who are engaged in researches in terrestrial magnetism and in the work of magnetic observatories. A meeting of the Committee was held on February 2, 1888, at which Professor W. Grylls Adams was requested to act as Secretary to the Committee, and to forward to the directors of magnetic observatories copies of the third report of the Committee, calling special attention to the paragraphs relating to the determination of scale coefficients.

At the second meeting of the Committee on July 11, 1888, Mr. W. L. Carpenter handed to the Committee a paper which had been prepared by Professor Balfour Stewart on a comparison between the wind values and declination disturbances at the Kew Observatory. The Committee have thought it right to recommend that this paper and the table accompanying it be printed as an appendix to the report.

The Committee learn that all the scientific material found among Dr. Stewart's papers is in the possession of Professor A. Schuster. Professor Schuster has continued his reduction of the diurnal variation of terrestrial magnetism and has nearly completed a paper on the subject, which he purposes to present to the Royal Society.

A paper has also been communicated to the Committee by Major Dawson on magnetic observations taken at Fort Rae in 1882-83, which is printed as Appendix II. to this report.

APPENDIX I. *Results of a comparison between the wind values and declination disturbances at the Kew Observatory.* By BALFOUR STEWART, M.A., LL.D., F.R.S., and WILLIAM LANT CARPENTER, B.A., B.Sc.

In a note communicated to the Royal Society on February 11, 1885, we gave the results of a preliminary comparison between the dates of cyclonic

storms in Great Britain and those of declination disturbances at the Kew Observatory. As we continued this investigation we came to the conclusion that the best method of procedure would be to compare together what may be termed wind-weather and declination-disturbance-weather, in order to see if there is any apparent connexion between them; our hope of a positive result being strengthened by the belief that there is accumulating evidence in favour of a connexion of some kind between the convection currents of the earth and the oscillations of terrestrial magnetism.

We shall, therefore, begin by defining precisely what we mean by wind weather and by disturbance weather. We have obtained, through the kindness of the Kew Committee, records of the total amount in miles gone over by the wind at Kew for each day of the years 1858-73 (sixteen years in all), and we have likewise obtained from the same source daily aggregates of the disturbance of magnetic declination at Kew separated by Sabine's method.

To begin with the wind values, we have first of all smoothed these down into daily averages of three days. Let us call this Table A.

We have next obtained a Table B, where each day's value is the average of 25 days of Table A, all being properly placed as regards dates.

Next, taking the difference between the entries of Tables A and B, we obtain a series representing departures from the mean—*plus* when in excess, and *minus* when in deficiency—which may be taken to represent *wind weather*. The declination aggregate daily disturbance numbers (for which the unit is $\frac{1}{100}$ of an inch measured on the curve) have been treated in exactly the same way as the wind numbers, and the differences finally obtained have been taken to represent *disturbance weather*. The values representing wind weather have then been formed into series of twelve terms, each so chosen that *maximum* wind values come together at the middle of each series. The yearly sums of these series, as well as four-yearly sums and total sum for 16 years, are exhibited in Table I_a.

The disturbance weather values have then been arranged into series of twelve terms each, so that each entry is two days previous in date to the corresponding entry of Table I_a. The yearly, four-yearly, and total sums of these series are given in Table I_b.

The values representing wind weather have next been formed into series of twelve terms each, so chosen that *minimum* wind values come together at the middle of each series. The yearly, four-yearly, and total sums of these series are given in Table II_a.

Finally, the disturbance-weather values have been arranged into series of twelve turns each, so that each entry is two days prior in date to the corresponding entry in Table II_a, and the sums of these are entered in Table II_b.

The general results of the comparison for the sixteen years are shown in the accompanying table, and if averages be taken from these for the three minimum sunspot years 1865-6-7, and for the three maximum years on either side thereof, we get

	Wind weather	Declination weather
1858-59-60	68·6	64·0
1865-66-67	65·0	51·8
1869-70-71	67·0	63·5

		Wind Velocity	Mag- netic Declina- tion		Wind Velocity	Mag- netic Declina- tion		Wind Velocity	Mag- netic Declina- tion		Wind Velocity	Mag- netic Declina- tion
January	1858	81	27	1862	84	66	1866	88	52	1870	88	78
February		61	52		85	44		102	79		109	61
March		95	92		90	47		56	54		53	48
April		104	94		51	88		72	45		46	48
May		68	69		57	38		84	35		80	72
June		37	79		68	34		49	17		39	54
July		49	55		44	56		46	36		48	25
August		49	24		53	83		60	44		47	54
September		76	61		76	45		57	66		57	105
October		62	53		59	115		41	76		53	96
November		130	39		80	43		55	31		98	66
December		96	78		82	100		80	22		65	105
January	1859	78	58	1863	92	70	1867	88	33	1871	82	35
February		68	69		46	80		82	71		73	119
March		72	37		69	52		66	41		92	79
April		82	70		79	62		75	33		40	82
May		56	46		85	36		55	52		36	56
June		45	55		49	24		59	49		41	44
July		37	41		41	60		65	30		54	39
August		59	78		41	39		45	15		44	69
September		47	118		49	80		50	49		62	32
October		45	102		92	89		47	36		65	59
November		84	81		86	71		76	29		108	70
December		78	70		67	50		75	28		69	29
January	1860	89	32	1864	89	41	1868	110	27	1872	101	25
February		64	71		75	48		70	38		42	82
March		92	81		72	66		54	87		59	47
April		116	72		56	89		93	97		73	66
May		70	42		49	72		71	64		54	52
June		59	91		35	87		38	31		50	46
July		43	87		56	66		63	60		44	67
August		55	84		42	56		58	69		61	95
September		64	57		57	91		94	102		63	55
October		60	47		99	87		53	108		54	178
November		50	41		62	85		82	52		100	45
December		49	53		79	61		89	23		69	48
January	1861	88	76	1865	102	63	1869	111	53	1873	64	98
February		80	85		60	108		97	55		111	53
March		68	72		97	54		64	66		90	69
April		70	48		56	85		78	124		63	62
May		53	28		55	72		72	73		52	31
June		61	41		53	54		49	38		47	57
July		51	30		44	67		42	56		47	47
August		33	40		49	97		48	49		36	29
September		65	33		45	62		76	89		61	32
October		69	83		45	110		75	62		77	45
November		63	59		94	54		59	42		86	30
December		63	76		67	14		92	56		87	—

APPENDIX II. *Magnetic Disturbances at Fort Rae in 1882-83.*

At the International Polar Conference in Vienna, in the spring of 1884, the subject of the treatment of magnetic disturbances was much discussed, but among the numerous schemes proposed none was universally accepted, and the matter was left undecided.

I have thought it worth while to make trial, on the observations of declination and horizontal intensity made at Fort Rae in 1882-83, of a method founded on that proposed by Dr. Wild, and the results obtained will not, I hope, be without interest.

From a comparison of lists of magnetically undisturbed days, supplied by most of the circumpolar stations, Dr. Wild selected from four to six days in each month, when the diurnal variation appeared to follow a normal course; and the hourly means obtained from these days are given in the Fort Rae observations. When, however, these values are plotted down they do not afford a very regular curve, because, though these days are free from disturbance as a whole, a good many decidedly disturbed observations are included. The readings for hours of magnetic disturbances were therefore struck out, the question of disturbance being decided by reference to the original observation-book, for, as nine observations were taken at each hour, it was easy to see whether the instruments were steady or not. Rather under 4 per cent. of the readings were so struck out, and from the remainder a fairly satisfactory set of hourly mean values was obtained for each month.

The mean of these values at any hour for any two adjacent months was then assumed to be the normal value at that hour on the middle day of the two months. Thus, for example, the mean horizontal intensity from the selected undisturbed days being, for January, at 11 A.M., $\cdot 07653$; for February, at the same hour, $\cdot 07661$; and for March, $\cdot 07669$; then the normal value for that hour was taken as $\cdot 07657$ on January 30, and $\cdot 07665$ on March 2.

Having thus obtained a set of hourly values at intervals of about a month, the values for the intermediate days were easily interpolated, and in this manner a normal value of declination and horizontal intensity was obtained for every hour of the year.

By subtracting each of these values from the corresponding observed value the 'disturbance' at each hour was obtained, sometimes with a +, sometimes with a - sign. These positive and negative disturbances were then entered in separate sheets, and their means are given in the appended tables (I.—IV.) These means are obtained by dividing the sums of disturbance by the number of observations; not by the number of + or - disturbances.

In order to determine whether the larger and smaller disturbances follow different laws the disturbances were classified according to their magnitude. Table V. shows the number of each class occurring at each hour.

H. P. DAWSON, *Maj. R.A.*

April 20, 1887.

TABLE I.—Hourly Means of Disturbance. Declination in Minutes of Arc.

+ or Easterly Declination.

Local Mean Time	1	2	3	4	5	6	7	8	9	10	11	Noon	1	2	3	4	5	6	7	8	9	10	11	night	Means
September	7	9	8	11	11	9	17	14	10	8	6	5	7	5	5	3	2	2	2	10	6	5	2	5	7
October	5	8	11	11	13	12	12	9	11	5	13	7	5	3	2	1	0	1	1	2	3	2	4	13	7
November	13	11	20	15	27	33	24	36	29	31	27	12	7	8	7	6	7	5	7	7	8	9	10	4	15
December	3	5	5	12	11	12	14	14	13	5	2	1	1	2	1	2	1	1	4	1	4	3	3	3	5
January	4	4	4	5	12	15	11	14	13	7	5	3	1	1	1	0	1	1	0	1	2	2	1	1	5
February	4	3	5	8	19	28	19	28	34	27	15	5	8	4	4	3	2	1	1	3	2	2	6	3	5
March	3	4	7	18	17	20	20	24	23	14	7	3	3	3	2	1	1	1	2	3	2	2	3	5	9
April	3	5	3	6	5	11	17	19	13	11	9	6	7	5	4	2	0	0	1	2	2	4	4	5	8
May	5	3	5	10	9	14	17	19	9	4	3	3	5	3	2	1	1	1	3	2	2	1	4	2	6
June	5	3	6	13	10	13	22	29	22	13	9	11	5	5	3	3	1	1	3	4	3	5	4	4	5
July	3	3	3	5	9	12	21	30	25	22	13	8	5	4	3	1	2	1	1	1	1	2	2	2	7
August	2	4	7	7	5	8	14	16	13	5	5	3	4	4	3	1	1	2	1	1	2	3	3	1	5
Means	4.7	5.2	7.1	10.7	11.9	14.6	17.6	21.0	17.9	12.7	9.7	5.6	4.9	3.9	3.0	1.8	1.5	1.4	2.3	3.1	3.0	3.2	3.8	4.5	7.25

— or Westerly Declination.

September	3	2	4	4	3	2	1	1	0	1	2	2	1	1	1	1	1	1	1	1	1	1	1	1	2
October	7	4	4	2	3	4	2	2	1	2	2	1	3	2	2	2	2	2	4	4	7	5	8	5	11
November	18	13	11	10	11	4	2	1	0	1	1	5	5	2	2	1	3	3	7	8	7	10	12	10	4
December	12	10	4	3	3	3	1	1	2	2	3	2	3	4	4	3	3	3	4	3	3	4	5	5	5
January	5	7	2	1	2	2	3	1	1	1	1	3	4	5	5	5	4	6	6	6	7	8	8	9	3
February	7	7	4	3	2	2	3	2	1	1	2	2	2	2	3	3	4	5	5	5	6	6	10	5	4
March	10	4	3	1	4	4	2	2	1	1	1	1	1	1	1	1	5	8	10	5	9	9	10	12	4
April	9	5	5	4	5	2	2	2	1	2	3	2	2	2	3	4	4	5	5	5	5	5	11	5	4
May	7	6	2	1	1	2	2	1	1	2	3	2	1	1	1	2	4	8	10	3	7	6	10	8	4
June	11	8	5	2	1	2	2	1	1	0	2	2	2	2	3	3	4	5	5	7	6	10	8	4	5
July	7	8	5	3	3	2	2	1	1	1	1	1	3	2	3	5	8	13	8	15	13	11	15	12	6
August	5	2	2	1	4	2	1	0	0	1	2	2	2	2	3	3	6	5	6	3	5	5	5	7	3
Means	8.4	6.1	3.7	2.5	2.3	2.5	2.1	1.3	0.8	1.2	1.7	2.1	2.3	2.2	3.0	3.5	4.7	5.2	5.7	5.7	6.7	7.4	8.2	9.2	4.1
Total mean disturbance irrespective of sign	13.1	11.3	10.8	13.2	14.2	17.1	19.7	22.3	18.7	13.9	11.4	7.7	7.2	C.	6.0	5.3	6.2	6.6	8.0	8.8	9.7	10.6	12.0	13.7	11.35

TABLE II.—Hourly Means of Disturbance. Horizontal Intensity in Absolute Measure, C. G. S.

Local Mean Time	+ or Increased Intensity												Mid-night	Means											
	1	2	3	4	5	6	7	8	9	10	11	Noon													
September	.00019	.014	.011	.014	.007	.015	.017	.026	.028	.023	.025	.016	.029	.031	.030	.044	.036	.032	.023	.023	.014	.013	.015	.022	
October	.00003	.004	.006	.003	.013	.007	.003	.006	.008	.002	.004	.010	.021	.027	.026	.034	.029	.032	.017	.014	.002	.001	.002	.001	.012
November	.00005	.004	.005	.010	.009	.013	.010	.010	.029	.022	.013	.010	.021	.025	.018	.033	.044	.047	.022	.025	.017	.011	.008	.007	.018
December	.00002	.003	.002	.001	.005	.004	.006	.002	.005	.007	.009	.015	.012	.014	.023	.031	.027	.019	.017	.029	.030	.023	.013	.005	.013
January	.00003	.004	.002	.004	.006	.004	.004	.006	.002	.008	.005	.008	.010	.013	.017	.018	.014	.019	.024	.028	.017	.016	.008	.008	.010
February	.00003	.001	.006	.009	.007	.008	.006	.003	.005	.007	.009	.008	.011	.022	.031	.041	.045	.032	.034	.036	.022	.020	.011	.006	.016
March	.00003	.003	.003	.006	.006	.003	.008	.003	.003	.002	.003	.005	.014	.028	.034	.032	.033	.035	.031	.017	.016	.011	.004	.003	.013
April	.00007	.010	.008	.005	.008	.005	.006	.010	.013	.008	.003	.006	.012	.028	.035	.020	.024	.020	.019	.007	.010	.009	.007	.008	.019
May	.00010	.010	.007	.008	.009	.008	.009	.012	.009	.006	.007	.012	.024	.037	.045	.045	.038	.041	.018	.031	.020	.018	.013	.008	.012
June	.00020	.011	.006	.005	.010	.010	.006	.002	.006	.010	.012	.014	.026	.045	.068	.051	.079	.060	.037	.028	.019	.013	.020	.013	.022
July	.00009	.009	.007	.006	.011	.009	.005	.004	.007	.007	.009	.017	.035	.038	.080	.054	.057	.058	.028	.031	.017	.013	.008	.003	.022
August	.00006	.005	.007	.005	.004	.007	.002	.005	.004	.005	.009	.014	.027	.038	.082	.084	.052	.029	.031	.032	.019	.007	.011	.008	.017
Means	.00007	.007	.006	.006	.008	.008	.006	.008	.010	.009	.009	.011	.020	.029	.037	.036	.040	.035	.026	.025	.018	.013	.010	.007	.016
Total mean disturbance irrespective of sign	.00082	.078	.074	.067	.075	.088	.083	.077	.063	.048	.037	.020	.029	.035	.041	.042	.048	.044	.043	.044	.049	.061	.072	.081	.057

Local Mean Time	- or Diminished Intensity.												Mid-night	Means											
	1	2	3	4	5	6	7	8	9	10	11	Noon													
September	.00057	.063	.057	.040	.053	.044	.052	.029	.016	.014	.015	.002	.003	.004	.005	.002	.002	.003	.003	.029	.021	.066	.042	.062	.028
October	.00106	.110	.100	.071	.061	.067	.053	.041	.039	.030	.053	.009	.014	.004	.003	.003	.005	.004	.011	.022	.084	.112	.095	.121	.051
November	.00188	.084	.188	.093	.124	.176	.143	.097	.086	.068	.088	.018	.023	.015	.018	.027	.029	.037	.049	.055	.063	.078	.134	.109	.073
December	.00039	.086	.053	.076	.068	.062	.065	.087	.048	.035	.013	.007	.010	.007	.002	.006	.007	.007	.013	.011	.017	.022	.060	.085	.038
January	.00061	.045	.071	.085	.074	.083	.075	.080	.049	.031	.029	.019	.009	.007	.005	.002	.005	.003	.006	.004	.014	.017	.025	.030	.033
February	.00101	.082	.060	.023	.065	.089	.087	.110	.125	.039	.068	.011	.016	.013	.001	.002	.003	.008	.030	.014	.019	.034	.070	.117	.052
March	.00059	.076	.054	.061	.076	.108	.086	.084	.060	.043	.023	.009	.007	.004	.001	.002	.002	.003	.002	.009	.017	.038	.075	.103	.045
April	.00082	.056	.036	.029	.046	.062	.063	.040	.024	.020	.025	.005	.003	.008	.005	.008	.012	.011	.011	.017	.029	.035	.065	.043	.031
May	.00061	.036	.040	.066	.068	.065	.064	.066	.023	.011	.008	.006	.003	.002	.001	.003	.006	.008	.019	.009	.020	.019	.088	.078	.031
June	.00045	.081	.055	.079	.065	.091	.097	.094	.053	.020	.010	.006	.006	.004	.001	.004	.007	.006	.010	.012	.016	.044	.039	.088	.034
July	.00047	.063	.046	.072	.071	.073	.094	.102	.084	.066	.025	.006	.005	.004	.005	.007	.020	.012	.038	.026	.029	.044	.045	.064	.038
August	.00033	.058	.055	.041	.046	.040	.048	.053	.032	.022	.005	.003	.002	.000	.000	.002	.003	.004	.005	.007	.008	.025	.034	.038	.024
Means	.00075	.071	.068	.061	.067	.080	.077	.069	.053	.039	.028	.009	.009	.006	.004	.006	.008	.009	.017	.019	.030	.048	.062	.074	.041

TABLE III.—Daily Means

	SEPTEMBER			OCTOBER			NOVEMBER			DECEMBER			JANUARY			FEBRUARY		
	E. or +	W. or -	Total	E. or +	W. or -	Total	E. or +	W. or -	Total	E. or +	W. or -	Total	E. or +	W. or -	Total	E. or +	W. or -	Total
1	—	—	—	1	9	10*	7	4	11	4	3	7	3	2	5	15	6	21
2	—	—	—	22	11	33	3	5	8	1	4	5	3	1	4*	23	7	30
3	—	—	—	2	6	8	5	1	6	1	4	5	4	0	4*	18	9	27
4	1	7	8	8	3	11	4	1	5*	9	6	15	2	6	8	9	8	17
5	11	3	14	20	11	31	3	2	5	0	6	6	1	4	5	5	4	9
6	11	5	16	10	5	15	5	1	6	1	3	4*	12	3	15	12	2	14
7	—	—	—	1	2	3	16	2	18	1	3	4	16	5	21	1	2	3*
8	—	—	—	0	5	5	8	1	9	0	5	5*	3	4	7	2	2	4*
9	8	1	9	3	7	10	20	1	21	4	6	10	7	4	11	1	7	8
10	8	1	9	8	6	14	4	0	4*	5	5	10	0	4	4	2	1	3*
11	14	3	17	4	5	9	10	0	10*	4	6	10	3	2	5*	1	2	3*
12	11	5	16	1	4	5	20	8	28	4	4	8	1	2	3	1	1	2*
13	13	1	14	1	4	5	44	4	48	1	4	5	3	2	5*	0	2	2*
14	13	2	15	11	2	13	38	9	47	0	2	2*	1	2	3	8	2	10
15	6	0	6	18	2	20	12	13	25	3	7	10*	8	3	11	2	2	4
16	4	2	6*	4	8	12	2	10	12	6	12	18	3	3	3	5	0	5
17	4	0	4	10	2	12	42	29	71	2	1	3	13	2	15	7	1	8
18	6	1	7	1	4	5	33	4	37	1	6	7	3	3	6	3	2	5
19	4	1	5	2	1	3*	38	8	46	3	2	5	3	3	6	1	2	3
20	3	1	4	0	1	1*	36	9	45	30	5	35	8	8	16	9	1	10
21	3	1	4	1	3	4*	28	11	39	17	2	19	6	2	8	4	5	9
22	4	1	5	10	6	16	5	2	7	7	5	12	4	3	7	23	4	27
23	10	0	10	6	4	10	13	4	17	6	5	11	2	2	4*	12	5	17
24	3	8	11	6	7	13	5	6	11	12	6	18	3	5	8	30	14	44
25	13	1	14	10	3	13	24	3	27	4	3	7	16	3	19	8	4	12
26	5	8	13	3	3	6	13	2	15	3	2	5	12	5	17	7	3	10
27	9	1	10	5	5	10	3	4	7	3	5	8	7	5	12	26	4	30
28	4	0	4	18	2	20	4	4	8	4	4	8	1	5	6	19	4	23
29	6	3	9*	7	1	8	0	3	3*	10	6	16	2	2	4	—	—	—
30	2	4	6*	10	0	10	4	6	10	7	4	11	1	6	7	—	—	—
31	—	—	—	4	1	5*	—	—	—	7	5	12	2	5	7	—	—	—
Mean	7	2	9	7	4	11	15	5	20	5	5	10	5	3	8	9	4	13

September	7	2	9
October	7	4	11
November	15	5	20
December	5	5	10
January	5	3	8
February	9	4	13

N.B.—Days marked (*) are those

of Disturbance. Declination.

MARCH			APRIL			MAY			JUNE			JULY			AUGUST		
E. or +	W. or -	Total	E. or +	W. or -	Total	E. or +	W. or -	Total	E. or +	W. or -	Total	E. or +	W. or -	Total	E. or +	W. or -	Total
23	5	28	2	4	6	4	3	7	6	6	12	15	9	24	13	10	23
23	9	32	4	5	9	10	2	12	16	7	23	1	5	6	4	1	5
11	3	14	19	7	26	3	3	6	8	3	11	9	4	13	4	1	5
5	2	7	11	4	15	4	4	8	7	1	8*	5	5	10	2	1	3*
6	1	7	8	4	12	2	6	8	4	1	5*	9	6	15	8	8	16
2	6	8	3	2	5	3	6	9	14	4	18	2	4	6	15	7	22
6	9	15	1	5	6	1	1	2	5	2	7	9	7	16	6	7	13
7	8	15	7	3	10	4	2	6	8	4	12	6	8	14	6	2	8
6	1	7	4	3	7	2	2	4*	12	2	14	2	5	7	2	0	2*
8	1	9	2	4	6*	1	2	3*	4	6	10	6	3	9	2	6	8*
5	0	5*	2	4	6	3	1	4*	3	3	6*	5	3	8	8	2	10
4	3	7	4	2	6	1	2	3*	5	3	8	6	2	8	4	1	5
9	3	12	3	4	7	4	7	11*	2	3	5	10	1	11	4	2	6
12	1	13	0	2	2*	3	2	5	6	0	6	15	3	18	4	5	9
2	2	4*	3	5	8	4	4	8*	1	3	4*	16	6	24	3	2	5
2	1	3	1	5	6	8	6	14	3	13	16	10	8	18	3	1	4*
1	2	3*	0	3	3*	4	4	8	13	7	20	3	3	6	4	1	5*
2	2	4	4	15	19	3	4	7	10	11	21	12	10	22	17	5	22
1	3	4*	14	19	33	3	2	5	6	6	12	4	7	11	3	1	4
4	5	9*	12	2	14	6	8	14	3	8	11	2	3	5	3	1	4
11	7	18	2	1	3*	23	8	31	2	2	4	0	3	3*	4	1	5
11	10	21	2	1	3*	8	6	14	12	10	22	1	2	3*	4	4	8
4	6	10	1	2	3*	8	1	9	10	5	15	2	8	10*	5	3	8
1	6	7	13	11	24	5	2	7	6	2	8	11	11	22	7	2	9
2	6	8	7	6	13	3	1	4	12	1	13	4	3	7	3	1	4
5	7	12	8	4	12	8	2	10	21	3	24	11	5	16	2	2	4
32	6	38	8	1	9	7	4	11	16	7	23	4	2	6	2	2	4
11	6	17	4	2	6	6	3	9	10	1	11	2	1	3*	2	2	4
15	5	20	8	1	9	8	1	9	7	5	12	1	17	18*	5	5	10
3	5	8	8	2	10	5	7	12	15	8	23	22	12	34	1	2	3
6	5	11	—	—	—	4	4	8	—	—	—	22	15	37	0	4	4*
8	4	12	6	4	10	5	4	9	8	5	13	7	6	13	5	3	8

March	6	4	12
April	6	4	10
May	5	4	9
June	8	5	13
July	7	6	13
August	5	3	8
Mean	7	4	11

selected as undisturbed by Dr. Wild.

TABLE IV.—Daily Means of Disturbance.

	SEPTEMBER			OCTOBER			NOVEMBER			DECEMBER			JANUARY			FEBRUARY		
	+	-	Total	+	-	Total	+	-	Total	+	-	Total	+	-	Total	+	-	Total
1	—	—	—	00006	025	031*	006	036	042	009	021	030	008	038	046	015	068	083
2	—	—	—	034	108	142	028	008	036	009	008	017	003	023	026*	022	159	181
3	—	—	—	006	036	042	011	011	022	014	012	026	001	022	023*	016	067	083
4	—	—	—	006	106	112	011	002	013*	010	066	076	011	017	028	021	059	080
5	00044	034	078	016	136	152	039	002	041	002	021	023	025	003	028	023	034	057
6	026	042	068	011	116	127	019	003	022	007	007	014*	015	048	063	009	060	069
7	039	022	061	003	012	015	015	029	044	004	013	019	016	110	126	007	003	010*
8	093	027	120	006	007	013	020	038	058	004	017	021*	015	039	054	003	015	018*
9	129	008	137	017	034	051	007	088	095	019	027	046	012	026	038	027	003	030
10	010	035	045	009	045	054	004	007	011*	005	012	017	020	002	022	004	010	014*
11	007	044	051	010	041	051	013	059	072*	021	053	074	004	004	008*	004	012	016*
12	023	055	078	003	025	028	021	140	161	008	041	049	005	009	014	002	009	011*
13	018	037	055	002	016	018	018	187	205	004	006	010	003	020	023*	007	005	012*
14	019	041	060	009	076	085	062	140	202	005	004	009*	003	008	011	010	042	052
15	008	030	038	007	098	105	016	048	064	056	010	066*	004	039	043	014	010	024
16	007	017	024*	044	059	103	034	041	075	012	057	069	003	037	040	001	036	037
17	007	010	017	018	034	052	020	349	369	012	009	021	006	075	081	011	040	051
18	008	013	021	003	020	023	015	126	141	008	038	046	009	039	048	012	011	023
19	015	003	018	000	016	016*	004	365	369	007	031	038	001	029	030	004	002	006
20	027	009	036	001	007	008*	057	212	269	015	197	212	014	074	088	011	081	092
21	007	004	011	003	017	020*	004	085	089	013	085	098	003	046	049	026	017	043
22	009	009	018	025	049	074	000	012	012	008	061	069	004	032	036	029	129	158
23	006	042	048	002	092	094	001	105	106	004	050	054	002	033	035*	021	053	074
24	018	021	039*	007	069	076	023	041	064	004	097	101	015	014	029	019	170	189
25	019	052	071	017	054	071	033	111	144	001	039	040	013	073	086	014	077	091
26	013	061	074	012	032	044	011	055	066	018	016	034	028	060	088	022	034	056
27	021	032	053	017	051	068	006	038	044	019	002	021	040	040	080	051	120	171
28	003	017	020	022	068	090	014	032	046	032	036	068	015	009	024	026	127	153
29	006	047	053*	022	063	085	003	015	018*	025	062	087	002	021	023	—	—	—
30	004	021	025*	006	035	041	014	016	030	017	031	048	010	016	026	—	—	—
31	—	—	—	012	022	034	—	—	—	019	034	053	008	020	028	—	—	—
Mean	022	028	050	012	051	063	018	073	091	013	038	051	010	033	043	016	052	068

September 00022 00028 00050
October 012 051 063
November 018 073 091
December 013 038 051
January 010 033 043
February 016 052 068
March 013 045 058

N.B.—Days marked (*) are:

Horizontal Intensity. C. G. S. Units.

MARCH			APRIL			MAY			JUNE			JULY			AUGUST		
+	-	Total	+	-	Total	+	-	Total	+	-	Total	+	-	Total	+	-	Total
019	119	138	005	014	019	035	038	073	036	038	074	022	093	115	037	086	123
019	108	127	009	048	057	027	041	068	034	079	113	010	024	034	018	016	034
016	041	057	027	046	073	028	027	055	007	030	037	031	047	078	015	026	041
016	033	049	008	065	073	019	020	039	007	019	026*	019	022	041	004	009	013*
013	019	032	016	049	065	015	020	035	009	007	016*	055	053	108	015	045	060
023	032	055	002	027	029	010	033	043	047	088	135	020	007	027	040	071	111
013	047	060	011	005	016	010	004	014	034	006	040	010	036	046	026	035	061
029	050	079	005	040	045	018	021	039	021	040	061	022	024	044	010	020	030
015	028	043	004	022	026	010	010	020*	015	049	064	019	010	029	003	010	013*
009	031	040	021	013	034*	012	005	017*	022	017	039	034	028	062	024	018	042*
001	024	025*	006	027	033	017	027	044*	012	012	024*	039	043	082	018	026	044
010	055	065	002	030	032	006	009	015*	011	026	037	004	034	038	005	018	023
008	037	045	009	031	040	033	014	047*	026	024	050	014	051	065	008	018	026
007	052	059	006	007	013*	009	009	018	008	019	027	003	071	074	050	018	068
004	018	022*	019	023	042	010	021	031*	012	009	021*	028	084	112	017	003	020
006	011	017	007	019	026	018	024	042	033	006	039	030	054	084	011	000	011*
005	009	014*	004	009	013*	045	011	056	031	032	113	012	010	022	011	006	016*
004	020	024	030	050	080	008	021	029	037	065	102	023	095	118	053	061	114
004	004	008*	017	108	125	011	051	062	024	041	065	045	025	070	012	012	024
009	013	022*	010	043	053	021	065	086	043	024	067	001	027	028	013	011	024
018	067	085	006	006	012*	045	133	178	010	011	021	002	017	019*	022	009	031
014	084	098	002	009	011*	032	055	087	015	047	062	008	014	022*	026	025	051
014	039	053	005	005	010*	009	023	032	040	034	074	011	021	032*	018	041	059
010	010	020	020	032	052	012	042	054	017	009	026	039	042	081	011	060	071
001	034	035	021	061	082	016	016	032	020	034	054	014	027	041	004	014	018
025	035	060	040	037	077	012	036	048	007	075	082	030	063	093	006	013	019
019	166	185	019	047	066	035	028	063	051	102	153	008	023	031	005	006	011
016	054	070	011	010	021	007	058	065	009	027	036	014	010	024*	011	014	025
025	067	092	012	024	036	006	031	037	025	016	041	021	049	070*	022	029	051
010	030	040	015	032	047	019	032	051	037	104	141	061	116	177	009	003	012
013	052	065	—	—	—	017	019	036	—	—	—	020	141	161	009	006	015*
013	045	058	012	031	043	019	031	050	023	038	061	022	044	066	017	024	041

April	00012	00031	00043
May	019	031	050
June	023	038	061
July	022	044	066
August	017	024	041

Mean 00016 00041 00057

selected as undisturbed by Dr. Wild.

TABLE V.—Total number of Disturbances observed at each hour—Local Mean Time—and their Approximate Magnitudes; also number of comparatively undisturbed observations during the year.

		(A.) Declination.												Mid- night		Sums											
		1	2	3	4	5	6	7	8	9	10	11	12	11	12	11	12										
D _r or D _l Disturbances of the Sun at each hour of the year	> 60'	5	3	6	9	12	19	23	38	24	17	11	4	6	2	2	0	1	1	0	2	3	3	4	5	4	198
	From 31' to 60'	8	10	16	24	19	31	54	44	46	22	15	9	6	2	2	1	4	1	3	3	4	4	4	9	343	
	From 21' to 30'	6	11	13	23	32	33	26	39	30	19	19	10	3	9	3	3	3	3	3	4	3	9	4	3	310	
	From 11' to 20'	22	23	32	54	65	60	60	47	43	42	34	32	28	22	18	7	3	2	6	17	13	15	9	23	677	
	From 6' to 10'	26	29	39	50	51	41	40	33	40	50	55	37	43	38	22	14	26	24	28	21	22	21	21	15	23	788
+	From 4' and 5'	24	24	30	31	18	14	15	14	19	32	19	34	27	38	21	26	21	21	20	19	22	22	16	22	574	
From + 3' to - 3'		108	133	135	110	90	70	61	93	121	131	134	153	189	177	162	177	159	166	154	140	141	122	112	122	3163	
D _r or D _l Disturbances of the Moon at each hour of the year	4' and 5'	24	23	27	22	16	21	25	24	21	23	28	21	33	22	33	34	49	28	37	31	28	37	29	37	667	
	From 6' to 10'	44	37	30	21	34	49	35	24	14	20	35	42	39	33	45	63	54	55	46	45	48	35	39	50	936	
	From 11' to 20'	56	38	16	7	16	16	19	3	2	3	9	15	18	14	23	24	37	40	39	34	34	50	61	61	615	
	From 21' to 30'	11	11	10	3	4	3	2	0	0	1	0	0	2	0	6	10	10	14	7	11	15	19	16	22	174	
	From 31' to 60'	20	15	4	5	3	2	0	1	0	0	1	1	1	2	0	3	3	3	9	8	11	20	27	23	159	
+	> 60'	6	3	2	1	0	1	0	0	0	0	0	0	0	0	0	0	0	2	4	4	4	3	3	3	36	
From + 0002 to - 0002		136	142	151	141	106	112	103	133	164	192	222	235	199	184	181	185	165	161	164	166	164	142	127	142	3840	
D _r or D _l Disturbances of the Planets at each hour of the year	> 00383 or 005X	0	0	0	0	0	0	0	0	0	1	0	0	0	0	1	0	0	1	0	0	0	0	0	0	0	5
	From 00383 to 00192	0	0	0	1	1	2	1	1	1	2	1	0	1	2	7	13	14	5	1	2	0	0	0	0	0	54
	From 00191 to 00077	1	1	4	5	2	5	2	4	2	3	3	3	4	19	37	49	44	52	48	34	39	18	12	7	3	398
	From 00076 to 00039	17	11	9	6	16	10	7	13	10	8	12	21	46	53	57	53	48	62	61	46	41	42	21	10	680	
	From 00038 to 00020	34	32	20	25	37	29	39	25	31	23	31	59	49	54	50	38	51	52	52	43	39	28	36	34	911	
From + 0002 to - 0002		136	142	151	141	106	112	103	133	164	192	222	235	199	184	181	185	165	161	164	166	164	142	127	142	3840	
D _r or D _l Disturbances of the Fixed Stars at each hour of the year	From 00020 to 00038	28	30	38	42	37	31	35	36	40	42	36	18	30	21	11	18	17	19	20	30	29	21	28	33	690	
	From 00039 to 00076	38	44	47	45	64	59	51	44	34	37	20	19	11	5	2	6	5	7	11	15	27	29	40	45	702	
	From 00077 to 00191	63	60	56	68	58	67	79	62	48	35	25	3	4	4	3	2	7	4	7	13	24	40	48	67	857	
	From 00192 to 00353	33	28	24	23	30	34	37	31	22	15	5	2	1	1	0	2	1	0	1	4	11	18	26	26	375	
	> 00383	11	13	12	6	9	13	8	12	7	3	6	0	1	0	0	0	1	1	4	4	4	7	13	16	152	

(B.) Horizontal Intensity.

Fourth Report of the Committee, consisting of Professor G. FORBES (Secretary), Captain ABNEY, Dr. J. HOPKINSON, Professor W. G. ADAMS, Professor G. C. FOSTER, Lord RAYLEIGH, Mr. PREECE, Professor SCHUSTER, Professor DEWAR, Mr. A. VERNON HARCOURT, Mr. H. TRUEMAN WOOD, Sir JAMES DOUGLASS, Professor H. B. DIXON, and Mr. DIBDIN, appointed for the purpose of reporting on Standards of Light.

THE Committee, which has now been in existence for four years, has at length arrived at certain definite conclusions as to the value of the different standards of light at present available. These conclusions have been arrived at mainly as the result of a large number of experiments undertaken by various members of the Committee.

The experiments of the past year are added to this report in the form of two appendices. The first contains an extensive series of experiments which have been tabulated, showing the relative constancy of the following proposed standards:—

1. Ordinary candles made by Messrs. Miller.
2. Ordinary candles made by Messrs. Brecknell and Turner.
3. Sperm candles, of six to the pound, of larger diameter, made by Messrs. Miller.
4. The Pentane Standard.
5. The Pentane Lamp.
6. The Amyl-acetate Lamp.

The other appendix relates to some experiments carried on with a view to making platinum heated to its melting-point a practical standard.

The Committee wishes to state that the result of all its experiments has been to confirm the conclusions arrived at by Mr. Dibdin in his report to the Metropolitan Board of Works in 1887.

Your Committee, in making its final report, is anxious to draw attention to a number of conclusions which will now be treated in order:—

(1) The present standard candle, as defined by Act of Parliament, is not worthy, in the present state of science, of being called a standard, and does not meet the practical requirements of those whose duty it is to test illuminants. The objections to the candle as a standard are so numerous, and most of them are so well understood, that space need not be taken up now in repeating them. It will suffice to say that the spermaceti employed is not a definite chemical substance and is mixed with other materials, and the constitution of the wick is not sufficiently well-defined, so that so-called standard candles, conforming to the definitions of the Act of Parliament, can be made which vary largely in illuminating power. The Committee wishes to add the important observation, which has been incontestably proved by the independent observations of different members of the Committee, that the illuminating power of a candle in a closed photometer, or in any small, ill-ventilated room, is considerably less than in an ordinary room.

That which forces itself upon the attention of any one who attempts to determine the value of any source of light by comparison with standard candles is the fluctuation from minute to minute, which is due to the varying length and form of the wick and the filling and emptying of the

cup of the candle according to the movement of the surrounding air. But these variations are to some extent neutralised by taking the average of many testings. A source of error, which is at once less easily recognised and more grave in its practical result, is the change in the average value of the standard candle, which is due to the improvements made from time to time in the manufacture of spermaceti. The manufacturer aims at separating as perfectly as possible the solid parts of his crude material, which constitute spermaceti, from the liquid parts which form sperm oil. To obtain as much oil and as 'dry' a spermaceti as possible is the object sought, and we are informed by one of the principal manufacturers of sperm candles that within the last ten years considerable improvements have been made in the process by which the separation is effected. As a consequence of the use in the making of standard candles of a drier sperm, it has been found necessary to provide them with thicker wicks, in order that the required rate of consumption may be maintained. Probably the drier sperm has a higher melting-point and furnishes a less limpid liquid. A thicker wick means less light for a given consumption; and thus the result of the improvements in spermaceti has been that standard candles give less light than they gave ten years ago, and probably still less light than they gave at an earlier date, when the average consumption of a sperm candle of six to the pound was 140 grs. per hour.

(2) Professor Violle's standard of molten platinum is, in the opinion of the Committee, not a practical standard of light. On this point your Committee is anxious to have it understood that it is quite prepared to agree to the adoption of the light emitted by a square centimetre of molten platinum as a unit of light, but not as a standard of light. Hence, in its recommendation, it is not challenging the conclusions arrived at by the International Congress of Electricians. The experiments detailed in the second appendix to this report confirm the Committee in its belief that there is no means at present known by which molten platinum can be used practically as a standard. In fact, a comparison of Violle's unit with any standard could be made only with great labour and but rarely. Violle's unit not having been universally adopted, your Committee would not propose to change the name of the unit hitherto in use, but would call it a standard candle, giving it that value which appears to have been intended by the Legislature, and was used in the adjustment of the Pentane standard.

(3) There seems unfortunately no prospect of any reliable electric standard of light being constructed. In the report of 1885 your Committee delayed making a definite recommendation until further information should be gained by experiment about the laws of radiation from carbon heated by an electric current. The information gained since then has led it to believe that but little help is to be gained from this quarter. Some of the reasons are given in the report of 1886; others are the variation in light by the blackening of the glass bulbs in which the carbons are enclosed, and by the wasting of the carbon filaments. Also the amount of radiation from carbon depends upon its surface and upon the treatment to which it has been subjected.

(4) The Amyl-acetate standard is very constant, but its red colour is a serious objection to its use. This conclusion has been arrived at as the result of a very large number of experiments in the hands of the Committee. The following experiments by the Committee show this well:—

The Amyl-acetate lamp was compared with the Standard Pentane flame by placing the two equidistant from the screen. The flame of the Amyl-acetate lamp was set at a height of 45 mm., and an observer watching the two halves of the screen turned up and down the Pentane flame until he judged the screen to be equally illuminated by the two lights. The Amyl-acetate lamp gave a distinctly redder light than the Pentane flame. In comparing the two lights four observers obtained results which were appreciably different, each result being constantly obtained in successive readings by the same observer. Two observers made the light from the Amyl-acetate flame exactly equal to the normal Pentane flame of $63\frac{1}{2}$ mm.; a third observer made the Amyl-acetate flame equal to a Pentane flame of 63 mm.; and a fourth made it equal to a Pentane flame of $62\frac{1}{2}$ mm.

On raising the Amyl-acetate flame to 50 mm. the same differences in the estimation of the two coloured flames were found, but the change in height of 5 mm. in the Amyl-acetate flame was compensated by a change in height of 2 mm. in the Pentane flame.

(5) The Pentane standard of Mr. Vernon Harcourt is reliable and convenient, and fulfils all the conditions required in the adoption of a standard of light. This standard attains this end by its having no wick and consuming a material of definite chemical composition. The experiments of your Committee also show that the light was not altered when the specific gravity of the pentane was '632 or '628, instead of the specified value of '630.

(6) Your Committee is not of opinion that the Pentane standard is the only one which can be made possessing the necessary qualifications, but it is the only one which has come under its notice, and it wishes most earnestly to urge the importance of undertaking such action as is possible to ensure the immediate rejection by the Board of Trade of the Parliamentary candle as a standard, and the adoption in all future work of the Pentane standard.

(7) Your Committee wishes further to draw attention to the following :

APPENDIX I.

Photometric comparison of Candles, the Pentane Standard, the New Pentane Lamp, and the Amyl-acetate Lamp.

By the courtesy of Mr. Dibdin and the Metropolitan Board of Works the testing-room at Spring Gardens was placed at the disposal of the Committee for conducting experiments. The photometer employed was a four-way one designed by Mr. Dibdin, the standard source of light in the centre being a portion of the flame of an argand burning coal gas enriched by passing over pentane. This central flame was kept at a height of about 3 inches, and only light from the middle of the flame was allowed to fall on the photometer discs. In a preliminary series of experiments made in January 1888 it was found that the light proceeding from the central burner along each of the four photometer bars was equal. The fittings and measurements of all parts of the photometer were also carefully verified by the Committee.

It was decided that the actual tests should be performed by two of the official gas-testers in the service of the Metropolitan Board. Messrs. G. W. Wood and R. Grimwood were selected by Mr. Dibdin to carry out the work, which they performed in a most careful and satisfactory manner.

Mr. Livingston kindly undertook to chronicle and keep the records of the experiments made, and also assist in the testings, and to him the Committee is beholden for the very considerable trouble he took on its behalf.

The experiments were conducted as follows:—The central flame being adjusted, one observer made a determination of its illuminating power by candles in the first arm and by the Pentane lamp in the second arm, making the readings alternately. At the same time the second observer made a determination of the illuminating power of the central burner by the Amyl-acetate lamp in the third arm and by the Pentane standard in the fourth arm, also making the readings alternately. The observers changed positions after each set of observations. The candle readings were corrected in the usual way for sperm consumed. On all the four bars the standards were kept fixed in position and the readings were made by moving the discs. The candles employed were those now manufactured by Mr. Miller and by Messrs. Brecknell and Turner for gas-testing, but tests were made also of other candles, of the same composition as the gas-testing candles, but larger in diameter, which were made by Mr. Miller. The Pentane lamp was of the new form manufactured by Messrs. Woodhouse and Rawson.

It was found that the central burner was nearly but not exactly constant in illuminating power from day to day, but during the hour and a half or two hours the tests lasted each day the light did not vary appreciably, according to the most uniform standards. In order to show the uniformity of the standards under trial, the average of the day's tests with each standard is taken and the individual tests compared with this mean. The divergencies of each standard from the mean of several tests *by the same standard* are evidence of the want of uniformity of that standard.

In the following table the corrected result of each test is given; 118 complete tests by each of the four standards were taken. By the side of each result is a number (obtained by dividing that result by the average of the day's tests and multiplying by 100) which expresses the ratio of that result to the average of the day by the same standard, the day's average being called 100. A glance at the table shows the uniformity or want of uniformity of the standards. Out of the 118 complete candle tests 86 differed by 1 per cent. from the day's average, 57 differed by 2 per cent., and 19 by 5 per cent. Variations of 9 and 10 per cent. occurred occasionally. Of the other standards the Amyl-acetate lamp showed a variation of 2 per cent. from the day's average on four occasions out of the 118 tests, and a variation of 1 per cent. on 11 occasions. The Pentane lamp twice only showed a variation of 1 per cent., the Pentane standard once only.

In the second table the averages of each day are tabulated and the general average of each standard is given. The Pentane standard and the Pentane lamp gave practically the same light; and the light was not altered when pentane of specific gravity .632 and of specific gravity .628 was employed, instead of pentane of specific gravity .630. The Amyl-acetate lamp was set too high, but although this was discovered soon after the experiments were begun it was thought better to maintain the flame at the same height than to alter it during the tests. The three lamps tested gave uniform results. The broader candles made by Mr. Miller gave less light than those ordinarily used for gas-testing, and they did not appear to burn more uniformly in this photometer.

TABLE I.

Tests of Central Burner made by four Standards in Four-way Photometer.

Date	Time	Candles	Pentane Standard	Pentane Lamp	Amyl-acetate Lamp	
					LAMP A— Per cent.	LAMP B— Per cent.
1888 April 16	P.M. 5. 0 5.30	MILLER'S— Per cent. 11-91 100-2 11-86 99-8	— — — —	Per cent. 12-27 101-6 11-89 98-4	12-19 100-4 12-09 99-6	12-08 100-4 11-98 99-6
		Mean 11-885 100-0	— —	12-08 100-0	12-14 100-0	12-03 100-0
April 17	4.50 5.10 5.40	MILLER'S NEW— 13-15 101-1 12-73 97-9 13-13 101-0	Per cent. 12-10 99-7 12-13 99-9 12-20 100-5	12-11 99-4 12-21 100-2 12-23 100-4	LAMP B— 12-11 101-0 12-00 100-0 11-88 99-1	Per cent. 12-08 100-4 100-0 99-1
		Mean 13-00 100-0	12-14 100-0	12-18 100-0	11-99 100-0	100-0
		MILLER'S NEW— 12-56 98-7 12-58 98-8 13-04 102-5	12-26 100-8 12-16 100-0 12-05 99-1	12-19 100-8 12-08 99-8 12-03 99-6	LAMP B— 11-59 100-5 11-71 101-6 11-28 97-8	100-5 101-6 97-8
April 18	5.30 5.45 6. 0	Mean 12-73 100-0	12-16 100-0	12-10 100-0	11-53 100-0	100-0
		MILLER'S NEW— 13-73 98-2 13-83 98-9 13-38 95-7 14-50 103-7 14-47 103-5	12-86 100-1 12-85 100-0 12-77 99-4 12-86 100-1 12-89 100-3	12-64 100-2 12-58 99-8 12-59 99-8 12-65 100-3 12-61 100-0	LAMP B— 12-44 102-7 11-91 98-4 11-82 97-6 12-15 100-3 12-24 101-1	102-7 98-4 97-6 100-3 101-1
April 23	5. 0 5.20 5.40 6. 0 6.20	Mean 13-98 100-0	12-85 100-0	12-61 100-0	12-11 100-0	100-0
		MILLER'S NEW— 12-10 91-4 13-36 100-9 13-28 100-3 13-43 101-4 13-54 102-3 13-74 103-8	12-32 99-4 12-35 99-8 12-48 100-9 12-33 99-7 12-34 99-8 12-40 100-2	12-40 99-9 12-42 100-0 12-38 99-8 12-44 100-2 12-36 99-6 12-48 100-6	LAMP A— 11-46 97-6 11-87 101-1 11-87 101-1 11-72 99-8 11-73 100-0 11-78 100-3	97-6 101-1 101-1 99-8 100-0 100-3
April 24	4.45 5. 0 5.20 5.40 5.55 6.15	Mean 13-14 100-0	12-37 100-0	12-41 100-0	11-74 100-0	100-0
		MILLER'S NEW— 13-14 98-2 12-49 93-4 14-60 109-1 14-18 106-0 13-57 101-4 12-34 92-2	12-33 99-8 12-35 100-0 12-36 100-1 12-36 100-1 12-35 100-0 12-35 100-0	12-38 99-6 12-41 99-8 12-55 100-9 12-44 100-1 12-40 99-8 12-44 100-0	LAMP A— 11-89 100-4 11-80 99-7 11-86 100-2 11-86 100-1 11-81 99-8 11-83 99-9	100-4 99-7 100-2 100-1 99-8 99-9
April 25	5.15 5.35 6. 0 6.20 6.35 6.50	Mean 13-38 100-0	12-35 100-0	12-43 100-0	11-84 100-0	100-0
		MILLER'S— 13-68 102-8 12-79 96-2 13-37 100-6 13-24 99-5 13-26 99-7 13-49 101-4	12-35 100-2 12-34 100-0 12-35 100-2 12-31 99-8 12-31 99-8 12-34 100-0	12-35 99-7 12-45 100-5 12-37 99-8 12-38 100-0 12-37 99-8 12-41 100-2	LAMP A 11-87 100-2 11-77 99-4 11-86 100-2 11-86 100-1 11-90 100-5 11-80 99-7	100-2 99-4 100-2 100-1 100-5 99-7
April 26	5.20 5.40 6. 0 6.15 6.30 6.45	Mean 13-30 100-0	12-33 100-0	12-39 100-0	11-84 100-0	100-0
		BRECKNELL'S— 13-38 100-8 13-30 100-2 13-57 102-2 12-87 96-9	12-34 99-8 12-35 99-9 12-36 100-0 12-38 100-2	12-37 100-1 12-37 100-0 12-36 100-0 12-35 99-9	LAMP B— 11-78 99-9 11-77 99-8 11-83 100-3 11-81 100-2	99-9 99-8 100-3 100-2
April 27	4.45 5. 0 5.15 5.50	Mean 13-28 100-0	12-36 100-0	12-36 100-0	11-79 100-0	100-0

TABLE I.—continued.

Date	Time	Candles	Pentane Standard	Pentane Lamp	Amyl-acetate Lamp
1888 April 30	P.M. 4.50 5. 5 5.20 5.45 6. 0	MILLER'S NEW— Per cent.	Per cent.	Per cent.	LAMP B— Per cent.
		13.14 94.1	12.37 100.0	12.43 99.8	11.93 100.5
		15.05 107.7	12.38 100.1	12.45 99.9	11.91 100.3
		13.77 98.6	12.35 99.8	12.46 100.0	11.84 99.8
		13.98 100.1	12.42 100.4	12.46 100.0	11.82 99.6
		13.95 99.8	12.36 99.9	12.51 100.4	11.84 99.8
	Mean	13.97 100.0	12.37 100.0	12.46 100.0	11.87 100.0
May 1	5. 0 5.20 5.40 6. 0 6.20	BRECKNELL'S—			LAMP C—
		14.48 107.5	12.35 100.1	12.35 100.2	11.71 100.6
		13.19 97.9	12.38 100.4	12.36 100.3	11.69 100.4
		13.84 102.7	12.36 100.2	12.30 99.8	11.71 100.6
		13.61 101.0	12.30 99.8	12.31 99.9	11.50 98.8
		12.22 90.7	12.29 99.7	12.28 99.7	11.57 99.4
	Mean	13.47 100.0	12.33 100.0	12.32 100.0	11.64 100.0
May 2	4.30 4.50 5.10 5.30	MILLER'S—	Special Pentane, Sp. Gr. .632	Special Pentane, Sp. Gr. .632	LAMP C—
		13.78 101.0	12.28 99.8	12.38 100.1	11.89 100.5
		13.86 101.6	12.28 99.8	12.38 100.1	11.83 100.0
		13.67 100.2	12.28 99.8	12.37 100.0	11.72 99.1
		13.29 97.4	12.38 100.6	12.34 99.8	11.87 100.3
			Mean	13.65 100.0	12.30 100.0
May 4	4.30 4.50 5.10 5.30 5.50	MILLER'S NEW—			LAMP C—
		12.63 93.7	12.34 99.9	12.35 99.8	11.74 99.8
		13.23 98.2	12.33 100.0	12.35 99.9	11.85 100.7
		14.26 105.4	12.35 100.2	12.42 100.4	11.71 99.5
		13.77 101.8	12.29 99.7	12.37 100.0	11.82 100.4
		13.65 100.9	12.35 100.2	12.35 99.9	11.73 99.7
	Mean	13.53 100.0	12.33 100.0	12.37 100.0	11.77 100.0
May 8	5.30 5.50 6.10 6.30	MILLER'S—			LAMP A—
		12.84 99.0	12.35 100.0	12.35 100.0	11.98 100.2
		12.70 97.9	12.35 100.0	12.34 99.9	11.95 100.0
		13.25 102.2	12.34 99.8	12.35 100.0	11.93 99.8
		13.08 100.9	12.37 100.2	12.36 100.1	11.94 99.9
			Mean	12.97 100.0	12.35 100.0
May 10	5.10 5.30 5.50 6.10 6.30	BRECKNELL'S—			LAMP C—
		13.06 98.2	12.34 100.1	12.35 100.0	11.90 99.3
		13.57 102.0	12.33 100.1	12.37 100.1	12.03 100.4
		13.26 99.7	12.25 99.4	12.34 99.9	12.08 100.8
		13.69 102.9	12.34 100.2	12.37 100.2	11.95 99.8
		12.92 97.1	12.35 100.2	12.35 100.0	11.95 99.8
	Mean	13.30 100.0	12.32 100.0	12.35 100.0	11.93 100.0
May 11	4.45 5.10 5.30 5.50	MILLER'S NEW—			LAMP C—
		12.83 93.4	12.37 99.9	12.31 99.0	12.06 100.6
		14.09 102.6	12.35 99.8	12.48 100.4	11.95 99.7
		13.99 101.9	12.44 100.5	12.42 99.9	11.97 99.8
		14.03 102.2	12.37 99.9	12.52 100.7	11.99 100.0
			Mean	13.73 100.0	12.38 100.0
May 14	5. 0 5.20 5.40 6. 0	MILLER'S—	Sp. Gr. .628		LAMP B—
		12.76 94.2	12.27 100.5	12.31 89.8	11.78 99.6
		13.87 102.4	12.27 100.5	12.36 100.2	11.76 99.4
		13.65 100.8	12.16 99.6	12.34 100.0	11.87 100.3
		13.90 102.6	12.14 99.4	12.34 100.0	11.91 100.6
				13.55 100.0	12.21 100.0

TABLE I.—*continued.*

Date	Time	Candles	Pentane Standard	Pentane Lamp	Amyl-acetate Lamp					
1888 May 15	P.M. 5·0 5·20 5·40 6·0 6·20 6·40	MILLER'S 7"— Per cent.		Per cent.		LAMP B— Per cent.				
		14·54	103·9	12·20	99·3	12·33	99·9	11·74	99·5	
		14·21	101·5	12·32	100·2	12·30	99·7	11·74	99·5	
		13·96	99·7	12·22	99·4	12·36	100·2	11·85	100·4	
		14·04	100·3	12·34	100·4	12·32	99·8	11·75	99·6	
		14·07	100·5	12·35	100·5	12·38	100·3	11·90	100·8	
		13·19	94·2	12·33	100·3	12·37	100·2	11·80	100·0	
		Mean	14·00	100·0	12·29	100·0	12·34	100·0	11·80	100·0
		May 17	5·30 5·50 6·10 6·30	BRECKNELL'S—				LAMP B—		
				12·88	96·3	12·32	99·8	12·43	99·6	12·00
13·33	99·6			12·34	100·0	12·62	100·3	12·09	100·2	
13·82	103·3			12·36	100·1	12·51	100·2	12·11	100·4	
13·44	100·4			12·36	100·2	12·48	100·0	12·03	99·8	
Mean	13·38			100·0	12·34	100·0	12·48	100·0	12·06	100·0
May 18	4·15 4·35 4·55 5·15	MILLER'S—				LAMP A—				
		14·00	100·3	12·47	100·6	12·56	100·0	11·67	99·6	
		13·59	97·3	12·37	99·8	12·59	100·2	11·76	100·3	
		14·14	101·3	12·42	100·2	12·57	100·1	11·74	100·2	
		14·12	101·1	12·34	99·5	12·53	99·8	11·72	100·0	
		Mean	13·96	100·0	12·40	100·0	12·56	100·0	11·72	100·0
May 25	4·50 5·10 5·30 5·50	MILLER'S—				LAMP B—				
		12·94	93·4	12·34	99·8	12·43	99·6	11·70	99·6	
		14·47	104·5	12·36	100·0	12·52	100·3	11·80	100·4	
		13·90	100·4	12·36	100·0	12·54	100·5	11·75	100·0	
		14·10	101·8	12·38	100·2	12·42	99·5	11·74	99·9	
		Mean	13·85	100·0	12·36	100·0	12·43	100·0	11·75	100·0
May 28	4·15 4·35 5·0 5·30	MILLER'S NEW 7"—				LAMP A—				
		14·21	103·7	12·32	99·0	12·56	100·1	11·82	99·9	
		14·00	102·2	12·46	100·1	12·46	99·3	11·83	100·0	
		13·08	95·5	12·53	100·6	12·58	100·2	11·83	100·0	
		13·53	98·8	12·47	100·2	12·59	100·3	11·84	101·1	
		Mean	13·70	100·0	12·45	100·0	12·55	100·0	11·83	100·0
May 29	4·45 5·5 5·25 5·45 6·10 6·30	BRECKNELL'S—		[Special Pentane, Sp. Gr. '629]		LAMP B—				
		13·29	99·4	12·46	100·1	12·60	99·8	11·79	99·6	
		13·20	98·7	12·43	99·8	12·65	100·3	11·87	100·2	
		13·59	101·6	12·46	100·1	12·68	100·5	11·84	100·0	
		13·11	98·0	12·45	100·0	12·57	99·6	11·84	100·0	
		13·68	102·3	12·45	100·0	12·62	100·0	11·86	100·2	
13·37	100·0	12·45	100·0	12·60	99·8	11·84	100·0			
May 30	5·50 6·10 6·30 7·0 7·20	MILLER'S—				LAMP A—				
		13·92	99·8	12·50	99·7	12·56	99·7	12·03	100·4	
		13·82	99·1	12·53	99·9	12·63	100·3	11·96	99·8	
		13·85	99·3	12·52	99·8	12·58	99·9	11·99	100·1	
		13·95	100·1	12·56	100·2	12·60	100·1	11·96	99·8	
		14·17	101·6	12·59	100·4	12·59	100·0	11·98	100·0	
Mean	13·94	100·0	12·54	100·0	12·59	100·0	11·98	100·0		
May 31	5·50 6·10 6·30 7·0 7·20	MILLER'S NEW 6"—				LAMP B—				
		12·60	89·2	12·56	100·0	12·65	99·9	11·89	99·5	
		13·46	95·2	12·52	99·7	12·64	99·8	11·93	99·8	
		14·35	101·5	12·57	100·1	12·68	100·2	11·98	100·2	
		15·30	108·2	12·58	100·2	12·65	99·9	12·01	100·5	
		14·99	106·0	12·56	100·0	12·68	100·2	11·96	100·1	
Mean	14·14	100·0	12·56	100·0	12·66	100·0	11·95	100·0		

TABLE I.—*continued.*

Date	Time	Candles	Pentane Standard	Pentane Lamp	Amyl-acetate Lamp
1888 June 4	P.M. 4.20 4.40 5. 0 5.30	MILLER'S—			LAMP A—
		Per cent.	Per cent.	Per cent.	Per cent.
		13.48 100.0	12.57 99.8	12.67 100.2	11.97 100.0
		13.56 100.5	12.56 99.8	12.63 99.8	11.96 99.9
		13.09 97.1	12.63 100.2	12.64 99.9	11.95 99.8
		13.81 102.4	12.63 100.2	12.67 100.2	11.99 100.2
		Mean 13.48 100.0	12.60 100.0	12.65 100.0	11.97 100.0
June 6	5. 0 5.20 5.40 6.30 6.50	MILLER'S NEW 6"—			LAMP C—
		13.77 99.2	12.58 99.8	12.69 100.1	11.93 99.7
		13.51 97.3	12.57 99.7	12.67 99.9	11.97 100.1
		13.42 96.7	12.59 99.8	12.68 100.0	11.95 99.9
		14.09 101.5	12.66 100.4	12.68 100.0	12.00 100.3
		14.61 105.3	12.63 100.2	12.67 99.9	11.96 100.0
		Mean 13.88 100.0	12.61 100.0	12.68 100.0	11.96 100.0

NOTE.—The testings were taken alternately by Messrs. Wood and Grimwood.

TABLE II.

Date	Miller and Brecknell's Candles	Miller's New Candles	Pentane Standard	Pentane Lamp	Amyl-acetate Lamp		
					A	B	C
1888 April 16	11.88 M	—	—	12.08	12.14	12.03	—
" 17	—	13.00	12.14	12.18	—	11.99	—
" 18	—	12.73	12.16	12.10	—	11.53	—
" 23	—	13.98	12.85	12.61	—	12.11	—
" 24	—	13.40	12.37	12.41	11.74	—	—
" 25	—	13.38	12.35	12.43	11.85	—	—
" 26	13.30 M	—	12.33	12.38	11.84	—	—
" 27	13.28 B	—	12.36	12.36	—	11.79	—
" 30	—	13.97	12.37	12.46	—	11.87	—
May 1	13.47 B	—	12.33	12.32	—	—	11.64
" 2	13.65 M	—	12.30 [632]	12.37	—	—	11.83
" 4	—	13.53	12.33	12.37	—	—	11.77
" 8	12.97 M	—	12.35	12.35	11.95	—	—
" 10	13.30 B	—	12.32	12.35	—	—	11.98
" 11	—	13.73 (6")	12.38	12.43	—	—	11.99
" 14	13.55 M	—	12.21 [628]	12.34	—	11.83	—
" 15	—	14.00 (7")	12.29	12.34	—	11.80	—
" 17	13.37 B	—	12.34	12.48	—	12.06	—
" 18	13.96 M	—	12.40	12.56	11.72	—	—
" 25	13.85 M	—	12.36	12.48	—	11.75	—
" 28	—	13.70 (7")	12.45	12.55	11.83	—	—
" 29	13.37 B	—	12.45 [629]	12.62	—	11.84	—
" 30	13.94 M	—	12.54	12.59	11.98	—	—
" 31	—	14.14 (6")	12.56	12.66	—	11.95	—
June 4	13.48 M	—	12.60	12.65	11.97	—	—
" 6	—	13.88 (6")	12.61	12.68	—	—	11.96
	Mean of Miller's 13.41 Mean of Brecknell's 13.36	13.62	12.39	12.43	A 11.89	B 11.88	C 11.86

APPENDIX II.

Incandescent Platinum.

The attention of the Committee was naturally directed to the proposed French standard suggested by M. Violle, namely, the light emitted by a square centimetre of liquid platinum at the solidifying point. The apparatus required for the production of such a standard is of necessity very cumbrous and inconvenient and extremely ill-suited for photometrical measurements. The attention of the Committee was therefore directed to methods of obtaining the same result in a more convenient manner and on a smaller scale, with the view of constructing apparatus which could without inconvenience be introduced into an ordinary photometer.

For this purpose the apparatus employed by Mr. Dibdin in his recent experiments was first tried. This consists of an arrangement by means of which a roll of platinum foil was stretched over two rollers, having an interval of about three inches between them, across which the foil was stretched. In front of the foil a steatite plate having a circular aperture of a quarter of an inch was placed, and immediately behind the foil was an oxyhydrogen burner so arranged that when a full flame was turned on it impinged upon the foil in a direction horizontal with the aperture in the steatite plate and thus heated the platinum to fusion. Although the mechanical part worked as satisfactorily as could be desired, the results obtained on the photometer were so variable that no reliance could be placed upon them. The method was then modified by placing the foil between two plates of perforated steatite so as to inclose the portion to be heated in a steatite cell. It was found, however, that the close contact of the steatite conducted the heat away from the platinum so rapidly that only an irregular portion in the middle of the cell was actually fused, and the results were even more unsatisfactory than before.

It was next considered desirable to vary the method by heating a thick rod of platinum to its melting-point and allowing the light from the fused bead of metal thus obtained to pass to the photometer disc through a small opening in a suitable mask. This method was found to be all but impracticable, but it gave results of value as indicating one cause of the uncertainty in the quantity of light emitted from molten metallic surfaces. It was observed that small scum-like particles were constantly floating over the surface of the molten platinum, and that these particles gave far more light than the mass of metal itself. Consequently as there existed no means of ensuring the absence of such particles it was obvious that there could be little certainty in the light emitted from such unevenly illuminated surfaces.

In addition to the blowpipe experiments, it appeared desirable to try the experiment of fusing platinum by means of the electric current as it seemed probable that by this means the platinum could be kept in any given condition of incandescence for a longer period, and that the experiment would be more under control. An apparatus for the purpose was consequently arranged. A strip of platinum was held between two metal clips insulated from each other. Close in front of the platinum was placed a small screen having a perforation of a quarter of an inch in

diameter through which the incandescent surface could be observed. This arrangement was placed in circuit with eight or ten cells of a secondary battery, an ammeter and an adjustable resistance being included in the circuit. It was necessary that the resistance should be capable of being taken out very slowly, so that the current might be gradually and regularly increased.

The arrangement devised answered very well in practice. It consisted of a frame across which was stretched a series of lengths of german silver wire, some of them being straight and others coiled so as to give varying amounts of resistance in each length. By means of plugs any or all of the lengths could be put in and out at pleasure, and by this means the resistance could be roughly adjusted. The fine adjustment was given by a cross-piece working along two of the straight wires and moved by a moderately fine screw. As the cross-pieces moved along the length of the wires it, by connecting the two, brought more or less resistance into the circuit. The resistance of the whole arrangement amounted to about one ohm. It was found that with this arrangement the strip of platinum could be rapidly raised to incandescence, and could be kept close to the melting-point for a considerable time, a very slight increase in the current being then sufficient to cause fusion. The photometric tests made with this arrangement confirmed those which had been made when the platinum was fused by the oxyhydrogen jet; that is to say, the observations showed considerable irregularity, so much indeed that it did not seem worth while to make, as had originally been intended, a long series of them, nor to construct apparatus more accurate than the first experimental one.

A decided defect in the apparatus was the buckling of the platinum. As it was tightly gripped at each end there was no room for expansion, and before melting there was considerable expansion and consequent buckling. Had it seemed worth while to do so, it would not have been difficult to devise an apparatus by which this might have been obviated, but the results were not sufficiently encouraging.

A few photographic tests were also made by permitting the light from the incandescent platinum to fall through a screen with openings in it upon a sensitive plate, a number of exposures from different pieces of platinum being made on the same plate. These of course could only be looked upon as rough tests, but they also seemed to indicate that the amount of radiation from a given surface of platinum at the moment of fusion is not absolutely constant under the conditions we have described, and so far as they are worth anything they may be taken as confirming the conclusion obtained by the other methods.

Report of the Committee, consisting of Professor CRUM BROWN (Secretary), Mr. MILNE-HOME, Dr. JOHN MURRAY, Lord McLAREN, and Dr. BUCHAN, appointed for the purpose of co-operating with the Scottish Meteorological Society in making Meteorological Observations on Ben Nevis.

THE laborious work of observing hourly by night and by day has been carried on by Mr. Omond and his assistants during the past year with the same enthusiasm and continuity as in previous years; and the five daily observations at Fort William, in connection with the observatory, have similarly been made with the greatest regularity by Mr. Livingston.

The state of the health of the observers, occasioned by their continuous residence on the top of the mountain, where active exercise in the open air is practically precluded during most of the year, rendered it absolutely necessary to give them relief during last winter. Accordingly the services of Mr. Drysdale, B.Sc., were secured for six months, thus affording Messrs. Omond and Rankin three months' residence each in Edinburgh, during which they gave assistance in the office of the Scottish Meteorological Society. In this way effective help was given in the preparation of the report, for the 'Transactions of the Royal Society of Edinburgh,' of the Ben Nevis observations from the opening of the observatory in November 1883 to December 1887, to which date the report has been brought down. To these observations have been added the five daily observations made at the low-level station at Fort William. All of these observations are already printed, and as the report itself is now nearly all in type, the volume will shortly be ready for publication. The delay of publication has been occasioned by the extension of the period to December last and by a pressure of other work, which has precluded Mr. Buchan from giving more than a small portion of his time to the preparation of the report.

A grant of 25*l.* was obtained from the Government Research Fund in May last for the purchase of the necessary apparatus for photographing clouds and other meteorological phenomena at the observatory. Attention is meantime chiefly directed to clouds, halos, and other optical phenomena, and much interest is attached to the questions which have been already raised by these lines of research that give good promise of leading to a knowledge of the constituents of clouds, but more particularly of the exact forms of the ice-crystals of which many of them are composed.

During the year Mr. Omond has continued the observations on earth-currents, begun by Mr. H. N. Dickson in a previous year, and has traced an important connection between them and the general state of the weather. Mr. Rankin has collected the eighteen cases of St. Elmo's Fire which have occurred at the observatory and discussed the observations of pressure, temperature, winds, &c., for thirty hours previous and eighteen hours subsequent to their occurrence, together with the cyclones and other weather phenomena which, as shown by the daily weather-maps of the Meteorological Office, had occurred in North-western Europe at the times. The papers on these subjects will shortly appear in the 'Journal of the Scottish Meteorological Society.' As regards the cases

1888.

of St. Elmo's Fire it may be enough here to say that they occur at certain well-defined phases in the non-periodic fluctuations of atmospheric pressure, temperature, humidity, changes of wind, and arrival from the Atlantic of equally well-defined types of weather with their characteristic cyclones.

In addition to these researches and the preparation of the Ben Nevis observations for the press Messrs. Omond and Rankin have been conducting, as time and opportunity permitted, the investigations referred to in last year's report.

For the year 1887 the following were the monthly mean pressures and temperatures, the hours of sunshine, the amounts of the rainfall, and number of days without rain as recorded at the observatory, the mean pressures at Fort William being reduced to 32° and sea-level, those of Ben Nevis Observatory to 32° only:—

—	Jan.	Feb.	March	April	May	June	July	Aug.	Sept.	Oct.	Nov.	Dec.	Year
<i>Mean Pressures in Inches.</i>													
Ben Nevis Observatory	25.159	25.494	25.390	25.375	25.472	25.680	25.426	25.424	25.359	25.445	25.086	25.089	25.366
Fort William	29.753	30.128	30.433	29.993	30.044	30.168	29.903	29.911	29.875	30.047	29.656	29.699	29.934
Difference	4.594	4.634	4.643	4.618	4.572	4.488	4.477	4.487	4.516	4.602	4.570	4.610	4.568
<i>Mean Temperatures.</i>													
Ben Nevis Observatory	24.9	27.1	24.0	25.6	32.2	45.4	41.3	40.0	36.6	28.4	26.0	22.7	31.2
Fort William	39.2	40.5	38.8	42.5	49.3	58.3	57.6	56.4	51.1	44.8	40.2	36.0	46.2
Difference	14.3	13.4	14.8	16.9	17.1	12.9	16.3	16.4	14.5	16.4	14.2	13.3	15.0
<i>Rainfall in Inches.</i>													
Ben Nevis Observatory	17.80	13.30	5.90	7.53	3.97	7.51	11.54	8.71	10.99	12.19	8.99	17.58	126.01
Days of no Rain	7	12	14	15	17	18	4	9	11	8	9	4	128
Fort William	12.73	11.40	3.50	3.49	1.87	3.23	7.90	3.03	4.55	6.22	5.09	8.18	71.19
<i>Hours of Sunshine to nearest Whole Hours at Ben Nevis Observatory.</i>													
No. of Hours	23	56	74	120	129	206	58	57	84	32	31	28	898
Possible Hours	231	264	365	426	508	529	528	467	381	319	242	210	4,470

For the year the mean temperature at Fort William was a degree below the average, the greatest defects from the means being 3°0 in April, 2°9 in December, 2°7 in October, and 2°3 in March. On the other hand, February was 1°6 above the average temperature of the month, and June 2°6. At the top of the Ben the mean temperature of June was even relatively higher than at Fort William, being 45°4, which is the highest monthly mean hitherto observed.

The minimum temperature on Ben Nevis for the year was 9°0 on March 12 at 2 A.M., which closely agrees with the minimum of previous years. The maximum was 67°0 on June 24, which is 7°0 higher than any previously recorded maximum. On seven days of this month the temperature rose above 60°0, and on September 20 a temperature of 58°8 was recorded. Indeed, an unusual occurrence of high temperatures was an outstanding feature of the meteorology of Ben Nevis during the year.

The registrations of the sunshine recorder showed 898 hours of sunshine during the year, the smallest number of hours, 23, occurred in

January, and the largest, 206, in June, the latter number being the largest for any month recorded down to the end of 1887. In June of 1888, however, there have been 250 hours' sunshine recorded, being nearly half the possible sunshine—an amount equalled at but few places in the British Islands last June. The hours of sunshine were 680 for 1885, 576 for 1886, and 898 for 1887, the amount of sunshine being thus greatly in excess of the two preceding years. In 1887 the amount was thus 20 per cent. of the possible sunshine, but in June the amount was 40 per cent. The distribution of the sunshine during the hours of the day from 6 A.M. to 6 P.M. was 29, 42, 62; 81, 90, 87; 88, 83, 76; 70, 51, and 46; a distribution closely agreeing with that of 1884, 1885, and 1886.

The amount of the rainfall for the year was 126·01 inches, the month of least rainfall, 3·97 inches, being May, and of greatest rainfall, 17·80 inches, January, the month of December, however, following close with a rainfall of 17·58 inches. The number of days on which the precipitation was *nil*, or less than 0·01 inch, was 128, being thus 31 dry days in excess of 1886. On the other hand the number of days on which one inch of rain, or upwards, fell were 37, or about one day in ten, being less frequent than in previous years, when such heavy rainfalls occurred once a week on the average. The unusually heavy rainfalls with the dates of their occurrence were 3·57 inches on January 27, 3·48 inches on December 3, 2·97 inches on December 4, 2·85 inches on February 23, 2·52 inches on the 24, and 2·47 inches on January 19. For longer periods the results are 7·19 inches for the four days ending January 28, 7·87 inches for the four days ending February 25, and 7·40 inches for the three days ending February 3.

Atmospheric pressure was considerably above the average for the year, the mean at Fort William being 29·934 inches instead of 29·834 inches. In November, December, and January it was considerably under the monthly means, but in every other month the means were exceeded, the greatest excess, 0·260 inch, being in June. Thus the June of 1887 is noteworthy in the meteorology of Ben Nevis for the prevalence of an unwonted high atmospheric pressure and for an equally unwonted high temperature, due to an unusual predominance of anticyclones over this part of Europe during at least the last two-thirds of the month, with the characteristic high temperatures and extremely dry states of the atmosphere which accompany them.

These warm, dry states of the atmosphere were most marked from the 22nd to the 25th. During these four days the means from the 24 hourly observations were:—

Day of Month	Dry	Wet	Pressure, Inches
22	58·2	50·6	25·943
23	59·3	48·0	25·912
24	60·7	49·9	25·931
25	58·3	50·3	25·865
Means	59·1	49·7	25·913
Means at Fort William	66·1	60·4	30·332
Differences	7·0	10·7	4·419

Thus, instead of the normal difference of $16^{\circ}0$ between the top and bottom of the mountain, it was only $7^{\circ}0$ during these four days, and, instead of the air at the top being moister than at the bottom, it was greatly drier. Hence the air at the top did not owe its great dryness and high temperature to ascending currents from lower levels up the sides of the mountain, heated by the strong insolation prevailing at the time, but to descending currents from great heights, which are characteristic of anticyclones, by which dryness and heat are developed much in the same way as happens in the case of the Föhn of the lower Alps. So markedly and so frequently did this type of weather prevail during June that the mean temperature of the month at the observatory was only $12^{\circ}9$ lower than that at Fort William, being the least monthly difference hitherto observed during any season of the year.

It may be here suggested that this peculiarity of anticyclones plays a highly important and beneficial part climatically in mitigating the rigours of winter over those portions of Asia and America which are almost continuously within extensive anticyclones during the winter months. For the investigation of this phase of weather and climate it is evident that the Ben Nevis observations afford data of the most invaluable description.

To this report is appended Table I., giving the hourly deviations from the mean atmospheric pressure for the months and the year, and Table II. the deviation from the mean temperature calculated from the four years' observations ending with 1887.

It was hoped that the work of discussing the Ben Nevis observations would by this time have extended farther than it has done beyond the determination of the hourly constants of the more prominent meteorological elements in the direction of the investigation of the relations of the observations to the weather of North-western Europe. But it was found that the preparation of the observations for the press, and seeing them through it, occupied much more time than had been anticipated. Indeed, this work occupied the whole time of Messrs. Omond and Rankin when they were in the office of the Scottish Meteorological Society, together with nearly the whole of the time of the treasurer's clerk; and, besides, since the beginning of the year less time has been at Mr. Buchan's disposal for personally carrying out the laborious work of the discussion.

In these circumstances the directors of the observatory have taken into consideration the whole question, and are maturing a plan for a thorough discussion of the Ben Nevis and Fort William observations in their scientific and practical bearings, which they hope to complete in the course of the autumn. This plan will require for the carrying of it out a small additional staff working in conjunction with the office in Edinburgh and the staff of the Ben Nevis Observatory for a period of at least three years.

In connection with the practical side of the inquiry your Committee refer with the greatest satisfaction to the publication by General Greely, chief signal officer of the United States Army, of Daily Weather Charts of the Atlantic, beginning with October 1886. These charts have been partially examined in connection with the Ben Nevis observations, and it is not possible to overestimate their importance in the large inquiry now in contemplation by the directors as to the relations of these observations to the weather of North-western Europe, which is truly an international undertaking. With the United States charts will be conjoined the obser-

vations of storms and other phenomena made at the Scottish lighthouses, as described in previous reports, and the bi-daily charts of the Meteorological Office. One of the points to which attention will be specially given will be to ascertain the earliest time at which storms, seen to be advancing over the Atlantic towards Europe, could be signalled from the Ben Nevis observations in combination with observations at lower levels; and, further, to endeavour from an investigation of the bearings of the Ben Nevis observations on the movements and courses of anticyclones and cyclones to ascertain the path the advancing cyclone will take, whether to the north of, across, or to the south of the British Islands in its easterly course.

As the British Association is aware, your Committee have from the commencement insisted on the necessity of an observatory at Fort William, near sea-level, at which hourly observations can be recorded, in order that the observations made at the top of Ben Nevis may be properly utilised in their scientific and practical bearings.

With reference to this low-level observatory a copy of the Report of the Council of the Scottish Meteorological Society, dated July 23, is sent herewith, with a passage marked on page 2 giving a correspondence with the Meteorological Council, who offer a grant towards the maintenance of the low-level observatory, 'which they regard as a very important adjunct to the existing high-level observatory,' and further to equip the observatory with the required outfit of meteorological instruments. The directors have applied to the Association of the Edinburgh International Exhibition of 1886 for a grant from their surplus fund towards the building of the observatory at Fort William, and they are in good hopes that they will in a month or two be in a position to commence the building.

TABLE I.—Showing the Hourly Variations from the Mean Atmospheric Pressure (expressed in Thousandths of an Inch) from the four years' observations ending with 1887.

	Jan.	Feb.	March	April	May	June	July	Aug.	Sept.	Oct.	Nov.	Dec.	Year
1 A.M.	6	5	1	-3	-1	1	-1	-2	-1	-1	8	7	1
2 "	1	1	-4	-8	-8	-6	-7	-8	-6	-8	2	4	-4
3 "	0	-5	-8	-12	-11	-12	-15	-13	-11	-14	-3	2	-9
4 "	-4	-12	-10	-16	-15	-14	-17	-17	-16	-17	-11	-4	-13
5 "	-7	-13	-12	-20	-20	-17	-21	-19	-22	-20	-15	-10	-16
6 "	-9	-14	-9	-17	-15	-15	-18	-17	-19	-20	-14	-12	-15
7 "	-8	-11	-7	-15	-11	-11	-14	-12	-13	-13	-14	-13	-12
8 "	-2	-7	-2	-9	-7	-7	-10	-8	-7	-6	-7	-9	-7
9 "	2	-3	1	-4	-4	-3	-6	-3	-2	1	-4	-5	-3
10 "	4	1	3	0	1	-1	-3	1	2	7	-2	0	1
11 "	4	4	4	5	5	2	1	3	4	9	2	1	4
Noon	1	6	6	8	8	5	5	7	7	10	-1	-1	5
1 P.M.	-6	0	4	9	10	7	8	9	9	8	-3	-6	4
2 "	-10	1	4	11	15	9	13	13	11	8	-3	-3	5
3 "	-10	-2	2	10	12	7	14	11	7	5	-1	-3	4
4 "	-5	-2	-1	7	10	8	12	8	4	5	0	0	4
5 "	-4	-1	-4	2	5	6	8	4	2	2	0	-1	1
6 "	0	2	-1	3	3	5	6	4	2	5	3	3	3
7 "	3	6	2	4	3	6	5	4	5	8	8	3	5
8 "	7	10	5	9	7	7	9	8	10	11	12	10	8
9 "	10	9	6	10	8	10	10	9	9	9	14	12	9
10 "	9	8	6	7	8	11	9	9	8	8	12	12	9
11 "	12	7	5	4	6	6	5	5	6	5	11	10	7
Midnight	10	5	3	3	2	4	1	0	3	1	11	9	4

TABLE II.—*Showing the Hourly Variations from the Mean Temperature from the four years' observations ending with 1887.*

	Jan.	Feb.	March	April	May	June	July	Aug.	Sept.	Oct.	Nov.	Dec.	Year
1 A.M.	-0.1	-0.3	-0.5	-0.8	-1.2	-1.1	-0.9	-0.8	-0.7	-0.4	-0.2	0.0	-0.6
2 "	-0.1	-0.4	-0.6	-1.0	-1.3	-1.3	-1.1	-1.1	-0.7	-0.6	-0.1	-0.2	-0.7
3 "	0.0	-0.4	-0.7	-1.1	-1.4	-1.4	-1.3	-1.2	-0.9	-0.5	-0.1	-0.2	-0.7
4 "	-0.2	-0.3	-0.6	-1.3	-1.5	-1.5	-1.5	-1.4	-0.9	-0.5	0.0	-0.2	-0.8
5 "	-0.3	-0.4	-0.8	-1.3	-1.4	-1.6	-1.6	-1.6	-1.1	-0.5	-0.1	-0.3	-0.9
6 "	-0.1	-0.4	-0.7	-1.3	-1.1	-1.4	-1.5	-1.5	-1.2	-0.5	-0.1	-0.4	-0.8
7 "	-0.1	-0.6	-0.7	-1.1	-0.9	-1.1	-1.2	-1.3	-1.1	-0.4	0.0	-0.3	-0.7
8 "	-0.1	-0.6	-0.5	-0.8	-0.5	-0.8	-0.8	-1.2	-0.6	-0.3	-0.1	-0.3	-0.5
9 "	-0.1	-0.4	-0.2	-0.2	-0.2	-0.3	-0.4	-0.5	-0.2	0.0	0.0	-0.3	-0.2
10 "	0.1	0.0	0.1	0.1	0.3	0.0	0.1	0.1	0.3	0.3	0.4	0.0	0.2
11 "	0.2	0.4	0.5	0.7	0.7	0.5	0.7	0.6	0.6	0.6	0.6	0.2	0.5
Noon	0.3	0.6	0.8	1.0	1.2	1.1	1.2	1.2	1.2	0.8	0.8	0.3	0.9
1 P.M.	0.3	0.8	0.8	1.1	1.4	1.5	1.4	1.5	1.6	0.9	0.6	0.4	1.1
2 "	0.2	0.8	1.0	1.3	1.6	1.8	1.7	1.9	1.7	0.8	0.5	0.4	1.2
3 "	0.3	0.7	0.9	1.3	1.6	1.9	1.7	1.9	1.6	0.8	0.3	0.3	1.1
4 "	0.1	0.5	0.7	1.3	1.6	1.8	1.7	1.8	1.3	0.5	0.1	0.1	1.0
5 "	0.0	0.2	0.3	1.2	1.1	1.7	1.4	1.6	0.8	0.2	-0.1	0.0	0.7
6 "	-0.1	0.0	0.2	0.9	0.9	1.3	1.0	1.1	0.3	0.0	-0.2	0.0	0.5
7 "	-0.1	-0.1	0.1	0.5	0.6	0.9	0.9	0.5	0.0	0.1	-0.2	-0.1	0.3
8 "	-0.1	-0.1	0.0	0.2	0.1	0.1	0.4	0.1	-0.2	0.0	-0.2	-0.1	0.0
9 "	-0.2	0.0	-0.1	0.0	0.0	-0.3	0.1	-0.2	-0.2	-0.1	-0.2	0.0	-0.1
10 "	-0.2	-0.1	-0.3	-0.3	-0.6	-0.5	-0.2	-0.5	-0.2	-0.1	-0.2	-0.1	-0.3
11 "	-0.2	-0.1	-0.3	-0.5	-0.9	-0.7	-0.5	-0.6	-0.4	-0.1	-0.2	-0.2	-0.4
Midnight	-0.2	-0.2	-0.4	-0.7	-1.0	-1.0	-0.7	-0.8	-0.6	-0.2	-0.2	0.0	-0.5

Second Report of the Committee, consisting of Professors TILDEN, McLEOD, PICKERING, RAMSAY, and YOUNG and Drs. A. R. LEEDS and NICOL (Secretary), appointed for the purpose of reporting on the Bibliography of Solution.

DURING the past year the following journals have been searched:—

Poggendorff's 'Annalen' (completed);
 'Annales de Chimie et de Physique';
 'Chemical News';
 'Philosophical Magazine';
 'Philosophical Transactions';
 'Proceedings of the Royal Society of London' (in part);

in all 350 volumes; with the result that 194 papers have been added to the list. These papers are distributed as follows:—

A. 1=8; 2=4 12
 B. 1=29; 2=1; 3=2 32
 C. 1=21; 3=6; 4=17; 5=10; 6=13; 7=5; 8=1; 10=1 74
 D. 1=15; 2=2 17
 Miscellaneous 59

The number of papers obtained in all is 549.



The Committee is indebted to Mr. T. J. Baker, B.Sc., King Edward's School, Birmingham, for assistance in searching the 'Annales de Chimie et de Physique.'

Report of the Committee, consisting of Professor G. CAREY FOSTER, Sir WILLIAM THOMSON, Professor AYRTON, Professor J. PERRY, Professor W. G. ADAMS, Lord RAYLEIGH, Dr. O. J. LODGE, Dr. JOHN HOPKINSON, Dr. A. MUIRHEAD, Mr. W. H. PREECE, Mr. HERBERT TAYLOR, Professor EVERETT, Professor SCHUSTER, Dr. J. A. FLEMING, Professor G. F. FITZGERALD, Mr. R. T. GLAZEBROOK (Secretary), Professor CHRYSAL, Mr. H. TOMLINSON, Professor W. GARNETT, Professor J. J. THOMSON, Mr. W. N. SHAW, Mr. J. T. BOTTOMLEY, and Mr. T. GRAY, appointed for the purpose of constructing and issuing Practical Standards for use in Electrical Measurements.



[PLATE I.]

THE Committee report that the work of testing resistance coils has been continued at the Cavendish Laboratory, and a table of the values found for the various coils is given.

Legal Ohms.

No. of Coil	Resistance in Legal Ohms	Temperature
Elliott, 193 . . .  No. 178	·99971	15°·5
Elliott, 201 . . .  No. 181	1·00005	14°·8

B.A. Units.

No. of Coil	Resistance in B.A. Units	Temperature
Elliott, 200 . . .  No. 71	1·00049	13°·8
Elliott, 43 . . .  No. 72	·99955	14°·7

In conformity with the opinion expressed by the Committee in their last report some steps have been taken towards the construction of an air-condenser.

A meeting was held in London and Dr. Alex. Muirhead exhibited an air-condenser, capacity about ·0035 mf. This condenser consists of a series of concentric cylinders of brass insulated from each other by glass rods.

Dr. Muirhead expressed his willingness to lend this condenser to the Committee with two others of similar construction, and it was agreed that the Secretary should be requested to test them and to make a determination of their absolute capacity. Some delay in sending the instruments to Cambridge unavoidably took place, but the experiments requisite are now in progress; so far, of the 80*l.* granted last year for the purpose only 2*l.* 10*s.* has been expended.

During the year the original resistance standards of the Association

have been compared with each other by the Secretary and Mr. T. C. Fitzpatrick; an account of the experiments is given in an appendix to the report, together with a chart giving the values of their resistance between 10° and 20° . The general result of the comparison is that with two exceptions the relative values of the standards between the temperatures of 10° and 20° have not seriously changed since they were constructed in 1865 until June 1888. A change of about $\cdot 0002$ B.A. Unit has been observed in the coil F since the end of June 1888.

The attention of the Committee has been directed by several practical electricians to the desirability of a redetermination of the value of the specific resistance of copper. It is known that copper wire is now made having a resistance 3 or 4 per cent. less than Matthiessen's standard.

In view of the importance of copper to electricians the Committee have undertaken to make experiments on the specific resistance of copper, and wish to thank the various gentlemen, who have brought the matter forward, for their offers of help.

At the last meeting of the Committee it was resolved, on the motion of Mr. W. H. Preece, to adopt the name 'Therm' for the Gramme-Water Degree Centigrade Unit of Heat.

Thus one 'Therm' is the quantity of heat required to raise one gramme of water at its maximum density one degree Centigrade.

It was also agreed to adopt the name 'Joule' for 10^7 C.G.S. units of work. Thus a Joule is equal to 10^7 ergs. It is the work done in one second by the power of one Watt, or again the work done when a current of one Ampère flows for one second between two points between which the difference of potential is one Volt, and hence a power of one Watt is one Joule per second.

Hence, also, if we take the value of the mechanical equivalent of heat as $4\cdot 2 \times 10^7$ ergs, we have

$$1 \text{ Therm} = 4\cdot 2 \text{ Joules.}$$

In accordance with a suggestion made at the Manchester meeting the value of the resistance of mercury in terms of the B.A. Unit has been again determined by the Secretary and Mr. Fitzpatrick.¹

They find that a column of mercury 1 metre long 1 sq. mm. in section has at 0° C. a resistance of $\cdot 95352$ B.A. Unit, and that the value of the ohm in centimetres of mercury is 106.29.

The Committee are of opinion that they should be reappointed, with the addition of the name of Mr. T. C. Fitzpatrick, to continue the experiments already referred to; they ask for a grant of 100*l.* They propose that Professor G. Carey Foster should be the Chairman and Mr. R. T. Glazebrook the Secretary.

APPENDIX.

On the Permanence of the Original Standards of Resistance of the British Association and of other Standard Coils. By R. T. GLAZEBROOK and T. C. FITZPATRICK.

The original standards were compared together by Messrs. Matthiessen and Hockin in 1865 and 1867, by Messrs. Chrystal and Saunder in 1876, by Dr. Fleming in 1879-81, and by the Secretary and Mr. Fitzpatrick in 1887-88. The details of Dr. Fleming's observations have never been

¹ *Proc. Royal Soc.* vol. xlv.; *Phil. Trans.* 1888.

published, and we have to thank him for having placed his note-book and papers at our disposal.

The question of the permanence of wire standards has been discussed recently by Professor Himstedt, 'Wied. Ann.' xxxi. p. 617, and it seemed desirable to bring together all the information attainable as to the original coils of the Association and others used by Messrs. Matthiessen and Hockin in 1867.

The original coils of the Association are six in number, and the temperatures at which each has a resistance of 1 B.A.U. are given by Mr. Hockin in the Report for 1867. In addition to these six coils Messrs. Chrystal and Saunder examined the coil No. 29, marked F by them, and also a coil known as Flat, which are not mentioned in Mr. Hockin's report. The results of these two comparisons are given in the following table:—

TABLE I.—Table giving the results of comparisons in 1867 and 1876.

Material of Coil	No. in 1867 Report	Mark in 1876 Report	Temperature at which Coil is 1 B.A.U., 1867	Temperature at which Coil is 1 B.A.U., 1876 ¹
Pt Ir	2	A	16°	16·1
Pt Ir	3	B	15·8	15·8
Au Ag	58	C	15·3	15·3
Pt	35	D	15·7	16
Pt	36	E	15·7	15·8
Pt Ag	29	F	not given	(19·4?)
Pt Ag	43	G	15·2	18·2

It will be noticed that the coil G of Pt Ag is the only one for which the table shows any marked alteration.

Now Matthiessen gives as the percentage increase of resistance per 1° C. for Pt Ir the value ·032. Our own experiments show it to be lower than this, and the value found for G by Dr. Fleming after a most careful series of experiments is ·0278. I can find no record of the temperature at which Hockin actually worked. If it were below 15° and the temperature at which the coil was right was found by the use of the coefficient ·032 the temperature so found would be too low.

If we assume Hockin's measurements to have been made at 0° C. and take Fleming's value ·028 for the coefficient we find the temperature at which the coil was right to be 18°·1.

We have next to consider the very complete series of measurements taken by Dr. J. A. Fleming in 1879–81; the results of these measurements were tabulated on a chart which has been kept with these coils since that date. For the details of the experiments we have to thank Dr. Fleming, who placed at our disposal his note-books. The principle of his observations was as follows. If X, Y be two coils to be compared, one X, say, was kept at 0° C., while the temperature of Y was varied from 0° to 20°. The differences between the resistance of X at 0° and Y at various temperatures were measured by Carey Foster's method in terms of the wire of the Fleming bridge. The values of this difference were plotted as ordinates, the temperatures being the abscissæ, and thus a curve was obtained giving the variation of resistance with temperature

¹ In obtaining this column it was assumed that B remained unchanged between 1867 and 1876.

for the coil Y. For the standard coil Flat this curve is accurately a straight line. This coil was then kept at 0° , and the temperature of X varied, and so on for all the coils.

Now, at the temperatures given in Table I., column 4, taken from the 1867 Report the resistances of all the coils should be the same. Fleming found that this was not quite strictly true. He defines therefore as the Mean B.A. Unit the mean of the values of the coils at the temperatures at which they were originally said to be equal. This value is shown on his diagram by a red horizontal line.

For the coils of platinum silver alloy, which is now used for standards, Fleming's results are accurately represented by straight lines for the temperature curves. This, however, is not so strictly the case for the coils A and B of platinum iridium alloy; thus for these two coils Fleming took observations in the neighbourhood of 0° , 4° , 8° , 15° , and 21° , numerous observations being made at each temperature; the straight line on the chart joining the means of the observations at 15° and 21° passes considerably above the observations at 0° , 4° , and 8° . The same too is the case, though in a less marked degree, for the platinum coils D and E. In the chart as drawn by Fleming it has been assumed that the temperature curves are straight lines, and these have been drawn to represent all the observations as closely as possible, but the differences are considerable.

If we draw curves instead of straight lines to represent Fleming's experiments these curves between 10° and 20° are in all cases nearly straight, and the differences, at the two temperatures, from Flat at 0° are given in bridge wire divisions in Table II.

TABLE II.

—	Temperature 10°	Temperature 20°
A	-88	205
B	-97	196
C	11	155
D	-280	338
E	-263	348
F	44	100
G	40	94
Flat	56	112

We could determine from this table the temperatures at which the various coils are equal, and hence compare Fleming's results with those of previous observers; it will be easier to do this after discussing our own observations.

During the past year and a half the coils have again been examined by ourselves. We find that between the temperatures of about 10° and 20° Centigrade the resistances of the coils, including an eighth coil H (No. 6 of the Report of 1867), may be represented by the formulæ given in Table III.

In obtaining the table it has been assumed, in accordance with the observations of Dr. Fleming, confirmed by Lord Rayleigh and ourselves, that the resistance of one division (about 1 mm.) of our bridge wire at a temperature of 15° is $\cdot 0000498$ B.A.U. The table gives in B.A. Units the value of R_t —Flat_t, R_t being the resistance of the coils in order at temperature t° , Flat_t that of Flat at 0° .

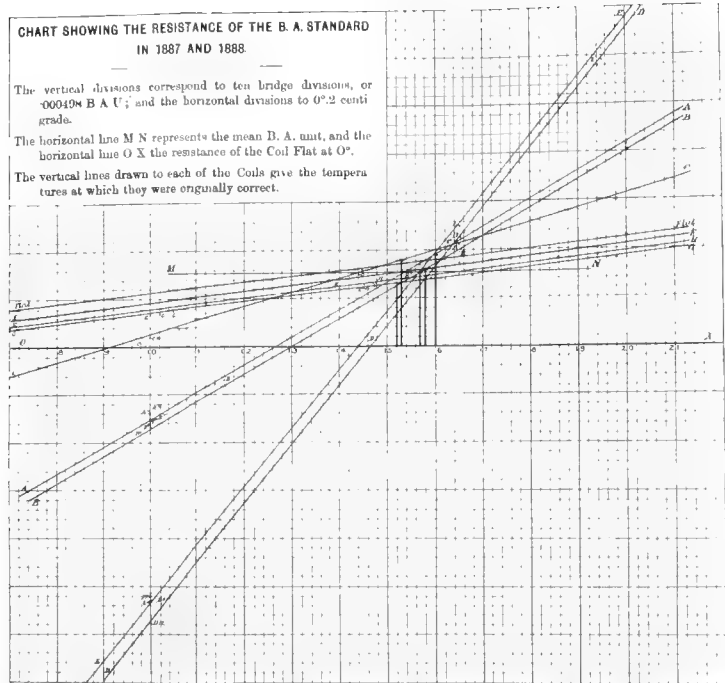

CHART SHOWING THE RESISTANCE OF THE B. A. STANDARD IN 1887 AND 1888

The vertical divisions correspond to ten bridge divisions, or '00049 M B A U'; and the horizontal divisions to 0°.2 centi grade.

The horizontal line M N represents the mean B. A. unit, and the horizontal line O X the resistance of the Coil Flat at 0°.

The vertical lines drawn to each of the Coils give the temperatures at which they were originally correct.



Illustrating the Report of the Committee for constructing & issuing Practical Standards for use in Electrical Measurements.

TABLE III.

Coil	$R_t - \text{Flat}_0$ in B.A.U.
A	- 00386 + 001426 ($t-10$)
B	- 00431 + 001436 ($t-10$)
C	+ 00057 + 000710 ($t-10$)
D	- 01434 + 003078 ($t-10$)
E	- 01330 + 003023 ($t-10$)
F	+ 00227 + 000286 ($t-10$)
G	+ 00192 + 000274 ($t-10$)
H	+ 00202 + 000281 ($t-10$)
Flat	+ 00279 + 000279 ($t-10$)

The results of these observations are given in the chart,¹ Plate I.

The vertical divisions are ten bridge divisions, and the horizontal divisions $0^{\circ}2C$. In the original chart, which is retained with the standards, the vertical divisions were one bridge division, or 0000498 B.A.U.

About eleven observations on each coil are recorded in the chart, and in but few cases is the error between observation and the corresponding straight line greater than that which would arise from an error of one-tenth of a degree Centigrade in the temperature of the coil.

If as above we adopt as the Mean B.A. Unit the mean of the value of the coils at the temperature at which each was said to be originally correct we find that this mean lies on our chart at a distance of $78\cdot3$ divisions above the value of Flat at 0° , so that

$$\text{Flat at } 0^{\circ} = 1 - 00390 \text{ B.A.U.}$$

The value given on Fleming's chart is Flat at $0^{\circ} = 1 - 00410$ B.A.U., and the difference is within the errors of reading on his chart.

We have thus the data for finding the resistance of any of the coils in Mean B.A.U. at any temperature between 10° and 20° .

It remains to compare these results and those of previous observers. We will take Fleming's observations first, and for this purpose have given in Table IV. the differences in bridge wire divisions between the coils at temperatures of 10° and 20° and Flat at 0° . For the sake of comparison Table II. is repeated.

TABLE IV.

Coil	Value of $R - \text{Flat}_0$ at 10°		Value of $R - \text{Flat}_0$ at 20°	
	1880	1888	1880	1888
A	-88	-77.5	205	209
B	-97	-86.5	196	202
C	11	11.5	155	154
D	-280	-288	338	330
E	-263	-267	348	340
F	44	45.5	100	103
G	40	38.5	94	93.5
H	—	40.5	—	97
Flat	56	56	112	112

¹ Note.—The smaller letters in brackets after some of the observations on the chart give the initials of the observer.

A comparison of the corresponding columns shows that the differences, except possibly in the case of A and B at the lower temperature, are probably not greater than the error of experiment. It must be remembered that A and B change by 28 bridge divisions for 1° Centigrade, while for D and E the change is about 60 divisions per degree; the temperature of the coils is hardly certain to 0·1 Centigrade and the differences are within that error. As to the platinum silver coils it would seem possible that F¹ has risen relatively to Flat by ·0001 B.A.U. and that G has fallen by ·00005; but these differences are almost too small to make certain of. With regard to the results for A and B at 10° it may be remarked that Fleming's line for these coils is more curved than for any of the others, and that his observations at 6°·9 and at 3° lie distinctly above the line which seems to represent best the observations at 0°, 9°, 15°, and higher temperatures. The observations are not at sufficiently close intervals of temperature to enable the curved line to be drawn with accuracy, and it is clear when plotting them that the curve near 10° may be wrong by as much as 5 or 6 bridge wire divisions.

We would conclude then that there is no certain evidence for a change in the coils in the interval 1880 to 1888. A comparison with the results of Hockin and Chrystal is not quite so easy. It is clear from the chart that the coils are not exactly equal at the temperatures originally stated, and any table of temperatures at which they may be said to have the value of 1 B.A. Unit will depend on the assumption made as to possible changes in any of the coils. Chrystal in 1876 found that the coils B and C were equal at the temperatures at which they were originally stated to be each 1 B.A. Unit. He supposed these coils had not altered and found on that assumption a table of standard temperatures which agrees well with that of Hockin except for the coil G. According to our observations the coils now marked as B and C are no longer equal at the temperatures mentioned. We find, however, that D, E, and G are practically equal at the temperatures given by Chrystal, and if we suppose G has not altered we get the following table of standard temperatures:—

TABLE V.

Coil	Standard Temperature, 1876	Standard Temperature, 1888
A	16·1	15·7
B	15·8	16
C	15·3	15·1
D	16	16
E	15·8	15·8
F	19·4?	16·9
G	18·4	18·4
H	—	17·9
Flat	—	15·2

The change in C, as shown in this table, is not large, probably hardly greater than would be accounted for by experimental error, while D, E, and G agree very closely.

The differences in the case of A, B, and F are important. To take F first. It is a platinum silver coil, No. 29 of the original report. Its

¹ The results of other experiments confirm this rise in the value of F.

temperature is, however, not given in the Report for 1867, p. 483, nor is it marked out in coil itself. Chrystal says that it was used in some of the experiments 'because its variation coefficient was small, but otherwise we have not bestowed much attention on it.' In his first table he states that the results given for F came from a single experiment, and he gives as its variation coefficient per 1° Centigrade 28 divisions of his bridge, while Flat and G, also platinum silver coils, have coefficients of 34 and 35 divisions. Now the observations of Fleming and ourselves show that without any doubt these coils Flat, F, and G have practically the same coefficient, viz., $\cdot 00028$ B.A.U. per 1° C. Taking Chrystal's bridge wire as $\cdot 075$ ohm as stated by him, his value for Flat and G comes to $\cdot 00026$ B.A.U., which is in fair agreement; while for F we find $\cdot 00021$, a value which is now undoubtedly too low. We must infer either that the value of F has changed considerably or that there is some accidental error in the one observation given in Chrystal's table. The change necessary to account for the temperature difference recorded in Table V. would be an increase in resistance of $\cdot 00067$ B.A.U.

Let us now examine the numbers for A and B. It will be seen at once that they have altered appreciably, having, in fact, just changed places. Their temperature coefficients are nearly the same, and there is no doubt that throughout Chrystal's observations the coil he called B was slightly higher in value than A, while throughout the observations of Fleming and ourselves the reverse has been the case. The question naturally arises, have the coils been interchanged? Chrystal (Report, 1876, p. 17) states that, though they have no proper labels, they are marked in some way or other so as to be identifiable. At the present time they have brass labels screwed on to the ebonite of the frame bearing the stamp B.A. 76 A and B.A. 76 B respectively. These were placed on at the time of Chrystal's observations, and there seems just the possibility of an accidental interchange.

The coil H, No. 6, of the original report is marked as correct at $15^{\circ}\cdot 3$. It is now correct in the sense used above at $17^{\circ}\cdot 9$, and here again we have apparently a large change. The resistance would appear to have gone down by about $\cdot 00070$ B.A.U. in the twenty-two years which have elapsed since it was made. This corresponds closely to the change in G observed by Chrystal between 1867 and 1876. Now we know that G has not changed relatively to C, D, and E, since 1876—unfortunately H was not examined by Chrystal—and we are led to ask whether the change was a real one, or due in some way to the observations. The suggestion already made in case of G applies again. The temperature coefficient used by Matthiessen and Hockin is certainly too high, $\cdot 00032$ instead of $\cdot 00028$. If his observations on the platinum silver coils were made at low temperatures, and then the value of the temperature at which the coil is correct were found by the use of the temperature coefficient, the result would be too low. It will be seen shortly that all the platinum silver coils examined, not merely those already mentioned, appear to have fallen appreciably in value relative to the others.

But we have another method of comparing the results. Chrystal has given a table of the differences at 10° between each of the coils and Flat. Now we have seen reason to believe that there is not much change in C, D, E, and G. Let us find from Chrystal's table the value of the difference between G and the various coils at 10° , and compare these with our results. In doing this some uncertainty is introduced from the fact that the value

of the bridge wire in Chrystal's observations was only determined approximately as $\cdot 075$ B.A.U. In this way we get the following Table VI.

TABLE VI.

x	Value of $G - X$ at 10° in B.A.U.		Difference
	1876	1888	
A	$\cdot 00693$	$\cdot 00583$	$\cdot 00110$
B	$\cdot 00648$	$\cdot 00635$	$\cdot 00013$
C	$\cdot 00162$	$\cdot 00135$	$\cdot 00027$
D	$\cdot 01596$	$\cdot 01632$	$-\cdot 00036$
E	$\cdot 01506$	01527	$-\cdot 00021$
F	$-\cdot 00018$	$-\cdot 00035$	$\cdot 00017$

On examining these differences it would seem that A has changed greatly, while B has remained unaltered. This is not in accordance with the conclusions derived from Table V., and will require further consideration. With regard to the other four coils, the differences are almost within errors of observation and are in fair agreement with Table V. Coil C appears to have risen relative to G by $\cdot 00027$; thus, since its temperature coefficient is $\cdot 00071$, this would correspond to an apparent fall in the temperature at which it is right of about $0^\circ\cdot 3$ Centigrade. Table V. shows that there has been a fall in this temperature of $0^\circ\cdot 2$.

The temperature coefficients of D and E are about $\cdot 00308$, so that the differences recorded for these coils would be accounted for by an error of $0\cdot 1$ in the temperature, while the change in F relative to G is so small as to be within the experimental errors. We are thus led to infer that, while C may have risen slightly, the others have not changed by any but a very small amount. This conclusion as regards F is at variance with the one derived from Table V. In fact, while at 10° F is above G in value; owing to the small temperature coefficient used by Chrystal for F, its curve of resistance crosses that of G, and at temperatures near 18° , at which G is about right, F is considerably below it.

If we take Chrystal's value for F at 10° and the temperature coefficient $\cdot 00026$ instead of $\cdot 00021$ used by him, we find that F would be right at about $17^\circ\cdot 6$ instead of at $19^\circ\cdot 4$, as given by Chrystal. This is much closer to $16^\circ\cdot 9$, the value given by our observations; if we take it instead of the $19\cdot 4$ of Table I., the results of this Table VI. and of Table V. would point to a rise in the value of F of about $\cdot 00017$.

The conclusion then that would seem to follow from a comparison of these two series of observations in 1876 and 1888 would seem to be that, while considerable uncertainty attaches to the coils A and B, changes in the other five coils, C, D, E, F, and G, if they have occurred at all, are probably not so great as $\cdot 0002$ B.A. Unit. C and F may possibly have risen by this amount, while D, E, and G have not varied at all.

Professor Chrystal's observations in 1876 are in accordance with those of Messrs. Matthiessen and Hockin in 1864 and 1867, while the results of Dr. Fleming's work in 1880 agree, as we have seen, with our own at the present date.

The observations recorded and discussed above were made mostly at temperatures between 10° and 20° . A considerable number more were made during the cold weather in January and February of the present year at temperatures near 0° , and we must now consider them.

At these low temperatures the observations are not nearly so concordant as those already considered. The terminals of the coils are stout rods of copper, and whenever the temperature of the room is different from that of the bath in which the coils are placed heat is conducted to them through the copper rods and the temperature becomes uncertain; besides this it is difficult to prevent the deposition of moisture on the paraffin with which the cases are filled, and this again becomes a source of error. Table VII. gives a series of the differences observed between the various coils and Flat. The coils were in a north room of which the windows were open, and the temperature in the room was on the average about 2° C. The differences are given in bridge wire divisions.

TABLE VII.

Coil	Feb. 2, Morning	Feb. 22, Afternoon	Feb. 23	Feb. 24, Afternoon	Feb. 25, Morning	Feb. 25, Afternoon	March	Mean
A	433.9	422.4	424.4	428	422.7	422.6	—	425.9
B	459.9	452.4	454.7	455.8	452.0	—	451.5	454.7
C	136	—	—	—	—	134.6	135.5	134.3
D	913.8	922.4	—	927.4	921.0	—	—	921.7
E	894.2	895.4	—	905.8	907.0	—	—	901.1
F	6.4	5.4	5.3	7.5	7.8	9.6	9	7.3
G	14.1	16.8	—	16.8	16.7	18.4	18	16.5
H	15.7	15.7	16	16.7	15.4	17	16	16.1

Now from Tables III. or IV. we can easily calculate what these differences ought to be if we suppose that the temperature curves are straight lines. In making a comparison of the results of this calculation with the observed values given in Table VII. some allowance must be made for the fact that the bridge wire referred to in IV. was at a mean temperature of about 15° , while in Table VII. the temperature was about 2° . Now the temperature coefficient of the bridge wire—platinum-iridium—is about $.00143$; thus the change in resistance for 13° of temperature will be $.0185$ of the resistance at 2° , and we shall have to reduce each of our observed values by this fraction of itself.

We thus get the following Table VIII. of values of the difference at 0° between Flat and the various coils.

TABLE VIII.

Coil	Observed Value of Flat—X corrected for temperature of bridge	Value of Flat—X at 0° obtained from Table III.	Difference
A	417.7	364	53.7
B	446.1	375	71.1
C	131.8	131	0.8
D	904.2	906	— 1.8
E	884.0	874	— 10
F	7.2	12	— 4.8
G	16.2	16.5	— 0.3
H	15.8	16	0.2

On examining these it is at once clear that the supposition that the temperature curves for A and B are straight lines is false.

The other coils, with perhaps the exception of F, would lie at 0° on the straight line which represents the observations between 10° and 20° within the limits of the errors of experiments.

The numbers given in Table VIII. agree well with those found by Fleming in 1880 with the exception of the coils A and B.

Some observations made at intermediate temperatures are in agreement with the statements just made. Thus on March 2, the temperature of the room being 12°, we found that at 4°·9 C. the difference between A and Flat at 0 was 256 bridge wire divisions, while for B at 4°·8 the difference was 280 bridge wire divisions.

Thus in conclusion we infer that while the observations in 1880 and 1888 are in close accord for temperatures between 10° and 20° there is a discrepancy between them at lower temperatures for the two coils of platinum iridium A and B. The other coils, however, do not show any marked evidence of change. For the same two coils there is a discrepancy between our results and those of Chrystal in 1876 and Hockin in 1867. For the other coils the agreement between Chrystal and ourselves is as close as can well be expected, and our results as well as those of Chrystal agree with Hockin's for the gold silver coil C and the platinum coils D and E. According to both Chrystal and ourselves the platinum silver coils have fallen in value relatively to the others by something like ·0006 B.A.U., corresponding to change in the temperature at which they are correct of some 2° Centigrade. We have seen, however, that G, the only one of these coils which was carefully examined by Chrystal in 1876, has not altered since. In its case the whole fall, if it occurred at all, took place between 1867 and 1876, and we suggest that possibly the fall has not been a real one, but merely apparent, owing to the use of the wrong temperature coefficient by Hockin.

TABLE IX.—*Giving the Values in 1888.*

Coil	Original No. See Report, 1867	Material	Temperature at which coil is cor- rect, 1867	Value of coil in Mean B.A. Units at the temperature given in 1867	Temperature at which coil is 1 B.A. Units, 1888	Temperature Coefficient in B.A. Units
A	2	Pt Ir	16°	1·00075	15·4	·00143
B	3	Pt Ir	15·8	1·00010	15·7	·00144
C	58	Au Ag	15·3	1·00050	14·8	·00071
D	35	Pt	15·7	·99930	15·9	·00308
E	36	Pt	15·7	1·00000	15·7	·00302
F	29	Pt Ag	—	—	15·7	·00028
G	43	Pt Ag	15·2	·99940	17·3	·00028
H	6 ¹	Pt Ag	15·3	—	16·8	·00028
Flat		Pt Ag	—	—	14·0	·00028

As has been said already, the value that has been assumed as the Mean B.A. Unit since Fleming constructed his chart in 1876 is the mean of the values of the six coils A, B, C, D, E, and G mentioned in the Report for 1867 at the temperatures at which they were then said to be



¹ This coil is not mentioned in the Report of 1867. The details given are from the label.

correct. In terms of this unit we find, Table IX., the present values at the temperatures of 1867. We also give in the last column but one the temperatures at which these coils have the value 1 B.A. Unit, and in the final column the temperature coefficients per 1° Centigrade also in B.A. Units.

There remains now for consideration the result of comparisons which we have made on various other standard coils originally issued by the Committee, and which have most kindly been put at our disposal by their owners for the purposes of the report.

Messrs. Elliott Bros. have three coils. One, No. 41 of the original set, was made by Matthiessen in 1864. A second, No. 56, was first examined by Lord Rayleigh in 1882: these two are B. A. Units, while the third, Elliott, No. 117, is a legal ohm, first tested by R.T.G. in 1884. These coils are all of platinum silver, with a temperature coefficient of $\cdot 00028$. Table X. gives the temperatures at which they were found correct at different dates.

TABLE X.

Coil and Mark on it at present	Matthiessen, 1864	Hockin, 1879	Hockin, 1880	Lord Rayleigh, 1882	Glazebrook, 1884	Glazebrook, 1885	Glazebrook, 1887
No. 41  No. 55	15·2	13·2	14·2	14·5	15·5	15	6·2
No. 56  No. 56	—	—	—	14·1	15·4	—	14·7
No. 117  No. 63	—	—	—	—	17·8	—	16·8

The observations made in 1887 are separated from the others by a double line because during 1886 it was observed that the paraffin used in the insulation was becoming green, and it was therefore removed and replaced by pure ozokerit. In consequence of this some change may easily have taken place in the coils, and the record after 1884 must be treated as a fresh one.

In the first coil the most noticeable point is the drop of 2° between 1864 and 1879; but since this drop is followed by a rise of 1° in the next twelve months one may feel uncertain as to whether it is real or due to some error in 1879.

In the next five years there appears to be a gradual rise in temperature corresponding to a fall in resistance; the total amount would correspond to a change in resistance of about $\cdot 0004$ B.A. Unit. The removal of the paraffin has seriously affected No. 41.

The next coil also of platinum silver, is one belonging to Professor Carey Foster. He writes as follows:—‘It professed to be equal to

1 B.A. Unit at 14°·2 C.

I had it direct from Matthiessen, who, I believe, adjusted it specially for me from his standards.’ On comparing it with F in May 1887 we find that it has a resistance of $\cdot 99983$ Mean B.A. Unit at 16°·2. It would therefore be right at 16·8.

This, of course, shows a considerable change, corresponding apparently to a fall in its resistance of about $\cdot 00073$ B.A. Unit. It will be noticed 1888.

that this fall is just about the same as that observed in the platinum silver units of this Committee—F, G, and H. We shall refer to it again in connection with the next series of observations.

But by far the most important series of coils are a set belonging to Mr. H. A. Taylor. With regard to them he writes:—‘Most of my coils belonged to Hockin long before I knew him, and at his death they were given to me by his father.’ ‘The early history of these coils is lost, unless it can be found in Matthiessen’s note-books. I am informed, however, that the one unit coil I sent you both last year and this, Ⓢ No. 68, was copied by Hockin from the B.A. coils you now have at Cambridge at the time when he had regular access to them. Whether from a particular standard or from the mean of several, I do not know; but he considered it to be at $15^{\circ}5$ C. less than B.A. Unit by $\cdot0003$. I presume the Au Ag coils, Nos. 19 and 34, were verified by Matthiessen and Hockin, as they have the formal B.A. stamp. With regard to the tens, one, I think, belonged to Hockin and the other was purchased by Messrs. H. C. Forde and Fleeming Jenkin of the Committee in the usual manner.’

Table XI. gives Mr. H. A. Taylor’s observations on his coils on the assumption that Hockin’s standard has not changed.

TABLE XI.—Assuming a Coil (Ⓢ Hockin’s Standard) tested by Electrical Standards Committee (Ⓢ No. 68) to be, as stated by Hockin, smaller than 1 B.A. Unit by $3^{\circ}/_{\infty}$ (three-hundredths per cent.) at $15^{\circ}5$ C. The Table shows the Resistance in terms of 1 B.A. Unit of other Standards $15^{\circ}5$ C. at the dates given.

	Material	Temperature Coefficient $\text{°}/_{\infty}$	December 1874, Observations at $15^{\circ}5$ C.	January 1875, Observations at $17^{\circ}3$ C.	May 1879, Observations at $15^{\circ}5$ C.	September 1879, Observations at $16^{\circ}6$ C.	June 1887, Observations at $16^{\circ}1$ C.	May 1888, Observations at $16^{\circ}47$ C.
1 (C. F. T.) copy called right at $16^{\circ}1$ Centigrade	Pt Ag	2·6	·99994	·99997	·99985	·99984	·99985	—
1 (No. 19) B.A. coil issued as right at $15^{\circ}5$ C.	Au Ag	6·5	—	·99969	·99980	·99979	·99963	—
1 (No. 34) B.A. coil issued as right at $15^{\circ}8$ C.	Au Ag	6·9	1·00007	1·00014	1·00023	1·00023	1·00016	1·00020
10 (C. F. T.) copy called right at $15^{\circ}6$ C.	Pt Ag	2·6	—	10·0001	9·9992	9·9991	9·9991	—
10 (No. 3) B.A. coil issued as right at (?)	Pt Ag	3·1	10·0008	10·0021	10·0013	10·0013	10·0012	10·0011
10 (No. 4) B.A. coil issued as right at $16^{\circ}0$ C.	Pt Ag	3·1	10·0009	—	9·9995	9·9999	9·9997	9·9991



Where the temperature of observation differs from $15^{\circ}5$ C. the reductions to that temperature are made by the temperature coefficients given.





The evidence of a change is very small. The observations have lasted over 14 years. For the first coil there would seem possibly to have been a drop of about $\cdot0001$ between 1875 and 1879. The next coil may have risen by as much and fallen again, while the third coil would seem to have risen by $\cdot00015$. The results for the ten ohm coils are much the same. From the six coils, some of platinum silver, some of gold silver, we conclude that there is certain evidence no change greater than 1 in 10,000 has occurred in the last fourteen years.

The next table enables us to compare these coils with the standards at

Cambridge. It will be noticed at once that relatively to the Cambridge standards the coils have all fallen.

TABLE XII.

Coils	Col. I.	Col. II.	Col. III.	Col. IV.	Col. V.	Col. VI.
	Nominal Value as Issued	Glazebrook's Determination	Temperature Coefficient (Hockin's)	Temperature Coefficient (Taylor's)	Present Resistance of the Coils at the Temperatures given in Col. I.	
	Cent.	Cent.	Hundredths	Per cent. per 1°	From Cols. II. and III.	From Cols. II. and IV.
No. 19 . . .	1·00000 at 15 ^o ·5	·99959 at 16 ^o ·5	6·5	6·97	·99894	·99889
No. 34 . . .	1·00000 at 15·8	1·00030 at 16·7	6·9	7·4	·99968	·99963
1 H  68 . . .	·99970 at 15·5	·99926 at 16·6	3·1	2·8	·99892	·99895
		(1888)	3·1	2·8	·99900	·99908
10 No. 3 =  69	10·00000 at 15·5	·99985 at 18·25	Assumed		9·99403	
		(1887)	3·1			
		10·00209 at 18·1				

Let us take first Hockin's standard  68. Using Taylor's temperature coefficient we find as its present value—the mean of the two given in the last column—at 15^o·5, ·99901. It has therefore fallen relatively to the Mean B.A. Unit by ·00069, practically the same fall as that found for all the other platinum silver coils examined. The coil C.F.T. (the first coil in Table XI.) will also clearly have fallen by the same amount. Similarly with the ten unit platinum silver coil  69; it has fallen from 10 to 9·9940, or by ·006, nearly the same percentage; and since, according to Table XI., the coils have not changed relatively to each other and to the gold silver coils by more than one-sixth of this amount since 1874, there is some probability that the change, if it has taken place at all, occurred between 1867 and 1874. It will be remembered that we arrived at a similar conclusion with regard to G. The difference between the values of  68, found by myself in 1887 and 1882 as recorded in the two last lines of Table XII., arises from the fact that in 1887 the coil was compared with F, and in 1888 with Flat and G. In making the calculation it was assumed that the values of F, Flat, and G in terms of the Mean B.A. Unit had remained unchanged since Fleming's time. The results of our comparisons given in Tables IV., V., &c., would, as has been said, point to a slight rise in F of possibly as much as ·0001, and this would reconcile the two values for 1 H or  68. As regards the gold silver coils Nos. 19 and 34, if we take the value as issued, the one has fallen by ·00111, the other by ·00037. We must remember that the temperature coefficients for these coils are much greater than for the platinum silver coils.

If, however, we compare the values as issued with those found by Taylor in 1875—Table XI., column five—we find that while No. 19 was

then .99969 at 15.5, showing a fall of .00031, No. 34 was 1.00014, showing a rise of .00014. Since this date No. 19 has fallen therefore by .0008, and No. 34 by .00051, and these numbers are within the limits of error of the fall of .00065 found for the platinum silver coils. We would infer then that while apparently there was a serious change in these coils relatively to the platinum silver standards between the date of issue and 1875, since that date there has been no change. On referring to Mr. Taylor's letter on p. 66 it will be noticed that the history of these coils previous to 1875 is uncertain; all that is known is that they have the formal B.A. stamp, and it is stated in the Fourth Report of the Committee, 1866, that all the coils issued are correct to .0001 at the temperatures stated.

There is still another coil of some interest. This is now marked  54. It was made in accordance with the suggestion of Chrystal in 1876, with a thermoelectric junction attached. Fleming compared it with his standards in 1879 and 1880. In 1884 it was again compared by us and found to have the value .99658 B.A.U. at 8.3, with a temperature coefficient of .000295. It was then sent to Professor Kohlrausch at Würzburg for comparison with some mercury units constructed by Strecker, and was returned by him at the end of his experiments.

In 1888 it was again compared and found to be .99653 B.A.U. at 8.3, with a coefficient of .000290. It will be seen that the change is .00005, which is within the temperature errors.

Thus we conclude, from this general account of the condition of the coils at present, that with the exception of the platinum iridium coils A and B there is no evidence of any change of as much as .0001 B.A.U. since the years 1874 or 1876, but that all the platinum silver coils and the two gold silver coils belonging to Mr. Taylor changed apparently by about .0007 B.A.U. between the time of their construction and the time at which they were examined by Chrystal and by Taylor respectively. This change may of course be a real one; we incline, however, to suppose that it is apparent only, and offer the following explanation, already several times referred to.

Hockin says in a note to his Table of Temperatures, 'British Association Report,' 1867, which gives the temperatures for the standard coils of the Association: 'The values given in the above table are deduced from the german-silver coil called B¹ used in your Committee's experiments in 1864.'

He does not seem to have compared among themselves the standards of various materials, but to have referred each to B. Now we are ignorant of the temperature at which the comparison was made, but we know he used the coefficient .00032. This at present is too high by .00004. If we suppose that Hockin made his determinations with the coils in ice, then this error in the temperature coefficient would lead him to a value for the coil at 15°, which would be too high by .0006.

Having once got a platinum silver coil supposed to be known, it would be natural to use it as a standard rather than any of the others, because of its low temperature coefficient, and the error made in the original determination of G would thus be perpetuated. This conclusion is borne out by the observations on Messrs. Elliott's coil No. 41, Table X. Its standard temperature fell apparently by 2° between the time of its issue by Matthiessen in 1864 and Hockin's comparison in 1879, and then rose

¹ This is not the same as our B.

again between 1879 and 1882. This would be accounted for if we suppose that Hockin's platinum silver standard was too low.

P.S.—*November 1888.*—Since the experiments detailed above were completed a considerable change has taken place in F. It is now almost exactly equal to Flat, that is, it has risen in value by $\cdot 00048$ B.A. Unit. Further investigations as to the cause of this must be left till the next report.

Second Report of the Committee, consisting of Professors TILDEN and W. CHANDLER ROBERTS-AUSTEN and Mr. T. TURNER (Secretary), appointed for the purpose of investigating the Influence of Silicon on the properties of Steel. (Drawn up by Mr. T. TURNER.)

In the previous Report of this Committee, presented at the Manchester meeting, an account was given of a series of experiments undertaken in order to determine the effect produced by silicon on the properties of the purest variety of iron met with commercially. For this purpose metal was taken from the basic Bessemer vessel at the end of the blow, before any carbon or manganese was introduced, and to this fluid metal weighed quantities of silicon pig, containing about 10 per cent. of silicon, were added. It was then shown that silicon rendered the metal quiet in the mould, and that in the proportions employed the metal was tough when cold, and welded well. The elastic limit and tensile strength were both increased by the presence of silicon, while the elongation and contraction of area were diminished; the appearance of the fracture also changed from silky to crystalline, and with over 0.13 per cent. of silicon in all cases the metal was so red-short that the ingots crumbled to pieces under the rolls.

The present Report has to do with a series of experiments very similar to those described last year, the chief difference being that ordinary basic ingot metal was used instead of the specially pure iron previously employed. In these experiments, therefore, the metal has been taken in the condition in which it would be sent into commerce, definite quantities of silicon have been added, and the product examined both chemically and mechanically. The method of procedure was as follows: In a covered fireclay crucible a weighed quantity of the silicious iron was melted, and into the red-hot crucible was run about 40 lbs. of molten metal, which was taken from the ladle about the middle of a cast. After allowing the contents of the crucible to stand for about a minute, the metal, which was still thoroughly fluid, was poured in to another red-hot clay crucible, in which the mixture was allowed to solidify. By this means a very thorough incorporation of the materials was obtained. The experiments were conducted, as before, at the works of the South Staffordshire Steel and Ingot Iron Co., Bilston. Mr. F. W. Harbord kindly superintended the works tests of the material; the mechanical tests were conducted by Professor A. B. W. Kennedy, and in each case duplicate experiments were made; the chemical analyses have been performed by Mr. J. P. Walton.

TABLE A.—*Influence of Silicon on Ingot Iron. General Summary of Results.*

No.	CHEMICAL ANALYSES. (By J. P. Walton)					WORKS TESTS. (By F. W. Harbord)				MECHANICAL TESTS. (By Professor A. B. W. Kennedy)					Relative Hardness
	Si	C	S	P	Mn	Rolling	Hot	Cold	Welding	Limit of Elasticity	Break-ing Load	Ratio of Limit to Break inches	Exten-sion per Cent. on 10 inches	Reduc-tion of Area per cent.	
1	0.01	0.16	0.05	0.06	0.55	Rolled well	Good	Perfect	Perfect	tons 22.00	tons 29.64	.743	23.1	48.8	tons 6.25
2	0.061	0.16	0.028	0.058	0.619	"	"	"	"	22.21	31.61	.703	20.4	40.7	5.80
3	0.070	0.15	0.084	0.051	0.500	"	"	Good	"	21.05	29.51	.713	22.9	51.5	6.12
4	0.092	0.21	0.084	0.064	0.634	"	"	Perfect	"	22.43	33.66	.666	19.4	44.1	5.82
5	0.102	0.18	0.028	0.066	0.662	"	"	Good	"	21.26	33.57	.634	20.6	51.4	6.06
6	0.121	0.19	0.064	0.068	0.576	"	Good, but rather red-short at welding heat	"	"	22.70	31.86	.712	21.9	43.7	6.31
7	0.135	0.13	0.028	0.057	0.48	"	Good	"	"	21.29	29.42	.724	24.8	56.6	6.62
8	0.247	0.19	0.028	0.074	0.642	"	"	"	"	22.23	34.70	.640	17.6	49.6	5.36
9	0.320	0.15	0.040	0.081	0.49	"	"	"	"	22.32	33.23	.671	16.7	36.1	4.96
10	0.382	0.16	0.042	0.087	0.533	"	"	Perfect	"	24.72	35.67	.693	18.0	30.7	5.79
11	0.504	0.18	0.094	0.121	0.455	"	"	Broke short at 50°	"	26.35	36.72	.717	19.4	34.8	6.45

Differences so small as to be scarcely perceptible.

A general summary of the results is given in Table A., which contains both the chemical analysis, the works tests, and the mean of the mechanical tests of the specimens prepared as before described.

Specimen No. 1 was prepared from the metal taken from the ladle, it being poured into a red-hot crucible, and afterwards treated in exactly the same way as in the ten succeeding experiments. In this case, however, no silicious iron was added, and the values given are intended merely for comparison with those which follow. The analysis of this specimen was not made from any of the samples actually tested, but is what may be considered an average composition of such metal. The mechanical values are the mean of four experiments with metal from two separate charges.

The silicon pig used had the following composition:—Carbon, 1·96; silicon, 10·30; sulphur, 0·02; manganese, 1·90; phosphorus, 0·17.

On examining the results in detail, the following observations will be made:—

1. CHEMICAL COMPOSITION. — The silicon gradually increases from specimen No. 2, through the series to No. 11. The other constituents, though tolerably uniform, still show sufficient variation to influence the properties of the product, and allowance must be made for these differences in composition in drawing any conclusion as to the influence exerted by silicon.

2. WORKS TESTS.—It will be noticed that all the specimens examined rolled well, and that, with one slight exception, all behaved satisfactorily under the hot test. This is in very marked contrast to what was observed in the previous experiments, when silicod produced distinct red-shortness; the difference in the present case is doubtless due to the presence of manganese in the ingot metal. The cold or bending test was also satisfactory in all cases, with the single exception of No. 11, which contained 0·504 per cent. of silicon and 0·121 per cent. of phosphorus. In this sample it is not certain that the metal would have behaved in the same way if the phosphorus had been as low as in the other cases. In the welding tests the metal behaved well in every instance, showing that the presence of silicon has no perceptible influence on the welding property. In the cold and welding tests the results are the same as was noticed in the previous series of experiments.

MECHANICAL TESTS.—In the original metal both the limit of elasticity and the breaking load, which are given in tons per square inch, are rather higher than usual in this class of metal, while the extension and reduction of area are rather lower than is common. These differences are, however, not great, and may be accounted for by the comparatively small scale on which the experiments were performed.

Limit of Elasticity.—This varies in the first six specimens (Nos. 2 to 7) over a maximum range of 1·65 tons, and these small variations are of such a kind as may be explained by differences of composition other than those of silicon. In the specimens with more silicon, however, there is a distinct increase in the elastic limit due to silicon.

Breaking Load.—This varies in a manner which closely resembles that observed with the limit of elasticity. In the first six specimens the variations are irregular, the maximum range being 4·1 tons, and this variation can be accounted for apart from any influence due to the silicon present. With more silicon, however, there is a distinct increase of the breaking load, and this is doubtless due to silicon.

Extension.—The specimens 2 to 7 have an extension which, though slightly lower than usual, still accords with what would be inferred from the elastic limit and breaking load. If silicon has exerted any influence in these specimens, it is not well marked, though the low extension may be partly due to this cause. With more silicon the extension is distinctly reduced.

Reduction of Area.—This follows much in the same order as the extension, and is distinctly lowered with the higher proportions of silicon.

These results may be summarised as follows:—

On adding silicon in proportions not exceeding 0·5 per cent. to ingot iron containing manganese, the metal rolls well, and does not show any signs of red-shortness; it welds perfectly with all proportions of silicon, and (with the somewhat doubtful exception containing 0·5 per cent.) is not brittle when cold. With less than about 0·15 per cent. of silicon the limit of elasticity, the breaking load, the extension, and reduction of area, are but little, if at all, appreciably affected by the presence of silicon, but with more than 0·15 per cent. of silicon the limit of elasticity and breaking load are increased, while the extension and reduction of area are distinctly decreased by the presence of silicon. The effect exerted by silicon in increasing the tenacity of ingot iron is not nearly so great as that of carbon. The relative hardness is very slightly affected by the proportions of silicon used in these experiments.

It is to be regretted that, largely on account of the outlay it would have involved, these experiments have been conducted on a comparatively small scale, the ingots used weighing only about 40 lbs. On this account it has not been found practicable to perform tests connected with resistance to shock, a point to which the attention of the Committee has been several times directed, and which is, from a practical point of view, of considerable interest.¹

Third Report of the Committee, consisting of General J. T. WALKER, Sir WILLIAM THOMSON, Sir J. H. LEFROY, General R. STRACHEY, Professors A. S. HERSHEL, G. CHRYSTAL, C. NIVEN, J. H. POYNTING (Secretary), and A. SCHUSTER, and Mr. C. V. BOYS, appointed for the purpose of inviting designs for a good Differential Gravity Meter in supersession of the pendulum, whereby satisfactory results may be obtained at each station of observation in a few hours instead of the many days over which it is necessary to extend pendulum observations.

Mr. BOYS has not yet been able to construct the instrument referred to in the last report. Meanwhile no new design has been received.

The Committee ask for reappointment and a renewal of the grant of 10*l.* made last year.

¹ A more complete account of the above experiments is in type, and will be published in the *Journal of the Chemical Society*.

Report of the Committee, consisting of Professor H. E. ARMSTRONG, Mr. J. T. DUNN, Professor W. R. DUNSTAN (Secretary), Dr. J. H. GLADSTONE, Mr. A. G. VERNON HARCOURT, Mr. FRANCIS JONES, Professor H. M'LEOD, Professor MELDOLA, Mr. PATTISON MUIR, Dr. W. J. RUSSELL, Mr. W. A. SHENSTONE, Professor SMITHELLS, and Mr. STALLARD, appointed for the purpose of inquiring into and reporting on the present methods of teaching Chemistry. (Drawn up by Professor DUNSTAN.)

THE Committee decided at first to restrict their inquiries to the teaching of chemistry in schools. With this object, in December last they addressed the following letter to the Head Masters of Schools and the Principals of Training Colleges, both in Great Britain and Ireland, in which chemistry forms a part of the curriculum. The list of these schools was compiled from the 'Educational Year-Book.'

COMMITTEE ON CHEMICAL TEACHING.

Dear Sir,—At the meeting of the British Association held at Manchester in September last, Professor H. E. Armstrong, F.R.S., Mr. J. T. Dunn, Professor W. R. Dunstan, Dr. J. H. Gladstone, F.R.S., Mr. A. G. Vernon Harcourt, F.R.S., Mr. Francis Jones, Professor M'Leod, F.R.S., Professor Meldola, F.R.S., Mr. Pattison Muir, Dr. W. J. Russell, F.R.S., Professor Smithells, Mr. W. A. Shenstone, and Mr. Stallard were appointed as a Committee for the purpose of inquiring into, and reporting on, the present methods of teaching chemistry.

It is felt that great difficulty exists at the present time in teaching chemistry to elementary students, owing chiefly to the absence of agreement among teachers as to the best modes of giving instruction and to the diverse views of examiners. It is hoped that an inquiry by this Committee will be valuable not only to teachers of elementary chemistry, but also to those who have the responsibility of examining in this subject. The members of the Committee venture, therefore, to hope that you will assist them by furnishing, at as early a date as possible, such a report on the chemical teaching in your school as you consider will be most likely to aid their inquiry, more particularly with regard to the following points :—

1. The objects with which chemistry should be taught in schools.
2. The difficulties that are met with in teaching, and the best way of obviating them; the influence exerted by external examiners on the character of the teaching.
3. The methods which, in your opinion, are most likely to render the teaching effective as a mental discipline, and as a preparation for subsequent instruction in the higher branches of the science or in applied chemistry.

The Committee will also be greatly obliged for information on any other points directly connected with the teaching of elementary chemistry; any data with which you may favour them will be regarded as con-

fidential, and nothing of a personal nature will be published without your previous consent.

In making any communication to the Committee, it will be convenient if you will kindly affix to the manuscript the paper which is enclosed.

I am, Sir,

Your obedient Servant,

WYNDHAM R. DUNSTAN,
Honorary Secretary to the Committee.

Five hundred copies of this letter were circulated, but only eighty-six more or less extended replies have been received; they include the majority of the largest public schools in Great Britain. These replies have been the subject of careful consideration by the Committee.

The schools which have reported represent a total number of 23,350 pupils, and of these 8,418 receive instruction in chemistry; that is, 36 per cent. It will be useful to summarise in this Report, by means of extracts from typical replies, the chief points of general interest which have been alluded to, particularly those that were raised by the three questions suggested by the Committee in their letter.

‘1. *The objects with which chemistry should be taught in schools.*’

There is almost unanimous agreement as to the high educational value of the science of chemistry. Teachers seem agreed that chemistry should be taught in schools with two objects: first, and mainly, on account of the mental training and intellectual discipline it affords; and secondly, for the sake of its applications in the different professions and trades which the boys may subsequently follow and also in its direct bearing on the facts of everyday life. This view of the importance of chemistry as a part of the school curriculum is well exemplified by the following extracts taken from the reports made by various schools, both large and small, and representing boys who afterwards follow a diversity of trades and professions.

I. ‘Chemistry should be taught in schools—(1) As an educational subject or mental discipline. In studying chemistry the pupils are led to cultivate habits of *observation*, because the statements made in chemistry are based on facts actually seen; of *reflection*, because the accurate statement of even the simplest observed fact requires not a little reflection; and of *reasoning*, because reasoning is required before one can decide that any one particular result in an experiment is due to some one particular antecedent circumstance out of several. Chemistry also is especially the science in which experiment can be most readily had recourse to by the pupil. (2) As a valuable branch of instruction. Supposing that the mental powers were not developed and strengthened by the study of chemistry, it might still be desirable that pupils should not leave our public schools wholly ignorant of the composition, properties, and uses of the materials of everyday life.’

II. ‘Science and history alone of the subjects taught in schools perform a twofold function. They give connection of ideas, logical power, and education in the fullest sense, while at the same time they store the mind with useful facts likely to make the possessor a more valuable member of the body politic. Hence chemistry may be taught to *all* boys just in the same way as ancient languages and higher mathematics, without any thought of the future career of the pupil, or whether chemical

knowledge is likely to be of practical use to him or not. In this way the practical demonstration of chemical facts becomes a great object-lesson, while chemical theory becomes an introduction to logic. Chemistry may be taught for other reasons:—(i) To enable boys who show no special aptitude for any other subject to obtain a scholarship and university education. (ii) As a special subject, likely to be useful for those who, having passed the preliminary arts' examination, intend to adopt a medical career.'

III. 'The objects with which chemistry should be taught in schools:—1st. To make lads take a keener interest in natural phenomena. A few well-chosen experiments will excite their wonder, and at the same time create an interest in the secrets of nature. 2nd. To teach lads to see, *i.e.*, to develop their powers of observation. 3rd. To impress upon lads that there is a definite law of order in Nature. Lads soon see that from the same bodies under similar conditions certain fixed results must follow. 4th. To make boys logical and not too hasty in generalisation from a few isolated observations. Chemistry is peculiarly well fitted for this purpose. 5th. To direct the powers of destructiveness and constructiveness which are always so pronounced in boys, since they soon learn to be interested in simplifying many complex forms and in building up others. 6th. To impress upon lads, as soon as possible, that everyday life must necessarily be influenced beneficially by a knowledge of the chemical properties of a very few simple bodies and the laws which determine their mutual interaction.'

IV. 'There are, I think, two considerations to be kept in view:—(a) the general educational value of the work which gives chemistry a claim to be considered a necessary part of any liberal education, whatever be the profession in view; (β) the necessity of teaching chemistry on such lines that the instruction given may be a sound and valuable apprenticeship for such boys as may be led to devote themselves specially to this subject in the future.'

The following sentences (V.) were written by the head-master of one of the first public schools in England.

V. 'I think that the objects with which chemistry should be taught in schools are three:—(α) To make every boy acquainted with common scientific facts, useful to him in every branch of life. (β) To give opportunity to boys with special aptitude for science to take up and develop the study; many a boy who seems dull at languages brightens over science. (γ) To enlarge the mind by the suggestion of new methods and processes and by the illustration of the mode in which Nature works.'

VI. 'I have found that the teaching of chemistry, besides its direct value for professional and business purposes, is of great importance as a means of developing the minds of boys who have no aptitude for other subjects. I have found that many boys who cannot get on at classics and mathematics take an interest in and learn chemistry, thus being greatly encouraged in their other work by the knowledge that there is something that they can do.'

VII. 'Chemistry should be taught chiefly for mental discipline. Practical chemistry is almost the only school subject in which hands and brains are equally employed.'

VIII. 'In schools chemistry, like other subjects, is, no doubt, taught with a double view—mental training and the imparting of valuable know-

ledge. As to the former of these, the subject is not, in the opinion of the present writer, of great value, for the methods of demonstration as they can be exhibited in a school laboratory are not very rigorous and logical, and at the best seem rather to afford a strong presumption than a satisfactory assurance in favour of any particular conclusion. As to the latter object, it may be said that it is not one about which educationists generally are very enthusiastic. At the same time, if there is any subject more than another the knowledge of which is desirable it is chemistry. The entire change of mental attitude towards physical surroundings, which even a slight knowledge of the principles of chemistry induces, is most noticeable, and boys find it both a source of healthy wonder and, though they do not observe it themselves, a great mental stimulus. There is, of course, one other object with which chemistry may be taught, namely, for the sake of those who will find it directly useful in after-life. But as they are, after all, only a small percentage of the whole, the argument of practical utility is one which cannot be advanced as in itself a justification for teaching the subject.'

IX. 'Chemistry should be taught in schools while boys are comparatively young, in order that those who have no taste for classics may find some work in which they can take a practical interest. There are boys who, without being stupid, have no taste whatever for books, and the chance of practical work, like chemistry, for which they can see some use of an obvious kind, may prevent many a boy from becoming a confirmed idler. The study of chemistry, therefore, should be encouraged as a distinct benefit to the character of many boys. It should also be encouraged for the public good, because any boy so interested in early life may be led to devote his after-years to the pursuit of scientific subjects. And again, it should be taught in schools to enable boys who go into business now very young to have some slight knowledge of scientific facts of an elementary kind while they still have time to learn.'

X. 'All my experience shows that even to young children chemistry may be made the threshold of the fairyland of science, and that by means of it they may early acquire a profound sense of the rigorous, unyielding nature of law and of the unity in the midst of diversity which pervades the world around us. Again, as a mere discipline for the intellect, I believe chemistry is destined to take the place of Latin and Greek grammar, when a definite course of teaching has been laid down, and teachers have themselves mastered that course as thoroughly as former teachers had mastered their accidence and syntax. To make the pupil aware of the existence of an unknown, unexplained, inscrutable side to every, and even the simplest phenomenon, is to awaken desire, expectation, pleasure—all the antecedents of healthy mental effort, and the difference between the daily, hourly life of one who has thus become conscious of the literally infinite, ineffable nature of things around him, and that of one who thinks he knows all about them, is immense.'

XI. 'Too much weight may easily be attached to the objection often urged against chemical teaching (and, indeed, against the study of other branches of natural science), that it fails to cultivate good taste and good style; that the learner is brought into contact merely with material facts and not with human thoughts, and so acquires a character and mode of expressing himself as hard, rough, and unsympathising as the laws of Nature with which he deals. It is certainly impossible to avoid noticing that the abstracts of lectures and answers to examination papers shown

up by those who have been, or are being, well trained in "the humanities" are composed in much better style than the productions of boys who have had less advantages of the kind, or who, from their dulness in other subjects, are considered to be exactly fitted for learning natural science. But the power of refuting this objection rests with the teacher. If he refuses to pass over bad spelling and bad grammar, if he takes the trouble not merely to point out slovenliness of expression, but to show how it may be corrected, and if the learner is compelled to rewrite any careless, inaccurate work in better form, there seems no reason why an account of the two oxides of carbon, including an intelligent comparison of their properties, may not be made as good an exercise in English composition as an essay on points of Greek and Roman history.'

2. *'The difficulties that are met with in teaching, and the best way of obviating them; the influence exerted by external examiners on the character of the teaching.'*

Much might be written about the various difficulties which are alluded to in these reports in answer to the second question suggested by the letter of the Committee. The chief difficulties are stated to be those which arise from:—(i) Defective organisation and considerations of expense; (ii) the lower value attached to chemistry, as compared with other subjects of the school curriculum; (iii) the time which is devoted to the subject; (iv) preparation for various examinations; (v) absence of good text-books; (vi) dearth of properly qualified teachers.

(i) The expenses incidental to chemical teaching and the defective organisation, which is often the result of insufficient endowment, are the subjects of general complaint. Sometimes no laboratory is provided; frequently the laboratory accommodation is inadequate; and it appears that the details of the preparations for lectures and practical work generally devolve on the teacher himself. The following statements may be quoted. The first two are from the reports of small schools.

XII. 'We have no laboratory or other facilities for practical work, and so our experiments have to be very simple and our work very elementary.'

XIII. 'The chemical teaching is quite elementary, and there is no apparatus, so that it is only taken as a lesson with figures drawn and explained on the black-board.'

XIV. 'Thus our difficulties are:—(a) Having too many to teach. I am responsible for about 160 boys, and have no help. (b) The want of a large laboratory. We have a small but very good laboratory. There is, however, only accommodation for 12 boys, while I always have about 70 doing practical chemistry in an aggregate of 6 hours a week. Hence each boy gets only one hour a week. (c) The want of sufficient time to prepare for experimental work. The whole of my school time, except three hours, is taken up in teaching, so that all preparation has to be done either before or afterwards, the practical result being that I am obliged to limit my experimental teaching to the two lowest and the highest forms.'

XV. 'The chief obstacle to the effective teaching of chemistry here is the poorness of the laboratory—a room in the basement, low pitched, ill lighted, and worse ventilated, accommodating only 15 boys, and in such connection with the other class-rooms as to make some of them

almost unbearable when experiments are made with any foul-smelling gas.' [This school contains 500 boys.]

XVI. 'To lecture properly, a master must have an assistant for the experiments. I do not know what is the rule; I hope I am an exception, for I am without one. I make use of one of the promising boys to help in the preparation preceding a lecture. This is not sufficient. A master cannot easily conduct his experiments, keep order, and carry on a judicious questioning and explanation at the same time.'

XVII. 'Every teacher of chemistry who has several lectures to deliver in the course of the week ought to have the services of a fairly intelligent assistant, who can get ready most of the experiments for him, or he ought to have extra time allowed him to do this himself. Of course it is possible to utilise the services of the more advanced pupils for the purpose, but this does not effect so much saving of time as might be thought, owing to the want of experience on the part of the boys, who in many cases require so much supervision that it is shorter for the teacher to do the work himself.'

XVIII. 'We have just abandoned the subject owing to its ruinous expense if taught thoroughly.'

XIX. 'We have no laboratory and have to do the best we can with a table in a class-room. Experiments are shown, but not performed by the boys for this reason.'

XX. 'Schools are often badly equipped with a suitable lecture-room, laboratory, and apparatus, partly from poverty and partly sometimes from inability on the part of the head-master or governing body to appreciate the needs of the subject.'

XXI. 'Another difficulty is that in many cases the teacher has not time to prepare adequate experimental illustration. Until recently the chemical teaching in this school was done by the second master, who had the whole of the school hours not engaged in teaching science occupied in his own form in general subjects. A public day-school does not usually (like a science college) possess paid demonstrators and assistants, hence, unless the teacher has a considerable amount of time not actually occupied in teaching, it is impossible for him to make and set up apparatus for experiments in a proper manner, and experiments that constantly fail are worse than none.'

(ii) The following statements deal with the difficulties that ensue from the relatively low place which is generally afforded to chemistry in the school curriculum, and the low value which is assigned to it in public examinations as compared with the value attached to other subjects. This, it is said, often leads to the restriction of chemical teaching to inferior boys, some of whom may have failed in classics and other subjects. The best boys may leave the school having received little or no instruction in chemistry.

XXII. 'One difficulty arises from the low standard of public opinion as regards science. This is chiefly due to the extraordinary and utterly unaccountable view (confined, I think, to England and America) which classical men have always had of scientific studies. In this school, owing to the exceptional liberal-mindedness of the powers that be, this evil is unknown, but in other schools where I have taught the jealousy between those who represented different kinds of study was enormous, and clever boys were therefore more attracted to literature than to science.'

XXIII. 'As regards the difficulties in teaching chemistry, I think per-

haps the first is non-classification. The boys are sent to chemistry lectures grouped according to classics; the result is confusion. Take the fifth form, for example. It is sent into the laboratory for an hour's lecture. In that form you have some of your promising boys, also some of the weak ones, very good classics possibly, whom to teach chemistry is, you know, hopeless. But the work must be done, so you take a medium course, pitching your discourse to suit the average boy; you must be very careful to aim low or you will certainly hit nothing. In doing this your lecture is below the promising boys, who feel a growing contempt for you or your subject, and at the same time the lowest boys are wearied by matter which they cannot grasp.'

XXIV. 'Two difficulties are:—(i) Want of sympathy with natural knowledge on the part of the majority of university men who take to school work; (ii) strong adverse traditions in many schools backed up by the fashionable superstition that literary rather than scientific studies constitute the education of a gentleman.'

XXV. 'The difficulty is that parents do not yet recognise chemistry as a "paying" subject, consequently their boys neglect it.'

XXVI. 'A serious difficulty is caused by the fact that boys may join a class in any term. This may not be a great evil in the case of languages or mathematics, but where from the very nature of the subject it is necessary, in order to understand and benefit by a lesson, that the preceding lesson should be first mastered, the case is altogether different, and it is not clear how this and the kindred difficulty of grouping in one set boys of very unequal powers and attainments can be obviated, seeing that schools are classified on other lines, generally according to proficiency in classics.'

XXVII. 'I believe that one of the great stumbling-blocks in the way of chemical teaching in day-schools is, that boys are often sent to the science master in classes determined by their position in classics or English subjects, so that there is no proper gradation in the teaching. This obtained here until recently, but now, by simultaneous teaching by three masters on two afternoons a week, it is possible to group the boys in the senior school according to their proficiency in science (mainly chemistry) alone. The result has been a considerable improvement in the quality of the work.'

XXVIII. 'The scholastic disrepute in which chemistry is held is apt to lead a head-master to devote to it the least mentally qualified boys, who have absolutely failed on the classical side.'

(iii) It appears that the time which is usually allotted to chemistry in schools is altogether inadequate, and frequently this defect seems to constitute one of the teacher's greatest difficulties.

XXIX. 'I suppose few grammar schools give more time to chemistry than four hours a week, and so long as competitive examinations assess chemistry at one-quarter the value of mathematics, and one-eighth that of classics, more time cannot be expected. When it comes to be recognised that the mind which is scientifically trained is most likely to produce work valuable to the community, and at the same time is best suited to grapple with the practical problems of everyday life, all this will be changed.'

XXX. 'This school contains 500 boys. The average number of those who receive instruction in chemistry is 30 and the time allotted to the subject is three hours a week.'

XXXI. 'The difficulty is to make all pupils take a real interest in the work. In the short time which is allowed to the subject it is apt to become a mere collection of facts in the boy's mind. It is a curious fact that a double labour is expected from the teacher of science, namely, a general development and quickening of the reasoning faculties, and the teaching of examination-chemistry at the same time; and all this has to be done in two hours a week! Parents at any rate tacitly pay a very high compliment to the resources of science when they expect this. As a matter of fact, the unfortunate science master very naturally leaves the great work of development to the master who monopolises the remaining 26 hours of the week's work.'

XXXII. 'The time allowed to the 65 boys who learn the subject is one period a week of 45 minutes.'

XXXIII. 'All the pupils who are taught chemistry—491—devote two hours per week to the subject, and 110 of these have in addition a weekly lesson in laboratory practice, lasting one hour and a half.'

(iv) A consideration of these replies has fully established the important fact that the chemical instruction which is given in schools is very largely influenced and guided by the requirements of the various Examining Boards, such as those of Oxford and Cambridge and of the Science and Art Department. Abundant testimony has been received on this point, and it is frequently declared to be a great, though apparently an inevitable, evil. The quotations cited below are selected as representing schools of very different grades.

XXXIV. 'The influence exerted by external examiners on the character of the teaching. This has always been to me the most subversive of good teaching and most damaging to the character of the work. I have had a large experience in the working of the various public examinations, and I unhesitatingly say that they cripple the work of teachers, afford no safe index as to the quality of the work, and lead to a system of book-work cram which militates against anything like mental discipline and against subsequent instruction in the higher branches of the subject.'

XXXV. 'But all difficulties are nothing compared with those that arise from the personal peculiarities of examiners. Unless with special pupils who, having spent most of their time on chemistry, have been able to acquire some knowledge of all its branches, a teacher is never sure that he will be able to prove to an examiner that he has taught any chemistry at all.'

XXXVI. 'It will be seen that the examinations for which our pupils are prepared are those of the Cambridge Local, the College of Preceptors, and the Science and Art Department, and the preparation for each is so varied that it has a very bad influence.'

XXXVII. 'The influence of external examiners, in my opinion, is too often to encourage mere cramming to meet out-of-the-way questions.'

XXXVIII. 'A class was formed from the pick of the school in connection with the Science and Art Department. My salary to a certain extent depended on the results of the May examinations. Since the number in the class had to be limited, I naturally chose only those boys who I thought would have the best chances of getting through. For a great part of the year chemistry would be treated as a by-subject, it was only for a month or so that it had its due share in the curriculum of the school, and I must conscientiously admit that during the short period before the examination I simply crammed the minds of my pupils with

equations, properties, graphic formulæ to such a degree as to ensure passing, which they all did. I was not surprised to find that in a short time all had been forgotten. This system is adopted at many places.'

XXXIX. 'The teaching of chemistry here is entirely regulated by the Science and Art Department, for the simple reason that it would not exist as a class subject without the pecuniary aid rendered by the Department. I believe some really good work is being done; but the teacher is very much of a machine, and, however conscientious he may be, he must primarily, under the circumstances, teach for examination, and at times neglect what would be useful to his pupils because it would not be useful for examination.'

XL. 'In this school chemistry is optional, and the primary object of its existence is the advantage of those boys who are going in for examinations in which it will prove useful.'

XLI. 'There is great variation in the standards and methods of various examinations. Three things are specially to be complained of:—(a) the bookish nature of some examination papers; (b) estimation of the value of answers by comparison with text-books by inferior men, not always the authors of the papers or themselves real chemists; (c) want of judgment in setting papers arising often from ignorance at first hand of the conditions of school work.'

XLII. 'With respect to examinations, I do object to men examining boys under sixteen who have never taught them, and who, therefore, do not understand that the work of such students must differ not only in quantity but also in quality from that of older pupils.'

XLIII. 'I believe that 90 per cent. of those who are now taught chemistry in this country are taught with the view of passing one or other of the examinations held on the subject. Further, I believe that most of the difficulties of teaching chemistry are difficulties of teaching it so as to comply with the requirements of examinations. Some one has said that in the regulations of the Science and Art Department so much is required to be known that there is no time for anything to be done, which is an exaggeration of what I mean. With ordinary teachers one thing is necessary—their pupils must pass. When that is secured they may indulge in such novelties of method and procedure as they like, but not until then. It would avail me nothing to say that my instructions were faulty, that I knew and followed a more excellent way.'

XLIV. 'As to the influence of examiners. In my own teaching it has been for the last few years *nil*. I have given up trying to fit the chemical instruction to the doubtful requirements of examination; to do so would take the vitality out of one's teaching and contract it.'

XLV. 'With regard to the influence of external examiners on the teaching, there is no doubt that this is very great, and that the character of the teaching in our schools must depend in these high-pressure examination-days on the requirements of the examiners.'

XLVI. 'We have subjected our boys to two examining bodies—the Science and Art Department and the University Board. In successive years the boys from the same teaching universally succeeded under the former and almost universally failed under the latter.'

XLVII. 'The examinations have been chiefly those held in connection with the Science and Art Department, South Kensington. These examinations have been for some years back highly satisfactory, and no undue prominence has been given to any one branch of chemical science.

They certainly do exert an influence on the character of the teaching, but it is a restraining and beneficial influence.'

XLVIII. 'The influence exerted by external examiners on the teaching is decidedly beneficial *when the examiners are experienced men.*'

XLIX. 'The influence exerted by external examiners on the character of the teaching is practically *nil*. They send their questions and substances, examine the results, and write their reports, and, with rare exceptions, never make a suggestion as to how the teaching may be improved or better results obtained.'

(v) The absence of good text-books suitable for use in schools is frequently stated to be a source of difficulty.

L. 'One of the chief difficulties in class teaching is the want of a suitable text-book, more especially when preparation is an important factor. A text-book should without any great amplification on the part of the teacher make itself intelligible to the boy on reading it for the first time, and it should not be overladen with facts.'

LI. 'We want a good school text-book. Existing books entirely lack connection in their various parts, and are generally made up of a series of more or less isolated facts grouped loosely under various heads. They are also too diffuse and wordy, and, therefore, very unsuited to a boy with but a limited time to prepare his lessons.'

LII. 'An additional difficulty is found in the absence of a satisfactory text-book, notwithstanding the multitude already extant, and this difficulty is not diminished by the consideration that, as a rule, the science master is required to devote a great portion of his time to teaching other subjects. According to my idea, the kind of book required is one that recognises the close connection between the lecture work and the practical work of the pupil; in fact, a book something after the plan of Huxley and Martin's "Biology."'

LIII. 'The greatest difficulty we meet in teaching chemistry is the want of a suitable text-book on which all our lecturers can base their teaching. Boys sometimes get different definitions of the same term, and a master does not know exactly how much boys have learnt in another class.'

LIV. 'Text-books are another difficulty. I have never found one yet that I liked to put into the hands of boys, for I have generally found that they are too elaborate and complete, using, sometimes, language which the ordinary schoolboy does not understand, and describing here and there experiments which he certainly cannot grasp. I have not found a book which I could put between the "Chemistry Primer" (which with the "Physics Primer" is always my preliminary course) and such a volume as Thorpe's or Roscoe's; these contain a great deal of matter too difficult and minutely exact for class work.'

LV. 'Further, there is the eternal text-book difficulty. A book at once clear, brief, and accurate is a desideratum.'

(vi) Some head-masters complain that they are unable to obtain properly qualified teachers of chemistry.

LVI. 'Difficulties arise from the circumstance that there stands before the class a chemist who is not a teacher, or a teacher who is not a chemist.'

LVII. 'The scholastic disrepute in which the subject is held is apt to affect the teacher. It is much easier to obtain a well-qualified teacher of classics than an equally well-qualified one of natural science.'

LVIII. 'Our two great difficulties here are:—(1) To get men, for

anything we can offer, who are at once chemists and teachers. Mere chemists are of no use from a pedagogic point of view, and even they would be hard to get. I am convinced that a *teacher* who had a strong grasp of the principles of the science could, and would, make it an eminently valuable means of mental training. (2) The entire non-recognition of chemistry by the two universities in the earlier stages of their arts courses.'

3. '*The methods which, in your opinion, are most likely to render the teaching effective as a mental discipline, and as a preparation for subsequent instruction in the higher branches of the science or in applied chemistry.*'

A great deal has been written in reply to the question as to the methods which ought to be followed in teaching elementary chemistry.

It is clear that the older plans of teaching, which are still largely used, are felt to be partly unsatisfactory, and that by modifying them chemistry might be made much more valuable as a mental discipline for boys. In particular protest is made against the undue proportion of time which is frequently assigned to qualitative analysis; indeed, the majority of teachers do not consider this to be the most valuable part of the subject. Others hold that it presents many advantages, and is, on the whole, the best adapted to school work, especially when instruction has to be given to large classes of boys. But while most teachers strongly deprecate a rigid adherence to the present system, and a few are able to point out the general lines on which the teaching might be more usefully conducted, it is evident that very few, if any, have yet put into operation a remodelled system of instruction. In fact, it appears that teachers stand very much in need of advice and assistance in preparing a modified scheme of teaching suitable for general adoption in schools. It has several times been suggested that this Committee might be able to render important help in this direction.

The following quotations are typical of many of the replies which have been made. They are written by the head-masters or science masters of both large and small schools, and are here reproduced, not only because they allude to some of the principal defects of the present methods, but also on account of suggestions they contain which seem likely to be valuable to those who are anxious to make chemical teaching more effective than it is at present.

LIX. 'The teaching should be experimental in all cases. The experiments need not be numerous, but apposite, and the utmost got out of them, both directly and indirectly. I find, for example, that I can get a good hour's work out of boys in the lower forms with such subjects as the separation of sand from a solution of salt, the action of water on lime, or the action of nitric acid on copper. I find that the same plan of limiting the attention to one or two important points is also most effective in the upper forms when the exigencies of examination-work admit of this kind of treatment. Notes of lessons should be relied on rather than text-books. I find, for example, that the ground covered at previous lessons is always known, but that I get next to nothing out of a set lesson from a book. This will be sure to follow from an experimental method of treatment. Above all, I would suggest the entire remodelling of all school examinations and the placing them in the hands of men who have had experience in teaching,

and know, therefore, what to expect of boys, rather than in those of men fresh from the "schools," and with only the experience of university teaching. I should also like to see the range limited and the examination papers graded. The extent of the ground covered by the Local Examination papers of the universities is too great for such schools as this, though Oxford has recently much curtailed them.

'I am led to hope that your Committee may see its way to step in and produce something like uniformity and system. Would it not be possible to draw out a scheme of teaching divided into "grades," and suited to a progressive course, as also to issue yearly sets of examination papers adapted to these different grades? I sincerely trust that this may be one of the results of your inquiry, for I feel sure that examination by so high an authority will have a most beneficial effect on science teaching, and have a value in the hands of examiners impossible under any of the present systems.'

LX. 'It is, in my opinion, no use crying out against the system of examinations in this country. For years to come the nation will go on demanding results and getting them. Can those results be made more worth having? I believe they can. It lies entirely within the power of the eminent and working chemists of the country to effect great and useful reforms almost at once. It should be acknowledged that the present requirements are obsolete. Looking at the enormous and ever-increasing number of important and interesting facts, has not the time come when chemistry should be taught to beginners as biology is taught? Instead of reading about hundreds of plants and animals, a student becomes practically acquainted with about a dozen of each at first hand. Why should not a similar plan be followed in chemistry? Why should not a thorough study of chlorine include all that an elementary pupil needs to know about the halogens? The principal member of each group of the non-metallic elements might be selected for special study. As to the metals, half-a-dozen, which might be varied from year to year, if really mastered, would be much better than the knowledge which is required of them under the present system. Room would thus be found for a few organic compounds. It is pure pedantry to maintain any longer the arbitrary distinction of inorganic and organic chemistry in a first and general course. As to analysis, I think the present comparatively complete course should give place to a sound knowledge of the separation of some half-dozen substances, and the time thus saved could be devoted to easy exercises in quantitative analysis. There can be no doubt that quantitative analysis is within the reach of any student who can perform a good qualitative analysis. What I have proposed amounts to rewriting a syllabus for a first or general course of chemistry, on the basis of selecting a few typical substances and making a more or less complete study of them, and, with regard to analysis, to restrict the substances to be studied, but to require the elements of gravimetric and volumetric determinations.'

LXI. 'To render the teaching of chemistry of educational value it must be made inductive, and not chiefly and largely deductive. The guiding motto should be, "Prove all things." Experiments should be made with as simple apparatus as will secure the desired result. In the earlier lessons avoid all definitions, all hypotheses of atoms and molecules, of atomic weight and of "bonds," but early establish the constancy of composition of compounds and the equivalent weights of certain elements in

combining with or displacing one another. I should like to see some encouragement given to the historical aspects of chemistry. I have found that explanations of when and how the chief elements, acids and alkalies came to be known add much to an intelligent interest in the subject.'

LXII. 'It has always appeared desirable that a boy should approach chemistry in the same way that all the founders and builders-up of the science have done: viz., not by first reading a printed account of facts and then verifying them or seeing them verified, but by studying the different forms of matter as substances hitherto unknown, the properties of which have to be investigated for the first time and compared with those of other substances. With this view the experiments shown are considered as questions put to Nature, the answers to which are as little known to the lecturer as to the learners. No predictions are made as to the results, although boys are not unfrequently asked what, arguing from experiments previously shown or the properties of analogous substances previously examined, may be expected to occur. All apparatus used is described; the reasons for any special arrangement of it being explained fully. Elaborate forms of apparatus with a profusion of drying tubes, Woulf's bottles, fantastically bent leading-tubes, are avoided as far as possible, their tendency being to draw off attention from the main point of the experiment. The arithmetical side of chemistry is not very much enlarged upon; it seems hardly desirable that boys should look upon experiments as pegs on which numerical problems are to be hung. Too much time may easily be spent in elaborate calculations on the quantity of zinc required to obtain enough hydrogen to decompose the nitrogen monoxide produced from ten grammes of ammonium nitrate. Innumerable examples, however, illustrative of important laws, such as those of Gay-Lussac and Avogadro, and of calculations actually required in quantitative work, are frequently set, generally at the beginning of each lecture, in reference to some point explained in the preceding one. No symbols, formulæ, or equations are used at first—not, in fact, until the properties of three or four elements, and of some of their compounds, have been studied and the laws of chemical combination deduced from them. Then, and not till then, it is thought that a learner can appreciate the value of Dalton's atomic theory in accounting for the facts he has observed, and can see the advantage of a system of chemical shorthand, and use it with intelligence and discrimination.'

LXIII. 'The method, in my opinion, most likely to render the teaching effective as a mental discipline is mercilessly to sweep off a large proportion of the facts at present dealt with, to confine the attention of the pupil to those that for various reasons are the most important, and to use them always as illustrations of general laws. For this purpose, there must be agreement among teachers and examiners. I do not think it beyond the scope of your inquiry to suggest that, to make chemistry or any natural science do all that it can do towards mental discipline, there must be an attempt to use it as a means of destroying the contempt which familiarity breeds in us all towards common things. Unless you can call forth the interest of your pupil, his admiration, even his reverential awe towards the mystery of Nature, you have perhaps done more harm than good.'

LXIV. 'Eternal analyses of simple salts and mixtures such as are required by examinations of the present day weary and worry the student,

waste his valuable time, and throw away labour which in nearly every individual case would be most profitably spent in carefully studying and testing some important laws or principles of chemistry, and which would make the student's knowledge of the subject thorough and personal. Chemistry is essentially an experimental science. The great value of the study of the whole subject lies in the practical work done and in the method of building the theoretical structure on the practical knowledge. It is therefore absolutely necessary to have a thoroughly good laboratory with a lecture-room attached, so that collective and individual work may be carried on with equal facility. At the present time, in our schools and colleges there is too much working for examinations, and the requirements to pass such examinations are as narrow as paper legislation can make them. The student is for ever testing mixtures or performing some exceedingly simple gravimetric analyses. He is tied down, has his knowledge fettered instead of having it expanded, and never reaches the more advanced and useful principles of chemical science, which he can only dream of from the hearsay of his text-book.'

LXV. 'There is no scale of value of the different parts of chemistry; there is no recognised system as to which should be taught first. I have known boys obtain scholarships simply because their teacher had been recently a pupil of their examiner and knew the kind of questions he was likely to set. The ordinary text-books, lectures, and practical work do but little for even the hardest worker. We want an authorised code of work issued by a consensus of the highest authorities.'

LXVI. 'I object strongly to boys in a laboratory being allowed to mix different solutions in test-tubes, day after day, to find out whether precipitates are formed or not. I have a high opinion of the advantages derivable from the teaching of chemistry when none of the harder parts are shirked, as a valuable mental discipline, and as giving, with drawing, the best means of teaching an ordinary boy the use of his hands as well as his head.'

LXVII. 'The result of the absence of practice in quantitative experiments is to create an unnatural breach in the minds of pupils between the actual phenomena of chemical action and the theories by which such phenomena are to be explained. It might be found possible to treat the subject more logically if some attempt were made to teach the facts in a more natural order. The historical sequence by which the science has attained its present proportions might form the basis of a rational arrangement of the parts of the subject. In this way, by placing the pupils in the attitude of mind of original discoverers, the logical necessity of theories to account for the facts would give them more real meaning and interest. I am not acquainted with a text-book suitable for school use in which such an order is followed.'

LXVIII. 'Boys have been lectured to as if they were students, thereby producing a condition of things described by some writer as the perfect paradise of a boys' school, where the masters learnt the lessons and the boys heard them. Chemistry should be taught as everything else is taught—by making the boys do the work themselves—and the lesson should be a system of question and answer.'

LXIX. 'The calculation of chemical quantities, involving atomic weights, ought to come quite late in the course, so that the atomic theory is kept in the background at first. The pupil should make several experiments on the diffusion of gases and liquids which will lead up to the idea

of molecules. I must say that I think that "equivalents" should be used for some time before any reference is made to atomic weights. As to cramming a boy in the methods of writing equations, and finding how much sulphuric acid and zinc will make so much hydrogen, I can only say that, as the boy never attempts to carry it out in practice, and that if he did he would find his calculations all wrong as compared with his results, he had better leave them until late in his course, for their symbolic value and, in many cases, real worthlessness can only be estimated by a worker in quantitative analysis. I think a boy's practical work should undergo great alteration. At present he is examined in "simple salts," so of course he is prepared for that by a system of "test-tubing" which teaches him very little. He ought to start as far as possible with elements which he knows, such as sulphur and iron, and he should prepare certain compounds which contain them. He should then study the action of metals on acids, and the salts formed; cases of oxidation and reduction; preparation and properties of gaseous elements and compounds.'

LXX. 'In order that chemistry may be a useful subject for the education of boys, it seems to me necessary that it should be taught from experiments involving measurements. Other experiments may be amusing, but do not appear to afford food for severe or productive thought. It seems to be now generally admitted that boys should be led as far as possible to make inferences from chemical experiments for themselves. If they are to be taught the principal facts of chemistry in this way, it follows that the experiments must be of the former nature. It seems to be an evil that so much importance is attached in many examinations to qualitative analysis, which appears, from an educational point of view, to be one of the least valuable parts of the subject. The result is that teachers are compelled to spend the time given to laboratory work on this, to the detriment of experiments of a more instructive kind.'

LXXI. 'For beginners the illustrated lecture, well supplemented by periodical questioning, examination of note-books, &c., seems the only feasible way of teaching large classes of, say, thirty or forty. When the class is very small the lecture can be largely replaced by laboratory work, in which the experiments are performed by each individual student. This seems to me the best method; but my experience is that it is impossible to satisfactorily conduct *large classes* of *young* boys in the laboratory except in such simple experiments as the action of metals on acids, which can be done with a few test-tubes and other very simple and inexpensive apparatus, the breakages being too serious in an ordinary school if it is attempted to go through the preparation of all the commoner gases with a large class of beginners, in laboratories as they are usually arranged. I think more satisfactory results might be obtained with such classes if a part of the laboratory were specially arranged for the purpose, a bench (with only a few necessary reagents) in the form of a semicircle being used, the students *facing* the teacher, who would stand inside the semicircle. In such a class the students would all perform the same experiment after being shown it by the teacher. With rather more advanced students I think the separate system is better, all students not working at the same experiment, as this obviates the necessity of providing a large number of pieces of apparatus of the same kind, and allows a quicker student to make more rapid progress. I think it is very important that quantitative experiments should be made as early as possible; but here again my experience is that young

beginners cannot be trusted with balances sufficiently delicate to be of much value. The stereotyped "test-tubing" course examination of simple salts and mixtures is certainly a very inadequate laboratory course taken by itself; but it has, I believe, its advantages for school purposes in teaching care, order, and cleanliness, and it serves well for the middle classes of the school if properly supplemented by class-teaching, in which the chemical actions concerned in the testing are carefully considered.'

LXXII. 'Chemistry cannot properly be taught apart from physics; there is a physical side to every chemical phenomenon. Lecture work should precede laboratory work, and continue *pari passu* with it. Analysis rationally (not mechanically) taught is an excellent mental training. The two should be closely correlated; exercises should be given in the laboratory preparatory to or suggested by the subjects treated in the lectures, and facts learnt in the laboratory should be turned to account in the lectures. The teacher must not be trammelled by text-books: these must be his instruments, not his masters. Quantitative treatment of subjects in the lectures should be introduced as far as possible from the first, and as pupils advance they should be trained individually in the use of the balance. Numerical exercises based on (not as a substitute for) lecture demonstration help to give fixity and precision to ideas. Pupils should be trained to think out in their note-books the connection between experimental demonstration and theory, and not have notes dictated to them to be committed to memory. Their knowledge should be tested by frequent short examination papers.'

LXXIII. 'With regard to the practical work in the laboratory, the value of which cannot be over-estimated as a means of bringing a boy into real touch with his bookwork and developing in him those valuable qualities of patience, accurate observation, and powers of deduction, so especially necessary to the student of science, analyses of complicated mixtures not found anywhere in the universe are no longer now considered as the object to be aimed at. But there is still too much tendency to regard mere analysis as the aim and object of laboratory work. Rather should a boy be introduced to a progressive course of work which illustrates the more important principles of chemistry, and so be enabled to test the truth of these for himself. Here especially a good text-book of practical work is required, as a busy teacher finds it so difficult to get time to devise as well as supervise. Such a course of work must necessarily be limited in many schools, owing to the want of sufficient apparatus or the short hours of work. But still something may be done in this direction, and the mental training will not only be of infinitely more value to the special student, but also to the ordinary boy, who will not be much the wiser for having gone through a course of simple and complex analysis only. I think your Committee might do much towards smoothing the path of teachers by drawing up a memorandum addressed to the head-masters of schools suggesting points for their consideration, and asking them to meet the Committee's views on the subject as far as lies in their power.'

The Committee feel that these reports have put them in possession of the actual facts connected with the teaching of chemistry in schools, and have made it clear that something should be done in the direction of promoting a more uniform and satisfactory treatment of the subject.

The Committee think that some suggestions might now be made as to the method of teaching chemistry which should be followed in schools. If this can be done, it will certainly confer a great benefit on both teachers and examiners, and will be likely to lead to a more emphatic recognition of the merits of the science as an instrument of elementary education. The Committee accordingly ask for reappointment.

Report of the Committee, consisting of Dr. RUSSELL, Captain ABNEY, Professor HARTLEY, and Dr. A. RICHARDSON (Secretary), appointed for the investigation of the action of Light on the Hydracids of Halogens in presence of Oxygen. (Drawn up by Dr. A. RICHARDSON.)

DURING the past year this Committee has made numerous experiments on the decomposition of gaseous hydrochloric acid, under the combined influence of sunlight and oxygen.

A series of bulbs containing a mixture of moist hydrochloric acid and varying quantities of moist oxygen were exposed to light for five months (from December 9 to May 26); the amount of free and combined chlorine was then determined (the details are given in Table I.). It will be seen that in bulbs 1, 2 the percentage of free chlorine is only 3·6 to 3·4, rising suddenly, however, in bulb 3 to 92·5 per cent.; in No. 4 the amount of chlorine liberated reaches the maximum, viz., 92·77 per cent.; when more oxygen is added the percentage of liberated chlorine is lowered, the effect being probably to dilute the hydrochloric acid gas. The next series consisted of bulbs similarly prepared, but exposed for sixty-nine days (from May 31 to August 7). From the analysis given in Table II. it will be seen that oxidation of the acid has taken place, even in presence of a small excess of oxygen; in many cases the whole of the acid has been oxidised to chlorine and water, and in some cases hypochlorous acid (or some other oxygen acid of chlorine) has been formed; this accounts for the percentage amount of free chlorine coming out too high.

It appears probable that the oxidation takes place in two stages, the first action of light being to oxidise part of the hydrochloric acid to hypochlorous acid: this is at first decomposed into chlorine and water by the excess of acid present, as is shown in the first series; but when the greater part of the hydrochloric acid has been removed the hypochlorous acid does not further suffer decomposition.

Rate at which oxidation takes place.—When gaseous hydrochloric acid and oxygen are first exposed to light the decomposition goes on with extreme slowness; it rapidly increases, however, with the amount of chlorine liberated. An experiment was made on this point in which a tube containing hydrochloric acid and oxygen was exposed to light together with a tube containing a similar mixture, which had, however, been previously exposed to light until 92·6 per cent. of free chlorine had been set free; when the chlorine was estimated in the two bulbs it was found that the first bulb contained 0·9 per cent. free chlorine, whereas the other tube had gained 7 per cent., making a total of 99 per cent. free chlorine.

Influence of free chlorine.—Experiments were made to determine what influence free chlorine had on the decomposition of the acid. For this

purpose four bulbs were filled with a mixture of hydrochloric acid and oxygen; a known quantity of chlorine was added to three of them. The four bulbs were exposed for the same length of time, and the chlorine was then estimated, when it was found that the mixture to which no free chlorine had been added contained 75·9 per cent. free chlorine, whilst the bulbs containing free chlorine in the first instance gave 100·93, 105·37, and 97·29 per cent. of free chlorine. Further experiments are being made in this direction; it appears, however, likely that the presence of chlorine renders the mixture less transparent to those rays which promote the oxidation of the acid.

Influence of bromine.—A weighed quantity of bromine was added to a mixture of hydrochloric acid and oxygen, and exposed in bulbs, together with those just described; when the gas was analysed it was found that only 10·85 per cent. of chlorine had been liberated in one bulb, and 5·05 per cent. in the other (the latter contained a larger quantity of bromine). It does not appear likely that this retarding action of the bromine can be due to its union with the chlorine liberated in the presence of excess of hydrochloric acid, and it will be interesting to observe the influence of bromine vapour on the oxidation of hydrobromic acid.

Influence of moisture.—It has already been stated that a mixture of dry hydrochloric acid and oxygen is unacted on in sunlight, and it was at first supposed that the partially dry mixture was completely stable in the light; it has, however, been found that a very prolonged exposure brings about slow oxidation, the rate depending on the amount of moisture present. The results obtained after four months' exposure show that when two-thirds of the gas was dried 23·6 per cent. of chlorine is set free; when one-third only of the gas was dried 42·8 per cent. is liberated; in the case of both gases saturated, as nearly as possible, 88 per cent. of chlorine is liberated.

Decomposition of chlorine water.—Experiments have been made on the action of light on chlorine water and chlorine and aqueous vapour; the results given on Table III. show that the amount of decomposition increases with the volume of water taken; the ultimate strength of acid, however, varies in each case, becoming more concentrated as the volume of water taken diminishes. On the other hand, the volume of oxygen set free diminishes with the water. With a dilute solution of chlorine water the decomposition is arrested by a comparatively large volume of oxygen acting on a weak solution of acid; with a strong solution a small volume of oxygen is tending to decompose a concentrated acid. These results can be represented graphically in the form of a curve by mapping the percentage of combined chlorine found after exposure against the volume of water taken.

Chlorine gas and water vapour.—A known volume of carbon dioxide saturated with water vapour was mixed with enough chlorine to theoretically decompose all the water; after exposure for thirty-three days 1·33 per cent. of chlorine had been converted into hydrochloric acid. In a second experiment oxygen was substituted for carbon dioxide. In this case 3 per cent. of chlorine was found to be present as chloride.

Further experiments are being made in which a large volume of moist gas is taken, the gas being only partially saturated, as it is possible that condensation took place on the sides of the flask.

Some preliminary experiments have been made with chlorine water exposed to light in coloured solutions. From these it appears that decom-

position takes place in rays considerably below the blue. How far this is due to heating effect has yet to be proved; an apparatus is being prepared to study with greater accuracy the influence of different parts of the spectrum on chlorine water and on hydrochloric acid and oxygen.

The influence of oxygen on a mixture of chlorine and hydrogen has been observed; the gases were exposed for periods varying from three hours to three days. At first it was found that, with increased exposure, the amount of free chlorine was reduced; but when all the hydrogen present had been converted into hydrochloric acid the green colour of the chlorine gradually returned, owing to the slow decomposition of the acid by the oxygen. Analysis gave—

After three hours' exposure, 41·2 per cent. free chlorine.

„ five „	„	31·1	„	„
„ seven „	„	6·29	„	„
„ two days'	„	20·3	„	„
„ three „	„	31·9	„	„

Little has been done on the oxidation of the other halogens. We hope, however, to be able to report on these when the Association meets next year.

TABLE I.—*Decomposition of Gaseous Hydrochloric Acid and Oxygen in Sunlight after 170 days' exposure, from December 9 to May 26.*

No. of Bulb	Proportion of HCl to O by Volume	Weight in Grams of Free Cl	Weight in Grams of Total Cl	Percentage Free Cl	Percentage Combined Cl
	HCl O				
1	4 2	·00532	·1478	3·608	96·39
2	4 3	·00335	·09656	3·460	96·54
3	4 4	·13135	·1420	92·50	7·50
4	4 5	·1349	·1562	92·77	7·23
5	4 6	·07455	·0852	87·50	12·50
6	4 7	·07100	·07668	92·59	7·41
7	4 8	·0639	·1278	50·0	50·0
8	4 10	·04615	·0852	54·16	45·84
9	4 16	·0284	·03996	71·0	29·00

TABLE II.—*After 69 days' exposure, from May 31 to August 7.*

No. of Bulb	Proportion of HCl to O by Volume	Weight in Grams of Free Cl	Weight in Grams of Total Cl	Percentage Free Cl	Percentage Combined Cl
	HCl O				
1	4 1	·11147	·12192	90·60	9·40
2	4 1·5	·17182	·16898	101·68	—
3	4 2	·1775	·17267	101·67	—
4	4 2·5	·11093	·11093	100·0	0
5	4 3	·11537	·11537	100·0	0
6	4 3·5	·15975	·15265	104·65	—
7	4 4	·1198	·11980	100·0	0
8	4 4·5	·08065	·08162	98·811	1·189
9	4 8	·11658	·1170	99·63	·37
10	4 10	·55025	·57813	95·16	4·84
11	4 16	·09762	·10561	92·34	7·66

TABLE III.—*Decomposition of Chlorine Water in Sunlight after 44 days' Exposure.*

No. of Bulb	Proportion of Cl to H ₂ O by Volume		Weight in Grams of Free Cl	Weight in Grams of Combined Cl	Weight of Liberated Oxygen	Per-centage Free Cl	Per-centage Combined Cl	Per-centage HCl in H ₂ O
	Cl	H ₂ O						
1	100	40	0	·7718	·1740	0	100	·6507
2	100	20	·09317	·5492	·1230	14·55	85·45	1·176
3	100	15	·1579	·4469	·1009	26·11	73·88	1·445
4	100	10	·2609	·2602	·0586	50·0	50·0	1·292
5	100	5	·3372	·2224	·0487	61·55	38·45	3·147
6	100	1	·1408	·0568	·0344	85·73	14·27	4·262
7	100	·07	·0814	·0028	·00063	96·78	3·22	14·18

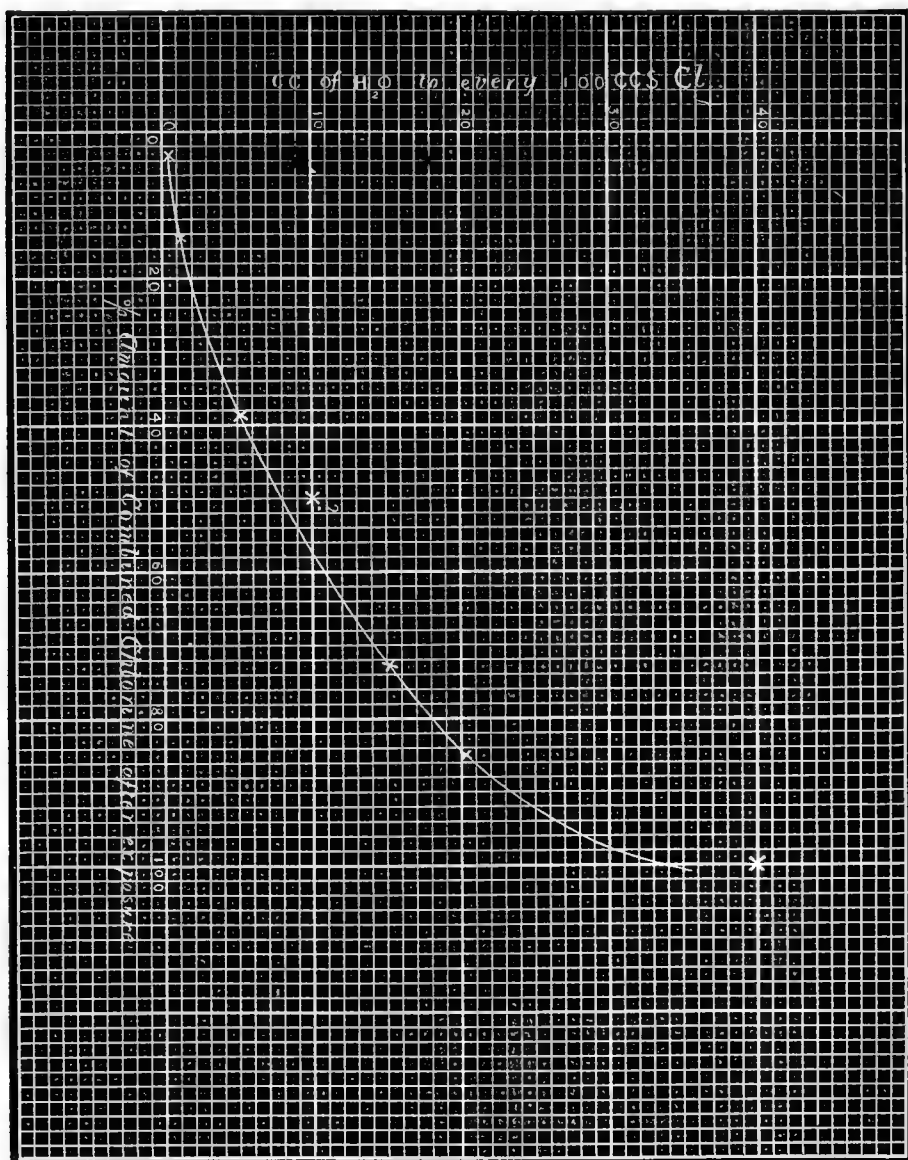

Second Report of the Committee, consisting of Professors TILDEN and RAMSAY and Dr. NICOL (Secretary), appointed for the purpose of investigating the Nature of Solution.

The mutual solubility of salts which do not act chemically on one another.

WHILE it has been long known that the presence of one salt greatly influences the solubility of another salt dissolved in the same mass of water, nothing is known of the laws regulating this phenomenon. Much of our ignorance on this point is doubtless due to the difficulties attending the determination of solubility in general, but more to the fact that experimenters have confined themselves to the task of ascertaining the effect of one salt on another when both are dissolved simultaneously to saturation.

An extended series of experiments has been made on the following lines:—

Solutions containing definite quantities of one salt have been prepared and a second salt dissolved to saturation in these. Thus solutions containing 2, 4, and 6 molecules of NaCl in $100\text{H}_2\text{O}$ were prepared and KCl was dissolved to saturation in these, a special apparatus being employed by means of which complete saturation was ensured without any loss of water by evaporation. Similar converse experiments were made with KCl solutions in which NaCl was dissolved and in all the mutual action of the following pairs was examined:

- | | |
|----------------------------|--------------------------------------|
| 1. NaCl in KCl | 5. KCl in KNO_3 |
| 2. KCl in NaCl | 6. KNO_3 in KCl |
| 3. NaCl in NaNO_3 | 7. NaNO_3 in KNO_3 |
| 4. NaNO_3 in NaCl | 8. KNO_3 in NaNO_3 |

In addition the densities of mixtures of the above salts in various definite proportions up to near the saturation point were determined, and also the mutual solubility to saturation of both members of each pair.

Time has not permitted us to complete the working out of the data thus obtained, but the general results may be stated as follows:—

In the first six cases the solubility of the first salt is diminished by the presence of the second when compared with the solubility in pure water. But if each salt is assumed to have its proportionate share of the water present then the solubility of both salts is increased.

In pair 7 the solubility of NaNO_3 is increased by the presence of KNO_3 , while in pair 8 the presence of a small quantity of NaNO_3 diminishes the solubility of KNO_3 , but a larger quantity increases it. Whether or not this anomalous behaviour is due to the isodimorphism of the two salts, as has been already suggested,¹ further experiments alone will show; but it may be here noted that the rhombic form of KNO_3 is much more soluble than the ordinary prismatic form, as is easily proved by allowing a drop of potassium nitrate to evaporate slowly on a glass plate and after rhombic crystals have separated, on touching the drop with a wire, instant crystallisation in the prismatic form results. This also is one of the few instances, if not the only one, of supersaturation in the case

¹ Nicol, *Phil. Mag.*, June 1884.

of a salt crystallising without water, and the dimorphism, and consequent supersaturation, lends support to the view that supersaturation is due to the fact that the individual in solution differs from that which crystallises out.

Solubility of salts in aqueous solutions of alcohol.

That salts are less soluble in alcohol than in water has been shown by the experiments of Schiff and Girardin, but hitherto the attempts to trace out the connection between the solubility and the amount of alcohol present have entirely failed.

A series of experiments on this subject has been commenced and considerable progress has been made towards completion. The method of experiment is as follows: Solutions of alcohol of definite strengths are prepared by diluting absolute alcohol with weighed quantities of water. The composition of the solutions thus obtained is checked by a comparison of their densities with the table given by Mendeléef; 10 to 15 cc. of these solutions, which are of definite molecular strength (5, 10, 15, &c., molecules of alcohol to $100\text{H}_2\text{O}$), are placed with excess of salt in the saturation apparatus referred to above, and after 24 hours, during which time the contents of the tubes have been shaken 20,000 times, the clear solution is poured off, evaporated to dryness, and weighed.

The salts suitable for these experiments are few in number. No hydrated salts can be used and the anhydrous salts must be freely soluble in water, otherwise their solubility in dilute alcohol sinks so low that the experimental error becomes too high.

Up to the present only four salts have been examined, NaCl , KCl , NaNO_3 , and KNO_3 , in four solutions of alcohol up to 20 molecules, but the densities of solutions of these salts in the alcohol solutions have also been determined. The results have yet to be worked out.

The Committee propose to complete the experiments in these two branches of the subject and then turn their attention to the vapour-pressures of water from solutions, the special apparatus for which has been long ready. With this view they desire to be appointed for another year.

Report of the Committee, consisting of Professor RAY LANKESTER Mr. P. L. SCLATER, Professor M. FOSTER, Mr. A. SEDGWICK, Mr. WALTER HEAPE, Professor A. C. HADDON, Professor MOSELEY, and Mr. PERCY SLADEN (Secretary), appointed for the purpose of making arrangements for assisting the Marine Biological Association Laboratory at Plymouth.

YOUR Committee have the pleasure to report that on June 30 last the laboratory and tanks of the Marine Biological Association at Plymouth were formally declared open and ready for work.

Immediately afterwards Mr. Cunningham, Mr. Weldon, and Mr. Bourne, assisted by Mr. Garstang, secretary to the Director, began to explore methodically that part of Plymouth Sound lying within the breakwater. The results of the exploration are not yet ready for publi-

cation, but it has proved that the fauna lying inside the breakwater is poor in comparison with that outside.

Mr. Cunningham has continued his special investigations upon the development of teleostean fishes.

Mr. Weldon has continued his work on Crustacea with special regard to the development of *Homarus* and *Palinurus*.

Mr. Bourne has devoted some time to an examination of the Hydroidea of the district.

Mr. Garstang is working out the Mollusca.

Mr. Hardy, of Caius College, Cambridge, arrived at the laboratory in July, and at once commenced an investigation upon the development of sponges (*Asconidæ*), which is proceeding. During the month of August Mr. Beddard has been investigating the marine oligochæte worms of the district, and Dr. C. A. MacMunn has been engaged in investigating the colouring matter of various marine invertebrates. Dr. Burdon Sanderson and Mr. Gotch are expected during September, and will continue their investigations on the electric organs of skates and rays.

Although the buildings are practically ready, and can be used for research, some delays and hindrances have occurred in the stocking of the aquarium attached to the laboratory, and the want of certain fittings, now supplied, has hindered the staff in making a complete collection of the fauna of the district.

At present Mr. Bourne and Mr. Weldon are making a series of observations with the surface-net, principally by night, with the view of gaining accurate knowledge of the pelagic fauna of the Channel.

It has been found that the work of the Association has been sadly hampered by the want of a small but seaworthy steamboat, such as the Naples steamboat 'Johannes Müller.' The Association does all its present work with a small hook-and-line boat of about five tons, and it is found that in calms, rough weather, and contrary winds much time is wasted. It is also a great disadvantage that the trawl or dredge has to be hauled in by hand, an operation which could be performed by a small steam winch on a steamboat. The Council of the Biological Association has authorised the Director to make a special appeal for funds towards purchasing and maintaining such a steamboat, and should the General Committee of the British Association be prepared to make a further grant towards the Plymouth laboratory, your Committee would venture to suggest that it should take the form of a donation to this special fund.

Your Committee have paid to the Marine Biological Association the sum of 100*l.*, placed at their disposal for that purpose; and the Council of the Biological Association have tendered to your Committee their thanks for the support given to the Biological Association by the Council of the British Association.

Your Committee beg to point out that it would, in their opinion, be desirable for the Council of the British Association to complete its contributions to the Marine Biological Association to the total of 500*l.*, and thus acquire the power of nominating a life governor of the Marine Biological Association.

Third Report of the Committee, consisting of Professors TILDEN and ARMSTRONG (Secretary), appointed for the purpose of investigating Isomeric Naphthalene Derivatives. (Drawn up by Professor ARMSTRONG.)

THE following is an outline of the work accomplished during the past year in the reporter's laboratory chiefly with the invaluable co-operation of Mr. W. P. Wynne, B.Sc.

In discussing the laws of substitution for naphthalene, attention was directed in the first report to the *alpha-law* as the dominant law; and it was pointed out that whenever departures from this law occur, as a rule, either the conditions are such as to favour secondary changes—as in the formation of β -sulphonic acids at high temperatures in presence of an excess of sulphuric acid—or a radicle such as OH or NH_2 is present which exercises a special influence. It was mentioned, however, in the same report, that when β -chloronaphthalene is sulphonated by means of SO_3HCl , two isomeric acids are formed which there is reason to believe are represented by the formulæ:—

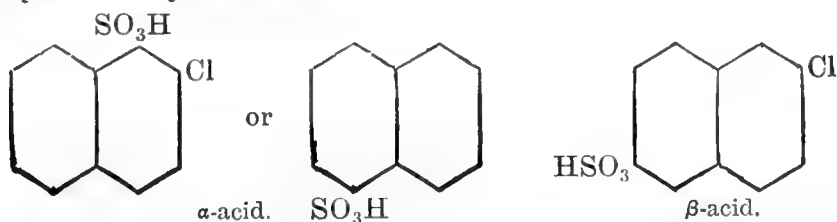

The conditions are such that the formation of the β -acid cannot be attributed to the occurrence of secondary changes such as in all probability take place when sulphuric acid is the agent; the production of this derivative, therefore, cannot well be reconciled with the *alpha law*, but is suggestive of the existence in the naphthalene molecule of a 'plane of symmetry' passing through the $\beta^2\beta^3$ -carbon atoms in which an influence is exercised. The observations on isomeric change briefly described in the last report prompted us, however, to determine whether the α -acid could not readily be converted into the β -acid by heating: the results entirely favour the view that the latter acid is in reality the product of isomeric change, and that its formation is in no way an exception to the *alpha-law*. When the sulphonation was effected in the cold, only three to four per cent. of the product consisted of the β -acid; after heating the product at 100° for half an hour the amount rose to eleven per cent.; heating at 150° for one hour increased the proportion of β -acid to twenty per cent.; and no less than fifty-three per cent. was present after heating at 150° for five hours.

These results have led us to study the behaviour of the chloronaphthalenesulphonic acids generally when heated, in order to determine whether, and in what way, they undergo isomeric change. In preparing the necessary material for these experiments we have converted the four isomeric modifications of betanaphthylaminesulphonic acid by Sandmeyer's method into the corresponding chloronaphthalenesulphonic acids, and by distilling these with phosphorus pentachloride have prepared the corresponding dichloronaphthalenes. The designation of the amido-acid, the

melting-point of the sulpho-chloride of the chloro-acid, and the designation and melting-point of the dichloronaphthalene are as follows:—

	Sulphochloride		Dichloronaphthalene	
		m. p.		m. p.
betanaphthylaminesulphonic acid (α) (Badische) .		129°	(θ')	63°·5
„ „ (β) (Brønner) .		109°	(ϵ)	135°
„ „ (γ) (Dahl) .		70°	(η)	48°
„ „ (δ) (Bayer and Duisberg)		86°	(δ)	114°

Isomeric dichloronaphthalenes.—No less than 12 isomeric dichloronaphthalenes have now been described. The conventional plane symbol of naphthalene serves to exhibit only ten, but a geometrical symbol may be constructed in accordance with the method followed by Herrmann in the case of benzene ('Berichte,' 1888, 1949), which foreshadows no less than sixteen. The following is a list of the reputed dichloronaphthalenes:—

(1) m.p. = 34°	(7) . . . ζ . . . m.p. = 83°
(2) . . . α . . . m.p. = 38°	(8) . . . κ . . . m.p. = 94°
(3) . . . η . . . m.p. = 48°	(9) . . . γ . . . m.p. = 107°
(4) . . . θ . . . m.p. = 61°·5	(10) . . . δ . . . m.p. = 114°
(5) . . . θ' . . . m.p. = 65°	(11) . . . ι . . . m.p. = 120°
(6) . . . β . . . m.p. = 68°	(12) . . . ϵ . . . m.p. = 135°

α - α -dichloronaphthalenes. Nos. 6, 7, and 9 in the list belong to this category and represent the three possible α - α -derivatives: β -dichloronaphthalene is undoubtedly the $\alpha^1:\alpha^4$ homonuclear modification, being obtainable from naphthalene tetrachloride and from naphthionic acid; γ - and ζ -dichloronaphthalenes are heteronuclear compounds, and if no other evidence were forthcoming, the fact that the γ -compound has the higher melting-point would alone justify us in regarding it as the symmetrical $\alpha^1:\alpha^4$ derivative; since, however, it is obtainable from the nitrosulphonic acid isomeric with the α - α -acid known as the Schölkopf acid, which—taking Bamberger's researches into account—is a so-called *peri* or hetero-ortho derivative, there cannot be any doubt that γ - is 1 : 4' and that ζ is 1 : 1' dichloronaphthalene.

β - β -dichloronaphthalenes.—Of the three possible β - β -modifications, δ - and ϵ -dichloronaphthalene are the two possible hetero-compounds; and from the high melting-point of the latter there can be practically no doubt that it is the symmetrical 2 : 3' modification, the δ -compound being therefore the 2 : 2' derivative.

α - β -dichloronaphthalenes.—Four are possible, two hetero- and two homonuclear. η - and θ' (m.p. 63°·5) dichloronaphthalenes may be prepared as above stated from Dahl's and the Badische modification of betanaphthylaminesulphonic acid respectively, and also from two α -nitro-acids obtained by Cleve by nitrating naphthalenebetasulphonic acid; they are therefore undoubtedly α - β - compounds, and are probably both heteronuclear. If these arguments be correct, the one is 1 : 2', the other 1 : 3' dichloronaphthalene.

θ -dichloronaphthalene (m.p. 61°·5) is either the 1 : 2 or the 1 : 3 modification. α -dichloronaphthalene, the product of the action of alkali on naphthalene tetrachloride, is undoubtedly a homonuclear compound. The modification melting at 34°, prepared by Cleve from chlorobetanaphthol and chlorobetanaphthylamine, is also homonuclear; this latter is an *alpha*-chloronaphthalene derivative (Cleve), so that the dichloronaphthalene melting at 34° if not the 1 : 2 is the 1 : 3 variety. By exclusion, it

would follow that α -dichloronaphthalene is the third β - β -, *i.e.*, β^2 - β^3 -dichloronaphthalene.

κ and ι -dichloronaphthalenes have thus far been omitted from consideration; the former is probably non-existent, the method by which it is said to have been prepared being one which is very unlikely to afford a dichloronaphthalene. It is not improbable that the ι -compound will also be found non-existent: if on treating naphthalene with chlorine a small quantity of an isomeric heteronuclear tetrachloride be formed, and this lose its α -chlorine atoms, ϵ -dichloronaphthalene would result, and it is possible that this substance in an impure state may have been regarded by mistake as a distinct substance.

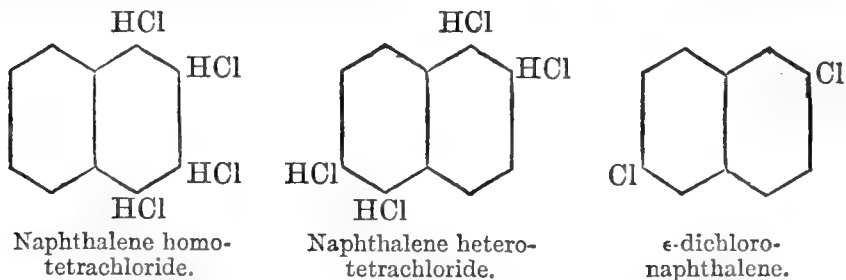

Isomeric dichloronaphthalenesulphonic acids.—With the object of further characterising and determining the individuality of the dichloronaphthalenes, the study of their sulphonic acids, to which reference was made in the last report, has now been extended to all. The chief result of interest is the fact that the dichloronaphthalene melting at 34° yields certainly two, perhaps three, isomeric sulphonic acids; the sulphochloride of the one acid crystallises in minute prisms melting at 168° , that of the other in massive prisms melting at 105° .

The dichloro-acids prepared by Widman by chlorinating naphthalene- α - and β -sulphochlorides have also been examined. That from the β -sulphochloride yields when hydrolysed β -, that from the α -sulphochloride what appears to be θ -dichloronaphthalene, m.p. $61^\circ 5$.

Addendum.—Since the meeting of the Association, Erdmann and Kirchoff ('Annalen,' 247, 366) have described the results of experiments on the synthetic production of chloronaphthalene derivatives which they contend afford proof of the constitution of the γ , η and θ varieties of dichloronaphthalene. Their method consists in preparing chlorophenylparaconic acids by interaction of succinic acid and chlorobenzaldehydes; by distilling the acids, chloronaphthols are obtained from which corresponding dichloronaphthalenes are prepared by distillation with phosphorus pentachloride. The conversion of phenylparaconic acid itself into alphanaphthol is supposed by Fittig and Erdmann to take place in the manner indicated by the following symbols:

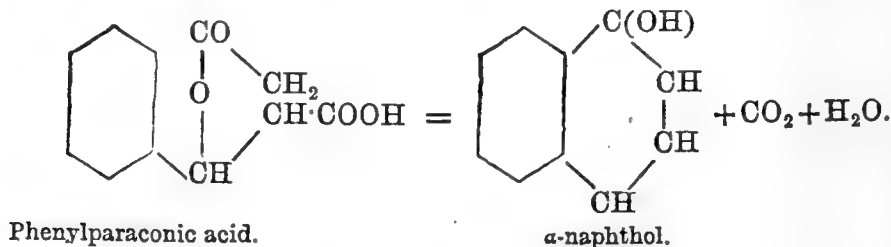

Assuming that the chloro-acids undergo a similar change, the acids derived from ortho- and parachlorobenzaldehyde should each yield but a single chloronaphthol, and that from the metachlor-aldehyde should alone be capable of yielding two isomers, viz.:—

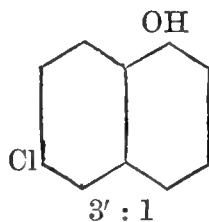
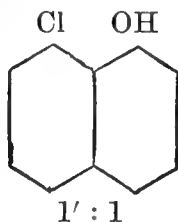

Actually they obtained eventually from the metachloro-acid η -dichloronaphthalene (m.p. 48°); and as ζ -dichloronaphthalene (m.p. 83°) is undoubtedly the 1 : 1' derivative, they regard the η as the 1 : 3' derivative. The orthochloro-acid was found to yield γ -dichloronaphthalene, and hence they regard this as the 1 : 4' derivative—a conclusion which harmonises with previous views. θ -dichloronaphthalene (m.p. $61^\circ.5$) was prepared from the parachloro-acid, and accordingly this is represented to be the 1 : 2' derivative.

But these conclusions are entirely based on the assumption that the naphthol-hydroxyl is derived from one of the carboxyl groups of the succinic acid, as indicated by the symbols given above: there is, however, no reason why it should not be derived from the COH group of the aldehyde, and in this case the η would be the 1 : 2' and the θ the 1 : 3' derivative. In any case, this objection entirely deprives Erdmann and Kirchhoff's arguments of their force: as in the case of benzene, there is little doubt that the constitution of naphthalene derivatives will be determined eventually by the study of naphthalene derivatives and not by synthetic methods of the character of those in question.

Third Report of the Committee, consisting of Dr. GARSON, Mr. PENGELLY, Mr. F. W. RUDLER, Mr. G. W. BLOXAM (Secretary), Mr. J. THEODORE BENT, and Mr. J. STUART GLENNIE, appointed for the purpose of investigating the Prehistoric Race in the Greek Islands.

THIS spring Mr. Bent commenced researches on the promontories jutting into the Ægean Sea along the coast of Asia Minor. On the most southern of these, opposite the island of Rhodes, was discovered near the ancient Loryma, which was identified by Leake, a curious little harbour, and near it the ruins of a town. After working here for two days, from inscriptions on tombs and the sites of temples, it was identified as having anciently been called Kasarea, or, as Ptolemy and Pliny respectively call it, *Κρησσα λιμὴν* and *Portus Cressa*.

Proceeding eastwards, on a promontory to the west of the Gulf of Makri, he found the ruins of another hitherto unknown town. Here he was able to work for many days and found much of interest, including 33 inscriptions, which informed him that this town was anciently *Lydæ*,

an important city of Lycia and the seat of a Roman proconsul. From these inscriptions much was gathered concerning the local government, its division into *demes*, the gods here worshipped, and the names of its chief families and benefactors.

About five miles inland, buried in a forest, he further identified the ruins of another town called Lissæ, and found two inscriptions of the date of the third century B.C., many tombs, and sites of buildings. Over one of the rock-cut tombs in this neighbourhood was found an inscription which appears to be a mixture of Lycian and some other language in use in this district, but which has not yet been deciphered.

The inhabitants of this district are all nomad and form an interesting subject for study. The difficulty of approaching them arising from their suspicion of strangers was only overcome after a few days' residence among them. It would appear that they are almost entirely self-governed, owing allegiance to the *ak-sakal* or white beard who dwells up in the mountains, whilst they wander from one pasturage to another, dwelling in huts and acting as woodcutters. Each division of a tribe is called a *yaela*, with its chief Yuruk Agha-si. Some few become sedentary and till the ground, others wander from place to place for pasturage. Mr. Bent hopes to return to these parts next winter and to make further investigations amongst them.

The things found during Mr. Bent's excavations are now deposited in the British Museum.

The Committee ask for reappointment with enlarged powers, and that the grant may be increased to 40*l*.

Report of the Committee, consisting of Sir RAWSON RAWSON, General PITT-RIVERS, Dr. MUIRHEAD, Mr. C. ROBERTS, Dr. J. BEDDOE, Mr. H. H. HOWORTH, Mr. F. W. RUDLER, Dr. G. W. HAMBLETON, Mr. HORACE DARWIN, Mr. G. W. BLOXAM, Dr. GARSON, and Dr. A. M. PATERSON, appointed for the purpose of investigating the effects of different occupations and employments on the Physical Development of the Human Body.

THE Committee met frequently during the past year. A circular has been issued asking for the active assistance of employers of labour and others who have access to large bodies of working men, and the Committee has received many promises of assistance.

Cards for recording observations have been printed, and a paper of instructions to ensure, as far as possible, uniformity in taking the observations has been drawn up.

It has been resolved to confine the operations of the Committee to one large centre of population at a time, and Manchester has been selected as a starting point. A sub-committee has been formed there, and the Committee anticipate valuable results during the ensuing winter, but no returns have yet been received.

The Committee respectfully ask for reappointment and for a renewal of the grant.

Sixteenth Report of the Committee, consisting of Professors J. PRESTWICH, W. BOYD DAWKINS, T. MCK. HUGHES, and T. G. BONNEY, Dr. H. W. CROSSKEY, and Messrs. C. E. DE RANCE, H. G. FORDHAM, D. MACKINTOSH, W. PENGELLY, J. PLANT, and R. H. TIDDEMAN, appointed for the purpose of recording the position, height above the sea, lithological characters, size, and origin of the Erratic Blocks of England, Wales, and Ireland, reporting other matters of interest connected with the same, and taking measures for their preservation. (Drawn up by Dr. CROSSKEY, Secretary.)

It was expected that this Committee would be able at an early date to summarise and conclude its reports; but as its existence and object are becoming more generally known, so large a number of new observations are being forwarded, that it is necessary that its work should still be carried on.

Among the important points that are being brought to light are: (1) the very distinct grouping of erratics in various localities, showing clearly that they have travelled in definitely marked courses; (2) the determination of the character of these groups by the physical geography of the country—ridges of existing highlands and hills effectually stopping or diverting the courses of the streams of boulders; (3) the occasional crossing of the groups of boulders—the meeting places of different streams being determinable; (4) the deposition of erratics at different periods.

When the summary of the reports is prepared, these facts will be found to stand out with great clearness and their bearing upon the glacial theories will prove to be of large importance.

YORKSHIRE.

Very remarkable facts were recorded in last year's report, respecting the boulders in the parish of Ingleby Greenhow, Northallerton; where blocks from the Lake district, from the S.W. of Scotland, from the Cheviot hills and adjoining districts, from more distant northern parts of Scotland, are intermixed with glaciated blocks of local origin.

The Rev. John Hawell supplements the information previously given and has examined 365 boulders (Professor Bonney and Mr. C. T. Clough giving their kind assistance in the determination of some of the specimens) with the following results:—

(1) Shap granite	3
(2) Granite of Criffel type	1
(3) Dolerites	9
(4) Syenite or diorite (Scotch)	1
(5) Quartzite	1
(6) Quartzose rock	1
(7) Quartzose greywacke	1
(8) Vein quartz	1
(9) Quartz-felsite (from St. John's Vale?)	2
(10) Felsite	1
(11) Porphyrites from Cheviots	67
(12) Porphyrites from Cheviots or S. Scotland	7

(13) Porphyrite (from near Kelso ?)	1
(14) Porphyrite from Cheviots or near Kelso	1
(15) Felsite or porphyrite (Scotch)	1
(16) Hornblendic porphyrite	1
(17) Hornblendic felsite or porphyrite	1
(18) Porphyrites from Borrowdale series	4
(19) Augite-andesites from Cheviots	2
(20) Old augite-andesites	2
(21) Augite-andesites from Cleveland Dyke	57
(22) Doubtfully from the Cleveland Dyke	1
(23) Basalt of uncertain derivation	4
(24) Basalt or augitic andesite	1
(25) Very compact basalt (Scotch)	3
(26) Porphyritic basalt (from Carter Fell ?)	3
(27) Indurated volcanic ashes from Borrowdale series	13
(28) Felstones from Borrowdale series	7
(29) Doubtfully felstones from Borrowdale series	3
(30) Felstone ?	1
(31) Hällellinta?	1
(32) Sandstones from local Inferior Oolite	81
(33) Sandstones, Oolitic and otherwise	11
(34) Coarse grits	11
(35) Millstone grits	2
(36) Fine quartz grit	1
(37) Calciferous sandstone	1
(38) Argillaceous limestone	1
(39) Calcareous cherty limestones	2
(40) Limestones	38
(41) Mudstones	4
(42) Brown calcareous rock	1
(43) Of uncertain character	4
(44) Notes too imperfect, or specimens mislaid	6
Total	365

(1) No. 234—In stream below Ingleby Mill Dam; rounded; $33 \times 21 \times 18$ in. No. 306—In Mr. H. Bainbridge's field; Greenhow; rounded; $15 \times 13 \times 10$ in. No. 328—Near Mr. H. Bainbridge's house; in stream; rounded; $22 \times 18 \times 16$ in.

(2) In bed of stream below Ingleby Manor House; rounded; diameter about 18 in.

(3) The dolerites may not improbably have been derived from the Whin Sill of Teesdale. Mr. Clough, however, says, 'The Whin Sill also occurs with much the same character in parts of Weardale, Northumberland, and there are also various dykes in N. of England of same character.' No. 243—In Ingleby Mill Dam; imperfectly rounded; $19 \times 16 \times 14$ in. No. 265—By side of railway near Mr. Gill's farm; rounded; $27 \times 22 \times 13$ in. No. 364—On Kirby-Moorside Road, above Bank Foot; rounded; $22 \times 20 \times 13$ in.

(4) No. 349—In stream below Ingleby Manor; subangular; $8 \times 6 \times 6$ in. 'Syenite or Diorite—Scotch' (Bonney). 'Might be from the shoulder of Criffel' (Clough).

(5) No. 268—In Mr. Gill's field; well rounded; $6 \times 5 \times 4$ in. 'Quartzite; possibly derived from an Old Red Conglomerate' (Bonney).

(6) No. 39—Ingleby Vicarage Garden; rounded; $13 \times 11 \times 10$ in.

(7) No. 176—Ingleby Mill Dam; rounded; $? \times 6 \times 6$ in. 'Quartzose Greywacke—probably S. Scotch' (Bonney).

(8) No. 352—Stream below Ingleby Mill Dam; rounded; $20 \times 16 \times 13$ in. 'Vein quartz—Chalcedonic' (Bonney).

(9) No. 98—Ingleby Mill Dam; hard, subangular; $13 \times 12 \times 6$ in. No. 158—Ingleby Mill Dam; angular; $? \times 7 \times 5$ in. 'Felsite or porphyrite (Bonney). These blocks may not improbably have been derived from the quartz-felsite of St. John's Vale, Cumberland.

(10) No. 93—Ingleby Mill Dam; subangular; $8 \times 4 \times 3$ in.

(11) No. 125—Ingleby Mill Dam; subangular; $17 \times 8 \times ?$ in. 'Porphyrite—old andesite (Cheviot?)' (Bonney). 'Possibly from the Cheviots, but not a common type there, and should think more probably from some of the porphyritic areas in the S. of Scotland' (Clough). No. 138—Ingleby Mill Dam; moderately rounded; $24 \times 15 \times ?$ in. No. 139—Ingleby Mill Dam; subangular; $21 \times 18 \times 10$ in. The above are some of the largest of these common blocks which so strongly characterise our local drift.

(13) No. 339—On right bank of stream below Ingleby Mill Dam; subangular; $16 \times ? \times 14$ in. 'Porphyrite—probably an old andesite' (Bonney). 'Very like some of the upper Old Red traps of the neighbourhood of Kelso. I have also noticed these rocks mixed with Cheviot rocks in considerable quantities in Bridlington Bay boulders' (Clough).

(14) No. 232—Ingleby Mill Dam; angular; $8 \times 7 \times 5$ in. 'Might well be from the Lower Old Red porphyritic district of the Cheviot Hills' (Clough).

(15) No. 275—In Mr. Gill's field, Ingleby; subangular; smoothed; $4 \times 8 \times 6$ in. 'Felsite or porphyrite—Scotch' (Bonney).

(16) No. 303—In stream below Ingleby Mill Dam; subangular; $10 \times 6 \times 6$ in. 'Hornblending porphyrite—S. Scotland' (Bonney). 'Not unlike portions of the lowest of the porphyritic flows at the head of Coquetdale, Cheviot Hills' (Clough).

(17) No. 319—In stream near Mr. H. Bainbridge's farm, Greenhow; rounded; $21 \times 17 \times 14$ in. 'Hornblending felsite or porphyrite' (Bonney). 'Very like some igneous masses in the Highlands near the head of Loch Katrine, Loch Lomond, &c.' (Clough).

(18) The largest of these is No. 302. In stream below Ingleby Mill Dam; subangular; $17 \times 10 \times 6$ in.

(21) As the Cleveland Dyke at its nearest point, near the village of Great Ayton, is distant only some four miles from the present position of the boulders to which these notes refer, and as the ice-sheet must have ploughed across it almost at right angles in the immediate direction of our locality, we should naturally expect to find what, in point of fact, we do find—numerous angular and subangular fragments derived from it, intermixed with the other boulders. The 'Whinstone,' as it is locally termed, is described in the memoir of the Geological Survey relating to the district as 'a bluish-grey augite-andesite, consisting of a ground mass apparently made up of augitic and felsitic matter, with small crystals of felspar and augite. Scattered through this are glassy crystals of triclinic felspar of much larger size, very distinctly visible to the unaided eye, and which give the rock a distinctive character by which it can be easily recognised.' As other dykes of a very similar character occur in the direction from which the ice-sheet came, it is possible that one or two from other sources may have been put down as from this source. The largest measures $48 \times 35 \times 34$ in. Others measure respectively 39 in., 33 in., 29 in., 28 in., 27 in. in their longest diameter.

(22) No. 113—Ingleby Mill Dam; imperfectly rounded, with smooth faces; $11 \times 8 \times 6$ in.

(24) No. 274—In Mr. Gill's field; moderately rounded; $13 \times 9 \times 7$ in. 'Basalt or augitic andesite—Northern' (Bonney).

(26) 'Porphyritic basalt—Scotch or north of England' (Bonney). 'Looks as if it might be from the porphyritic basalt rock of Lumsden Law or the Carter Fell or from some other of the similar basaltic rocks of the Border country' (Clough).

(27) Two in Greenhow measure respectively $31 \times 20 \times 13$ in. and $27 \times 17 \times ?$ in.

(28) The largest of these measures $13 \times 12 \times 10$ in.

(29) A subangular boulder at Ingleby Mill Dam measures $18 \times 13 \times 7$ in.

(30) No. 326—In Mr. H. Bainbridge's field, Greenhow; rounded; $10 \times 6 \times 4$ in.

(31) No. 73—By side of road near Ingleby Church; imperfectly rounded; hard; green; $14 \times 9 \times 5$ in. 'Not igneous—a Hällefinta' (Bonney). 'Should strongly suppose this to be one of the rocks of the volcanic series of Borrowdale' (Clough).

(32) The real proportion of these blocks is somewhat higher than is represented by the number 81, since some small ones have been passed over where more unfamiliar rocks would have been noted. The following are the measurements of a few of the largest: $36 \times 20 \times 17$ in.; $33 \times 18 \times 12$ in.; $30 \times 22 \times ?$ in.; $29 \times 14 \times ?$ in.; $29 \times ? \times 12$ in.; $24 \times ? \times 16$ in.; $23 \times 22 \times 14$ in. The majority of the above consist of a somewhat compact sandstone, not easily worn and resisting decomposition.

(33) Some of these are probably from the Oolite; others from the Carboniferous. The largest measures $16 \times 10 \times 7$ in.

(34) These are probably *all* from the Inferior Oolite. The largest of them, which is at the Ingleby Mill Dam, measures $29 \times ? \times 8$ in.; others measure $24 \times 17 \times ?$ in.; $23 \times ? \times 19$ in.

(36) No. 150—Ingleby Mill Dam; $6 \times 6 \times 4$ in. 'Fine quartz grit; probably Carboniferous' (Bonney).

(37) No. 145—Ingleby Mill Dam; subangular; $? \times 9 \times 4$ in.

(38) No. 351—In stream below Mill Dam; subangular; $22 \times 19 \times ?$ in.; argillaceous limestone: perhaps from the Oolite.

(39) No. 166—Ingleby Mill Dam; subangular; $17 \times ? \times 10$ in. No. 299—In stream below Mill Dam; angular; $10 \times 6 \times 4$ in.

(40) The majority, but not all, of these are from the Mountain Limestone. Some are greenish or yellowish; others very light coloured; a few nearly black. No. 165—Ingleby Mill Dam; a flat slab; finely stratified; $28 \times ? \times 5$ in. No. 282—In stream immediately below Mill Dam, having recently fallen from left bank; angular; cubical; ordinary mountain limestone, full of fossils, including *Spirifera bisulcata*, *Syringopora geniculata*, *Athyris ambigua*, *Terebratulula vesicularis*, and a shell which I take to be *Spiriferina cristata*, var. *octoplicata*; $22 \times 19 \times 14$ in.

(41) No. 256—Marsh Lane; rounded and flattened; stratified; striated on one side in various directions; $18 \times 14 \times 5$ in. 'Mudstone' (Bonney). No. 48—Ingleby Vicarage Garden; discoidal; $9 \times 7 \times 3$ in. 'Mudstone—Scotch Silurian(?)' (Bonney). 'Very like one of the Coniston flagstones of the English Lake district; probably came over the watershed W. of Bowes with the Shap granite boulders' (Clough).

(42) No. 350—In stream below Ingleby Mill Dam; angular; $1 \times 18 \times 3$ in.

The Committee have received the subjoined valuable reports from the

'Yorkshire Boulder Committee,' formed in connection with the 'Yorkshire Naturalists' Union.'

That Committee have had the advantage of the services of Professor Green, F.R.S., as chairman, and Mr. S. A. Adamson, F.G.S., as secretary, and have examined and passed all the reports which are subjoined.

The Rev. E. M. Cole, M.A., Wetwang, forwards the following reports:—

In a field, about 350 yards north of Gristhorpe station, near Filey, and about 50 yards east of the railway, is an isolated boulder of basalt; sub-angular; 4 ft. 7 in. × 2 ft. 10 in. × 1 ft. 11 in. Partially imbedded in ground.

In the North Skeugh Field, Stillington, near Easingwold, is a boulder 4 ft. 3 in. × 3 ft. × 2 ft. 7 in.; rounded; has not been moved; longest axis N.E. and S.W. No striæ apparent. A very hard cherty limestone. About 150 feet above sea-level. Rests upon Middle Lias.

In and around the village of Muston, near Filey, are the following boulders:—

- No. 1. 3 ft. × 2 ft. × 1½ ft., basalt, smoothed.
- „ 2. 1 ft. 3 in. × 1 ft. 9 in. × 1 ft. 6 in., basalt, sharp edges.
- „ 3. 2 ft. × 3 ft. × 1 ft. 8 in., basalt, smoothed.
- „ 4. 4 ft. 5 in. × 1 ft. 10 in. × 2 ft., basalt, triangular-shaped end.
- „ 5. 3 ft. × 2 ft. 4 in. × 1 ft. 8 in., basalt, angular.
- „ 6. 1 ft. 8 in. × 2 ft. 6 in. × 2 ft. 11 in., basalt, smoothed on one side.
- „ 7. 4 ft. 6 in. × 1 ft. 7 in. × 1 ft. 3 in., grit.

Round the sign-post in the centre of Muston village are two boulders: Basalt—2 ft. 7 in. × 2 ft. 3 in. × 8 in. (embedded in ground), and 2 ft. 9 in. × 2 ft. (embedded in ground).

A boulder at the corner of a house close by; basalt, 2 ft. 3 in. × 1 ft. 8 in. × 9 in.

There are at least half a dozen others from 1 ft. to 2 ft. cubes.

In a bank, surmounted by a hedge, at the Hunmanby end of the village, are three gritstone boulders: 3 ft. 3 in. × 1 ft. 8 in. × 1 ft. 1 in.; 2 ft. 7 in. × 1 ft. 8 in.; 3 ft. × 1 ft. 5 in.

In the middle of a grass field, half-way between Muston and Hunmanby, in a straight line, is an isolated boulder of basalt; rounded, 3 ft. 6 in. × 3 ft. × 1 ft. 1½ in. Embedded in the ground.

There are two groups of boulders at Bempton and Buckton (East Riding):—

3 ft. × 2 ft. and 2 ft. cube is the ordinary shape. A few angular, a few sub-angular, but mostly rounded. The stones referred to have all been moved by man, built into foundations of houses, set up at corners of streets; also used as seats. There is no doubt whatever the boulders have been removed from adjacent fields. By far the greater number are whinstone. There are many blocks of various sandstones, but four-fifths are whinstone. 250 feet above sea-level. They are abundant in the villages of Bempton and Buckton. Speaking only of the large ones: 5 may be seen at the well; 10 at the pond close by; 10 more in the cottages towards Cliff Lane; 5 forming steps in the lane itself; hundreds in the walls of smaller size but upwards of 1 ft. cube; 10 in Buckton, upwards of 2 ft.; 15 at least in Old Bridlington at the corner of streets, upwards of 2 ft., some smoothed; 24 by the pond at Flambro', removed thither from adjacent fields.

All the above mentioned are whinstone : it is the characteristic boulder of the Buckton, Bempton, and Flambro' cliffs, and seems ubiquitous.

Two boulders occur at Bempton (E. Riding) in the fields known as 'The Leys,' a few yards from the top of Bempton Cliffs, opposite Scale Nab; the boulders are about 50 yards apart.

Boulder No. 1.—4 ft. \times 3 ft. \times 1 ft. 6 in. Sub-angular. North, inclined to W. Whinstone. Above sea-level, 275 ft. Isolated.

Boulder No. 2.—4 ft. \times 4 ft. \times 1 ft. 6 in. Sub-angular. Above sea-level, 280 ft. Isolated.

Both rest on a thin boulder clay on chalk.

At Carr Naze, Filey Brigg, are the following erratic blocks :—

1. Rounded block on surface of third field from Filey Church, due north, near cliff, 2 ft. 7 in. \times 2 ft. 5 in. \times 1 ft. 5 in. Whinstone.

2. A similar but flatter block, lying at *base* of boulder clay, partially exposed, on north side of Naze, just above Oolitic rocks, 2 ft. 11 in. \times 2 ft. 8 in. \times 1 ft. 2 in. Direction E.N.E. Beautifully furrowed with ice-marks. Whinstone.

3. A mass lying exposed on Oolitic rocks, about 50 ft. above sea-level, evidently washed out of boulder clay above, 3 ft. 8 in. \times 2 ft. \times 1 ft. 4 in. Smooth edges, flat surface. Mica trap.

4. Small block, on ledge, fallen as above. Quartz felsite.

5. In boulder clay on S. side of Naze. Black earthy limestone with iron pyrites.

6. Fine mass of Lias, all Lower Lias fossils (*Gryphæa*, *Mya*, &c.), 1 ft. \times 1 ft. 5 in. \times 7 in. Washed out of boulder clay on N. side of the Naze.

7. Mass of freestone lying partially exposed half-way up N. face of boulder clay at Carr Naze, 3 ft. 10 in. \times 2 ft. 4 in. \times 1 ft. Direction N. No markings.

Dr. Carter Mitchell, Topcliffe, Thirsk, reports a boulder of Shap granite in the parish of Cundall, on the Leckby estate, five miles from Boroughbridge, about a quarter of a mile above 'Elmire Ings,' as given on the Ordnance Map. It is in the bed of the river Swale, close to the Leckby bank. It is entirely out of the water when the river is very low; 4 ft. 3 in. \times 3 ft. \times 2 ft. 9 in. Is more or less rounded. No striæ or groovings. Is about 50 ft. above sea-level. There is a long ridge of gravel and sand about a quarter of a mile from where the boulder lies.

Mr. H. M. Platnauer, B.Sc., F.G.S. (Curator of the York Museum), records the following erratic blocks which were obtained from the boulder clay that was dug out when the York new station was built, and are now placed about the grounds of the Philosophical Society of that city :—

1. Shap granite, irregular shape, smooth, 2 ft. 9 in. \times 1 ft. 10 in. \times 11 in.

2. Shap granite, irregular paralleliped, rough surface, 1 ft. 4 in. \times 1 ft. 4 in. \times 10 in.

3. Shap granite, roughly ellipsoidal, smooth surface, 2 ft. 2 in. \times 1 ft. 1 in. \times 1 ft. 2 in.

4. Shap granite, irregular mass, rounded but not smooth, 3 ft. 1 in. \times 2 ft. 8 in. \times 1 ft. 10 in.

5. Shap granite, irregular oval, smooth, 2 ft. 9 in. \times 1 ft. 10 in. \times 1 ft. 7 in.

6. Whitish limestone, flat piece, polished and striated on one side, 3 ft. \times 1 ft. 3 in. \times 8 in.

7. Estuarine sandstone, rounded mass, 1 ft. 4 in. \times 1 ft. 1 in. \times 9 in.

8. Dark-coloured Mountain limestone, polished and striated, 1 ft. 5 in. \times 1 ft. 2 in. \times 9 in.

9. Limestone (Oolitic, but of what horizon I cannot say), smooth, striated on one side, 1 ft. 4 in. \times 1 ft. 3 in. \times 9 in.

10. Similar to No. 9, 1 ft. 3 in. \times 1 ft. 2 in. \times 7 in.

11. Sandstone (probably estuarine), angular, irregular, 1 ft. 5 in. \times 1 ft. 2 in. \times 1 ft. 1 in.

12. Grey arenaceous limestone (probably Jurassic), irregular, smoothed on one side, 1 ft. 1 in. \times 1 ft. 3 in. \times 10 in.

13. Similar to No. 12, smooth on one side, 1 ft. 8 in. \times 1 ft. 4 in. \times 1 ft. 1 in.

14. Light coloured limestone, smooth, egg-shaped, striated, 2 ft. \times 1 ft. 2 in. \times 1 ft. 6 in.

15. Lithostrotion, small, polished, and rounded mass, 1 ft. \times 9 in. \times 7 in.

16. Greenish-grey trap, probably a hornblende-andesite. An irregular quadrate mass, trapezoidal in section at one direction; the faces at an obtuse angle are polished and somewhat striated, 2 ft. 6 in. \times 2 ft. \times 1 ft. 4 in.

The Rev. Thomas Parkinson, Vicar of North Otterington, near Northallerton, reports as follows:—

In the centre of the village of Thornton-le-Beans, near Northallerton, at the left or north side of the street going eastwards, parish of North Otterington, is a block of Shap granite. Length, 3 ft. 10 in. E. and W. Breadth, 3' 2" N. and S. Above ground 2ft. 4 in., and probably about the same in the ground. Rounded. Uncertain whether it has been moved or not. Longest axis E. and W. No striæ or groovings. Isolated. Rests on clay.

In the township of Thornton-le-Moor, parish of North Otterington, are three boulders.

1. In an open field, near a well named 'Stockeld's Well.' About 4 ft. 6 in. \times 2 ft. 8 in. \times 2 ft. 8 in. Somewhat wedge-shaped. Rounded. Cannot say whether it has been moved or not. Longest axis N. and S. (nearly). Granite, ice-worn. Isolated. Rests on clay.

2. In a lane called 'Endecon,' about 300 yards from south end of village of Thornton-le-Moor, 3 ft. 2 in. \times 2 ft. \times 2 ft. Was considerably broken a few years ago. Has been moved. Coarse dolerite. Isolated. Rests on clay.

3. On the roadside, near farmhouse called Hill Top or Thief Hole Farm, 3 ft. 8 in. \times 2 ft. 9 in. \times 2 ft. 9 in., all above ground. Rounded a little, angular in some parts. Has been moved—taken out when foundation was dug of an adjacent building. Close grained trap or highly altered fine ash. Isolated. Rests on clay.

In township of North Otterington, on Otterington Farm, in field near the entrance gate from Northallerton road, and about 300 yards on the road from North Otterington Church; 4 ft. \times by 2 ft. 11 in. Height above ground, one side, 1 ft. 6 in.; the other, 3 to 4 in. Somewhat wedge-shaped. Angles all rounded. Has been moved. There are four ruts running longitudinally on the top and in the direction of longest axis. Granite. Rests on gravel.

Mr. Robert Mortimer, of Fimber, reports that at Youlthorpe, between Bishop Wilton and Stamford Bridge, is a large isolated boulder of pure white very quartzose sandstone. Had not been moved by man until recently, when it was carted into the farmyard of Mr. Hawkins. Is now used as a mounting block, 3 ft. 9 in. \times 2 ft. 9 in. \times 2 ft. 10 in.

Youlthorpe is on the Keuper marl, and not far from the foot of the chalk escarpment of the Wolds.

The Rev. R. A. Summerfield, Vicar of North Stainley, reports that in the parish of North Stainley, near the hamlet of North Leys, and about 100 yards from the 'Smithy' (so marked on the 6 in. Ordnance Map), on the west side of the road to North Stainley, is a block of Carboniferous grit, 3 ft. 3 in. \times 2 ft. 5 in. \times 1 ft. 7 in. Sub-angular. It has been moved from the adjoining field to the place it now occupies about twenty years ago, being a hindrance to ploughing, &c. About 170 ft. above sea-level. Connected probably with a long gravel ridge which abuts on the river bank and underlies all the parish, in which are a large quantity of scratched, grooved, and polished blocks, varying much in size. One block, 5 ft. \times 3 ft. \times 1 ft. 3 in., is a mass of large Producti.

The Rev. Arthur Watts, F.G.S., Vice-Principal of Bede College, Durham, reports that there is a block of encrinital Carboniferous limestone in the grounds of R. L. Hawthorne, Esq., Hawthorne Tower, Seaham Harbour, on north side of Hawthorne Drive and west of the tower. Was removed from an adjacent field when draining to its present position, 5 ft. 10 in. \times 3 ft. 8 in. \times 1 ft. 3 in. Weight, 1 ton 18.79 cwt. Sub-angular. It originally pointed by its long axis 20° E. of N., 42° E. of N. true bearing. There are seven grooves across the stone, five perfect, two imperfect. There are two sets of striæ: the one set of six are nearly obliterated by the other, numbering about seventy. The smaller group of striæ are nearly in the line of the longest axis; the larger group make an angle of about 60° with the long side.

The nearest similar rock known *in situ* is 25 miles due west at Frosterley.

The boulder has no popular name or legend. Is about 80 ft. above sea-level. It was discovered in March 1879, and is not indicated on any map. It formed part of a mass of clay, sand, gravel, and boulders that is seen in a coast section to be in a hollow in the magnesian limestone, about 100 yards wide and 60 ft. or more deep.

Mr. Wm. Gregson, Baldersby, Thirsk, reports upon two boulders in the Priory Grounds, Guisborough, both resting on the Lower Lias.

Boulder No. 1: 4 ft. \times 3 ft. 6 in. \times 1 ft. 3 in. Sub-angular. No groovings or striations. Grey granite 300 ft. above the sea. Isolated. Resting on Lower Lias:

Boulder No. 2: 3 ft. 6 in. \times 3 ft. 2 in. \times 1 ft. Sub-angular. No groovings or striations. Grey granite. 300 ft. above the sea. Isolated. Resting on Lower Lias.

Dr. W. Y. Veitch, Middlesbro', records a Shap-fell granite boulder at Saltburn 30 feet from the top of the road leading up from the beach, almost opposite the Zetland Hotel; 3 ft. 8 in. high, 14 ft. in circumference; is entirely out of ground on one side; rounded; has no long axis, no groovings or striations; has no popular name and is without a legend; about 150 feet above sea-level; is not indicated upon any map. It rests upon Middle Glacial drift.

Mr. C. Brownridge, F.G.S., Leeds, reports on two boulders on the west front of Lindholme Hall, which is about four miles to the S.E. of Hatfield. The hall is upon slightly elevated ground in the centre of Hatfield Chase, a wide extent of bog. The deposits in the vicinity of the hall consist of gravel and sand resting upon Triassic sandstone. The boulders extracted from the gravel include magnesian limestone, Car-

boniferous sandstones of various kinds, gannister and millstone grit, porphyries and basalts, quartzite, vein quartz, black flints, chert, &c.

Boulder No. 1.—1 ft. 10 in. \times 1 ft. 9 in. \times 1 ft. 8 in. ; longest axis N.E. to S.W. ; sub-angular ; Hällefintna, not unlike some Lake Country rocks in character ; no groovings or striations observed.

Boulder No. 2.—2 ft. 11 in. \times 2 ft. 0½ in. \times 1 ft. 7 in. ; longest axis N.E. to S.W. ; rounded ; a coarse grit, almost a conglomerate, with large quartz pebbles ; no groovings or striations observed.

A mythical personage, half giant, half hermit, known as William of Lindholme, is said to have lived at Lindholme and to have brought the above stones, known traditionally as the 'Thumb Stone' and the 'Little Finger Stone,' to their present position.

Mr. J. W. Davis, F.G.S., Hon. Sec. Yorkshire Geological and Polytechnic Society, furnishes the following note on the groups of boulders at Norber, near Clapham :—

All sizes up to 16 to 20 feet in diameter ; angular ; slight striations ; under surface rarely striated. Rock identical with that of the boulders is found in the valley to the north at various spots, varying from a mile to a mile and a half from the place where the boulders are most thickly congregated. They are composed of Silurian grit and rest on mountain limestone ; 800 to 1,250 feet above the sea ; area covered is three-fourths of a mile square ; several hundreds in number ; all exposed on the surface. In many instances the masses of Silurian grit have protected the limestone immediately beneath, whilst the surrounding surface has been removed, and they now stand on pedestals of limestone, 12 to 18 inches in height.

REFERENCES TO THE NORBER BLOCKS.

Phillips, 'Trans. Geol. Soc.,' vol. iii. p. 13 ; 'Rivers, Mountains, and Sea Coast of Yorks.,' p. 111.

Hughes, 'Proceeds. Yorks. Geol. and Polytech. Soc.' (1867), vol. iv. p. 574 ; 'Quar. Journ. Geol. Soc.' (1886), xlii. 527.

Tiddeman, 'Quar. Journ. Geol. Soc.' (1872), vol. xxxviii. p. 477.

Davis, 'Proceeds. Yorks. Geol. and Polytech. Soc.,' vol. vii. p. 266.

Davis and Lees, 'West Yorkshire,' pp. 200, 201, 267.

Adamson, 'Trans. Leeds Geol. Assoc.,' Part I. (1885), pp. 32-34.

Mr. W. Hodgson Gill, of Stourton, reports the following boulders :—

At Filey, Yorkshire, on the beach behind the wooden piles at the base of cliff, near Ravine Villas, 3 ft. 3 in. \times 2 ft. 2 in. \times 2 ft. 2 in. ; is rounded ; no groovings or striations ; Shap-fell granite ; it rests on boulder clay.

At Hunmanby, at the end of the road leading to the beach, 3 ft. 7 in. \times 2 ft. 3 in. \times 2 ft. 3 in. ; is sub-angular ; no groovings or striations ; Shap-fell granite ; it rests on boulder clay.

At Filey, on the beach between Primrose Valley and Hunmanby Road ; 4 ft. 1 in. \times 2 ft. 9 in. \times 2 ft. 1 in. ; angular ; no groovings or striations ; calcareous sandstone with nodules and pebbles ; it rests on boulder clay.

Mr. Samuel Chadwick, Curator of the Malton Museum, sends the following reports :—

In the parish of Cropton, four miles from Pickering, North Riding, and in a grass-field belonging to Mr. James Dixon, Loand House farm, 3 ft. 4 in. \times 2 ft. 5 in. \times 1 ft. 10 in. out of ground. Rounded. Its longest axis is nearly E. and W. Sandstone, approaching quartzite ; not unlike

some of the Yoredale sandstones of the Yorkshire dales. No striations. Rests on fine loamy soil, about 200 ft. above the sea.

On the farm occupied by Mr. Grundon (estate of J. R. Grimston, Esq.), Neswick, S W. of Driffield. At present 4 ft. \times 2 ft. 6 in. \times 1 ft. 3 in., but some portion has been broken away. Sub-angular. Not moved by man. Is long-shaped. Longest axis E. and W. Whinstone. 250 ft. above the sea. Isolated. Boulder clay, resting upon chalk.

Grosmont, near Whitby, on the estate of Messrs. Bagnall, Grosmont Iron Works, 2 ft. 3 in. \times 1 ft. 10 in. \times 2 ft. Well rounded. Has been moved. No striæ or groovings. Shap-fell granite. About 100 ft. above the sea. Was originally found in the bed of the river Esk, which is 300 yards E. of the railway station, and the boulder was found about 50 yards to the N. of the first railway bridge crossing the stream. The boulder rests upon the alum shales of the Lias, through which the river Esk cuts its way.

In Sleights parish, near Whitby; on the Sleights Hall estate, about 300 yards W. of Sleights railway station, and on the E. side of the river Esk, 2 ft. \times 1 ft. 6 in. \times 1 ft. 6 in. out of ground. Sub-angular. Rather long-shaped, but has been moved. No striæ or groovings. Granite. 100 ft. above the sea. Was originally in a small bed of gravel, cut through at the making of the railway. On gravel resting upon the Lias alum shale.

In a grass field three-quarters of a mile due E. from Kirkby Underdale and half a mile S. of Uncleby are two boulders. One is 5 ft. \times 3 ft. 6 in. \times 1 ft. 3 in.; angular; longest axis N. and S. The other is 6 ft. 3 in. \times 3 ft. \times 2 ft. 6 in. above ground; sub-angular; longest axis direct N. and S. These are both composed of ferruginous Oolitic limestone (Inferior Oolite), resting upon the red chalk. No striæ or groovings are visible upon exposed surfaces. Are about 300 ft. above sea-level.

Speeton, near Filey. On Mr. Wilson's farm, in a field, and going from the high road to the house, is a boulder, 2 ft. 9 in. \times 2 ft. 9 in. \times 2 ft. Nearly a square angular block. Whinstone. About 350 ft. above sea-level. Is isolated. Rests on boulder clay.

In a field near the mill belonging to Mr. Plews is a boulder, 3 ft. 7 in. \times 1 ft. 3 in. \times 1 ft. 3 in. Oblong; rounded at each end. No striæ or groovings observed. Whinstone. About 350 ft. above sea-level. Rests on boulder clay, with chalk underlying.

At the corner of Mr. Wilson's garden are three boulders. No. 1—1 ft. 6 in. \times 1 ft. 6 in. \times 1 ft.; angular. No. 2—3 ft. \times 1 ft. 6 in. \times 1 ft.; rounder. No. 3—3 ft. \times 2 ft. \times 2 ft.; sub-angular. No striæ or groovings observed. All are whinstone. About 350 ft. above sea-level. Rests on boulder clay, with chalk underlying.

In the village road leading from the high road are twenty-three boulders, the three largest being of the following dimensions: No. 1—2 ft. \times 1 ft. 2 in. \times 1 ft. 2 in. No. 2—1 ft. 6 in. \times 1 ft. \times 1 ft. No. 3—1 ft. 2 in. \times 1 ft. 2 in. \times 1 ft. Irregularly shaped and angular. The majority are whinstone, the remainder fine sandstone. About 350 ft. above sea-level.

NOTE.—In various parts of the village whinstone boulders may be found, some rounded, others angular. The average size about 1 ft. 3 in. \times 1 ft. Many of them have been moved and are now used for support of stacks and other purposes.

On a farm known as 'Airy Hill,' occupied by Mr. Woodcock, about

one mile E. of Hunmanby and two and a half miles S. of Filey, 2 ft. 4 in. \times 2 ft. 2 in. \times 5 in. A square angular block. Has been moved. No groovings or striæ. A hard sandstone very like Kellaway's rock, 150 ft. above sea-level. Was found on the top of a knoll which is composed principally of boulder clay.

On the same farm are several boulders, in front of the house, which have been collected from adjacent fields. Five are composed of whinstone, varying in size from 2 ft. 10 in. \times 1 ft. 10 in. \times 1 ft. 4 in. to 1 ft. 6 in. \times 1 ft. 6 in. \times 1 ft. There are also three of Shap granite and one of grey granite, the largest being 2 ft. 3 in. \times 2 ft. 2 in. \times 11 in. They are rounded to sub-angular. The surface in this district undulates and any sections are through boulder clay.

On the Glenton farm, on W. side of road leading from Reighton to Filey, are two boulders, 1 ft. 7 in. \times 1 ft. 7 in. \times 1 ft.; grey granite; rounded, 3 ft. \times 2 ft. 10 in. \times 2 ft.; mountain limestone; rounded. No striæ or groovings. Have doubtless been taken from an adjacent ridge of gravel, which runs nearly N. and S.

On Colonel Mitford's estate, and on a farm occupied by Mr. Hornby, a mile and a half E. of Hunmanby and three and a half miles S. of Filey, are two boulders, 1 ft. 3½ in. \times 1 ft. \times 9 in.; 1 ft. 10 in. \times 1 ft. 5 in. \times 7 in. Both are hard, fine-grained sandstone, and have been removed from adjacent land. They originally rested upon the top of a bank close to the cliff. All the above are from 150 ft. to 200 ft. above sea-level.

On the Graffitoe farm, about 100 yards E. of farmstead, two miles E. of Hunmanby, and three miles S. of Filey, are two boulders. No. 1—2 ft. 2 in. \times 1 ft. 11 in. \times 1 ft. 4 in. Sub-angular. Has been moved, but formerly rested upon boulder clay intermixed with gravel. No striæ or groovings. Red sandstone. No. 2—4 ft. 1 in. \times 3 ft. 2 in. \times 2 ft. Oblong and sub-angular. Has been moved, but when found its longest axis was direct N. and S. No striæ. Grey granite. Formerly rested on same bed as preceding boulder.

At the base of a cutting on the North-Eastern Railway, about a mile S. of Filey Railway Station, 3 ft. 6 in. \times 2 ft. 11 in., and projects above the ground about 1 ft. 6 in. Oblong and sub-angular. Has not been moved. Longest axis N. to S. No striæ or groovings. Dark blue whinstone, 150 ft. above sea-level. Is about midway in the centre of a ridge of boulder clay, sand, and gravel.

On the property of Mr. Gullan, Reighton, near Filey, and on the south side of St. Helen's Road (2½ miles from Hunmanby E. and 4½ miles S. from Filey), are two boulders: 2 ft. 2 in. \times 1 ft. 7 in. \times 1 ft. 6 in.; 1 ft. 9 in. \times 1 ft. 6 in. \times 10 in. Both are sub-angular and are dark blue whinstone. They were taken from a ridge of gravel and boulder clay close by, about 150 ft. above sea-level. No striæ or groovings.

On Mr. Crow's Manor farm, about 100 yards W. of Reighton village, are two boulders: 2 ft. 4 in. \times 1 ft. 7 in. \times 1 ft. 2 in.; 1 ft. 10 in. \times 1 ft. 2 in. \times 1 ft. Both are oblong and sub-angular, and are dark blue whinstone. They were both taken from a field close by and were exposed on the surface. No striæ or groovings. Are about the same level as preceding blocks.

At the entrance to Reighton village are four boulders: 3 ft. 5 in. \times 1 ft. 10 in. \times 1 ft.; 2 ft. 3 in. \times 1 ft. 11 in. \times 1 ft. 4 in.; 3 ft. 5 in. \times 1 ft. 1 in. \times 11 in.; 2 ft. 3 in. \times 1 ft. 4 in. \times 9 in. All are oblong and sub-angular, and are dark blue whinstone. Have no striæ or groovings.

Have been in present position beyond memory, but there is little doubt have been originally upon surface of adjoining fields and removed for agriculture, but could not be broken for repairing of roads.

At Cayton, near Scarbro'.—On Dr. Taylor's estate and in the farm-yard of Mr. N. Smith, on the west side of the village; 2 ft. 8 in. \times 1 ft. 9 in. \times 1 ft. 2 in. Angular. Has been moved. No striæ or groovings. Whinstone. It is now used as a mounting block; 150 ft. above sea-level. It rests upon drift composed of gravel, sand, and clay.

On Mr. Hodgson's estate. It is close to Mr. Smith's blacksmith's shop, and used for a seat; also for a mounting stone; 2 ft. \times 1 ft. 8 in. \times 1 ft. 3 in. Sub-angular. Has been moved. No striæ or groovings. Whinstone; 200 feet above sea-level. It rests now upon surface soil.

On Mr. Stead's estate. It now forms the foundation-stone at the south corner of an old house inhabited by W. Fowler, shoemaker, on the side of the village main street; 1 ft. 9 in. \times 1 ft. 6 in. \times 1 ft. 3 in. Flat angular block. Has been moved. No striæ or groovings; 150 ft. above sea-level. Whinstone.

Is about 100 yards E. of the railway station; at the N. side of the road, close to the gate, leading into the valley field occupied by Mr. N. Smith; 2 ft. 2 in. \times 1 ft. 8 in. \times 1 ft. Sub-angular. Probably has been moved. No striæ or groovings. Whinstone; 150 ft. above sea-level. Rests on surface soil.

In the foundations of an old cottage, belonging to Mr. Stephenson, on the E. side of the street. This cottage is about 250 yards N. of the church; 2 ft. 7 in. \times 1 ft. \times 1 ft. 2 in. Rounded and oblong. Has been moved. No striæ or groovings exposed. Coarsely grained dolerite; 150 ft. above sea-level. Rests on surface soil.

On Mrs. Wilson's estate; in the centre of the village on the W. side of the Scarbro' and Filey road; 2 ft. 5 in. \times 1 ft. 10 in. \times 1 ft. 3 in. Rounded. Has been moved. No striæ or groovings. Dolerite. 200 ft. above sea-level.

NOTE.—The possession of this boulder is at present in dispute. It originally was in the foundation of some very old thatched cottages, and when the new property was built some years ago a large block of sandstone was given in exchange, and now that the sandstone is a fixture they dispute the other being taken away.

On Dr. Layton's estate, Cayton Carr, about a mile and a half W. of Cayton village. It was taken out of a ridge of gravel that runs through the centre of a field, called the Six Acre Strip, in the occupation of Mr. Smith. Its present position is close to the gate entering the field in which it was found; 2 ft. 4 in. \times 1 ft. 7 in. \times 9 in. Sub-angular. No striæ or groovings. Whinstone; 250 ft. above sea-level.

NOTE.—In a heap close by are several smaller boulders taken out of the same field, comprising grey granite, red granite, mountain limestone, whinstone, and sandstone.

Is at the S. corner of a wall surrounding the engine-house of the Scarbro' Waterworks Company, about one mile E. of the village of Cayton; 2 ft. \times 1 ft. 8 in. \times 1 ft. 3 in. Rounded. Long-shaped. No striæ or groovings. Mountain limestone.

NOTE.—It was brought from the beach below to strengthen the corner of the wall.

In a by-road leading from Cayton to Scarbro' is a large number of

boulders of which upwards of thirty will average 1 ft. 4 in. \times 9 in. and over seventy others are over a foot in diameter. The larger ones are sub-angular; the smaller ones rounded. All have no doubt been conveyed from adjacent fields. No striæ or groovings are to be seen on *exposed* surfaces. They are different kinds of sandstone. They are about 150 ft. above sea-level.

On Miss Craven's estate, in the village of Cayton, about 300 yards N. of the church, and on the main road to Scarbro', is a group of nine boulders, four of which are whinstone, and upon an average 1 ft. 11 in. \times 1 ft.; the other five are sandstone and average 1 ft. 8 in. \times 1 ft. 2 in. The whinstones are mostly sub-angular; the sandstones angular. There are no striæ or groovings exposed. They are about 150 ft. above sea-level. Some of them are entirely exposed, the rest being partially covered with other stones and soil.

On Miss Craven's estate in the village of Cayton, and about 250 yards N. of the church, in a by-road called North Lane, are a number of boulders, the seven largest of which I have noted as follows:—No. 1—1 ft. 11 in. \times 1 ft. 4 in. \times 1 ft.; red sandstone; angular. No. 2—2 ft. 6 in. \times 1 ft. 2 in. \times 1 ft.; whinstone; angular. No. 3—1 ft. 10 in. \times 1 ft. 4 in. \times 1 ft. 3 in.; whinstone; rounded. No. 4—1 ft. 5 in. \times 1 ft. 3 in. \times 1 ft.; hard, grey sandstone; sub-angular. No. 5—1 ft. 6 in. \times 1 ft. \times 9 in.; whinstone; rounded. No. 6—1 ft. 4 in. \times 9 in. \times 7 in.; mottled granite; sub-angular. No. 7—2 ft. 4 in. \times 1 ft. 2 in. \times 6 in.; whinstone; angular. I could not observe any striæ or groovings. The rising ground is principally composed of drift, gravel, sand, and clay, whilst the hollows are filled with deep peat bogs.

NOTE.—The great bulk of the boulders in this district are composed of sandstone and whinstone; of these thousands have been broken up and used to mend the roads from time unknown. There is no doubt about the roads having received their supply of metal from this source. Those left behind (as above) are those which could not be broken up, or which have been taken out of the land at a recent date.

Lebberston, near Scarbro'.—On Mr. Wardell's estate, in a grass-field at the E. end of the village, and about 100 yards W. of the Scarbro' and Filey road, 4 ft. 3 in. \times 2 ft. 5 in. \times 2 ft. 7 in., but evidently one-half of it is embedded; sub-angular. Longest axis N.W. to S.E.; should think it has not been moved. There are remains of several groovings, which are much worn, and there are also striæ on the side of the block, in the direction of the longest axis. Whinstone. Is 200 feet above sea-level. Is near the top of a ridge of gravel drift.

On Mr. Jackson's estate, at the E. end of the village, near a yard door on the W. side of the road, 2 ft. 3 in. \times 1 ft. 9 in. \times 2 ft. 3 in. Angular, and is used as a stepping or mounting stone. Has been moved, but is known to have been in its present position for more than a century. No striæ or groovings. Whinstone. 200 ft. above sea-level. No doubt has been obtained from gravel drift in vicinity, but now rests on the surface soil.

On Mr. H. Watson's estate. Is in a grass-field, about a quarter mile N. of the Gristhorpe Railway Station, Hull and Scarbro' branch, 4 ft. 2½ in. \times 2 ft. 5 in. \times 3 ft. 6 in., and partially embedded. Sub-angular, flat on one surface. Long-shaped; its bearing N. and S. There appear to be some striæ, which have become very faint from exposure, but the stone being grown over with lichen, they are difficult to determine.

Upon the under side, however, is a well-defined groove about 1 ft. long. Whinstone. The popular tradition is, that it was thrown by his Satanic Majesty at one of his satellites for staying out too long. An old farmer avers he found it one morning, but the previous evening it was not there. 200 ft. above sea-level. Rests on boulder clay.

On Mr. Welburn's estate, and upon a farm in the village occupied by Mr. R. Brown, are two boulders, 150 ft. above sea-level. Dimensions of No. 1 boulder: 3 ft. 2 in. \times 1 ft. 10 in. \times 1 ft. 2 in. Sub-angular. Has been moved. Whinstone. Dimensions of No. 2 boulder: 3 ft. 2 in. \times 2 ft. \times 1 ft. 8 in. Angular. Has been moved. Whinstone. Both have evidently been found in the land. No. 2 was dug out of the garden in front of the house close to the street, and moved to its present position. Lebberston village is situated on a ridge of gravel.

In Leys Lane, at the entrance to the village of Lebberston, on the N. side of the lane and W. end of village, is a group of boulders. No. 1—2 ft. 7 in. \times 1 ft. 6 in. \times 9 in., and No. 2—2 ft. 3 in. \times 1 ft. 3 in. \times 10 in.; whinstone; sub-angular. No. 3—2 ft. 1 in. \times 2 ft. 1 in. \times 1 ft. 2 in.; coarsely grained dolerite; rounded. No. 4—2 ft. 4 in. \times 1 ft. \times 9 in., and No. 5—2 ft. 1 in. \times 1 ft. 6 in. \times 1 ft.; sandstone; sub-angular. There are no striæ or groovings upon them. They are about 100 ft. above sea-level; are all close together and exposed on the surface.

There is a boulder in the North-Eastern Railway cutting, about one mile N. of Filey, in the direction of Gristhorpe, 2 ft. 10 in. \times 2 ft. 3 in. \times 1 ft. 4 in. Rounded; pear-shaped. Has been moved; is now at the base of the cutting laid across a gutter or waterway. No striæ or groovings. Dark blue whinstone. 200 ft. above sea-level. Was connected with a long ridge of gravel, sand, and clay, which was cut through when making the line.

There is a boulder in the North-Eastern Railway cutting about 200 yards N. of Gristhorpe Station, and on the east bank of the cutting. It is in the parish of Gristhorpe, near Scarbro', 2 ft. \times 1 ft. 10 in. \times 1 ft. Angular, almost square; longest axis N. and S. Has not been moved. No groovings or striæ can be seen, but it is now almost covered with soil which has fallen from above. It is a light-coloured sandstone, like the moor grit near Scarbro'; 200 ft. above sea-level. It is in a bank of rough gravel, clay, and sand.

In the parish of Seamer, near Scarbro' (N. Riding), about three miles S.S.W. of Scarbro' and about two miles S.E. of Seamer village, and close to Seamer Junction, North-Eastern Railway, on the estate of Lord Londesborough, is a group of boulders. No. 1—1 ft. \times 9 in. \times 6 in.; red granite. No. 2—2 ft. 6 in. \times 1 ft. 10 in. \times 1 ft. 4 in.; Shap granite. No. 3—1 ft. \times 1 ft. \times 9 in.; Shap granite. No. 4—1 ft. 6 in. \times 1 ft. \times 9 in.; Shap granite. No. 5—1 ft. 2 in. \times 1 ft. \times 8 in.; Shap granite. No. 6—1 ft. 8 in. \times 1 ft. 6 in. \times 9 in.; Shap granite. No. 7—1 ft. 6 in. \times 1 ft. 2 in. \times 8 in.; mica schist. No. 8—1 ft. 6 in. \times 1 ft. 6 in. \times 1 ft. 6 in.; red granite. All are rounded. They have been moved, but were obtained from the Seamer gravel drift. No striæ or groovings are visible. About 200 ft. The gravel drift of Seamer overlies the Coralline Oolite.

The Committee have been favoured by the Rev. A. W. ROWE, of Felstead, with the following Report upon boulders in N.W. Essex.

The boulders mentioned in the accompanying list are all lying within the limits of a small district in the N.W. of Essex: a few only have been

specified which are less than 12 inches in length, though there are an immense number which fall only a little short of that limit, especially boulders of igneous rocks: but even with the omission of these the list is not by any means an exhaustive one, as some portions of the district have scarcely been examined. They have been found within six miles of the village of Felstead, which will be found marked on the Ordnance Map nearly mid-way between Braintree on the east, Dunmow on the west, Little Saling on the north, and Great Waltham on the south. The general character of the district is that of a tableland, ranging from 200 to 250 feet above sea-level, intersected by small valleys cut out chiefly by local streams. The superficial deposits are chalky boulder clay and beds of glacial gravel: these gravel beds really underlie the chalky boulder clay, as could be well seen in the railway cutting $\frac{3}{4}$ mile west of Dunmow Station before it was overgrown, but owing to the extensive denudation of the clay the beds of gravel are frequently found at the surface on the high ground. London clay underlies all these superficial deposits, and in several valleys, notably that of the Chelmer, the streams have cut their way down to it; nearly all the larger boulders have been found on the high ground. Some of these seem to require special mention. Of the sandstone boulders three measure respectively $77 \times 36 \times 20$ in. and $64 \times 63 \times 14$ in. and $61 \times 34 \times 17$ in., this last having a circumference of 158 inches, and nine others exceed 40 inches in length, including the conglomerates: nearly all appear to be unfossiliferous, but in one, which in texture and general appearance may be considered characteristic of the greater number, I found some small fragments of Crinoid stems and some casts of portions of *Aviculopecten*: in another rounded boulder of about 12 in. in diameter I found some very well defined casts of *Productus* (*P. semireticulatus*, *P. Martini*, *P. orthoceras*, *P. hemisphericus*), *Streptorhynchus crenistria*, *Euomphalus pentangulatus*, *Bellerophon*, showing that the boulder was millstone grit; and Mr. H. Keeping, who also examined the casts, tells me that it agrees very well with the beds of buff sandstone near Oswestry. In two other large boulders, which I have described in a previous paper ('Q. J. G. S.' August 1887, p. 360) as being masses of a greyish yellow sandstone permeated with a thin film of calcite, giving them a peculiar glazed appearance wherever fractured, I found fragments of *Pecten orbicularis*. Mr. Whitaker informed me that a great number of boulders of this rock are found in the boulder clay in Norfolk, and Mr. Keeping identified it as being of the same character as that which occurs in the Spilsby beds in Lincolnshire. Another very large boulder of a buff coloured sandstone, fine-grained but not very compact, was dug out of the bottom of a pond a few weeks ago: it contains *Belemnites* in abundance, some of a large size. Among numerous boulders of Hertfordshire pudding-stone there are two which measure respectively $52 \times 23 \times 16$ in. and 52×43 in., this latter being so completely buried in the ground that its thickness could not be ascertained. The limestone boulders are fragments of Carboniferous, Jurassic, and Cretaceous rocks. The Carboniferous are almost without exception so exceedingly fine that scarcely any fossil shells can be detected in them without the aid of the microscope, the one exception being a boulder lately dug up at Bocking Place almost entirely composed of shells of *Productus giganteus*. Of the Jurassic rocks two boulders of Kimmeridge clay, taken out of the chalky boulder clay in the cutting near Dunmow, were wonderfully

striated with deep grooves of almost parallel striæ on two sides, and many of the boulders of clunch and hard chalk are also clearly striated, but the direction of the striæ is very irregular. Among the whitened flints also there are some exceedingly good examples of cross-striation. Striæ are not often to be seen on the hard sandstones and the igneous boulders, though there are a few good examples of it; but most of these boulders are quite smoothed and some are highly polished. Of the igneous rocks some are so much weathered that the outer surface comes off in successive coats, like a thick-coated onion, whereas others, and especially the larger boulders, are perfectly unweathered and have a very dark almost black polished surface, so hard and rounded that it is often exceedingly difficult to get a hand specimen. They consist mainly of fine-grained dolerites and microcrystalline basalts, with a fair sprinkling of quartz-porphyrates, mostly containing tourmaline, felspar-porphyrates, and hornblende schists and gneiss. Amid the almost complete absence of boulders, or even pebbles, of granite or syenite, one boulder which I have lately found is remarkable: it is a large boulder of a pinkish grey syenite, of very distinct rather coarse texture and containing abundant orthoclase, not much quartz, not a great amount of hornblende, and a little biotite. Dr. A. Geikie has seen a hand specimen and microscopic section of it, and he informs me that he cannot identify it with any British rock known to him, and that Dr. Hatch cannot find any specimen at the Jermyn Street Museum really like it. I have also been informed by Dr. Crosskey that nothing like it has been found among the erratics in the Midlands, though a considerable number of boulders of syenite have been found there. I have sent a hand specimen to Christiania to see if it can be identified there. In a gravel pit on the high ground near Felstead I dug out a remarkable boulder of quartz and tourmaline, almost round and highly polished and striped with parallel bands of black and yellow, and among the specimens of erratics in the Midlands which Dr. Crosskey has collected I found one that was identical with it. Of the boulders of dolerite it is somewhat remarkable that, although smaller boulders occur in all directions, yet all the larger boulders which I have at present found lie north of the old Roman road which runs through Braintree and Dunmow; as many as six large boulders are lying within a comparatively small area, one of these being distinctly columnar in form and one being very clearly striated. As regards the dolerites generally I have already stated ('Q. J. G. S.' August 1887, p. 356) that some of them are strikingly similar in specific gravity, in general appearance, and in some remarkable microscopic points with some specimens of dolerites sent me from Sweden, and that others are almost identical with the rocks of the Whin Sill in the north of England, though these also might well be Scandinavian boulders, as I understand that the Hunneberg rocks have been shown to be of the Whin Sill type. But one of the most remarkable of the boulders which I have as yet found was exposed in digging the foundations of a new house at Bocking Place, Braintree (Mr. S. Courtauld): it was found at a depth of eight feet from the surface and measures $22 \times 18 \times 11$ in.; it is rounded and smoothed, roughly triangular in shape, and has two more or less flat surfaces: both of these surfaces are very distinctly grooved with irregular striæ. I sent a hand specimen and a microscopic section to Professor Bonney, who kindly examined both and wrote as follows: 'The rock is a curious one and must have come a long distance. . . . So far as I can venture to

pronounce, the aspect of the slide reminds me rather of a modified crystalline rock than a partially crystallised sedimentary rock. It is therefore now a kind of gneiss—what I should call a pressure-gneiss—resulting from the modification of a crystalline rock which may have been a quartziferous mica-diorite. The fragmental aspect I attribute to the result of pressure which has acted on a crystalline rock, and has been followed by a certain amount of mineral change in the constituents; of course an *arkose* of the right constituents might give a similar appearance, but though the enlargement of fragments *in situ* is not unknown, it is not common and generally occurs (except in the case of quartz) in very ancient rocks only. The boulder must have had a long journey, for such a rock could not be found *in situ* nearer than the Scotch Highlands or Scandinavia.’

BOULDERS IN ESSEX, N.W.

District on the Ordnance Map, Little Saling, N. ; Great Waltham, S. ; Braintree, E. ; Dunmow, W. ; centre of district, Felstead ; radius, from five to six miles.

Parish, *Great Saling*, 4 miles N.E.

1. In Village Street—Boulder of dolerite, $33 \times 29 \times 18$ in. ; roughly conical in shape ; rounded and polished ; no striæ visible ; olivine-dolerite.
2. In Newbister Lane—Three smaller boulders of dolerite, less than 12 in. in diameter ; one olivine dolerite, the others plagioclase-augite rock.

Parish, *Little Saling*, 5 miles N.N.E.

1. By the church wall—Boulder of calcareous sandstone, $61 \times 34 \times 17$ in. ; circumference, 158 in. ; pudding-shaped ; rather soft loose texture ; dark grey colour ; fine-grained, with fragments of shells.

2. At farm near the church—Boulder of sandstone, $45 \times 35 \times 24$ in. ; oblong ; slightly striated ; rather soft ; fine-grained ; buff-coloured ; containing many Belemnites ; quite lately dug out of the bottom of a pond ; Kellaways rock (?). Boulder of dolerite, $37 \times 30 \times 18$ in. ; roughly triangular ; distinctly striated on two surfaces with parallel striæ ; rest polished ; olivine-dolerite.

3. At Woolpits Farm—Boulder of dolerite, $39 \times 38 \times 19$ in. ; nearly square ; distinctly striated and polished ; dug out of a ditch on the farm ; plagioclase and augite ; no olivine.

Parish, *Stebbing*, 3 miles N.

1. At Mount Farm—Boulder of sandstone, $64 \times 63 \times 14$ in. ; flat, sub-angular ; fine-grained ; white colour ; lately dug up on the farm. Boulder of sandstone, $22 \times 20 \times 12$ in. ; sub-angular ; fossiliferous. Boulder of sandstone, $23 \times 19 \times 9$ in. ; rounded ; gritty ; grey colour ; unfossiliferous. Boulder of dolerite, $30 \times 26 \times 17$ in. ; columnar dolerite ; shape well marked ; microcrystalline ; no striæ, but highly polished.

2. Stebbing Green—Boulder of dolerite, $30 \times 27 \times 24$ in. ; conical shape, with semicircular base ; no striæ, but highly polished.

3. In fields near the Green—Five smaller boulders of dolerite under 12 in. in diameter, one being a highly vitreous olivine-basalt.

4. At Green Farm—Boulder of quartz rock, $20 \times 16 \times 11$ in. ; rounded ; polished ; yellow colour. Boulder of quartzite, $16 \times 12 \times 11$ in. Boulder of felsite, $12 \times 10 \times 9$ in. ; oblong ; dark grey ; very compact and hard.

Boulder of dolerite, $29 \times 24 \times 11$ in.; oblong; rounded; very much weathered.

5. At Scallops Farm—Boulder of limestone, $29 \times 24 \times 8$ in.; sub-angular; Carboniferous limestone. Boulder of sandstone, $22 \times 21 \times 10$ in.; sub-angular; compact; bright red colour. Boulder of porphyrite, $12 \times 11 \times 8$ in.; rounded; quartz-porphyrite (?).

Parish, *Little Easton*, 6 miles N.W.

1. Near the Park Gates—Boulder of sandstone, $42 \times 40 \times 21$ in.; rounded; oblong; fine-grained; compact; pinkish yellow. Boulder of sandstone, $36 \times 30 \times 20$ in.; oblong; fine-grained; compact, greyish yellow; very clearly striated, and in parts highly polished. Boulder of sandstone, $27 \times 24 \times 20$ in.; very similar to last mentioned, but not striated. Boulder of sandstone, $24 \times 24 \times 13$ in.; very similar to last two. Boulder of limestone, $28 \times 24 \times 10$ in.; rounded oblong; exceedingly fossiliferous; Oxford clay (?). Two boulders of conglomerate (pudding-stone), $34 \times 20 \times 14$ in. and $30 \times 24 \times 13$ in.

Parish, *Little Dunmow*, 2 miles N.W.

1. At Blatches Farm—Boulder of sandstone, $48 \times 41 \times 13$ in.; oblong; fine-grained; sub-angular; traces of striæ on upper surface. Small boulder of olivine-basalt.

2. At Bouchiers Farm—Boulder of flint, $19 \times 14 \times 6$ in. Boulder of syenite, $22 \times 15 \times 9$ in.; oblong, rounded; rather coarse-grained; greyish yellow. Two boulders of limestone (Carboniferous), $27 \times 22 \times 6$ in. and $30 \times 22 \times 11$ in.; pinkish colour; fine-grained, much cracked. Boulder of calcareous grit, $21 \times 18 \times 11$ in.; very coarse, and rather loose texture. Two boulders of sandstone, $46 \times 22 \times 17$ in. and $36 \times 30 \times 19$ in.; fine-grained; compact; whitish yellow; rounded and polished. Boulder of dolerite, $18 \times 12 \times 6$ in.; oblong; much weathered; crust peeling off in coats. Small boulder of olivine basalt; rounded and very much weathered.

At Parsonage Farm—Boulder of sandstone, $48 \times 42 \times 19$ in.; oblong; rounded; slightly striated; micaceous. Boulder of limestone (Carboniferous), $23 \times 14 \times 12$ in.; oblong; smoothed; clearly striated in direction of longer axis. Boulder of sandstone, $18 \times 15 \times 5$ in.; rounded; exceedingly compact.

In Cap Lane—Large pebble of grey syenite.

Road near village—Boulder of felsite; spherulitic.

At Burnt Cottage—Two boulders of clunch (Oxford clay?), $13 \times 8 \times 5$ in. and $12 \times 8 \times 7$ in.; just dug out of chalky clay; very clearly striated. Several large whitened flints, also striated. In gravel pit—Boulder of quartz-tourmaline rock; rounded and highly polished; curiously striped.

Parish, *Barnston*, 2 miles W.

At Absol Park Farm—Boulder of limestone (Carboniferous); oblong; rounded and smoothed; finely crystalline.

Near Rectory—Small boulder of mica schist; very small boulder of syenite.

Parish, *Great Waltham, North End*, $1\frac{1}{2}$ mile S.S.W.

At North End Place—Boulder of sandstone, $35 \times 19 \times 18$ in.; sub-

angular; no striæ; very fine-grained; white. Boulder of sandstone, $25 \times 16 \times 14$ in.; sub-angular; no striæ; fine-grained; yellow. Two boulders of conglomerate (pudding-stone), $21 \times 18 \times 11$ in. and $16 \times 11 \times 6$ in.; one very coarse and pebbles varying in size, the other with much smaller pebbles and all of a size.

In lane—Large boulder of felspar porphyrite; rounded and polished, and very hard.

Parish, *Great Waltham, Ford or Fourth End*, 3 miles S.

Ford End Hill—Boulder of sandstone, 19×10 in.; buried in ground; grey; micaceous. Boulder of limestone (Carboniferous), 16×16 in. Boulder of flint, 19×14 in. Boulder of sandstone, 16×11 in.; gritty, red.

At Hill Farm—Boulder of sandstone; $30 \times 19 \times 11$ in.; ridge-shaped; sub-angular; fine-grained; yellow. Boulder of sandstone, $29 \times 22 \times 20$ in.; oblong; rounded; gritty and loose; white. Four boulders of sandstone, respectively $28 \times 24 \times 16$ in.; compact; yellow, $21 \times 17 \times 16$ in.; conical; compact; yellow, $17 \times 16 \times 12$ in.; sub-angular; hard; greyish yellow, $16 \times 13 \times 7$ in.; sub-angular; gritty; micaceous. Two smaller boulders of dolerite.

At Littley Park, 2 miles S.S.E.—Boulder of sandstone, $33 \times 25 \times 22$ in.; roughly columnar; much polished; compact; yellow.

At Littley Green, $2\frac{1}{2}$ miles, S.S.E.—Boulder of limestone (Carboniferous), $28 \times 26 \times 12$ in.; nearly square; striated; hard; compact; fine-grained.

Parish, *Little Leighs*, 4 miles S.E.

Near Leighs Priory—Boulder of dolerite, $13 \times 9 \times 6$ in.; much weathered. Smaller boulder of dolerite. Large boulder of felspar porphyry broken in several pieces; matrix bright red; felspar very clear. Sandstone, $26 \times 16 \times 7$ in.; much polished; compact; yellow.

Parish, *Great Leighs*, 6 miles S.E.

At Fulbourn's Farm—Boulder of conglomerate, buried in ground so that surface is level with ground, 52×43 in.; Herts. pudding-stone. Boulder of sandstone, $48 \times 20 \times 12$ in.; ridge-shaped; compact; yellow.

Parish, *Braintree*, 6 miles E.N.E.

At Bocking Place—Boulder of gneiss, $22 \times 18 \times 11$ in.; roughly triangular, with two flat surfaces, deeply striated irregularly. Boulder of limestone (Carboniferous) almost composed of large shells of *Productus*.

Parish, *Felstead*.

At Princes Halfyards Farm, $1\frac{1}{4}$ mile N.—Boulder of sandstone, $77 \times 36 \times 20$ in., fixed deeply in ground, so that 36 in. does not represent its real height; gritty, yellowish, grey. Three boulders of dolerite, broken up before being measured, but none exceeding 12 in. in diameter.

At Moor Farm, $1\frac{1}{2}$ mile N.E.—Boulder of dolerite and boulder of porphyrite, both broken up, not exceeding 12 in. in diameter.

At Cock Green, 2 miles S.E.—Boulder of dolerite, almost circular, scarcely weathered, rather over 12 in. in diameter; hypersthene-bearing ophtic dolerite.

At French's Green, 3 miles E.—Very large boulder of compact yellow sandstone, since removed. A large heap of several hundred

smaller boulders lately dug up in land-ditching, chiefly flints, but containing also porphyrite, olivine-basalt, dolerite, Mountain limestone, Jurassic limestone, and ferruginous sandstone.

At Whelpstones Farm, $2\frac{1}{2}$ miles E.S.E.—Large boulder of compact yellow sandstone split into two halves, one half being left in the ground, the half removed to farmyard measuring $27 \times 21 \times 16$ in. Boulder of sandstone, $20 \times 16 \times 10$ in., soft, buff-coloured.

At Pond Park, $1\frac{1}{2}$ mile S.E.—Boulder of sandstone, $40 \times 39 \times 17$ in.; oblong, much smoothed, glazed with calcite, Lower Cretaceous. Two boulders of septaria with veins of calcite, $25 \times 21 \times 8$ in. and $22 \times 16 \times 12$ in. Two boulders of flint, $20 \times 13 \times 8$ in. and $20 \times 9 \times 11$ in., whitened, not striated. Boulder of sandstone just dug up, $32 \times 22 \times 11$ in., subangular, polished, whitish yellow, compact. Five boulders of sandstone, $24 \times 12 \times 11$ in. compact, light yellow; $18 \times 15 \times 7$ in., compact, deep red; $17 \times 8 \times 6$ in., compact, grey; $14 \times 6 \times 7$ in., compact, light yellow; $13 \times 11 \times 6$ in., compact, yellowish white. Boulder of conglomerate (pudding-stone), $19 \times 14 \times 6$ in. Several smaller boulders of dolerite.

At Potash Farm, 1 mile S.S.E.—Boulder of sandstone, $40 \times 33 \times 16$ in., much polished, but not striated; compact, yellow. Boulder of sandstone dug up in May and brought to farmyard, $31 \times 30 \times 15$ in., oblong, yellow, not very compact. Boulder of sandstone, $17 \times 15 \times 8$ in., rather coarse and gritty, red. Five smaller boulders, all measuring 12 in. or over. Two boulders of quartz rock, $14 \times 8 \times 7$ in. and $14 \times 13 \times 7$ in.

At Causeway End, $\frac{3}{4}$ mile S.—Four boulders of sandstone, all exceeding 12 in. and polished. Large boulder of dolerite dug out in clay pit from boulder clay, and found to be split into several large fragments; olivine dolerite, containing unusual quantity of magnetite.

In Snows Lane, 1 mile S.W.—Two boulders of olivine dolerite not exceeding 12 in.

At Mill House, 1 mile S.W.—Boulder of sandstone, striated and polished.

At Bury Farm, in the village—Boulder of conglomerate (pudding-stone), $52 \times 23 \times 16$ in. Boulder of contorted gneiss, $15 \times 15 \times 14$ in., rounded and much polished, hornblende gneiss. Seven boulders of sandstone, $35 \times 20 \times 11$ in., compact, yellow; $30 \times 21 \times 6$ in., very compact, yellow; $19 \times 18 \times 12$ in.; $18 \times 9 \times 8$ in., gritty, yellow; $17 \times 14 \times 11$ in., fine, compact, yellow; $16 \times 15 \times 6$ in., compact, grey; $14 \times 11 \times 5$ in., gritty, yellow. Two boulders of flint, $20 \times 11 \times 8$ in. and $18 \times 13 \times 3$ in. Boulder of quartzite, $15 \times 15 \times 5$ in. Boulder of quartz rock $14 \times 11 \times 6$ in., rounded and polished. Four boulders of limestone (Carboniferous), $23 \times 12 \times 7$ in. and $19 \times 9 \times 7$ in.; $20 \times 17 \times 5$ in. and $15 \times 10 \times 9$ in., much smoothed and rounded, of fine texture and grey colour. Three boulders of mica-schist, one being garnetiferous, the garnets being decomposed. Two boulders of quartz porphyrite, one containing schorl. One large fragment of silicified wood, coniferous (?). Two boulders of dolerite, very much weathered.

At Chequers Inn—Boulder of limestone (Carboniferous), $26 \times 18 \times 12$ in., much rounded and smoothed. Boulder of calcareous sandstone, $30 \times 24 \times 18$ in.

At Vicarage—Boulder of sandstone dug up in the churchyard, $32 \times 16 \times 15$ in., oblong, yellow, gritty.

At Sewell's Farm—Boulder of millstone grit not exceeding 12 in., containing abundant casts of shells, soft, buff-coloured.

At Felstead Place—Boulder of dolerite, broken up before it could be

measured. Boulder of sandstone, 37 × 17 × 12 in., oblong, much smoothed, compact.

At Coal Yard—Boulder of sandstone, 34 × 20 × 15 in., oblong, rounded and smoothed, compact, greyish yellow.

In Village Street—Fourteen boulders of sandstone, smoothed and rounded, 21 × 16 × 6 in., fine-grained, compact, yellow; 24 × 18 × 6 in., fine-grained, compact, yellow; 18 × 10 × 11 in., gritty, loose, very dark, almost black; 26 × 10 in. (buried), 23 × 9 in. (buried), and 18 × 7 in. (buried), very compact, mottled, bright, red and yellow, fine, compact; 31 × 11 × 11 in., fine, compact, yellow; 17 × 11 × 11 in.; 14 × 13 × 10 in., grey brown, gritty, glazed with calcite; 17 × 12 × 9 in., very compact, reddish yellow; 20 × 10 × 9 in., fine, compact, grey; 22 × 17 × 13 in., fine, grey; 17 × 11 × 10 in. and 22 × 19 × 6 in., coarse, gritty, glazed with calcite. Two boulders of flint, 27 × 10 × 6 in. and 23 × 11 × 5 in. Three boulders of dolerite, 15 × 9 × 8 in. and 12 × 9 × 10 in., and one under 12 in.

LANCASHIRE AND CHESHIRE.

A valuable list and description of erratics which have been found in the drainage areas of the Oldham Corporation Waterworks by Mr. W. Watts will be found in the 'Transactions of the Manchester Geological Society,' Session 1887-88, p. 584 *et seq.*

In the 'Transactions' of the same society (Feb. 7, 1888) Mr. Herbert Bolton describes the boulders in the high level drift of Bacup.

Mr. Ratcliffe furnishes the following description of the erratics in Dukinfield, Stalybridge, Millbottom, and Micklehurst. The term 'boulder clay' is used to denote the clays, marls, sands, and gravels containing boulders, but must not be taken as always synonymous with the lower boulder clay or 'till.'

At Dukinfield the boulder clay rests upon the edges of the Upper, Middle, and Lower Coal measures, from the river Tame to Line Edge, and beyond to the base of Harrop Edge the drift consists of alternate layers of clay, sand, and gravel; in some cases thick layers of marl come in between the upper sand and gravel.

The top clay is extensively used for brick-making, the sand for building and moulding purposes. The gravel contains often large boulders, and almost in every case yields large quantities of water.

At Dukinfield Hall there is a total depth of 20 ft. 7 in. to the rock head, whilst to the north at Ashton Moss Colliery the section in the sands, clays, and gravels, of which the boulders are formed, is as follows:—

	ft.	in.
Soil turf and sand	4	0
Strong marl	11	0
Sand and marl	1	6
Dark wet sand	8	2
Strong marl	11	4
Sand and gravel	2	0
Dry sand	8	6
„ gravel	0	6
„ sand	26	4
„ marl	6	0
„ sand	11	6
Wet „	17	6
Strong marl	26	8
Marl and stones mixed	7	11

To the east of the Ashton Moss Colliery the Lords' Field Colliery passed through the following:—

	ft.	in.
Soil and clay	6	0
Strong marl	43	6
Dry sand	24	0
Wet „	4	0
Strong brown marl	101	9
Wet gravel, 7,000 gallons of water per hour	7	9
	<hr/>	
To rock head	187	0

Returning to the Cheshire side of the river Tame the drift covers the edges of the middle series, the dip of which is west at an angle varying from 18° to 42°, and along the line of Chapel Hill, where it covers the lower seams of the middle series. The following is a section at Victoria Colliery:—

	ft.	in.
Soil	0	6
Clay	2	0
Marl	9	6
	<hr/>	
To rock head	12	0

The boulders distributed over this area, extending from the river Tame at Dukinfield Hall to Lyne Edge, varying in size from a few hundredweight to three tons, are found mostly resting upon the marl at the base of the gravel beds, and consist of felsites, hornblendic granites, andesite, and andesitic ash, some micro-granites and Eskdale granites. They are mostly rounded, sub-angular, and in some cases striated.

Beyond Lyne Edge to the base of Harrop Edge, where the millstone grit appears, are strong marls, with sand and gravel beds beneath. In the marl a few feet below the soil are boulders, smooth and well rounded, consisting of andesitic ash, rhyolitic breccia, Eskdale granite, vein rock, and crushed altered ash.

Along the base of Shaw Moor the boulder clay is upwards of 30 ft. thick, containing a variety of small boulders, pieces of gannister, &c. One large boulder, a felsite from the Lake district, is upwards of seven tons in weight; another is rather smaller in size, a felsite with epidote, also from the Lake district; another is about thirty hundredweight, and is a Criffel granite from the S.W. of Scotland.

The boulder clay from the river Tame to the base of the hills, from Millbottom to Micklehurst, consists of boulder clay resting upon sand, and gravel, from which a good supply of water can be readily obtained.

The clay contains a large number of small boulders, often intermixed with thin bands of sand and small gravel, and occasionally larger boulders of the Eskdale series: andesitic ash (crushed), felsites, syenite, vein rock, and hornblendic granite from Buttermere. These are rounded, smooth, the softer portions showing slight striations.

The following sections show the exact positions of some of the erratics at different points in the area described:—

	ft.	in.
Soil	0	6
Sand	5	0
BOULDERS—		
Loam and sand	7	6
Gravel	2	0
Sand with water	6	0
	<hr/>	
Rock base	21	0

		ft.	in.
Soil		0	6
Yellow clay		3	0
Sand		15	0
Gravel		2	0
BOULDERS—			
Marl		4	0
Rock base		24	6
		ft.	in.
Soil		1	0
Gravel and sand (with water)		9	9
BOULDERS—			
Marl		4	0
Rock base		14	9
		ft.	in.
Soil and gravel		12	0
BOULDERS—			
Marls		8	7
Rock base		20	7

Mr. Plant continues his reports and describes the erratic blocks at Spinney Hills, near Leicester.

A fine group of blocks has been uncovered on the Spinney Hills, to the east of Leicester; they were scattered over about two acres of land, and lying on the lower Rhætic beds, under about 6 ft. of a stiff upper boulder clay which covers these hills, and varies from 3 to 12 ft. deep, and is succeeded by the hard white clay and shales of the Rhætic beds. All the blocks except two are granite from Mount Sorrel, 6½ miles distant due N. The following is a list:—

	Length.	Breadth.	Depth.
No. 1	3 ft. 3 in. × 3 ft. 0 in. × 2 ft. 6 in.		
No. 2	3 ft. 0 in. × 2 ft. 10 in. × 2 ft. 0 in.		

No. 2 block is unique, being the first I have found that has a *smooth polished surface* and slightly striated, the edges and angles clean and sharp. The above will be removed to the Museum grounds at Leicester. The other blocks are as follows:—

	Length.	Breadth.	Depth.
No. 3	2 ft. 0 in. × 2 ft. 0 in. × 1 ft. 6 in.		
No. 4	2 ft. 0 in. × 1 ft. 8 in. × 1 ft. 0 in.		
No. 5	2 ft. 6 in. × 1 ft. 6 in. × 1 ft. 0 in.		
No. 6	1 ft. 6 in. × 1 ft. 6 in. × 1 ft. 0 in.		

The above blocks are roughly cubical, the angles and edges are sharp and some of the sides quite fresh, *i.e.*, not weather-worn. Besides these, seven other smaller blocks, rough cubes, of 1 ft. 6 in. on the face; these are of Mount Sorrel granite, 6½ miles distant; two others about the same size, but much rounded and worn, were coarse sandstones or millstone-grit, which must have come from the north some 30 miles. Two others, one Oolite and the other Lias limestone, must have come N.E. distant 12 or 14 miles. Height above the sea about 280 ft.

Blocks at Newfound Pool, near ancient Roman Road, 'The Fosse Way.'—Some large blocks have been uncovered in the excavations for new streets at the above place, which is about 1½ mile on the west side of the

town. All were in Upper Boulder clay, containing more sand than usual, which must have been derived from the beds below the Upper Keuper sandstone, which extends for some miles on that side of Leicester, the 'drift' varying from 6 ft. to as many inches in different places. The blocks were associated with a unique find (as far as this county is concerned), viz., a huge fin-bone, 2 ft. 6 in. long by 1 ft. 8 in. wide, of some species of whale. This was under about 4 ft. of drift of the Upper Boulder clay. Nearly all the animal tissue had been taken out of the bone, owing to its lying so little below the surface in the sandy drift. No other bones or teeth of the whale were found. It has been placed in the Leicester Museum.

Description of blocks :—

	Length.	Breadth.	Depth.
No. 1 . . .	5 ft. 0 in. ×	3 ft. 0 in. ×	2 ft. 6 in. (sub-angular)
No. 2 . . .	1 ft. 8 in. ×	1 ft. 6 in. ×	1 ft. 2 in. (angles very sharp)
No. 3 . . .	1 ft. 4 in. ×	1 ft. 2 in. ×	1 ft. 0 in.

All syenite from Groby or Markfield, distant about 4 miles. Height above the sea 210 ft.

Report of the Committee, consisting of Professor VALENTINE BALL, Mr. H. G. FORDHAM, Professor HADDON, Professor HILLHOUSE, Mr. JOHN HOPKINSON, Dr. MACFARLANE, Professor MILNES MARSHALL, Mr. F. T. MOTT (Secretary), Dr. TRAQUAIR, and Dr. H. WOODWARD, reappointed at Manchester for the purpose of preparing a further Report upon the Provincial Museums of the United Kingdom.

THE Report of this Committee which was presented last year dealt mainly with the statistics of museums throughout the United Kingdom. The Committee was reappointed for the purpose of considering the ideal to which provincial museums should endeavour to attain, and of suggesting practical methods for approaching that ideal.

The provincial museums now existing may be classified roughly into the following six groups, viz. :—

1. Museums of Science and Art on a large scale, supported by Government, as at Edinburgh and Dublin.
2. Municipal Rate-supported Free Museums.
3. University Museums.
4. Teaching Museums attached to schools and colleges.
5. Museums belonging to local societies.
6. Proprietary Museums.

Of these typical groups the *first* must always be few in number, while the *third*, *fourth*, *fifth* and *sixth* have special objects, in pursuit of which they may properly diverge from any fixed standard.

The *second* type, the Municipal Rate-supported Free Museum, is already numerous, and is becoming annually more so. Its objects include those of all the others, and it may fairly be taken as a standard by which others may be gauged.

We propose, therefore, to consider what is the complete ideal which the authorities of a free rate-supported museum should keep before

them; not merely what is practicable under existing circumstances, but what would be the best under ideal conditions, and therefore what are the aims to be kept in view, and the lines upon which labour and money should be chiefly expended.

The general objects common to all museums are:—

1. To preserve, for the purpose of comparison and study, such specimens, whether of natural or artificial production, as may illustrate the history of the earth and its inhabitants.

2. So to arrange and display these specimens as to make them most available for such purposes.

The special objects of a free rate-supported museum in a provincial town should be:—

1. To contribute its share to the general scientific statistics of the country by collecting and preserving specimens of the natural and artificial productions of the district in which it is situated.

2. To procure such other specimens as may be desirable for illustrating the general principles of science, and the relations of the locality to the rest of the world.

3. To receive and preserve local collections or single specimens having any scientific value which the possessors may desire to devote to public use.

4. So to arrange and display the specimens collected as to afford the greatest amount of popular instruction consistent with their safe preservation and accessibility as objects of scientific study.

5. To render special assistance to local students and teachers of science.

Respecting the general objects of all museums, we do not think that there is much difference of opinion, and on this point little need be said. These objects, however, can be fully carried out only in such extensive buildings and with such large resources as are rarely attainable except in metropolitan cities. To represent the history of the entire inorganic world, and of the development and present condition of its vegetable and animal life, as far as these things are known to science, is an object worthy of a great State department but impracticable in any ordinary provincial town. Nor could even a State department hope to accomplish this work in full detail unless it could command much more extensive buildings and a much larger income than any nation has ever yet devoted to such a purpose.

What a national museum can practically do is to represent the history and present condition of the world and its inhabitants in an epitomised form, illustrating all the salient points and filling in the details of a few selected periods and types. It will also be the repository for important special collections and for very rare and costly objects which have a wide general interest.

In the series of specimens preserved in such a museum the national territory will be represented as a matter of course in its proper place, and in its due proportion to the whole. There may indeed be an additional department for that section of the earth's surface, with its geology, natural history, and archæology represented as a distinct group, and somewhat more elaborately than in the general collection; but to illustrate the full details of nature in the varied aspects presented by each parish and county, even within the limits of a single empire, would be impracticable in a museum devoted to the history of the world.

It is here that the provincial museums should take up the work, and should find their legitimate and most useful sphere. Every provincial museum ought, in the first place, to be a *fully illustrated monograph of its own district*. The details of each district can be worked up more thoroughly and more cheaply by the local museums than by any other agency, and if the entire history of the district and its inhabitants is thus represented, special attention being given to any group of objects for which the district is remarkable, this will be almost as much as any local institution can accomplish.

But science is daily becoming more exacting in its demands. Details which were thought ample in any provincial museum twenty years ago would now be regarded as quite insufficient.

In the department of geology every local variety of rock, with its fossils and its minerals, must be illustrated by specimens, by microscopic slides, and by chemical analysis; the stratigraphy and its relations to the physiography, the drainage, and the water supply, must be shown by diagrams, maps, and models, and careful records of every boring, sinking, and cutting, systematically procured and preserved.

In natural history the animal and vegetable life of the district must be represented in the most complete manner possible. There must be specimens of every indigenous animal from the highest vertebrate to the amœba, and of every plant, including the lowest cryptogams, and at least those forms which are characteristic of the district must have their whole life histories illustrated by specimens of male, female, young in various stages, the skeletons and the nests or habitations of animals, and the soils and habitats natural to the plants.

The history of man in the district must be elaborately represented from the earliest pre-historic relic up to the latest phase, every local speciality of food, art, dress, customs, and language being recorded.

Thus much must be accomplished by every provincial museum if it is to 'contribute its share to the general scientific statistics of the country.' But if its collections are also to serve the purpose of interesting and instructing the local population, much more will be required.

For the purposes of general science, and for the use of experts, it is best to keep nearly all museum specimens in drawers and closed cabinets, protected from light, air, and dust; but for the instruction of the public a considerable number must be displayed in such a manner that they can be seen, studied, and compared without being handled. To do this involves without doubt the sacrifice of many specimens which will be destroyed in a few years by exposure to light and dust, and must be frequently replaced; and of much money which might be otherwise devoted to the furtherance of scientific investigation. This sacrifice, however, is absolutely necessary. The people who pay for the museum will insist upon its being administered for their direct and immediate benefit, as well as for their indirect advantage through the cultivation of science in its higher branches. And their demand is justifiable. It is as important to social progress that the millions should be educated as that the few should advance knowledge beyond its existing limits. The ideal Free Rate-supported Museum must do its best in both directions. While therefore a complete collection of all local specimens of a perishable nature must be carefully preserved for reference in closed cabinets, the imperishable ones, such as most geological and archæological objects, as well as duplicates of those perishable kinds which can be

readily replaced, must be displayed in glazed cases for the inspection of the public.

The difficult question here arises: In what manner shall this display be carried out so as to secure the maximum of instruction with the minimum of expense, and so as to make the museum attractive and interesting, yet not a place for mere idle amusement?

The Rev. H. H. Higgins, in his pamphlet on 'Museums of Natural History,' has pointed out that the public who visit museums may be divided into three classes, viz.: (1) Those who are already interested in science and come for information. (2) Those who have enough general culture to wish for more, and who come in the hope of learning something. (3) The very ignorant, who care only to be amused. To these classes he gives the appropriate designations of Students, Observers, and Loungers. Of the weekly visitors to a popular museum, the students probably do not form more than 5 per cent., the observers perhaps 75, and the loungers 20 per cent. It is obvious that, neglecting altogether the small proportion of loungers, a great deal may be done for the scientific instruction of those who come prepared to take intelligent interest in what they see.

The value of scientific instruction lies mainly (1) in the insight which it gives into the laws and processes of nature, thus greatly enlarging the mental purview; (2) in its training of the senses by the habit of accurate observation, and of the reasoning powers by the tracing out of causes and effects; (3) in its revelation of facts which may be turned to man's practical advantage.

In placing any scientific collections before the public with an educational object, all these points should be borne in mind. Accurate observation is to be cultivated chiefly by frequent comparisons of allied forms, and when a series of such comparisons reveals the lines of change, and the large effects of many small changes, the intellectual faculties are stimulated to investigate the forces which have been in operation.

Comparison, therefore, should be made easy, and the observer should be led up to the groupings and the lines of divergence in each department, and induced to look back into the past history and forward into the future prospects of the earth and its various inhabitants.

For these purposes it is not enough to place in the cases rows of specimens with their names and localities only. The natural groupings must be very conspicuously marked, and their points of connection and of divergence very clearly indicated. Attention must be drawn to the special characters of families, genera, and species, to geographical distribution, and to the varied aspects of nature in different localities.

The method of *labelling* in a public museum is of vital importance, and should receive the fullest attention of the curator. If a label contains too much, it will not be read; if it contains too little, its purpose is not effected. The titles of the large groups should be visible at some distance; their limits and their subdivisions should be so marked as to be very easily grasped by the mind of the observer. If Greek or Latin terms are used in these titles, English equivalents, wherever it is possible, should be added. Probably it is wiser at the present time to place the English first.

Nature draws no hard and fast line between the life of past ages and of the present epoch. The organic world is a continuous current, and to separate palæontology from biology cannot represent the actual facts in

their natural connection. Such separation may be convenient for students, but for the instruction of the public selected examples of fossil organisms should be in some manner associated with the living forms. It may not be easy to accomplish this, and it is not necessary that it should be done in any uniform method. Thoughtful curators who recognise the advantage will do the best they can with the means at their command.

The same may be said of the much-debated question—How best to display the forms of existing life? Methods may vary in detail, if the essential principles are carried out, viz., that comparison of allied forms must be rendered easy; that the grouping must be conspicuous; that the connections and divergences of groups must be indicated; that the labelling must be distinct and full; that as many of the facts of nature must be got into the allotted space as can be made clearly visible there, and that their practical bearing upon the wants of man must be shown, if possible.

Professor Herdman's phylogenetic system of arrangement has the great merit of presenting the life-groups in the true order of nature, as far as this is known. In a building suitable for such an arrangement, it would be an excellent scheme, and its leading idea should be borne in mind in all cases, but it could not generally be carried out in detail. Undoubtedly some orderly arrangement of groups should be adopted as a foundation in every museum. To have one room devoted to birds, the next to insects, and the next to fishes, would be wrong under all circumstances.

In considering the best form for cases and the best arrangement of the specimens, it must be remembered that the strength of every provincial museum ought to lie in its local collections. It is the special business of the local museum to collect the utmost possible amount of information respecting the locality, and as much of this should be laid before the public as can be made clear to them without risking the destruction of rare and perishable objects.

These local collections should form the central and most prominent display. Local objects can be obtained in the greatest abundance and at the least cost, and they will always have a peculiar attractiveness for the local public, who can best be instructed by being led from familiar objects of which they have some knowledge to those which are comparatively strange and unfamiliar, and which, if presented without such associations, would often be incomprehensible. Geological collections must be accompanied by maps, diagrams, sections, and models, so that the relation of each rock to the general series may be readily perceived. These maps, &c., may be of small size, but they are wanted in juxtaposition with the specimens, not hanging on distant walls, although, of course, large wall diagrams of a more general character are useful also. The building up of sections with slabs of the actual rocks has been adopted in some museums with very good effect. Such sections on a large scale erected in the surrounding grounds may give a good idea of the stratigraphy of the district. The relations between the rocks and the physiography, the drainage and the water supply, is best shown by relief models in clay, paper, or other material. In the display of minerals, their connection with various commercial products ought to be indicated. Throughout the whole of the geological department the results of chemical and microscopical analysis of the various rocks and minerals must be briefly stated.

Taking the local geology as the foundation, and confining to the local rocks the details above referred to, the relation of these to the known geology of the world requires to be very clearly represented. Specimens of all the principal strata not occurring in the district must be exhibited, and their absence from the district distinctly pointed out. To display a typical series of the rocks of the world in one line, and those of the district in a separate and parallel line, with the tablets or the labels of contrasted colours, is perhaps the best arrangement; but if space cannot be spared for this, a single line with differences of colour may be adopted.

In the geological department the arrangement must be chronological and stratigraphical. Each fossil-bearing rock must be accompanied by specimens of at least some of its characteristic fossils; in the case of local rocks these should be as numerous as space will admit.

In the natural history department a zoological arrangement will form the basis and the local species the principal display, the chronological evolution of these species being shown by duplicate fossils and drawings of extinct forms, and their relations to the fauna of the world by foreign types on a separate but parallel line as in the geological department.

It seems necessary that the vertebrates should be separated from the invertebrates. The immense difference in individual size and in the numbers of species compels a distinctly different method of display.

In each of these two great branches of zoology the same fundamental system must be adopted, viz., to give precedence to the local forms, to treat these in full detail, giving the utmost amount of information respecting them which can be satisfactorily shown within the given space, and to indicate their relations to the fauna of the world, and their evolution in geological periods.

The information which can be given to the public respecting the local forms of life will relate chiefly to their organic structure and their life-histories. The structure of invertebrates must be chiefly shown by drawings or models, and of vertebrates by skeletons. The life-history can be illustrated by specimens of the sexes, of the young in various stages, of the nests or other habitations, of the food, and of the habitats. If these, while remaining in their proper place in the series, can be grouped together in a pictorial manner so as to be fairly true to nature, the interest of the public will be greatly increased, additional instruction will be conveyed by them, and science will not suffer. But isolated groups are of much less value, and the tendency to set these up in a dramatic or artistic manner merely as sensational ornaments should be rigidly repressed.

It is of the first importance that the stuffing and mounting of vertebrates should be skilfully done. A large proportion of those at present displayed in provincial museums are mere delusions. They do not represent nature. An unstuffed skin is much more useful in every way than one which is set up untruthfully.

In the archæological and anthropological departments the same system must be carried out, but the arrangement here must be chronological.

Starting with the earliest relics of man discovered in the district, the series of examples of his work and habits should be continued even to the current date, particular attention being devoted to any local peculiarities. The changes which have taken place from age to age in his tools, his clothing, his architecture, pottery, ornaments, coinage, weapons, &c., as illustrated by purely local specimens, will be of the utmost interest and importance; and the whole local series should be supplemented by a few

examples of corresponding dates from various other parts of the world placed in a parallel arrangement for easy comparison.

The developments of the agriculture, the manufactures and the commerce of the district, will require to be exhibited in a distinct technological department, which, if well arranged, will be to a large number of visitors the most interesting and valuable part of the museum.

The botanical department is perhaps the most difficult to deal with in a public gallery. The herbarium in its usual form is scarcely available for the general use of the public, while collections of seeds, woods, and vegetable products, though of great value in themselves, give no insight into plant life. The modelling of plant forms is now carried to great perfection in decorative art. If typical plants of each order in the local flora were exhibited in this way, with corresponding examples of remarkable foreign species behind, and fossil forms in front, much interesting instruction would be afforded, and the cost would not be excessive.

Dried specimens of the whole local flora might well be exhibited in a cabinet of very shallow glazed drawers which the public could draw out but not remove.

The glass jar as now used for zoological purposes might be effectively applied to botanical specimens for the illustration of the life-history of typical species.

Provincial museums have made their collections hitherto in a very unsystematic manner, by donation or purchase as opportunities occurred.

In order that the scientific statistics of the country may be thoroughly investigated and made known as quickly as possible, a much more business-like system of collection should be adopted. The district should be divided into sections, and a paid collector appointed for each of them, whose whole time should be occupied for several years in obtaining specimens and records in every branch of science represented in the museum. In nearly every part of the kingdom competent men could be found to do this work for very moderate salaries. The necessary apparatus must be provided for them, they would generally require some amount of instruction, and during the period of their operations a sufficient staff of assistants must be employed at the museum to deal with the specimens brought in.

To carry out the work in this systematic manner, funds on a more liberal scale than is now usual must be provided for the first few years, but the value of the museum would be immensely enhanced, and when the local collections were made tolerably complete the permanent income required for maintenance would be very much less.

Taking, as an example, a town of 100,000 inhabitants, the centre of a district included within an average radius of ten miles, it may be roughly estimated that the cost of erecting a building thoroughly suitable for a museum, including the site and fittings, would not be less than 10,000*l.*, and that during the first three years an annual income of 1,500*l.* would be required, with a permanent income thereafter of not less than 600*l.* For smaller towns or smaller districts the estimate might be considerably less, but the penny rate authorised by the Public Libraries and Museums Act is insufficient to support both library and museum in one town on a satisfactory scale.

Every well-appointed museum should contain, in addition to its public galleries, an office for the curator, work rooms for the assistants, store rooms, a students' room with table, microscope, books of reference, and

a few chemical re-agents; and a keeper's residence. A residence for the curator, that he may be always on the spot, is desirable, if not essential; and, unless the town contains a separate college of science, a class-room, lecture theatre, and laboratory would be valuable additions. A library of standard scientific works, comprising not less than 500 volumes, is absolutely essential to the proper working of a museum. No curator can undertake to name and properly label the specimens collected without constant reference to books. All local scientific societies should be encouraged to hold their meetings at the museum, where a suitable room with lock-up cupboards might advantageously be provided for them, small rents being charged, except where this would involve the rating of the whole premises.

When donations are offered to a public museum the authorities should consider that they are concerned only for the public interest, and that they have no right to occupy space by the storage of objects which are of no public value. It is generally undesirable to accept any donations with restrictions as to what should be done with them. When they are given to the museum they become public property, to be dealt with freely for the public benefit. When presented they may be considered good examples of their kind, but if superior ones afterwards come to hand the authorities should have power freely to exchange or sell. Exceptions to this rule may be made in special cases. Collections brought together by eminent scientists often acquire a classical reputation and should not be broken up, or single specimens, even though of little value in themselves, may have a place in the history of science which should render them sacred. Such objects may be accepted under any reasonable conditions.

A movement has recently been inaugurated at York for bringing the curators of museums into closer communication and assisting in the exchange of duplicates. Something of the kind is much needed. A periodical publication, in which curators could from time to time describe portions of their duplicates, would probably be found useful. If it were possible to appoint a travelling inspector, who should devote his time to visiting the provincial museums in rotation, arranging exchanges, spreading the knowledge of new inventions in museum apparatus, assisting in the naming of doubtful specimens, taking notes of desiderata which might be supplied by other museums, and acting as a general medium of communication and consulting visitor, such an officer might be of very great service. An adequate salary would have to be provided, either by Government or by some independent society, with contributions from the museums visited. It might be difficult to find a man of sufficient tact, judgment, and knowledge who would undertake the post, but without doubt there is much to be done in this direction.

The town museum should be the place to which all students and teachers of science in the district should naturally go for assistance. To *bonâ fide* students every encouragement and facility should be given, and loan collections should be prepared for teachers. A system of travelling museums which circulate among the principal schools of the town has been adopted at Liverpool with great success.

The practical value of museums as important factors in all adequate systems of education is not yet recognised by the general public. Too many of these institutions have hitherto been but toys and hobbies, and require complete re-organisation. We are not aware of a single free rate-

supported provincial museum in the kingdom which has attained to the ideal recommended in this report.

- In the first report of this Committee, published in the Manchester volume, the following corrections and additions should now be made, viz.:—
- Page 4, after No. 10.—Birmingham. *Insert* 'Mason College Museums—Professors Lapworth, Bridge, and Smith. Class 1. Coll.-general, Zoo., Geo., Mech. Free daily.'
- „ 4, No. 15.—Bootle. *For* '1885' *read* '1887.' *Insert* 'J. J. Ogle, 43 Brook Road,' curator. Visitors, 600. *Strike out* 'not yet opened.'
- „ 6, No. 24.—Cambridge. *Insert* 'M. of Zoology. S. W. Clark, cur. Class 1. Coll.-general, Zoo.; Comp. Anat.'
- „ 6, No. 24.—*Strike out* 'Trin. Coll.'
- „ 6, after No. 37, *Insert* 'Christchurch, Hants. Hart, owner. Coll.-local. Ornith.'
- „ 6, No. 44.—Derby. *Insert* 'weekly visitors, 2,000.'
- „ 6, No. 45.—Devizes. *For* 'Cunningham' *read* 'Cunnington,' and *insert* 'deceased.'
- „ 6, No. 46.—Devonport. *For* 'Rome' *read* 'Rowe.'
- „ 6, No. 47.—Dorchester. *After* 'Moule' *insert* 'M.A.'
- „ 8, after No. 61, *Insert* 'Guernsey. Guille-Allé M.'
- „ 8, No. 66.—Huddersfield. *For* 'Mossley' *read* 'Mosley.'
- „ 10, No. 106.—Norwich. *For* 'Reade' *read* 'Reeve.'
- „ 10, No. 110.—Oxford, Bodleian. *Insert* date '1598,' and *for* 'G. B. Nicholson' *read* 'E. B. Nicholson.'
- „ 10, No. 112.—Oxford, Ashmolean. *Insert* date '1679,' and *for* 'J. H. Parker, C.B.' *read* 'Arthur J. Evans, F.S.A.'
- „ 10, after No. 113, *Insert* 'University Galleries, 1841. Joseph Fisher, keeper. Coll.-general Arch. Art, supported by the University.'
- „ 12, after No. 130, Sheffield, *insert* 'St. George's M. Founded by Mr. John Ruskin for Objects illustrating the Beautiful in Nature and Art.'
- „ 12, No. 132.—Southampton. *Insert* under Coll.-local 'Geo.'
- „ 12, No. 157.—Woolwich. *Strike out* 'Royal Artillery Institution.' *Insert* date '1820.' *For* 'Harman' *read* 'Crookenden.' Under Coll.-general *add* 'and Military Models.'
- „ 14, No. 159.—York. *Insert* date '1823.'
- „ 16, No. 211.—The Powys-Land M. has been transferred to the Corporation of Welshpool, the town having recently adopted the Museum Act.
- „ 18, Number of Museums estimated as First Class, for '56' *read* '59.' Second Class, for '55' *read* '58.' Total, for '211' *read* '217.'
- „ 20, *Under* 'Archæology,' *insert* 'Roman from Cambridgeshire, &c. Cambridge, M. of Archæology,' *also* 'from Ribchester, Blackburn.'
- „ 21, line 18, *After* 'Alnwick' *insert* 'Oxford, Ashmolean.'
- „ 21, line 20, *After* 'Cambridge' *insert* 'M. of Archæology.'
- „ 21, line 21, *After* 'Cambridge' *insert* 'Fitzwilliam M.'
- „ 21, line 31, *After* 'College' *insert* 'Oxford, Ashmolean and M. of Archæology.'
- „ 21, line 34, *For* 'Fitzwilliam M.' *read* 'M. of Archæology.'
- „ 21, At end of list of Anthropology *add*:—
 Ethnological Library Oxford, M. of Archæology.
 Anglo-Saxon, with K. Alfred's
 Jewel Oxford, Ashmolean.
 The Tradescant Collection ” ”
 Greek Vases ” ”
 Arundel Marbles ” ”
- „ 22, line 29.—The annual receipts at York vary between 150% and 350%.
- „ 30, line 4, *For* 'Newcastle' *read* 'Northumberland.'

NOTE.—The pages refer to the Report as printed separately, not as in the volume.

Second Report of the Committee, consisting of Mr. R. ETHERIDGE, Dr. H. WOODWARD, and Mr. A. BELL (Secretary), appointed for the purpose of reporting upon the 'Manure' Gravels of Wexford. (Drawn up by Mr. A. BELL.)

NOTE.—In the following report it has been endeavoured to trace the nature, limits, and contents of, first, the so-called 'manure' gravels, their mode of occurrence and geological position; secondly, that of the sea-coast marls; and thirdly, the relations in which these stand to the drift deposits south of Dublin with which they have been correlated.

The fossils obtained have been transferred to the Geological Department, British Museum.

Nature of Ground.

Before entering upon the main purpose of this report a few words descriptive of the ground upon which the Wexford deposits rest may be desirable.

The bed-rocks of the district consist of purple conglomerates, slates, and sandstones of Cambrian and Cambro-Silurian age metamorphosed by the intrusion of vast masses of quartz rock into schists and felsites of varying hardness, and forming considerable elevations, upon whose summits the quartz stands out in precipitous masses. These elevations rise from the shore of the Slaney river, forming the ridge, upon part of whose seaward face Wexford city is built, to about 300 feet, and then descend rapidly before rising again to produce the Forth Mountain, a ridge extending 3 to 4 miles N.E. to S.W., with a height of 690 feet. A ridge of Palæozoic rocks also continued across the present Slaney valley to the north before the drainage of this part of Ireland was altered by the breaking down of a portion of it at Ferry Carrig, by Fitzstephen's Castle, forming the gorge of the modern Slaney river.

Between the Wexford and Wicklow Railway and the sea the ground rises into high hills and ranges, with occasional bog-lands at foot. Gneiss and granite are present at the extreme S.E. at Carnsore Point, and black calc limestones at Drinagh, near Wexford.

The later deposits of Wexford fall into three divisions, viz., (1) the so-called 'manure' gravel series; (2) marls and clays; (3) an illusory or fictitious drift. The first of these occur *only* on the *landward* side of the elevations and hills just referred to; the second on their *seaward* faces and cover in part the previous gravels; the third is forming wherever the bed-rock is exposed to atmospheric influences.

(i) *The 'Manure' Gravel Series.*

These consist in ascending order of fine sands passing up into a comminuted shell gravel covered by a débris of, for the most part, local rocks. Of these the sands are lowest and most persistent, appearing in the banks of the Slaney river, which has cut through them since their deposition. In a sandpit near St. Peter's College, Wexford, various igneous rocks, as quartz and granite, are present on the floor; but as in the side of the pit

near the top a large mass of felsite, one face measuring 2 feet or more, is *in situ*, pressing down and contorting the water-sorted gravel seams, these are doubtless not in their original place. The granite has probably come from the Carnsore horizon. Large transported rocks are, however, not common in these sands. From the shore at Artramon, on the eastern bank of the Slaney, all the way up the ascent to Castlebridge, the road exhibits this sand, which in a pit near Pulregan is beautifully exposed, passing up into comminuted shell gravel.

The section at Little Clonard is a very instructive one, and is the deposit referred to by earlier writers as being on the Forth Mountain. More accurately it is upon the land face of the Wexford ridge, *opposite to* the mountain. Down the slope of this ridge it extends for a distance of 150 yards, with a vertical thickness of about 20 to 24 feet. At the base of the section is a sheet of concreted or cemented gravelly sand a few inches thick. Upon this reposes a thick mass of sand with many pebble seams containing much small limestone, the fossils being most plentiful in these seams. Over this is a drift of stones very local in position, in some places absent, in others 3 feet thick. The upper beds having been much turned over during the 100 years the section has been open and the sand removed, no accurate idea can be conveyed as to the original condition of this portion of the pit; but in a continuation of the sheet of gravel a few perches away a pit has been opened within the last three years that may supply the deficiency. Here, below the surface soil, is a bed of clean sand with a brown marl 4 feet in thickness, this covering the fine limestone gravel. The larger drift is here absent, but may be seen further on the road in Mr. Moody's grounds at Rathaspick. The largest stones occur in the surface soil.

The next place where these shell gravels occur is on the side and top of the hill near Castlebridge at Pulregan; here the gravels are finer and sandier, and the local covering drift is less conspicuous.

For purposes of comparison with other deposits elsewhere, which have been considered as the equivalents of these gravels, a careful examination was made as to the nature and condition of this covering *débris*, and to this end the mean of several groups of twenty specimens, each picked at random from the face of the section, gave the following results:—

	Little Clonard	Pulregan	
		No. 1.	No. 2
Quartz and quartz rock	6	7	10
Cambrian or Ordovician	8	9	8
Limestone	5	1	1
Chalk flint	0	2	1
Granitic pebble	1	1	0
	20	20	20

The examination of a heap piled at one side in Little Clonard pit yielded a larger proportion of quartz and Cambrian and less of limestone. At neither place did the stones bear those marks of glaciation, *striæ*, and polishing that occur in the limestone drift proper. The pebbles are also more rounded.

Professor Harkness, 'Geol. Mag.,' vol. vi. p. 543, remarks on an exposure of these beds at Castle Ellis, about eight miles to the N.W. of Pulregan, that the sands and gravels are covered by a boulder clay 40 feet thick, 'abounding in angular, sub-angular, and rounded blocks,

chiefly Cambrian and Silurian, many beautifully striated.' This description so strongly applies to what I have termed an illusory drift that at present I am inclined to consider it a similar accumulation.

This is a drift, or rather a clay, resulting from the decomposition of the metamorphosed Palæozoic rocks wherever exposed to atmospheric influences. This is well seen between the Slaney and the Forth Mountain, and in and about Wexford, at Killurin and Macmine Junction, and almost everywhere at the foot of the hills along the railway line, wherever a cutting or excavation has been opened. This clay is full of blocks in various stages of degradation, occasionally covered and coloured by iron-froth. The soft nature of the metamorphosed Cambrian rocks renders their situation of less value in this point of view than if they were limestones.

The fauna contained in the gravels is very interesting; the only hitherto available lists are those made so many years back by Captain James and Professor Forbes, their usefulness being impaired by the uncertainty as to whether the fossils came from the gravel or the marl. I have therefore given in the following only those which I have obtained directly from the gravels, adding subsequently those of the earlier lists.

A large proportion of the shells are much abraded fragments, very few of the Pelecypoda being intact, the Gastropods suffering less damage.

The condition in which the remains occur does not altogether suggest more than a normal amount of violence or far removal, since equally broken fragments are to be seen in any ancient or modern sea-beach, such as the raised beach at Thatcher Island, or on the level stretch of sands at Paignton, both in Torbay.

Their distribution is rather capricious. Professor Forbes, *op. cit.*, p. 377, speaks of the abundance of *Purpura lapillus* and the presence of *Littorina littorea* as especially characteristic of the Wexford shelly gravels containing *Fusus contrarius*. These are rare in the southern parts of the district, where *Venus verrucosa*, doubtfully recognised by Professor Forbes as a Wexford fossil, is, on the contrary, not uncommon.

Many of the pits formerly open are now closed or water-logged. Kilbride, co. Wicklow, the locality given in the 'Fossil Catalogue' of the School of Mines, London, for some of Captain James' rarer fossils, has not been worked for forty years past, I am told by Mr Gawan, who has been resident there during that time, and directed my attention to one or two exposures of gravel. Only the local upper gravel with sand was visible. In the same manner as the Slaney in the south cut through the series since their deposition, so also has the Ovoca in the north, the Kilbride gravels being on the Wicklow side of the river.

(1) *Shells collected by A. Bell in the Wexford Gravels.*

Buccinum undatum.		<i>Nassa</i> incrassata.
Cypræa europea.		„ reticulata.
Dentalium entalis.		„ nitida.
<i>Fusus gracilis</i> .		„ pygmæa.
„ antiquus.		<i>Natica</i> greenlandica.
„ contrarius.		<i>Purpura</i> lapillus.
„ islandica jav.		„ incrassata.
„ Menapii, M.S. (n. sp.)		<i>Pleurotoma</i> pyramidalis.
<i>Fissurella</i> græca.		„ rufa.
<i>Murex</i> erinaceus.		„ (var. semicostata.)

Pleurotoma (var. Ulideana.)	Mya truncata.
" turrlicula.	Mytilus edulis.
Trophon muricatus.	" modiolus.
" clathratus.	Nucula Cobboldiæ?
" truncatus.	Ostrea edulis.
" craticulatus.	Pinna.
Turritella incrassata.	Pectunculus glycymeris.
" terebra	Pecten pusio.
Astarte borealis.	" opercularis.
" compressa.	" maximus.
" elliptica.	Solen marginatus.
" (var. sulcata.)	Tapes decussatus.
Cardium edule	Tellina Balthica.
" echinatum.	" crassa.
" rusticum.	Venus casina.
Cyprina islandica.	" verrucosa.
Mactra subtruncata.	Cliona.
Mya arenaria.	Balanus.

And several other forms still undetermined.

(2) *Species recorded by Captain James¹ not found by A. Bell.*

Aporrhais pes pelicani.	Trochus exasperatus.
Cypræa ? sp.	Trichotropis borealis.
Fusus crispus ?	Trophon Barvicensis.
Lacuna puteolus.	Anomia ephippium.
Littorina rudis.	Leda pusio ?
" littorea.	" pernula.
Mitra (? cornea) ?	" oblongoides ?
Melampus pyramidata.	Mactra solida.
Nassa semistriata.	Nucula nucleus.
Patella vulgata.	" proxima ?
Pleurotoma.	Pholas crispata.
Scalaria Trevelyana.	Saxicava arctica.
" greenlandica.	Venus exoleta.

Of these a number are either extinct or only found in seas north or south of Britain, and such an association in the same area needs some explanation. The species are:

North—*Astarte borealis*, **Leda oblongoides*, *L. pernula*, **Nucula Cobboldiæ*, **N. proxima*, *Scalaria greenlandica*, *Purpura incrassata*, *Pleurotoma pyramidalis*, *Trophon clathratus*, *T. craticulatus*, *Meyeria pusilla*.

South—**Leda pusio*, **Cypræa* sp., *Turritella incrassata*, **Nassa semistriata*, **Mitra* sp., **Pleurotoma*, 2 sp.

Habitat unknown. *Fusus* (*Menapii* M.S.), *F. n. sp.*, or allied to **F. crispus*, *Melampus pyramidata*.

Those marked * are uncertain ascriptions according to Professor Forbes, and the *Mitra*, *Nassa*, *Fusus*, and *Ledas*, like Captain James' notes, are no longer in evidence, being either lost or mislaid. Of *Nucula Cobboldiæ*, a living Japanese species, I have a rolled fragment, which seems to exhibit the peculiar sculpture of the shell. The *Cypræa* now (with *Melampus*) in the Museum of Practical Geology, London, requires confirmation.

The *Mitre*, according to Forbes, was an imperfect specimen, too

¹ *Journ. Dublin Geol. Soc.*, vol. iii. Some of these may have been obtained from the marls and not from the gravels.

much broken for identification of species; it might be either *M. greenlandica* or *M. cornea*, both of which Mr. R. A. C. Godwin-Austen, in 'The Natural History of the European Seas,' p. 262, states to occur here. This is, I venture to think, an error on his part.

Of the existence of the other species in the list there can be no doubt, and the question arises, by what routes did they come, and where do similar accumulations occur? On the latter point *Melampus pyramidata* is valuable evidence; its last appearance as a fossil occurring in Eastern England, in the Chillesford beds of Suffolk, in association with *Leda oblongoides*, *Nucula Cobboldia*, *Turritella incrassata*, *Scalaria greenlandica*, *Trophon clathratus*, and others in the list just given.

On the west coast of England it, in company with numerous other shells of southern origin and Pliocene age, occurs in the St. Erth valley in Cornwall, *Turritella incrassata* being a very abundant form; and the conclusion arrived at by the writer is that the Wexford series cannot be placed earlier than at or about the close of the Pliocene stage of East Britain, such as the Weybourn beds of Norfolk.

Professor Forbes was the first to suggest that 'there was a communication between the Mediterranean and the North Seas during this period.' Messrs. Dolfuss and Dautzenberg have also pointed out that the Cotentin deposit in North France is but an extension in continuation of the late Miocene seas.

The deposit at St. Erth¹ is evidently a further extension in a westerly direction, and a still further prolongation in a line northerly from St. Erth to the west of Carnsore Point would strike the valley between the Wexford ridge and the Forth Mountain, and continuing round the inland face of the hills already referred to reach the present coast-line just north of Arklow.

Such an extension would account for the presence of these southern species in the Wexford area. By what route the northern species arrived will be considered in the final report.

(ii) *Marls and Clays.*

On the survey maps it is said, 'The low lands of this coast and the interior up to a height of between 200 and 300 feet are covered by Pleistocene deposits, consisting of marls interstratified with sand and gravel containing arctic and other shells, chalk flint, pebbles of Antrim chalk, jasper, coal, and magnetic iron-sand.'

This description is not very definite, as the deposits vary much in character and are apparently of different ages. In Rosslare Bay, near Ballygeary, the lowest bed rests directly upon the base rock, and is a stiff black clay, originating from the black Carboniferous limestone a short distance away, and is only occasionally relieved by a few quartz pebbles, Cambrian rocks, or a limestone pebble or fossil. A bed of sand, more or less intermittent, ranging from three inches to three feet in thickness, separates this from an overlying very dark clay, with a few large stones and occasional seams of gravel. Fossils are present, but are fragmentary and difficult to find in the clay, but are better preserved in the pebble seams, from one of which, situated towards the top of the cliff to the west of the pier, the following species were obtained:—

¹ On the Pliocene beds of St. Erth, by P. F. Kendall (the late), R. G. Bell, F.G.S., *Quart. Journ. Geol. Soc.*, Lond., 1886, p. 202 *et seq.*

Cypræa europæa.
 Helcion pellucidum.
 „ var. lævis.
 Hydrobia ulvæ.
 Lacuna puteolus.
 Littorina neritoides.
 „ obtusata.
 „ littorea.
 Murex erinaceus.
 Nassa pygmæa.
 „ reticulata.
 Purpura lapillus.
 Patella vulgata.
 Trochus cinerarius.
 „ zizyphinus.

Trochus umbilicatus.
 Astarte sulcata.
 Cardium edule.
 Lutraria elliptica.
 Leda pernula.
 Lucina borealis.
 Mactra elliptica.
 Mytilus edulis.
 Nucula nucleus.
 Ostrea edulis.
 Pecten opercularis.
 „ varius.
 Tapes virginea.
 Crab claw.
 Balanus.

Above this layer were embedded in the face of the cliff numerous land shells, such as *Helix hispida*, *Helix ericetorum*, &c. These may be of no great age. Traces of upland peat occur, and the freshwater *Limnea truncatula* is not uncommon, embedded in the cliff face.

The marine shells are also present in the railway cutting, and fragments may be noticed in the more friable clay or marl beds on either side of Wexford Harbour from the water level to some distance up the sides of the elevations already referred to. Near Wexford the clay becomes more sandy and yellowish, due probably to an admixture of the sands of the earlier series. Here traces of an old layer of oysters are visible. Elsewhere, as in the cliffs south of Arklow, it puts on the look of a rain-wash or brick earth, with few included rocks and without fossils.

The sand at Ballygeary yielded a broken Trophon *Barvicensis*, and the stiff black clay a fragment each of *Astarte sulcata* and *Pectunculus glycimeris*.

The only northern species obtained after close search were *Leda pernula* and, doubtfully, *Astarte borealis*.

Captain James described (1839) the cliffs at Ballygeary as consisting of dark tenacious clays, with rows of Nullipores. The only trace of this alga found was on a limestone pebble in the lowest clay, with a serpula attached to it.

(iii) *The Coast from Delgany to Killiney.*

To ascertain what relations (if any) the Wexford series of deposits had to the so-called Lower, Middle, and Upper drifts of the Dublin area, it became necessary to examine the coast-line with some attention, from the rise of the cliffs at Delgany past Greystones to the sides of Bray Head, and thence to the granite boundary at Killiney and Dalkey, especially the fine exposure at Ballybrack in Killiney Bay, where, according to Professor Hull, the three sections are to be seen, as well as elsewhere. However it may be elsewhere, I was unable to detect any traces of an Upper drift; a conclusion I have since discovered was arrived at some years ago by Mr. G. H. Kinahan,¹ who, in discussing the question, states his opinion 'that there is no deposit between Killiney Hill and the Bray river that could possibly be called an Upper boulder clay drift,' as given by Professor Hull in the section in his paper upon Irish drifts.²

The older drift in Killiney Bay is made up of large and small rocks,

¹ *Geol. Mag.* vol. ix. p. 265 *et seq.* ('Middle Gravels of Ireland').

² *Ibid.* vol. viii. p. 295.

limestone, quartz, schists, and granites (many of the limestones being beautifully striated), intermixed with thick beds of sand, often tilted at an angle of 70° to 80° to the beach, beneath which they pass, reappearing at intervals near the Shanganagh and Bray rivers.

Resting upon, and in places overlying it, are the beds associated with the Middle drifts, made up of loose sands, gravel, and occasionally large blocks of granite and quartz, the cliffs gradually declining towards the south, where they sink to the shore a short distance north of the Shanganagh river. The upper portion of the section is composed of smaller gravel, and is so similar to the older drift that it is impossible to separate them, water action having mixed them together. The fossils in this horizon are chiefly confined to the lower portion of the section and are rather local in their distribution.

A shell-bearing gravel has been recognised for many years past as existing high up the Three Rock and Kilmashogue Mountains at elevations of 1,000 to 1,200 feet. Beyond the facts that these mountain gravels are largely limestone, and the shells all included in the fauna of the lower ones, there is nothing to connect the two. On the contrary, the shells, unlike the lower-lying species, are many of them scratched, and none of the arctic forms are at present known¹ to occur there.

The Shanganagh river flows by the base of a perpendicular cliff, about fourteen feet high, sloping rapidly from the coast inland. The base is a limestone drift (lower drift), passing upwards into a marly clay full of large, rounded granites, angular limestone blocks, and quartz rocks. Coastwise it is of limited extent, soon disappearing beneath the sandy marls referred to in the next section as occurring north of the Bray river. A few fragments of shell are present in the marl, which contains a few seams of pebbly gravel. It may be worth notice that where the marl is seen resting upon the limestone drift large blocks of granite abound, and limestone is almost, if not altogether, wanting. One out of a large number of granite blocks lying upon the shore I found to be 16 feet in circumference.

The shell gravels at Ballybrack have yielded an interesting series of fossils. I have, as in the case of the Wexford lists, given those collected by myself and then those obtained by other searchers not included in my own finds:—

Aporrhais pes pelicani.
Buccinum undatum.
Dentalium entalis.
 „ *Tarentinum.*
Fusus antiquus.
Hydrobia ulvæ.
 „ *ventricosa.*
Littorina littorea.
 „ *rudis.*
 „ *obtusata.*
Nassa reticulata.
 „ *pygmæa.*
 „ *nitida.*
 „ *granulata.*
Natica Alderi.
 „ *catena?*
Pleurotoma costata.

Rissoa parva.
 „ *membranacea.*
Succinea oblonga.
Turritella terebra.
Trophon truncatus
Astarte borealis.
 „ *compressa.*
 „ *sulcata.*
Cardium edule.
 „ *echinatum.*
 „ *pygmæum.*
Cyprina islandica.
Corbula nucleus.
Leda pernula.
 „ *buccata.*
 „ *minuta.*
Lutraria elliptica.

¹ See lists in 'The Elevated Shell-bearing Gravels near Dublin,' Rev. Maxwell Close, M.A., *Journ. Roy. Geol. Soc. Dublin*, 1874, vol. iv. p. 36.

Mya truncata.
 Mytilus edulis.
 Mactra elliptica.
 Ostrea edulis.
 Pecten tigrinus.
 Pectunculus glycymeris.
 Psammobia ferroensis.
 Pholas dactylus.
 Saxicava arctica.

Scrobicularia piperita.
 Tellina Balthica.
 „ calcarea.
 Tapes decussatus.
 Venus gallina.
 „ verrucosa.
 (Artemis) exoleta.
 Balanus.
 Fish vertebra.

Found by Canon Grainger (G.), W. W. Walpole (Appendix, Dr. Gwyn Jeffreys, 'Brit. Conch.' vol. v.) (W.), Professor Oldham (O.):—

Cypræa europea (G.).
 Pleurotoma rufa (W.).
 Trochus cinerarius (G.).
 Loripes divaricatus (W.).

Mya arenaria (G.)
 Psammobia vespertina (W.).
 Woodia digitaria (W.)

A comparison of these lists with those given as from the Wexford gravels effectually disposes of the suggestion that the fauna of the two deposits are identical.

(iv) *From Delgany to the Bray River.*

In this district the cliffs rise from the shore a little S. of Greystones, and passing northwards thicken considerably, the deposits rising to more than 300 feet up the sides of Bray Head. The lowest beds at Delgany are limestone drift, containing the usual quartz, granite, and Cambrian boulders, capped by another gravel largely made up of Cambrian slates, micaceous schists, grits, quartz, and granitic rocks, Old Red sandstones, chalk flints, with comparatively little limestone. Yellow clay or marl, resembling a brick earth, occurs, at first sparingly, with seams of fine pebbles, thickening out northwards and infilling the hollows in the underlying beds. North of Bray Head it appears in the cliffs, dying out near the beach at the Shanganagh river, as already mentioned. South of Greystones, at the top of the gravel, a few fragments of *Mytilus modiolus*, with adherent epidermis and a portion of *Tapes virginea*, were the only fossils obtained.

Between Greystones and the Head the gravels overlies sands, to which they are presently seen to lie unconformable, the sands and pebbly seams beneath exposing strong current bedding, at an angle of about 20°, for a short distance, when an irregular mass of limestone débris appears, resting upon a thick bed of dark clay, with seams of sand and small gravel, exhibiting much contortion—even to the doubling of the seams upon themselves—the overlying débris pressing down into the hollows left by the contortions.

Evidences of water sorting are very prevalent all through the mass in the seams of pebbly sand which are interspersed in the drifts. Small fragments of shells are not uncommon in the gravel, especially in the rise above the line of railway before it enters the tunnel (*Astarte sulcata* and *compressa*, *Cardium echinatum*, *Tellina* and *Cyprina*), but are seldom determinable:

The like conditions are found north of Bray Head, where the gravel and bedded seams are seen to pass down to the sandy marls before mentioned. The bivalves just referred to are present here also, with a few pieces of *Purpura* and *Turritella*.

From the results obtained and described in the foregoing notes it would appear that—

1st. The Wexford gravel series proper are the sole remains of a series of sands and gravel deposited in an arm of the sea, occupying a channel opened out from a southern direction prior to the existence in this neighbourhood of the Slaney and Ovoca rivers, their fauna indicating their age to be immediately pre-Glacial.

2nd. That the gravel beds in Killiney Bay are of newer age,¹ and the contents do not bear out the suggestion that has been made as to their being coequal in time.

3rd. That the series of marls, clays, and brick earths of the coast had their origin and were formed subsequently under submersion, and are the newest deposits of all.

In a final report I propose to give a *résumé* of the Irish fossiliferous drifts in general, with a view to their bearings upon the distribution of the mollusca in other parts of Britain.

Report of the Committee, consisting of Professors MCINTOSH (Secretary), ALLMAN, LANKESTER, BURDON SANDERSON, CLELAND, EWART, STIRLING, and MCKENDRICK, DR. CLEGHORN, and DR. TRAQUAIR, for continuing the Researches on Food-Fishes at the St. Andrews Marine Laboratory.

SINCE September 1887, the period included under the present grant, considerable additions have been made to the researches on the development and life-histories of the food-fishes. Thus the larval stages of the gadoids have been followed to the early post-larval stages, so that a fairly complete history, in several instances, can now be produced. Nevertheless it is true that in the earlier post-larval stages of the round fishes, it is difficult, *e.g.*, to distinguish between the cod, haddock, and whiting; at least this may be predicated of all the post-larval forms hitherto procured in May, the period when they first become conspicuous in the large mid-water net. It is only when the pigment assumes its definite character, for instance, the tessellated condition in the young cod, or when the barbel appears, and the fins become clearly outlined, that certainty is reached. In the case of the young cod, recognition is readily made on June 1, though the pigment has not yet assumed the distinctive tessellated condition; and the differences between this species and the young green cod at an early post-larval stage were also minutely examined this season.

Though it cannot yet be proved that a general migration of the young round fishes, *e.g.*, cod, haddock, and whiting, takes place from deep to shallow water, there are certain facts which bear upon such a habit. Thus, the post-larval cod are rarely met with on the grounds frequented by the adults, but appear in considerable numbers at a somewhat later stage in St. Andrews Bay, and in June at the margin of the tidal rocks at low water. As formerly mentioned, they increase in size as the season advances. Some remain for a year off the rocky coasts, and are caught

¹ Whether these Killiney gravels correspond to the Middle drift of the English and North Wales districts is not clear. I hope to trace the connection, if any, in the final report. At present the evidence is rather against than for such being the case.—A. B.

(as rock-cod) by hand-lines; while others of the same size, but having a less ruddy hue, abound at a somewhat greater distance from shore, *e.g.*, south-east of Girdleness in Aberdeenshire, and off the Bell Rock, and are caught in numbers by both liners and trawlers. The large cod frequent the deeper water at some distance from shore as a rule, though in pursuit of herrings they approach the shore more closely at certain seasons.

The post-larval stages of the haddock have hitherto escaped recognition; though G. O. Sars speaks of distinguishing the early post-larval haddock by their shorter and stouter form as contrasted with the young cod.

The life-history of the whiting has especially been elucidated during the year, and further additions made to the post-larval stages of the ling. It is interesting that two yellowish longitudinal bands occur along the sides of the former in the adult condition, especially in connection with the characteristic yellowish larval pigment. The development of the Clupeoids of the bay has also been followed, and observations made on their growth. The larval and post-larval stages of the sand-eel, so very abundant in the bay, have likewise been studied.

Amongst flat fishes (Pleuronectidæ), the post-larval stages of the common flounder, the long rough dab and other forms, have been examined, and their life-histories followed more or less completely. The eggs apparently of the sole have been found late in summer near the surface of the bay, and though the adults are few, there is no reason why they should not be increased by artificial aid, such as the introduction of a number of adults from Scarborough and other convenient localities. The food of the sole is very abundant in St. Andrews Bay, and the only difficulty will be competition with the hardy plaice so numerous in this ground. The post-larval stage apparently of the turbot was procured towards the end of August, and is remarkable for its peculiar yellowish coloration. Several unknown eggs probably belonging to the same group (Pleuronectidæ), and which were first met with in the trawling expeditions of 1884, were also again observed, and further steps made to their identification.

A post-larval *Labrus maculatus*, 11 mm. in length, procured by the mid-water net in September, showed some interesting features in coloration, the chief being a series of white touches on a greenish ground, with brown bands on the head. The soft rays of the dorsal fins have not yet attained the proportionally elongated condition of the adult organ. The pectorals are large, and their rapid vibratory movement resembles that of *Hippocampus* and the Sygnathidæ. A brown bar marks their basal region, which in this and many other post-larval fishes is much larger in proportion than in the adult—a condition probably connected with increased functional activity. The ventral fins are opaque white, with a brownish belt in front (anterior rays). The anal fin, like the dorsal, has a brown patch in front. None of the blue, yellow, or orange, so common in the adult, has yet appeared.

Additional observations have also been made on the spawning period of various fishes about which little is at present known, such as the bass, Yarrell's blenny, wrasse, &c. Remarkable cases in which mussels (*Mytilus edulis*) have grown to a considerable size on the branchiæ of the haddock have likewise been observed.

Besides the food-fishes, further advances have been made on the development of the gunnel, the adults of which remain with their ova in holes (*e.g.*, those bored by *Pholas*) in rocks, and on the larval and post-

larval stages of *Agonus*, *Motella*, and other forms. The early post-larval stage of *Agonus* is peculiar from its fusiform outline and yellowish coloration. The former is due to the great median development of the marginal fin dorsally and ventrally. The post-larval condition of *Liparis montagui* has likewise come under notice when about 10 mm. in length. The notochord still projects superiorly from the tip of the tail, and the hypural edge is almost vertical. The caudal region, with its fin-rays, is bluntly conical. A marked feature is the elevation of the first region of the dorsal fin and its wider rays, a differentiation, perhaps, indicating the relationship with a form in which such is present in the adult. The head and cheeks have a few black specks, and these also occur on the anterior region of the body. The pectorals are speckled in a similar manner. The elongated rays of these fins are not yet developed, so that this is a subsequent character. Their margins trend evenly from the anterior part of the sucker backward and upward. The difference in regard to the size of the eye of such a species as this and one of the post-larval gadoids is marked, the large eyes of the latter being diagnostic, and probably associated with their greater adroitness and activity in catching minute prey.

The researches on the development and life-histories of the food- and other fishes made by the Secretary (Professor McIntosh) and Mr. E. E. Prince, B.A. (Cantab.), comprising upwards of 400 pages MS. and 31 quarto plates, containing many coloured figures, have recently (June 18) been communicated to the Royal Society of Edinburgh.

A special research was carried out by Mr. E. E. Prince on the Morphology of the Limbs of Teleosteans, and illustrated by three quarto plates. This work, like that already published or about to be published, reflects great credit on its author, both for the careful nature of the observations and the beauty and accuracy of the drawings.

Another investigation, no less able, is that of Dr. Marcus Gunn, M.A., M.R.C.S., one of the surgeons of Moorfields Hospital, London, on the Embryology of the Retina of the Teleosteans. A preliminary paper on this important subject appears in the 'Annals of Natural History' for this month (September).

Professor D. J. Cunningham, M.D., M.R.I.A., is also engaged on the Development of the Teleostean Vertebral Column; while Professor Burdon Sanderson and Mr. Gotch¹ carried on during the summer an investigation (in the living skate) of the caudal electrical organ. Many embryo skates have since been sent to Dr. Minot of America and Professor Ewart for microscopic purposes in connection with this research and other investigations. Mr. Kennedy, B.Sc. of Glasgow University, also spent a few weeks in working at the development of the haddock, and Mr. Grabham, B.A. of Cambridge, a similar period in examining the spinal nerves of the cod.

One of the most interesting results of the steady use of the mid-water and other nets for some years in St. Andrews Bay and elsewhere has been the testing of the Pelagic life at various seasons, so as to elucidate the nature of the food of the post-larval food-fishes, and also throw light on other questions. For the year 1888 the continuation of this work has been specially undertaken for the Fishery Board for Scotland, and will therefore be dealt with elsewhere. Independently, however, of the bearings of the fauna and flora (diatoms, &c.) on the food of fishes, some remarkable forms have come under notice, and the growth and habits of

¹ Vide *Proc. Roy. Soc.*, 1888.

others less rare have also been periodically noted. No group is more interesting in this respect, perhaps, than the Ctenophores, and certainly none is more abundant. Besides the ordinary forms at all stages, a new British species, viz., *Lesueuria vitrea*, M. Ed., has been procured in St. Andrews Bay in great profusion and for an extended period. The examples ranged from the most minute up to those $2\frac{1}{2}$ inches in length, but of all the British Ctenophores, or even Medusæ, it is the most delicate. The mere pouring of the water containing it from one vessel to another is sufficient to rupture it irretrievably, and indeed any undue commotion in the water has the same effect. It is well known as an inhabitant of the Mediterranean since it was originally described by Milne Edwards, and it has also been found on the American coast by Alex. Agassiz. An allied form, again, was procured on the shores of Norway by M. Sars.

During this summer, also, the great abundance of the ecto-parasitic larvæ of *Peachia* on *Thaumantias* has been a conspicuous feature, and many have been preserved for the further researches of Professor Haddon, M.A., D.Sc., M.R.I.A., who this month (September) contributes an interesting paper on the subject to the 'Annals of Natural History.'

In the winter, numerous examples of the common star-fish (*Asterias rubens*), brought from the bay on the lines of the fishermen, showed many ecto-parasitic crustaceans (*Podalirius typicus*, Kröyer). These generally adhered by the posterior legs, with their bodies projecting at right angles from the rays of the star-fish. In previous descriptions of this form the habitat seems to have been overlooked, for Spence-Bate and Westwood simply state that it was procured in the Forth, upon a shell brought up by a haddock-line, and in the recent catalogue of the Mediterranean Fauna¹ no allusion to commensalism occurs.

Further observations have also been made on the development and life-history of the common mussel, which forms a valuable 'bed' in the estuary of the Eden. These have chiefly been carried out by Mr. John Wilson, B.Sc., who lately published an important paper with four quarto plates on the subject in the Fifth Annual Report of the Fishery Board for Scotland.²

Mr. Herbert E. Durham, B.A., lately Vintner Exhibitioner at Cambridge, continued the interesting researches of last year on the Amoeboid corpuscles in the star-fish, and also on the madreporite of *Cribrella sanguinolenta*.³

Besides the use of the yacht 'Dalhousie,' the services of the steam tender 'Garland' were placed at the disposal of the Secretary for some days by the courtesy of the Fishery Board for Scotland for work in the deeper water at a distance from shore. Certain well-known fishing and

¹ *Prodromus Faunæ Mediterraneæ*, pars ii. p. 390, 1885.

² Previous to a lecture on this subject in the University of St. Andrews in November 1883, the Town Council requested the convener to give a report dealing with the preservation and increase of the mussel-beds of the Eden. The work for H. M. Trawling Commission, however, supervened, and occupied the whole of the following year. Thereafter the subject was steadily kept in view, as indicated in the Third Annual Report of the Fishery Board (1885, p. 57). A short abstract was also published in the *Annals of Natural History* for February 1885. It being apparent that a thorough knowledge of the development and life-history of the species was indispensable for advancing the subject on a sound basis, Mr. John Wilson took up this portion of the work, his observations being published in the Fourth Annual Report of the Fishery Board (1886, p. 218), and next year in the Fifth Report with three quarto plates (1887, p. 247).

³ *Proc. Roy. Soc.* January, 1888.

trawling grounds were thus examined in connection with the observations on the development and life-histories of the food-fishes.

Considering the importance of the work in relation to our knowledge of the food- and other fishes, and the advances in Invertebrate Zoology, the Committee beg to recommend a renewal of the grant (50*l.*) for the ensuing year.

Fourteenth Report of the Committee, consisting of Drs. E. HULL and H. W. CROSSKEY, Sir DOUGLAS GALTON, Professor G. A. LEBOUR, and Messrs. JAMES GLAISHER, E. B. MARTEN, G. H. MORTON, W. PENGELLY, JAMES PLANT, J. PRESTWICH, I. ROBERTS, T. S. STOOKE, G. J. SYMONS, W. TOPLEY, TYLDEN-WRIGHT, E. WETHERED, W. WHITAKER, and C. E. DE RANCE (Secretary), appointed for the purpose of investigating the Circulation of Underground Waters in the Permeable Formations of England and Wales, and the Quantity and Character of the Water supplied to various Towns and Districts from these Formations. (Drawn up by C. E. DE RANCE, Reporter.)

THE drought to which your Committee drew attention in their report last year was continued up to June of the present year, and had a very marked influence in diminishing the volume of water yielded by a large number of springs, and a very considerable diminution of the supply afforded by the remainder, over the greater portion of the central area of England, an area in which underground stores give the larger proportion of the daily water-supply of the population.

Much useful information has been obtained as to the amount of diminution experienced, but it has been thought advisable to combine it with information now being collected, showing the effect of the recent heavy rains in re-charging the underground stores.

Statistics of this nature collected during the past season, probably the most exceptional season of the present century, will necessarily have a permanent value in future calculations as to the actual yield likely to be obtained from a given area after successive years of minimum rainfall.

It has been thought advisable to defer publishing the information already obtained until next year, when it can be given in a more complete and useful form. Your Committee hope that the attention of the Delegates of the Associated Scientific Societies may be drawn to the importance of this inquiry, and that local observers will give special attention to the date at which the springs of their neighbourhood diminished in yield and subsequently increased; the date at which any springs ceased to flow, and that on which they recommenced; the amount of flow of any springs either daily, weekly, or monthly; similar records of the heights of the water in wells and borings, whether for long or short periods. The value of such observations would be much enhanced if descriptions be given that will enable the locality to be identified on the one-inch map of the Ordnance Survey and the levels referred to the Ordnance Datum.

Your Committee seek re-election, but do not require a grant to carry on their investigations.

*Report of the Committee, consisting of Mr. JOHN CORDEAUX (Secretary), Professor A. NEWTON, Mr. J. A. HARVIE-BROWN, Mr. WILLIAM EAGLE CLARKE, Mr. R. M. BARRINGTON, and Mr. A. G. MORE, reappointed at Manchester for the purpose of obtaining (with the consent of the Master and Brethren of the Trinity House and the Commissioners of Northern and Irish Lights) observations on the Migration of Birds at Lighthouses and Lightvessels, and of reporting on the same.*¹

ALTOGETHER about two hundred lighthouses and lightships on the coasts of Great Britain and Ireland, and the outlying islands, were supplied with printed tables for recording the movements of migratory birds. The collected results of the observations have been again published by the Committee in their ninth report. There has been a considerable increase in the number of schedules sent in, and it is satisfactory to note that the majority of the returns show increased care, and much intelligent interest on the part of the observer.

Commencing with the east coast of Scotland, Mr. John Nichol, the principal of the North Unst Lighthouse, reports that several pied-ravens, presumably visitors from the Faroes, were seen in June and July near Lerwick; one of these had white wings, another with white head and tips of wings, others also variously marked.

At the Pentland Skerries a curl-bunting was obtained on November 2. This species has only been recorded four or five times in Scotland, and never so far north in the country.

At the same period there was at this station a large 'rush' of fieldfares, redwings, thrushes and blackbirds, gold-crested wrens, snow-buntings and woodcocks with a south-east wind. A hoopoe was also seen on October 9.

Between the middle of August and up to October several pied-flycatchers are also recorded at Pentland Skerries.

A considerable number of schedules from the chief stations on the east coast of Scotland have been filled with the movements of the gannet, and these, with other accounts already published, will, at some future date, constitute materials for a thorough treatment of the wanderings of this species, and their relations to the migration of the herring in the northern seas.

The number of schedules sent in from thirty-four stations on the east coast of England was eighty-four.

After January 2 depressions of a very considerable size passed by our north-western and northern shores, with sudden changes of temperature of an unusual character, and great magnitude; showers of cold rain, sleet and hail, from day to day, and very severe frosts at night. There are very clear indications in the diary of migration that a 'great rush' of birds, going southward along the coast, was concurrent with these atmospheric disturbances. The birds chiefly noted being fieldfares, blackbirds, thrushes, redwings, larks, chaffinches, linnets, starlings, and some crows.

¹ 'Report on the Migration of Birds in the Spring and Autumn of 1887.' McFarlane and Erskine, 19 St. James's Square, Edinburgh.

In the latter part of February and throughout March there are indications of the passage of crows, rooks, daws, starlings, larks, and others to the Continent; also the same species moving in the reverse direction to the south-east coast of England. Great numbers of starlings, thrushes, and larks were observed at the lanterns at night, showing that the movement was very general and of very considerable extent.

A remarkable 'rush' of the smaller summer visitants occurred on the south-east coast, from Thanet to Hunstanton, at early morning of April 29. A very strongly-pronounced movement was also observed at Hanois L. H., Guernsey, on May 2, and on the 3rd and 4th. There were extraordinary 'rushes' of summer immigrants at the Eddystone and Nash stations, and at Helwick L. V., South Wales, on the 5th, when wheatears, whitethroats, sedge-warblers, willow-wrens, wood-warblers, blackcaps, reed-warblers, redstarts and pied-flycatchers, and also some swallows, were killed, some of these in considerable numbers; the weather at the earlier period, April 29, being very rainy and unsettled in the south-east, and very cold over England, with north-east winds. On the 30th, there was a thunderstorm in the south-west of France, with very cold, unsettled, and rainy weather generally in the south of Europe.

The autumn movement of birds commenced early in July, but did not become very distinctly pronounced before the beginning of August. One of the most interesting features of the autumnal migration has been the simultaneous occurrence of the pygmy curlew (*Tringa subarquata*) and the little stint (*T. minuta*) on the coast, between the Tees and Yarmouth. The former is first recorded from Redcar on August 16, and from the Spurn on August 23; the little stint on the 25th.

The woodcock is first recorded at Seaton-Carew, Durham, on September 19, and at Cromer L. H. on the 25th from 12.30 to 2.30 a.m. (S.E. 4). Our observer, Mr. Comben, says, 'I never saw so many woodcocks at one time before; there seemed to be a constant stream flying round the lantern; none struck.' Woodcocks appear to have come in at irregular intervals between September 30 and November 3, the great 'rush' or flight, on the 9th, 10th, and 11th of October. It is somewhat remarkable that the only notice of this species on the east coast of Scotland occurs at the Pentland Skerries and Dunnet Head L. H., Caithness, early in November and again in December.

Throughout September there was a steady, and almost daily increasing, migration observed at the east coast stations, and from the 29th, throughout October, and to November 3, an almost continuous night and day rush of immigrants, the chief of those recorded being crows, rooks, daws, starlings, larks, chaffinches, linnets, and sparrows; much the greater proportion of the entries in the schedules during this period consisting of these readily distinguishable species. The weather during the period of this great and continuous 'rush' was up to October 25 mainly anti-cyclonic, cold, quiet, and dry; the prevailing winds, north and north-easterly; after the 25th, cyclonic, with west and south-westerly winds, wet, rough and milder. The average temperature of the month was much colder than the corresponding months in the two preceding years. There is no evidence that the change of weather and of the wind after the 25th had the slightest influence in controlling the migratory movement, birds continuing to arrive in undiminished numbers.

The direction and force of the wind at the time appear to have little effect in controlling the great autumnal 'rushes,' for when the period of

the year has arrived birds cross the North Sea independent of weather. There can, however, be no doubt that the prevailing wind at the time of crossing is an important factor in governing the direction in which migrants travel, and the angle at which the line of flight will intersect the coast. To changes of temperature, either sudden or more gradual, rather than the force and direction of winds, we must probably look for the impelling cause of these seasonal phenomena. After the 3rd and to the 19th of November birds continued to arrive, but in greatly reduced numbers, the throbs and pulsations of the great inrush becoming daily more feeble and less sustained.

On the west coast of England migration, although considerable in October, was more strongly pronounced in November, particularly from the 7th to the 19th. On the afternoon of the 11th an anti-cyclonic period commenced, and prevailed, with little break, until the 17th. And there were important general movements on the 11th, 13th, and 14th, and on the 17th and 18th at south-west stations.

The entries in the schedules show that swans and geese have been remarkably scarce, brent geese fairly numerous—ducks of various species have occurred in unusually large numbers in all favourable localities. The common scoter in enormous flocks, also several velvet scoters, and very considerable numbers of the long-tailed duck have visited the coast between the Farn Islands and Yarmouth. A bearded reedling (*Panurus biarmicus*) was seen at the Languard L. H. on February 16, at 7.40 a.m., and at Yarmouth on November 13 many are said to have come in at a great height from the east.

Amongst the rare and more interesting wanderers to our shores we may notice the occurrences of Temminck's stint at the Spurn and the eared-grebe at the same place, Richard's pipit on the Lincolnshire coast, the Alpine swift, avosets, and the pectoral sandpiper of America near Yarmouth, also an osprey obtained at the Cromer Lighthouse. The isabelline wheatear, a spring visitor from the south to south-eastern Russia, was shot at Allonby, Cumberland, on November 11.

From the Irish coasts the schedules received from the light-keepers in 1887 were perhaps the best and most carefully filled of any year so far. They number about 70 besides many letters inquiring the names of particular species or remarking on special movements of birds. These have been furnished by about 30 stations situated all round the Irish coast. Over 150 legs and wings and specimens in the flesh have been received, being a larger number than on any previous occasion. This is satisfactory because the species can be ascertained with certainty.

Two birds have been added to the Irish list, *i.e.*, the Lapland bunting and the red-breasted flycatcher. The former was found dead at the Fastnet Rock Lighthouse, October 16; the latter was killed striking the Arklow South Light-ship on October 23. Both specimens were forwarded in the flesh. A magnificent old male *Falco candicans* was shot by the light-keeper on the Great Skelly Rock, co. Kerry, on September 28. This bird is occasionally met with on the west coast of Ireland at light-stations, and the inquiry has shown that it occurs more frequently than was formerly supposed.

Among other rarities received may be mentioned a redstart from the Fastnet (a rare species in Ireland), killed October 5; a woodlark and spotted crake from the Tearaght Rock, co. Kerry, also killed in October; and a hoopoe from Eagle Island, off Mayo (April 12).

Of the warblers the sedge warbler strikes the lanterns more frequently than any other, but the western and northern stations are almost a blank, few warblers striking.

The great bulk of the summer migrants arrive in Ireland on the south coast and the southern portion of the east coast below Drogheda.

During the second and third weeks of November the waterrail was forwarded from stations all round Ireland. It has not occurred in such numbers before.

A large immigration of the siskin and brambling took place in October and November. These birds have seldom been received from the light-keepers until 1887.

The autumn rushes of most species were on a larger scale than usual in 1887, and both summer and winter migrants seem to prefer the south-east portion of Ireland when arriving. The snow-bunting is one of the few birds which is rarely met with during the season of immigration on our south-east coasts.

The woodcock seldom strikes the lanterns anywhere.

So far as waders are concerned there is no clear evidence derived from the light-stations to show that they arrive in greater numbers on our northern stations in the autumn than on the south-east and south coasts.

This inquiry has now been continued for nine years, and an immense number of facts have been collected and brought together in the Annual Reports in connection with the seasonal movement of birds on the British coasts. The value of the materials thus acquired has been very considerably increased by the wings and legs sent in from the lighthouses and lightvessels of birds killed against the lanterns. Your Committee are aware that if this inquiry is to lead to any practical scientific results, much yet remains to be done; they would, therefore, respectfully suggest that the collection of further facts and materials should for the present be suspended, and an attempt rather be made to utilise, digest, and classify the mass of information already at their disposal. This your Committee are anxious and willing to undertake, and have already made arrangements for carrying into effect, so as to show in a concise form the results both statistically and otherwise on strictly scientific lines, and in as condensed and clear a method as possible.

The Committee have much pleasure in stating that one of their number, Mr. William Eagle Clarke, of the Museum of Science and Art in Edinburgh, has undertaken the laborious task of thus reducing the mass of observations collected. This will not be executed from the reports already published, but from an examination *de novo* of the schedules sent in. When it is accomplished, the question of publishing the results will arise, and the Committee trust that, if necessary, the aid of the British Association may again be successfully invoked. The Committee are quite sensible of the liberality with which the Association has for so many years responded to, and even more than once anticipated, their demands, and have to express their gratitude for the generosity not only of the Association, but of private individuals towards their investigations; but the Committee must point out that the crowning work has yet to be done, and, while abstaining at this time from any application for pecuniary help, they hope that it may be forthcoming, if required, at some future date.

Report of the Committee, consisting of Professor W. C. WILLIAMSON and Mr. W. CASH, appointed for the purpose of investigating the Flora of the Carboniferous Rocks of Lancashire and West Yorkshire. (Drawn up by Professor W. C. WILLIAMSON.)

As I had occasion to report to the Association at Manchester last year, much labour has now to be expended in order to reap a very small harvest. Our many years of persevering research have well-nigh exhausted the supply of the more conspicuous facts connected with the organisation of the Carboniferous vegetation. At the same time there is still much respecting which more information is needed, and the work of the past year has not been devoid of some important observations.

One of the most curious structural and physiological facts revealed by the study of the exogenous Carboniferous Cryptogams relates to the development of their conspicuous piths. This is especially the case amongst the arborescent Lycopodiaceæ. I have from time to time called attention to some curious facts bearing upon this matter. I have shown that in the young twigs of some of these plants the central vascular bundle, corresponding to what the late Professor De Bary would designate as the 'leaf-trace' in contradistinction to a Canline one, is composed of a number of scalariform vessels, as is the case with the twigs of many of the living Lycopodiaceæ. But unlike these living representatives of the group, there lurked in the centre of each of these palæozoic bundles, an invisible germ or germs of a parenchymatous tissue which developed as the plant grew, and ultimately expanded into a conspicuous, persistent pith of large dimensions; not only so, but portions of this medullary tissue assumed the functions of a Cambium by developing additions to the vascular ring by which it was surrounded. Botanists will at once recognise the differences between this mode of development of a medulla and what occurs amongst ordinary living Exogens.

Some of my most important results obtained during the past year consist of new facts relating to this curious physiological and morphological feature of the Palæozoic Flora; explanations which I previously advanced hypothetically now assume the appearance of unquestionable truths. Hence I believe I am now in a position to publish what I hope to do with little delay, viz., a fairly complete history of the anomalous development of these palæozoic medullary organs.

Report of the Committee, consisting of Professor RAY LANKESTER, Mr. P. L. SCLATER, Professor M. FOSTER, Mr. A. SEDGWICK, Professor A. M. MARSHALL, Professor A. C. HADDON, Professor MOSELEY, and Mr. PERCY SLADEN (Secretary), appointed for the purpose of arranging for the occupation of a Table at the Zoological Station at Naples.

YOUR Committee have to report several notable advances in the scope of the Zoological Station, which give promise of important results in the future.

The past year has been marked by the opening of the physiological laboratory, which occupies a new and handsome building adjacent to,

and nearly as large as, the original Station. The progress of the work has been mentioned in several previous Reports; and the Direction is now to be congratulated on the completion of this costly undertaking. Most of the rooms are already occupied.)

A bacteriological laboratory, which is placed under the direction of Dr. Frank, formerly assistant to Professor Koch, was opened on May 1. This department, which is especially maintained by Italian contributions, and is intended to promote a knowledge of marine bacteria, will in the first instance co-operate with the local efforts to investigate the sanitary condition of the Port of Naples and the neighbouring coast. Two or three naturalists are now devoting themselves to these researches.

The chemical department of the physiological laboratory has been completed under the direction of Dr. W. v. Schroeder, of Strasburg, who has previously carried out physiological investigations at the Station. Several universities and states are already taking an interest in this department—a circumstance which it is anticipated will contribute towards the success as well as the support of the new branch.

Investigations of a practical bearing on the fishery industry, carried out primarily at the instigation of the Italian Ministry of Agriculture and Commerce, have been prosecuted with energy. An important memoir on the question of the propagation of fishes and the nature of their ova has been published in the 'Mittheilungen' and the official 'Bulletin,' by Dr. Raffaele, of Naples, one of the assistants in the Station. Special arrangements have been made for these studies in the new building and the researches are being carried on actively. Additional proof of the urgent need of such practical investigations was furnished by an agitation on the question of trawl-fishing, which was got up last year in Naples and the neighbourhood, and resulted in numerous contradictory demands being addressed to the Ministry upon the subject.

Several officers belonging to the Italian and Russian navies have received instruction during the past year in the methods of collecting marine animals and plants. These gentlemen are now embarked on men-of-war, and interesting results may be anticipated from the labours of collectors thus thoroughly qualified.

During the past year two tables have been taken by Austria. This circumstance is especially significant, as hitherto when applications were made either by Austrian naturalists or by Professor Dohrn himself to the Austrian Government, soliciting the engagement of a table in the Naples Station, the applications have been rejected on the ground that the existence of a zoological station at Trieste rendered it unnecessary for Austria to lease a table in the Naples Station. It was urged against this argument that the Naples Station ought to be considered as a central institution, and that whatever local institutions might be founded, the international character of the Neapolitan establishment rendered it not only desirable but necessary to secure a footing there. At last two tables have been taken, in consequence of a collective requisition made by the four Austrian universities, in which it was stated that in spite of possessing a zoological station at Trieste the participation of Austria in the Naples Station was still desirable; its highly-developed organisation, the richness of the local fauna, the excellence of the library, and the association there of scientific workers from all countries, rendering such a participation necessary in the interests of Austrian naturalists.

Negotiations for securing three tables for Spain are proceeding, and

a royal decree charging the Ministry with direct propositions to Professor Dohrn has been published.

The Publications of the Station.—The progress of the various works undertaken by the Station is here summarised:—

1. Of the 'Fauna und Flora des Golfes von Neapel' the following two monographs have been published since the last Report:

XV. G. von Koch, *Gorgonidæ*.

XVI. H. Eisig, *Capitellidæ*.

The plates for the following works are in the press: Falkenberg on 'Rhodomelæ'; Spengel on 'Balanoglossus'; Della Valle on 'Amphipoda'; Giesbrecht on 'Copepoda'; and Vosmaer on 'Porifera incalcarea.' The text for the last-mentioned work will be in English.

2. Of the 'Mittheilungen aus der Zoologischen Station zu Neapel,' vol. vii., parts ii., iii., and iv., with 24 plates, have been published.

3. Of the 'Zoologischer Jahresbericht' for 1885, parts i. and iv. and a 'Nachtrag (Vermes)' have been published; and the whole 'Bericht' for 1886 (dealing no longer with systematic and faunistic papers).

Extracts from the General Report of the Zoological Station.—The officers of the Station have courteously furnished lists (1) of the naturalists who have occupied tables since the last report, (2) of the works published during 1887 by naturalists who have worked at the Zoological Station, (3) of the specimens sent out by the Station during the past year. These details show a large increase in the number of naturalists who have worked at the Station, as compared with any previous year, and an increase also in the total value of the specimens distributed.

The British Association Table.—Three naturalists have occupied the British Association Table during the past year. Mr. John Gardiner, who had occupied the table for five months during the preceding year, was still in possession at the commencement of the past year, and had intended to occupy the table until December, in accordance with the permission of your Committee. Unfortunately a dangerous illness prevented the carrying out of these intentions, and the climate of Naples being considered unsuitable for Mr. Gardiner's restoration to health, he was obliged to resign the table after occupying it a little more than two months in the year with which the present report is concerned. Mr. Gardiner sent an interesting report on the result of some of his work to the Committee, which was submitted at the last meeting of the Association, and the supplementary report on the remainder of his occupation, which Mr. Gardiner has sent from Colorado, will be found appended.

The use of the table has been granted during the past year to Mr. Andrew David Sloan, of Edinburgh, and subsequently to Professor R. J. Anderson, of Queen's College, Galway, both of whom have furnished reports on the nature of their investigations. The reports are appended.

Your Committee have received two applications for permission to use the British Association table during the current and coming year, which they approve; and hope that the Council will enable them to sanction the applications by renewing the grant (100*l.*) for the ensuing year. In the opinion of your Committee the report now submitted fully justifies them in strongly recommending the renewal of the grant.

I. *Report on the Occupation of the Table, by Mr. JOHN GARDINER.*

Soon after the date of my last report, I began to study the local species of *Sargassum*. At first I merely familiarised myself with the

histology of the plant, then later I investigated the development of the 'Fasergrübchen,' on which subject I am disposed to come to conclusions opposed to those of Valiante in his monograph on the *Cystoceiræ*. But the greater part of the time was employed in investigating the development of the reproductive organs, and of the embryos of *Sargassum*. I was able to follow the development of the antherozoids up to the time of their discharge, which, however, I did not see. I also followed out the development of the oosphere, but did not observe the process of fertilisation. I reared and carefully observed a large number of embryos, which in their early stages much resembled those of *Cystoceira*, though many exhibited peculiarities of cell-division and growth partly due to the conditions under which they were grown. I had collected a large amount of well-preserved material, besides drawings and notes from fresh specimens, and it was my hope to have sufficient for a monograph of the Mediterranean species of the genus.

My health, however, which had been failing for some time, finally compelled me to leave Naples on August 20, 1887, four months before the end of the period granted me by the Committee. I hoped to be able to return after a short rest, but I was disappointed. Since then I have been unable to do any work, and for that reason I beg the Committee to excuse the brevity of this report.

I must express my gratitude to the Committee for the great privilege they granted me in allowing me to study at Naples, and my regret that I have been able to do so little work. I wish also to express my thanks to Dr. Dohrn and the staff of the Zoological Station for the great kindness which they showed to me, as to everyone who studies there, and for the valuable assistance they often gave me.

II. *Report on the Occupation of the Table, by Mr. ANDREW DAVID SLOAN.*

For the past year I have been deeply interested in the subject of electric organs. While assistant in the Natural History Department of Edinburgh University my attention was directed to the so-called pseudo-electric organs in the skate, and the large number of specimens obtained for dissection by the students afforded me ample material for their study. My interest in the investigation was greatly intensified by the confirmatory work of Dr. Sanderson, which supported from a physiological point of view the opinion urged by Robin after a study of its structure, viz., that the organ in the rays hitherto regarded as pseudo-electric really discharged the functions of an electric organ. I found, however, that I should be greatly aided in coming to just conclusions regarding the organ in the skates were I fully prepared for its study by a personal examination of the analogous organ of the Torpedo, which had to a much greater extent received the attention of histologists, and thus I welcomed the opportunity of effecting this purpose, which the kindness of the Committee afforded me in placing at my disposal their table in the Zoological Station at Naples.

Immediately on my arrival at the Station on March 16, everything was in readiness for me, and an abundance of living torpedoes (*T. ocellata*) at hand, and I at once began my study of the electric organ, being guided by the recent researches of Ranvier, Babuchin, Boll, Krause, &c., in the methods of treatment and observation. I was thus able to make preparations which showed me the distribution and final terminations of the

nerves, and gave me an idea of the minute structure of the electric plates. Of Wagner's 'bouquet,' a name which well denotes the appearance presented by the remarkable behaviour of the nerves before entering the plates, and of the beautiful ramifications of the branches on the plate itself, I made preparations, which, however, do no more than confirm the observations of Ranvier. The final terminations of the nerve-twigs were well brought out by the gold and silver methods, the former giving a positive and the latter a negative picture of the terminal nerve-branchings. On the disputed point as to whether the twigs from neighbouring branches communicate so as to form a network, my preparations throw some light. In many places a distinct network is visible, although very commonly the reticulation is only apparent, observation by means of a high power and more exact focussing showing a want of continuity. It is quite possible, however, that the want of continuity in these places is due to rupture of the network during the treatment or to unequal action of the stain.

The 'Punktirung' of Boll, corresponding to the 'Palisade' of Remak and the 'electric cilia' of Ranvier and Ciaccio, and of such doubtful significance, is well seen in my gold preparations, being represented by numerous violet-coloured points regularly disposed on the terminal nerve-branchings. I am sorry that I have not yet had time to make a careful examination of transverse sections of the 'electric plates,' which would reveal the little rods or 'Stäbchen' of which the 'Pünktchen' are the inferior ends. I further regret this, as I might have been able to express an opinion as to the nature of the intermediary layers of the plate, in which Krause mentions the presence of sinuous fibres.

The organ in the rays, which must now be regarded as electric, although functionally it is not of such importance as the corresponding structure in other electric fishes, would appear to be represented in all the members of the group. I have found it present in the species *Raia clavata*, *R. batis*, *R. oxyrhynchus*, *R. miraletus*, Couch (= *R. circularis*, Day), in all of which it is large and well developed, and in *R. radiata*, in which it consists of a small slender cylinder. It was first noticed in *R. clavata* by Stark (1844) and was later described by Robin in *R. clavata*, *R. rubus*, and *R. batis*, while Professor Ewart, in a series of papers read quite recently before the Royal Society, gives an account of the development of the organ in the species *R. batis*, *R. fullonica*, *R. circularis*, and *R. radiata*. The form which occurred most commonly at Naples was named *R. asterias* in the Aquarium Catalogue, and is evidently identical with our species *R. clavata*. Making use of this form, I employed my time in going over some of the ground already traversed by Robin in following out the nerve-supply and general relations of the organ. The results compared with the condition observed in the torpedo, and briefly stated, are these:—The organ is long and cylindrical in form, and tapering both anteriorly and posteriorly; it occupies a position on each side of the tail for the posterior two-thirds of its length. Its origin is in the centre of the sacro-lumbar muscle, which after the appearance of the organ gradually ceases, the electrical apparatus in like gradual manner taking its place. Indeed, embryological research shows that the electrical organ arises from a transformation of this muscle, in which the contractile substance has undergone a change. It reaches its maximum diameter about the beginning of the first dorsal fin, and after continuing of uniform thickness for several centimètres it gradually diminishes towards the tip of the tail, into which it, however, extends. In the

torpedo, on the other hand, the electric organ is somewhat flat and uniform in thickness, and occupies the entire region bounded laterally by the head and branchial sac and the margin of the body, anteriorly by the anterior boundary of the body and posteriorly by the cartilages of the pectoral fins.

In both forms the organ consists of a large number of pillars or columns, but while in the torpedo these run vertically and occupy the whole thickness of the organ, and are on the whole of a similar and uniform diameter, in the rays they run longitudinally, are of variable thickness, and have pointed extremities; nor do they extend the whole length of the organ, but after a somewhat oblique course they very soon die out. Indeed, the constituent elements of the electrical apparatus of rays are much less regularly disposed than is the case with torpedoes. The walls of the pillar consist of connective tissue, in which the nerves and blood-vessels run, and in torpedoes adjoining columns may be separated from one another, but this I have not found possible in the rays.

The columns are found to consist of a large number of superimposed plates, the electric plates, separated from each other by thin transverse partitions of connective tissue, and on one side of these the nerves ramify to a great extent and then terminate. In rays the number of plates is much less numerous than in torpedoes, the individual plates or discs are a great deal smaller in diameter, and of a much greater thickness; and, further, the ramification of the nerves takes place on the ventral face of the plate in torpedoes, while in rays it is on the anteriorly directed surface.

In the case of rays I have not been able to find any division of the nerves to supply the plates corresponding to Wagner's bouquet; they seem rather to branch in the usual way, and distribute themselves along the transverse partitions by which the columns are divided. In the torpedo the nerves run from the partition to the ventral surface of the electric plate, and there divide again and again very frequently in a perfectly dichotomous manner; this ramification takes place pretty nearly in the same plane, so that by simply placing the plate on a slide with its ventral face upwards one is able to make a study of the nerve-branchings. In rays, on the other hand, the nerves run backward from the partition immediately in front of the plate, and on their way undergo many divisions, and so reach it in the form of very delicate branches, which run perpendicularly to the surface of the disc. This can only be seen to any advantage in longitudinal or very oblique transverse sections of the organ. Before giving rise to the fine perpendicular twigs the branches of adjoining nerves anastomose, and frequently at the point of union a large nucleus is present. It is not improbable that this anastomosis may correspond to the final branching and network in the plates of the torpedo, while the fine delicate twigs may have as their homologues the 'Stäbchen' of Boll. What becomes of the nerve-fibres after they reach the plate I have not been able to make out; that they give rise to a second reticulation, and by further division become smaller and smaller and gradually pass into the substance of the plate as is stated by Schultze, I have not succeeded in confirming, and consider far from likely, the structure and development of the plate showing its elements to be muscular, and not nervous, as Schultze maintained.

The disc on which the nerves end consists anteriorly of a finely granular groundwork in which large nuclei are embedded; then follows a layer of considerable thickness characterised by the presence of

numerous long wavy lines, which according to Schultze indicates a lamellar structure, and this in turn is followed by a still thicker layer of finely granular substance containing large oval nuclei similar to that first described, but excavated and tunnelled to such an extent as to receive the name of 'Schwammkörper' from an early observer. These layers pass quite insensibly into one another, the striated appearance often occurring on the trabeculæ bounding the vacuolations, and the oval nuclei occasionally occurring amidst the sinuous lineations of the central portions. The homologue would appear to be the intermediary nucleated layer in the plate of the torpedo in which Krause describes the presence of transverse linear markings. As Robin has shown, the electrical apparatus is supplied exclusively by spinal nerves, but a point of great interest, suggested to me by Dr. Meyer, and which I hope some day to investigate, is the question as to where the fibres originate. There is strong reason to believe that they do not spring from the spinal column, but have their source in the brain.

In observing the movements of the torpedo and of the skates in the Aquarium I was struck with the difference in their modes of locomotion. The torpedo employs the tail with its powerful muscles to discharge the function of a propeller, while the skate makes use only of the pectoral fins, the tail remaining quite rigid and evidently serving to some extent as a rudder. This fact appears to me worthy of remark, and brings into prominence the importance of the organ in the skate, for it is inconceivable that a structure involving for its accommodation the transference of the entire function of locomotion to a different system of muscles should not subserve some very important function.

I frequently endeavoured to obtain a 'shock' from the skate by grasping the tails of living specimens, but although I have repeatedly made an attempt both with the smaller specimens I got at Naples and with the much larger forms which I secured when recently superintending the work of the 'Garland' for the Fishery Board for Scotland, I never succeeded in experiencing a perceptible discharge.

But besides giving attention to the structure of the electric organs in the torpedo and in the skate I devoted a considerable amount of time to the search for homologous organs among their nearest allies. This appeared to be necessary in order to throw light on the obscure problem as to how the transformation of a muscular into an electric organ could have been effected—a transformation which the researches of Babuchin, and more recently of Ewart, prove beyond a doubt. It is clear that the discovery of an imperfectly developed or of an abortive organ in any member of a neighbouring group would aid greatly in the elucidation of the question.

First of all I examined the organ in the skate, which M'Donnell described and regarded as the homologue of the electric organ in the torpedo, his work receiving a welcome recognition from Mr. Darwin; but I find it is present in a well-developed condition also in the torpedo, along with the electric organ, and exists more or less perfectly in other Elasmobranchs, e.g., in *Squatina angelus* and *Mustelus laevis*. Indeed, it is no other than the thymus gland, and its structure has no characters in common with electric organs. I studied it both in a fresh condition and by means of sections, and find it both in its intimate structure and in the nature of its contents to present a close resemblance to the thyroid, so that it evidently performs a similar function.

I further examined the tails of several other Elasmobranchs in search of an organ homologous with that of the skate, but without success. In *Torpedo ocellata*, *T. marmorata*, *Mustelus laevis*, *Scyllium canicula*, *Notidanus cinereus*, *Scymnus lichia*, the tails of which I carefully studied, I was unable to discover any trace of the structure so well developed in rays. The condition of the sacro-lumbar muscle in *Squatina angelus*, however, is worthy of remark. Its outer part is quite different in appearance from that nearest the vertebræ, being divided by connective-tissue septa into a number of longitudinal columns. The resemblance to an electric organ is, however, purely macroscopical, an examination of the more intimate structure showing no traces of change from ordinary muscle. The matter, nevertheless, is worthy of further attention, and it is interesting to note that this peculiar condition of the muscle occurs in a form which is intermediate between the round (Selachoides) and the flat (Batoidei) members of the Elasmobranch group.

Another question which I set myself to elucidate was in how far the electric organ of the skates, which varies considerably in the different species in form and size, and relation to surrounding muscles, might be made a character in determining species, but I have not yet sufficiently studied my notes to justify the expression of an opinion.

In concluding my report, I take the opportunity of expressing my deep gratitude to the Committee for their kindness in affording me such splendid facilities for prosecuting my research, and further I desire to convey my sincerest thanks to Dr. Dohrn and all the members of the staff at the Zoological Station for their unfailing courtesy and the willing help which they were always ready to render.

III. Report on the Occupation of the Table, by Professor R. J. ANDERSON.

I arrived in Naples on June 4. The table was furnished immediately with instruments and preserving fluids. I decided to examine the myotomes in a great number of fishes. The importance of the subject at once appears. The muscles are less complex than in other vertebrates, the primitive arrangement is largely maintained, and we have, to start with, the works of Cuvier, Meckel, Müller, and Stannius, and of Owen, Schneider and Humphry, together with the special work of Vetter, Fürbringer (whose work has some bearing on the subject), Albrecht, Goette and others. English readers are most familiar with the myological work of Humphry through his contributions to the English Journal of Anatomy and his special work on 'Myology.' The whole subject is, however, so difficult that we require abundance of facts to make any certain advance. I have, therefore, measured and noted the arrangement of the metamers in a great many fishes. I have made no reference to the embryological conditions. The general condition of things is to be found in Müller's myxinoid fishes. His description is adopted by everyone, and my work goes mainly to tease out some of the observations of that anatomist.

The fibrous partitions that separate the metamers are not planes, and the line of outcrop is a curved line. The number of the metamers, their thickness, and the number and character of the bendings all vary. The distance to which the anterior metamers reach in the cranium is not constant. I have, then, recorded—

1. The number of metamers.
2. The exact length of each segment of a number of metamers, as it appears on the surface.

3. The breadth of the metamer at the surface (lateral part).

The amount of the overlap is given in some cases. Additional facts of interest have also been given, as for instance: (a) the distinct presence of a rectus; (b) the separability of the dorsal part of the dorso-lateral muscle mass; and (c) the position of the limits with reference to the metamers. The term *rectus* is used to indicate the median ventral muscles running from the anus (each side) along each side of the median line to the pelvis, or from the pelvic to the pectoral girdle.

The actual deviation from a line on the surface formed by a transverse plane, is in many cases very considerable. The second metamer in *Sargus annularis* gives a measurement for the outcrop of its dorsal portion of 17 mm., and this runs beyond the tenth part of the entire animal. The metamer (dorsal piece) is directed from before backwards and downwards. The dorsal part of the sixth metamer reaches 24 mm. and therefore traverses one-sixth of the length of the fish. The thirteenth metamer gives 28 mm. for the first or dorsal piece. The entire length of the surface line is nearly one half the length of the animal.

Again the sixth metamer of *Gobius capito*, which has a supero-inferior diameter of 35 mm., is 57 mm. in length; the length of the fish being 187 mm., and the number of metamers, 27. The twenty-third metamer of the same fish gave a length of 52 mm. for a breadth of 20 mm. These measurements take no account of the overlap. This overlap was 24 mm. for the seventeenth metamer.

The twenty-third metamer of *Mugil cephalus* reaches 11 mm. beneath the antecedent metamers, and projects 5 mm. beneath the succeeding. In some metamers I have noted 36 mm. as the range, and this means that for an antero-posterior extent of 36 mm. an individual metamer by its zigzag windings has a situation. The seventh metamer is 92 mm. long, whilst the semi-circumference is 46 mm. The seventeenth is 72 mm. long, with a semi-circumference of 29 mm.

Trachinus Draco, one of Müller's examples, shows 12 mm. for the dorsal portion of the first, and 25 mm. for the twenty-fifth metamer. The semi-diameter is 35 mm. in the first case and 18 mm. in the second.

The dorsal part of the dorso-lateral mass is not easily distinguished as a separate mass in all fishes. In *Trigla* I was able to separate it. In *Umbrina* it can be separated for 10 metamers.

In some fishes a distinct terminal bend is to be seen in the ventral region as well as in the anterior part of the median line behind. In *Mustelus* the bends are sharp. In various fishes, in *Corvina*, for example, the dorsal curve is very distinct anteriorly. The dorsal bend is also seen well in *Belone*. In *Gobius* the ventral and lateral. The rectus is seen in *Pagellus*. Bands on each side of the anus run forwards to the pelvis. These bands correspond to the bend inwards of the myotomes, and I am inclined to think that there is some connection. The dorsal bend is well seen in *Uranoscopus scaber*.

Without giving any undue importance to the varieties in the appearances presented by the myotomes, I may state that between the condition in which there are three sharp angles anteriorly and two posteriorly superficial markings and that condition in which we have the myotome running a direct course from the median dorsal line to the median ventral, we have a great many varieties. How far the dorsal bends have a connection with the separation of the dorsal fin muscles, the dorsal, &c., I am not yet prepared to offer any opinion whatever. The bend in the lateral

line which breaks the continuity of the dorsal portion of the myotome into the ventral portion in the posterior region of some fishes is another difficulty. The full details of the observations I hope soon to complete.

IV. *A List of Papers which have been published in the year 1887 by Naturalists who have occupied Tables at the Zoological Station.*

- Dr. F. Zschokke . . . Studien über den anatomischen u. histologischen Bau der Cestoden. 'Centralblatt für Bacteriologie u. Parasitenkunde,' Bd. i. 1887.
- " . . . Helminthologische Bemerkungen. 'Mitth. Zool. Station, Neapel,' Bd. vii. 1887.
- Dr. J. Rückert . . . Ueber die Anlage des mittleren Keimblatts u. die erste Blutbildung bei Torpedo. 'Anat. Anzeiger,' 1887.
- Dr. R. Semon . . . Beiträge zur Naturgeschichte der Synaptiden des Mittelmeeres. 'Mitth. Zool. Station,' Bd. vii. 1887.
- " . . . Beiträge zur Naturgeschichte der Synaptiden des Mittelmeeres. 2. Mittheilung. 15 plates. *Ibid.*
- Dr. F. S. Monticelli . . . Osservazioni intorno ad alcune specie di Acantocefali. 'Bollettino Soc. dei Naturalisti in Napoli,' vol. i. 1887.
- " . . . Note elmintologiche. Sul nutrimento e sui parassiti della Sardina (*Clupea pilchardus*, C. V.) del Golfo di Napoli. *Ibid.*
- Dr. F. Raffaele . . . Uova e larve di Teleostei. 1^a nota. 'Bollettino Soc. dei Naturalisti in Napoli,' vol. i. 1887.
- Dr. G. Jatta . . . Sopra il cosiddetto ganglio olfattivo dei Cefalopodi. *Ibid.*
- " . . . La vera origine del nervo olfattivo nei Cefalopodi. *Ibid.*
- Dr. A. Ostroumoff . . . Zur Entwicklungsgeschichte der cyclostomen Seebryozoen. 'Mitth. Zool. Station, Neapel,' Bd. vii. 1887.
- Prof. W. Preyer . . . Ueber die Bewegungen der Seesterne. II. Hälfte. 'Mitth. Zool. Station, Neapel,' Bd. vii. 1887.
- Dr. L. Plate . . . Ueber einige ectoparasitische Rotatorien des Golfs von Neapel. 'Mitth. Zool. Station, Neapel,' Bd. vii. 1887.
- Prof. J. Steiner . . . Sur la fonction des canaux semi-circulaires. 'Comptes Rendus,' t. civ. 1887.
- Prof. C. Emery . . . Intorno alla muscolatura liscia e striata della *Nephthys scolopendroides* D. Ch. (con 13 tav.). 'Mitth. Zool. Station, Neapel,' Bd. vii. 1887.
- Dr. F. Noll . . . Ueber Membranwachsthum u. einige physiologische Erscheinungen bei Siphoneen. 'Bot. Zeit.,' 1887, No. 30.
- " . . . Experimentelle Untersuchungen über das Wachstum der Zellmembran. 'Abh. Senckenbergische Ges., Frankfurt a/M.' 1. Tfl., 15. Bd.
- Dr. A. A. Tichomiroff . . . Zur Entwicklungsgeschichte der Hydroiden. 'Nachr. d. Ges. Freunde d. Naturw., Moskau,' Bd. xxx.
- Prof. S. Trinchese . . . Come le fibre muscolari in via di sviluppo si uniscono alle fibre nervose. Comm. preliminare. 'Rendic. Accad. Lincei,' vol. ii.
- " . . . Nuove osservazioni sulla *Rhodope Veramii* (Kölliker). Comm. prelim. 'Rendic. Accad. Napoli,' 1887.
- Dr. E. de Daday . . . Monographie der Familie der Tintinnodeen. 'Mitth. Zool. Station, Neapel,' Bd. vii. 1887.
- Dr. S. v. Apáthy . . . Methode zur Verfertigung längerer Schnittserien in Celloiden. *Ibid.*
- Dr. B. Rawitz . . . Die Fussdrüse der Opistobranchier. 'Abh. Preuss. Akad. Wiss.,' 1887.
- Dr. M. de Davidoff . . . Ueber die ersten Entwicklungsvorgänge bei *Distaplia magnilarva*, Della Valle, einer zusammengesetzten Ascidie. 'Anat. Anz.,' 2. Jgg. 1887.
- " . . . Ueber die freie Kernbildung in Zellen. 'Votr. Ges. Morph. Phys. München,' 1887.

V. *A List of Naturalists who have worked at the Station from the end of June 1887 to the end of June 1888.*

Number on List	Naturalist's Name	State or University whose Table was made use of	Duration of Occupancy	
			Arrival	Departure
400	Dr. F. Sanfelice . . .	Italy	Aug. 1, 1887	—
401	Dr. Ficalbi	"	" 3, "	Sept. 19, 1887
402	Dr. D. Carazzi	"	" 16, "	" 9, "
403	Sr. Blas Lázaro é Ibiza	Spain	" 23, "	Nov. 1, "
404	Mr A. de Krasnoff ' . . .	Russia	" 30, "	Sept. 30, "
405	Dr. N. Kastschenko . . .	"	Sept. 5, "	May 10, 1888
406	Prof. R. Klunzinger . . .	Württemberg	" 15, "	Oct. 10, 1887
407	Dr. W. Müller	Prussia	" 30, "	Feb. 27, 1888
408	Prof. A. Mosso	Italy	Oct. 13, "	Oct. 16, 1887
409	Dr. A. Strubell	Saxony	" 16, "	Apr. 11, 1888
410	Prof. de Famintzin . . .	Russia	" 21, "	" 29, "
411	Dr. J. Thiele	Prussia	Nov. 1, "	" 30, "
412	Dr. P. Mingazzini . . .	Italy	" 25, "	—
413	Dr. G. Tacchetti	Italian Navy	Dec. 3, "	May 10, "
414	Lieutenant Guarienti . .	" "	" 3, "	" 8, "
415	Dr. P. Oppenheim	Prussia	" 7, "	" 2, "
416	Prof. A. Weismann	Baden	" 28, "	" 16, "
417	Dr. Ishikawa	Zoological Station	" 28, "	" 16, "
418	Dr. C. Hartlaub	Hamburg	" 29, "	" 11, "
419	Dr. W. Issaëff	Russian Navy	" 30, "	June 11, "
420	Dr. M. de Davidoff	Zoological Station	" 30, "	May 29, "
421	Prof. A. Mosso	Italy	" 31, "	Feb. 15, "
422	Dr. G. Jatta	"	Jan. 1, 1888	—
423	Dr. F. Raffaele	"	" 1, "	—
424	Dr. F. Balsamo	Province of Naples	" 1, "	—
425	Dr. F. S. Monticelli . . .	" "	" 1, "	—
426	Dr. T. Boveri	Bavaria	" 7, "	Apr. 11, "
427	Dr. J. van Rees	Holland	" 7, "	" 11, "
428	Dr. H. Henking	Prussia	" 7, "	" 17, "
429	Dr. H. Debus	Hesse	" 16, "	Mar. 1, "
430	Mr. H. Bury	Cambridge	" 24, "	May 28, "
431	Dr. O. von Rath	Strasburg	Feb. 2, "	Apr. 30, "
432	Dr. W. von Schröder . . .	Zoological Station	" 14, "	May 12, "
433	Stud. C. Sapper	Württemberg	" 18, "	Apr. 24, "
434	Dr. M. P. Traustedt	Zoological Station	" 21, "	Mar. 10, "
435	Dr. E. Pergens	Belgium	Mar. 5, "	June 23, "
436	Dr. G. Kalide	Berlin Academy	" 9, "	—
437	Mr. A. D. Sloan	British Association	" 16, "	May 15, "
438	Prof. D. C. Rabl	Austria	" 18, "	Apr. 8, "
439	Dr. M. Joseph	Prussia	" 19, "	" 18, "
440	Dr. J. Kohl	"	" 19, "	" 12, "
441	Dr. J. Vosseler	Württemberg	" 19, "	May 23, "
442	Dr. G. Frank	Zoological Station	" 20, "	—
443	Dr. L. Plate	Prussia	" 27, "	May 10, "
444	Prof. B. Hatschek	Austria	Apr. 5, "	Apr. 20, "
445	Dr. Cori	"	" 5, "	" 20, "
446	Dr. J. Rückert	Bavaria	" 14, "	May 10, "
447	Prof. G. von Koch	Hesse	" 28, "	" 12, "
448	Dr. B. Rawitz	Prussia	" 28, "	June 27, "
449	Dr. F. Went	Holland	" 28, "	—
450	Dr. C. Fisch	Bavaria	" 28, "	—
451	Prof. R. J. Anderson	British Association	June 4, "	—
452	Prof. A. Della Valle	Italy	" 25, "	—

VI. *A List of Naturalists, &c., to whom Specimens have been sent from the end of June 1887 to the end of June 1888.*

			Lire c.
1887.	July	5 Zoolog. Institut, Kiel	Siphonophora 140·60
"	"	Prof. A. C. Haddon, Dublin	Actinia 58·95
"	"	Dr. O. Hamann, Göttingen	Echinodermata 43·25
"	"	9 Museo Civico, Venice	Various 77·55
"	"	12 Mr. A. Wenke, Jaromer	Various 40·
"	"	Laboratoire de Zoologie, Geneva	Various 28·35
"	"	13 Veterinär-Institut, Dorpat	Collection 376·35
"	"	Conte Peracca, Turin	Elaphis 55·
"	"	15 Prof. P. d'Oliveira, Coimbra	Various 182·55
"	"	20 Museo Zoologico, Palermo	Collection 589·50
"	"	30 Städt. Museum, Barmen	Collection 1250·
"	"	Dr. Krukenberg, Jena	Chimaera 19·50
"	"	31 Morphological Laboratory, Cambridge	Sepia, Sipunculus 303·25
Aug.	"	3 Prof. Ciaccio, Bologna	Torpedo 23·85
"	"	Dr. W. Patten, Milwaukee	Cymothoa 23·30
"	"	4 Prof. Wiedersheim, Freiburg i/B.	Petromyzon 58·05
"	"	5 Prof. A. Froriep, Tübingen	Embryos of Pristiurus 43·05
"	"	12 Dr. Krukenberg, Jena	Murex 3·90
"	"	16 Mr. R. D. Darbishire, Manchester	Cephalopoda 28·10
"	"	Stud. R. Driesch, Wiesbaden	Various 29·80
"	"	22 Obergymnasium, Sarajevo	Various 111·85
"	"	24 Dr. Stein, Frankfurt a/M.	Embryos of Torpedo 30·70
"	"	Prof. Rabl, Prague	Embryos of Torpedo 15·60
"	"	27 Morphological Laboratory, Cambridge	Pelagia 232·50
"	"	Prof. A. Korotneff, Kiew	Collection 385·40
Sept.	"	14 Laboratoire d'Anatomie, Geneva	Cerianthus 23·40
"	"	17 Mr. A. Kreidl, Prague	Collection 453·60
"	"	22 Mr. W. Schlüter, Halle a/S.	Collection 125·80
"	"	Ecole Normale Supérieure, Paris	Mollusca 48·55
"	"	Istituto Tecnico, Verona	Collection 137·45
Oct.	"	6 Polytechnikum, Stuttgart	Collection 374·20
"	"	Landwirthschaftliche Akademie, Hohenheim	Collection 133·90
"	"	7 Dr. C. F. Jickeli, Hermannstadt	Starfish 23·30
"	"	University College, London	Scorpions 14·50
"	"	10 Prof. A. Froriep, Tübingen	Embryos of Torpedo 16·90
"	"	Prof. A. Babuchin, Moscow	Electric Organs of Torpedo 10·50
"	"	26 Mr. Putze, Hamburg	Various 56·60
"	"	Dr. P. Pelseneer, Brussels	Fissurella 1·90
"	"	University College, London	Various 35·55
"	"	27 Prof. Batelli, Perugia	Bonellia 24·70
"	"	28 R. Museo dei Vertebrati, Florence	Thymnus 72·
Nov.	"	5 Prof. Mosso, Turin	Pectunculus 6·40
"	"	7 Zool. Institut, Breslau	Amphioxus 15·75
"	"	8 Prof. Moriggia, Rome	Electric Organs of Torpedo 22·30
"	"	Mr. E. Penard, Wiesbaden	Various 21·85
"	"	Prof. Della Valle, Museo Zool., Modena	Collection 136·
"	"	14 Realschule, Ludwigshafen	Collection 124·90
"	"	Realschule, Brünswick	Collection 62·50
"	"	15 Prof. Ludwig, Zool. Inst., Bonn.	Various 165·45
"	"	Prof. Mosso, Turin	Arca Noae 7·40
"	"	17 Zool. Institut, Göttingen	Collection 349·40

1888.

M

			Li re c.	
1887	Nov.	17 Seminario, Caserta	Collection	105·10
	"	" 18 Museo Civico, Venice	Various	26·75
"	"	" Mr. E. Marie, Paris	Various	54·90
"	"	" Dr. Korschelt, Berlin	Various	5·65
"	"	" 19 Dr. Kükenthal, Jena	Ophelia, &c.	23·65
"	"	" Mr. George Brook, Edinburgh	Lepadogaster	8·55
"	"	" 20 Dr. F. Noll, Würzburg	Caulerpa	5·90
"	"	" 21 Ecole de Médecine, Cairo	Collection	300·
"	"	" Dr. A. Kaufmann, Bern	Cephalopoda	14·60
"	"	" 23 Mr. Misslowitz, Habercorn	Sepia	8·25
"	"	" 28 Labor. de Zoologie, Nancy	Mollusca	14·35
"	"	" Zool. Museum, Warsaw	Collection	500·
"	"	" Dr. P. de Vescovi, Rome	Various	14·85
"	"	" Prof. P. d'Oliveira, Coimbra	Various	31·60
Dec.	"	3 Mr. Baraldi, Zool. Mus., Turin	Anemonia	13·85
"	"	12 Cabinet Zootomique, Univ. St. Petersburg	Myzostomum	13·
"	"	" Dr. C. J. Jickeli, Hermannstadt	Antedon	13·60
"	"	" Ecole de la Marine, St. Petersburg	Collection	250·
"	"	" 14 Prof. Vitzou, Univ. Bucarest	Collection	392·85
"	"	" Mr. V. Fric, Prague	Various	136·80
"	"	" 15 Prof. Hubrecht, Utrecht	Cerebratulus	5·50
"	"	" 20 Mr. E. Schulz, Glogau	Various	13·15
"	"	" Prof. P. d'Oliveira, Coimbra	Collection	315·15
"	"	" 22 Baron de S. Joseph, Paris	Various	26·35
"	"	" 26 MM. André and Lientier, Marseilles	Collection	242·10
"	"	" 30 Mr. W. Schlüter, Halle	Collection	121·05
"	"	" Queen's College, Prof. Anderson, Galway	Collection	242·50
"	"	" Mr. Shipley, Cambridge	Worms	63·40
1888.	Jan.	7 Mr. A. Amrhein, Vienna	Diatoms	8·80
"	"	" 16 Prof. P. d'Oliveira, Coimbra	Collection	544·65
"	"	" 17 Museo Zoologico, Naples	Collection	200·
"	"	" 20 Conte Peracca, Turin	Lacerta	19·40
"	"	" 22 Prof. Ciaccio, Bologna	Lophius	12·60
"	"	" Museo Zoologico, Bologna	Physophora, &c.	51·35
"	"	" 26 Mr. R. Damon, Weymouth	Collection	787·75
"	"	" 30 Prof. Steenstrup, Copenhagen	Cephalopoda	43·30
"	"	" 31 Dr. P. Pelseneer, Brussels	Mollusca	6·75
"	"	" Mr. Marqua, Linz	Amphioxus	5·80
Feb.	"	17 School of Physic, Dublin	Collection	121·15
"	"	" Realgymnasium, Sprottau	Various	47·15
"	"	" 20 Prof. Wiedersheim, Friburg i/B	Scyllium	34·
"	"	" 23 Mr. A. Certes, Paris	Various	91·55
"	"	" 25 University College, London	Various	31·85
"	"	" Museo Zoologico, Pisa	Collection	313·95
"	"	" Zoolog. Museum, Dorpat	Collection	49·55
"	"	" Mr. T. Tempère, Paris	Various	56·80
"	"	" 27 Prof. G. Schwalbe, Strasburg	Dogfish	99·90
March	"	3 Conte Peracca, Turin	Lacerta	10·50
"	"	" 14 Prof. J. van Ankum, Groningen	Siphonophora	166·90
"	"	" 15 Mr. C. Weber-Sulzer, Winterthur	Various	24·30
"	"	" Labor. de Zoologie, Nancy	Various	17·50
"	"	" Dr. P. Pelseneer, Brussels	Mollusca	7·80
"	"	" Prof. Ciaccio, Bologna	Salpa	8·90
"	"	" 20 Zool. Institut, Univ. Berlin	Collection	2241·90
"	"	" 29 Mr. C. Bassi	Tavernelle	200·
April	"	6 Mr. Fullarton, Univ. Glasgow	Various	172·45
"	"	" Dr. H. Debus, Strasburg	Collection	290·70
"	"	" Dr. Traustedt, Herlufsholm	Collection	212·95

				Lire c.	
1888.	April	6	Mr. E. Marie, Paris	Various	120·80
	"	"	Dr. van Wijhe	Amphioxus	5·75
	"	10	Prof. Carnoy, Louvain	Various	19·35
	"	"	Musée d'Histoire Nat., Paris	Siphonophora	66·10
	"	11	Mr. F. Bernard, Paris	Siphonophora	31·50
	"	16	Botanical Institute, Rostock	Sargassum	34·
	"	"	Prof. Hubrecht, Utrecht	Aplysia	45·25
	"	"	Morphol. Laboratory, Cambridge	Lepas, Sepia, &c.	685·15
	"	"	Prof. P. d'Oliveira, Coimbra	Various	10·
	"	"	Museo Zoologico, Naples	Various	53·95
	"	"	Mr. P. Krause, Dresden	Living specimens	29·95
	"	26	Collegio Pontano, Naples	Collection	33·
	"	27	O Fensege Josef Agost, Alesuth	Collection	46·05
	"	"	Zool. Zoot. Institute, Göttingen	Various	105·15
	"	30	Zool. Museum, Bern	Various	40·55
May		8	Museum der Rhein. Naturf. Gesellschaft, Mainz	Collection	1405·
	"	10	Anatom. Instit., Munich	Embryos of Torpedo	51·70
	"	"	Lab. de Zoologie, Nancy	Various	14·85
	"	"	Dr. B. Hofer, Königsberg	Various	14·75
	"	"	Mr. E. Kestleven, London	Amphioxus	5·
	"	"	Mr. W. H. Tyas, Manchester	—	5·
	"	14	Realgymnasium, Pensa	Collection	289·70
	"	"	Mr. W. Schlüter, Halle	Collection	118·55
	"	18	Mr. C. Bellotti, Milan	Scorpena	10·
	"	"	Dr. Rückert, Munich	Young Pristiurus	36·40
	"	"	Grossherzgl. Museum, Darmstadt	Various	67·95
	"	"	University College, London	Amphioxus	4·85
	"	23	Realschule, Fürth	Collection	100·
	"	24	R. Scuola Tecnica, Rome	Collection	300·
	"	25	Prof. Krimmel, Reutlingen	Cœlenterata	50·05
	"	"	Prof. Mosso, Turin	Murena	11·70
	"	28	Prof. S. Matsubara, Tokio	Collection	209·
	"	"	Prof. P. d'Oliveira, Coimbra	Portunus	2·20
June		4	Cabinet Zootom., Univ. St. Petersburg	Collection	645·10
	"	"	Mason College, Birmingham	Various	115·
	"	"	Laboratoire de Zoologie, Lausanne	Amphioxus	2·80
	"	9	G. B. Paravia & Co., Rome	Collection	600·
	"	11	Dr. Münder, Göttingen	Turbo rugosum, opercula	2·
	"	12	Anatom. Inst. Munich	Petromyzon	38·95
	"	"	Mr. J. C. Rinnböck, Vienna	Algæ, Diatoms	9·95
	"	14	University College, London	Sepia, Sipunculus, &c.	180·20
	"	16	Rijks Museum, Leyden	Annelides	98·15
	"	17	R. Museo dei Vertebrati, Florence	Lampris luna	99·
	"	20	Muséum d'Hist. Nat., Lyons	Siphonophora, &c.	187·15
	"	26	Mr. H. C. Chadwick, Manchester	Various	21·45
	"	"	Owens College, Manchester	Collection	710·25
	"	"	Mr. H. Meller, Manchester	Polyophthalmus	2·20
	"	"	Dr. Ziegler, Freiburg i/B	Embryos of Torpedo	33·10
	"	30	Prof. G. Vimercati, Florence	Various	35·25
	"	"	Prof. Gilson, Louvain	Coleoptera	4·45

22,258·65

Report of the Committee, consisting of Dr. J. H. GLADSTONE (Secretary), Professor ARMSTRONG, Mr. STEPHEN BOURNE, Miss LYDIA BECKER, Sir JOHN LUBBOCK, Bart., Dr. H. W. CROSSKEY, Sir RICHARD TEMPLE, Bart., Sir HENRY E. ROSCOE, Mr. JAMES HEYWOOD, and Professor N. STORY MASKELYNE, appointed for the purpose of continuing the inquiries relating to the teaching of Science in Elementary Schools.

WHEN your Committee made their last report in August 1887, the Government had just abandoned their Technical Instruction Bill for England, but had expressed their intention of proceeding with the Scotch Bill. The latter passed the House shortly afterwards, and provides that any School Board, after the next election, may provide and maintain Technical Schools, or that two or more School Boards may join for that purpose. A copy of the Act is given in Appendix I. A circular was issued by the Scotch Education Department in February last, calling the attention of the School Boards to the matter, and discussing the subject at considerable length. The definition of technical education given in this circular is set out in Appendix II. The Scotch Code of this year has been considerably modified in consequence of this Act; besides which it has a provision which is very interesting in its bearing on your Committee's previous recommendations. Instead of English being the subject which must be taken as the first class subject, the article now runs: 'Not more than three class subjects may be taken, and if any such subjects are taken, one must be English or Elementary Science.'

No alteration has been made in the English Code this year; and the disabilities under which the Brighton School Board and the Beethoven Street School (London) were suffering at the date of last report have not been removed.

Manual instruction has, however, been given by the London School Board, through the assistance of the City and Guilds of London Technical Institute, who have provided the sum of 1,000*l.* for one year for the equipment and maintenance of classes. A joint committee of representatives of the School Board and Institute have selected six centres, three north and three south of the Thames, and have appointed two special teachers and two artisan assistants who devote all their time to the work. In this way about 600 boys are receiving nearly three hours' instruction a week in the scientific principles and the practical work of carpentry. The School Board has asked for a further grant for a second year in consequence of no legislation having taken place this session.

The return of the Education Department for this year shows that the diminution in the teaching of the science subjects, noted in previous reports, still continues. The statistics of the class subjects for five years are given in the subjoined table, which shows an actual decrease in Geography and Elementary Science, notwithstanding the increase in the number of departments examined. The growing practice of taking needle-work in girls' schools as the second class subject (and thus obtaining for it a larger grant than would be paid for it otherwise) is gradually excluding geography.

Class Subjects.—Departments	1882-3	1883-4	1884-5	1885-6	1886-7
English	18,363	19,080	19,431	19,608	19,917
Geography	12,823	12,775	12,336	12,055	12,035
Elementary Science.	48	51	45	43	39
History	367	382	386	375	383
Drawing	—	—	—	240	505
Needlework	5,286	5,929	6,499	6,809	7,137
Total	18,524	19,137	19,266	19,522	20,099

The return of scholars individually examined in the scientific specific subjects shows again an actual falling off in the total, and either an actual or relative falling off in every subject except mechanics A and chemistry, which have both considerably increased. The figures are given in the following table:—

Specific Subjects.—Children	1882-3	1883-4	1884-5	1885-6	1886-7
Algebra	26,547	24,787	25,347	25,393	25,103
Euclid and Mensuration	1,942	2,010	1,269	1,247	995
Mechanics A	2,042	3,174	3,527	4,844	6,315
" B	—	206	239	128	33
Animal Physiology	22,759	22,857	20,869	18,523	17,338
Botany	3,280	2,604	2,415	1,992	1,589
Principles of Agriculture	1,357	1,859	1,481	1,351	1,137
Chemistry	1,183	1,047	1,095	1,158	1,488
Sound, Light and Heat	630	1,253	1,231	1,334	1,158
Magnetism and Electricity	3,643	3,244	2,864	2,951	2,250
Domestic Economy	19,582	21,458	19,437	19,556	20,716
Total.	82,965	84,499	79,774	78,477	78,122
Number of Scholars in Standards V., VI., and VII.	286,355	325,255	352,860	393,289	432,097

The rapid and serious decrease of attention paid to these science subjects is shown by the percentage of children who have taken them, as compared with the number of scholars that might have taken these subjects, viz. :—

In 1882-3	29·0 per cent.
„ 1883-4	26·0 „
„ 1884-5	22·6 „
„ 1885-6	19·9 „
„ 1886-7	18·1 „

and it must be remembered that children who have taken two of these subjects count twice over.

The Special Committee of the London School Board ‘on the subjects and modes of instruction in the Board’s schools,’ which was referred to on the last occasion, has presented its report. The report itself, prepared by Mr. W. Bousfield, which is a lengthy and important document, is strongly in favour of much greater attention being paid to science. The

appendix contains valuable evidence from several scientific men, amongst others; and statistical tables relating to the instruction now given in the schools under the Board. From these it appears that object lessons are given in all the infant schools, occupying on an average about one and a half hours per week, and in 91 per cent. of the boys' and girls' schools; but in the case of many of these they are confined to the lower standards, and the average time devoted to them is less than three-quarters of an hour per week. This is in strange contrast with the ten and a quarter hours per week, which is the average quantity given in the boys' schools, and nine and a quarter in the girls' schools, to the literary subjects of instruction—reading, writing, spelling, and grammar—and to the four hours at least per week which the girls are expected to give to needle-work. Though these object lessons are the principal means by which a knowledge of science is given, about half of the elder boys get some instruction in some scientific specific subjects. The principal recommendations in which your Committee are interested are:—

1. That the methods of Kindergarten teaching in infants' schools be developed for senior scholars throughout the standards in schools, so as to supply a graduated course of manual training in connection with science teaching and object lessons.

2. That the teaching of all subjects be accompanied, where possible, by experiments and ocular demonstration, and that the necessary apparatus be supplied to the schools.

10. That greater attention be paid to the teaching of mechanics as a specific subject, and that models for illustrating the instruction be placed on the requisition list.

16. That, in order to allow time for experimental teaching and manual work, the time now given to spelling, parsing, and grammar generally, be reduced.

28. That application be made to the Education Department that the new Code be revised, as follows:—

(*b.*) By applying to senior departments the regulation made with regard to infants' departments in Article 106 (*b.*) of the new Code, viz., that the award of a merit grant should have 'regard to the provision made for . . . simple lessons on objects, and on the phenomena of nature and of common life.'

(*c.*) By providing that more freedom of choice may be given to managers and teachers in the selection of class subjects, in order that the first class subject need not necessarily be English.

(*f.*) By rendering it obligatory upon pupil-teachers to exhibit a knowledge of elementary science in some form at their annual examinations. (Schedule V.)

A lengthy discussion on the general principles of the Report has taken place, and the first recommendation has been carried, with the addition of the words, 'but not so as to include teaching the practice of any trade or industry, and that the method of Kindergarten in the senior schools be tried first in a few special schools throughout London.'

Two Technical Instruction Bills have been brought into Parliament again this year—the one by Sir Henry E. Roscoe and the other by the Government—but each of them considerably varied from those of the preceding year. Neither of them progressed beyond the first reading; the former having been supplanted by the Bill of the Government, which,

however, met with little approval, and was withdrawn in July along with several others.

The reason generally given why legislative and executive changes have not been made during the year is that the Government is waiting for the Report of the Royal Commission on the working of the Elementary Education Acts of England and Wales. Since the Manchester meeting the Royal Commission have published another volume of evidence, and an analysis of the whole; but they have not yet finally settled their recommendations.

In the meantime public opinion has considerably ripened upon the subject of scientific and practical education. This is evident by the earnest manner in which it is now discussed by politicians and teachers, and in the columns of the periodical press.

APPENDIX I.

Technical Schools (Scotland) Act, 1887.

Be it enacted by the Queen's Most Excellent Majesty, by and with the advice and consent of the Lords Spiritual and Temporal, and Commons, in this present Parliament assembled, and by the authority of the same, as follows :

I. This Act may be cited as the Technical Schools (Scotland) Act, 1887, and shall in so far as consistent with the tenor thereof be construed as one with the Education (Scotland) Acts, 1872 to 1883.

II. This Act shall commence to have effect in each parish and burgh in Scotland from and after the next ensuing triennial election of a school board therein respectively, and shall apply to Scotland only.

III. (1.) A school board may pass a resolution that it is expedient to provide a technical school for its district, and thereupon may, subject to the provisions of this Act, provide such a school accordingly, and pay the expenses of providing and maintaining the school, including the expense, if any, of providing tools, apparatus, and drawing and other materials, in so far as the same remain the property of the school board, out of the school fund. The subjects to be taught in the school shall be such as may from time to time be approved of by the Scotch Education Department.

The school board shall fix the school fees to be paid for attendance at each technical school under their management, and such fees shall be paid to the treasurer of the board, and a separate account shall be kept of the amount of the fees derived from such school, and it shall be lawful for the school board, if they see fit, to pay to the teachers of a technical school the fees derived from such school, and to divide the same among them as the school board shall determine. Any deficiency which may exist on the technical school account shall be payable out of the school fund provided under the Education (Scotland) Acts, 1872 to 1883.

(2.) If the resolution is not confirmed as hereinafter mentioned, it shall not be carried into effect, and shall not be again proposed until the expiration of not less than twelve months.

IV. A resolution of a school board, as in the last section mentioned, shall be of no effect unless and until—

(1.) It is confirmed at a subsequent meeting of the school board held after the resolution has been published in the prescribed manner, and

after the expiration of the prescribed time, being not earlier than one month after the first publication of such resolution ; and

(2.) It is confirmed by the Scotch Education Department by a Minute or Order.

V. (1.) Every school provided under this Act if it claim a grant from the Department of Science and Art shall, with respect to any subject for which such grant is claimed, be conducted in accordance with the conditions specified in the Minutes of the Department of Science and Art in force for the time being, and required to be fulfilled by such a school in order to obtain a grant from that Department.

(2.) Those conditions shall, amongst other things, provide that a grant shall not be made by the Department of Science and Art in respect of a scholar admitted to the school unless or until he has obtained such a certificate from the Scotch Education Department as is hereinafter mentioned.

(3.) A Minute of the Department of Science and Art not in force at the passing of this Act shall not be deemed to be in force for the purposes of this Act until it has lain for not less than one month during one session on the Table of both Houses of Parliament.

VI. Every school provided under this Act shall, in respect to all subjects other than those for which a grant is claimed from the Science and Art Department, be conducted in accordance with the conditions which may from time to time be set forth in the Scotch Education Code annually laid before Parliament under the heading 'Technical Schools.'

VII. (1.) Every school board providing a technical school shall, subject to the provisions of this Act, maintain and keep efficient the school so provided.

(2.) For the purpose of providing any such school, a school board shall have the same powers, but subject to the same conditions, as a school board has for providing sufficient school accommodation for its district.

(3.) For the purpose of maintaining any such school, a school board shall have the same powers, but subject to the same conditions, as a school board has in regard to the maintenance of a higher class public school under section eighteen of the Education (Scotland) Act, 1878.

(4.) A school board may, with the consent of the Scotch Education Department, use for the purposes of a technical school any buildings, or part of any buildings, vested therein for the purposes of the Education (Scotland) Acts, 1872 to 1883, and a school board, or combination of school boards, may, with the consent of the Scotch Education Department, use for the purposes of the Education (Scotland) Acts, 1872 to 1883, any buildings, or part of any buildings, authorised by this Act.

(5.) A school board may, with the consent of the Scotch Education Department, spread the payment of the expense of providing a technical school over a number of years, not exceeding thirty-five years, unless with the sanction of the Treasury, and in any case not exceeding fifty, and may borrow money for that purpose ; and for the purpose of such borrowing section forty-five of the Education (Scotland) Act, 1872, shall be held to apply to the loan, and such provision shall be deemed to be a work for which a school board is authorised to borrow, and the Public Works Loan Commissioners are authorised to lend, within the meaning of the ninth section and the First Schedule of the Public Works Loans Act, 1875.

(6.) Where a school board has provided any such school, it may discontinue the school, or change the site thereof, if it satisfies the Scotch Education Department that the school to be discontinued is unnecessary, or that the change of site is expedient.

VIII. Any two or more school boards may resolve to combine together for the purpose of providing and maintaining a technical school under this Act common to the districts of such school boards, provided that no such resolution shall have any effect unless and until it has been published and confirmed in manner hereinbefore provided; and if such resolution is confirmed as aforesaid, the same provisions shall have effect as in the case of a resolution to provide a technical school, and if the resolution is carried into effect the expenses of providing or maintaining the school, and the sum necessary to meet any deficiency on the technical school account, shall be paid out of the school funds of the combining school boards in terms of the said resolution.

IX. The provisions of sections thirty-eight and thirty-nine of the Education (Scotland) Act, 1872, with respect to the transference of schools in pursuance of those sections, shall apply to technical schools now existing, or which may hereafter exist, in the same manner as they now apply to the schools which may presently be transferred in pursuance of those sections.

X. No scholar shall be admitted to a technical school unless or until he has obtained a certificate under section seventy-three of the Education (Scotland) Act, 1872, as amended by section seven of the Education (Scotland) Act, 1883, or an examination equivalent thereto.

XI. A technical school provided and maintained under this Act shall be deemed to be a public school, but attendance thereat shall not be reckoned as attendance for the purpose of any grant from moneys voted by Parliament under the Education (Scotland) Acts, 1872 to 1883.

XII. In this Act—

The expression 'technical school' means a school or department of a school in which technical instruction is given, and school board shall include combination of school boards.

The expression 'technical instruction' means instruction in subjects approved by the Scotch Education Department, and in the branches of science and art with respect to which grants are for the time being made by the Department of Science and Art, or in any other subject which may for the time being be sanctioned by that Department.

The expression 'prescribed' means prescribed by the Scotch Education Department.

APPENDIX II.

'However desirable it might be, it is scarcely possible to frame a definition of technical education which can be satisfactory from all points of view; but without any such comprehensive definition it may be possible to lay down certain outlines of the operations permissible under the Act. Their lordships assume that such instruction may be held to cover not only the general scientific principles which underlie the leading manufactures and industries of the kingdom, but also some knowledge of the manner in which these general principles are applied, and some acquaintance with the practical conditions under which they are applied in various industries, and in various localities. Besides this general description, they apprehend that the ordinary interpretation of the term covers some

practical training of hand and eye, some adapting of the ordinary lessons of the school to the affairs of life, and to the acquiring of aptitude in the special occupation in which the scholar is to be engaged.'

POSTSCRIPT.

Since the foregoing report was prepared Mr. Samuel Smith's Continuation Schools Bill has been printed, and the final report of the Royal Commission on the Working of the Elementary Education Acts, England and Wales, has been issued.

The former provides that in the Continuation schools proposed to be created instruction must be given in at least three of the subjects specified in the First Schedule, which includes, *inter alia*, elementary mathematics, mechanical drawing, and elements of agricultural science, and may be given in any of the subjects specified in the Second Schedule, which includes use of tools, and art handwork generally.

The final report of the Royal Commission is a very lengthy document, and contains a large amount of matter bearing upon the subject with which your Committee have to deal. The following are some of the principal recommendations affecting the teaching of science in elementary schools:—

'(15.) That in making future appointments to the office of inspector, it would be desirable, in regard to a larger proportion of them than at present, to give special weight to the possession of an adequate knowledge of natural science.

'(89.) That, as far as practicable, the children should be grounded in all the four class subjects, and that when only some of them are taken the selection should be left to the school authorities.

'(90.) That the provision of the Code, which requires that if only one class subject is taken it must be "English," should be repealed.

'(93.) That geography, if properly taught, is a branch of elementary science, which should not be separated from the other branches, and might well be taught along with object lessons, in accordance with the recommendations of the Royal Commission on Technical Instruction.

'(94.) That in Standard VII. the time allotted to geography might advantageously be devoted to specialising some particular branch of the subject.

'(114.) That the following subjects of elementary instruction are to be regarded as essential, subject to the qualifications we have already made:—

.

Geography, especially of the British Empire.

Lessons on common objects in the lower standards, leading up to a knowledge of elementary science in the higher standards.

'(118.) That though boys while at school should not be taught a trade, some elementary instruction in science is only second in importance to the three elementary subjects.

'(120.) That the curriculum of elementary scientific subjects might vary according to the special requirements of each locality.

'(121.) That object lessons should be continued in the lower standards in succession to similar teaching in the infant school.

'(123.) That the curriculum in the ordinary elementary schools might often include not only instruction in the elementary principles of science,

but also, in certain standards, elementary manual instruction in the use of tools; and in higher schools and evening schools this work might be carried still further.

‘(124.) That if technical instruction of this kind is to be given in our schools, it should not be applicable to boys under ten years of age. The ultimate object of such instruction, however, might be furthered by judicious systematical science teaching given to the younger scholars, in which they should be associated in preparing specimens, helping to make models on their geography lessons, and so forth.

‘(125.) That examinations in science should as far as possible be conducted orally and not on paper, especially in the first five standards.

‘(126.) That if it should be thought that children ought to receive some instruction in manual employment other than that which the elementary schools available for their use can give, the best way of meeting the need would be by the establishment in connection with some higher institution of a workshop for boys of exceptional ability, or for others to whom it was considered desirable to give this instruction.

‘(127.) That arrangements might be made to substitute attendance at such a centre on one or two afternoons in the week for attendance at the elementary school.

‘(128.) That the higher grades of elementary schools in which more advanced science is taught, and where a certain number of children stay beyond the seventh standard, may be regarded as continuation schools.

‘(136.) That it is desirable that the management of technical instruction should be entrusted to the Education Department, and not to the Science and Art Department.

‘(142.) That the evening school system should be thoroughly revised; that a special curriculum and special schedules of standards and subjects should be allowed, suitable to the needs of a locality, and that the local managers should be encouraged to submit such schedules to the Department for approval; that the provision embodied in the Code requiring all scholars in evening schools to pass in the three elementary subjects as a condition of taking of additional subjects should cease to be enforced; and that no superior limit of age should be imposed on the scholars.

‘(151.) That a knowledge of the principles of agriculture, which might be taught in higher elementary schools, where such existed in country places, would be of great value to those children who might hereafter be engaged in agricultural labour.

‘(152.) That in certain cases the object of higher elementary schools might be secured by attaching to an ordinary elementary school a class or section in which higher instruction was provided for scholars who had passed the seventh standard. That liberal grants made, as in Scotland, to the managers of elementary schools for advanced instruction to scholars who have passed the highest standard, would facilitate the provision of such higher instruction in the smaller and less populous school districts.’

These recommendations were signed by fifteen out of the twenty-three Commissioners. The remaining eight presented an entirely separate report, as they differed from their colleagues on many other points; but they agree in principle with the above recommendations so far as your Committee have quoted them. The following are some of the comments of the minority, which will show that they are at least equally desirous of seeing greater facilities given for instruction in science in elementary schools.

‘We agree that the present special preference of English above the other class subjects should be removed from the Code.

‘We agree that higher elementary schools are a useful (we would rather say a necessary) addition to our school machinery for primary education. . . . That where such schools cannot be founded, higher classes for children who have passed the seventh standard should be attached to an ordinary elementary school.

‘We dissent from the recommendations of our colleagues as to the management of technical schools when established. . . . We would say . . . that these schools, which should be the crown and development of elementary education, should be in touch and close sympathy through their management with our elementary school system.

‘In reference to the subject of technical and scientific instruction, we draw an important distinction between technical instruction or instruction which is designed with special reference to, and as a preliminary training for, the commercial or industrial occupations of life, and manual instruction regarded as a training of the hand and eye so as to bring them under the control of the brain and will, as a general preparation for the future career in life, whatever it may be.

‘Bearing in mind the age of children in elementary schools, it may be a question whether technical instruction, as we have defined it, should be commenced any earlier than the sixth standard. But we are of opinion that, after the children have left the infant school, transitional methods should be adopted, which will develop their activity and train their powers by drawing in all cases, and by such other means as, for instance, modelling, or the collection and mounting of botanical specimens.

‘This training would, on the one hand, be advantageous as naturally leading up to technical instruction, and, on the other hand, far from interfering with the more literary studies, the latter would, we believe, benefit considerably by the variety and relief which would thus be introduced.

‘We recommend that the examination of the scientific teaching given in our elementary schools should be mainly oral, especially up to and including the present fifth standard. If science is to be well taught, care should be taken that where the ordinary teachers are not qualified, specially trained teachers should be employed.

‘Higher grade schools should be encouraged which will prepare scholars for advanced technical and commercial instruction.

‘Technical teaching in the school cannot replace the practical teaching, which is best learnt in the workshop.

‘In ordinary elementary schools good teaching of drawing and of elementary science are the best, and in the lower classes the only fitting preparation for the work of the technical school, and these subjects should be generally taught.

‘Technical instruction should cover commercial and agricultural as well as industrial instruction.’

*Sixth Report of the Committee, consisting of Mr. R. ETHERIDGE,
Dr. H. WOODWARD, and Professor T. RUPERT JONES (Secretary),
on the Fossil Phyllopoda of the Palæozoic Rocks.*

- | | |
|---|---|
| <p>§ I. Monograph of the Palæozoic <i>Ceratiocaridæ</i>.</p> <p>§ II. <i>Ceratiocaris tyrannus</i> from Troutbeck.</p> <p>§ III. Scandinavian <i>Phyllocarida</i>, and teeth of <i>Ceratiocaris</i>.</p> <p>§ IV. M. Novák's <i>Aristozoe solitaria</i>, <i>Ceratiocaris</i>, spp., and note on <i>Cryptocaris</i>.</p> <p>§ V. M. Novák's note on <i>Ptychocaris</i> (?) <i>Jaschei</i>, F. A. Roemer.</p> <p>§ VI. Mr. Clarke's Devonian <i>Phyllocarida</i> of New-York State.</p> | <p>§ VII. <i>Bactropus</i> in Devonshire.</p> <p>§ VIII. Tremadoc Fossils.</p> <p>1. <i>Saccocaris major</i>, Salter.</p> <p>2. <i>Lingulocaris Salteriana</i> nov.</p> <p>3. <i>Lingulocaris siliquiformis</i> J. & W.</p> <p>4. <i>Ceratiocaris</i> (?)</p> <p>5. <i>Hymenocaris vermicauda</i>, Salter.</p> <p>§ IX. <i>Estheria</i> from Orkney.</p> <p>§ X. Devonian Phyllocarids of New-York State, &c.</p> |
|---|---|

§ I. *Monograph*.—‘A Monograph of the British Palæozoic *Phyllopoda* (*Phyllocarida*, Packard), Part I., *Ceratiocaridæ*,’ based on our former Reports to the British Association for the Advancement of Science, was published in January of this year by the Palæontographical Society. The genera and species treated of are those enumerated in the table at page 234 of the Report for 1886, excepting that *Ceratiocaris attenuata* was found to be Salter's *C. tyrannus*; to this species also may be referred pl. 2, fig. 4, pl. 4, fig. 3, pl. 5, fig. 6, and pl. 6, fig. 11 of the Monograph. the style or telson being strong and straight (not curved as in its near ally, *C. Murchisoni*). The Portuguese fossil Phyllocarid, first named and described by D. Sharpe as *Dithyrocaris* (?) *longicauda* (?) is also included, with illustrations (being within reach at the Geological Society of London), as a doubtful *Ceratiocaris*.

§ II. *Ceratiocaris tyrannus*.—Professor Sven Leonhard Törnquist, of Lund, has sent to us for examination some fragments of the caudal appendage of a *Ceratiocaris* from the Upper Coldwell Beds, near Troutbeck, Westmoreland. The specimen consists of a style and two stylets, imperfect at the ends, in a sandy mudstone. One stylet lies close to the style, and the other is indicated by a cast at an angle with its fellow. They are all straight and the style shows a lateral row of pits (bases of spinules). It is too straight for *C. Murchisoni*, and the pits are too small for *C. gigas*. It may belong to *C. tyrannus*, like the specimen (also from Westmoreland), referred to *C. valida*, perhaps wrongly, ‘Monogr. Foss. Phyll.’ p. 21, pl. 6, f. 11. The specimen shown by pl. 4, fig. 3, is also probably *C. tyrannus* and not *C. Murchisoni*.

§ III. *Ceratiocaridæ from Sweden*.—The Scandinavian Phyllocarida mentioned in the last ‘Report’ (Manchester meeting, 1887), pp. 60–62, have been fully described and figured in the ‘Geological Magazine’ for March 1888, pp. 97–100, pl. 5, and for April, pp. 145–150, pl. 6 and woodcuts. *Ceratiocaris valida* has been added with some probability as occurring in Sweden. In *C. Angelini* the style (telson) was probably only 7·(not 15) mm. longer than in pl. 5, fig. 1, p. 97; and the row of little pits (bases of prickles) is on the right-hand (not left-hand) side of the cast as figured, *ibid.*, see also *ibid.*, p. 150.

With this revised and enlarged description of the Phyllocaridal remains from Sweden are associated descriptions and figures of both Scandinavian and British specimens of the masticatory organs ('teeth') of *Ceratiocaris*.

We ought to have added that Mr. T. P. Barkas has given two rough figures of a similar tooth, belonging probably to *Dithyrocaris*,¹ in his 'Manual of Coal-measure Palæontology,' or 'Illustrated Guide to the Fish, Amphibian, Reptilian, and supposed Mammalian Remains of the Northumberland Carboniferous Strata,' 8vo, and 'Atlas of Carboniferous Fossils from the Northumberland Carboniferous Strata,' fol., 1873. These enlarged views of a Crustacean tooth are figs. 161 and 162 in pl. 5, and the specimen is described as the *Anthropodontoides Bailesii*, at p. 45.

§ IV. *Bohemian Phyllocarida, &c.*—M. Ottomar Novák has further enlarged our knowledge of the Palæozoic Phyllopodous Crustaceans during his critical examination of the 'Barrande Collection,' of which he has the charge in the Prague Museum.

In the Stage F-f1, of the Hercynian Formation, he finds an undescribed telson, relatively short and stout, 39 mm. in length, swollen for about 10 mm. from the top, afterwards neatly ridged and fluted dorsally, and bearing a row of small pits along each outer ridge. This he defines as *Aristozoe solitaria*, at p. 15, pl. 1, figs. 15-19, of his 'Zur Kenntniss der Fauna der Etage F-f1 in der paläozoischen Schichtengruppe Böhmens'; 'Sitzungsber. k. böhm. Gesell. Wissensch.,' Jahrgang 1886. At p. 15 M. Novák explains that *Aristozoe* had only one caudal spine, namely, the telson or style. In the Table at p. 17 he mentions two new species of *Ceratiocaris* (not described, *C. modesta* and *C. Damesi*) from the same Stage.

In our Second Report (for 1884), at p. 87, we offered the remark that most of Barrande's species of *Cryptocaris* and *Zonozoe* were probably opercula of some Shells, or possibly of some Corals such as *Goniophyllum*. M. Novák finds evidence that some at least of the *Cryptocarides* are referable to the Conularian *Orthotheca* or *Hyolithes*, and that *Cryptocaris suavis*, Barrande, in particular, is the operculum of *Orthotheca* (*Hyolithes*) *intermedia*, Novák. 'Sitzungsber. böhm. Ges. Wiss.' 1886, pp. 7-14, pl. 1, figs. 9-13.

We may add that in his 'Illustrations of the Fauna of the St.-John Group, No. III.,' in the 'Transact. Roy. Soc. Canada,' Section IV., 1885, Mr. G. F. Matthew has described and figured some fossil Pteropoda (*Hyolithes*, &c.), together with their opercula (p. 48, &c., pl. 6, figs. 1, 2, 5, 6, 7). These latter are evidently the same as Barrande's *Cryptocaris*. Other probable opercula are figured and described in the same work (pp. 61-66, pl. 6, figs. 16-21), under the generic names of *Lepiditta*, *Lepidilla*, *Hipponicharion*, and *Beyrichona*; some being regarded as Ostracods, and others doubtfully as Phyllopods.

§ V. *Ptychocaris* (?) *Jaschei*.—M. Ottomar Novák has favoured us with the following note:—

'*Dithyrocaris Jaschei*, figured by Kayser in the "Abhandl.," &c., pl. 1, fig. 13, and mentioned in the Fifth Report on the Fossil Phyllopoda of the Palæozoic Rocks, p. 66, shows some resemblance to my *Ptychocaris*

¹ Similar to those described and figured in the *Geol. Mag.*, 1865, p. 401, pl. 11, fig. 8; and 1873, p. 486, pl. 16, fig. 2g.

(see Fourth Report, &c., p. 233), which occurs at an equivalent horizon—the “Hercynian” of Beyrich and Kayser, = “Étages F, G, and H,” of Barrande.’

§ VI. *Devonian Phyllocarida of New-York State*.—In the ‘Bulletin of the U. S. Geological Survey,’ No. 16, 8vo, 1885, Mr. John M. Clarke has given a memoir ‘On the Higher Devonian Faunas of Ontario County, New York,’ in which he describes and figures the following Phyllocarida:—

1. *Ceratiocaris simplex*, J. M. C., p. 43 (77), pl. 2, fig. 2. Carapace-valve nearly oval in outline, 30 mm. long and about 10 mm. wide (high).

2. *C. Beecheri*, J. M. C., p. 44 (78), pl. 2, fig. 1. Three abdominal segments and three caudal spines, not well preserved. Proportionally too large for the foregoing species. The ultimate segment is apparently shorter than usual in this genus.

3. *Echinocaris Whitfieldi*, J. M. C., p. 45 (79), pl. 2, figs. 3 and 4. Carapace-valve 27 mm. long and 16 mm. wide (high); with the middle and one of the lateral caudal spines, the latter longer than the former.

4. *Equisetides Wrightiana*, Dawson, 1881 (*Echinocaris Wrightiana*, J. & W. ‘Geol. Mag.’, 1884, p. 395, pl. 13, fig. 1), is mentioned at p. 66 (100). See also our Third Report (for 1885), p. 360.

5. *Spathiocaris Emersoni*, J. M. C. Notes on the genus and localities for this species are given at pp. 46 (80) and 47 (81).

In the Table at p. 69 (103) *Ceratiocaris longicauda*, Hall, is noted as occurring in the ‘Genessee Shales’ and the ‘Portage Beds,’ in which latter occur also *Dipterocaris pennæ-Dædali*, Cl., *D. pes-cervæ*, Cl., and *D. Procne*, Cl. The ‘Naples Shales’ have yielded *Ceratiocaris simplex*, Cl., *C. Beecheri*, Cl., *Echinocaris Whitfieldi*, Cl., *Ech. Wrightiana* (Dawson), and *Spathiocaris Emersoni*, Cl. See also our Second Report (for 1884), pp. 78, 80, 81.

§ VII. *Bactropus in Devonshire*.—The Rev. G. F. Whidborne, F.G.S., has identified from the Devonian strata of Torquay a specimen of *Bactropus longipes*(?), Barrande, which M. Ottomar Novák¹ has shown to be really the chief abdominal segment (or ‘post-abdomen’) of Barrande’s *Aristozoe regina*; whilst *Ceratiocaris debilis*, Barrande, is the style (telson) of the same bivalved Crustacean (Phyllocarid).

§ VIII. *Tremadoc Fossils*.—In the First Report on the Palæozoic Phyllopoda (1883) a tabular synopsis of the known fossil genera was published, together with descriptive notes on some of the species, from the Tremadoc and other old rocks, including *Hymenocaris*, *Caryocaris*, and *Lingulocaris*. The well-known *Hymenocaris vermicauda* is therein described from specimens obtained from many localities of the Lingula-flag and Tremadoc-slate series of North Wales, and preserved in the collections of the British Museum, Geological Survey, Cambridge University, and Owens College. The track-marks on Lingula-flags, near Tremadoc, ascribed by Salter to *Hymenocaris*, are also alluded to.

The ‘*Hymenocaris (Saccocaris) major*’ of Salter is also referred to at pp. 219, 220. Though three specimens have been thus labelled in the Cambridge Museum, with some doubt and possibly by Salter himself, only one of them answers to Salter’s brief generic description, and on this the following determination is founded.

¹ *Sitzungsber. k. böhm. Gesell. Wissensch.*, Jahrgang 1885, pp. 239–243, pl. 1. See also our Report for 1885, p. 359.

1. SACCOCARIS MAJOR, Salter. (Woodcut, Fig. 1.)

Saccocaris, Salter, 1868. 'Report Proc. Geol. Polytech. Soc. West Riding of Yorkshire' (for 1867), vol. iv. 1868, p. 588.

Hymenocaris (Saccocaris) major, Salter, 1873. 'Catal. Palæoz. Fossils, Cambridge Museum,' p. 7. Referring to 'Halifax Trans.' 1867,' by mistake.

The particular specimen which most nearly corresponds with the original description, namely, 'a large ovate carapace, strongly emarginate behind, and larger than *H. vermicauda*,' is a relatively large, thin, filmy, compressed valve, $4\frac{2}{10}$ inches long and 2 inches high,¹ suboblong, with nearly parallel dorsal and ventral borders, the former straighter than the latter, which has a slight outward (downward) curve. Obliquely elliptical in front, the acme of the curvature being above the mesial line, thus making the antero-dorsal much shorter than the antero-ventral curve. Apparently blunt or truncate behind, with a gentle outward curve rather above the middle. The exact line of this posterior margin is not clearly seen, owing to its being shredded or frayed off, thus passing into the substance of the black schistose mudstone; the valve having been delicately plaited (with the stone) by lateral pressure acting at right angles to its length, and this longitudinal plaiting being transverse to the hind border. The front edge has not been affected nearly so much, having probably been thicker, or even slightly rimmed. This pressure has, perhaps, somewhat elongated the valve, and lessened its original height, besides giving it a gentle undulation, as well as the plaiting (pleating), throughout.

The valve, slightly hollow, is probably the right-hand valve, showing its inside. Several concentric, irregular, narrow foldings, following the contour of the anterior and antero-ventral border, are apparently due to the compression of the convexity of the valve.

This specimen, No. 1, at p. 220 of the First Report, and fig. 1 of the accompanying woodcuts, is marked $\frac{A}{160}$, $\frac{b}{237}$, in the Woodwardian Museum of the Cambridge University, and was collected by Mr. D. Homfray from the upper part of the Lower Lingula-flags at Caer-y-coed, near Maentwrog.

This was at first (in 1867) regarded by Mr. Salter as a flat carapace, 'after the manner of *Apus*'; but afterwards (in 1873) he referred it to the bivalved, folded, or Nebaloid forms of carapace, and placed it as an ally of *Hymenocaris*, with the name *Saccocaris*. In shape it differs much from the valves of that genus, as it wants their triangular form, due to the dorsal line forming an angle with the front edge, which slopes rapidly downwards and backwards all along the ventral, to join the posterior margin with a bold, oblique, postero-ventral curve. Differing also remarkably in size, it must be assigned to a different generic group; and it will be best to recall the name Salter was at first inclined to give it, namely, SACCOCARIS.

2. LINGULOCARIS SALTERIANA, sp. nov. (Woodcuts, Figs. 6 & 7.)

The British Museum has lately acquired a fine specimen of one of the old Cambrian Phyllocarids, from the Tremadoc-slate series. It is a black,

¹ *H. vermicauda* rarely attained more than an inch in length along the back, 8 or 9 tenths of an inch in height, and one and 3 or 4 tenths of an inch in the greatest angular length from antero-dorsal to postero-ventral region

shining, and filmy valve (or compressed bivalved carapace), seen as an impression and counterpart on a split slab of hard, grey, micaceous mudstone, which has been subjected to the usual lateral pressure. The valve ($3\frac{1}{4}$? \times $1\frac{1}{8}$ inch) is acutely subovate, or sharply boat-shaped in outline, convex below and straight above, and was acute probably at each end, though one of them is damaged. It retains a remnant of one of the small, subtriangular, terminal extensions of the dorsal edge, such as are present in *L. siliquiformis*. See fig. 6 of the annexed woodcuts.

The surface is peculiarly marked with what seem to be modifications of ornamental striæ or linear plaits, namely, very small lenticular and bead-like elevations, which may have resulted from raised longitudinal striæ being crossed by the delicate plaiting of lateral pressure at slightly different angles.

We dedicate this fine species to the memory of our friend, Mr. J. W. Salter, whose labours in elucidating these old Phyllopodous forms are well known. It was found by Dr. R. Roberts in the Tuhwntirbwch quarry at Portmadoc.

Another of the old associates of *Hymenocaris* in the Tremadoc series is the 'second specimen' mentioned at p. 220 of our First Report (1883). Though smaller than the foregoing ($2\frac{6}{8} \times 1\frac{3}{8}$ inch), it is of a similar shape, having been acute at both ends (probably, though one is broken), elliptically curved below and nearly straight above, thus having the outline of a sharp-ended boat (fig. 7 of the annexed woodcuts). It is not really 'emarginate' at one end, as stated at p. 220 of the Report, that appearance being due to a slight transverse crack and some inequality of the surface near the end, which was probably acute, but has been squeezed out of shape and frayed away by the longitudinal plaiting of the hard, compressed, slaty shale or mudstone. The cross-pressure has also coarsely plaited the valve throughout, and somewhat lengthened it.

From the upper part of the Lower Lingula-flags, at Caer-y-coed, near Maentwrog. Collected by Mr. D. Homfray. In the Woodwardian Museum, Cambridge.

A somewhat similar, but badly preserved, fossil from the Brethay Flags of Long Sleddale (Marr Coll. in the Cambridge Museum) is probably a *Lingulocaris* of the same, or a closely allied, species.

3. LINGULOCARIS SILIQUIFORMIS, J. and W. (Woodcuts, Figs. 8 & 9.) 'Geol. Mag.,' 1883, p. 464.

At p. 223 of the First Report (1883) we described this Cambrian Phyllocarid as differing from Salter's *L. lingulæcomes*¹ by being longer, sharper at one end, and more nearly resembling a pea-pod in shape. One specimen (fig. 8 of the annexed woodcuts), rather wrinkled by crush, from the Upper Tremadoc series at Garth Hill, Portmadoc, was presented to the British Museum by the Rev. J. F. Blake. Another (fig. 9), also in the British Museum, is marked '48654 from the Bala Schist at Bwlch-y-gaseg, near Cynwyn, Corwen; J.P., March 14, 1868.'

A fragmental specimen from the Upper Tremadoc series at Garth, Portmadoc, is in the Museum of Practical Geology, marked $\frac{2}{4}$; and referred to *L. lingulæcomes* at p. 15, 'Catal. Cambr. and Silur. Foss. M. P. G.,' 1878.

¹ Besides the two specimens, $\frac{A}{273}$ in the Woodwardian Museum (see First Report p. 223), from Garth, there is one in the British Museum, No. 48,001, from the same locality.

4. CERATIOCARIS (?), sp. Fig. 10, of the Woodcuts.

A posterior portion of a valve like that of *Ceratiocaris* was described at p. 220 of the First Report (1883). It is $\frac{2}{10} \times \frac{1}{2}$ inch in measurement; from Wern, near Portmadoc; and marked $\frac{A}{170}$ in the Woodwardian Museum, Cambridge.

The body-pieces known as Salter's *Ceratiocaris* (?) *lata*, from Garth, and *C.* (?) *insperata*, from Penmorfa (see our First Report, p. 221, and Third Report, 1885, p. 351), appear to be too large for this species from Wern.

5. HYMENOCARIS. (Woodcuts, Figs. 2-5.)

In illustration of *Hymenocaris vermicauda*, Salter, outline sketches of some of the best known specimens are given in figs. 2-5 of the accompanying woodcuts. The modified shapes of the valves, and of the body-rings variable in number, are here indicated to illustrate the descriptions in the First Report, pp. 218, 219; and to serve for comparison with their associates *Saccocaris*, *Lingulocaris*, and *Ceratiocaris* (?), above described (figs. 1, 6-10).

Explanation of the Figures (Woodcuts). Natural size.

- FIG. 1. *Saccocaris major*, Salter. Caer-y-coed, near Maentwrog; upper part of the Lower Lingula-flags.
- FIG. 2. *Hymenocaris vermicauda*, Salter. Carapace much narrowed by transverse pressure. Borth, Portmadoc; Ffestiniog group.
- FIG. 3. ——— Carapace and abdomen modified by pressure. Borth.
- FIG. 4. ——— Carapace and abdomen the former somewhat shortened and widened by pressure, but nearly of the original shape. Borth.
- FIG. 5. ——— Carapace and abdomen modified by pressure. Borth.
- FIG. 6. *Lingulocaris Salteriana*, sp. nov. Flattened carapace; damaged at the ends. Tuhwntirbwch quarry, Portmadoc.
- FIG. 7. ——— (?). Smaller individual. Carapace flattened, and somewhat narrowed and lengthened by transverse pressure. Caer-y-coed, near Maentwrog; Lower Lingula-flags.
- FIG. 8. ——— *siliquiformis*, J. & W. Garth Hill, Tremadoc; Upper Tremadoc series.
- FIG. 9. ——— Bwlch-y-gaseg, near Cynwyd, Corwen; Bala-schist.
- FIG. 10. *Ceratiocaris* (?), sp. Hinder moiety of valve. Portmadoc; Ffestiniog group.

§ IX. *Estheria*.—Some specimens of *Estheria membranacea* (Pacht), in a black limestone, including the long variety (p. 15: 'Monogr. Foss. Estheriæ,' 1863), collected lately by Mr. Jex, in Orkney, have been placed in the British Museum.

§ X. *Devonian Phyllocarids of New-York State, &c.*—The following genera and species are fully noticed and carefully figured in Prof. Dr. James Hall's last volume of the 'Palæontology of the State of New York,' just lately published. They are of Devonian age, and with few exceptions from the district mentioned. The title of this important volume is 'Geological Survey of the State of New York. Palæontology: Vol. VII. Text and plates. Containing descriptions of the Trilobites and other Crustacea of the Oriskany, Upper Helderberg, Hamilton, Portage, Chemung, and Catskill Groups. By James Hall, State Geologist and Palæontologist. Assisted by John M. Clarke.' 4to, lxiv. and 236 pages, 45 plates. Albany, N.Y., 1888. Together with a 'Supplement to Vol. V., Part 2, of the Palæontology of New-York State. Pteropoda, Cephalopoda, and Annelida,' 42 pages, and plates 114 to 129.

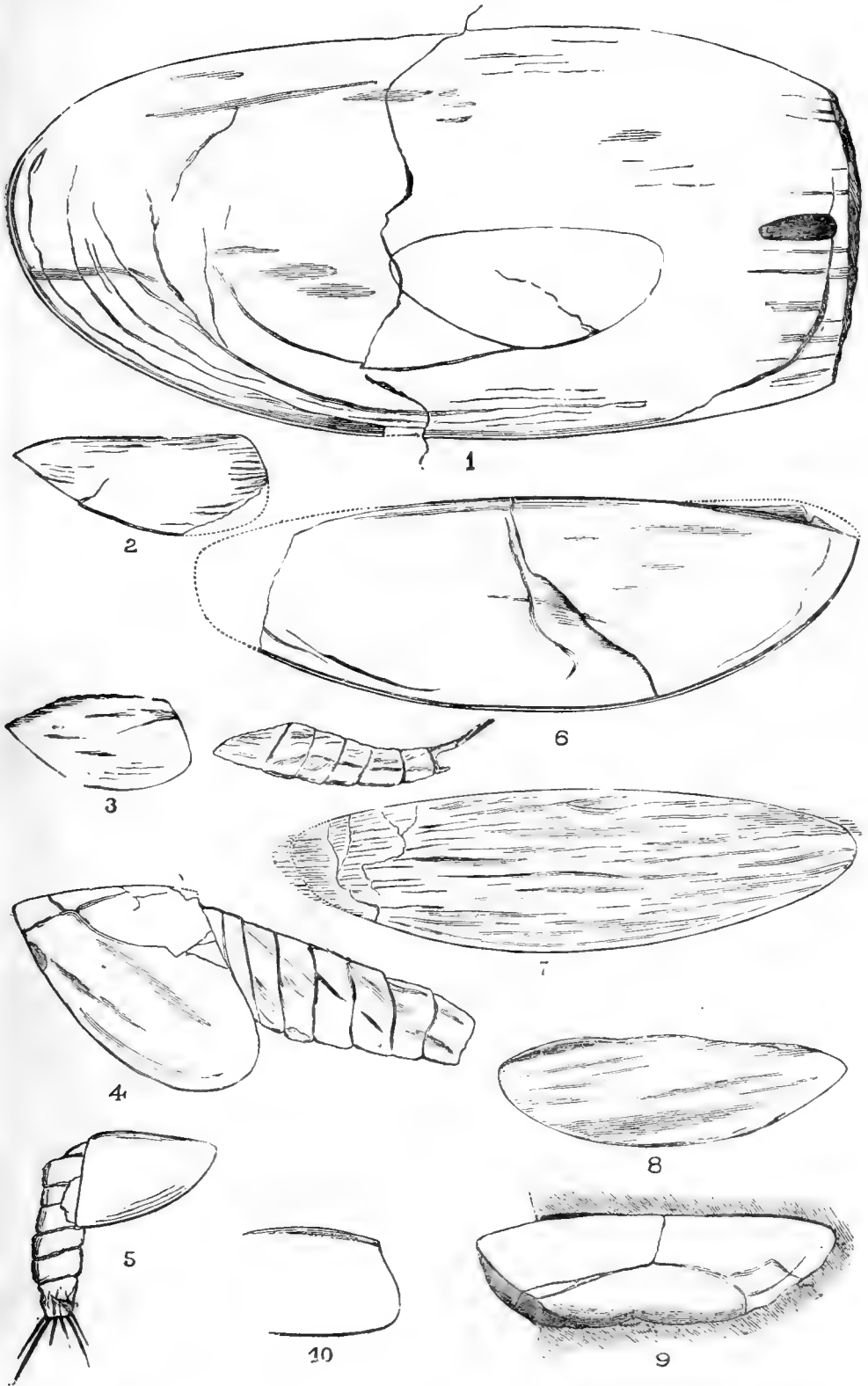

The groupings of families, genera, &c., are as follow:—

I. PHYLLOCARIDA.

A. CERATIOCARIDÆ.

I. CERATIOCARIS, McCoy, 1849. Occurring in the *Genessee* and *Portage* formations.

1. *C. longicauda*, Hall, p. 163, pl. 31, fig. 1.
2. *C. Beecheri*, Clarke, p. 164, pl. 31, fig. 3.
3. *C. (?) simplex*, Clarke, p. 165, pl. 31, fig. 2.

II. *Echinocaris*, Whitfield, 1880. Occurring in the *Hamilton*, *Portage*, and *Chemung* formations.

1. *E. punctata*, Hall, p. 166, pl. 27, fig. 10; pl. 28, figs. 1-7; pl. 29, figs. 1-8. Prof. Hall prefers to keep *punctata* rather than *armata* for the specific name (p. 170): see our Third Report, 1885, p. 360. The Mandibles of *Phyllocarida* are treated of at pp. 170, 171; pl. 30, figs. 13-19.
2. *E. Whitfieldi*, Clarke, p. 172, pl. 29, figs. 20, 21.
3. *E. condylepis*, n. sp., p. 173, pl. 29, figs. 14-17.
4. *E. socialis*, Beecher, p. 174, pl. 30, figs. 1-12.
5. *E. sublævis*, Whitfield, p. 176, pl. 29, figs. 11-13.
6. *E. pustulosa*, Whitfield, p. 178, pl. 29, figs. 9, 10.
7. *E. multinodosa*, Whitfield, p. 180, pl. 29, figs. 18, 19.

The *Equisetides Wrightiana*, referred by Woodward and Jones to *Echinocaris* (Third Report, 1885, p. 360), is provisionally placed by Prof. Hall with *Stylonurus*, by reason of the character of the spinous elevations, pp. 161, 162.

III. ELYMOCARIS, Beecher, 1884. Occurring in the *Hamilton* and *Chemung* formations.

1. *E. capsella*, n. sp., p. 181, pl. 31, fig. 4.
2. *E. siliqua*, Beecher, p. 182, pl. 31, figs. 5, 6.

IV. TROPIDOCARIS, Beecher, 1884. Occurring in the *Hamilton* and *Chemung* formations.

1. *T. bicarinata*, Beecher, p. 184, pl. 31, figs. 7-12.
2. *T. interrupta*, Beecher, p. 185, pl. 31, fig. 13.
3. *T. alternata*, Beecher, p. 186, pl. 31, figs. 14, 15.

B. PINACARIDÆ.

I. MESOTHYRA, n.g. Occurring in the *Marcellus*, *Hamilton*, and *Portage* formations.

1. *M. Oceani*, n. sp., p. 187, pl. 32, figs. 1-6; pl. 33, figs. 4-7; pl. 34, figs. 1-5. Separated from *M.* (formerly *Dithyrocaris*) *Neptuni*, Hall, on account of some differences in the caudal appendages.
2. *M. Neptuni*, Hall, p. 191, pl. 32, fig. 7; pl. 33, fig. 1.
3. *M. spumæa*, n. sp., p. 193, pl. 32, figs. 8, 9; pl. 34, fig. 2.
4. *M. (Dithyrocaris ?) Veneris*, n. sp., p. 193, pl. 33, fig. 3.

[II. DITHYROCARI, Scouler, 1843.] In the *Hamilton* formation.

1. *D. Belli*, Woodward, p. 184 (Gaspé).

C. RHINOCARIDÆ.

I. RHINOCARIS, n.g. (J. M. C.) Occurring in the *Hamilton* formation.

- Rh. columbina*, n. sp., p. 195, pl. 31, figs. 16-21.
- Rh. scaphoptera*, n. sp., p. 197, pl. 31, figs. 22, 23.

D. DISCINOCARIDÆ.

I. SPATHIOCARIS, Clarke, 1882. In the *Portage* formation.1. *Sp. Emersoni*, Clarke, p. 199, pl. 35, figs. 12-18.II. DIPTEROCARIS, Clarke, 1882. In the *Portage* and *Chemung* formations.1. *D. pennæ-Dædali*, Clarke, p. 200, pl. 35, fig. 24.2. *D. Procne*, Clarke, p. 201, pl. 35, figs. 25-27.3. *D. pes-cervæ*, Clarke, p. 202, pl. 35, figs. 20, 21.

II. PHYLLOPODA.

A. LIMNADIADÆ.

I. ESTHERIA, Rüppel, 1857. In the *Hamilton* formation.1. *E. pulex*, Clarke, p. 206, pl. 35, figs. 10, 11.II. SCHIZODISCUS, n.g. (J. M. C.), p. 203. In the *Hamilton* formation.1. *S. capsæ*, n. sp., p. 207, pl. 35, figs. 1-9.

Second Report of the Committee, consisting of Mr. S. BOURNE, Professor F. Y. EDGEWORTH (Secretary), Professor H. S. FOXWELL, Mr. ROBERT GIFFEN, Professor ALFRED MARSHALL, Mr. J. B. MARTIN, Professor J. S. NICHOLSON, Mr. R. H. INGLIS PALGRAVE, and Professor H. SIDGWICK, appointed for the purpose of investigating the best method of ascertaining and measuring Variations in the Value of the Monetary Standard. (Drawn up by Mr. GIFFEN.)

IN their reports last year the Committee discussed fully the theoretical aspects of the problem of measuring variations in the value of the monetary standard. It was abundantly clear, from this discussion, they think, that even if statistical data were more complete than they are the question is a most complicated and difficult one: how to measure variations in the value of the monetary standard would in no case be a simple matter. They desire now to report on one or two of the more definite issues involved as connected with problems of immediate practical interest, of which it may be possible for the public to attempt an approximately correct practical solution.

The main practical uses for which the measurement of variations in a monetary standard has been desired appear to be the following:—

1. The fixation of rents or other deferred payments extending over long periods of time, for which it has been desired to obtain a currency of a more stable sort than money is supposed to be. This has been a practical question of great importance from the days of Fleetwood's 'Chronicon Preciosum,' which begins, as is well known, with a remarkable case of conscience—whether a man in order to receive a bursary or scholarship, for which a declaration that his private income does not exceed, say, five pounds a year, is required, is justified, the value of money having fallen proportionately, in making the declaration upon an income not exceeding thirty pounds a year. In recent times there is at least one instance of a different standard from metal being deliberately

substituted on a large scale, viz., the tithe averages, these being made to vary with the value of grain, so that in effect the tithe is so much grain, and not so much money. The Scotch Fiars prices have existed for more than two centuries for similar purposes.

2. To enable comparisons to be made between the value of money incomes in different places, which is often an object of great practical interest, not only individuals contemplating residential changes having to consider it, but Governments and other large spending bodies, spending money in widely distant places, having to do the like. Apart from directly business issues of this sort, such questions are of obvious practical interest to economic students, and through them to the general public.

3. To enable historians and other students making comparisons between past and present to give an approximate meaning to the money expressions which they deal with, and say roughly what a given fine, or payment, or amount of national revenue or expenditure in a past age would mean in modern language. To the student of history from the economic point of view some such method of giving a meaning to money expressions is indispensable.

And it has been seen theoretically that the only way to accomplish these objects is to form 'index-numbers,' that is, to substitute for money some other measure by which the value of money or any other single commodity relative to an aggregate of commodities may be ascertained. If all commodities could be included in such an index-number, and a proper weight assigned to each, and if the same commodities existed in the same proportion in past times and at different places as exist now at a given place, the new measure would be perfect for the purposes required, *provided that there were any possibility of ascertaining the prices themselves*, and approximately, apart from this special difficulty of obtaining prices, there may be such a new measure which will be useful, though it is not ideally perfect. For the purposes above stated, it is obvious something that is very useful may be obtained without even an approach to ideal perfection. The intervals of time and the differences of place may be so great that useful distinctions may be drawn out, even although there is a wide margin of error, and although it is certain that from such causes as the introduction of new commodities and the dropping out of others, and the continual changes in the proportions in use of all the others, absolutely exact comparisons cannot be made.

But, apart from all such difficulties, which were fully discussed in last report, it may be stated broadly that hitherto both students and practical politicians have been limited even more effectually in their means of measuring variations in the monetary standard by the absolute deficiency of the data. It is practically, for instance, unnecessary for them to consider whether they are to use the retail prices which must be used if an ideal index-number based on *desiderata* is to be employed, because there is no complete record of retail prices even at the present time, and certainly there are no such records of retail prices in many different places, and going back over historical periods. Similarly there can be no question, as regards the past or present, of such an ideal standard as that suggested by Professor Nicholson, which depends on a valuation of the property in a country, for no valuation approximately accurate enough for such a purpose could be made in any country at the present time, much less could it be carried backwards for any lengthened period.

For these reasons practically the best must be made of wholesale

prices, for these are the only prices of which there are records—of which it may almost be said there can be records, retail prices being subject to many difficulties, including the degree of ‘retailing’ which may exist, to become the basis of records capable of solving the practical problems stated.

In actual fact students and politicians have been still more limited. There are prices and prices. Practically it is found that only the prices of leading commodities, capable of being dealt with in large wholesale markets, can be made use of, while the assumption must be made, so numerous and varying are qualities, that certain articles may be taken as types. For instance, in dealing with the values of wheat it is convenient to take *English* wheat, as represented by the *Gazette average*, as a type, and assume that all wheat sold in England varies in price as *English* wheat does; but the assumption may not be quite correct, while the *Gazette average* itself, if we look at the question historically, only goes back a hundred years, and previous to that the historical student must fall back on the records of the value of wheat at a particular place, such as Windsor. Even greater difficulties arise with regard to other articles, while for some purposes the prices of large masses of articles, which are obtained by such means as the division of the aggregate quantities of the imports by aggregate values, are deficient, owing to the changes in the qualities of the constituents of the group from year to year or from period to period. In dealing with the question practically, therefore, those concerned must always have an eye upon the data and consider what is practically obtainable and what use may be made thereof.

Looking at the subject in this way, then, the most important conclusion seems to be that for such practical purposes as those above mentioned the methods already followed may be and have, in fact, been approximately successful. With improvements they may be made more useful, although ideal perfection is unobtainable, and even inconceivable. What has to be considered is that the prices of leading commodities are likely to vary on the average as all commodities vary on the average; that, if such commodities are selected without bias, the result, as regards the selected articles, may be accepted as representative of the average result; that wholesale and retail prices will vary in much the same way, and that consequently the mean of a number of prices taken almost at random, if there is a sufficient number to get rid of chance errors, may be depended on to measure variations in the monetary standard in lieu of a standard composed of all articles whatsoever, each receiving its proper weight. Rough approximations only are possible, but according to the logic of statistics the defectiveness of the statistical data, though it has to be recognised, is not an insuperable barrier to the adoption of rough approximations which are valuable. Let us see what has been accomplished.

The ‘*Chronicon Preciosum*,’ dealing with the chief articles only, as to which records of price happened to remain, and using a plan of means in which each article was considered to be of equal importance, showed approximately that the value of money had changed from century to century; that, measured by the common articles of trade and consumption, a sovereign did not go so far in the time of that book as it did several centuries before—that it only commanded a sixth part of the average of leading commodities which it had commanded several centuries

previously. The whole calculation was very rough, but it conveyed a sound historical idea which was useful and fruitful in the absence of a better. It also may be held to justify the action Bishop Fleetwood suggested in the case of conscience referred to.

Adam Smith, substituting wheat alone as a standard, was able to show changes in the purchasing power of money, though, of course, it would have been better to use more articles. Still the conclusion for wheat alone, considering its great importance in those times, was good enough to prove a change in the value of money.

Sir George Evelyn's index-number, submitted to the Royal Society in 1798, led to a broad conclusion not substantially different from those of Adam Smith and Fleetwood.

In later times the researches of Professor Jevons and the index-numbers of the *Economist*, Sauerbeck, and others, have demonstrated conclusively that there has been a common movement in the prices of leading wholesale commodities, proving a variation in the value of money, relative to an aggregate of these leading commodities, which can, no doubt, be made use of by historians and economic students when they wish to give meaning to the money expressions of different periods. There is, no doubt, a great lack of quantitative exactness in the past discussions, and it may be fairly urged that more consideration should be given to the question of how to allow for the changes in the efficiency of the human unit—a question raised by Adam Smith's selection of wheat on the express ground that the labour employed in producing a quarter of wheat had remained unchanged; but to suggest that a particular method which has produced useful ideas may be improved upon and made to yield more exact results is not to show that it is useless.

The Gazette average prices of grain used for the tithe averages have also proved conclusively, on a large scale, that a currency different from money may be practically made useful in deferred payments—that the process can be put into a working Act of Parliament.

The considerations we have to suggest as now most important practically, in preparation for more exact and complete measurements in the future, are the following:—

1. In the absence of retail prices—which it would be most convenient to use in forming a standard of *desiderata*—use must necessarily be made of wholesale prices only. No other prices are obtainable, and those prices must be preferred, in the selection of typical articles, where the records are best.

It appears, however, from the best consideration of the subject, that the differences likely to be made from the true result which would be obtained from a more complete record of prices are not likely to be material. On this head the Committee would refer to a paper by Mr. Edgeworth, which has been prepared for their use, and which is appended. The prices of articles taken without bias from a group are likely to be fairly representative of the average course of prices of that group.

2. While an index-number assigning relative weight to different articles so selected is an important means of arriving at a useful result, it cannot be said, in the present state of the data on the subject, to be an altogether indispensable means. The articles as to which records of prices are obtainable being themselves only a portion of the whole, nearly as good a final result may apparently be arrived at by a selection with-

out bias, according to no better principle than accessibility of record, as by a careful attention to weighting. On this head the Committee may refer to the above paper of Mr. Edgeworth, which seems conclusive on the subject.

3. Practically the Committee would recommend the use of a weighted index-number of some kind, as, on the whole, commanding more confidence. But they feel bound to point out that the scientific evidence is in favour of the kind of index-number used by Professor Jevons—provided there is a large number of articles—as not insufficient for the purpose in hand. Nothing is more remarkable in the comparisons of the recent index-numbers than the correspondence of the curves of general course of prices indicated. A *weighted* index-number, in one aspect, is almost an unnecessary precaution to secure accuracy, though, on the whole, the Committee recommend it.

4. The Committee have had before them a suggestion for a new index-number, which might be used for some official and private purposes, based on the practical considerations referred to, and making use of the best wholesale prices, while having regard to the ultimate standard of *desiderata*. The nature and object of this index-number is explained in the accompanying memorandum, which has the general approval of the Committee, though they do not consider it necessary here to go into all the details. The object is to provide something for which it would be possible to obtain and publish official prices, and by reference to which contracts could be made, and it is submitted for discussion and future reference.

5. It would be most desirable to supplement any such index-number by a good statistical account from time to time of the aggregate income of the people and the relative numbers and aggregates of incomes of different amounts. In some index-numbers in past times the wage of a day-labourer is inserted as one of the articles. This may have been correct enough for some purposes, and in the circumstances would not prevent the index-number from indicating the general changes in the value of money in the periods compared. But the more useful method would seem to be to distinguish between the human unit in production and the thing produced. Among the most important comparisons for which such figures are used at all are the effectiveness of labour at different times and places, and the command of the labourer or other earner over the amounts produced; and these comparisons can only be made when an independent standard of the production and consumption of the labourer is set up, with which his earnings may be compared. No argument is needed to show that, along with index-numbers as to prices of commodities, there should be an endeavour to ascertain the aggregate earnings of a community and the distribution of the earnings so as to show on the one side the command over commodities which different classes possess—the real as distinguished from the nominal incomes—and on the other side the relative effectiveness of the labour of a community at different times or of one community compared with another.

The matters referred to them not being fully exhausted, the Committee would recommend their reappointment, with a view especially to considering the question of an official index-number or numbers for future use in contracts, and what are the chief points to be looked at in the necessary enactments, both for obtaining the necessary price data and for settling forms in which contracts may be expressed.

MEMORANDUM ON AN OFFICIAL INDEX-NUMBER.

TABLE FOR THE CONSTRUCTION OF AN INDEX-NUMBER.

Statement showing the estimated amount of the expenditure on the undermentioned articles in the United Kingdom and the proportion of the amount in each case to the total expenditure on all such articles, with suggestions for an index-number based approximately on the proportions stated, but with modifications so as to substitute percentages in round figures; showing also the description of the specific wholesale article, the price of which it is proposed to use in the calculation of the index-number; giving also the price-list or other source from which quotations are to be obtained.

1	2	3	4	5	6	7
Heads of articles	Articles consumed or used up	Estimated expenditure per ann. on each article	Percentage of each amount in column 3 to total	Relative importance proposed for each article in index-number reduced to percentages	Description of the specific article of which the price is to be quoted as typical	Price-list or other source for price quotations
Breadstuffs	Wheat . .	£ 000,000				
	Barley ¹ . .	60	6.5	5	English wheat . . . " barley . . . " oats . . . " potatoes . .	Gazette average
	Oats . .	30	3.25	5		" "
	Potatoes, } rice, &c. }	50	5.4	5		" "
	50	5.4	5	Average import price		
Meat and dairy food	Meat . .	100	11	10	Mean of live meat per stone of 8lbs. Smithfield Average per cwt. landed { Cheese Butter	Weekly market quotations
	Fish . . .	20	2.2	2½		Official returns (Board of Trade)
	Cheese } Butter } Milk }	60	6.5	7½		Average import price
						" " "
Mass luxuries	Sugar . .	30	3.3	2½	Refined sugar imported Tea imported . . . Beer exported . . . Spirits imported . . . Wine imported . . . Tobacco imported . .	Average import price
	Tea . . .	20	2.2	2½		" " "
	Beer . .	100	11	9		Average export price
	Spirits . .	40	4.3	2½		Average import price
	Wine . .	10	1	1		" " "
	Tobacco . .	10	1	2½		" " "
Clothing	Cotton . .	20	2.2	2½	Cotton imported . . . Wool imported . . . Raw silk imported . . . Hides imported . . .	Average import price
	Wool . .	30	3.3	2½		" " "
	Silk . .	20	2.2	2½		" " "
	Leather . .	10	1.1	2½		" " "
Metals and minerals	Coal . .	100	11	10	Coal exported . . . Scotch pig-iron . . . Copper ore imported . . . Lead ore imported . . .	Average export price
	Iron . .	50	5.4	5		Market price
	Copper . .	25	2.7	2½		Average import price
	Lead, zinc, tin, &c.	25	2.7	2½		" " "
Miscellaneous	Timber . .	30	3.3	3	Timber imported . . . Petroleum imported . . . Indigo imported . . . Flax imported . . . Palm oil imported . . . Caoutchouc imported . . .	Average import price
	Petroleum . .	5	.6	1		" " "
	Indigo . .	5	.6	1		" " "
	Flax and linseed	10	1.1	3		" " "
	Palm oil . .	5	.6	1		" " "
	Caoutchouc	5	.6	1		" " "
	Totals .	920	100	100		

In this table the first column indicates six leading genera which comprehend the twenty-seven classes of articles specified in the second

¹ There is a large consumption of barley, exclusive of its use in the manufacture of beer.

column. These articles are either finished products (things ready for consumption, like cheese and milk) or *represent* such things by entering into their production, as coal (used in manufacturing) and timber, for instance, go to the production of houses and furniture.

The third column gives in round numbers (000,000's being omitted) the average national expenditure on each class of article at present and for the last few years, and presumably also for the immediate future the *proportions* at least, if not the absolute amounts, of expenditure (such proportions, as shown in Mr. Giffen's reports on the variation in the prices of exports and imports, remaining pretty constant during a period of years). In the estimated amount of consumption allowance is made for the addition to the value made before the articles are in the form in which they are finally consumed.

In column 4 these amounts (or proportions) are reduced to percentages (of the total amount expended on such articles).

In column 5 the relative importance proposed to be assigned to each article in the index-number is stated, mainly on the basis of the percentages in column 4, but with modifications so as to substitute even figures for the convenience of handling.

In column 6 the specific articles are described, of which it is proposed to obtain the prices as typical of the group really included on the corresponding line in column 2. Wheat, for instance, consists of many different kinds and qualities; the one quality and kind it is proposed to quote as typical of the whole is English wheat as returned officially to the Comptroller of the corn returns, which itself no doubt comprises many qualities. Of iron, again, there are innumerable qualities and kinds; it is proposed to take Scotch pig-iron, in which there are large dealings, as typical of the whole. The same with other articles. In most cases large groups are dealt with because the article selected is the average imported or exported, which includes many qualities, but it should be distinctly understood that in any case the most that can be done is to select specific articles which are typical of large groups.

In column 7 the source from which the quotation of the specific articles mentioned in column 6 is to be obtained is stated.

The above is of course only a rough suggestion for an index-number. Even if the method is generally approved of, many questions might be discussed as to the amounts of the annual consumption of each group of articles specified in column 2, as to the relative importance to be assigned practically in column 5, and as to the selection of the article in column 6 which is to be treated as typical of the group. It would be possible to introduce two or more quotations instead of one for a particular group if thought desirable, but this would be troublesome in working. For practical purposes there must not be too many articles. Mr. Edgeworth's mathematical deductions as to the consequences of taking the price of an article selected at random from a group, instead of the general average course of prices for the group, appear to justify the expediency of this procedure.

Were such a general index-number introduced, and prices calculated upon it backwards and forwards, it would be easy to rearrange it for any special purpose, such as to give more or less weight to one or more groups according as they are assumed to enter into the consumption of a particular class of persons whose position at different times as affected by the course of prices is to be specially investigated. The index-number could

also be compared with other index-numbers upon some other objective basis, such as the relative importance of each article in the import and export trade of a country; and index-numbers for one country and place could be compared with those for other countries or places. The index-number now suggested is only put forward as a convenient one, illustrating the variations in prices in England according to what is called the standard of *desiderata*, and which could be made use of—not neglecting others—in many investigations.

It would also be an index-number on which, if people were so inclined, they could make contracts in a way analogous to the contracts for the commutation of tithe; in which the tithe is made to vary according to the prices of corn. To make the index-number useful for this purpose an Act would have to be passed prescribing the way in which the prices are to be obtained and published, and defining and giving a form for the contracts which might be made for payments, to vary according to the variation in the aggregate index-number. This would be a practical Tabular Standard such as Joseph Lowe, Jevons, and lately Professor Marshall, have suggested.

All such index-numbers are liable to the observation that innumerable articles are, and must be, in the nature of things, wholly excluded. The variety of small articles is almost infinite. The assumption may also be made, I think, that on balance the permanent tendency is for such articles on the average, through the progress of invention, to increase in aggregate importance in proportion to the other articles which can be got into an index-number and, at the same time, individually to fall relatively in price. In investigations general facts of this kind would, of course, have to be borne in mind as qualifying deductions based upon the precise figures which the index-numbers may give. People making contracts based on index-numbers would also require to study what the effect would be likely to be on the result they wish to arrive at.

MEMORANDUM BY THE SECRETARY, PROFESSOR F. Y. EDGEWORTH, ON THE ACCURACY OF THE PROPOSED CALCULATION OF INDEX-NUMBERS.

ANALYSIS OF CONTENTS.

	PAGE
Theoretical estimate of the discrepancy likely to exist between the results obtained by the Committee and those which they might obtain if the materials were perfect	188-198
Practical verification and summary statement of this estimate	198-201
Comparison of the Committee's Index-number with other schemes	201-219
Where the data are the same for the compared methods	201-209
The Simple Arithmetic Mean	201-204
The Weighted Arithmetic Mean	204-205
The Geometric Mean	205-206
The Median	206-209
Where the data are not the same for the compared methods	209-213
Appendix showing the extent and significance of the difference between the Committee's scheme and others	213

The usefulness of our result will be enhanced by an estimate of its accuracy. It would be desirable, if possible, to ascertain a numerical limit which the *error*¹ incurred by our calculation cannot possibly, or at

¹ The use of the term 'error' to denote a deviation from an unknown ideal is somewhat infelicitous. But the advantage which the term has in being familiar to

least with any reasonable probability, exceed. But it is doubtful whether such a limit admits of being fixed with precision. The erroneousness of the conclusion could only be ascertained by inference from the inaccuracy of the premises. But it is difficult to appreciate with mathematical precision the error to which our data are liable. We may, however, argue that, if the erroneousness of the premises is approximately of a certain amount, if the error of the data is of a certain *order*, then the error of the conclusion will be of a certain other order.

Of course, it will be understood that, in attempting to evaluate mathematically the error of our result, we mean its deviation from the real numerical value of that quantity which we have here taken as our *quæsitum*: namely, the total national expenditure on material products at any given time comparative with an initial epoch (abstraction being made of any change in the total quantity of products which may have occurred between the epochs).¹ The philosophical error which may be committed by taking this sort of index-number as our ideal is the subject of another sort of analysis.

The subject of our investigation being thus defined, we may show that the erroneousness of the result is *less* than that of the data. There are two lines of proof converging to the truth of this theory. *First*, we may reason *à priori* by the Calculus of Probabilities that the index-number is subject to a smaller percentage of error than the weights and price-variations (given or referred to in columns 5 and 6 of the table). *Secondly*, this deduction may be verified by actual trial. We may assign a certain set of weights and price-variations as correct, and construct several sets of variants diverging from the 'correct' figures in haphazard fashion. Then, operating with each set of variant data, we may calculate several variant index-numbers. These, it will be found, diverge less—that is by a smaller percentage—from the correct index-number than any set of variant data from the corresponding correct datum.

The second part of the evidence cannot be fully appreciated without the prior reasoning. By itself it conveys only a moiety of the truth. Those who are content with that fraction of knowledge are advised to skip the small type and close reasoning of the immediately following paragraphs and to pass on to the more easily read lessons of experience.

The index-number which is the result of our calculation is subject to a less error than the data which enter into it, for two reasons. *First*: The numerator and denominator of the fraction which constitutes the index-number form each an aggregate of elements or parts, whereof each element is subject to a presumably independent error. Now, by a well-known principle of the Calculus of Probabilities, the percentage error of such an aggregate is less than the percentage error incident to each element (or at least to an element of average erroneousess). This principle applies to the errors both of the *weights* and the *observations* (price-variations). The next consideration applies only to the former class of data. An error in any *weight* affects both the numerator and denominator in the same direction, whether of excess or defect, and thus is to a certain extent self-corrected.

This reasoning may be exhibited more fully by the aid of symbols. Let us put the series $p_1, p_2, \&c. \dots p_n$ for the *real* price-variations. These price-variations

the student of Probabilities may, it is hoped, preponderate over the disadvantage that it suggests to the general reader a more gross, blameworthy, and avoidable mistake than is contemplated here.

¹ For a more exact definition of the *quæsitum*, see in the First Report of the Committee the formula for the 'Principal Standard.'

may be conceived as percentages obtained after the manner of Mr. Palgrave (see Table 26 of Memorandum in Appendix to 'Third Report of the Commission on Depression of Trade') by multiplying the ratio $\frac{\text{New price}}{\text{Old price}}$ by 100. Let us denote

the *apparent* price-variations, the erroneous observations, as $p_1(1+e_1)$, $p_2(1+e_2)$. . . $p_n(1+e_n)$, where e_1, e_2 . . . e_n are each positive or negative errors, usually proper fractions. Similarly let w_1, w_2 , &c., be the *real* weights; and $w_1(1+\epsilon_1)$, $w_2(1+\epsilon_2)$ &c., be the *apparent*, or erroneous, weights.

The index-number obtained from such data is

$$\frac{w_1(1+\epsilon_1) \times p_1(1+e_1) + w_2(1+\epsilon_2) \times p_2(1+e_2) + \&c.}{w_1(1+\epsilon_1) + w_2(1+\epsilon_2) + \&c.}$$

Alike in the numerator and denominator of this expression we may segregate the *correct* and the *erroneous* portion; and reason by the first of the principles above mentioned that the incorrect portion is of a smaller order than the sum of the correct terms (the number of observations being sufficiently great). Accordingly it will be allowable to expand by Taylor's Theorem and neglect higher terms. We shall thus obtain a simple expression for the error of the resultant index-number in terms of the errors to which each class of the data is liable.

This investigation may be broken up into three steps: we may consider successively three cases in an order of increasing complexity. First (1) we shall suppose that the weights only are liable to error. Then (2) we shall introduce the circumstance that the observations, the price-variations, are themselves incorrect. Lastly (3) we shall take account of the fact that certain categories of articles may be altogether unrepresented.

(1) Under the first head we shall first consider the simple case when the weights are really equal, though apparently somewhat unequal. In this preliminary case the symbolic expression above written becomes simplified by the disappearance both of the e 's and the w 's. Expanding and segregating the heterogeneous elements in the manner indicated, we may write our result thus:—

$$\frac{p_1 + p_2 + \&c.}{n} \left\{ 1 + \frac{p_1\epsilon_1 + p_2\epsilon_2 + \&c.}{p_1 + p_2 + \&c.} - \frac{\epsilon_1 + \epsilon_2 + \&c.}{n} \right\},$$

where the term outside the brackets is the *correct* index-number, and the difference of the second and third terms within the bracket is the error of the index-number: the relative error, as it may be called, or (if multiplied by 100) the percentage error, in symbols $\frac{\Delta I}{I}$, if I is the correct index-number. The result obtained may

be written

$$\frac{\Delta I}{I} = \frac{Sp}{n} \left\{ 1 + \epsilon_1 \left(\frac{p_1}{Sp} - \frac{1}{n} \right) + \epsilon_2 \left(\frac{p_2}{Sp} - \frac{1}{n} \right) + \&c. \right\}.$$

In this expression call the factors of ϵ_1, ϵ_2 , &c., respectively $\frac{1}{n}E_1, \frac{1}{n}E_2$, &c.

Then $\frac{\Delta I}{I}$, the error whose magnitude we have to estimate, is $\frac{1}{n}(E_1\epsilon_1 + E_2\epsilon_2 + \&c.)$.

To determine the probable and improbable limits of this quantity we require to know the magnitude, or at least the average extent, both of the E 's and the ϵ 's. The former datum depends upon the dispersion of the observations (the price-variations) about their mean. For any E , *e.g.*,

$$E_r = n \left(\frac{p_r}{Sp} - \frac{1}{n} \right) = n \frac{\left(\frac{Sp}{n} - p_r \right)}{Sp} = \frac{\left(\frac{Sp}{n} - p_r \right)}{\frac{Sp}{n}}$$

= the deviation or *error* incurred by the individual price-variation as compared with

the average of a whole set; *relative* to (divided by) the average. Such a deviation might be symbolised as $\frac{\Delta p}{p}$, if we put p for the average price-variation.

We may now proceed in two ways: (a) we may either suppose the deviations E_1, E_2 , ascertained for the particular year or epoch to which the calculation in hand may refer; (b) or we may seek a measure for general use, and available without the trouble of examining the dispersion of the price-variations for a particular year. In either case we are to regard the ϵ 's as errors grouped in random fashion about a mean, which is zero. The coefficient which measures the dispersion of these errors, the *modulus* for the ϵ -fluctuation, must be supposed knowable. Call it κ .

(a) On the former understanding, we are to regard E_1, E_2 , &c., as known factors. Accordingly by a well-known theorem we have for the *modulus*, which measures the extent of the error,

$$\frac{1}{n} (E_1 \epsilon_1 + E_2 \epsilon_2 + \&c.),$$

$$\frac{1}{n} \sqrt{E_1^2 + E_2^2 + \&c.} \times \kappa,$$

or

$$\frac{1}{\sqrt{n}} \sqrt{\frac{E_1^2 + E_2^2 + \&c.}{n}} \times \kappa.$$

(b) Otherwise we are to regard E_1, E_2 , as samples, so to speak, taken from an indefinite number—a complete series (in Dr. Venn's phrase) of E 's. We must suppose the coefficient of fluctuation, or modulus, for this series to be given by prior experience. Let it be C . Then we may put as the most probable value for the measure or *modulus* of $\frac{\Delta I}{I}$, the error under consideration,

$$\frac{1}{\sqrt{n}} \times \frac{C}{\sqrt{2}} \times \kappa.$$

But this *most probable* measure cannot safely be used as the *best* measure. We must take into account that the real measure *may* be larger, and accordingly that, by adopting the measure described as 'most probable,' we may be underrating the probability of each extent of deviation (from zero) to which the quantity $\frac{1}{n} [E_1 \epsilon_1 + E_2 \epsilon_2, \&c.]$ is liable. However, the error thus introduced is only of the

order $\frac{1}{\sqrt{n}}$, that is, the $\frac{1}{\sqrt{n}}$ -th part of the magnitude to be evaluated. Now that degree of error has been already incurred by the neglect of the higher terms in the expansion of $\frac{\Delta I}{I}$. Accordingly it would be nugatory to apply correctives to the error now under consideration.

We have now to introduce the circumstance that the weights, both real and apparent, differ from unity. It is easy to see that in the new expression for $\frac{\Delta I}{I}$ the coefficient of any weight-error ϵ_r is $\frac{w_r p_r}{Sw} - \frac{w_r}{Sw}$; which may be put in the form $\frac{w_r}{Sw} E'_r$, where E'_r is now the proportional deviation of p_r from the *weighted* mean of the p ; viz., $\frac{Sw p}{Sw}$. Accordingly the modulus of $\frac{\Delta I}{I}$ becomes

$$\frac{\sqrt{w_1^2 E'^2 + w_2^2 E'^2 + \&c.}}{Sw} \kappa.$$

In evaluating the coefficient of κ there are, as before, two courses. Either (a) we operate upon the known values of E'_1, E'_2 , &c., for the particular year or epoch with which we are concerned; or (b) we may make a general estimate based upon

several years' experience, and roughly applicable to the unexamined data of any year.

(a) In the former case there is nothing more to be said, except that it will be legitimate in the evaluation of the modulus to put for $w_1, w_2, \&c.$, their *apparent* values; which may be written $w_1 + \Delta w_1, w_2 + \Delta w_2, \&c.$ For the error thus introduced into the modulus is of a neglectible order.

(β) The general expression in terms of the E-fluctuation is found by considering that the most probable value of the quantity under the radical sign in the last written expression is $\sqrt{(w_1^2 + w_2^2 + \&c.) \frac{C^2}{2}}$, where $\frac{C^2}{2}$ is the mean square of error measured, not, as before, from the simple (arithmetical) mean (of many batches of p 's), but from the weighted mean $\frac{Swp}{Sw}$; a difference which may easily be shown to be for our purpose of an order which may be neglected.

This may be proved thus:

The deviation of any p from the Weighted Mean—the relative or proportionate deviation— E'

$$E'_r = \frac{\frac{Spw}{sw} - p_r}{\frac{Spw}{sw}}$$

This ratio may be thus expressed in terms of E_r , the deviation of p_r from the *Simple Arithmetic* Mean. Put v for the difference between the weighted and simple means. Then we have

$$E'_r = \frac{\left(\frac{Sp}{n} - p_r\right) - v}{\frac{Sp}{n} - v} = \frac{E_r - \frac{v}{p}}{1 - \frac{v}{p}}$$

if we put p for the Arithmetic Mean of the p 's.

Now
$$v = \frac{Sp}{n} - \frac{Spw}{Sw} = \frac{p_1 + p_2 + \&c.}{n} - \frac{p_1 w_1 + p_2 w_2 + \&c.}{w_1 + w_2 + \&c.}$$

Substitute for p_1 its value $p(1 + E_1)$ (where p is the Arithmetic Mean of the p 's); and we have

$$v = p \left[\frac{E_1 + E_2 + \&c.}{n} - \frac{w_1 E_1 + w_2 E_2 + \&c.}{w_1 + w_2 + \&c.} \right]$$

$$= \frac{1}{n} p E_1 \frac{\frac{Sw}{n} - w_1}{\frac{Sw}{n}} + \frac{1}{n} p E_2 \frac{\frac{Sw}{n} - w_2}{\frac{Sw}{n}} + \&c.$$

Put for the relative deviation of any w from the Arithmetic Mean of all the w 's (the coefficient of $\frac{1}{n} p E_r$ in the last written expression) η_r . Then we have

$$v = \frac{1}{n} p [E_1 \eta_1 + E_2 \eta_2 + \&c.].$$

The expression in brackets hovers about the value zero according to a law of error whose modulus is $\frac{\sqrt{n} C \chi}{\sqrt{2}}$; where C , as before, is the modulus of the E 's, and $\frac{\chi^2}{2}$ is

the mean square of the η 's. Hence $\frac{v}{p}$ is of an order \sqrt{n} times smaller than $C \chi$.

But from the equation connecting E' and E it appears that the sum of squares $E'^2_1 + E'^2_2 + \&c.$ which occurs in the complete expression for the modulus of $\frac{\Delta I}{I}$ may be written

$$\frac{SE_r^2 + n\left(\frac{v}{p}\right)^2}{\left(1 - \frac{v}{p}\right)}$$

whence, as $SE_r^2 = n \frac{C^2}{2}$, it appears that the influence of $\frac{v}{p}$ may be neglected, n being supposed large.

We may therefore write

$$\text{Modulus of } \frac{\Delta I}{I} = \frac{\sqrt{Sw_r^2}}{Sw} \frac{C}{\sqrt{2}} \kappa;$$

or, employing the notation which we had lately occasion to introduce:

$$\text{Modulus of } \frac{\Delta I}{I} = \frac{1}{\sqrt{n}} \times \sqrt{1 + \frac{\chi^2}{2}} \times \frac{C}{\sqrt{2}} \times \kappa.$$

This formula may be employed to utilise present as well as past experience. If we treat $\frac{\chi^2}{2}$ and $\frac{C^2}{2}$ as respectively the mean square of deviation obtained from the set of weights and price-returns entering into the index-number which we are computing, we shall thus have an approximate formula more convenient than the complete expression for the Modulus.

(2) We have now to introduce the circumstance that each p is liable to an error pe . Each element of error of the form Πe_r is now aggravated by an element of the form Pe_r . Accordingly the modulus of the total error will be $\sqrt{\Pi^2 + P^2 c^2}$, where κ and c are the moduli for the independent partial errors respectively, Π is the coefficient of κ in the expression for the modulus of $\frac{\Delta I}{I}$ in case (2) and P^2 is easily seen to be equal to $\frac{Sw_r^2 p_r^2}{(Sw p)^2}$.

There may now be required, as before, a general formula applicable without any examination of the prices and weights on a particular occasion; or without other data than the coefficients expressing the dispersion of the prices and weights respectively. With this view, employing the notation already explained, and rejecting terms which may be shown to be of an inferior order, we may put for

$$\frac{Sw_r^2 p_r^2}{(Sw p)^2} \text{ the expression } \left(1 + \frac{\chi^2}{2}\right) \left(1 + \frac{C^2}{2}\right).$$

Hence for the modulus of $\frac{\Delta I}{I}$ in the general case we have

$$\frac{1}{\sqrt{n}} \times \sqrt{1 + \frac{\chi^2}{2}} \times \sqrt{\frac{C^2}{2} \kappa^2 + \left(1 + \frac{C^2}{2}\right) c^2}.$$

(3) So far we have been estimating the errors due to the weights and prices of the articles which enter into our index-number not being accurate. We have now to take into account that not only are all those articles misrepresented, but also that certain other articles may be wholly unrepresented. For it is unlikely that all the classes of products which ought by rights to enter into an index-number can, even constructively, put in an appearance.

We have now to superinduce the error due to such omission upon the errors already estimated. To effect this we proceed in the same way as when compounding the errors proper to our first and second headings. That is, we shall separately evaluate for the third species of error its modulus squared, or *fluctuation*, as the present writer has proposed to term this important coefficient. Then we shall add the third fluctuation to the sum of the two preceding: that is, to the square of the formula given at the end of the second heading.

To find the fluctuation proper to the third heading, let us begin with the simple case in which the weights are all equal. As before, let Sp represent the sum of the 1888.

observed (comparative) prices; let n be their number; and for $\frac{Sp}{n}$ put simple p . Let $S'p$ be the sum, and n' the number, of the *unobserved* prices. Then the error incurred by putting p for the Mean of all the prices, the relative error $\frac{\Delta I}{I}$, is

$$\left\{ \frac{Sp + S'p}{n + n'} - \frac{Sp}{n} \right\} \div \frac{Sp + S'p}{n + n'}.$$

The most probable value of this expression is zero; while its *fluctuation* is found to be, in terms and by methods already explained,

$$\frac{1}{n} \times \frac{2nn'}{(n + n')^2} \times C^2.$$

Now superadd the circumstance that the weights are various, dispersed about their mean according to the modulus χ . The effect of this attribute is to multiply the fluctuation last written by $1 + \frac{\chi^2}{2}$. The resulting expression is to be added to the square of the formula given at the end of heading (2). The effect of this addition is to insert a new term under the last radical in the formula for the Modulus. This new term is

$$\frac{2nn'}{(n + n')^2} C^2.$$

This formula will require modification, if there is reason to believe that the omitted articles have not the same average weight as those which are included; for instance, if, as is likely, the omissions are many in number, but inconsiderable in weight.

It will be noticed that in passing from (the dispersion of) the observed prices and weights to what has not been observed there is an inductive hazard greater than is involved by solutions of cases (1) and (2) in their more exact form, and while we suppose (as in the examples which will be adduced below) that the errors of weight and price emanate from regular and stable sources, so as to admit of safe prediction.

As in case (2), we may suppose the coefficients χ and C based either on prior experience or on the data appertaining to the particular calculation which is in hand.

It will be observed that these coefficients do not contribute equally to the resultant error represented by our formula. C , expressing the dispersion of the prices, is more efficacious than χ , appertaining to the weights. Similarly c , the measure of the error incident to the prices, affects the error of the index-number more than κ , the corresponding modulus of the weights.

It is proposed now to illustrate the formulæ which have been given by working a few examples. In these examples the statistical materials, the prices and weights, are taken out of Mr. Palgrave's *Memorandum*, from tables 26 and 27 respectively. The unstatistical arbitrary assumptions which will be made are that any price, and likewise any weight, is as likely as not to be out, in excess or defect, of the true figure by 10 per cent., but very unlikely to be out by 40 per cent., or, more exactly, that the apparent values fluctuate about the real one in conformity with a modulus which is 21 per cent.

Of the immense variety of cases which might be constructed by combining in different ways the attributes which define the preceding paragraphs, it will be sufficient here to discuss the most important case (2) of both weights and prices subject to error—divided into two species, according as (a) we utilise all the data special to the calculation in hand, or (b) content ourselves with the most summary estimate.

Let us apply these tests to Mr. Palgrave's computation of a weighted mean for the year 1885 (*Memorandum* in Appendix to *Third Report on the Depression of Trade*). First, according to method (a), the expression for the (proportionate) error due to a particular element of the index-number, the weight and price of a particular commodity, is

$$\epsilon_r \frac{w_r}{Sw_p} \left[p_r - \frac{Sw_p}{sw} \right] + e_r \frac{w_r}{sw} p$$

Whence, as the Modulus of the error to which the computed index-number is liable, we have—putting p' for the *weighted mean* of the price-returns, and remembering that c and κ are the Moduli of the errors e and ϵ respectively—

$$\frac{1}{Sw_p} \sqrt{Sw_r^2 (p' - p_r)^2 \kappa^2 + Sw_r^2 p_r^2 c^2}$$

The w 's are given in Mr. Palgrave's column headed 'Relative Importance,' (table 27, year 1885). The p 's are to be extracted from his table 26. The weighted mean p' is, according to him, 76. And Sw_p is the sum of his column (for the year 1885), headed 'Comparative,' &c., multiplied by 100; that is 166,900. The rest of the expression above written is evaluated in the following table; of which the materials are taken from the sources named. The third column is formed by subtracting from each of the entries for 1885 in Mr. Palgrave's table 26—e.g., 38 the price of cotton (comparative with 1865-9)—the weighted mean 76. The last three columns in Mr. Palgrave's table 26, relating to *Cotton Wool*, *Cotton Yarn*, and *Cotton Cloth*, are omitted, as they do not figure in this table 27, and, it may be added, cannot be supposed *independent* of the price of cotton. The last column in our table is formed by squaring each entry in Mr. Palgrave's column headed 'Comparative,' &c. (table 27, year 1885), and omitting the last digit:—

No. of Article	Name of Article	w	w^2	$(p_r - p')$	$(p' - p_r)^2$	$w^2(p' - p_r)^2$	$w_r^2 p_r^2$
			00's omitted			00,000's omitted	00,000's omitted
1	Cotton	263	691	-38	1,444	998	1,000
2	Silk	12	1	-23	529	0	4
3	Flax, &c. . . .	49	24	-15	225	0	90
4	Wool	142	202	-7	49	10	980
5	Meat	524	2,745	+26	676	1,855	28,622
6	Iron	150	225	+6	36	8	1,510
7	Copper	39	15	-27	729	11	53
8	Lead	13	2	-19	341	1	5
9	Tin.	15	23	+2	4	0	14
10	Timber	164	269	+31	961	258	3,099
11	Tallow	28	8	+8	64	0	58
12	Leather	80	64	+34	1,156	73	774
13	Indigo	5	0	+35	1,225	0	4
14	Oils	49	24	-7	49	1	116
15	Coffee	8	1	-14	196	0	3
16	Sugar	149	223	-23	576	128	624
17	Tea	71	50	-7	49	2	240
18	Tobacco	29	8	+27	729	6	90
19	Wheat	410	1,681	-16	256	430	5,856
Sums		2,200	6,256			3,781	43,142

According to the hypotheses above made let us put c and κ each = .21. Then for the sought Modulus we have

$$.21 \frac{\sqrt{378,100,000 + 4,314,200,000}}{166,900} = .21 \times .41 \text{ (nearly).}$$

Thus the error incident to each of the data has been reduced by a half in the result. It may be observed that the prices contribute much more largely than the weights to the total error. If we reduce the error incident to each price-return by a half, making its modulus .1, instead of .21, the total error of the result will be reduced by nearly a half—from modulus .086 to modulus .046. If we suppose the price-return to be quite correct, then the error of the result due to the weights alone would be nearly half as small again, namely, of modulus .025. This is agreeable to what was said above, that an error of the prices affecting only the numerator of the index-number is not, as in the case of the weights, compensated by an error affecting the denominator in the same sense.

Let us see now (β) how we should have fared if we had based our estimate on the grouping of the weights and prices in prior experience.

The dispersion of the price-returns, the coefficient C in the general formula, is thus to be found—in the case of the year 1884 for example. The arithmetic mean of the first nineteen entries in table 26 for 1884 is 81 nearly. The ‘differences’ and squares of differences are computed in the accompanying table. The mean square of difference 353 divided by the square of the mean 6561 forms an approximate, a *prima facie* value for $\frac{C^2}{2}$, namely, .04.

Name of Article	Differences		Squares of Differences
	—	+	
Coffee	11		121
Sugar	4		16
Tea		0	—
Tobacco		9	81
Wheat	8		64
Meat		22	484
Cotton	44		1,936
Silk	15		225
Flax, &c.	22		484
Wool	8		64
Indigo		26	676
Oils		0	—
Timber		24	576
Tallow		28	784
Leather		25	625
Copper	11		121
Iron	5		25
Lead	20		400
Tin		9	81
Sums	148	143	6,765

$$\text{Mean square of difference} = \frac{6765}{19} = 353.$$

For the year 1880, taken similarly as a random specimen, the mean (of the nineteen prices) is found to be 93.5, and the mean square of differences 434. Accordingly the value for $\frac{C^2}{2}$ is .05. Proceeding similarly for 1873, another year taken at random, we find for $\frac{C^2}{2}$ again .05. As the mean of the three values we may put .05.

To find the dispersion of the w 's we proceed similarly. The arithmetical mean is for every year $2200 \div 19$, or 116 nearly. The 'differences' are to be formed by subtracting this figure from each of the entries in Mr. Palgrave's column headed *Relative Importance*. The sum of the squares of the differences is to be divided by 19 for the absolute mean square of difference as it may be called. This result, divided by 116^2 , gives the mean square of error relatively to the mean weight. The values thus extricated for the years 1873, 1880, and 1884 respectively are, in round numbers, 354,000, 35,100, 357,000: each divided by 255,664 ($= 19 \times 116^2$); whereof the mean value is 1.38.

Substituting in the general or summary formula for the modulus of $\frac{\Delta I}{I}$ the values for C^2 and χ^2 just ascertained, and for C and κ the assumed value .21, we have

$$\frac{1}{\sqrt{19}} \times \sqrt{2.38} \times \sqrt{.05 \times .044 + 1.05 \times .044} = \frac{1}{4.36} \times 1.54 \times .22 \text{ (nearly)} = .077 ;$$

whereas the answer found by the more exact method was .086. This concision seems greater than might have been expected, considering the small number of the elements entering into the computation—only nineteen—and the scantiness of the induction by which we determined the coefficients C and χ .

If we employ the summary formula as a short method of utilising the data special to the index-number of 1885, we shall find that $\frac{C^2}{2}$ as based upon the fluctuation of prices for this year is .08; and $\frac{\chi^2}{2}$ the mean square of deviation for the w 's is still 1.38. Hence, as the approximate expression for the modulus, we have

$$\frac{1}{4.36} \times 1.54 \times .21 \sqrt{1.16} = .08.$$

Thus we reach much the same result by the shorter as by the more tedious route.

We shall presently—in the portion of this paper addressed to the general reader—try an experiment calculated to verify our deductive reasoning—so far as a theorem in the Calculus of Probabilities can be verified by a single experiment. We shall affect each of the elements in Mr. Palgrave's index-number for 1885, each weight and price, with a figure taken at random from a series of figures hovering about unity in conformity with a modulus equal to .21. Such a series the writer happens to have ready to hand: consisting of sums of twenty digits taken at random from mathematical tables, where the mean value is 90 and the absolute modulus 19. The relative modulus, therefore, the modulus for the series when we divide each aggregate by 90, is .21. Accordingly it will be sufficient to multiply each weight both in the numerator and the denominator with one of the sums (of twenty digits) taken at random, and similarly affect each price entering into the numerator, while the denominator is multiplied by 90.

To resume now, in popular language, this somewhat technical inquiry. The subject under investigation is the error to which our computation of index-numbers is liable—the error relative to, or per cent. of, the true value which we seek. We want to know, for instance, whether it is as likely as not that our calculation exceeds (or falls short of) the correct result by 10 per cent. of that result; whether it is very improbable that the excess (or defect) should be as great as 25 per cent.

The error thus conceived is found to depend in a definite manner upon six distinct circumstances. The erroneousness of the result is greater, the greater the inaccuracy of the data, viz., the weights, and the (comparative) prices. The erroneousness of the result is also greater, the greater the inequality of the weights, and the greater the inequality of the price-returns. Lastly, the result is more accurate, the greater the number of the data, and the smaller the number of omitted articles.

These circumstances are not all equally operative. Other things being the same, the inaccuracy of the price-returns affects the result more than

inaccuracy of the weights; and the inequality of the price-returns more than the inequality of the weights.

The only proof of the theory which can be offered to the unmathematical reader is to verify it by actual trial. We may assume a certain set of data as perfectly correct: then affect each of them with an error such that the modified datum is, say, as likely as not to be in excess or defect by 10 per cent.; is very unlikely to be out by 30 or 40 per cent.; and cannot, humanly speaking, be out by more than 50 per cent. A simple method of affecting a given set of figures with an error of this degree is to multiply each of them with a figure formed by adding together twenty digits taken at random from mathematical tables or statistical returns; dividing each product by 90 (the mean about which aggregates of twenty random digits hover). The data thus artificially affected with error are now to be used in the computation of an index-number, an erroneous number, which is to be compared with the result assumed to be true as having been deduced from the unfalsified data. A great number of such trials having been made, it will appear that the erroneous index-numbers deviate from the true one with the frequency and to the extent predicted by theory.

A specimen of this verificatory process is subjoined here. The data employed by Mr. Palgrave in his computation of an index-number for 1885¹ are assumed to be correct; then each datum is displaced or falsi-

Articles	Real weights	Sums of twenty digits	Apparent weights	Real prices	Sums of twenty digits	Apparent prices × 90	Apparent weights × apparent prices, 0,000's omitted
Cotton	263	81	18903	38	82	3316	6268
Silk	12	69	828	53	99	5247	434
Flax, &c.	49	97	4753	61	97	5917	2812
Wool	142	80	11360	69	81	5589	6349
Meat	524	68	35632	102	74	7548	26913
Iron	150	81	12150	82	88	7216	8767
Copper	39	87	3393	59	87	5133	1739
Lead	13	6	858	57	85	4845	415
Tin	15	85	1275	78	104	8112	1034
Timber	164	71	11644	107	110	11770	13705
Tallow	28	87	2436	84	94	7896	1924
Leather, &c.	80	110	8800	110	84	9240	8131
Indigo	5	74	370	111	110	12210	4518
Oils	49	89	4361	69	69	4761	20805
Coffee	8	85	680	62	62	3844	2613
Sugar	149	80	11920	53	109	5777	6886
Tea	71	96	6816	69	79	5451	3438
Tobacco	29	93	2697	103	89	9167	2478
Wheat	410	81	33210	60	111	6660	22118
Sums	—	—	172486	1427	1714	129697	141348
	—	—	—	75·1	—	75·7	81

¹ See above, p. 195.

fied in the manner above described, and a new (erroneous) index-number is deduced.

In this table the first column contains the names of articles in the order adopted by Mr. Palgrave in his table 27. The second column contains the 'weights' assigned by him under the heading of 'Relative Importance.' The third column consists of multipliers formed by adding twenty digits at random, and thus calculated to deflect the weights from their respective true values to the extent of, say, 12 per cent. on an average. The fourth column gives the new system of weights thus affected with error. The fifth column contains (comparative) prices taken from Mr. Palgrave's table 26. The sixth column furnishes a new set of multipliers assigned by chance. The seventh column gives the prices affected by error, and multiplied by 90 (the average value of the chance-multipliers). The eighth column gives the product of the erroneous weights and the erroneous prices ($\times 90$). The sum of this last column, 1,413,480,000, divided by ninety times the sum of the erroneous weights, which sum is 172,486, gives the erroneous index-number 81; whereas the true index-number, on the assumption here made that Mr. Palgrave's data are absolutely correct, is, as computed by him, 76.¹

Thus the falsified result is too great by $\frac{5}{76}$, or about 6 or 7 per cent. That is a result quite consonant with the theory which assigns such a *measure* of the error to be expected² that the result is as likely as not to be out by 4 per cent., and that the odds are only five to one against the error being so large as 8 or 9 per cent. It would have been nothing miraculous if the result had been out by *sixteen* per cent.; nothing more extraordinary than, for instance, the fortuitous sequence which may be observed in our third column of *eight* random aggregates falling below the average about which they should oscillate, namely 90.³

The same table furnishes another verification, if, making abstraction of Mr. Palgrave's weights, we assume the index-number calculated on the principle of the economist to be correct, and regard the figures in our sixth column as erroneous weights (the true weights being all equal). Upon this understanding we have the true result, the Simple Arithmetic Mean of the comparative prices, 75.1; whereas the erroneously Weighted Mean is 75.7, that is, it is in excess by about .8 per cent. Now the measure of error here predicted by theory⁴ is such that an error of .7 per cent. is as likely as not to occur. The occurrence of .8 per cent. is therefore eminently consonant with the theory.⁵

¹ *Third Report on Depression of Trade*, Appendix B. Memorandum by R. I. Palgrave. Tables 26 and 27.

² Taking 8.5 as the *Modulus* of the resultant error. See above, p. 197.

³ The probability of an error exceeding 1.9 times its modulus is .0072. The probability of the sequence referred to is .0078 ($= \frac{1}{27}$).

⁴ By case (1) above, p. 11, the modulus is $\frac{1}{\sqrt{n}} \times \sqrt{\frac{SE_r^2}{n}} \times \kappa$. Here n is 19; $\frac{SE_r^2}{n}$

is found to be .08, and κ is .21. Whence the modulus is about .014, or 1.5 per cent.

⁵ Perhaps it may be asked here whether the example given is suited to exemplify our estimate of the *third* species of error (see above, p. 193): that due to the total omission of certain articles. The answer is that this estimate, involving a larger element of induction, does not profess to be so amenable to verification as those which are derived from known and steady 'sources of error,' like our aggregates of

It might be desirable to apply this sort of test on a large scale to the computation recommended by the Committee, and to prove by specific experience the conclusions which are deducible from the Theory of Probabilities concerning the accuracy of any index-number.

These conclusions cannot be stated in their most exact form until the price-returns, as well as the weights which enter into the computation to be tested, are assigned. But even at the present stage of our procedure, and without reference to the price-returns of a particular year, we may approximately estimate the accuracy of index-numbers of the kind proposed by the Committee. For the purpose of a rough estimate it is enough to know the weights (which are assigned in the Second Report of the Committee) and to utilise past experience concerning the course of prices in this country. A certain datum,¹ which had better be determined precisely from the price-returns from the particular year to which the index-number relates, may be approximately obtained by induction from the experience of past years.

Eliciting the required datum from the prices recorded by the *Economist*,² we may provisionally assert the following propositions concerning the accuracy of index-numbers such as the Committee has proposed. These, it will be recollected, involve twenty-seven English price-returns and twenty-seven assigned weights.³

(1) In such an index-number, if the weights alone are supposed subject to error, then the average error of the result, its erroneousness as one may say, is *twenty* times less than the error to which each weight is liable.

(2) If the price-returns alone are liable to error, the erroneousness of the result is about *four-and-a-half* times less than that of each datum.

(3) In the general case, when both prices and weights are liable to error, then, if that error be the same for both species of data, the error of the result is still about *four-and-a-half* times less than that same. If the error of the weights become twice as great as that which is incident to the prices, other things being the same, the error of the result is not materially increased. The error of the weights would need to be *five* times as great as that of the prices in order to increase the error of the result by 50 per cent. (making it only *three* times less than the error incident to the prices alone).

The practical conclusion from these propositions appears to be: Take more care about the prices than the weights.

More detailed statements cannot be made without some assumption as to the degree of inaccuracy to which our data are liable, the extent to which our estimates of weights and prices deviate from the figures which would be assigned if our knowledge and theory were perfect. In entertaining any suppositions as to the extent of this discrepancy, it is proper to conceive that the larger deviations, the more extensive errors, are less frequent in the long run, or more improbable. Thus, if we suppose that a deviation of each datum, weight or price, to the extent of 10 per cent.

digits. Moreover, such verification as the theory admits would require a larger number of items than the table in the text contains. For in general it must be assumed that the numbers both of the included and excluded articles are large. Now it is impossible to carve two sets of 'large numbers' out of *nineteen*.

¹ The coefficient C defined above, p. 191.

² As given in Mr. Palgrave's table 26 (see above, p. 196).

³ Namely, 5, 5, 5, 5; 10, $2\frac{1}{2}$, $7\frac{1}{2}$; $2\frac{1}{2}$, $2\frac{1}{2}$, 9, $2\frac{1}{2}$, 1, $2\frac{1}{2}$; $2\frac{1}{2}$, $2\frac{1}{2}$, $2\frac{1}{2}$, $2\frac{1}{2}$; 10, 5, $2\frac{1}{2}$, $2\frac{1}{2}$;

3, 1, 1, 3, 1, 1. Whence the value of $\frac{Swr^2}{(Sw)^2}$ (see above, p. 193) is found to be .05.

is as likely as not, then it may be presumed that a deviation of 20 per cent. is not likely, of 30 per cent. very unlikely. Upon this hypothesis, according to the general formulæ above investigated, the error, or fortuitous deviation from the ideal, to which the Committee's index-number is liable is as likely as not to be as large as 2 or 3 per cent., but is unlikely to be 6 per cent., and very unlikely to be 10 per cent. Now let us entertain the more unfavourable and almost certainly extravagant hypothesis that each datum is as likely as not to be out by 25 per cent., and may just possibly err to the extent of cent. per cent. (an error which, if possible *in excess*, is almost inconceivable *in defect*). Upon this hypothesis our index-number is as likely as not to be out 5 per cent. but is not likely to be out by 10, and very unlikely to be out by 15, per cent.

The presumption that our calculation is not likely to be far out is confirmed by comparing the results obtainable by our method with those obtained by other operators upon different principles. If the compared figures differ little from each other it is presumable that they differ little from the true, the ideally best, figure: that which would be obtained if the data were perfect.

The index-numbers which challenge comparison with that proposed by the Committee may be arranged under four categories, namely:

I. Those which are formed by taking the *Simple Arithmetical Mean* of the given price-variation; the principle of the *Economist's* index-number, or rather what would be the principle of that operation if the prices operated on had not been selected with some reference to the quantity of the corresponding commodities.

II. What may be called the *Weighted Arithmetical Mean*, each price-variation being affected with a factor proportioned to the quantity of the corresponding commodity, the principle adopted by the Committee.

III. The *Geometric Mean*, as employed by Jevons.

IV. The *Median*, proposed by the present writer as appropriate to certain purposes.¹ It is (in its simplest variety) formed by arranging the given price-variation (*e.g.*, 98, 80, 88, 87, 85) in the order of magnitude (*e.g.*, 80, 85, 87, 88, 98) and taking as the Mean the *middle* figure (in the above example the *third* figure, *i.e.*, 87).

Under each of these headings it is desirable to supplement actual verification with *à priori* reasoning based on the principles laid down in the earlier part of the Memorandum.

We may begin with the case (A) in which the price-variations are supposed the same for the compared index-numbers. Later on (B) we shall take examples in which both the price-variations and the mode of combining them are different.

A.

I. Let us take the prices which are to hand for 21 (out of the 27) items of our index-number in Mr. Sauerbeck's well-known paper on the prices of commodities.² Let us form the Simple Arithmetic Mean of these prices for the year 1885, and compare it with the Mean obtained by applying our system of weights to the same prices. The operation is

¹ See sect. ix. of Memorandum 'On the Methods of measuring Variations in the Value of the Monetary Standard,' *Brit. Assoc. Report*, 1887.

² *Journal of the Statistical Society*, 1886.

1	1885			1873		
	2	3	4	5	6	7
Articles common to Sauerbeck and the Committee	Price-variations for 1885 given by Sauerbeck	Weights assigned by the Committee	Product of columns 2 and 3	Price-variations for 1873 given by Sauerbeck	Weights assigned by the Committee	Product of columns 6 and 7
Wheat	60	5	300	108	5	540
Barley	77	5	385	104	5	520
Oats	79	5	395	98	5	490
Potatoes and rice	67	5	335	116	5	580
Meat	88	10	880	109	10	1090
Butter	89	7½	668	98	7½	735
Sugar	59	2½	147·5	101	2½	252·5
Tea	64	2½	160	102	2½	255·5
Cotton	62	2½	155	100	2½	250
Wool	73	2½	182·5	118	2½	345
Silk	55	2½	137·5	95	2½	237·5
Leather	94	2½	235·5	117	2½	292·5
Coal	72	10	720	145	10	1450
Iron	60	5	300	170	5	850
Copper	57	2½	142·5	112	2½	280
Lead	57	2½	142·5	117	2½	292·5
Timber	81	3	243	111	3	333
Petroleum	55	1	55	122	1	122
Indigo	72	1	72	92	1	92
Flax	73	3	219	97	3	291
Palm oil	77	1	77	97	1	97
Sums	1,471	81·5	5952	2329	81·5	9394·5
Means	70		70·6	110·4		115

exhibited in the annexed table, the latter columns of which present a similar comparison for the year 1873. The two results may thus be summed up :

	1885	1873
Simple Arithmetic Mean	70	110·5
The Committee's Weighted Arithmetic Mean	70·6	115

The relation between these results is predictable by, and consistent with, the conclusions of *à priori* reasoning. Accordingly the inference that the deviation between the two computations is not likely to exceed a small percentage may safely be extended to adjacent cases.

It follows, from the principles laid down in the earlier part of this Memorandum, that the discrepancy to be expected between the two results depends on three circumstances: the number of items, the inequality of the price-variations, and the

inequality of the weights. The measure or *modulus* of the discrepancy is, in our notation,

$$\frac{1}{\sqrt{2n}} \times C \times \chi,$$

where n is 21; C is presumed (by a sufficient, but certainly not very copious, induction) to be from .2 to .3; and χ is found to be about .9.¹

It follows that of the observed discrepancies, .6 and 5, one is, *à priori*, more likely than not to occur, and the other not unlikely. A rapidly increasing improbability attaches to the higher degrees of divergence.

Of course it must be understood that this theorem in Probabilities, this statement of what will occur in the long run, is based upon the supposition that the weights are distributed impartially among the price-variations. But if throughout the whole run the largest weight is attached to the largest, or smallest, observation, the then fortuitous character of the phenomenon is impaired. In fact the 'long run' of which the theory may be expected to be true is a series of heterogeneous index-numbers not of consecutive years. Something of this sort is observable in the case of Mr. Palgrave's Weighted Mean compared with the corresponding Simple Arithmetic Mean. The enormous weights attached to the continually low-priced *Cotton* and the continually high-priced *Meat* seem to affect the Weighted Mean abnormally. To effect the comparison, we must not take the averages given in Mr. Palgrave's table 26, but those which are obtained by omitting from that table the three items *Cotton Wool*, *Cotton Yarn*, and *Cotton Cloth*, which do not occur in the compared table 27. The annexed comparison does not present the appearance of pure chance. The discrepancies are rather *less* in magnitude than the theory requires. For the modulus, as deduced from Mr. Palgrave's system of weights, proves to be about 8.5 per cent. of the Mean 80 or 90:² that is about 7, corresponding to a probable error of about 3.5. The set of differences above registered seems to range a little within the limits so defined.

	1870	1871	1872	1873	1874	1875	1876	1877	1878	1879	1880	1881	1882	1883	1884	1885
Mr. Palgrave's Weighted Mean for 19 articles	90	93	100	104	108	97	99	100	95	82	89	93	87	88	80	76
The Simple Arithmetic Mean for the same articles	94	95	102	107.5	107	92	99	101	93	82	93.5	86	89	85.5	81	75
Excess of Arithmetic over Weighted Mean	+4	+2	+2	+3.5	-1	-5	0	+1	-2	0	+4.5	-7	+2	-2.5	+1	-1

The reason is, doubtless, that the impartial sprinkling of the prices among the weights, presupposed by theory, is not fulfilled in fact. Had it happened that

¹ See above, p. 196, where the present writer records the *Mean Square of Deviation* for the price-variation of nineteen different articles (given by the *Economist*) in different years. The *Mean Square of Deviation* for the figures given by Mr. Sauerbeck seems to be much the same. Again, the writer has, with much the same result, ascertained (by the Galton-Quetelet method) the quartiles for a few groups of English prices, like those given by Jevons. For example, in the case of the thirty-nine figures of the prices for prime articles in 1860-62 comparative with 1845-50 (*Currency and Finance*, pp. 51, 52) the quartile (half the interval between the tenth and the thirtieth) proves to be 11, corresponding to a modulus of about 22 per cent. If, however, we take in all the 118 articles given on the same page the quartile is 17. The groups of thirty-nine on Jevons' page 44, so far as they have been examined, give much the same result as the thirty-nine on pages 51, 52. Jevons himself gives $2\frac{1}{2}$ as the 'probable error' incident to the *Mean* of thirty-six price-variations (*Currency and Finance*, p. 157)—corresponding to a probable error of 15, a modulus of 30 for the *individual* price-return. Doubtless the dispersion may be expected to be greater the more distant the base. If precision could be expected, it would be proper to express the coefficient as a percentage of the mean price-variations at each epoch rather than of the initial price or basis.

² See end of last note.

throughout the whole run all the largest weights had been attached to the articles whose prices were continually low, *e.g.*, *cotton*, and (for the last few years at least) *silk* and *flax*, then the discrepancies (between the weighted and simple mean) would have been rather larger than theory predicts. Thus, for the year 1885 I make *silk* exchange weights with *meat*, and thus bring down the index-number to 64; a discrepancy from the Arithmetic Mean which, if continued—as it probably would be—from year to year, would be a little too great. Similarly, when *wheat* exchanges weight with *leather*, and *cotton* with *indigo*, the index-number works out to 92—a discrepancy of two moduli, which is much too large for a continuance.

This sort of abnormality is less likely to occur in the case of our scheme, where none of the weights are so large as some of Mr. Palgrave's. Still, before pressing the theory, it is proper to examine whether the larger weights—in our case those of *meat*, *fish*, and *coal*—are, from year to year, coupled with extreme price-variations.¹

Whenever law of this sort is discernible the doctrine of Chances hides its inferior light, which is serviceable only in the night of total ignorance. The pure theory of Probabilities must be taken *cum grano* when we are treating concrete problems. The relation between the mathematical reasoning and the numerical facts is very much the same as that which holds between the abstract theory of Economics and the actual industrial world—a varying and undefinable degree of consilience, exaggerated by pedants, ignored by the vulgar, and used by the wise.

II. Next let us compare our result with that obtained by using some other system of weights, *e.g.*, Mr. Sauerbeck's. In the annexed table, page 205, column 1 is the same as column 2 of the last table, containing Mr. Sauerbeck's prices. Column 2 gives Mr. Sauerbeck's weights (for 1885) reduced to percentages of the total weight assigned by him to the twenty-one articles which are common to him and the Committee. For example, 61 is the weight actually assigned by him to wheat. This, multiplied by 100, and divided by 559, the sum of all the weights assigned by him to the twenty-one articles, gives 11 (nearly).

It is an interesting result of theory that the difference to be expected between the two weighted index-numbers (for the same twenty-one price-variations) is about the same as, or only a little less than, that between one of them and the Simple Unweighted Arithmetic Mean. This result is found by putting for $\frac{S\epsilon^2}{n}$ in the formula given above² $\frac{S(\epsilon - \epsilon')^2}{n}$, where ϵ' , ϵ'' , express deviations for the two systems of weights respectively.

	1885	1873
The Committee's System of Weights	70.6	115
Mr. Sauerbeck's System of Weights	73	115

The comparison between the two systems is presented in the accompanying summary. The slightness of the difference between the com-

¹ The effect of large weights combined with high prices is strikingly shown in an index-number (attributed to Dr. Paasche) which is published in Conrad's *Jahrbücher*, vol. xxiii. p. 171. There are twenty-two items, among which *Rye* obtains about thirty per cent. of the total weight, and the Cereals generally (between whose prices there is a certain solidarity) about seventy per cent. It is no wonder that in the year 1868, when the price of the Cereals was exceptionally high, the Weighted Mean should be 118, while the Simple Arithmetic Mean of the twenty-two comparative prices is only 104.

² The expression proves to be equal to .4.

1	2	3	4	5
Price-variations for 1885	Weights assigned by Sauerbeck	Product of columns 1 and 2	Price-variations for 1873	Product of columns 2 and 4
60	11	660	108	1188
77	5.5	423	104	572
79	6	474	98	588
67	6	402	116	696
88	15.5	1364	109	1689.5
89	3	267	98	294
59	5.5	325	101	555.5
64	2	128	102	204
62	10	620	100	1000
73	7.5	537.5	118	885
55	1	55	95	95
94	8	752	117	936
72	13	936	145	1885
60	5	300	170	850
57	1	57	112	112
57	0.5	28.5	117	58.5
81	2	162	111	222
55	0.5	27.5	122	61
72	0.5	36	92	49
73	1	73	97	97
77	0.2	15	97	19
Sum . . .	105	7652	—	12052
Mean . . .	—	73	—	115

pared results might have been predicted by theory, and may be predicted safely of adjacent cases.

III. We come next to the index-number of Jevons: the Geometric Mean of the price-variations appertaining to a number of groups. The definition of these groups is not wholly irrespective of their importance to the consumer and producer. There is evinced more or less concern that each article of equal importance should 'count for one' in the composition of the index-number. But Jevons does not affect precision of weight. *Pepper*, for instance, forms one of the constituent thirty-nine articles.¹

The analogue of this operation for our materials appears to be the Simple Geometric Mean of the price-variations for each of the articles specified in our scheme; except, indeed, those to which a very small weight, namely 1, has been assigned. Accordingly *Petroleum*, *Indigo*, *Palm Oil*, and *Caoutchouc* may, with propriety, be lumped into one group, for which the mean price-variation is to be ascertained geometrically. For the sake of comparison with Mr. Sauerbeck's result, *Caoutchouc* (not

¹ In the 'Serious Fall,' republished in *Currency and Finance*, p. 44. In the 'Variation of Prices' (*ibid.*, p. 142) Jevons seems to have employed the practice of weighting rather more extensively. He says, 'Several qualities of one commodity have been joined and averaged before being thrown as one unit into larger groups'—in the case of certain articles which are not very clearly indicated. For the period after 1844 the [unweighted] 'average prices, as calculated from the price-lists of the *Economist* . . . were mostly used.'

recorded by him) may be omitted from this little group. The Mean of the group so constituted is to be placed along with the price-variations for the remaining eighteen articles common to us and Mr. Sauerbeck, and the Geometric Mean of all the nineteen is to be taken. It proves to be 69, presenting the comparison herewith exhibited.¹

The Committee's Weighted Mean of 21 articles	70·6
The slightly adjusted Geometrical Mean of the same	69

The slightness of this divergence is conformable to theory. For it has been shown that the Weighted Mean (of twenty-one articles) is not likely to differ very much from the Simple Arithmetic Mean of the same. And it may be shown that the Arithmetic Mean is not likely to differ very much from the Geometric when the number of price-observations is large, and if they are not very unequal. This proposition may be illustrated by the following figures, the first row of which is obtained by taking the Arithmetic Mean of the thirty-nine price-percentages given by Jevons in his paper on a 'Serious Fall,' &c. (*Currency and Finance*, p. 44.) The second row consists of the Geometric Means, as given by him at p. 46, for the same figures. The superior magnitude of the Arithmetic Mean will be noticed. This circumstance (which Jevons thought an advantage on the side of his procedure) could not be predicated of a *Weighted* Arithmetic Mean (such as our index-number), as compared with the Geometric:—

	1851	1852	1853	1855	1857	1859
Geometric Mean for 39 articles:	92·4	93·8	111·3	117·6	128·8	116
Arithmetic Mean for same	94·6	94·6	112·4	119	134	119

IV. We come now to the *Median*, which has been recommended by the present writer as the formula for the most objective sort of Mean between prices, not directed to any special purpose, such as the wants of the consumer or the difficulties of the producer, but more impersonal and absolute.

Below 70	Between 70 and 80	Above 80
.	72 72 73 73 77 77 79
Ten below 70	Median = 72	Four above 80

Of the twenty-one price-variations for 1855 given in column 1 of table 1, we have to take that which is the *eleventh* in the order of magnitude. To ascertain this we need not arrange *all* the figures in order. Having an inkling that the Mean is between 70 and 80, we shall find it sufficient to note the number of returns which lie outside those limits, and to write down in the order of magnitude only the returns which lie between 70 and 80. Thus, running our eye down the column of figures, we make a dot on the right for every return which is greater than 80, on the left for every one less than 70; and write down in the central compartment the figures which lie between 70 and 80 inclusive. Whence it

¹ If we lump together *Barley* and *Oats* into one group, *Sugar* and *Tea* into another, and again *Copper* and *Lead*, the Geometric Mean of the sixteen returns thus presented is 70·2.

appears that 72 is the figure eleventh in the order of magnitude : that is the Median.

1	2	3
Price-variations	Precisions determined by mass	Arbitrary precisions
60	2	2
67	2	1
59	1·5	2
64	1·5	2
62	1·5	1
55	1·5	1
60	2	1
57	1·5	2
57	1·5	1
55	1	2
	16	15
72	3	2
72	1	1
73	1·5	1
73	1·5	1
77	1	1
77	2	2
79	2	1
	12	9
88	3	2
89	2·5	1
94	1·5	1
81	1·5	2
	8·5	6
	36·5	30

This is the Simple or Unweighted Median. There is a variety constituted by assigning special importance to those returns which we have reason to suppose are specially good representatives of the changes affecting the value of money. If, as in the writer's Memorandum often referred to,¹ we take mass of commodity as the principle of ponderation, we shall have to proceed as follows with our twenty-one articles :

As before, make three compartments for returns below 70, for those between 70 and 80, and for those above 80 respectively. Write down in the first and third compartments the returns in the order in which they occur (in any order) ; but in the central compartment in the order of magnitude.² In the second column of each compartment write the figures representing the relative *precision* assigned to each return. If these estimates of precision are based upon the quantities of commodities, it is recommended that they should be equal to, or rather less than, the square roots of the proportionate masses. Accordingly 2 has been put for the square root of 5, 1·5 for the square root of 2½, and so on. Add together

¹ Sect. ix. of 'Memorandum' in *Report of Brit. Assoc.*, 1887.

² It will probably be convenient to write these returns first in the order of their occurrence, and then rearrange them.

the sums of all the second columns. Thus, $16 + 12 + 8.5 = 36.5$. Find the central figure of the total second column: that is the figure which as nearly as may be has 18 for the sum of figures above it and below it. This figure proves to be the 3 at the top of the second compartment opposite 72. Then 72 is the required Mean.

In the third column another system of precisions has been tried to illustrate the effect of treating some price-variations as more typical of the change in the value of money than others. Tossing up a coin, the writer has stuck down (corresponding to each figure in the first column) 2 if heads turned up, 1 if tails. The sum of these arbitrary coefficients of precision is 30, and accordingly the adjusted Median is the point intermediate between 72 and the return next below in the order of magnitude, which proves to be 67. The adjusted Median is, therefore, 69.5.

By operating similarly on the price-returns for 1873 (given above) it is found that the Simple Median is 108, the Median adjusted by taking account of quantities still 108.

The deviation between the Median and the Simple (or other) Arithmetic Mean cannot, so far as the writer knows, be formulated exactly. It diminishes with the number of observations, being of the order $\frac{1}{\sqrt{n}}$. A superior limit is given by the expression $\sqrt{1 + \frac{1}{2}\pi} \times$ Modulus of the observation; in our case say .1, or 10 per cent.¹ This limit is probably very superior, as the following trials, in addition to those given above, suggest:

	1851	1852	1853	1855	1857	1859
Arithmetic Mean for 39 articles	94.6	94.6	112.4	119	134	119
Median for the same	92	92	108	111	127	116.5
Geometric Mean for the same	92.4	93.8	111.3	117.6	128.8	116

The thirty-nine figures are those above referred to, given by Jevons at p. 44 of his *Currency and Finance*. The Geometric Means have been cited again here in order to bring out the curious fact that the Median seems to keep closer to the Geometric than the Arithmetic. This property (which it would be desirable to verify more fully) is agreeable to the theory, first advanced by the present writer so far as he is aware, that prices are apt to group themselves in an unsymmetrical fashion after the pattern of the annexed curve, whose ordinates indicate the frequency of

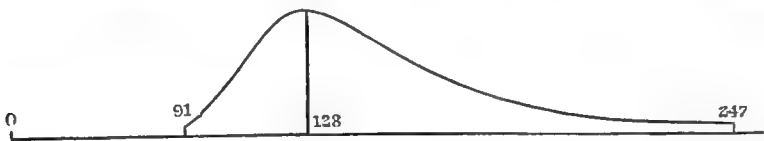

each price-variation. In the year 1857, for instance, the smallest figure was 91, the largest 247; while the Geometric, Median, and Arithmetic Means were respectively 129, 127, and 134. There is some reason to believe that the Geometric and Median—especially the latter—are more apt to be coincident with the point at which the greatest number of returns cluster, the greatest ordinate of the curve.

If then we take as our quæsitum that figure which would be presented by the greatest number of price-variations in the complete series of returns

¹ See the writer's paper in 'Problems in Probabilities,' *Phil. Mag.*, Oct. 1886.

for all articles great and small, then, regarding our twenty-one, or it may be forty-five, articles as *specimens* of this series, we shall best operate on them by taking their Median.

And, even if this reasoning is not accepted, if the asymmetry of the price-curve should not be regarded as serious, and the central point of the supposed symmetrical complete curve or series be taken as the *quæsitum*, still, even upon this hypothesis, the Median would have special claims.¹

Another advantage—or the same otherwise viewed—on the side of the Median is its insensibility to accidental alterations of ‘weight.’ You may considerably increase or lighten the weights without causing this Mean to be depressed or elated. In the Arithmetic Mean a large weight happening to concur with an extreme price-variation produces a derangement which with reference to the present objective² (as distinguished from the ‘consumption’) standard may be regarded as accidental. The Median is free from this fortuitous disturbance. The rationale of this stability is supplied by the Calculus of Probabilities.

It appears, therefore, that our index-number, though not likely to be wide of any mark which has been proposed, is not the one which is most accurately directed to a particular, or rather, indeed, the most general object. It is no matter for surprise or complaint that we should not hit full in the centre an object which has not been our aim; our index-number being mainly a *Standard of Desiderata*, measuring the variation in value of the national consumption. Our primary aim, indeed, is more comprehensive, not this special, but a collective, or ‘compromise,’ scope; not so much to hit a particular bird, but so to shoot among the closely clustered covey as to bring down most game. But then we are brought back to, or nearly to, the directer aim and simpler object by a consideration which has great weight in practical economics, the necessity of adopting a principle—as Mill says with respect to convertible currency—‘intelligible to the most untaught capacity.’ Now every tyro in our subject makes straight for the Consumption Standard; but the more delicate distinctions of the Producers’ Standard and the typical or quasi-objective index-number evade popular perception.

In view of this practical exigency it may well be that the Committee’s index-number is the one best adapted to purposes in general—the principal standard as defined in the First Report. What is here contended is that, with respect to a certain purpose other than the consumers’ interest, the Committee’s index-number is on the one hand likely to be a very good measure, and on the other hand not the very best possible.

B.

We have now to compare index-numbers differing as to the prices operated on as well as the methods of operation. One important case is where the prices of the principal articles are the same for the compared index-numbers, the data differing only as to a small part of the total value. For example, of the total value covered by Mr. Sauerbeck’s index-number about $\frac{9}{10}$ is common to the Committee’s scheme. For Mr. Sauerbeck’s weights (or ‘nominal values’) of the twenty-one articles common to both calculations make up (for the year 1885) 559, while the sum for all the items treated by him is 617.

¹ The problem would then be analogous to the reduction of symmetrical observations relating to a physical quantity. On account of the ‘discordance’ of the price-observations, their very different liability to fluctuation, the writer would recommend the use of the Median on the grounds which he has stated in the paper on ‘Discordant Observations,’ *Phil. Mag.*, April 1886.

² See ‘Memorandum,’ *Report of Brit. Assoc.*, 1887, and also *Journal of the Statistical Society*, June 1888.

Let us see, then, what difference is caused by operating on all Mr. Sauerbeck's forty-five articles instead of only the twenty-one principal items which are common to his price list and ours. He himself at p. 595 (of the ' Journ. Stat. Soc.,' 1886) gives us the Means of Comparison :

	1885	1873
Mr. Sauerbeck's Weighted Mean for 45 articles . . .	71·2	115·2
The Committee's Weighted Mean for 21 of those articles	70·6	115

It is interesting to observe that the Median does not suffer any change by being extended from twenty-one to forty-five articles. The attention of the reader is invited also to the ease of this method. In order to take

Above 80	Between 70 and 80												Below 70		
Dots to the number of 12	79	78	77	77	76	75	75	73	73	73	72	72	71	70	Dots to the number of 19

in the twenty-four additional articles we have only to write down a few more figures in the central compartment, to add a few more dots in the extreme compartments, as shown in the annexed diagram. Indeed it is not

1	2	3	1 (continued)	2 (continued)	3 (continued)
Price-variations	Precision	Another System of Precision	Price-variations	Precision	Another System of Precision
60	2	3	72	1	3
62	3	3	73	2	1
63	3	3	73	2	2
64	2	2	73	1	3
59	1	2	75	1	1
62	2	1	75	2	2
65	3	2	76	1	1
64	3	2	77	3	2
60	2	1	77	2	3
59	1	1	78	1	2
57	2	3	79	1	2
57	2	3		3	1
62	2	2		3	3
63	1	3		2	3
63	1	2		2	3
59	2	2		1	3
55	1	2		3	2
55	2	1		3	2
60	3	3		3	3
				1	1
70	2	1		2	1
71	2	2		2	1
72	1	3		1	2
Sums .	43	47	—	43	47

necessary to record the number of observations (by way of dots) in more than *one* of the extreme compartments. The Median is the *twenty-third* figure in the order of magnitude, that is, 72. Proceeding similarly for the year 1873, we find the Median of Mr. Sauerbeck's forty-five price-variations 109.

Now let us try the effect of weighting. Running my eye over some pages of statistics, I assign the digits 1, 2, 3 as they occur to the price-variations, which are in pell-mell order up to 70; between 70 and 80 in the order of magnitude; and above 80 not represented at all. The sum of the whole second column thus formed is 86. The central point corresponding to half that sum is at the foot of the first half of the second column, corresponding to the entry 72 in the first column. Accordingly 72 is the adjusted Median. I try another system of precision-factors arbitrarily assigned. And still the Median is 72!

The comparisons offered by Mr. Sauerbeck's materials are summed up in the accompanying table :

	1885		1873	
	The 21 articles common to the Committee and Sauerbeck	Sauerbeck's 45 articles	The 21 articles common to the Committee and Sauerbeck	Sauerbeck's 45 articles
The Simple Arithmetic Mean .	70	74	110.5	111
The Committee's Weighted Mean .	70.6	—	115	—
Sauerbeck's Weighted Mean . .	73	72.5	115	115.2
Jevons' adjusted Geometric Mean .	69	—	—	—
The Simple Median . . .	72	72	108	109
The Median adjusted according to <i>quantity</i>	72	—	108	—
The Median adjusted on an arbitrary principle	69.5	72	—	—

For estimating the extent of difference to be expected between two index-numbers which overlap as to some of their items, the following formula is derivable from the reasoning at p. 194. Let n be the number of items common to both schemes, n' the number special to one, and n'' to the other. Put χ'^2 for the fluctuation of one system of weights, and χ''^2 for the other; and for $2 \frac{\sum (\epsilon' - \epsilon'')^2}{n}$

(above, p. 204) put χ^2 . Then for the modulus of the difference between the compared results we have

$$\frac{1}{\sqrt{n}} \times \sqrt{\frac{\chi^2}{2} + \frac{n'}{n+n'} \left(1 + \frac{\chi'^2}{2}\right) + \frac{n''}{n+n''} \left(1 + \frac{\chi''^2}{2}\right)} \times C;$$

where C, as before, is the measure of the *dispersion* incident to returns of comparative prices. In practice we may put for $\frac{n'}{n+n'}$ the ratio between the summed weights of the item special to each index-number and the sum total for all the items. These fractions are derivable from the third and fourth columns in the last table of the Appendix. In calculating the fifth and sixth columns of that table

the formula just given has been used. But it has been thought allowable to deduce χ not from the Mean *square* of error (as theoretically best), but from the Mean error given in the second column of the table, putting $\chi = \sqrt{\pi} \times$ Mean error. The calculations of χ' and χ'' have been similarly rough.

Of course, as the number of items common to two compared index-numbers is diminished the chances of their dissilience are increased. The *art of conjecturing* can in such a case throw only a very feeble light—offered by the third formula above—on the relation between two such index-numbers. For instance, it could hardly have been predicted that the Simple Arithmetic Mean for Mr. Sauerbeck's forty-five articles should differ so little as .5 from the same Mean for twenty-one articles, as proved to be the case for the year 1873. It is even more surprising that if for 1885 we complete our index-number, taking account of the six items belonging to our scheme not included by Mr. Sauerbeck, there is a marked rise in the index-number owing to all these six returns being above the average. The annexed little table is formed by comparing the prices in 1885 with the average for 1866-77 as given in the *Statistical Abstract*:—

Articles omitted hitherto	Price-variations for 1885	Weight assigned by the Committee	Product of Columns 2 and 3
1	2	3	4
Fish ¹	104	2½	260
Beer	76	9	68
Spirits ²	120	2½	300
Wine	100	1	100
Tobacco	85	2½	212½
Caoutchouc	109	1	109
Sums	594	18.5	1665
Means	97	—	90

If we add the outcome of this table to that of the first table representing the other twenty-one articles, we have $1665 + 5952 = 7617$; which, divided by 100, gives the new index-number 76.

Of course in applying the doctrine of Chances to this problem we must abstract all *animus*. If you pick out the large variations of price and the large weights you will doubtless succeed, like Mr. Forsell, in producing discrepancies—though even his success in that attempt seems less than might have been expected.

In concluding this comparison of results the writer may say, in the phrase of Jevons, that he has taken more than reasonable pains to secure arithmetical accuracy. No doubt mistakes will have come. But, as the calculations have been performed without any conscious bias, any *animus mensurandi*, it may be hoped that the errors will neutralise each other, and that the general impression left by the work is correct.

¹ Fish imported.

² Spirits other than rum and brandy.

APPENDIX.

STATEMENT OF THE EXTENT, AND ESTIMATE OF THE SIGNIFICANCE, OF THE DIFFERENCE BETWEEN THE COMMITTEE'S SCHEME AND OTHERS.

TABLE I.

Articles common to the Committee and Mr. Sauerbeck's Weighted Index-number	Weights actually assigned		Weights as Percentages of Total Weight of the Common Articles		Differences between Columns 4 and 5
	The Committee	Mr. Sauerbeck	The Committee	Mr. Sauerbeck	
1	2	3	4	5	6
Wheat	5	61	6	11	5
Barley	5	30	6	5.5	.5
Oats	5	32	6	6	0
Potatoes and rice	5	32	6	6	0
Meat	10	88	12	15.5	3.5
Butter	7½	23	9	3	6
Sugar	2½	30	3	5.5	2.5
Tea	2½	15	3	2	1
Cotton	2½	57	3	10	7
Wool	2½	42	3	7.5	4.5
Silk	2½	4	3	1	2
Leather	2½	10	3	2	1
Coal	10	74	12	13	1
Iron	5	27	6	5	1
Copper	2½	7	3	1	2
Lead	2½	3	3	.5	2.5
Timber	3	17	4	2	2
Petroleum	1	3	1	.5	.5
Indigo	1	3	1	.5	.5
Flax	3	4.5	4	1	3
Palm oil	1	1.5	1	0	1
Sums	81.5	564	98	98	46.5

TABLE II.

Articles common to the Committee and Mr. Palgrave	Weights as Percentages of Total Weight of the Common Articles		Differences between Columns 2 and 3
	The Committee	Mr. Palgrave	
1	2	3	4
Wheat	10	19	9
Meat	20	25	5
Sugar	5	7	2
Tea	5	3·5	1·5
Tobacco	5	1	4
Cotton	5	12	7
Wool	5	6·5	1·5
Silk	5	·6	4·5
Leather	5	3·5	1·5
Iron	10	7	3
Copper	5	1·5	3·5
Lead	5	·5	4·5
Timber	6	7·5	1·5
Indigo	2	0	2
Flax	6	2	4
Oil ¹	2	2	0
Sums	101	98·5	54·5

¹ *Palm oil* in the Committee's scheme; *oils* in Mr. Palgrave's.

TABLE III.

Articles common to the Committee and Mr. Sauerbeck's Unweighted Index-number	Weights actually assigned		Weights as Percentages of Total Weight of the Common Articles		Differences between Columns 4 and 5
	The Committee	Mr. Sauerbeck	The Committee	Mr. Sauerbeck	
1	2	3	4	5	6
Wheat	5	3	6	8·5	2·5
Barley	5	1	6	3	3
Oats	5	1	6	3	3
Potatoes and rice	5	2	6	6	0
Meat	10	6	12·5	17	4·5
Butter	7 $\frac{1}{2}$	1	9	3	6
Sugar	2 $\frac{1}{3}$	2	3	6	3
Tea	2 $\frac{1}{2}$	1	3	3	0
Cotton	2 $\frac{1}{2}$	2	3	6	3
Wool	2 $\frac{1}{2}$	2	3	6	3
Silk	2 $\frac{1}{2}$	1	3	3	0
Leather	2 $\frac{1}{2}$	2	3	6	3
Coal	10	2	12·5	6	6·5
Iron	5	2	6	6	0
Copper	2 $\frac{1}{2}$	1	3	3	0
Lead	2 $\frac{1}{2}$	1	3	3	0
Timber	3	1	4	3	1
Petroleum	1	1	1	3	2
Flax	3	1	4	3	1
Indigo	1	1	1	3	2
Palm oil	1	1	1	3	2
Sums	81·5	35	99	103·5	45·5

TABLE IV.

Articles common to the Committee and Dr. Soetbeer	Weights actually assigned		Weights as Percentages of Total Weight of the Common Articles		Differences between Columns 4 and 5
	The Committee	Dr. Soetbeer	The Committee	Dr. Soetbeer	
1	2	3	4	5	6
Wheat	5	2	Practically same as Column 2	4.5	.5
Barley	5	2		4.5	.5
Oats	5	1		2	3
Potatoes and rice .	5	2		4.5	.5
Meat	10	4		9	1
Fish	2½	2		4.5	2
Butter, milk, and cheese	7½	2		4.5	3
Sugar	2½	2		4.5	2
Tea	2½	1		2	.5
Beer	9	1		2	7
Spirits	2½	3		7	4.5
Wine	1 ¹	2		4.5	3.5
Tobacco	2½	1		2	.5
Cotton	2½	1		2	.5
Wool	2½	1		2	.5
Silk	2½	1		2	.5
Leather, &c. . . .	2½	3		7	4.5
Coal	10	1		2	8
Iron	5	3		7	2
Copper	2½	1		2	.5
Lead	2½	1	2	.5	
Timber	3	3	7	4	
Indigo	1	1	2	1	
Flax	3	1	2	1	
Palm oil	1	1	2	1	
Sums	98	43	98	94.5	53

¹ Hops.

TABLE V.

Articles common to the Committee and Jevons	Weights actually assigned			Weights relative to the Total Weight of the Common Articles			Differences between Columns 6 and 5	Differences between Columns 7 and 5
	The Committee	Jevons		The Committee	Jevons			
		a ¹	b ²		a ¹	b ²		
1	2	3	4	5	6	7	8	9
Wheat . . .	5	1	1	7	3·5	2	3·5	5
Barley . . .	5	1	1	7	3·5	2	3·5	5
Oats . . .	5	1	1	7	3·5	2	3·5	5
Meat . . .	10	3	5	14·5	11	9	2·5	55
Butter and cheese.	7½	1	3	11	3·5	6	7·5	5
Sugar . . .	2½	1	3	4	3·5	5	·5	1
Tea . . .	2½	1	4	4	3·5	7	·5	3
Spirits . . .	2½	1	3	4	3·5	6	·5	2
Cotton . . .	2½	3	3	4	11	6	7	2
Wool . . .	2½	1	2	4	3·5	4	·5	0
Silk . . .	2½	1	3	4	3·5	6	·5	2
Leather . . .	2½	2	4	4	7	7	3	3
Iron . . .	5	3	3	7	11	6	4	1
Copper . . .	2½	1	1	4	3·5	2	·5	2
Lead . . .	2½	1	4	4	3·5	7	·5	3
Timber . . .	3	2	6	4·5	7	11	2·5	6·5
Flax . . .	3	1	1	4·5	3·5	2	1	2·5
Indigo . . .	1	1	1	1·5	3·5	2	2	·5
Palm oil . . .	1	1	1	1·5	3·5	2	2	·5
(Wine) . . .	(2½)	—	4	(4)	—	7	—	3
Sums . . .	68	27	54	101	100	101	45·5	57·5
	(70·5)	—	—	(105)	—	—	—	—

¹ First form of index-number based upon 39 articles ('Serious Fall').

² Second form of index-number based upon 118 articles (*ibid.*)

TABLE VI.

Index-numbers compared with the Committee's	Mr. Sauerbeck's Weighted	Mr. Palgrave's	Mr. Sauerbeck's Unweighted	Dr. Soetbeer's	Jevons	
					a	b
Number of articles common to the Committee's and other index-numbers	21	16	21	25	19	20
Mean difference (per cent.) between the weights of the common articles according to the Committee's and other schemes	47	54	45	53	45	58
Weight of the common articles per cent. of the weight of all the articles in the Committee's scheme	81.5	50.5	81.5	98	68	70.5
Weight of the common articles per cent. of the weight of all the articles in other schemes	90.5	98	78	44	70	54
Discrepancy as likely as not to occur between the Committee's and other results	2	2.5	2	2	2.5	2.5
Discrepancy very unlikely to occur between the Committee's and other results	8	11	8	8	10	11

Remarks upon the preceding Tables.

These tables present a comparison between the index-number proposed by the Committee and some other well-known constructions of the same kind. In the first five tables the feature of comparison consists of those articles or items which are common to the Committee's and the compared schemes. The tables show the different importance or 'weight' assigned to the same items in the Committee's and each of the other schemes. For the purpose of exhibiting this difference it is proper to contrast, not the actual weights employed by the Committee and each compared index-number, but the weights relative to the total weight assigned to the common items by the Committee's and the compared scheme respectively. Thus, in the first table, the first column states the articles, twenty-one in number, which are common to the Committee's index-number and to one which has been given by Mr. Sauerbeck ('Journ. Stat. Soc.' 1886, p. 595). The second and third columns give the weights actually affixed by the Committee and Mr. Sauerbeck respectively to the comparative prices of those twenty-one articles. The third and fourth columns give the weights relative to the total weight of the coincident portions of the two systems. Thus, 61 being the weight actually assigned by Mr. Sauerbeck to wheat, while 564 is the sum of the weights attached by him to all the articles common to him and the Committee, $\frac{61}{564}$, or the same fraction multiplied by 100 (=11 nearly), is taken as the proper

weight according to Mr. Sauerbeck for wheat; in a curtailed index-number covering only those articles common to him and the Committee. By parity $\frac{5}{81 \cdot 5} \times 100$, or six nearly, is the weight for the same article according to the Committee. In the sixth column the differences—the absolute differences without regard to *sign*—between the respective weights are given. To appreciate the importance of this difference of weight, we must consider it in relation to the absolute (mean) weight.

Thus $\frac{\text{Mean difference of weight}}{\text{Mean weight}}$ is the fraction (or, multiplied by 100, the percentage) which most, or at least very, properly measures the discrepancy between the two systems. Now the Mean weight for each of the two compared systems is $\frac{100}{21}$. Therefore we have for the required measure $\frac{\text{Sum of differences}}{21} \div \frac{100}{21}$, or simply $\frac{\text{Sum of differences}}{100}$ (or, expressed as a percentage, the sum of differences). Thus in the case before us the average deviation between the compared weights is 46·5, or 47 per cent. (nearly). This figure is useful as enabling us (taking into account the number of common items) to predict the extent of discrepancy which is likely to exist between the results of the two methods of treating the common data.

The second table presents a similar comparison between the Committee's and Mr. Palgrave's index-number ('Third Report of the Committee on Depression of Trade,' Appendix B). It has not been thought necessary to record the actual weights. Those employed in the computation of the 'relative' weights according to Mr. Palgrave were the figures of *comparative importance* given by him for the year 1885, which differ very little from the corresponding entries in previous years. The coefficient of discrepancy between the two systems being much the same as in the former comparison, we may expect much the same difference between the results; or rather one somewhat larger, since the number of common items (sixteen) is here somewhat smaller (than twenty-one).

The remaining index-numbers do not equally admit of being laid alongside that of the Committee for the purpose of comparison. They are as it were in a different plane, adopting a different formula (as well as different constants) from the Committee. In these schemes, unlike the Committee's, each comparative price is not affected with a factor or weight corresponding to its importance. *Primâ facie* every price-variation counts for one; but the principle of weight is to some extent asserted by introducing as independent items several species belonging to one genus. Thus in Mr. Sauerbeck's *unweighted* index-number, our Table 3, there figure *two* species of *wheat* and also one of *flour*; in effect assigning a weight of *three* to *wheat*. There is indeed something arbitrary in such interpretation. For in comparing this sort of index-numbers with the Committee's it is hardly possible—as in the case of the explicitly weighted index-numbers—to suppose the prices (for the common articles) to be the *same* in the two compared calculations. For example, our price of wheat is taken from the 'Gazette'; theirs may be a Mean of that price and the price of flour. Accordingly the estimate of the difference to be expected (proportioned to the total of the last column) is apt to be less accurate, to be under the mark, in these cases. A further inaccuracy affects this estimate in the case of Jevons' index-number, our Table 5, namely, that he adopted the *Geometrical* method of combining price-variations. In fact, our estimates apply only to the *Arithmetic* com-

bination of Jevons' materials, to be supplemented by the observed fact that the Arithmetic and Geometric Means of prices do not much differ.

The last table resumes the results of the first five in its first and second rows. The first row states the number of items common to the Committee with each of the compared schemes—a necessary datum for the estimate of the discrepancy likely to exist between the results. *Cæteris paribus*, this discrepancy is *inversely* proportioned to the *square root* of the number of common items. The second row gives the mean difference between the respective weights as above defined. The third and fourth rows compare the Committee's index-number with each of the others as to the extent of the materials not common to both. The comparison may be thus illustrated. Let CO represent by its length the



quantity of weight common to the Committee and the other index-number. Let CC' represent the total weight of all the articles in the Committee's system, and OO' that of the other system. The third row gives the ratio of CO to CC', and the fourth column the ratio of CO to OO'.

The last two rows give an estimate of the discrepancy likely or unlikely to occur between the results of the compared computations. This estimate involves (in addition to the data contained in the preceding rows) a constant or coefficient deduced from the course of English prices in past years: the inequality or *dispersion* of price-variations, which keeps pretty constant from year to year. The estimates are therefore only applicable to England. They are to be taken *cum grano*, with the reservations stated in various parts of the Memorandum.

Report of the Committee, consisting of Mr. S. BOURNE, Professor F. Y. EDGEWORTH (Secretary), Professor H. S. FOXWELL, Mr. ROBERT GIFFEN, Professor ALFRED MARSHALL, Mr. J. B. MARTIN, Professor J. S. NICHOLSON, and Mr. R. H. INGLIS PALGRAVE, appointed for the purpose of inquiring and reporting as to the Statistical Data available for determining the amount of the Precious Metals in use as Money in the principal Countries, the chief forms in which the Money is employed, and the amount annually used in the Arts. (Drawn up by the Secretary.)

(The bracketed numerals refer to the Remarks appended to the Report.)

UPON the first head of the proposed inquiry the Committee are unable to report favourably. They have not found data available for determining with any degree of precision the amount of gold in use as money in the United Kingdom. Several ways of making an estimate have been indicated by eminent statisticians. But it appears to the Committee that all these computations, as applied to the United Kingdom, fail; owing, not to the incorrectness of the reasoning, but the unsoundness of the data. They remark in detail upon the three methods which appear to deserve most consideration.

I. Newmarch's method, as developed by later statisticians (1), consists of the two following steps:—1. Estimate the amount of precious metal in

circulation at some initial epoch when there has occurred a general or partial recoinage, or other event favourable to the formation of a precise estimate. 2. Add thereto the coin issued from the mint in subsequent years and the coin imported, and subtract the coin withdrawn from circulation as light, the coin exported, and the coin used in the arts.

On this method it may suffice to remark that, as applied to the United Kingdom, it breaks down at the first step. For the only initial datum available is the one which Newmarch employed (2). This is based upon the fact that the light gold in 1843 amounted to 12,000,000*l.*, and the estimate that the light gold formed a third or a fourth part of the total circulation. But this estimate is too rough to permit much confidence in the result, whether 36,000,000*l.* or 49,000,000*l.* as the circulation in 1844.

But, even if that datum were admissible, the reasoning would still be nugatory, failing an estimate of the amount of coin used in the arts during the last forty years, not to insist on the imperfection of statistics relating to the export and import of coin (3).

II. The general idea of Newmarch's method is embodied in a somewhat different scheme, which is largely employed by M. Ottomar Haupt (4). In this second as in the first method we start with the amount of circulation at an initial epoch, and we proceed to add thereto and subtract therefrom. But the mode of estimating the increment and decrement is less direct. The influx and efflux are, so to speak, now observed at a greater distance from the reservoir whose contents it is desired to ascertain. The addendum is now the amount of precious metal imported into (or produced within) the country: not specie only, as before, but also bullion and, we may add, ore (5). The subtrahend is the precious metal exported, together with that which has been consumed in the arts.

The initial datum of this method being the same as for the first method is open to the same objections. And the reasoning built upon that loose foundation is rendered additionally insecure by the proved unsoundness of the statistics which profess to record the exports and imports of precious metal for the United Kingdom (6).

III. There remains Jevons' method (7). His well-known reasoning turns upon two data: 1, the proportion between the number of coins of a certain date which are now in circulation and the total number of coins of all dates which are in circulation; 2, the absolute number of coins bearing the assigned date which are now in circulation, or at any rate a number greater than, a *superior limit* to, the number of those coins.

The first datum appears to admit of being determined with some precision by the inspection of samples taken at random from the circulation. But for the absolute number of the coins bearing an assigned date it seems in general impossible to find a limit which is at once accurate and serviceable. If we take as the limit the number of coins issued from the mint during the assigned period, we are certainly on the safe side. The number of coins issued is indubitably a superior limit to the number of coins circulating. The superior limit to the total circulation which is deduced from this datum may be accepted with peculiar confidence. But this limit is too superior to be of any use for the purpose of making an approximation. Thus Mr. J. B. Martin, operating with the periods 1871-2 and 1876-7 respectively, has found by this method, as superior limits to the circulation of the United Kingdom, the figures 162,803,000*l.* and 182,321,000*l.*! It seems to be obvious, from

the known facts as to the paper circulation of countries which use paper instead of gold, and which are in circumstances otherwise analogous to those of gold-using countries—*e.g.*, Scotland, which uses one-pound notes where sovereigns are used in England—that the above figures as to gold used in England must be greatly exaggerated.

But if we attempt after the manner of Jevons to make corrections for the amount of coin exported, the imperfection of the statistical material recurs upon us with aggravated force (8).

There is added, in the case of the United Kingdom, the special difficulty that the superior limit afforded by the statistics of coinage must be enormously in excess, consisting as it does (for recent years) of the number of coins issued from the mints in Australia as well as the United Kingdom.

Altogether it appears to us that none of these methods can at present afford other than the most vague estimate of the amount of coin circulating in the United Kingdom. With respect to other countries indeed the objections which we insist upon may be less forcible (9).

The Committee have cast about how to remedy the defects which have been noticed (10). The suggestion has been made to reason from the known number of one-pound notes in Scotland to the unknown number of sovereigns in England after this manner. As the volume of transactions in Scotland is to the volume of transactions in England, so is the number of one-pound notes to the number of sovereigns (11). But however good this suggestion may be by way of criticism, and if it is carefully handled, it would not of course be sufficiently trustworthy by itself to yield a conclusion that could be relied on.

The Committee entertain the possibility of making inquiry as to the amount of coin held by different localities or by different classes (12). Such a monetary census would undoubtedly be very incomplete. But if the enumeration, though not exhaustive, were sufficiently impartial and *sporadic*, it seems possible by a cautious and methodical inference from samples to attain a rough estimate (13).

The most that can be expected from the converging lines of inquiry is that three or four very imperfect estimates should be reached by independent methods. The Mean of such estimates—a mean *weighted* according to the presumed trustworthiness of the different sources—appears to be the best result attainable (14). That the best will be imperfect is to be feared.

The second and third inquiries (as to the chief forms in which money is employed and as to the amount of money annually used in the arts) are intimately connected with the first. Accordingly we have thought it best to postpone recommendations under these heads until we have instituted the first investigation more perfectly. To this end, and in view of the extent and difficulty of the subject, we recommend that the Committee should be re-appointed for the ensuing year.

REMARKS.

(1) Mr. Kimbal, Director of the Mint at Washington, and his predecessors have elaborated 'Newmarch's Method.'

(2) See 'History of Prices,' vol. vi. Appendix XXII. There is not much objection to the *method* by which Newmarch obtains the estimate 49,000,000*l.*: namely, deter-

mining the *proportion* of light gold by an inspection of samples taken from the circulation, and multiplying the *quantity* of light gold withdrawn for recoinage by the ratio which the total circulation was found to bear to the light gold. The chief doubt is whether the inspection was made sufficiently carefully. The materials for a more accurate estimate on the occasion of the next recoinage exist in the statistics relative to the state of our coinage obtained by Mr. J. B. Martin ('Journal of the Bankers' Institute,' 1882); supposing them, of course, to be continued up to the date of the recoinage, whenever that may be.

(3) The returns of exported and imported coin published in the Annual Statement of the trade of the United Kingdom do not extend back to the year 1844. There is also the difficulty of estimating the amount of coin in the pockets of travellers; a difficulty which is perhaps peculiarly insuperable in the case of the United Kingdom, owing to the currency of the sovereign on the Continent.

(4) See 'Histoire Monétaire' and 'Währungs-Politik,' by Ottomar Haupt. The distinction between methods I. and II. is well defined by Mr. Kimbal, the Director of the Mint at Washington, in his Report for 1886 (p. 46).

(5) The import of Silver ore into the United Kingdom is not inconsiderable, as pointed out by Mr. Giffen in the First Report of the Committee on Precious Metals.

(6) As pointed out by Dr. Soetbeer ('Materials,' Exports and Imports, Taussig's translation, p. 532), there is a total failure of consilience between the recorded imports of precious metal into England from France and exports from France to England, and *vice versâ*. Not even when an average over many years is taken does an appearance of regularity arise (*loc. cit.*). And we may add that if the difference between the efflux from and influx into England—the datum with which we are immediately concerned—be deduced from the English and French statistics respectively, the results are still found to be totally disparate.

The annexed table, compiled from Dr. Soetbeer's *materials* (*loc. cit.*), shows the net influx of gold and silver into England, as deduced from the English and French statistics respectively (000's omitted).

Periods of Years	Net Influx of Gold		Net Influx of Silver	
	English Statistics	French Statistics	English Statistics	French Statistics
1871-75	-766	-38,601	- 705	-48,125
1876-80	-600	-55,414	+ 666	- 8,438
1881-84	+616	- 2,971	+1,506	- 672

On the other hand the returns of the trade in precious metals between the United Kingdom and the United States may inspire some confidence (Soetbeer, *loc. cit.*).

(7) 'Journal of the Statistical Society,' 1868; republished in 'Currency and Finance.' It is as if we should take the census of a population by, 1, ascertaining the ratio between the number of infants, say three years old, and the population of all ages; 2, the actual number of such infants. This absolute number divided by that ratio gives the total population.

A brilliant application of Jevons' method to the statistics of the circulation in France has been made by M. de Foville ('Journal de Statistique de Paris,' 1879 and 1886).

(8) It may well be that the return of exported and imported coin, or rather—what we are concerned with—the difference between these two amounts, is very inaccurate for any single year; but that in a series of years the errors tend to compensate each other. Suppose, for example, that for any single year the estimate of the difference in question is liable to an error of *fifty* per cent.; then the sum of such differences for twenty years—the sort of datum required for our first method—would be liable only to an error of *eleven* per cent. In such a case the first

method might be fairly accurate; while the third method, relying on the exports and imports of a single year (or a biennial period), would be fatally inaccurate.

Moreover, there exists in the third method a difficulty from which the first is free—as to the incidence of the exports for any year on the different strata of the circulation. This difficulty is considered by Mr. Edgeworth in a *Memorandum* on Jevons' method which he has prepared for the British Association.

(9) The careful computations made by Mr. Kimbal, Director of the Mint at Washington ('Reports,' 1886 *et seq.*), inspire confidence. In the case of the United States there is, *first*, a pretty accurate initial datum for the year 1873—on the occasion of the resumption of specie payments. *Secondly*, the statistics of exports and imports are perhaps specially deserving of confidence (cf. above, Remark 6). Mr. Kimbal seems to regard them as satisfactory. *Thirdly*, some attention has been paid to the amount of coin used annually in the arts, though hardly so much attention even yet as to command complete confidence.

(10) It has been suggested by Mr. Edgeworth, in the *Memorandum* above referred to, that Jevons' method may admit of improvement. First, the *ratio* on which the reasoning turns might be determined with greater precision by a more careful and methodical sifting of the data. This correction by itself would not come to much in view of the extreme incorrectness of the other datum (above, Remark 6). But it is further submitted that in some countries the coinage for a particular year or short period may have suffered particularly little from exportation. In fact, something of the sort appears to have occurred in France according to the statistics given by M. de Foville in the papers above referred to.

To revert to the metaphor above employed, the monetary census is effected according to Jevons' method: 1, by ascertaining from samples the proportion of, say, three-year-old infants to the total population; 2, in the absence of accurate data for the number of three-year-old infants now *alive*, the number of infants *born* three years ago. Now suppose, as M. de Foville shows grounds for supposing, that a particular generation escaped in an extraordinary degree the maladies to which infancy is liable; then it might be the best plan to operate, not on infants, as usually taken for granted, but upon that favoured generation, already, perhaps, adult or even superannuated, always supposing that the other datum, the *ratio* determined by sampling, can be ascertained for the favoured generation with adequate precision. But this appears to be doubtful, owing to the circumstance that the generations appearing to enjoy extraordinary longevity consist each of comparatively few individuals. Now a deserved suspicion attaches to the use of *small numbers* in statistics. At any rate, it is not contended that the correction would have any application to the United Kingdom.

(11) In comparing the use of sovereigns in England and one-pound notes in Scotland it would be desirable if possible to make an allowance for the difference which may exist in the use of half-sovereigns in the two countries; and for other differences.

(12) As a specimen of the results which may be attainable, we submit an estimate obtained by Mr. R. H. Inglis Palgrave with respect to a particular town. This town contains about 6,000 inhabitants. It is a railway junction, and also stands upon a river by which seagoing vessels can reach the place. There is also a considerable inland navigation connected with it. The surrounding district is agricultural. The town may be regarded as above the average in prosperity for the agricultural districts. In this town Mr. Palgrave estimates, as the result of investigations set on foot by him, that there would be on an average, taking one time with another, about 4,000*l.* in coin in the hands of the population; that is to say, about 15*s.* a head in gold and silver. This estimate does not include the specie held by the banks. The proportion of gold to silver is about 4:5. Mr. Palgrave is more certain about this proportion than about the absolute amounts. He thinks the latter may be exaggerated, as the country districts surrounding the town are to a certain extent included in the supply of specie mentioned. If this estimate were a fair average it is quite possible that, including the country population referred to in the districts surrounding the town in question, the whole specie in active circulation may not exceed 12*s.*, or even 10*s.*, a head. Further investigation on the point is highly desirable.

(13) Laplace—by a calculation strikingly analogous to Jevons' method above stated—has shown ('Théorie Analytique des Probabilités,' Book II. Chapter VI.) how the method of inference from samples may be used to ascertain the 'population of a great empire.' There is no doubt that this method of reasoning is agreeable to a sound theory of Probabilities, although in incompetent hands it has often produced absurd results. We must guard against proceeding like the statistician mentioned by M. de Foville, who, in order to determine the production of potatoes in France, simply multiplied the production in his own commune by the number of communes in France—with a result out by a hundred per cent.

(14) Supposing the quantity of the circulation as estimated by four different methods of varying trustworthiness were respectively Q_1 , Q_2 , Q_3 , and Q_4 (in ascending order of worth), then the proper Mean might be

$$\frac{Q_1 + 2Q_2 + 3Q_3 + 4Q_4}{1 + 2 + 3 + 4}$$

MEMORANDUM BY THE SECRETARY ON JEVONS' METHOD OF ASCERTAINING THE NUMBER OF COINS IN CIRCULATION.

PART I.—EXPOSITION.

Jevons' method consists of two stages: (1) the main line of argument, and (2) what may be called a second approximation.

(1) The first step is to ascertain the proportion in the existing circulation of coins bearing each date, or, as¹ Jevons puts it, the number of coins bearing any assigned date, 'now existing in 100,000 [coins] circulating.' This *datum* is obtained by examining a great number of coins taken at random from the circulation.² It is assumed that the proportions in which this collection of samples comprises coins of different dates are approximately identical with the proportions which would be presented if we could examine the whole existing circulation. We have thus:

Total number of coins in circulation : Number of coins of a certain date in circulation :: Total number of samples : Number of samples bearing the assigned date. Whence

Total number of coins = $\frac{\text{Total number of samples}}{\text{Number of samples bearing a certain date}} \times \text{Number of coins of that date in circulation.}$

Now the number of coins of any date now in circulation is *less* than the number of coins of that date issued from the Mint. Whence it follows that the total number of coins in circulation is *less* than

$\frac{\text{Total number of samples}}{\text{Number of samples bearing a certain date}} \times \text{Number of coins of that date issued from the Mint.}$

We have thus a figure certainly greater than—a 'superior limit' to—the total number of coins in circulation. Or rather we have, or may have, a

¹ *Jour. Stat. Soc.*, 1868, p. 440; *Currency and Finance*, p. 264.

² The principal instances of this operation known to the writer are, for England 165,510 coins (sovereigns and half-sovereigns) examined by Jevons in 1868; 251,107 by Mr. Martin in 1882 (*Journal of the Institute of Bankers*, 1882); by the French Government 2,222,965 coins (of different kinds) examined in 1878, 1,791,808 in 1885 (*Bulletin de Statistique, France*, 1878, 1885); in Belgium, 1878, 103,475 coins by the *Banque Nationale*, 83,599 by the *Ministère des Finances* (*Bulletin de Statistique, France*, 1878). Of the *enquête* said to have been made in France in 1868 the writer has not been able to find any particulars.

great many superior limits, one being afforded by each year (or at any rate each short period¹ of years) as far back as our data reach: in England as far back as 1817, in France 1803.

It remains then to consider which of all these data it is best to employ. Evidently the smallest superior limit will be afforded by the year (or short period) for which the
$$\frac{\text{Number of coins issued}}{\text{Number of coins now in circulation}}$$
 is a minimum; in other words, that year whose coinage has suffered least loss. Now *à priori* there is a presumption that the coinage which has been longest in circulation will have lost most. And this theoretical conclusion is corroborated by observation. It is shown by Jevons that the 'proportions of coinage surviving' are smaller for the older coinages.² The general truth of the proposition is similarly confirmed by the results of the French *enquêtes*.

It is proper, therefore, to select a recent coinage as that which should enter into the formula above given.³ Accordingly Jevons (writing in 1868) takes the period 1863-4 as his basis. The number of sovereigns coined in that period, 14,578,000*l.*, is to be diminished⁴ by 600,000 known not to have entered into circulation. The remainder, 14,000,000 (nearly), is to be multiplied by $\frac{10,000,000}{13,671}$; this being the ratio of the total number of sample sovereigns to the number of samples of sovereigns dated 1863 or 1864. The result is 75,000,000, to which may be added certain sums known not to have entered into circulation, but to be 'lying in bags as received from the Mint' in the Bank of England.

By similar reasoning⁵ De Foville finds, as a superior limit to the number of twenty-franc pieces in France, 175,000,000.

De Foville places this reasoning in a somewhat different shape, or rather in two different shapes. The substantial identity of the various forms may best be contemplated by the aid of symbols. Let E be the required total number of coins in the existing circulation. Put S for the total number of samples, and $s_1, s_2, \dots, s_r, \dots$ for the number of samples bearing date year 1, 2, 3, &c., respectively (the years⁶ being reckoned either onwards from the date of the oldest coin in circulation, or backwards from the most recent period). Let the number of coins issued from the Mint for the corresponding years be c_1, c_2, \dots, c_r . By the reasoning above stated

¹ Owing to the practice which used to prevail of coining with dies which had become out of date, it may not be safe to treat the yearly return as perfectly accurate. See, on the practice alluded to, Jevons, *Currency and Finance*, p. 280; Martin, *Journal of the Institute of Bankers*, 1882, p. 311; De Foville, *Journal de Statistique*, 1886, p. 11.

² *Currency and Finance*, p. 281. Jevons, in the passage referred to, is calculating what may be called the absolute proportion of each coinage surviving; but for our present purpose it is sufficient to know how many times the diminution, or mortality so to speak, of one coinage is greater than that of another. For this purpose we need not suppose, with Jevons in the passage referred to, the total number of coins in circulation to be known. We are concerned here only with the *proportions* between the figures in the second column of Jevons' table at p. 281; and for that part of Jevons' conclusion we do not require the whole of his premisses. We can deduce immediately from the table at p. 264 that part of the table at p. 281 which we here require; namely, that the proportion surviving of coins issued in '63-64 is greater than the corresponding proportion for the period '59-62, and still greater than the proportions for the earlier periods.

³ This general rule and the possible exceptions are illustrated by the diagram on p. 8. The whole matter is placed by De Foville in a clear light (*Journal de Statistique*, 1879, p. 36; 1885, p. 12).

⁴ *Currency and Finance*, p. 265.

⁵ *Journal de Statistique de Paris*, 1878 and 1885.

⁶ Or short periods. See note 2 above.

$E < \frac{S}{s_r} c_r$. One of the forms into which De Foville throws this inequation is $E < \frac{S}{s^r} c_r$. ('Journal de .. Statistique,' 1886, p. 14). Another form (suggested in his paper dated 1879) is $c_1 + \rho_2 c_2 + \rho_3 c_3 + \&c.$; where the years (or short periods) are reckoned backwards from the present, and where $\rho_2, \rho_3, \&c.$, are fractions corresponding to the greater loss which the coinages of early periods, as compared with the most recent, have undergone.

Let e_1, e_2 be the (unknown) number of coins bearing each date in the existing circulation. By hypothesis

$$\frac{E}{S} = \frac{e_1}{s_1} = \frac{e_2}{s_2} \dots = \frac{e_r}{s_r} \dots \dots \dots (1)$$

Also $E = e_1 + e_2 + \&c. + e_r \dots \dots \dots (2)$

$$= \frac{e_1}{c_1} \left[\begin{array}{cc} \frac{e_2}{c_2} & \frac{e_r}{c_r} \\ c_1 + c_2 \frac{e_2}{e_1} + \&c. + c_r \frac{e_r}{e_1} & \\ c_1 & c_1 \end{array} \right]$$

$$= \frac{e_1}{c_1} \left[\begin{array}{cc} \frac{c_1}{c_1} & \frac{c_1}{c_1} \\ c_1 + c_2 \frac{e_1}{e_2} + \&c. + c_r \frac{e_1}{e_r} & \\ e_2 & e_r \end{array} \right]$$

Now each of the fractions of the form $\frac{e_1}{e_r}$ is reducible to $\frac{c_1}{s_r}$; multiplying both the

numerator and denominator by $\frac{E}{S}$ and taking account of equation (1). The factors in this new shape are known quantities derivable from our data. Call them $1, \rho_2, \rho_3 \dots \rho_r$, respectively. Then we have

$$E = \frac{e_1}{c_1} [c_1 + \rho_2 c_2 + \&c. + \rho_r c_r]$$

Whence, as $\frac{e_1}{c_1}$ is a proper fraction (or at any rate not greater than units), we have

$$E < \text{(or at most =)} C_1 + \rho_2 c_2 + \&c. + \rho_r c_r.$$

A geometrical illustration may put the matter in a clearer light. In the annexed diagram the line SS' represents the total number of samples, and its segments $s_1, s_2, \&c.$, the number of samples bearing date 1, 2, 3, &c. The line EE' , divided into the proportionate segments $e_1, e_2, \&c.$, represents the total number of coins in circulation and the numbers thereof bearing each date. The numbers of coins issued from the Mint each year are represented by the lines $c_1, c_2, \&c.$ In general, the more recent the year, the less has the coinage of that year lost, the smaller is the ratio $\frac{e}{c}$. But, as we shall have occasion to remark afterwards, there may be an exception to this rule, as the figure shows in the case of the year 5.

Now the essence of the reasoning is that $EE' < C_1 C_1'$ (and than any corresponding line, e.g., $C_2 C_2'$). Whether is it easier to say (a) with us, $EE' < \frac{SS'}{s_1} c_1$ or (β) after

De Foville's second redaction (1885) $EE' < SS' \frac{c_1}{s_1}$, or (γ), in the spirit of his first paper, $EE' < c_1 + a_2 + a_3 + \&c.$, where $a_2, a_3, \&c.$, are the remaining segments of the line $C_1 C_1'$. Any of these segments a may thus be expressed in terms of c_r and other known quantities:

¹ $\beta_1, \beta_3 \&c.$ might be used to designate the 'remaining' segments of $C_2 C_2'$.

$$a = \frac{CC'}{SS'} s_r = c_r \frac{CC'}{SS'} \frac{s_r}{c_r} = c \frac{c_1 s_r}{s_1 c_r} = c_r \frac{s_1}{c} = \text{say } c \rho .$$

Whence

$$EE' < c_1 + \rho_2 c_2 + \rho_3 c_3 + \&c.$$

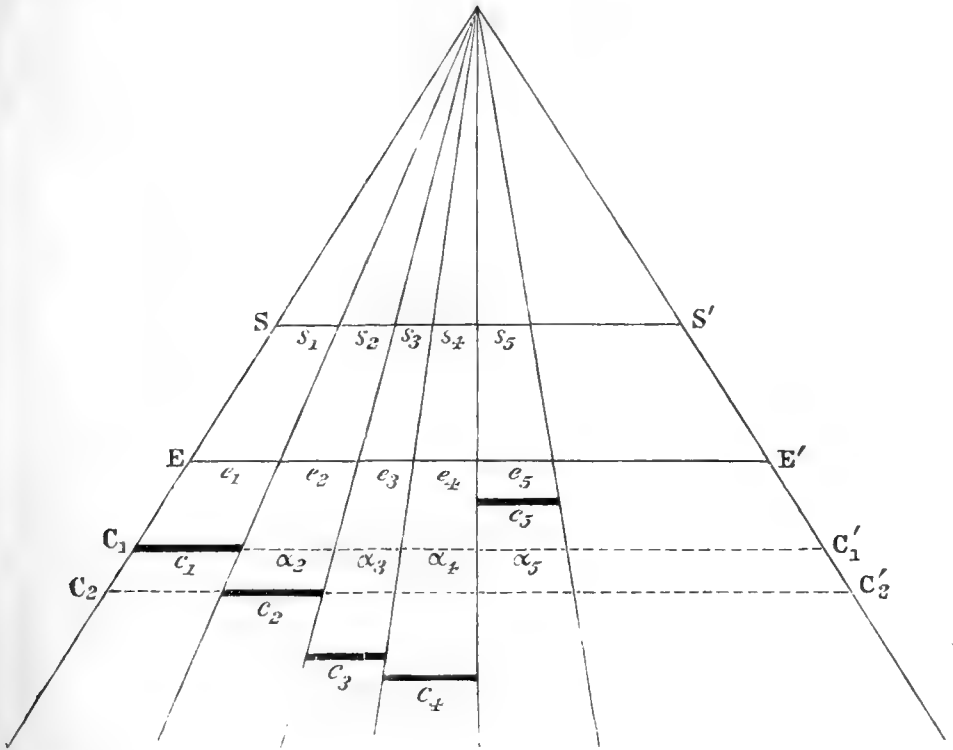

(2) Jevons attempts to improve upon the result which has been obtained by means of a second approximation. He seeks a nearer limit to the total number of coins by subtracting from the number of coins issued from the Mint in the most recent period (which forms the datum of the first approximation) a certain proportion which may be known to have been exported.¹ The coinage of 1863-64 forming the basis of his calculation, he ascertains the quantity of coin exported during the short interval of time (1865-67) between the end of that period and the date at which he wrote, which quantity proves to be 8,664,653. He then goes on: 'There are no means of determining from the above, with accuracy, how much of the coinage of 1863-64 has been exported; but as exporters prefer the newest and heaviest coin, we are probably within the truth in assuming that the sovereigns of 1863-64, which form about one-fifth of the sovereign currency, also form one-fifth of the above exports.' Accordingly he subtracts from 14,578,000, the number of sovereigns issued from the Mint in 1863-64 (which constituted the uncorrected datum of the simpler² calculation) one-fifth of 8,664,653. He thus succeeds in obtaining a considerably lower limit than by the uncorrected method.

This reasoning admits, or should admit, of being expanded and illustrated as follows. In the annexed figure let the height of each column up to the unbroken

¹ *Currency and Finance*, p. 267.

² Above, p. 225.

line represent the numbers of coins of each date existing in the circulation at the end of the most recent period designated 1. At that time let exportation act for a short period. Its ravages falling unequally on columns 1, 2, 3, &c., the elevation of

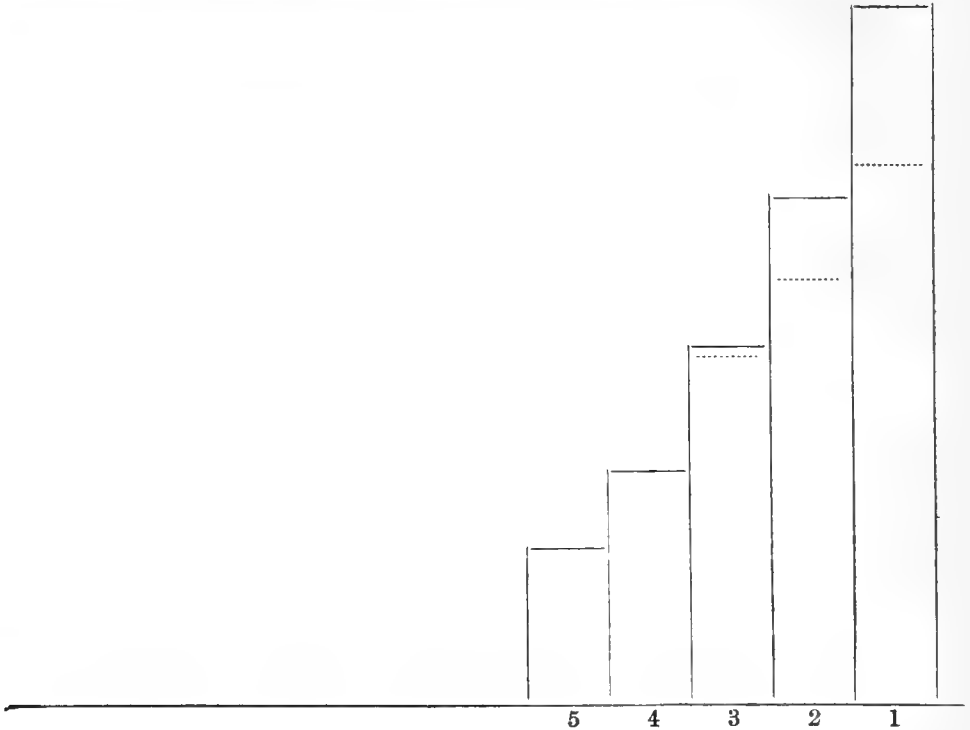

the *broken* lines will represent the new distribution of proportions. Call the new heights $h'_1, h'_2, \&c.$, the old heights being $h_1, h_2, \&c.$ At the beginning of the short period of exportation at least $\frac{h}{Sh}$ of the initial exportation falls upon column 1. At the end of the period at least $\frac{h'}{Sh'}$ of the later drains are taken from that column. Now $\frac{h}{Sh}$ is greater than $\frac{h'}{Sh'}$. Hence for the *whole* period at least $\frac{h'}{Sh'}$ of the total exportation falls upon column 1; $\frac{h'}{Sh'}$ being the proportion of coins dated 1 existing in the circulation at the end of the period of exportation.

It is thus that Jevons argues, or must be supposed to argue: that, as the coinage of 1863-64 constituted in 1868 about one-fifth of the then existing circulation, therefore at least a fifth of the exportation during the period 1865-67 must have fallen upon the coinage of 1863-64.

PART II.—CRITICISM AND CORRECTION.

In criticising this method we may adopt the same order as in expounding it, and separately consider the reasoning which constitutes the first and the second approximation. (1) The fundamental position of the argument is undoubtedly sound, provided that the proportions derived from the inspection of sample collections are sufficiently accurate. For the validity of these data (in the case of one of them at least) we have the high authority of Jevons. 'I feel certain,' he says, 'after drawing up

many averages, that this proportion must be very near the truth.'¹ Still stronger evidence is supplied by the consilience between the results of the French *enquêtes* made in 1878 and 1885. The two curves which represent the proportions in which the circulation in the years 1878 and 1885 respectively comprised coins of each date earlier than 1878 correspond, not only in their general character, but even as to their minuter traits.²

If further accuracy is required, it would be proper to apply the Mathematical Method of Statistics, the doctrine of Errors, to the data. The case is as if we had observed the proportion of males in a great number, say 100,000, births taken at random, so to speak, from the general population. We might suppose a number of subdistricts all over the country selected on some random principle (such as the alphabetical order of their initial letter) and the birth-rate observed for the heterogeneous aggregate thus formed. It is required to determine with what accuracy we can infer, from this aggregate of samples, the proportions prevailing in the total number of births, say 1,000,000, appertaining to the entire population. Suppose that for the aggregate of 100,000 the observed ratio was .51. What extent of deviation from that ratio are the returns for the entire population likely to present?

The proper course would be to break up the aggregate of 100,000 samples into a good number, say 50 (or 25), of smaller parcels consisting each of about 2,000 (or 4,000) units. Let the proportion of male births in each of these small groups be observed. Call these partial ratios r_1, r_2 , &c. . . . r_{50} ; the ratio for the entire aggregate being .51. Form the mean-square-of-error

$$\frac{(\cdot 51 - r_1)^2 + (\cdot 51 - r_2)^2 + \&c. + (\cdot 51 - r_{50})^2}{50};$$

and put the square-root of double the mean-square-of-error, say μ , for the *modulus*, that constant upon which all the higher operations of the Calculus of Probabilities turn. The modulus for the proportion of male births in a group of 2,000 being μ say .016,³ the modulus for the same ratio in an aggregate of 100,000 births should be $\frac{\mu}{\sqrt{50}}$; or some rather

larger figure which good sense tempering theory may prescribe, say .003. Then we may affirm with confidence that the ratio presented by 100,000 births will not differ from that which would be presented by a much larger number by more than $3 \times .003$; and, therefore, that the proportion of males in 1,000,000 births does not differ from .51 (the observed proportion in 100,000) by more than the calculated limit of error, say .01.

These are not mere anticipations of theory, but practical rules which have been verified by copious experience.

For illustrations of the Theory of Errors applied to statistical reasoning see the writer's 'Methods of Statistics,' *Journal of the Statistical Society*, jubilee vol. 1885, and 'Methods of Ascertaining Rates,' *ibid.* Dec. 1885. It may be observed that in the illustration just given we are not, as in most statistical inductions, inferring from what has been observed of one time or place, to what is true of another time or place; but, from the constitution of samples selected at random to the constitution of the aggregate from which they were taken. The validity of the inference depends upon the impartiality of the selection.

¹ *Currency and Finance*, p. 265.

² See De Foville, *Journal de Statistique*, 1886, p. 12, and *Bulletin de France*, 1885.

³ As may be gathered from the researches of Professor Lexis.

Another illustration may make this point clearer. Suppose that we took 700 hexameters from the 'Æneid,' not *en bloc* from one or two books, as described in the papers referred to, but by a perfectly random process from the whole poem indiscriminately. Suppose (as is likely enough) that these samples being examined should yield the same modulus for the proportion of dactyls as was afforded by the actual specimens examined by the writer: namely .3 (for lines of four feet, the almost unvarying last two feet of the hexameter being left out of account). In this case we may be fairly certain that the proportion of dactyls presented by the sample, say .4, will not differ from the proportion in the whole 'Æneid' by more than $3 \times \frac{.3}{\sqrt{700}}$, say .035. He who carefully considers the verifications adduced

in the second of the papers referred to cannot reasonably doubt this proportion, or, rather, will not feel more than the theoretical degree of uncertainty about it.¹

But when, as in the actual statistics to which reference has been made, the specimens have not been selected with indiscriminate impartiality, then the inductive hazard in inferring from a part to the whole becomes more serious. Even then, however, the inference may be sufficiently safe if inspection has convinced us of the general homogeneity of the total aggregate concerning which we wish to draw a conclusion. The 700 Virgilian lines examined by the writer, though far from being perfect samples, seem still to justify an inference as to the constitution of the whole 'Æneid.' There being in the whole poem some 9,900 lines, it is reasonably certain that a superior limit to number of dactyls in the 'Æneid' is given by the following formula, in which account is taken of the *fifth foot* and of the unfinished lines; whose number we shall call *n*.

Total number of dactyls in the 'Æneid' is less than

$$4(9900 - n) \left(.4 + 3 \frac{.3}{\sqrt{9900 - n}} \right) + \text{number of dactyls in the } n \text{ unfinished lines} \\ + (9900 - n - \text{number of spondaic lines}).$$

We ought similarly to test the validity of the ratio which constitutes the foundation of the Jevonian argument. We should break up the aggregate of samples into some fifty parcels, observe the ratio for each batch, and thence extricate the necessary coefficient. Of course it would be desirable to employ judgment in testing the worth of our result. We might notice, for instance, whether the modulus derived from one half our samples was much the same as that which the other half yielded. We should observe whether the modulus for batches of 4,000 is as much less as it ought to be than the modulus found for batches of 2,000. Such inspections intelligently performed would suggest to what extent the general rule above exemplified might require some relaxation in view of the specially loose character of our materials.

We shall thus determine the utmost extent of error which we are likely to commit in putting the observed ratio

$$\frac{\text{Number of samples bearing a certain date}}{\text{Total number of samples}} \left(\text{say } \frac{s_1}{S} \right)$$

for the (unknown) ratio $\frac{\text{Number of coins of that date in circulation}}{\text{Total circulation}}.$

Call this maximum of error (which may be either in excess or defect) λ . By means of this datum we can correct the superior limit (to the circulation) obtained lately.

That superior limit, it may be recollected, was—

$$\frac{\text{Total number of samples}}{\text{Number of samples bearing a certain (recent) date}} \times \text{coins issued}$$

¹ One source of uncertainty is that the determination of the modulus from a limited number of observations is liable to a certain error.

from the Mint at that date; ¹ in symbols $\frac{S}{s_1} c_1$. But we have now to take account that $\frac{S}{s_1}$ may be too small. It may be as much too small as $\frac{s_1}{S}$ may be too large. The true ratio which $\frac{S}{s_1}$ represents cannot then be larger than $\frac{1}{\frac{S_1 - \lambda}{s}}$. That expression, multiplied by c_1 , constitutes a perfectly safe superior limit—comparable to the *safe load* or *breaking load* of mechanical construction.

No doubt a similar degree of evidence might be attained by repeated *enquêtes*, such as those performed by the French Government. The marvellous consilience between most of the ratios yielded by the samples of 1878 and 1885 goes far, as already observed, to establish the accuracy of those ratios. It is, however, desirable, for the purpose of exact computation, to have a *numerical* limit to the possible error of each proportion which we utilise. And, at any rate, it is philosophical not to expend labour in increasing our materials, when the same amount of evidence could be crushed out of a smaller quantity of material by a properly directed scientific process.

Moreover, if this operation be performed, we shall be able, so to speak, to cut the argument much more finely; to obtain a smaller, perhaps much smaller, superior limit than would be safe for the empirical statistician. It will be recollected that a coinage of recent date was selected as the basis of our calculation, because, in general, recent coinages have suffered less loss. But there is some evidence that there are exceptions to this rule. Now, if this evidence were confirmed by rigid application of the mathematical test, we might obtain a much more favourable basis for the calculation than it has hitherto been safe to employ.

The matter is placed in a very clear light by the French statistics, which tabulate for each year the ratio $\frac{\text{Number of samples}}{\text{Number of coins issued}}$ (in De Foville's notation y). Now the expression for the superior limit may, after De Foville, be written

$$\frac{\text{Number of coins issued}}{\text{Number of samples}} \times \text{Total number of samples.}$$

For our purpose, to find the smallest superior limit, the *largest value* of the ratio designated by the French as y would be the best, provided that it is accurate.

De Foville employs a ratio of about $\frac{2}{1000}$; but there occur in the French statistics the entries 7, 12, 17, nay 26 (each to be divided by 1000); and in the Belgian statistics much more startling proportions. Supposing we were assured that $\frac{4}{1000}$ was a genuine ratio (the coinage of the particular year corresponding having suffered particularly little—a quite reasonable supposition, as De Foville shows), then, the number

¹ See above, p. 225 and p. 227.

of samples being 384,302, for our superior limit we should have $\frac{384,302,000}{4} = 96,000,000$ (pieces of 20-francs) nearly; whereas De Foville has 175,000,000.

(2) We have now to criticise the logic of the 'second approximation' which takes into account the exportations of coin. The reasoning which has been described appears to be formally correct provided that the period during which the exportation is supposed to act is sufficiently small; ideally diminished in the spirit of the differential calculus. But it is a matter of delicacy extending the conclusion to cases in which the 'period' cannot be regarded as infinitesimal. An illustration, Jevons' own, will best exhibit the difficulty. Jevons argues that, as the coinage of 1863-4 constitutes about one-fifth of the existing circulation, therefore at least a fifth of the exportation during the period 1865-7 must have fallen upon the coinage of 1863-4. But how is it known that the main part of the exportation of 1867 (or even 1866) did not fall upon the coinage of 1865?

But it is needless to examine how much the reasoning leaks here, if a more serious gap is caused by the omission of all reference to imported coin. How do we know that the imports during the later portion of the period of 1865-7 did not bring back many of the coins which the exports at the beginning of the period had taken away?

The following correctives are suggested. For a certain period (such as Jevons selected, 1865-7, or shorter) observe *samples* of the exports and imports (opening and examining many outward-bound treasure-chests) and thereby determine the proportion both of the exports and of the imports (for that period) which consists of coins belonging to a certain recent period corresponding to Jevons' 1863-4. Then we may reason thus; placing ourselves in imagination at Jevons' epoch 1868 (or, *mutatis mutandis*, in 1888).

(1) Number of coins dated '63-4 now in circulation = *at most* number of coins issued '63-4 *minus* (proportion of exports '65-7, consisting of coins '63-4) \times (exports '65-7) *plus* (proportion of imports '65-7, consisting of coins '63-4) \times (imports '65-7) *minus* bags in Bank of England, as mentioned by Jevons (and other known items).

(2) (Total number of coins (of all dates) in circulation) \times proportion of coinage '63-4 in existing circulation (found by sample) = number of coins dated '63-4 in circulation.

(3) Total number of coins in circulation is *greater than the right-hand member of equation*, or rather *in-equation* (1), *divided by* proportion of coinage '63-4 in existing circulation.

This reasoning takes for granted that the invisible or unregistered exports are compensated, or at least not exceeded, by the imports of the same species. It must be assumed also—what has been doubted upon good authority¹—that the statistics which we have are fairly accurate. A chink in the logical structure may be filled up; but rottenness of the statistical material is irreparable.

¹ See Soetbeer's *Materialen*, p. 48. It is possible that the conditions necessary for the application of Jevons' method may fail for the United Kingdom, but may be partially fulfilled for some other of the 'principal countries' which are comprehended in our province.

Fourth Report of the Committee, consisting of Dr. E. B. TYLOR, Dr. G. M. DAWSON, General Sir J. H. LEFROY, Dr. DANIEL WILSON, Mr. R. G. HALIBURTON, and Mr. GEORGE W. BLOXAM (Secretary), appointed for the purpose of investigating and publishing reports on the physical characters, languages, and industrial and social condition of the North-Western Tribes of the Dominion of Canada.

THE Committee report that, in addition to Mr. Wilson, of Sault Ste. Marie, who contributes some valuable remarks upon the Sarcee Indians, they have been enabled to secure the services of Dr. Franz Boas (now of New York, and one of the editors of 'Science'), who has been for several years engaged in ethnological investigations in America, particularly among the Eskimo and in British Columbia, and who has consented to return to that province for the purpose of continuing his researches there on behalf of the Committee, and in accordance with the instructions comprised in their 'Circular of Inquiry.' Only eight or nine weeks—in May, June, and July last—were available for his trip, but, with the advantage of the experience and information obtained in his previous journey, he has been able to gather a large mass of valuable material. The results of his inquiries will be given in his final report, to be presented next year. For the present occasion he has prepared some preliminary notes, with an introductory letter (addressed to Mr. Hale), containing a brief account of his proceedings, and some important suggestions concerning future inquiries and the condition of the Indians of that province. The letter is as follows:—

'I beg to transmit the following report of my proceedings, with preliminary notes on the results of my researches in British Columbia. In your instructions dated May 22, 1888, you made it my particular object, on the present trip, to obtain as complete an account as possible of the coast tribes and their languages. As on my previous journey, in the winter of 1886-87, I had collected a considerable amount of material respecting the southern tribes, I turned my attention at once to the Indians inhabiting the northern parts of the coast, including the Tlingit. On June 1 I arrived in Vancouver, and after ascertaining certain doubtful points regarding the Skqomish, who live opposite the city, I proceeded to Victoria on June 3. Mayor J. Grant, of that city, kindly gave me permission to take anthropometric measurements of such Indians as were in gaol. This proved the more valuable, as the natives were very reluctant to have any measurements taken. I sought to obtain measurements and drawings of skulls in private collections in Victoria, and was fortunate enough to be able to measure eighty-eight skulls from various parts of the coast. The results of these measurements must be reserved for the final report. I will mention only the remarkable fact that skulls of closely related tribes show great and constant differences. Comparisons of ten skulls each from Victoria, Sanitch, and Comox give the following results:—

	Length Mill	Length-breadth Index	Length-height Index
Victoria . . .	184.5	77.7	75.0
Sanitch . . .	161.0	95.5	80.8
Comox . . .	176.6	77.9	77.4

These differences are in part due to artificial deformation. It seems, however, that this explanation is not sufficient. These tribes belong to the Salish stock.

‘As soon as an opportunity offered to start northward, I left Victoria and stayed the greater part of June in Port Essington, where I studied the customs and language of the Tsimshian, and obtained notes on the Haida. When returning to Victoria a few Hēiltsuk from Bella Bella were on board the vessel, and I obtained notes on this tribe, which supplement to some extent my former observations. After my return to Victoria I took up the Tlingit and Haida languages, and when several canoes from the west coast of Vancouver Island arrived, that of the Nutka. In the beginning of July, Father J. Nicolai, who is thoroughly conversant with the Nutka language, arrived there from Kayokwaht, and in a number of conversations gave me valuable information regarding the grammar of that language. I obtained information respecting their legends and customs from a few natives, and on July 11 went to the mainland. After staying two days in Lytton I proceeded to Golden and up the Columbia river, in order to devote the rest of the available time to the Kootenay. On July 26 I returned east.

‘The results of my reconnoissance are necessarily fragmentary, as I was not able to devote more than a few days to each tribe. I obtained, however, sufficient material to determine the number of linguistic stocks, and the number of important dialects of those stocks which I visited. The vocabularies which I collected during my former and on the present trip contain from 500 to 1,000 words, and embrace the following languages: Tlingit, Haida, Tsimshian, Kwākiutl (Hēiltsuk and Lekwiltok dialects), Nutka, Salish (Bilqula, Pentlatsh, Comox, Nanaimo, Lkungen, Sishiatl, Skqomish, Ntlakápmuq dialects), and Kootenay. I obtained, also, grammatical notes on all these languages, and texts in some of them.

‘I may be allowed to add a few remarks on future researches on the ethnology of British Columbia. Only among the tribes from Bentinck Arm to Johnson Strait the customs of the natives may be studied uninfluenced by the whites. But here, also, their extinction is only a question of a few years. Catholic missionaries are working successfully among the Nutka; the fishing and lumbering industries bring the natives of the whole coast into closer contact with the whites. In all other parts of the country, except on the upper Skeena, the student is, to a great extent, compelled to collect reports from old people who have witnessed the customs of their fathers, who heard the old myths told over and over again. In the interior of the province even these are few, and it is only with great difficulty that individuals well versed in the history of olden times can be met with. After ten years it will be impossible in this region to obtain any reliable information regarding the customs of the natives in pre-Christian times. Even the languages are decaying since the advent of the whites and on account of the extensive use of Chinook. Young people neither understand the elaborate speeches of old chiefs nor the old songs and legends when properly told. Even the elaborate grammatical rules of these languages are being forgotten. For instance, old Nutka will never form the plural of the verb without reduplication, while young men almost always omit it. Instead of the numerous modi, phrases are used—in short, the languages are decaying rapidly. The study of the anthropological features of these races is also becoming more and more difficult on account of their frequent intermarriages with whites; and the

consequent difficulty of finding full-blood Indians. The once abundant material of old native crania and skeletons lying scattered all over the province is becoming more and more scarce as it decays and the country is being reclaimed.

‘It is nowhere sufficient to study languages alone in order to solve ethnological problems; but in this province the study of a large amount of anthropological material is an absolute necessity on account of the diversity of languages and the great dialectic differences in some of them. The Salish stock in British Columbia, for instance, is spoken in eleven dialects, which are each unintelligible to the speakers of the others. It would be of great importance to study the anthropological features of this race, the northern tribes of which are physically very much like the Kwākiutl.

‘Last of all I mention the antiquities of the province. Valuable relics are destroyed every day. They are turned up by the plough and thrown away: graves and mounds are levelled, shell heaps are used for manuring purposes, cairns are removed. The destruction will be very thorough, as those parts in which relics are found are at the same time those which are the earliest to be reclaimed.

‘For all these reasons an early study of the ethnology of the province must be considered a necessity. In the course of a few years much might be done to preserve the most important facts. The languages might be reduced to writing, the interesting poems and songs that are still afloat might be preserved, we might obtain a complete account of the mythology, and sufficient material for anthropological researches. A few years hence it will be impossible to obtain a great part of the information that may now be gathered at a comparatively slight expense.

‘I cannot close these remarks without adding a few words on the present state of the Coast Indians. It is well known that they have been greatly reduced in numbers since the advent of the whites, and that they are still diminishing. It is also well known that, with few exceptions, they have made no progress whatever. The reasons for these facts are easily understood: the natives become accustomed to products of our manufacture, and in order to purchase them become servants where they have been masters before. At the same time their native industries decay. This process is hastened by the influence of missionaries, who discourage all native arts, as connected with their heathenish customs, without being able to supply anything in their stead. Thus the psychical life of the natives is impoverished, and this, I think, accounts principally for their rapid degradation after their first contact with the whites. The only way to civilise these tribes is clearly shown by Mr. W. Duncan’s success at Metlakahtla. He made the Indians of Metlakahtla a self-sustaining, independent community. Similar results are gradually being obtained in other places, and these results show that the establishment of independent industries on co-operative principles will educate the Indians and make them capable of becoming useful members of the State. The easiest and soundest way to do this is to encourage native industries and arts—fishing and working in wood. At the same time the natives ought to be educated to a more sanitary way of living. This can be attained only by putting energetic medical men in charge of Indian districts. There can be no doubt that an intelligent man, capable of adjusting his argument to the mind of the Indian, would easily induce them to a thorough sanitation. The Indians do not individually give up their old customs, but invariably do so in council. By gaining their confidence, the council

could be easily induced to listen to sound advice. I do not believe that it is too late to save the Indian from utter destruction; and we may still hope that the spectacle of an intelligent race becoming more and more degraded and vanishing from the earth's surface will cease to exert its saddening influence upon the traveller who visits the shores of British Columbia.'

To this letter Dr. Boas adds the following:—

PRELIMINARY NOTES ON THE INDIANS OF BRITISH COLUMBIA.

Although the Indians of the north-west coast of America belong to a great number of linguistic stocks, and although their physical peculiarities suggest that they belong to various races, their customs are so much alike that it is impossible to describe one tribe without having reference to all the others. For this reason it is necessary in a general survey to treat their languages and their physical and ethnographical character separately, although from the standpoint of the psychologist it would seem more desirable to describe each tribe by itself.

The following are the principal races inhabiting the province, including the coast strip of Alaska: 1. the Tinnè (or Tinneh), who occupy the interior from the extreme north to Quesnelle and Chilcot in the south. 2. The Tlingit, on the coast of Alaska; and the Haida, on Queen Charlotte Islands and the southern part of Prince of Wales Archipelago. 3. The Tsimshian, on Nass and Skeena Rivers and the adjoining islands. 4. The Kwākiutl, from Douglas Channel to the central part of Vancouver Island, excepting the west coast of that island and Dean Inlet and Bentinck Arm. 5. The Nutka, of the west coast of Vancouver Island and Cape Flattery. 6. The Salish, on the south-eastern part of Vancouver Island, on the mainland as far as Quesnelle Lake and Selkirk Range, and on Bentinck Arm. 7. The Kutonaqa, on Kootenay Lake and River, and on the Upper Columbia.

[Dr. Boas here gives brief notes on the grammatical structure peculiar to each of the six linguistic stocks which he has studied—the Tlingit (and Haida), Tsimshian, Kwākiutl, Nutka, Salish, and Kutonaqa. It has seemed advisable, however, to defer the publication of these notes until they can appear in fuller form in the final report, where they will be accompanied by the comparative vocabularies and the ethnographical map, and can have the benefit of the author's revision of the proofs.]

In the Indian words comprised in this report the vowels are to be pronounced as in Italian, and the consonants, for the most part, as in English. The letters *k'* and *g'* represent deep gutturals corresponding to the ordinary *k* *g*. The *h* represents the German *ch* in *ich*. The *q* denotes the sound of the Scotch *ch* in *loch*. By *tl* an exploded *l* is indicated, and by *k'* an exploded *ku*, the *u* pronounced very indistinctly.]

SOCIAL ORGANISATION.

I confine myself, in these preliminary notes, to a brief description of the totemism of these tribes, leaving a more detailed discussion of the prerogatives of the chiefs and of certain families to the final report. Among the Tlingit and Haida we find a great number of crests, which, however,

are divided into two groups—the raven and the wolf among the Tlingit, the raven and the eagle among the Haida. The Tsimshian have four totems, the raven (called *K'anha'da*), the eagle (*Laqski'yek*), the wolf (*Laqkyebō'*), and the bear (*Gyispōtue'dā*). The Hēiltsuk and their northern neighbours have three totems; the killer (*Delphinus orca*) (*Ha'nq'aihtēnoq*), the raven (*K'ō'ihhtēnoq*), and the eagle (*Wik'oahtēnoq*). It is a very remarkable fact that among the other tribes of Kāwkiutl lineage no totemism, in its strict meaning, is found. The tribes enumerated above have the system of relationship in the female line. The child belongs to the mother's crest, and, although the wife follows her husband to his village, the children, when grown up, always return to their mother's tribe. I conclude from the fact that the Kwākiutl, south of Rivers Inlet, have the system of relationship in the male line, or, more properly speaking, in both lines; that the Hēiltsuk adopted their system of totems from the Tsimshian. I have not heard a single tradition to the effect that the gentes consider themselves the descendants of their totem; the Tlingit and Haida, as well as the Tsimshian and Hēiltsuk, have certain traditions referring to ancestors who had encounters with certain spirits or animals who gave them their crests. It is true that the Haida and Tlingit claim to have been created by the raven, but the legend has no reference whatever to the totem. The Kwākiutl and Salish tribes are also divided into gentes, but these are not distinguished by animal totems, but derive their origin each from a man who was sent down from heaven by the deity, and who, in some way or other, obtained his crest from a spirit. These legends are of the same character as the corresponding ones of the Tsimshian. The crest of the family is represented on paintings on the house fronts, on the 'totem posts,' and on tattooings. The latter are probably not used by the Tlingit, while the Haida tattoo breast, back, arms, and legs. The Tsimshian tattoo only the wrists, according to their crest. Tattoo marks are also used by the Nutka. The figures on posts and houses have always a reference to the being encountered by the ancestor, but sometimes also figures of the father's crest are used by the owner, the father having the right to permit his child to use them. The posts do not represent a continuous story, but every figure refers to one tradition. Each gens has also names of its own, which among the Tsimshian must have a reference to the father's gens. Thus, on hearing a name a Tsimshian knows at once to what gens both the bearer and his father belong. Among the Salish and Kwākiutl the child follows, as a rule, the father's gens, but he may also acquire his mother's gens. By marriage he always acquires the prerogatives of his wife's family. It is only here that such prerogatives are connected with the gentes. They refer generally to the use of masks and certain ceremonies of the winter dance, the most important of which is the *Hā'mats'a*, the man-biter. But the accession to these privileges is not only a right of the young man, it is also his duty to accept them. Among the Salish tribes of the Gulf of Georgia the division into gentes is not as clearly defined as farther north. Here a group of gentes forms a tribe, each gens inhabiting one village. In removing the village from one place to the other they retain the same name, which, however, is not the name of the people, properly speaking, but that of their village. Each gens derives its origin from a single man who descended from heaven, and whose sons and grandsons became the ancestors of the gens, the child always belonging to his father's gens. While among the northern tribes marriages

in the same gens, or phratry, are strictly prohibited, there exists no such law among the Salish.

I have not found any trace of a division into gentes among the Kutonaqa.

MYTHOLOGY.

It is one of the most interesting problems of ethnology to study the development of a system of mythology. On the north-west coast of America this study is the more interesting, as we can show how legends migrated from tribe to tribe. The great hero of the mythology of the northern tribes is the raven, who created daylight, mountains, trees, men. These raven legends have spread very far south, being even known to the Cowitchin of Vancouver Island, and probably still farther south. The hero of the mythology of the southern tribes, on the other hand, is the great wanderer, the son of the deity, who, on his migrations all over the world, transformed men into animals, and animals into men. It appears that this legend, which is known from the mouth of the Columbia to Bella Bella, originated with the Salish tribes; however, we do not know how far it extends inland. Another legend belonging to these tribes has spread far north. It refers to a visit to heaven, and the marriage of a young man to the sun's daughter. Traces of this tale are found among the Tsimshian. The myths of the Kutona'qa and of the Okanagan refer principally to the coyote. I shall proceed to describe briefly the myths of the various tribes, at the same time pointing out their connection among each other.

The Tlingit say that the world was originally swinging to and fro in space. There was something underneath it that was to serve as a rest for the world; the latter approached it, but never succeeded in joining it. All animals tried in vain to fasten the world to it. At last a female spirit, Harishane'kō (=the woman under us), smeared her belly with deer tallow, lay down under the world, and when the latter approached the underworld again the tallow fastened both together. The earth is considered square, the corners pointing north, south, east, and west. In the north there is an enormous hole into which the water of the ocean gushes, and from which it returns, thus causing the tides. There is another idea, to the effect that the world is sharp like a knife's edge, but this seems to be said more in a moral aspect, the meaning being that the road of right doing is narrow; whoever does wrong falls from the road and dies. The earth rests on Harishane'kō, and when the latter moves there is an earthquake. The moon is the sun's husband. There is a chief in heaven called Tahit, the ruler of those who fall in war. These fighting souls produce the aurora. It is worth remarking that this belief is also found among the Eskimo. On the same level with the earth, but outside its borders, is the country of those who died of sickness.

The creation legend of the Tlingit is as follows:—In the beginning there lived a great chief and his sister. The chief killed all his sister's sons as soon as they were born. One day when the woman went to the beach mourning the death of her children, a seagull advised her to swallow three stones. She obeyed, and after a few days gave birth to three boys, the oldest of whom was Yētl, the raven. He wanted to avenge the death of his brothers, and challenged his uncle. The latter tried to drown Yētl by making the waters rise until the whole earth was covered. He kept himself afloat by means of his hat, which grew higher as the waters were

rising. Yētl, however, flew up to the sky, and at last pressed down his uncle's hat, thus drowning his enemy. The waters disappeared again, and then Yētl obtained the sun, which was in possession of a chief, and the fresh water, which was owned by the fabulous K'anū'k'. He made trees and mountains next, and finally tried to create man. First he shaped human figures out of stone and wood, but did not succeed. Then he made man out of grass, and for this reason men are mortal. After this Yētl began to wander all over the world, and in all his further adventures he is described as extremely voracious and greedy.

The mythology of the Haida is substantially the same as that of the Tlingit. The raven is called Yētl by the Kaigani, while on Queen Charlotte Island his name is Qoia. His uncle's name is Nenkyilstla's.

The Tsimshian have also traditions referring to the raven, but he is not considered the creator of men. They consider the Nass River region as their original home, and the Nass language the oldest dialect of the Tsimshian. The origin of men is thus accounted for:—A long time ago a rock and an elder, near the mouth of Nass River, were about to give birth to men. The children of the elder were the first to be born, therefore man is mortal. If the children of the rock had been born first, he would have been immortal. From the rock, however, he received the nails on hands and feet.

The Tsimshian worship the deity in heaven, Leqa', who lives above the sun. The raven myths were evidently imported from some foreign sources, and then the raven was made the descendant of this deity in order to account for his supernatural powers. This legend, which is found from Nass river as far south as the northern portion of Vancouver Island, is substantially as follows:—A chief's wife, who was with child, died and was buried. In the grave she gave birth to a boy, who grew up feeding upon his mother's body. Eventually he was discovered and claimed by the chief, who grew to be very fond of him. The boy used to shoot birds and to skin them. One day he put on a bird's skin and flew up to heaven, where he married the deity's daughter. They had a son, who, when born, dropped from his mother's hand and fell into the ocean. He was found by a chief, and in course of time became Tqēmsem, of whom the same adventures are told which Yētl is said to have accomplished. He appears generally in the shape of the raven.

The flood, of which the Tsimshian also tell, is said to have been sent by heaven as a punishment for the ill-behaviour of man. First, all people, with the exception of a few, were destroyed by a flood, and later on by fire. Before the flood the earth was not as it is now, but there were no mountains and no trees. After the flood Leqa' created these too. The earth is considered to be round, and resting on a pillar that is held by an old woman.

The most important of the Kwākiutl legends is that of the wanderer K'ā'nikila. He is the son of the deity, and descended from heaven to earth, where he was born again of a woman. When he came to be grown up he wandered all over the world, transforming his enemies into animals and making friends with many a mighty chief. Another important legend is that of the mink, Tlē'selakila (meaning the son of the sun), who made a chain of arrows reaching from the sky to the earth, on which he climbed up and visited his father, who let him carry the sun in his stead. When, however, he went too fast, and set the earth on fire, his father cast him into the sea. While the northern tribes of this race

are acquainted with the raven legends, those farther south ascribe all the adventures of the raven to the mink. Another class of legends of the Kwākiutl is of great importance as referring to the spirits of the dances. I will mention in this place that these remarkable dances have evidently originated with the Kwākiutl, although they are at present practised by the Tsimshian and Haida, and by some of the southern tribes. The Tsimshian practise only a few of them, the names of the dances being all of Kwākiutl origin. According to their own statements they were obtained by intermarriage with the Hēiltsuk. The Haida adopted them from the Tsimshian. In all these dances ornaments of cedar bark, dyed red, are used, and it appears that this custom also originated among the Kwākiutl. The most prominent figure of this winter dance is the man-eater, called Hā'mats'a (the eater) by the Kwākiutl, Elaqō'tla by the Bilqula, Ō'lala by the Haida and Tsimshian. The latter call his dance also the Wihalai't (the great dance). The Hā'mats'a is initiated by a spirit, referring to which numerous traditions exist. It is a peculiarity of Kwākiutl mythology that it treats of many supernatural beings, while farther north almost exclusively the heaven, the sun, moon, and raven have supernatural power. Among these beings the following are of importance:—The Tsōnō'k'oa (probably a mythical form of the grizzly bear), the Thunderbird, the Sī'siūtl (the double-headed snake), and a cuttlefish of enormous size. The myths of the Hēiltsuk are much influenced by those of the Bilqula, their eastern neighbours.

The legends of the Nutka treat also principally of the great wanderer, and embody, so far as I am aware, no element which is not found among the Kwākiutl.

The legends of the Salish vary to a great extent among the various tribes, those of the coast tribes resembling the myths of the Kwākiutl. The wanderer and the sun are here the heroes of the greater part of the myths. The legend of the wanderer does not differ from that of the Kwākiutl, except in that he is himself the deity. Each remarkable stone or rock is described as being a man transformed by him. He made a great fire in order to destroy man, and later on made the ocean rise and cover the land. The ascent to heaven on a chain of arrows is one of the principal objects of their legends, the tale treating frequently of a murder of the old sun and the origin of the new one. Besides this, the double-headed snake is of importance, even more so than among the Kwākiutl.

The mythology of the Bilqula, whose language is closely related to that of the dialects of the Gulf of Georgia, differs greatly from that of the other Salish tribes, being evidently influenced by their neighbours. Their mythology, on the other hand, has influenced that of the Hēiltsuk. I do not think that the wanderer legend is found among them. They tell of the raven who created daylight, and of two men, Masmalā'niq and Yula'timot, who descended from heaven, created man, and gave him his arts. This legend is one of the most beautiful of those found on the coast. Its origin is doubtful. It would be necessary to study the mythology of the tribes of the interior more closely in order to arrive at a satisfactory understanding of this myth. The Bilqula have also the legend of the mink carrying the sun. They call him T'ōtk'oa'ya.

I am not well acquainted with the myths of the tribes of the interior, having collected only a limited number among the Ntlakapamuq. They also tell of the wanderer who transformed men into stones, but it is doubtful whether he is in any way connected with the deity. Their

legends referring to the sun are numerous, one of the most important being the visit to the sun. There are many legends referring to the raven and to the mink, and here for the first time we find the coyote playing an important part in the mythology.

The heroes of the myths of the Kutoṇāqa are the sun and the coyote. These myths are more closely connected with those of their south-eastern neighbours than with those of the north-west coast Indians. It is, however, of interest to notice that the legend of a chain of arrows reaching up to the sky, and a conquest of the sky, which is so important in the Salish tales, occurs here also. One of the most interesting legends is that of the origin of the sun. The animals tried by turns to act as the sun, but none succeeded. The coyote almost succeeded, but as he made it too hot, and as he told everything he saw going on upon the earth, he was also compelled to give up his place in the sky, and then the two sons of the lynx became sun and moon. Later on, the coyote became the father-in-law of the sun, and many are the tales that refer to his adventures. He plays a part similar to that of the raven in the tales of the Tlingit.

RELIGION, SHAMANISM, MORTUARY CUSTOMS.

A study of mythology and of customs shows that the Indians of this province worshipped principally the sun or the heaven. The Tlingit and Haida pray to the moon, and in praying blow feathers up as an offering. They also pray to mountains, and believe that the animals of their crest protect them, although they are not forbidden to kill them. They believe in the transmigration of souls, the soul of the deceased being born again in a child of the same gens. The souls of animals return in the same way in their young. Sickness is to a great extent ascribed to witchcraft, and it is the duty of the shaman to cure the sick and to find out the witch. The shaman is initiated by acquiring a spirit. Cleanliness is considered as being agreeable to the spirits; therefore the novice must bathe frequently. Great powers are ascribed to people who abstained from sexual intercourse. The dead, except shamans, are burned, and the ashes put up in small boxes. Shamans are buried near the beach, one coffin being deposited on top of the other.

The Tsimshian have a supreme deity called Leqa'. Prayers are frequently not addressed to him directly, but to spirits, the Neqno'q, who convey them to him. Most of the prayers have conventional forms. In praying for clear weather for instance, they say: 'Neqno'q, Neqno'q, chief, chief, have mercy! Look down upon thy people under thee. Pull up thy foot and wipe thy face!' They think that the existence of man is pleasing to the deity, and that he enjoys the smoke rising from their fires. They pray: 'Have mercy upon us! Else there will be nobody to make the smoke rise up to thee. Have pity upon us!' The Tsimshian believe that the dead live in a country similar to our own, and that they are never in want. The dead are buried, but the heart is taken out and buried apart. Chiefs are sometimes burnt, and so are shamans. If a series of deaths occurred in a family, the mourners used to cut off the first joint of the fourth finger, in order to put an end to the misfortunes of their family.

The Kwākiutl worship the sun. It is not quite clear whether they worship Kanikila, the wanderer, besides, or whether they address their prayers only to the sun. Their dances are closely connected with their

religious ideas, particularly the dance Tlok'oola (= something unexpected coming from above), which, in course of time, has partly been adopted by all their neighbours. There are a great number of spirits of this dance, each of which has his own class of shamans, the duties and prerogatives of whom vary according to the character of their genii. The Kwākiutl bury their dead in boxes, which are placed in small houses or on trees. Posts, carved according to the crest of the deceased, are placed in front of the graves. Food is burnt for the dead on the beach. Their mourning ceremonies are very complicated and rigorous.

The Coast Salish worship the sun. They pray to him and are not allowed to take their morning meal until the day is well advanced. The wanderer, called Kumsnō'otl by the Comox, Qāls by the Cowitchin and Lkungen, and Qāis by the Skqomish, is also worshipped. They believe that he lives in heaven and loves the good, but punishes the bad. The art of shamanism was bestowed by him upon the first man, who brought it down from heaven.

The Kutonāqa are also sun-worshippers, even more decidedly so than any of the other tribes. They pray to the sun. They offer him a smoke from their pipe before smoking themselves, and sacrifice their eldest children in order to secure prosperity to their families. They believe that the souls of the deceased go towards the east, and will return in course of time with the sun. Occasionally they have great festivals, during which they expect the return of the dead. They have also the custom of cutting off the first joints of the fingers as a sacrifice to the sun. They pierce their breasts and arms with sharp needles and cut off pieces of flesh, which they offer to the sun. It is doubtful whether they practise the sun-dance of their eastern neighbours. The dead are buried, their heads facing the east. It is of interest that the positions of the body after death are considered to be prophetic of future events. The mourners cut their hair and bury it with the deceased. Warriors are buried among trees which are peeled and painted red. Each shaman has his own genius, generally a bird or another animal, which he acquires by fasting in the woods or on the mountains. The shamans are able to speak with the souls of absent or deceased persons, and are skilful jugglers.

Report on the Sarcee Indians, by the Rev. E. F. Wilson.

The Sarcee Indians belong to the great Athabaskan or Tinneh stock, to which the Chipewyans, Beavers, Hares, and others in the North-West and, it is said, the Navajoes, in New Mexico, also belong. They were formerly a powerful nation, but are now reduced to a few hundreds. Their reserve, which consists of a fine tract of prairie land, about a hundred square miles in extent, adjoins that of the Blackfeet, in Alberta, a little south of the Canadian Pacific Railway line, and seventy or eighty miles east of the Rocky Mountains. Although friendly and formerly confederate with the Blackfeet, they bear no affinity to that people; they belong to a distinct stock and speak an altogether different language. They are divided into two bands—the Blood Sarcees and the Real Sarcees.

During my visit, which lasted seven days, I had several interviews with their chief, 'Bull's Head,' a tall, powerful man, about sixty years of age; and it was from him and one or two of his leading men that I

gathered most of my information. I found, however, that the Sarcees were not so ready to converse, or to tell either about their language or their history, as were the Blackfeet, whom I visited last summer. Tea and tobacco seemed to be with them the chief desiderata, and except with gifts of this kind it seemed almost impossible to gain anything from them. And after all, even when plied with these commodities, the information they gave was very meagre, and often far from satisfactory. From what little I saw of these people I should be inclined to say that they are of a lower order and inferior in mental capacity to the Blackfeet; I judge this chiefly by the style in which they told their stories and traditions, such as they were, and by their having no elaborated theories as to certain phenomena in nature, about which many other of the Indian tribes have always so much to say.

Chief 'Bull's Head,' in reply to my questions as to their early history, made a great show of oratory, both by voice and gesture, but much of what he said was very childish and confused, and seemed to be scarcely worth the trouble of putting down.

These people call the Blackfeet 'Katce,' the Crees 'Nishinna,' the Sioux 'Kaispa,' and themselves 'Soténnä.' The Indians of their own stock, as I understand, they call 'Tinnätte.' These two last names seem certainly to connect them with the great 'Tinneh' or Athabaskan nation. Sarcee (or rather Sarxi) is the name by which they are called by the Blackfeet.

WHENCE THESE PEOPLE CAME.

'Formerly,' said 'Bull's Head,' 'the Sarcee territory extended from the Rocky Mountains to the Big River (either the Saskatchewan or the Peace River). Our delight was to make corrals for the buffaloes, and to drive them over the cut bank and let them fall. Those were glorious days, when we could mount our swift-footed horses, and ride like the wind after the flying herd; but now the buffalo is gone we hang our heads, we are poor. And then, too, we used to fight those liars, the Crees: we engaged in many a bloody battle, and their bullets pierced our teepees. Thirty battles have I seen. When I was a child the Sarcees were in number like the grass; the Blackfeet and Bloods and Peigans were as nothing in comparison. Battles with the Crees and disease brought in among us by the white man have reduced us to our present pitiable state.'

Another Indian told us how the Sarcees were at one time one people with the Chipewyans, and gave us the myth which accounts for their separation. 'Formerly,' he said, 'we lived in the north country. We were many thousands in number. We were travelling south. It was winter, and we had to cross a big lake on the ice. There was an elk's horn sticking out of the ice. A squaw went and struck the horn with an axe. The elk raised himself from the ice and shook his head. The people were all frightened and ran away. Those that ran toward the north became the Chipewyans, and we who ran toward the south are the "Soténnä" or "Sarcees."'

'The Chipewyans,' said 'Bull's Head,' 'speak our language. It is twenty years since I saw a Chipewyan. We call them "Tcohtin." They live up north, beyond the Big River' (probably the Peace River).

THEIR TRADITIONS, BELIEFS, &c.

'There was a time,' said 'Bull's Head,' 'when there were no lakes. The lakes and rivers were occasioned by the bursting of the belly of the buffalo. It was when the belly of the buffalo burst that the people divided; some went to the north and some to the south. For years and years I have been told that the Creator made all people, and I believe it. I have heard my mother and other old people speak of the days when there were no guns and no horses, when our people had only arrows, and had to hunt the buffalo on foot; that must have been a very long time ago.'

The Sarcees have a tradition similar to that of the Blackfeet about men and women being first made separately, and then being brought together through the action of the mythical being 'Napiw.'

They have also a tradition of the flood, which accords in its main features with that of the Ojibways, Crees, and other Canadian tribes. They say that when the world was flooded there were only one man and one woman left, and these two saved themselves on a raft, on which they also collected animals and birds of all sorts. The man sent a beaver down to dive and it brought up a little mud from the bottom, and this the man moulded in his hands to form a new world. At first the world was so small that a little bird could walk round it, but it kept getting bigger and bigger. 'First,' said the narrator, 'our father took up his abode on it, then there were men, then women, then animals, then birds. Our father then created the rivers, the mountains, the trees, and all the things as we now see them.'

When the story was finished I told the narrator that the Ojibway tradition was very much the same as theirs, only that they said it was a *musk-rat* that brought up the earth and not a beaver. Upon this five or six of the men who were squatting around inside the teepee smoking cried, 'Yes, yes! The man has told you lies; it was a musk-rat, it was a musk-rat!'

It seems dubious whether the Sarcees are sun-worshippers; but, like the Blackfeet, they call the sun 'our father,' and the earth 'our mother.' They also engage each summer in the 'sun-dance.' They depend also for guidance in their actions on signs in the sky and on dreams. They think they know when there is going to be a fight by the appearance of the moon. One of their number, named 'Many Swans,' says he is going to have a good crop this year, for he dreamed that a white woman came down from above and asked to see his garden, and he showed his garden to the woman, and it was all green.

'Bull's Head' had no theory to give as to the cause of thunder; he knew that Indians of other tribes said it was a big bird flapping its wings, but his people did not say so; they did not know what it was; neither had they anything to say about an eclipse.

MANNER OF LIVING.

The Sarcee Indians are at present all pagans; they appear to have no liking for the white people, and the white people seem to have little liking for them, and would gladly deprive them of their lands and drive them away farther into the wilderness were they permitted to do so. But the paternal Government, as represented by the Indian Department,

takes care that they are not imposed upon. There is an Indian Agent stationed on their reserve, who twice a week doles out to them the Government rations, consisting of excellent fresh beef and good flour; and there is also a farm instructor, who has charge of the farming stock and implements, and does what he can to induce these warriors and hunters to farm.

They have also residing among them a missionary of the Church of England, who visits them in their teepees, and does his best to collect their little blanket children to school, giving two Government biscuits to each scholar as a reward for attendance. But the people are evidently averse to all these things, which are being done for their good. Their only idea of the white man seems to be that of a trespassing individual, who has more in his possession than he knows what to do with, and may therefore fairly be preyed upon.

The dress of these people consists, as with other wild Indians, of a breech-clout, a pair of blanket leggings, beaded moccasins, and a blanket thrown loosely, but gracefully, over one or both shoulders. They wear their long black hair in plaits, hanging vertically, one plait on each side of the face, and one or more at the back. Some of them knot their hair on the top of the head; and some, I noticed, wore a coloured handkerchief folded and tied round the temples. This, I believe, is one distinguishing mark of the Navajo Indians in New Mexico. Very often the leggings and moccasins are dispensed with, and the man appears to have nothing on except his grey, white, or coloured blanket. The women wear an ordinary woman's dress of rough make and material, and short in the skirt, next to the skin, leggings and moccasins, and a blanket round the shoulders. Ornaments are worn by both sexes, but chiefly by the men. They consist of brooches and earrings made of steel, necklaces and bracelets made of bright-coloured beads, bones, claws, teeth, and brass wire, and finger-rings, also of brass wire, coiled ten or twelve times, and covering the lower joint of the finger. Every finger of each hand is sometimes covered with these rings. Both men and women paint the upper part of the face with ochre or vermilion. The people live in 'teepees,' conical-shaped lodges, made of poles covered with tent cotton, in the summer, and in low log huts, plastered over with mud, in winter. They depend for their subsistence almost entirely on the rations supplied by Government. They keep numbers of ponies, but seem to make little use of them beyond riding about. They keep no cattle or animals of any kind beyond their ponies and dogs. The latter are savage, and are said to be descendants of the wolf and the coyote, with which animals they still often breed. They seem to have no manufactures; they make no canoes, baskets, &c., but they know how to prepare the hides and skins of the animals they kill, and they make their own clothing, saddles, bows and arrows, and moccasins. Some of the women do very excellent bead-work. Bridles they do not use; a rope or thong fastened to the pony's lower jaw takes the place of a bridle; their whips are a short stout stick, studded with brass nails, and provided with two leathern thongs as lashes at one end, and a loop for the wrist at the other. Their bows are of cherry wood, strung with a leathern thong, and their arrows of the Saskatoon willow, winged with feathers, and pointed with scrap-iron, filed to a sharp point. The shaft of the arrow has four shallow grooves down its entire length.

GAMBLING.

The Sarcees, like most other wild Indians, are inveterate gamblers. They will gamble everything away—ponies, teepees, blankets, leggings, moccasins—till they have nothing left but their breech-clout. In my report of the Blackfeet last year I mentioned the use of a little hoop or wheel for gambling purposes. I find that the Sarcees also use this, and two of them showed me how they play the game. A little piece of board, if procurable, or two or three flattened sticks, laid one on the other, are put for a target, at a distance of eighteen or twenty feet from the starting-point, and the two players then take their places beside each other; one has the little wheel in his left hand, an arrow in his right; the other one has only an arrow. The play is to roll the wheel and to deliver the two arrows simultaneously, all aiming at the mark which has been set up. If the wheel falls over on one of the arrows, it counts so many points, according to the number of beads on the wire spoke of the wheel that touch the arrow. Nothing is counted unless the little wheel falls on one of the arrows. The articles for which they play are valued at so many points each. A blanket is worth, perhaps, ten points, a pony fifty, and so on.

Another method by which these people gamble is as follows: Two men squat side by side on the ground, with a blanket over their knees, and they have some small article, such as two or three brass beads tied together, which they pass from one to another under the blanket; and the other side, which also consists of two persons, has to guess in which hand the article is to be found—very much like our children's 'hunt the whistle.' The Sarcees use also the English playing cards, but it is a game of their own that they play with them. Whoever gets the most cards is the winner.

MATRIMONY.

The Sarcees are polygamous, the men having two, three, or four wives. The time of moving camp is generally looked upon as a propitious time for love-making. The camp is in the form of a ring, with the horses picketed in the centre. Early in the morning the young men drive the horses to a swamp or slough to water them. They are thinking, perhaps, of some young squaw whom they wish to approach, but they are ashamed to speak to her. Then, as soon as all is ready for the move, the chief gives the word, and the callers summon the people to start on the march. The chief goes first and leads the way. Now is the opportunity for the bashful young swains; they drop behind the rest and manage to ride alongside the young women of their choice, and to get a few words into their ears. If the young woman approves the offer, she follows her white sister's example by referring the young man to her parents. If the parents consent, mutual presents are exchanged, such as horses, blankets, &c.; the girl is dressed in her best, and her face painted, and the young man takes her away. A husband can divorce himself from his wife at any time if he pleases, but he has to restore the presents that he received with her, or their equivalent. Girls are often betrothed at ten years of age and married at fourteen. A betrothed girl may not look in a man's face until after her marriage. A man may not meet his mother-in-law; if he chance to touch her accidentally he must give her a present. At a feast among the Blackfeet at which I was present an impatient mother-in-law was standing without and sending messages to the son-in-law within to make haste and leave before all the good things

were done, so that she might come in and get her share; but he sent word back that he was in no hurry. Parents do not often punish their children, but sometimes, in a fit of ill-temper, will beat them cruelly. They are more cruel to their wives than to their children. While I was making these notes a Sarcee woman came into the lodge with her nose cut off; her husband had done it as a punishment for her keeping company with another man.

MEDICINE.

The Sarcees are not considered to be much versed in the use of medicinal roots and herbs; they are much more ready to take the white man's medicine than are their neighbours, the Blackfeet.

Among themselves they depend chiefly on magic and witchcraft for recovery from sickness. There are about a dozen so-called 'medicine-men' in the camp, but most of them are *women*. Chief among them is an old squaw named 'Good Lodge.' They are always highly paid for their services, whether the patient recovers or not. A medicine-man when called in to see a sick person will first make a stone red-hot in the fire, then touch the stone with his finger, and with the same finger press various parts of the patient's body, to ascertain the locality and character of the sickness. Then he will suck the place vigorously and keep spitting the disease (so he pretends) from his mouth. This is accompanied by drum-beating and shaking a rattle. The Sarcees do not bleed or cup, but they blister (often quite efficaciously) by applying the end of a piece of burning touchwood to the affected part. They also use the vapour-bath. To do this a little bower, about three feet high, is made of pliable green sticks, covered over closely with blankets. Several stones are heated red and placed in a small hole in the ground inside the bower; and over these the patient sits in a state of nudity and keeps putting water on the stones, which is supplied to him by an attendant from without. When thoroughly steamed, and almost boiled, he rushes out, and plunges into cold water. This treatment sometimes effects a cure, but more often induces bad results and death. The vapour-bath, as above described, is used very extensively by Indians of many different tribes; some, however, omit the plunge into cold water.

BURIAL CUSTOMS.

I had a good opportunity to investigate the burial customs of these people. Riding across the prairie with a young Englishman who had spent several years in the neighbourhood, we came upon a 'bluff,' or small copse, of fir and poplar trees, covering some two or three acres of ground. We suspected it was a burial-ground, and, dismounting from our horses, entered it. No sooner had we done so than we found ourselves in the midst of the dead—the bodies wound up in blankets and tent-cloth, like mummies, and deposited on scaffolds from six to eight feet from the ground. Four or five of these bodies could be seen from one point, and others became visible as we pushed our way through the tangled underbrush. A little baby's body, wrapped up in cloth, was jammed into the forked branch of a fir-tree about five-and-a-half feet from the ground. The earth was black and boggy and the stench nauseous. Here and there lay the bleached bones and tangled manes of ponies that had been shot when their warrior owners died—the idea being that the equine spirits would accompany the deceased persons to the other world,

and make themselves useful there. Beside each body lay a bundle of earthly goods—blankets, leggings, saddles, &c., also cups, tin pots, kettles, and everything that the spirit of the departed could be supposed to want. Pursuing our explorations we came upon a 'death teepee.' I had heard of these, and had often desired to see one. It was just an ordinary teepee, or Indian lodge, made of poles leaning from the edge of a circle, fifteen feet or so in diameter, to a point at the top, and covered with common tent-cloth. The stench was disgusting, and the ground like a cesspool; but I wanted to see all, so we effected an entrance and examined the contents. The old warrior, whoever he may have been, was wrapped up in rotting, sodden blankets, sitting with his back against an ordinary Indian back-rest. We could not see his face, as the blanket covered it, but the top of his scalp was visible and a great bunch of slimy, filthy-looking eagle feathers adorned his head; just behind him hung his leathern quiver, ornamented with a leathern fringe, two feet in length and full of arrows; also his beaded tobacco-pouch; and by his side were a tin basin, a fire-blackened tin pot with a cover, and a large bundle of blankets, clothing, and other effects. I made a hasty sketch of the dismal scene and then retired. We were glad to mount our horses once more and to breathe again the fresh air of the prairie.

PHYSICAL DEVELOPMENT.

The Sarcees do not strike me as so fine or tall a race as the Blackfeet, although one whose measure I here give was of about the same height as the Blackfoot Indian, 'Boy Chief,' whom I measured last year. They have remarkably small hands and feet. I traced on paper the hand of a Sarcee Indian named 'Head above Water.'

Following is the measurement of an adult Sarcee, about thirty years of age, named 'Many Shields.'

	ft.	in.
1. Height from ground to vertex ¹	5	8 $\frac{1}{4}$
2. " " meatus auditorius	5	3 $\frac{1}{4}$
3. " " chin	4	11 $\frac{1}{8}$
5. " " umbilicus	3	5 $\frac{3}{8}$
7. " " fork	2	8
8. " " knee-cap joint	1	8 $\frac{1}{8}$
11. " " elbow (bent)	3	6 $\frac{1}{2}$
12. " " tip of finger (hanging vertically)	2	2 $\frac{1}{4}$
13. Height—sitting on the ground	2	11 $\frac{1}{4}$
16. Circumference of chest at armpits	3	0
17. " " mammæ	2	11 $\frac{1}{4}$
18. " " at haunches	2	11 $\frac{1}{2}$
26. Span—outstretched arms	5	8 $\frac{1}{4}$
27. " thumb to middle finger	0	7 $\frac{1}{2}$
28. Length of thumb	0	2 $\frac{1}{2}$
29. " foot	0	9 $\frac{3}{4}$
30. Head—greatest circumference (over glabella)	1	11 $\frac{3}{4}$
31. " arc, root of nose toinion	1	4
32. " " meatus auditorius, over head	1	1 $\frac{3}{4}$
33. " " over glabella to meatus auditorius	1	1
41. " length of face, root of nose to chin	0	5 $\frac{1}{4}$

Hair, eyes, and skin the same as those of the Blackfoot Indian 'Boy Chief' (see Report of 1887).

¹ In the measurements of the Blackfoot 'Boy Chief,' given in the Report of last year, the 'height from ground to vertex' should have been 5 ft. 8 $\frac{3}{4}$ in., instead of 4 ft. 8 $\frac{3}{4}$ in., as printed.

Two or three young Indians tried the strength of their eyesight. They could count the prescribed dots at a distance of 28 feet.

LANGUAGE.

I cannot give as full a report of the Sarcee language as I did of the Blackfoot, for the reason that no one, so far as I could learn, outside the Sarcee tribe has any knowledge of it. The missionary in charge had only arrived a few weeks before, and though he knew the Blackfoot, and through that medium could make himself understood by a few of the people, he knew nothing whatever of Sarcee. We were told that it was an exceedingly difficult language to acquire, and full of gutturals; others said that it had no vowels in it; others that it was like a hen cackling. Under these circumstances it was vain to expect to make out the grammatical rules of the language, but I thought I would do what I could to collect a small vocabulary of words. A few of the people understood Blackfoot, and some few others Cree, and through the medium of these two languages I was able to collect the following Sarcee words and short sentences:—

VOCABULARY.

Pronounce *a* and *ä* as the first and second *a* in larva, *e* as in they, *i* as in pique, *ï* as in pick, *o* as in note, *u* as in rule, *ai* as in aisle, *au* as in bough, *h* guttural as in *ich* (German), *ġ* (a sound found also in the Sioux language) pronounced like the Arabic *ghain*, a *ghr* sound; *tc* like *ch* in church, *ñ* like the French nasal *n* in *bon*.

man (or men)	kättini	a big man	kättini tcu
woman	tsikä'	women	tsikuá
boy	sittá	boys	sittámika
girl	etráka		
infant	tsittá		
my, thy, his father	itrá, nitrá, mitrá	my son	siġá
my mother	inná	Bull's Head's son	ilgátsi mägála
thy son	niġála	younger brother	nish'itla
elder brother	kinigá		
Indians (prairie people),	tklukodissána		
Indians (probably of Tinne nation),	Tinn'ätte		
my head	sitsitsi'n	thy head	nitsits'ina
Bull's Head's head	ilgátsi mitsitsina		
my eye	sinnägá'	my nose	sitsi
my arm	s'ikanná	my leg	sigùs
my, thy, his hand	s'illa, ñilla, milla		
my foot	sikká	my heart	sitsánnägá
my blood	sittikla	town	natsiġan'ikláte
chief	hak'itci	my friend	kléssá
house	nátsiga	a small house	natsiga sitla
teepee	kauwá	kettle	missokólilli
tinpot	äsrá	small ditto	äsrá sitla
basin	tcistlá	axe	tsilh
knife	mäs	my knife	sim'assa
thy knife	nim'assa	his knife	mäskisklá
boat	tän'ikäss'i	moccasin	naka
boot	kástcagé	pipe [pouch]	mistoté
tobacco	katein	his tobacco	natisgáni kisklá
sun	tcátrá	moon	inägá

star	soh	day	tsinnis
night	itlăggé	spring	taggănăgă
summer	hatakùsi	autumn	hă'ssini
winter	sásskăhe	next winter	klikă sásskăhe
last winter (snow)	tanatsósosáte	it is snowing	sosáte
the wind is blowing	tikăn'istei	it is cold	koskáss
it is warm	kákow'iskis	it is raining	tcaté
fire	koh	water	tuh
earth	nilka	river	s'iska
lake	totcu	well or spring	hat'allălilly
prairie	tklùka	the Rocky Moun-	tca
island	no	stone [tains	tsa
tree	itei	a pine tree	kah
a big tree	itei tcu	a small tree	itei sitla
wood	đitsiá	a log of wood	misseá
brushwood	titci	grass	kutló
meat, flesh	ăl'ină	dog, klih	dogs, klikah
horse	isklih	horses	isklikah
my dog	sil'itsa klih	my dog or horse	sil'itsa
mare	isklih hănimaká	my mare	hănimaká sil'itsa
ox	haidéklishi	cow	hănimaká haideklishi
buffalo	hănni	buffaloes	hannile
a black ox	haidéklishi, di'skăshi		
deer	kuini	elk	tcăse
the black elk	ádidinidjé	rabbit	niklă'tila
snake	natósăgă	bird	ilkăge
egg	igasa	duck	tces
fish	klúka	pig (big dog)	klikă tcu
gun	sitrána	cart	măsséklăshi
book	đjinishă	hat	sitsin'itila
coat	đilkoshi	handkerchief	sili'ssităniga
trousers	istlă	leggings	isttăkok'ita
shirt	kitcistaniă	blanket	tc'iyisi-tcascide
flour	netsokăssi	yes	a
paper	tătklishi	no	itsi'tawa
money	diltilih	one	ăgligah (klikkazah)
whip	istlăhiklă	two	akiye (ăkinnă)
red	dilgăssé	three	trănki (traanah)
white	dig'ăssigă	four	didji (dizhnă)
black	dishkoshé	five	kosita
God (the Creator)	iskluni	six	kostranni
„ (our Father)	nătuninan	seven	tcistcidi
devil	sinómato'ikli	eight	clashdédji
heaven	tselaráh	nine	klăkubigă
minister	dikăhatsi dikală	ten	kúnisnăñ
soldier	trăskillah	eleven	kli'kkumităn
big	tcu	twelve	akămităn
small	sitlă	thirteen	trăgimităn
strong	magánisis'ta	fourteen	đidjimităn
old	tcanátc	fifteen	wiltăñmităn
it is good	mókanilli	sixteen	wistăñmităn
it is not good	mátogugli	seventeen	tcistimitan
„ „ „	tósăma	eighteen	clashdédjimităn
he is dead	trăsitsă	nineteen	klikuañmităn
this	teigé	twenty	ak'adde
that	tetegéla	twenty-one	akădde egligimitan
all	kănniltălă	twenty-two	„ ekămităn
many	niklă	twenty-three	„ etrănkimităn
who is it ?	matağanita ?	twenty-four	„ edijimităn
far off	kússă	thirty	trañte
near	wiltoá	forty	pisde
here	tătigé	fifty	kosităté
there	niugúte	sixty	kóstrăté

what is that ?	tatáita? tata . . . ?	seventy	t'cisteidi'nni
yesterday	ilkhá	eighty	clashedjedje
to-morrow	nákkodikái' or eklátsi	ninety	klakúhidinná
white man	dikáhálli	one hundred	konisnáñte
American	mám'assi-nitsáná	I walk	sinna nishelkh
I	sinni, sinna . . .	thou walkest	ninna kiyelkh
thou	ninn'íla, ninna . . .	he walks	yiyelkh
he	átigan'ítta, in'íila	I am asleep	sinna nista
they	kisálnátaí	he is asleep	sitti
thou art asleep	ninna nitta		

Is it your knife?

I love him

you love him

he loves him

I love it

I do not love it

two men

two women

one dog

the boy runs

the dog runs

the dogs run

one dog runs

I run

thou runnest

he runs

we

I arrive

thou

he

we

they

he rides

I smoke

you smoke

he smokes

the Blackfoot smokes

we smoke

they smoke

I smoked yesterday

I shall smoke to-morrow

he will smoke to-morrow

I will look for them to-morrow

I drive them home

if he goes he will see you

if I go you will see me

king, big chief

go home

come in

my house is good

my horses are good

it is not good

give it to me

he gave it to me

come here

be quick

do not be afraid

I am hungry

I am sick

I am very sick

are you sick?

he is not sick

he is tired

ni mássä láh ?

sinna tsit tó midisi

ninna tsit tó midininni

tsitto midininni

tsitto midisi

totsitto midisi

ákiye k'áttini

ák'íye tsikúah

klih klikazah

sittá kahilkla

klih kahilkla

klikah nilkla (?)

klih klikazah nilkla

sinna kaniskla

ninna ékanilkla

kanilkla

eklitänilkla

sinna nänishrá

ninna enähieilá

ihíla enänikátilá

nánie naniëigáhtik (?)

kisálnáta naniësäliëila or nanáltátila (?)

klikadiskla

siñiisto

niniito

itotila (or does he smoke ?)

katci itóttila

isáitóttila

átóttila

ilkha siñiistóte

eklátsi sin itá isto

eklátsi itá isto

eklátsi makögidisi

naniishó

itsitiya ti istca

nitsitiya ti nistca

Akitsi nakáwa

nátishá

kuniá

sahokókáñilli

silftcikákonilli

to mákanilli

sahanáha (or tástóa)

sahanahá

tást'iyá

a wùt tá

to minna nìdji

sitsá'ähidso

sakútila

tiggá sakútila

nokútilá lah ?

to mákútila

istástca

he is very tired	tiggä istástca
he is not tired	to istastca
are you not tired?	to stanístcaki lah?
where have you been?	astákotci disiya?
what is your name?	tatánisáta?
I don't know	mátsikonishrá
I don't understand	tó nidístel
do you understand	ni dítcaki lah?
I have none	nitowá.

NOTES ON THE LANGUAGE.

It will be noted in the above vocabulary—

1. That the first, second, and third persons of the personal pronoun appear to be *sinna*, *ninna*, *iníila*; when used as possessives with a noun *si* . . . , *ni* . . . , *ma* . . . ; and when governing a verb (e.g., to smoke, see vocab.), *si* . . . , *ni* . . . , *i* . . . It appears, however, from the various verbs given in the vocabulary, that (if correctly obtained) there must be a great variation in the mode of forming the persons; and this, I expect, is due to their belonging to distinct paradigms.

2. The negative appears to be *to* prefixed to the verb. The Blackfeet Indians prefix *mat* to the verb, and follow it by *ats*. Ojibways prefix *karwin*, and end the verb with *si*. The Sioux simply use *shni* after the verb. Crees prefix *námă*.

3. The interrogative particle appears to be *kilah*, or *lah* after the verb. Blackfeet express this by *kút* before the verb and *pa* after it. Ojibways by *nă*, Crees by *tei*, Sioux by *he*—all after the verb.

4. The numerals in this language are rather puzzling. There appears to be a double set. *Kositá* was given me as 5; yet 15 was *wiltanimitań*; and 50 took again the first form, *kositáté*. So with 16: *kostrani* is 6; *wistańmitań*, 16; *kostrate*, 60. I notice also that the word for 6 seems to be an extension of the word for 3, and the word for 8 an extension of the word for 4. 10 seems to stand alone, the endings for the 'teens' being *mitań*, which seems to have nothing to do with *kunishnăn*. It seems curious also that the 'teen-ending' should be continued through the 'ties'; twenty-one would seem to be expressed in Sarcee as 10+11; but this is merely a surmise of mine, and if I knew more of the language I could probably explain these seeming irregularities. I may mention here, in connection with this, that the Ojibways count 1 to 5 with distinct words, then seem to begin 1, 2 again with the ending *waswi* from 6 to 10. Ojibways and Crees have almost the same words for the numbers 1 to 6, entirely different words for 7, 8, 9, and are nearly the same again for 10 and 20.

5. The plural of the noun appears to be *ika* or *a*. There does not appear to be any distinction made in the plural endings between animate and inanimate objects.

6. There does not appear to be any distinction made in the first person plural of the verb between 'we exclusive of the party addressed' and 'we inclusive.' In these two points (5 and 6) there is a decided divergence from languages of the Algonkin stock, and a leaning towards the Siouan.

7. *Ittra*, *ninna*, it seems, mean—the first, 'father,' or 'my father,' the second 'mother,' or 'my mother,' the possessive pronoun not being used in the first person for nouns of near relationship. This agrees with the Sioux.

8. The adjective follows the noun, the same as in the Sioux.

9. In the foregoing 260 words and sentences I do not recognise one word as similar to any word in any other Indian language with which I am familiar. But I have never before examined any of the 'Tinneh' or Athabaskan stock. I might, perhaps, except *ninna, ni . . .*, the second person of the pronoun, which is analogous to *niye, ni . . .* of the Siouan dialects.

10. The sign of the past tense may be *te*, and of the future *ita* (see *smoke* in vocab.), but of this I cannot be sure.

11. The Sarcees seem to keep their lips parted while speaking, and the accent is generally on the *last* syllable of the word. The language has rather a clicking, 'slishing' sound.

12. In inflecting some of the verbs I have introduced the personal pronouns, but I imagine their presence is not necessary except for emphasis.

Notes by Mr. H. Hale on the foregoing Report.

Mr. Wilson's report on the Sarcees is specially valuable as being the only detailed account we possess of this interesting branch of the great Tinneh or Athabaskan family. Some information concerning the tribe has been given incidentally by various writers, including Sir Alexander Mackenzie, Umfreville, and Petitot, but no particular description of the people has been heretofore published. It has been known merely that they spoke a dialect of the Tinneh language, and that they lived in close alliance with the Blackfoot tribes.

The Tinneh family, or stock, has attracted much attention from ethnologists, partly from the peculiar character of its members and partly from its wide diffusion, in which respect, as Mr. H. H. Bancroft has observed, it may be compared with the Aryan and Semitic families of the Old World. It occupies the whole northern portion of the American continent, from Hudson Bay to the Rocky Mountains, except the coasts, which belong to the Eskimo. Tinneh tribes also possess the interior of Alaska and British Columbia. Other scattered bands—Umpquas, Tlatskanais, and Kwalhioquas—are found in Oregon. The Hoopas and some smaller tribes live in Northern California. Thence, spreading eastward, Tinneh tribes, under various designations—Navahoes (or Navajos), Apaches, Lipanes, Pelones, Tontos, and others—are widely diffused over Arizona, New Mexico, Texas, and the northern provinces of the Mexican Republic.

The best account of the Northern Tinneh, east of the Rocky Mountains, is found in the introductory portion of the 'Dictionnaire de la langue Dènè-Dindjié' of the eminent missionary-philologist, the Abbé Petitot, who resided many years among them, and studied their languages, customs, and traditions with much care. In his list of the tribes belonging to this portion of the stock he makes a division styled mountaineers (*Montagnards*), possessing the country on both sides of the Rocky Mountains. The southernmost tribe of this division, on the east side of the mountains, is the Tsa-ttinnè, a name which he renders 'dwellers among the beavers.' The name is derived from *tsa*, beaver (which has various other dialectical forms, *tso, sa, za, and so*), and *tinnè* (otherwise *tennè, tena, atena, tunneh, dènè, danneh, dindjié, &c.*), the word for 'man' in the different dialects. M. Petitot describes the Tsa-ttinnè, or 'Beaver Indians,' as comprising two septs—a northern tribe, who hunt along the

Peace River, and a southern, who dwell about the head-waters of the North Saskatchewan, towards the Rocky Mountains. The latter, he says, are the *Sarcis*, who have separated themselves from the northern band. The tribal name of Soténnä, which Mr. Wilson obtained from the Sarcees, is evidently a dialectical variation of M. Petitot's Tsa-tinnè.

It has been supposed that the separation of the Sarcees from their Tinneh kindred, followed by their union with the Blackfeet, was the result of dissensions among the Tinneh tribes. But the information obtained by Mr. Wilson shows that this idea was not well founded. The separation is now ascribed by the Sarcees to a superstitious panic, but very probably resulted merely from the natural desire of their forefathers to find a better country and climate. Their southward advance brought them in contact with the Blackfeet, with whom they confederated, not against their Tinneh kindred, as had been supposed, but against the Crees, who have from time immemorial been the common enemies of the Tinneh and Blackfoot tribes.

The legend of the deluge, which Mr. Wilson obtained, is given by M. Petitot in a slightly different form, which on some accounts is worthy of notice. In early times, we are told, there was a 'deluge of snow' in September. This was changed to a flood of water by the act of 'the mouse,' an important character in the mythology of some of the Tinneh tribes, being regarded as 'the symbol or genius of death.' He pierced the skin-bag in which 'the heat' was contained, and the snow was forthwith melted. The flood quickly rose above the mountains and drowned the whole human race except one old man, who had foreseen the catastrophe and had vainly warned his neighbours. He had made for himself a large canoe, in which he floated, gathering on it all the animals he met. After a time he ordered several of these animals to dive and seek for earth. These were the beaver, the otter, the musk-rat, and the arctic duck. According to this version of the story, it was neither the beaver nor the musk-rat that brought up the earth, but the duck. This morsel of earth was extended by the breath of the old man, who blew upon it until it became an immense island, on which he placed successively, during six days, all the animals, and finally disembarked himself.

This story is evidently made up from various sources. The skin-bag of heat bitten through by the mouse seems to be a genuine Tinneh invention. The diving of the animals, with the formation of the new earth, is a well-known creation myth of the Algonkin and Iroquois tribes; and the 'six days' are probably a late addition derived from the missionary teachings. An inquirer among the Indian tribes is constantly coming across such composite myths, which require careful study and analysis.

Other observers agree with Mr. Wilson in regarding the Northern Tinneh tribes as inferior in intelligence to the neighbouring Indians of other stocks. This is doubtless a just view. The inferiority, however, would seem to be not from any natural deficiency, but rather the result of the very unfavourable conditions under which the former are condemned to live. Not much can be expected from bands of widely scattered nomads, often famine-stricken, wandering over a barren region, under inclement skies. In better surroundings their good natural endowments become apparent. The Hoopas of California display much intelligence and energy. Mr. Stephen Powers, in his account of the 'Tribes of California,' published by the American Bureau of Ethnology,

speaks of the Hoopas with much admiration, and styles them 'the Romans of Northern California'; he states that they had reduced most of the surrounding tribes to a condition of semi-vassalage. Mr. J. P. Dunn, an able and experienced writer, in his recent work, 'The Massacres of the Mountains,' describes the Navahoes as the most interesting of all the western tribes. They are a peaceful, pastoral, and agricultural people, remarkable for their industry and for their ingenuity in various manufactures. Their women weave excellent blankets, which, he says, 'have been the wonder and admiration of civilised people for many years. They are very thick, and so closely woven that a first-class one is practically water-tight, requiring five or six hours to be soaked through.' They make pottery, and 'have numerous silversmiths, who work cunningly in that metal.' Their women are well treated, are consulted in all bargains, and hold their own property independently. In 1884 the tribe numbered 17,000 souls, cultivated 15,000 acres of land, raised 220,000 bushels of maize and 21,000 bushels of wheat; they had 35,000 horses and 1,000,000 sheep. It has seemed proper to mention these facts as evidence that the Indians who inhabit so large a portion of British America, and whose descendants are probably destined to hold much of it permanently, belong to a stock which, under favouring circumstances, displays a good aptitude for civilisation.

M. Petitot, it should be observed, speaks of the Sarcee language as forming a connecting link between the languages of the northern and southern Tinneh tribes. Mr. Wilson's vocabulary, though taken under many disadvantages, will doubtless be found extensive enough to afford useful data to philologists in classifying the idioms of this important family.

The Committee ask for reappointment, with a renewal of the grant.

Report of the Corresponding Societies Committee, consisting of Mr. FRANCIS GALTON (Chairman), Professor A. W. WILLIAMSON, Sir DOUGLAS GALTON, Professor BOYD DAWKINS, Sir RAWSON RAWSON, Dr. J. G. GARSON, Dr. J. EVANS, Mr. J. HOPKINSON, Professor R. MELDOLA (Secretary), Mr. W. WHITAKER, Mr. G. J. SYMONS, General PITT-RIVERS, Mr. W. TOPLEY, Mr. H. G. FORDHAM, and Mr. WILLIAM WHITE.

THE Corresponding Societies Committee of the British Association beg to report to the General Committee that the Conferences of Delegates were held on Thursday, September 1, and Tuesday, September 6, 1887, at 3.30 P.M., in the Court Room of Owens College.

The following Delegates were nominated for the Manchester meeting:—

Mr. Thomas Lister	Barnsley Naturalists' Society.
Rev. H. H. Winwood, M.A., F.G.S.	Bath Natural History and Antiquarian Field Club.
Mr. William Gray, M.R.I.A.	Belfast Naturalists' Field Club.
Mr. W. P. Marshall, M.Inst.C.E.	Birmingham Natural History and Microscopical Society.
Rev. H. W. Crosskey, LL.D., F.G.S.	Birmingham Philosophical Society.
Mr. Sydney Young, D.Sc.	Bristol Naturalists' Society.
Mr. Horace Brown, F.G.S., F.C.S.	Burton-on-Trent Natural History and Archæological Society.

Mr. Alfred O. Walker, F.L.S.	. Chester Society of Natural Science.
Rev. J. M. Mello, M.A., F.G.S.	. Chesterfield and Midland Counties Institution of Engineers.
Mr. T. Cushing Croydon Microscopical and Natural History Society.
Mr. J. G. Goodchild, F.G.S. .	. Cumberland and Westmorland Association for the Advancement of Literature and Science.
Mr. A. S. Reid, M.A., F.G.S. .	. East Kent Natural History Society.
Mr. Ralph Richardson, F.R.S.E.	. Edinburgh Geological Society.
Prof. R. Meldola, F.R.S., F.C.S.	. Essex Field Club.
Mr. D. Corse Glen, C.E., F.G.S.	. Glasgow Geological Society; Glasgow Natural History Society.
Mr. W. C. Crawford, M.A. . .	. Glasgow Philosophical Society.
Mr. H. George Fordham, F.G.S.	. Hertfordshire Natural History Society and Field Club.
Dr. Ogilvie Grant Inverness Scientific Society and Field Club.
Mr. A. W. Moore, M.A., J.P. .	. Isle of Man Natural History and Antiquarian Society.
Mr. F. T. Mott, F.R.G.S. Leicester Literary and Philosophical Society.
Mr. R. L. Tapscott Liverpool Engineering Society.
Mr. G. H. Morton, F.G.S. Liverpool Geological Society.
Mr. Eli Sowerbutts Manchester Geographical Society.
Mr. Mark Stirrup, F.G.S. Manchester Geological Society.
Mr. Henry Wilson, M.A. Midland Union of Natural History Societies.
Prof. G. A. Lebour, M.A., F.G.S.	. North of England Institute of Mining and Mechanical Engineers.
Mr. J. T. Arlidge, A.M., M.D. .	. North Staffordshire Naturalists' Field Club and Archæological Society.
Mr. Matthew Blair, F.G.S. Paisley Philosophical Institution.
Mr. Robert Pullar, F.R.S.E. . .	. Perthshire Society of Natural Science.
Mr. Hugh R. Mill, D.Sc., F.R.S.E.	. Royal Scottish Geographical Society.
Mr. J. W. Davis, F.G.S. Yorkshire Geological Society.
Mr. C. P. Hobkirk, F.L.S. Yorkshire Naturalists' Union.

At the first meeting of the Conference the chair was taken by Professor W. Boyd Dawkins, F.R.S.; the Corresponding Societies Committee being represented by Dr. J. G. Garson and Professor R. Meldola, F.R.S., Secretary.

The Secretary read the Report of the Corresponding Societies Committee which had been presented to the General Committee of the Association at the meeting on Wednesday, August 31.

The Chairman called upon the Delegates to make any statements respecting the action that had been taken by their Societies with reference to the suggestions put forward last year, and which had been embodied in the Report just read.

Prehistoric Remains Committee.—Mr. J. W. Davis stated that this Committee had been carrying on its work during the past year, and proposed to apply for reappointment. Two reports had been obtained relating to the bronze implements of the East and West Ridings of Yorkshire, and several others had been promised.

Preservation of Stonehenge.—Dr. Garson stated that the resolution which had been submitted last year to the Delegates at the Birmingham Conference¹ had been considered by the Committee of Section H, and having been adopted by it, had been brought before the General Com-

¹ Report for 1887, p. 465.

mittee and accepted. He believed that in consequence of this action negotiations were now going on between the Council of the British Association and the proprietor of these remains.¹

Professor Boyd Dawkins remarked that the state of neglect into which Stonehenge had been allowed to fall had by no means been overstated in the resolution referred to. A person had recently been seen on a ladder chipping off pieces from the horizontal stone of one of the trilithons.

Ancient Monuments Act.—Dr. Garson pointed out that the local Societies could do good service by inducing the proprietors of prehistoric remains to communicate with General Pitt-Rivers, the Inspector of Ancient Monuments, with the object of placing these remains under Government protection. The Chairman urged those Delegates who represented the Northern and especially the Scotch Societies to use their influence in inducing the owners of ancient remains to assist in carrying out the objects of the Act. In reply to a question by Mr. F. T. Mott, as to whether camps and earthworks were to be taken into consideration, he did not think that any Government could be expected to become a landowner to the extent of all the earthworks in the country.

Provincial Museums Committee.—Mr. F. T. Mott stated that this Committee had been engaged during the past year in collecting particulars respecting museums other than those in London. Considerable assistance had been given by the Secretaries of many of the local Societies.

Professor Boyd Dawkins stated that the schedule issued by this Committee was a very difficult one to fill up, and he expressed a hope that something shorter and simpler would be sent out. The Rev. H. Winwood expressed similar views.

Earth Tremors.—Professor Lebour stated that this subject, which he had brought forward at the Conference of Delegates last year at Birmingham, had since taken a more practical shape, and that it now seemed to be time that a Committee of the British Association should be formed for taking the investigation in hand. Through the advocacy of Mr. Symons, who was unable to be present at the Conference, Sections A and G had agreed to recommend the appointment of such a Committee in conjunction with Section C. The work to be done was of a preliminary character, and its object was rather to inquire into the best methods of conducting observations on Earth-Tremors than to actually cause such observations to be made. The North of England Institute of Mining and Mechanical Engineers had, since the Birmingham meeting, carried on a series of seismoscopic observations at Marsden in the county of Durham, and the daily results, extending over several months and compared with a barometric curve, were shown to the meeting in the form of a diagram by Mr. Walton Brown, the Secretary of the Newcastle Institute Committee. The Institute possessed also a more elaborate instrument, made after a pattern supplied by Professor Ewing, which registered the intensity and direction of the tremors. He stated that, although such instruments as the last mentioned were probably too costly to be placed at all desirable stations, this would not be the case with the simpler seismoscope, which recorded merely the fact of earth-tremors having taken place and the time of their occurrence. Such records would be valuable though limited. The Corresponding Societies, if they would interest themselves in the matter, might be the means of establish-

¹ Report for 1887, p. lxxv.

ing a great network of seismoscopes with a few seismographs in suitable localities, and results of value would by this means be, in all probability, obtained. These results would be valuable in proportion as well-equipped seismometrical observing stations were numerous. The expense must in any case be considerable in the aggregate, but need not be great in individual cases. A sufficiently good seismoscope might be had for about 2*l.*, a seismograph for 14*l.* to 15*l.*, and the cost of keeping them in order would not be great. He hoped the Delegates present would help in establishing such a network of observing stations all over the country, and he would be happy to communicate with anyone interested in the subject.

Professor Ewing, in response to the Chairman, said that from his experience of earth-tremor observations in Japan he could concur in the remarks of Professor Lebour. To investigate fully the character of the motion, even at one station, required delicate and costly apparatus, and the cost was greatly increased when it was attempted to bring a number of stations into correspondence so as to determine the motion over a large area. It was possible, however, to record the fact that a tremor had occurred, and even to learn something of its character by means of inexpensive seismoscopes; and it certainly seemed to him that no bodies could more appropriately undertake that work than the local Societies represented at the Conference acting in conjunction with a Committee of the Association. From recent observations it appeared probable that tremors would be found wherever they were tested for with sufficient delicacy, so that a Society undertaking the search was not likely to be disappointed.

At the second Conference the chair was taken by Professor Boyd Dawkins, F.R.S., who was succeeded by Mr. W. Topley, F.G.S., the Corresponding Societies Committee being further represented by Mr. G. J. Symons, F.R.S., Dr. Garson, Mr. William White, and Professor R. Meldola, F.R.S., Secretary.

The Chairman invited discussion on the recommendations received from the various Sections.

SECTION A.

Temperature Variation in Lakes, Rivers, and Estuaries.—The following resolution was forwarded to the Secretary of the Conference by the Secretary of this Section:—

‘That Mr. John Murray, Professor Chrystal, Dr. A. Buchan, Rev. C. J. Steward, Hon. R. Abercromby, Mr. J. Y. Buchanan, Mr. David Cunningham, Mr. Isaac Roberts, Dr. H. R. Mill, and Professor Fitzgerald be appointed a Committee to arrange for an investigation of the seasonal variations of temperature in lakes, rivers, and estuaries in various parts of the United Kingdom in co-operation with the local Societies represented at the Association; and that Mr. John Murray be Secretary.’

Dr. H. R. Mill, as representing this Committee, stated that the question proposed had not been fully worked out, but that the few observations made showed relations of a very interesting kind. As a branch of meteorology, this research was particularly promising, and was one in which the co-operation of local Societies would be valuable. He proposed that the Societies situated in the neighbourhood of rivers and estuaries which were willing to undertake this work should appoint some

member to observe the temperature daily or weekly, as the case might be, in accordance with the rules to be drawn up by the Committee. It was first proposed to ascertain how many observers would offer themselves in various parts of the country, then to draw up a scheme of observations and arrange for this being adopted.

Mr. G. J. Symons pointed out the necessity in such observations for having a well-considered scheme drawn up, as well as for having absolutely reliable thermometers, without which no observations would be of value. He also asked whether it was proposed that the cost of the instruments should be met by a grant from the British Association, or whether the Societies taking part in the observations should provide their own thermometers.

Mr. De Rance remarked that in the case of the Committee which had been formed for the observation of underground temperatures, and of which Professor Lebour was a member, the thermometers had been supplied by the Association.

Mr. J. W. Davis raised the question as to whether it would be of use to extend the observations to the streams in manufacturing districts. He also asked what the Committee proposed to consider as an estuary.

The Rev. H. Winwood remarked that it would be necessary in all cases to record the depth at which the thermometer-reading was taken. As a point of interest bearing upon the proposed observations, he stated that it had been observed that the temperature of the lakes in the Hebrides had been unusually high this year.

Professor Lebour stated that the thermometers used by the Underground Temperature Committee had been supplied by the Association, but these instruments were very costly, and only a few observers had taken part in the work. He was of opinion that if numerous Societies took part in the observations, these should in each case bear the expense.

Dr. Garson expressed a hope that the temperatures would be recorded on the Centigrade scale.

Dr. Mill, in reply, said that he understood that the fact of the investigation being sanctioned by a Committee of Section A was a sufficient guarantee that it should be carried out in a thoroughly scientific manner with properly verified instruments of a uniform pattern, and employed in the same way. The experience of the Scottish Marine Station for three years suggested many precautions which should be adopted in this work. The temperature of streams in manufacturing districts should certainly be ascertained in as many cases as possible, in order to find whether the increase of temperature of a river passing through a manufacturing town is in any sense permanent. The term 'estuary' should, in his opinion, be used as meaning all parts of a tidal river between the upper limit of the tide and the open sea. Each local Society should be asked to supply its own thermometers, but all these should be verified at Kew, or compared by some person appointed by the Committee. The observations would, of course, be made on a uniform plan, and it would, probably, be found more convenient to use the Fahrenheit than the Centigrade scale, but the readings could be easily converted, if necessary.

Earth Tremor Committee — See under Section C.

SECTION B.

No recommendations forwarded or suggestions made.

SECTION C.

Mr. C. E. De Rance, who represented this Section, referred to the work of the three Committees which he had brought under the notice of the Delegates on former occasions, viz.: (1) The Underground Water Committee; (2) The Erratic Blocks Committee; and (3) The Sea Coasts Erosion Committee.¹

The first of these Committees requires information as to the depth of wells, the sections passed through, the height at which the water stands before and after pumping, daily records of the height and chemical analyses of the waters.

The *Erratic Blocks Committee* wants information as to the position, size, and character of boulders of foreign origin that may occur in drift-covered areas, and is anxious that the position of the same should be noted on the one-inch map of the Ordnance Survey.

The *Sea-Coasts Erosion Committee*, like the other two Committees, has a printed form of inquiry, which can be obtained on application to Mr. Topley.

With reference to the work of this last Committee, Mr. Topley stated that but little assistance had as yet been received from the local Societies. The Natural History Society of the Isle of Man had undertaken to collect information; and all similar Societies in maritime counties might greatly assist the Committee by local observation as to present changes, and by researches as to past conditions of the coast.

With respect to the work of the Erratic Blocks Committee, Professor Meldola said that he had been authorised to state on behalf of the Manchester Geological Society that several members of that Society had been interesting themselves in the distribution of boulders in their district, and it was expected that their results would be available by the next meeting of the Association. It was also mentioned that Mr. Adamson had been rendering assistance to this Committee on behalf of the Yorkshire Naturalists' Union.

Mr. Ralph Richardson, as the representative of the Edinburgh Geological Society, pointed out that Scotland had been omitted from the localities dealt with by the Erratic Blocks Committee. He stated that much work in this field had already been carried out under the auspices of the Royal Society of Edinburgh, and he hoped the Committee would be able to utilise their results.

Earth-Tremor Committee.—Professor Lebour stated that since the last meeting of the Conference the formation of a joint committee by Sections A, C, and G had been agreed to, and the resolution forwarded to the Committee of Recommendations. The resolution was the following:—

‘That Sir F. J. Bramwell, Mr. E. A. Cowper, Mr. G. J. Symons, Professor G. H. Darwin, Professor Ewing, Mr. Isaac Roberts, Mr. Thomas Gray, Dr. John Evans, Professor Lebour, Professor Prestwich, Professor Hull, Professor Meldola, and Professor Judd be a Committee for the purpose of considering the advisability and possibility of establishing in other parts of the country observations upon the prevalence of earth-tremors, similar to those now being made in Durham in connection with coal-mine explosions, and that Professor G. A. Lebour be the Secretary.’

Mr. De Rance remarked that the proposed observations might possibly

¹ Report for 1887, p. 462.

under certain circumstances become connected with the work of the Underground Water Committee. Thus the Essex earthquake of April 22, 1884, had caused a rise in the level of the water in Messrs. Courtauld's well at Bocking, which had reached its maximum in June of the same year. Since then the level had been gradually falling, and at its present rate it might be expected that the water would be at the same level as it was before the earthquake about next August.

SECTION D.

Life Histories of Plants.—Professor Meldola said that during a recent visit to Oxford he had had an opportunity of hearing a suggestion in the course of a conversation with Professor Bayley Balfour, which had appeared to him as likely to be of use to the members of local Societies. He had therefore invited Professor Balfour to attend the Conference and explain his views on the suggested subject, but as that gentleman was prevented from being present he had forwarded the following communication:—

‘It appears to me that much good scientific work might be done by members of local Societies in a direction which has not attracted so much attention in Great Britain as it deserves. The discovery and description of new forms, and the distribution of our indigenous plants is in Botany the line upon which most of the energies of local Societies are principally spent, whilst habit, construction, and generally the features of life-history of plants come in for attention in quite a secondary way. This arises, I think, in great part from the prevalent notion that the facts of the life-history of our common plants are all well known, and that there is little, if anything, more to find out about them. That this is an erroneous idea may easily be shown—witness, for example, the interesting observations recently published by Sir John Lubbock—and there is a field for a great deal of sound work upon plants growing at our doors.

‘Within recent years Mr. Darwin's work, followed up by that of such men as Hermann Müller, Kerner, Ogle, and others, has given a stimulus to observations of adaptations between the vegetable and animal kingdoms in connection with pollination in flowers; and many interesting facts about British plants have been brought to light by workers in local Societies. But little has been done for the subject of the vegetative organs of these plants—I mean the arrangement, true nature, and structure of the members that carry on plant-life. In Germany many years ago Wydler and Irmisch published a splendid series of contributions to the knowledge of these features in indigenous German plants—why has this not been done for Britain?

‘Now I venture to think that good results would follow if you would bring before the Delegates at the meeting to-day the importance of encouraging the members of their Societies to study the life-histories of indigenous plants in their entirety, *i.e.*, from the stage of embryo in the seed up to the production of fruit and seed again. Anyone who will take up this line of study will assuredly derive great pleasure from it, and will be able to add a great deal to the sum of our knowledge of plant-life. Such work can be well combined with the more usual systematic work, it can be easily accomplished, and it will be found to give much additional interest to the study of British Botany.’

Mr. C. P. Hobkirk considered that Professor Balfour's letter was a very important one, and that, as therein suggested, the time and energies

of the members of local Societies would be far more usefully employed by following the lines indicated by Professor Balfour than, as at present, in simply collecting, naming, and registering local plants. As far as he was concerned, he was prepared personally, and also on behalf of the Yorkshire Naturalists' Union which he represented, to do everything in his power to assist in carrying out practically Professor Balfour's most useful proposition. Although the compilation of local floras was most useful and necessary work, yet the actual life-history of individual forms was now of really paramount importance, and members of local Societies should be urgently requested to carry on this work without delay.

SECTIONS E and F.

No recommendations forwarded or suggestions made.

SECTION G.

Earth-Tremor Committee.—See under Section C.

SECTION H.

Ancient Monuments Act.—The Secretary read the following communication from General Pitt-Rivers:—

‘I am much afraid I shall not be able to be present at the meeting of Delegates of local Societies on Tuesday; but the subject is so important for the preservation of these monuments that, in case I am not there, I write in order that you may know what my view of the matter is.

‘Perhaps I cannot do better than state in a few words what the work of the Inspector of Ancient Monuments is, and you will then see what kind of progress is likely to be made without some assistance such as has been proposed,¹ and in what way the assistance of local Societies can be given.

‘You are probably aware that, in the original Act of 1882, fifty ancient monuments in Great Britain were scheduled as monuments to which the Act could apply at once if the owners were willing. Some persons suppose that by scheduling these monuments they were actually placed under the Act, but this is not the case. The scheduling was done without the knowledge or consent of the owners, and their consent had to be obtained both for these and for every other monument that has been since added to the list. This has entailed the examination and survey of all these monuments which are distributed over England, Scotland, and Wales. The addresses of the owners had to be obtained, and this could only be done on the spot. After that the owners had to be visited personally, for I soon found an official letter, without a verbal explanation, almost invariably produced a refusal. On this account I have of late found it advisable never to approach an owner without a personal introduction, or without doing it in such a way as to induce him to consider the matter favourably. This mode of procedure for the whole country has, of course, taken a long time, and the result has been that about half of these fifty monuments have been voluntarily put under the Act by their owners, and of the

¹ This refers to the work of the Prehistoric Remains Committee of the British Association.

remainder some of the proprietors have refused, whilst in the case of others it has been found impracticable owing to peculiarities in the ownership. All the monuments have, however, been carefully surveyed, planned, and drawn, and in every case in which there has been a refusal the owners have stated their intention of taking good care of the monuments themselves. In one case only a camp has been partly damaged, and this owing to mining operations involving a question of a large sum of money which made it impossible for the Government to interfere. Other non-scheduled monuments have since been added to the list, and the number is steadily but not rapidly increasing.

‘The Government makes no allowance for an assistant, not even so much as a man to hold the end of the tape in measuring, without which no proper survey of the monuments can be made, and I have to employ a private assistant, whom I take about with me at my own cost. With his assistance, and by dividing the work with him—I making the necessary notes and measurements while he is drawing—each monument takes on an average about one day; without an assistant the time would be about doubled. After this the owner has to be visited, and as he generally lives at a distance from the monument, this frequently takes another day or more. A great deal of this time might be saved by the assistance of persons living in the localities, and with better chance of success.

‘I issued a circular to a number of local Societies inviting them to cooperate, but few responded. One instance, however, shows what may be done in this way. Sir Herbert Maxwell has not only sent me the addresses of several owners in Wigtonshire and Kirkcudbrightshire, but, by using his influence with these, has been the means of placing several monuments under the Act. I would suggest that the same course might well be followed by others.

‘The recommendation I would make is this:—Local Societies should (1) report to me what monuments in their district they think worthy of being put under the Act; (2) they should send me the names and addresses of the owners; (3) they should communicate with the owners, and, if possible, obtain their consent to have the monuments placed under the Act, subject, of course, to their subsequent acceptance by the Office of Works; and (4) they should report to me any damage that they find being done or contemplated either to the monuments under the Act, or to others not so protected. With such assistance I think that much more rapid progress may be made.’

Prehistoric Remains Committee.—Mr. J. W. Davis stated that this Committee had been recommended for reappointment by the Committee of Section H. The recommendation is as follows:—‘That Sir John Lubbock, Dr. John Evans, Professor Boyd Dawkins, Dr. R. Munro, Mr. Pengelly, Dr. Hicks, Mr. J. W. Davis, Professor Meldola, and Dr. Muirhead be reappointed a Committee for the purpose of ascertaining and recording the localities in the British Islands in which evidences of the existence of prehistoric inhabitants of the country are found; and that Mr. J. W. Davis be the Secretary.’

Professor Lebour suggested that it would be convenient if, in registering prehistoric remains, the Committee would adopt a uniform scheme of signs—if possible an international one.

Mr. William Gray stated that the work of registering ancient remains had been carried on for 25 or 30 years by members of his Society (Belfast Naturalists' Field Club) and others in Ireland, and they had

long felt the want of some central organisation such as that of the present Committee. He also alluded to the necessity for a uniform system of signs.

Mr. William White remarked upon the difficulty which private individuals often experienced in approaching the proprietors of ancient remains, and pointed out that individual efforts would be likely to be more successful if members of local Societies could make overtures backed up by the sanction of a British Association Committee such as the present one.

STATUS OF THE CONFERENCE OF DELEGATES.

At the Manchester meeting of the Association an important resolution was framed at the instigation of Sir Douglas Galton with the object of conferring additional powers upon the Conference. According to the former rules the Delegates had no power of submitting resolutions or recommendations to the Committee of Recommendations, but the resolution referred to is calculated to give them the necessary power, and thus to put the Conference on the same footing as the Sectional Committees. The resolution in question was passed last year, on the motion of the Secretary of the Corresponding Societies Committee, by the Committees of Sections B and C, and had been accepted in due form by the Committee of Recommendations and by the General Committee, so that it is now a rule of the Association. The resolution is as follows:—

‘That the Conference of Delegates of Corresponding Societies be empowered to send recommendations to the Committee of Recommendations for their consideration, and for report to the General Committee.’

Nomination of Delegates.—At the Conference of Delegates held last year the Secretary of the Corresponding Societies Committee stated that some of the local Societies had nominated delegates to attend the Manchester meeting without having previously submitted any claim for admission as Corresponding Societies. This probably arose from a misunderstanding of the rules, and the Corresponding Societies Committee has to point out that such Delegates cannot be officially recognised by the Association, as it is only those Societies which have been admitted as Corresponding Societies, and which are still on the list, that are thus entitled to be officially represented. *According to the Rules no Society can be admitted without first sending in a formal application, accompanied by a specimen of its publications; this application would be considered by the Corresponding Societies Committee, and only in the event of the Society being recommended for election by this Committee, and this recommendation being confirmed by the General Committee, would it be admitted to the privileges of a Corresponding Society.*

The Corresponding Societies Committee recommends that all the Societies on last year’s list should be retained, and that the Belfast Natural History and Philosophical Society, the Leeds Geological Association, and the Nottingham Naturalists’ Society should be enrolled as Corresponding Societies.

The Corresponding Societies of the British Association for 1888-89.

Full Title and Date of Foundation	Abbreviated Title	Head-quarters or Name and Address of Secretary	No. of Members	Entrance Fee	Annual Subscription	Title and Frequency of Issue of Publications
Barnsley Naturalists' Society, 1867	Barnsley Nat. Soc.	Public Hall, Barnsley. Edwin Hirst, Hopwood Street	70	2s.	6s. and 10s. 6d.	Transactions, occasionally.
Bath Natural History and Antiquarian Field Club, 1865	Bath N. H. A. F. C.	Rev. H. H. Winwood, Royal Literary and Scientific Institution, Bath	87	5s.	10s.	Proceedings, annually.
Bedfordshire Archaeological and Natural History Society, 1887	Beds. A. N. H. Soc.	F. A. Blaydes and F. B. W. Phillips, M.A., Harpur Place, Bedford	50	None	7s. 6d.	Transactions, occasionally.
Belfast Natural History and Philo-sophical Society, 1821	Belfast N. H. Phil. Soc.	Museum, College Square, R. M. Young, B.A.	shrhdrs. 186 7/8 per Share Members 31 270	None	Varies	Report and Proceedings, annually.
Belfast Naturalists' Field Club, 1863	Belfast Nat. F. C.	William Swanston, F.G.S., and F.W. Lockwood, 50 King Street, Belfast	200	None	17. 1s. 5s.	Report and Proceedings, annually.
Birmingham Natural History and Microscopical Society, 1864	Birm. N. H. M. Soc.	W. N. Wilkinson and William P. Marshall, Mason College, Bir-mingham	130	None	17. 1s.	'Midland Naturalist,' Monthly.
Birmingham Philosophical Society.	Birm. Phil. Soc.	J. H. Poynting and B. C. A. Windle, Medical Institute, Birmingham	226	5s.	10s.	Proceedings, annually.
Bristol Naturalists' Society, 1862	Bristol Nat. Soc.	University College, Bristol. Pro-fessor Adolph Leipner, 47 Hamp-ton Park, Clifton, Bristol	160	None	5s.	Annual Report. Transac-tions occasionally.
Burton-on-Trent Natural History and Archaeological Society, 1876	Burt. N. H. Arch. Soc.	46 High Street, G. Harris Morris, Ph.D., F.I.C., Avondale, Alexan-dra Road, Burton-on-Trent	416	None	10s.	Report and Transactions, half-yearly
Cardiff Naturalists' Society, 1867	Cardiff Nat. Soc.	R. W. Atkinson, B.Sc., F.I.C., 44 Lou-don Square, Cardiff	582	None	5s.	Annual Report. Transac-tions every three or four years.
Chester Society of Natural Science, 1871	Chester Soc. Nat. Sci.	Grosvenor Museum, Chester. G. R. Griffith and W. H. Okell	257	17. 1s.	Members 31s. 6d.; Subscribers 21s.; Associates and Students 20s. Minimum, 10s. 6d. 17. 1s.	Transactions, quarterly.
Chesterfield and Midland Counties Institution of Engineers, 1871	Chesterf. Mid. Count. Inst.	Stephenson Memorial Hall. W. F. Howard, 13 Cavendish Street, Chesterfield	300	None	None	Transactions, annually.
Cornwall, Mining Association and Institute of, 1884	Cornw. Min. Assoc. Inst.	William Thomas, F.G.S., Tucking-mill, Camborne	103, and 18 Associates	None	None	Report and Transactions, annually
Cornwall, Royal Geological Society of, 1814	Cornw. R. Geol. Soc.	G. B. Millet, Fenzance	280	None	10s.	Proceedings and Transac-tions, annually.
Croydon Microscopical and Natural History Club, 1870	Croydon M. N. H. C.	W. Low Sarjeant, 7 Belgrave Road, South Norwood, S.E.	864	None	5s.	Transactions, annually.
Cumberland and Westmorland Association for the Advancement of Literature and Science, 1876	Cumb. West. Assoc.	J. B. Bailey, 28 Eaglesfield Street, Maryport		None		

SELECTED LIST OF SOCIETIES, &c. (continued).

Full Title and Date of Foundation	Abbreviated Title	Head-quarters or Name and Address of Secretary	No. of Members	Entrance Fee	Annual Subscription	Title and Frequency of Issue of Publications
Dorset Natural History and Antiquarian Field Club, 1875	Dorset N. H. A. F. C.	M. G. Stuart, Blandford St. Mary's, Blandford, Dorset	200	None	10s.	Proceedings, annually.
Dumfriesshire and Galloway Natural History and Antiquarian Society, 1876	Dum. Gal. N. H. A. Soc.	Dumfries, J. Wilson, 3 Norfolk Terrace, Dumfries	220	2s. 6d. (Gentlemen only)	2s. 6d.	Transactions and Journal of Proceedings, annually or biennially.
East Kent Natural History Society, 1858	E. Kent N. H. Soc.	William P. Mann, B.A., Langton School, Canterbury	75	None	Gentlemen, 10s.; Ladies, 6s.	Transactions, occasionally.
East of Scotland Union of Naturalists' Sociétés, 1884	E. Scot. Union	William D. Sang, 12 Townsend Crescent, Kirkcaldy, N.B.	10 Societies, 1,091 Members.	None	Assessment of 4d. per member	Proceedings, annually.
Edinburgh Geological Society, 1834	Edinb. Geol. Soc.	H. M. Cadell, 5 St. Andrew's Square, Edinburgh	231	10s. 6d.	12s. 6d.	Transactions, annually.
Essex Field Club, 1880	Essex F. C.	William Cole, 7 Knighton Villas, Buckhurst Hill, Essex	350	10s. 6d.	10s. 6d.	'Essex Naturalist,' monthly; Special Memoirs occasionally.
Glasgow, Geological Society of, 1858	Glasgow Geol. Soc.	J. B. Murdoch, Capelrig, Mcarns, Glasgow	250	None	10s.	Transactions, annually.
Glasgow, Natural History Society of, 1851	Glasgow N. H. Soc.	D. A. Boyd and J. Trotter, 207 Bath Street, Glasgow	349	7s. 6d.	7s. 6d.	Proceedings and Transactions, annually.
Glasgow, Philosophical Society of, 1802	Glasgow Phil. Soc.	John Mayer, 207 Bath Street, Glasgow	672	11. 1s.	11. 1s.	Proceedings, annually.
Hertfordshire Natural History Society and Field Club, 1875	Herts N. H. Soc.	Public Library, Watford, F. G. Lloyd and C. E. Shelly	265	10s.	10s.	Transactions, quarterly.
Holmesdale Natural History Club, 1857	Holmesdale N. H. C.	A. J. Crosfield, Carr End, Reigate	77	10s.	10s.	Proceedings, usually every two years.
Inverness Scientific Society and Field Club, 1875	Inverness Sci. Soc.	Thomas Wallace, High School, Inverness	160	None	5s.	Transactions, occasionally.
Ireland, Royal Geological Society of, 1831	R. Geol. Soc. Ireland	Prof. W. J. Sollas, F.G.S., Trinity College, Dublin	140	None	None	Journal, generally annually.
Ireland, Statistical and Social Inquiry Society of, 1847	Stat. Soc. Ireland	C. F. Bastable, 35 Molesworth Street, Dublin	150	None	11.	Journal, annually.
Leeds Geological Association, 1874	Leeds Geol. Assoc.	S. A. Adamson, 52 Well Close Terrace, Leeds	102	None	5s.	Transactions, annually.
Leicester Literary and Philosophical Society, 1835	Leicester Lit. Phil. Soc.	C. J. Billson, M.A., Town Museum, Leicester	330	None	Members 11. 1s.; Associates 10s. 6d.	Transactions, quarterly.
Liverpool Engineering Society, 1874	Liv'pool E. Soc.	Royal Institution, J. H. T. Turner, 14 North John Street, Liverpool	177	None	11. 1s.	Transactions, annually.
Liverpool Geological Society, 1849	Liv'pool Geol. Soc.	Royal Institution, W. Hewitt, B.Sc., 16 Clarence Road, Birkenhead	55	None	11. 1s.	Proceedings, annually.

Liverpool, Literary and Philosophical Society of, 1812	Liv'pool Lit. Phil. Soc.	271	10s. 6d.	17. 1s.	Proceedings, annually.
Liverpool Microscopical Society, 1868	Liv'pool Mic. Soc.	157	10s. 6d.	10s. 6d.	Report, annually.
Man, Isle of, Natural History and Antiquarian Society, 1879	I. of Man N. H. A. Soc.	120	2s. 6d.	5s.	Transactions, occasionally.
Manchester Geographical Society, 1884	Manch. Geog. Soc.	520	None	Ordinary 17. 1s. Associates 10s. 6d.	Journal; usually quarterly.
Manchester Geological Society, 1838	Manch. Geol. Soc.	220	None	17.	Transactions; about nine parts per annum.
Manchester Statistical Society, 1833	Manch. Stat. Soc.	Ordinary 183 Corresponding 22	10s. 6d.	10s. 6d.	Transactions, annually.
Marlborough College Natural History Society, 1865	Marlb. Coll. N. H. Soc.	130	1s. 6d.	3s.	Report, annually.
Midland Union of Natural History Societies, 1877	Mid. Union	2,000	—	—	'Midland Naturalist,' monthly.
North of England Institute of Mining and Mechanical Engineers, 1852	N. Eng. Inst.	735	None	21s., 42s., 63s.	Transactions, every two months.
North Staffordshire Naturalists' Field Club and Archaeological Society, 1865	N. Staff. N. F. C. A. Soc.	377	5s.	5s.	Report and Transactions, annually.
Northamptonshire Natural History Society and Field Club, 1876	N'ton, N. H. Soc.	200	None	10s.	Journal, quarterly.
Nottingham Naturalists' Society, 1852	Nott. Nat. Soc.	Honorary 6, Annual 1, Ordinary 161 Corresponding 11	None None None None	None 17. 1s. 5s. 2s. 6d.	Transactions and Report, annually.
Paisley Philosophical Institution, 1808	Paisley Phil. Inst.	344	5s.	Members 7s. 6d. Assoc. 5s.	Report, annually.
Penzance Natural History and Antiquarian Society, 1839	Penz. N. H. A. Soc.	88	None	10s. 6d.	Transactions, annually.
Perthshire Society of Natural Science, 1867	Perths. Soc. N. Sci.	309	2s. 6d.	5s. 6d.	Transactions and Proceedings, annually.
Rochester Naturalists' Club, 1878	Rochester N. C.	112	2s. 6d.	3s. 6d.	'Rochester Naturalist,' quarterly.
Royal Scottish Geographical Society, 1884	R. Scot. Geog. Soc.	1,142	None	17. 1s.	'Scottish Geographical Magazine,' monthly.
South African Philosophical Society, 1877	S. African Phil. Soc.	72	None	27.	Transactions, annually.
Warwickshire Naturalists' and Archaeologists' Field Club, 1854	Warw. N. A. F. C.	75	2s. 6d.	5s.	Proceedings, annually.
Yorkshire Geological and Polytechnic Society, 1857	Yorks. Geol. Poly. Soc.	240	None	13s.	Proceedings, annually.
Yorkshire Naturalists' Union, 1861	Yorks. Nat. Union	375 and 2,105 Associates	None	10s. 6d.	Transactions, annually; 'The Naturalist,' monthly.
Royal Institution, John Rutherford, L.L.B., Wason Chambers, 4 Harrington Street, Liverpool					
Royal Institution, T. W. Bruce, 27 Wapping, Liverpool					
P. M. C. Kermode, Seabridge Cottage, Ramsey, Isle of Man					
Eli Soverbutts, F.R.G.S., 44 Brown Street, Manchester					
Mark Skirrup, F.G.S., 36 George Street, Manchester					
Francis E. M. Beardsall and G. H. Pownall, 25 Booth Street, Manchester					
Marlborough College, Rev. T. N. Hart Smith (Pres.)					
Thomas H. Waller, 71 Gough Road, Birmingham					
Prof. G. A. Lebour, Newcastle-on-Tyne					
Rev. T. W. Daltry, M.A., Madeley Vicarage, Newcastle, Staffs.					
The Museum, Guildhall Road, Northampton. H. N. Dixon					
W. Handley Kay, Gresham Chambers, Beestmarket Hill, Nottingham					
J. Gardner, 3 County Place, Paisley					
G. F. Tregelles, Penzance					
Tay Street, Perth. S. T. Ellison					
John Hepworth, Union Street, Rochester					
80A Princes Street, Edinburgh. A. Silva White					
David Gill, F.R.S., Royal Observatory, Cape Town					
Rev. P. B. Brodie, M.A., Rowington Vicarage, Warwick					
James W. Davis, F.G.S., Chevin-edge, Halifax					
W. Denison Roebuck, Sunny Bank, Leeds					

Index of the more important Papers, and especially those referring to Local Scientific Investigations, published by the above-named Societies during the year ending June 1, 1888.

* * This catalogue contains only the titles of papers published in the volumes or parts of the publications of the Corresponding Societies sent to the Secretary of the Committee in accordance with Rule 2.

Section A.—MATHEMATICAL AND PHYSICAL SCIENCE.						
Name of Author	Title of Paper	Abbreviated Title of Society	Title of Publication	Volume or Part	Page	Published
Anderson, Rev. W.	Meteorological Notes for 1886	Dum. Gal. N. H. A. Soc.	<i>Trans. and Journ. Report.</i>	5	14	1888
Anonymous	The Weather of 1887	Marlb. Coll. N. H. Soc.	<i>Roch. Naturalist.</i>	36	146	"
Bird, C.	Rochester Rainfall	Rochester N. C.	<i>Proc.</i>	1	329	"
Brown, W.	On Preliminary Experiments on the Effects of Percussion in changing the Magnetic Moments of Steel Magnets	Glasgow Phil. Soc.		XVIII.	41	1887
Bunning, T. W.	Barometer and Thermometer Readings for 1886	N. Eng. Inst.	<i>Trans.</i>	XXXVI.	225	—
Burder, Dr. G. F.	Rainfall at Clifton in 1886	Bristol Nat. Soc.	<i>Proc.</i>	V.	143	1887
Cambridge, Rev. O. P.	On the Effects of a Flash of Lightning at Bloxworth on the 9th of April, 1886	Dorset N. H. A. F. C.	"	VIII.	74	"
Evans, F. G.	The Meteorology and kindred Phenomena of 1887	Cardiff Nat. Soc.	<i>Report and Trans.</i>	XIX.	78	1888
Finlay, W. H.	On the Variations of Level of the Cape Transit Circle	S. African Phil. Soc.	<i>Trans.</i>	IV.	6	1887
"	Approximate Elliptic Elements of Comet 1884b	"	"	"	10	"
Fordham, H. G.	Fog-bows at Odsey	Herts N. H. Soc.	"	"	221	"
Gamble, J. G.	Meteorological Notes	S. African Phil. Soc.	"	"	10	"
Gravey, J.	Investigations in Electrical Induction	Cardiff Nat. Soc.	<i>Report and Trans.</i>	XIX.	26	"
Gore, Dr. G.	Relation of 'Transfer-Resistance' to the Molecular Weight and Chemical Composition of Electrolytes	Birm. Phil. Soc.	<i>Proc.</i>	V.	426	"
Harvey, Rev. C. W.	Meteorological Observations taken at Throcking, Herts, during the year 1886	Herts N. H. Soc.	<i>Trans.</i>	IV.	209	"
"	Report on the Rainfall in Hertfordshire in 1886	"	"	"	214	"
Henderson, Dr. A.	Meteorological Observations taken at Coats Observatory, Paisley	Paisley Phil. Inst.	<i>Proc.</i>	1	7	1888
Herschel, Prof. A. S.	On an improved form of Seismoscope	N. Eng. Inst.	<i>Trans.</i>	XXXVII.	101	—

Hopkinson, J.	Meteorological Observations taken at Wansford House, Watford, during the year 1886	Herts N. H. Soc.	"	IV.	169	1887
"	Meteorological Observations taken at Watford during the year 1877	"	"	"	205	"
Howard, A. G.	An Investigation into the Isobaric Influences and Cyclonic Paths of South Africa	S. African Phil. Soc.	"	"	25	"
Jupp, H. B.	Meteorological Observations as regards Temperature, taken at Clifton, 1886	Bristol Nat. Soc.	<i>Proc.</i>	V.	146	"
Law, F.	Parhelia or Mock Suns	N'ton. N. H. Soc.	<i>Journal</i>	4	241	"
"	Meteorological Reports and Observations, 1887	"	"	"	243, 291, 330	"
McLandsborough, J., & A. E. Preston	Meteorological Tables	Yorks. Geol. Poly. Soc.	<i>Proc.</i>	IX.	—	1888
"	Meteorological Returns for Bradford for 1886 and 1887	Yorks. Nat. Union.	<i>Trans.</i>	10	—	"
Marshall, W. P.	On the Measurement of the Magnifying Power of Microscope Objectives	Birm. N. H. M. Soc.	<i>Mid. Naturalist</i>	X.	226	1887
Mendham, W. P.	The Deposition of Smoke and Dust by means of Electricity	Bristol Nat. Soc.	<i>Proc.</i>	V.	187	"
Mill, Dr. H. R.	On the Physical Conditions of the Water in the Clyde Sea-Area	Glasgow Phil. Soc.	"	XVIII.	332	"
"	Recent Physical Researches in the North Sea	R. Scot. Geog. Soc.	<i>Magazine</i>	III.	385	"
Murray, Dr. J.	On the Height of the Land and the Depth of the Ocean	"	"	IV.	1	1888
Poynting, Prof. J. H.	The Electric Current and its Connection with the Surrounding Field	Birm. Phil. Soc.	<i>Proc.</i>	V.	337	1887
Poynting, Prof. J. H., and E. F. J. Love	On the Law of the Propagation of Light	"	"	"	354	"
Schultze, A.	Abbe's Apochromatic Micro-Objectives and Compensating Eye-pieces	Glasgow Phil. Soc.	"	XVIII.	28	"
Turtle, L.	Meteorological Summary and Monthly Weather Notes	Belfast Nat. F. C.	<i>Report and Proc.</i>	II.	549	1888
Tyack, S. W.	The Physical Formation of the Earth	Bristol Nat. Soc.	<i>Proc.</i>	V.	192	1887
Wilson, J. S. G.	A Bathymetrical Survey of the chief Perthshire Lochs and their relation to the Glaciation of that District	R. Scot. Geog. Soc.	<i>Magazine</i>	IV.	251	1888
Wood, J. S.	Approximate Conversion Numbers for the use of Naturalists	Yorks. Nat. Union.	<i>The Naturalist</i>	For 1888	90	"

Section B.—CHEMICAL SCIENCE.

Name of Author	Title of Paper	Abbreviated Title of Society	Title of Publication	Volume or Part	Page	Published
Gore, Dr. G.	On the Electrolysis of Alcoholic and Ethereal Solutions of Metallic Salts	Birm. Phil. Soc.	<i>Proc.</i>	V.	371	1887
"	On the Effect of Heat upon Fluoride of Cerium	"	"	"	375	"
Thorpe, Prof. T. E.	On certain modern developments of Graham's Ideas concerning the Constitution of Matter. (The Graham Lecture.)	Glasgow Phil. Soc.	"	XVIII.	118	"
Turner, T.	The Estimation of Silicon in Iron and Steel	Birm. Phil. Soc.	"	V.	485	"

Section C.—GEOLOGY.

Adamson, S. A.	The Bunter Pebble Beds at Sutton Park	Leeds Geol. Assoc.	<i>Trans.</i>	III.	115	1888
"	Geological Excursions in Yorkshire	"	"	"	127	"
"	On some Sections exposed in making the Skipton and Ilkley Railway	Yorks. Geol. Poly. Soc.	<i>Proc.</i>	IX.	363	"
"	Amongst the Yorkshire Oolites	Yorks. Nat. Union	<i>The Naturalist</i>	For 1887	177	1887
"	Geology of the Skipton and Ilkley Railway	"	"	"	202	"
"	The Yorkshire Boulder Committee and its First Year's Work	"	"	For 1888	17	1888
Allan, J.	The Pyrites Deposits of the Province of Huelva	N. Eng. Inst.	<i>Trans.</i>	XXXVII.	27	—
Anonymous	Boring in Chalk at Marlborough Brewery	Marlb. Coll. N. H. Soc.	<i>Report.</i>	36	132	1888
Baker, J. G.	North Yorkshire: Studies of its Geology, Botany, Climate, and Physical Geography	Yorks. Nat. Union	<i>Bot. Trans.</i>	II.	1	"
Beasley, H. C.	Some Instances of Horizontally Striated Slickensides	Liv'pool Geol. Soc.	<i>Proc.</i>	V.	246	1887
Beaumont, G. F.	Well Section at Kelvedon, Essex	Essex F. C.	<i>Essex Naturalist</i>	I.	189	"
Bedford, E. J.	Glaciers and Glacier Action	Not. Nat. Soc.	<i>Trans. and Report</i>	For 1887	14	1888
Bedford, J. E.	The Effects of Denudation	Leeds Geol. Assoc.	<i>Trans.</i>	III.	110	"
Bell, D.	On the Glacial Phenomena of Scotland, with reference to the Reports of the Boulder Committee of the Royal Society of Edinburgh	Glasgow Geol. Soc.	"	VIII.	237	"
"	On some Boulders near Arden, Loch Lomond	"	"	"	"	"
Bell, W. H.	Exposures of the Old Red Sandstone between Callander and Criff	Edinb. Geol. Soc.	"	V.	254	"
"	"	"	"	"	361	1887
Bennie, J.	The Redemption of Sandstone Quarries	Glasgow Geol. Soc.	"	VIII.	302	1888

Black, W. G.	Brighton Beaches after the Storms of October 15 and December 8, 1886	Edinb. Geol. Soc.	"	"	399	1887
Bolton, H.	Observations on Boulders from the High-Level Drift of Bacup	Manch. Geol. Soc.	"	XIX.	393	1888
Bramwell, H.	Notes on the Horizon of the Low Main Seam in a Portion of the Durham Coalfield	N. Eng. Inst.	"	XXXVII.	151	—
Brodie, Rev. P. B.	On the Discovery of a new Species of Fish, <i>Semionotus</i> , with a brief Account of the Section in the Upper Keuper Sandstone near Warwick, and Remarks on the Trias generally, and on some other Fish found in it near Nottingham	Warw. N. A. F. C.	Proc.	1	2	1888
"	On the Range, Extent, and Fossils of the Rhætic Formation in Warwickshire	"	"	"	19	"
Brown, M. W.	A further Attempt for the Correlation of the Coal Seams of the Carboniferous Formation of the North of England, with some Notes upon the probable Duration of the Coalfield	N. Eng. Inst.	Trans.	XXXVII.	3	—
Brownridge, C.	On the Occurrence of Quarzite and other Boulders in the Lower Coal-measures at Wortley, near Leeds	Leeds Geol. Assoc.	Proc.	III.	113	1888
"	Interesting Discovery of Boulders in the Coal-measures at Wortley, near Leeds	Yorks. Geol. Poly. Soc.	"	IX.	405	"
Burns, W.	Notes on the Heads of Ayr	Yorks. Nat. Union	The Naturalist	For 1888	49	"
Cash, W.	On the Fossil Fructifications of the Yorkshire Coal-measures	Glasgow Geol. Soc.	Trans.	VIII.	287	"
Cheetham, W.	A Visit to Shap	Yorks. Geol. Poly. Soc.	Proc.	IX.	435	"
Christy, R. W.	Well Section at Roxwell, Essex	Leeds Geol. Assoc.	Trans.	III.	107	"
Coates, H.	Origin of Interbedded and Intrusive Volcanic Rocks of Kinnoull Hill	Essex F. C.	Essex Naturalist	I.	150	1887
Coke, G. E.	The Dumb Fault, near Alfreton	Perths. Soc. N. S.	Trans. and Proc.	1	24	"
Cole, Rev. E. M.	Note on Dry Valleys in the Chalk	Chesterf. Mid. Count. Inst.	Trans.	XVI.	187	1888
"	On the Frequent Occurrence of Whinstone Erratics at Flamborough	Yorks. Geol. Poly. Soc.	Proc.	IX.	343	"
"	The Rudstone	Yorks. Nat. Union	The Naturalist	For 1887	289	1887
Cole, W.	Blocks of Sandstone near Orsett and Corringham, Essex	Essex F. C.	"	For 1888	81	1888
Cornish, V.	On the Artificial Reproduction of Minerals and Rocks	"	Essex Naturalist	II.	19	"
Cowburn, H.	On Boulders in Coal Seams	Manch. Geol. Soc.	Trans.	XIX.	477	"
		"	"	"	404	"

Name of Author	Title of Paper	Abbreviated Title of Society	Title of Publication	Volume or Part	Page	Published
Craig, R.	On the Post-Pliocene Beds of the Irvine Valley, Kilmours, and Dreghorn Districts	Glasgow Geol. Soc.	<i>Trans.</i>	VIII.	213	1888
Dairon, J.	The Graptolites of the Moffat District	Dum. Gal. N. H. A. Soc.	<i>Trans and Journ.</i>	5	52	"
Davis, J. W.	Note on a Fossil Species of <i>Chlamydoseleachus</i>	Yorks. Geol. Poly. Soc.	<i>Proc.</i>	IX.	392	"
"	Summary of Geological Literature relating to Yorkshire, 1887	"	"	"	490	"
Dickinson, J.	On the Progress of Mining and Geology	Manch. Geol. Soc.	<i>Trans.</i>	XIX.	272	1887
Dickson, E.	Notes on the Excavations for the Preston Docks	Liv'pool Geol. Soc.	<i>Proc.</i>	V.	249	"
Dugdale, C.	General Section of the Lower Coal-measures and Millstone Grit Rocks in the Forest of Rossendale, with Remarks on some of the Fossiliferous Beds contained therein	Manch. Geol. Soc.	<i>Trans.</i>	XIX.	220	"
Dunlop, R.	Note on a Section of Boulder Clay containing a Bed of Peat near Airdrie	Glasgow Geol. Soc.	"	VIII.	312	1888
Durham, G.	Note on an ancient Volcanic Glass near Newport, Fifeshire	E. Scot. Union	<i>Proc.</i>	—	25	"
Edward, G.	On the Old Red Sandstone of Caithness and its Fossils	Manch. Geol. Soc.	<i>Trans.</i>	XIX.	374	"
Eunson, H. J.	Deep Boring at Bletchley.	N'ton. N. H. Soc.	<i>Journal</i>	4	254	1887
"	William Smith	"	"	"	287	"
Eve, A. S.	Some ancient Wiltshire Leas	Marib. Coll. N. H. Soc.	<i>Report.</i>	36	77	1888
Fitzpatrick, J. J.	Some Uses of the Carboniferous Limestone	Liv'pool Geol. Soc.	<i>Proc.</i>	V.	259	1887
French, J.	On the Alluvial and other recent Deposits at Felstead, Essex	Essex F. C.	<i>Essex Naturalist.</i>	II.	56	1888
Garnett, W. (for Committee)	Report on Earth Tremor Observations	N. Eng. Inst.	<i>Trans.</i>	XXXVII.	55	—
Goodchild, J. G.	Ice Work in Edenside and some of the adjoining parts of North-Western England	Cumb. West Assoc.	"	XII.	111	1887
"	Notes upon some Mounds near the Estuary of the Thames	Essex F. C.	<i>Essex Naturalist.</i>	I.	210	"
Grainger, Rev. Canon	A Question concerning the Antrim Gravels	Belfast N. H. Phil. Soc.	<i>Report and Proc.</i>	For 1886-7	39	"
Green, Prof. A. H.	Some Structures common to Sub-aërial Lavas	Leeds Geol. Assoc.	<i>Trans.</i>	III.	118	1888
Gresley, W. S.	On the Occurrence of Boulders and Pebbles in the Coal-measures	Manch. Geol. Soc.	"	XIX.	488	"

1887	1888	1887	1888	1887	1888	1887	1888
Hampton, W., and H. W. Kew	The 'Blue Stone' Boulder, Louth	Yorks. Nat. Union.	<i>The Naturalist</i>	For 1887	225	1887	"
Hardwick, C.	The Granite of the Mullet, Ireland	Manch. Geol. Soc.	<i>Trans.</i>	XIX.	429	1888	1888
Hemwingway, W.	Notes on the Mineralogy of Barnsley	Barnsley Nat. Soc.	"	V.	3	"	"
Henderson, G. G.	Note on the Composition of a Carbonaceous Sandstone	Glasgow Geol. Soc.	"	VIII.	276	"	"
Henderson, J.	On Sands and Gravels containing the Remains of Drifted Trees at Olive Bank, Musselburgh, and at Stockbridge	Edinb. Geol. Soc.	"	V.	350	1887	1887
"	On Sections exposed in making a Drain through the Queen's Park at Holyrood	"	"	"	407	"	"
Hinde, Dr. G. J.	The Microscopic Structure of the so-called Malm or Firestone Rock of Mersham and Godstone, Surrey	Croydon M. N. H. C.	<i>Trans. and Proc.</i>	3	124	"	"
Holmes, T. V.	Notes on Drift Maps, with especial reference to those of Essex	Essex F. C.	<i>Essex Naturalist</i>	II.	21	1888	1888
"	Section in a new Railway Cutting at Maldon	"	"	I.	149	1887	1887
Jeffs, O. W.	The Calday-Grange Fault, West Kirby	Liv'pool Geol. Soc.	<i>Proc.</i>	V.	247	"	"
Johnstone, A.	On the Evolution and Classification of Igneous Rocks	Edinb. Geol. Soc.	<i>Trans.</i>	"	412	"	"
Jones, Prof. T. R., and C. D. Sherborn	On some Ostracoda from the Fuller's-Earth Oolite and Bradford Clay	Bath N. H. A. F. C.	<i>Proc.</i>	VI.	249	1888	1888
Judd, Prof. J. W.	The Relation between the Central Scientific Societies and Local ones	Yorks. Geol. Poly. Soc.	"	IX.	474	"	"
Kidston, R.	Note on the Nature of the Fossil Trees found at Whiteinch	Glasgow Geol. Soc.	<i>Trans.</i>	VIII.	235	"	"
Kinnear, W. T.	Notes on a recent Revision of the Species of the Genus <i>Fenestella</i>	Edinb. Geol. Soc.	"	V.	355	1887	1887
Lamplugh, G. W.	On the larger Boulders of Flamborough Head. Part I.	Yorks. Geol. Poly. Soc.	<i>Proc.</i>	IX.	339	1888	1888
"	Report on the Buried Cliff at Sewerby, near Bridlington	"	"	"	381	"	"
"	On a Mammaliferous Gravel at Elloughton, in the Humber Valley	"	"	"	407	"	"
"	On the Photograph of Cliff Section at Hiddethorpe (The Photograph)	"	"	"	433	"	"
Lomas, J.	On the Occurrence of Internal Calcareous Spicules in Polyzoa	Liv'pool Geol. Soc.	"	V.	241	1887	1887

Section C.—GEOLOGY (continued).

Name of Author	Title of Paper	Abbreviated Title of Society	Title of Publication	Volume or Part	Page	Published
Lomas, J.	On a Section of Boulder Clay near Hyde, Cheshire	Liv'pool Geol. Soc.	<i>Proc.</i>	V.	257	1887
McDiarmid, W. R.	Notes on, and Exhibition of, part of the Core of a Boring from the Permian of Dumfries	Edinb. Geol. Soc.	<i>Trans.</i>	"	410	"
McKay, G.	Notes on Geology of the Coast between the Fish and Juja Rivers in South Africa	S. African Phil. Soc.	"	IV.	3	"
McLennan, J. S.	Notes on the Jordanhill Coalfield	Glasgow Geol. Soc.	"	VIII.	271	1888
Marloth, Dr. R.	On the Origin of the Diamond Mines of South Africa	S. African Phil. Soc.	"	IV.	62	1887
Marshall, W. P.	On the recent Riviera Earthquake	Birm. N. H. M. Soc.	<i>Mid. Naturalist</i>	X.	241	"
Martin, F. W.	On some Sections of the Drift between Soho and Perry Bar, near Birmingham	Birm. Phil. Soc.	<i>Proc.</i>	V.	364	"
Mathews, C.	The Halesowen District of the South Staffordshire Coalfield	"	"	"	313	"
Moore, Dr. C. A.	The Aylestone Sandpit in the Soar Valley	Leicester Lit. Phil. Soc.	<i>Trans.</i>	VI.	22	1888
Morgan, Prof. C. Ll.	The Severn Tunnel Section	Bristol Nat. Soc.	<i>Proc.</i>	V.	82	1887
"	Bristol Building Stones	"	"	"	95	"
"	On the Origin of Mountain Ranges	"	"	"	149	"
Morton, G. H.	Early Life on the Earth	Liv'pool Geol. Soc.	"	"	209	"
"	The Carboniferous Limestone Fishes of North Wales	"	"	"	243	"
"	The Microscopic Characters of the Millstone Grit of South-West Lancashire	"	"	"	280	"
Praeger, R. Ll.	The Estuarine Clays at the new Alexandra Docks, Belfast, with List of Fossils	Belfast Nat. F. C.	<i>Report and Proc.</i>	II.	App.	1888
Pumphrey, W.	Landslips and Subsidences	Bath N. H. A. F. C.	<i>Proc.</i>	VI.	278	"
"	The recent Landslip at Zug	Birm. N. H. M. Soc.	<i>Mid. Naturalist</i>	XI.	104	"
Richardson, R.	On the Antiquity of Man, and the Discovery of Fossil Mammalia in Devonshire and Scotland	Edinb. Geol. Soc.	<i>Trans.</i>	V.	335	1887
Ricketts, Dr. C.	The Base of the Carboniferous Limestone	Liv'pool Geol. Soc.	<i>Proc.</i>	"	262	"
Rowe, Rev. A. W.	Some Essex Boulders	Essex F. C.	<i>Essex Naturalist</i>	I.	117	"
Scott, T.	Some Notes on the Geology of the District about Tarbert, Lochfyne	Glasgow Geol. Soc.	<i>Trans.</i>	VIII.	262	1888
"	Some Notes on a Bed of Shell-bearing Clay at	"	"	"	267	"

Section C.—GEOLOGY (continued).

Name of Author	Title of Paper	Abbreviated Title of Society	Title of Publication	Volume or Part	Page	Published
Young, J.	Quartz as a Rock-forming Mineral	Glasgow Geol. Soc.	<i>Trans.</i>	VIII.	278	1888
"	Notes on the Scottish Carboniferous Genera of the Molluscan Family <i>Anatimide</i>	"	"	"	291	"
Young, J., and D. Corse Glen	Carboniferous Strata, containing erect Stems of Fossil Trees and Beds of Intrusive Dolerite, in the Old Whimstone Quarry, Victoria Park, Lower Balsbagra, near Whiteinch and Par-tick	"	"	"	227	"

Section D.—BIOLOGY.

Abel, W. J.	Smell and Taste	Nott. Nat. Soc.	<i>Trans. and Report</i>	For 1887	25	1888
Aplin, O. V.	A Visit to Rainworth Lodge	Yorks. Nat. Union.	<i>The Naturalist</i>	"	193	1887
Apperley, Rev. J. M.	Presidential Address	Rochester N. C.	<i>Rech. Naturalist</i>	1	281	"
Armistead, J. J.	Atmospheric and other Influences on the Migration of Fishes	Dum. Gal. N. H. A. Soc.	<i>Trans. and Journal</i>	5	30	1888
Ashford, C.	Another Yorkshire Locality for <i>Vertigo angustior</i>	Yorks. Nat. Union.	<i>The Naturalist</i>	For 1888	89	"
Backham, J., jun.	The Sooty Shearwater at Flamborough Head	"	"	For 1887	291	1887
"	Notes on and Additions to the Avifauna of Upper Teesdale	"	"	For 1888	79	1888
Baker, J. G.	The Botany of the Cumberland part of the Pennine Range	"	"	"	33	"
Barclay, W.	The Flora of the Woody Island	Perth. Soc. N. S.	<i>Trans. and Proc.</i>	1	30	1887
Batley, F.	Flora of Barnsley and Neighbourhood	Barnsley Nat. Soc.	<i>Trans.</i>	V.	11	"
Bayford, E. G.	Coleoptera	"	"	IV.	1	"
Beck, J. M.	Pathological Evolution	S. African Phil. Soc.	"	3	34, 40	"
Beiby, W. H.	On some Additions to the Flora of Surrey	Croydon M. N. H. C.	<i>Trans. and Proc.</i>	VI.	121	"
Blathwayt, Lieut.-Col.	Remarks on some Hemiptera-Heteroptera taken in the Neighbourhood of Bath	Bath N. H. A. F. C.	<i>Proc.</i>	"	315	1888
Bower, Prof. F. O.	Note on a Morphological Peculiarity of <i>Corday-line australis</i>	Glasgow Phil. Soc.	"	XVIII.	317	1887

Brady, W. E.	trophilous Plant A List of the Macro-Lepidoptera of Barnsley (concluded)	Barnsley Nat. Soc.	Trans.	V.	15	"
Brett, Dr. A. T.	A Nectarine growing on a Peach Tree	Herts N. H. Soc.	"	IV.	222	"
Bucknall, C.	The Fungi of the Bristol District. Part X.	Bristol Nat. Soc.	Proc.	"	126	1887
Burder, Dr. G. F.	The Potato Tercentenary.	Herts N. H. Soc.	Trans.	"	165	"
Cambridge, Rev. O. P.	On some Rare and Local Lepidoptera lately found in Dorsetshire	Dorset N. H. A. F. C.	"	VIII.	55	"
"	Spiders and their Allies	Marlb. Coll. N. H. Soc.	Report.	36	63	1888
Campbell, F. M.	The Hessian Fly	Herts N. H. Soc.	Trans.	IV.	180	1887
Carmichael, Dr. N.	An Experimental Research on the Artificial Cultivation of Vaccine Lymph, with Observations on the Nature of Vaccine and the Immunity produced by Vaccinia	Glasgow Phil. Soc.	Proc.	XVIII.	369	1888
Carpenter, Dr. A.	Disease Germs	Croydon M. N. H. C.	Trans. and Proc.	3	111	1887
Cash, J.	The Early Botanical Work of W. Wilson.	Yorks. Nat. Union.	The Naturalist	For 1887	181	"
Chaney, W.	The Macro-Lepidoptera of the Rochester and Chatham District—Fifth Paper	Rochester N. C.	Ich. Naturalist	1	287	"
"	The Macro-Lepidoptera of the Rochester and Chatham District—Sixth Paper	"	"	"	303	"
"	The Macro-Lepidoptera of the Rochester and Chatham District—Supplementary Notes	"	"	"	321	1888
Charbonnier, H. J.	Notes on the Reptiles, Amphibia, and Fish of the Bristol District	Bristol Nat. Soc.	Proc.	V.	133	1887
Clarke, W. Eagle.	The Pinkey or Scaley of the Yorkshire Esk	Yorks. Nat. Union.	The Naturalist	For 1887	274	"
Cooke, Dr. M. C.	Preliminary List of the Microscopic Fungi of Essex— <i>Ustilaginei</i> and <i>Zizidomyces</i>	Essex F. C.	Essex Naturalist	I.	184	"
Cordeaux, J.	Heligoland	Yorks. Nat. Union.	The Naturalist	For 1888	1	1888
Crouch, W.	Notes on the Whale Rudolph's Rorqual (<i>Balaenoptera borealis</i> , Lesson), and Record of a Male Specimen stranded at Tilbury, and of a Female stranded in the Humber	Essex F. C.	Essex Naturalist	II.	41	"
Davidson, Dr.	Notes on Local Botany for 1886	Dum. Gal. N. H. A. Soc.	Trans. and Jour.	5	8	"
Dixon, H. N.	Phenological Observations for 1886	N'ton. N. H. Soc.	Journal	4	232	1887
"	Second Supplementary List of Northamptonshire Mosses	"	"	"	308	"
Druce, G. C.	The Flora of Northamptonshire	"	"	"	235	"
Duckworth, T.	Our Summer Visitors. Part III.	Cumb. West. Assoc.	Trans.	XII.	87	"
Editors	Bibliography for the Northern Counties—Lepidoptera for 1885, 1886, and 1887	Yorks. Nat. Union.	The Naturalist	For 1888	58	1888

Section D.—BIOLOGY (continued).

Name of Author	Title of Paper	Abbreviated Title of Society	Title of Publication	Volume or Part	Page	Published
Ellis, J. W.	Coleoptera of Liverpool District	Yorks. Nat. Union	<i>The Naturalist</i>	For 1887	209	1887
"	Lepidopterous Fauna of Lancashire and Cheshire	"	"	"	367	"
Ewing, P.	On <i>Carex spivialis</i> , a Species new to Science	Glasgow N. H. Soc.	<i>Proc. and Trans.</i>	II.	110	1888
"	On some Scandinavian Forms of Scottish Alpine Plants	"	"	"	111	"
Fielding, Rev. C. H.	General Wild Flowers	Rochester N. C.	<i>Roch. Naturalist</i>	I	313, 339	"
Fitch, E. A.	Two new Essex Gall Makers	Essex F. C.	<i>Essex Naturalist</i>	I.	177	1887
"	The Bean Beetle (<i>Bruchus rufimanus</i> , Boh.) in Essex	"	"	II.	48	1888
Fortham, H. G.	A Naturalist's Calendar for North Herts	Herts N. H. Soc.	<i>Trans.</i>	IV.	193	1887
Fowler, W.	Lincolnshire Bog and Moorland Plants	Yorks. Nat. Union	<i>The Naturalist</i>	For 1887	349	"
"	Lincolnshire Marsh and Water Plants	"	"	For 1888	111	1888
Fowler, W. W.	Aristotle on Birds	Marlb. Coll. N. H. Soc.	<i>Report</i>	36	25	"
French, J.	Preliminary List of the Land and Freshwater Mollusca occurring in the neighbourhood of Felstead, Essex	Essex F. C.	<i>Essex Naturalist</i>	II.	1, 46	"
Friend, Rev. H.	Notes on the Flora of North Nottinghamshire	Nott. Nat. Soc.	<i>Trans. and Report</i>	For 1887	33	"
Fullarton, J. H.	On Biological Teaching in Germany and in this Country	Glasgow Phil. Soc.	<i>Proc.</i>	XVIII.	327	1887
Gätke, H.	Bird Notes from Helligoland for year 1886	Yorks. Nat. Union	<i>The Naturalist</i>	For 1887	305	"
George, C. F.	Aculeate Hymenoptera in North Lincolnshire	"	"	For 1888	107	1888
Grenfell, J. G.	Five Weeks at the Zoological Laboratory at Roscoff	Bristol Nat. Soc.	<i>Proc.</i>	V.	200	1887
Hagger, J.	The Leafing of the Oak and Ash	Yorks. Nat. Union	<i>The Naturalist</i>	For 1887	365	"
Hastings, W.	Local Ornithological Notes for 1886	Dum. Gal. N. H. A. Soc.	<i>Trans. and Jour.</i>	5	7	1888
Hay, Col. H. M. D.	Notes on some rare Perthshire Birds lately placed in the Museum	Perths. Soc. N. S.	<i>Trans. and Proc.</i>	I	1	1887
Hey, Rev. W. C.	List of Coleoptera of Yorkshire (continuation)	Yorks. Nat. Union	<i>Ent. Trans.</i>	10	17	1888
Hillhouse, Prof. W.	Some Investigations into the Function of Tannin in the Vegetable Kingdom	Birm. N. H. M. Soc.	<i>Mid. Naturalist</i>	X.	269	1887
Hobkirk, C. P.	A curious Habitat of some Mosses	Yorks. Nat. Union	<i>The Naturalist</i>	For 1888	13	1888
"	The Leafing of the Oak and Ash	"	"	"	14	"
Holmes, E. M.	On a new British Alga (<i>Vaucheria sphaerospora</i> , Nordst.), lately found near Maldon	Essex F. C.	<i>Essex Naturalist</i>	I.	151	1887
Hopkinson, J.	Report on Phenological Phenomena observed in Hertfordshire during the year 1886	Herts N. H. Soc.	<i>Trans.</i>	IV.	176	"

Hughes, W. R.	The Principles of Biology	Birm. N. H. M. Soc.	<i>Mid. Naturalist</i>	X.	309	"
Kemp-Welch, R. B.	On the great Earwig <i>Labiadura riparia</i> (Pallas)	Dorset N. H. A. F. C.	<i>Proc.</i>	VIII.	61	"
Kerr, R. N.	Notes on the Dipper, Water Ouzel, or Water Crow (<i>Chinclus aquaticus</i>)	E. Scot. Union	"	—	19	1888
Kidson, E.	Spontaneous Generation	Nott. Nat. Soc.	<i>Trans. and Report</i>	For 1887	20	"
King, J. J. F. X.	Notes on a small Collection of Neuroptera from the Island of Coll	Glasgow N. H. Soc.	<i>Proc. and Trans.</i>	II.	133	"
Kinnear, W. T.	Note on the Occurrence of a new Carboniferous Crustacean at Ardross Castle, Fife	Edin. Geol. Soc.	<i>Trans.</i>	V.	467	1887
Lee, P. F.	Flora of Dewsbury and Neighbourhood	Yorks. Nat. Union	<i>Bot. Trans.</i>	I.	225	1888
"	<i>Rubus podophyllus</i> in England	"	<i>The Naturalist</i>	For 1887	276	1887
Lees, F. Arnold	The Flora of West Yorkshire	"	<i>Bot. Trans.</i>	II.	—	1888
"	Botanical Notes from North-East Yorkshire	"	<i>The Naturalist</i>	For 1887	273	1887
Lett, Rev. H. W.	On the Fungi collected in County Down in 1886	Belfast Nat. F. C.	<i>Report and Proc.</i>	II.	533	1888
"	On the alleged Heliotropism of the Common Sunflower	"	"	"	"	—
Letts, Dr. E. A.	Fermentation and kindred Phenomena	Belfast N. H. Phil. Soc.	"	For 1886-87	74	1887
Lilford, Lord	Notes on the Birds of Northamptonshire	N'ton. N. H. Soc.	<i>Journal</i>	4	267	"
"	Notes on the Ornithology of Northamptonshire	"	"	"	246, 310,	"
"	"	"	"	"	321	"
Lister, T.	Report on Vertebrate Zoology, 1886	Barnsley Nat. Soc.	<i>Trans.</i>	V.	7	1888
Littleboy, J. E.	Notes on Birds observed in Hertfordshire during the year 1886	Herts N. H. Soc.	"	IV.	161	1887
"	Biography of a Cuckoo	"	"	"	223	"
McAndrew, J.	Botanical Notes from Portpatrick, 1886	Glasgow N. H. Soc.	<i>Proc. and Trans.</i>	II.	135	"
Mackay, Dr. J. Y.	On the Arterial System of Vertebrates homologically considered	Glasgow Phil. Soc.	<i>Proc.</i>	XVIII.	302	"
MacOwan, P.	Personalia of Botanical Collectors at the Cape	S. African Phil. Soc.	<i>Trans.</i>	IV.	xxx.	"
Macpherson, A. H.	The Migration of Birds	Marlb. Coll. N. H. Soc.	<i>Report.</i>	36	43	1888
Macpherson, Rev. H. A., and W. Duckworth	Zoological Record for Cumberland, 1886	Cumb. West. Assoc.	<i>Trans.</i>	XII.	29	1887
Mansell-Pleydell, J. C.	Decoys and Swan Marks	Dorset N. H. A. F. C.	<i>Proc.</i>	VIII.	1	"
Martindale J. A.	Sedbergh District Lichens	Yorks. Nat. Union	<i>The Naturalist</i>	For 1887	285	"
"	Notes on British Lichens	"	"	"	295	"
"	Notes on British Lichens: <i>Lecanora murorum</i> and its more immediate Allies	"	"	"	355	"
"	The Lichens of Westmoreland	"	"	"	"	"
"	History of the County Botany of Worcester	"	<i>Nat. Naturalist</i>	For 1888	25	1888
Mathews, W.	"	Birm. N. H. M. Soc.	"	X.	150	1887

Section D.—BIOLOGY (continued).

Name of Author	Title of Paper	Abbreviated Title of Society	Title of Publication	Volume or Part	Page	Published
Meldrum, R. H.	<i>Minium riparium</i> , Mitt., in Scotland	Perths. Soc. N. S.	<i>Trans. and Proc.</i>	I	15	1887
"	Some Localities for Perthshire Plants	"	"	"	18	"
Melvin, J.	Hutton's Views of the Vegetable Soil or Mould and Vegetable and Animal Life	Edinb. Geol. Soc.	<i>Trans.</i>	V.	468	"
Milne, W.	On a new Tentaculiferous Protozoon and other Infusoria, with Notes on Reproduction and the Function of the Contractile Vesicle	Glasgow Phil. Soc.	<i>Proc.</i>	XVIII.	48	"
Moggridge, M. W.	Trap-door Spiders	Cardiff Nat. Soc.	<i>Report and Trans. Proc.</i>	XIX. V.	1	"
Morgan, Prof. C. Lloyd	The Senses and Sense Organs of Insects	Bristol Nat. Soc.	<i>Proc.</i>	V.	178	"
Morton, K. J.	On the Oral Apparatus of the Larva of <i>Wormaldia</i> , a Genus of Trichoptera	Glasgow N. H. Soc.	<i>Proc. and Trans.</i>	II.	115	1888
Mott, F. T.	On the Voices of Animals	Leicester Lit. Phil. Soc.	<i>Trans.</i>	V.	7	1887
"	Foreign Fruits available for Acclimatisation in England	"	"	"	10	"
"	The Songs of some Leicestershire Birds	"	"	VI.	24	1888
"	The Cause and the Limits of Organic Growth	"	"	VII.	13	"
Neale, J. J.	Trawl Fishes of the Bristol Channel	Cardiff Nat. Soc.	<i>Report and Trans.</i>	XIX.	111	"
Nelson, T. H.	A Visit to Chillingham Park	Yorks. Nat. Union	<i>The Naturalist</i>	For 1887	229	1887
Newton, Prof. A.	The British Example of Bulwer's Petrel	"	"	For 1888	156	1888
Parker, Prof. W. N.	Trawling off Lundy	Cardiff Nat. Soc.	<i>Report and Trans.</i>	XIX.	31	1887
Percival, J.	The Flora of Wensleydale, North-West Yorkshire	Yorks. Nat. Union	<i>The Naturalist</i>	For 1888	125	1888
Péringuey, L.	Insects injurious to Forest Trees in South Africa	S. African Phil. Soc.	<i>Trans.</i>	IV.	15	1887
"	A Note on <i>Phylloxera vastatrix</i> at the Cape	"	"	II.	57	1888
Phillips, W. H.	On the Reproduction of Ferns	Belfast Nat. F. C.	<i>Report and Proc.</i>	II.	535	1888
Porrirt, G. T.	Yorkshire Entomological Notes	Yorks. Nat. Union	<i>The Naturalist</i>	For 1888	12	"
"	An Entomological Expedition to North Wales and the Isle of Man	"	"	"	103	"
Quilter, H. E.	Land and Freshwater Mollusca collected in Leicestershire during 1885-86-87	Leicester Lit. Phil. Soc.	<i>Trans.</i>	VII.	17	"
Ramsay, Prof. W.	On Colour Blindness	Bristol Nat. Soc.	<i>Proc.</i>	V.	195	1887
Robertson, D.	A Contribution towards a Catalogue of the Amphipoda and Isopoda of the Firth of Clyde	Glasgow N. H. Soc.	<i>Proc. and Trans.</i>	II.	9	1888

Section D.—BIOLOGY (continued).

Name of Author	Title of Paper	Abbreviated Title of Society	Title of Publication	Volume or Part	Page	Published
Turner, W. B.	Notes on Algae collected at Gormire and Thirkleby, with Notice of a new Species	Yorks. Nat. Union . . .	<i>The Naturalist</i> . . .	For 1887	275	1887
Tutt, J. W.	Rochester Entomology	Rochester N. C.	<i>Roch. Naturalist</i> . . .	1	297	"
Various	Botanical Report	Marlb. Coll. N. H. Soc. . .	<i>Report</i>	36	90	1888
"	Ornithological Report	"	"	"	103	"
"	Entomological Report	"	"	"	118	"
White, Dr. F. B.	Opening Address—On the Summer Excursions of the Society	Perths. Soc. Nat. Sci. . . .	<i>Trans. and Proc.</i> . . .	1	I.	1887
"	Presidential Address	"	"	"	XIII.	"
White, J. W.	Supplemental Notes on the Flora of the Bristol Coalfield	Bristol Nat. Soc.	<i>Proc.</i>	V.	116	"
Wilkinson, W. N.	On Colour Reaction and its use to the Microscopist and the Biologist	Birm. N. H. M. Soc.	<i>Mid. Naturalist</i> . . .	XI.	1	1888
Wilson, W., jun.	On <i>Chlumba liria</i> in Central Aberdeenshire	E. Scot. Union	<i>Proc.</i>	—	23	"
Windle, Dr. B. C. A.	Notes on the Myology of <i>Hapale jacehus</i> . . .	Birm. Phil. Soc.	"	V.	277	1887
"	On the Abductor Muscles of the Hand	"	"	"	377	"
Wishart, R. S.	A Glance at the July Flora of Alyth.	Glasgow N. H. Soc.	<i>Proc. and Trans.</i> . . .	II.	118	"
Young, John	Note on a new Family of the Polyzoa— <i>Clystodictyonida</i> (E. O. Ulrich)—with Notice of three Carboniferous Species	Edinb. Geol. Soc.	<i>Trans.</i>	V.	461	"

Section E.—GEOGRAPHY.

Name of Author	Title of Paper	Abbreviated Title of Society	Title of Publication	Volume or Part	Page	Published
Ashe, Rev. R. P.	Buganda	Manch. Geog. Soc.	<i>Journal</i>	3	53	1887
Colquhoun, A. R.	The Railway Connection of Burmah and China	"	"	"	141	"
"	The Physical Geography and Trade of Formosa	"	"	"	226	"
Coquilhat, Capt.	The Bangala	"	"	"	239	"
Dawkins, Prof. W. Boyd	The Discovery of Britain	"	"	"	13	"
Geikie, Prof. J.	Geography and Geology	R. Scot. Geog. Soc.	<i>Magazine</i>	III.	398	"
Haynes, Capt. C. E.	Matabeleland and the Country between the Zambesi and the Limpopo Rivers	Manch. Geog. Soc.	<i>Journal</i>	3	244	"
James, H. E. M.	Manchuria: Notes of a recent Journey	"	"	"	205	"

Le Bon, Dr. G. (translated by M. Stirrup)	Modern India	"	"	"	"	2	352
Little, A. J.	The Geography and Trade of Western China	"	"	"	"	3	1
Macfarlane, Rev. S.	Exploration in New Guinea	"	"	"	"	2	307
Martin, W.	On Geographical Alto-Relievo Models and their place in Education	"	"	"	"	XVIII.	108
Mill, Dr. H. R.	The Relations between Commerce and Geography	"	"	"	"	III.	626
Porter, Rev. W. C.	The Magwangwara	"	"	"	"	2	265
Sowerbutts, E.	The Delegates' Report of the British Association Meeting, 1887	"	"	"	"	3	256
Streeter, G. S.	The Ruby Mines of Burmah	"	"	"	"	"	16
Sturgeon, Miss M. K.	The Teaching of Elementary Geography—a practical Lesson with Models	"	"	"	"	"	285

Section F.—ECONOMIC SCIENCE AND STATISTICS.

Bunning, T. W.	The Mining Institutions of Great Britain	N. Eng. Inst.	"	"	"	XXXVI.	167
Bythell, J. K.	Railways in India; their Advantages and the Necessity for their Extension	Manch. Geog. Soc.	"	"	"	3	26
Casartelli, L. C.	The Modern Languages Problem in Modern Education	Manch. Stat. Soc.	"	"	"	For 1887-88	105
Clifford, W.	On Foreign and Home Mine Rents and Royalties	Manch. Geol. Soc.	"	"	"	XIX.	541
Cornish, T.	Our Gold Supply; its Effects on Finance, Trade, Commerce, and Industries	Manch. Geog. Soc.	"	"	"	3	66
Credland, W. R.	The Free Library Movement in Manchester	Manch. Stat. Soc.	"	"	"	For 1887-88	132
Dennett, R. E.	The Congo from a Trader's Point of View	Manch. Geog. Soc.	"	"	"	2	283
Duncan, Dr. E.	On the Reform of our present Methods of Disposal of the Dead: Earth-to-Earth Burial <i>versus</i> Cremation	Glasgow Phil. Soc.	"	"	"	XVIII.	257
Elliott, T. H.	Notes on Taxation and Rating	Manch. Stat. Soc.	"	"	"	For 1887-88	63
Gardner, C.	An Examination of the Report of the Royal Commission on Depression of Trade	Glasgow Phil. Soc.	"	"	"	XVIII.	133
Graham, Prof. W.	Socialism: its Argument and Aims	Manch. Stat. Soc.	"	"	"	For 1887-88	1
Gray, W.	Technical Education and our Methods of promoting it	Belfast N. H. Phil. Soc.	"	"	"	For 1886-87	55

Section I'.—ECONOMIC SCIENCE AND STATISTICS (continued).

Name of Author	Title of Paper	Abbreviated Title of Society	Title of Publication	Volume or Part	Page	Published
Greenwood, Alderman	The Growth of the Cotton Trade	Manch. Geog. Soc.	<i>Journal</i>	3	42	1887
Hale, Hon. E. J.	The Constitution of the United States	Manch. Stat. Soc.	<i>Trans.</i>	For 1887-88	149	1888
Hillhouse, Prof. W.	On the Present and Future of Science Teaching in England, with special reference to Botany	Birn. N. H. M. Soc.	<i>Mid. Naturalist</i>	XI.	81	"
Lawson, W.	On the Desirability of establishing by Act of Parliament a Corporate Body to act as Trustee, Executor, Administrator, &c.	Stat. Soc. Ireland	<i>Journal</i>	IX.	181	—
Martin, J. S.	On Mine Rents and Royalties	Manch. Geol. Soc.	<i>Trans.</i>	XIX.	538	1888
Meadows, J. W. C.	On Irish Mine Rents	"	"	"	540	"
Merriman, J. X.	Some Remarks on the Taxation of the Cape Colony	S. African Phil. Soc.	"	IV.	46	1887
O'Brien, M.	Continental Land Banks and Land Registers	Stat. Soc. Ireland	<i>Journal</i>	IX.	192	—
Pain, C. S.	Presidential Retiring Address on Trade Depression	Liv'pool E. Soc.	<i>Trans.</i>	VII.	122	1887
Pankhurst, Dr. R. M.	The Prospects of International Arbitration	Manch. Stat. Soc.	"	For 1887-88	29	1888
Patterson, R. L.	Some Account of the Whale and Seal Fisheries, past and present	Belfast N. H. Phil. Soc.	<i>Report and Proc.</i>	For 1886-87	112	1887
Percy, C. M.	On Mine Rents and Mineral Royalties	Manch. Geol. Soc.	<i>Trans.</i>	XIX.	433	1888
Ransome, Dr. A.	The Vital Statistics of Towns	Manch. Stat. Soc.	"	For 1887-88	87	"
Richards, R. C.	A Consideration of some of the Effects of the Landlord's Preferential Position upon Commerce and Agriculture	"	"	"	49	"
Samuels, A. W.	The Law of Divorce in Ireland	Stat. Soc. Ireland	<i>Journal</i>	IX.	186	—
Sandeman, D.	On the Progress of Technical Education with special reference to the Glasgow Weaving College	Glasgow Phil. Soc.	<i>Proc.</i>	XVIII.	73	1887
Scott, C.	Epidemic Diseases—Can they be stamped out?	Belfast N. H. Phil. Soc.	<i>Report and Proc.</i>	For 1886-87	115	"
Strauss, A.	Foreign Mining Laws	Cornw. Min. Assoc. Inst.	<i>Trans.</i>	II.	30	1888
Walmsley, O.	On Mine Rents and Mineral Royalties	Manch. Geol. Soc.	"	XIX.	511	"

Watson, Major	Trade Prospects with the Soudan	Manch. Geog. Soc.	Journal	3	170	1887
C. M.						
Wyde, A. B.	The Red Sea Trade	"	"	"	181	"

Section G.—MECHANICAL SCIENCE.

Ackroyd, W.	Ackroyd and Best's Miner's Safety Lamp Cleaning Machine	N. Eng. Inst.	Trans.	XXXVII.	121	—
Anonymous	Programme of the Excursions made during the Visit of the Mining Engineers to Newcastle-on-Tyne, August 3 to 6, 1887	Chesterf. Mid. Count. Inst.	"	XVI.	69	1887
Ashworth, J.	On Ashworth's Patent Hepplewhite-Gray Safety Lamp	Manch. Geol. Soc.	"	XIX.	548	1888
Bainbridge, E.	On a new description of Miner's Safety Lamp	"	"	"	360	"
"	Description of a Miner's Safety Lamp, designed to meet the requirements of the Mines Regulation Act coming into force on January 1, 1888	N. Eng. Inst.	"	XXXVII.	75	—
Bell, Sir L.	Presidential Address	"	"	XXXVI.	131	—
Benjamin, L.	The Practical Use of Stability Calculations	Liv'pool E. Soc.	"	VII.	106	1887
Bramall, H.	On a new Lead Rivet Mould	Manch. Geol. Soc.	"	XIX.	364	1888
Brodie, J. S.	Dredging at Newhaven Harbour: Notes of Cost by different systems	Liv'pool E. Soc.	"	VII.	98	1887
Burrows, J. S.	New Electric Lamp adapted for Mining Purposes	Manch. Geol. Soc.	"	XIX.	235	"
Burton, G. L.	Modern Milling, with special reference to the 'Carter' Process	Liv'pool E. Soc.	"	VII.	10	"
Carswell, T. P.	Automatic Electrical Lighting of Railway Trains in Tunnels	Glasgow Phil. Soc.	Proc.	XVIII.	391	"
Dumas, E. L.	Bornet's Hand-boring Machine.	N. Eng. Inst.	Trans.	XXXVII.	117	—
Dyer, H.	On the Development of the Marine Engine	Glasgow Phil. Soc.	Proc.	XVIII.	1	1887
Ferber, E. G.	Wasting in Marine Boilers, with some curious instances	Liv'pool E. Soc.	Trans.	VII.	74	"
Foster, Dr. C. Le Neve	Some Mining Notes in 1887	Cornw. Min. Assoc. Inst.	"	II.	126	1888
Garland, J.	Copper Mining at Tilt Cove, Newfoundland	Cornw. R. Geol. Soc.	"	XI.	99	"

Section G.—MECHANICAL SCIENCE (continued).

Name of Author	Title of Paper	Abbreviated Title of Society	Title of Publication	Volume or Part	Page	Published
Hall, H. Hartland, W. H.	An improved Tin Can Lamp Sewage Disposal and River Pollution, its present and future aspects from a sanitary and economic point of view	Manch. Geol. Soc. Belfast N. H. Phil. Soc.	<i>Trans.</i> <i>Report and Proc.</i>	XIX. For 1886-87	368 69	1888 1887
Harvey, J. W.	On the Method adopted to compound a pair of ordinary Oscillating Paddle-wheel Engines	Bristol Nat. Soc.	<i>Proc.</i>	V.	19	"
Hurtzig, A. C.	A Formula and Diagram for ascertaining the Resisting Power of Piles	Liv'pool E. Soc.	<i>Trans.</i>	VII.	111	"
Husband, W.	The Ventilation of Cornish Mines	Cornw. Min. Assoc. Inst.	"	II.	6	1888
Kayser, H. W. F.	Ore Dressing by Automatic Machinery	"	"	"	51	"
Key, W.	On Coal Gas; and the Coal Question in its bearings on the Illuminating Power of Gas	Glasgow Phil. Soc.	<i>Proc.</i>	XVIII.	87	1887
Lee, G.	The Endless Chain in Spain	N. Eng. Inst.	<i>Trans.</i>	XXXVII.	81	—
Lupton, A.	Safety Lamp Tests	Chesterf. Mid. Count. Inst.	"	XVI.	128	1887
Lyster, A. G.	The Manchester Ship Canal	Liv'pool E. Soc.	"	VII.	47	"
McKinless, J.	On a Gauzeless Safety Lamp	N. Eng. Inst.	"	XXXVII.	69	—
Magninus, A. J.	A strange Failure of Steel Boilers	Liv'pool E. Soc.	"	VII.	1	1887
Marshall, W. P.	On Tresca's remarkable Investigations into the Flow of Solids under great pressures	Birm. N. H. M. Soc.	<i>Mid. Naturalist</i>	X.	137	"
Mayer, J.	On Foulis' Gas-Fire; a new Departure in using Gaseous Fuel for Domestic Purposes	Glasgow Phil. Soc.	<i>Proc.</i>	XVIII.	365	"
Mercier, M.	On Cunliffe's Patent Hydraulic Coal-getter	Manch. Geol. Soc.	<i>Trans.</i>	XIX.	556	1888
Metcalf, A. W.	Brick and Masonry Arches	Liv'pool E. Soc.	"	VII.	19	1887
Meyer, G., and W. J. Bird	The use of Iron Supports in Mines instead of Timbering or Masonry	N. Eng. Inst.	"	XXXVII.	135	—
Mills, W. E.	Notes on the Damage sustained by a large Building from Subsidence, and the Means taken for its Support	Liv'pool E. Soc.	"	VII.	67	1887
Moore, J. E.	On Pearson's Patent 'Eclipse' Miner's Safety Lamp	Manch Geol. Soc.	"	XIX.	554	1888
Morgan, T.	Chilled Iron	Bristol Nat. Soc.	<i>Proc.</i>	V.	13	1887
Richardson, C.	The President's Inaugural Address to the Engineering Section	"	"	"	2	"
"	The Severn Tunnel	"	"	"	49	"

Routledge, W. H.	A simple Safety Blasting Cartridge for use in Mines	Chesterf. Mid. Count. Inst.	Trans.	XVI.	66	"
Shoobred, J. N.	Tidal Works on the Seine and other Rivers	Liv'pool E. Soc.	"	VII.	83	"
Smith, G. E.	A new Electric Exploder for Fuses	Chesterf. Mid. Count. Inst.	"	XVI.	63	"
Stanley, R.	Stanley's Coal Heading Machine	"	"	"	192	1888
Stoess, Le Chevalier C. de W.	The Panama Canal	Liv'pool E. Soc.	"	VII.	17	1887
Sutcliffe, G. W.	Notes on Stationary Engines	Bristol Nat. Soc.	Proc.	V.	32	"
Sweete, O.	A new Electric Miner's Lamp	Manch. Geol. Soc.	Trans.	XIX.	369	1888
Teale, W. E.	Automatic Lock for Shields or Bonnets of Safety Lamps	"	"	"	366	"
Thomson, G. C.	Notes on the Bursting of Lead Service Pipes by Water and Frost	Glasgow Phil. Soc.	Proc.	XVIII.	102	1887
Timms, J.	Past and present Methods of Banking Coal at Annesley Colliery, with a brief Description of Mechanical Appliances adopted to facilitate the labour	Chesterf. Mid. Count. Inst.	Trans.	XVI.	157	1888
Tonkin, J.	Motive Power	Corn. Min Assoc. Inst.	Trans.	II.	88	"
Turner, T.	The Hardness of Metals	Birm. Phil. Soc.	Proc.	V.	282	1887
Unquhart, Mr.	The Miner's Sunlight Electric Lamp	N. Eng. Inst.	Trans.	XXXVII.	113	—
Watts, A.	Coal Dust and Explosions in Coal Mines	Yorks. Nat. Union	The Naturalist	For 1888	145	1888
Wilson, A. B.	Power	Belfast N. H. Phil. Soc.	Report and Proc.	For 1886-87	34	1887

Section II.—ANTHROPOLOGY.

Fedford, J. E.	Notes on Flint-flake Implements found in the Isle of Man	Yorks. Geol. Poly. Soc.	Proc.	IX.	369	1888
Boynton, T.	On the Bronze Implements found in the East Riding of Yorkshire	"	"	"	426	"
Claypole, Prof. E. W.	The Lake Age in Ohio; or, Some Episodes in the Retreat of the North American Glacier	Edinb. Geol. Soc.	Trans.	V.	421	1887
Coles, F. R.	Recent Cup and Ring Mark Discoveries in Kirkcudbrightshire	Dum. Gal. N. H. A. Soc.	Trans. and Journ.	5	41	1888
Davis, J. W.	On the Ancient Flint-users of Yorkshire	Yorks. Geol. Poly. Soc.	Proc.	IX.	411	"
Dunn, Rev. E.	The Dyaks of Sarawak, Borneo	Manch. Geol. Soc.	Journal	3	221	1887
Evans, Rev. W. F.	Roman and Romano-British Remains at Felstead	Essex F. C.	Essex Naturalist	I.	207	"

Section II.—ANTHROPOLOGY (continued).









Name of Author	Title of Paper	Abbreviated Title of Society	Title of Publication	Volume or Part	Page	Published
Eve, A. H., and others	Weights and Measures of Boys at Marlborough College	Marlb. Coll. N. H. Soc.	<i>Report</i>	36	163	1888
George, T. J.	Notes on Prehistoric Man in Northamptonshire	N'ton. N. H. Soc.	<i>Journal</i>	4	333	1887
Grainger, Rev. Canon	An Ancient Irish Lake Dwelling	Belfast Nat. F. C.	<i>Report and Proc.</i>	II.	517	1888
Holmes, J.	Notes on Discoveries of Bronze Implements, &c., in the West Riding	Yorks. Geol. Poly. Soc.	<i>Proc.</i>	IX.	427	"
Holmes, T. V., and W. Cole	Report on the Denehole Explorations at Hangman's Wood, Grays, 1884 and 1887 (with five Appendices)	Essex F. C.	<i>Essex Naturalist</i>	I.	225	1887
King, A. J.	The Destruction of the two Churches of St. Mary in Bath	Bath N. H. A. F. C.	<i>Proc.</i>	VI.	285	1888
Knowles, W. J.	The Worked Flints from the Raised Beach at Larne and elsewhere in the North of Ireland	Belfast Nat. F. C.	<i>Report and Proc.</i>	II.	539	"
Lovett, E.	The Gun-flint Manufactory, with reference to its connection with the Stone Age	Croydon M. N. H. C.	<i>Trans. and Proc.</i>	3	113	1887
Milligan, S. F.	Recent Archaeological Explorations in County Sligo	Belfast N. H. Phil. Soc.	<i>Report and Proc.</i>	For 1886-87	40	"
Mott, F. T.	The Hairless Condition of the Human Skin	Leicester Lit. Phil. Soc.	<i>Trans.</i>	IV.	7	"
Patterson, W. H.	Some Later Views respecting the Irish Round Towers	Belfast N. H. Phil. Soc.	<i>Report and Proc.</i>	For 1886-87	20	"
Phibbs, E. W.	Note on a Sacred War Trophy from Ecuador	Bristol Nat. Soc.	<i>Proc.</i>	V.	183	"
Phillips, R. C.	The Social System of the Lower Congo	Manch. Geog. Soc.	<i>Journal</i>	3	164	"
Shenstone, J. C.	Salting Mounds	Essex F. C.	<i>Essex Naturalist</i>	I.	181	"
Smith, W. G.	Primæval Man in the Valley of the Lea	"	"	"	125	"
"	Prehistoric Stone Pestle from Epping Forest	"	"	II.	4	1888
Swanston, W.	Report on the Larne Gravels and their worked Flints	Belfast Nat. F. C.	<i>Report and Proc.</i>	"	519	"
Wilson, J.	Cinerary Urn found at Greystone, Dumfries	Dum. Gal. N. H. A. Soc.	<i>Trans. and Journ.</i>	5	38	"
Workman, T.	Eastern Reminiscences, China and Manilla	Belfast N. H. Phil. Soc.	<i>Report and Proc.</i>	For 1887	28	1887
Worth, R. N.	On the Discovery of Human Remains in a Devonshire Bone Cave	Cornw. R. Geol. Soc.	<i>Trans.</i>	XI.	105	"

Second Report of the Committee, consisting of Sir JOHN LUBBOCK, Dr. JOHN EVANS, Professor BOYD DAWKINS, Dr. ROBERT MUNRO, Mr. PENGELLY, Dr. HENRY HICKS, Professor MELDOLA, Dr. MUIRHEAD, and Mr. JAMES W. DAVIS, appointed for the purpose of ascertaining and recording the localities in the British Islands in which evidences of the existence of Prehistoric Inhabitants of the country are found. (Drawn up by JAMES W. DAVIS.)

In the report presented last year it was proposed that distinctive signs should be adopted to indicate the character of prehistoric objects on maps. This subject has had careful attention and it is recommended:—

I. That the one-inch ordnance survey map may be used.

II. That the signs and colours adopted by the Commission appointed by the International Congress of Anthropologists and Archæologists at Stockholm in 1874 be employed. The Commission consisted of representatives of eleven European countries; the one for Great Britain was Dr. John Evans. The subject received long and serious discussion, and the results have been generally accepted; they are tabulated at considerable length in the ‘Comptes Rendus du Congrès,’ vol. ii. p. 937 *et seq.* 1876. For the purposes of this committee the signs given below will probably suffice; should more specialised signs be required the recorder may be referred to the ‘Comptes Rendus.’

- | | |
|---|---|
| 1. Caves and caverns |  |
| 2. Camps and earthworks |  |
| 3. Lake-dwellings and crannoges |  |
| 4. Menhirs |  |
| Dolmens |  |
| 5. Barrows or tumuli |  |
| Other burial-places |  |
| To which may be added:— | |
| 6. Kjökkenmödding |  |

The different ages of the objects may be indicated by colour if the objects are extended over considerable areas; or, by signs if the objects are single, or too limited in area to be represented by colour.
1888.

Thus:—

	Colour.	Signs.
1. Palæolithic stone age . . .	Yellow-brown	↑
2. Neolithic stone age . . .	Green	↑
3. Bronze age	Red	↑
4. Iron age	Blue	□

It may be noted that the more rudimentary state of civilisation is represented by the simplest sign, and as the civilisation becomes developed the sign becomes more complex.

A combination of the signs indicating age may be made with those given previously which show the character of the object.

During the past year a list of prehistoric objects found in Derbyshire has been compiled and is appended herewith. Others are in course of preparation and will be available for future reports. In addition to the names of gentlemen who have undertaken to record the occurrence of objects in the localities also indicated which were printed in the report of last year, the following have signified their intention to furnish material for the purposes of the Committee, viz. :—

M. G. Stuart, Esq., Hon. Secretary of the Dorset Natural History and Antiquarian Field Club, for the county of Dorset.

Henry Wilson, Esq., Malvern Link, for the counties of Worcester and Herefordshire.

William Gray, Esq., of Belfast, for the counties of Antrim and Down.

George H. Parke, Esq., of Furness Abbey, for North Lancashire and Westmoreland.

On the Prehistoric Inhabitants of Great Britain.

DERBYSHIRE.

Recorder.—Rev. J. MAGENS MELLO, M.A., F.G.S., local secretary for Derbyshire, Soc. Antiq., Lond.

TABLE I.—*Palæolithic Age.*
CAVES.

No. and Name of Object	Locality	Date	Previous Description	Where Deposited	Length	Remarks
					In.	
a. Quartzite Implements— No. 1. Quartzite hâche .	CRESWELL CAVES— Robin Hood Cave	1875 to 1879	Q Journ. Geol. Soc., vols. for 1875, 6, 7, 9. Papers by Rev. J. M. Mello and Prof. W. B. Dawkins 'Les Grottes de Creswell'	British Museum	4½	The Quartzite and Flint implements were associated with the Pleistocene fauna Figd. 'Q. J. G. S.' 1876, p. 250, fig. 2.
2. " flake .	" "	" "	Annales de la Soc. Scientifique de Bruxelles, 1882	Owens College (Vict. Univ.) Museum, Manchester	3½	" fig. 3.
3. " oval implement	" "	" "	'Palæolithic Man at Creswell,' Derbyshire, 'Arch. and Nat. Hist. Soc. Trans.' vol. i.	Derby Museum	3	" fig. 4, p. 251.
4. Quartzite hammer	" "	" "		Nottingham Natural History Museum	2	Figd. 'Geol. of Derbyshire,' plate 1.
5. " flake .	" "	" "		Sheffield Public Museum	3½	" "

TABLE I.—PALEOLITHIC AGE. CAVES—*continued.*

No. and Name of Object	Locality	Date	Previous Description	Where Deposited	Length	Remarks
No. 6. Quartzite flake .	Robin Hood Cave	1875 to 1879	Report of the Assoc. Française, 1887 Handbook to the Geol. of Derbyshire by Rev. J. M. Mello	Rev. J. M. Mello's Collection	In. 2½	Figd. 'Annales de la Soc. Sc. Brux.' fig. 6.
7. " " "	" "	" "	" "	" "	2	" fig. 8.
8. Ironstone oval implement	" "	" "	" "	" "	—	'Q. J. G. S.' 1876, p. 251, fig. 5.
9. Ironstone hâche .	" "	" "	'The Creswell Caves,' Geol. and Polyt. Soc. West Riding of Yorks, 1880	" "	3½	'Annales' fig. 9, River gravel type. 'Q. J. G. S.' 1877, p. 593.
12 Quartzite choppers	" "	" "	" "	" "	—	—
24 " hammers	" "	" "	" "	" "	—	—
48 Quartzite round pebbles	" "	" "	" "	" "	—	—
534 Quartzite worked pebbles and chips	" "	" "	" "	" "	—	—
8 Quartzite scrapers or flakes	" "	" "	" "	" "	—	—
1 Oval ironstone implement	" "	" "	" "	" "	—	—
b. Flint Implements—						
No. 1. Lanceolate flake .	" "	" "	" "	" "	3	Worked on both sides
2. Lance head .	" "	" "	" "	" "	4	" both these are figd. 'Q. J. G. S.' 1876, p. 252. Also 'Annales de la Soc. Sc. Brux.' figs. 1, 2, and plate 1 'Geol. of Derbyshire'
3. Pointed flake bevel edged	" "	" "	" "	" "	1½	'Q. J. G. S.' 1876, p. 253, figs. 9, 10
4. Pointed flake bevel edged	" "	" "	" "	" "	1¾	'Annales,' fig. 3, 4
Boring tool .	" "	" "	" "	" "	1½	" figs. 11, 5
Long knife-like flake	" "	" "	" "	" "	3	'Geol. Derb.' figd. plate 1
Long knife-like flake	" "	" "	" "	" "	3	" "
420 Flint flakes .	" "	" "	" "	" "	—	—
20 " scrapers .	" "	" "	" "	" "	—	—
1 " double scrapers	" "	" "	" "	" "	—	—
5 Lanceolate flakes .	" "	" "	" "	" "	—	—
3 Oval " "	" "	" "	" "	" "	—	—
10 Bevel edged " "	" "	" "	" "	" "	—	—
3 Cores .	" "	" "	" "	" "	—	—
1 Awl or borer .	" "	" "	" "	" "	—	—
296 Chips .	" "	" "	" "	" "	—	—
Fragments of red ochre	" "	" "	" "	" "	—	—
Piece of amber .	" "	" "	" "	" "	—	—
Charcoal .	" "	" "	" "	" "	—	—
c. Bone Implements—						
44 Pointed antler tips	" "	" "	" "	" "	" "	—
No. 1. Arrow head or piercer	" "	" "	" "	" "	20	Made of a plate of Mammoth tooth
2. Arrow head of antler	" "	" "	" "	" "	" "	Figd. 'Q. J. G. S.' 1876, p. 250, fig. 1
3. Bone awl .	" "	" "	" "	" "	" "	Made from Meta-carpel of reindeer
4. Incised bone .	" "	" "	" "	" "	—	—

TABLE I.—PALÆOLITHIC AGE. CAVES.—*continued.*

No. and Name of Object	Locality	Date	Previous Description	Where Deposited	Length	Remarks
5. Engraved bone . .	Robin Hood Cave	1875 to 1879	'The Creswell Caves,' Geol. and Polyt. Soc. West Riding of Yorks. 1888.	British Museum	In. 3	Figure of head and fore-quarters of a horse, unique specimen from Great Britain. Figd. 'Q. J. G. S.' 1877, p. 592, fig. 1. 'Annales,' fig.
Flint scraper . .	Pin Hole Cave	1875	" "	" "	—	Figd. 'Q. J. G. S.' 1876, p. 253, fig. 8
Flint flakes . .	Mother Grundy's Parlour	1879	" "	" "	—	Implements few, resembling those of the other caves
4 Quartzite flakes . .	" "	" "	" "	" "	—	Age of skeletons doubtful. One skull perhaps Neolithic
a. Bone Implements—						
Bone needle . .	Church Hole Cave	1875, 1876, 1877	'Q. J. G. S.' for 1877. Papers by Rev. J. M. Mello and P. W. Boyd	Owens College Museum, Manchester	3	Figd. 'Q. J. G. S.' 1877, p. 603, fig. 4
3 " awls . .	Notts' side of ravine	" "	" "	British Museum	—	—
2 " spear heads .	" "	" "	'Les Grottes de Creswell'	Rev. J. M. Mello's Collection	—	—
2 Spear or gouges of Reindeer antler . .	" "	" "	'Annales' de la Soc. Scientifique de Bruxelles	" "	4 $\frac{3}{4}$	'Q. J. G. S.' 1877, p. 603, fig. 7. 'Annales' de la Soc. Sc. Brux.
Serrated bone . .	" "	" "	'Palæolithic Man at Creswell,' Derbyshire Arch. and Nat. His. Soc. Trans., vol. i. 1879	" "	2	'Q. J. G. S.' 1877, p. 603, fig. 6
b. Flint Implements—						
70 Flint flakes . .	" "	" "	" "	" "	—	—
2 " awls . .	" "	" "	" "	" "	—	—
1 Simple scraper . .	" "	" "	" "	" "	—	—
2 Bevelled flakes . .	" "	" "	" "	" "	—	—
62 Flint chips . .	" "	" "	" "	" "	—	—
c. Quartzite Implements—						
73 Round pebbles . .	" "	" "	" "	" "	—	—
5 Quartzite choppers	" "	" "	" "	" "	—	—
3 " flakes . .	" "	" "	" "	" "	—	—
12 " chips . .	" "	" "	" "	" "	—	—
Fragments of charcoal	" "	" "	" "	" "	—	—
Burnt bones . .	" "	" "	" "	" "	—	—

N.B.—Although the Church Hole Cave is, strictly speaking, in Nottinghamshire, it will probably be considered most convenient not to separate its contents from those of the other caves belonging to the same group.

In cataloguing the Prehistoric remains found in the Derbyshire Tumuli I have found it almost impossible to separate the Neolithic from the Bronze age interments, owing to the constant intermingling of the two, and therefore I have grouped them together under one heading. The two civilisations naturally blend; there is no such gap between them as there is between the Palæolithic and Neolithic ages.

TABLE II.—*Neolithic and Bronze Ages.*

Name of Object	Locality	Previous Description	Remarks
1. EARTH-WORKS AND FORTIFICATIONS.			
1. Pit dwellings.	Crich, Linda Spring Wood	'Vestiges of the Antiquities of Derbyshire.' By T. Bateman and S. Glover. ('V. A. D.' used to denote this work.)	2 rows of circular pits, called the Pitsteads, each about 15 ft. diam., 6 ft. deep.
2. " "	Abney Moor . . .	'Barrows and Bone Caves of Derbyshire.' R. Pennington.	Excavated in the rock.
3. Quadrangular enclosures	Smyrill Grange, near Middleton-by-Youlgrave	'V. A. D.' . . .	4 yds. to 10 yds. square, built of Limestone blocks. Coarse pottery within.
4. Stone pavements	Harthill Moor . . .	" . . .	Supposed floors of circular huts.
5. Camp . . .	Mam Tor, Castle-ton	" also 'Barrows and Bone Caves,' &c.	—
6. Fort? . . .	Alport Castle. . .	" "	Barrows and fort? Remains of rampart of rough stones.
7. Fort or camp.	Markland Grips, near Creswell	—	—
8. Fort? . . .	Carlsark, Hathersage	'V. A. D.' p. 122; 'Ten Years' Diggings,' p. 253; 'Reliquary,' vol. i. 159; 'Archæologia,' vol. vii.	Encampment walled with large stones.
2. CIRCLES.			
1. Megalithic circle	Arborlow . . .	'V. A. D.' . . .	Circle of Limestone blocks overthrown, surrounded by a ditch and vallum; connected by a serpentine vallum with a tumulus $\frac{1}{4}$ mile distant. Barrows near circle.
2. Circle . . .	Harthill Moor, ('Ninestone Close')	" . . .	7 rude stones; 2 others 80 yds. to S.
3. " . . .	Brassington Moor . . .	" . . .	Circle of 2-ft.-high stones, 39 ft. diam.; another smaller (22 ft. diam.) 16 ft. distant.
4. " . . .	Abney Moor, near Highlow Moor	" . . .	33 ft. diam., enclosed by vallum; 4 large upright stones within. In 1755 there were 9 large equidistant stones.
5. " . . .	Eyam Moor, Wet Withens	" . . .	16 upright blocks of gritstone, 30 yds. diam.; there was a large central block.
6-18. Circle . . .	" "	" . . .	At least 12 more circles, each surrounded with circular mounds of earth, some with stones.
19. " . . .	Froggatt Edge . . .	" . . .	About 12 yds. diam., with central block.
20. " . . .	East Moor, Baslow	" . . .	13 stones; 12 yds. diam.
21. " . . .	Hathersage Moor . . .	" . . .	6 stones; one 7 ft. high near.
22. " . . .	Stanton Moor ('Nine Ladies')	Figured, 'V. A. D.' p. 112	9 erect stones, 3 ft. to 4 ft. high; 1 stone 34 yds. distant.
23. " . . .	Offerton Moor . . .	'Barrows and Bone Caves of Derbyshire.' R. Pennington.	89 ft. by 83 ft.; rampart 7 ft. wide.
24. " . . .	Wet Withens Moor	" "	100 ft. diam.; rampart 17 ft. wide; 11 stones standing.
3. ROCKING STONES.			
Rocking stones . . .	Stanton Moor, Birchover (Row-to Rocks)	'V. A. D.' p. 115, &c. . .	An outlier of Kinderscout Grit had several rocking stones.
" " . . .	Bradley Tor, near the above	" . . .	$\frac{1}{4}$ mile from the above another outlier with rocking stone.
" " . . .	Ashover Common ('Robin Hood's Mark')	" . . .	—
" " . . .	Hathersage Moor . . .	" also Spencer Hall's 'Rambles in the Country,' p. 28.	Several stones in this locality; were movable in 1842.

TABLE III.—*List of Barrows.*

Compiled from T. Bateman's 'Ten Years' Diggings,' 1861.

No.	Name of Barrow	Locality	No.	Name of Barrow	Locality
1	Abbot Low .	Hopton.	51	Darby Low .	Fairfield.
2	Abney Low .	Abney Moor.	52	Dars Low .	Monyash.
3	Arbor Low .	Middleton-by- Youlgrave.	53	Dirt Low .	Ashford.
4	At Low . .	Hognaston.	54	Dow Low .	Church Sterndale.
5	Bailey Hill .	Hanson.	55	Drake Low .	—
6	Bargoes, The .	Middleton-by- Youlgrave.	56	Elk Low .	Hartington.
7	Bar Low .	Chesterfield.	57	End Low .	"
8	Barrow Sedge	Hartington.	58	Fairfield Low	Buxton.
9	Bas Low .	Chatsworth.	59	Far Low .	Cauldon.
10	Bee Low .	Youlgrave.	60	" "	Tideswell.
11	Birk Low .	Hathersage.	61	Fin Cop .	Ashford.
12	Blake Low .	Bonsal.	62	Find Low .	Chelmorton.
13	" "	Etwall.	63	Foo Low .	Eyam.
14	" "	Hassop.	64	Fowse Low .	Hopton.
15	Blind Low .	Hartington.	65	Fox Low .	Buxton.
16	" "	Chelmorton.	66	Galley Low .	Brassington
17	Boar Low .	Tissington.	67	Gib Low .	Middleton-by- Youlgrave.
18	Bole Hill .	Bakewell.	68	Great Low .	Chelmorton.
19	" "	Wirksworth.	69	" "	Hartington.
20	" Low .	Bamford.	70	" "	Tideswell.
21	Booth Low .	Sheldon.	71	Green Low .	Alsop Moor.
22	Burrows, The	Middleton-by- Youlgrave.	72	" "	Brassington.
23	Borther Low .	" "	73	" "	New Inns.
24	Brier Low .	Buxton.	74	" "	Wheston.
25	Broad Low .	Ashbourne.	75	Grind Low .	Eyam.
26	" "	Tideswell.	76	" "	Over Haddon.
27	Brown Low .	Hartington.	77	Gris Low .	Calver.
28	Brund Cliff .	"	78	Hal Low .	Pleasley.
29	Bullock Low .	"	79	Har Low .	Bradbourne.
30	Burnet Low .	Grindon.	80	Hare Low .	Bamford.
31	Cal Low .	Hathersage.	81	" "	Tideswell.
32	" "	Hopton.	82	Harefoot Low	Hartington.
33	Ca-Low .	Chesterfield.	83	Hawkes Low .	Parwich.
34	Calling Low .	Youlgrave.	84	Hay Cop .	Monsal Dale.
35	Calver Low .	Calver.	85	Heathy Low .	Tideswell.
36	Carder Low .	Hartington.	86	Herns Low .	Eyam.
37	Carter Low .	"	87	High Low .	Atlow.
38	Cas Low .	Mayfield.	88	" "	Hathersage.
39	Casking Low .	Hartington.	89	" "	Monyash.
40	Cast Low .	"	90	Hind Low .	Church Sterndale.
41	Chelmorton Low	Chelmorton.	91	Hoar Low .	Hartington.
42	Cop Low .	Great Hucklow.	92	Hob Hurst's House	Baslow Moor.
43	Cow Low .	Buxton.	93	Hoo Low .	Fairfield.
44	" "	Chapel-en-le-Frith.	94	Huck Low, Great	Great Hucklow.
45	" "	Hartington.	95	Huck Low, Little	Little "
46	" "	Holme End.	96	Hurd Low .	Hartington.
47	" "	Middleton-by- Youlgrave.	97	Kens Low .	Middleton-by- Youlgrave.
48	Crake Low .	Parwich.	98	Kirk Low .	Tideswell.
49	Cronkstone Low	Hartington.	99	Knock Low .	Milnhouse Dale.
50	Cross Low .	Parwich.	100	Knot Low .	Flagg.
			101	Ladmans Low	Buxton.

TABLE III.—LIST OF BARROWS—*continued.*

No.	Name of Barrow	Locality	No.	Name of Barrow	Locality
102	Lady Low .	Chapel-en-le-Frith.	150	Rusden Low .	Middleton-by- Youlgrave.
103	Lapwing Hill	Cressbrook.	151	Saint Low .	Parwich.
104	Larks Low .	Middleton-by- Youlgrave.	152	Sandpit Low .	Bradbourne.
105	Lean Low .	Hartington.	153	Seen Low .	Hartington.
106	Lidd Low .	Thorpe.	154	Senni Low .	"
107	Liffs Low .	Biggen.	155	Shack Low .	Bakewell.
108	Little Low .	Parwich.	156	" " .	Sheldon.
109	Long Low .	Hartington.	157	Shal Low .	Flagg.
110	Low, The .	Alsop Moor.	158	Shar Low .	Bradbourne.
111	Low Close .	Eckington.	159	Shard Low .	Derby.
112	Low Field .	Middleton-by- Youlgrave.	160	Sharp Low .	Dovedale.
113	" " .	Woodlands,	161	Sinfin Low .	Repton.
114	Low Moor .	Parwich.	162	Sitter Low .	Parwich.
115	Low Top .	Ashbourne.	163	Sitting Low .	Chapel-en-le-Frith.
116	Lower Low .	Wheston.	164	Sliper Low .	Brassington.
117	Masson Low .	Matlock.	165	Slipper Low .	Taddington.
118	Mick Low .	Edale.	166	Staden Low .	Buxton.
119	Mining Low .	Brassington.	167	Stan Low Moor	Great Hucklow.
120	Moot Low .	Hanson.	168	Stand Low	Dovedale.
121	" " .	Grange Mill.	169	Stannage Low	Biggen.
122	" " .	Youlgrave.	170	Stone Low .	Baslow.
123	Mosey Low .	Pilsbury.	171	" " .	Hartington.
124	Mouse Low .	Glossop.	172	Stoney Low .	Brassington.
125	Nay Low .	Tideswell.	173	" " .	Cold Eaton.
126	Needham Low	Wheston.	174	" " .	Hartington.
127	Net Low .	Alsop Moor.	175	Swains Low .	—
128	Nether Low .	Chelmorton.	176	Swarkeston Low	Swarkeston.
129	Over Low .	Hartington.	177	Thirkel Low .	Buxton.
130	Ox Low .	Peak Forest.	178	Tids Low .	Tideswell.
131	Painstor Low	Alsop.	179	Turning Low .	Hartington.
132	Peas Low .	Chapel-en-le-Frith.	180	Under Low .	Heathcote.
133	Peg Low .	Wheston.	181	" " .	Chelmorton.
134	Penny Low .	Hartington.	182	Upper Low .	"
135	Pig Tor .	Buxton.	183	Waggon Low .	Cronkstone.
136	Pinch Low .	Hartington.	184	Ward Low .	—
137	Priest Cliff .	Taddington.	185	Warry Low .	—
138	Queen Low .	—	186	West Low .	Litton.
139	Rams Low .	Elton.	187	White Low .	Ible.
140	Ravens Low .	—	188	" " .	Winster.
141	Rick Low .	Monyash.	189	Wigbarrow Low	Bradbourne.
142	Ringham Low	Middleton-by- Youlgrave.	190	Will Low .	Parwich.
143	" " .	Monyash.	191	Wind Low .	Wormhill.
144	Ringing Low	Brampton.	192	Withery Low	"
145	Risboro' Low	Etwall.	193	Wool Low or Hoo Low	Buxton.
146	Rocky Low .	Wheston.	194	Yarns Low .	Eyam.
147	Rolley Low .	Wardlow.			
148	Round Low .	Hopton.			
149	Row Low .	Youlgrave.			

TABLE IV.—*Neolithic and Bronze Ages.*

LIST OF STONE CELTS, &C.

Name of Object	Material	Locality	Date	Previous Description	Where Deposited	Length	Remarks
1. Celt . . .	Basalt . . .	Stanton Moor .	17—?	'A Descriptive Catalogue of the Antiquities, &c., preserved in the Museum of Thos. Bateman,' 1855. ('D. C. A.' used to denote this work.)	Bateman Collection, Sheffield Public Museum	Ins	Figured 'D. C. A.'
2. " . . .	" . . .	Haddon Hall .	1785	" " "	" "	5 $\frac{3}{8}$	Thick.
3. Dagger . . .	Flint . . .	Blakelow, Matlock	1786	" " "	" "	5 $\frac{1}{2}$	Figured 'D. C. A.' p. 47
4. Celt (broken)	Green coloured stone	Gib Hill Barrow	1824	" " "	" "	—	—
5. " . . .	Diorite ?	Monyash . . .	1826	" " "	" "	5	—
6. " . . .	Toadstone (Dolerite)	Newhaven . . .	1827	" " "	" "	7 $\frac{1}{4}$	Thick and narrow.
7. " . . .	Slate . . .	" " "	"	'V. A. D.'	" "	3 $\frac{1}{8}$	—
8. " . . .	Basalt . . .	" " "	—	" " "	" "	4 $\frac{6}{8}$	—
9. " . . .	Yellow-veined	Hopton . . .	1791	" " "	" "	—	Polished.
10. " (broken)	—	Cross Flats, Middleton	1828	" " "	" "	4 $\frac{1}{8}$	—
11. " . . .	Slate . . .	Youlgrave . . .	1831	" " "	" "	—	—
12. " . . .	" . . .	Monyash . . .	1832	" " "	" "	5 $\frac{1}{8}$	—
13. " . . .	Toadstone	Newhaven . . .	1833	" " "	" "	6 $\frac{3}{8}$	—
14. " . . .	Basalt . . .	Bakewell Moor	?	" " "	" "	—	Highly polished.
15. " . . .	? . . .	Youlgrave . . .	1830	" " "	" "	3	—
16. " . . .	Flint . . .	Youlgrave Moor	—	" " "	" "	—	—
17. " . . .	Basalt . . .	—	1832	" " "	" "	2 $\frac{1}{2}$	Thick.
18. " . . .	Slate . . .	Arborlow . . .	1839	" " "	" "	7 $\frac{1}{2}$	Long or narrow part polished
19. " . . .	Grey Flint	Liff's Low, Biggen	1843	" " "	" "	5 $\frac{1}{2}$	—
20. " . . .	" " "	" " "	"	" " "	" "	—	—
21. " . . .	Dark Flint	Lean Low, Newhaven	"	" " "	" "	3 $\frac{1}{2}$ × 2 $\frac{1}{2}$	Polished; both ends sharp; one side flat, other convex.
22. " . . .	Block Limestone	Middleton Moor	1839	" " "	" "	4 $\frac{1}{2}$	—
23. Hone . . .	Slate . . .	Bakewell . . .	1844	" " "	" "	7	Concave sides broken
24. Celt . . .	" . . .	" " "	"	" " "	" "	—	—
25. " . . .	Green Slate	Smerrill Moor . . .	1826	" " "	" "	—	—
26. " (broken)	Basalt . . .	Hartle Moor . . .	—	" " "	" "	8 $\frac{1}{4}$	—
27. " . . .	Slate . . .	" " "	1845	" " "	" "	4 $\frac{1}{8}$	—
28. " . . .	Basalt ? . . .	Newhaven Lodge	"	" " "	" "	4 $\frac{1}{4}$	—
29. " . . .	Green slate	" " "	"	" " "	" "	4	—
30. " . . .	Black Limestone	" " "	"	" " "	" "	—	—
31. " (broken)	Slate . . .	Arborlow . . .	1844	" " "	" "	5	—
32. " . . .	Yellow flint	Taddington . . .	1845	" " "	" "	5 $\frac{1}{2}$	—
33. " . . .	Flint . . .	" " "	"	" " "	" "	—	—
34. " . . .	Green slate	Monyash . . .	"	" " "	" "	—	—
35. " (broken)	Slate . . .	Smerrill Moor . . .	"	" " "	" "	—	—
36. " . . .	Toadstone	Arborlow . . .	"	" " "	" "	—	—
37. " (broken)	Green slate	Middleton Moor	1846	" " "	" "	—	—
38. " . . .	Flint . . .	Sheldon Moor . . .	1840	" " "	" "	6 $\frac{1}{2}$	—
39. " . . .	Basalt . . .	Smerrill Moor . . .	1847	" " "	" "	—	—
40. " (broken)	" . . .	Newhaven Lodge	"	" " "	" "	—	—
41. " . . .	" . . .	Taddington . . .	"	" " "	" "	—	—
42. " . . .	Slate . . .	Middleton Moor	"	" " "	" "	—	—
43. " . . .	Basalt . . .	Cross Flats, Middleton	1848	" " "	" "	4 $\frac{1}{2}$	—

TABLE IV.—NEOLITHIC AND BRONZE AGES. LIS OF STONE CELTS, &C.—*continued.*

Name of Object	Material	Locality	Date	Previous Description	Where Deposited	Length	Remarks
44. Celt	Basalt	Newhaven	1848	'V. A. D.'	Bateman Collection, Sheffield Public Museum	5½ Ins	—
45. "	Slate	" "	"	" "	" "	3½	—
46. "	"	Elk Low, Hartington	"	" "	" "	—	—
47. "	"	Greenseats, Middleton	"	" "	" "	3	—
48. "	"	Gib Hill, Middleton	"	" "	" "	4	—
49. "	Sandstone	Greenseats, Middleton	"	" "	" "	—	—
50. "(fragment)	Slate	" "	"	" "	" "	—	—
51. "	"	" "	"	" "	" "	—	—
52. "	"	Kenslow Knoll	"	" "	" "	—	—
53. "	Basalt	Smerrill Farm	"	" "	" "	—	—
54. "	Slate	Greenseats	1849	" "	" "	—	—
55. "	"	" "	"	" "	" "	—	—
56. Hone	"	" "	"	" "	" "	—	—
57. Celt	"	" "	"	" "	" "	—	—
58. "	Sand agate	—	—	" "	" "	5	—
59. "(fragment)	—	Newhaven Lodge	1851	" "	" "	—	Polished.
60. "(imperfect)	Flint	Arborlow	"	" "	" "	—	—
61. "(rough)	"	Kenslow, Middleton	"	" "	" "	—	—
62. "	Slate	Pike Hall	"	" "	" "	—	—
63. "(broken)	"	Smerrill Moor	"	" "	" "	—	—
64. "	"	Arborlow	1854	" "	" "	—	—
65. "	"	Youlgrave	1853	" "	" "	—	—
66. "	"	" "	"	" "	" "	—	—
67. "	Basalt	Biggen	"	" "	" "	—	—
68. "	"	Smerrill Moor	"	" "	" "	5½	Has a cavity worked in each side.
69. Hammer or axe	Red Granite	Borrowash	1841	" "	" "	—	Raised mouldings; figured 'D. C. A.' p. 3
70. "	—	Birchover	1848	" "	" "	7½	—
71. "	—	Middleton - by Youlgrave	1827	" "	" "	4½	—
72. "	—	Taddington	—	" "	" "	—	—
73. "	—	Tideswell	1844	" "	" "	4½	Two edged.
74. "	Jasper	Castleton	—	" "	" "	3	—
75. "	—	Winster Common	1750	" "	" "	—	—
76. "	Basalt	Sheldon Moor	1848	" "	" "	3½	—
77. Querns	—	Harthill Moor	1845	" "	" "	—	One figured 'V. A. D.' p. 127.
78. 3 querns	—	Over Oldhams, Arborlow	—	" "	" "	—	—
79. "(conical)	—	Taddington	—	" "	" "	—	—
80. Pestle?	—	Harthill Moor	—	" "	British Museum	—	—
81. Implement	Ironstone	—	—	" " also Camden's 'Britannica,' 1806, vol. ii. p. 422	" "	22	Figured 'Gentmn.'s Mag.' 1783, p. 393; 'D. C. A.' p. 10.
82. Celt	—	Near Doveholes	18—?	'Barrows and Bone Caves', p. 62, &c.	" "	—	—
83. "	—	Hope	—	" "	" "	—	—
84. Pestle	Sandstone	Near Castleton	—	" "	" "	—	—
85. Spindle-wheel	Flint	Doveholes	—	" "	" "	—	A natural perforation.

TABLE V.—*Bronze Age.*
LIST OF BRONZE WEAPONS, &c.

No. and Name of Object	Locality	Date	Previous Description	Where Deposited	Length	Remarks
CELTS						
1. Half-socketed celt or palstave	Winster Moor	1766	'D. C. A.'	Bateman Collection	6 Ins.	—
2. Half-socketed "	Ashover . .	1787	" "	Sheffield Public Museum	6	—
3. Full-socketed "	Brough . .	1807	" "	" "	4½	Ornamented with raised lines, figd. 'D. C. A.' p. 74; also in Marriott's 'Antiq. of Lyme,' 1810, p. 303
4. Simple flat "	Hartle Moor .	1824	" "	" "	7½	Figd. 'D.C.A.' p. 73
5. Small "	Biggen Grange	—	" "	" "	4½	" "
6. Full-socketed "	Peak Forest .	1828	" "	" "	4½	" "
7. Half-socketed "	Upper Oldham, Middleton	1832	" "	" "	4½	" "
8. Small "	Borther Low, Middleton	1843	" "	" "	2	—
9. Half-socketed "	Stonecliffe quarry, Darley dale	1844	" "	" "	—	—
10. Part of large flat "	Oker Hill, Darley dale	1840	" "	" "	—	—
11. Half-socketed "	near Horsley Castle	1844	" "	" "	—	Similar to No. 9
12. " "	Youlgrave .	1843	" "	" "	6½	—
13. Flat "	Moot Low, Dove-dale	1845	" "	" "	—	—
14. — "	Blake Low, Longstone	1846	" "	" "	4½	—
15. Flat "	Shuttlestone .	1848	" " also 'Journal of Brit. Archæol. Assoc.,' 1850, p. 210	" "	—	Found together with a bronze dagger
16. — "	Millfield . .	" "	" " also 'D. C. A.'	" "	—	—
17. Slightly ornamented "	Grind, Buxton	1850	" "	" "	—	—
18. " "	— "	1856	" "	" "	9½	Figd. 'T.Y.D.' p. 247
19. Half-socketed "	Chatsworth .	1851	" "	" "	—	—
20. " "	Bakewell .	1845	'V. A. D'	" "	—	—
21. " "	Win Hill, Castle-ton	" "	" "	" "	—	—
22. " "	Mam Tor, Castleton	—	" "	" "	—	—
23. " "	Haddon Hall .	—	" "	" "	—	—
24. " "	Millers Dale	—	" "	" "	—	—
25. " "	Worm Hill .	1826	" "	" "	—	—
26. " "	" "	—	" "	" "	—	—
27. Rude "	Arborlow .	—	" "	" "	—	—
28. Ornamented "	High Low, Hathersage	1872	'Barrows and Caves of Derbyshire'	The late Rooke Pennington's Collection	—	—
29. " "	High Low, Hathersage	—	" " also 'Reliquary,' vol. iv. p. 63	" "	—	—
30. — "	Cave Dale, Castleton	1872	'Barrows and Caves of D.'	" "	—	Contains zinc
31. Half-socketed "	Chesterfield .	1860	—	Rev. J. M. Mello's Collection	6½	—
DAGGERS						
1. Bronze dagger	Brier Low, Buxton	1845	'D. C. A.'	Bateman Collection, Sheffield Public Museum	5½	Handle had three large rivets

TABLE V.—BRONZE AGE. LIST OF BRONZE WEAPONS, &C.—*continued.*

No. and Name of Object	Locality	Date	Previous Description	Where Deposited	Length	Remarks
DAGGERS—<i>cont.</i>						
2. Bronze dagger	Carder Low, Hartington	1845	'D. C. A.'	Bateman Collection, Sheffield Public Museum	Ins. 5½	Figd. 'D.C.A.' p. 6
3. " "	New Inns	"	" " "	" "	5½	
4. " "	New Inns	"	" " "	" "	—	Handle ornaments, two pins and thirty studs
5. " "	Near Wormhill	1846	" " "	" "	6½	—
6. " "	Dow Low	"	" " "	" "	5	Blade fluted
7. " "	Kens Low	"	" " "	" "	3½	
8. " "	Parcelly Hay	1848	" " "	" "	—	Three handle studs or rivets
9. " "	Shuttlestone	"	" " "	" "	—	Two rivets, traces of horn handle found with Celt No. 15
10. " "	End Low, Hartington	"	" " "	" "	6½	Figd. 'T.Y.D.' p. 39. Three handle rivets
11. " "	Minning Low	1849	" " "	" "	—	Archaic, no rivets, only holes for thongs, con- torted by fire
12. " "	Lid Low	1851	" " "	" "	7½	Two rivets
13. " "	Bole Hill, BAKEWELL	1854	" " "	" "	—	
14. " "	The Rake, Buxton	1856	" " "	" "	9½	Two holes to tie handle
SPEARS						
1. Bronze spear-head	Wardlow	1825	'D. C. A.'	" "	—	—
2. " "	"	"	" " "	" "	—	—
3. " "	Litton	1831	" " "	" "	—	—
4. " "	Matlock Bath	1806	" " "	" "	4½	Has two loops to socket
5. " "	Darley Dale	—	" " "	" "	7	Looped each side socket
6. " "	Lathkill Dale	—	" " "	" "	—	Point only
7. " "	Heage	—	" " "	" "	—	Unusually wide blade looped on either side of socket. Type figd. 'V.A.D.' p. 9; also 'D.C.A.' p. 21
8. " "	Moor Low, Hanson	1844	" " "	" "	3	—
9. " "	Stanedge, Newhaven	1853	" " "	" "	6½	—

TABLE VI.—*Neolithic and Bronze Ages.*
SO-CALLED CELTIC POTTERY FROM T. BATEMAN'S LIST.

Name of Object	Locality	Date	Previous Description	Where Deposited	Height	Remarks
1. Ornamented vase . . .	Ashford . . .	1832	T. Bateman's Catalogue of Antiquities, 1855	Sheffield Public Museum	Ins. 43 $\frac{1}{2}$	—
2. Incense cup . . .	Larks Low, Middleton	1825	" "	Bateman's collection	—	Figd. Catal. of Antiquity, p. 81
3. Ornamented cup . . .	Minninglow . . .	1843	" "	" "	8 $\frac{1}{2}$	—
4. Small vase . . .	Liff's Low . . .	"	" "	" "	—	—
5. Small ornamented vase	Cross Low, Parwich	"	" "	" "	—	Figd. Catal. of Antiquity, p. 83.
6. Larger slightly ornamented vase	Cross Low, Parwich	"	" "	" "	—	—
7. Smaller, coarse texture	Cross Low, Parwich	"	" "	" "	—	—
8. Large urn, broken	Moot Low . . .	1844	" "	" "	—	—
9. Highly ornamented cup	Sliper Low . . .	1844	" "	" "	—	Figd. ' Journ. of the Arch. Instit.' Vol. i. p. 248
10. Small cup . . .	Stone Low, Baslow	1830	" "	" "	—	—
11. Ornamented vase . . .	Rolley Low . . .	1844	" "	" "	—	—
12. Highly decorated cup	Green Low, Alsop Moor	"	" "	" "	7 $\frac{1}{2}$	Figd. Catal. of Antiquity, p. 85.
13. Large urn . . .	Near Sheldon . . .	"	" "	" "	—	—
14. Rudely ornamented vase	Arborlow . . .	"	" "	" "	—	—
15. Ornamented vase . . .	" . . .	"	" "	" "	4 $\frac{3}{4}$	Wide-mouthed 9 $\frac{1}{2}$ in. diam.
16. " " . . .	Hartle Moor . . .	"	" "	" "	—	Figd. Catal. of Antiquity, p. 87.
17. Small cup . . .	" " . . .	"	" "	" "	—	Figd. Catal. of Antiquity, p. 87
18. Fine ornamented urn	Flax Dale, Middleton	1847	" "	" "	14	Figd. Catal. of Antiquity, p. 89
19. Decorated vase . . .	Lean Low, Hartington	"	" "	" "	—	—
20. Small " . . .	Gib Low . . .	1848	" "	" "	—	—
21. Decorated vase . . .	Bostorn, Dove-dale	"	" "	" "	—	—
22. Very fine cup . . .	Mouse Low, Glossop	"	" "	" "	8 $\frac{3}{4}$	—
23. Small vase . . .	Crake Low, Tissington	"	" "	" "	—	—
24. " cup . . .	Dow Low, Sterndale	"	" "	" "	7	—
25. Decorated cup . . .	Blake Low, Longstone	"	" "	" "	7 $\frac{1}{2}$	—
26. Rudely ornamented vase	Longstone Edge	"	" "	" "	—	—
27. Rudely ornamented vase	Longstone Edge	"	" "	" "	—	—
28. Finely ornamented cup	Rusden Low, Middleton	"	" "	" "	—	—
29. Incense cup . . .	Matlock Bridge	"	" "	" "	4	—
30. Finely ornamented cup	Bee Low, . . .	1851	" "	" "	6 $\frac{5}{8}$	—
31. Vase . . .	near Ashford . . .	"	" "	" "	—	—
32. Ornamented vase . . .	Monsal Dale . . .	"	" "	" "	5 $\frac{1}{2}$	—
33. Cup . . .	" " . . .	"	" "	" "	7 $\frac{1}{2}$	—
34. Richly moulded decorated vase	" " . . .	"	" "	" "	4 $\frac{3}{8}$	—
35. Finely ornamented urn	" " . . .	"	" "	" "	12	—
36. Rudely ornamented cup	Staker Hill . . .	"	" "	" "	7 $\frac{3}{4}$	—
37. Small rudely ornamented vase	Waggon Low . . .	1852	" "	" "	4 $\frac{1}{2}$	—

TABLE VII.—*Neolithic and Bronze Ages.*

CONTENTS OF BARROWS.

Name of Object	Locality	Date	Previous Description	Where Deposited	Height (6 diam. month)	Remarks
Coarse clay urn . . .	Calton . . .	1789	'Vestiges of the Antiquities of Derbyshire,' p. 22	Bateman Collection, Weston Park Museum, Sheffield	Ins. 5	Urn has zig-zag scratches; contained ashes
Three coarse clay urns, one small one	Stanton Moor	1787				
Several urns with burnt bones; bone and bronze pins; some flint chips; 3 urns with burnt bones, and a flint implement	Stanton Moor barrows	1799	'A Descriptive Catalogue of the Antiquities, &c., preserved in the Museum of Thomas Bateman	" "	—	—
		1847				
Skeleton; 2 flint arrow heads, burnt bones; 3 coarse urns with burnt bones; 2 skeletons; flint spear head; small stuccoed stone	Fin Cop, Ashford	1795	" "	" "	—	Two barrows
Rude sun-baked urns with burnt bones	Hathersage .	1834	" "	" "	—	—
2 large urns with calcined bones and flints; small incense cup; large flattish vessel of red clay, perforated with holes at bottom	East Moor, near Baslow (Stonelow)	1830	" "	" "	—	—
2 skeletons; ivory or bone pendent; circular bronze fibula; fragments of pottery; broken axe of basalt; polished pebble	Kenslow, near Middleton-by-Dale		" "	Brampton Museum, Bateman Collection	—	—
Burnt human bones; flint arrow head; broken basaltic celt; calcined flints	Gibb Hill (Arbor Low)	1824	" "	" "	2.5	—
Skeleton; flint arrow head; 2 flint implements; bone pin; clay urn	Bee Low, Youlgrave	1843	" "	" "	—	—
Contracted skeleton; hammer head of red deer antler; 2 flint arrow heads; 2 flint celts; 2 flint spear heads; 2 flint knives; flint chips; fragments of red ochre; 2 large boars' tusks; coarse urn	Biggin (The Liffs)	1843	" "	" "	—	Barrows rich in contents
3 chipped flints; arrow head of flint; 2 circular flint implements; coarse urn fragments	Brassington Moor	1843	" "	" "	2.5	—
Skeleton; flint lance head; 3 flint implements; burnt human bones; flint arrow head; coarse clay urn	Elk Low . . .	1843	" "	" "	—	—
Skeleton; coarse clay urn; flint arrow head; small bronze celt	Borther Low, Middleton-by-Youlgrave	1843	" "	" "	—	—

TABLE VII.—NEOLITHIC AND BRONZE AGES—*continued.*

Name of Object	Locality	Date	Previous Description	Where Deposited	Length	Remarks
Skeleton; small urn; bone pin; cist with skeleton; coarse urn; broken celt; chipped flint; burnt bones of 2 children; 2 urns; 5 skeletons	Cross Low (Parwich)	1843	'Vestiges of the Antiquities of Derbyshire,' T. Bateman and S. Glover. A Descriptive Catalogue of the Antiquities, &c., preserved in the Museum of T. Bateman	Bateman Collection, Weston Park Museum, Sheffield	Ins. —	First 3 objects from secondary interment
Urn of fine black clay; urn of coarse black clay; flint chips and implement	Ringham Low (Middleton Moor)	1821 1843	" "	" "	—	—
Large urn with burnt bones	Moot Low (Grange Mill)	1844	" "	" "	3-16 ins. high, 13 ins. diam. at mouth	Secondary interment
Bronze spear	—	—	" "	" "	3-25	Has hole for rivet
Contracted skeleton	—	—	" "	" "	—	Primary interment
3 skeletons; broken stone celt; 5 flint implements; burnt bones; 2 flint arrow heads; 2 flint implements; skeleton of child; small ornamented urn	Sliper Low (Brassington Moor)	1844	" "	" "	—	—
Large flint arrow head; fragment of urn; fragment of pyrites; urn containing 3 quartz pebbles; flat piece of polished iron ore; small flint celt with round polished edge; beautifully chipped implement; 21 circular flint implements; 17 ruder ones	Elton Moor Low	1844	" "	" "	—	—
Broken urns; human bones; flint chips	One Ash farm	1844	" "	" "	—	—
Coarse urn; 2 skeletons; 3 flint implements; contracted skeleton; ornamented urn; 2 flint arrow heads; large boar tusk; flint spear head	Rolley Low (Wardlow Common)	1844	" "	" "	—	—
6 skeletons; clay urn; flint arrow head; flint chips	Upper Haddon Moor (Barrow)	1844	" "	" "	—	—
5 flint implements	Hunter Mere (Ashford Moor)	1845	" "	" "	—	—

TABLE VII.—NEOLITHIC AND BRONZE AGES—*continued.*

Name of Object	Locality	Date	Previous Description	Where Deposited	Length	Remarks
Contracted skeleton; ornamented cup; spherical pyrites; circular flint implement; fine flint dagger; 3 flint barbed arrow heads; 7 flint implements; 3 bone implements; bone pin; skeleton of infant	Green Low (Alsop Moor)	1845	'Vestiges of the Antiquities of Derbyshire,' T. Bateman & S. Glover. A Descriptive Catalogue of the Antiquities preserved in the Museum of Thos. Bateman	Bateman Collection, Weston Park Museum, Sheffield	Ins.	The cup is figured, p. 59, 'V. A. D.' also some of the implements
Fragments of urns; flint chips; 2 skeletons; large urn with burnt bones; flint chips	Sheldon barrow	1845	" "	" "	—	—
Contracted skeleton; burnt bones; bronze dagger	Brier Low (Buxton)	1845	" "	" "	—	The dagger has 3 rivets attached
Rude urn; skeleton of infant; flint arrow head; flint saw; flint spear head; human bones	Hind Low (Church Sterndale)	1845	" "	" "	5½	—
Flint arrow head; fragments of urns; contracted skeleton; bronze dagger	Carder Low (Hartington)	1845	" "	" "	—	—
fine stone axe 3 whetstones	—	—	" "	" "	5½	Dagger has 3 rivets attached, figured, 'Descriptive Catalogue,' p. 6; The axe is perforated and had been polished; figured 'Descriptive Catalogue,' p. 6
Burnt human bones; kidney-shaped flint implement; bone pin; iron pyrites; 2 coarse clay urns	Arbor Low	1845	" "	" "	—	—
Contracted skeleton; bronze dagger 2 bronze rivets; 2 flint implements 2 jet studs	New Inn (Alsop le Dale)	1845	" "	" "	5½	Traces of a wooden sheath
Female skeleton; 2 flint implements	Painstorbarrow (Alsop Moor)	1845	" "	" "	—	Figured, 'Descriptive Catalogue,' p. 8
Contracted skeleton; bronze celt	Moot Low (between Alsop Moor and Dovedale)	1845	" "	" "	—	—
Skeleton; urn fragments; large bronze dagger; 2 polished studs of Kimmeridge coal; some flint implements	Net Low (Alsop Moor)	1845	" "	" "	—	Dagger broken; handle decorated with 30 rivets and 2 bronze pins

TABLE VII.—NEOLITHIC AND BRONZE AGES—*continued.*

Name of Object	Locality	Date	Previous Description	Where Deposited	Length	Remarks
Contracted skeleton; 2 flint implements; burnt human bones	Bostorn barrow, near Dovedale	1845	'Vestiges of the Antiquities of Derbyshire,' T. Bateman. A Descriptive Catalogue of the Antiquities &c., preserved in the Museum of Thomas Bateman	Bateman Collection, Weston Park Museum, Sheffield	Ins.	—
2 contracted skeletons, m. and f.	—	—	" "	" "	—	Female skeleton headless
2 small urns; 1 large urn; calcined bones; 2 flint implements	Harthill Moor	1845	" "	" "	—	Urns figured 'V. A. D.,' p. 72
Skeleton of infant; burnt human bones; 2 bone pins (burnt); fine flint spear head; arrow head of flint; contracted female skeleton; skeleton of man in sitting posture; flint spear head; portions of other skeletons; circular and other flint chips	Castern, near Wetton	1845	" "	" "	—	—
Contracted skeleton; small coarse urn	Lid Low (Thorpe)	1845	" "	" "	—	Vase figured, 'V. A. D.,' p. 87
Contracted skeleton; flint implements; highly ornamented vase	Castern, near Wetton	1846	" "	" "	—	Necklace figured, 'V. A. D.,' p. 89, 'Descriptive Catalogue,' p. 10
Contracted skeleton, f.; 2 skeletons; 2 skeletons of infants; ivory pin; necklace of Kimmeridge coal beads with ivory ornaments	Windle Nook, near Hargate Wall	1846	" "	" "	—	—
Contracted skeleton; bronze dagger; remains of wooden sheath; 4 flint implements; burnt human bones	near Buxton (Barrow)	1846	" "	" "	6.25	—
Fragment of urn; flints	" "	1846	" "	" "	—	—
Flint arrow head; calcined bones 12 indiv.	Five Wells Hill (Taddington)	1846	" "	" "	—	—
Contracted skeleton, f.?	Cow Low (Buxton)	1846	" "	" "	—	—
calcined human bones; bone needle; many human bones; contracted skeleton, f.; 117 Kimmeridge coal beads						
Circular flint implement; broken urn	—	—	" "	" "	—	Figured 'Descriptive Catalogue,' p. 11
2 skeletons; fluted bronze dagger; flint chips; iron-stone amulet; burnt human bones	Dowe Low (Church Sterndale)	1846	" "	" "	5	Dagger figured, 'V. A. D.,' p. 96, and 'Descriptive Catalogue,' p. 12
Flint spear head; calcined bones	Chelmorton Low	1846	" "	" "	—	—
Flint arrow head	Hinde Low (Sterndale)	1846	" "	" "	—	—

TABLE VII.—NEOLITHIC AND BRONZE AGES—*continued.*

Name of Object	Locality	Date	Previous Description	Where Deposited	Length	Remarks
Contracted skeleton; flint spear head; circular ended flint implement; sandstone ball	Calling Low Farm (near Middleton)	1846	'Vestiges of the Antiquities of Derbyshire,' T. Bateman and S. Glover. A Descriptive Catalogue of the Antiquities, &c., preserved in the museum of Thomas Bateman	Bateman Collection, Weston Park Museum, Sheffield	Ins.	—
Flint implement; broken urns; two skeletons	Near above	1846	" "	" "	—	—
Contracted skeleton	Moot Low Bank (Middleton)	1847	" "	" "	—	—
Small urn	Stanton Moor	1847	" "	" "	—	—
Fine urn with burnt bones; flint arrow heads; fragments of human skull	Middleton-by-Youlgrave	1847	" "	" "	—	—
Coarse clay urn; calcined bones; flint flake; contracted skeleton	Lean Low	1847	" "	" "	—	—
Fragments of pottery; flint chips	Harthill Moor	1847	" "	" "	—	—
Skeleton; flint chips	Ringham Low (Monyash)	1847	" "	" "	—	—
Two flint implements; sawn fragment of antler; skeleton; cut antler; contracted skeleton; flint spear head; bronze pin	Gotam	1847	" "	" "	—	—
Flint implements; bone lance head	Middleton Moor	1847	" "	" "	—	—
Flint flakes and chips; flint arrow head; 2 semi-circular flint implements; small urn; burnt bones	Gib Hill (Middleton Moor)	1848	'Ten Years Diggings,' by T. Bateman. 'T. Y. D.' used to denote this work. A Descriptive Catalogue of the Antiquities, &c. preserved in the Museum of Thos. Bateman	" "	—	Large barrow near Arborlow. The cist is figured, 'T. Y. D.,' p. 18, 19
Flint implements; fragment of stone celt; 7 crescent shaped bone ornaments; fragments of coarse clay urn; fragment of ring of Kimmeridge coal; bone spatula; part of human skeleton; bronze dagger; bone needle; bone spear head	Kenslow (Middleton - by-Youlgrave)	1848	" "	" "	—	Also opened in 1821, see 'V. A. D.'
—	—	—	" "	" "	3	The dagger has 3 rivets attached
Basalt celt; fragments of querns; some flints; fragments of pottery; fragments of skeleton	Cross Flatts plantation (Middleton - by - Youlgrave)	1848	" "	" "	—	—

TABLE VII.—NEOLITHIC AND BRONZE AGES—*continued.*

Name of Object	Locality	Date	Previous Description	Where Deposited	Length	Remarks
Contracted sitting skeleton; chipped flints; broken urn	Parcelly Hay (Hartington)	1848	'Ten Years Diggings,' by T. Bateman. 'T. Y. D.' used to denote this work. A Descriptive Catalogue of the Antiquities, &c. preserved in the Museum of Thos. Bateman	Bateman Collection, Weston Park Museum, Sheffield	Ins. —	Cist and skeleton figured 'T. Y. D.,' p. 23
Skeleton contracted; granite axe head; bronze dagger	—	—	" "	" "	—	This interment was on the covering stones of the above, axe head perforated; dagger with 3 studs
Fragments of skeletons and burnt bones; whet-stone; flint arrow head; female skeleton contracted; skeleton of child	Middleton Moor, near Arborlow	1848	" "	" "	—	Leaf shaped arrow head; cow's tooth found with skeleton, an article Bateman says uniformly found with the more ancient interments
Necklace of jet and bone beads	—	—	" "	" "	—	Consisted of 420 beads found round neck of the woman's skeleton, see 'T. Y. D.,' figured, p. 25
Calcined bones; broken urn	Sharp Low, near Tissington	1848	" "	" "	—	—
Contracted skeleton; broken urn	Near Thorpe Cloud, Dove-dale	1848	" "	" "	—	—
Skeleton; bronze celt; bronze dagger; jet bead; circular flint implement	Parwich Moor	1848	" "	" "	—	This skeleton had been wrapped in a dark red skin, traces of the hair left around it and on the bronze weapons, on which are also traces of fern leaves by which the body was surrounded. 'T. Y. D.,' p. 34
Burnt bones; coarse urn; flints	Round Low (Hopton)	1848	" "	" "	—	—
Skeleton; burnt bones; flints; small coarse urn; 2 skeletons; small urn	Crake Low (Tissington)	1848	" "	" "	—	—
	—	1848	" "	" "	5.5 hgh	—

TABLE VII.—NEOLITHIC AND BRONZE AGES—*continued.*

Name of Object	Locality	Date	Previous Description	Where Deposited	Length	Remarks
Skeleton; bronze dagger; flint spear head	End Low, near (Hartington)	1848	'Ten Years' Diggings,' by T. Bateman	Bateman Collection, Weston Park Museum, Sheffield	Ins. 6½	Skull engraved in Crania Brit., dagger figured 'T.Y. D.,' p. 39
Fragments of flint; fragments of skeletons; 2 skeletons; contracted flint spear head; flint chips	Moneystones (Hartington)	1848	'A Descriptive Catalogue of the Antiquities, &c., preserved in the Museum of Thomas Bateman'	" "	—	—
6 skeletons; 4 flint implements; fragments of urn; contracted skeleton of girl; bones of an infant; small vase; fragments of small vase	Blake Low, Longstone Edge	1848	" "	" "	—	—
Burnt bones of man; skeleton of child; 2 urns; fragment of flint	Blake Low, Longstone Edge	1848	" "	" "	7.5 high	—
Contracted skeleton; flint spear head; flint arrow head; contracted female skeleton; skeleton of infant	Middleton-by-Youlgrave	1848	" "	" "	—	—
Broken clay cup . . . Flint implement; fragments of cup; flint arrow head; part of a quern					—	The cups highly ornamented
Fragments of skeleton; fragments of calcined flint implements; bone spear head	Youlgrave (Greenstor Meadow)	1848	" "	" "	—	—
Contracted skeleton; flint arrow head; fragment of stone celt	Borthor Low, Middleton	1849	" "	" "	—	—
3 contracted skeletons; some flint implements	Grind Low, Overhaddon	1849	" "	" "	—	—
73 jet beads (necklace) Broken flint spear head						Necklace figured 'T.Y. D.,' p. 48
Skeleton of infant; fragments of urn	Parwich . .	1849	" "	" "	—	—
Contracted skeleton; 2 skeletons; flint implement	Vincent Knoll, (Parcelly Hay)	1849	" "	" "	—	—
Contracted skeleton; leaf-shaped flint dagger; flint spear head; skeleton; flint flake; fragment of hæmatite; jet bead; 2 skeletons; flint arrow head; flint implement	Chelmorton, Netherlow	"	" "	" "	4.5	Lower half of dagger serrated
Contracted skeleton; circular flint implement; burnt human bones	Cronkstone Low (Hartington)	1849	" "	" "	—	—
Burnt human bones; flint implements; broken bone implement	Minning Low (Brassington)	"	" "	" "	—	A stone cairn barrow with a later earth mound attached

TABLE VII.—NEOLITHIC AND BRONZE AGES—*continued.*

Name of Object	Locality	Date	Previous Description	Where Deposited	Length	Remarks
Bronze dagger . . .	—	—	'Ten Years' Diggings,' by T. Bateman. 'A Descriptive Catalogue of the Antiquities, &c., preserved in the Museum of Thos. Bateman'	Bateman Collection, Weston Park Museum, Sheffield	Ins.	Dagger archaic in form, holes in it for thongs, no rivets, dagger contorted by fire
Burnt bones; fragments of urn; 4 skeletons	Ballidon Moor	"	" " "	" "	—	Ballidon Moor barrow figured 'T. Y. D.,' p. 60
Contracted skeleton . Burnt and unburnt human bones	—	"	" " "	" "	—	Skull of contracted skeleton is engraved 'Crania Britannica,' typical Brachycephalic
Fine urn with burnt bones	—	"	" " "	" "	—	Urn figured 'T. Y. D.,' p. 59
Flint arrow head	—	"	" " "	" "	—	—
Skeleton of child; fragment of ornamented pottery	Ryestone Grange (Minning Low)	"	" " "	" "	—	—
Burnt bones; flint chips; fragment of stone celt	Flax Dale Barrow (Middleton-by-Youlgrave)	"	" " "	" "	—	Barrow figured 'T. Y. D.,' p. 63
Burnt bones; small vase; fragments	Calton Pasture (Chatsworth)	1850	" " "	" "	—	—
Extended skeleton; flint implement	Hasling Houses (Buxton)	"	" " "	" "	—	Skeleton perhaps Saxon.—T. B.
81 jet beads and plates; several disturbed skeletons	Hill Head (Buxton)	"	" " "	" "	—	—
Bronze awl; skeleton; flint implement	Stakor Hill (Buxton)	"	" " "	" "	—	—
2 contracted skeletons; large flint implement; 2 small flint implements	Vincent Knoll	"	" " "	" "	—	—
Burnt bones; flint chips	Upper Edge (Sterndale)	"	" " "	" "	—	—
Fragments of 4 skeletons; burnt bones; fragments of vase; bone implement	Crakendale Pasture (Bakewell)	1851	" " "	" "	—	—
Contracted skeleton; 3 bronze implements; contracted skeleton	Bee Low (Youlgrave)	"	" " "	" "	—	—
Drinking cup . . .	—	"	" " "	" "	6-75 high	Cup ornamented by two variations of lozenge pattern
Flint implement . . .	—	"	" " "	" "	4	—
Burnt bones; bronze pin; skeleton; 2 flint implements; fragment of infant's skull	—	"	" " "	" "	—	—
Fragments of skeletons; broken urn; skeleton; skeleton of child; 2 flints	Monsal Dale .	"	" " "	" "	—	—

TABLE VII.—NEOLITHIC AND BRONZE AGES—continued.

Name of Object	Locality	Date	Previous Description	Where Deposited	Length	Remarks
Numerous skeletons; 10 jet beads; 3 flint arrow heads; bone pendant; contracted skeleton	Hay Top Cressbrook	1851	'Ten Years' Diggings,' by T. Bateman 'A Descriptive Catalogue of the Antiquities, &c., preserved in the Museum of Thos. Bateman	Bateman Collection, Weston Park Museum, Sheffield	Ins.	—
Urn	—	—	" "	" "	5.5	—
Bone needle	—	—	" "	" "	6	—
2 human skulls; small urn	Hay Top, Cressbrook	"	" "	" "	7.25 hgh	Barrowfigured 'T.Y.D.', p. 76
Flint implement; skeleton of child; jet bead	—	"	" "	" "	—	—
Contracted skeleton of child	—	—	" "	Skeleton in glass case, B. Col.	4½ hgh	—
Small highly ornamented urn	—	—	" "	" "	—	—
Burnt bones	—	—	" "	" "	—	—
Urn with burnt bones,	Hay Top, Cressbrook, 2nd Tumulus	"	" "	" "	12 hgh	Barrowfigured 'T.Y.D.', p. 78
Bone pin	—	"	" "	" "	5	—
Bone celt	—	—	" "	" "	—	—
2 skeletons of children; 2 skeletons, one a child	—	—	" "	" "	—	—
Flint spear head	—	"	" "	" "	2.5	—
2 flint implements; skeleton; ditto, contracted; 2 of infants; flint arrow head; sandstone pestle	—	"	" "	" "	—	—
Skeleton; broken pottery	Longstone Edge	"	" "	" "	—	—
Burnt human bone; flint spear head; bone implement	"	"	" "	" "	—	—
Contracted skeleton; 2 bone implements; burnt human bones; 2 flint implements; child's bones; contracted female skeleton; broken urn; flint spear head; 2 bronze fragments; (earrings?)	Near Stakor Hill (Buxton)	"	" "	" "	—	—
Burnt bones	Hollings	"	" "	" "	—	—
Bones burnt and unburnt; flint implements; bone pin	Minninglow	"	" "	" "	—	Fine megalithic chamber figured. 'T.Y.D.' p. 82
Burnt bones; fragments of urns	Stanton	1852	" "	" "	—	Urns flower-pot shaped
Burnt bones; flint arrow head; bone implement	Waggon Low, High Needham	"	" "	" "	—	—
Small urn, coarse clay	—	"	" "	" "	4.5 hgh	—
2 skeletons, one a child; contracted skeleton	—	"	" "	In case, Bateman Collection	—	—
3 flint implements	" "	—	" "	—	—	—
Bronze awl	—	—	" "	—	1.5	—
Contracted skeleton	—	—	" "	—	—	—
Burnt bones; cut and charred wood	Hob Hurst's House, Baslow Moor	1853	" "	" "	—	Barrowfigured 'T.Y.D.' pp. 87, 88 The deposits separated by pebbles

TABLE VII.—NEOLITHIC AND BRONZE AGES—*continued.*

Name of Object	Locality	Date	Previous Description	Where Deposited	Length	Remarks
Broken coarse urn; 1 flint; sawed stag's horns	High Low, King Stern-dale	1853	'Ten Years' Diggings,' by T. Bateman. 'A Descriptive Catalogue of the Antiquities preserved in the museum of Thos. Bateman'	In case, Bateman Collection	Ins.	—
Skeleton; circular flint implement	Monsal Dale	1854	" "	" "	—	In a cavity in bank of calc tuff
Point of bronze dagger; contracted skeleton, rude circular flint implement	Bole Hill, Bakewell Moor	"	" "	" "	—	—
12 skeletons (2 infants, 10 adults)	Ringham Low, Moneyash	"	" "	" "	—	Cf. 'V.A.D.', p 103, figured, 'T.Y.D.', p.94, 97.
1 leaf-shaped flint arrow head; 2 ditto; 4 skeletons; bone pins; 2 skeletons; 2 leaf-shaped flint arrow heads	—	—	" "	" "	2.25 long	—
Fragments of skeleton; bone pendant; burnt bones; skeleton of infant	Eldon Hill	1856	" "	" "	—	—
Flint spear head	—	—	" "	" "	2	—
Small urn	—	—	" "	" "	4 $\frac{3}{4}$ high	—
Fragments of 12 skeletons; burnt bones; flint spear head; contracted female skeleton; 2 flint flakes; contracted male skeleton	Smerrill Moor, near Middleton-by-Youlgrave	1857	" "	" "	—	—
Fine ornamented urn	" "	"	" "	" "	8 $\frac{3}{4}$ high	—
Bone implement	—	—	" "	" "	12	—
Flint dagger	—	—	" "	" "	4 $\frac{3}{4}$	—
Flint spear head	—	—	" "	" "	3	—
4 flint implements	—	—	" "	" "	—	—
Contracted skeleton; flint	" "	1857	" "	" "	—	—
Contracted skeleton; fragments of 3 skeletons	Bole Hill, Bakewell Moor	1859	" "	" "	—	—
Contracted skeleton; small urn	Haddon Field, Bakewell	1860	" "	" "	6.5 high	—
Flint arrow head	—	—	" "	" "	6 $\frac{1}{2}$	—
Bone tool	—	—	" "	" "	—	Modelling tool, rounded ends, from antler
Bronze awl	—	—	—	—	—	—
Awl of antler of deer; fragments of pottery	Eldon Hill, Barrow	1871? to 1873	Barrows and bone caves of Derbyshire, by Rooke Pennington	The late Mr. R. Pennington's coll.	—	Circular barrow
Contracted skeletons flint-flake and quartzite pebbles	" "	—	" "	" "	—	Old and young man

TABLE VII.—NEOLITHIC AND BRONZE AGES—*continued.*

Name of Object	Locality	Date	Previous Description	Where Deposited	Length	Remarks
Burnt human bones; flint flakes; chert flake; jet beads; amber beads; flint arrow head	Abney Moor, large Barrow	1871? to 1873	Barrows and bone caves of Derbyshire, by Rooke, Pennington	The late Mr. R. Pennington's coll.	Ins.	Large barrow with vallum 9 or 10 blocks of stone; equidistant round it. Each 3ft. high; now destroyed
Fragments of pottery; 2 flint flakes; flint arrow head; fragment of bronze	Abney Moor, Small Barrow	"	" "	" "	—	—
Skeleton	Oxlow, Castleton	"	" "	" "	—	—
Stone hammer, pierced	—	"	" "	" "	—	—
Contracted skeletons; flint flakes; flint arrow head; bone pin; broken urn	Gautriss, Barrow	"	" "	" "	—	Circular barrow
Contracted skeletons; numerous remains of funeral banquet	Perryfoot, Barrow	"	" "	" "	—	Irregular oblong barrow, bones of short-horned ox, red deer, roe deer, horse, pig, goat, dog
Contracted skeleton; bronzering; jet bead; human bones; flint flakes	Siggett, Barrow	"	Also 'Tumuli and Stone Circles,' Journal of Anthropol. Instit. Vol. iv. p. 377	" "	—	—
Rude urn with burnt bones	—	1873	" "	" "	—	Urn hand-made with thumb-nail impressions
Skeleton of child and burnt human bones; 2 flint flakes; quartz pebbles; fragments of urn and burnt bones	—	"	" "	" "	—	—
Skeleton of child; flint celt; burnt human bones	—	"	" "	" "	—	—
Urn with burnt bones	—	"	" "	" "	18	Ornamented by pressing twisted grass on the wet clay
Human bones, burnt 2 bronze celts	High Low, Hathersage	"	Also 'Reliquary,' Vol. iv. p. 63	" "	—	Celts with zig-zag ornamentation
Broken pottery Human bones	— Cave Dale, Castleton	1872	— Barrows and Bone Caves	" " " "	— —	— —
Rude pottery; flint flakes; bone comb; bronze celt	—	"	" "	" "	—	This celt contains zinc
Fragment of jet	—	"	" "	" "	—	—
Broken perforated hammer-head (sandstone)	Creep Hole, Castleton	"	" "	" "	—	—
Pottery	Gelly or Hartledale Cave	"	" "	" "	—	Irregularly ornamented by punctures

For a descriptive list of skeletons, skulls, and bones from the Derbyshire Barrows, see 'Ten Years' Diggings,' by Thos. Bateman, pp. 256-278; also the 'Descriptive Catalogue.' Observations on the pottery will be found in 'Ten Years' Diggings,' pp. 279-987.

TABLE VIII.—*Neolithic and Bronze Ages.*
CASUAL FINDS ON MOORS, &C.

Name of Object	Locality	Date	Previous Description	Where Deposited	Length	Remarks
a. <i>Stone Implements—</i> Oval flint scraper .	Middleton-by- Youlgrave	—	'A Descriptive Catalogue of the Anti- quities,' &c. preserved in the museum of Thomas Bateman, 1855	Bateman Collec- tion, Weston Park Museum, Sheffield	Ins.	—
8 flint implements . Barbed flint lance head	Near " " Waggon Low, Cronk- stone	—	" "	" "	—	Figured in 'A Descriptive Catalogue'
140 flint implements .	Middleton Moor	1839- 44	" "	" "	—	Amongst the miscella- neous flint implements are many varied forms including numerous arrow heads unclassified
43 " " .	" "	1844	" "	" "	—	—
158 " " .	" "	1815	" "	" "	—	—
8 flint arrow heads .	" "	1846	" "	" "	—	—
1 " " " .	" "	" "	" "	" "	—	—
" " spear head .	" "	" "	" "	" "	—	—
103 " " arrows, &c. .	" "	" "	" "	" "	—	—
279 " " implements .	" "	1847	" "	" "	—	—
4 circular flint imple- ments	" "	" "	" "	" "	—	—
791 flint implements .	" "	1848	" "	" "	—	—
4 " " arrow heads .	" "	" "	" "	" "	—	—
4 " " spear heads .	" "	" "	" "	" "	—	—
Oval scraper .	" "	" "	" "	" "	—	—
Chert ball .	" "	" "	" "	" "	—	—
1038 flint implements .	" "	1849	" "	" "	—	—
14 " " arrow heads .	" "	" "	" "	" "	—	—
2 round ended flints	" "	" "	" "	" "	—	—
206 flint implements .	" "	1850	" "	" "	—	—
94 " " .	Dilland Hollow, Middleton	" "	" "	" "	—	—
Fragment of celt .	Middleton	1851	" "	" "	—	—
418 flint implements .	" "	" "	" "	" "	—	—
Round ended flint	" "	1852	" "	" "	3½	—
Elliptical flint im- plement	" "	" "	" "	" "	3½ dia.	—
132 flint implements .	" "	" "	" "	" "	—	—
5 " " arrows .	" "	" "	" "	" "	—	—
Flint spear .	" "	1853	" "	" "	—	—
91 flint implements .	" "	" "	" "	" "	—	—
Pestle .	" "	1854	" "	" "	—	—
Flint knife .	" "	" "	" "	" "	—	—
" " dagger .	" "	" "	" "	" "	4½	—
257 implements .	" "	" "	" "	" "	—	—
4 flint implements .	Hurdlow	1844	" "	" "	—	—
3 " " .	" "	1848	" "	" "	—	—
3 " " .	" "	1852	" "	" "	—	—
5 " " .	" "	1853	" "	" "	—	—
Flint arrow head .	Smerrill Moor	1827	" "	" "	—	—
" " " .	" "	1842	" "	" "	—	—
3 " " " .	" "	1845	" "	" "	—	—
Round flint .	" "	" "	" "	" "	—	—
" " .	" "	1846	" "	" "	—	—

TABLE VIII.—NEOLITHIC AND BRONZE AGES—*continued.*

Name of Object	Locality	Date	Previous Description	Where Deposited	Length	Remarks
5 implements . . .	Smerrill Moor	1847	'A Descriptive Catalogue of the Antiquities, &c., preserved in the museum of Thomas Bateman, 1855	Bateman Collection, Weston Park Museum, Sheffield	Ins.	—
5 " " . . .	" "	1848	" "	" "	—	—
Lance head . . .	" "	" "	" "	" "	—	—
" " . . .	" "	1849	" "	" "	—	—
Flint core . . .	" "	" "	" "	" "	—	—
Round edged flint . . .	" "	" "	" "	" "	—	—
Circular implements . . .	" "	" "	" "	" "	—	—
30 implements . . .	" "	" "	" "	" "	—	—
36 " " . . .	" "	1850	" "	" "	—	—
Spear head . . .	" "	1851	" "	" "	—	—
5 barbed arrows . . .	" "	" "	" "	" "	—	—
6 arrow heads . . .	" "	" "	" "	" "	—	—
42 flint implements . . .	" "	" "	" "	" "	—	—
38 " " . . .	" "	1852	" "	" "	—	—
16 " " . . .	" "	1854	" "	" "	—	—
2 " " . . .	Brassington Moor	1844	" "	" "	—	—
2 " " . . .	" "	1847	" "	" "	—	—
5 " " . . .	Bakewell Moor	" "	" "	" "	—	—
4 " circular implements . . .	" "	1849	" "	" "	—	—
96 " implements . . .	" "	" "	" "	" "	—	—
41 " " . . .	" "	1850	" "	" "	—	—
Flint circular implement . . .	Near Mam Tor	—	'Barrows and Bone Caves of Derbyshire'	" "	—	—
Flint arrow heads . . .	Win Hill, Castleton	—	" "	—	—	—
" " . . .	Bradwell Moor	—	" "	—	—	—
" " . . .	Eyam	—	" "	—	—	—
" scraper . . .	Rushup Edge	—	" "	—	—	—
" flakes . . .	Bole Hill, Buxton	—	" "	—	—	—
" arrow heads . . .	East Moor, Baslow	—	" "	—	—	—
2 round ended implements . . .	Newhaven Lodge	1845	Bateman's 'Catalogue of Antiquities,' 1855	Bateman's Collection, Sheffield Museum	—	—
43 flint implements . . .	" "	" "	" "	" "	—	—
Large flint arrow head . . .	" "	" "	" "	" "	—	—
Flint arrow head . . .	" "	" "	" "	" "	—	—
36 flint implements . . .	" "	1846	" "	" "	—	—
162 " " . . .	" "	1847	" "	" "	—	—
5 circular flints . . .	" "	1848	" "	" "	—	—
Oval scraper . . .	" "	" "	" "	" "	—	—
Flint dagger . . .	" "	" "	" "	" "	—	—
341 flint implements . . .	" "	" "	" "	" "	—	—
Slate implement . . .	" "	" "	" "	" "	—	—
606 flint implements . . .	" "	1849	" "	" "	—	—
4 arrow heads . . .	" "	" "	" "	" "	—	—
139 flint implements . . .	" "	1850	" "	" "	—	—
5 " arrow heads . . .	" "	1851	" "	" "	—	—
Circular edged implement . . .	" "	" "	" "	" "	—	—
140 flint implements . . .	" "	1852	" "	" "	—	—
168 " " . . .	" "	" "	" "	" "	—	—
106 " " . . .	" "	" "	" "	" "	—	—
Flint spear head . . .	" "	" "	" "	" "	—	—
143 flint implements . . .	" "	1853	" "	" "	—	—
2 circular flints . . .	Alsop Moor .	1845	" "	" "	—	—
3 arrow heads . . .	" "	" "	" "	" "	—	—
12 flint implements . . .	" "	" "	" "	" "	—	—
5 arrow heads . . .	Liffs Low, Biggen	1844	" "	" "	—	—

TABLE VIII.—NEOLITHIC AND BRONZE AGES—*continued.*

Name of Object	Locality	Date	Previous Description	Where Deposited	Length	Remarks
Arrow head	Cold Eaton	1844	Bateman's Catalogue of Antiquities, 1855	Bateman's Collection, Sheffield Museum	Ins.	—
2 " "	Hawkslow Parwich	"	" "	" "	—	—
Circular ended flint	Upper Haddon Moor	"	" "	" "	—	—
Fine flint dagger	" "	1848	" "	" "	—	—
10 flint implements	" "	"	" "	" "	—	—
2 " "	" "	1849	" "	" "	—	—
18 " "	" "	1851	" "	" "	—	—
12 " "	" "	1854	" "	" "	—	—
Arrow head	One Ash	1844	" "	" "	—	—
Fine dagger	—	1849	" "	" "	—	—
8 flint implements	Cold Eaton	1845	" "	" "	—	—
2 arrow heads	Hartle Moor	"	" "	" "	—	—
Fine lance head	" "	1846	" "	" "	—	—
16 flint implements	" "	1847	" "	" "	—	—
11 lance heads	" "	1849	" "	" "	—	Yellow flint
6 " "	" "	"	" "	" "	—	—
6 " "	" "	1850	" "	" "	—	—
Rough circular	" "	1854	" "	" "	—	—
31 flint implements	Kenslow	1845	" "	" "	—	—
2 " arrow heads	—	1849	" "	" "	—	—
6 " implements	—	1853	" "	" "	—	—
Large implement	near Biggen	1846	" "	" "	—	—
Spear head	" "	"	" "	" "	—	—
2 arrow heads	" "	1847	" "	" "	—	—
19 implements	" "	1852	" "	" "	—	—
1 dagger	—	"	" "	" "	—	—
Arrow head	—	"	" "	" "	—	—
Large implement	Stonecliff Quarry, Darley Dale	1846	" "	" "	—	—
10 flint implements	Grindleford Bridge	"	" "	" "	—	—
Round " "	" "	1847	" "	" "	—	—
2 flints	Lomberdale	"	" "	" "	—	—
Small round flint	" "	1848	" "	" "	—	—
Circular flint	Arborlow	1847	" "	" "	—	—
13 flint implements	" "	"	" "	" "	—	—
Flint spear head	" "	1848	" "	" "	—	—
26 " implements	" "	"	" "	" "	—	—
12 " "	" "	1849	" "	" "	—	—
4 " "	" "	1850	" "	" "	—	—
Circular implement	" "	1854	" "	" "	—	—
Arrow head	Liffs Low Biggen	1849	" "	" "	—	—
Large implement	Youlgrave Moor	1847	" "	Sheffield Public Museum	—	—
8 flint implements	" "	"	" "	" "	—	—
6 " "	" "	1848	" "	" "	—	—
10 " "	" "	1849	" "	" "	—	—
102 " "	" "	1851	" "	" "	—	—
3 " "	" "	1852	" "	" "	—	—
2 circular " implements	" "	1854	" "	" "	—	—
3 flint implements	Ringham Low	1847	" "	" "	—	—
4 " "	Tideswell	"	" "	" "	—	—
2 " "	Birchover	"	" "	" "	—	—
5 " "	Parcelly Hay	1848	" "	" "	—	—
1 " "	Hopton Moor	"	" "	" "	—	—
12 " "	Benty Grange (Moneyash)	"	" "	" "	—	—
15 " "	" "	1849	" "	" "	—	—
75 " "	" "	1850	" "	" "	—	—
37 " "	" "	1851	" "	" "	—	—
Flint dagger	Andle Stone, Stanton Moor	"	" "	" "	—	—
Core	" "	"	" "	" "	—	—
36 flint implements	Oldhams	"	" "	" "	—	—
Round implement	Gratton	"	" "	" "	—	—

TABLE VIII.—NEOLITHIC AND BRONZE AGES—*continued.*

Name of Object	Locality	Date	Previous Description	Where Deposited	Length	Remarks
7 flint implements .	Gratton . .	1854	'Bateman's Catalogue of Antiquities,' 1855	Sheffield Public Museum	Ins.	—
6 " " .	" " .	"	" "	" "	—	—
10 " " .	Meadow Place	"	" "	" "	—	—
38 " " .	Sheldon Moor .	"	" "	" "	—	—
Spear head .	Grindon Moor .	"	" "	" "	—	—
6 flint implements .	Ell Meadows, near Grindon	"	" "	" "	—	—
10 " " .	Hartington .	"	" "	" "	—	—
Spear head .	" " .	"	" "	" "	—	—
4 flint implements .	" " .	1851	" "	" "	—	—
Arrow head .	Wild " Park (Derby)	1850	" "	" "	—	—
Spear head .	Five Wells (Teddington)	"	" "	" "	—	—
3 flint implements .	—	1851	" "	" "	—	—
Spear head .	Rowsley . .	1852	" "	" "	2½	—
10 flint implements .	Lowfield (Mid-dleton)	1849	" "	" "	—	—
4 " " .	" " .	1850	" "	" "	—	—
Round edged flint implement	Low Moor (Par-wich)	1849	" "	" "	—	—
12 flint implements	Lady Low . .	"	" "	" "	—	—
6 " " .	Moneyash . .	"	" "	" "	—	—
2 " " .	" " .	1854	" "	" "	—	—
Flint arrow head	Winster Moor .	1853	" "	" "	—	—
8 flint implements	" " .	"	" "	" "	—	—
Spear head .	Minninglow .	1849	" "	" "	—	—
19 flint implements .	" " .	"	" "	" "	—	—
19 " " .	" " .	1853	" "	" "	—	—
7 " " .	Great Rocks .	1849	" "	" "	—	—
2 " " .	" " .	1851	" "	" "	—	—
20 " " .	Elk Low (Har-tington)	1849	" "	" "	—	—
2 arrow heads .	Longstone . .	1850	" "	" "	—	—
Arrow head .	Rowton Hall .	1852	" "	" "	—	—
3 flint implements .	Cowlow . .	1854	" "	" "	—	—
53 " " .	Vincent House	1849	" "	" "	—	—
Arrow head .	" " .	1850	" "	" "	—	—
63 " " .	Pike Hall " .	1849	" "	" "	—	—
Round flint .	" " .	"	" "	" "	—	—
5 flint implements .	" " .	1852	" "	" "	—	—
23 " " .	" " .	1853	" "	" "	—	—
9 " " .	" " .	1854	" "	" "	—	—
Arrow head .	Bonsal Moor .	1850	" "	" "	—	—
Basanite arrow head	Monsal Dale .	1851	" "	" "	—	—
14 flint implements .	Buxton . .	1852	" "	" "	—	—
Flint spear .	" " .	"	" "	" "	—	—

TABLE IX.—*Neolithic and Bronze Ages.*

NOTE ON THE BURIALS RECORDED BY T. BATEMAN.
(Compiled from 'The Barrows and Bone Caves of Derbyshire.')

Corpse Extended	Corpse Contracted	Corpse Burnt	Total
I. BARROWS CONTAINING STONE IMPLEMENTS ONLY.			
1	76	40	117
II. BARROWS CONTAINING STONE AND BRONZE IMPLEMENTS.			
1	18	12	31

NOTE.—The late Mr. Rooke Pennington, from whose work the above data are derived, has shown that infanticide was probably not uncommon during the Neolithic and Bronze Ages, no fewer than twenty-three cases of children's bones buried with adults having been found in the Barrows, the ages of the children being between four years and ten years. The adults were very frequently females. Of the twenty-three cases only four occurred in Barrows containing bronze alone, and one in a Barrow where the two classes of implements were mixed.

The general practice amongst the Neolithic populations and those of the Bronze Age seems to have been to bury the bodies in a contracted position, the knees being drawn up towards the chin. Cremation was also very generally prevalent during the whole period.

Third Report of the Committee, consisting of Sir JOSEPH D. HOOKER, Sir JOHN LUBBOCK, Sir GEORGE NARES, General J. T. WALKER, Sir LEOPOLD MCCLINTOCK, Admiral Sir GEORGE H. RICHARDS, Professor FLOWER, Professor HUXLEY, Dr. SCLATER, Professor MOSELEY, Mr. JOHN MURRAY, General STRACHEY, Sir WILLIAM THOMSON, and Admiral Sir ERASMUS OMMANNEY (Secretary), appointed for the purpose of drawing attention to the desirability of prosecuting further research in the Antarctic Regions.

SINCE the meeting held at Manchester last year the above Committee have been in communication with the scientific bodies in Australia, New Zealand, and Tasmania. These colonies have manifested a very great desire for exploration of the Antarctic regions, which is strongly advocated by their respective Governments. The result is that the Government of Victoria voted the sum of 5,000*l.* towards an expedition, provided that the Imperial Government contributed a similar grant.

The Colonial Office submitted the application to H.M. Treasury for favourable consideration, who sent it to the Royal Society for their report on the expediency of the undertaking. A very influential committee was accordingly appointed by that learned body to consider the matter. The reply from the Royal Society together with a letter from the Colonial Office and the Treasury are annexed herewith, which sufficiently explains the motives for declining to make the grant.

It may be inferred from the tone expressed in the official letters that H.M. Government is favourably disposed towards the despatch of an expedition efficiently equipped for the perils of Antarctic research. It is therefore to be hoped that the leading scientific societies and men of eminence in this country may combine in preparing a case to submit to H.M. Government that will justify an appeal to Parliament for an expedition being prepared on a scale equivalent to the one which met with such valuable results under Sir James Ross.

It should be stated that the subject has been brought under the notice of the Admiralty, and your Committee have met with the support of the Royal Geographical Society and other influential bodies, besides eliciting favourable encouragement from men of great eminence in the promotion of science.

Your Committee, having thus given publicity to this desirable project, feel that their services are no longer required at present, but they trust the Council of the British Association may embrace an early opportunity for approaching H.M. Government to carry out this noble work of research into the Antarctic regions.

Downing Street, December 12, 1887.

I am directed by the Secretary of State for the Colonies to transmit to you, to be laid before the Lords Commissioners of the Treasury, a copy of a letter from the Agent-General for Victoria, inquiring whether Her Majesty's Government will contribute the sum of 5,000*l.*, in the event of the Australian Colonies making a like contribution, towards the cost of an Antarctic exploration. Copies of letters on the subject are also enclosed from the Admiralty, the Royal Colonial Institute, the Royal Geographical Society, and the Royal Society, which their Lordships will observe are all in favour of the co-operation of Her Majesty's Government in this work. A reference was also made to the Board of Trade, and it will be seen from the accompanying copy of their reply that in their opinion it does not appear necessary in the interests of trade that Her Majesty's Government should contribute towards the expense. The Board of Trade do not, however, seem to have regarded the probability of a considerable trade in sperm oil and other products of whale fishery arising in the future, or the importance of the expedition for scientific purposes, which it is believed would constitute the principal object of the expedition, and the value of which is strongly attested by the Royal Geographical Society and the Royal Society. Sir H. Holland trusts their Lordships will give their favourable consideration to this application on behalf of the Government of Victoria and consent to the contribution of the sum of 5,000*l.* towards the scientific objects of the expedition. It would seem undesirable for Her Majesty's Government to take any direct share in the equipment or management of the expedition.

I am, &c.,

JOHN BRAMSTON.

The Secretary to the Treasury.

Treasury Chambers, January 3, 1888.

The Lords Commissioners of Her Majesty's Treasury request you to inform Secretary Sir Henry Holland that they have had before them Mr. Bramston's letter of the 12th ultimo, submitting for their favourable consideration an inquiry, made by the Agent-General for Victoria, whether Her Majesty's Government would contribute 5,000*l.* towards the cost of an expedition to explore the Antarctic regions, if such an expedition were undertaken by the Australian Colonies. The objects of this expedition would be (1) the promotion of trade and (2) scientific inquiry. But the department best able to judge of the first does not think the interests involved sufficient to justify the proposed imperial contribution; and the general result of the communications regarding the second object, received from scientific bodies, is to show that an expedition on the scale contemplated could do very little in the way of scientific investigation, and would have to be regarded simply as a pioneer of future more complete and costly expeditions. In view of this testimony, and of the many other pressing calls for imperial aid which they have felt it necessary to refuse, my Lords do not feel that they would be warranted in asking Parliament

to provide the proposed contribution. They arrive at this conclusion, however, with sincere regret, and would have been glad to have co-operated with the Australian Colonies in an enterprise having something more than a merely commercial purpose. Perhaps, however, my Lords may be allowed to regard the present proposal as an indication that if any like expedition be undertaken hereafter by the Imperial Government some of the British Colonies more closely interested in it might not be unwilling to contribute towards its cost.

C. G. BARRINGTON.

The Under-Secretary of State, Colonial Office.

The Committee appointed (October 27) to consider and report upon the letter from the Colonial Office having reference to the question of an Antarctic expedition beg leave to embody their report in the following draft reply :—

Sir,—Your letter of August 27, with enclosures relative to a proposed Antarctic expedition, has been carefully considered by the President and Council, with the assistance of a committee consisting of Fellows of the Society specially qualified to form a judgment on the matter, and I am directed to reply as follows :—

Many observations of great scientific value might be made in the Antarctic regions, and it would be very desirable in the interests of science to embrace an opportunity of making them. Among such observations may be mentioned, in what is perhaps the order of their importance—

1. Hydrographical observations, especially with regard to the distribution of open sea.

2. Meteorological observations, especially with regard to the barometric pressure and the direction of the winds, to which may be added observations on the Aurora australis.

3. Magnetic observations, more particularly with a view to determine the changes which have taken place in the magnetic elements since the expedition of Sir J. Ross in 1839–43.

4. Observations on the temperature of the ocean and on ocean currents.

5. Soundings and dredgings and observations on the nature of the sea-bottom.

6. Collections and observations on the marine fauna and flora.

7. Should land be anywhere discovered geological and biological observations thereon would be of exceedingly great value.

It is obvious that an expedition adequately prepared and equipped to carry out all the above various observations would involve an expenditure far exceeding the 10,000*l.* mentioned in your letter; but the President and Council are led to believe that this sum would suffice for a smaller pioneer expedition, which, while avowedly not designed to undertake an exhaustive inquiry, would be able, under competent direction, to make a careful survey of the northern boundary of the circumpolar ice region to determine approximately the distribution of open water and the direction of oceanic currents, to take magnetical and meteorological observations, and, by means of the tow-net and the dredge, used at moderate depths, to collect pelagic animals and plants.

The results of such a general survey, even though not wholly complete, would not only of themselves be of great interest and value, but

also be of paramount importance in guiding a decision as to the desirability, or the contrary, of sending out in the future expeditions more thoroughly equipped for special observations, and in preparing the way for such expeditions, should the preliminary results seem to render these desirable.

Should H.M. Government, therefore, decide to accept the proposal of the Government of Victoria, and to place the sum in question on the estimates of the coming year, the President and Council will regard that decision with great satisfaction, and I am directed to say that such further assistance or advice as they can give is at the service of H.M. Government.

In their deliberations on the matter the President and Council were much assisted by a memorandum drawn up by Admiral Sir G. H. Richards and another by Sir J. D. Hooker. These memoranda, written by gentlemen having very special qualifications derived from exceptional experience for offering important suggestions, contain so much that is interesting and valuable that copies of them have been enclosed with this letter. Should you think it desirable that the Colonial Governments should be acquainted with these memoranda copies of them will be placed at your disposal.

I have the honour to be, &c.,
(Signed) M. FOSTER.

Report of the Committee, consisting of Dr. ALEX. BUCHAN, Professor MCKENDRICK, Professor CHRYSAL, and Dr. JOHN MURRAY (Secretary), appointed for the purpose of aiding in the maintenance of the establishment of a Marine Biological Station at Granton, Scotland.

DURING the past year the Committee have maintained, for the use of naturalists desirous of making use of them—

1. A laboratory at Granton, near Edinburgh;
2. A small laboratory at Millport, Cumbrae, in the Firth of Clyde; and
3. The steam yacht 'Medusa,' which has been employed throughout the year carrying on continuous physical and biological observations.

A large number of naturalists have availed themselves of these facilities, and many important investigations have been carried on and the results published. Papers on some of these will be submitted to this meeting of the Association by Dr. Mill, Mr. Hoyle, and others. A large number of specimens of the British fauna have been sent to the British and other Museums.

The Committee believe that these investigations are of much value, and should be continued and the laboratories maintained as heretofore; and with this object they beg to recommend that a further grant of 100*l.* should be made by the Association to aid in the maintenance of the Scottish Marine Station during the ensuing year.

Report of the Committee, consisting of Mr. H. BAUERMAN, Mr. F. W. RUDLER, Mr. J. J. H. TEALL, and Dr. H. J. JOHNSTON-LAVIS, appointed for the investigation of the Volcanic Phenomena of Vesuvius and its neighbourhood. (Drawn up by Dr. H. J. JOHNSTON-LAVIS, F.G.S., Secretary.)

THE reporter is glad to be able to announce that since last year some very interesting additions to our knowledge of this region have been made, some of which have a very important bearing on general questions in vulcanology.

Geological Map of Vesuvius and Monte Somma.—It is with a feeling of relief that the reporter is able to lay before the British Association his work in a completed state. The preparation of the last sheet gave equal trouble with the other three of the south side of the mountain, the district being covered with habitations and high garden walls. The mapping of the dykes of the Atrio del Cavallo, which had been left from the other sheets, was carried out during the month of June of this year, and required residence near the Observatory. As far as space and a plan map of a very steep section would allow, all the principal dykes have been marked in. The reporter has numbered forty of the more striking of them in large figures, from one to four feet high, in white paint, which correspond to similar numbers on the geological map. Specimens of the salband and interior of all these have been collected, and will be subjected to suitable investigations; also notes regarding the characters as observed in the field, together with thickness, &c., have been made. An examination of this section has revealed at least half a dozen hollow dykes, similar to that giving rise to the eruption of May 2, 1885, which the writer was able to study the formation of and describe, and has since observed at Stromboli and Vulcano. Amongst those of Monte Somma, one was observed full at the lower part of the section, but hollow at the upper, showing that it had just drained out to the level of the parasitic cone or lateral eruptive mouth that had been formed.

Most important, however, was a dyke near the western end of the Atrio section, which can be seen to be a hollow dyke refilled, and the second filling to have been in part drained out, leaving a lava tunnel.

The object of numbering the dykes in white paint is to identify them both on the map and in the field, and to serve as a guide to anyone who may care to investigate them. Many years since R. Mallet numbered twenty-seven of them in red (not sufficiently conspicuous), but no signs of such could be met with. It would be well worth the trouble to have these numbers repainted every two years, which could be done by any ship's painter for a few francs.

State of Vesuvius.—During August 1887 the crater of 1885 had not further increased. It, as mentioned in the last report, was divided into two crateral depressions, the active being the easterly one. To its north side there is still visible a remnant of the old 1881–2 rim, whilst its southern was split by a deep gully, the remains of the old fissure above the dyke that gave origin to the lava outpour of May 2, 1885. An attempt was being made to build up a cone of eruption. During the whole time since then this cone of eruption has been growing, and has now

reached nearly to the level of the crater edge (June 10, 1888). The activity of the volcano has been most constant, generally ranging from first to second degree, and never exceeding the third. Lava, as in my last report, has continued to flow without cessation, varying slightly in quantity. It has been chiefly occupied in oozing forth in different parts of the Val d'Inferno, which it has further choked by piling up hills of no considerable volume.

An examination of the materials withdrawn from Russo's well at Ponticelli, mentioned in last year's report, is not yet complete. It will be remembered that after descending nearly 50m. below sea-level, leucitic lavas were met with, with a thickness of over 50m. Beneath these lavas, from 105·44m. to 107·50m., beautiful rounded pebbles and sand are met with. These consist of rounded fragments of a trachyte which strikingly resembles that of the larger mass met with in the tunnel of the Cumana railway at Naples. More important, however, were beautiful black pebbles of a typical basalt, indicating that either from Vesuvius or the neighbouring volcanic region this rock had been poured out at an early date in the history of the eruptive activity of this region.

This discovery is of still further importance in regard to theorising on the sequence of rocks erupted in a given region, which will be further on referred to.

EXCAVATIONS NEAR NAPLES.

Cumana Railway.—Geologists, engineers, and contractors, all believed that the hills which back Naples, and are prolonged into the promontory of Posilippo, consisted of a fairly uniform mass of yellow tuff. In last year's report mention was made of large masses of trachyte being found in the new railway tunnel, which is now near completion, and exhibits from beginning to end sections of deep interest, both local and general. Investigations are being carried on continually from the stratigraphical, lithological, petrographical, and chemical aspects of the subject, but are not yet complete, and therefore will only be referred to in general. Entering the tunnel from Monte Santo, we meet with 530m. of tuffs, which are capable of various subdivisions. From this point to 910m. one continuous mass of trachyte is met with, that is for near upon half a kilomètre. This trachyte is in some places compact and very fine grained, in others soft and spongy. At some spots thick beds of sodalitic fine-grained scoria covering the surface may be seen, and in other places beds of blacker scoria, as if near an eruptive cone, occupy a similar position. The scoriaceous surface continuous with the underlying compact trachyte mass could be well seen at 730m. Unfortunately much is soon covered up by masonry, so that frequent visits must be made to keep one thoroughly *au courant* of the discoveries.

This mass of trachyte is followed by yellow tuffs with variable coarseness, compactness, and other characters, which graduate into a greenish grey mottled with yellow tuff, and this eventually into a pure greenish grey tuff. We have most distinct evidence of the gradual formation of a yellow tuff from a compacted mass of fragments of pumice and scoria. The process is distinctly due to the hydration of the glassy part of the pumice and scoria. In many examples the surface of a block of pumice has undergone this change, leaving an unaltered nucleus. The chemical and microscopical changes involved in this process are undergoing investigation, and will soon be published in full.

Later on yellow tuffs appear again, until at 1,890m. the great mass of trachyte, referred to last year, continues for 110m. This will probably be looked upon in future as the most beautiful specimen of sodalite trachyte known, whilst its cavities, where the rock is vesicular, are lined by some six or seven species of minerals. At both ends it is seen to be limited by an escarpment, against which a talus of its own blocks exists, and over these, but similarly inclined, a number of pumice and ash beds, followed by compact tuffs. The remaining part of the tunnel is cut in the compact yellow tuff of the district, except near its mouth, where it is overlaid by the usual loose pozzolana. The same railway traverses the Posilippo ridge parallel to the two existing tunnels, but, like them, traverses compact yellow tuff.

On the road to Pozzuoli, just beyond the thermo-mineral baths of La Pietra, of Bagnoli, a yellow tuff has been cut down, upon which exists a raised beach composed of large, more or less rounded, masses of the same. In the interpaces between these, as the result of solfataric action, beautiful branched efflorescent masses of gypsum were met with, attached to the surface of the tufa.

Not far beyond this, a tunnel is in course of construction which runs parallel to the cliff and road, and only a few mètres from the surface. The beginning, or Naples end of it, is cut in sand, breccia and gravel constituting the raised beach underlying the trachyte eruptions of the solfataria, and eventually enters the deposits of black scoria belonging to the same. The heat is so intense that work was suspended till the ventilating windows and shafts, now being made, be finished.

The last point of importance on this line, is the tunnel intended to be cut through the hill of Baja, of which in the last report doubts were expressed as to the practicability. This work has only been commenced a few days, at the entrance beneath the baths of Nero, but the altered pumice in the tuff, deposits of silica in fissures, and a gradually increasing temperature seem pretty sure indications of the difficulties to be contended with.

Collettore Pluviale delle Colline.—The main collector of the pluvial water from the hills backing the west of Naples is now nearly complete. It may be said to run roughly parallel with the Cumana Railway tunnel, but at some distance from it and at a lower level. In this a mass of trachyte was traversed for 28m. It differs from both the masses of the Cumana Railway tunnel in some of its characters, but approaches mostly the smaller one to which it is more nearly situated. What is very interesting about it is that its fissures (it is not vesicular) are often lined by beautiful octahedra and pseudoprisms of what was once sodalite, but is now nothing more than a shell, of bright brick-red colour, of a mixture of substances which has replaced the original mineral. In some places the latter is unaltered, and all gradations can be met with in the process. This mineral and its products are accompanied by many needles of titanite, amphibole, some zeolite, &c. This trachyte is enveloped in the Rione Amedeo tuff, but going west this is overlaid by the usual compact yellow tuff, and eventually pozzolana. In the tuff near the trachyte blocks of piperno were met with, and in the Rione Amedeo large masses of grey plastic clay (Pliocene), quite unaltered and containing many fossils.

Funicular Railway of Rione Amedeo.—This work, composed principally of a tunnel with some open cutting, is placed above and at right angles to the Cumana Railway and the Pluvial Collector, and joins a side adit

from the former. We have at its lower part Rione Amedeo tuff, superimposed upon which come beds of pumice and ash, continuous with the well-known synclinal fold of these beds on the Corso Vitt. Emmanuele. Above this comes the common yellow tuff.

Funicular Railway of Monte Santo.—This is only in the early stages of construction, but is likely to afford very important data for disentangling the complex structure of the Campi Phlegreæ. Entering the tunnel from the Corso Vitt. Emmanuele, some four mètres (vertical measurement) of a loose brown pozzolana are met with, in which occur fine-structured, dirty-white pumice. This is overlaid by a bed of small white pumice lapillæ without any *accessory* or accidental ejectamenta superimposed, upon which comes 4m. of similar pumice, interstratified with thin bands of pozzolana of buff or red colour. Upon these deposits we have another greyish-white pumice bed 0·80m. thick, and composed of large masses, up to the size of a cocoa-nut. The upper part of this pumice has undergone a peculiar reddening, which I shall refer to later. Above this is a black ash-band 0·10m. thick, and then about 4·50m. of grey pipernoid tuff, the lowest 0·30m. of which is red in colour, and shades into the grey above. This tuff is identical in character with similar tuffs of Sorrento, Nocera, Capua, and Roccamonfina, and contained a small block of piperno with large marialite crystals. Superimposed on this comes 2·50m. of coarse breccia of reddish pumice with numerous large blocks, consisting of pieces of vitreous piperno, sodalite trachyte, a bright red vesicular basic rock (andesite?), pyroxenic lava (dolerite?), tuffs of various kinds, and pieces of black obsidian. At the opposite or descending end of the tunnel only yellow tuff has, so far, been met with.

To appreciate the value of these sections, it is necessary to refer to some others in the neighbourhood. The breccia bed in this section is identical with that overlying the piperno of Pianura and Soccavo. The banded ash and pumice beds are identical with some seen underlying the above-mentioned breccia behind Soccavo, and the grey pipernoid tuff is stratigraphically in the same position as the piperno of those localities; besides, it contained a most characteristic fragment of that rock, made doubly certain by the marialite crystals. The facts, I think, are sufficient to satisfy anyone that piperno and this grey pipernoid tuff are derived from the same source. But beyond this, at Fossa Lupara, between Nocera and Sarno, this same grey tuff is red at the bottom and reposes on a reddened pumice, like that in the section of Monte Santo Funicular Railway tunnel; whereas, at the Codola tunnel, near Nocera, a thin bed of white pumice underlies the grey tuff.

In both these cases the pumice is smaller, and in the latter small in quantity, as if transported aerially from a great distance. These conclusions immediately bring up in our thoughts the unsettled question as to what is the piperno of Pianura and Soccavo. There it has all the compactness of a lava, with distinct evidence of flow structure in its components. Elsewhere it looks like a tuff. It is supposed by some to be a metamorphosed or refused tuff in places; but if that were so the underlying pumices at Soccavo should have been similarly altered. Besides, at Soccavo, at the west end of the section, two distinct beds of piperno may be met with (I believe so far unnoticed by other observers), interstratified with similar materials as far as heat could influence them, whilst the pipernoid banding of the ejected blocks immediately overlying

them is oriented in all directions, a fact sufficient to negative all question about refusion or metamorphism, unless this took place on the surface of the ground. Lastly, pieces of peculiar yellow tuff enclosed in the massive piperno, in the overlying breccia blocks at Pianura, at Soccavo, and also at Naples, are quite unaffected by fusion, or changed more than what would occur by being caught up in a quickly cooling lava stream. Two explanations remain open to my mind. First, piperno is a true lava, of which the grey tuffs are the cinders and ashes of the more explosive stage of the eruption or eruptions. Against this we have the stratified structure of piperno, independent of its banding due to the presence of more or less in number of the enclosed blacker lenticles, and secondly, the long, thin bed of uniform thickness of the upper piperno of Soccavo. Secondly, the eruption of magma towards the end or at the beginning of an eruption, fairly free from aqueous inclusion, which, falling still hot, became more or less fused together in the immediate neighbourhood of the vent, as may be seen at any active volcano. In favour of this we have the fact that often the piperno appears to be composed of fragments in part fused together, as if the heat were insufficient to complete the operation. In both cases we must suppose a mixture of two magmas. They may, however, be nothing more than the same one, part from the upper, cooler portion of the chimney and part from the lower, hotter and more aquiferous, just as in the banded trachytes of Palmarola. This is supported by the ejected blocks having the black part composed of obsidian, whilst the grey is much more vitreous than the massive rock.

To limit this report, the remaining conclusions are given categorically, open to correction in the studies to be published in full:—

The oldest rocks, so far known in mass near Naples, are the sodalite trachytes of the Cumana tunnel. These are overlaid by the Rione Amedeo tuffs, probably the explosive eruptive products of the same magma.

This is followed by the Pianura volcano, all the southern part of which has been destroyed by later explosive eruptions, and by the erosion of the sea, which deposited the raised beach of the Lucrine Lake, ruined the south of Monte Barbaro, deposited the Starza Cliff and the raised terrace of Stabia and Castelammare.

That this volcano was the main mouth (perhaps with others) from which was derived the grey tuff of the Campania, Terra di Lavoro, &c., and the breccia beds, and to which belongs the lapillo bed near the Parco Grifeo of the Corso Vitt. Emmanuele.

That the eruptions of Roccamonfina were earlier than the eruptions of the Pianura volcano, but that Vesuvius was in great part later, because no signs of grey tuff can be met with in the Atrio section, and because the nearly complete series of Somma pumices can be seen overlying the grey tuff at Nocera.

That volcanic activity has followed a regular course southwards on the mainland of Italy.

That the yellow tuff of Posilippo, &c., is later than these deposits upon which it is superimposed, thus constituting, with the underlying segment of the Pianura volcano, the highest point near Naples, that is Camaldoli.

And that in all probability these yellow tuffs were derived, in part at least, from the Monte Barbaro and Campiglione volcano.

That any attempt to study the sequence of magmas in such a region is impossible till the whole history is carefully marked out, as shown by

the presence of basic and acid rocks amongst the ejected blocks of the piperno volcano.

That the fluoriferous metamorphism of limestone in the grey tuff occurs only where the alluvium of the buried limestone mountains enveloped fragments of that rock.

Artesian Borings and Sections at Pozzuoli.—Nine more borings have been made on the coast and in the sea at from 100m. to 150m. from the temple of Serapis. Along the sea-border, historic deposits were met with at from 11m. to 13·24m. in different borings; at 30m. from the beach historic deposits reach 9·37m.; whilst at 50m. distant, in two borings they were traversed to 21m. and 22m. At 140m., beneath 5m. of water, rounded bricks and pottery-fragments extended down to 14m. and 15·50m. respectively in two borings. Beneath the historic deposits nothing but sea-sand and mud were met with; but none of the borings extended much beyond 20m. At one point hard rock was struck at a small depth, and four other borings were made within a few yards, all touching hard rock. It is much to be regretted that none of this was detached for examination.

Nothing of any importance is demonstrated by these deposits except the very considerable deposit filled by brick, pottery, marble and other fragments, and still further confirming the depression of this region.

In cutting the new road opposite the main entrance to Sir W. Armstrong, Mitchell & Co.'s Works, a raised beach of post-Roman age was exhibited, with clean sand, many pebbles of bricks, marble and rounded fragments of mosaic. There are masses of wall fallen from the cliff-edge above as it was cut back by the sea, in which the edges, angles, &c., had been much rounded by the waves. The highest point, so far as this beach was exposed, occurs at 3·75m. above present mean sea-level.

A similar condition exists against the foot of the Villa of Cicero (*i.e.* the ruin beneath the Villa Armstrong), and west of the extremity of the valley in which the new reservoir has been constructed. There this beach reaches to nearly 5m. above mean sea-level. We have in these two localities distinct evidence of depression of the coast having reached at least 5m. lower than at present; evidence quite independent of that afforded by the temple of Serapis. At the moment that the land was at its lowest, the cliff was cut back considerably, causing the old Roman foundation to be exposed and in part to fall, to be broken up and rounded by the sea.

Close to the main entrance of the Armstrong Works the shrinking pit has been sunk to a maximum depth of about 15m., 12 of which are below sea-level. Various beds of lapillæ and pumice were met with, and near the bottom many ejected blocks of a peculiar trachyte, together with tuffs, some of each much altered by solfataric action. Most interesting was a peculiar mica-diorite (?) containing much pyrites. This rock I have occasionally met with elsewhere in the region; but it is always of rare occurrence. Professor Roth, of Berlin, who examined the specimens with me *in situ*, expressed great interest and astonishment at their occurrence. These are reserved for further study. The influx of water into the excavation was interesting, that on the side of the sea being very salt, whilst a cascade of warm mineral water flowed from a fissure on the land side, the two keeping a 20-horse pump constantly at work.

This report is but a slight sketch of the observations being carried on, which require constant and untiring attention. Even as it is, great

difficulty is often encountered in keeping pace with new exposures, borings, or sections, which are quickly built-up, choked, or otherwise effaced. In a region which is taken as a type, and upon which thousands of pages have been written, every new fact is of great general importance in elucidating many of the most important questions in dynamical geology.

In conclusion, I would express my thanks for kind assistance to Mrs. Guppy and my wife; and to Messrs. D. Roberts, Chartier, W. H. Bell, Ohlsen, A. Minozzi, and many others, in either providing me with specimens, data, or permission to visit their works.

Report of the Committee, consisting of Mr. JOHN MURRAY (Secretary), Professor CHRYSTAL, Dr. A. BUCHAN, Rev. C. J. STEWARD, Hon. R. ABERCROMBY, Mr. J. Y. BUCHANAN, Mr. DAVID CUNNINGHAM, Mr. ISAAC ROBERTS, Dr. H. R. MILL, and Professor FITZGERALD, appointed to arrange an investigation of the Seasonal Variations of Temperature in Lakes, Rivers, and Estuaries in various parts of the United Kingdom in co-operation with the local societies represented on the Association.

THE work of the Committee has been confined to testing the methods for carrying on a series of systematic general observations on the temperature of the surface water in streams, lakes, estuaries, or sea. To be satisfactory such observations must be conducted simultaneously for a period of several years in as many parts of the country as possible. Volunteer observers will be necessary, and for this purpose it seems to the Committee eminently desirable to obtain the co-operation of local societies, the members of which might feel disposed to take up the work for a definite time. During the present year a commencement has been made in Scotland. There were twenty observers at work for the Committee, supplied with thermometers of a uniform pattern. Observing books ruled for date, hour, temperature of air and water, and remarks on state of river and weather, were provided, with full printed instructions at the beginning of each book for properly and uniformly making the observations. The names of observers and their stations were as follows, and we have to thank these gentlemen for their services:—

Rivers, &c.	Observers	Observations begun	Observations ended or still proceeding
Tay	Mr. P. Dow	December 5, 1887	May 15, 1888
"	Mr. W. Wilson	" " "	" 14 "
"	Mr. A. M. Mechi	" 14, "	April 24 "
Tummel	Mr. J. Kennedy	January 25, 1888	Proceeding
Lochy	Messrs. Macnair & McRae	" 4 "	March 30, 1888
Dochert	" " "	" " "	April 30 "
Almond	Mr. J. Paterson	" " "	Proceeding
Earn	Mr. John Ellis	" 18 "	" "
Aray	Mr. G. Taylor	December 19 "	" "
Thurso	Mr. D. Coghill	" 26, 1887	" "
"	Mr. A. Harper	January 10, 1888	July 18, 1888
Wick	Mr. J. Simpson	" 28 "	Proceeding
"	Mr. J. McKay	" 16 "	April 16, 1888
LOCH—Tay	Messrs. Macnair & McRae	" 4 "	" 19 "
SEA—Scrabster	Mr. Watson Kerr	February 22 "	Proceeding

List of Thermometers broken.

Cause of Breakage	Number
In transit	6
During observations	7
By accident when not in use	1
Unaccounted for	2
	<hr/>
Total	16

Accurate mercurial thermometers by Adie & Wedderburn, divided on the stem and fitted into copper cases, and costing 7s. 6d. each, had previously been used; but the expense incurred by accidental breakage was great, and as many of the observers read only to quarter of a degree, it seemed unnecessary to employ such delicate instruments. A number of small mercurial thermometers with cylindrical bulbs, and provided with paper scales divided into Fahrenheit degrees from 10° to 120°, were accordingly ordered from Germany, and supplied at the rate of 15s. per dozen.

Japanned tin cases were made in Edinburgh for 13s. per dozen, including an outer tin case for travelling, the total cost being thus 2s. 4d. each. All the thermometers were compared with the Kew standard in the Chemical Laboratory of the University of Edinburgh, and the corrections noted; these rarely exceeded 0·2°, and in many cases were negligible. The instruments appear quite suited for the work, and can be replaced when broken at a trifling cost. More careful packing will practically obviate breaking in transit, and as the observers gain experience accidents occur less frequently. The observations on the Tay river system are of particular interest, as there were a number of stations on the main river, its tributaries, and feeding lakes. The curves for the various stations from December or January down to April, and in some cases to July, show distinct differences, due to the nature of the country drained by the rivers and to the altitude.

The care and regularity with which the observers in general carried out their work convinces us that it is quite practicable to carry on the observations on a large scale, and that it is desirable to extend it to England as well as to enlarge its scope in Scotland. Your Committee accordingly recommend that they be reappointed, with a grant of 50l. to be expended as follows:—

Clerical assistance	£ 20
Observation books and circulars	15
Thermometers	10
Postages of instruments, books, &c	5
	<hr/>
Total	50

The Secretary desires to say that while he has taken the general oversight of the work, the actual arrangements have been mainly carried out by Dr. H. R. Mill, assisted by Mr. John Gunn of the 'Challenger' office. The Secretary also begs to resign his position, and the Committee recommend that Dr. Mill be appointed in his place.

Several stations besides those included in the above list have been lately established, but sufficient time has not yet elapsed for the observers to have collected data sufficient to be reported upon.

A discussion of the more important results of these observations will be submitted to this meeting by Dr. Mill.

Report of the Committee, consisting of Mr. J. W. DAVIS, Mr. W. CASH, Dr. H. HICKS, Mr. G. W. LAMPLUGH, Mr. CLEMENT REID, Dr. H. WOODWARD, and Mr. T. BOYNTON, appointed for the purpose of investigating an Ancient Sea-beach near Bridlington Quay. (Drawn up by G. W. LAMPLUGH, Secretary.)

YOUR Committee report that, having obtained permission of the lord of the manor, the Rev. Yarburgh Lloyd-Greame, they commenced the practical work of the exploration on June 29 last by employing labourers to carry further the excavation in the cliff at Sewerby begun last year by the Yorkshire Geological and Polytechnic Society, continuing this work through the month of July and until the end of the first week in August, with sometimes three and sometimes four workmen, under the personal supervision of Messrs. Boynton, Reid, and Lamplugh. During this time the deposits banked against the buried cliff of chalk have been wholly removed for the distance of 24 feet to a breadth of 30 feet, and partially for the further distance of 12 feet, and from the excavated material a large number of the bones and teeth of mammals have been obtained, together with remains of birds and fish and a few shells of land and marine mollusca.

Several borings have also been put down between Sewerby and Bridlington Quay, with boring rods belonging to the Geological Survey, which were kindly placed at our disposal; and in this way we have obtained important evidence as to the southward and seaward extension of the deposits and their relation to the Glacial beds.

The excavation has now been suspended because of the great thickness of incoherent sand which, as the beds recede into the cliff, is capped with heavy boulder clay, and is apt to come down in sudden falls, thus rendering dangerous any further removal of the old beach unless a large mass of the superficial beds were first thrown off; and this, with the funds at their disposal, your Committee have not been able to undertake, and are, indeed, doubtful of the expediency of doing. A short gallery has, however, been driven along the face of the old cliff for about 12 feet beyond the open working.

The following account of the deposits will show the results obtained up to the present time.

History and Literature.—These deposits, for which we propose the name of 'the Sewerby Cliff-beds,' have nearly always been hidden in the cliff-foot under a long talus of drift slipped from above, and remained undiscovered until the winter of 1883-4, when your reporter's attention was drawn to them by a fisherman, who had noticed two bones in a portion of the cliff recently laid bare by storms. The writer knew that the tusk of an elephant had been found some years before near this place, but until this time he could not find the bed from which it had been obtained, though in his examination of the section he noticed the abruptness with which the chalk ended, and, in a paper on the Speeton Shell-bed,¹ mentioned the discovery of the tusk and suggested that it might have come from some bed below the drift.

It was at first believed that the two bones formed part of a skeleton,

¹ *Geological Magazine*, Dec. II. vol. viii. p. 174.

but when they were excavated by the writer's friend, Mr. J. R. Mortimer, they proved to be disconnected and isolated.

No further investigation was made at this time, but a few months later one of this Committee, Mr. C. Reid, who was carrying out the work of the Geological Survey in Holderness, had the beds pointed out to him. Recognising the importance of the section, he had a trench cut into the cliff to show the sequence of the deposits, and published an account of them in 1835 in his Survey Memoir on 'Holderness' (pp. 47 to 49), this being, so far as we know, the earliest printed description.

A short reference was also made to the beds in the Sheet Memoir on Bridlington Bay, by J. R. Dakyns and C. Fox-Strangways, p. 1, published in the same year.

Mr. Reid having strongly recommended further investigation, the Council of the Yorkshire Geological and Polytechnic Society undertook the work, granting the sum of 10*l.* towards the expenses of an excavation which was carried out last summer under the superintendence of Mr. T. Boynton and your reporter. It was then shown that the deposits rested on a floor of solid chalk, and had no Glacial beds below them; and that the whole of the boulder-clay series present in the recent cliff above the chalk rested unconformably on these beds and cut them out. From this excavation a large number of bones and teeth and other remains were obtained, which were deposited in the museum of the Yorkshire Philosophical Society at York. A paper on the results of this excavation by Mr. J. W. Davis was read at the last meeting of the Association, and an abstract of this is printed in the last 'Annual Report,' p. 694.

A detailed account of the beds with a list of the fossils as then determined is contained in the report sent in to the Yorkshire Geological and Polytechnic Society by the writer, which was printed in their 'Proceedings' for last year (p. 381), and is illustrated by a woodcut section and lithograph sketch.

These are the only references known to your reporter.

The Ancient Cliff: its Position and Relation to the present Shore-line.—Flamborough Head has long existed as a feature on the coast line of Yorkshire, for, as Professor Phillips long ago pointed out, its main features were already carved out in Pre-Glacial times. It consists of a mass of hard chalk, everywhere covered with Glacial deposits varying very greatly in thickness. The middle portion of the chalk contains much flint, and is a massive well-knit rock, while the upper and lower parts have no flint, and are softer and more fissile and shaken, so as to yield more readily to the sea; and to this difference in the rock the shape of the headland is largely due, for where the southerly dip brings the Upper Chalk to the beach on the south side of the promontory, the cliff line recedes; and where, on the other hand, the Lower Chalk rises above the shore on the north side, it also is attacked and suffers; while where the cliff from top to bottom consists of the massive flinty rock, there are many signs that the denudation goes on very slowly.

The drift-covering hides up many inequalities of the old rock surface, and makes others of its own, so that, were it not for the continuous cliff sections, we should be greatly deceived as to the shape of the ancient land.

This is strikingly exemplified in the cliff at Sewerby, on the south side of the Head, about four miles west of the easternmost point, and about one mile east from Bridlington Quay.

Here, near the Park, the cliff is about 75 feet high, the lower 40 feet,

consisting of chalk, which is overlain by about 35 feet of Glacial beds; but, when we go a few yards to the southward, the chalk is seen to end abruptly in a cliff that is quite vertical, and in some places overhanging; and beyond this point no solid chalk is seen in the section. On the surface this bold feature is so well masked by the thickening of the drifts that its presence would not be suspected. There is, indeed, an obscure line to be traced for a short distance across the fields, where the ground sinks for a few feet, but this is quite uncertain, and is probably nothing more than a bank of the uppermost gravel, such as is common in the neighbourhood.

When this cliff formed part of the ancient shore-line, though the sea stood at somewhere about its present level, the physical geography of the country must have been quite different.

The headland must then have been a far more prominent feature than it is to-day, that rubble heap of drift which we call Holderness having then no existence, except as a shallow sea-bottom, across which throughout Yorkshire, and probably throughout Lincolnshire also, the waves washed till they reached the eastern foot of the Wolds. There is evidence, moreover, that the sea has reached into the hollow ground on the northern side of the headland, now occupied by the drift, since at Speeton an estuarine shell-bed is found below the Glacial series, resting on the Speeton Clay, at a short distance from the edge of the chalk escarpment. This bed, however, is at least 85 feet above high-water mark, and is, therefore, probably not exactly contemporaneous with the Sewerby Cliff-beds.

It is where the present shore-line intersects this ancient shore-line at Sewerby that our excavation has been carried out, and as the lines cross each other at a low angle—the recent beach striking N.E. and S.W. nearly, while the old cliff strikes about E.N.E. and W.S.W.—we have been able to work for some distance along the denudation-slope of the recent cliff, where the ancient beach deposits are stripped of their covering of boulder clay; but the gradual recession of the old cliff inland has brought us so far into the slope that this mode of working can no longer be carried on.

The face of chalk in the old cliff above the old tide-level is everywhere smoothed and rounded in a manner strikingly different from the angular mode of weathering of the recent cliff adjoining.

Against it are banked the deposits we have excavated, in the order now to be described.

The Old Sea-beach.—At the bottom, resting on the terraced ‘scaur’ of the chalk, is a sea-beach composed of water-worn chalk pebbles of all sizes, from fine gravel to large stones over a foot in diameter. These are nearly always of the flat oval form that characterises this chalk as a beach material. Many are perforated by the borings of *Pholas*, *Saxicava* and *Cliona*, which shows that an uncovered scaur of chalk has extended at least to near low-water mark. Besides chalk there are also pebbles of grey flint, some rather large in size, of the kind found in the Middle Chalk on the north side of the headland. The chalk in the immediate neighbourhood has no flint, and these pebbles must have drifted not less than four or five miles. They are more plentiful than in the recent beach at this place.

The old beach also contains a few pebbles that are not of local origin. These are comparatively very rare, but we have this year found more of such stones, and some of larger size, than in our last year’s excavation, the

largest being a boulder of basalt measuring 12 in. \times 5 \times 3, and another of porphyrite 7 in. \times 4 \times 3. The proportion of these stones evidently varies in different parts of the beach, being very low indeed close to the cliff-foot, but rising higher as we work outwards and downwards. Nowhere, however, have we found them to form more than a very fractional percentage of the whole.

The most plentiful rock among these strangers is a brown or black laminated bituminous shale, with obscure traces of plants and other fossils. This shale is very light, and when perfectly dry will float, so that it may have drifted along the coast into its present position. Its origin is doubtful, but it is not unlike some of the shales in the estuarine Oolites of the Scarborough district. Other pebbles are of basalt, granite, quartz of various colours, porphyrite, &c., the whole forming an assemblage not strikingly different from that of our Glacial beds. Some of these pebbles are well rounded, but others do not seem to have been rolling long on the beach and are almost subangular. The presence of these pebbles is a fact of much importance, since we shall be able to show that the Cliff-beds underlie the oldest boulder clay known in Yorkshire, and these pebbles are the first indications we have had of the existence of glacial conditions in still earlier times. It is evident, however, that they have not been derived from the sub-aerial waste of any Glacial beds capping the old cliff, for in that case we should have found them plentifully in the rain-wash from the cliff presently to be described; nor are they, in the opinion of the writer, present in sufficient numbers to indicate the waste of pre-existing Glacial beds anywhere in the immediate neighbourhood, though they may have come from the denudation of such beds at a distance.

Here and there among the gravel and stones of the beach occur the bones of mammals, birds, and fish, and, still more rarely, shells of the periwinkle, oyster, and other molluscs. These remains are nearly always in a bad state of preservation, being often crushed into small fragments (as are also many of the chalk pebbles) by the settling of the beds, perhaps under the weight of the ice in the extreme Glacial period; and they are, besides, so softened by the percolating waters that when first found they may often be rubbed into a paste between the finger and thumb. When exposed to the air, however, they harden, and occasionally when a bone has lain close under the sheltering cliff, or between the larger stones of the beach, the pressure has been so far removed that they may be got out in fair condition, and then, when gelatinised and repaired, they make good museum specimens.

The thickness of this beach close to the old cliff is from 3 to 5 feet, but it thickens as we pass down the ledges of the chalk floor on which it rests, so that at the outer edge of our trench, 30 feet from the cliff, it was over 7 feet thick, and in a section we cut further south, where we struck the beds still further from the cliff face, we passed through 9 feet of beach-shingle and sand before reaching the solid chalk. As it thickens it becomes more sandy, so that, though close to the cliff it consists of nothing but loose stones, in passing outwards and downwards we find much sand mixed with the stones, while in the above-mentioned cutting thick seams of pure sand are reached. In this respect the old beach is an exact counterpart of the recent beach at this place, in which there is a similar arrangement of rough loose shingle under the cliff-foot, passing outwards into a flat sandy shore.

The chalk floor close to the cliff is at about the level of the present high-water mark, so that the top of the beach here is decidedly above that level, though not so far above but that a stormy sea and heavy tide might yet overwhelm it. Now, though on a long sloping shore the beach material is usually flung to the highest point that the tide reaches, against a vertical cliff the sea nearly always rises higher than its shingle, and we therefore think that when the old beach was formed the land stood slightly higher than at present. It is remarkable, however, how slight is the difference in level between these two beaches, separated as they are by such a wide interval of time, and by such a cycle of changes as the Glacial period. Nor, were it not for the comparative scarcity of foreign pebbles in the former, is there much difference in appearance between the ancient and the modern beach. The chalk pebbles in both are worn into the same shapes and bored in the same way, and the few shells that are to be found in either are of the same species. It is not until we come to examine the bones of the mammals that we find the effect of the lapse of time. The elephant, rhinoceros, hippopotamus, and elk have gone, but the periwinkle and oyster remain.

The Land-surface.—Close at the cliff-foot the beach is covered by a deposit of marly clay with angular and subangular masses of fallen chalk and streaks of drifted sand, that has evidently accumulated sub-aerially as talus and rain-wash. This deposit is about 5 feet thick where it touches the cliff, but does not extend far outwards, dovetailing rapidly into the blown-sand, so that no trace of it is to be found at more than 20 feet from the cliff.

Bones occasionally occur in this bed, generally in the lower part of it, and we also found in a seam of yellow earthy clay many small land-shells and obscure traces of vegetation along with two or three teeth of vole and fragments of birds' bones.

It contains no marine remains whatever, and no sea-worn pebbles. The sea had evidently quite abandoned the cliff when this bed was formed, though the character of the junction with the old beach shows that this abandonment took place gradually. Possibly, with no change of level, the sand dunes may have accumulated so as to shut out the sea, and this deposit may then have formed in the hollow between them and the cliff. A few very small angular fragments of grey flint occur in the bed (which are noteworthy, as there is no flint in the cliff above), and we also occasionally found small rounded bean-like pebbles of ancient rocks. These, as one of our Committee pointed out, have probably drifted up from the sea-shore of the period entangled in rolling balls of seaweed, such as travel with the wind on most sandy shores.

This bed, though so limited in breadth, has extended along the whole length of cliff already exposed and shows no signs of thinning, so that it is probably not, as we at first thought probable, a local talus-heap but a regular accumulation extending laterally along the cliff-foot.

We thought this our most promising ground, somewhat analogous to a 'cave earth' formed in the open; but in our recent excavations it has disappointed us, our finds in this part of the series being fewer and poorer than those of last year.

The Blown-sands.—A great mass of clean yellow sand, without admixture save for a few blocks of fallen chalk and an occasional bone, overlies the rain-wash, and also overlaps it so as to rest directly on the old beach at the outer edge of our excavation. This reaches quite up to

the top of the old cliff, and has no doubt once extended over its brow, but is now cut off there by the chalky rubble at the base of the drifts. It is quite 25 feet thick in one part of our excavation, and seems to thicken as the cliff recedes inland. It frequently exhibits fine cross-bedding. The upper 15 feet seems to be quite unfossiliferous; but lower down, at about the level of the rain-wash, we found a few bones, these being usually far better preserved than those found in the other beds. We have already referred to the anxiety which this sand caused us from its tendency to suddenly collapse and slide in on us; this happened even on a long low slope. It has evidently been accumulated under the shelter of the cliffs by the wind, and the cliff-face behind it has been beautifully smoothed and rounded by the drifting of its wind-driven particles. The same feature is seen on the cliff-face behind the rain-wash, but stops short at the old beach where the weathering takes a different form. This rounded surface is quite characteristic of the old cliff, and, as already mentioned, is in marked contrast with the adjoining recent cliff, whose outline is splintered and angular through the action of the winter frosts. This feature points to a long-continued prevalence of strong winds from the south or south-east, unaccompanied by frost, that have driven up the sand from a wide sandy shore lying to the southward, so as to form great dunes overtopping the cliff.

The Fossils.—A list of the species that have been identified from among the fossils found in the Cliff-beds is given on the opposite page. We are indebted to Messrs. E. T. Newton, C. Reid, and H. M. Platnauer for the determinations.

The asterisks in the columns denote in which bed the fossil was found.

In the old beach the bones are generally water-worn and rounded, and also often in the rain-wash; but in the blown-sand they are frequently quite unworn, and in a few instances have their finer angles and delicate muscular markings beautifully preserved.

Careful search was made for any evidence of man's presence, but with negative results, for among the large number of flints examined none showed any certain signs of having been worked.

The Glacial Deposits, and their Relation to the Cliff-beds.—We have accounted for about 40 feet of the recent cliff at Sewerby. The remaining 35 feet consists of Glacial beds, which it will now be necessary to describe.

The Chalk-rubble.—At the base of the drifts, resting directly on the chalk on the old cliff, we find a variable thickness of chalk-rubble or gravel, made up of angular and sub-angular fragments of chalk, generally of small size, often partially cemented together by a clayey matrix. This bed is found at the base of the drifts nearly everywhere on Flambro' Head, and overlaps the solid chalk, passing down on the north side at Speeton for some distance over the Speeton Clays. Small drift-pebbles may occasionally be found in it, but these are rare. In appearance it is such a bed as might result from the sub-aerial wash, and weathering of the chalk, and this origin is generally assigned to it. But whatever the mode of its accumulation, its connection with the overlying Glacial beds is very close. No organic remains have yet been found in it.

In our section this chalk-rubble is seen to pass off from the top of the old cliff and to continue over the blown-sands with very little immediate change of level. Before leaving the chalk it is about one foot thick, though

Fossils from the Sewerby Cliff-beds	Old Beach	Rain Wash	Blown-sand	Remarks
<i>Elephas</i> (? <i>primigenius</i> , Blum.). The Mammoth	—	—	*	Several molars from the old beach and two from the blown-sand. One molar only seems to belong to the Mammoth, the others being referable to <i>E. antiquus</i> . Also some broken limb-bones, badly preserved, in the old beach.
<i>Elephas antiquus</i> , Falc. Elephant	*	—	—	
<i>Rhinoceros</i> , probably <i>leptorhinus</i> , Cuv. Rhinoceros	*	—	—	Several molars and portion of a lower jaw; possibly also other bones.
<i>Hippopotamus amphibius</i> , Linn. The Hippopotamus	*	—	—	One molar and a badly preserved tusk
<i>Equus</i> . Horse	*	—	—	A single tooth.
<i>Cervus</i> (? <i>megaceros</i> , Hart.). The Irish Elk, and perhaps another	—	*	*	Teeth, lower jaw, &c.
<i>Bos primigenius</i> , Boj. Urus.	*	*	*	} Many bones.
? <i>Bison</i> sp.	*	*	*	
A Carnivo., perhaps Hyena	*	—	*	Indicated by gnawed bones.
<i>Arvicola amphibius</i> , Linn. The Vole	—	*	—	Lower front molar (determined) and two incisors (presumably the same species).
Birds	*	*	—	Three or four limb-bones.
A Snake	—	—	? *	Portion of a jaw.
Teleostean Fish, probably including the Cod	*	—	—	Vertebrae and bones of the head abundant.
LAND MOLLUSCA.				
<i>Helix hispida</i> , Linn.	—	*	—	} All species still living on sandy tracts in the neighbourhood.
<i>Helix pulchella</i> , Müll.	—	*	—	
<i>Pupa marginata</i> (= <i>P. muscorum</i> , Linn.)	—	*	—	
<i>Zua lubrica</i> , Müll.	—	*	—	
MARINE MOLLUSCA.				
<i>Purpura lapillus</i> , L.	*	—	—	} All, except <i>Ostrea</i> , still found living in great numbers on the present beach.
<i>Littorina littorea</i> , L. The Periwinkle	*	—	—	
<i>Ostrea edulis</i> , L. The Oyster	*	—	—	
<i>Mytilus edulis</i> , L. The Mussel	*	—	—	} Indicated by borings only.
<i>Pholas</i>	*	—	—	
<i>Saxicava</i>	*	—	—	

its exact thickness is difficult to measure, since there is at this place no clear line between it and the shaken chalk of the cliff-top; but where it extends over the blown-sands it thins to 3 or 4 inches, and in one place seems to disappear for a short space altogether, being apparently cut out by the overlying boulder clay. Soon after leaving the chalk cliff it begins to descend, thickening rapidly in doing so, and cutting into the blown-sand. Thus, at 50 yards from our excavation it has sunk so that its base is only about 20 feet above sea-level, it is composed of finer material, and its thickness has increased to 11½ feet. Beyond this the cliff section seemed to show over 25 feet of this material at the bottom; but when we commenced

to cut a trench into it, thinking to strike the Cliff-beds somewhere behind it, we soon found that the lower part of the section was not the chalk-rubble but a talus slope from that bed covering the blown-sands, and that the thickness of the rubble here was not more than 12 feet. A second trench 80 yards south of our excavation gave similar results, though the base of the chalk-rubble had now sunk to about 6 feet above high-water mark, with a corresponding diminution in the thickness of the blown-sands. It was in this trench that we went through 9 feet of old beach and reached the solid chalk floor. Seventy yards further south, though the chalk-rubble is still 13 feet thick in the cliff, its base has reached the sea-level, and a short boring was necessary to get below it. This boring showed us that there is here about 4 feet of the bed below high-water mark, and that it rests directly upon a sea-beach of sand with rolled pebbles, the blown-sands having quite disappeared.

We put down another bore into this bed 30 yards further south, starting in the cliff-foot about 2 feet below the top of the bed, and here we bored into it for 21 feet without reaching its base. The same result followed a boring on the beach 60 yards nearer Bridlington, where the upper surface of the bed has sunk below high-water mark and the cliff-foot is held by the overlying boulder clay. Here we went through 23 feet of chalk-rubble, with sandy and clayey seams full of water, without reaching its base. One of the clay seams passed through in this boring somewhat resembled a boulder clay in appearance, and, though the samples brought up by the auger were not sufficient for us to decide whether this was indeed a boulder-clay, there are other reasons for thinking that the rubble is partly contemporaneous with the Basement boulder clay, and that there is in places a certain amount of dovetailing between them.

The Basement Boulder Clay.—The cliff section for half a mile southward from our excavation is nearly always hidden, except just at the top, by a long slope of slipped clay and gravel, and is not often washed by the sea; but, by a fortunate combination of circumstances, during last March high tides and heavy seas swept the base of this cliff clearer than it has been for ten or fifteen years, and also laid bare a long strip of foreshore stretching at one time or another as far as the sea defences of Bridlington Quay. These exposures enabled the writer to trace the lowest boulder clay of the cliff at Sewerby into the 'Shelly' or 'Basement' boulder clay of Bridlington Quay.

The clay changes considerably in character in this distance, but was traced continuously northward from opposite Sands Cottage, where it is a dark greenish boulder clay of the normal 'Basement' type, full of shell fragments, to the cliff near our excavation, where it is rather different in colour, is more earthy, has few or no shells and also few boulders, and passes over (and possibly, as already mentioned, partly into) the chalk-rubble just described. As it follows the rise of that bed over the blown-sands to the top of the chalk cliff, it is reduced to a thickness of only 8 feet, though there is over 25 feet of it at Bridlington Quay. Above the chalk it may readily be traced along the cliff for two miles to Danes' Dyke, where there is so much splitting up of the beds that it is more difficult to follow; but there is every reason for believing that it continues beyond, and forms the lowest boulder clay almost everywhere on the headland. Where its base is seen the lowest two or three inches are generally distinctly stratified, with the bedding planes marked by thin films of silty sand; but, except in a few places, this character dies

out upwards and the remainder of the clay generally forms a solid mass, broken only by the occurrence here and there of irregular pockets of sand, gravel, and clay that seem to have been caught up and included in it. This inclusion of other beds is its most characteristic feature, and one that is sure to be found wherever the clay can be traced for any distance. In the neighbourhood of our section these patches are of chalk-rubble or of clayey silt and sand; but further east on the headland, near the lighthouses, the lowest boulder clay (almost certainly this Basement clay) includes transported masses of Speeton clay mixed with some red chalk, while at Bridlington Quay and elsewhere some of the patches of clay and sand which it encircles are richly fossiliferous, and form the deposit long known as 'the Bridlington Crag.' These shelly patches contain a peculiarly Arctic molluscan fauna of great richness and variety, and are the fragments of an old sea-bottom formed under extremely glacial conditions.

Until the exposures of last spring the continuity of this shelly Basement clay with the boulder clay covering the Cliff-beds was extremely doubtful, and the writer was inclined to believe, for reasons that will presently be given, that the Basement clay was not represented in our section, or was represented only by the chalk-rubble, but the new evidence has determined this point.

The upper limit of the Basement clay in our section is well marked by a thin seam of fine shingle and sand about four inches thick. This parting, though here so slight, if followed southward for a few hundred yards, is found to develop into a thick bed of finely laminated elastic clay with a seam of fine gravel above and below it, that forms for some distance a well-marked horizon.

This laminated clay contains no organic remains and no pebbles. It seems to have been accumulated in the hollows of an uneven surface of the Basement clay, and is not found much above high-water mark.

The Purple Clay.—Next in the Sewerby section comes a thick homogeneous mass (18 feet) of tough brownish-coloured boulder clay that is rather more stony than the Basement clay, and not so earthy in texture. No dividing line has been found in it in this section; but if the clay be followed southward for a short distance, it is found to split into an upper and a lower division that are separated by the intervention of a variable bed of sand and gravel that often shows contortions, and this division may be traced through the greater part of Holderness.

It was the absence of this line, and the consequent presence of only two beds of boulder clay over the chalk, instead of the three seen so well at Bridlington Quay, that led the writer and others to doubt whether the Basement clay passed up over the chalk in the cliff.

The Sewerby Gravel.—A well stratified bed of chalky gravel 10 feet thick caps the section, and may be traced southward along the cliff-top nearly to Bridlington Quay.

This is known as the Sewerby Gravel, and, though rather newer than the boulder clays, it probably dates back to the time when the ice was retreating, and can scarcely be called Post-Glacial. But through it a passage to more recent times may be traced, by way of certain low-level gravels of fresh-water origin with which it seems to be connected near Bridlington Quay, and which in turn lead up to the fresh-water marls that lie in the hollows on either side of the town, whose formation has probably gone on till comparatively recent times.

Age of the Buried Cliff-beds.—In your reporter's communication to

the Yorkshire Geol. and P. Society on these beds, he suggested that they might be called *Pre-Glacial*, since they were so distinctly older than the Basement clay, which has been regarded (perhaps without much evidence) as the oldest bed of the Yorkshire Glacial deposits. But it has since been suggested that the term *Sub-Glacial* would better indicate this relationship without inference as to the age, and our recent discovery of foreign pebbles in greater numbers and of larger size than before shows the wisdom of this suggestion.

While the presence of a few travelled pebbles is scarcely alone sufficient evidence of the Glacial age of the beds, since such pebbles occur in beds that are allowed to be Pre-Glacial; as, for example, in the Norfolk Forest-bed series; yet the fauna, as at present determined, lends no countenance to the view that the beds are actually Pre-Glacial, though, on the other hand, it contains nothing that is decisively against this view. A large number of the bones obtained, however, are yet in an indeterminate condition, and we hope that when they shall have been repaired and examined they may yield closer results.

The Basement clay contains so much evidence of the destruction of an old sea-bottom at some distance from the shore, that the idea naturally arises that the beach we have been examining may have formed the shoreline of that period. But the evidence of their respective faunas is quite opposed to this, for the Bridlington shells denote a very cold climate—not quite but nearly the coldest we have evidence for in Great Britain—whereas the old beach, with its hippopotamus and oysters and its unfrosted cliff-face, indicates a climate, if anything, warmer than we enjoy at present.

Of course it may be urged that, as the shell-beds of the Basement clay are not in place, they may have been carried for long distances, and are not evidence for an extreme climate in their present resting-place. But even if far transported they must still have been formed somewhere within the North Sea basin, and the presence of such a fauna anywhere within so shallow and limited an area seems hardly compatible with the contemporaneous occurrence of a warm climate on its shores. So that the correlation of the old beach with the shell-beds of the Basement clay seems an improbable one.

The presence of foreign pebbles in the beach is certainly evidence for the existence of ice in some form, either during the formation of the beach or prior to it; but unfortunately we cannot say whether these have been derived from pre-existing Glacial beds somewhere within reach of the sea, or have come more directly through the stranding of small drifting bergs or coast-ice.

Independently of its fauna, the Basement clay is in itself the proof of a very severe climate, and shows a set of conditions that could not suddenly have arisen. Possibly the minor oscillations that may have occurred during the gradual approach of the great Glacial period, before the maximum cold set in, may account for the somewhat contradictory evidence of these beds.

It is unfortunate that we have been able to recover so small a portion of the fauna which must have existed at that time. Our list is evidently a mere fragment, and both on land and sea there has undoubtedly been abundant and varied life.

But the circumstances are not favourable. For sea-shells we have had only the highest and roughest portion of an old beach to explore, 1888.

wherein we could not in any case have expected to find many shells, while here the conditions have been so unfavourable for their preservation that even such strong shells as *Littorina* are only imperfectly preserved and crumble with a touch. Similarly with the land-shells, our collecting ground has been what at one time was a range of barren shifting sand-hills whereon the fauna was probably always very limited; and for the preservation of the specimens we possess we are indebted to the clayey matrix of one particular seam not much over an inch thick. So with the mammalia. We have not reached their dens or haunts, but have chiefly to rely for our specimens on the bones sporadically scattered along a sea-beach; and under these circumstances it is not surprising that we have not been able to identify the carnivor whose teeth-marks we have found on some of the bones, nor to specifically determine some of the other animals. Indeed it is remarkable enough that under such conditions we have found so much; and we are inclined to think that the presence at that period of a river in the Main Wold valley, which opens to the sea at Bridlington Quay, may have caused slightly estuarine conditions to prevail over this part of the old bay, and so have brought about the comparative abundance of animal remains in the beach and the presence of the hippopotamus.

Relation to other Deposits.—These Cliff-beds cannot safely be correlated with any other deposit known in Yorkshire. Their nearest analogue is the estuarine shell-bed at Speeton mentioned in an earlier part of this report; but, as was before pointed out, the difference of level between them is so considerable that it is unlikely they have been exactly contemporaneous.

In several other places on Flamborough Head the coast section reveals steep bluffs of chalk below the drifts, but in no case except this have any fossiliferous deposits been found in connection with them, and they seem in most cases not to be sea-cliffs, but steep valley walls. At Flamborough South Landing under one of these bluffs there is an accumulation of rough pebbles somewhat resembling a beach, but it differs from the Sewerby beach in the presence of a multitude of foreign stones and in the absence of *Pholas*-bored pebbles or fossils of any kind.

Your Committee ask to be re-appointed for the purpose of completing the repair and determination of the fossils already obtained, but do not propose at present to ask for a renewal of the grant.

Report of the Committee, consisting of Professor LANKESTER, Professor MILNES MARSHALL, Mr. SEDGWICK, and Mr. G. H. FOWLER (Secretary), appointed for the purpose of investigating the Development of the Oviduct and connected structures in certain fresh-water Teleostei.

WITH regard to the grant made, I regret to say that I have been unable to make use of it. For various reasons the perch was selected as the most suitable subject for investigation, and arrangements were made with Mr. Armistead, of the Solway Fisheries, for supplies of ova and fry. These, however, unfortunately, altogether broke down, and that at a time when the spawning season was just over, and when, consequently, no further attempts could be made till the ensuing spring. The

grant of 15*l.* is still unbroken, and if the Committee should be disposed to continue it, different arrangements next year would probably lead to a more favourable result.

Third Report of the Committee, consisting of Professors ARMSTRONG, LODGE, Sir WILLIAM THOMSON, Lord RAYLEIGH, FITZGERALD, J. J. THOMSON, SCHUSTER, POYNTING, CRUM BROWN, RAMSAY, FRANKLAND, TILDEN, HARTLEY, S. P. THOMPSON, MCLEOD, ROBERTS-AUSTEN, RÜCKER, REINOLD, CAREY FOSTER, and H. B. DIXON, Captain ABNEY, Drs. GLADSTONE, HOPKINSON, and FLEMING, and Messrs. CROOKES, SHELFORD BIDWELL, W. N. SHAW, J. LARMOR, J. T. BOTTOMLEY, R. T. GLAZEBROOK, J. BROWN, E. J. LOVE, and JOHN M. THOMSON, appointed for the purpose of considering the subject of Electrolysis in its Physical and Chemical Bearings.

DURING the past year work has been done by the Committee as follows:—

Prof. Fitzgerald and Mr. Trouton have continued their investigation into the accuracy of Ohm's law in electrolytes, with the result that the coefficient h in $e=rc(1-hc^2)$ is now known to be less than 3×10^{-6} in sulphate of copper solution. Their communication is annexed in continuation of their previous contributions on the same subject as given in the 1886 Report, p. 312, and in the 1887 Report, p. 345.

Lord Rayleigh has experimentally examined the question whether the velocity of light through an electrolyte is affected by the passage of an electric current in the same direction, and his account of the experiment and of its result is annexed.

Dr. Gladstone and Mr. Hibbert have experimented on the mode of conduction of alloys and solid sulphides, and their paper is appended to this report.

Dr. Armstrong has been preparing some pure selenium, with the view of examining its conductivity; and Mr. Crompton, in his laboratory, is engaged in determining the resistance of sulphuric acid of various strengths at different temperatures, with the object of applying to the results Mendelejeff's theory of solution, as explained and partially reported in the 'Transactions of the Chemical Society' for January 1888.

Mr. Shaw is continuing the drawing up of his report on recent progress in the whole subject of electrolysis.

Prof. Willard Gibbs has sent a letter to the Secretary, replying to some observations made in last year's report concerning a communication with which he had previously favoured the Committee: see Report, 1886, p. 388; and 1887, p. 340. This letter is printed below.

Prof. Clausius has sent a letter to the Secretary with respect to the nomenclature often adopted in England for the dissociation hypothesis of electrolytic conduction, which, on the Continent, is known by his name alone. The Committee record the deep regret with which they have quite recently heard of his death.

The paper by Prof. von Helmholtz, 'Further Researches respecting the Electrolysis of Water,' as translated and communicated to the

Section last year, has appeared in the Physical Society's collection and reprint of papers.

The Committee may also call attention to a paper by Prof. Horace Lamb, 'On the Theory of Electric Endosmose and Other Allied Phenomena,' printed *in extenso* in the Manchester Volume, 1887, p. 495.

Mr. Fitzpatrick's paper on Electrolytic Conductivity, communicated to the Section last year, has been printed in the 'Philosophical Magazine' for November 1887.

Bulletin No. 36 of the United States Geological Survey, 'On the Subsidence of Fine Solid Particles in Liquids,' by Carl Barus, has been sent from the Government printing-office at Washington to the Secretary. It is interesting as containing an application of electrolysis to accelerate the settling of turbidity; and Dr. Gladstone's paper last year (1887 Report, p. 344), 'On the Action of an Electric Current in hastening the Formation of Lagging Compounds,' may be mentioned in connection with it.

Dr. Arrhenius has transmitted to the Secretaries various reprints bearing on the dissociation hypothesis of electrolytic conduction and other matters, and one manuscript, which is appended to this Report.

Dr. Richarz has also sent some papers, one of which, not being elsewhere published, is annexed.

The work of Prof. Rowland and Mr. Bell, 'On the Effect of a Magnet on Chemical Action,' communicated verbally to the Section last year at Manchester, has now appeared in the 'American Journal of Science' for July 1888, and in the 'Philosophical Magazine' for August 1888.

The Committee, at a previous meeting, instructed their Secretary to endeavour to obtain the translation and publication of some of von Helmholtz's papers. They have seen with great satisfaction that the action of the Physical Society of London has rendered further motion on their part in this direction unnecessary, and they congratulate Prof. Carey Foster on the volume which has appeared under his supervision.

The most remarkable experimental result within the scope of the Committee to be recorded in the past year is that obtained by Dr. Hertz, subsequently confirmed and further investigated by E. Wiedemann and Ebert, Hallwachs, and Arrhenius, on the effect of ultra-violet light in making air or any gas conducting, and especially in breaking down the transition resistance or obstructive film at the cathode of an electric sparking arrangement. The experiment is exceedingly easy to perform with either a small induction coil or a Voss or Wimshurst machine, the light used being either the light of another spark, or of magnesium wire, or of an arc lamp. The length of a short spark may be trebled by mere illumination with ultra-violet light: the difference of potential between the terminals being kept constant.

The fact that the effective cause of this phenomenon is not the long waves of ordinary electric oscillation, but is the light which most nearly corresponds in frequency to electric oscillation in bodies the size of molecules, suggests some chemical or dissociation cause of the effect.

Of the 50*l.* grant made to the Committee last year, 30*l.* has been drawn and spent, partly in a rapid vibrator for the use of those experimenting on Ohm's law, partly in expenses connected with the preparation of pure selenium, and the rest (some 15*l.*) in separate copies, printing, and postage. It is proposed to ask for reappointment, with the sum which has now lapsed renewed.

On the Accuracy of Ohm's Law in Electrolytes.

By Professor FITZGERALD and F. TROUTON.

Experiments have been made with the faster fork alluded to in last year's report, with the result of bringing the determination to about twice the degree of refinement then mentioned as attained, or ' h ' to be less than 3×10^{-6} . The rate of this fork (about 290 vibrations per second) is nearly twice that of the previously employed fork (160 per second). From the experiment described below the possible increase in refinement obtainable by doubling the rate appears to be about fourfold, or twice that obtained.

Considering that the difficulties of working increase greatly with the rate of the fork, it was thought more advisable for the further prosecution of the investigation to try some other method of breaking the contacts than to prepare a still faster fork.

A commutation arrangement attached to the spindle of a small magneto has been employed with fairly satisfactory results. As great a refinement, however, has not yet been reached with it as was attained with the fork method,¹ chiefly through the difficulties connected with running the magneto uniformly; but we hope soon to have storage cells in the laboratory, and thus to get over this difficulty.

The magneto arrangement, however, on account of the facilities for changing the speed, was found admirably adapted for confirming the supposition that the observed deviation from Ohm's law is due to 'heating effects,' for the deviation always tended to disappear as the speed of contact-breaking was gradually increased; also for investigating the manner in which the minimum value of ' h ' obtainable varies with the speed of contact-breaking. This was found to be, approximately, inversely as the square of the speed.

Is the Velocity of Light in an Electrolytic Liquid influenced by an Electric Current in the direction of propagation? By Lord RAYLEIGH, Sec.R.S.

The question here proposed has been considered by Roiti (Pogg. 'Ann.' 150, p. 164, 1873) and by Zecher ('Rep. de Phys.' 20, p. 151, 1884).² My experiments were made in ignorance of the work of these observers, and the results would scarcely be worth recording were it not that the examination seems to have been pushed further than hitherto. It may be well to say at once that the result is negative.

The interference fringes were produced by the method of Michelson, as used in his important investigation respecting 'The Influence of Motion of the Medium upon the Velocity of Light.'³ The incident ray ab meets a half-silvered surface at b , by which part of the light is reflected and part is transmitted. The reflected ray follows the course $abcdefbg$, being in all twice reflected at b . The transmitted ray takes the course $abfedcbg$, being twice transmitted at b . These rays, having pursued identical paths, are in a condition to form the centre of a system of fringes, however long and far apart may be the courses cd , ef .

There is here nothing to distinguish the ray ab from a neighbouring parallel ray. The incident plane *wave-front* perpendicular to ab gives rise eventually to two coincident wave-fronts perpendicular to bg . With a wave incident in another direction the case is different. The two emergent wave-fronts remain, indeed, necessarily parallel, both having experienced an even number of reflections (four and six). But there will exist in general a relative retardation, of amount (for wave-fronts perpendicular to the plane of the diagram) proportional to the deviation from the principal wave-front. Hence, if the incident light comes in all directions, a

¹ A very unsatisfactory experiment with the magneto at a speed of about 400 vibrations per second gave, as the value of h , 1.25×10^{-6} .

² Mr. Wilberforce has experimented upon displacement currents in a dielectric (*Camb. Phil. Trans.* t. xiv. p. 170, 1887).

³ *Am. Journ.* xxxi. p. 377, 1886.

telescope at *g*, focussed for infinitely distant objects, reveals a system of interference bands, whose direction should be vertical, if the adjustments could be perfectly carried out in the manner intended.

The success of the method does not require the complete symmetry of the diagram. If the reflections at *d*, *e* are effected by a right-angled prism, it is necessary that *cd*, *fe* be parallel to one another, but not that they be parallel to the surface *b*. Supposing all the surfaces to remain vertical in any case, the positions of *b*, *f*, and the incident ray *ab* may be chosen arbitrarily. If the distance *de* between the parallel courses is not closely prescribed, one adjustment by rotation of the mirror *c* will suffice. In my experiments the optical parts were mounted upon a large iron plate, so that the movable pieces *c*, *de* could be shifted without loss of level. The incident ray *ab* was defined by a small hole near the paraffin lamp which served as a source of light, and by the centre of a moderately large circular aperture perforated in a screen and illuminated when necessary with a candle. The mirror *c* was then rotated until the rays *cd*, *fe* were parallel. This was tested by observing the equality of their mutual distances near the extremities of their course.

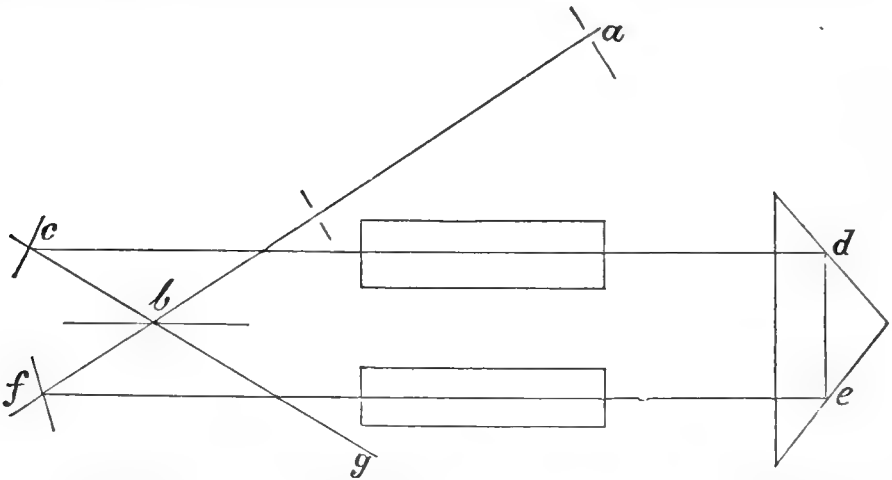

If the distance between the parallel rays is prescribed, the adjustment is more troublesome. The line *fe* being fixed, sights are laid down defining the desired position of *cd*. These sights, as well as those before referred to defining the incident ray, have now to be brought to apparent superposition as seen by an eye looking along *de*. For this purpose *two* conditions have to be satisfied by, and two motions must be provided for, the mirror *c*. One of these should be a movement of rotation, and the other of translation in a direction nearly perpendicular to the plane of the mirror. Thus the mounting may consist of a circular turntable resting upon the iron plate, the curved edge of which is guided by the sides of a *V*, cut out of a flat piece of metal and clamped to the plate. In each position of the *V* the angular motions are easily swept over, and the double adjustment is effected without much difficulty. When the parallelism of the rays is secured, the insertion of the reflecting prism is all that remains. The adjustment of this is best effected with the eye at the observing telescope, which at this stage should be focussed upon the small aperture in the neighbourhood of the flame. By a motion of the prism parallel to its hypotenuse the two images are brought to coincidence,¹ and then the bands appear, if not at once, when the telescope is accommodated for infinitely distant objects.

¹ It should be noticed that if the object were at infinity, or if with the aid of a collimating lens an image of it were thrown to infinity, the two images as seen focussed through the telescope would overlap in any case; for it may be proved that, whatever may be the positions of the five reflecting surfaces, the two emergent rays, corresponding to any incident ray, are necessarily parallel.

The half-silvered central plate would be at its best if it reflected light of the same intensity as it transmits. I have generally found the reflection on the side next the air more powerful than upon the side next the glass; so that the ideal would require the geometric mean of the two reflections to be equal to that of the two transmissions. A very slight silvering is all that is wanted, such as from its want of coherence and brilliancy would be useless for other purposes; and the bands appear tolerably black, even though the interfering lights are of decidedly unequal intensities. There is, of course, a reflection from the unsilvered surface of the plate. Owing to a want of parallelism in my apparatus, this image was distinctly separated from the other. The two back reflectors were of flat glass, silvered by the milk-sugar process, and used as specula.

The imperfections of the surfaces disturbed the formation of the bands from full accordance with theory. The definition was usually better when the pencils were limited, as by the screens employed to define the incident ray, than when all obstruction was removed. The final adjustments for the distinctness and desired width of bands were made with the eye at the telescope by shifting the reflecting prism, and occasionally by slight displacements of one of the other reflectors.

The tubes enclosing parts of *cd*, *fe*, and containing the electrolyte (diluted sulphuric acid of nearly maximum conductivity), were closed at the ends by plates of parallel glass. The current entered by lateral attachments, so arranged that liquid (or gas) rising or falling from the platinum electrodes would not at first enter the operative part of the tubes. The diameter of the tubes was about $\frac{3}{4}$ inch, and the effective length about 11 inches.

It will be sufficient to give the details of one experiment. The two tubes were connected in multiple arc, and of course in such a manner that the current travelled in opposite directions. The magnitude of the whole current (say, from eight Grove cells) was 1.5 ampère; so that the current *density*, in ampères per sq. cm., was

$$\frac{.75}{\pi \times .38^2 \times 2.54^2} = .26.$$

Now, one of the interfering rays travelled 22 inches, or 56 centimetres, with the current, and the other ray the same distance against the current. On *reversal* of the current no shift of the bands could be perceived, under conditions where a shift of $\frac{1}{10}$ of a band must have been evident. Hence we may conclude that a current of the above-mentioned density does not accelerate (or retard) the propagation of light in the ratio of $\frac{1}{10} \lambda$ to 22.4 cms. In the liquid we may take $\lambda = 4 \times 10^{-5}$ cm.; and if we reduce the result so as to correspond to density unity, we may say that in dilute sulphuric acid a current of one ampère per square centimetre does not alter the velocity of light by 1 part in 13 millions, or by 15 metres per second.

It would probably be possible to carry the test ten or fifteen times further by the use of much larger tubes and a more powerful battery, but there seems to be no sufficient encouragement at present to make the attempt. The case would, of course, be very different were anyone to show by *a priori* argument a reason for expecting an effect of this order of magnitude.

Electro-Chemical Thermo-Dynamics. (Letter from Professor WILLARD GIBBS to the Secretary of the Electrolysis Committee of the British Association.)

New Haven: November 21, 1887.

Professor OLIVER J. LODGE,

Dear Sir,—As the letter which I wrote you some time since concerning the *rendement* of a perfect or reversible galvanic cell seems to have occasioned some discussion, I should like to express my views a little more fully.

It is easy to put the matter in the canonical form of a Carnot's cycle. Let a unit of electricity pass through the cell producing certain changes. We may sup-

¹ Probably I might say $\frac{1}{20}$, but it is best to be upon the safe side. When the contact was maintained a slight shift was observed, but in a direction independent of that of the current.

pose the cell brought back to its original condition by some reversible chemical process, involving a certain expenditure (positive or negative) of work and heat, but involving no electrical current nor any permanent changes in other bodies except the supply of this work and heat.

Now the first law of thermo-dynamics requires that the algebraic sum of all the work and heat (measured in 'equivalent' units) supplied by external bodies during the passage of the electricity through the cell, and the subsequent processes by which the cell is restored to its original condition, shall be zero.

And the second law requires that the algebraic sum of all the heat received from external bodies, divided, each portion thereof, by the absolute temperature at which it is received, shall be zero.

Let us write W for the work and Q for the heat supplied by external bodies during the passage of the electricity, and $[W]$, $[Q]$ for the work and heat supplied in the subsequent processes.

Then
$$W + Q + [W] + [Q] = 0, \quad . \quad . \quad . \quad . \quad . \quad (1)$$

and
$$\frac{Q}{t'} + \int \frac{d[Q]}{t} = 0, \quad . \quad . \quad . \quad . \quad . \quad (2)$$

where t under the integral sign denotes the temperature at which the element of heat $d[Q]$ is supplied, and t' the temperature of the cell, which we may suppose constant.

Now the work W includes that required to carry a unit of electricity from the cathode having the potential V'' to the anode having the potential V' . (These potentials are to be measured in masses of the same kind of metal attached to the electrodes.) When there is any change of volume, a part of the work will be done by the atmosphere or other body enclosing the cell. Let this part be denoted by W_p . In some cases it may be necessary to add a term relating to gravity, but as such considerations are somewhat foreign to the essential nature of the problem which we are considering, we may set such cases aside. We have then

$$W = V' - V'' + W_p \quad . \quad . \quad . \quad . \quad . \quad (3)$$

Combining these equations we obtain

$$V'' - V' = W_p + [W] + [Q] - t' \int \frac{d[Q]}{t} \quad . \quad . \quad . \quad . \quad (4)$$

It will be observed that this equation gives the electromotive force in terms of quantities which may be determined *without setting up the cell*.

Now $[W] + [Q]$ represents the increase of the intrinsic energy of the substances in the cell during the processes to which the brackets relate, and $\int \frac{d[Q]}{t}$ represents their increase of entropy during the same processes. The same expressions, therefore, with the contrary signs, will represent the increase of energy and entropy in the cell during the passage of the current. We may therefore write

$$V'' - V' = -\Delta\epsilon + t'\Delta\eta + W_p \quad . \quad . \quad . \quad . \quad (5)$$

where $\Delta\epsilon$ and $\Delta\eta$ denote respectively the increase of energy and entropy in the cell during the passage of a unit of electricity. This equation is identical in meaning, and nearly so in form, with equation (694) of the paper cited in my former letter, except that the latter contains the term relating to gravity. See 'Trans. Connect. Acad.' III. (1878), p. 509. The matter is thus reduced to a question of energy and entropy. Thus, if we knew the energy and entropy of oxygen and hydrogen at the temperature and pressure at which they are disengaged in an electrolytic cell, and also the energy and entropy of the acidulated water from which they are set free (the latter, in strictness, as functions of the degree of concentration of the acid), we could at once determine the electromotive force for a reversible cell. This would be a limit below which the electromotive force required in an actual cell used electrolytically could not fall, and above which the electromotive force of any such cell used to produce a current (as in a Grove's gas battery) could not reach.

Returning to equation (4), we may observe that if t under the integral sign has a constant value, say t'' , the equation will reduce to

$$V'' - V' = \frac{t'' - t'}{t''} [Q] + [W] + W_p \dots \dots \dots (6)$$

Such would be the case if we should suppose that at the temperature t'' the chemical processes to which the brackets relate take place reversibly with evolution or absorption of heat, and that the heat required to bring the substances from the temperature of the cell to the temperature t'' , and that obtained in bringing them back again to the temperature of the cell, may be neglected as counterbalancing each other. This is the point of view of my former letter. I do not know that it is necessary to discuss the question whether any such case has a real existence. It appears to me that in supposing such a case we do not exceed the liberty usually allowed in theoretical discussions. But if this should appear doubtful, I would observe that the equation (6) must hold in all cases if we give a slightly different definition to t'' , viz., if t'' be defined as a temperature determined so that

$$\frac{[Q]}{t''} = \int \frac{d[Q]}{t} \dots \dots \dots (7)$$

The temperature t'' , thus defined, will have an important physical meaning. For by means of perfect thermo-dynamic engines we may change a supply of heat $[Q]$ at the constant temperature t'' into a supply distributed among the various temperatures represented by t in the manner implied in the integral, or *vice versa*. We may therefore, while vastly complicating the experimental operations involved, obtain a theoretical result which may be very simply stated and discussed. For we now see that after the passage of the current we may (theoretically) by reversible processes bring back the cell to its original state simply by the expenditure of the heat $[Q]$ supplied at the temperature t'' , with perhaps a certain amount of work represented by $[W]$, and that the electromotive force of the cell is determined by these quantities in the manner indicated by equation (6), which may sometimes be further simplified by the vanishing of $[W]$ and W_p .

If the current causes a separation of radicles, which are afterwards united with evolution of heat, $[Q]$ being in this case negative, t'' represents the highest temperature at which this heat can be obtained. I do not mean the highest at which any part of the heat can be obtained—that would be quite indefinite—but the highest at which the whole can be obtained. I should add that if the effect of the union of the radicles is obtained partly in work— $[W]$, and partly in heat— $[Q]$, we may vary the proportion of work and heat; and t'' will then vary directly as $[Q]$. But if the effect is obtained entirely in heat, t'' will have a perfectly definite value.

It is easy to show that these results are in complete accordance with Helmholtz's differential equation. We have only to differentiate the value which we have found for the electromotive force. For this purpose equation (5) is most suitable. It will be convenient to write E for the electromotive force $V' - V''$, and for the differences $\Delta\epsilon$, $\Delta\eta$ to write the fuller forms $\epsilon'' - \epsilon'$, $\eta'' - \eta'$, where the single and double accents distinguish the values before and after the passage of the current. We may also set $p(v'' - v')$ for W_p , where p is the pressure (supposed uniform) to which the cell is subjected, and $v'' - v'$ is the increase of volume due to the passage of the current. If we also omit the accent on the t , which is no longer required, the equation will read

$$E = \epsilon'' - \epsilon' - t(\eta'' - \eta') + p(v'' - v') \dots \dots \dots (8)$$

If we suppose the temperature to vary, the pressure remaining constant, we have

$$dE = d\epsilon'' - d\epsilon' - t d\eta'' + t d\eta' - (\eta'' - \eta') dt + p dv'' - p dv' \dots \dots \dots (9)$$

Now, the increase of energy $d\epsilon'$ is equal to the heat required to increase the temperature of the cell by dt diminished by the work done by the cell in expanding. Since $d\eta'$ is the heat imparted divided by the temperature, the heat imparted is $t d\eta'$, and the work is obviously $p dv'$. Hence

$$d\epsilon' = t d\eta' - p dv',$$

'Treatise on Electricity and Magnetism,' Vol. I., p. 309, speaks of 'the theory of Clausius' simply.

I trust, therefore, that you will kindly arrange so that terms conveying a meaning not intended by the Committee may be avoided by them, lest they excite a false impression in the minds of readers.—With assurances, &c., faithfully yours,

R. CLAUSIUS.

On the Conduction of Alloys and Solid Sulphides.

By J. H. GLADSTONE, *Ph.D.*, *F.R.S.*, and WALTER HIBBERT, *F.I.C.*

The following experiments were instituted in connection with the work of the British Association Committee on Electrolysis. One of the questions originally raised was whether there was any resemblance between the conduction of an alloy and that of an electrolyte; or, to put it in another way, whether the passage of an electric current through an alloy is associated with any separation of its constituents.

The method adopted by us depends on the assumption that any such separation would produce changes of resistance, the changes being, in all probability, different at one electrode from what they would be at the other.

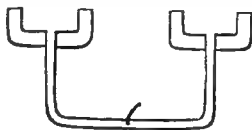

The apparatus consisted of a U tube of glass of the following dimensions:—

Internal diameter, 0.45 centimetres; total length, 28 centimetres; horizontal portion, 11 centimetres; each vertical portion, 8.5 centimetres. The ends of the tube were carefully fitted with corks, so bored as to form large terminal cups, as shown in section in the above diagram.

In the middle of the horizontal part of the U a platinum wire was fused through the glass for the purpose of making connection with the central part of the alloy whilst the current was passing through it.

The alloy used was the 'fusible alloy,' sold by Messrs. Hopkin & Williams, containing bismuth, lead, tin, and a little cadmium. It was chosen because of its low fusing-point, which enabled us to keep it perfectly liquid at the temperature of boiling water. A suitable quantity was fused and poured into the U tube, some care being needed to drive out all air-bubbles. The tube was then placed in a water oven and kept at 100° Centigrade. Connections were made through the lid of the oven by means of three thick insulated copper wires, two of them going to the cups at the end of the U tube, and the third to a mercury cup at the bottom of the oven, into which there dipped the platinum wire from the middle of the U. By means of these connections the two halves of the tube were joined to the ends of a metre bridge wire, and the ratio of the resistance of one half to that of the other obtained in the usual way.

In the earlier experiments a slight modification of Carey Foster's arrangement of the bridge was tried, but it was found a little inconvenient for these particular experiments, and was therefore replaced by the ordinary simpler form.

The currents employed varied in different experiments from 5 down to 0.2 ampères, running generally for four or five hours, with two or three tests during that time. On one occasion a current of about 0.4 ampère was continued for twenty-four hours.

The results of the experiments were always negative, no change of resistance being detected which did not fall within the limit of probable error.

It ought to be pointed out that the sources of error were considerably greater than usual. The resistances under comparison were so small, and such great temperature differences existed between the various junctions, that great pre-

cautions had to be taken against thermo-electric disturbance. Errors arising from this source were generally eliminated by repeating the observations with a reversed current. In some cases the battery circuit was completed after the index of the galvanometer had come to rest under the action of the thermo-current; but this was not considered so decisive as the other method.

A few experiments were made by a method depending on the fall of potential in one half of the tube compared with that in the other half, but they yielded the same negative result.

This conclusion is true for nearly all our experiments to 1 part in 500 and for many of them to 1 part in 1,000. The conclusion is strengthened by the fact that when small changes did occur they were shown to be due to some influence not dependent on the direction of the current. Thus in one experiment already alluded to, in which the current continued for twenty-four hours, a change of zero amounting to 0·7 of a millimetre was observed. As this was a fairly large change compared with the usual result, the current was reversed for twelve hours. At the end of that time the zero had moved a little further in the *same* direction, showing that the alteration was due to some other cause than the one we were seeking to detect.

One or two data obtained incidentally may be of interest.

The alloy had a specific resistance at 100° C. of about 107,000 c.g.s. units—*i.e.*, a cubic centimetre of it had between opposite faces a resistance of 0·00107 ohm.

To assure ourselves that changes in composition would affect the resistance two experiments were made. To the alloy in one half of the U tube 0·5 per cent. of lead was added. This was done with some care, but it could hardly be expected that the distribution of the lead would be uniform through the one half and confined to it. However, a fall in the ratio of the resistances of the two limbs of nearly 3 per cent. was noticed. In the second experiment the amount of lead added was 1 per cent., and the fall in resistance of that half of the tube was about 5 per cent.

This negative result is in accordance with that arrived at by Professor Roberts-Austen with other alloys and by a different method.

SOLID SULPHIDES.—It is well known that certain mineral sulphides conduct electricity, and it is evident that if such a compound were placed between two sheets of silver, and an electric current passed through, the condition of the silver would at once reveal whether any sulphur had combined with it on the one side, or any metal had been deposited on the other. Experiments made some years ago gave a negative result, but they have been repeated more carefully recently. The plates of silver were connected with an astatic galvanometer and a battery, and the current varied in different experiments from a very small value up to about 1·5 ampère.

The condition of the sulphide was also varied. Sometimes we used small blocks of native galena, cinnabar, &c., ground smooth on two opposite faces; in other experiments we employed finely divided powders.

The sulphides generally produced a slight tarnishing of the plates, but it was found that something similar occurred without the current. In the case of three sulphides—lead, mercury, and copper—however, the tarnishing was extremely small compared with what would have occurred if the whole current had passed electrolytically. We concluded, therefore, that there was no electrolytic conduction, or, if any, very little in comparison with the non-electrolytic.

During the course of these experiments it came to our knowledge that Hittorf, in 1851, had experimented on silver sulphide fused into solid cylinders, and showed that the sulphide is electrolysed with the formation of threads of metallic silver. This we confirmed, working with tightly compressed powder; and we observed that the current was at first small, but rose gradually, and then jumped to a much greater value, no doubt at the moment when the space between the poles was bridged over by the metallic threads. Under the microscope the reduced silver seemed to be fused. Hittorf observed a similar decomposition of cuprous sulphide.

The following are the additional results we have arrived at:—

Lead Sulphide.—This compound, whether in the form of powdered galena or the precipitated sulphide, conducts pretty easily. It always gave a slight indication of

polarisation after the current had passed through, but so slight that it might have been due to impurity. The conduction was almost entirely non-electrolytic.

Copper Sulphide, CuS.—This compound also, whether fused and powdered or obtained as a precipitate, conducts readily enough. When silver electrodes were used no polarisation could be detected. With platinum electrodes very little. The silver plates remained bright when the fused sulphide was employed; with the precipitated substance they were both marked.

Iron Sulphide.—Natural iron pyrites gave no polarisation or discolouration of the silver electrodes. An artificially-prepared fused compound gave a little polarisation, but its composition varies.

Bismuth Sulphide.—Conducts very little. No polarisation was obtained.

Mercury Sulphide (cinnabar).—Same results.

Potassium Sulphhydrate.—Dried at a red heat, this was found to be a non-conductor. The same appears to be true of the *sulphides of calcium and barium.*

It appeared, therefore, that solid sulphides divide themselves into two classes: those which are electrolysed, and those which conduct with little or no decomposition. Now it happens that the two sulphides which are easily electrolysed—namely, the silver and cuprous sulphides, are of analogous constitution, Ag_2S and Cu_2S , and differ in that respect from the others. It occurred to us that the thallium sulphide Tl_2S might be like them. Mr. Crookes kindly gave us some small bars of this compound, saying at the same time that he had found its power of conducting electricity to be very rapidly augmented on heating. We found that it rapidly increased in conductivity to about 105° , about which temperature it also softened, and the conduction was accompanied by considerable electrolysis. We dissolved up this specimen and estimated the thallium and sulphur. The results showed that it contained much more sulphur than the compound Tl_2S . It was probably a mixture of that body with the compound Tl_2S_3 , which is said to be soft even at a summer temperature.

We therefore prepared a specimen of the thallious sulphide Tl_2S ourselves, and, after carefully drying it at 125° in a current of carbonic acid, found it on analysis to be nearly pure Tl_2S . This compound was not melted even at a temperature of 290° – 300° C. It shows a small conduction at ordinary temperatures, and up to 100° , after which it increases slowly to about 170° . Beyond this the increase is more rapid.

Throughout the greater part of this range of temperature—that is, from 50° upwards—there was evidence of polarisation, the value of which increased very rapidly as the temperature rose from 100° to 130° . Measurements were made by the potentiometer method, the highest value obtained being very nearly 0.3 volt.

The results, therefore, in this case agree with our anticipation that solid sulphides similar in constitution to the silver and cuprous sulphides are capable of being electrolysed; while solid sulphides of the type MS conduct with little or no decomposition.

On the Electrolysis of Thallium Trisulphide.

By J. H. GLADSTONE, Ph.D., F.R.S., and W. HIBBERT, F.I.C.

In a communication made to the Committee in the early part of this year we gave the results of some experiments on the electrolysis of solid sulphides. It was pointed out that the sulphides electrolysed up to that time—silver and cuprous sulphides—were of analogous constitution, containing two atoms of metal to one of sulphur. Led by this circumstance, we succeeded in getting electrolysis of another similar compound—thallious sulphide, Tl_2S .

Some of our early experiments happened to be made with a compound containing more sulphur than that required by the formula Tl_2S , and this suggested an attempt to electrolyse the compound of thallium and sulphur which has the formula Tl_2S_3 . This compound is soft and plastic at the temperature of a warm summer day, and might reasonably be expected to show electrolysis.

We found some difficulty in preparing the compound by the method given—*i.e.*, by fusing thallium with excess of sulphur, and driving off the excess at a very high

temperature. It was much easier to obtain it by first making some pure Tl_2S and then gently heating this with the theoretical amount of finely-divided sulphur. At about the melting-point of sulphur ($120^\circ C.$) combination ensues, and at a slightly higher temperature appears complete. Thus prepared, Tl_2S_3 is a dark grey compound, behaving like an extremely viscous body. Under comparatively slight pressure, and at ordinary summer temperatures, it can be easily bent and moulded.

In testing whether this compound could be electrolysed, we enclosed a little of it in a glass tube and then pressed a metallic electrode into contact with it at each end. Sometimes these electrodes were made of silver, but in most of the experiments they were of platinum.

Three Grove's cells were employed. The resistance of the trisulphide was very high, and the deflection, even when using a high-resistance Thomson reflecting galvanometer, was generally small. At $12^\circ C.$ the current was very weak, but it showed a tendency to increase if the battery was left on for an hour or two. The polarisation was not detectable with such a small current. At temperatures ranging from 20° to 40° or $50^\circ C.$ the current increases, and polarisation becomes evident. The values obtained for the polarisation E.M.F. vary so much with the temperature and the duration of the electrolysing current that only an approximation can be stated. Generally speaking, the polarisation E.M.F. increased with the electrolysing current, and reached in some cases a value somewhat over half a volt. In one case a potentiometer measurement indicated approximately 0.8 volt.

It was observed, after all the experiments, that the pellet of trisulphide was no longer plastic, but had become hard and brittle. As this might be indicative of a change in composition, a little of the sulphide, simply enclosed in a glass tube, was sometimes placed in the water-oven along with the specimen undergoing electrolysis. At the close the two specimens presented about the same degree of hardness and brittleness; and we therefore concluded that the trisulphide is subject to a molecular change through heat, independent of any effect due to electrolysis.

The effect of the molecular change was evident during the experiments. After an hour or so of heating the current would begin to diminish and fall towards zero. The diminution was probably caused by an increase in the resistance of the trisulphide, seeing that the polarisation E.M.F. was little altered so long as it could be measured. It was this phenomenon that generally brought the experiments to a close.

We thought this increased resistance might be due to a decomposition of the compound Tl_2S_3 at the temperature employed (30° – 50°), accompanied by a separation of sulphur. On trying, however, to obtain evidence of such separation, by treating the specimens with carbon bisulphide, we quite failed. Only a trace of sulphur was separated, and the quantity was practically the same from both the original and the changed specimens.

The alteration in properties, which we have supposed to be due to a molecular change, has a considerable bearing on the interpretation of the results; for in its plastic form the trisulphide can hardly be looked upon as a solid comparable with the cuprous, argentic, and thallic sulphides. In the hard and brittle form it can hardly be classed as a conductor. Thus our previous conclusion is not invalidated by it.

On the Polarisation of small Electrodes in Dilute Sulphuric Acid.

By Dr. FRANZ RICHARZ, of Berlin.

I examined the greatest value the electro-motive force of galvanic polarisation possesses with platinum wires of very small surface in the electrolysis of dilute sulphuric acid.

I. Older experiments by Buff (Pogg. 'Ann.' 130, p. 341, 1867) and Fromme (Wied. 'Ann.' 33, p. 80, 1888) have given under those conditions 3.3 and 4.3 Daniells for the maximum. In these experiments the polarisation is calculated from measurements of the intensity of the galvanic current during the electrolysis, tacitly assuming that the resistance of the decomposition cell is independent of the intensity of the galvanic current. The correctness of this supposition has not

been proved. I tried experiments by similar methods, and obtained yet greater values of the polarisation; it was calculated with a current density of 12 ampères per square centimetre as 4.4 Daniells, and increased more and more with increasing intensity of the galvanic current. It is very improbable that this can be right. By supposing, however, that the resistance of the decomposition-cell is not independent of the intensity, but decreases in a fixed manner with increasing intensity, the calculation of the same experiments gives small and constant values of polarisation.

II. Such a decrease of the resistance of a decomposition-cell with very thin platinum wires with increasing intensity may be inferred from the following reasons:—

(a) The resistance of the cell has its principal seat in the fluid layers immediately near the electrodes. These layers, however, grow warmer the greater the intensity is, and the warmer these layers are, the less their resistance will be. The heating so produced can be very great. Calculation shows for my experiments that (loss of heat not being taken into account), at the greatest intensities employed (*circa* 1 ampère), the fluid immediately at the electrode is heated to boiling heat after a seventh of a second. The heating is proved experimentally by the appearance of a phenomenon very similar to Leidenfrost's phenomenon, and depending on the formation of a steam-case round the electrode.

(b) With small intensities the evolution of gas does not take place over the whole wire but only on some spots of it; with the least intensities only on one spot.

(c) The diffusion in the fluid of the gases evolved by electrolysis corresponds to a 'transition-resistance' (H. von Helmholtz, 'Sitzungsber. d. Berl. Akad.' 1883, p. 664). That resistance must relatively be the more important as compared with the other effects in the cell, the smaller the latter are; therefore it must appear as a resistance increasing with decreasing intensity.

These three causes produce a considerable decrease of the resistance with increasing intensity. The hypothesis according to which the methods mentioned under I. gave such very high values for the polarisation is thus not fulfilled.

III. I have made measurements of the polarisation of very thin platinum wires in sulphuric acid, by a new method, which is independent of the resistance of the decomposition-cell. The circuit of the galvanic current, which contains the polarising battery B and the cell z , is closed by the first contact c_1 of Helmholtz's pendulum-interrupter (Wied. 'Electr.' iv. p. 219, 227). A branch wire proceeds from either side of c_1 to a galvanometer g . This branch circuit includes the second contact c_2 of the pendulum-interrupter, and a very great resistance (40,000 Siemens units). While c_1 is closed the current is very weak in the galvanometer. In the short time between the interruption of c_1 and c_2 a current, strong for the sensibility of

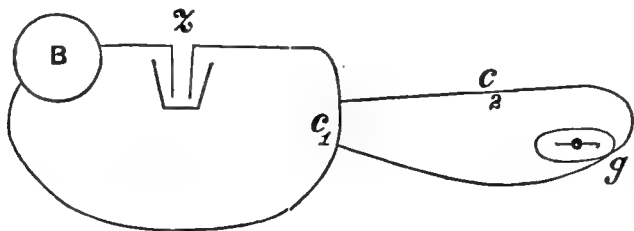

the galvanometer, goes through it. The impact of the galvanic current is proportional to the electromotive force of the battery minus the polarisation. From the deflection of the galvanometer I can calculate the mean value of the polarisation in the time between the interruptions of c_1 and c_2 , and by diminishing this time more and more I can judge if the polarisation during this time has already decreased considerably. I shortened that time to 0.00059 second, and diminished the surface of the platina wires to 0.8 sq. mm., and increased the intensity at those electrodes to 0.4 ampère. The values of polarisation which I found were never greater than nearly 2.4 Daniells, and, taking account of the decrease of polarisation, its value before

the interruption would amount to at most 2.5 Daniells. That is, the same maximum as was found for the polarisation also with large platinum plates in dilute sulphuric acid. Now, with thin wires a great deal of ozone, peroxide of hydrogen, and persulphuric acid is evolved at the anode; at plates only common oxygen. As the electromotive force of polarisation has the same value in either case, it is to be concluded from the facts that the evolving of those hyper-oxides has no influence upon the polarisation; and, further, that the primary electrolytical process by which the strength of the polarisation is chiefly conditioned is the very same during the development of common oxygen as at the evolving of O_3, H_2O_2 and $S_2O_8H_2$ from dilute sulphuric acid.

IV. The influence of the formation of $S_2O_8H_2$ on the polarisation may be judged, too, from the electromotive behaviour of platinum in $S_2O_8H_2$. I found the electromotive force

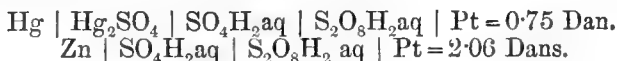

From which may be calculated



In this last cell the process effected by the galvanic current is the reduction of the persulphuric acid, according to the formula



Its heat of formation (Berthelot, 'Compt. Rend.' 90, p. 331, 1880) is equivalent to 0.56 Daniell. It is to be concluded from the conformity of the found with the calculated value that the reduction of the persulphuric acid in that cell is a primary electrolytical process. Besides, it must seem very probable that the formation of $S_2O_8H_2$ at the anode, also corresponding to the inverse process, is a primary electrolytical process. To its chemical heat of formation a polarisation of the anode of 0.56 Dan. would correspond. Generally, however, neither the polarisation alone is given by the chemical heat, nor is $S_2O_8H_2$ alone formed under any circumstances at the anode.

Reply to Professor Armstrong's Criticisms regarding the Dissociation Theory of Electrolysis. By SVANTE ARRHENIUS.

In his communication at Manchester to the Electrolysis Committee of the British Association, Professor Armstrong has honoured my views on electrolysis with a critical analysis from a chemist's point of view. In the following lines I will attempt to show how the chief objections that he has made can be removed, and also that his views present difficulties which greatly militate against their acceptance.

1 and 2.¹ Professor Armstrong finds it difficult to explain why some single bodies, *e.g.*, silver iodide, conduct electrolytically, whereas other pure bodies, *e.g.*, water or hydrogen chloride, are non-conductors. We certainly are bound to assume that fused silver iodide is to a sensible degree dissociated into its ions, and that the dissociated parts of the non-conductor escape our observation. But it may be remarked that no exact comparison can be made between the two cases, silver iodide being examined at temperatures above 530° (the melting-point of AgI), H_2O and HCl at ordinary temperatures, it being very probable that dissociation increases rapidly with the temperature. Also, too much stress must not be laid on the behaviour of pure bodies or of concentrated solutions, as experience shows that dilute solutions are characterised by very remarkable regularities, analogous to those which obtain in the case of gases, and that these regularities vanish as the solutions attain a greater degree of concentration; indeed, there seems to be no connection between the facility with which compounds are electrolytically dissociated in dilute solutions and the stability of the same compounds in the pure

¹ The numbers correspond with same numbers in Professor Armstrong's paper above referred to, 'Comparison between the Views of Dr. Arrhenius and Professor Armstrong on Electrolysis.' See 1887 Report, p. 354.

state, as Faraday has already remarked. Because of the regularities which characterise dilute solutions, the dissociation hypothesis has reference almost exclusively to matter in this state, and has, in my opinion, very successfully explained a great many of its properties.

3. Professor Armstrong asserts that solutions in absolute alcohol oppose a practically infinite resistance. This view is not supported by the recent investigations of Fitzpatrick and Hartwig, from which it seems to follow that 'any neutral solvent renders electrolysis possible,' in accordance with the demands of the dissociation electrolytic hypothesis.

4. According to Professor Armstrong, on the dissociation hypothesis, both water and salt are to be regarded as dissociated; nevertheless, the dissociation hypothesis assumes that conduction takes place only through the agency of the atoms of the dissociated salt, and not at all through that of the water. From chemical facts, *e.g.*, the partial decomposition of certain salts into base and acid by large quantities of water, it is very probable that water is to a very slight degree dissociated into H and OH.¹ But experiments show also that this occurs to an extent so extremely small that it will perhaps for ever be impossible to detect it by measuring the conductivity of water. Also, I have essayed to show that the only fact cited in favour of a sensible conductivity of water can be satisfactorily explained without this assumption. In the same manner, different electrolytes, *e.g.*, HCl and C₂H₃O₂H, are very differently electrolytically dissociated by the same quantity of water, so that the one conducts very well, the other hardly sensibly; but we know representatives of all intermediate stages between these two extremes, so that there is no ground for assuming anything but a quantitative difference. Experiments on the conductivity of pure water, or of dilute salt solutions, lead to the assumption that water is not dissociated to any perceptible degree. If, therefore, as Professor Armstrong asserts, the opinion is common among chemists that in the case of the electrolysis of ammoniacal solutions water is (sensibly) electrolysed, then is this opinion a remnant of old views now abandoned through force of incontestible arguments?

6. In his article Professor Armstrong makes no objection to the dissociation electrolytic hypothesis, but says: 'I do not mean for one moment to assert that anything which we know of the conditions on which chemical change depends negatives beyond question the dissociation hypothesis.'

7. Professor Armstrong interprets the figures of Lenz concerning the parallelism between diffusivity and conductivity of alcoholic aqueous solutions as an 'almost conclusive argument in favour of his theory.' It must be remarked that there are many exceptions to this rule. Thus, *e.g.*, MgSO₄ and cane sugar diffuse nearly at the same rate (Graham), although in aqueous solutions MgSO₄ is a good conductor, while cane sugar seems not to conduct at all; consequently, the two phenomena are not of the same order, as they should be according to Professor Armstrong's hypothesis. 'The diminution in conductivity and also in diffusivity as the amount of alcohol is increased is most striking. If the solvent be neutral, the substitution of alcohol for water should have little influence; but if, as I suppose, the solvent be active, alcohol being far less active than water, the effect to be expected is precisely of the nature of that observed.' In coming to this conclusion a very important thing is lost sight of. The conductivity depends on two circumstances—*viz.*, the degree of electrolytic dissociation, and the friction which the ions must overcome in their passage through the solution. The first circumstance must, as Professor Armstrong asserts, have but little altered in Lenz's experiments with diluted KI and NaI; the diminution in conductivity must consequently have chiefly depended on the increase of the friction with the quantity of alcohol, which is *à priori* very probable. Evidently one must expect that the diffusivity also diminishes as the internal friction increases, and in this manner the parallelism between conductivity and diffusivity in Lenz's figures is quite explicable by means of the electrolytic dissociation hypothesis.

8. 'Why, then, should it (the electromotive force) not give direction to the moving molecules, if these are still possessed of "residual affinity"—*i.e.*, if some

¹ Wied. *Annalen*, xxxiii., p. 58, and *Phil. Mag.* (5), xxiv., p. 377.

portion of the original charge of the atom be still unneutralised?' According to this passage I cannot understand Professor Armstrong to mean otherwise than that the molecules will be directed by the electromotive forces, and consequently themselves move along the lines of flow. This way of viewing the question would lead one to expect the molecules to separate at the electrodes; but it is found experimentally that not molecules but ions are transported to the electrodes.

9. Professor Armstrong finds it difficult to explain why phenylpropionic acid $C_6H_5.C\equiv C.CO_2H$ conducts better—*i.e.*, is more dissociated, than hydrocinnamic acid, $C_6H_5.CH_2-CH_2.CO_2H$. But there are other peculiarities, which, perhaps, are very nearly connected with this circumstance, *viz.*, the physical properties (heat of combustion, refraction of light), which indicate that the triple union in $C_6H_5.C\equiv C.CO_2H$ is less firm than the simple union in $C_6H_5.CH_2-CH_2.CO_2H$.

10. The formula proposed by Professor Armstrong—

$$C = E/R,$$

'C being the amount of change, E the intensity of the total chemical effect,' and R the resistance of the solution in which the interaction takes place, is not verified by experience. Thus, in the case of the hydrolysis of ethylic acetate by means of bases, 'the intensity of the total chemical effect' (E) must be but very little influenced by the presence of neutral salts; R, on the contrary, very much. But experience shows that 'the amount of change' (the velocity of interaction C) alters but very little (for strong bases) if R be increased by addition of neutral salt from 1 to about 20. In the case of ammonia C decreases extremely rapidly, when R decreases in consequence of added neutral salt. These phenomena are easily explained by the electrolytic dissociation hypothesis, the velocity of interaction being proportional to the quantity of OH in the form of ion.

The arguments brought forward by Mr. Crompton on the conductivity of sulphuric acid seem to me not very convincing in favour of the view that hydration of H_2SO_4 should condition the electrolytic conductivity.¹ There is no reason mentioned why the second derivative d^2k/dp^2 (where *k* is conductivity and *p* concentration of the acid in per cents.) should have angular points at the places mentioned; on the contrary, the author says that he had expected to find such angular points in the dk/dp curve, but when he did not find them there he proceeded to the examination of d^2k/dp^2 . The author does not take heed of the errors of experiment; a search would probably have shown that these errors in many cases are of the same magnitude as d^2k/dp^2 itself.² Further, the author does not find the same hydrates as Mendelejeff ($H_2SO_4 + 24 H_2O$ not appearing in Mendelejeff's curve, $H_2SO_4 + 6H_2O$ not being marked by Crompton's curve). The part of Crompton's curve between H_2SO_4 and $H_2SO_4 + 2H_2O$ can hardly be considered as consisting of two straight lines, as the author asserts. The artificial nature of the proposed formulæ is manifested by the circumstance that they give very different values of *k* at the limiting points where two formulæ should be applicable. Moreover, there is a very important difference between the views of Mendelejeff and of Crompton. Mendelejeff says, 'Ich habe schon lange die schwachen Lösungen als die interessantesten angesehen und dieselben dem zerstreuten oder verteilten Zustande der Materie in Dampfform an die Seite gestellt. Die bemerkenswerten Untersuchungen von van 't Hoff haben gegenwärtig dafür einen vollständigen Beweis erbracht,' whereas, according to Mr. Crompton, dilute solutions are characterised by their irregularities.

The above observations will, I believe, suffice to show that the objections

¹ In saying this I wish not to deny that some (but very few) hydrates (*e.g.*, $H_2SO_4 + H_2O$, as Kohlrausch has stated) exert an influence on the conductivity, but only to say that the assertions of Mr. Crompton are to a very high degree exaggerated.

² Being fully conscious that existing data are insufficient for the complete discussion of the problem, Mr. Crompton is engaged in determining the change in conductivity with concentration of a number of solutions; and with the object of discriminating between errors of experiment and true changes in direction of the curves he is paying particular attention to the influence of temperature (H. E. A.).

urged against the dissociation electrolytic hypothesis are unsatisfactory, and that the arguments in favour of the residual affinity hypothesis need a more convincing corroboration than hitherto given. On the other hand, the dissociation electrolytic hypothesis has latterly acquired a highly increased probability, as the lowering of the freezing-point on addition of salts to water, and the additive properties of salt solutions can be explained by it. In a preliminary notice Ostwald has announced that the conductivity of acids and bases can be calculated upon the basis of this hypothesis; and in a paper soon to be published in the 'Zeitschrift f. Phys. Ch.' I will attempt to prove that the known facts regarding conductivity of mixtures, velocity of interaction, and double decomposition between electrolytes can easily be accounted for on the same hypothesis.

Note on the foregoing Reply. By HENRY E. ARMSTRONG.

It is not, I think, desirable for me to attempt to reply at length to Dr. Arrhenius; evidently he retains his original position, but apparently he has not appreciated the character of all my arguments. Thus I cannot imagine how he conceives (§ 9) that any conclusion as to the triple union in the acid $C_6H_5.C\equiv C.CO_2H$ being less firm than the simple union in $C_6H_5.CH_2-CH_2.CO_2H$ —which I entirely dispute (*cf.* 'Phil. Mag.' 1887, 23, 103)—affects the question at issue, which is whether phenylpropionic or cinnamic acid is the more readily separable into its ions, *i.e.*, $C_6H_5.C\equiv C.CO_2$ and H in the one case, and $C_6H_5.CH_2.CH_2.CO_2$ and H in the other.

R in the formula $C = E|R$ (§ 10) was never regarded by me as simply the resistance of the *solution* in which the interaction takes place; it is the resistance of the *circuit* in which interaction occurs. This latter may be quite different from the former, as of a number of substances in solution some only may be capable of entering into the true circuit of change. The influence of added neutral salt may be of a very complex character, and until we know more of the constitution of solutions it is very difficult to arrive at any decision as to its exact character.

No doubt I exaggerated, and should have said (§ 3) that the resistance of alcoholic solutions is very great in comparison with that of corresponding aqueous solutions. I cannot accept either Fitzpatrick's or Hartwig's results as final, interesting as they are, as they were obtained with 'commercial' alcohols; it is very important that *pure* alcoholic solutions should be examined, but this would be a task of exceptional difficulty.

Dr. Arrhenius says (§ 7) that diminution in conductivity on addition of alcohol must chiefly depend on the increase of friction with the quantity of alcohol, *which is à priori very probable*. But is it? We know that alcohol does occasionally form compounds corresponding to hydrates, but as a rule they are far less stable than the hydrates. To the chemist it would therefore seem probable, *à priori*, that friction would diminish with the quantity of alcohol. Cane sugar, as Dr. Arrhenius points out, appears not to be a conductor in aqueous solution, nor is water: therefore, neither is appreciably dissociated in aqueous solution, according to the dissociation hypothesis; yet cane sugar may be hydrolysed by mere heating with water alone. This and a multitude of similar facts appear to me to weigh heavily against the dissociation hypothesis.¹

I cannot believe that the sudden increase in conductivity of solid silver iodide (§§ 1, 2) at about 150° is due to a sudden dissociation of the molecules into

¹ The hydrolysis of cane sugar under such circumstances is conceivably conditioned by the presence of metallic salts, derived from the glass vessel in which the operation is performed. A more effective argument is supplied by the extraordinarily rapid hydrolysis of cane sugar, which is induced by the unorganised ferment *invertase*, derivable from yeast. As typical of the mode of action of such a substance, I may refer to the hydrolysis of the isocyanides R.NC of Gautier and Hofmann, which are unaffected by alkalis, but immediately attacked by aqueous acids: it is significant that these cyanides form crystalline *compounds* with hydrogen chloride and a number of anhydrous acids, and that the compounds at once interact with water.

the constituent atoms or ions; the change appears to me to be precisely of the character of that which occurs when ice suddenly liquefies at 0° , and may equally be regarded as the result of a sudden alteration in molecular structure.

I will only add that I have attempted to take into account the properties of matter in all states, not merely the state of extreme dilution.

The following remarks by the Chemical Secretary, Dr. Armstrong, are appended, in order to direct attention to what he considers the uncertainty in which our conceptions of the fundamental phenomena of electrolysis are still enshrouded, notwithstanding the very definite assertions of recent foreign workers:—

There can be no doubt that the work done during the past year—which in many ways has been one of remarkable activity¹—has tended more and more to favour the acceptance of the dissociation theory of electrolysis, that the conviction has been strengthened that electrolysis is primarily an affair of atoms: indeed, so far has this idea gained ground, that it is even argued by Arrhenius, whose conclusions are accepted by Ostwald and others, that in dilute solutions of hydrogen chloride, for example, as much as 90 per cent. of the HCl is dissociated into its ions. Prof. J. J. Thomson, in his recent work, 'Applications of Dynamics to Physics and Chemistry,' has, I think, very happily criticised this conclusion in the following passage (p. 213):—

'The reasons given for this conclusion do not seem to me to be very convincing, and the experimental results on which they are based seem to admit of a very different interpretation. The supporters of this theory urge that, for the salt to produce the effect which in some cases it does, it is necessary to suppose that the molecules of the salt exert a greater pressure than they would if they occupied the same volume at the same temperature when in the gaseous condition. This reasoning is founded on the assumption that all the effects due to the dissolved salt may be completely explained merely by supposing the volume occupied by the solvent to be filled with the molecules of the salt in the gaseous condition. Now, though we may admit that the salt does produce the effects that would be produced by this hypothetical distribution of gaseous molecules, still it does not follow that these are the only effects produced by the salt. The salt may change the properties of the solvent, and the effects attributed to the dissociation of the molecules may in reality be due to this change.'

Deville, who studied the behaviour of hydrogen chloride at high temperatures by means of his well-known apparatus with an internal cooled tube, observed only traces of dissociation at 1300° , and Crafts and F. Meier could detect no appreciable dissociation in porcelain vessels at 1500° , although in platinum at about 1700° , according to Victor Meyer and Langer, it is to a considerable extent resolved into the component elements. That a gas of such stability should be almost entirely dissociated by mere dissolution in water is to me incredible.

Apart from actual electrolytic studies such as those of Arrhenius and Ostwald, the most important influence in forming opinion has been exercised (*a*) by van 't Hoff's masterly generalisation (*cf.* 'Phil. Mag.,' 1888, 26, 81), to which Prof. J. J. Thomson is referring in the above-quoted passage, that the molecules of dissolved substances in dilute solutions exert the same pressure as they would if they were in the gaseous state at the same temperature and volume; and (*b*) by the introduction of Raoult's method of ascertaining molecular weights of dissolved substances by determining the extent to which they depress the freezing-point of the solvent (*cf.* 'Chemical Society's Transactions,' 1888, 610). While recognising the beauty of the conceptions, and while ready to admit that they may be applicable in many cases, my opinion is very much that expressed by Prof. J. J. Thomson. I agree with him that it is both possible and probable that a change in the constitution of the solvent is effected by the dissolved substance (*cf.* 'Chemical Society's Transactions,' 1888, 125). The extraordinary effect on the properties of gold and copper, for example, of small amounts of certain foreign matters, so well known to

¹ *Cf.* Ostwald and van 't Hoff's *Zeitschrift für physikalische Chemie*.

electricians in the case of copper, and which has recently been brought prominently into notice in the case of gold by Prof. Roberts-Austen, may be cited in illustration of the kind of effect on the solvent which conceivably may arise.¹

The arguments in favour of the dissociation theory appear indeed to be based on a narrow interpretation of the results: the dissolved substance alone is regarded as active, the solvent is neutral; the indubitable complexity of the phenomena of dissolution and of chemical interchange generally is entirely left out of consideration. Many chemists and physicists continue to regard values as simple constants which there is the strongest reason to believe are composite. The law of the constancy of the so-called atomic heats of the elements is an illustration. It is well known that in the case of the majority of the elements the product of specific heat by atomic weight is approximately a constant: we are thereby enabled in many cases to determine *atomic* weights, but, be it noted, by a measurement effected with the aid of molecules, not of atoms; these molecules are undoubtedly of very varied atomic complexity, and it would seem that we are bound to assume that the nearly constant value of the so-called atomic heat is the outcome of a kind of balance—that as, in raising the temperature of a solid, work is done *inter-* and *intra-*molecularly, the amount of intermolecular work is greater in some cases and less in others, and the amount of intramolecular work proportionally less or greater, the amount per atom being, however, about the same in most cases. May we not interpret the simple results obtained by Raoult's method in a similar manner? Is it not probable that the effects are in reality often produced by molecular complexes of the *fundamental* molecules, the latter corresponding to the atoms to which we refer the result in discussing variation of specific heat with atomic weight? Perhaps it is only in cases in which *atomic* rearrangement has taken place that Raoult's method affords evidence of increased molecular complexity, as in the case of aldehyde and paraldehyde, for example; in such a case as that of dextrose, which, whether freshly dissolved or not, produces an effect such as is required on the assumption that its molecule has a weight corresponding to the formula $C_6H_{12}O_6$, there may be no atomic rearrangement but the mere juxtaposition of molecules involved in the formation of a 'molecular' compound.

Arrhenius, Ostwald and others regard both electrical conductivity and chemical activity as similarly conditioned by the degree of dissociation—in their opinion, very active substances, such as sulphuric acid, are to a large extent dissociated in solution; inert substances, such as acetic acid, are but to a slight extent dissociated in solution. But the adherents of this school all overlook the fact that there are two distinct theories of chemical interchange: the older theory that the interacting molecules initially combine and that the resulting complex then splits up—which may be termed the integration theory; and the more modern dissociation theory. I am led to regard the former as the more comprehensive and generally applicable, especially as comparatively so few compounds are electrolytes, and I venture to think that physicists also would incline more to my belief if they would assume a somewhat different mental attitude towards the facts, and would seek to fully unravel the entire series of changes involved in chemical interactions.

The attention of the Committee has in previous years been directed to the question whether electrolytic conduction and metallic conduction are sharply separated from one another, and last year experiments by Prof. Roberts-Austen were described which appeared to show that alloys do not conduct electrolytically. Prof. J. J. Thomson deals with this question in his already-mentioned work in the following passage (p. 296):—

'There does not seem any necessity for supposing that the passage of electricity through metals and alloys is accomplished in a fundamentally different way from that through gases and electrolytes. For the chief differences between conduction through metals and through electrolytes are—(1) that in electrolytic conduction the components of the electrolyte appear at the electrodes, and we have polarisation;

¹ Prof. Roberts-Austen informs me that the melting-point of gold is lowered to about that of zinc by $\frac{2}{1000}$ of silicon.

and (2) that the conductivities of electrolytes increase while those of metals diminish as the temperature increases.

'A little consideration will show that we could hardly expect to detect [polarisation] in the case of metals or alloys, for here instead of, as in electrolytes, the property of splitting up being confined to a few molecules sparsely scattered through a non-conducting solvent, the whole of the molecules can thus split up; thus the rate of disappearance of any abnormal condition would be almost infinitely greater than in the case of electrolytes, so that if any polarisation were produced it would probably die away before it could be detected. The only case in which we could expect to detect the appearance of the constituents of the conductor at the electrodes is that of the alloys, but even in this case Prof. Roberts-Austen was unable to detect any change in composition in the alloy round the electrodes. We must remember, however, that an alloy differs very materially from an electrolyte, because while in the latter we have a few active molecules embedded in a non-conductor, in the former it is as if the solvent as well as the salt conducted, so that the discharge is not concentrated on a few molecules of definite composition, but can travel by an almost infinite variety of paths.

'Then, again, the statements about the effect of heat on the conductivity of elements and electrolytes though true in general are subject to exceptions; thus, the conductivities of selenium, phosphorus and carbon increase as the temperature increases; that of bismuth is said to increase at certain temperatures; and I have lately found that the conductivity of an amalgam containing about 30 per cent. of zinc and 70 of mercury is greater at 80° than at 15°. We must remember, too, that the rate of increase of conductivity with temperature for electrolytes diminishes as the concentration increases. No sharp line of demarcation can therefore be drawn between the two classes of conductors on this account.

'There does not seem any difference between metallic and electrolytic conduction which could not be attributed to the vastly greater number of molecules taking part in metallic conduction, whilst assuming that in all cases the current consists of a series of intermittent discharges caused by the rearrangement of the constituents of molecular systems.'

I call attention to Prof. J. J. Thomson's remarks both on account of their suggestiveness and in order to point out that we are not in a position to make any such statement as the above regarding selenium, phosphorus and carbon. All observers hitherto have dealt with more or less *impure* substances—everyone, in fact, knows that the so-called carbon which conducts is not carbon at all in the true chemical sense. The conductivity of the substances in question may well be conditioned by the presence of the associated impurities, just as that of water appears to be, and hence their behaviour as electrolytes in respect of temperature changes; Shelford Bidwell's experiments with selenium distinctly favour this view. The differences between metals and non-metals are so great that the chemist has difficulty in resisting the conclusion that there is some very radical distinction to be drawn between metallic and non-metallic matter, although in practice it is impossible to say where metals end and non-metals begin. If it be found that the more nearly pure a non-metal is the greater is the resistance which it opposes, it will some day be possible, perhaps, to classify the elements into metals and non-metals on the basis of their electrical behaviour. In the hope of obtaining evidence on this point I have latterly been engaged in purifying selenium, with the object ultimately of determining its specific resistance; it appears highly desirable that 'metalloids' such as arsenic and antimony should also be carefully examined from this point of view.

The increase in conductivity of bismuth and of Prof. J. J. Thomson's zinc amalgam at higher temperatures may well be due to a change in molecular composition, such as occurs in solid silver iodide, for example; both are cases in which the occurrence of such a change may be considered as probable. That molecular structure is an all-important element in influencing conductivity is all but established by the extraordinary diminution in conductivity effected by minute quantities of foreign elements in the case of copper, for example. In short, I am of opinion that as yet there is no experimental evidence to justify any modification of the time-honoured

conclusion that electrolytic and metallic conduction are essentially distinct phenomena.

Considerable discussion has taken place during previous years in the Committee as to the theoretical determination of E.M.F. on the lines originally indicated by Sir Wm. Thomson from thermochemical data, and attention has been directed to the necessity of taking into account reversible heat effects. I may be allowed to reiterate the opinion that the evidence tending to throw doubt on Sir Wm. Thomson's law connecting the E.M.F. of a cell with the attendant chemical changes cannot as yet be regarded as in the least degree conclusive, and I venture to offer a brief criticism on the experimental work which has been done in this direction—chiefly by F. Braun (Wiedemann's 'Annalen,' 1882, 16, 561; 17, 593) and by Wright ('Proceedings of the Physical Society'), who have measured the E.M.F.'s of a large number of different cells, and have compared the values found with those calculated from the chemical changes which they *assume* take place in them. The calculated and observed E.M.F.'s were found to agree in only a limited number of cases; in a considerable number the observed E.M.F. fell more or less below that calculated; in a few it was greater; and Wright has specially instanced a number of cells in which the current flows in the opposite direction to that which was to be anticipated.

The measurement of E.M.F. was made either by means of an electrometer; or with a galvanometer, *using currents of very small intensity*; and there is no reason to doubt the results. But both observers were, as I have said, content to *assume* that the chemical changes were of a particular kind, and made no attempt whatsoever to study them in detail from the chemist's point of view.

Now it has been pointed out by Laurie ('Phil. Mag.' August 1886) that the extraordinary results obtained by Wright with aluminium zinc cells, which give an E.M.F. opposed to that calculated from the thermal data (of no less than 1.5 volt in the case of the sulphates), are to be accounted for on the assumption that he was not dealing with aluminium at all but with *aluminium oxide* supported on an aluminium plate. It appears to me, then, that the whole of Braun's and Wright's results are open to this criticism, as the method of measurement which they adopted is one that would permit every surface impurity, every impurity in the

		Chemical Energy in heat units		Observed relative E.M.F.
		Absolute ¹	Relative	
1	{ Zn—H ₂ SO ₄ +100H ₂ O	50,130	1	1
	{ Cu—conc.CuSO ₄ ,Aq			
2	{ Zn—H ₂ SO ₄ ,Aq	16,210	.32	.32
	{ Cd—conc.CdSO ₄ ,Aq			
3	{ Zn—HCl,Aq	54,080	1.08	1.065
	{ Ag—AgCl			
4	{ Zn—H ₂ SO ₄ +100H ₂ O	96,080	1.92	1.86
	{ Carbon—HNO ₃			
5	{ Zn—H ₂ SO ₄ +100H ₂ O	82,810	1.65	1.69
	{ Carbon—HNO ₃ +7H ₂ O			
6	{ Zn—H ₂ SO ₄ +100H ₂ O	99,790	1.99	1.85
	{ Carbon—CrO ₃ +SO ₃ ,Aq			
7	{ Cu—H ₂ SO ₄ +100H ₂ O	45,950	.92	.88
	{ Carbon—HNO ₃			
7b	{ Cu—H ₂ SO ₄ +100H ₂ O	32,680	.65	.73
	{ Carbon—HNO ₃ +7H ₂ O			
8	{ Fe—FeCl ₂ ,Aq	44,410	.89	.90
	{ Carbon—Fe ₂ Cl ₆ ,Aq			

¹ To reduce heat units per dyad gramme-molecule direct to volts, use the divisor 46,000. The column headed 'relative' in the table would then run, 1.1, .35, 1.18 2.08, 1.80, 2.16, 1.00, .71, .97.

agents—not excluding dissolved oxygen—to exercise its proper effect. Julius Thomsen has expressly recognised this source of error, and has pointed out the absolute necessity of measuring the E.M.F. of the element in full activity if it be desired to determine the full effect produced by the chemical interchanges which are involved in its action ('Thermoch. Untersuchungen,' III., p. 487). On this account his comparisons of observed and calculated E.M.F.'s may well be set against those of Braun and Wright; they are as given on the preceding page.

When it is borne in mind that in the case of nitric acid the products of change gradually accumulate and produce an effect, the agreement between theory and practice is remarkable.

Braun argues that 'chemical energy' is of the form of heat energy, and that in its conversion into electrical energy in the cell there must therefore necessarily be some loss—some degradation; he terms that fraction of the total energy which takes the form of current the *electromotive efficiency* (Helmholtz's *Freie Energie*), and seeks to connect this with the dissociation temperature of the compounds formed at the electrodes. But if, to use Faraday's words, 'the forces termed chemical affinity and electricity are one and the same,' there is, I imagine, no *a priori* objection to be urged against Sir Wm. Thomson's law.

Braun has based a determination of the 'electromotive efficiency' of a number of chemical changes on the assumption that the E.M.F. developed, for example, between silver, silver bromide, bromine and platinum, is to be regarded as developed simply in the formation from silver and bromine of silver bromide: the value found was 84; that deduced from the heat of formation is 91; so the electromotive efficiency is $\frac{84}{91} = .93$. The experiments were made in a very careful manner, and excep-

tional precautions were taken in purifying and drying the materials, the bromine used being purified by Staa's method. But the fact that a current *was* produced between silver, bromine and platinum, and between silver coated with silver bromide, bromine and platinum is, to my mind, sufficient to throw doubt on the results. It is impossible to prepare *pure* bromine; and it is a fair assumption to make that, if the materials had been pure, no current would have been observed: the determination of the E.M.F. is therefore of uncertain value; the number deduced cannot have been the outcome simply of the formation of silver bromide, as secondary change must have taken place to some extent.

I therefore venture to think that, up to the present, no experimental disproof of Sir Wm. Thomson's generalisation has been given: on the other hand, the fluctuations in E.M.F. which accompany slight changes in composition—such as have been so clearly brought out by Lord Rayleigh's investigation of the Clark cell and by Wright's and Fleming's investigations of the Daniell cell—and also the influence which every change in the conditions exercises on the course of chemical change, would appear to favour the assumption that the electromotive efficiency of chemical change does not differ from the theoretical to the extraordinary extent that Braun suggests.

Before the temperature of dissociation can be taken into account as suggested by Willard Gibbs, we require to know to what extent this depends on the nature of the surface in contact with the dissociating substance.

It is also desirable that a clearer statement of the nature of the reversible heat effects should be given. I can picture to myself that on passing a current across a metallic junction the molecules become somewhat deflected from their original positions, or rotated, and that heat is developed on their subsequent return towards the normal position; but if this be the nature of the Peltier effect, and the converse action occur when thermo-electric currents are developed, it does not appear probable that the reversible heat effects at metal-liquid and liquid-liquid junctions would be of the magnitude to account for the extraordinary differences said to obtain in many cases between observed and calculated E.M.F.

Report of the Committee, consisting of Messrs. W. CARRUTHERS, W. F. R. WELDON, J. G. BAKER, G. M. MURRAY, and W. T. THISELTON-DYER (Secretary), appointed for the purpose of exploring the Flora of the Bahamas.

THE Committee accepted the proposal of the well-known Danish botanist, Baron Eggers, to undertake the work entrusted to them as far as the sum at their disposal would allow. Baron Eggers left Europe in November last and returned in April. Mr. Baker, the principal assistant in the herbarium of the Royal Gardens, Kew, has examined the collection transmitted by Baron Eggers to Kew (a similar one has been sent to the Botanical Department of the Natural History Museum). He has favoured the Committee with the following report upon it:—

The collection made by Baron Eggers contains representatives of 357 numbers. Of these eight are flowerless and indeterminable, and thirty-five represent duplicates or a second form of a species; so that the collection contains 314 species of which the genus can be determined, and these represent 214 genera and 74 natural orders. A catalogue has been made, which will be kept for reference at Kew.

Previous Collections.—A few species were collected in the Bahamas by Catesby early in the eighteenth century, some of which are figured in his 'Natural History of Carolina,' which was published in 1754. In Grisebach's 'Flora of the British West Indian Islands,' the first of the series of colonial floras issued from Kew, which was published in 1864, under 200 species are recorded from the group, mainly on the authority of a collection sent long ago by Mr. Swainson to Sir W. J. Hooker. Between 1877 and 1880 Mr. L. J. K. Brace sent, through Governor Robinson, to Kew seven parcels, containing in all 525 numbers. The collections of Swainson and Brace probably contain about 200 species not gathered by Baron Eggers, so that we now know from the Bahaman group about 500 species.

Analysis of the Bahaman Flora.—Grisebach considered, and no doubt rightly, that the Bahamas, with Turks Island, should be regarded botanically as a distinct province of the West Indian region. In the whole of the British West Indies about 3,000 plants are known. There are about twenty inhabited islands in the Bahaman group, none of which rise to any considerable elevation. Its area is given in the Colonial Office List at 4,466 square miles, which is a little more than that of Jamaica. The islands range over six degrees of latitude (21° to 27° N. lat.), and form the northern province of the West Indian region. It is only here that the Conifers form dense woods at a low level. The Bahaman *Pinus* is endemic, and is not included in Parlatore's monograph. Only the cones were known to Grisebach, but now Brace and Eggers have obtained full material. It has three leaves in a bundle and they are nearly a foot long, so that, as Grisebach suspected, it is allied to *Pinus Taeda*. Baron Eggers describes it as a tree forty feet in height with a trunk a foot in diameter. He has obtained flowerless specimens of the Bahaman cedar, which we did not before possess in the Kew Herbarium. So far as the material goes, it agrees with the Bermudan *Juniperus bermudiana*, which is also found in the mountains of Jamaica. In New Providence this also forms a tree forty feet in height. Several of the more tropical

West Indian orders, e.g., *Dilleniaceæ*, *Piperaceæ*, *Guttiferæ*, *Ternstroemiaceæ*, and *Gesneriaceæ*, are not represented in the Bahamas, and other large characteristically tropical orders, such as *Myrtaceæ*, *Lauraceæ*, and *Melastomaceæ* very feebly. The predominant orders are *Compositæ*, *Leguminosæ*, *Rubiaceæ*, and *Euphorbiaceæ*. There is a very large proportion of genera to species, no genus being represented by more than five or six species. A bamboo was collected without flowers, both by Brace and Eggers. There are three palms, all of which are widely spread West Indian types. Upwards of twenty shrubs, trees, and perennial herbs are supposed to be endemic in the Bahamas. Of these the most interesting are the *Pinus bahamensis* already mentioned; three *Mimoseæ*, *Mimosa bahamensis*, *Acacia acuífera*, and *A. coriophylla*; two *Compositæ*, *Vernonia bahamensis* and *Salmea petroboides*; one Passion-flower (*Passiflora pectinata*); *Croton Eluteria*, *C. Cascarilla*, and *Argithamnia sericea* in *Euphorbiaceæ*; in *Orchideæ*, *Bletia purpurea* and two or three Epidendrums; *Jacaranda bahamensis* in *Bignoniaceæ*; and *Phialanthus myrtilloides*, and *Stenostomum myrtifolium* in *Rubiaceæ*. The non-endemic plants of the group may be classified in three groups:—

1. Characteristically West Indian types.
2. Widely spread tropical American types.
3. Cosmopolitan weeds and shore plants, such as *Suriana maritima*, *Ximenia americana*, and *Ruppia maritima*. Each of the three is largely represented.

The Collection of Baron Eggers.—The collection of Baron Eggers was mainly made in the small island of New Providence, where the capital (Nassau) is situated, and as this was also the case with the plants of Mr. Brace, a large proportion of the species are identical. The two collections supplement each other very usefully, for the shrubby plants of the Bahamas often show evidence of a considerable amount of such alteration as is produced by greater exposure, and in several genera (for instance, *Erythroxyllum*, *Eugenia*, *Psychotria*, *Ficus*, and *Coccoloba*) it will be needful to have further specimens of the New Providence types before it can be safely decided what their relations are with the Cuban or the Jamaican species. One of the most interesting plants Eggers has gathered is the *Achras*, figured by Catesby (vol. ii. t. 87), which is evidently distinct specifically from the well-known *Achras Sapota*. He has added to the Bahaman flora the Rhamnaceous genus *Reynosia*, known previously in Florida. He has found a new species of the Mutisiaceous genus *Anastrophia*, of which several species are known in Cuba. In *Schœpfia Buxus* and *Linum* he has obtained full material of new endemic Bahaman species before known imperfectly. In a few cases his material shows that species supposed to be endemic are not really distinct. For instance, he has connected *Croton Hjalmarsonii* of Grisebach with the widely spread *Croton lucidus* of Linnæus.

Economic Bahaman Plants.—The group produces several interesting plants of economic value. Of these the principal are—

Mahogany—*Swietenia Mahogani*.

White Cinnamon—*Canella alba*.

Lignum vitæ—*Guaiacum sanctum*.

Sabicu—*Lysiloma Sabicu*.

Cascarilla Bark—*Croton Eluteria*.

„ „ *Croton Cascarilla*.

„ „ *Sideroxyllon mastichodendron*.

Further Exploration.—Out of the twenty islands we can only look upon New Providence, which is a small island twenty miles long by seven miles broad, as at all adequately searched. Besides New Providence, Baron Eggers has collected a few species in Acklin's Island, Hog Island, Long Island, and Fortune Island. The five largest islands of the group are still nearly or quite unknown botanically. The island of Andros is nearly a hundred miles long by thirty miles broad, and has a mere fringe of population and a centre made up of forest and swamp. Abaco is nearly as long, but narrower and less promising. Eleuthera is the island in which pine-apples and other fruit are mainly grown for the American market. St. Salvador, the first land touched by Columbus, and the Great Bahama are both islands of considerable size, quite unknown botanically, so that there is abundance of work for future explorers.

Second Report of the Committee, consisting of Professors SCHÄFER (Secretary), MICHAEL FOSTER, and LANKESTER, and Dr. W. D. HALLIBURTON, appointed for the purpose of investigating the Physiology of the Lymphatic System. (Drawn up by Dr. W. D. HALLIBURTON.)

LAST year the committee appointed for the purpose of investigating the physiology of the lymphatic system presented a preliminary report dealing with the chemical physiology of the lymph cells as contained in lymphatic glands. They are able this year to present a report dealing with the same subject from a rather different standpoint. The work has been carried out by Dr. Halliburton in the Physiological Laboratory, University College, London.

Professor Schäfer and Dr. Halliburton have in the same laboratory commenced observations upon the movements of the walls of lymphatic vessels. This research is not, however, sufficiently advanced to enable the investigators to present a report as yet; they hope, however, next year to be able to continue their researches in this direction.

The following is Dr. Halliburton's report on the chemical physiology of lymph cells.

It was stated in the report presented last year that the following proteids are contained in the protoplasm of the cells of lymphatic glands:—

1. A globulin which coagulates at 48° to 50° C. *Cell-globulin a.*
2. A globulin which coagulates at 75° C. *Cell-globulin β.*
3. An albumin which coagulates at 73° C. *Cell-albumin a.*
4. An albumin which coagulates at 80° C. *Cell-albumin β.*
5. A peculiar proteid, with physical properties like mucin; with other characters like a globulin, and which was described provisionally as a *mucin-like globulin.*

These proteids are contained in extracts of the lymph cells made with various saline fluids, and can be separated by the usual methods of precipitation by neutral salts and fractional heat coagulation.

A few quantitative experiments have shown that the mucinoid globulin is the most abundant, and composes the greater part of the cell protoplasm; the cell-globulin β is the next most important quantitatively

of the proteids present. Cell-globulin α and the two albumins, especially the β variety, are present in only small quantities, and cell-albumin β seems to be often altogether absent.

Some further investigations upon the properties of the mucin-like proteid have led me to conclude that it belongs to a class of proteids called by Hammarsten¹ nucleo-albumins. These proteids resemble globulins in the way in which they are precipitated by salts, and also in their insolubility in distilled water. They, however, differ from globulins by yielding an ash rich in phosphorus, and on gastric digestion yielding an insoluble residue of the nature of nuclein, which is also rich in phosphorus. The substance was purified in the following way :—

An extract of the cells in 10 per cent. sodium chloride solution has a slimy mucus-like consistency; it filters very slowly, but it can be separated from the insoluble residues of the cells (nuclei, &c.) by filtration under pressure. On pouring this filtrate into a large excess of distilled water, the globulins are precipitated in a finely flocculent condition, and sink to the bottom; whereas the mucin-like proteid is precipitated throughout the water in the form of cohesive strings, which in a few minutes contract, and finally collect in sticky lumps which float upon the surface of the water. These were thoroughly washed with and kneaded in distilled water, and finally washed with rectified spirit and absolute alcohol. This substance after ignition yielded an ash rich in phosphorus. It was easily soluble in 1 per cent. hydrochloric acid; on diluting this solution fivefold or even tenfold with water there was no reprecipitation of the proteid.

A large quantity of such a solution in 1 per cent. hydrochloric acid was diluted till the strength of the acid was 0.2 per cent. On keeping this solution at the temperature of 40° C. in an incubator for twenty-four hours there was no precipitate; but on adding to it an active solution of pepsin there was in the course of three or four hours, at the same temperature, a cloudiness, which became denser, and ultimately a flocculent precipitate formed. This did not tend to disappear or become lessened after very prolonged digestion; it could not, therefore, be anti-albumid, the comparatively insoluble by-product which occurs in the digestion of ordinary albumin; for anti-albumid is, after prolonged digestion, largely converted into peptones.

This precipitate was collected, washed with 0.2 per cent. acid, and then distilled water and alcohol. It was soluble in alkalis (*e.g.*, baryta water), and it also yielded an ash rich in phosphorus.

The filtrate from which the precipitate had been removed contained albumoses and peptones, the usual products of gastric digestion, and contained the merest traces of phosphorus. No such precipitate was produced by pancreatic digestion.

It is on these results of gastric digestion, as well as on the other physical and chemical characteristics of this substance, that I am inclined to include this proteid among the nucleo-albumins. Similar mucin-like globulins have been separated by Hammarsten from the cells of the sub-maxillary gland, which contain, however, true mucin in addition; from the synovial fluid and from bile, where they have long been mistaken for mucin.

With regard to the remaining proteids in lymph cells, I have not

¹ *Zeit. Physiol. Chem.* vol. xii. p. 163.

made out anything in addition to the facts I have already given (see last year's report), with one exception, viz., the heat-coagulation temperature of cell-globulin β is, as there stated, 75° C. when it is dissolved in a magnesium sulphate solution, or in a solution containing a minimal quantity of sodium chloride; but in a solution in which 5–10 per cent. of sodium chloride is present the temperature of heat-coagulation falls to about 60° C.

The next subject to which I directed my attention was the influence of these various proteids on the coagulation of the blood.

The proteids were separated in the manner already detailed, excess of salt removed by dialysis, and their influence on coagulation tested by adding them to dilute salted plasma, to hydrocele or pericardial fluid, or to vein-plasma obtained from the jugular vein of the horse by what is known as the 'living test-tube' experiment.

A complete communication on this portion of the subject has been sent to the 'Journal of Physiology,' but the main results of the investigation are as follows: their especial importance is the light they throw upon the nature of the fibrin ferment.

1. The only proteid in the cells which has any effect in hastening the coagulation of blood-plasma is the cell-globulin, which coagulates at 75° C. This substance, in fact, acts like fibrin ferment.

2. Fibrin ferment, as extracted from the dried alcoholic precipitate of serum (Schmidt's method of preparation), is found on concentration to be a globulin with the properties of cell-globulin.

3. The fibrin ferment, as extracted by saline solutions from what was termed 'washed blood-clot' by Buchanan, is a globulin and this globulin is also identical with cell-globulin.

4. Serum globulin, as prepared from hydrocele fluid, has no fibrinoplastic properties. It may be better termed *plasma-globulin*.

5. Serum globulin, as prepared from serum, has marked fibrinoplastic properties. This is because it consists of plasma-globulin *plus* cell-globulin, derived from the disintegration of white blood corpuscles, which are in origin lymph cells.

6. The cause of the coagulation of the blood is primarily the disintegration of the white blood corpuscles, and, perhaps, also of the blood tablets; they liberate cell-globulin, which acts as a ferment, converting fibrinogen into fibrin. It does not apparently become a constituent part of the fibrin formed.

Wooldridge's theory of coagulation, which makes lecithin the chief agent in the process, is not considered tenable; full reasons are given in the communication to the 'Journal of Physiology'; the essential objection to that theory is, however, this: it rests upon observations chiefly made with peptone-plasma, which is a very abnormal form of plasma. The precipitate produced by cold and the influence of lecithin in hastening coagulation, as described by Wooldridge, cannot be demonstrated with salted plasma, nor with vein-plasma: observations upon this latter form of plasma are of especial importance, as it is unmixed with any foreign substance. On the other hand, the addition of cell-globulin to this plasma hastens its coagulation very considerably.

To the cell-globulin theory an objection might be urged that the ferment and the globulin are not identical, but only closely associated together. This objection cannot at present be fully met; if, however, the two are not identical but only combined, it must be admitted that the

association is an exceedingly close one; none of the methods adopted for preparing the globulin pure separate it from the ferment. Until some method is shown by which any substance can be separated into two, we are not justified in saying that it is other than a single substance. Certain facts, however, of which the two most important are the action of alcohol and the action of heat, go far to prove that the ferment is the proteid.

The action of alcohol.—The ferment is precipitated by alcohol; and it is generally stated that, unlike proteids, it is not rendered subsequently insoluble in water by the prolonged action of alcohol. It is this fact upon which Schmidt bases his method of preparing the ferment, viz., extracting with water the dried alcoholic precipitate of serum. Hammarsten, however, has noticed the loss of activity which the ferment undergoes after exposure to the action of alcohol; and in the present research it was found that an exposure of the ferment to the action of alcohol for six to seven months renders it absolutely inactive. The ferment is thus, like proteids, rendered ultimately insoluble by alcohol, though more slowly than ordinary albumin is.

The action of heat.—The most striking fact that goes to prove the identity of the ferment and proteid is that the activity of the ferment is abolished at the same temperature as that at which the distinctive characters of the proteid are destroyed (about 75° C.).

Granting that the ferment is a proteid, it is undoubtedly a globulin: it is insoluble in distilled water, as Gamgee first pointed out when he prepared it from what was termed by Buchanan 'washed blood-clot.' The apparent solubility in water of the ferment prepared by Schmidt's method is due to the fact that a portion of the salts in the ferment powder enters into solution at the same time. If the ferment powder be first subjected to prolonged washing with distilled water, and finally to dialysis to remove the salts, a watery extract has then little or no ferment action, while a saline extract has powerful ferment properties. The ferment action of such a solution is lessened but not destroyed by dialysis: this is apparently due to the fact that even prolonged dialysis is never sufficient to precipitate all the globulin in a solution.

The proteids of the cells of the thymus gland.—This gland is a structure which histologically is very similar to lymphatic glands. I have made a few experiments with the object of determining whether the resemblance is borne out from a chemical point of view also.

My observations under this head will be of a preliminary nature only, as the experiments are not at present completed. The chief points I have made out are the two following:—

1. That the greater part of the cell-protoplasm is made up of a nucleo-albumin with properties similar to those already described.
2. That a globulin coagulating at 75° C. is the next most abundant proteid present. This has fibrino-plastic properties exactly similar to those already described as belonging to the cell-globulin derived from the lymphatic glands.



*Report of the Committee, consisting of Professor T. G. BONNEY, Mr. J. J. H. TEALL, and Professor J. F. BLAKE (Secretary), appointed to investigate the Microscopic Structure of the Older Rocks of Anglesey. (Drawn up by the Secretary.)*¹

[PLATES II.-V.]

THE rocks which form the subject of the present report have already received the attention of geologists, and some eighty or ninety of them have been described by Professor Bonney, mostly in appendices to various stratigraphical papers by other authors.² They have also been examined and used for stratigraphical purposes by the Secretary.³

The present object, however, is to study them for the information they may give on the nature and cause of the metamorphism to which many have been subjected, and to determine how far their microscopic structure may throw light upon their origin. Their special interest lies in the fact that the series includes both altered and unaltered rocks, as also foliated and non-foliated, and hence gives promise of throwing some light on the connection between them.

Although the work already done upon the rocks of Anglesey has not been of a systematic character from this point of view, being limited to the determination of the particular nature of individual rocks, yet, as could not fail to be the case, many valuable observations of general interest have been included in these descriptions. Moreover, the rocks at St. Davids, which are in part the equivalents of these, and to some extent of the same character, have been dealt with from a general point of view by Dr. A. Geikie,⁴ whose conclusions may be usefully compared with those of this report.

For the purposes of study the older rocks of Anglesey may be divided as follows:—

1. Rocks which on stratigraphical grounds are generally considered sedimentary, including volcanic contributions.
2. Rocks of special origin.
3. Crystalline rocks which may be of igneous origin.

In referring to the localities whence the rocks are derived, and in indicating their general stratigraphical relations, those subdivisions will be adopted which are laid down in the paper above referred to on the Monian system. It is there shown that those rocks in Anglesey which are at least older than the Ordovician lie in six distinct areas, which are severally called the Western, Central, Eastern, and Northern Districts, and the districts south of Traeth Dulas and north-east of Parys Mountain. The series of rocks which lie to the south of the fault which divides Holyhead Island is spoken of as the South Stack Series. The Central dis-

¹ The other members of the Committee wish it to be understood that, as this report deals with subjects on some of which there is much controversy, Professor Blake is solely responsible for the statements therein contained.

² *Quart. Journ. Geol. Soc.* vol. xxxv. p. 305. *Ib.* vol. xxxvii. p. 40 and p. 232. *b.* vol. xxxix. p. 470. *Ib.* vol. xl. p. 200 and p. 283. *Geol. Mag. N.S.* Dec. II. vol. vii. p. 125.

³ *Quart. Journ. Geol. Soc.* vol. xlv. p. 463 *et seq.* The further study of these rocks has, in a few instances, led to a slight modification of some of the petrographical statements in that paper.

⁴ *Quart. Journ. Geol. Soc.* vol. xxxix. p. 261 *et seq.*

trict is divided into two—the Eastern and the Western portions—by a line running along the west boundary of the grey gneiss.

ROCKS OF SEDIMENTARY ORIGIN.

The study of these has reference, first, to their mineral constitution; secondly, to their original structure; and, thirdly, to their alteration.

1. *The Minerals of the Sedimentary Rocks.*—The greater number of these may be said to belong to the acid type, the ordinary constituents of basic rocks being comparatively rare.

Quartz is the most abundant mineral of all. If we except the limestones and other special rocks, there is hardly another in the whole series in which, when the minerals are recognisable, quartz is not among them. It occurs both authigenetically and as derived fragments. In the latter case it sometimes contains needles of apatite, as in the quartzite of Holyhead Mountain (1), and sometimes fine needles of rutile, as in the slates of Roscolyn (66). It usually has numerous bubbles, which mostly occur along cracks, and these cracks are often continuous from one element to another, and must therefore have been produced in the quartz after it had been placed where it now is. Some of the derived fragments of quartz, however, have their lines of cracks terminating at their boundaries. Occasionally the silica along broad bands is chalcedonic, as at Peniel (11), and more rarely small rounded fragments of bluish tint may indicate opal.

Felspar.—In the absence of any structural lines it is often impossible to do more than determine the family. When felspar and quartz are associated, and both are of minute size, it is often difficult to distinguish between them. In the quartz the inclosures may generally be recognised as bubbles, in the felspar as dust or small crystals. When, however, both are water-clear and too small to give any reaction in convergent polarised light they can only be distinguished by the slightly higher refractive index of the quartz, which makes it stand out from the felspar when both are together. The larger crystals of felspar present a very characteristic phenomenon. (See fig. 1.) They are filled with minute flaky or tabular small crystals. These may be arranged in intersecting lines, or be quite irregular. They are often of considerable relative size, as in the derivative fragments in the mica schists of the Eastern district (151). Whether the small crystals are original inclusions or results of decomposition is difficult to say, but their general character and arrangement seem to indicate the latter. Such 'speckled' felspars are not always indeterminate, but are often banded plagioclase; they are almost invariably derivative, or at least of an older generation than the bulk of the rock. This speckling seems to be a further stage to 'schillerisation.'

Plagioclase.—The banding which is presumed to characterise the plagioclastic group of felspars may have more than one origin. Professor Judd¹ has recently suggested that in some cases it is brought out by pressure. There are numerous instances in these Anglesey rocks, as at Bodlew (148), of the bands being continuous across only half of the crystal. In these cases they are less regular and distinct. When two such series of lines cross at right angles we get the phenomena of microcline; but in this also there is great irregularity—the bands die out and change position as the slide is rotated. Such are seen in the grey gneiss of Gwalchmai (69) and at Ty Gwyn (188), but they are better shown in

¹ *Mineralogical Mag.* 1888.

Fig. 1. (151)



Fig. 2. (81)



Fig. 3. (5)



Fig. 4. (32)

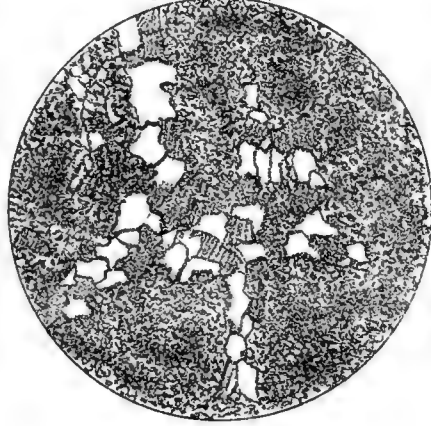

Fig. 5. (75)

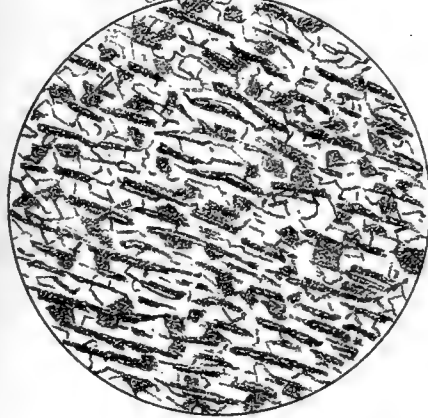
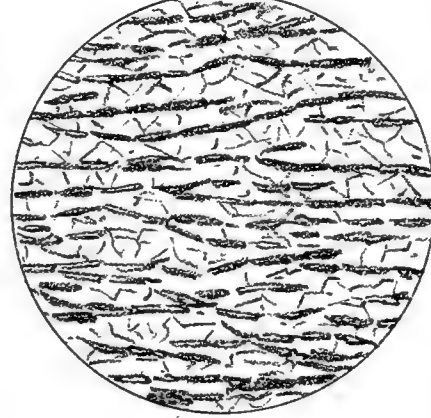

Fig. 6. (150)





the rocks of igneous origin. In these cases it cannot be considered true twinning which produces the bands, but a reconstruction under pressure of a single mineral. There are, however, in numerous rocks small angular fragments, in which the lines of twinning have the utmost regularity and definition—*e.g.*, at Llanelian (223). These are probably true plagioclase. As far as observed they invariably are derivative, being angular and isolated, and often lie transverse to the general direction of foliation.

Mica.—The most characteristic species of this family observed in the sedimentary rocks is muscovite. It is colourless for all rays, and polarises vividly. It is commonly of small size, but is best developed where the other elements are large, as in the gneisses and mica schists of the Eastern and Central districts. It also occurs as large fragments in the midst of a non-micaceous matrix in the slates of Roscolyn (67), and the quartzite of Porth-yr-Ogof, Holyhead (4). Inclusions are rare, but in a rock full of mica, on the Llanerchymedd Railway (93), the larger elements are full of other crystals, thus resembling a speckled felspar.

Chlorite.—It appears that two distinct species have been referred to under this name, the only common characters being greenness and transparency. The true chlorite is more or less amorphous, and occurs in large sheets as well as more fibrous masses. It often forms the whole groundmass of the rock, as at Bryn Minceg, near Llandegfan (189). It also occurs as beautiful vermicular aggregates amongst the large vein substance, as in the mica schist of Bodowyr (146) and Gaerwen (160); and occasionally it crystallises transversely in a lenticle, as at Roscolyn (67). In these cases it has very little polarising power, remaining nearly dark between crossed Nicols, or giving bluish and purplish tints. There is not much of such chlorite in the Western district, but it is more abundant in the Eastern, where also epidote more commonly occurs, after which it is often found as a decomposition product, as in the rock at Hafody (145).

Green-mica.—This is the so-called chlorite of the Western district, being the essential ingredient in the 'chloritic' schists. It occurs in long thin crystalline flakes, with parallel sides but imperfect terminations, and may be either isolated or aggregated in groups. It is transparent and greenish in tint, and extinguishes parallel to the trace of cleavage. The polarisation colours are either brown or fairly brilliant tints of red and green. It is often surrounded by the true chlorite as by a decomposition product.

Sericite.—This term is applied to the colourless strings and broader patches in which no individuals can be distinguished, but which polarises in fairly brilliant colours between crossed Nicols. It occupies the cracks and minute interstices between the other elements, and is especially characteristic of rocks which have been partially disintegrated by pressure.

Epidote.—It is generally supposed that this species is a decomposition product from felspar. In the sedimentary rocks of Anglesey there is no special evidence that this is its direct source. It is here always highly fractured and more or less dusty, and occurs in isodiametric patches without crystalline form. It shows high polarisation tints in the centre, which change rapidly towards the edges, owing to the thinning off of the grains. It gives rise by decomposition to dust of a characteristically crystalline aspect, by which it may be recognised even when too small or decayed to show colour between the Nicols. It is most abundant in

the Eastern and Northern districts; occurring in the former in the laminated schists often imbedded in chlorite, as at Hafodty (145), and also as rounded derivative grains in the newer dust rocks, which is its principal mode of occurrence in the sedimentary rocks of the north.

Kaolin is perhaps the best name to apply to the white amorphous dust which is so abundantly scattered over the great majority of rocks, lying either in isolated grains in the less completely crystallised bands, or pushed aside into the interstices between well-formed crystals. In the former case it may be pretty nearly in its original position of deposit; in the latter, it is either the residuum which has refused to crystallise, or the relics of former crystalline substances which have since disintegrated. There is, however, no evidence as to its chemical composition, though kaolinite in definite crystalline forms has been discovered some time ago in the slaty rocks of the Northern district.

Pyrites occurs in well-formed, usually cubic crystals, in rocks of very fine grain in the Northern and Central districts. It does not seem very certain whether these are derivative from older rocks or authigenetic, though the latter seems more probable.

Ferrite is sometimes seen surrounding the pyrites as a red translucent decomposition product; but the substance usually quoted by this name consists of a brown amorphous dust found in similar circumstances to those of kaolin, but in more basic rocks.

Garnet occurs in rounded, worn-looking, or imperfectly formed crystals in the mica schists of the Eastern district, as near Gaerwen (156). They are here so abundant that in spite of their numerous cracks, filled with a later crystallisation, there seems no evidence of their being derivative, the whole rock being completely crystallised. These are generally of a pale green tint.

Zircons, in characteristic short prismatic crystals with worn pyramidal ends, are tolerably abundant in some of the quartzites, as at Porth-yr-Ogof (2). Here they are certainly derivative. They also occur in the mica schist of Abersant (19) and in the quartzitic rocks of the South Stack series (64, 65); also in the quartzose gneisses and quartzites of the Central district, as at Gwalchmai (70) and Bodafon (109); but they have not been observed in the sedimentary series either of the Eastern or Northern districts. Possibly these latter were derived from a different source.

Such are the principal minerals which enter into the composition of the oldest stratified rocks of Anglesey. Others, such as sphene, rutile, apatite, and tourmaline, are either very rare, occur only as enclosures, or are doubtfully determined.

2. *The Structure of the Sedimentary Rocks.*—The present structure of the rocks depends in part on their original constitution, and in part on the alterations which they have undergone; but it is not always easy to determine which of these has most influence on the observed results. Some of the rocks are crystalline, and are undoubtedly much altered; others are composed of dust or fragments, and these may be either original or the results of crushing *in situ*. In this case their probable origin must be sought in their stratigraphy; and by examining the structure of those rocks which are thus proved to be original, and comparing it with those in which crushing may have had a considerable effect, we may obtain characteristics which shall be of avail when stratigraphy gives doubtful information. So far, then, as may be judged by their strati-

graphy, the original rocks may be classified as follows : (1) rocks composed of uniformly small elements ; (2) rocks of larger grain ; (3) rocks with larger fragments imbedded in a finer matrix ; (4) laminated rocks.

In the study of these we have to determine, as far as possible, the criteria by which we may distinguish—(1) original fine dust from the results of crushing or decomposition ; (2) fragments of minerals obtained from earlier rocks from crystals formed *in situ*, and from fragments produced by crushing ; (3) lamination from foliation.

In determining these points it will be well to lay down beforehand the principles of interpretation adopted, most of which are, of course, well known, and only need to be definitely formulated. In addition, however, to ordinary methods, a plan of observation, not as yet, so far as I am aware, applied to the microscopic sections of rocks, has been found of great value—viz., the use of a paraboloid with a binocular microscope. The appearance of a rock, when examined in this way, is of course very different to that between crossed Nicols, or even by plain transmitted light ; but the structure is sometimes shown with a clearness which is quite astonishing. Everything in the interior capable of reflecting the light is brought out brilliantly, and the perspective of the binocular shows the true relative position of such objects. If a rock contains fragments in the midst of authigenetic elements, it will very seldom happen that the union of the two will be complete, and thus the boundary of the fragment will be marked by a reflecting border ; whereas the individual authigenetic elements being in optical contact the light passes through unbroken. The natural shade of colour, both of opaque and transparent objects, is also well brought out by this method ; and the special characters of the cleavage of various minerals is indicated by the reflection of the light from their surface. The fine particles of dust are very clearly seen, whether isolated or in lines, and by the peculiar glistening they may be distinguished, however minute, as crystalline or amorphous. The characters of individual minerals as seen in this way are not very describable, but when once the general aspect has been seized, the minerals are easily recognised and their presence is immediately revealed.

The distinction between original dust and that produced by crushing or decomposition is not perhaps always very clear ; but if there has been crushing it will seldom, if ever, happen that none of the other signs, to be hereafter described, shall be present. If the dust be aggregated in the forms assumed by authigenetic elements, either such as they had at first, or such as may have been superinduced, it may be assumed to be due to the decomposition of such. But when it is scattered about irregularly, or lies in loose bands of indeterminate form, there can be little reason for considering it as anything but original.

The distinction of authigenetic elements from fragments when both are crystalline is not in all cases possible. Both may be so small as to present few characters for discrimination, or the metamorphosis may be carried so far as to absorb the boundaries of the fragment, and make the outside practically authigenetic. In general, however, we may rely upon the following criteria. A fragment in an altered rock being less easily absorbed, according to its size, will generally be a larger isolated element in the midst of a minuter groundmass. Authigenetic elements being formed from a magma which is capable of motion and mixing, will generally be uniformly distributed throughout the mass ; hence a stray

element of a common mineral, such as plagioclase, amongst abundant elements of another character, may be considered to be a fragment. This will not, of course, apply to such minerals as are always more or less sporadic, and are known to be products of alteration, such as garnets. The most important distinction is the following. The outline of a fragment may be rounded or angular, and the shape in the latter case may be peculiar, especially if the rock has been compressed; but when the elements are forming authigenetically in a rock the crystallisation will set up at two or more neighbouring spots, and the growth of the crystals will continue till they meet. The line of junction in this case may be and often is an exceedingly irregular one, curving in and out like the lines of junction of two bones which ossify from distinct centres. In the case of bones such junctions are called sutures, and we may therefore conveniently describe the similar junctions between crystals as *sutural*, and define this well-known peculiarity by stating that sutural junctions are characteristic of authigenetic crystals. (See fig. 2.)

The distinction between fragments of sedimentary origin and those produced by crushing is in general easy if the crushing has taken place subsequently to the crystallisation, for it can very seldom happen that absolute resistance and absolute yielding to the crush can be found side by side; hence crushed fragments are in groups obviously once united into a larger element, but fragments of sedimentary origin are entirely independent; and the same difference may also be of assistance when crystallisation has succeeded the crush.

Lamination may be confounded with foliation when the latter is parallel to the bedding, as seen on the large scale; but the essence of lamination is the alternate occurrence of different kinds of mineral substance in the bands. Now, unless there has been confusion of the substance of a rock, far beyond the point of contorting the laminae, these original differences will have their effect upon the result even when the rock is crystalline, for one kind of crystal will be more abundant in alternate bands, and the least easily crystallisable will remain as dusty fragments, which will also lie scattered between the crystals along the same lines. Such phenomena, which are quite distinct from foliation or the orientation of crystals, are taken to indicate original lamination. (See fig. 3.) The principal case in which doubt arises is when the rock, though composed of a uniform substance, is more separable along the line of deposit, and clean crystallised quartz has segregated out in this direction and given rise to an apparent alternation.

The Rocks Composed of Uniformly Small Elements are probably much more numerous in the oldest series in Anglesey than would be gathered from a comparison of the numbers described in the present report, since few of them would tempt microscopical examination. Yet, excluding those which contain larger fragments, 34 out of 168 of the sedimentary rocks examined have this character. In the Western district this type of rock is largely developed. In four instances it consists of practically unaltered dust. One of these is an indurated purple shale or slate, well bedded, and passing into chloritic schists. It occurs on the east side of the Holyhead Straits (7). There is a certain amount of irregular parallelism in the dust, and there are a few irregular cracks filled with quartz; but otherwise there is nothing to show that the rock has suffered any change beyond an ordinary compacting by superincumbent pressure. This is a remarkable case as occurring in the lower part of the series. The other three belong

to the unstratified portion, to which a more or less volcanic origin is assigned; in fact, they are indurated tuffs. These are the green rock at Peniel (11), the unstratified yet feebly false-bedded tuff of Church Bay (29), and the dust rock at Pant-yr-Eglwys (34). The remaining fine-grained rocks in this district show more or less metamorphism, the greatest amount occurring nearest to Holyhead Island. Of these may be cited the rocks at Caer Ceiliog (9) and Bodedern (23), also from near Llanddeussant (20, 25), Llanfachreth (18), Llanfaethlu (27), and Llanrhyddlad (30). These are in parts of the series which are far separated from each other on stratigraphical grounds; but there is little to choose between the rocks. Another, dynamically altered, occurs at Porth Dryw (12). Only one of this type has been examined from the South Stack Series at Porth-y-crug (62).

In the Central district the fine-grained rocks occupy two distinct positions. In the western portion the mass between the granite areas at Llanfaelog (82, 83) is of this type (though much metamorphosed), and so are almost all the rocks examined between Bodafon and Llanerchymedd. One near Chlorach Bach (103) is highly calcareous; the others, from Trewyn (104), Clegyr (108), and the west side of Bodafon (110), are more crystalline. In the eastern portion there is a longitudinal band of such rocks from Cerryg-ddwyffordd (98) to Llangefni (100), and so on, to the banks of the Cefni, half-way to Llangwyllog (102).

In the Eastern district a fine tuff occurs in association with the igneous rocks at Gwladys (208), but the remainder belong to the stratified series, and are chiefly found along the eastern edges, as at Bodlew (147), Cadnant Vale, near Menai Bridge (187), Clawdd-y-parc, near Llandegfan (196), Ty-garw, near Beaumaris (195), and Tyddyn, north of Beaumaris (199). In all these places they have become finely crystalline. The only place in which the dust may be suspected of being produced by local crushing is on the north-eastern edge of Malldraeth Marsh (190). Dust rocks of doubtful character, which appear to have undergone only a slight chemical or infiltrational metamorphosis, occur at Llyn Bodgolched (198), in the road between Garth Ferry and Beaumaris (192), and in the country behind this road (191); in the latter case the rock is full of derivative epidote. In the Northern district so many of the rocks have a slaty aspect that few have been examined. Most of them, however, contain larger fragments, and two only have been found free from them—viz., at Mynydd Mechell (212) and Bodewryd (220). Both of these have become minutely crystalline.

It will thus be seen that only six out of the thirty-four examined can be said to be in any sense unaltered, and many of them are completely crystalline. This is entirely in conformity with the observations of Dr. A. Geikie on the rocks of St. Davids, that 'certain layers or particular kinds of fine detritus, more especially some of the finely comminuted volcanic dust, have been specially susceptible of change.'

Rocks of Coarser Grain may arise either from the running together of the materials of finer rocks in the process of crystallisation—and such must be omitted for the present—or from the original elements being larger. The interest of these latter arises from the fact of their association with the finer rocks, after the manner of ordinary sediments, and from the greater difficulty in their metamorphism leaving them more unaltered. Thus, on the west side of Cemmaes (216) we find a rock of which one half is fine-grained and the other half coarser, composed of

well recognisable grains of quartz and felspar. So at Bodafon (106, 107) and Ty Croes (85) coarser and finer rocks are associated. In the Eastern district we find such at Wugan (201), and at Pen-y-parc, Beaumaris (193), where the original fragments were recognised by Professor Bonney. The most characteristic occurrence, however, of these coarser rocks is in the South Stack Series. In this group there are numerous unexamined fine-grained rocks, but almost all those which have tempted examination have turned out to be gritty in character, the original quartz grains being closely packed and very uniform in size. Of these may be cited as examples the rock from the bottom of the gorge at Gogarth (59), and a flaggy bed at the lighthouse steps (60); also one from Porth-dafarch (61), and one from Porth-y-crug, near Roscolyn (63). Even when there are larger fragments imbedded the groundmass of these rocks is of a coarser character, as in the quartzites of Porth-y-gwalch (64) and of Roscolyn (65), and in the neighbouring darker rocks (66). The rocks, therefore, of this series are as well marked by their microscopic structure as regards their original composition, as they are by their bedded character as seen on the large scale.

Rocks containing Larger Fragments in a Finer Groundmass.—These fall into several categories—those in which the principal part is groundmass of minute elements, with only a few of the characteristic fragments scattered here and there; those in which the fragments constitute the principal part, and the groundmass is reduced gradually to a minimum; and those in which the groundmass is also of coarse elements. The first of these groups, in which the fragments are comparatively rare, approximate very closely to the finer-grained rocks, especially when both have undergone crystallisation. Such are well seen in the eastern end of the Northern district—as at Pengorphwysfa (222), Point Ælianus (224), and Llaneilian (223), where there are but a few angular pieces of quartz and felspar, possibly of volcanic origin. As we pass west, towards Pen-bryn-yr Eglwys, a focus of eruption, these fragments become more numerous, as at Llechog Ucha (221), in the slates between Llanrhydrus and Camlyn (213), at Mynydd Mechell (211), till they become most numerous near Llanfechell (219), forming a grit largely composed of fragments of quartz and felspar, and containing also pulled-out pieces of a minutely crystalline substance. This is the rock of which Prof. Bonney recorded that it contained almost certainly fragments derived from the older series. It does not, however, seem certain to the writer that these pieces are anything more than a peculiar vein substance, such as occurs in several rocks, and in some cases they may be decayed and reconstituted felspar. In the Western district, besides the laminated rocks, to be described further on, there are several of this group associated with the finer-grained rocks, as at Caerdeon (24), beyond Porth Dryw (13), and in the tuffs of Church Bay (28). In the other districts only one of this group has been met with—viz., in the northern part of the Eastern district, at Coedmawr, near Llanfaes (200). It is suggested that these fragments for the most part are volcanic ejectamenta, contributed to the finer deposits, in which there is in general a complete absence of stratification either on the large or the microscopic scale.

The group with abundant fragments in a less abundant groundmass has not been observed in the Northern district, which was probably further removed from the sources of eruption, but in the other districts such rocks are numerous and important. In the Western district two of great interest

have been examined from the crossing of the river Alaw on the road to Llanfachreth (10), and from near Llanfaban (22). They are decidedly of a more basic type. They contain few fragments of quartz, but abundance of felspathic fragments, sometimes of fresh banded plagioclase, sometimes speckled, and sometimes entirely passed over into sericite. There are also fragments of the finer crystalline material, as at Llanfechell, with minute crystals of green-mica in a clear groundmass; also of quartz vein stuff, and much epidote; possibly also olivine and magnetite. One is tempted to ask if these can be in any way connected with the eruption of gabbro, which took place not very far to the south. Another rock, whose numerous fragments are mostly quartz, and the matrix the usual fine-grained material, occurs in the hill over Ogo Lowry, near Llanrhyddlad (31), which has fragments of volcanic rock similar to that which forms the agglomerates occurring within little more than a mile. In the Central district the rocks with abundant fragments are an important group. They occur associated with the dust rocks at Cerryg-ddwyffordd (99). Here there is very little matrix at all, the fragments of felspar are more numerous than those of quartz, and there are a number of dusty fragments which may be in some cases devitrified lava, in others lapilli of tuff. This is one of the rocks described by Professor Bonney, who suggests the same origin. Further south the rocks are seen to contain, scattered irregularly through them, nodular hard masses. A microscopical examination of one of these (89) shows they are places of aggregation of the large fragments of quartz and occasionally of felspar, so closely packed as to leave scarcely any room for matrix, which consists of amorphous chlorite only. At Dinas Llwyd (126) the rocks of this group are similar to that at Cerryg-ddwyffordd, but contain also fragments of a dark rock, consisting of lath-shaped felspars in a black matrix, a type found *in situ* at Gwalchmai. In the Eastern district two rocks with abundant fragments have been examined. In that from Ty Gwyn, near Menai Bridge (188), the fragments are of quartz and plagioclase, with beautiful banding, set in abundant matrix, much modified by pressure. In the other, from Bryn Minceg, near Llandegfan (189), the fragments are smaller and are embedded in abundant chlorite. This also has suffered from pressure.

The group in which the groundmass is also of coarse elements includes the various quartzites. In that of Holyhead Mountain (1) the groundmass is so altered that it is difficult to distinguish the smaller elements as derivative or authigenetic. The larger fragments are of all sizes, varying from such as are scarcely distinguishable from the groundmass up to large pieces .04 inch in diameter, all except the little zircons being of quartz. In the quartzites at Porth-yr-Ogof (2, 4) less change is apparent, and the groundmass consists of tight-fitting fragments, with only room for a little green-mica between, and the large fragments are less numerous and conspicuous. At the junction with the chloritic schists (4) there is an appreciable admixture of felspar fragments. The rock in the centre of the island (3), though it contains more green-mica in the interstices, more resembles the quartzites of the South Stack Series in having little differentiation between the sizes of the fragments; but it is allied to the Holyhead quartzites by its zircons, and it contains also felspar fragments. It is not, therefore, so homogeneous as the rocks of the South Stack Series. The great masses of quartzite at Bodafon (109) and Craig Fryr (111), however different they may now be, were originally

of similar type, though the general size of the elements was smaller, and the larger fragments are fewer; but they are characterised, as at Holyhead, by their zircons and possible tourmalines, and other peculiar but uncertain minerals.

Laminated Rocks, as defined by the alternation of different materials in bands, are not abundant in Anglesey, but when present they are easily distinguished. They occur only, as far as observed, on one horizon—namely, immediately above the quartzites or equivalent rocks, where the series is complete; they are thus confined to the Western and Eastern districts. Their structure is admirably seen in the rock from Porth-y-felin, Holyhead (5), in which the laminae are beautifully bent. The rock is now a highly crystalline one, with green-mica distributed abundantly throughout; but in certain narrow, well-marked lines it becomes much more abundant, and has granules of dust-like epidote mixed with it. Any one of these bands may be traced continuously from one end of the slide to the other, always keeping its distance from the next, and following every bend in the rock. These bands are of different thicknesses and separated by different intervals; about twenty of each may be counted in half an inch. The principal part of the rock is quartz, but a few fragments of plagioclase are scattered here and there. There are seldom any phenomena indicating pressure after the formation of the rock. These features indicate a true laminated original deposit. In another example, from Porthyr-Corwgl (6), we find the same alternation of more and less micaceous and dusty bands, but here a later pressure has been at work. It has, however, only served to destroy the individuality of the crystals, and to intensify the difference between the bands. These are still continuous and equidistant, and the original fragments of quartz and felspar have not been obliterated. The rocks to the south of Porth-y-defaid (17) are also beautiful examples of this type; specimens occur which are neither contorted nor pressed, but simply altered by crystallisation, with the derivative fragments relatively large and abundant. It will be remembered that not far from here is the place of occurrence of the unaltered slate. The finer-grained rock from near the chapel, Four-mile Bridge (8), described by Professor Bonney as a 'normal schist,' shows the same lamination, but not quite so distinctly, the micaceous bands being broader, and their regularity somewhat interfered with by the introduction of segregation veins of quartz. It is, in fact, a somewhat intermediate rock between those of Holyhead and the fine-grained rocks to the north-east. Its lamination is clearly recognised by Professor Bonney, who says the rock 'has a banded structure, probably due to original bedding.'

In the Eastern district the only two rocks of this kind examined have suffered much disturbance, so that their laminated character is much more easily recognised with a hand-magnifier than with a microscope. In that from Tyn-y-mynydd, on Mynydd Llwyddiart (163), there are some bands less disturbed, and these are quite equidistant and continuous. They contain epidote in the lighter bands, and large plates of mica in the darker. Elsewhere they become more contorted. Both here, however, and at Hafodty (145) in the south, the peculiar character of the rock is nowhere lost.

All the above-named rocks maintain as their present essential character the structure they originally possessed, but there are a large number of others in which metamorphism has gone so far that its results are the

most conspicuous feature of the rocks, and yet not every sign of the original deposit has disappeared. The last things to disappear are the large fragments, which are usually of felspar, and often lie in a transverse direction to the general orientation. That these fragments are not 'eyes,' in the sense of being the only parts of a felspathic rock which has escaped destruction by pressure, may be gathered from their general occurrence also in the rocks already described, especially in the laminated rocks, and the probability of the origin in the two cases being similar. It may be added that there is usually no sign of pressure in connection with these fragments. They may rather be accounted for by the difficulty of their absorption and recrystallisation, owing to their size. The following may be cited as illustrations of these solitary fragments. In the cleaved rocks of Roscolyn (67) there are many large pieces of quartz and mica. In the Northern district the rock at Llanflewlin (210) has rather small fragments, including plagioclase. In the Central district only one out of five of the highly altered rocks examined contained any original fragments—namely, that at Porth-gwyfen (76), and these are of speckled felspar. In the Eastern district, also, only a small proportion—five out of twenty-seven examined—show any fragments; and in only two are the fragments at all conspicuous—namely, in peculiar rocks near Berw Ycha, south of Holland Arms (152). These fragments are of quartz.

From the above descriptions it will be seen that a large proportion of the older rocks of Anglesey, obtained from all parts of the series, still retain unobliterated their original structure, though it has been altered by later actions of several kinds. These original structures vary, as do the ordinary deposits of later date, and show us fine muds, coarse grits, and volcanic accumulations intermingled one with another, and with intermediate types of deposit. These form a fixed starting-point, whence we may set out on our examination of the metamorphism of the region.

3. *The Alteration of the Sedimentary Rocks.*—Although that group of rocks which on stratigraphical grounds is considered to be the oldest shows the most complete metamorphism, it does not appear to be a general rule that the amount of change in a rock of the series being studied is proportional to its age. The amount of alteration appears, in fact, to depend in part upon the constitution of the rock, and in part upon accidental circumstances, amongst which latter may, perhaps, be included the intrusion of vast masses of granite. The rocks which have most resisted alteration have been either very fine-grained rocks, which may possibly have been impervious, and those in which the fragments have been so closely packed that there has been little room for matrix between. The least amount of alteration of a chemical kind consists in the introduction of a little green-mica or sericite into the original interstices, and very few rocks have escaped this amount. The interest, however, arising from the alteration commences when it is carried further.

In this case we may consider separately the alterations which are of chemical, and those which are of mechanical, nature. The chemical alterations are those which bring about the crystallisation of the materials *in situ*. With the cause of the chemical alterations itself we need have nothing at present to do. The crystals arising in the rock, if they possess one axis longer than the other, as is usually the case, may have this axis constantly fixed throughout the rock in approximately the same direction. In this case the elements are *orientated*; but if there is

no longer axis, or the different crystals are arranged in different directions, there is no orientation. The latter of these two alternatives is usually confined to igneous rocks; and hence we find that such sedimentary rocks as are not orientated have isodiametric elements, and thus form a mosaic. The term mosaic felspar has been used when the elements belong to that family, but there are other minerals of the same habit, under similar circumstances, so that we may extend the term and speak of *mosaic rocks*.

The mosaic rocks arise principally by the alteration of those of fine original grain, and form a very characteristic group. We may take as examples of these the rock at Llanfaethlu (27), Llanrhyddlad (30), and the hill over Ogo Lowry (32) (see fig. 4). When the most unbroken parts of these are examined with the paraboloid they are seen to consist of a transparent mass, in which there float very minute specks of reflecting matter. These specks are comparable in size with the finest cavities in quartz, or those which give a slight opacity to a translucent felspar. Where the grain of the rock is smallest, the specks appear uniformly distributed; but in the slightly coarser parts they are aggregated into minute patches separated by clearer lines. These aggregates are seen between crossed Nicols to represent the individual crystals, and when they appear uniformly distributed the crystals are too small to be individualised. Amongst these may float more or fewer crystals of chlorite, so minute as to be visible only under a high power, and quite indistinguishable between Nicols. This kind of rock appears specially liable to be cracked and torn—the cracks being of more than one age, and sometimes filled with larger crystals of quartz, and sometimes only with dust—and these again are twisted and bent. Such is the minute structure of the rock, which has been called a ‘marbled slate.’ It is of wide occurrence in Anglesey.

Very nearly allied to this type of altered rock are those which contain angular fragments in a fine groundmass. This groundmass has become a fine crystalline mosaic, but here and there is seen a peculiar kind of discontinuity which may be called a tension area. Such areas are more or less in the form of three-rayed stars of very irregular form, and they are occupied by elements of larger size than the rest. Now, wherever an ordinary crack traverses a rock, the elements with which it is filled up are of medium size; and therefore larger than the finest. We may suppose, therefore, that these irregular areas, which die out on all sides, represent spots where, as in cracks, the pressure has been relieved. Rocks showing this structure have been examined from near the river Alaw (22), at Caer-deon, near Llanddeussant (24), near Cemmaes (216), at Llechog Ucha (221), Pengorhwyfisa (222), Llanelilian (223), and Point Ælianus (224). In the last case there is an apparent orientation, but it is found not to affect the substance of the rock, but to be due to a number of later parallel cracks which have been filled with sericite. This is the ‘foliation oblique to the bedding’ of Sir A. Ramsay.

From these we are led on to a type of rock which is very difficult to explain. It consists entirely of unorientated elements of medium size, large enough to show sutural junctions. These are not all of one kind, but apparently consist of felspar and quartz in equal proportions. The best of these is the remarkable rock associated with the granite to the west of Gwalchmai (86), and usually called a hälléfinta; except for its apparent bedding on the large scale it might almost be a felsite



Fig. 7. (155)

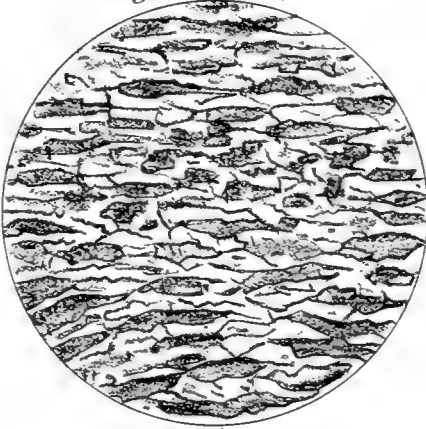

Fig. 8. (69)

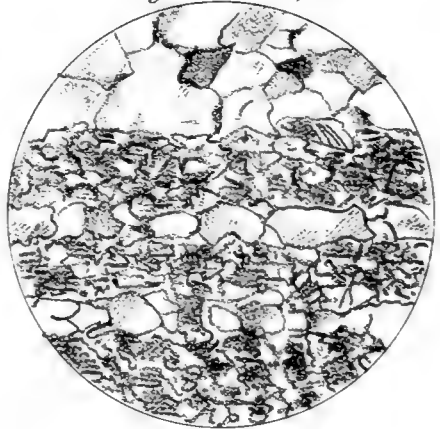

Fig. 9. (66)



Fig. 10. (20)

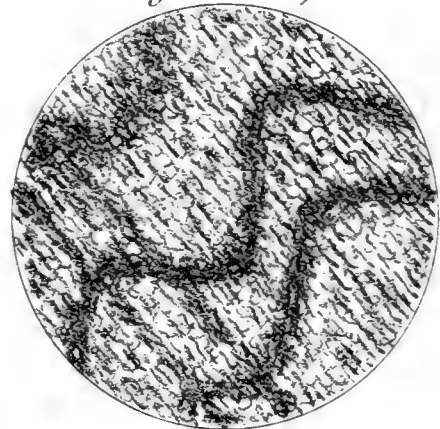

Fig. 11. (147)



Fig. 12. (1)



Another in the district south of Tracth Dulas (140) is still more like a felsite. Others at Porth-ceryg-defaid (83) and north of Llangwlllog (87) are so broken up that their origin is still more obscure.

We have next to study the introduction of orientation into this type of rock. Now orientation, as shown in the altered rocks of Anglesey, may be of several kinds. In a great number of instances it depends solely on the occurrence of flaky minerals. The lowest kind of orientation is when these flakes are scattered promiscuously amongst the other elements; but, wherever they may be, their long axes lie in the same direction. This may be called *quincuncial* orientation (see fig. 5). A higher kind is when such flaky minerals occur in definite lines. In this case there is often no perfect parallelism of the individuals, but they may make considerable angles with each other; yet the general direction is constant. It is this kind of orientation which produces the most perfect schists. It may be called *linear* orientation (see fig. 6). The highest kind is when the orientation depends not only on special minerals, but on all the elements, whose long axes are either accurately or generally in the same direction. This may be called *elemental* orientation (see fig. 7). In all these cases individual crystals are orientated; but there are other kinds of orientation seen only in the rock as a whole. Thus in some the elements of quartz and felspar, of which the rock is composed, though they may themselves be isodiametric, lie in bands side by side. From the similarity of the result to lamination we may call this *laminar* orientation (see fig. 8). In other cases no orientation can be observed in the small portion of the rock which comes under the microscope at one time; but when the slide is viewed with a hand-lens, there is seen to be a rough parallelism in the collocation of the more conspicuous elements. Such may be called *confused* orientation. Examples of all these forms of orientation will be found in the various rocks to be yet described.

False orientation, which does not affect the substance of the rock itself, is that produced by a series of parallel cracks (see fig. 9), which may be afterwards cemented by mineral matter, as we have seen to be the case with the rocks at Point Ælianus. There is also the orientation due to original bedding in the case of the laminated rocks. A very remarkable instance of this may be here mentioned as occurring in a rock at Ty-garw, near Beaumaris (195). Between crossed Nicols, when the crystalline elements are most conspicuous, little or no orientation can be seen, but the rock looks like an ordinary mosaic; but with the paraboloid it is seen to be broken up into fragments, which lie rather irregularly in the midst of a cementing material of clear quartz with larger elements, but each fragment is seen to belong to a rock which was originally laminated with exceedingly fine lines of ferruginous dust.

The orientation developed in the fine-grained rocks seldom rises above the quincuncial, the orientating mineral being in every case a green mica, though where this is crowded in bands the orientation becomes practically linear. The rocks which best exhibit this are found in the north-eastern portion of the Western district and the neighbouring locality Mynydd Mechell. In the rock from the latter (212) the direction of the individual crystals follows the banding, as marked by the greater or less abundance of the mica, and the bands follow the contortions. Hence we may assume the orientation to be coincident with the bedding. But in the fine schists found at Caer Ceiliog (9) and Llanddeussant (20) (see fig. 10) it is different. In these, and particularly in the former, certain narrow

bands of dustier material are seen to pass in an undulating manner across the slide, marking the contortions to which the rock has been subjected. But the crystals of green mica have no relation to these lines of bedding, but are arranged somewhat obliquely with reference to a series of parallel cracks, which have produced what is practically a strain-slip cleavage. The direction, therefore, of the orientation is governed by the stresses to which the rocks have been subjected. A somewhat similar phenomenon is seen in a rock at Bodedern (23), only in addition the mica is so crowded in certain bands as to be satiny, and the orientation becomes in part elemental.

An increase in the green mica of such rocks produces very beautiful and characteristic results. In some cases the fine flakes are so crowded, and have an orientation in two directions, that they produce a kind of *felted* structure (see fig. 11). Such a kind of rock is seen below Bodafon Mountain (110), where there is least regularity in the flakes. In the so-called Silurian at Llanfaelog (82), and at Bodlew in the Eastern district (147), one set of flakes pass in one direction, and a smaller set are at right angles to them. But at Trewyn, near Bodafon (104), and at Bodewryd, in the Northern district (220), there is a very close quincuncial orientation, with a laminar orientation of ferruginous dust. These differences doubtless depend on the original material of the rock; but, practically, the metamorphism of these felted rocks and that of the mosaic rocks has gone as far as it can in either case.

We now pass to the chemical alterations effected in rocks of larger elements. Some of these we have already seen to have their matrix pass over into a mosaic, with or without the addition of some green-mica. Others, in which the large elements are more abundant, as that to the west of Llanfehell (219) and near Llanrhwydrus (213), have simply chlorite infused between the fragments; a method of alteration which attains its maximum at Bryn Minceg, near Llandegfan (189). In other cases, as at Ty Croes (85), green mica is the interstitial mineral; and in others, as near Bodafon Farm (106), both are present, particularly in the neighbourhood of some parallel cracks which give a bedded appearance to the rock.

More interesting is the study of the quartzitic rocks, in which alteration would seem harder to induce, and less easy to be made to result in orientation. Yet the greater number of those examined are known to show cleavage on a large scale. Of the ten rocks of this kind examined, three belong to the Bodafon district, two to Holyhead, and five to the South Stack Series. Now, it is known that while the rocks of the two latter localities cleave well, those of the first do not. This difference in behaviour ought to correspond to some difference in structure. A very short examination shows there is a marked difference. In the three Bodafon rocks from Carnedd a Tre'r beidr (107), the summit of the hill (109), and Craig Fryr (110), the orientation is elemental; there is abundant green mica or sericite, but the quartz fragments are themselves elongated, and their junctions have become sutural where they come into contact, and they show further signs of pressure. In contrast to this, the rocks from the other districts have no elemental orientation, and show fewer signs of pressure. The deduction from these facts appears to be that elemental orientation is not favourable to cleavage, and that though cleavage may be produced by pressure, there is a point beyond which, if the pressure be increased, the cleavage is destroyed again.

The cleavage in the Holyhead quartzite (1) is not of the ordinary character, as may be well imagined, seeing that quartzite is not one of the most usually cleaving rocks. It is, however, remarkably orientated with a variety of quincuncial orientation—*i.e.*, instead of isolated crystals being orientated, there are groups of such crystals. These, which are flakes of colourless mica, form a large portion of the rock, and the intervals between them are filled with quartz elements without very clear boundaries. The orientated mica does not in the least turn aside in the neighbourhood of the quartz fragments; on the contrary, the ends go straight against them, and seem to cut into them, so that their boundaries are jagged. In this rock, therefore, the cleavage is the result of the orientation, and there is no deformation of the particles. We must not, therefore, in this case speak of cleavage-foliation, but rather distinguish this—the foliation—as one cause of cleavage, which may be called *foliation-cleavage* (see fig. 12). The quartzites of Roscolyn (65), Porth-y-gwalch (64), and other beds in the neighbourhood (66) are also well cleaved, but the cleavage is brought about in a different way. As before noted, the fragments are smaller, and they fit closer together, so that there is not room for much mica. What mica is present is quincuncially orientated in the usual way, and would scarcely account for the cleavage. The rocks, however, are affected by a number of cracks, and along these the mica is continuous, and it is doubtless along these also that the rock separates, as is the case at Point Ælianus. This is, therefore, a distinct method in which cleavage may be brought about. Such cleavage might be called *fracture-cleavage* (see fig. 9).

In this group there is another remarkable rock, which has been discussed by Sir A. Ramsay—*viz.*, the flaggy bed at the South Stack Lighthouse (60), which seems to show false-bedding, and foliation along the lines of the false-bedding. In the section of this rock the primary bedding is well shown by lines of brown dust, but when the rock is examined with the paraboloid there is nothing seen between these which should indicate false-bedding. There are, however, a number of parallel oblique lines, scarcely definite enough to be called cracks, in which the mica is continuous; but the individual elements are not placed in the direction of these lines, not parallel to the bedding, but in a direction intermediate between these two, so that they overlap like a dislocated pack of cards. It is to these oblique lines that the appearance of false-bedding is due; it is in reality a kind of oblique foliation, whose origin is not very clear. Similar phenomena have been noticed by authors in other districts.

The foliation of the laminated rocks does not require many words of description. In the Western district it is typically quincuncial, but there is a tendency to pass over into the linear, especially as the elements of the green-mica and chlorite are more closely aggregated in the darker bands of lamination, and the orientation of the individual elements is not very closely defined. In the Eastern district it is more entirely linear, the elements of mica being very irregularly arranged and often of large size. In the rock at Porth-yr-corwgl (6) we have the orientation intensified by the pressure which has taken place perpendicular to its direction. In this rock is seen an interesting phenomenon, illustrative of the origin of authigenetic quartz (see fig. 13). There is a large rounded quartz fragment, caught with its longer axis transverse to the lines of lamination, and therefore more or less in the direction of pressure; one side of this has accordingly broken down, and from the products of fracture there has

been developed a lenticle composed of sutural elements of quartz surrounding the original fragment, and pushing asunder on either side the lines of lamination.

We next come to that large group of rocks which are at the same time crystalline and foliated. Of these we do not actually know the original condition, and it has to be deduced, if possible, from the phenomena of the altered rock. The general composition of these rocks is pretty much the same throughout; the differences are only minor ones. In all there is a large proportion of quartz, while felspar is more abundant in the rocks of the Central district than in those of the Eastern; epidote is an occasional ingredient in the rocks of every district, and mica is found in almost all. These minerals being authigenetic the material from which they have been derived must have been in a different form, and may have been, for all we know, of the same kind as elsewhere forms the slates and grits. The reason that these rocks now differ so greatly from the others must be either that they were different originally, or have been subjected to different processes since their deposition. But they do not differ in the nature of their ingredients, and it can be shown to be probable that they did not differ in the state of its aggregation; in other words, they were probably fine-grained rocks like those which produced the mosaics. In those examples which contain unaltered fragments, the groundmass differs in no respect from those from which fragments are absent; we may therefore restrict ourselves to the former. These fragments are most commonly felspar, a mineral not likely to resist more than others crushing or decomposition. Similar fragments of felspar are met with among the mosaic rocks—in fact they are the last to disappear—while they are very rare among the coarse-grained quartzites. It is probable therefore that the felspar fragments in both cases owe their preservation to their larger size, in which case the matrix must have been of fine material. It may have been laminated, and very probably was. The fine-grained rocks also are more liable to change, as far as the experience of those hitherto examined goes, than the coarse-grained rocks. The conclusion is, that the present size of the crystalline elements is no criterion of the original texture, which was probably fine. Hence the greater crystals must be due to later processes, which have affected these rocks more than the others. Some light may possibly be thrown on the reasons for these differences, by considering the distribution of the rocks with larger and smaller crystals respectively. The elements being throughout of proportionate size, we can judge by the size of the mica. Now the largest mica crystals with linear orientation occur in the neighbourhood of Gaerwen, northward to Penmynydd and southwards to Llangaffo (150, 151, 152, 153, 156, 158), in the Eastern district; also at Porth-y-ly-wod (74) and Gwalchmai Turnpike (71) in the Central district. If we are able at all to tell stratigraphically the centres of change, these would be in their neighbourhood; whereas, when we approach the districts of less altered rocks, as at Bodowyr (146), Bwlch, near Llanddona (209), south of Hafodty (144), Porth-y-fawch (75), and Llangwyfen (77), Mynydd Mechell (211), and the district south of Traeth Dulas (142), we find the mica in smaller elements, and for the most part only quincuncially orientated. This seems to indicate that the greater crystals are due to more intense metamorphism, as we might expect, since the crystals being authigenetic, every large one must have been a small one first. With regard to the other minerals, the present size seems to de-

pend also on the greater or less homogeneity of the material. Thus, in the Eastern district, where the rocks are more thoroughly quartzose, the elements are larger; but in the Central district, where felspar and quartz are about equally abundant, both are of smaller size. In this last case they commonly show laminar orientation, and have a peculiar aspect, like a mass of boiled sago, especially well seen by the use of the paraboloid. Such are the 'grey gneisses' of Gwalchmai (69), Bodwrog (72), Pen-y-carnisiog (73), north of Llangwlllog (78), and south of Holland Arms (154). Why the metamorphism should be greater in one place than another is not easy to say. Certainly in one case there is a neighbouring mass of granite, and in the other a large number of intrusive masses, yet the phenomena have no relation to contact metamorphism. But the presence of these masses, on the one hand, indicates the proximity of heated conditions; and on the other, when pressure was brought to bear upon the rocks, they might act as buttresses. There is no special evidence to connect any of these crystallisations with particular intensities of pressure.

With regard to the orientation of these rocks, we have every kind exemplified amongst them. The quincuncial orientation is, as before stated, best shown when the elements of mica are small. It is beautifully seen in the rock at Porth-y-fawch (75), in which the mica crystals are exceedingly sharp and clean, and two or three of them often stand end to end. At Llangwyfen (77) maxima and minima of mica occur in alternate bands, the former being probably a later product, developed in parallel cracks. The rock at Penlon (142) shows a sago structure in its other elements, and at Mynydd Mechell (211) there are numerous derivative fragments.

The linear orientation is especially characteristic of the Eastern district. It is well seen to the east of Gaerwen (156), where magnificent crystals of mica run in irregular lines, or crowd in bands, the other elements being quite unorientated. In this and two others in the neighbourhood garnets are found, probably as the final result of crystallisation. The rock in Llangaffo cutting (150) is remarkable for the straightness of its mica, and that at Berw Ycha (152), which is full of quartz fragments, shows that, in spite of these, crystallisation of the matrix can be carried to its furthest extent, and linear orientation still be carried out, in remarkable contrast to the quartzite of Holyhead. This is also the character of the orientation in the two rocks of the Central district at Gwalchmai Turnpike (71) and Porth-y-ly-wod (74), already referred to as containing large mica crystals. Both of these, however, are more dusty rocks, the former from the presence of actual dust, the latter containing granular epidote. The laminar orientation of the sago-like grey gneisses of the Central district has already been mentioned. In three of them—viz., at Pen-y-carnisiog (73), Gwalchmai (69), and Bodwrog (72) the orientation is assisted by quincuncial mica; but in that north of Llangwlllog (78) there is very little mica at all.

Elemental orientation, which would seem at first sight to require more pressure, and therefore more metamorphism, does not appear to characterise anywhere the grey gneisses or mica schists, but rather to occur in localities removed from these, where the rocks are generally surrounded by less altered types. The only exceptions to this are at Bodowyr (146) and Hafodty (144), in the Eastern district, and these appear to owe their character to a pressure acting subsequently to their first metamorphism.

The best examples of elemental orientation are seen at Abersant (19), in the Western district—the only locality in that district where coarse mica-schist occurs; also near Bodafon (105) and at Tros-y-gors (155), near Menai Bridge. All these are composed of elements which in an ordinary section polarise in neutral tints, whose long diameters are in general about twice the short ones, and whose boundaries are sutural; the mica is, of course, parallel to these, but varies in amount, most of it occurring at Abersant and least at Tros-y-gors.

Confused orientation is seen in the rocks at Llanflewlin (210), Roscolyn (67), and south of Traeth Dulas (141), only some of the elements being orientated, and all containing numerous original fragments. In these the orientation is also assisted by lines of epidote which, as in the case of the Roscolyn rock, is aggregated along certain lines and produces cleavage. At Y Foel, Llanerchymedd (80) the rock has no crystals of mica, as that mineral has passed over into fine granular sericite, and the principal orientation is due to the other elements.

There are two other crystalline rocks which cannot well be included in any of the above groups; they differ widely from the gneisses, yet have no resemblance to the mosaic rocks. One of these is a highly micaeous rock in the railway between Llanerchymedd and Llangwlllog (93), containing both derivative and authigenetic mica, while the quartz and felspar have sutural boundaries. It looks like a peculiarly altered volcanic tuff. The other is from Gorse Mill, Gwyndy (81). It also has large derivative mica, but the authigenetic elements are much decomposed, and only occasionally show elemental orientation.

We have now to consider the alterations of a mechanical nature. It is by no means assumed that mechanical forces have played no part in bringing about the chemical changes already described, but the effects in these cases are not direct. The phenomena now to be dealt with are the immediate results of mechanical forces observable in the rocks as they now are. The results of these forces will be different according to the power of the rock to resist disintegration. If it possesses that power the effects, if any, will be observable in the elements themselves; if not, their relations to each other will be affected.

The effect of pressure on a crystal or an isotropic substance is well known. When an ordinary unpressed crystal is viewed between crossed Nicols it will show a definite colour according to its position relatively to the planes of vibration in the Nicols, and as it is rotated the colour will change equally all over the crystal, and every part in a certain position will extinguish at the same time. When, however, such a crystal has been subjected to pressure sufficiently great to have an effect on its molecular constitution it will show unequal polarisation. Hence the colour of any such crystal will not be the same throughout, but will vary from spot to spot, and when it is rotated different parts will extinguish at different times, and the darkness will pass over it like a wave (see fig. 13). Such an extinction has been called undulose extinction. As, however, the corresponding phenomenon is seen without rotating to extinction, and the colours pass over the crystal like a shadow, a more general title to use would be *spectral polarisation*, without any reference to extinction. This phenomenon has also been beautifully referred to as 'strain-shadows.' The mode of description here proposed, however, lends itself more easily to grammatical inflexion. Such a phenomenon, then, may be taken to prove that the crystal has been strained beyond its limit of perfect recovery.

Fig. 13. (6)



Fig. 14. (157)

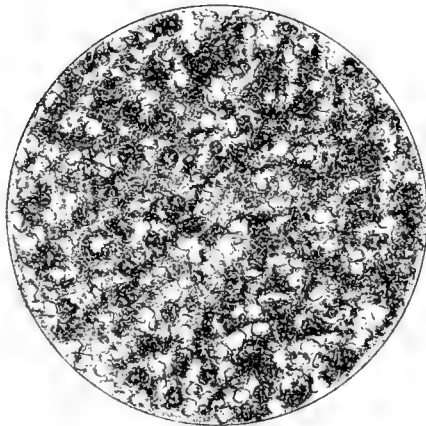

Fig. 15. (148)

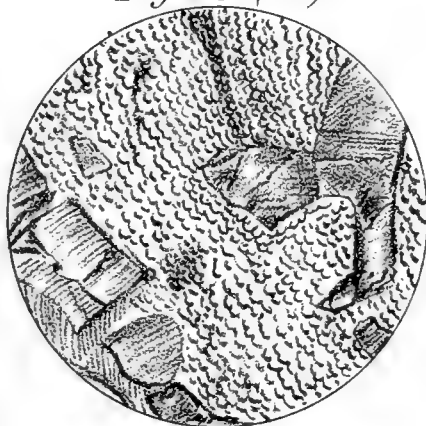

Fig. 16. (62)

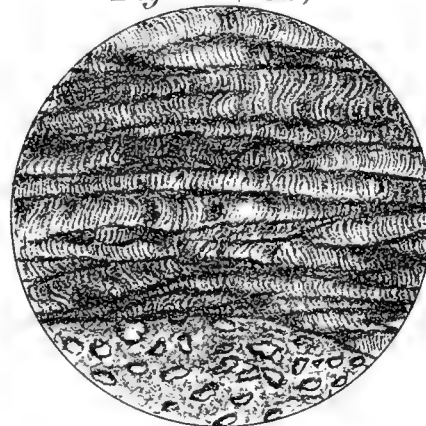

Fig. 17. (193)

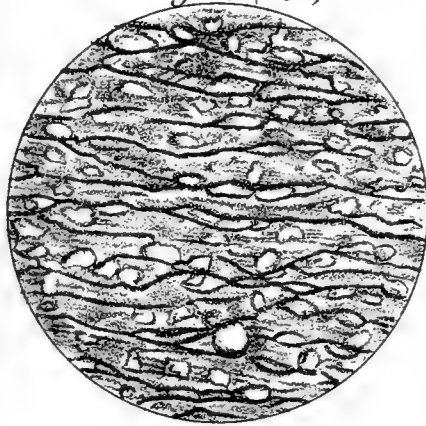

Fig. 18. (232)





When, however, a complex of small elements, whether original or produced by the disintegration of a larger crystal under pressure, is similarly affected, the colour of each small element changes towards the edges and thus becomes confused with that of its neighbours. Hence, instead of each element being distinctly marked off, the colour gradually fades on all sides into that of the others, and a general haziness and indefiniteness of the complex mass is the result. This phenomenon is immediately recognised on slightly rotating, or even simply examining a slide affected by it, and it is proposed to refer to it as *microspectral polarisation* (see fig. 14). It is the most faithful indication of the previous stress the rock has been subject to. It is sometimes referred to as a quartz-felspar mosaic, but it differs essentially from such a mosaic as is produced by the growth of small definite crystals, and should not therefore be designated by the same word. Numerous instances of this occur in the rocks already referred to. Thus the quartzites of Bodafon (109) and the cleaved rocks of Roscolyn (66, 67) show it in a high degree, while the cases in which individual crystals show ordinary spectral polarisation are too numerous to mention.

The two cases, however, must be distinguished in which, on the one hand, a complex of small elements is the primary subject of pressure, and, on the other, when the pseudo-elements are the results of the disruption of a larger one. In the latter case the boundaries are much more indefinite. In the cases above referred to the elements were originally small; and of this kind another example may be quoted—viz., the rock near the river Cefni (102), which has a slaty aspect on the large scale, in which not only the quartzose or felspathic elements are affected, but also the abundant mica which had previously filled the cracks. In an example, however, from Bodlew (148) both varieties are seen side by side. In this the original small elements produced by primary metamorphism are indicated by fine interstitial flakes of mica, while in the midst is an infiltrated quartz vein which is broken up into optical elements, so that the greater indefiniteness in the latter case can be easily appreciated. When such a rock is examined with the paraboloid, the elements which have thus optically broken up are seen to possess a peculiar structure. They are affected by a number of curved or crinkly cracks, like the surface of crape, which are sometimes parallel throughout the original element, and sometimes radiate from the apex of an adjoining crystal. In the rock at Bodlew they are seen to occupy the intervals between the broken fragments of a large microcline crystal, and cannot therefore be in anything but vein-stuff. These cracks are very minute, about $\cdot 0005$ inch apart, and can only be seen with the paraboloid. Such a structure may be called *crape structure* (see fig. 15). It is necessarily accompanied by microspectral polarisation, but the converse of this does not hold. In the case above quoted both the original small elements and the later vein are microspectrally polarised; but in another case in which the elements of primary metamorphism are larger—*e.g.*, at Ty Mawr, Llandaniel (149)—they are unaffected, while the interstitial segregation quartz shows the crape structure. This would seem to suggest that the elements of primary metamorphism were formed under so great a pressure that the later pressure, producing the new phenomena, did not reach their limit of elasticity, and consequently they were unaffected. If this be the case, since small elements are affected they must have been produced under less pressure.

Besides those already quoted there are admirable examples of this structure in the boss of rock in the field on the east of Gaerwen Windmill (158), and at the northern extremity of the mass marked 'gneiss' on the survey map (160); in both cases all regularity of structure on the large scale has been destroyed. The rock at Y-graig (159), near Gaerwen, seems to have been subjected to still greater pressure, since, accompanying an unusual amount of spectral polarisation in the elements, the structure is commencing to show itself on their edges, which break up into optical fragments. A similar explanation applies to a fine-grained rock at Gors Llwyd, Llaniestyn (161), the edges of whose elements are optically very intricate indeed.

The results of pressure which affect the relations of elements between themselves are various. The simplest is the production of ordinary cracks, which in no way interfere with the remainder of the rock but are filled with new elements, usually of quartz of larger size, but occasionally of felspar, as in the gneiss of Gwalchmai (69). In some cases in the Western district these cracks are filled with a complex group of quartz and green mica crystals, the latter arranged quincuncially, so that the result is very like a fine schist, and in fact illustrates the formation of such, and may be taken for it in fragments as at Llanfechell. There are very few rocks in the whole sedimentary series which are not affected by later cracks, often of two or even more periods of formation, but they do not materially alter the character of the rock. Particular instances, however, have already been noticed in which such cracks are numerous and parallel, and are filled with some flaky mineral, and in these cases they give a banded appearance to the whole mass, and cause it to split or cleave into fairly thin plates. In the fine-grained rock at Caer Ceiliog (9) and others it has also been noticed that the minute flakes of green mica are arranged obliquely in reference to a series of small parallel cracks transverse to the original bedding. The most remarkable example, however, of this strain, produced on the neighbouring material by the formation of cracks, is seen in a rock from the South Stack Series at Porth-y-crug (62) (see fig. 16). The section contains part of the gritty filling of a worm-track, as it seems, in the midst of very fine detritus which has now become silky with the numerous sericite flakes. Possibly this tube of grit has formed a buttress in the movement of the rock, for now the remainder is broken up into a series of cracks, associated in parallel groups, which have had the effect of contorting the fibres into beautiful sigmoid folds, which often now run perpendicular to their original direction. It is a sort of 'strain-slip cleavage' on a small scale. The whole phenomenon dies away at a little distance from the tube.

When the fracture of the rock is carried further, the original structure may be quite obscured, all regularity may be lost, and the bulk of the material may be the infilling of the cracks. Such results are by no means uncommon, and, indeed, most of the rocks which do not reveal their nature by a microscopic examination owe their peculiarities to the fracturing they have undergone. The most instructive examples, however, of this structure are met with in the Eastern and Central districts, where the general metamorphism has been the greatest. Thus the rock at Minffordd waste (162), which weathers into pencil-shaped pieces, is more than half occupied by an infilling of chlorite—the fragments being of a coarsely crystalline irregular aggregate. So in the rock at Gallows Point, Beaumaris (197) there is so much quartzose calcitic

vein stuff that the original fine-grained chloritic material itself looks like a vein in the rest. Again, the rock at Bryn Gorsddu, near Newborough (143), was once one of the ordinary coarse mica schists; but now the intervals between the fragments into which it has been broken are filled with a new and abundant growth of secondary mica, which gives the characteristic appearance to hand specimens. In the railway cutting south of Holland Arms (151) one of the rocks has patches of larger elements of quartz and mica confusedly mixed with smaller elements. Naturally, micro-spectral polarisation is common in such rocks, and in some cases is better shown than in the less fractured ones. For instance, at Cefn Du, Gaerwen (157), in the segregation veins of quartz, this and the crape structure are a perfect picture (see fig. 14). In another case in this district, between Garth Ferry and Beaumaris (194), the bulk of the rock is a mosaic of fair-sized elements, but the whole is utterly broken up and irregular; yet there is orientation produced by the various materials that time after time have filled up the cracks. In the Central district such broken rocks occur near a line along which, on stratigraphical grounds, a fault is believed to run—*i.e.*, at Porth-y-ly-wod (84), west of Gwalchmai (70), at Ynys Coed, Coedana (135), and in the area north of Llangwlog (79). These are all broken up grey gneisses. The rock at Ynys Coed, Coedana, is particularly instructive, as, the cracks being filled with abundance of chlorite, it has been taken for a 'greenstone.' There is also another rock in this neighbourhood, north of Llangwlog, which has been called a hälleflinta (87), which is so utterly broken up and recemented that its origin is quite doubtful. Other rocks of an entirely confused nature, owing to dislocation and infiltration, have been observed near Bodorgan (88) and Llangefni (101). In the former of these, the shifting is made plain by the dislocations of a small vein which crosses several elements of quartz. The whole of these rocks, though not originating as holocrystalline ones, may be referred to as cataclastic, since they have undergone the same disintegrating mechanical processes as those which are so called.

A more important effect of pressure, because more widely developed and of more theoretical interest, is the production of mylonitic lines. These are peculiar features characteristic of the rocks which have been called Mylonites by Professor Lapworth. The most typical of these mylonites occupy the position of the thrust planes which divide up the rocks in the north-west Highlands. An examination of one of these from the Erribol district will give us the characters of such rocks. We find in it abundant micro-spectral polarisation, as we should expect, but it also contains, in the midst of crystalline matter, a number of lines, which are remarkable for their continuity, and often for their tenuity, and which part asunder on reaching a fragment, to curve round again into contact when the fragment is passed. Many of them are composed of opaque white dust, whose particles are indistinguishably small; but many others are converted into sericite, which, when it terminates, is frayed out into indefinitely fine ends, like cirrus clouds. These are the mylonitic lines. In the case quoted, their production has been accompanied by motion of the rock in their direction, combined with great pressure perpendicular to that direction—in other words, they have been produced by shearing. The converse of this may be safely assumed, and when stratigraphical evidence of shearing is absent, these lines in a rock may be taken to prove that it has been subjected to such a stress. Such

lines are admirably shown in many of the Anglesey rocks. In some they occur as simple lines of dust, which may give a pseudo-laminated, or slaty aspect to the rock, as at Porth Dryw (12). A more remarkable example is in the north-east of Malldraeth Marsh (190). The rock has all the aspect of a purple slate, and, indeed, both it and the rock at Porth Dryw may never have been anything else. But at present the mylonitic lines obscure all other features, the whole rock being mylonised, and the intervening substance, though very minute, is microspectrally polarised. In the rock at Pen-y-Parc, Beaumaris (193), they have to pass round the numerous small fragments of quartz, which they do in a characteristic way, and they are largely converted into frayed-out sericite (see fig. 17). In the rock at Tyddyn, north of Beaumaris (199), they are so abundant that with the frayed-out sericite they occupy broad bands, leaving only small intervening portions, in which microspectral polarisation may be observed. In most of these cases special causes may be suggested that should cause shearing in these localities. In other cases the lines are now entirely crystalline, but can still be recognised by their other characteristics, and by the fraying out of the ends of the sericite. In this state they are well seen in the slaty-looking rock at Porth-da-farch, Holyhead (61), at Clawd-y-parc, Llandegfan (196), at Coedmawr, Llanfaes (200), and at Llechog Ucha, Amlwch (221). In some cases the lines are so abundant and regular that they may probably coincide with the original lines of lamination, which have been drawn out in their own direction, as beyond Porth Dryw (13), and at Pont Scyphydd, Llanddeussant (25).

ROCKS OF SPECIAL ORIGIN.

Amongst the ordinary sedimentary rocks of Anglesey are found certain special types which differ from the rest both in their mineralogical composition and in their mode of occurrence. These are found in isolated masses, often of peculiar form, and are quite characteristic of the series to which they belong. Their origin must be partly determined by their stratigraphy, but their microscopic structure may throw some light upon the question. The two principal types are limestone and quartz rocks.

Limestones.—These are of several types, some of which have been already described by Professor Bonney.

One form of limestone, which occurs, like all the rest, in isolated or lenticular patches, is found amongst the crystalline rocks of the Central district, and partakes of their character. Since the rocks amongst which they are found have been recrystallised, these have doubtless been also, especially as they are distinguished from the rest by the large size of their elements, which vary from .02 to .04 inch in diameter. The crystals are characteristically twinned, and occupy the mass of the rock, with only a few grains of quartz, mica, or black dust in the interstices. The one at Trecastle (90), discovered by Dr. Callaway, is orientated with the rest of the schists, but that at Bodwrog (91), inserted on the Survey maps, is disturbed and irregular. These were, doubtless, like the other varieties before their recrystallisation, and may be considered to have had a similar origin. There are limestones also in the older or more stratified portion of the series in the Western district. One at Porth Delise (15) occurs in an irregular tongue in a disturbed area, and is doubtless out of its original place. Its later alteration is well marked by the abundance of large crystals of mica associated with the calcite; another at Cruglas,



Fig. 19. (217)



Fig. 20. (225)



Fig. 21. (228)



Fig. 22. (207)

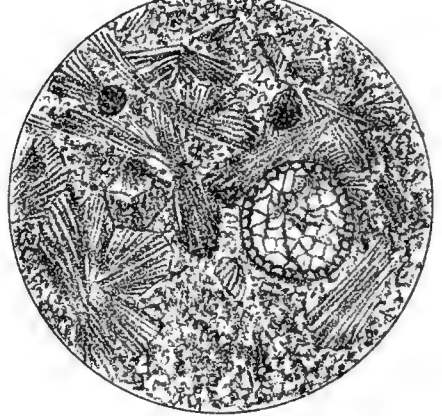

Fig. 23. (50)

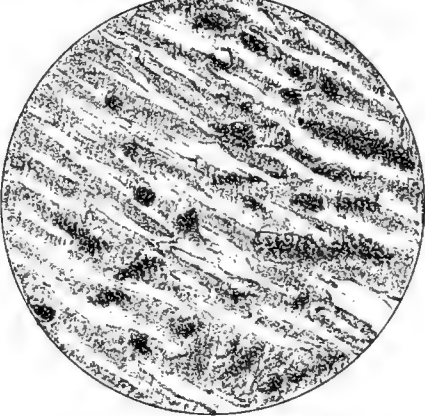
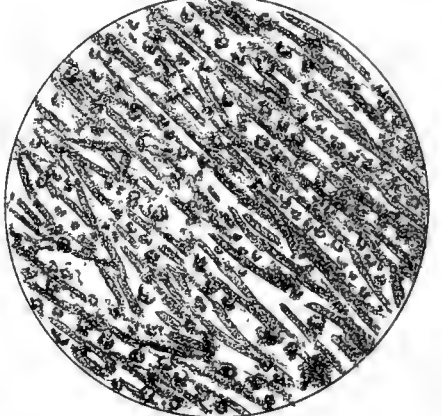

Fig. 24. (165)



and a third at Ceryg Moelion, are closely associated with the serpentine of that area, and will be described in connection with the latter. The one at Ceryg Moelion has been considered by Professor Bonney to be an infiltration from carboniferous limestone which may once have overspread the district.

Another type occurs amongst the unstratified materials, either where the rocks are fine-grained, or where they are obviously volcanic accumulations. These are generally formed of small isodiametric crystals, without twinning, which form a mosaic, and only contain the large twinned crystals in later cracks. They are exceedingly pure, and show no signs whatever of pressure, and occurring as they do in lenticular patches it is impossible to believe that they are parts of bedded rocks brought into their present position by folding; they must, on the contrary, have crystallised *in situ*. Those with the largest crystals, about .002 inch diameter, occur where the rocks are most altered, as behind the Druid Inn on the old Holyhead Road (92) in the Central, and at Rhyd Eilian (202) in the Eastern, district. A similar rock has been described by Professor Bonney from Wugan, Pentreath. Where the rocks are of finer grain, as at Llanfaethlu (26), the calcitic, or perhaps dolomitic, elements are smaller; but the smallest of all, being not more than .0002 inch diameter, are found in the limestone at Llanlliana (218), where the rock is on a larger scale, and is more or less stratified. In those masses which are found amidst volcanic accumulations, and whose mode of occurrence is similar to that of an intrusive rock, there is generally some admixture of quartz. Thus at Port Unal, on the Northern coast (215), the general elements are small dolomitic (?) ones, but the shrinkage cracks are filled with quartz; and at Careg Gwladys (205) quartz occupies narrow interstices between the calcareous elements, as well as the cracks, and sometimes increases so much as to form the greater part of the rock.

Another remarkable type, but of somewhat similar mode of occurrence, is the oolitic rock of Llanbadrig (217) (see fig. 19). The original basis of this is a crystalline mass of small elements with shrinkage areas of larger ones, and is therefore identical with the Llanfaethlu limestone. But this original mass has been broken up into fragments, each fragment has been coated with a band of calcitic dust, and then these dust-coated fragments are enclosed in a similar matrix to the original. Two or three thus imbedded go to form a larger fragment, and this again is coated with another layer of calcitic dust, or a second coat may be deposited on an original fragment, and this process goes on again and again; and, lastly, the interstices between the final fragments have been filled up with calcite in larger elements. We can thus trace the gradual building up of the rock *in situ*, and can recognise that the process is exactly what might take place in the action of a calcareous spring, producing a chemical deposit.

Certain limestones in the series have a more bedded aspect in the field, and these are found to differ fundamentally in their structure from the above. Thus another rock at Careg Gwladys (204), which looks more coarsely crystalline, has a number of large, well-formed rhombohedral crystals of dolomite, either isolated or in groups, imbedded in a matrix of quartzose fragments interspersed with a brownish opaque dust. The edges of the dolomite crystals generally have a band of clearer crystalline matter, but they are often broken and irregular. Such a

structure seems to indicate a sedimentary rock whose materials were obtained from other deposits in the neighbourhood. The rock at Cerrig Ceinwen (94) consists of a mixture of fragments of calcite and jasper, re-cemented in a mass of calcite. These fragments are irregular and unworn, so that, whatever was their first origin, they have been broken up *in situ*—*i.e.*, the rock is cataclastic. Its structure is beautifully shown by the paraboloid.

With these limestones may be included certain rocks which owe their origin to an infiltration of calcareous matter into rocks already formed. A very considerable number of the ordinary rocks have a certain amount of calcite in veins, proving the presence of such material in the infiltrating water; but only in two cases amongst the rocks observed has this gone so far as to make the calcitic element predominate. One of these occurs in the laminated schists at Porth-y-defaid (16), and gradually passes into the ordinary rock in the direction of the laminae. The groundmass is quartz in large elements, and the calcite is imperfectly crystallised in minute particles which aggregate together in irregular areas. There is also here a quantity of chalcopyrite, which decomposes into a homogeneous transparent substance with the colour of malachite. The other is in the fine-grained rocks at Chlorach Bach, near Llanerchymedd (103), where a quantity of calcareous matter without crystalline form is mixed up uniformly with a mass of minute elements of quartz and sericite. It differs only from the other rocks of the neighbourhood by the abundance of the calcareous matter.

Quartz Knobs.—The rocks to be described under this head all occur as isolated knobs of greater or less size, surrounded on all sides by shales or schists, in whose orientation they take no part and produce no interference. They have, in fact, no orientation, either on the large or on the microscopic scale, and they show no signs of contortion. Hence their stratigraphical relations in no way suggest, but, on the contrary, strongly oppose, the idea of their being brought into their present position by the folding of any bed. They occur in various places and in various relations, yet they have always approximately the same form. These facts must be borne in mind when we attempt to interpret their structure. They are for the most part entirely composed of quartz; only one or two, which must be referred to the same group, contain a trace of other minerals. By this character they are completely cut off from all the other rocks of Anglesey—even the whitest quartzite in a bedded form, such as that at Porth-y-gwalch, being much less pure. We may consider, first, those in which no certainly derivative elements can be recognised; and then those in which they are certainly present.

Of the first group the foremost place must be given to the great knob to the south-west of the Parys Mountain (232) (see fig. 18). This is for the most part composed of large quartz elements, comparable with those of a granite, which from their intimate sutural boundaries may be certainly judged to be authigenetic. These are dotted over with very minute white specks, which are almost absent from their boundaries, so that, as seen with the paraboloid, the rock is divided into a number of closely-fitting polygons. This *polygonal* structure, which is very characteristic of these quartz knobs, is to be seen also in many of the veins and patches of secondary quartz in the ordinary sedimentary rocks, and hence may be taken to be an additional evidence of authigenesis.

There are also occasional irregular patches of smaller elements. In

no case in this rock is there the slightest evidence of anything between one element and another, nor of the presence of any other mineral than quartz. When seen on the large scale there are appearances of a previous fine banding in some parts of the rock, and of these being subsequently broken up, and recemented by fresh quartz. One such band is recognisable in the slide. It is composed of rather clearer elements, followed by a crack, on the other side of which the elements are smaller. This crack is thrown into such deep sigmoid folds that, if ever it was straight, the rock must have been greatly compressed; yet the only sign of pressure is a slight amount of spectral polarisation. The rock is also traversed by veins, in which the elements are clear, but are nevertheless in optical continuity with the previously-formed elements on either side. These veins were subsequent to the folding of the crack, as the crests of the sigmoids are cut off by them. The rock has, therefore, had a long history, and the earliest form traceable is the polygonal structure. If now we compare this with the structure of a jasper, such as is associated with the limestone at Cerrig Ceinwen (95), we find in the latter also the whole mass, with the exception of the fine ferric dust, to be siliceous and mostly quartz, but the elements are small and irregular, though with sutural boundaries. In this case we are sure that the rock has been produced directly from siliceous waters, and the chief difference between the two is in the size of the elements. There is just the same difference between the elements of a granite and a felsite of the same composition. It is possible, therefore, that there may be the same relation between the quartz rock and the jasper as between these two. In other words, the quartz rock was more slowly formed, and at greater depths beneath the surface. From these considerations, from the banding of portions of the rock, from its purity, and from the mode of its occurrence it has been suggested that such a knob represents the underground base of a hot spring of the period.

If this is the most satisfactory explanation of this particular rock it must be allowed to have its weight in the interpretation of the others, which resemble it in mode of occurrence, but which present greater difficulties. The purest of these occur also in the Northern district, and have been examined from Bull Bay (231), Port Unal (214), and Pen-bryn-yr-Eglwys (36). In these the elements are not so uniformly large, though the larger ones have equally sutural boundaries and polygonal outlines; but there is also a considerable quantity of finer elements irregularly dispersed, and some of them have a minute sericitic boundary. There are, moreover, in the two first some rare and minute zircons, and in the last some certainly derived fragments which are not of quartz. Still the rocks are essentially pure quartz, of which by far the greater part is certainly authigenetic. Although it is difficult to account for so great purity in a sedimentary rock, like an ordinary quartzite, it is not difficult to account for the slight impurities that might be present in the deposit from a siliceous spring.

In the case of the other quartz knobs which have more numerous derived fragments, these still have a special character, though, no doubt, if it were not for the peculiar stratigraphy, and the existence of purer quartz rocks having the same form, some of these might well pass for grits. If we examine the quartz rock of Bethel, Bodorgan (96), we find that the most conspicuous of the derivative elements are quite peculiar. They are larger than all the rest, and their outlines are very rounded, and they

have a layer of sericite clinging closely to their surface. At the same time they are clearer, the specks in them are not scattered irregularly, or absent from an external band, but lie in different planes produced by cracks which go across from side to side and intersect each other; many of them are also crowded with fine crystalline needles. These rounded grains are not at all like any of the fragments in the ordinary quartzites, nor like any authigenetic element in the schists, more especially in the particular of the fine needles—these point to a source such as that which produces granitic rocks. In any case these rounded derivatives are sharply marked off by all their characters from the remainder of the rock, which consists of polygonal authigenetic elements of almost complete purity, with the exception of a little sericite. The rock thus contrasts strongly with any of the bedded quartzites, notwithstanding that it is quite small in bulk, and surrounded by slaty rocks, and the peculiar roundness of the derivatives presumes a long attrition. Have these been worn by the very water from which the matrix has derived its silica? and has the attrition taken place, not in streams on the surface, but in circulating currents underground?

From this we may pass to the knob of quartz at Pen-y-Parc, Beaumaris (203), described by Professor Bonney. In this the derivatives are very numerous, and not all of quartz; yet is the general character of the rock the same, and it has the characteristic mode of occurrence, and it is impossible to imagine it brought into its present place by folding. In fact, though the neighbouring rocks have been shown to be crowded with mylonitic lines, no spectral polarisation affects the quartz. On the contrary, one of the derivatives shows microspectral polarisation developed before its deposit, and not continued into the surrounding matrix. Notwithstanding, therefore, its great similarity, in many respects, to an ordinary quartzite, we may conclude that the circumstances of its origin were different, and the general method of production the same as in the other quartz knobs.

There are many other similar quartz knobs in the island, which have not been examined, but the great mass at Llangefni (97), marked 'greenstone' on the Survey map, is peculiar. It is much larger than any other, and from a distance looks to have almost a bedded appearance. There are a great many derivative fragments in it, but in the character of these and of the matrix it much more closely resembles those above described than any of the ordinary quartzites.

Green Rocks.—Besides the limestones and quartz rocks, there occur occasionally, in similar isolated masses which often weather into knobs, certain green rocks which show no structure on the large scale but look minutely granular. These are found to be composed of minute crystals of definite minerals, which seem to have segregated in such separate masses. Some, as at Borthwen, near Roscolyn (68), are composed of epidote, whose crystals are separated by lines of black dust, and with shrinkage areas filled with quartz. Others, as at Porth Delise (14), which are more fibrous-looking, are composed of a greenish transparent mineral arranged in tufts, which polarise with a grey tint like serpentine, of which they are probably a variety. In another, south of Beaumaris (192), the nature of the principal dusty mineral without any form is obscure, and may be decomposed epidote; the green colour is produced by the ground-mass of chlorite. These masses are mostly confined to the most altered rocks, and seem, like the others of this group, to have a chemical aqueous origin.

CRYSTALLINE ROCKS WITH THE HABIT OF IGNEOUS ROCKS.

The nature and origin of the rocks of this group have been and still are the subject of much difference of opinion. Those in which no foliation is perceptible are considered granites and diorites by some, while others have noted in them peculiarities which have suggested that they are extremely altered sedimentary rocks, and have made comparisons between them and the Laurentian gneiss. Those in which schistosity is manifest have been generally taken to be of sedimentary origin; but recently it has been shown that similar structures may characterise igneous rocks under suitable circumstances.

The solution of these questions will not depend on the microscope alone, and the writer has shown what he believes to be satisfactory evidence of intrusion, and therefore of igneous origin, in both cases. However, the present business is to examine their structure, that any conclusions which may be come to may be in the light of our knowledge of this. One thing is certain, that if they be altered rocks we have no knowledge of any unaltered representatives of them in Anglesey, and can only study them as they are. It is, however, for convenience, and not with the intention of begging the question, that in their description they will be referred to as granites, felsites, diorites, &c. Many of these rocks have undergone much alteration, even after they were crystalline as we now find them; but in this case the alterations are so dependent on the original rock that they cannot be considered separately, but we can only consider—(1) their component minerals; (2) their structure, original and induced.

Minerals of the Rocks of Igneous Habit.—*Quartz* is far less abundant than in the rocks of sedimentary origin. In one large subdivision it is absent from the original rock, and occurs only in veins or bands in which it has segregated. Even in the other subdivision it never forms the greater part of the rock, and is more common as the latest-formed mineral in the intervals between the others than as one of primary consolidation and of large size. This is a common feature of the quartz of igneous rocks; on the other hand, considering the exceedingly quartzose character of the undoubtedly sedimentary series, it would be rather strange, though not beyond the bounds of possibility, that a more basic group should have succeeded them in the same neighbourhood.

Felspar.—In the absence of the characteristic banding of plagioclase, and in the presence of abundance of saussuritic decomposition, it is not always possible to determine the species, especially when there are no crystal outlines or cleavages. Doubtless much is orthoclase, but plagioclastic species must be at least equally abundant. With regard to the banding, nearly the same may be said as with regard to the fragments, &c., in the sedimentary rocks. Perfectly regular banding, certainly representing twinning on the albite plan, is very common, but the lines often die out in the midst of the crystal. There are seen also in the coarser granites the finer cross lines, which represent the pericline twinning. The appearances referred to microcline are more abundant in these rocks, and are sometimes beautifully shown, as in the granite at Ynys Dodyn (118). They have all the characteristic indefiniteness and changeability as the slide is rotated, and are also seen cutting at oblique angles down to 60° , probably owing to the obliquity of the section. It is suggestive of these bands being developed by pressure that they are found chiefly in

rocks which for other reasons are known to have been subjected to such pressure, as in the neighbourhood of Llanfaelog and Gwalchmai. Some feldspars also show a broad obscure banding, independent of all the above, which probably represents an imperfect zonal structure.

Mica is not abundant in this group of rocks, except in isolated examples, and in the more basic group it is generally entirely absent. Perhaps muscovite is the most generally diffused species; but whereas ordinary biotite is entirely absent from the sedimentary series, it is here nearly as abundant as any other, to judge by the darker colour and dichroism. It is especially characteristic of the cleanest granites, but is most abundant where the rock is foliated at the margins of the granite areas, as at Tafarn-y-botel (123) and Ty Newydd (245), and in the district north-east of Parys Mountain (251).

Hornblende may be considered the characteristic mineral of the rocks of igneous habit, inasmuch as it never occurs in the sedimentary rocks of Anglesey, either as a derivative or authigenetic. A large number, however, of these igneous rocks contain it as an essential ingredient, always in the common green form. It is entirely absent from the rocks of the Northern district, but occurs in the district east of Parys Mountain. In the Western district it is found only at Pen-bryn-yr-Eglwys, and at Llyn Trefwll, in both cases in association with granitic rocks. The principal localities, however, are in the Central and Eastern districts, where it sometimes forms the greater part of the rock, as near Holland Arms (181).

Glaucophane.—The occurrence of this mineral in the Anglesey schists has recently been recorded by the writer ('Geol. Mag.' N.S. Dec. III. vol. v. p. 125). It is there stated to occur in long narrow prisms with incomplete terminations, which have a rhombic cross section with an angle of about 124° , sometimes modified by the clinopinakoid. The extinction, as far as can be determined, makes an angle of about 15° with the length of the prism, which is somewhat greater than the characteristic amount, and approaches the angle of hornblende. Hence Italians would call the mineral 'gastaldite.' The characteristic blue colour is seen when the length of the prism coincides with the short axis of the polariser, and it has a violet tint when placed in the perpendicular direction. In the rhombic section it has a slightly yellowish tint. The crystals are usually interfelted, so as to have no definite boundaries, but they are occasionally seen floating separately in the layers of quartz which sometimes penetrate the rock. This mineral has only been hitherto found in one very schistose group of rocks in the Eastern district, and even there it passes locally into hornblende and decomposes into chlorite. It is best seen in the rock near Anglesey monument (168, 169). For a figure of this rock see Teall's 'British Petrography,' plate 37.

Epidote is perhaps the most widely distributed of all the minerals in these rocks, though from its small comparative amount in each the aggregate is not so great as of others. It usually occurs in isodiametric elements, often with crystal outlines, and occasionally lath-shaped and radiating. It also occurs in long pulled-out bands in rocks which have been dynamically metamorphosed. It is most abundant in the gabbro schists of the Western district, in the diorites of the Central district, and in the hornblende and glaucophane schists of the Eastern district. In many cases there is no direct evidence of its being a secondary product; and in one case, that of a spheroidal rock, near Amlwch (227), it appears to have developed out of felspathic groundmass, without actual feldspar preceding it.

Chlorite is equally abundant as a decomposition product in the igneous as in the sedimentary rocks. It is formed from either hornblende, epidote, or mica. It shows feeble polarisation, and therefore is not the green-mica of the sedimentary rocks.

Sericite is also common as a result of the decomposition of white mica, or as an infilling of the interstices between other minerals.

Sphene is an abundant and characteristic element in the hornblendic rocks of the Central district, especially in one at Craig-yr-allor (131). The crystals are never perfect, but their brownish tint, high refractive index, characteristic cleavages, and weak double refraction are quite distinctive. It occurs in the midst of feldspars or other minerals in irregular grains, which are often worn so as to look as if they belonged to a previous generation. It is sometimes associated with ilmenite in such a way as to suggest its derivation from that mineral, as has been shown to be the case in some American rocks.

Ilmenite and Leucoxene.—The presence of one or other of these depends on the state of decomposition only, so that the presence of the latter indicates the original presence of the other. The dark black substance which is associated either with leucoxene or sphene is taken to be ilmenite. It occurs in abundance in the hornblendic rocks of the Central and Western districts, and also in the finer-grained granites. The leucoxene is often in skeleton crystals, only partially presenting hexagonal outlines. It is best seen in the diabase between Amlwch and Parys Mountain (229).

Rutile is not a common mineral here. It occurs as isolated crystals of prismatic form in some of the hornblendic rocks of the Central district, as at Plas Llanfihangel (136), and also in much smaller grains in some of the finer rocks of the same kind at Gaerwen (177).

Apatite is an abundant mineral in the hornblendic rocks. In mode of occurrence it agrees entirely with the sphenes, and is seen side by side with them in the rocks at Penterfyn (134). Like that mineral its refractive index is high, but not so high, and it is remarkable for its beautiful clearness. It often occurs in characteristic hexagonal prisms. There are many occurrences, however, of irregular masses, which by all other characters must be assigned to the same mineral. Apatite also occurs in needle-like prisms in several of the feldspars and quartzes of the granites.

Garnets are numerous in certain of the rocks, especially in the volcanic group north-east of Parys Mountain, both in the crystalline and the associated tuffs. But they are very peculiar in their characters. They seldom even make an approach to a crystalline form, but sometimes they are round and sometimes they spread out in a kind of ophitic sheet, without regular boundaries. Moreover, there is often very little garnet left in them. In the first place they contain many inclusions, mostly of quartz, but sometimes of sphene or apatite. Then the actual garnet has been cracked in many directions, and along these lines runs a band of ferric dust, bounded on either side by sericite, occupying, on the whole, a considerable portion of the mineral. The intervening fragments have mostly turned to chlorite, and there is only left here and there a few small pieces, which prove to be isotropic and highly refracting, to represent the original material, and even these are often broken out in the cutting of the slide.

Zircon seems rare in these rocks, unless it has sometimes been mis-

taken for sphene. When the crystals are small they are not always easily distinguished. But in the granitic rocks of Tafarn-y-botel (123) and to the south there are highly refracting and doubly refracting crystals, which are clearer in colour and more vivid between crossed Nicols, which almost certainly belong to this species. It is usually associated with quartz, but not always.

Augite is essentially the mineral of the dykes and minor igneous sheets in this region. Such masses occur amongst the grey gneisses of Llangwfen (125), at the boundary of the chloritic schists of Llyn Trefwll (56, 57), in the boss between Amlwch and Parys Mountain (229), and amongst the volcanic group north-east of Parys Mountain (243). It is generally of the colourless variety, and is well characterised by its cleavage and optical properties.

Olivine in a fairly fresh state occurs in diabases south of Bodowen (127), which stratigraphical and other considerations would assign to part of the volcanic group in the older series.

Diallage is equally characteristic of the gabbro area near Four Mile Bridge and on Holyhead Island, where its well-marked cleavage leaves no doubt of its identification. It has not been found elsewhere. No unaltered olivine has yet been found in association with these rocks.

Enstatite occurs in at least one of the better preserved rocks of the gabbro area—viz., at Ty Newydd (45). It is distinguished from the ordinary pyroxenes by extinguishing parallel to the traces of the cleavage planes. It may be more common amongst these rocks, but not many suitable slides have been examined.

Chrysolite occurs in veins in the gabbro area in the midst of that rock and of the serpentine at the inlet on Holyhead Island, south of the Four Mile Bridge. It is well characterised by its fibrous structure and low polarising tints.

Serpentine, of course, forms the bulk of the rocks in the serpentine area of the Western district, and is not always developed as a pseudomorph of any particular mineral, but occurs also in veins and cracks traversing calcareous and other rocks.

Talc is considered by Professor Bonney to be the mineral which produces the rock quarried as 'soapstone.' It is found at Pwll Clai (54).

Pyrites is a rare mineral in these rocks, but occurs as isolated crystals in a few of the granitic rocks and in the pyroxenic rocks of the volcanic group N.E. of Parys Mountain.

Hematite also occurs in minute brilliantly scarlet crystals, sometimes of hexagonal outline, in the granites of Pen-bryn-yr-Eglwys.

Magnetite may be the black mineral in undistinguishable grains which makes up the groundmass of a rock at Gwalchmai (138), and it is also dispersed throughout the serpentines.

Calcite occurs in many of the rocks in such abundance as to form an essential ingredient. In some cases it is undoubtedly a filtration-product, as at Nebo (248).

Tourmaline.—A few narrow purplish blue crystals, which extinguish parallel to their length without the analyser and look hexagonal, may belong to this species, though the crystals are very small. They occur, where we might expect them, at the edge of the granite mass where it is intrusive into micaceous schists at Maengwyn (122), and also in a quartz segregation area in the glaucophane schist near Castellor (171).

Structure of the Rocks of Igneous Habit.—The rocks now to be described

may be conveniently divided into five groups:—1. The granitic rocks and their associates. 2. The volcanic group east of Parys Mountain. 3. The dioritic rocks and their allies. 4. The gabbros and serpentines. 5. The isolated masses and dykes.

1. *The Granitic Rocks and their Associates.*—These rocks are immediately distinguished from the sedimentary rocks of similar composition—*i.e.*, the mica schists and gneisses—by the largeness of their elements. They seem indeed quite another order of rock; instead of the numerous minute elements of the schists, a single crystal of felspar will often occupy more than the whole field of view, and though the rock is holocrystalline there are none of the sutural junctions so characteristic of the schists. The only orientation in any of them is a very rough linear one, not observable under the microscope. If the larger size of the resulting elements is taken to indicate a greater intensity of metamorphism, then these granites must have been subjected to such influences to a point far beyond the gneisses. The orientation of the latter indicates that the forces they were subject to were ‘directed,’ but its absence in the granites indicates agencies without direction. These conditions are satisfied only by the production of a mobile magma. In other words, the rocks must have been melted. The only evidence of any previous state consists in the occurrence of such minerals as quartz, mica, and felspar as enclosures in the various elements which now form the rock.

The largest mass of granite occurs in the Central district, where it shows several types. We may divide them roughly into those in which quartz is a considerable element, and those in which there is little or none. Of the first of these divisions the freshest examined is that at Henblas, Llandrygarn (117). In this the felspar elements are very large, and the greater proportion are plagioclase. They are very dusty, and in some cases are so much altered as never to completely extinguish; in other cases they are scarcely altered at all. There are some brown mica elements, whose position and relations indicate that they are of the same order of consolidation as the felspar. The quartz is more continuous, and encloses areas of felspar, so that it plays the rôle of groundmass, though some of its elements are large. Fresh, however, as the rock appears, it has abundant signs of having been submitted to pressure since its consolidation. The quartz often breaks up into smaller elements, showing an imperfect microspectral polarisation; the larger elements polarise spectrally, and the appearances of microcline are seen in some of the felspars. If this rock be compared with the granite of Killiney, the resemblance is remarkable. The latter is certainly fresher, but it has the same relations of the elements, and shows also spectral polarisation and microcline structure, but the quartz is not so broken up into smaller elements. On the whole, it appears to only require subjection to a little more pressure to become identical. The best preserved granites at Llanfaelog (112) and Craig-yr-allor (116) are practically the same rocks, and in some parts of the former the quartz is unbroken, and the resemblance of these parts to the Killiney granite is almost complete. On the whole, however, the quartz has been broken by cracks, and these have become broadened and filled with mica, now passed over into chlorite, so that the aspect of the ultimate product is very different from the original. The great majority of the granites examined, however, are thoroughly cataclastic rocks—as, for example, the tongue of that rock at Porth-y-ly-wod (113), at Gwalchmai (115), at Bryn Twrog further north (120) and at Ynys Coed, Coedana (121).

These rocks are shivered into fragments, and the larger are re-cemented amongst the smaller, presenting a true mortar-structure. It is often difficult to recognise the identity of such rocks with a fresher granite, and it is only in the larger pieces which have escaped disintegration that the original character can be seen. It is important to examine the structure of the granite where it is so clearly intrusive in its mode of occurrence at Maengwyn (122). Here it is coarse-grained like the rest, and the felspars are broken and the quartzes microspectral, and there are a few tourmaline crystals, but it is of the same general type as the rest. The surrounding rock, with which it has an irregular boundary, is a dusty schist, whose small elements have partially crystallised, and which contains large flakes of white mica which have been developed in relation to cracks.

The remarkable foliated rock at Tafarn-y-botel (123), which has so much the aspect of a Highland gneiss, has a very distinct structure. The felspar and quartz are about equally developed, and neither plays the rôle of groundmass to the other. The elements are smaller than in the granites, but much larger than in the gneisses of the district. The quartz often occurs as rounded grains, of which many are included in the felspar. There is also a considerable quantity of brown mica, which assists in the foliation. This, however, is principally produced by the presence of a dusty mineral, with well-marked cleavage, which will not extinguish as a whole, and which looks like an altered sphene. The rock is also richer than usual in accessory minerals, zircon occurring in the quartz, and apatite in the felspars.

The quartzless group of these rocks is more local, being found only in the neighbourhood of Llecheyn-farwy. It is difficult to give a name to these rocks, of which the bulk is felspar and a large proportion plagioclase, while the other minerals have undergone a change into chlorite or calcite. Such is the rock near Llecheyn-farwy church (124). Its large close-fitting felspars are thoroughly speckled with small crystals of calcite or sericite; there are a few scattered areas which may have been hornblende or mica, but are now mostly changed to chlorite, and there are zircon, apatite, and leucoxene as accessories. There is no observable alteration due to pressure.

Another rock of this type, at Ynys Dodyn (118), requires great caution. At first it appears to be in a fresher condition, but a closer examination indicates that it has undergone a cataclastic modification, with a re-formation of its crystals. Plagioclase is still the principal ingredient, and, in certain patches, it is much speckled and contains in the intervals between its crystals the remains of mica now altered to chlorite. These patches are separated by, and often isolated in, continuous areas of fresher plagioclase in which there is no mica, but epidote fills the intervals between adjacent crystals. Thus the speckled portions appear to represent the original rock, which has broken up, and the fresher felspar has crystallised between and around the fragments. It is remarkable that, as in the case with the mica schists, the later pressure has produced spectral polarisation in the fresh elements, while the original fragments are left unaffected. There are other cataclastic forms of this type in the neighbourhood in which recrystallisation has not gone so far, which need not be further specially noticed.

Associated with the granites of this district are several quartz felsites, of which two have been examined from Tyn-y-Pwll (119) and Pen-y-carnisiog (114). It is by no means certain from their stratigraphical

relations whether these are apophyses of the more crystalline rock, or dykes within its substance; on the whole, the former appears more probable. They consist of a rather coarse groundmass of felsitic elements with large idiomorphic crystals of quartz, twinned orthoclase, plagioclase and mica. The latter rock has much more sericite in its finer groundmass. They are thus 'microgranites.' The porphyritic elements, or 'insets,'¹ are not always simple crystals, but crystalline aggregates of feldspar and quartz or mica, so that it is 'glomeroporphyritic.' Most of the feldspars are speckled with small crystals, and the quartzes show spectral, or even microspectral, polarisation. The obvious connection of these insets with granite seems to show that these are not ordinary quartz porphyries, but special modifications of the granite itself.

Another important, though small, area of granite exists in the neighbourhood of Pen-bryn-yr-Eglwys, in the north-west. The chief peculiarity of the rock here is the almost entire absence of any micaceous element, except such secondary mica as has been developed in well-marked cracks. The freshest rock of the district is behind the farm of Monachty (44). In this the quartz and feldspar, most of which is plagioclase, are of equal importance, crystallising simultaneously in large plates, and occasionally inter-growing pegmatitically. The quartz is much cracked, and shows occasionally some spectral polarisation, and a few of the feldspars are speckled; otherwise it is hard to discover any changes which have taken place in the rock, which is as good a granite, or rather aplite, as one could conceive. It only requires the presence of epidote to bring it into close agreement with the rock of Bryn-y-garn, St. Davids. This same rock at its junction with the surrounding sedimentary rocks (43) loses most of its quartz and becomes brecciated. Its enclosing rock is finely granular and sericitic.

Nearly as clean a rock as the above occurs on the north side of Pen-bryn-yr-Eglwys (40), but much of the quartz is here disintegrated into smaller elements, and there is some apparently original mica. The accessory minerals observed in these are some small needles of apatite, and minute rhombohedral or hexagonal crystals of brilliant red hematite, a few crystals of pyrites, and very rare zircons. All the other examples from this district are merely cataclastic modifications of this. In one, obtained from what was supposed to be the junction of the granite with the surrounding rocks (41), there are numerous and closely set, somewhat parallel, cracks now filled with mica, so that the rock is a kind of false mica schist; but it is pretty certain from this that the true junction is not here seen. Finally, on the northern side of the hill, close to an important fault (42), the slide shows an indiscriminate mixture of granite fragments and dust, in which there is no regularity whatever. These observations show that the neighbouring schistose rocks are derived by dynamic agencies from the granite, and not the granite from them. They also show how far these changes may go without our losing sight of the previous condition and structure of the rock. With these granites are associated certain felsites, which seem in the field to take its place. One of these near Pant-yr-Eglwys (35) does not differ particularly from an

¹ No satisfactory name for the crystals in a porphyritic rock has yet been proposed, and a paraphrase has always to be adopted. The name used by the Germans is 'Einsprengling,' and the nearest English term available corresponding to this would be 'inset,' which it is therefore proposed to use instead of porphyritic constituent.

ordinary felsite, with insets of eroded quartz and felspar in an indefinitely crystallised groundmass. But in others, as on the east side of Pen-bryn-yr-Eglwys (37), and at Pant-yr-Eglwys (33), proved to be felsites by the occurrence of numerous, though altered, insets, the groundmass is composed of definite round elements, all of the same size and substance, and divided by thin lines of sericite. These elements are so much like grains that, except for the insets, the rock under the microscope might be taken for a sedimentary one.

In the district south of Traeth Dulas the best preserved granite is a beautiful white rock (139), which microscopically appears quite fresh. It is characterised by its glistening white mica, most of which appears to be original. But in spite of its fresh appearance it is much broken up, and fresh mica is developed along the cracks, the spectral polarisation is strong, the quartz is disintegrated, and a confused orientation is introduced. It is, therefore, more or less cataclastic.

The rock at Llyn Trefwll (55) is still more cataclastic, though destitute of mica. The débris are very small, and only a few grains of epidote break the monotony. The rock from this neighbourhood, examined by Professor Bonney, appears to have been less broken. There are granites also in the group of rocks to be next discussed, but they will be best dealt with in connection with their surroundings.

2. *The Volcanic Group north-east of Parys Mountain.*—This is a marvellous group of rocks, quite unlike anything else in the island, or even, perhaps, in Britain. On the large scale, there is no regularity about them; but they seem to become crystalline in lamps and patches with no definite boundaries, but shading off into earthy-looking or sericitic rocks. Neither their stratigraphy nor their structure, however, suggests that the more crystalline portions are 'eyes' produced by the relative motions of the several parts; but give more the idea of their being a volcanic complex of fused and clastic materials. They are not all suitable for microscopic examination; but such as are, though they may be earthy in appearance, turn out to be crystalline in structure, and the irregularity of the mass is mirrored in the irregularity of the elements. They may be divided for description into two groups, according as the component elements are large or small. Those with larger elements have a crystalline appearance in the field, and some may be classed as granites and some as diorites.

The granitic type is well seen at various places on the shore, north of Porth Lygan (233). It consists of large masses of quartz divided by sutural lines, and equal masses of felspar which are occasionally idiomorphic, but are now so speckled as to be composed of little more than sericite and calcite, while many of them are banded. Between these two, isolated in their midst, and fitting closely against them, are patches of both brown and white mica, which are, therefore, judged to be original. The rock is therefore a typical granite, showing no signs of pressure, and has no schistose associates. Yet it is of the same type as the other granitic rocks of the island, both in the bands of the quartzes and in the alterations of the felspar, and differs chiefly in the absence of accessory minerals. When, however, this granite is broken, as at Pen-yr-Allt (244) garnets are found in it, though in such a state of alteration, as already explained, that little of the original mineral is left.

Those rocks on the east side of Parys Mountain, in the band that lies to the south of the main development of the group, that may be referred to the granitic type (252), are, like the rocks near Llecheyn-farwy, more

basic in composition. They contain no quartz, but are principally composed of large crystals of plagioclase, with some possibly original mica. It is, however, irregularly cracked, and the cracks are filled with mica and with a certain amount of hornblende of apparently secondary origin. This is closely associated with the rocks of dioritic type, which, as elsewhere in the island, are of a schistose character, apparently owing to the tendency of the hornblende to orientation. In one example examined (249) this mineral is very abundant, and is certainly of the same generation as the accompanying plagioclase, both being clearly crystallised and of equal importance. There is also abundance of isolated, and therefore probably original, brown mica. Quartz occurs sparingly, both as separate elements and as small inclusions, in the mica. The accessory minerals are numerous and important, including apatite and ilmenite, and a few crystals of sphene. Another example (251) contains the largest crystal of sphene seen anywhere in Anglesey. All the elements of these rocks are smaller than those of the granites. It is difficult to be certain of the origin of these schistose diorites in this locality, their stratigraphical relations being obscure. They are probably unconnected with the granites and later in date. Their basic character, their accessory minerals, and their association, all speak against their being developed from the neighbouring sedimentary rocks, as supposed by Mr. Allport. They show no signs of pressure.

We can in fact observe what may well be considered as the true sedimentaries in the immediate neighbourhood (250), and these are of an entirely different character. They are slightly orientated, and are composed of rather rounded elements of quartz, mica, and felspar, much of the latter being plagioclase; and in general they closely resemble the gneisses of other districts. It is probable that these are the rocks which formed the ground out of which the volcanic products were erupted.

The small-grained rocks of the district are exceedingly various, and it seems almost impossible to classify them, each one examined being different to the others. Moreover, their structure is utterly irregular, being nothing but a confused mixture of various minerals; according to the collocation of these minerals so is the rock. Very few, however, show any signs of pressure. In one group there is much secondary mica. Of these there is a beautiful example at Abertywedog (239), full of dark mica, interspersed with ferrite, and containing also quartz in irregular patches and sericitised felspar. Its chief peculiarity, however, is its containing the beautiful decomposed garnets, already described, some of which are large enough to occupy the whole field of view. In another of the same micaceous type, at Penrhyn-glas (246), and which also contains some ilmenite, the decomposed garnets are so abundant as to almost play the rôle of groundmass to the other elements. The others of this group take their character from the principal second ingredient. Thus at Llanwenllwyfo (242) we have a micaceous rock, in which the principal mineral is quartz, with apatite and brilliant zircons. In one south of Nebo (247) the principal mineral is sericitised felspar, with apatite and ilmenite; and in one at Dulas (237) the quartz and felspar are about equal in amount. One of the rocks of this group, at Porth Lygan (235), exceptionally shows feeble signs of foliation. It has abundant brown mica, with sericitised felspar, small scattered elements of quartz, with ilmenite or leucoxene, and another mineral, now utterly altered and decomposed, but which occasionally shows the cleavages of hornblende.

This may be compared with the hornblendic granite already described. In another rock near the same spot (236), but close to a crystalline mass, the whole mass has been broken up into fragments or torn out into strings. The best interpretation which can be suggested for these is that they are irregular masses composed of the materials of a granite in the form of volcanic *débris*.

A non-micaceous group has some quartzose representatives, as at Abertywedog (240), where the other elements are fairly preserved plagioclase and calcite, with a little leucoxene and apatite; and also some which are quartzless, as to the south of Nebo (248), where the rock consists of an irregular aggregation of plagioclase and calcite without definite boundaries. It also contains a considerable quantity of sphene, and a small amount of apatite and garnet.

Besides the above, which are composed more or less of granitic elements, there is associated with them in the same complex, and apparently of the same general age, a group of rocks which in some cases is certainly, and in others probably, pyroxenic. The clearest of these, at Rhos Manarch, inland (243), may almost be called a dolerite, though the general arrangement of its elements is very like the irregular rocks described above. It contains abundant augite, in broadish plates of irregular eroded outline, and also, to judge by the cleavage, similar plates of diallage, associated in an indefinite way with unbanded felspar, together with small sphenes and garnet. It is full of crystalline calcite, and has a skeleton crystal of pyrites. The former of these may well be secondary, as a similar mineral fills the numerous cracks. Of the others, owing to their state of decomposition, it is not so easy to be certain. One at Trwyn (241), which forms a beautiful object with the paraboloid and is somewhat orientated, has a groundmass of sericitic material, which from its arrangement may be the result of the entire decomposition of some felspar; with this are long patches of minute and feebly polarising elements, not unlike serpentine, which are also probably the result of entire decomposition of a second mineral. These spaces are scored with parallel cracks, now filled with calcite, whose crystals on either side eat into the adjoining spaces. Thirdly, there are some opaque areas of brownish dust, crossed by lines which appear to indicate a cleavage such as that of augite; and, lastly, there are many sphenes. Though utterly decomposed this appears to have been a holocrystalline rock of felspar and two pyroxenes.

There are two other rocks in this district which it does not appear possible at present to classify with certainty, though both are well-defined in their peculiarities. One of these, at Abertywedog (238), has a groundmass of garnet, much clear quartz in rather rounded elements, with inclusions of zircon and apatite, irregular patches of calcite, and crystals of decomposed sphene with brownish sub-opaque patches like worn crystals, with numerous parallel lines of brown dust, which seem to indicate a well-marked cleavage, such as that of diallage. In this the quartz, like the garnet and the calcite, may be secondary and adventitious, but at present, if the dusty material be diallage, it has not the associates we should expect. The other, from Porth Lygan (234), consists of uniform, small, rounded elements, apparently of felspar, with the narrow crevices filled with slightly orientated sericite. From the occurrence of insets in a similar rock at Pant-yr-Eglwys we know that this must be an altered felsite, but it looks more like one composed of minute lapilli.

This complex of various rocks is for the most part bounded by

faults, so that we have little opportunity of comparing them with neighbouring sedimentary types. One, however, of this class, from the northern side at Ty Newydd (245), has been examined, and is seen to differ essentially in structure, and correspond to the more altered gneisses. It consists of larger elements, bounded by dark lines, probably due to decay, of rather rounded outline and closely fitting. The larger ones are felspar, and the smaller quartz, and orientation is produced by abundance of brown mica. It contains also a lapillus of a rock, consisting of a mixture of quartz and sericitised felspar in small elements. This so closely resembles in general structure the supposed sedimentary rock from the east of Parys Mountain, that the conclusion is strengthened that these are the true sedimentaries, and the group of rocks above described are of special and volcanic origin.

3. *The Dioritic Rocks and their Allies.*—The Dioritic type of rocks, besides those described in connection with the last group, occur in large quantities in the Central and Eastern districts, and to a small extent, in connection with the granite, in the north-west.

In the Central district there are various patches between Craig-yr-allor and Plas Llanfihangel. At Craig-yr-allor itself (130) the rock is very rich in hornblende, and consequently has a dark-green colour. The crystalline elements are small throughout, and individually are very irregularly arranged. The rock, however, in hand specimens shows some confused orientation. The feldspathic elements, which are now entirely converted into sericite, play the rôle of groundmass, and in these there are dusty patches of the decomposed and not yet recrystallised felspar, in one of which the twinning lines may still be seen. The hornblende is scattered over this without crystal outlines, and the rock is very rich in sphene in small crystals and patches, with an occasional nucleus of ilmenite. In certain spots there is a pyroxene, which occurs in a similar manner to the hornblende, but less conspicuously. In one case it appears to form part of a hornblende crystal. It would appear, therefore, not improbable that the rock was originally a dolerite, in which each mineral has changed to its appropriate substitute, and the whole become somewhat schistose in the process. In another rock from the neighbourhood (131) there is a more conspicuous banding by the irregular segregation of the hornblende and felspar. The latter is often scarcely altered, but may be traced gradually becoming sericitised. The former is very clean, and the only signs of pyroxene are some apparent inclusions in certain of the crystals. In its other features the rock agrees with the above. The rock on the summit of the craig itself (128) is a much finer-grained rock, and is only very obscurely orientated. Here the small, rather rounded felspar elements are very clearly seen, and the hornblende is clearly crystallised, and the titaniferous element is represented entirely by ilmenite. It would appear, therefore, that the rock is less altered as a whole than the first described. Yet, if it be really derived from a dolerite, it is remarkable that the only sign of pyroxene occurs in minute corners and specks at the edges of the hornblende. As far as the evidence of these rocks themselves may go, they show no sign of disturbance since their first consolidation, any alterations observable or suggested being entirely chemical. But in another rock in the district (129) the whole has been broken into fragments, the larger ones lying in a cement of the smaller ones, making a true mortar-structure. Yet the large fragments are very clean, the felspar is well preserved and contains inclusions of apatite, and

the hornblende is well crystallised. A second rock from the northern boss (132) has the change carried still further and combined with the chemical, the whole rock being an irregular mass of calcite and chlorite, with stray fragments of unaltered felspar and hornblende, to show whence it has been derived.

The rocks which lie to the north of Llandrygarn, though well supplied with hornblende, appear to belong to a different group, more nearly allied to the granites. Two of these, one near Llandrygarn (133), and the other near Penterfyn (134), are very much alike. In these the felspars are in much larger elements, and often contain apatite, and there are isolated areas of quartz. The hornblende, mica, ilmenite, and sphene which make up the rock crystallise only in the intervals, and have therefore what may be called negative outlines. A similar type of rock occurs in the valley south of Llecheynfarwy. The band of diorite which extends northwards to Plas Llanfihangel has been examined near the latter spot. It represents the Craig-yr-allor types in rather larger elements. In the rock to the south-west of the farm (136) the hornblende and felspar are about equal in amount. The latter is much sericitised and contains a little apatite, and the former has in many places pyroxenic patches taking the place of a part or the whole of the crystal. There are also some dark brown rutiles. The rock to the east of the farm (137) is one of the most complex in the island. It has a kind of groundmass composed of a complex of small and very irregular elements of quartz and felspar, the latter being the most abundant and often occurring in large sericitised plates and containing apatite. The hornblende is in large patches, each of a single crystal, generally decomposed along the cleavage lines, and without definite boundaries. There are several well-preserved patches of augite, some of large size, and not in this case connected with the hornblende; there is a considerable amount of the usual sphene; and, finally, there are large ophitic masses of the ordinary garnet. Some short, dusty, high refracting pieces may even represent decomposed rutile. If this rock commenced as an ordinary dolerite, chemical metamorphosis could hardly go much further.

It is remarkable that at Pen-bryn-yr-Eglwys we have, in a small band, the two varieties which are seen to occur in the Central district; one of these (38) is the coarse form, such as occurs north of Llandrygarn. It has a groundmass of well-banded plagioclase in large elements, with little crystals of apatite; and the hornblendic element, which is in irregular, lenticular, and somewhat orientated bands, is now entirely converted into chlorite; the mica also which was present is mostly now in the same form; but there is no quartz. The other (39) corresponds entirely with the finer rocks at Craig-yr-allor. There is the same uniformity of size and distribution of the small elements; the felspar is apatite-bearing, there is the same unaltered ilmenite; but the hornblende, readily recognised by its cleavages and general build, has now, as in the last case, been entirely changed to chlorite.

When we put these observations together, and call to mind the various alterations traceable in these rocks, both mechanical and chemical, which succeeded the presence of hornblende within them, we may be certain that, if this hornblende has ever been derived from an augite, the change must have taken place at a very early period, and under quite different conditions to those which have brought about the later changes.

In the Eastern district there is an important mass of diorite in the

neighbourhood of Gaerwen, essentially of the same nature as that at Craig-yr-allor, but more foliated throughout. The closest resemblance is in the so-called 'gneiss' by Holland Arms (175), which has the same uniformly distributed small elements of felspar and hornblende and numerous minute sphenes. Some few of the hornblende elements have small corners which present the characters of a pyroxene; but their long axes are all in the same direction, and they are not deformed. In every other case examined the elements have been more or less pulled out into lenticles, whereby their aspect is greatly changed. The first stage of this process and its results are beautifully seen in the rock at Gaerwen Windmill (173). Here the hornblende has become rather fibrous, but is otherwise little changed except in shape; but the felspar, assuming it to have been originally present, is now in the form of dusty, not very transparent lenticles, which have the optical characters of epidote. These have parallel sides for some distance, and then terminate gradually. The quartz which was present is found in microspectrally polarised bands. There are also the usual sphenes and a little pyrites. Some later veins in this rock are of interest, being composed of clear felspar, with needles of actinolite (?) radiating from the ends of the hornblende layers. In a rock at the most northern end (182) we find a second stage. Here the same elements of hornblende, epidote, and sphene can be seen to be present, but the rock is now crowded with mylonitic lines, between which the epidote is ground to powder, and only a few recognisable fragments of hornblende are left. It is strange that this shearing should not have been followed by any chemical changes, especially as there are transverse cracks filled with calcite, and a very low polarising mineral, perhaps serpentine. In this case the strain has acted so as to intensify the foliation; but in a rock from the wood north of Y-graig (179) it has broken it up, so that orientation can only be observed in small fragments. It is remarkable that no epidote can be observed in this rock, the felspathic element having broken up and become microspectral or mosaic.

The interpretation of some other rocks of larger elements will now be easier. There is a banded rock composing the hill north of Y-graig (178) in which dark-green bands alternate with white ones. This corresponds on a larger scale with the rock at the windmill, the green bands being elongated hornblende, and the white ones decomposed epidote much broken up. The rock at Ysgubor Llwyd (180) is of still larger elements, difficult to identify: some are certainly hornblende, and others epidote and felspar, but there are large porphyritic crystals with strong cleavages in one direction, and others occasionally cutting them at $87\frac{1}{2}^{\circ}$, and the extinction makes an angle of 14° with the first. It may be a felspar. Another is colourless and non-dichroic, in long flakes like mica, with cleavages in the same direction, and the extinction making an angle of 18° with these. It may be a pyroxene. The rock has been much broken. A third, to the north of Holland Arms (181), is almost entirely hornblende, in large frayed-out crystals with spectral polarisation, a phenomenon rare in this mineral. A few narrow lenticles of epidote, and crystals of sphene bring it into the same group as the rest.

The rocks in the narrow band which runs up to Pentreath can be at once compared with and understood by the aid of that at the northern end of the 'gneiss' area. One, at the crossing of the Beaumaris road (183), which is entirely cataclastic, shows some relics of hornblende and epidote, but the intervals are filled with calcite. In the rocks nearer

Pentreath (184) almost all the hornblende is gone, and very little epidote is left, and this is in dust-like fragments—the base has crystallised into microspectral felspar. The end of this long series could scarcely be more different from the beginning than it is.

Besides these coarser-grained rocks there is in this district a remarkable series which is schistose in the highest degree. The connection between these and the others is easily traced through a rock just to the south of Y-graig (177), or one at the back of Gaerwen Windmill (174). In the former we have very long and narrow crystals of hornblende of no definite shape, and small isodiametric crystals of epidote and quartz, and there are also a number of minute brown rutiles. All these are perfectly clean and fresh, and do not appear to have been in any way modified since their formation. In the latter the hornblende has more shred-like ends, the epidote is elongated, and there are only a few minute sphenes. They thus differ only from the former group by their much more marked orientation. It is essentially the same rock as this which occurs in an intrusive form in the Llangaffo cutting. Much of this is highly orientated, though the specimen examined (164) does not show this well, but has larger hornblende crystals, inclosing more or less isolated areas in which there is little but epidote and quartz. From these we pass to a rock at Tyn-drain (167), which agrees with them in every respect, especially with the one at Gaerwen Windmill, except in the replacement of the ordinary hornblende by beautiful blue glaucophane. It contains, however, some scattered elements of speckled felspar and of hornblende, which do not conform to the general orientation. From this, again, it is but a step to the glaucophane schists of the quarry near Anglesey Monument (168, 169), in which that mineral is more pulled out and interfelted, and is in such abundance as to almost play the rôle of groundmass to the epidote. There is little else than these two in the rock, only a few specks of hematite, and some probably segregation veins of quartz. In the latter float some separated crystals of glaucophane, which may either have been torn from the sides or re-formed with it. The orientation in these rocks cannot be properly called foliation, since it has, at present at least, no relation to a plane, but only to a line—*i.e.*, there is no orientation in a transverse section. Many of these rocks have been examined from various localities, but, with the exception of those that follow, none show any essential difference from the above or peculiarities worth noting. In a rock from near Castellor (172), and another from the south of Newborough (164), there are enclosed small spherical areas, bounded by ferric dust and filled with complex growths of epidote, like the smaller vacuoles figured by Fouquet and Lévy in the 'Variolites.' In another rock, near Castellor (171), one of the quartz veins, as already noted, contains small prisms of tourmaline. Like the group with larger crystals, these can undergo still further changes under the action of pressure or stress. Thus, at Carnen Goch (170) the hornblende is torn out in shreds, the epidote is broken up and elongated, and there are numerous cracks and veins of feldspathic and calcitic crystals. Near Holland Arms (176) the lines of orientation are so contorted and crumpled that they can scarcely be recognised under the microscope, but are evident without it. Finally, at Bryn Gwyn (165) (see fig. 24), and elsewhere on the eastern margin, the elements are so pulled out that they are reduced to little more than dust, and the rock looks little better than an earthy slate.

In the extreme north the rocks are of the same character as the last described group, but not glaucophane bearing; but their regularity is much interfered with, and the cracks and intervals are filled with fresh quartz or felspar. This is well seen in the rock at Ty Lon (185) and on the summit of Mynydd Llwyddiart (185), and in these perhaps we see the maximum change of the series.

4. *The Gabbros and Serpentine*.—These rocks having been already systematically studied and described by Professor Bonney, there is the less necessity for dealing with them at length. The existence of gabbro as well as serpentine in the area has been proved, and the derivation of the latter from olivine-bearing rocks has been demonstrated. Nevertheless, the present examination has brought out some additional points of interest. The gabbro at Ty Newydd, near Four Mile Bridge (45), is a well-marked rock. The numerous diallage crystals now stand out porphyritically from the groundmass; they are fairly well preserved, and have secondary enlargements which are not optically continuous with the original crystal. Two minerals at least contributed to the groundmass. One, which was probably the felspar, is now represented by opaque dust, the crystalline aspect of which with the paraboloid suggests its previous conversion into epidote. The other mineral has produced transparent patches, which show a fine fibrous or closely cleaved structure, parallel to which it extinguishes. It may therefore have been an enstatite.

Starting with this normal rock we may now by several steps trace its passage under the action of pressure and shearing into a schist which may easily be mistaken for one of the ordinary schists of the island; thus confirming the suspicion of Professor Bonney with regard to the schistose rock of Tyddyn Gob, that it might be 'an altered gabbro with pressure foliation.'

In the rock at Dinas Fawr (46) the diallage looks still more porphyritic from the groundmass having passed over entirely into a microspectral mass, in which all individualisation of the original feldspathic crystals is entirely lost, and the whole has become saussuritic; where it has been pulled asunder the interstices are filled up by growth from the surrounding diallage crystals. The indestructibility of the diallage in the midst of these changes is noteworthy, and assists greatly in the chain of evidence which leads us at last to the schists. The next link is at the same spot, and forming one large knob with the last (47). This example is almost entirely composed of fine crystalline strings, tailing off, or interosculating with each other, and having the pulled-out look characteristic of mylonites; but amongst these are some distorted fragments of diallage. As diallage has nowhere else been found than in the gabbros, its occurrence may be taken as evidence that the rock has been derived from its neighbour by mechanical deformation. The proof of this depends on the indestructibility of the diallage. But the diallage is not entirely indestructible. In the former rock the slight alteration of the diallage produces crystalline fibres, and in the latter the abundance of these is correlated to the few relics of the original mineral. These fibres appear to be of the same nature as those which produce the 'soapstone,' so that we may call them talcose. The origin of these talcose schists at this spot is certainly from diallage-bearing rocks. We must therefore be prepared for further chemical changes. In the next rock of the series, at Yr Hendty (48), the diallage is entirely

converted into the talcose material, which is mostly in fibres, but occasionally has a fragmental form with diallage cleavages. This material is in porphyritic patches. The remainder is partly mosaic feldspar and partly epidote, the latter in patches which are obviously cracked, drawn out, and separated. Thus our eyed gabbro has become a talcose epidote schist. Here, however, the original positions of the diallage crystals are still indicated, so that the rock at Penrhyn Fadoc (49) is a still further stage. In this epidote is very abundant, but it occurs not only in pulled-out bands, but in scattered recrystallisations lying in clusters in a groundmass of the talcose fibres. The freedom of certain spots from these new crystals is the only indication of where diallage has originally been, except that by good fortune one or two small fragments of the unaltered mineral are actually left. Finally, in the rock in the railway cutting (50) (see fig. 23) there are whisps of talcose fibres, like cirrus clouds, flashing out on a dark background, consisting of broken and drawn-out fragments of epidote, now ground to opaque dust or partially recrystallised to form mosaic feldspar.

These igneous mylonites, whose origin is thus demonstrated, however schistose they may be, nevertheless differ entirely from the neighbouring schists of the island both in their chemical constitution and in the character of the orientation that affects them. For this reason it is probable that the soapstone at Pwll Clai (54) is not an altered schist, but is derived from the decomposition and recrystallisation of one of the gabbro group, in association with which it occurs. It consists, like the last described, of talcose fibres, small mosaic feldspar, and a few epidote crystals; but it is much cleaner, and though it has been a mylonite by the general arrangement of its lines, it has since that time recrystallised.

Of the serpentines, the most typical observed is from the base of the first inlet south of Four Mile Bridge (51). In this the original crystals of olivine can still be seen in outline in certain parts, floating in a transparent matrix, which is of apparently later origin. Fitting in with these in a holocrystalline manner are several areas showing the fine fibrous cleavage structure of enstatite. The ferric constituent is not found distributed in the cracks, but occurs chiefly in the form of rounded masses like eroded crystals, or scattered like dust, both in the olivine areas and elsewhere. The alteration of the olivine has taken place along lines which have a tolerably uniform direction throughout the rock, and which pass through the enstatite patches. We may therefore conclude that they were produced by the general forces which have brought about the foliation of the district, and that the rock is in fact a foliated serpentine, which was once a Saxonite. From the primary lines of alteration in the olivine areas a transverse set of lines has proceeded, so that the whole crystal is changed into a series of broken parallel bands of chrysolite. The enstatite areas, on the contrary, though roughly traversed by the general lines, have their fibres arranged along, and perpendicular to, the most conspicuous cleavage lines. The intervening matrix must be of later date than the primary alteration, as it interrupts the parallel lines; it is composed of indefinitely small fibres, doubtless serpentinous, which, being arranged promiscuously, scarcely have any effect on polarised light. The whole is re-cracked in many directions, and the new cracks filled with serpentine. The metamorphosis of the rock does not seem, therefore, to have followed the usual course.

Another totally distinct form of serpentine occurs near Cruglas (52). Quite half of it is composed of very minutely crystalline calcite or dolomite, not forming a mosaic, but speckling the whole rock in clumps. These clumps are in some places irregular, and in others occupy more definite shapes; the remainder, or groundmass, is of crossing fibres of serpentine of various sizes and dispositions. There is also much black magnetite, sometimes forming the centres of patches surrounded by cracks, but never occurring in the cracks themselves. This calcite is doubtless an infusion from neighbouring calcareous rocks, and has assisted in the alteration of the rock. At first sight it seems impossible to recognise any original minerals; but towards the circumference of the slide are seen calcitic areas which are outlined in such a way as to suggest the original presence of augite; and in one case there is a section without calcite, distinguished from the rest by its transparency, and having very distinctly the section of a crystal of augite, cut perpendicularly to its vertical axis. This remains dark between crossed Nicols, and gives a biaxial cross in convergent light. In another case a crystal of the same shape and properties has narrow lines of calcite along the nearly rectangular directions of cleavage. These we may safely consider to be altered augite. In certain other areas the calcite is seen orientated in the direction of the longest axis of the original crystal, and the serpentine is also separated along lines parallel to this. It is probable that these areas represent enstatite. It is not so easy to recognise the original olivine, but when the slide is examined with a hand-glass, there is evidence that half of it is occupied by a single large crystal lying in the centre. A portion with a yellower tint than the rest is outlined by a polygon; and it is always beyond this boundary that the indications of augite and enstatite occur, while within, all is characteristically irregular. If the nature of this be rightly judged, the original rock was a porphyritic Llerzolite. It is now an ophicalcite.

In the above rock the neighbouring calcite has affected the serpentine; in another close at hand (53) the converse phenomenon is seen. Of this the same calcitic crystalline material forms the bulk, but there is nothing in any way to suggest previous crystals whose place it has taken. On the contrary, the whole is traversed by irregular, undulating, subparallel lines of magnetite, from which, as also from minor cracks without magnetite, the serpentine crystals grow out in radiating sheaths. This is most easily interpreted as a recrystallised limestone, into which serpentinous matter has been infused from without.

5. *The Isolated Masses and Dykes.*—For this section are reserved all such peculiar rocks as are either known from field evidence to form dykes, or occur in so sporadic a manner that they are probably of similar origin to dykes. No dykes, however, that are intrusive into Ordovician rocks, or are similar in character to such as are, will be included. For all that is known to the contrary, all the following rocks *may* have been produced before the commencement of the Ordovician period. We may commence with the felsites.

No felsites have been recorded, or have been observed by the writer, in the Eastern district, and those that occur in the Western and Central districts, and that south of Traeth Dulas are so intimately associated with their respective granites that they have scarcely a separate existence. Thus the only isolated felsites occur in the Northern district, of which four have been examined.

The first is from a dyke east of Mynydd Mechell (225) (see fig. 20). In this there are no proper insets, but here and there are little collections of epidote crystals—sometimes almost isolated and sometimes attaining the magnitude of a fair-sized spherule—but they are not radiate, nor regular in outline. The groundmass, as seen by the paraboloid, looks like an almost uniform glass, but dim and shadowy outlines separating very feebly dotted spaces indicate a subdivision into larger elements. When seen between crossed Nicols these larger elements are still conspicuous as a kind of substratum, or earlier stage of division; but they are greatly interfered with by the development, with sutural boundaries, of numerous smaller crystals, whose long axes are in general irregularly arranged, but which in many spots radiate from a point, like ill-formed spherulites, or from the circumference of the epidote nests. This combination of larger elements with smaller spherulitically arranged ones is so peculiar that if it is met with elsewhere it should receive a name, such as *macro-felsitic* structure. In a second dyke from the same district (226) the groundmass is microgranitic, and there are no insets or epidote nests, but it is crowded with large spherulites of the ordinary fibrous radiating type. These have occasionally successional rings; where most crowded the interspaces are filled with larger elements. Its present state has therefore been reached by at least two stages. The rock at a large boss at Tygoch-wyfa, east of Amlwch (230), is a typical microgranite, whose insets are idiomorphic quartz and twinned orthoclase, which are often surrounded by a spherulitic border. The most beautiful of all these rocks, however, is that of Hafod-onen, south of Amlwch (228) (see fig. 21), marked on the Survey map as 'greenstone.' Its original structure is rather obscured as seen between crossed Nicols, but with the paraboloid it is seen to be truly porphyritic, all the insets being felspar and most of them idiomorphic, and some speckled. In the groundmass there is a little microgranite, but the characteristic structure is that of a beautiful granophyre. The elements composing this are very minute, and are arranged with the longer diameters of several in succession in one direction, so as to form a lacework pattern. The difference between the materials of the elements cannot be demonstrated between crossed Nicols, but by oblique light there is seen to be a difference in the refractive index. The structure is therefore that of a true micropegmatite. In many cases the network starts from the sides of a small rectangular inset and grows out in bushes, forming an hour-glass pattern in the mass, which is bounded on all sides by similar growth from other crystals. They thus form the pseudo-spherulites of Rosenbusch, with this difference only, that their outlines are regulated by the interference of neighbouring growths and by the size and shape of the originating crystal.

Another group of rocks consists of those which weather spheroidally, and all of which have a more or less common structure. One of the simplest is largely developed among the volcanic rocks of Careg Gwladys (206). In this there is an abundant base, which remains dark between crossed Nicols, but it is scarcely a glass, to judge by its dusty appearance in ordinary light, but it may be microfelsitic—there are a few minute polarising specks in it. In this groundmass are scattered numerous microliths of a lath-shaped plagioclase, which, from its low extinction angle, is probably oligoclase. These lie in every direction and interlace with each other without any regularity. We have thus the absolute reverse of orientation, seeing we start with axial crystals. To distinguish this we may compare

it with the arrangement of spicules in some sponges, and call it *spicular* arrangement. In the same district we find a more complex form (207) (see fig. 22), which may really be the same rock under different and special circumstances. It is seen running into the crevices and wrapping round the surface of a purple calcareous rock, and is characterised in the hand specimen by a number of small pea-like bodies which are brought out on its surface by weathering. The base of this is also a dusty substance with minute polarising specks, in which are scattered very fine felspathic microliths, which are in general irregularly placed, but in some places they aggregate into sheaths, and elsewhere, particularly near the contact with the shale, become complete spherulites, though without a circular outline. None of this structure, however, represents the pea-like bodies. These in a thin section form rounded areas, with a closely-set narrow border of minute epidote crystals, with larger crystals of the same, or of some other unrecognised mineral, filling the centre without any arrangement. They vary in size from .005 inch upwards. No particular information is afforded by this rock as to the origin of such varioles, as they ought probably to be called, from their resemblance to some of the structures seen in the Variolites of the Durance. We can compare them also with the epidote nests seen in the diorites near Newborough and in the felsite at Mynydd Mechell. There are also in the rock several areas now composed of an aggregate of epidote crystals, and having the external form of orthoclase crystals. These appear to be altered insets. There are also a few small patches of augite.

A third remarkable spheroidal rock occurs as an isolated boss to the west of Amlwch (227). The original structure of this can be best made out with the paraboloid. We thus see that it contained a number of acicular microliths, floating irregularly in what was probably a glassy base, but it is now filled with infinitesimal particles of a shiny crystalline appearance. These are arranged in relation to the microliths, often forming a border to them, and sometimes appearing to radiate from them. The whole mass is also separated into larger areas of very obscure and irregular outline, which polarise as a whole somewhat after the manner of the macrofelsite of Mynydd Mechell. But over and above all this the rock has a special feature, which is the most striking one on first examination, but which is evidently of secondary origin. This is the development of a crowd of small prismatic crystals of epidote, which stand isolated or congregate in groups and have no regularity of arrangement. That they are of later origin than the microliths is proved by their often wrapping round and partially enclosing them. There are also a number of calcitic patches and lines of ferric dust.

It would seem from the structure of these rocks that an irregular arrangement of long narrow crystals is the most favourable for the development of large spheroids by weathering—the structure and the form being alike peculiar, and in every case combined. It may be called to mind that such is the structure of basalt, which is also noted for its spheroidal weathering. The spherical surfaces are, of course, anterior to the weathering, which only brings them out, and it is not suggested that the spicular structure is the *cause* of these spherical shells, but that the two are correlated as the double results of a single cause. If from the circumstances of cooling, or the materials of the rock, a spicular structure is brought about, it is probable that a spheroidal form will follow.

A peculiar rock at Gwalchmai (138), which unfortunately is not seen in a weathered state but only in a quarry in the village, has essentially the same general structure as the above group, but it looks quite black, and like an earthy pelite. It consists entirely of rather larger microliths, crowded together and overlapping, and which also appear from their extinction angle to be oligoclase. They are set in a matrix which contains nothing but black and red ferric dust, and a non-polarising base. It might almost be called a basalt but for the absence of any magnesian constituent. Perhaps andesite would be the best name to apply generally to these rocks. The interest of this black one lies in the fact that it is the only one of its kind yet found *in situ* in Anglesey, whereas numerous fragments with a similar structure occur in the overlying rocks near Bangor and elsewhere.

The only remaining rocks whose structure the microscope is of value in elucidating, are the diabases. There are, of course, many such rocks in Anglesey of more recent date, but those now to be described are entirely confined to the oldest series. One of the most interesting is that near Llyn Trefwll, which lies between the chloritic schists and the great Ordovician beach breccias, and with which the small mass of granite already described is associated. Some of this is schistose, some is not. A non-schistose example (56) consists of a dusty, but otherwise transparent, base, in which are numerous felspar microliths as well as black specks, which may be magnetite; it is dark between crossed Nicols, but this is partly due to the development of a non-polarising chloritic substance. In this base are numerous insets of augite, many of the smaller of which are idiomorphic. There are also some patches of dark earthy matter, apparently included fragments. The rock is therefore a typical diabase. The schistose variety (57) differs in no essential respect from this, except that the augite is smaller, is scarcely ever idiomorphic, and looks fragmentary. The apparent schistosity is due solely to a few nearly parallel cracks, and an almost imperceptible orientation of some of the microliths. Apparently continuous with this rock is a green mass which contains fragments of granite (58). This green rock, however, is really a diorite like that of the Central district, rich in hornblende, with a little apatite. It is, therefore, probably unconnected with the diabase, and forms part of the breccia bound to it by pressure. This is the more probable, as the fragments of granite described by Professor Bonney were associated with a slaty matrix. In the neighbourhood of Dinas Llwyd, and northwards to Bodowen, there are numerous lenticular patches of igneous rock, which, unlike the later dykes, are orientated with the sedimentary rocks of the district, here largely of volcanic origin. One of these has recently been described by Mr. Harker ('Geol. Mag.' N.S. Dec. III. vol. v. p. 267) as an olivine diabase. The specimen examined for this report, from nearer Dinas Llwyd (127), would be rightly described by that title. It does not, however, show the ophitic character of the augite, which is described by Mr. Harker, but, like his specimen, it contains large masses of ilmenite, a characteristic mineral of the older but not of the newer rocks. It is probable for all reasons that this belongs to the older group, and in this case it is the only one in which olivine has been recognised. A mylonitic form of apparently the same type of rock occurs a little west of Llangwyfen (125), in the same district. It has drawn-out crystals of augite, plagioclase, and perhaps of diallage, in the midst of lines of

crystals composed of epidote, chlorite, and calcite, with a fibrous mineral elsewhere referred to talc.

A mass marked 'greenstone' on the road between Amlwch and Parys Mountain, protruding through the old schists like a neck (229), is another of these diabases. It shows a groundmass entirely composed of secondary epidote, in which there are many insets of augite, some of them idiomorphic, with large masses of leucoxene in the form of skeleton rhombohedra. This last fact, together with the total conversion of the felspathic constituent into epidote, suggests that it is not much younger in date than the rocks amongst which it occurs.

There are several other masses of diabase which have either not been examined, or have been found so utterly broken down that little of their original structure can be made out.

CONCLUSIONS.

The series of rocks above described are so various in their composition and structure that the results of their study cannot be fully stated in a single proposition, but there are many conclusions of which they either afford demonstration or render the probability considerably stronger. It is of course understood that these conclusions refer only to the rocks of Anglesey, so far as this Report is concerned. These may be formulated as follows:—

1. The use of the paraboloid and binocular microscope throws new and valuable light upon the structure of such rocks.
2. The amount of alteration in rocks which form part of the same complex may vary very greatly without our being able at present to assign any adequate cause for the difference.
3. Rocks may become entirely crystalline without the slightest sign of foliation, a mosaic type of structure being produced, in which areas of yielding to tension may be seen.
4. Fine-grained rocks more easily become entirely crystalline than coarse-grained ones.
5. In those crystalline rocks which are most clearly connected with unaltered ones the crystal elements are small.
6. Foliation-cleavage is produced by the orientation of some of the new minerals, the others remaining unaltered.
7. Fracture-cleavage is produced by larger cracks, which are afterwards filled with mineral matter.
8. More complete foliation is unaccompanied by cleavage.
9. Original structures, such as that of lamination, need not be destroyed by foliation.
10. Very few, except fine-grained, rocks are entirely recrystallised so as to lose all trace of original fragments.
11. Rocks which under pressure have been contorted or cleaved may have their elements orientated in relation to the pressure, and not to the bedding.
12. In no case is perfect foliation known to obliterate the bedding, though there are foliated rocks whose original bedding is not certainly known.
13. The orientation of the minerals in a rock is of various kinds—quincuncial, linear, laminar, elemental, and confused—some of which are

more complete than others. This must have been produced under the action of a directed force, which caused no motion in the mass as a whole, and may therefore be called statical.

14. The effect of pressure on a crystalline rock is to produce spectral polarisation, and a further amount to produce microspectral polarisation.

15. In the case of felspars, a structure closely resembling that of microcline is often found in rocks which have been subjected to pressure, and may be due to that pressure.

16. Pressure accompanied by shearing produces mylonitic lines, which may influence subsequent crystallisation, but which are quite distinct from ordinary orientation, the force brought to bear resulting in motion of the mass, and being therefore dynamical.

17. The pressure under which rocks have become foliated is greater than that necessary to produce microspectral polarisation.

18. Some of these ancient rocks have been produced by the agency of calcareous and siliceous springs.

19. The chemical composition of the rocks considered igneous is different from that of the general sedimentary rocks, and often includes special minerals.

20. The elements of the holocrystalline igneous rocks of acid type are of a different order of magnitude from those of the sedimentary rocks.

21. Such acid igneous rocks are of various mineral constitution and have undoubted felsites intimately associated with them.

22. Some of the most peculiar of the crystalline rocks are altered volcanic products without orientation.

23. The basic igneous rocks have a great tendency to foliation, and may become as foliated as any schist.

24. Some of the hornblende schists may be altered dolerites, without showing any signs of subsequent pressure or shearing.

25. The serpentines are derived from more than one variety of original rock, including saxonite and lherzolite.

26. Igneous rocks, including gabbros, have their mylonitic representatives, whereby they may become schistose, and the production of schistosity may be accompanied by chemical changes.

27. The difference in character between these and the regularly foliated rocks indicates a different form of pressure in the two cases, the latter being practically unaccompanied by shearing; and standing, as in the case of the sedimentary rocks, in the relation of a statical to a dynamical force.

28. Almost all varieties of rock have their cataclastic representatives, unaccompanied by any radical chemical change.

29. Many rocks have very long histories, the events of which have left their traces in the structure, and all of which may be subsequent to their foliation.

30. The dykes and isolated masses have peculiar characters—macro-felsitic, granophyric, variolitic, &c., distinguishing them on the one hand from the more ancient crystalline rocks, and on the other from the newer dykes of the district.

31. An irregular arrangement of minute elongated crystals—in other words, a spicular structure—is favourable for the production of spheroidal structure, as indicated by the mode of weathering.

32. Finally, the whole series of rocks presents many original forms which are still recognisable, and the metamorphosis they have undergone,

leaving evident traces in their structure, does not prevent our recognising in them a vast and varied complex to which perhaps there is no parallel in the later rocks of Britain.

LIST OF THE ROCKS REFERRED TO IN THE FOREGOING REPORT.

1. Great Quarry, Holyhead—Quartzite with foliation cleavage (fig. 12).
2. Porth-yr-Ogof, Holyhead—Quartzite with coarse groundmass.
3. Central series, Holyhead—Impure quartzite.
4. Porth-yr-Ogof, Holyhead, at junction—Impure quartzite with mica fragments.
5. Porth-y-felin, Holyhead—Laminated with parallel foliation (fig. 3).
6. Porth-yr-Corwgl, Holyhead—Showing solution of broken quartz (fig. 13).
7. East side of Straits, near Valley—Fine-grained rock.
8. Near Chapel, Four Mile Bridge—Fine laminated schist.
9. Caer Ceiliog, near Valley—Fine-grained rock, with mica orientated obliquely to a strain-slip cleavage.
10. Crossing of River Alaw—Coarse fragmental rock.
11. Peniel—Green dust rock.
12. Porth Dryw—Fine mylonitic slate.
13. Beyond Porth Dryw—Mylonised in direction of bedding, with large fragments.
14. South point of Porth Delise—Serpentinous mineral in tufts.
15. South point of Porth Delise—Irregular calcite with large mica.
16. Infusion south of Porth Defaid—Infusion of calcite and quartz with chalcopyrite.
17. South of Porth Defaid—Laminated schist.
18. Green, East of Llanfachreth—Fine-grained rock.
19. Abersant, Llantrissant—mica-schist with elemental orientation—zircons.
20. Llanddeussant—Fine-grained rock with mica orientated obliquely to a strain-slip cleavage (fig. 10).
21. North of River Alaw—Coarse fragmental rock, fragments mostly felspar.
22. Llanbaban—Mosaic rock with tension areas.
23. East of Bodedern—Fine-grained rock with abundant orientated green mica.
24. By Caer-deon, Llanddeussant—Fine-grained rock with tension areas.
25. Pont-scyphydd, north of Llanddeussant—Fine-grained rock, mylonised in the direction of the bedding.
26. Llanfaethlu limestone—Fine mosaic limestone.
27. Associate of Llanfaethlu limestone—Fine mosaic rock.
28. Church Bay—Fine-grained rock with large fragments.
29. Church Bay—Fine tuff.
30. Llanrhyddlad—Fine mosaic rock.
31. Summit over Ogo Lowry—Fine-grained rock with many quartzose fragments.
32. Hill over Ogo Lowry—Mosaic rock or marbled slate (fig. 4).
33. Pant-yr-Eglwys—Granular felsite.
34. Pant-yr-Eglwys—Dust rock.
35. Near Pant-yr-Eglwys—Felsite.
36. Quartz knob, Pen-bryn-yr-Eglwys—Quartz elements with sericitic boundaries.
37. Pen-bryn-yr-Eglwys—Granular felsite.
38. Pen-bryn-yr-Eglwys—Plagioclase and chlorite.
39. Near summit, Pen-bryn-yr-Eglwys—Chloritised (epi ?) diorite.
40. Pen-bryn-yr-Eglwys, north side—Granite with minute hematites.
41. Pen-bryn-yr-Eglwys, north side—Cataclastic granite.
42. Bottom of Pen-bryn-yr-Eglwys, by fault—Powdered granite.
43. Monachty, junction of granite and ash, Brecciated granite.
44. Behind Monachty—Aplite.
45. Ty Newydd, Valley—Enstatite gabbro.
46. Dinas Fawr, Four Mile Bridge—Gabbro with eyes of diallage.
47. Dinas Fawr, Four Mile Bridge—Mylonised gabbro with relics of diallage.
48. Yr Hendty, Four Mile Bridge—Talcose epidote schist.
49. Penryn Fadoc, Four Mile Bridge—Mylonised talcose epidote schist.

50. Tywyn Railway Cutting—Ditto, more altered (fig. 23).
51. South side of inlet, Four Mile Bridge—Serpentine derived from saxonite.
52. Valley, near Cruglas - Ophicalcite derived from lherzolite.
53. Cruglas—Ophicalcite from limestone.
54. Pwll Clai, north of Roscolyn—Talcose schist.
55. Llyn Trefwll—Cataclastic granite.
56. Llyn Trefwll—Diabase.
57. Llyn Trefwll—Slightly schistose diabase.
58. Llyn Trefwll—Diorite with fragment of granite.
59. Bottom of Gogarth—Medium-grained grit.
60. Flaggy beds at South Stack—Fine-grained rock, with foliation oblique to both bedding and cracks.
61. Slaty, Porth-da-farch—Medium-grained rock, mylonised.
62. Porth-y-crug—Fine-grained rock, with strain-slip cleavage, against a cylinder of grit (? a worm casting) (fig. 16).
63. Porth-y-crug—Medium-grained grit.
64. Porth-y-gwalch—Quartzite, showing fracture cleavage, zircons.
65. Roscolyn—Quartzite, showing fracture cleavage, zircons.
66. South of Roscolyn—Microspectral schist with fracture cleavage, rutiles (fig. 9).
67. Roscolyn slate—Confused microspectral schist with few fragments, some of mica, chlorite transverse in nests.
68. Green rock, north side of Borthwen—Epidote crystals in dark dust.
69. Gwalchmai Lowest, west of stream—Gneiss, with laminar orientation, and microcline, &c., in cracks (fig. 8).
70. West of Gwalchmai—Cataclastic gneiss.
71. Gwalchmai Turnpike—Coarse mica schist, with linear orientation.
72. Bodwrog Church—Gneiss with laminar orientation.
73. Road north of Pen-y-carnisiog—Gneiss with laminar orientation.
74. Porth-y-ly-wod Island—Coarse mica schist with linear orientation.
75. Porth-y-fawch—Fine mica schist with quincuncial orientation (fig. 5).
76. Porth Gwyfen, east side—Gneiss with few remaining fragments.
77. Llangwyfen—Fine mica schist with quincuncial orientation.
78. North of Llangwlllog stream—Gneiss with laminar orientation, very little mica.
79. South of Llangwlllog stream—Cataclastic gneiss.
80. Y Foel, Llanerchymedd—Sericitic gneiss.
81. Gorse Mill, South of Llanerchymedd—Decomposed gneiss with derivative mica (fig. 2).
82. By Llanfaelog Church—Fine felted mica.
83. East of Porth-ceryg-defaid—Fine cataclastic quartz-felspar mosaic.
84. Nearest gneiss, Porth-y-ly-wod—Cataclastic gneiss.
85. Between Ty Croes and Llanfaelog—Fine-grained, micaceous, with larger fragments.
86. Gwalchmai, between granites—Quartz-felspar mosaic.
87. North side of Llangwlllog—Cataclastic quartz-felspar mosaic.
88. West of Bodorgan—Dislocated cataclastic rock.
89. Lump in ashy bed, Llancadwaladr—Coarse quartzose fragmental rock.
90. In gneiss, west side of Trecastle Bay—Large orientated calcite.
91. Bodwrog—Irregular large calcite.
92. Behind Druid Inn—Coarse mosaic limestone.
93. Railway Cutting, north of Llangwlllog—Volcanic tuff, with mica of two generations, the first with inclusions.
94. South of Cerrig Ceinwen—Fragments of calcite and jasper in calcitic cement.
95. In limestone south of Cerrig Ceinwen—Jasper of small siliceous elements.
96. Quartz knob, Bethel, Bodorgan—Large rounded quartz fragments with needles in a polygonal quartz matrix.
97. Quartz knob, east of Llangefni—Various rounded fragments in pure quartz matrix.
98. Ceryg-ddwyffordd—Fine-grained rock.
99. Ceryg-ddwyffordd—Fragmental rock.
100. Just north of Llangefni—Fine-grained rock.
101. Further north of Llangefni—Dislocated and cataclastic.
102. Side of River Cefni—Fine-grained rock, spectrally polarised.

103. Chlorach Bach, Llanerchymedd—Fine-grained rock with infusion of calcite.
104. Trewyn, Bodafon—Fine-grained rock with abundant quincuncial mica.
105. Under southern hill, Bodafon—Showing elemental orientation.
106. By Bodafon Farm—Fine-grained micaceous rock with fragments.
107. Carnedd a Tre'r beidr, Bodafon—Fine-grained, with fragments elementally orientated.
108. Clegyr, Bodafon—Fine-grained rock.
109. Bodafon Hill—Quartzite of coarse groundmass elementally orientated.
110. West side of Bodafon—Fine felted mica.
111. Craig Fryr—Quartzite of coarse groundmass elementally orientated.
112. Llanfaelog—Chloritised granite.
113. Intrusion, west of Porth-y-ly-wod—Cataclastic granite or mortar structure.
114. Border of granite, near Pen-y-carnisiog—Glomeroporphyritic microgranitic felsite.
115. Gwalchmai—Cataclastic granite or mortar structure.
116. Near Craig-yr-allor—Chloritised granite.
117. Henblas, Llandrygarn—Clean granite.
118. Ynys Dodyn, south of Rhos Goch—Cataclastic granite, microspectraï and with microcline in cracks only.
119. Tyn-y-Pwll, south of Llanerchymedd—Glomeroporphyritic microgranitic felsite.
120. Bryn-Twrog, south of Llanerchymedd—Cataclastic granite.
121. Yrynys Coed, Coedana—Cataclastic granite or mortar-structure.
122. Junction at Maengwyn, Coedana—Coarse granite with tourmaline, in dusty schist, with mica in cracks.
123. Tafarn-y-botel, Llanerchymedd—Gneissose granite, or granitoid gneiss.
124. Just north of Llecheyn-farwy—Plagioclastic rock.
125. First green band, west of Llangwfen—Mylonitic diabase.
126. Dinas Llwyd—Coarse fragmental rock.
127. South of Bodowen—Olivine diabase.
128. Craig-yr-allor—Foliated hornblende, plagioclase, and ilmenite.
129. Craig-yr-allor—Cataclastic (epi?) diorite.
130. Craig-yr-allor—(Epi?) diorite, formerly a dolerite.
131. Near Craig-yr-Allor—Foliated (epi?) diorite with abundant sphene.
132. Northern boss, Craig-yr-allor—Cataclastic diorite, now chlorite and calcite.
133. North of Llandrygarn—Coarse mica diorite with sphene.
134. West of Penterfyn, Rhos Goch—Coarse mica diorite with apatite and sphene.
135. Yynys Coed, Coedana—Cataclastic gneiss with chlorite.
136. South-west of Plas Llanfihangel—(Epi?) diorite.
137. East of Plas Llanfihangel—Complex of minerals, including pyroxene and rutile.
138. Gwalchmai—Spicular plagioclase in magnetite
139. South of Traeth Dulas—Somewhat cataclastic white granite.
140. South of Traeth Dulas—Quartz-felspar mosaic.
141. South of Traeth Dulas—Gneiss with confused orientation.
142. South of Traeth Dulas—Fine mica schist, quincuncial orientation.
143. Newborough Warren, Bryn Gorsddu—Fragments with mica infilling.
144. South of Hafodty—Fine mica schist with elemental orientation.
145. Hafodty, south of Llangaffo—Laminated rock, epidote, surrounded by chlorite.
146. Bodowyr, valley of River Braint—Fine mica schist with elemental orientation, vermiculite.
147. South of Bodlew, River Braint (E.)—Fine felted mica (fig. 11).
148. South of Bodlew, River Braint (W.)—Mosaic rock with microspectral crape structure (fig. 15).
149. Ty Mawr, south of Llandaniel—Crape structure in quartz vein only.
150. Llangaffo Cutting—Coarse mica schist, straight linear mica (fig. 6).
151. Main line, south of Holland Arms—Cataclastic coarse mica-schist, speckled felspar (fig. 1).
152. Quartzose lump, Berw Ycha—Coarse mica schist with linear orientation, and fragments.
153. Farm, south of Holland Arms—Coarse mica schist.

154. South of Plas Berw—Gneiss with laminar orientation.
155. Tros-y-gors, near Menai Bridge—Elemental orientation (fig. 7).
156. North of Union Inn, Holyhead Road—Coarse mica schist with linear orientation and garnets.
157. Cefn Du, Gaerwen—Microspectral and crape structure (fig. 14).
158. East of Gaerwen Windmill—Coarse microspectral mica schist.
159. Y-graig, Gaerwen—Gneiss microspectrally polarised at edges of elements.
160. North end of 'gneiss,' Holland Arms—Microspectral, vermiculite.
161. Gors Llwyd, near Llanestyn—Microspectrally polarised at edges of fragments.
162. Minffordd Waste—Fragmentary with chloritic base.
163. Over Tyn-y-Mynydd, Mynydd Llwyddiart—Laminated schist.
164. South of Newborough—Variolitic hornblende epidote schist.
165. Side of River Braint, Bryn Gwyn—Slate-like mylonised hornblende epidote schist (fig. 24).
166. Intrusive, in Llangaffo Cutting—Fine-grained hornblende epidote rock.¹
167. Tyn-drain, River Braint—Glaucophane and epidote.
168. Anglesey Monument (longitudinal)—Felted glaucophane and epidote schist.
169. Anglesey Monument (transverse)—Felted glaucophane and epidote schist.
170. Carnen Goch, near Llanfair—Mylonised glaucophane epidote schist.
171. Road to Castellor (S.)—Glaucophane and epidote schist with tourmaline.
172. Road to Castellor (N.)—Variolitic glaucophane epidote schist.
173. Gaerwen Windmill—Squeezed hornblende and epidote in bands.
174. Behind Gaerwen Windmill—Orientated fine-grained hornblende and epidote.
175. North of Holland Arms—(Epi ?) diorite with sphene.
176. North of Holland Arms—Contorted hornblende epidote schist.
177. South of Y-graig—Fine-grained hornblende and epidote schist with rutiles.
178. North end of wood, Y-graig—Decomposed epidote and hornblende in bands.
179. North of Y-graig—Cataclastic diorite.
180. Ysgubor Llwyd, Gaerwen—Coarse (epi ?) diorite.
181. North of Holland Arms—Abundant hornblende with epidote and sphene.
182. North end of 'gneiss,' Holland Arms—Mylonitic diorite.
183. Llangefni to Beaumaris—Cataclastic diorite.
184. South of Pentreath—Powdered diorite.
185. West of Tyn Lon—Cracked fine-grained hornblende and epidote.
186. Summit of Mynydd Llwyddiart—Cracked fine-grained hornblende and epidote.
187. Cadnant Vale, Menai Bridge—Fine-grained rock.
188. Ty Gwyn, Menai Bridge—Fine-grained rock with fragments, microcline.
189. Bryn Minceg, North of Llandegfan—Many fragments in chloritic groundmass.
190. North-east end of Malldraeth Marsh—Fine mylonitic slate.
191. South of Beaumaris—Fine epidote dust rock.
192. Garth Ferry to Beaumaris—Fine decomposed epidote in groundmass of chlorite.
193. Pen-y-Parc, Beaumaris—Mylonitic grit (fig. 17).
194. North of Garth Ferry—Entirely cataclastic.
195. Ty Garw, Beaumaris—Fine-grained rock.
196. Clawd-y-Parc, north of Llandegfan—Mylonitic crystalline fine-grained rock.
197. Gallows Point, Beaumaris—Fragments in quartzose and calcitic mass.
198. Llyn Bodgolched, north of Beaumaris—Fine-grained rock.
199. Tyddyn, north of Beaumaris—Fine-grained rock, full of mylonitic lines.
200. Near Coedmawr, Llanfaes—Mylonised fine-grained rock with fragments.
201. Penrhos, near Wugan—Medium-grained rock.
202. Rhyd Eilian—Coarse mosaic limestone.
203. Quartz knob, Pen-y-Parc, Beaumaris—Various rounded fragments, mostly quartz, in pure quartz matrix.
204. Gwladys—Isolated rhombohedral calcite in dusty matrix.
205. Intrusive, Gwladys—Fine mosaic of calcite and quartz.
206. Spheroidal rock, Gwladys—Spicular plagioclase.
207. Variolitic, Gwladys—Spicular with imperfect spherules and varioles (fig. 22).
208. Gwladys—Fine-grained rock.

209. Junction near Bwlch, Llanddona—Fine mica schist.
 210. Llanflewlin—Fine-grained rock with few fragments, and confused orientation.
 211. Mynydd Mechell—Fine mica schist with quincuncial orientation.
 212. Mynydd Mechell—Fine quincuncial orientation, parallel to bedding.
 213. Llanrhwydrus to Camlyn—Fine-grained chloritic rock with fragments.
 214. Port Unal, Camlyn—Quartz elements with sericitic boundaries, zircon.
 215. Intrusive, Port Unal—Fine mosaic limestone with quartzose cracks.
 216. West of Cemmaes—Fine and coarse mixed; tension areas.
 217. Llanbadrig—Oolitic limestone (fig. 19).
 218. Llanlliana—Fine mosaic limestone.
 219. West of Llanfechell—Fine-grained chloritic rock with fragments.
 220. Bodewryd Turret—Fine abundant mica quincuncially orientated.
 221. Llechog Ucha, west of Amlwch—Mylonised fine-grained rock with tension areas.
 222. Pengorhwyfsa, east of Amlwch—Fine-grained rock with fragments; tension areas.
 223. Llanelian, east of Amlwch—Plagioclase well preserved.
 224. Point Ælianus, east of Amlwch—Plagioclase well preserved.
 225. Dyke, east of Mynydd Mechell—Macrofelsite with epidote nests (fig. 20).
 226. Dyke, east of Mynydd Mechell—Spherulitic microgranite.
 227. Spheroidal boss, west of Almwh—Spicular macrofelsite with idiomorphic epidote.
 228. Hafod Onen, south of Amlwch—Pseudo-spherulitic granophyr (fig. 21).
 229. Almwh to Parys Mountain—Diabase with epidote and leucoxene.
 230. Boss at Tygorhwyfsa—Microgranite.
 231. Quartz mass, west of Bull Bay—Quartz elements with sericitic boundaries.
 232. Quartz knob, south-west of Parys Mountain—Pure quartz of polygonal structure (fig. 18).
 233. North side of Porth Lygan—Typical granite.
 234. Porth Lygan district—Granular sericitic felsite.
 235. Porth Lygan—Non-quartzose, slightly foliated micaceous tuff.
 236. Porth Lygan—Mylonised micaceous tuff.
 237. Opposite island, Porth Lygan—Quartzo-felspathic micaceous tuff.
 238. Abertywedog—Garnet, quartz, and diallage (?).
 239. Abertywedog—Micaceous tuff with altered garnets.
 240. Abertywedog—Quartzose non-micaceous tuff.
 241. Trwyn, near Abertywedog—Decomposed plagioclase, two pyroxenes and sphene. (Paraboloid.)
 242. Llanwenllwyfo, south end—Quartzose micaceous tuff.
 243. Rhos Manarch, inland—Dolerite.
 244. Pen-yr-Allt, west of Porth Lygan—Granite with altered garnets.
 245. Ty Newydd, north of Nebo—Gneiss with brown mica.
 246. Penrhynglas, Llanwenllwyfo—Micaceous tuff with garnet groundmass.
 247. Nebo, south of Road—Felspathic micaceous tuff.
 248. In micaceous rock, Nebo—Calcite, plagioclase, and sphene.
 249. Outer ridge, east of Parys Mountain—Mica-diorite with apatite, &c.
 250. East of Parys Mountain—Grey gneiss.
 251. East of Parys Mountain—Brown-mica-diorite with sphene, apatite, &c.
 252. East of Parys Mountain—Plagioclastic rock with mica in cracks.

LIST OF FIGURES.

1. No. 151. Showing speckled felspar in fragments (1, 2, 3, 4).
 2. „ 81. Sutural junctions of elements.
 3. „ 5. Lamination and foliation coincident.
 4. „ 32. Fine-grained mosaic rock with tension areas.
 5. „ 75. Quincuncial orientation.
 6. „ 150. Linear orientation.
 7. „ 155. Elemental orientation.
 8. „ 69. Lamellar orientation.
 9. „ 66. False orientation by a series of cracks, producing fracture cleavage.
 10. „ 20. Foliation oblique to bedding, and to cracks in a fine-grained rock.

11. No. 147. Felted structure.
12. " 1. Foliation cleavage.
13. " 6. Spectral polarisation in a large quartz fragment which has been broken, and forms an 'eye.'
14. " 157. Microspectral polarisation.
15. " 148. Crape structure.
16. " 62. Strain slip cleavage in fine micaceous schist.
17. " 193. Mylonitic lines.
18. " 232. Polygonal structure in quartz rock.
19. " 217. Multiple oolite.
20. " 225. Macrofelsite. The crossed areas are epidote.
21. " 228. Pseudospherulitic granophyr.
22. " 207. Variolitic. The circular spots, with borders, are the varioles.
23. " 50. Talcose schist derived from gabbro. The dark patches are epidote, the lightest talc.
24. " 165. Slaty diorite. The dark spots are epidote, the lightly shaded hornblende or chlorite.

Report of the Committee, consisting of Mr. THISELTON-DYER (Secretary), Mr. CARRUTHERS, Mr. BALL, Professor OLIVER, and Mr. FORBES, appointed for the purpose of continuing the preparation of a Report on our present knowledge of the Flora of China.

THE further grant made by the Association has assisted the Committee in advancing rapidly with the work, the importance of which is generally acknowledged by botanists. It is based, in the first instance, on the manuscript collections made by Mr. Forbes, as the result of many years' work. These collections have been placed by him, with great liberality, in the hands of the Committee. With these collections are worked up the additional material derived from an examination of the herbaria of Kew and the British Museum (including Dr. Hance's extensive Chinese herbarium acquired last year by the trustees of the latter institution). The Committee pay the expense of drawing up the successive portions of the report from these materials, and also the cost of setting up in type and printing 100 copies of each part. These are distributed to everyone in China whose co-operation there is any likelihood of enlisting in obtaining further collections which would throw light upon its flora. The result has been to excite an amount of interest which could hardly have been anticipated. The Committee have in particular to express the obligations they are under to various members of the Inland China Mission, of the Chinese Imperial Maritime Customs, and of the British Diplomatic Service in China. The Committee have been further aided by grants from the Government Grant Committee of the Royal Society.

In order to make the result of their labours of permanent usefulness to the scientific world, the Committee have allowed the Linnean Society to print from the type, at its own expense, copies for distribution to its fellows. The Council of the Society further pay the expense of two plates for each part.

During the past year three more numbers have appeared, and the grant made by the Association about covers the expense of setting these up in type. This brings the Report down to the beginning of *Compositæ*,

and Mr. Hemsley has since made rapid progress with this order, the discussion of which will occupy about 100 pages.

Dr. A. Henry has presented further large collections to Kew, with a view to their being used for the Report. These have yielded numerous novelties—the most remarkable of which have been published in Hooker's 'Icones Plantarum.' One of the most important is a new genus (*Trapella*, Oliver), a peculiar aquatic type, which is the subject of an elaborate memoir by Dr. F. Oliver in 'The Annals of Botany.'

Another important collection has been received from the Rev. E. Faber from the western province of Szechuen, and chiefly on Mount Omei, which has an altitude of 11,000 feet. These contain an element of Indian species, intermixed with others which are identical with those sent by Dr. Henry from the neighbourhood of Hupeh. There are also many new species, amongst them *Nertera sinensis*, Hemsl., a new species of a genus whose head-quarters are in the Southern Hemisphere. The ferns contain twelve new species, besides an equal number of others not previously known, from China. Scarcely any of the plants, however, are the same as those from the mountainous regions of Yunnan. Other small collections have also been received.

As an interesting sample of the flora of China, attention may be drawn to the *Caprifoliaceæ*, published in the last part of the Index. There are eleven genera, one of which is new, and seventy-seven species, of which fifteen are new. *Viburnum* and *Lonicera* number respectively twenty-seven and thirty-four species. This is by far the greatest concentration of the order.

The Committee recommend their reappointment, and that a further sum of 100*l.* be placed at their disposal.

Second Report of the Committee, consisting of Professor FOSTER, Professor BAYLEY BALFOUR, Mr. THISELTON-DYER, Dr. TRIMEN, Professor MARSHALL WARD, Mr. CARRUTHERS, Professor HARTOG, and Professor BOWER (Secretary), appointed for the purpose of taking steps for the establishment of a Botanical Station at Peradeniya, Ceylon.

THE Committee report that no part of the grant has as yet been expended. Though several botanists have expressed themselves as desirous of going to Peradeniya, in the end no one was able technically to accept the situation during last year. The Committee now learn that Mr. Potter, of St. Peter's College, Cambridge, has decided to go out during the ensuing winter. The grant of 50*l.* has accordingly been drawn, and the Secretary is in communication with Dr. Trimen, Director of the Royal Gardens, Peradeniya, as to the apparatus which should be purchased with that sum.

The Committee, in presenting this as an interim report, request that they may be reappointed for the ensuing year, but do not ask for any further grant at present.

Eighth Report of the Committee, consisting of Mr. R. ETHERIDGE, Mr. THOMAS GRAY, and Professor JOHN MILNE (Secretary), appointed for the purpose of investigating the Earthquake and Volcanic Phenomena of Japan. (Drawn up by the Secretary.)

EARTHQUAKES IN 1886.

IN my fourth report to the British Association (1884) I gave the results obtained from the observation of 387 earthquakes which had occurred between October 1881 and October 1883 in North Japan. The valuable nature of these results led the Meteorological Department of this country to establish post-card stations throughout the empire, with the object of making similar but more extended observations. An epitome of the results obtained during 1885 was given in my sixth report to the British Association, and through the kindness of Mr. Aria Ikunosake, the Director of the Meteorological Department, I am now enabled to give a summary of the observations made in 1886. Here and there these are supplemented with my own remarks.

(a) *Frequency of Earthquakes.*—During 1886 the number of earthquakes recorded in Japan was 472, which is equivalent to an average of 1·3 per day. In 1885 there were 482. The greatest number of shakings felt in any one province was in Shimotsake, 30 or 40 miles north of Tokio, where sixty-one shakings were recorded. Some of the provinces on the western side of the empire do not appear to have felt any shakings.

(b) *Distribution of Seismic Energy.*—Speaking generally, the eastern part of Japan was greatly shaken, while to the west of the mountains, forming the backbone of the country, disturbances were rare. The general distribution of seismic energy therefore remains as it has been in previous years. If, however, we make a detailed examination of this distribution, a few exceptions to the observations of 1885 may be discovered, one of which was the great increase in the earthquakes felt in Shinano, an inland province 60 miles east of Tokio, and the other in the province of Echigo, about 100 miles north of Tokio. In Shinano the number of shocks increased from 9 to 19, while in Echigo they increased from 3 to 31. In other provinces a decrease was observed.

It is extremely interesting to observe that Echigo and Shinano lie along a N.N.W. line, which, so far as the strike of rocks is concerned, divides the main island of Japan into two halves. Along this line, and to the north and east of it, there are many volcanoes, while to the west and south there are practically none. The strongest shock was the Echigo-Shinano shock of July 25, which caused considerable damage to buildings, walls, bridges, &c.

The districts most shaken were the east coast from Tokio northwards, the north-east corner of Yezo, the southern extremity of the Kii peninsula, and the southern part of Kinshin.

The positions of the origins of the shocks which have been recorded were approximately as follows:—

	Originating beneath the sea or on the coast	Originating beneath the land	Total
Total number	228	244	472
Shocks shaking a large area	15	11	26
Shocks shaking a moderate area	50	70	120
Shocks shaking a small area	163	163	326
Total	228	244	472

In many respects the relationship of earthquakes to volcanoes was the same as in the previous years; as, for example, in Central Japan, where there are many volcanoes and many earthquakes, the earthquakes have not originated from the volcanoes. Again in the Kii peninsula, where there are no volcanoes, earthquakes were frequent. In other districts there are many volcanoes and comparatively few earthquakes.

(c) *Distribution of Earthquakes in Time.*—The number of earthquakes which occurred in different months and seasons will be seen from the following table:—

January 38	} Spring, 126.	July 36	} Autumn, 123.
February 39		August 46	
March 49		September 41	
April 38	} Summer, 126.	October 33	} Winter, 97.
May 58		November 22	
June 30		December 42	
Cold months, 223.		Hot months, 249.	

The distribution of earthquakes, according to the hours of the day, during 1885 and 1886 is shown in the following table:—

Time	Jan.	Feb.	Mar.	Apr.	May	June	July	Aug.	Sept.	Oct.	Nov.	Dec.	Total
0 to 1 A.M.	0	4	2	3	2	6	4	3	0	1	4	4	33
1 to 2 "	2	7	3	0	2	6	3	0	4	6	2	1	36
2 to 3 "	4	3	7	5	8	4	5	11	11	1	3	3	65
3 to 4 "	4	4	3	4	10	0	4	3	5	3	4	4	48
4 to 5 "	1	4	0	3	6	4	1	2	3	1	1	1	27
5 to 6 "	2	1	7	2	10	0	4	4	1	6	3	0	40
6 to 7 "	4	2	2	3	4	1	4	2	4	2	1	5	34
7 to 8 "	3	1	3	6	3	3	1	1	1	3	5	3	33
8 to 9 "	4	3	5	4	4	2	4	3	8	1	1	2	41
9 to 10 "	4	4	3	5	2	8	2	2	3	4	1	1	39
10 to 11 "	6	0	2	4	0	2	1	1	2	2	2	3	25
11 to 12 "	2	3	3	4	6	4	4	2	4	3	3	6	44
0 to 1 P.M.	2	2	1	1	3	1	3	2	6	3	2	2	28
1 to 2 "	2	4	4	3	10	3	2	3	4	6	5	3	49
2 to 3 "	6	2	9	3	5	3	6	4	3	3	3	4	51
3 to 4 "	1	3	1	5	4	1	2	5	4	2	2	3	33
4 to 5 "	2	2	6	2	5	3	2	2	1	1	1	2	29
5 to 6 "	3	8	3	2	3	5	2	0	2	0	0	1	29
6 to 7 "	2	2	3	3	4	3	3	3	6	4	2	4	39
7 to 8 "	3	5	2	4	2	3	3	4	2	5	3	3	39
8 to 9 "	1	2	3	4	6	2	4	4	4	5	8	7	50
9 to 10 "	2	2	4	1	5	3	2	4	6	3	5	6	43
10 to 11 "	6	9	7	2	3	5	1	4	0	6	4	9	56
11 to 12 "	5	6	3	2	2	4	1	7	2	3	4	5	44
Total .	71	83	86	75	109	76	68	76	86	74	69	82	955

The mean number of earthquakes which occurred per hour is approximately 40. Calling the time from 6 P.M. to 6 A.M. night, and the remaining hours out of the twenty-four, day, we find that 86 more earthquakes were recorded during the night than during the day. The probable explanation of this observation is, that during the night persons are more favourably situated for the observation of small disturbances than they are during the day. During the day, when a person is engaged in active work, especially if out of doors, it has often been observed that earthquakes are passed by unnoticed, while at night, if not sleeping too soundly, the slightest tremor may be recorded.

Under the heading 'Seismic Survey of Tokio' reference is again made to this subject.

(d) *Area shaken by Earthquakes in 1885 and 1886.*—Inasmuch as there are many reasons for believing that the depth at which an earthquake originates is usually incomparable with the radius of the area shaken, the area shaken may be taken as a very fair estimate of the intensity of any given disturbance. The following table gives the sum of the areas shaken per month and the mean area per shock. The unit is one square ri, or 5.9553 square miles.

	TOTAL AREA			MEAN AREA PER SHOCK		
	1885	1886	Average	1885	1886	Average
	sq. ri	sq. ri	sq. ri	sq. ri	sq. ri	sq. ri
January	10,020	3,240	6,630	370	80	195
February	16,980	5,550	11,265	390	140	265
March	7,320	4,810	6,065	200	100	150
April	4,750	12,480	8,615	130	330	230
May	10,380	15,380	12,880	200	260	230
June	15,890	5,080	10,485	370	170	270
July	9,170	10,490	9,830	290	290	290
August	6,060	10,820	8,440	210	230	220
September	4,570	9,500	12,035	320	230	275
October	21,340	3,860	12,600	520	120	320
November	4,120	2,480	3,300	80	110	90
December	1,170	8,360	10,030	290	200	245
Total	111,770	92,050	112,175	3,370	2,260	2,780
Average	11,025	7,671	9,348	276	189	232

The total area, 92,050 square ri, shaken in 1886 is 3.8 times the area of the empire, which, exclusive of small islands and Loo Choo, is 24,352 square ri. There were only 66 earthquakes which exceeded the mean value of 189 square ri.

From the following table we see that the greater intensity of 1885 was due to the fact that in that year there were more shocks of large extension than in 1886, when the majority of shocks (349) were local in their character. It also gives the number of earthquakes of different intensities, reckoned as areas shaken, felt during different months.

Area	Year	Jan.	Feb.	Mar.	Apr.	May	June	July	Aug.	Sept.	Oct.	Nov.	Dec.	Total	Mean
More than 5,000 sq. ri.	1885	—	1	—	—	—	—	—	—	—	1	—	—	2	1.5
	1886	—	—	—	—	—	—	1	—	—	—	—	—	1	1
More than 4,000 sq. ri.	1885	—	—	—	—	—	—	—	—	—	—	—	—	—	—
	1886	—	—	—	1	—	—	—	—	—	—	—	—	1	1
More than 3,000 sq. ri.	1885	—	—	1	—	1	1	1	—	1	1	—	—	6	5.5
	1886	—	—	—	—	1	1	1	1	—	—	—	—	3	3.3
More than 2,000 sq. ri.	1885	1	2	—	—	1	2	1	—	3	1	—	2	13	1.1
	1886	—	—	—	1	2	—	—	1	1	—	—	—	5	4
More than 1,000 sq. ri.	1885	—	1	—	1	—	1	—	—	—	4	—	1	9	8
	1886	—	1	—	1	1	1	—	1	3	—	1	1	9	8
Sum for . . .	1885	1	4	1	1	2	4	2	1	4	7	—	3	30	2.5
Sum for . . .	1886	—	1	—	3	4	1	2	2	4	—	1	1	19	1.6
Comparison of 1885 and 1886		-1	-3	-1	+2	+2	-3	=	+1	=	-7	+1	-2	-11	-0.9
More than 750 sq. ri.	1885	2	1	1	—	—	2	1	1	2	—	—	2	12	1
	1886	—	1	2	1	2	1	—	2	1	1	—	2	12	1
More than 500 sq. ri.	1885	5	4	1	1	—	1	—	2	1	2	—	—	17	1.4
	1886	1	1	—	2	—	—	—	1	2	2	—	4	13	1.1
More than 300 sq. ri.	1885	2	1	—	2	4	1	2	1	—	6	1	4	24	2
	1886	2	2	2	1	3	4	1	1	—	2	1	1	20	1.7
More than 200 sq. ri.	1885	—	1	2	1	1	4	—	4	1	2	9	2	27	2.2
	1886	2	—	4	1	4	2	2	2	1	—	—	2	20	1.7
More than 100 sq. ri.	1885	3	6	5	6	16	7	4	2	4	—	5	5	63	5.2
	1886	5	3	2	3	4	4	1	5	4	3	1	4	39	3.2
Sum for . . .	1885	12	13	9	10	21	15	7	10	8	10	15	13	143	11.9
Sum for . . .	1886	10	7	10	8	13	11	4	11	7	8	2	13	104	8.7
Comparison of 1885 and 1886		-2	-6	+1	-2	-8	-4	-3	+1	-1	-2	-13	=	-39	-3.2
Less than 100 sq. ri.	1885	19	27	27	26	28	27	23	19	33	24	32	24	309	25.7
	1886	28	31	39	27	41	18	30	33	30	25	19	28	349	29.0
Sum for . . .	1885	19	27	27	26	28	27	23	19	33	24	32	24	309	25.7
Sum for . . .	1886	28	31	39	27	41	18	30	33	30	25	19	28	349	29.1
Comparison of 1885 and 1886		+9	+4	+12	+1	+13	-9	+7	+14	-3	+1	-13	+4	+40	+3.3
Total . . .	1885	32	44	37	37	51	46	32	30	45	41	47	40	482	40.2
Total . . .	1886	38	39	49	38	58	30	36	46	41	33	22	42	472	39.2
Comparison of 1885 and 1886		+6	-5	+12	+1	+7	-16	+4	+16	-4	-8	-25	+2	-10	-8

(e) *Special Earthquakes.*—On April 13, at 5.50 A.M., a strong earthquake, extending over 4,980 ri, was felt in the north part of the main island. It commenced with a rumbling, and the shaking lasted for three minutes. It does not appear to have been felt in Yezo, from which the shaken districts are only separated by straits, which at one point are only 10 miles in width. At Nemuro, at the north-eastern corner of Yezo, a

slight shock was felt; while, to the west of the centre of this island, the Tarumai volcano burst into eruption. These two earthquakes and the volcanic eruption all took place within at most a few minutes of each other.

On July 23, at 1 A.M., the provinces of Shinano and Echigo were violently shaken by a disturbance extending over 2,990 square ri. This is a district where in the previous year, although there are volcanoes in the vicinity, there had not been any earthquakes. During the next five hours this severe shock was followed by 23 minor disturbances. Here and there cliffs fell down, roads and bridges were damaged, houses upset or tilted, stone walls thrown over, and much damage done to roofs, furniture, and especially to the contents of stores. At the same time a small shock was felt more than 100 miles to the south-east in the province of Mino.

On August 10, at 9.30 P.M., a strong shock originated in the Bungo Channel between the islands of Shikoka and Kiushiu, which extended a considerable distance inland. It was succeeded by two or three other disturbances. Shocks have often been noticed on the shores of the Bungo Channel, but this one is remarkable as being the most severe which has occurred in that locality for many years.

EARTHQUAKES RECORDED IN TOKIO.

The systematic observations of earthquakes by the Meteorological Department in Tokio commenced in 1875. From that time up to 1885 Palmieri's instruments were employed. From 1885 up to the present time a Gray-Milne seismograph has been the standard instrument and Palmieri's instruments are no longer employed. From 1876 to 1882 the observations were made in a district known as Avicho; since then, owing to the removal of the Central Meteorological Station, the observations have been made at Hon Maru, in the castle grounds in the centre of the city. From 1876 to 1886 inclusive 658 earthquakes were recorded. The following analyses of these disturbances are of interest, as they refer to a particular seismic area, the earthquakes felt in which, for the most part, probably come from one or two particular origins, whereas the earthquakes referred to in previous tables originated from a large number of different centres distributed throughout the empire.

(a) *Distribution according to Time.*—The following table gives the distribution of earthquakes according to months in different years:—

Year	Jan.	Feb.	Mar.	Apr.	May	June	July	Aug.	Sept.	Oct.	Nov.	Dec.	Total	Average
1876	3	4	6	11	5	3	3	5	3	3	4	6	56	5
1877	4	5	6	5	8	6	6	4	1	8	6	9	71	6
1878	3	8	7	2	5	4	4	1	2	4	6	4	50	4
1879	6	7	14	0	9	4	3	4	1	7	6	9	70	6
1880	9	9	6	6	2	9	8	4	1	3	10	10	77	6
1881	13	8	8	8	4	3	3	3	2	3	3	8	66	5
1882	4	7	15	6	3	2	2	1	1	4	1	0	46	4
1883	6	0	3	3	6	2	3	1	0	1	3	4	32	3
1884	5	2	8	2	9	4	1	4	2	8	8	15	68	6
1885	7	9	8	4	3	6	0	3	8	10	3	7	68	6
1886	3	3	3	2	8	4	2	8	7	4	2	8	54	4
Total	63	62	84	49	62	50	35	38	28	55	52	80	658	54.8
Average	6	5	8	5	6	5	3	3	2	5	5	7	60	5

Considering March, April, and May as Spring, and the following three groups of three months respectively, Summer, Autumn, and Winter, the distribution of shocks according to these seasons has been as follows :—

Year	Spring	Summer	Autumn	Winter	Average
1876	22	11	10	13	14
1877	19	19	15	18	18
1878	14	9	12	15	25
1879	23	11	14	22	17
1880	14	21	14	28	19
1881	20	9	8	29	16
1882	24	5	6	11	11
1883	12	6	4	10	8
1884	19	9	18	22	17
1885	15	9	21	23	17
1886	13	14	13	14	13
Average	18	11	12	19	15

The distribution of earthquakes in relation to the cold months and warm months has been as follows :—

Year	Cold	Warm	Average
1876	26	30	28
1877	38	33	35
1878	32	18	25
1879	49	21	35
1880	47	30	39
1881	43	23	33
1882	31	15	23
1883	17	15	16
1884	46	22	34
1885	44	24	34
1886	23	31	27
Average	36	24	30

The following table gives the distribution of 658 earthquakes according to hours :—

Time	Jan.	Feb.	Mar.	Apr.	May	June	July	Aug.	Sept.	Oct.	Nov.	Dec.	Total	
A.M.	0 to 1	4	4	2	2	1	2	2	1	2	2	0	6	28
	1 to 2	1	0	2	0	3	2	1	0	2	1	4	2	18
	2 to 3	1	5	3	4	4	2	2	3	1	2	2	1	30
	3 to 4	1	0	4	0	1	3	2	2	1	6	3	3	26
	4 to 5	1	2	5	4	1	0	2	3	0	1	2	3	24
	5 to 6	2	2	2	4	2	1	0	3	3	3	2	6	30
	6 to 7	3	2	4	0	2	0	1	0	0	0	1	5	18
	7 to 8	3	2	2	3	3	0	0	2	0	3	0	4	22
	8 to 9	0	1	0	2	4	4	0	0	2	2	1	1	17
	9 to 10	4	4	4	1	5	4	1	2	0	3	4	6	38
	10 to 11	5	1	1	0	2	3	2	2	2	3	3	2	26
	11 to 12	4	1	3	1	1	2	1	0	0	0	0	3	16
Carried forward .	29	24	32	21	29	23	14	18	13	26	22	42	293	

THE DISTRIBUTION OF 658 EARTHQUAKES—*continued.*

Time	Jan.	Feb.	Mar.	Apr.	May	June	July	Aug.	Sept.	Oct.	Nov.	Dec.	Total
Brought forward .	29	24	32	21	29	23	14	18	13	26	22	42	293
P.M.													
0 to 1	2	1	2	1	4	6	3	0	2	0	4	4	29
1 to 2	3	4	4	3	1	2	2	1	2	6	2	2	32
2 to 3	2	4	4	1	0	1	2	3	0	0	0	3	20
3 to 4	3	5	3	3	4	2	3	0	2	0	6	0	31
4 to 5	3	1	9	3	0	3	2	3	2	1	2	3	32
5 to 6	2	3	2	2	8	2	1	1	1	1	1	2	26
6 to 7	3	2	5	2	2	5	0	2	0	3	1	2	27
7 to 8	4	3	4	2	0	0	0	2	0	3	2	3	23
8 to 9	3	4	4	3	2	0	3	3	3	8	6	8	47
9 to 10	3	2	4	4	5	1	2	2	1	2	3	3	32
10 to 11	3	4	5	3	2	2	1	2	1	3	0	6	32
11 to 12	3	5	6	1	5	3	2	1	1	2	3	2	34
Total . . .	63	62	84	49	62	50	35	38	28	55	52	80	658

As the above records were obtained from instruments, any results they may yield are probably more trustworthy than those obtained from any tables which have been previously published. The greatest number of earthquakes have occurred between 8 and 9 P.M. and 9 and 10 A.M., while the fewest have been recorded between 11 and 12 A.M. and 8 and 9 A.M.

Between 6 P.M. and 6 A.M. 351 earthquakes were recorded, while during the day, that is from 6 A.M. to 6 P.M., 307 were noted.

The hours at which earthquakes have been most frequent in successive months are in nearly all cases quite different.

(b) *Severe Earthquakes.*—The following are the most severe earthquakes felt in Tokio in successive years:—

Year	Month and Day	Time	Range of Motion, &c.
		H. M. S.	
1876	Jan. 20	8 44 30 P.M.	21°
1877	July 22	4 49 17 P.M.	11°
1878	Feb. 23	6 3 45 A.M.	19° 20'
1879	Dec. 3	7 8 0 A.M.	18° 30'
1880	Feb. 22	0 50 19 A.M.	78°
1881	June 18	10 25 0 A.M.	8° 30'
1882	March 11	7 50 54 P.M.	11° 20'
1883	June 10	10 15 0 P.M.	18° 20'
1884	Oct. 15	4 21 54 A.M.	95° 10'
1885	March 20	1 1 13 P.M.	22°
1886	May 8	10 14 0 P.M.	2.8 mm. in .4 sec.

As Palmieri's instrument is only graduated to 25°, two of the above measurements were estimated. On October 15, 1884, a few walls were cracked in Tokio, several brick chimneys fell, tiles were dislodged, a few storehouses fell, and much furniture was damaged. On February 22, 1880, there was similar damage in Tokio.

The following is an abstract of notes on these and other earthquakes, which I drew up for the consideration of a committee now sitting in Tokio to consider the question of construction in earthquake countries.

*February 22, 1880.*¹—This earthquake created considerable destruction in Yokohama. At that place very many brick chimneys fell. At many houses the tiles on the roof were shaken loose, while several were

¹ *Trans. Seis. Soc.* vol. i., part 2.

completely unroofed, one of which was a strong brick building. The main timbers in certain roofs were broken. Grave-stones were rotated. Many windows were broken, and bodies like the tops of stone lanterns, corner stones of chimneys, &c., were projected.

In Tokio a few chimneys fell, tiles were dislodged from the eaves of buildings, and portions of a few walls were cracked or shattered. In some instances these latter fell.

In Yokohama the range of horizontal motion appears to have been from 15 millimetres ($\frac{5}{8}$ inch) to a maximum of 50 millimetres (3 inches). Calculations of maximum velocity were made, but as the data on which they were founded do not appear to have been satisfactory they are here omitted.

In Tokio the amplitude (range of motion) observed at Surugadai was 21 millimetres. Assuming the larger vibrations to have been performed at the rate of one per second, this would indicate a maximum velocity of 60 millimetres per second, and a maximum acceleration of 360 millimetres per second. With a period of two seconds, which is probably a more correct assumption, the above quantities would respectively become 30 and 90 millimetres.

October 15, 1884.—One or two chimneys fell in Tokio, plaster fell from ceilings, and several brick walls were cracked. In Tokio, at Hitotsubashi-soto the greatest horizontal motion observed was 43 millimetres and the period two seconds. This indicates a maximum velocity of 68 millimetres and a maximum acceleration of 210 millimetres.

January 15, 1887.¹—This disturbance originated about 35 miles to the south-west of Tokio. Near to its origin it destroyed many *kura* (fire-proof storehouses built of wood, with a clay covering and a heavy roof of tiles), and opened fissures in the ground. In Yokohama, say ten miles from the origin, it destroyed many chimneys and slightly shattered several buildings. In Tokio a few brick walls were slightly cracked.

In Yokohama a horizontal motion of 35 millimetres was recorded.

In Tokio the following observations were made:—

—	Range of motion in millimetres	Period in seconds	Maximum velocity	Maximum acceleration	Vertical motion	Period of vertical motion in second
Hitotsubashi . . .	21	2.5	26	66	1.8	0.9
Hongo	7.2	2.2	12	36	1.3	1.0
Chirikioku	19.2	2.3	24	64	5.5	0.8

Hongo and the Chirikioku (Imperial Meteorological Observatory) are situated on moderately high ground, which is dry and hard. At Hitotsubashi, which is low, the ground is damp and soft.

The above measurements of range of motion and period were made on solid foundations. The range of motion at the top of a building would be greater while the period might be less. It seems from these observations that when there is an earth-movement of about 18 millimetres ($\frac{3}{4}$ inch) or over, it is likely that the period will be sufficiently short to result in some form of destruction.

Earthquakes of this description, Professor Sekiya observes, occur in Japan about once a year, and near to Tokio every few years.

¹ *Trans. Seis. Soc.* vol. ix.

(c) *Direction of Motion in Earthquakes.*—The following table shows the principal direction of movement of earthquakes as recorded in Tokio :—

Direction	PALMIERI												GRAY-MILNE	Total
	At Avicho								At Castle					
	1876	1877	1878	1879	1880	1881	1882	Total	1883	1884	1885	Total		
N.-S.	—	—	—	—	—	—	—	—	5	6	16	27	8	35
N.N.E.-S.S.W.	—	3	3	15	20	1	1	43	—	—	—	—	2	45
N.E.-S.W.	—	—	—	—	—	—	—	—	5	10	6	21	—	24
E.N.E.-W.S.W.	8	15	3	10	1	3	12	52	—	—	—	—	2	54
E.-W.	—	—	—	—	—	—	—	—	8	25	7	40	14	54
E.S.E.-W.N.W.	12	12	22	9	7	26	3	91	—	—	—	—	5	96
S.E.-N.W.	—	—	—	—	—	—	—	—	3	5	4	12	13	25
S.S.E.-N.N.W.	—	4	1	11	24	7	14	61	—	—	—	—	3	64
Uncertain	38	40	21	30	32	32	19	212	12	25	38	75	4	291
Total . .	58	74	50	75	84	69	49	459	33	71	71	175	54	688

When Palmieri's instrument was removed to the castle its orientation was changed to N.S., E.W. The above table shows that the principal direction of movement in Tokio is between E.-W. and S.E.-N.W., a fact which is of considerable importance to builders.

(d) *Earthquakes and Atmospheric Pressure.*—The following table shows the number of earthquakes which occurred between 1878 and 1886, during different months, with the barometer at different heights. The barometric readings are in millimetres :—

Barometer in mm.	Jan.	Feb.	Mar.	Apr.	May	June	July	Aug.	Sept.	Oct.	Nov.	Dec.	Total
745	1	—	—	—	—	1	—	—	—	—	—	—	2
746	1	—	—	—	—	—	—	—	—	—	—	—	1
747	1	—	—	—	2	1	—	—	—	—	—	—	4
748	—	—	—	—	—	—	—	—	—	—	—	—	—
749	—	—	—	1	1	1	—	—	—	—	1	—	4
750	3	—	2	—	1	—	—	1	—	—	—	—	7
751	1	—	1	—	—	3	—	—	—	—	—	—	5
752	3	—	2	1	—	—	—	—	—	—	—	1	7
753	—	—	—	1	3	1	—	—	—	—	—	—	6
754	2	—	—	1	2	4	4	1	—	1	1	1	17
755	2	3	1	—	1	2	6	1	1	2	—	6	25
756	—	4	1	1	2	4	1	2	1	2	—	1	19
757	3	1	1	—	2	3	4	5	2	—	2	7	30
758	—	6	2	—	4	2	5	1	2	3	—	3	28
759	2	4	3	2	6	4	1	5	—	2	6	3	38
760	3	4	6	—	5	7	3	4	2	2	2	2	40
761	3	7	3	3	4	1	1	7	3	7	2	3	44
762	6	2	3	3	2	1	1	1	6	2	5	5	37
763	5	5	8	5	5	1	—	—	4	1	6	4	44
Carried forward	36	36	33	18	40	36	26	28	21	22	25	37	358

EARTHQUAKES BETWEEN 1878 AND 1886—*continued.*

Barometer in mm.	Jan.	Feb.	Mar.	Apr.	May	June	July	Aug.	Sept.	Oct.	Nov.	Dec.	Total
Br. forward.	36	36	33	18	40	36	26	28	21	22	25	37	358
764	2	3	6	—	1	2	—	—	2	1	3	7	27
765	2	2	6	3	5	—	—	1	—	3	2	2	26
766	3	2	4	2	1	—	—	—	1	2	5	3	23
767	—	2	9	2	1	—	—	—	—	6	2	3	25
768	1	1	4	3	—	—	—	—	—	1	—	3	13
769	4	2	1	—	—	—	—	—	—	1	1	6	15
770	4	4	4	1	1	—	—	—	—	3	—	—	17
771	2	—	4	3	—	—	—	—	—	1	—	—	10
772	—	—	1	1	—	—	—	—	—	2	2	3	9
773	—	—	—	—	—	—	—	—	—	2	—	—	2
774	2	—	—	—	—	—	—	—	—	—	—	1	3
755	—	1	—	—	—	—	—	—	—	—	1	—	2
Total . . .	56	53	72	33	49	38	26	29	24	44	41	65	530

The ratio of the number of earthquakes which have occurred when the barometer has been below the average pressure, to the number when the barometer has been above the average pressure, is as 56 : 44.

The number of earthquakes which have occurred in each month when the atmospheric pressure has been above the average, and the number which have occurred when it has been below the average, are given in the following table:—

—	Jan.	Feb.	Mar.	Apr.	May	June	July	Aug.	Sept.	Oct.	Nov.	Dec.	Total
Above average pressure .	23	15	43	17	28	17	6	16	17	21	19	34	256
Below average pressure .	33	38	29	16	21	21	20	13	7	23	23	31	275
Total . . .	56	53	72	33	49	38	26	29	24	44	42	65	531

The next table gives the number of earthquakes which have occurred when the barometer has been rising, when it has been falling, and when it was steady:—

—	Jan.	Feb.	Mar.	Apr.	May	June	July	Aug.	Sept.	Oct.	Nov.	Dec.	Total
Rising . . .	21	19	19	12	15	9	9	15	6	19	12	14	170
Falling . . .	15	20	24	12	11	7	6	1	5	13	13	26	153
Steady . . .	20	14	29	9	23	22	11	13	13	12	17	25	208
Total . . .	56	53	72	33	49	38	26	29	24	44	42	65	531

Earthquakes therefore appear to be most frequent when the barometer has been steady, less when it has been rising, and least when it has been falling.

(e) *Earthquakes and Temperature.*—The following table gives the number of earthquakes felt between 1877 and 1886, when the thermometer has shown different temperatures:—

Temperature	Jan.	Feb.	Mar.	Apr.	May	June	July	Aug.	Sept.	Oct.	Nov.	Dec.	Total
-6°	—	1	—	—	—	—	—	—	—	—	—	—	1
-5°	—	—	—	—	—	—	—	—	—	—	—	—	0
-4°	1	—	—	—	—	—	—	—	—	—	—	—	1
-3°	6	—	1	—	—	—	—	—	—	—	—	2	9
-2°	3	1	—	—	—	—	—	—	—	—	—	1	5
-1°	5	2	4	—	—	—	—	—	—	—	1	2	14
0°	6	5	5	—	—	—	—	—	—	—	1	6	23
+1°	9	2	5	1	—	—	—	—	—	—	—	12	29
2°	3	8	6	—	—	—	—	—	—	—	—	6	23
3°	5	5	6	1	—	—	—	—	—	—	—	9	26
4°	7	10	8	1	—	—	—	—	—	—	2	8	36
5°	1	3	6	1	—	—	—	—	—	1	3	4	19
6°	3	6	2	2	—	—	—	—	—	—	2	5	20
7°	4	5	8	2	—	—	—	—	—	1	4	5	29
8°	2	7	5	5	1	—	—	—	—	—	4	2	26
9°	3	1	3	2	—	—	—	—	—	2	8	5	24
10°	—	2	8	3	4	—	—	—	—	2	5	6	30
11°	2	—	2	—	2	—	—	—	—	1	2	—	9
12°	—	—	1	2	2	—	—	—	—	6	2	1	14
13°	—	—	2	2	5	—	—	—	—	4	5	—	18
14°	—	—	2	5	1	—	—	—	—	4	3	—	15
15°	—	—	2	3	6	—	—	—	—	8	2	—	21
16°	—	—	2	1	9	1	—	—	3	6	—	—	22
17°	—	—	—	1	9	6	—	—	2	4	4	—	26
18°	—	—	—	3	2	2	1	1	2	5	—	—	16
19°	—	—	—	—	3	4	—	1	1	1	—	—	10
20°	—	—	—	1	3	6	—	—	1	1	—	—	12
21°	—	—	—	2	6	5	2	1	1	3	—	—	20
22°	—	—	—	—	4	5	3	2	8	1	—	—	23
23°	—	—	—	—	—	6	6	5	1	1	—	—	19
24°	—	—	—	—	—	3	3	3	—	1	—	—	10
25°	—	—	—	—	—	2	2	4	1	—	—	—	9
26°	—	—	—	—	—	—	3	3	1	—	—	—	7
27°	—	—	—	—	—	2	2	3	1	—	—	—	8
28°	—	—	—	—	—	4	2	3	1	—	—	—	10
29°	—	—	—	—	—	1	2	2	2	—	—	—	7
30°	—	—	—	—	—	—	4	3	—	—	—	—	7
31°	—	—	—	—	—	—	2	1	—	—	—	—	3
32°	—	—	—	—	—	—	—	1	—	—	—	—	1
Total	60	58	78	38	57	47	32	33	25	52	48	74	602

The average temperature in Tokio is 14° C.

The following table shows the number of earthquakes which have occurred during each month when the temperature has been above or below the average temperature of the month:—

—	Jan.	Feb.	Mar.	Apr.	May	June	July	Aug.	Sep.	Oct.	Nov.	Dec.	Total
Above average temperature.	25	36	36	19	22	31	19	18	11	20	20	26	283
Below average temperature.	35	22	42	19	35	16	13	15	14	32	28	48	319
Total	60	58	78	38	57	47	32	33	25	52	48	74	602

The number of earthquakes which have been recorded when the temperature has been below the average are to the number which have

been recorded when the temperature has been above the average as 60 : 40.

The number of earthquakes which have occurred each month when the temperature has been rising, falling, or steady are given in the following table:—

—	Jan.	Feb.	Mar.	Apr.	May	June	July	Aug.	Sep.	Oct.	Nov.	Dec.	Total
Rising . . .	24	19	24	10	21	19	6	10	5	18	15	34	205
Falling . . .	31	29	39	18	31	22	22	21	15	27	31	35	321
Steady . . .	5	10	15	10	5	6	4	2	5	7	2	5	76
Total . . .	60	58	78	38	57	47	32	33	25	52	48	74	602

Earthquakes have therefore been more numerous when the temperature is falling. To connect these observations with those relating to barometric pressure, it may be well to remember that generally a low temperature accompanies a high barometric pressure, and a high temperature a low barometric pressure.

These latter results respecting earthquakes and fluctuations of atmospheric pressure and temperature are similar to results obtained by the analyses of more meagre data which the Meteorological Department very kindly placed at my disposal some years ago. As I did not consider that the results were of sufficient importance for publication, until now no special reference has been made to them. The belief that there is an immediate connection between earthquakes and atmospheric conditions is, however, very general, and it is for the purpose of showing how little foundation there is for such a belief that I have been led to incorporate the previous analyses in the present report. The facts which have been recorded may also be of value to investigators who wish to carry out analyses on other lines.

EARTH-TREMORS.

In the report to the British Association for 1887 I gave an account of observations made with an automatic tromometer of tremors which had been observed between January 13, 1885, and May 14, 1886. Details of these observations may be found in 'Trans. Seis. Soc.' vol. xi. p. 1-78. The records referred to in the present note were obtained between December 22, 1886, and February 1888.

Results of Analysis.—From a general inspection of the tri-daily weather maps, it is quite clear that when little or no wind is indicated, or when the isobars are few, no tremors have been recorded; while, on the contrary, when the wind is strong at many stations in Central Japan, and when the isobars occur in close proximity, tremors are almost always recorded. On the Japanese maps the isobars are drawn at intervals of five millimetres of pressure. On the Italian maps, when the intervals are only one millimetre, the relationship between tremors and the frequency of isobars, which, when they are numerous, indicates a steep gradient, is even more marked than it appears to be in Japan. On the Italian maps, which are published under the direction of Professor M. S. de Rossi, the state of the wind is not indicated, but it may be inferred that when the gradients over the Italian peninsula are steep, wind is blowing somewhere in the peninsula, 1888.

and therefore in Italy as in Japan tremors are accompanied by wind, although the wind may not be blowing at some particular place where the tremors are observed. Certainly tremors often occur with a low barometer, but the greater frequency of tremors apparently happens when the gradient is steep, no matter whether the barometer is high or whether it is low, and cases may therefore be observed of low barometer unaccompanied by tremors. Observations like these have inclined me to the opinion that tremors are more closely connected with wind than with barometric pressure. An examination of the observations which have been made shows :—

1. That there are 80 cases of well-pronounced tremors having occurred with strong winds blowing in Central Japan. In several instances tremors were observed in Tokio some hours ahead of the wind, which was blowing heavily to the S.W., and travelling up the country towards Tokio. By Central Japan is meant all the country within 200 or 300 miles of Tokio.

2. There have been 40 cases of strong wind and no tremors. In 34 of these cases the wind has been local or of short duration ; that is to say, it was only observed in Tokio, or it was only observed at one of the tri-daily observations. In the remaining six cases, if tremors are the result of wind they ought to have been observed.

3. With no wind and no tremors there are 79 cases.

4. With *no* wind and *small* tremors there are 63 cases. In 39 of these cases the record on one band of paper showed no tremors, and therefore these 39 cases might have been classified in the preceding group. On the other band tremors were barely visible. In 8 of the remaining 26 cases the tremors observed were immediately in advance of a heavy wind, or were tremors continuing after a heavy wind had passed, at which time tremors had been well pronounced. There are therefore only 18 cases (26-8) where tremors can be said to have occurred where there was no wind, and these tremors were slight. The above results may be tabulated as follows :—

	No. of cases.
1. Strong wind and well-pronounced tremors	80
2. Strong wind and no tremors, 40 cases which may be subdivided into :	
(a) Cases where tremors ought to have occurred	6
(b) Cases where the wind was local or of short duration, and it is doubtful whether tremors should have been recorded	34
3. With no wind and no tremors	79
4. With no wind and slight tremors, 63 cases, which may be subdivided into :	
(a) Cases where tremors were so small that they were only recorded on one band of paper, 39 + a possible 16 =	55
(b) Cases which may have been due to wind	8
Total	<u>262</u>

The conclusion then is, that out of 86 cases of strong wind there are only six cases where tremors were not observed, while when there was no wind there were no tremors, or, at most, tremors so slight that they were barely recorded. These results agree with the results obtained in previous years.

For three months an automatic spark record was kept of tremors which might be due to vertical motion, but as these only occurred when tremors were recorded by the ordinary tromometer, and were extremely

small, the observations were discontinued. The instrument employed was a horizontal lever spring seismograph with an index having a multiplication of about 100.

In addition to the above-mentioned work large numbers of other investigations have been made. Amongst these may be mentioned a crude attempt to carry out a seismic survey of Tokio, which, so far as it has gone, shows remarkable differences as to the intensity of earthquake movement and the number of earthquakes felt in different parts of the city. The observations which have been made are extremely numerous; and as their analysis will occupy considerable time it is not yet possible to report upon them. Another report which must also be reserved is the work undertaken by a committee summoned by the Government to consider questions relating to construction in earthquake countries. At my suggestion a number of experiments are being made relating to the movement experienced at the time of an earthquake on different kinds of ground, the efficacy of different kinds of foundations, the experimental determination of constants for the stability of masonry and brickwork to suddenly applied horizontal stresses, &c.

Catalogue of Earthquakes recorded at the Meteorological Observatory, Tokio, between June 1887 and June 1888 by the Gray-Milne Seismograph.

No.	Month	Day	Time	Period in secs.	Ampli- tude in mm.	Direction	Duration
1887.							
			H. M. S.				M. S.
740	VI.	17	1 41 41 A.M.	very	slight	—	—
741	"	20	8 16 57 A.M.	1·8	0·6	S. 26° W.	1 30
742	"	21	2 2 35 P.M.	slight	—	E.-W.	0 10
743	"	22	7 42 39 A.M.	very	slight	—	—
744	"	30	8 0 35 A.M.	very	slight	—	—
745	VII.	1	2 41 49 P.M.	very	slight	—	—
746	"	2	3 12 26 P.M.	0·8	0·5	S. 22° E.	1 30
			vertical motion =	very	slight	—	—
747	"	11	3 7 42 P.M.	very	slight	—	—
748	"	"	10 17 17 P.M.	very	slight	—	—
749	"	22	8 27 0 P.M.	0·9	1·7	S.S.W.-N.N.E.	3 34
750	"	27	5 14 29 P.M.	very	slight	—	1 30
751	VIII.	6	6 47 42 P.M.	very	slight	—	—
752	"	15	0 59 15 A.M.	1·5	1·1	E.S.E.-W.N.W.	3 0
753	IX.	2	5 52 49 P.M.	0·7	0·4	E.-W.	0 10
			vertical motion =	very	slight	—	—
754	"	3	4 50 30 A.M.	very	slight	—	—
755	"	5	3 23 23 P.M.	2·3	25·7	S.E.-N.W	6 0
			vertical motion =	0·8	6·5	—	—
756	"	6	8 12 50 A.M.	—	0·4	E. 26° S.	0 40
757	"	8	3 55 30 P.M.	very	slight	—	—
758	"	11	6 20 0 A.M.	very	slight	E.-W.	0 25
759	"	13	8 16 52 P.M.	1·2	0·2	E. 38° N.	0 12
760	"	15	4 41 41 P.M.	0·3	0·2	E. W.	0 3
761	"	25	8 56 11 A.M.	1·8	1·0	E.S.E.-W.N.W.	2 0
			vertical motion =	slight	—	—	—
762	XI.	15	3 54 51 P.M.	2·4	0·6	E. 26° 30' S.	2 0
763	"	20	0 2 31 P.M.	0·5	0·2	N. 17° E.	0 45
764	"	"	abt. 9 45 0 P.M.	very	slight	—	—
765	"	23	abt. 6 5 0 P.M.	very	slight	—	—
766	"	30	9 24 18 A.M.	1·2	1·3	S.S.E.-N.N.W.	1 30
767	XII.	5	0 57 16 P.M.	very	slight	—	0 15

CATALOGUE OF EARTHQUAKES—*continued.*

No.	Month	Day	Time	Period in secs.	Ampli- tude in mm.	Direction	Duration
			H. M. S.				M. S.
768	XII.	8	8 2 0 P.M.	0·5	0·4	S.W.-N.E.	0 50
769	"	11	9 55 47 P.M.	very	slight	—	—
770	"	14	11 55 12 A.M.	2·3	0·2	S.-N.	2 12
771	"	"	10 55 9 P.M.	2·0	0·3	S.S.E.-N.N.W.	2 30
772	"	16	8 28 21 A.M.	1·5	2·5	W.N.W.-E.S.E.	2 0
			vertical motion =	0·4	0·3	—	—
773	"	17	0 17 8 A.M.	slight	—	—	0 10
774	"	"	6 17 22 A.M.	very	slight	—	—
775	"	"	11 41 14 P.M.	0·6	0·2	E.-W.	0 10
776	"	19	6 0 20 P.M.	very	slight	—	—
777	"	21	2 5 55 P.M.	very	slight	—	0 15
778	"	24	4 9 41 A.M.	very	slight	—	—
779	"	"	7 51 38 A.M.	2·0	0·2	S.W.-N.E.	abt. 1 0
780	"	31	1 24 45 A.M.	very	slight	—	—
1888.							
781	I.	1	3 31 38 P.M.	very	slight	—	—
782	"	11	8 50 36 A.M.	1·8	0·4	E.S.E.-W.N.W.	1 0
783	"	14	5 31 55 P.M.	slight	—	E.-W.	0 15
			vertical motion =	very	slight	—	—
784	"	27	10 5 33 P.M.	very	slight	S.-N.	abt. 0 10
785	II.	2	1 11 15 P.M.	3·7	13·0	W.N.W.-E.S.E.	3 48
			vertical motion	—	0·5	—	—
786	"	"	2 23 46 P.M.	1·4	0·7	E.-W.	1 49
787	"	"	3 0 14 P.M.	very	slight	—	—
788	"	"	3 41 27 P.M.	2·4	3·8	W.S.W.-E.N.E.	4 5
789	"	5	0 50 56 A.M.	2·1	1·6	S.W.-N.E.	abt. 1 0
790	"	10	3 26 55 P.M.	very	slight	N.E.-S.W.	0 10
791	"	"	6 38 7 P.M.	very	slight	E.-W.	0 12
792	"	11	3 38 56 P.M.	very	slight	—	—
793	"	13	11 33 44 A.M.	slight	—	S.-N.	0 25
794	"	15	3 43 38 P.M.	very	slight	E.-W.	0 30
795	"	17	0 16 17 P.M.	very	slight	E.-W.	0 50
796	"	18	6 13 45 P.M.	very	slight	E.-W.	0 15
797	"	22	10 24 43 A.M.	3·2	0·7	E.-W.	1 30
798	"	23	11 10 50 P.M.	very	slight	S.-N.	0 10
799	"	24	2 7 6 A.M.	very	slight	E.-W.	—
800	III.	1	3 30 15 P.M.	slight	—	W.S.W.-E.N.E.	1 15
801	"	"	9 54 12 P.M.	slight	—	S.-N.	0 30
802	"	9	4 54 16 A.M.	0·2	0·4	N.N.W.-S.S.E.	0 25
803	"	"	10 17 1 P.M.	very	slight	—	—
804	"	16	5 58 2 A.M.	0·8	0·2	S.E.-N.W.	0 30
805	"	"	6 43 32 A.M.	0·8	0·4	S.E.-N.W.	2 50
806	"	17	7 55 36 P.M.	very	slight	—	—
807	IV.	1	6 17 8 A.M.	very	slight	—	—
808	"	5	2 30 29 P.M.	0·7	1·2	S.E.-N.W.	2 0
			vertical motion	0·3	0·5	—	—
809	"	8	2 22 32 P.M.	very	slight	—	—
810	"	16	11 6 43 P.M.	very	slight	—	—
811	"	27	8 34 34 A.M.	1·5	0·2	S.W.-N.E.	2 0
812	"	29	10 0 33 A.M.	0·8	5·6	S.E.-N.W.	8 0
			vertical motion =	0·6	1·5	—	—
813	"	30	5 44 38 A.M.	very	slight	E.-W.	—
814	V.	5	8 52 24 P.M.	very	slight	—	—
815	"	8	4 7 56 A.M.	very	slight	—	—

CATALOGUE OF EARTHQUAKES—*continued.*

No.	Month	Day	Time	Period in secs.	Ampli- tude in mm.	Direction	Duration
			H. M. S.				M. S.
816	V.	8	4 51 41 A.M.	slight	—	—	—
817	"	10	10 12 0 A.M.	very slight	—	—	—
818	"	13	4 51 52 A.M.	0·5	0·2	N.W.—S.E.	abt. 0 10
819	"	"	11 17 41 P.M.	very slight	—	—	—
820	"	22	6 9 20 P.M.	2·6	1·5	E.S.E.—W.N.W.	4 30
			vertical motion =	0·7	0·2	—	—
821	"	24	9 35 37 A.M.	slight	—	E.—W.	1 0
822	"	"	11 45 5 A.M.	very slight	—	—	—
823	"	26	6 17 14 P.M.	very slight	—	—	—
824	"	27	7 5 9 P.M.	very slight	—	—	—
825	VI.	3	7 53 8 A.M.	1·3	1·5	W.N.W.—E.S.E.	3 0

Report of the Committee, consisting of Mr. THISELTON-DYER (Secretary), Professor NEWTON, Professor FLOWER, Mr. CARRUTHERS, and Mr. SCLATER, appointed for the purpose of reporting on the present state of our knowledge of the Zoology and Botany of the West India Islands, and taking steps to investigate ascertained deficiencies in the Fauna and Flora.

THE Committee appointed by the Association held its first meeting on January 4, 1888. At this meeting it was decided to co-operate with the Committee appointed for a similar purpose by the Government Grant Committee of the Royal Society. Dr. Günther and Dr. Sharp, the only members of the latter Committee who were not already members of the Association Committee, were therefore added to it, and it was decided to further invite the adhesion of Lieut.-Colonel Feilden, of the Army Pay Department, and of Mr. D. Morris, Assistant-Director of the Royal Gardens, Kew.

Lieut.-Colonel Feilden's official duties will keep him for the next few years in the British West Indies, and for the present he will act as local secretary in Barbados, while Dr. H. A. Alford Nicholls, F.L.S., C.M.Z.S., has kindly agreed to assist in the same capacity in Dominica. In order to commence their investigations without delay the Committee have secured the services of Mr. George A. Ramage, who was lately associated with Mr. Ridley in his expedition to the Island of Fernando Noronha, and has since been collecting at Pernambuco. Mr. Ramage arrived in Dominica in March last, and has proceeded to his work with great zeal. In May, after passing five weeks at Laudat, on the right bank of the Roseau River, about 2,000 feet above the sea-level, he moved to St. Aroment, an estate belonging to Dr. Nicholls just above Roseau, which he found to be a better locality for getting his plants dried. At Laudat he met with great difficulty in this matter on account of the extreme wetness of the climate. Writing in May last, Mr. Ramage speaks of having got, besides his plants, 'a good lot of insects, lizards, small snakes, and land molluscs.' Besides these he had also obtained three examples of *Peripatus*.

Two cases of zoological specimens and one case of botanical specimens have been already received from Mr. Ramage, and one case of living snakes and lizards has been forwarded direct to the gardens of the Zoological Society. A further case of botanical specimens and two cases of animals are now in transit. The collections received are now under examination. They have too recently come to hand to allow of any results being included in the present report.

After spending the summer season in Dominica, Mr. Ramage is proceeding to St. Lucia, whence he will return to Dominica to complete his collections at a later period.

Considerable interest is being shown in the work of the Committee by Government officers and residents in the islands concerned, and hopes are entertained that collections will be made by private enterprise to supplement those made by the collectors engaged by the Committee.

A circular setting forth the objects sought by the Committee has been prepared and printed, and to this have been added hints as regards the special subjects requiring investigation and the best way of preserving specimens for transit to this country.

In order to carry out their instructions to report upon the present state of our knowledge of the zoology and botany of the Lesser Antilles, a bibliography of the existing literature relating to the fauna and flora has been prepared by a Sub-Committee consisting of Mr. Thiselton Dyer and Dr. Sharp. The Committee desire that this should be printed *in extenso* as an appendix to the present report.

The Committee recommend their reappointment with the addition of those gentlemen who have co-operated with them in the work of the past year. They further recommend that a grant of 250*l.* be placed at their disposal.

APPENDIX.

Botanical and Zoological Bibliography of the Lesser Antilles, Caribbee Islands, or Windward and Leeward Islands, West Indies (Tobago to Porto-Rico inclusive).

BOTANY—By W. B. HEMSLEY. ZOOLOGY—By D. SHARP.

This bibliography includes all works and memoirs that the compilers have been able to discover relative to the islands forming the object of the list; but it does not include references to many systematic works of a general character, in which species from the Lesser Antilles are described or mentioned.

Where desirable the same work is named under both Botany and Zoology.

Books relating to more than one island are first enumerated in chronological order, and the islands follow, arranged alphabetically, any special literature being cited under the island to which it refers. The position, size, and elevation of each island are given, and for these particulars we are almost wholly indebted to the Colonial Office List for 1887. Some interesting information has also been obtained from the 'Handbook and Catalogue of the West Indies and British Honduras for the Colonial and Indian Exhibition, 1886.'

BOTANY.

Nominally all the British West Indian Islands are included in Grisebach's 'Flora of the British West Indian Islands,' but that work was mainly based on collections from Jamaica and Trinidad, and the vegetation of the Lesser Antilles is still very imperfectly known. So far as it is known, however, it presents great sameness throughout, and the number of endemic species in each island is either very small or there is none. Moreover it is not anticipated that future investigations will add materially to the number of peculiar forms, and the principal feature of interest in the flora is the direction in which its constituents have extended.

ZOOLOGY.

The list does not include any comprehensive work on the zoology of the Windward Islands, nor of any one of the islands separately. The most complete list appears to be that of the birds by Cory: this group of animals has received more attention than the others, but the work that has been done at it is of a fragmentary nature, and some islands have been little or not at all explored even for birds.

Very little has been published about the mammalia, reptilia, and batrachia. In the case of mammals this might be attributed to there being but few in the archipelago; but in the case of the reptilia and batrachia, at any rate, it is more probably due to want of investigation, as is shown by the fact that Garman's recently (1887) published paper consists, to a considerable extent, of descriptions of novelties.

The land Mollusca are known chiefly by lists published by naturalists a generation or more ago of the species of the islands of the group belonging to France; but less has been done in the other islands, and investigation even in this comparatively rich and favourite class has apparently been very unequal.

A most singular dearth of information exists as regards the Arthropoda, and in this—the most extensive department of zoology—nearly everything remains to be done. Undoubtedly a considerable number of insects and other arthropods from the Lesser Antilles exist in collections, but they are rare and indicate that very little has been done in collecting; while insular lists are almost entirely wanting, and there is no information as to the distribution of the species in the various islands.

The bibliography includes a considerable number of memoirs on marine zoology, but it is not necessary to remark on these, as it is presumed that the exploration of marine zoology will be considered by the Committee as subordinate in present importance to that of the terrestrial fauna.

The abbreviations of titles of several works are those used in the 'Zoological Record.'

Books and Papers referring to the West Indies generally or to more than one island, chronologically arranged.

BOTANY.

Oviedo, G. F. de. Primera parte de la historia natural y general de las Indias, yslas y tierra firma. Sevilla, 1535. Folio with rude woodcuts 'Ad rem herbariam pertinent libri vii., viii., ix., x.' Pritzel.

- Rochefort, C. de.** Histoire Naturelle et Morale des Iles Antilles d'Amérique. Rotterdam, 1658. 4to.
- Tertre, J. B. du.** Histoire Générale des Antilles habitées par les Français. Paris, 1667-71. 4 vols. 4to.
- Feuillée, L.** Journal des Observations . . . botaniques faites . . . dans les Indes Occidentales depuis 1707-12. Paris, 1714. 3 vols. 4to
- Voyage aux Iles Antilles**, iii. 162. Arrival at Martinique, iii. 173. St. Thomas, p. 389. Guadeloupe, p. 421.
- Labat, Père.** Nouveau Voyage aux Iles de l'Amérique. Paris, 1724. 2 vols. 4to.
- Burman, J.** Plantarum Americanarum . . . Carol. Plumier detexit Ins. Antil. depinxit. Amsterdam, 1755-60. Folio, with 262 plates.
- Jacquin, N. J.** Enumeratio Systematica Plantarum quas in insulis Caribæis . . . Lugduno Batav. 1760. 8vo.
- Jacquin, N. J.** Selectarum Stirpium Americanarum Historia. Vindobonæ, 1763. Folio. 183 plates.
- Edwards, B.** The History, Civil and Commercial, of the British Colonies in the West Indies. 1793-1801. 3 vols. 4to. Botany, i. pp. 198-211, and an appendix, 'Hortus Eastensis,' by Arthur Broughton.
- Euphrasen, B. A.** Beskrifning öfver Svenska vestindiska ön St. Barthelemy, samt öarne St. Eustache och St. Christopher. Stockholm, 1795.
- Euphrasen, B. A.** Reise nach den Westindischen Inseln St. Barthelemy, St. Eustache, und St. Christoph. Göttingen, 1798. 8vo.
- Swartz, O.** Flora Indiæ Occidentalis. Erlangæ, 1797-1806. 3 vols. 8vo.
- Tussac, F. R. de.** Flora Antillarum . . . Paris, 1808-27. 4 vols., folio, containing 138 coloured plates.
- Descourtiz, M.** Flore Médicale des Antilles. Paris, 1821-29. 8 vols. 8vo. 600 (very inferior) coloured plates.
- Purdie, W.** Journal of a Botanical Mission to the West Indies. 'Hooker's London Journal of Botany,' iii. 1844, pp. 501-533; iv. pp. 14-27. Also a reprint.
- Grisebach, A. H. R.** Flora of the British West Indian Islands. London, 1859-64. 8vo.
- Daniell, W. F.** Cascarilla Plants of the West India and Bahama Islands. 'Pharmaceutical Journal,' 1863, pp. 144-150 and 226-281. Also a reprint.
- Grisebach, A. H. R.** Die Geographische Verbreitung der Pflanzen Westindiens. 'Göttingen Abhandlungen,' xii. 1866. 'Gesammelte Abhandlungen,' pp. 222-285.
- Roussel, E.** Énumération des Champignons récoltés par M. F. Husnot aux Antilles Françaises. 'Bulletin de la Société Linnéenne de Normandie,' 2^{me} série, iii. Also reprint.
- Nylander, M. W.** Énumération des Lichens récoltés par M. Husnot aux Antilles Françaises. 'Bulletin de la Société Linnéenne de Normandie,' 2^{me} série, ii. 1869. Also reprint.
- Husnot, F.** Catalogue des Cryptogames recueillis aux Antilles Françaises en 1868. 'Bulletin de la Société Linnéenne de Normandie,' 1870. (Ferns and Lycopods, 60 pages.)
- Husnot, F., and Constance, A.** Énumération des Glumacées récoltées aux Antilles Françaises. Caen, 1871. 8vo. pp. 35.
- Grisebach, A. H. R.** Vegetation der Erde. Leipzig, 1872. 2 vols.

Svo. Westindien, ii. pp. 338-357 and 600-604. (The second edition, 1884, is substantially a reprint without additional data.)

Tchihatchef, P. de. La Végétation du Globe . . . par A. H. R. Grisebach, ouvrage traduit de l'allemand avec des annotations du traducteur. Paris, 1875-78. 2 vols. Svo. Indes Occidentales. ii. pp. 500-530.

Bescherelle, E. Florule Bryologique des Antilles Françaises. 'Annales des Sciences Naturelles.' 6^{me} série, iii. (1876), pp. 175-265.

Bernard, A. C. J. Vergleichung der Floren des Westindischen und Ostindischen Archipels. Halle, 1877. Svo. pp. 90.

Cleve, P. T. Diatoms from the West Indian Archipelago. Stockholm, 1878. 'Bihang till K. Svenska Vet. Akad. Handlingar,' Band V.

Eggers, H. F. A. Naturen paa de dansk-vestindiske Öer. 'Tidsskr. popul. Fremst. Naturvid.' 1878. With map and woodcuts.

Berkeley, T. B. H. The Leeward Islands: their past and present condition. 'Proceedings of the Royal Colonial Institute,' xii. 1880-81, pp. 9-50.

Johow, Fr. Die chlorophyllfreien Humusbewohner Westindiens. 'Pringsheims Jahrbücher,' xvi. (1885), pp. 415-449, tt. 16-18.

Benko, J. F. von. Reise S. M. Schiffe's 'Zringi' über Malta, Tanger und Teneriffa nach Westindien in den Jahren 1885 und 1886. Pola, 1887, pp. 7 and 274.

Pp. 40-126 are devoted to the islands of the Lesser Antilles, but the information given is chiefly geographical and economical, the remarks on zoology being almost *nil*.

Handbook and Catalogue of the West Indies and British Honduras. Colonial and Indian Exhibition, 1886.

Colonial Office List, 1887.

Hemsley, W. B. Biologia Centrali-Americana (Salvin and Godman). Botany, vol. iv. (1887). Appendix, pp. 168-315. Distribution.

ZOOLOGY.

Tertre, J. B. du. Histoire générale des îles de S. Christophe, de la Guadeloupe, de la Martinique et autres dans l'Amérique . . . de plus la description de tous les animaux de la Mer, de l'Air et de la Terre . . . &c. Paris, 1654, pp. 481.

The 'quatrième partie,' divided into three chapters, is devoted to zoology.

Rochefort, C. de. Histoire Naturelle et Morale des îles Antilles de l'Amérique, enrichie d'un grand nombre de belles Figures en taille douce, qui représentent au naturel les Places et les Raretez les plus considérables qui y sont décrites. Rotterdam, 1681. Dernière édition.

Gives much information as to the zoology of different islands of the Lesser Antilles. The first edition, published 1658, I have not seen.

Sloane, H. A voyage to the islands Madeira, Barbados, Nieves, St. Christopher's, and Jamaica, with the Natural history of the Herbs and Trees, Four-footed Beasts, Fishes, Birds, Insects, &c., of the last of those islands. 2 vols. London, 1707.

The information in this work about the zoology of the Lesser Antilles is almost *nil*.

Labat, P. Nouveau Voyage aux Iles d'Amérique, contenant l'histoire naturelle de ces pays, l'Origine, les Mœurs, la Religion et le Gouvernement des Habitants anciens et modernes, &c., &c. Paris, 1722. 10 vols.

Contains chapters on the zoology of the French islands. An edition in two vols. 4to was published at La Haye in 1724. (See also BOTANY.)

West, H. Bidrag til beskrivelse over Ste Croix med en kort udsigt over St. Thomas, St. Jan, Tortola, Spanishtown og Crabeneiland. Copenhagen, 1793.

Includes a chapter on the reptiles, fishes, and crustaceans.

Ledru, A. P. Voyage aux îles de Ténériffe, La Trinité, Saint-Thomas, Sainte-Croix et Porto-Ricco. . . . Paris, 1810. 2 vols.

Contains chapters on the natural history of the Danish islands and Porto Rico, including lists of the animals found there.

Leblond, J. B. Voyage aux Antilles et à l'Amérique méridionale, commencé en 1767 et fini en 1802. Paris, 1813, pp. 474.

Slight and unimportant observations on zoology.

Waterton, C. Wanderings in South America, the North-west of the United States, and the Antilles. London, 1825.

Information about the Antilles is brief and unimportant.

Ferguson, W. On the Poisonous Fishes of the Caribbee Islands. 'Tr. R. Soc. Edinb.' ix. (1823), pp. 65-79.

Devoted to the economical, not the zoological, aspect of the subject.

Guilding, L. Observations on the Zoology of the Caribbean Islands. 'Zool. Journ.' iii. (1828), pp. 403-408 and 527-544; *op. cit.* iv. (1829), pp. 164-175.

Contents—'Radiata Caribbæana,' 'Mollusca Caribbæana,' 'Notice of the living Guana of the West Indies,' 'Analecta zoologica,' 'Notice of the discovery of a recent Encrinus.'

Guilding, L. An account of Margarodes, a new genus of insects found in the neighbourhood of Ants' Nests. 'Tr. Linn. Soc.' xvi. (1883), pp. 115-119. Plate XII.

Occurs in Antigua. Other papers by this author exist in the 'Tr. L. Soc.' xiv.-xvi., in which insects from the West Indies are described. St. Vincent is in these cases the probable locality.

Hartlaub, G. Ueber den heutigen Zustand unserer Kenntnisse von Westindiens Ornithologie. 'Isis,' 1847, pp. 603-615.

Recapitulates what was known as to the ornithology of the islands (including Porto Rico, St. Thomas, Guadeloupe, Martinique, Barbados, and Tobago) in 1847.

Duchassaing, P. Animaux radiaires des Antilles. Paris, 1850. Pp. 35. Plate II.

Special localities are scarcely mentioned.

Duchassaing, P. Note sur les mœurs des Crustacés des Antilles. 'Rev. et Mag. Zool.' (2) iii. (1851), pp. 77-81.

11 species: probably relates to Guadeloupe, though it does not say so.

Pfeiffer, L. Beiträge zur Molluskenfauna Westindiens. 'Mal. Blatt.' ii. 1856, pp. 98-106.

Several new species from St. Croix and St. Thomas.

Shuttleworth, R. I. Description de nouvelles espèces. Première décade; espèces nouvelles pour la faune des Antilles. 'J. de Conch.' v. (1856), pp. 168-175.

Shells from Guadeloupe, St. Thomas, Porto Rico.

Beau, —. De l'utilité de certains Mollusques marins vivant sur les côtes de la Guadeloupe et de la Martinique. 'J. de Conch.' iii. (1858), pp. 25-40.

Bland, T. Notes on certain terrestrial Molluscs which inhabit the West Indies. 'Ann. Lyc. New York,' vi. (1858), pp. 147-155.

Relates to several of the islands of the Lesser Antilles.

Saussure, H. de. Mémoire sur divers Crustacés nouveaux des Antilles et du Mexique. 'Mém. Soc. Phys. Genève,' xiv. (1858), pp. 417-496. Plates i.-vi.

Several species from Guadeloupe and St. Thomas, besides others from the larger islands.

Saussure, H. de. Mémoires pour servir à l'histoire naturelle du Mexique, des Antilles et des États-Unis. Tome premier: 1^{re} livraison: Crustacés. Geneva, 1858. 2^{me}: Myriapodes. 1860. 3^{me} et 4^{me}: Orthoptères-Blattides. Geneva, 1864-5. Tome 2^{me}: Mantides Américains. Geneva, 1871.

These relate only in small part to the Lesser Antilles.

Slater, P. L. Descriptions of two new species of American Parrots. 'Ann. N. H.' (3), 4 (1859), pp. 224-226.

Includes list of the parrots of the Antilles, including Porto Rico, St. Thomas, and St. Vincent.

Duchassaing, P., and Michelotti, J. Mémoire sur les Corallaires des Antilles. 'Mém. Acc. Tor.' (2), xix. (1861), pp. 279-365. Plates I.-X. with supplement in vol. xxiii. 1866, pp. 97-206. Plates I.-XI.

Important memoirs, enumerating 400 species from St. Thomas, Guadeloupe, St. Croix, Tobago, Barbados, and in fact most of the islands.

Bland, T. On the geographical distribution of the Genera and Species of Land Shells of the West India Islands, with a catalogue of the Species of each island. 'Ann. Lyc. New York,' vii. (1862), pp. 335-361.

The Lesser Antilles are treated as one island.

Reinhardt, J., and Lütken, C. F. Bidrag til det vestindiske Origes og navnlig til de dansk-vestindiske Öers Herpetologie. 'Vid. Medd.' 1862, pp. 153-291.

In this list of the West Indian reptiles the Lesser Antilles are treated as one group (Karabaiske Öer).

Stimpson, W. Notes on North American Crustacea, Nos. I. and II. 'Ann. Lyc. New York,' vii. (1862), pp. 49-93, pl. i., and pp. 176-246. Plates II., III.

Includes several new species from St. Thomas and Barbados.

Mörch, O. A. L. Contributions à la Faune malacologique des Antilles danoises. 'J. de Conch.' xi. (1863), pp. 21-43.

Numerous species, including several new, from St. Thomas, St. Croix, St. Vincent.

Duchassaing, P. de F., and Michelotti, G. Spongiaires de la Mer Caraïbe. 'Nat. Verh. Wet. Haarlem,' xxi. (1864), p. 115. Plate XXV.

A large number of new species are described from various islands of the Lesser Antilles, most of them from St. Thomas.

Lütken, Chr. Om Vestindiens Pentacriner. 'Vid. Medd.' 1864, pp. 195-245. Plates IV. and V.

Pentacrinus Mülleri. 'Danish Islands.'

Bland, T. Remarks on the Origin and Distribution of the operculated land-shells which inhabit the continent of America and the West Indies, with a catalogue of the American species. 'Am. J. Conch.' ii. (1866), pp. 54-63, 136-143.

'Origiu' means the 'maximum specific representation.'

Bland, T. Remarks on the distribution of the inoperculated land-shells which inhabit the continent of America and the West Indies. *T. c.* pp. 349-370.

Guyon, —. Des animaux disparus de la Martinique et de la Guadeloupe depuis notre établissement dans ces îles. 'Comptes Rendus,' lxxiii. (1866), pp. 589-593.

8 species. 1 mammal, 6 birds, 1 frog.

Crosse, H., and Fischer, P. Note sur la distribution géographique des Brachiopodes aux Antilles et description d'espèces nouvelles de la Guadeloupe. 'J. de Conch.' xiv. (1866), pp. 265-273.

5 species catalogued, 2 described, from Martinique and Guadeloupe.

Bland, T. Notes on the Land-shells of Trinidad, Grenada, and Dominica, and also of Curaçao and Buen Ayre, W. I. 'Am. Journ. Conch.' iv. (1868), pp. 177-192.

14 species from Grenada, 21 from Dominica.

Guppy, R. J. L. On the terrestrial Mollusks of Dominica and Grenada, with an account of some new species from Trinidad. 'Ann. Mag. Nat. Hist.' (4) i. (1868), pp. 429-442.

20 species, 9 new.

Bland, T. Additional notes on the geographical distribution of Land-shells in the West Indies. 'Ann. Lyc. N. York,' ix. (1870), pp. 238-241.

Lists of species from Anegada, Anguilla, and St. Bartholomew.

Duchassaing, P. de F. Revue des Zoophytes et des Spongiaires des Antilles. Paris, 1870.

Bland, T. Notes relating to the physical geography and geology of, and the distribution of Terrestrial Mollusca in, certain of the West India Islands. 'P. Am. Phil. Soc.' xii. (1871), pp. 56-63.

Cope, E. D. Contribution to the Ichthyology of the Lesser Antilles. 'Tr. Am. Phil. Soc.' xiv. (1871), pp. 445-483.

Records a large number of species, including several new. Most of the islands are mentioned.

Dall, W. H. Report on the Brachiopoda obtained by the United States Coast Survey Expedition, in charge of L. F. de Pourtales. 'Bull. Mus. C. Z.' iii. No. 1 (1871), pp. 1-42.

Chiefly a systematic paper, but mentions a few species from Guadeloupe, &c.

Elliott, D. G. The Humming-birds of the West Indies. 'Ibis,' 1872, pp. 345-357.

The species are enumerated, and the islands in which each has been found mentioned.

Saussure, H. D., and Humbert, A. Catalogue général des Myriapodes américains in 'Miss. Sci. au Mexique et l'Amér. centr. Zool.' (1872) 6^{me} partie, 2^e section, pp. 149-211.

Includes the species known to occur in the Antilles. St. Thomas, Martinique, Porto Rico, St. Vincent, St. Croix, St. Bartholomew are mentioned as localities of a few species.

Stimpson, W. Notes on North American Crustacea in the Museum of the Smithsonian Institute. 'Ann. Lyc. New York,' x. (1874), pp. 92-136.

Includes several new species from Barbados and St. Thomas.

Lyman, T. Zoological results of the 'Hassler' Expedition. 'Cat. Mus. C. Z.' viii. 2 (1875). Ophiuridæ and Astrophytidæ, pp. 1-34. Plates. I.-V.

Numerous species, some new, from Barbados.

Lindström, G. Contributions to the Actinology of the Atlantic Ocean. 'K. Svensk. Vet. Ak. Hand.' xiv. 2 (1876), No. 6, 26 pp. 3 plates.

Many species of corals from St. Bartholomew, and a few from other islands of the Lesser Antilles are recorded in this list.

Wallace, A. R. The geographical distribution of animals. 'The West Indian Islands, or Antillean Sub-region,' vol. ii. (1876), pp. 60-80.

Edwards, H. Milne. Recherches zoologiques pour servir à l'histoire de la Faune de l'Amérique centrale et du Mexique. 'Miss. Sci. au Mexique et l'Amérique centr. Zool.' 5^{me} partie, Xiphosures et Crustacés. Paris, 1873-1880.

Includes species from various islands of the Lesser Antilles.

Martens, E. V. Land- und Süßwasser-Schnecken von Puertorico. 'J. B. mal. Ges.' iv. 1877, pp. 340-362.

120 species from Porto Rico are mentioned, and there is a table of the distribution of the species in the West Indies, including the Lesser Antilles.

Lawrence, G. N. A general catalogue of the birds noted from the islands of the Lesser Antilles visited by Mr. Fred A. Ober, with a table showing their distribution, and those found in the United States. 'P. U. S. Nat. Mus.' i. (1878), pp. 486-488.

A list of 128 species from all the islands.

Lawrence, G. N. Catalogue of the birds of Antigua and Barbuda, from collections made for the Smithsonian Institut by Mr. Fred A. Ober, with his observations. 'P. U. S. Nat. Mus.' i. (1878), pp. 232-242.

39 species, including a new Speotyto.

Poulsen, C. M. Catalogue of West Indian Shells in the collection of C. M. Poulsen. Copenhagen, 16 pp. 1878.

The Land-shells of the Lesser Antilles are given in two separate lists.

Marshall, T. A. Notes on the entomology of the Windward Islands. 'P. Ent. Soc. Lond.' 1878, pp. xxvii-xxxviii.

A few species of various orders from Antigua and Martinique.

Waterhouse, C. O. Notice of a small collection of Coleoptera from Jamaica, with descriptions of new species from the West Indies. 'Tr. Ent. Soc. Lond.' 1878, pp. 303-311.

Includes two or three species from St. Thomas and St. Bartholomew.

Gibbons, J. S. Notes on the Habits and Distribution of certain West Indian *Pulmonifera*. 'J. Conch.' ii. (1879), pp. 129-134.

Mentions a few species from various islands of the Lesser Antilles.

Lawrence, G. N. Descriptions of supposed new species of birds from the islands of Grenada and Dominica, West Indies. 'Ann. N. York Ac.' i. (1879), pp. 160-163.

4 species.

Schmidt, O. Die Spongien des Meerbusen von Mexico (und des Caraibischen Meeres. Heft I. Jena, 1879, 4 pls. Zweites (Schluss-) Heft, pp. 33. Plates V.-X. Jena, 1880.

The new species described in the first Heft are mostly from Havannah, but there are a few from Sombrero and Barbados; those in the second Heft are mostly from the Lesser Antilles.

Théel, H. Reports on the results of dredging under the supervision of Alexander Agassiz in the Gulf of Mexico (1877-78), in the Caribbean

Sea (1879-80) . . . &c., &c. Report on the *Holothurioidea*, 'Bull. Mus. C. Z.' xiii. No. 1, pp. 1-21, pl. i.

New species from off several islands of the Lesser Antilles.

Cope, E. D. Eleventh contribution to the Herpetology of Tropical America, vi., vii. 'P. Am. Phil. Soc.' xviii. (1880), pp. 274-277.

These parts relate to Dominica (with four species, three of them new) and Tobago (one new sub-species).

Kobelt, W. Die geographische Verbreitung der Mollusken. III. Die Inselfaunen. 'J. B. mal. Ges.' vii. 1880, pp. 243-286.

Gives lists of the species known from each island.

Lawrence, G. N. Description of a new species of *Icterus* from the West Indies. 'P. U. S. Nat. Mus.' iii. (1880), p. 351.

From Montserrat.

Ober, F. A. Camps in the Caribbees; the adventures of a naturalist in the Lesser Antilles. Edinburgh, 1880, pp. xviii and 366.

The author, the discoverer of the species of birds described by Lawrence in his memoirs, gives a few field-notes relating to birds.

Pourtales, L. F. Reports on the results of dredging, under the supervision of Alexander Agassiz, in the Caribbean Sea, 1878-79, by the United States Coast Survey steamer 'Blake.' VI. Report on the *Corals* and *Antipatharia*. 'Bull. Mus. C. Z.' vi. No. 4 (1880), pp. 95-120. Plates I.-III.

Numerous species, some new, are mentioned; the stations are nearly all off the islands of the Lesser Antilles.

Agassiz, A. Reports on the results of dredging by the United States Coast Survey steamer 'Blake.' IX. Preliminary Report on the Echini. 'Bull. Mus. C. Z.' viii. (1880-81) pp. 69-84.

The localities for each species are nearly all in the Lesser Antilles.

Thomson, Sir C. W., and Murray, J. The Voyage of H.M.S. 'Challenger.' 'Zoology,' vols. i.-xxv. London, 1880-88.

These volumes contain additions to the marine fauna of the West India Islands.

Edwards, A. Milne. Reports on the results of dredging, under the supervision of Alexander Agassiz, in the Gulf of Mexico and in the Caribbean Sea, by the U. S. Coast Survey steamer 'Blake.' VIII. Études préliminaires sur les Crustacés. 'Bull. Mus. C. Z.' viii. (1880-81) pp. 1-69. Plates I., II.

The localities given are chiefly the various islands of the Lesser Antilles: 214 species are mentioned, and many new are described.

Fewkes, J. W. Reports on the results of dredging by the United States Coast Survey steamer 'Blake.' XI. Report on the *Acalephæ*. 'Bull. Mus. C. Z.' viii. (1880-81), pp. 127-140. Plates I.-IV.

Several new species are described and the localities given are mostly islands of the Lesser Antilles.

Garman, S. Reports on the results of dredging by the United States Coast Survey steamer 'Blake.' XII. Report on the Selachians. 'Bull. Mus. C. Z.' (1880-81) pp. 231-237.

Some of the Lesser Antilles are mentioned as localities for two species.

Lethierry, L. Liste des Hémiptères recueillis par M. Delaunay à la Guadeloupe, la Martinique et Saint Barthélemy. 'Ann. Ent. Belg.' xxv. (1881), pp. 8-19.

62 species, several new, mostly from Guadeloupe.

Carpenter, P. H. Report on the results of dredging by the United States Coast Survey steamer 'Blake.' XVI. Preliminary Report on the Comatulæ. 'Bull. Mus. C. Z.' ix. (1881-82), pp. 151-170. Plate I.

New species of Antedon from Guadeloupe and Martinique.

Carter, H. J. Some Sponges from the West Indies and Acapulco in the Liverpool Free Museum described, with general and classificatory remarks. 'Ann. N. H.' (5), ix. (1882), pp. 266-301, and 346-368. Plates XI, XII.

Includes several new species from different islands of the Lesser Antilles.

Stejneger, L. Synopsis of the West Indian *Myadestes*. 'P. U. S. Nat. Mus.' v. (1882), pp. 15-27. Plate II.

Two new species from Saint Lucia and Dominica.

Traustedt, P. A. Vestindiske Ascidiæ simplices. 'Vid. Medd.' 1881, pp. 257-288, plates IV., V., and 1882, pp. 108-136, plates V., VI.

Several new species are described from St. Thomas, St. Croix, and other islands.

Mazé, H. Catalogue révisé des Mollusques terrestres et fluviatiles de la Guadeloupe et de ses dépendances. 'J. de Conch.' xxxi. (1883), pp. 5-54.

80 species from Guadeloupe, 25 from Saintes, 16 from Marie-Galante, 9 from La Désirade.

Lyman, T. Reports on the results of dredging by the United States Coast Survey steamer 'Blake.' XX. Report on the Ophiuroidea. 'Bull. Mus. C. Z.' x. (1882-83), pp. 227-287. Plates I.-VIII.

The localities of the numerous species are chiefly islands of the Lesser Antilles.

Carpenter, P. H. Report on the results of dredging by the United States Coast Survey steamer 'Blake.' XVIII. The stalked Crinoids of the Caribbean Sea. 'Bull. Mus. C. Z.' x. (1882-83), pp. 165-181.

Includes an additional species and Caribbean localities for the other species mentioned.

Agassiz, A. Reports on the results of dredging . . . xxiv. Part I. Report on the Echini. 'Mem. Mus. C. Z.' x. No. 1 (1883), pp. 1-94. Plate XXXII.

Includes list of the Echini of the West Indies.

Graff, L. v. Reports on the results of dredging, under the supervision of Alexander Agassiz . . . xxvi. Verzeichniss der von den United States Coast Survey steamers 'Hassler' und 'Blake' von 1867 zu 1879 gesammelten Myzostomiden. 'Bull. Mus. C. Z.' xi. (1883), pp. 125-133.

Reitter, E. Beitrag zur Kenntniss der *Clavigeriden*, *Pselaphiden* und *Scydmaeniden* von West Indien (*Coleoptera*). 'Deutsche ent. Zeit.' xxvii. (1883), pp. 33-46.

21 species, mostly from St. Thomas, nearly all new. Found by Baron V. Eggers.

Verrill, A. E. Report on the results of dredging under the supervision of Alexander Agassiz on the east coast of the United States . . . by the U. S. Coast Survey steamer 'Blake.' XXI. Report on the Anthozoa. 'Bull. Mus. C. Z.' xi. No. 1 (1883), pp. 1-72. Plates I.-VIII.

Goode, G. B., and Bean, T. H. Reports on the results of dredging by the United States Coast Survey steamer 'Blake.' XXVIII. Description of thirteen species and two genera of fishes from the 'Blake' Collection. 'Bull. Mus. C. Z.' xii. (1885-86), pp. 153-170.

The localities given are chiefly islands of the Lesser Antilles.

Ridgway, R. Description of three supposed new Honey-creepers from the Lesser Antilles, with a synopsis of the species of the genus *Certhiola*. 'P. U. S. Nat. Mus.' viii. (1885), pp. 25-30.

2 new species from Guadeloupe and Dominica.

Dall, W. H. Reports on the results of dredging, under the supervision of Alexander Agassiz in the Gulf of Mexico (1877-78) and in the Caribbean Sea (1879-80) by the U. S. Coast Survey steamer 'Blake.' Report on the Mollusca. Part I., *Brachiopoda* and *Pelecypoda*. 'Bull. Mus. C. Z.' xii. No. 6 (1886), pp. 171-318. Plates I.-IX.

Many species from the Lesser Antilles, including Barbados.

Cory, C. B. Descriptions of new species of birds from the West Indies. 'Auk,' iii. (1886), pp. 381, 382.

Guadeloupe, St. Lucia, Barbados.

Cory, C. B. On a collection of birds from several little-known islands of the West Indies. 'Ibis,' 1886, pp. 471-475.

Lists of species found in Barbados, St. Vincent, Marie-Galante, La Désirade, Grande Terre, St. Lucia.

Cory, C. B. The Birds of the West Indies, including the Bahama Islands, the Greater and Lesser Antilles, excepting the islands of Tobago and Trinidad. 'Auk,' iii. (1886), pp. 1-59, 187-245, 337-381, and 454-472; *op. cit.* iv. (1887), pp. 37-51, 108-120, 223-232, 311-328; *op. cit.* v. (1888), 48-82 and 155-159.

A complete list with references, synonymy, brief characters, and woodcuts of heads.

Jordan, D. S. A Preliminary List of the fishes of the West Indies. 'P. U. S. Nat. Mus.' ix. (1886), pp. 554-608.

Nearly 900 species.

Garman, S. On West Indian Reptiles in the Museum of Comparative Zoology at Cambridge, Mass. 'P. Am. Phil. Soc.' xxiv. (1887), pp. 278-286.

Refers to snakes, turtles, and crocodiles, and records several species from the Lesser Antilles.

Garman, S. On West Indian Reptiles in the Museum of Comparative Zoology, Cambridge, Mass. 'Bull. Essex Institute' xix. (1887), pp. 1-53.

Several new species from various islands of the Lesser Antilles, as well as the larger islands and Trinidad.

Agassiz, A. Three cruises of the United States Coast and Geodetic Survey steamer 'Blake' in the Gulf of Mexico, in the Caribbean Sea, and along the Atlantic coast of the United States from 1877 to 1880. Vols. i. and ii. London, 1888.

Chap. V. vol. i. 'Relations of the West Indian Fauna and Flora,' and Chap. XIV. vol. ii. 'The West Indian Fauna,' relate to the fauna of the Lesser Antilles and Caribbean Sea. The larger portion of the memoirs on marine zoology recorded in this bibliographical list are the results of these cruises, and it may therefore be well to state that the fauna referred to in them is that extending from the hundred-fathom line to deep water off the lee side of the Caribbean islands. Cf. vol. i. Introduction, p. xii.

ANEGADA (SEE VIRGIN ISLANDS).

ANGUILLA.

About sixty miles north-west of St. Kitts, in 18° 12' N. lat. The area is thirty-five square miles and the elevation very slight. The adjacent Dog and Sombrero Islands belong to Anguilla politically.

Owing to great droughts and the absence of fresh-water springs, this island is not very fertile, yet a considerable amount of garden produce is raised and finds a ready market in St. Thomas.

Seal and Scrub are islets a little north of Anguilla, and regarded as appendages to it.

ANTIGUA.

Situated in $17^{\circ} 5'$ N. lat. and $61^{\circ} 50'$ W. long., and about seventy miles in circumference. The mountains reach a height of 2,200 feet, but the vegetation is not so luxuriant as in most of the neighbouring islands on account of the comparatively small rainfall.

Five Islands are on the western side.

BOTANY.

Very complete collections of plants were made in this island by Wullschlägel and elaborated by Grisebach in his 'Flora of the British West Indies.' Only one endemic flowering plant, a grass (*Bouteloua elatior*) is recorded, and that, as Grisebach remarks, may occur elsewhere.

The vegetation of this and the other non-volcanic islands seems to be of comparatively recent derivation, like that of the Bahamas and the more distant Bermudas.

'Report upon Antigua in Relation to Forestry.' By E. D. M. Hooper. Indian Forest Department, Colonial Office, 1888.

ZOOLOGY.

Putzeys, J. Note sur les Cicindèles et Carabiques recueillis dans l'île d'Antigua par M. Purves. 'Ann. Ent. Soc. Belg.' xvii. pp. 117-120. 10 species, 2 new.

Purves, —. Shells of Antigua. 'Bull. Malac. Belg.' vii. (1872), pp. xcix-ci.

He found 38 species, only 6 being previously known from the island.

Roelofs, W. Note sur les Curculionides recueillis par M. Purves à l'île d'Antigua. 'C. R. Ent. Soc. Belg.' xviii. pp. 25, 26.

The species previously described (3) are mentioned, 6 are undescribed, one of them here described.

Sharp, D. Aquatic Coleoptera collected by M. J. C. Purves in Antigua during the summer of 1872. 'Ann. Ent. Belg.' xx. pp. 120, 121.

13 species, one new.

Lameere, A. Longicornes recueillis par M. Purves à Antigua. 'Ann. Ent. Belg.' xxviii. pp. 100, 101.

5 species.

BARBADOS.

Situated in $13^{\circ} 4'$ N. lat. and $59^{\circ} 30'$ W. long., and the most easterly of the West Indian islands. It is nearly twenty-one miles long by fourteen in breadth, and has an area of 166 square miles. The eastern side is very rugged and the greatest elevation 1,150 feet above the level of the sea.

BOTANY.

Ligon, R. A History of the Island of Barbados. London, 1657, and reprinted in 1673 . . . Principal trees and plants, pp. 66-84, with curious illustrations.

1888.

Hughes, Griffith. The Natural History of the Barbados. In 10 books. London, 1750. Folio, pp. 314, tt. 29. Botany, pp. 97–256.

Maycock, J. D. Flora Barbadosensis. London, 1830. 8vo, with a geological map.

Schomburgk, R. The History of Barbados. London. 1848. 8vo. 'Botany,' pp. 573–633.

Notwithstanding that the vegetation of Barbados has been dealt with by so many different writers, it has not been critically and exhaustively elaborated. It possesses, however, no special interest. Schomburgk enumerates 896 species of flowering plants; yet, according to Grisebach ('Geograph. Verbr. Pflanz. W. Ind. '), only one species is peculiar to the island against twelve in St. Vincent and twenty-nine in Dominica. 'Hughes' Natural History' is a fine old work, containing admirable engravings by Ehret.

ZOOLOGY.

Ligon, R. A true and exact History of the island of Barbados. London, 1657. 122 pp. Woodcuts.

Pp. 60–65 relate to the birds, lesser animals, and insects.

Hughes, G. The Natural History of Barbados. In 10 books. London, 1750.

Includes particulars about the 'quadrupeds, volatiles, and insects.'

Schomburgk, Sir R. H. A History of Barbados; comprising a geographical and statistical description of the island, and a sketch of historical events since the settlement, and an account of its geology and natural productions. London, 1848. Pp. xx and 722.

Chapter V. pp. 635–683. 'Animated Nature as developed in Barbados,' includes lists of the insects, crustacea, molluscous animals, and vertebral animals. A part is reprinted under the title, A Description of some new species of fishes from the sea surrounding the island of Barbados, in 'Ann. N. H.' (2), ii. (1848), pp. 11–20.

Steindachner, F. Ueber einige neue oder seltene Fischarten von Westindien und Surinam. 'S. B. Ak Wien.' lvi. (1867), pp. 347–357.
14 species, mostly from Barbados.

Agassiz, A., and Pourtales, L. F. de. Zoological results of the 'Hassler' Expedition. I. Echini, Crinoids, and Corals. 'Cat. Mus. C. Z.' viii. (1874). pp. 1–31. Plates I.–IV.

Numerous species from Barbados, including several new.

Slater, P. L. On a small collection of Birds from Barbados. 'P. Z. S.' 1874, pp. 174, 175.

9 species.

Cory, C. B. An apparently new Elainea from Barbados, West Indies. Auk, v. (1888), p. 47.

BARBUDA.

A small and very flat island, about half a degree north of Antigua in 17° 40' N. lat. The population is small, and chiefly engaged in breeding cattle and horses. Vegetation consists mainly of brushwood.

LA DESIRADE (SEE GUADELOUPE).

DOMINICA.

This island lies between the French islands of Guadeloupe to the north-west, and Martinique, to the south-east, in 15° 20' N. lat. and

61° W. long. It is twenty-nine miles long by sixteen broad, with an area of 292 square miles, and the mountains attain an altitude of nearly 5,000 feet.

BOTANY.

Johow, F. Vegetationsbilder aus Westindien: eine Excursion nach dem Kochenden See auf Dominica. 'Kosmos,' ii. 1884, pp. 112-130, 270-285. Abstract in 'Engler's Jahrbücher,' vii. (1886), 'Literaturbericht,' p. 76.

Nicholls, H. A. A. The Natural Resources of Dominica. Handbook of the West Indies and British Honduras, Colonial and Indian Exhibition, 1886. Vegetation, &c., pp. 120-126.

Dominica shares with Guadeloupe a comparatively rich flora, and has been almost thoroughly botanised by Dr. Imray, whose collections were elaborated by Grisebach in his Flora of the British West Indies, and subsequently by Baron Eggers, who, from time to time, has sent to Kew specimens of about 250 species of flowering plants. The forests are described as extensive, and abounding in valuable timber. Indeed it is stated that only 55,000 acres, out of 186,000, are under cultivation, and that the rest of the land is for the most part covered with virgin forests. So far as Grisebach's data go, Dominica is by far the richest in endemic species of all the Lesser Antilles; yet it is barely half the size of Guadeloupe, immediately to the north, and the nearer Martinique to the south. Twenty-nine species of flowering plants are apparently endemic in Dominica, against two in Martinique and one in Guadeloupe.

ZOOLOGY.

Guppy, R. J. L. Notes of a Visit to Dominica. 'P. Sci. Ass. Trinidad.' Part VIII. (1869), pp. 377-392.

Besides list of Land-shells there is another of 'Organic Remains from the Pliocene Coral Formation of Dominica.'

Lawrence, G. N. A provisional List of the Birds preserved and noticed by Mr. F. A. Ober in the island of Dominica. 'Forest and Stream,' New York, 1877.

Lawrence, G. N. Description of new Species of Birds from the island of Dominica. 'Ann. N. Y. Ac.' i. 1879, pp. 46-49. 1877.

3 species.

Lawrence, G. N. Catalogue of the Birds of Dominica from collections made for the Smithsonian Institute by Fred. A. Ober, together with his Notes and Observations. 'P. U. S. Nat. Mus.' i. (1878), pp. 48-69.

56 species.

Lawrence, G. N. Description of a new species of Parrot of the genus *Chrysotis* from the island of Dominica. 'P. U. S. Nat. Mus.' iii. (1880), pp. 254-257.

Other birds are mentioned in this.

Lawrence, G. N. Description of a new species of Bird of the family Turdidæ from the island of Dominica, W. I. 'P. U. S. Nat. Mus.' iii. (1880), p. 16.

Angas, G. F. On the terrestrial Mollusca of Dominica. Collected during a recent visit to that island. 'P. Z. S.' 1883, pp. 594-597.

20 species.

Godman, F. D., and Salvin, O. A list of the Rhopalocera collected by Mr. G. French Angas in the island of Dominica. 'P. Z. S.' 1884, pp. 314-320. Plate XXV.

27 species, 3 new.

Druce, H. On a collection of Heterocera from Dominica. 'P. Z. S.' 1884, pp. 321-326.

104 species.

Cory, C. B. Description of a supposed new form of Margarops from Dominica. 'Ank,' v. (1888), p. 47.

Smith, E. A. On the Mollusca collected by Mr. G. A. Ramage at the Island of Dominica. 'Ann. N. H.' (6) II. (1888), pp. 227-234.

GRANDE TERRE (SEE GUADELOUPE).

GRENADA.

Situated between 11° 58' and 12° 30' N. lat. and 61° 20' to 61° 35' W. long., and about 68 miles south-west of St. Vincent. About 21 miles long by 12 miles in its greatest breadth, with an area of 125 square miles. Mountainous and picturesque and abounding in streams. The Grand Etang, a lake on the summit of the mountain ridge, at an elevation of 1,740 feet, is one of the most remarkable natural features. About 17,000 acres, out of a total of 76,653, are cultivated, but much of the uncultivated land is described as inaccessible. Valuable timber is reported to be abundant, particularly bullet-tree (? *Sideroxylon*), locust (*Hymenæa*), mahogany (*Swietenia*), white cedar (*Cedrela*), and galba (*Calophyllum*). Vanilla and several varieties of gum-yielding trees have lately been discovered.

BOTANY.

This island has never been thoroughly botanised, but it is one of those visited by Jacquin about the middle of the last century, and Mr. G. Murray, of the British Museum, spent two or three weeks there in 1887. Recently a small botanic garden has been established, and Mr. Elliott, the present superintendent, has already partially explored the island botanically, and sent a small collection of dried plants to Kew, from which it appears that there are very few, if any, plants peculiar to the island.

Murray, G. A Half-holiday in Grenada. 'Gardeners' Chronicle,' series 3 (1888), iii. p. 8.

'Report upon the Forests of Grenada and Carriacou.' By E. D. M. Hooper, of the Indian Forest Department, Colonial Office. 1887.

ZOOLOGY.

Lawrence, G. N. Catalogue of the Birds of Grenada, from a collection made by Mr. Fred. A. Ober for the Smithsonian Institute, including others seen by him but not obtained. 'P. U. S.' Nat. Mus. i. (1878), pp. 265-278.

54 species.

Wells, J. G. A Catalogue of the Birds of Grenada, West Indies, with observations thereon. Edited by G. N. Lawrence. 'P. U. S. Nat. Mus.' ix. (1886), pp. 609-633.

92 species.

Wells, J. G. A List of the Birds of Grenada. St. Andrews. 1886.
12 pp.
93 species.

Lawrence, G. N. Description of a new species of Thrush from the Island of Grenada, West Indies. 'Ann. New York Ac.' iv. (1887), pp. 23, 24.

GRENADINES.

A group of small islands lying between Grenada and St. Vincent, many of them being little more than rocks. Bequia and Carriacou are the largest. Other named islands are Ronde, The Sisters, Les Tantes, Savan, Hillsborough, Frigate, Union, Little Martinique, Bird, Mayero, Cannouan, Little Cannouan, Sail, Quatre, Moustique, and Baliceaux.

Mr. D. Morris informs us that these islands have been practically denuded of their timber trees to supply Barbados with fuel.

GADELOUPE.

Including the adjacent islands of Marie-Galante, Petite Terre, Les Saintes, and La Désirade. This group extends from 15° 55' to 16° 30' N. lat. and from 60° 57' to 61° 50' W. long. The main island consists of two nearly equal areas, Grande Terre and Guadeloupe proper, connected by a very narrow neck of land. Total area estimated at 635 square miles, and the greatest altitude exceeds 5,000 feet.

Grisebach ('Verbreitung der Pflanzen Westindiens') indicates only one very distinct flowering plant as endemic in Guadeloupe, namely, *Cremanium coriaceum* (Melastomaceæ). Yet this island is one of the most thoroughly explored botanically.

BOTANY.

L'Herminier, F. J. Rélation de l'Histoire médicale tirée des trois règnes dans l'île de la Guadeloupe. 'Journal de Pharmacie,' iii. 1817, pp. 461-477.

Wikström, J. E. Öfversigt af Ön Guadeloupe's Flora. 'Kongliga Svenska Vetenskaps Akademiens Handlingar,' 1827, pp. 51-79.

Duchassaing, P., et Walpers, G. Plantæ novæ et minus cognitæ in . . . insulis Guadeloupe et Sti. Thomæ collectæ. 'Linnæa,' xxiii. 1850, pp. 737-756.

Montagne, C. Deux Champignons de la Guadeloupe. 'Bulletin de la Société Botanique de France,' iv. 1857, p. 444.

Grisebach, A. H. R. Systematische Untersuchungen über die Vegetation der Karaien, insbesondere der Insel Guadeloupe. 'Abhandlungen der Königlichen Gesellschaft der Wissenschaften zu Göttingen,' 1857. Also a reprint, 4to, pp. 138.

Mazé, H., and Schramm, A. Essai de Classification des Algues de la Guadeloupe. Basse-Terre, Guadeloupe, 1870-77. Deuxième édition. 4to. Pp. 283. 'See Bulletin de la Société Botanique de France,' xxv. Revue Bibliographique, p. 119.

This enumeration contains 940 species.

Mazé, M. Nomenclature des Arbres et des Arbrisseaux indigènes ou naturalisés à la Guadeloupe, avec leurs noms vulgaires. 'Bulletin de la Société Botanique de France,' 1883, xxx. pp. 100-109.

ZOOLOGY.

L'Herminier, — Observations sur les habitudes des Insectes de la Guadeloupe. 'Ann. Soc. Ent. Fr.' vi. (1837), pp. 497-513.

Lafresnaye, F. de. Description de quelques oiseaux de la Guadeloupe. 'Rev. Zool.' vii. (1844), pp. 167-169.

3 new species.

Saussaye, Petit de la. Catalogue des Coquilles trouvées à l'île de la Guadeloupe. 'J. de Conch.' ii. (1851), pp. 422-430. Supplément, *op. cit.* iv. pp. 149-158.

About 400 species.

Deshayes, G. P. Note sur différents Mollusques de la Guadeloupe envoyés par M. Schramm. 'J. de Conch.' vi. (1857), pp. 137-143.

One or two new.

Beau, — Catalogue des Coquilles recueillies à la Guadeloupe et ses dépendances. Paris. Baillièrè (1858). (Cf. 'J. de Conch.' vii. p. 393, note.) Not seen by the bibliographer.

Chevrolat, A. *Ino præusta*. 'Rev. Mag. Zool.' (2), x. (1858), p. 212.

A beetle from Guadeloupe.

Bernardi, — Description d'un Cône nouveau. 'J. de Conch.' x. (1862), p. 404.

From Guadeloupe.

Crosse, H. Description d'une espèce nouvelle de la Guadeloupe. 'J. de Conch.' xi. (1863), p. 82.

Engina Schrammi.

Crosse, H. Description d'espèces nouvelles de la Guadeloupe. 'J. de Conch.' xiii. (1865), pp. 27-38.

6 species.

Schramm, Alph. Crustacés de la Guadeloupe d'après un manuscrit du Dr. Isis Desbonne, comparé avec les échantillons de Crustacés de sa collection. Première partie. *Brachyures*. Basse-Terre. Imp. du Gouvernement. 8vo, pp. 65, with 8 plates of photographs (1867).

85 species.

Schramm, A. Catalogue des Coquilles et des Crustacés de la Guadeloupe envoyés à l'Exposition universelle de 1867, par l'Administration de la Colonie. Deuxième édition. Basse-Terre, 1869.

781 species of Mollusca.

Lawrence, G. N. Catalogue of a Collection of Birds obtained in Guadeloupe for the Smithsonian Institute by Mr. Fred. A. Ober. 'P. U. S. Nat. Mus.' i. (1878), pp. 449-462.

45 species; but the paper also includes a list of L'Herminier's, enumerating 135 species, most of which were observed also in Martinique.

Chevrolat, A. Diagnoses de Coléoptères Curculionides de la Guadeloupe. 'Le Naturaliste,' i. (1879), pp. 84 and 108.

Several new species.

Chevrolat, A. Diagnoses de Coléoptères des Antilles. 'Le Naturaliste,' i. (1879), pp. 190, 300, 306, 315.

About 20 new species from Guadeloupe.

Lawrence, G. N. List of a few species of Birds new to the fauna of Guadeloupe, with a new species of *Ceryle*. 'P. U. S. Nat. Mus.' viii. (1885), pp. 621-635.

10 species.

Ridgway, R. Description of a new species of Coot from the West Indies. 'P. U. S. Nat. Mus.' vii. (1885), p. 358.

Fischer et Bernardi. Description d'un Pleurotomaire vivant. 'J. de Conch.' v. pp. 160-166. Plate V. f. 1.
In Marie-Galante.

JOST VAN DYKE (SEE VIRGIN ISLANDS).

LA DESIRADE (SEE GUADELOUPE).

MARIE-GALANTE (SEE GUADELOUPE).

MARTINIQUE.

Situated between 14° 23' and 14° 52' N. lat. and 60° 45' and 62° 15' W. long., and about fifty miles long by sixteen in the broadest part, with an area of about 380 square miles. The mountains reach an elevation of nearly 4,500 feet.

BOTANY.

Chanvalon, Thibault de. Voyage à la Martinique. Paris, 1763. 4to.
See general bibliography for works dealing with the botany of this and other French islands.

The botany of Martinique has been so far investigated that large collections of the plants have been dried and distributed to the principal herbaria, but no complete enumeration of them has been published. Hahn was perhaps the largest collector, and the set of his plants in the Kew Herbarium contains about 675 species of flowering plants and forty ferns. Apparently the endemic element is very poor, for only two species of flowering plants were regarded by Grisebach as peculiar to this island.

ZOOLOGY.

Moreau de Jonnès. Monographie du Trigonocephale des Antilles ou grande Vipère Fer-de-Lance de la Martinique. Paris (no date. ? 1816), 42 pp.

Coquerel, C. Observations entomologiques sur divers Coléoptères recueillis aux Antilles. 'Ann. Soc. Ent. Fr.' (2), vii. (1849), pp. 441-454.
Includes three or four new species from Martinique.

(Anonymous.) List of Birds from Martinique exhibited in the international exhibition of 1862 by M. Belanger. 'Ibis,' iv. (1862), pp. 288, 289.

34 species.

Taylor, E. C. Five months in the West Indies. Part II. Martinique, Dominica, and Porto Rico. 'Ibis,' vi. (1864), pp. 157-173.

48 species of birds mentioned, with notes on their abundance or rarity, &c.

Crosse, H. Diagnoses Molluscorum Martinicensium novorum. 'J. de Conch.' xxii. (1874), pp. 118, 119.

3 species.

Mazé, H. Catalogue des Coquilles terrestres et fluviatiles recueillies à la Martinique en 1873. 'J. de Conch.' xxii. (1874), pp. 158-173.

51 species.

Lawrence, G. N. Catalogue of the Birds collected in Martinique by Mr. Fred. A. Ober for the Smithsonian Institute. 'P. U. S. Nat. Mus.' i. (1878), pp. 349-360.

40 species.

True, F. W. On the occurrence of *Loncheres armatus*, Wagner, in the island of Martinique. 'P. U. S. Nat. Mus.' vii. (1885), p. 550.

(A mammal.)

Cory, C. B. A List of the Birds collected by Mr. W. B. Richardson in the island of Martinique. 'Auk,' iv. (1887), pp. 95, 96.

38 species, 1 new.

MONA (SEE PORTO RICO).

MONTSERRAT.

Situated 16° 45' N. lat. and 62° 10' W. long., and having an area of 35 square miles. It is very mountainous, the highest peak slightly exceeding 3,000 feet, and several of them reaching 2,500 feet. The mountains are reputed to be covered to their summits with virgin forests.

BOTANY.

Grisebach records only two species of flowering plants as being restricted to this island.

ZOOLOGY.

Slater, P. L. 14 species of Birds obtained at the island of Montserrat. 'P. Z. S.' 1879, p. 764.

Three others are added in a postscript.

Grisdale, T. On the Birds of Montserrat. 'Ibis,' 1882, pp. 485-493, pl. xiii.

14 species.

NEVIS.

This island lies to the south-east of St. Kitts, from which it is about two miles distant. Its area is about 50 square miles, and its greatest elevation 3,200 feet.—Redonda is a very small island between Nevis and Montserrat.

BOTANY.

Smith, Rev. W. A Natural History of Nevis and the rest of the English Leeward Caribbee Islands. Cambridge, 1745.

Sloane visited Nevis, but made no collections there.

ZOOLOGY.

For some fragmentary observations on zoology see Smith's work in botany above.

PETITE TERRE (SEE GUADELOUPE).

PORTO RICO.

This is by far the largest of the islands in the chain eastward of San Domingo. It is situated between 18° to 18° 30' N. lat. and 65° 35' and 67° 20' W. long., and has an area of nearly 3,700 square miles, the mountains rising to a height of 3,000 feet.—Mona is a small island lying between Porto Rico and San Domingo.

BOTANY.

At present no complete account of the botany exists, but large collections of dried plants have been made, the latest by Mr. Sintenis being perhaps the most important. Baron Eggers and Mr. Garber have also added to our knowledge of the flora of the island.

Dr. J. Urban, of Berlin, is preparing, with the co-operation of other botanists, a complete 'Flora of Porto Rico, San Domingo, and Cuba.'

Bello y Espinosa, Don Domingo. Apuntes para la Flora de Puerto Rico. 'Anal. Soc. Esp. Hist. Nat.' x. 1881, pp. 231-304, xii. 1883, pp. 103-130, tt. 3.

Eggers, H. F. A. Die Poyales des östlichen Portorico. 'Botanisches Centralblatt,' 1882, xi. pp. 331, 332.

Baillon, H. Cinnamodendron macranthum from Porto Rico. 'Bulletin de la Société Linnéenne de Paris,' 1882, p. 317.

Reichenbach, H. G. Orchidæ coll. primæ a cl. Sintenis in Puerto-Rico lectæ. 'Berichte der deutschen Botanischen Gesellschaft,' iii. 1885, pp. 274-280.

Cogniaux, A. Melastomaceæ et Cucurbitaceæ Portoricenses. 'Jahrbuch K. bot. Garten' . . . Berlin, iv. 1886, pp. 276-285.

Urban, I. Marcgravia Sintenisii et Sinaruba Tulæ. 'Jahrbuch K. bot. Garten,' iv. 1886, p. 245.

Hauck, F. Meeresalgen von Porto-Rico. 'Engler's Jahrbücher,' ix. 1888, pp. 457-470.

ZOOLOGY.

Moritz, C. Notizen zur Fauna der Insel Puertorico. 'Arch. f. Nat.' ii. Jahr. (1), pp. 373-392.

Account of a collector's expedition.

Shuttleworth, R. J. Beiträge zur näheren Kenntniss der Land- und Süßwasser-Mollusken der Insel Portorico. 'MT. Nat. Ges. Bern,' 1854, pp. 33-56 and 89-103.

101 species, including several new.

Bryant, H. A List of Birds from Porto Rico presented to the Smithsonian Institute by Messrs. Robert Swift and George Latimer, with descriptions of new species or varieties. 'P. Bost. Soc. N. H.' x. (1866), pp. 248-257.

About 40 species.

Sundevall, C. J. Foglarne på ön Portorico, efter Hr. Hjalmarsons insamlingar framställda af. 'Öfv. K. Vet. Ak. Forh.' xxvi. (1869), pp. 593-603.

90 species.

Bello y Espinosa. Zoologische Notizen aus Puerto Rico. 'Zool. Garten,' xii. (1871), pp. 348-351.

A list of birds and remarks on other vertebrates.

Gundlach, J. Beitrag zur Ornithologie der Insel Portorico. 'J. f. Ornithol.' xxii. (1874), pp. 304-315.

116 species.

Pfeiffer, L. Zur Molluskenfauna von Portorico. 'Mal. Blatt.' xxii. (1875), pp. 118, 119.

2 new species.

Peters, W. Ueber eine von Hrn. Vice-Consul L. Krug und Dr. J. Gundlach auf der Insel Puertorico gemachte Sammlung von Säugethieren

und Amphibien so wie über die Entwicklung eines Batrachiers, *Hylodes martinicensis* Dum. Bibr. ohne Metamorphose. 'M. B. Ak. Wiss. Berl.' 1876, pp. 703-714, pl. i.

5 species mammalia, 19 of amphibia, 2 new.

Dewitz, H. Tagschmetterlinge von Porto Rico. 'S. E. Z.' xxxviii. 1877, pp. 233-245, pl. i.

85 species.

Dewitz, H. Dämmerungs und Nachtfalter von Portorico gesammelt von Herrn Consul Krug. 'Mitt. Munch. ent. Ver.' 1877, i. pp. 91-96.

Nearly 60 species, 2 new.

Gundlach, J. Neue Beiträge zur Ornithologie der Insel Portorico. 'J. f. Ornithol.' xxvi. (1878), pp. 157-194.

A complete list including 153 species; many remarks.

Ridgway, R. Description of a new owl from Porto Rico. 'P. U. S. Nat. Mus.' iv. (1881), pp. 366-371.

Dewitz, H. Hymenopteren von Porto Rico. 'B. E. Z.' xxv. (1881), pp. 197-208.

A list of 75 species, 12 new.

Martens, E. V. Description of two species of Land-shells from Porto Rico, W. I. 'Ann. N. York Ac.' ii. (1882), pp. 370, 371.

Röder, V. von. Diptern von der Insel Portorico. 'S. E. Z.' xlvi. (1885), pp. 337-349.

108 species, 10 new.

Weise, J. Beitrag zur Chrysomeliden und Coccinelliden-Fauna Porto Ricos. 'Arch. f. Nat.' (2), li. (1885), pp. 144-168. Plate VIII.

51 species Chrysomelidæ, 10 of Coccinellidæ.

Quedenfeldt, G. Neue und seltner Käfer von Porto Rico. 'B. E. Z.' xxx. (1886), pp. 119-128.

16 species, 7 new.

Stahl, A. Beitrag zur Vogelfauna auf Portorico. 'Ornis,' iii. (1887). He says 154 species are now known.

Gundlach, J. Apuntes para la fauna Puerto riquena. Primera parte, 'An. Soc. Esp.' vii. (1878), pp. 135-234. Segunda parte, t.c. pp. 343-421. Tercera parte, *op. cit.* x. (1881), pp. 305-350. Cuarta parte, *op. cit.* xii. (1883), pp. 5-58. Quinta parte, t.c. pp. 441-484. Sexta parte, *op. cit.* xvi. pp. 115-199.

This is a list of the animals of Porto Rico so far as they are at present known; it is still (1888) in course of publication. The lists of Mammalia, Aves, Reptilia and Batrachia, Pisces, Mollusca, Crustacea, and Myriapoda are completed, and the Insecta in progress. It includes also bibliographical lists of the works referred to.

REDONDA (SEE NEVIS).

SABA.

Situated between St. Eustatius and St. Bartholomew in 17° 38' N. lat. and 63° 12' W. long. It is about nine miles in circumference and rises to a height of nearly 3,000 feet.

ST. BARTHELEMY, OR ST. BARTHOLOMEW.

A small island situated a little to the south-east of St. Martin in 17° 53' N. lat. and 62° 50' W. long., and having an area of twenty-five

square miles. The soil is fertile, but there are neither springs nor streams, so that vegetation is entirely dependent on the season's rainfall.

BOTANY.

Wikström, J. E. Öfversigt af Ön Sanct Barthelemi's Flora. 'Kongliga Svenska Vetenskaps Akademiens Handlingar,' 1825, pp. 411-423.

ZOOLOGY.

Sundevall, C. J. Foglarne på ön St. Barthelemy, efter de af Dr. A. von Goës hemsända samlingarna bestämde. 'Öfv. K. Vet. Ak. Förh.' xxvi. (1869), pp. 579-591.

47 species of birds.

Wallengren, H. D. J. Bidrag till kännedom af Fjärilfaunan på St. Barthelemy. 'Öfv. K. Vet. Ak. Förh.' xxviii. (1871), pp. 909-919.

35 species, a few new, of butterflies and moths.

ST. CHRISTOPHER (SEE ST. KITTS).

ST. CROIX, OR SANTA CRUZ.

In 17° 45' N. lat. and 64° 50' W. long., and about twenty miles from east to west and five miles in its greatest breadth, with an area of fifty-seven square miles. The hills average from 600 to 800 feet high, and the highest point, Mount Eagle, reaches 1,150 feet.

BOTANY.

Eggers, H. F. A. St. Croix's Flora. 'Videnskabelige Meddelelser fra den naturhistoriske Forening i Kjöbenhavn,' 1876, pp. 33, with a phytogeographical map.

Eggers, H. F. A. The Flora of St. Croix and the Virgin Islands. Bulletin of the United States National Museum, No. 13. Washington, 1879. 8vo. pp. 133.

Baron Eggers has fully investigated the flora of St. Croix, and he tabulates it in the work cited above. There are no endemic flowering plants, and the total number of vascular plants regarded as indigenous is 666. These include only three orchids, namely, *Epidendrum bifidum*, *E. ciliare*, and *E. cochleatum*. *Oreodoxa regia* is common, and of the only other native palm, *Thrinax argentea*, only one specimen was seen.

ZOOLOGY.

Newton, A. and E. Observations on the Birds of St. Croix, West Indies, made between February 20 and August 6, 1857, by Alfred Newton, and between March 4 and September 28, 1858, by Edward Newton. 'Ibis,' i. pp. 59-69, 138-150, 252-264, 365-379. Plates I. and XII.

64 species.

Gunther, A. On the Reptiles from St. Croix, West Indies, collected by Messrs. A. and E. Newton. 'Ann. N. H.' (3) iv. (1859), pp. 209-217. Plate IV.

5 species, two of them new; also a new frog from St. Thomas.

Lütken, C. En ny Vestindisk Sandorm, *Arenicola (Pteroscolex) Antillensis*. 'Vid. Medd.' 1864. Pp. 120-122. From St. Croix.

Bland, T. On the Relations of the Flora and Fauna of Santa Cruz, West Indies. 'Ann. New York. Ac.' ii. (1882), pp. 117–126. A discussion in connection with the mollusca living and extinct in St. Croix.

ST. EUSTATIUS, OR ST. EUSTACHE.

A small island lying between St. Kitts and Saba, in about 63° W. long. and 17° 30' N. lat. It rises in a pyramidal form from the sea to a height of nearly 2,000 feet.

ST. KITTS, OR ST. CHRISTOPHER'S.

Situated to the north-west of Antigua, in 17° 20' N. lat. and 62° 45' W. long., and having an area of sixty-eight square miles. Mount Misery, the highest peak, has an altitude of 4,060 feet.

BOTANY.

'The higher slopes of the mountains are clothed with grass, while their summits are crowned with noyean or ironwood, Spanish ash, red sweetwood, wild mahoe, snakewood, white box, dogwood, and other forest trees.'—Handbook of the West Indies and British Honduras, Colonial and Indian Exhibition, 1886.

ZOOLOGY.

Lawrence, G. N. Description of a new sub-species of *Loxigilla* from the island of St. Christopher, West Indies. 'P. U. S. Nat. Mus.' iv. (1881), p. 204.

ST. LUCIA.

One of the most picturesque of the Windward Islands, situated south of Martinique, in 14° N. lat. and 61° W. long. It is forty-two miles long and twenty-one in its greatest breadth, with an area of 243 square miles. The greatest altitude is about 3,300 feet, and here, as in St. Vincent, there is a 'souffrière,' or sulphur mountain.

Maria, Gros, and Pigeon are adjacent islets.

BOTANY.

There is no complete account of the botany of this island. Grisebach saw very few plants thence, including a solitary endemic species.

'Report upon the Forests of St. Lucia.' By E. D. Hooper, Indian Forest Department Colonial Office, 1887.

ZOOLOGY.

Tyler, R. E. Notes on the Serpents of Santa Lucia. 'P. Z. S.' 1849, pp. 100–104.

4 species.

Tyler, R. E. On the Iguana of Santa Lucia. 'P. Z. S.' 1850, pp. 106–110.

Description and habits.

Slater, P. L. On the Birds of the island of Santa Lucia, West Indies. 'P. Z. S.' 1871, pp. 263–272, pl. xxi.

20 species, and a valuable summary of the work that had been done at the avifauna of the Lesser Antilles up to that date.

Semper, J. E. Observations on the Birds of St. Lucia, with notes by P. L. Sclater. 'P. Z. S.' 1872, pp. 647-653.

6 species added to the former list.

Sclater, P. L. On some additional species of birds from Santa Lucia, West Indies. 'P. Z. S.' 1876, pp. 13, 14, pl. ii.

8 additional species, including a new genus and 2 new species.

Allen, J. A. On the Birds of Santa Lucia, West Indies. 'Bull. Nutt. Orn. Club.' v. (1880), pp. 163-169.

Adds 16 species to the list.

Sclater, P. L. Notes upon some West Indian Birds. 'Ibis' (4), iv. (1880), pp. 71-75. Plate I.

One new species from Santa Lucia.

Ridgway, R. Description of a new Warbler from the island of Santa Lucia, West Indies. 'P. U. S. Nat. Mus.' v. (1882), pp. 525, 526.

Cory, C. B. Description of a new species of *Rhamphocinclus* from St. Lucia. 'Auk,' iv. (1887), p. 94.

ST. MARTIN.

To the south of Anguilla, in 18° 4' N. lat. and 63° 5' W. long., and having an area of thirty square miles and an elevation of nearly 2,000 feet.—Tintamarre is an islet on the north-east side of St. Martin.

ST. THOMAS (SEE VIRGIN ISLANDS).

ST. VINCENT.

This island is in 13° 10' N. lat. and 60° 57' W. long., and is about eighteen miles long by eleven broad, with an area of 140 square miles. Surface mainly undulating and suitable for cultivation; but the extinct volcano, called the Souffrière, in the north, rises to a height of 3,700 feet, and the Morne à Garou to 4,000 feet. The road to the Souffrière is described as being embroidered with flowers, such as begonias and orchids, and groves of magnificent tree-ferns abound.

BOTANY.

Guilding, Lansdown. An account of the Botanic Garden in the island of St. Vincent, Glasgow, 1825. 4to, pp. 47, with three coloured views in the garden and a plan.

Report upon the Forests of St. Vincent. By E. D. M. Hooper, of the Indian Forest Department, Colonial Office, 1886.

Jacquin collected in St. Vincent, and the Rev. Lansdown Guilding made considerable collections of dried plants between 1820 and 1830 and transmitted them to Sir William Hooker; but as he was a zoologist rather than a botanist, it is probable that he did not exhaust the flora.

Grisebach describes twelve endemic plants, a larger number than known to him from all the rest of the chain of islands, excluding Dominica, from Tobago to Antigua.

Guilding's history of the foundation (1765) and progress of the botanic garden of St. Vincent is an interesting and valuable record. It was here

that Captain Bligh landed the best portion of his cargo of plants of the breadfruit early in 1793.

ZOOLOGY.

Guilding, L. Description of a new species of Onchidium. 'Tr. Linn. Soc.' xiv. (1825), pp. 322-324. Plate IX.

From St. Vincent.

Guilding, L. An Account of some rare West Indian Crustacea. 'Tr. Linn. Soc.' xiv. (1825), pp. 334-338.

7 species. The localities mentioned are St. Vincent and the 'Caribbean Sea.'

Guilding, L. On some of the Terrestrial Mollusca of the West Indies. 'Tr. Linn. Soc.' xiv. (1825), pp. 339-341.

4 species from St. Vincent.

Guilding, L. Mollusca caribbæana. 'Zool. Journ.' ii. (1826), pp. 437-444. Plate XIV.

A few new species from St. Vincent, including *Peripatus juliformis* which is figured.

Walker, F. Descriptions of Chalcidites, discovered in St. Vincent's Isle by the Rev. Lansdown Guilding. 'Ann. N. H.' xii. (1843), pp. 46-48.

8 new species.

Lawrence, G. N. Catalogue of the Birds of St. Vincent, from collections made by Mr. F. O. Ober under the direction of the Smithsonian Institute, with his notes thereon. 'P. U. S. Nat. Mus.' 1878, pp. 185-198.

59 species.

Lawrence, G. N. Description of seven new species of Birds from the island of St. Vincent, West Indies. 'Ann. New York Ac.' i. (1879), pp. 147-153.

Lister, C. E. Field-notes on the Birds of St. Vincent. 'Ibis' (4), iv. 1880 pp. 38-44.

32 species.

Guppy, R. J. L. Terrestrial Mollusca of St. Vincent. 'P. Sci. Assoc. Trinidad,' Part XII. (1881), pp. 164-166.

16 species.

SANTA CRUZ (SEE ST. CROIX).

SOMBRERO.

A small island lying between Anguilla and the Virgin Islands. Nothing has been published on its vegetation.

ZOOLOGY.

Lawrence, G. N. Catalogue of Birds collected at the island of Sombrero, W. I., with observations by A. A. Julien. 'Ann. Lyc. N. Y.' viii. (1867), pp. 92-106.

34 species.

TOBAGO.

The most southerly of the windward group of the British West Indian Islands, lying in about 11° 9' N. lat and 60° 12' W. long., and about twenty miles from Trinidad. It is twenty-six miles long by

seven and a half broad, with an area of 114 square miles, and is mountainous and picturesque, the maximum elevation being 1,800 feet. There are no rivers nor streams navigable by even small boats, hence the virgin forest of the central mountain ridge remains intact. It is estimated that there are forty square miles of forest under valuable timber, and probably thirty under wood, of no great value except as fuel.

BOTANY.

Meyer, G. L. A Botanist's House in Tobago. 'Gardeners' Chronicle,' n. s. xiv. p. 456, with a view. A fragment.

Little is known of the botany, but that little points to a luxuriant if not a very varied flora. Mr. G. L. Meyer resided some months in the island, but he was only able to dry a few plants that grew near his dwelling; yet out of thirty-two species two or three at least were previously unknown.

ZOOLOGY.

Jardine, Sir W. Birds of Tobago. 'Ann. N. H.' xviii. (1846), pp. 114-121; xix. (1847), pp. 78-83; and xx. (1847), pp. 328-334 and 370-378.

TORTOLA (SEE VIRGIN ISLANDS).

VIRGIN GORDA (SEE VIRGIN ISLANDS).

VIRGIN ISLANDS.

A cluster of islands lying to the east of Porto Rico, between 18° to 18° 50' N. lat. and 64° 20' and 65° 40' W. long. The principal islands are Vieques and Culebra belonging to Spain, St. Croix, St. Thomas, and St. Jan belonging to Denmark, and Virgin Gorda, Anegada, Jost Van Dyke, Tortola, and Peter's Island belonging to England. The area of the larger islands is only from sixteen to forty square miles, and the greatest elevations are 1,780 feet in Tortola and 1,550 feet in St. Thomas, St. Jan, or St. John, and Virgin Gorda being a little lower, whilst in the western Culebra and Vieques the hills are only 500 to 600 feet high. Anegada, as its Spanish name implies, is half submerged, or rather elevated only a few feet above the level of the sea.

St. Croix is much the largest island, and its natural history has been separately discussed and contrasted with that of the smaller and more contiguous islands (see p. 459).

Among the smaller named islands of this group are Cockroach, Savana, Tobago, Frenchman's Norman, Peter, Ginger, Guano, and Camanoe.

BOTANY.

Knox, J. P. An historical account of St. Thomas, W. I., with notices of St. Croix and St. John. New York. 1852. 271 pp.

The chapter on zoology is very slight and unimportant, though there is 'a complete list' of the plants of St. Thomas.

West, H. Bidrag til beskrivelse over St. Croix med en kort udsigt over St. Thomas, St. Jan, Tortola, Spanishtown og Crabeneiland. Copenhagen, 1793. 8vo. Vegetation of St. Croix and St. Thomas described, pp. 259–336.

Krebs, E. Bidrag til St. Thomas' Flora. 'Kroyer Naturhistorisk Tidsskrift,' ii. (1846–49), pp. 291–302.

Eggers, H. F. A. The Flora of St. Croix and the Virgin Islands. 'Bulletin of the United States National Museum.' Washington, 1879. 8vo, pp. 133.

Baron Eggers' enumeration is based mainly on plants from St. Croix and St. Thomas. He has 783 indigenous plants from the Virgin Islands, against 666 from St. Croix. There is almost no endemic element, and nearly all the plants are common to Porto Rico. *Eggersia*, Hook, f. (in Hook, Ic. Pl. t. 1401), a new genus of Nyctagineæ, discovered by Baron Eggers in the island of St. Thomas, is an interesting exception, so far as is known at present, but it may occur in Porto Rico.

ZOOLOGY.

See **Knox** in botany above.

Forel, A. Die Ameisen der Antille St. Thomas. 'Mitth. Münch. ent. Ver.' v. (1881), pp. 1–16.

13 species, four being new.

Bland, T. Note on the geographical distribution of the terrestrial Molluscs which inhabit the island of St. Thomas. 'Ann. Lyc. New York,' vi. (1858), pp. 74, 75.

Shuttleworth, R. J. Catalogue of the terrestrial and fluviatile shells of St. Thomas, West Indies. 'Ann. Lyc. New York,' vi. (1858), pp. 68–73. 42 species.

Cassin, J. Catalogue of Birds from the island of St. Thomas, West Indies, collected and presented to the Academy of Natural Sciences by Mr. Robert Swift. 'P. Ac. Sci. Phil.' 1860, pp. 374–379.

27 species.

Gunther, A. (See St. Croix.)

Snellen, P. C. T. Opgave der Geometrina en Pyralidina in Nieuw Granada en op St. Thomas en Jamaica verzameld door von Nolcken. 'Tijdschr. Ent.' xvii. (1874), pp. 1–108, and xviii. (1875), pp. 187–264.

The species from St. Thomas are not specially pointed out.

Kirby, W. F. On the Hymenoptera collected during the recent expedition of H.M.S. 'Challenger.' 'Ann. N. H.' (5), xiii. (1884), pp. 402–413.

5 species from St. Thomas.

Butler, A. G. The Lepidoptera collected during the recent expedition of H.M.S. 'Challenger.' Part II. 'Ann. N. H.' (5), xiii. (1884), pp. 183–188.

From St. Thomas and Bermuda, 19 species from the former.

Rathbun, R. Report upon the Echini collected by the United States Fish Commission steamer 'Albatross' in the Caribbean Sea and Gulf of Mexico. 'P. U. S. Nat. Mus.' viii. pp. 83–89, and l. c. pp. 606–620.

A few species from St. Thomas.

Smith, E. A. An account of the Land and Fresh-water Mollusca collected during the voyage of the 'Challenger.' 'P. Z. S.' 1884, pp. 258–281.

P. 277 gives a list of 6 species from St. Thomas.

Second Report on our Experimental Knowledge of the Properties of Matter with respect to Volume, Pressure, Temperature, and Specific Heat. By P. T. MAIN, M.A.

SINCE the first part of this report was written further investigations have been made on some elements and compounds with the view of determining the variations in vapour-density with rise of temperature, and the molecular weights of bodies.

Vapour-density Determinations.

In a paper contributed to the Royal Society of Edinburgh, July 18, 1887, Dr. A. Scott, using a modified form of V. Meyer's apparatus, described in a paper published in 1879,¹ obtains the vapour-densities, at high temperatures, of a number of elements and compounds, and deduces the molecular weights given below:—

Na, K, Hg, S₂, CsI, CsCl, RbI, RbCl, KI, AgCl, PbCl₂, MnCl₂, FeCl₂, CrCl₃, CdBr₂.

A table is given showing the theoretical numbers side by side with the experimental.

Vapour-densities of Nitric Oxide; and of Antimony.

In 1886² Mensching and V. Meyer found that zinc had, at very high temperatures, vapour-densities, such that Zn is the molecule of zinc, so that mercury, cadmium, and zinc all consist of monatomic molecules in the gaseous state; magnesium they did not succeed in volatilising; but with germanium, the boiling point of which is not far from that of zinc according to Winkler, they hope to be more successful.

In 1887³ they found that at a low temperature, viz., at 100°, nitric oxide has the same vapour-density (relative) as at higher temperatures, the contraction of the air in an air-thermometer and of the gas in a thermometer filled with nitric oxide instead of air being precisely the same, as the air and the gas were cooled equally.

In 'Chem. Soc. Trans.' 1887, p. 397, Dr. A. Richardson shows that, whereas the dissociation of nitric peroxide into NO₂ molecules is complete at 140°, a further dissociation of the NO₂ begins immediately at higher temperatures, and is completed at 620°, the products being nitric oxide and oxygen; the density at 620° being two-thirds that at 140°.

Mensching and V. Meyer,⁴ having found that at a white heat the vapour-densities approached those corresponding to the molecular weights P₂, As₂ for the elements phosphorus and arsenic, without, however, quite reaching the values required, found at the highest temperatures vapour-densities for antimony which were less than for the formula Sb₃; but, as they did not arrive at any temperature at which the coefficient of expansion and the vapour-density remain constant, they were unable to decide whether Sb₂ or Sb is the molecular weight of antimony.

¹ *Proc. Roy. Soc. London*, 32, 1879.

³ *Ber.* 20, p. 1832.

² *Ber.* 19, p. 3295.

⁴ *Ibid.* 20, 1887, p. 1833.

Vapour-densities of Aluminium Chloride.

Nilson and Pettersson¹ found for aluminium chloride at temperatures from 440° to 1260° vapour-densities varying from 7·789 to 4·277, the density decreasing very rapidly from 440° to 760°, and still diminishing regularly, till at about 1100° it remained nearly constant up to 1260°, the value between these temperatures being somewhat lower than that required by the formula AlCl_3 on account of the platinum of the apparatus being attacked by the chloride at these high temperatures. The result of their observations showed that at no range of temperatures at which the chloride was entirely gaseous was the formula Al_2Cl_6 applicable. They adopt, therefore, AlCl_3 as the formula.

Vapour-densities of Aluminium-ethyl and -methyl.

L. Roux and E. Louise² find, for aluminium-ethyl (boiling at 195°–200°), vapour-density 8·1 at 235°, 6·2 at 258°, 2·5 at 310° and at 350°. The first number corresponds to the formula $\text{Al}_2(\text{C}_2\text{H}_5)_6$, and the last to less than one-third of it. The authors conclude that the true formula is $\text{Al}_2(\text{C}_2\text{H}_5)_6$, and that the diminution of density is due to some cause unknown at present.

Again, the same authors³ find vapour-densities of aluminium-methyl by V. Meyer's method, obtaining 5·1, 4·75, 4·6, 2·4, 1·8 for densities at the temperatures 182°, 216°, 310°, 340°, 440°; the theoretical density of the vapour for the formula $\text{Al}_2(\text{CH}_3)_6$ is 5·02, which they consider to be approximately reached at 310°; as to the diminution of vapour-density at higher temperatures, they find that that is due to a decomposition of the compound into aluminium, olefines, and hydrogen.

At the end of a paper on some vapour-densities by W. Grünwald and V. Meyer,⁴ they say that Roux and Louise have given to aluminium-ethyl the formula $\text{Al}_2(\text{C}_2\text{H}_5)_6$ without, as seems to them, adequate proof; and that from investigations on aluminium-methyl they have come to the conclusion that no molecule with the formula $\text{Al}_2(\text{CH}_3)_6$ exists at any temperature.

Vapour-densities of Stannous Chloride and Cuprous Chloride.

Using a form of air-thermometer described by Goldschmidt and V. Meyer,⁵ Biltz and V. Meyer find the boiling-point of stannous chloride to be 606·1.⁶ For this compound V. Meyer had, in conjunction with C. Meyer, also with Züblin,⁷ found two molecular formulæ Sn_2Cl_4 and SnCl_2 for different temperatures. Biltz and V. Meyer, on making a fresh series of observations with very accurate determinations of the temperatures at which they were made, found that there was no range of temperature at which the vapour-density becomes constant, corresponding to a molecular formula Sn_2Cl_4 , but that the vapour-densities at

temperatures 639°; 678°; 699°; 759°·6; 790°; 1113°
are . . . 8·34; 8·57; 8·49; 8·26; 7·7; 7·08

¹ *Zeitschr. f. Phys. Chem.* 8, p. 459; *Ber.* 20, 1887, *Ref.* 623.

² *C. R.* 106, 73, 1888; *Ber. Ref.* 1888, p. 125.

³ *C. R.* 106, 602; *Ber.* 1888, *Ref.* 219.

⁴ *Ber.* 21, 1888, pp. 687-701.

⁵ *Ber.* 15, 1882, p. 141.

⁶ *Ber.* 21, p. 22.

⁷ *Ber.* 12, 1879, p. 1195; and 13, 1880, p. 811.

For Sn_2Cl_4 the density would be 13.06, and for SnCl_2 , 6.53.¹ The molecular formula for stannous chloride is inferred to be SnCl_2 .

The molecular formula Cu_2Cl_2 remains unaltered at the highest temperatures used by Biltz and V. Meyer.

Vapour-densities of Ferric Chloride.

Next appears a paper by Grünwald and V. Meyer,² in which these authors attempt to find the vapour-densities of ferric chloride at high temperatures with the view of deciding whether these indicate a molecule Fe_2Cl_6 at any temperature-range, and whether there is a molecule FeCl_3 . For this purpose they make a series of determinations at the temperatures of boiling sulphur, 448°, boiling phosphoric sulphide, 518°, and boiling stannous chloride, 606°. At the temperature of boiling sulphur the ferric chloride was volatilised slowly and completely, and its vapour-density, from the mean of four determinations—10.675, 10.559, 10.227, 10.487—was 10.487 at 448°; now the vapour-density for Fe_2Cl_6 would be 11.2, which is greater than this mean result and than either of the individual numbers. The authors say that determinations at even slightly lower temperatures are inadmissible, for the temperature of volatilisation must be very close to 448° (see Friedel and Crafts further on). At 518° they found 9.569 for the vapour-density as the mean of three determinations; but they found that even at this temperature about one-tenth part of the ferric chloride had been converted into ferrous chloride and chlorine, the ferrous chloride being much less volatile than the ferric; the vapour-density would be that of the ferric chloride remaining as vapour together with the chlorine.

At 606°, that is, by heating in the vapour of stannous chloride, the six experiments at this temperature gave a mean result 8.383; about one-eighth part of the ferric chloride was decomposed.

At about 750° in a Perrot's furnace the mean of three experiments gave 5.436; but here about a third of the ferric chloride was decomposed into ferrous chloride and chlorine.

At 1077° experiment gave 5.307; while at 1036° it gave 4.915, the larger number for the higher temperature being due to volatilisation of some of the ferrous chloride.

At about 1300° the numbers found by two vapour-density determinations were 5.155 and 5.115.

It is seen that no temperature at which the vapour-density was determined in the above experiments, in which ferric chloride was volatilised in an atmosphere of nitrogen, gave the vapour-density 5.6, corresponding to the formula FeCl_3 ; and in such experiments it is hopeless to expect it, as the ferric chloride at high temperatures is decomposed into chlorine and ferrous chloride; but, as the only conclusion which is consistent with their experiments, the authors infer that there is no molecule Fe_2Cl_6 , and that FeCl_3 is the only formula for ferric chloride.

Experiments in an atmosphere of chlorine do not modify this conclusion.

It is noticeable, however, that at about 448° the vapour-density is in some determinations over 10.6, while the formula Fe_2Cl_6 requires 11.2, which is but little larger. The possibility of the coexistence of Fe_2Cl_6

¹ *Beil.* 1888, p. 412; and *Nachr. d. kgl. Ges. d. Wiss.* Göttingen, 2, 1888, p. 19.

² *Ber.* 21, 1888, p. 687.

molecules with FeCl_3 molecules at temperatures above the volatilisation-point of ferric chloride is, therefore, an hypothesis for which there appears at present to be no sufficient experimental proof; but the cases of acetic acid and nitric peroxide are somewhat similar, and in the latter case Ramsay has by Raoult's method found,¹ besides the formula NO_2 at high temperatures, that there is a formula N_2O_4 for low temperatures, although the vapour-densities at low temperatures above the boiling-point are always intermediate between those required by the two formulæ.

Vapour-densities—Friedel and Crafts.

In Crafts' study relative to the vapour-density of iodine² he showed that, contrary to the opinion of V. Meyer at that time, the results got by V. Meyer's process must differ from those by Dumas' process, where in the former process the vapour-density can vary with the tension *i.e.*, vapour-pressure (of the iodine), as well as when there is dissociation. Thus, in V. Meyer's process it is generally conceived that the substance which is volatilised in the vapour-pressure cylinder acts by forming a more or less dense layer of vapour at the bottom of the cylinder, which, expanding rapidly, acts like a piston in expelling a quantity of (generally) nitrogen, the volume of which at the high temperature employed is equal to that of the expanded vapour. If, however, the temperature is very much above the boiling-point or the volatilising-point of the substance vapourised, the conditions are different, the vapour *diffusing* to a considerable extent in the space occupied by the nitrogen; in this case there is no longer reason to expect that the volume of the nitrogen expelled measures the amount of the substance volatilised in the manner contemplated by V. Meyer's method.

Troost³ had found a variety of different densities of iodine-vapour at 400° , and at pressures varying from 768 mm. to 34.52, these densities varying from 8.70 to 7.35, the density corresponding to I_2 compared with air being 8.8; and attributed these results to a deviation from Gay-Lussac's law of dilatation.

Now Crafts admits a difference of the vapour-density due to reduction of vapour-pressure by diffusion, the diffusion having the effect of increasing its volume, diminishing its pressure, and thus bringing it nearer to the state of a gas considerably above its boiling-point at the reduced pressure, and more nearly to the state of a perfect gas; the results of Crafts and Meier in one set of experiments for iodine were obtained by a modification of Dumas' method, the globe being filled partly with air, partly with vapour of iodine, the vapour-pressure of the iodine in some of the experiments being a tenth of an atmosphere. In correctly calculating from the experimental results the densities of iodine-vapour, account has to be taken of the deviation of iodine from Boyle's and Gay-Lussac's laws; but Crafts and Meier⁴ found that at the reduced pressure the rate of dilatation from 355° upwards was the same as that of air. The vapour-densities (referred to air at the same pressure and temperature) at still higher temperatures were attributed by him to a gradual dissociation, the rapidity of which was increased by diminished pressure, as happens in the case of Friedel's hydrochlorate of methyl oxide, and as shown by Lemoine for HI.

¹ *C. S. J.* 1888, 621.

² *C. R.* 92, 1881, p. 39.

³ *C. R.* 91, 1880, p. 54.

⁴ *C. R.* 92, 1881, p. 39.

Acting on the principle which Crafts and Meier had used for iodine-vapour, Friedel and Crafts¹ obtained for aluminium chloride, by acting under diminished pressure, a range of comparatively low temperatures (218° to 433°), during which this body had a coefficient of dilatation nearly the same as that of air—not deviating more than CO₂ does. By the modification of Dumas' process they found vapour-densities throughout this range of 215 degrees varying between 8·31 and 9·93, the higher and lower values being indiscriminately scattered through this temperature-range. Now the value which Deville and Troost² had found was 9·35, corresponding to Al₂Cl₆; and Friedel and Crafts found this to be practically constant from 218° to 433°. Within this range, therefore, they assume that Al₂Cl₆ is not dissociated into molecules AlCl₃.

No fewer than twenty-one determinations were made for determinations of vapour-densities within these limits of temperature.

Thus, though Nilson and Pettersson have proved that AlCl₃ is the molecule at very high temperatures, it is proved that aluminium chloride at lower temperatures can exist in the gaseous state as made up of Al₂Cl₆ molecules.

The same authors (Friedel and Crafts³) find that ferric chloride in an atmosphere of chlorine was not dissociated at 440°, no deposit of crystallised ferrous chloride being visible even at that temperature. Having determined the densities of chlorine gas at different temperatures, and its coefficient of dilatation, they used this as the gas with which vapour of ferric chloride was made to mix in the modification of Dumas' method. The results deduced by them for the vapour-density of ferric chloride between 321°·6 and 442°·2 were as follows:—

temperatures 321°·6; 325°·2; 356°·9; 357°; 442°·2; 442°·2
densities . . 11·41; 12·47; 12·04; 11·85; 11·66; 11·30

The number for Fe₂Cl₆ is 11·25.

Again, the same authors⁴ find for gallium chloride (B.P. 215°) in the same way 11·73 at 237°; Lecoq de Boisbandran had found 13·4 at 247°, and 11·9 at 273°; the theoretical density for Ga₂Cl₆ is 12·2, which holds approximately from about 237° to 273°; the boiling-point is about 215°: hence between these temperatures gallium chloride is Ga₂Cl₆, which at higher temperatures dissociates into GaCl₃ molecules.

Friedel and Crafts remark that Al₂Cl₆, Ga₂Cl₆, In₂Cl₆ are more readily dissociated into the smaller molecules the higher the atomic weight of this group of metals.

Vapour-densities of Sulphur—Biltz.

Finding that the tendency of investigations on vapour-densities is apparently to give simpler molecules to some compounds, such as aluminium chloride, to which Deville and Troost had given the formula Al₂Cl₆, and to replace the formula Sn₂Cl₄ by SnCl₂, Fe₂Cl₆ by FeCl₃, Biltz undertakes⁵ to examine sulphur with the view of deciding whether its vapour-densities give at any temperature-range the formula S₆, and whether they confirm the formula S₂ at higher temperatures. For this purpose he uses the form of apparatus which had been used by Grüne-

¹ *C. R.* 106, 1888, p. 1764.

² *Ann. Chim. Ph.* 3, 58, 1860, p 257.

³ *C. R.* 107, 1888, p. 301.

⁴ *Loc. cit.*

⁵ *Ber.* 21, 1888, p. 2013.

wald and V. Meyer for ferric chloride, and makes determinations at the temperature of boiling stannous chloride, 606° , which give a mean value 3.6. Now Dumas and Mitscherlich¹ had found—Dumas for temperatures 506° to 524° values 6.512 to 6.581 nearly constant during interval of temperature 18° ; Mitscherlich 6.9 at 508° (?); the very wide difference between these results and 3.6 for vapour-density of sulphur at a temperature not very far removed, and the insufficiency of Dumas' and Mitscherlich's proof of S_6 , their temperature interval being much too small—these considerations led Biltz to determine, at the temperature 518° of boiling phosphoric sulphide, the density by Dumas' method; this gave, as a mean result of several nearly agreeing determinations, the value 7.0. By the same method he obtained a nearly constant value 4.7 at 606° in vapour of boiling stannous chloride.

The values by Dumas' method were constant in different determinations at the same temperature, and gave higher results than those given by V. Meyer's method of replacement by nitrogen.

Biltz made a series of experiments by the nitrogen-displacement method at the same temperature 518° , but varying the amount of the substance, and obtained (p. 2016) a series of thirteen results, in which, while the amount of substance varied from .1067 gram to .0450 gram, the density found varied regularly from 7.104 to 4.509. These results are due, according to Biltz, to the greater or less dilution of the vapour of the substance with nitrogen, the observed density being less the less the amount of substance, and thereby the more the amount of dilution.

He brings forward as instances of this effect of dilution Horstmann's experiments² on acetic acid, Meier and Crafts on the densities of vapour of iodine,³ and V. Meyer and C. Langer's⁴ experiments with bromine vapour. Moreover he himself confirms this explanation by making vapour-density determinations by Dumas' method, but leaving in the vapour-density vessel a mixture of nitrogen with sulphur vapour, and obtaining thus, at the same temperature, different values for the vapour-density of sulphur, as before. By experiments by Dumas' method in a series of vapour-densities at intervals from 467.9° to 606° , nearly equally divided among ten determinations, results were obtained varying from 7.937 to 4.734; but these gave no constancy for vapour-density corresponding to S_6 through any range of temperature, as may be seen from a graphic representation of the results.

By varying the method used and by making a series of observations over a considerable range of high temperatures he finds constant results only for S_2 .

Biltz continued his investigation into the influence of the size and shape of the vessel on vapour-density determinations;⁵ and in another article⁶ he has described a new method of taking the vapour-densities of volatile chlorides.

The method consists in heating the metal in an atmosphere of chlorine, and thus forming the chloride by absorbing chlorine, the amount of which by volume is either equal to, greater than, or less than, the volume of the product according to the volume of chlorine in the molecular

¹ *Ann. Chim. Ph.* [2], 50, 1832, p. 178; and 55, 1834, p. 31.

² *Ber.* 3, 1870, p. 78.

³ *C. R.* 1881, p. 181.

⁴ *Pyrochem. Untersuch. Braunschweig*, 1885.

⁵ *Ber.* 21, 1888, p. 2772.

⁶ *Loc. cit.* p. 2766.

weight of the chloride; the change of volume of the chlorine (if any) was measured by a method first used by Crafts.

In the other paper mentioned Biltz discusses the effect of using smaller and smaller quantities of substance with larger vessels in vapour-densities in reference to cases in which at the same temperature different values are obtained, due either to dissociation, or to expansion towards the perfectly gaseous state.

Vapour-density of Hydrofluoric Acid.

Gore has found that the volume of hydrofluoric acid obtained by passing hydrogen over heated silver fluoride was, when measured at about 100° , twice that of the hydrogen which went to form it; hence that the formula of hydrofluoric acid is HF, where F is 19; but that at lower temperatures the volume of hydrofluoric acid diminished rapidly with diminution of temperature in comparison with the hydrogen.¹

Mallet determined the density of hydrofluoric acid at 30.5° , and found it to correspond to the molecular weight 39.32 at that temperature, nearly the number for H_2F_2 .²

Thorpe and Hambly³ find that at fourteen temperatures ranging at short intervals between 26.4° and 88.3° the densities correspond to molecular weights ranging from 51.19 at 26.4° to 20.58 at 88.3° , there being no range of temperatures corresponding to a formula H_2F_2 ; they therefore consider the case similar to that of acetic acid, and that the only molecular formula is HF.

The vapour-density determinations by Nilson and Pettersson, by V. Meyer in conjunction with others which have just been referred to, of sulphur by Biltz, of nitric peroxide by Ramsay, of hydrofluoric acid by Thorpe, of aluminic, ferric, and gallic chlorides by Friedel and Crafts, have had for one of their objects that of ascertaining whether certain supposed more complex formulæ assigned to an element or a compound could be maintained on investigation in cases where the body in the state of gas at higher temperatures was known to consist of simpler molecules. In some of the cases the answer from experiment has been that there is no longer reason from vapour-densities to believe in the more complex molecular groupings, as in the case of sulphur; while in other cases, *e.g.*, iodine, nitric peroxide, there seems no room to doubt that the body exists in two distinct states, in one of which the gas or vapour consists of molecules of half the mass of the molecules of the body in the other state; to this case there may be added the case of the chlorides examined by Friedel and Crafts. Acetic acid and nitric peroxide have some similar characters in reference to the vapour-densities of the *saturated* vapours from their liquids, and to the behaviour of equal volumes in relation to pressure and temperature, as shown by Ramsay and Young; and it remains to be seen whether acetic acid does not consist at low temperatures of molecules in which are combined two of the molecules of acetic acid at moderately high temperatures.

In the case of bodies which are dissociated by heat the dissociation is gradual, and in general although not always the temperature-range from the beginning to the end of the dissociation is considerable; this seems to be the distinguishing feature of bodies undergoing dissociation, and

¹ *Phil. Trans.* 1869, p. 173.

² *Amer. Chem. Journ.* 3, 1881, p. 189.

³ *C. S. J.* 1888; *Trans.* p. 765.

is exhibited in the case of iodine, whose two-atom molecules undergo by heat dissociation, which is gradually brought to completion after passing through more than 300° under ordinary conditions.

When bodies in the state of vapour are heated and found to have, not far from their boiling-points, vapour-densities corresponding to definite molecular weights, we have in by far the majority of cases no dissociation, and these are the molecular weights of the compounds; the contrast between these cases and the preceding is in the short temperature-range from the boiling-point at which a constant (relative) vapour-density has been arrived at.

It is the force of general considerations such as these that makes one hesitate, in cases such as that of sulphur, antimony, aluminium chloride, ferric chloride, in which the simpler formulæ S_2 , Sb_2 (?), $AlCl_3$, $FeCl_3$ are not attained until a temperature has been reached very far above the volatilising or boiling-point, before assuming that we are simply dealing with vapours which do not attain the approximately gaseous state for an extraordinarily long interval above the temperature at which they boil or volatilise.

Although positive proof may be absent of the existence of more complex molecules, it may be that at intermediate temperatures there exists, mixed with the simpler molecules, a larger proportion of more complex molecules as the temperature sinks from the point at which the simpler molecules exist alone.

The alternative to some such supposition is that Gay-Lussac's law, as a purely physical law, has a few recently discovered very remarkable exceptions in the case of bodies, some of which have not very high boiling or volatilising points; that certain bodies, in fact, expand for a very long range of temperatures much more rapidly than Gay-Lussac's law requires.

In the Bakerian Lecture, May 1887, Professor J. J. Thomson gives an account of the effect of passing the electric discharge, by sparks or by the silent discharge, through the vapours of iodine, bromine, nitric peroxide, and chlorine. An abstract of this paper is given in the 'Proc. Roy. Soc.' 42, 1887, p. 343. Among the results obtained is that in a tube exhausted of air and containing vapour of iodine, maintained at a temperature 214° the vapour-density of the iodine is diminished from 130 ($H=1$) to 84; this result, which was a permanent change, lasting at least for several hours, was produced by direct heating by Crafts and Meier at a temperature estimated by them at 1400° .¹ The effect of sparking bromine vapour is transient, but while it lasts produces a considerable increase of pressure, due, as Professor Thomson thinks, to a transient dissociation of bromine molecules. The vapour-density determinations in these experiments 'showed that bromine vapour is dissociated if it is heated for a long time at a low pressure, even though the temperature is not very high.' He makes the remark—which seems to be of great importance, in determinations of vapour-densities, in all cases where molecules may be undergoing dissociation—that 'for experiments on vapour-density the gas should be maintained at a constant temperature for some time before the experiments are made.' The neglect of this precaution may not unlikely account for a number of discrepancies between different experimenters, or the same acting under

¹ *C. R.* 90, 1880, p. 690.

different conditions, in respect of the temperatures corresponding to vapour-densities.¹

In the case of iodine the striking feature is the fact that it can remain for some considerable time at ordinary temperatures in a state in which a large proportion of the two-atom molecules are dissociated.

In the first part of their report, p. 22, 1886, experiments with solid and liquid benzene by W. Fischer² were alluded to, from which Fischer constructed curves for the vapour-pressures at different temperatures in the neighbourhood of the melting-point of solid benzene; but the curves for solid and liquid benzene did not, as they should, meet at the melting-point of the solid.

Ramsay and Young have since shown³ that Fischer's experimental results were sufficiently accurate, but the construction of his curves was at fault; for the curves could not be accurately drawn from the formulæ he used. On calculating the constants in a Biot's formula $p = a + ba^t$, the calculated results were more nearly than those found by Fischer's formula in agreement with his experimental results; and in particular near the melting-point Fischer's recalculated numbers are found to be in close accordance with Ramsay and Young's; indeed, the agreement is so close as to afford a strong presumption of the purity of the benzene used in both cases.

Specific Heat and Temperature.

When a mass m of a body is raised from temperature t_1 to temperature t_2 , under given conditions, the amount of heat consumed in the process being Q , the quantity $\frac{Q}{t_2 - t_1}$ is called the mean capacity of the mass for heat between those temperatures; for example, if t_1 be 0° and $t_2 = t^\circ$, then Q/t is the mean capacity for heat between 0° and t° of the mass m of the given body under the conditions. If, now, for all temperatures from 0° to beyond t , Q should be found to be proportional to t , then Q/t is the capacity for heat of mass m of the body for each degree from 0° to t° , where t is any temperature whatever within the limit; but if, as is in general the case, Q/t varies as t varies, then this ratio gives no information as to the capacity for heat for the various temperature-intervals between t_1 and t_2 , but gives for the whole interval t_1 to t_2 the mean heat-capacity of mass m .

The mean capacity for heat for *unit mass* for interval δt , called the mean specific heat, is $\frac{1}{m} \frac{\delta Q}{\delta t}$, where δQ is the heat consumed in raising the temperature of mass m of the body under the given conditions from t to $t + \delta t$; and, as the capacity for heat increases usually with the temperature, and the expenditure of heat on a body will in general raise its temperature, we have generally a limit value $\frac{1}{m} \frac{dQ}{dt}$ for the capacity for heat between t and $t + \delta t$ when δt has become indefinitely small.

This quantity $\frac{1}{m} \frac{dQ}{dt}$ is the specific heat of the body at t° under the given conditions; if δt is 1° , $\frac{1}{m} \frac{\delta Q}{\delta t}$ is undistinguishable from $\frac{1}{m} \frac{dQ}{dt}$,

¹ See first part of this report, 1886, pp. 18 and 40. ² *Wied. Ann.* 38, 1886, p. 400.

³ Physical Society, Dec. 11, 1886; and *Phil. Mag.* Jan. 1887.

the specific heat being sensibly constant for an interval of one degree. When no mass is mentioned unit mass is understood.

The conditions referred to above may be various as to pressure and volume of the body, but in practice only two are necessary to discuss, viz., (1) when the body is kept at constant pressure, *e.g.*, that of the atmosphere; (2) when the body is kept, or reckoned as kept, at constant volume.

The necessity for taking account of these two conditions is most obvious in the case of bodies in the state of gas or vapour, the change of volume of bodies in the liquid and solid conditions being comparatively small; but as the liquid and the gaseous states merge one into the other, there are circumstances in which the change of volume cannot be neglected in the case of bodies in the liquid state.

Experiment enables the mean capacity for heat to be determined from 0° C. to t° C., giving a numerical value for Q/t . A number of similar determinations may be made for other temperatures; referring the results to unit mass of the body we thus get a number of mean specific heats between 0° and t_1° , 0° and t_2° , 0° and t_3° , and so on. From a sufficient number of such determinations, if the intermediate temperatures t_1° , t_2° , . . . are fairly uniformly distributed between 0° and t° it is possible to find an interpolation formula $Q/t = C_0 + at + bt^2 + \dots$ for the heat-capacity of the body between 0° and t° , where t is any temperature between 0° and the extreme limit of temperature in the set of experiments. Hence we can deduce the specific heat of the body at any such temperature; for, for unit mass, $\frac{dQ}{dt}$ is this specific heat; if we call this C_0 at 0° and C at t_1° we have, $Q = C_0t + at^2 + bt^3 + \dots$; whence dQ/dt (or C) = $C_0 + 2at + 3bt^2 + \dots$

This is the principle of the method by which from experimental results formulæ are obtained, giving approximately the specific heat of a body for a range of temperatures more or less extended, from 0° C., and from which curves can be drawn representing the relation of specific heat to temperature in the case of each body.

It is evident, from what has been said, that it is not always a matter of indifference what temperature is chosen at which to compare solid bodies, simple or compound, as to specific heat; for, although for most solids the temperature is not required to be known accurately, the variation in specific heat being very slow, in others the variation of this with the temperature is sufficient to make it a matter of importance whether the specific heat used be that at ordinary, or at lower, or higher temperatures.

For the present this part of the subject may be dismissed, to be reconsidered later on.

Specific Heats—Solids.

In the introduction to a series of memoirs on this subject, Regnault¹ says that although the subject had been attacked by many physicists before Dulong and Petit, it is to these last, with the exception of some very careful and accurate experiments by Lavoisier and Laplace, that we are indebted up to his time for any accurate determinations of the heat-

¹ *Ann. Chim.* (2), 73, 1840, p. 5.

capacities of bodies, and in which the principal causes of error incidental to such delicate experiments had been obviated.

Dulong and Petit—Elements.

In their great work on the laws of cooling, published in the 'Jour. de l'Ecole Polytech.' tome xi., Dulong and Petit gave determinations of specific heats between 0° and 350° and showed that the specific heats of bodies in general increase with rise of temperature; examples of this are given also in 'Ann. Chim. Ph.' (2), 7, 1818; as an example, among others, the mean heat capacity of iron

	between 0° and 100°	=	1098
"	0 "	200	= 1150
"	0 "	300	= 1218
"	0 "	350	= 1255

This gives a fair idea of the general rate of increase of specific heat of metals and other solid bodies generally with rise of temperature. Dulong and Petit in a subsequent paper¹ enunciate the following law: '*The atoms of all simple bodies (elements) have exactly the same capacity for heat.*' This law is arrived at by multiplying the specific heats of a number of elements in the solid state, viz., Bi, Pb, An, Pt, Sn, Ag, Zn, Te, Cu, Ni, Fe, Co, S, by their atomic weights; it is true that the products so obtained were not exactly the same for each element, but this deviation was attributed by these physicists to errors arising from two sources—the determination of the specific heats, and the analyses from the results of which the then received atomic weights were deduced. And this law was not restricted by them to bodies in the solid state alone, but was supposed to apply to bodies in the liquid and gaseous states. This opinion was supported by the specific heats of oxygen and nitrogen gases as determined by de Laroche and Berard, and of hydrogen; the number for the last gas they find somewhat too small, but consider that the determination of its specific heat was vitiated by an error which de Laroche and Berard had overlooked. In the number given by Dulong and Petit the atomic weights were referred to that of oxygen taken as unit, and the specific heats to that of water.

Neumann's Law for Compounds.

In 1831 Neumann published² a set of determinations of specific heats of minerals, and attempts to apply to them the principle of Dulong and Petit's law; to find, in fact, if there exist any simple relations among their molecular heats corresponding to what Dulong and Petit had apparently established as to the atomic heats of elements. He includes in his determinations, however, some elements, and finds that arsenic and antimony are, or seem to be, exceptions to the law of atomic heats. Noticing that these crystallise in forms not belonging to the regular system, the doubt occurs to him whether the specific heat is independent of crystalline form, and whether it is the same for substances of the same chemical composition but crystallising in different systems. This doubt is, however, set at rest by his observation that calc spar and aragonite have the same specific heat, and similarly in other cases of dimorphism.

¹ *Ann. Chim.* (2), 10, 1819, p. 405.

² *Pogg. Ann.* 23, 1831, p. 1.

By examination of a number of well-known minerals he arrives at the following general conclusion: 'The specific heats of bodies of similar chemical composition are inversely as their stöchiometric quantities.' As examples the following are adduced: calc spar, CaCO_3 ; bitter spar ($\text{CaMg})\text{CO}_3$; magnesite $(\text{MgFe})\text{CO}_3$; spathose iron ore, FeCO_3 ; and calamine, ZnCO_3 . These are bodies of similar chemical composition; the stöchiometric quantities are the quantities found thus (taking, for example, magnesite): find the value assigned to CO_3 , according to the atomic weights of C and O, and add the amounts of magnesium and iron according to the proportions of these metals found on analysis of the mineral.

The product of the specific heat and the stöchiometric quantity is found to be approximately the same for all the above minerals. Similarly for the minerals heavy spar, anhydrite, celestin— BaSO_4 , CaSO_4 , SrSO_4 —also for magnesium-, mercuric-, zinc-, cupric-, calcium- oxides; for cinnabar HgS , realgar AsS , lead glance PbS , blende ZnS ; and for ferric oxide, minium, chromic oxide, in the case of each of which he remarks that two [stöchiometric] parts (antheile) are combined with three of oxygen.

The above examples are reproduced here principally to show in what sense Neumann meant the words 'similar chemical composition' to be applied.

*Regnault's Determinations*¹—*Elements and Compounds.*

In his first memoir² Regnault deals with solid elements, making fresh determinations of those examined by Dulong and Petit, and on which they founded their law, and in addition finding the specific heats of a number of elements which they had not determined; on pp. 61–64 of this memoir he gives a table of his results. Comparing the atomic weights with that of oxygen as 100, the atomic weights of the elements examined by him vary from 200 to 1400, while the atomic heats vary only from 38 to 42, with the exception of that of carbon, which is too small unless its atomic weight is doubled; he halves the then received atomic weight of silver, thereby bringing it in harmony with the law and bringing the formula of its sulphide from that adopted before (AgS) to Ag_2S , whereby the isomorphism of this sulphide with cuprous sulphide is represented by giving to the two similar formulæ. With the exception of carbon and possible exceptions of a few elements of which he had not at the time pure specimens in sufficient quantity, including boron and silicon, Regnault concludes that Dulong and Petit's law applies to the elements generally with fair approximation, but not with accuracy, even allowing for experimental errors. He expresses the opinion that possibly their law may be true quite rigorously if each element were examined at a definite point of the thermometric scale appropriate to it, and if the specific heat were obtained free from admixture with the heat which is used up in expanding the body, and if the body is at a temperature so far removed from the temperature of fusion that no portion of the heat of fusion enters into the observed number representing the specific heat.

In his second memoir³ on the specific heat of simple and compound

¹ Regnault, *Ann. Chim.* 2, 73, 1840, p. 5; 3, 1, 1841, p. 129; 9, 1843, p. 322; 3, 38, 1853, p. 129; 46, 1856, p. 257; 63, 1861, p. 5; 67, 1863, p. 427; 4, 3, 1864, p. 495; 7, 1866, p. 450.

² *Ann. Chim.* (2), 73, 1840, p. 5.

³ *Ibid.* (3), 1, 1841, p. 129.

bodies Regnault discusses the question which Neumann had raised in 1831 and applies to it all the resources of his experimental skill, not confining himself to natural minerals as Neumann had done, but using a variety of compounds prepared pure in the laboratory. A number of alloys examined by him gave heat-capacities equal to the sum of those of their component parts in most of the twelve cases he gives; but in some cases in which the alloy was fused or near its fusing-point at the higher temperature, the specific heat calculated on this supposition differed considerably from the observed. He then examines a large variety of oxides, sulphides, chlorides, bromides, iodides, fluorides, nitrates, chlorates, phosphates, metaphosphates, pyrophosphates, arseniates, sulphates, chromates, borates, tungstates, silicates, carbonates; each of these sets—*e.g.*, oxides—he divides into series, each series having a like chemical formula, that is, corresponding to the same general formula, as RO representing the series of oxides PbO , HgO , MnO , CuO , NiO , MgO , MgO ; R_2O_3 representing the series Fe_2O_3 , As_2O_3 , Cr_2O_3 , Sb_2O_3 , Bi_2O_3 , Al_2O_3 , the numbers of each series being compared among themselves as to their specific heats and formula-weights. Among the protoxides the product of the specific heat and the formula-weight is nearly the same as a rule, but there are two exceptions—oxide of magnesium and oxide of zinc. Among the sesquioxides the same general rule holds good for what we will call the molecular heats, with the exception of alumina, in the form of corundum especially, which has a far lower molecular heat than the other sesquioxides. These apparently exceptional cases Regnault explains by a difference in the state of aggregation of these oxides. Another difficulty is the case of iron pyrites, which has the same formula RS_2 as stannic sulphide but a much lower molecular heat; this Regnault explains by saying (p. 191) that there is no analogy between these two sulphides, while bisulphide of molybdenum, which has a molecular heat not very different from that of stannic sulphide, presents, he says, some resemblance to it in physical constitution. Regnault here seems to recognise that it is not sufficient that the formulæ should be similar and the bodies belong to the same series; it is necessary also that the formulæ should, as it were, not be accidentally similar, but be similar as representing also bodies of the same class.

Although Regnault finds that calcite and aragonite do not differ in their molecular heats, he finds that the specific heat of chalk and of saccharoid marble are about the same and markedly higher than the other forms. Regnault sums up the general result of this memoir thus: 'In all compounds of similar atomic composition and chemical constitution the specific heats are inversely as the ['atomic'] molecular heats'; and he gives the same reasons for the fact of this law being only approximately true, as in the case of elements.

In further communications on the specific heats of solids Regnault finds by direct determination that of potassium, cooled by contact with solid CO_2 and let fall into a calorimeter containing naphtha, and shows that if the then accepted atomic weight of potassium is halved, this new atomic weight is in accordance with Dulong and Petit's law; and this new atomic weight separates potassium from the alkaline earth metals and other metals in the state of oxidation RO , with which metals in fact potassium¹ has no relations of isomorphism; that ordinary phosphorus

¹ *Ann. Chim.* (3), 26, 184), p. 261.

has a specific heat rapidly rising with the temperature, the mean between -78° and $+10^{\circ}$ being $\cdot 1740$, and between $+10^{\circ}$ and $+30^{\circ}$ being $\cdot 1887$; that solid mercury has between -78° and -40° a mean specific heat $\cdot 3192$; that of solid bromine between -78° and -9° is $\cdot 087$, and between -78° and -20° it is $\cdot 082$, the melting-point of bromine being taken to be not lower than -9° . [As a fact, the melting or the solidifying point of bromine has been the subject of a considerable number of determinations, and the temperature has been estimated by different experimenters at points varying from $-7\cdot 2^{\circ}$ to -25° ; the most recent values and the most trustworthy, however, are about $-7\cdot 2^{\circ}$.]

It is seen that mercury and bromine in the solid state obey the law of specific heat, while the atomic heat of phosphorus is somewhat small. The specific heat of *red* phosphorus¹ is only slightly less than that of ordinary phosphorus, the difference being perhaps due to the remoteness of red phosphorus from its melting-point. The two varieties are considered by Regnault to have a difference which is inconsiderable.

It will be noticed that the specific heat is always greater at higher than at lower temperatures.

In two subsequent papers Regnault² makes determinations of various metals, including those accompanying platinum, cobalt, and nickel whose specific heats he finds nearly equal; manganese, magnesium, which all fall into line with Dulong and Petit's law; sodium (by surrounding the tube containing the metal with a freezing mixture at -34°), attributing to it half the then accepted atomic weight by which change sodium is found to be in complete accord with the law; lithium chloride, from which he found that the molecular heat was only slightly less than that of sodium chloride, which was slightly less than that of potassium chloride, from which facts he infers that lithium chloride must have a similar atomic composition to these others, thus halving the atomic weight of lithium to make the formula of lithium chloride LiCl (instead of LiCl_2). In confirmation of this view he says (t. 46, p. 278): '*For bodies of the same chemical composition the product of the specific heat by the molecular weight is smaller the smaller the molecular weight.*' Thus for RCl_2 —e.g., CaCl_2 and BaCl_2 —the molecular heats are $114\cdot 72$ and $116\cdot 44$; again each of these numbers is quite different from those for R_2Cl_2 , as Li_2Cl_2 , Na_2Cl_2 , K_2Cl_2 , which are $148\cdot 09$, $156\cdot 97$, $161\cdot 19$. For aluminium he finds the atomic heat somewhat smaller than for most of the others.

Just as in the case of the two varieties of phosphorus, so he finds for the vitreous and metallic varieties of selenion examined at low temperatures sensibly the same specific heat agreeing well with Dulong and Petit's law, and mentions the fact (t. 46, p. 288) that the vitreous and porcelain modifications of arsenious oxide have the same specific heat; but remarks on the unexpected result that the enormous evolution of heat accompanying the transformation of vitreous into metallic selenion has no appreciable effect on the specific heat of this body; a similar result he obtains afterwards for silicon (t. 63). By direct determination he afterwards obtains a specific heat for lithium, which agrees with the formula LiCl , and includes lithium among the elements conforming to Dulong and Petit's law. For boron and silicon he tries, by using a different atomic weight for each from that then used, to place these

¹ *Ann. Chim.* (3), 38, 1853, p. 129.

² *Ibid.* (3), 46, 1856, p. 256; and 63, 1861, p. 5.

elements among those to which the law of atomic heats applies, but without success.

It is noticeable that Regnault, finding so large a number of elements conform to the law of specific heats, is at last disinclined to admit any exception for elements in the solid state, and is only deterred from doubling the atomic weight of carbon with the object of including this element by finding how widely the values of the specific heats¹ differ from one another for carbon from different sources.

The constancy of specific heat in spite of allotropic variations of the body examined, as mentioned above, is disputed by Bettendorf and Wüllner² for selenion and for arsenicum; but for the former one may prefer Regnault's result, and the latter is perhaps open to criticism. A marked exception is, no doubt, the case of diamond, the specific heat of which is much less—between 100° and 0°—than that of other varieties of carbon. The highest temperature in Regnault's experiments on the specific heats of solid bodies was 100° or, in a few cases, a few degrees higher; generally it was lower than 100°, and much lower in cases where the fusing-point of the body was low.

Wæstyn's Law of Molecular Heats.

In 1848 Wæstyn³ enunciated the following law as to the specific heats of compounds: 'If C is the specific heat and A the formula-weight of a compound of certain elements, the atomic weights of which are a_1, a_2, \dots and the specific heats c_1, c_2 , and if n_1, n_2, \dots be the number of atoms of each element in the formula of the compound, then $AC = n_1a_1c_1 + n_2a_2c_2 + \dots$ '

It is taken as a fact by Wæstyn that different elements have different atomic heats—that a_1c_1, a_2c_2, \dots are not all equal; and, therefore, as an accident if the molecular heats of compounds of similar atomic composition are equal or approximately so. Thus it follows from his principle that lead sulphate and calcium sulphate should have different molecular heats, the difference being that between the atomic heats of lead and calcium; it also follows from his principle that there should be the *same* difference between the molecular heats of the carbonates, of the protoxides, of the nitrates, chlorides, bromides, iodides, chlorates . . . of this pair of metals; and similarly for any other pair of metals which form salts and oxides of similar atomic composition.

By taking the differences between the known molecular heats of an oxide of lead and corresponding sulphide, and so for mercury and for bismuth, and antimony for the same amount of combined oxygen, he finds numbers which according to his law should be equal, being the difference in each case between the atomic heats of sulphur and oxygen, and which are, in fact, nearly equal. The law, tested by a considerable number of compounds, is found to give results very fairly in accordance with it.

Extension of Dulong and Petit's Law to Compounds.

Although Neumann, and after him Regnault, showed most interesting relations among molecular heats of compounds, from which Regnault

¹ *Ann. Chim.* (3), 1, 1841, p. 204.

² *Pogg.* 133, 1868, p. 293; and *Ann. Chim.* (4), 14, 1868, p. 476.

³ *Ann. Chim.* (3), 23, 1848, p. 296.

had in fact been able to deduce the atomic weights of elements which were not at the time capable of examination as to their specific heats directly, as in the cases of Rb, Cs; of Li; of Sr, and Ba; by means of the rule that the molecular heats of bodies of similar atomic composition and chemical constitution are equal; no rule had been found by which the molecular heats of compounds were connected with the atomic heats of the component atoms; with the exception of Wœstyn's law (1848) that the molecular heat is the sum of the atomic heats for all the atoms in the molecule. But this exception was indeed important (1) for the frank recognition of the fact that the atomic heats of elements cannot be reckoned as equals—at the best as varying within narrow limits; in fact, as putting forward as of fundamental importance that Dulong and Petit's law is only approximate and not a very near approximation; (2) for the extension to compounds generally of the rule which Regnault had found to apply to alloys. But Wœstyn's law led to no important results, as it was not followed up by a determined attempt to confront the questions, what are the atomic heats which must be assigned to elements such as chlorine, oxygen, hydrogen, nitrogen, fluorine, and others, the specific heats of which in the solid state cannot be determined directly; and of carbon, the specific heat of which in the free state at ordinary temperatures varies so much with its state of aggregation and in allotropic modifications of it. The number of compounds which contain one of these elements or more is so very large a proportion of the compounds to which the rule should be applied, and by means of which it should be verified, that it is not to be wondered at that no important generalisation resulted from it. To Wœstyn, however, must be given the credit of giving definite expression to an idea which Hermann Kopp independently took as the basis of his great work on the subject.

Garnier in 1852¹ proposed, as did Cannizzaro in 1858,² the following relation: if C be the specific heat of a compound, n the number of atoms, and A the molecular weight, then $\frac{AC}{n}$ is constant.

Kopp's Investigations on Specific Heats.

Hermann Kopp was among the first to draw the attention of chemists to the relation of physical properties of compounds to chemical composition; as early as 1841 he first stated his law of boiling points of homologous series of carbon compounds. The very existence of such a law-like relation struck many chemists as paradoxical; so axiomatic had seemed to them the assumption that the properties of elements are extinguished when these enter into combination that the regularity of the effect on the boiling-point of the addition of one atom of carbon and two of hydrogen to the molecule of a compound was combated at first, but has long been accepted in principle universally; other investigations with a similar object by H. Kopp need not be mentioned here. His work on specific heats of bodies in the solid state was part of this general plan, and his object in it was to find if possible a relation between the specific heats of compounds and of their component elements. With this object he made a large number of determinations of specific heats of elements, and of compounds prepared in the laboratory, as also of a number of minerals;³ and

¹ *C. R.* 37, p. 130.

² *Il Nuovo Cimento*, 7, p. 321.

³ *L. Ann. Supplement*, b. 3, 1864, p. 1; and *loc. cit.* p. 289.

showed how nearly the molecular heats calculated according to his theory agreed with those observed chiefly by himself and by Neumann, Regnault, and Pape. The principle of Kopp's theory is that each element in combination has the same atomic heat as when free in the solid state at such temperatures that both the element and the compound are so far removed from their melting-points that they may be considered to approximate to the state (if one may use the expression) of 'perfect' solids; for most of the elements the atomic heat is known by direct experiment; in other cases, according to Kopp, a value can be assigned to the atomic heat such that the molecular heats calculated by assuming it for compounds of this element shall agree well with those found by direct experiment, the molecular heat of a compound being thus supposed to be independent of its constitution, but dependent only on the number and specific heats of the elements composing it. As an example of his method of finding on his theory a theoretical specific heat of an element in the solid state take the case of oxygen; for oxides of the formula RO , where R is the atom of copper, magnesium, and a number of other metals whose atomic heats are for each not far from 6.4 which is the average value, Kopp finds the molecular heats of all, including for each the results of several experimenters, and calculates for all a mean value 11.1. Subtracting from this 6.4 the remainder 4.7 is the atomic heat of oxygen as deduced from the molecular heats of those oxides. Similarly for oxides of the general formula R_2O_3 he gets the mean molecular heat 27.1. Now, as R includes metals, all of which are shown to have atomic heat about 6.4, and the average atomic heat is 6.4, three times the atomic heat of oxygen = $27.1 - 12.8 = 14.3$; and the atomic heat of oxygen, as deduced from these oxides is 4.8. Other values obtained in a similar way are 3.7, 4.1, 4.2, 4.0, 3.4, 3.9. From all the separate values Kopp deduced an average of 4.0 for the atomic heat of oxygen; for that of sulphur and of phosphorus, 5.4; fluorine, 5; silicon 3.8; boron, 2.7; hydrogen, 2.3; and carbon, 1.8. For the rest of the elements in general, including the well-known metals except beryllium, together with nitrogen and bromine, he gives the atomic heat 6.4.¹

Specific Heats of Carbon, Boron, and Silicon—Weber.

Among the exceptions to Dulong and Petit's law, Kopp was obliged to admit carbon, boron, and silicon. Weber² was struck by the agreement of several experimenters as to the fact of the specific heats of different forms of carbon being unlike, and the atomic heats calculated from them having different values; and on comparing the temperatures within which Regnault, De la Rive, and Marcet, Kopp, Wüllner, and Bettendorf obtained their numbers for charcoal, gas-carbon, natural graphite, blast-furnace graphite, and diamond, he noticed that although for each form the different observers got different numbers, there was this peculiarity, that the lower numbers for each form of carbon always corresponded to lower temperatures: for example, the mean specific heat found by De la Rive and Marcet for diamond was .1146, the range of temperature being 3° to 14°; and that found by Regnault was .1469, the range being 8° to 98°.

On investigation Weber found that the specific heat of this substance, carbon, increases more rapidly than that of any other substance with rise of temperature, the specific heat of diamond near 200° being three times as great as it is near 0°. In order to get correct values of the specific heat

¹ *Loc. cit.* p. 329.

² *Ber.* 5, 1872, p. 503.

of diamond between 0° and 200° , he finds the mean heat-capacity of diamond at twelve nearly equal intervals between 0° and 200° , and thus finds the constants in an equation of the form $C'_0 = a + bt - ct^2$ to represent the mean heat-capacity between 0° and t° ; whence the specific heat at t is $a + 2bt - 3ct^2$. Similarly he finds for graphite an equation of the form, $\gamma_t = a + bt$ for specific heat at temperatures between 0° and 100° .

Dewar by an experiment in which varieties of carbon were successively heated by an oxyhydrogen flame on a bed of quicklime, using a water-calorimeter, found a mean specific heat $\cdot 42$ up to a temperature of about 2100° ; which would give an atomic heat of about 5 at some temperatures very much higher than 200° . This shows that a temperature can be reached at which the specific heat of carbon gives an atomic heat not much less than that required by Dulong and Petit's law.

Previously Dewar had found¹ a mean value of the specific heats of varieties of carbon between 20° and 940° , the temperature of boiling zinc; this mean specific heat was $3\cdot 2$.

Weber in 1874² continued his researches on the specific heats of varieties of carbon, and found results from a large number of experiments, from which he was able to deduce specific heats of diamond at a variety of temperatures up to nearly 1000° , the determinations of the specific heats of other forms of carbon being made at temperatures under 250° , at which their specific heats began to approach that of diamond closely. Weber's determinations showed that in reference to specific heat the forms of carbon other than diamond behave alike, but differently from diamond at the lower temperatures.

In accordance with what is known with regard to the relation of specific heat to temperature generally, there is no point at which it ceases to increase with rise of temperature; and although the true specific heat of a solid body will not be given at any temperature at which it begins to soften or to approach its liquid state, in the case of carbon there is no such danger; for the temperature at which it tends to soften or become liquid is so high that we cannot suppose that we are in the neighbourhood of it at 1000° . An inspection of the curve in Weber's paper of 1874, taken in conjunction with the curves of variation of specific heats of metals alluded to later on, will suggest that it is possible, by taking temperatures higher and higher by hundreds of degrees, to arrive at results in excess of the specific heat demanded by Dulong and Petit's law. The temperatures at which Dulong and Petit's law holds good for metals are not temperatures at which the specific heat is constant, but at which it varies steadily and slowly; and if this is the case, as it is for metals generally at ordinary temperatures, the specific heats are such as are in accordance with Dulong and Petit's law; this is a general result of experiment, but in the case of metals, which still at higher temperatures have specific heats increasing steadily above 100° as they do between 0° and 100° , experience does not warrant us in using the specific heats at higher temperatures (see Pionchon's results further on). The case of carbon has been shown by Weber to be entirely different from that of the metals, for at ordinary temperatures the specific heat increases with rise of temperature very much more rapidly; but after the temperature has been raised sufficiently high the specific heat at higher temperatures increases only moderately with rise of temperature, and carbon reaches the steady state

¹ *Phil. Mag.* 4, 44, p. 461.

² *Jahresb. f. Chem.* 1874, p. 64; and *Ann. Chim.* 5, 1876, p. 7.

in this respect, in which it is comparable with the general rule in respect to metals. Now this temperature, as is well seen in the diagram, is reached by diamond at 600° : and therefore if we are not arbitrarily to choose a temperature at which the specific heat will be such that the atomic heat of carbon is 6.4, the range of temperature within which we should determine the specific heat to test the conformity of carbon with the law of Dulong and Petit should not much exceed 900° , at about which temperature the specific heat is .45: this would give atomic heat of carbon 5.4.

By experiments with crystallised boron and crystallised silicon Weber found that the specific heats of both increased rapidly as the temperature rose, the specially rapid variation ceasing for silicon before 100° ; the atomic heat of silicon being 5.63 at 184° , and 5.74 at 300° . In the case of boron the specific heat rose rapidly up to 230° , and there is no result given to show at what temperature it becomes nearly constant. Moreover, the crystallised boron is not pure, always containing aluminium, as Hampe has shown.¹

It may be remarked that in respect of the relation of Dulong and Petit's law to the molecular heat of compounds at ordinary temperatures, Kopp finds that this relation is best expressed by taking the low atomic heats of carbon 1.8 rather than the value which more nearly agrees with Dulong and Petit's law.

Beryllium ;—Humpidge ; Nilson and Pettersson.

The specific heat of beryllium between 10° and 100° was found to be .47, from which the atomic weight 13.6 was deduced by applying the law of atomic heats. The impossibility of finding a place for a metal with this atomic weight in the classification of elements in the periodic system led chemists to doubt the accuracy of this specific heat, especially as the metal from which the specific heat was got was known to be not free from impurity. With the object of settling this point the late Professor Humpidge devoted a great amount of labour to preparing beryllium in a state as nearly pure as he could; and he succeeded in preparing some with not more than 0.8 per cent. of impurity.² He proceeded to make a great number of determinations of specific heats at various temperatures, and found that beryllium, like carbon, silicon, and boron, has a specific heat which rapidly increases with rise of temperature, and becomes nearly constant at temperatures above 400° , from that to 500° increasing quite slowly. The number .5403 within those limits when multiplied by 9.1 gives 5.64, which is not far from that required by the law of Dulong and Petit. Now analyses of the chloride and bromide had shown that, if their formulæ are BeCl_2 , BeBr_2 the atomic weight is 9.1; whereas the formulæ BeCl_3 , BeBr_3 correspond to atomic weight 13.6. Humpidge published a further paper³ giving details of his work on the specific heat, and of his determinations of the vapour-densities of the chloride and bromide, confirming that got by Nilson and Pettersson for the chloride.

The results of Humpidge were partly anticipated by Nilson and Pettersson in respect of the rapid increase of specific heat of the element,

¹ *L. Ann.* 183, 1876, p. 75.

² *Proc. Roy. Soc.* 38, 1884, p. 188; *Abs. C. S. J.* 1885.

³ *Proc. Roy. Soc.* 39, 1885, pp. 1-19.

in papers published by these authors in 1880.¹ But Humpidge worked without knowledge of this, and the general result thus obtained independently is conclusively established.

Nilson and Pettersson recently made² a series of determinations, in a new improved apparatus, of the vapour-densities of the chloride of beryllium at temperatures from 490° to 1500°, and found that above 680° the vapour-density remains constantly of the value corresponding to the formula BeCl_2 ; the vapour-densities for the chloride and the bromide mentioned before as determined by Humpidge led to the same result as to the atomic weight of beryllium, giving the formulæ BeCl_2 and BeBr_2 .

Specific Heats at Different Temperatures.

The variation of specific heat with temperature was investigated by Bède³ for certain metals; he found that the specific heat between 0° and t° was sufficiently accurately expressed by the formula $c = k + at$, in which k and a are constants depending on the nature of the metal. The results are given in the following table:—

Copper $k = \cdot 0910$	$a = \cdot 000023$
Iron = $\cdot 1053$	= $\cdot 000071$
Lead = $\cdot 0286$	= $\cdot 000019$
Tin = $\cdot 0500$	= $\cdot 000044$
Zinc = $\cdot 0865$	= $\cdot 000044$

The smallness of the fractions a shows how slow the increase of specific heat is with rise of temperature.

This, as Pionchon's investigations show, can only hold for moderate ranges of temperature.

Pionchon. Specific Heats at High Temperature.

Pionchon⁴ finds expressions for the total heat-capacities and the specific heats at temperatures from 0° to 1100° and over for the metals silver, tin, iron, nickel, cobalt, giving formulæ for these physical quantities for various high temperatures and wide intervals of temperature.

Thus, for silver, from 0° to 907°:—

$$Q = \cdot 0578t + 0_544t^2 + \cdot 0_86t^3;$$

whence

$$c = \cdot 0578 + \cdot 0_588t + \cdot 0_718t^2;$$

also for 907° to 1100°;

$$Q = \cdot 0748t + 17\cdot 20;$$

whence

$$c = \cdot 0748;$$

making for silver a nearly constant specific heat between 900° and 1100°.

Similarly for iron he finds the specific heat constant at $\cdot 218$ between 720° and 1000°; and again at $\cdot 1987$ between 1050° and 1200°.

For silver at 0° specific heat is $\cdot 05758$, and at 900° it is $\cdot 08008$.

Iron has at 0°, 600°, 660°, 700° specific heats $\cdot 11012$, $\cdot 19956$, $\cdot 2442$, $\cdot 32433$. These examples illustrate the great increase in specific heat as the temperature rises through hundreds of degrees in the case of these metals, and the increase is very striking in the case of iron, seeing that at the highest

¹ *Ber.* 13, 1451, 1784.

² *Ann. Chim.* 6, 9, 1886, p. 554.

³ *Mém. couronnés par l'Acad. Roy. de Belg.* 27, 1855, p. 1.

⁴ *C. R.* 103, 1886, p. 1122; *Ann. Chim.* 6, 1887, p. 1133.

temperature quoted the metal is very far from its melting or softening point; there is in fact, as these experiments, taken as a whole, show, a gradual increase in specific heat, which at three or four hundred degrees would remove the metal from the state with respect to specific heat required by Dulong and Petit's law.

He finds that silver melts at 907° , and that its specific heat before and after fusion is the same.

As in the case of silver, so in the case of iron, Pionchon refers the absorption of heat and almost constant specific heat of iron at two temperatures to some change of state in iron at those temperatures; and he thinks this idea confirmed by changes, at the neighbourhood of those temperatures, of the sign of the specific heat of electricity of iron observed by Thomson and by Tait.

Tin melts at quite a low temperature, about 230° ; 232.7° as found by Person;¹ and may be heated to a high temperature without volatilising. Thus Pionchon was able to make a thorough investigation into the specific heat of *liquid tin* from 232.7° to 1110° .

This investigation in respect of metals and Weber's on the specific heats of carbon constitute the greatest advance in our knowledge of the variation of specific heat of bodies in the solid state that has hitherto been made; for hitherto we had to be content with determinations made, as those by Dulong and Petit, and afterwards by Bède, at temperatures up to no higher than 350° .

The calorimetric method which Pionchon used is founded on Pouillet's principle² of determining the temperature of a ball of platinum by means of an air-thermometer, and the specific heat by letting the ball drop into a water-calorimeter of sufficient depth. A formula was thus obtained by Pouillet applicable to temperatures up to 1200° for the specific heat at any temperature t ; thus total heat-capacity of platinum between 0° and t° , or

$$q'_0 = .03237t + .000041t^2;$$

whence

$$c = .03237 + .000082t$$

gives the specific heat at t° by the air-thermometer.

Violle subsequently, in 1887, adopting Pouillet's method, found specific heats of platinum and other metals, using a more accurate air-thermometer than Pouillet's;³ his more accurate results for platinum were

$$q'_0 = .0317t + .000006t^2;$$

whence

$$c = .0317 + .000012t,$$

which is an equation from which t can be found when c is known.

Pionchon in this memoir finds the melting-point of silver to be 907° as against the temperature found by Violle, viz., 954° , which is much too high.

The Specific Heat of Water.

The specific heat of water is required in the determinations of temperatures by the use of the platinum ball and the water calorimeter; this was found by Regnault⁴ to be $1 + .00004t + .0000009t^2$ for temperatures between 0° and 230° by the air-thermometer.

¹ *Jahresb. f. Chem.* Fittica, 1847.

² *C. R.* 3. 1836, p. 782.

³ *C. R.* 1877, p. 543; 1878, p. 981; 1879, p. 702.

⁴ *Mém. de l'Acad.* 21, p. 729.

J. Bosscha gives¹ a formula $c=1+0.0022(t-18)$ as giving more accurate values, as he thinks, for the specific heat of water at various temperatures than Regnault's.

Neesen² found, as some other observers before him had found, that the specific heat of water diminishes from 0° up to a temperature as to which they are not agreed, and increases after that temperature. If this is so it is an exception to the otherwise almost invariable rule of increase of specific heat with rise of temperature.

According to some recent experiments by Cardani and Tomasini³ the mean specific heat of liquid water below 0° *diminishes* with rise of temperature, being, *e.g.*, .985 between -10.67° and 0°, and .953 between -6.52° and 0°.

In a paper by Professor Rowland on the mechanical equivalent of heat, presented to the American Academy of Arts and Sciences, June 11, 1879, the author shows how, by assuming the axiom that the heat equivalent to a definite quantity of energy is definite and constant, and repeating Joule's experiments, using a large range of temperature of the water in the calorimeter, the heat-capacity of water between two temperatures can be determined so as to enable the specific heats at various temperatures within those limits to be known, approximately. By this method, as also by the method of mixtures, referring the temperatures to Sir W. Thomson's absolute scale, Rowland was able to deduce the conclusion that the specific heat of water decreases through 4° to about 30° to 35°; a temperature at which it is a minimum, and above which the specific heat of water as usual increases with rise of temperature without change of the state of the water.

Carbon Compounds—De Heen.

Several organic compounds, organic acids and salts of organic acids in particular, gave, as found by P. de Heen,⁴ specific heats which varied considerably with the temperature below 100°; this may possibly be due to the temperatures being too high in these cases—or in most of them—to give specific heats corresponding to the truly solid condition as suggested by H. Kopp,⁵ the body being more or less softened by the heat. A similar caution had been mentioned by Regnault, who looked upon a *portion* of the latent heat of fusion as being added to the true specific heat in many cases, and in part accounting for the deviation of specific heats from the law of atomic heats. It was on account of an incipient softening effect of heat near 90° on the 'vitreous' modification of selenion⁶ that Regnault compared the specific heat of this modification with that of 'metallic' selenion at low temperatures, *e.g.* -20°.

Other Specific Heats.

Naccari⁷ gives a formula $\gamma=a(1+bt)$ for the specific heat at temperatures from 0° to over 200° for the metals copper, antimony, silver, cadmium, aluminium, lead, zinc, nickel, and iron; as an example,

¹ *Pogg. Ann.* 1874; *Jubelbd.* 549. ² *Wied. Ann.* 2, 18, 1883, p. 369.

³ *Nuovo Cimento* (3), 21, 185; *C. S. J. Abs.* 1888, p. 102.

⁴ *Bull. Acad. Roy. Belg.* (3), 5, 1883, p. 757; *Ber.* 16, 1883, p. 2655.

⁵ *Ber.* 19, 1886, p. 817.

⁶ *Ann. Chim.* 3, 46, 1856, p. 286.

⁷ *R. Acc. di Torino*, 23, 1887, p. 22; and *Beibl.* 12, 1888, p. 326.

for silver, a is $\cdot 05449$, and $b = \cdot 0003929$; so that ab , which is the coefficient of t , is $\cdot 0000184$.

And for copper, $a = \cdot 09205$; $b = \cdot 0002308$; and the specific heat of copper is

$$\cdot 09205 + \cdot 000021252t;$$

which agrees with Bède's

$$\cdot 0910 + \cdot 000023t$$

so far as Bède carried his approximation.

Quite recently Pionchon has made determinations¹ on the specific heat of quartz up to 1000° , and finds that it increases rapidly up to 400° from $\cdot 1737$ to $\cdot 305$; that from 400° to 1000° it remains remarkably constant. Now the molecular heat during this interval within which the specific heat of quartz is so nearly constant is $60 \times \cdot 305 = 18\cdot 3$; and this is $3 \times 6\cdot 1$, so that at these temperatures silica in the form of quartz has a molecular heat which corresponds to Cannizzaro's rule.

In reference to this Kopp quotes, from a memoir which he published in 1879,² a passage in which he says that it is not unlikely that the molecular heats of *compounds* of elements, which at ordinary temperatures have atomic weights not in accordance with Dulong and Petit's law, may possibly when raised to higher temperatures be so increased as to be in accordance with Garnier and Cannizzaro's rule, and that compounds, which are exceptions of Neumann's law as to the molecular heats of compounds of like atomic composition, may in this way come into accordance with it; although it is often impossible to realise the conditions required on account of approaching the fusing-point of the body, or exceeding the temperature at which the compound begins to decompose.

Kopp remarks that the molecular heat $18\cdot 3$ for SiO_2 , not only gives a result $3 \times 6\cdot 1$ nearly in accordance with Garnier and Cannizzaro's rule, but approaches nearly to the numbers for compounds of the formulæ XCl_2 , XBr_2 , XI_2 ; which are found by his experiments to vary between this number and $19\cdot 0$; and at the high temperatures of Pionchon for quartz this compound ranges itself among the compounds to which Neumann's rule applies.

The elements which are at ordinary temperatures exceptions to Dulong and Petit's law, so far as is known at present, are elements with small atomic weights, including sulphur, with atomic weight 32. The metal magnesium, with atomic weight 24, has a normal atomic heat; while that of aluminium, atomic weight 27, is low, about $5\cdot 7$; and that of beryllium, atomic weight $9\cdot 1$, is among the exceptions, the atomic heat being about 4; but the specific heat of beryllium varies immensely between 0° and 400° .³

Specific Heat—Liquids.

The specific heat of many liquids was found by Regnault⁴ for various temperatures; these were found always to increase with rise of temperature; but no general relation could be found connecting specific heats of bodies in the liquid state with molecular weights, temperature, or dilatation. In the liquid state the considerable internal, as well as some external, work complicates the expression, the dilatation, in fact, in the

¹ *C. R.* 106, 1888, p. 1344.

² *Ber.* 12, p. 896.

³ See Humpidge, *Proc. Roy. Soc.* 1885.

⁴ *Mém. de l'Acad.* t. 26, pp. 262–295.

case of liquids being rapid, so that the internal work becomes a very important part of the whole heat consumed in raising the temperature.

Recently Schiff has studied the specific heats of liquid organic compounds,¹ and has determined the specific heats of liquid hydrocarbons, alcohols, acids, and ethereal salts at different temperatures, and arrives at the following results among others: All ethereal salts of fatty acids, of the formula $C_nH_{2n}O_2$, have the same specific heat at the same temperature, being represented by the formula $K = 4416 + 00088t$. Again, following Van der Waals' method for finding points of comparison for bodies in the liquid or gaseous state, he finds the critical temperature by the rule laid down by Pawlewski² for the same ethereal salts—that their critical temperatures are to be found by adding 182.3 to their boiling-points at 760mm. Schiff divides the distance of the critical temperature from the absolute zero into 100 equal parts, which he calls critical degrees, and finds that *equal volumes* of these liquids have the same heat-capacity at the same critical degree.

Specific Heat. Gases and Vapours.

We will now consider the case of specific heats of bodies in the state of gas or vapour.

Gay-Lussac³ gave an account of some experiments for determining specific heats of gases at *constant pressure*, and concluded that the specific heats (or heat-capacities) of equal volumes of bodies in the gaseous state were equal; but further investigations by himself and a number of other physicists made it soon appear that the problem was more complex than was supposed, and that variations of temperature are of vital consequence.

It was not until Regnault undertook his investigations that any satisfactory collection of experimental results was obtained. From 1840 onwards Regnault occupied himself, among other physical and chemical investigations, with the subject of specific heats of bodies in the solid, liquid, and gaseous states. The work on this subject in respect of the gaseous state is part of the vol. xxvi. of the 'Mém. de l'Acad. des Sc.'

Regnault's Results for Gases and Vapours.

The following results were obtained by Regnault for atmospheric air at atmospheric pressure approximately constant:—

Between 30° and +10°	. . .	0 . . . +100°	0 . . . +200°
Specific heat	0.23771 . . .	0.23741	0.23751

hence the specific heat of air between 0° and 200° (for a certain nearly constant pressure, viz., atmospheric pressure) is independent of the temperature and = 0.2375. The temperatures were those of an air-thermometer.

For oxygen two experiments gave 0.21627, 0.21876, or a mean value 0.21751 for the specific heat between 7° and 200°. To compare the heat-capacities of equal *volumes* of oxygen and air, 1.10563 being the specific gravity of oxygen (air = 1), we have 1.10563×0.2175 to 0.2375, or 0.2405 to 0.2375 as the ratio of the heat-capacities. Thus the heat-capacity of a volume of oxygen at 760 mm. and a temperature between

¹ *L. Ann.* 231, p. 300; *C. S. J. Abs.* 1887, p. 6.

² *Ber.* 15, p. 2460; *C. S. J. Abs.* 1883, p. 276.

³ *Mém. d'Arcueil*, t. i. 1807, p. 180.

0° and 200° is greater than, but very little different from, that of the same volume of air under the same conditions.

And, for *nitrogen*, the heat-capacity between 0° and 200° is about the same as that of the same volume of air or of oxygen, for atmospheric air consists mainly of nitrogen and oxygen.

For *hydrogen* between about 0° and 200° the specific heat was found in four experiments to be:—

3·4196 3·4042 3·4108 3·4014

of which the mean value is 3·4090 for specific heat of hydrogen under the conditions of atmospheric pressure and any temperature between 0° and 200°. For low temperatures, as between 10° and -30°, Regnault got a mean value 3·3996, agreeing fairly with the value for higher temperatures. As in the case of oxygen, so here, multiplying the four results by 0·0692, the specific gravity of hydrogen (air = 1), the mean of the results compared with 0·2375 is the heat-capacity of hydrogen gas compared with that of an equal volume of air; this is 0·2359 to 0·2375; thus the heat-capacity of hydrogen is sensibly the same as that of an equal *volume* of air, the experiments giving for hydrogen a very slightly lower value.

On the above results Regnault remarks that air and gases, which at ordinary temperatures obey Boyle's law, are equally expanded by equal increments of temperature up to temperatures as high as and higher than 300°; and that, as shown above, the heat-capacity of air is the same for equal temperature-intervals independently of the initial temperature as measured by the dilatation of air (by an air-thermometer); and, as the same constancy is observed in the case of other gases which obey Boyle's law, shall we not, he asks, *be led to admit that the air-thermometer indicates temperatures in a manner proportionally to the quantities of heat which it receives?* (p. 109.)

The above and a few other of Regnault's results are tabulated below:—

	Specific heat	Heat-capacities of equal volumes
Air	0·2375	0·2375
Oxygen	0·2175	0·2415
Nitrogen	0·2368	0·2438
Hydrogen	3·4090	0·2359
Hydric chloride	0·1845	0·2333
Carbon monoxide	0·2450	0·2370
Nitric oxide	0·2321	0·2406
Chlorine	0·1210	0·2964
Carbon dioxide	0·2169	0·3307
Nitrous oxide	0·2262	0·3447

In the case of the first seven of the above gases the specific heat remained constant up to 200°, and these seven are gases which very approximately obey Boyle's law. It is to be remarked that in the case of these the heat-capacities of equal volumes are very nearly equal at atmospheric pressure.

In the case of chlorine, and still more of carbon dioxides and nitrous oxide, the heat-capacities of equal volumes vary with the temperature, the values for a given range of temperature being less the lower the mean temperature of the range and increasing as this temperature rises up to 170° in these experiments; the specific heats therefore increase

with rise of temperature. Regnault (p. 129) remarks that this increase of specific heat with rise of temperature is probably true of all gases the elasticity of which deviates much from Boyle's law.

Volatile Liquids—Regnault.

The specific heats of vapours of volatile liquids were determined by Regnault, by experiments described in this memoir, in which the total heat was directly given which was yielded by the body in the state of vapour in passing from the temperature of the vapour to the temperature of the calorimeter, in which the liquid was condensed: this heat consists of the heat-capacity of the vapour from the highest temperature taken to the temperature of condensation *plus* the heat given off at this temperature by the mass of vapour in becoming liquid *plus* the heat given out by the liquefied vapour in passing from this temperature to the temperature of the calorimeter. Thus the heat-capacity of the vapour as such between two temperatures is not given by any one experiment. Regnault endeavours to get rid of the two unknown quantities of heat simultaneously by eliminating them between two different experiments, in the one the temperature of the vapour being lower than in the other; in each experiment the weight of the liquid condensed is found, as also the difference between the highest temperature of the vapour and the temperature of the calorimeter, whence can be calculated the total heat given out by *unit weight* of the substance in passing from the temperature of the vapour at starting to the temperature of the calorimeter. Now the results of the two experiments differ in respect of the initial temperature of the vapour and the final temperature of the liquid in the calorimeter; the initial temperature in one of the experiments is taken as high as conveniently can be, and the final temperatures are reduced to 0° by adding to the total heat in the case of each experiment the total heat-capacity of the liquid between the temperature of the calorimeter (say about 8° to 20°) and 0°. This last is a comparatively small *correction* for each experiment, and the *difference* only of these corrections enters into the result. For the result is obtained by subtracting the corrected result of one experiment from that of the other, the difference being the total heat-capacity of the *vapour* between the initial higher temperatures of the pair of experiments. Dividing the number thus got by the interval of temperature, the quotient is the mean specific heat of the vapour between these temperatures.

In addition to the bodies in the list given above, Regnault obtained results for heat-capacities of equal volumes of the following gases and vapours: marsh gas, olefiant gas, sulphur dioxide, ethyl chloride, hydric sulphide, ammonia; and the vapours of water, ether, alcohol, carbon disulphide, benzene, oil of turpentine, methyl alcohol, ethyl cyanide (propionitril), ethyl bromide, ethyl sulphhydride, ethyl acetate, acetone, ethene dibromide, chloroform, bromine, silicon chloride, phosphorous chloride, arsenious chloride, titanous chloride, stannous chloride. As the result of the whole series of experiments on the bodies chosen, Regnault comes to the conclusion that there is no *general relation* of the specific heat and molecular weights of bodies in the state of gas or vapour corresponding to Dulong and Petit's law as to elements in the solid state.

Specific Heat and Pressure.

In the cases of atmospheric air, hydrogen, and carbon dioxide, Regnault found by experiments at several atmospheres' pressure, *e.g.*, for air 12·4 atmos., no observable difference in the specific heat of unit mass due to pressure, but that this is not the case for chlorine, at least at ordinary temperatures, and is probably only true for bodies at temperatures at which they conform to Boyle's law.

Specific Heat of Elements in the Gaseous State.

He concludes¹ that the law which had been announced by several physicists, 'that simple bodies (elements) in the state of gas had identical specific heats (heat-capacities) of equal volumes,' can only be considered as an 'ideal law,' applicable to bodies which had quite uniform laws of compressibility and dilatation (obeying Boyle's and Gay-Lussac's laws exactly), and therefore not applicable to bodies as we actually know them in the state of gas.

Specific Heats of Liquids—Regnault.

From experiments on a number of bodies, *viz.*, water, bromine, alcohol, ether, carbon disulphide, methyl alcohol, acetone, ethyl sulphide, ethyl chloride, ethyl bromide, ethyl cyanide, ethyl acetate, chloroform, ethene dibromide, benzene, oil of turpentine, silicon chloride, phosphorous chloride, arsenious chloride, stannic chloride, titanous chloride, of which the specific heats in state of vapour were determined, Regnault determined the specific heats in the liquid state, and found that the mean specific heat of each body in the state of gas is always less than in the liquid state, especially when compared at about the same range of temperature; and that in the case of several of the bodies the former value is only a small fraction, less than half, of the latter. Hence, he says, there cannot exist a rigorous law connecting specific heats of bodies with their atomic (or molecular) heats alone, for the specific heats vary, as he has shown, with change of temperature and of state.

It must here be mentioned that Joule² published the results of three experiments on the specific heat of air, the mean of which gave 0·2296; these are noticed by Regnault.³

Specific Heat at Constant Volume—Regnault.

The experimental results given by Regnault are obtained in every case by finding the amount of heat given to the calorimeter by a gas or vapour parting with heat either at atmospheric pressure or at some constant, or nearly constant, pressure greater than atmospheric. The problem of finding the specific heat of a gas or vapour, the *volume* of which is not allowed to vary, is solved by applying the principles of thermodynamics to the results for constant pressure. Through the ranges of temperature within which Regnault worked, the following gases alone were found to have specific heats independent of temperature and of pressure, so far as the effect of pressure was determined: oxygen,

¹ *Mém.* xxvi. p. 309.² *Phil. Mag.* vi. p. 143.³ *Mém.* xxvi. p. 40.

nitrogen, hydric chloride, carbon monoxide, nitric oxide; bodies which, as gases, show a remarkable conformity to Boyle's and Gay-Lussac's laws in respect of the variation of volume with compression and dilatation; for such bodies the heat-capacities of equal volumes at *constant pressure* were found to be nearly the same, the smallest value being 0·2333 for hydric chloride, and the largest 0·2438 for nitrogen.

If we can assume for each of these gases that a volume of it experiences no change of temperature as a consequence of expansion into a vacuum—that therefore no *internal work* is employed in the act of expanding—the specific heat at *constant volume* can be calculated from that at constant pressure in each case by calculating the thermal equivalent of the external work done by the expansion of 1 gram of the gas from 0° to 1° against the pressure of the atmosphere and subtracting this result from the specific heat at constant pressure; the remainder is the specific heat at constant volume.

From this can easily be deduced the heat-capacity of a litre of the gas at constant volume by multiplying the specific heat of (a gram of) the gas by the gram-weight of a litre of it; the result so obtained as the heat-capacity of a litre of air at constant volume is 0·218; and the difference would be the same for each of the gases mentioned if its changes of volume by compression and dilatation accurately followed Boyle's and Gay-Lussac's laws, and if the internal energy suffered absolutely no change. The actual result in each case is only approximate and subject to varying amounts of error, due to the greater or less deviation of the above suppositions from accuracy within the conditions of the experiments.

The approximate specific heat of air at constant volume is ·1685; at constant pressure ·2375, the difference ·0690 being the heat equivalent of the external work done by one gram of air against atmospheric pressure under the conditions.

Again the specific heat of hydrogen at constant pressure being 3·408, that at constant volume is 2·415, the difference being ·993 which is the equivalent of the work done by the expansion of 11·16 litres (the volume of 1 gram of hydrogen at 0° and 76 cm.) against the atmospheric pressure 76 cm. during the rise of temperature of this volume of hydrogen from 0° to 1°.

The heat-capacity of 2 grams (or 22·32 litres under the same conditions) of hydrogen is therefore 6·816 at constant pressure, 4·830 at constant volume, the difference being $2 \times \cdot993 = 1·986$.

The appended table gives the specific heats at constant pressure and at constant volume of 22·32 litres of a number of gases referred to 0° and 76 cm., calculating that at constant volume from that at constant pressure as above.

	At constant pressure.	At constant volume.
Hydrogen	6·846	4·830
Nitrogen	6·826	4·840
Oxygen	6·960	4·974
Hydric chloride	6·769	4·783
Carbon monoxide	6·860	4·874
Nitric oxide	6·951	4·965
Chlorine	8·591	6·605
Ammonia	8·643	6·657
Methane	9·488	7·502
Ethylene	11·312	9·326

In the above table it will be noticed that the first six gases have

nearly identical heat-capacities (of 22·32 litres) whether at constant pressure or at constant volume; and these are the gases for which Regnault found that the specific heats did not vary much with variation of pressure or of temperature; they also obey the laws of Boyle and Gay-Lussac very well. Of the remaining four, chlorine deviates more than the others from agreement with the laws mentioned; while ammonia behaves in accordance with these laws, and methane does not deviate much; but the heat-capacity of a given volume of ammonia is very different from that of an equal volume of either of the first six gases in the table, as also are those of the gases methane, ethylene, chlorine, and others; while the heat-capacities of equal volumes of vapours of a large number of liquids examined were still farther removed from those of the same volume of the six gases mentioned in the table; of which the heat-capacities of equal volumes are equal to that of air within 1 per cent., with the exceptions of oxygen and nitric oxide, in which the difference is just above 1 per cent. and of hydric chloride in which the difference is a little less than 2 per cent. Now the aberrations of chlorine and ammonia from the rule of constant heat-capacities of equal volumes of bodies in the gaseous state are, as seen by comparison with the six gases, glaringly wide; the rule does not hold even approximately for chlorine and ammonia. The deviations of these two gases from conformity with Boyle's and Gay-Lussac's laws seem an inadequate explanation; in the case of ethylene, again, the rule of heat-capacities entirely fails. This rule is therefore not supported by these wide investigations of Regnault.

E. Wiedemann on Specific Heats of Gases.

E. Wiedemann¹ repeats a number of Regnault's experiments on these specific heats, with improved apparatus and methods, and with a modification which in the case of vapours avoids condensation in the calorimeter, so that the specific heat of the vapour is determined directly in *one* experiment and not by the difference of two experiments, as in Regnault's method; the results differ slightly from Regnault's and are probably more accurate, but go no nearer to finding any general law. The chief addition made by Wiedemann is the determination of the variation of specific heat with temperature in the case of a considerable number of gases and vapours. With reference to the hint thrown out by Regnault, as to the possibility of an ideal law applicable to ideal gases, and corresponding to Dulong and Petit's law for solids, Wiedemann finds the true specific heats of various gases, including nitrous oxide, carbon dioxide, and ammonia, and finds that the specific heat of ammonia varies less with the temperature than either of the other two, while it approaches more nearly to a perfect gas in its elasticity or in its conformity with Boyle's law. Thus Regnault gives² for $pv/p'v'$, where p' is about $=2p$, the values 1·00651 and 1·01881 for nitrous oxide and ammonia respectively, showing nitrous oxide as nearer to the condition of a perfect gas than ammonia. Thus of the two gases nitrous oxide and ammonia the more nearly perfect gas, nitrous oxide, has a more variable specific heat than the less perfect gas ammonia. But these two gases, as also carbonic acid gas, are too far from perfect gases to justify any inference on that score alone as to specific heats; it is still possible that, if all three gases could have their specific heats

¹ *Pogg. Ann.* 157, pp. 1-42; and *Wied. Ann.* 2, 1877, p. 195.

² *Mém. de l'Acad.* t. xxvi. pp. 251, 252.

determined with sufficient accuracy at such higher temperatures and lower pressures that they conformed in regard to both compressibility and dilatation as well as do hydrogen, nitrogen, and oxygen under normal conditions, the specific heat of each of the three gaseous compounds mentioned would behave similarly. But in fact, as will be seen further on, the nature of the molecule itself affects most powerfully the value of the specific heat; while the specific heat of a gas or vapour increases with rise of temperature, and is independent of the pressure at temperatures such that the gas nearly obeys Boyle's law.

The Ratio of the two Specific Heats.

The ratio (k) of specific heat at constant pressure to that at constant volume is greater than unity; in the case of air and of another gas or mixtures of gases whose dilatation is normal, the *maximum* value of this ratio was calculated by Clausius to be $1\frac{2}{3}$, or 1.6. This number was by A. Naumann¹ supposed to represent the value for gases whose molecules are single atoms and as an example for mercury-vapour.

Relation of k to the Velocity of Sound.

The value of the velocity of sound at any given temperature was shown by Laplace to depend on the ratio k ; so that experiments on a gas from which the velocity of sound can be deduced give the means of determining k . Now values of the velocity of sound in various media have from time to time been found by a number of experimenters, and from these values in the case of gases or vapours approximate values of k have been calculated. Kundt, after determining the velocity of sound by a new method devised by him in 1866² in a number of solid bodies, applied his method, in conjunction with Warburg,³ in 1868 to a comparison of k' for mercury vapour with k for air; a number of determinations were made with different forms of apparatus, and the mean of the values (1.1886) multiplied by the ratio k for air is the ratio k' for mercury vapour. Now Röntgen⁴ found the value 1.405 for air; hence for mercury vapour $k'=1.67$ ⁵ which is almost exactly the same as the number $1\frac{2}{3}$ calculated by Clausius.

Specific Heats of Gases and Vapours at High Temperatures.

The results obtained for specific heats of bodies, simple and compound, in the state of gas or vapour, although of great physical importance, admit of no inference of a general nature as to the relations of specific heats to known properties, physical or chemical, of the chemical elements themselves in the free state or in combination. The specific heats of a few elements and compounds which obey Boyle's and Gay-Lussac's laws very nearly in the gaseous state are approximately, within the limits of temperature 0° to 200°, independent of pressure and temperature, and are such that the heat-capacities of equal volumes are nearly the same for these gases; but with all other gases and vapours this is not true, not even approximately for ammonia or chlorine; and we are far, apparently, from any very important generalisations with regard to specific heats

¹ *Ann. Ch. Pharm.* 142, 1867, p. 267.

² *Pogg. Ann.* 127, p. 497.

³ *Ibid.* 135, pp. 337, 527.

⁴ *Ibid.* 148, p. 980.

⁵ *Ber.* 8, 1875, pp. 945-948.

of bodies in the gaseous state. And this is the case in spite of very important work in this direction done in recent years, and in which the range of temperature has been extended enormously; yet as the results of these experiments throw light on properties of bodies at high temperatures in the state of gas, and give a new method of investigating specific heats at very high temperatures, they cannot be passed over.

The investigations referred to are those of Mallard and Le Châtelier on the one hand, and on the other those of Berthelot and Vieille; and the method of investigation—which was not directed wholly nor even mainly to the determination of specific heats—was that of exploding explosive gaseous mixtures in a closed spherical or cylindrical metal reservoir, the mixture being exploded alone in some experiments, and in others mixed with varying quantities of one of the two gases of the explosive mixture, or of some other gas; by an explosive mixture being here meant a mixture of two gases in the proportions in which they react to produce the explosion. So far as these investigations are concerned with specific heats of gases, it is evident that these are specific heats of constant volume.

Investigations of Mallard and Le Châtelier.

It is impossible to do justice to the work either of Mallard and Le Châtelier, or of Berthelot and Vieille, in reference to specific heats of gases as deduced from their experiments without an elaborate digest of their work on explosions; it will suffice the purpose of this paper to give a very brief summary of results. The complete work of Mallard and Le Châtelier on the 'Combustion of Gaseous Explosive Mixtures' is published in the 'Annales des Mines,' 1883, 'Mémoires,' t. iv. pp. 274-568, the scope of the communication being (p. 275) the determination for the different gaseous mixtures studied of—

1. The conditions necessary to the production of quick combustion, *i.e.*, the *temperature* of ignition.

2. The *rate* at which inflammation started at a point *propagates itself* in a gaseous mixture, and in general the circumstances which characterise this propagation.

3. The *pressure* which is produced in a close vessel in consequence of the combustion of the gaseous mixture which is enclosed; whence one can deduce the *law of cooling* of hot gases situated in a cold enclosure; the *temperature* produced by the combustion; and finally the nature of the variations which a very high temperature makes in the *specific heats* of gases.

Each of these three parts is the object of a special memoir in this volume.

The Apparatus used.

At first Mallard and Le Châtelier used a modified and enlarged form of eudiometer, such as was used by Bunsen in his experiments¹ but with a Deprez indicator to give the maximum pressure in each experiment; the eudiometer was provided with platinum wires between which an electric spark passing exploded the mixture of gases, and the maximum pressure due to the explosion was recorded. It was soon found, however, that explosions in such an apparatus gave irregular results from which no certain conclusions could be drawn; for explosions in narrow tubes gave

¹ *Pogg. Ann.* t. cxxxi. 1867, p. 161; and *Ann. Chim.* (4), t. xiv. 1868, p. 446.

rise, after a very small fraction of a second from the beginning, in the most explosive mixtures to a very fugitive pressure, due to an effect of the 'explosive wave' discovered by Vieille and Berthelot¹ whereby pressure is added during the propagation of the wave of pressure, so that the pressure of a layer distant from the centre of propagation is momentarily greater than of those nearer, and is therefore greater than the pressure becomes after the very short interval during which it is equalised; the very sensitiveness of the Deprez arrangement and the fact that it recorded just the *maximum* pressure were therefore obstacles against getting a true idea of the state of the gas as a whole during the explosion as to pressure. The explosive wave for oxyhydrogen mixture has the uniform velocity of about 2,810 metres per second; this is called the *specific* velocity of the explosive wave for this gaseous mixture, and is independent of the initial pressure.

The Deprez indicator was therefore discarded in favour of a manometer devised by Bourdon, which indicated the pressures throughout the whole process of explosion and cooling. In place of the eudiometer a cylindrical vessel was used with diameter of its circular base equal to the height of the cylinder, the explosion being made at the centre of the cylinder; the propagation of the explosion in this vessel was free from the irregularities incident to the eudiometer. This wide cylinder in fact was nearer in its shape and in its action to a sphere in which the explosion is started at the centre, this being an arrangement the extreme importance of which was not fully recognised at first; the advantage of the spherical arrangement being that, as the propagation of the explosion takes place uniformly in all directions, the effect would reach all parts of the inner surface of the sphere at the same time, the temperature and pressure would be more rapidly equalised throughout the gaseous mixture, and the cooling would be regular from every portion of the outer surface.

Connected with this manometer was a style for marking on a sheet of paper surrounding a vertical cylinder, which is made to rotate rapidly and uniformly during an experiment, a line representing the rise and fall of pressure throughout the explosion and subsequent cooling.

The whole duration of an explosion is a small fraction of a second in the case of the most explosive mixtures, and generally one second in these experiments is a large interval of time.

Mallard and Le Châtelier. Experiments and Results.

By observation of the rate of cooling, or strictly of the variations of the pressure during the whole period of cooling, after an explosion, through the diminution of pressure as registered by the chronograph for intervals of 0.01 or a smaller fraction of a second, a curve is got giving the relation between pressure and time, intervals of time being registered by the abscissæ, and the pressures by the ordinates. An equation is then found by theory to express the results of direct observation, and the equation is normally that of a straight line, of which the abscissæ and ordinates are known from the conditions and recorded progress of the pressure in each experiment. The form of the equation will be different according as there is or is not condensation, as there is, *e.g.*, when water is one of the products of explosion. Now by these formulæ the rate of cooling is represented by means of a straight line, and this straight line in most cases should cor-

¹ *C. R.* t. xciii. p. 21; t. xciv. pp. 101, 149, 822; t. xcv. pp. 151 and 199; *Ann. de Chim.* (5), 28, 1883, p. 289.

respond with the result obtained from the tracings of the style during the whole period of cooling; this, however, is not always the case, and in the exceptional cases it is found that, if the new curve is plotted out from the numbers given by the experiment, the later portion of the cooling will be represented by a straight line almost exactly for a considerable distance; but the line is found in some cases to be for a portion of its length curved, the curved portion corresponding to very great temperatures and pressures. The interpretation of these cases is that at the highest pressures, and therefore the highest temperatures, there is *dissociation*, and that on cooling the dissociated gases gradually recombine till at the temperature and pressure at which they have entirely combined the line becomes straight through the rest of the cooling. Thus the line deduced from the observed rates of cooling by means of the formula is straight except in cases of dissociation.

A case in point is carbonic acid gas which undergoes dissociation at high temperatures, so that when CO and O are mixed without being dried¹ and the mixture exploded it is calculated that a temperature of 3100° is reached, and that only about '6 of the mixed gases have combined; on cooling the remaining mixture of CO with O gradually combines until at about 1800° there is no dissociation, and from 1800° to the temperature of the room throughout CO₂ is the only gas cooling. H₂O vapour is not dissociated in the conditions of these experiments below 3350°.

From Berthelot's and J. Thomsen's long-continued thermo-chemical researches there are obtainable abundant data for the total heat of combustion of hydrogen, carbon monoxide, cyanogen, methane, for the heat of formation of hydric chloride from its elements, and of the conversion of cyanogen by oxygen into nitrogen and carbon monoxide, and for other reactions between gases which can be brought about by explosion.

In the case of an explosive mixture of hydrogen and oxygen it is found that there is no dissociation at the temperature of combustion 3360°, the pressure corrected for cooling during combustion being 619 cm. of mercury. By adding to the explosive mixture a volume of hydrogen and exploding after this addition, the temperature of explosion, as found from the observed pressure and rate of cooling, is lower the more the mixture is diluted with hydrogen, remaining explosive. Calling now in any case the total heat of combination Q , the temperature (corrected for cooling) T , and c the mean heat-capacity of 18 grams of water-vapour between 0° and T °, we have $Q = cT$; whence c is found to be 16·5 for the high temperature 3360° of this experiment (allowance having been made for water-vapour present before the explosion). Values of c for lower temperatures are found by adding CO₂ to the explosive mixture of hydrogen and oxygen, the explosion giving temperatures at which CO₂ is not appreciably dissociated; from these values of c the next step is to find a formula of the form $c = a + bt$, or with a third term in t^2 , for the heat-capacities of 18 grams of water-vapour for temperatures up to or beyond 3000°.

Returning now to cases in which oxyhydrogen mixture is mixed with hydrogen and this mixture exploded, Q being the heat produced by the explosion, at constant volume, of the hydrogen and oxygen which form 18 parts of water, and m being the mass of hydrogen added, c' the mean heat-capacity of this hydrogen from 0° to the temperature T' produced by the

¹ See Dixon, *Phil. Trans.* 1884, Part II.; and *Chem. News*, 46, pp. 151, 152. 1888.

explosion, we have $Q = (c + mc') T$, from which now that c is known c' can be found for various temperatures; and hence the specific heat of hydrogen at different temperatures can be deduced. Similarly for the specific heats of oxygen and nitrogen.

Above we have assumed the specific heats of CO_2 known below the temperatures of its dissociation: these are found from the results of exploding CO and O with varying quantities of CO_2 sufficient for the mixture to explode at temperatures below 2000° ; from the results of such experiments, the product being CO_2 alone, a formula can be found to give the specific heats of CO_2 at various temperatures below 2000° .

It should be mentioned in reference to the specific heats of vapour of water that Wüllner¹ deduces, from experiments of his own combined with Regnault's, the number 1.173 as the ratio between the specific heat at 100° and 0° , and that Winckelmann,² from experiments with reference to the coefficients of conduction of heat by gases and vapours, deduced for the same ratio the number 1.172, which agrees closely with Wüllner's.

For the very high temperatures produced in these explosion experiments the observed pressures, which excluded the momentary highest pressure of the explosive wave, often exceed 600 cm. of mercury, but do not exceed 10 atmospheres, and are under 8 mètres; and it may therefore be safely said that, apart from dissociation, the gases raised to these high temperatures at constant volume behave approximately as perfect gases in respect to pressure and temperature, so that for each gas the pressure is nearly proportional to the absolute temperature. The equation $C_p = C_v + 1.98$ therefore holds approximately (p. 28) and gives us an easy method of deducing the specific heats, and also the molecular heat-capacities of the gases at constant pressure.

MM. Mallard and Le Châtelier found that if for any volume of one of the four gases hydrogen, oxygen, nitrogen, carbon monoxide we replace in an explosive mixture of gases an equal volume of another of the four, throughout the whole range of temperatures embraced in their experiments the temperature of combustion remains unaltered; these observations led them to propound in 1882³ the following law: *The molecular heat-capacities of perfect gases which are equal to each other at ordinary temperatures are also equal to each other at about 3000° and perhaps above.*

As the temperature rises the specific heats, not only of gases and vapours in general, but of those called perfect gases also, increase; the latter, it is true, *very much more slowly*, so that the difference between the specific heats of, e.g., water-vapour or CO_2 and of the so-called perfect gases is a great deal more marked at 2000° than at 0° : this is seen in the numbers given below for the molecular heat-capacities at constant volume of

	at 0°	at 2000°
The 'perfect' gases	4.8	6.0
H_2O vapour	5.6	12.2
CO_2	6.3	13.6

HCl was shown to have the same specific heat, or nearly, as the other perfect gases up to 1800° , and to dissociate not much before 2400° , the temperature of explosion of HCl . A similar rapid increase in specific heat with rise of temperature was observed for chlorine as for CO_2 and H_2O . These results were confirmed subsequently by Berthelot and Vieille.

¹ *Wied. Ann.* 4, 1878, p. 7.

² *Pogg. Ann.* 159, 1876, p. 177.

³ *C. R.* 96, 1883.

The authors, by showing that the specific heats of the so-called perfect gases obey the law applicable to all other gases and vapours—that the specific heat increases as the temperature rises—have shown that one supposed distinction between these and the rest does not exist; and draw this distinction between specific heats of gases and Boyle's and Gay-Lussac's volume relations, that whereas the latter are concerned with intermolecular actions mostly and with the motions of the centres of mass of the molecules, *the former are concerned also with the nature of the molecule itself and of the relations of its component parts to each other.*

So far as specific heats are concerned it would seem then that the general results gained by these experiments at very high temperatures were two: that the specific heat in all cases of bodies in the state of gas or vapour increases with the temperature, and that when a gas at high temperatures obeys Boyle's law its specific heat is independent of the pressure; but this is not quite all, for that the laws of specific heats of bodies in the gaseous state are to be looked for in the very molecules themselves is a very important guide for any future investigations.

Papers on portions of the above subject have appeared from time to time in the 'C. R.'; as in 'C. R.' 91, pp. 125–828; 93, pp. 145–148; pp. 1014–1016; pp. 1076–1079; 95, pp. 599, 1352; 97, pp. 102, 157; also in the 'Bull. de la Soc. Chim.'; 'Bull.' 2, 39, pp. 268, 369, 572; 48, p. 122.

In the last-named communication¹ Le Châtelier, noticing that the curves of specific heats of CO₂ and H₂O vapour converge to a point below the absolute zero, infers that probably the specific heats of *all gases* tend to the same limit as the temperature approaches absolute zero. He proposes a formula for the molecular heat-capacities of gases, $C = 6.8 + aT$, at constant pressure, 6.8 being the value for 'perfect' gases, T the absolute temperature, and *a* a constant for each gas depending on the nature of the molecule of the gas, and being greater the more complex the molecule. Applying this formula to CO₂ and vapour of water, the results for different temperatures agree well with those given by the experiments of Mallard and Le Châtelier. If this result is accepted the problem of specific heats of bodies in the state of gas or vapour reduces itself to that of finding the general relation which connects *a* with the molecule.

*Specific Heats of Gases and Vapours at High Temperatures—
Berthelot and Vieille.*

The investigations of Berthelot and Vieille on explosions of gaseous mixtures led to similar conclusions to those deduced by Mallard and Le Châtelier as to the specific heats of bodies in the state of gas at very high temperatures.

In the 'C. R.' 94, pp. 101–108 Berthelot and Vieille give an account of the phenomena accompanying the detonation in a long narrow tube of explosive mixtures of hydrogen and oxygen and of carbon monoxide and oxygen, and find the velocities of the *explosive wave* for the two cases, their experiments giving 2,810 metres per second, and 1,089 metres per second for the two explosive mixtures; the theoretical bearing of these results are discussed by Berthelot.² Experiments were made by these

¹ *C. S. J. Abs.* March 1888, p. 213.

² *C. R.* 94, 1882, pp. 149–152.

authors with different explosive mixtures, including as combustibles hydrocarbons, cyanogen, and carbon monoxide and nitrous oxide as oxidisers; and the results of mixing the explosive mixture with an inert gas are investigated and the experimental results discussed.¹ A summary of the experimental methods, results, and conclusions drawn from them are given in 'Ann. Chim.' (6), 4, 1885, pp. 13-90.

The apparatus used for the explosions was a *spherical* steel bomb provided with a very exactly fitting piston of known mass and section, by means of which, as it moves under the influence of the pressures developed during the explosion, the motion of a point rigidly connected with it is recorded on a cylinder rotating in a period of about two thousandth parts of a second. The readings were taken at intervals of four ten-thousandths of a second, each interval corresponding in one set of experiments to 5 mm. on a circular section of the cylinder as it rotates round its axis with uniform motion; at intervals of 15 mm. in another set.

Calling lines parallel to the circular section of the cylinder abscissæ and lines parallel to the axis ordinates, values of δy for successive intervals of time δt are easily got, for intervals, say, of time δt corresponding to 5 mm.; and again from this row of values of δy , values of $\delta^2 y$ for equal intervals of time δt are found; thus a series of ratios $\frac{\delta^2 y}{\delta t^2}$ are obtained. The greatest value of these ratios combined with the mass of the piston is the maximum force exerted on the base of the piston during the explosion, whence, from the known mass and section of the piston, the pressure per square cm. is deduced. Thus successive pressures during the explosion, and in particular the maximum pressure, are known.

It is noticeable that Berthelot and Vieille account for the difference between the pressure got by Mallard and Le Châtelier 9.95 atmos. and their own value 10.1 for the explosion of CO+O by the statement that their number, 10.1, was got with *dry* gases, while the lower number was the result of exploding in a mixture containing vapour of water; they point also to the fact that Bunsen obtained 10.5 atmos, which agreed with theirs better than with Mallard and Le Châtelier's number. But it is probable that the lower number is more nearly correct, as Dixon has shown² that the results of exploding CO and O partially dried are uncertain, varying according to the amount of the trace of water-vapour present, and that a perfectly dry mixture of the gases cannot be exploded by sparks from an induction-coil.

The following are among the results obtained for temperatures up to 3000° and even getting on to 4000° (air-thermometer):—

The specific heats of gases are independent of the density or of the volume of unit mass at these high temperatures, as is the case near 0°. The apparent specific heat (of a gas or a gaseous mixture) increases as the amount of heat absorbed increases. These conclusions (p. 58) are arrived at independently of any hypothesis about laws of gases and their physical constitution, *i.e.*, independent of Avogadro's hypothesis and of any views as to the molecular constitution, and without assuming the applicability of Boyle's and Gay-Lussac's laws (p. 51).

Mallard and Le Châtelier did not give results for the highest pressures (and temperatures) given by the explosions; but for temperatures up to

¹ *C. R.* 94, p. 822; 95, pp. 151, 199.

² *Phil. Trans.* 1884.

about 2800° for the specific heats of hydrogen, oxygen, nitrogen (the so-called 'perfect gases'), as also of carbon monoxide and hydric chloride, they found results agreeing with the formula for C_v , the specific heat at constant volume

$$C_v = 4.8 + .0006t.$$

Berthelot and Vieille found by experiments for greater pressures and higher temperatures values for C_v greater than were given by this formula; and it is certain that the above formula cannot legitimately be used for temperatures much higher than those on observations at which the formula is founded; on the other hand, it is doubtful whether the results obtained from observations concerned only with the very highest pressures are so accurate as the others. However this may be, Berthelot and Vieille find that the mean specific heats of equal volumes of hydrogen, oxygen, nitrogen, and carbon monoxide at constant volume is doubled in passing from 0° to 4500°; and they give the formula $C_v = 6.7 + .0016(t - 2800)$ for temperatures above 2800°. Except in respect of these very high temperatures, the results agree for the gases named remarkably well with those of Mallard and Le Châtelier.

Gases such as chlorine, nitrous oxide, carbon dioxide, which have specific heats between 0° and 200° greater than those of the gases mentioned, and which, according to Regnault's results and those of E. Wiedemann, have nearly equal specific heats at these lower temperatures, have nearly equal specific heats at about 1800°.

For vapour of water the molecular heat-capacity was found to be 18.12 at 3240°. Mallard and Le Châtelier had found 16.6 at 3350° and that there was no dissociation at this temperature: these results are in fair accordance with those of Berthelot and Vieille.

These authors go on to discuss the absorption of heat in the form of specific heat and in dissociation; attributing the former to actions on the molecules themselves either in increasing the kinetic energy of rotation and vibration of the molecules or of their component parts, or to a disgregation of the molecules without dissociation; as in the cases of CO_2 and N_2O , in which cases heat is absorbed up to 200°, as shown by Regnault's results as to the specific heat of these gases and the increase of specific heat with rise of temperature.

This absorption of heat during the disgregation of molecules, &c., as shown by the rise of specific heat with rise of temperature has an important bearing on the heat of combustion at different temperatures, as, e.g., in the cases of CO and H_2 to form CO_2 and H_2O . In the case of the formation of HCl from 1 gram of hydrogen at constant pressure, although this gives 22,000 thermal units at 0°, yet at 2000° the heat evolved is about 26,000, the difference being due (apart from dissociation) to the very great increase in the specific heat of chlorine between 0° and 2000°; whereas 1 gram of hydrogen, in combining with oxygen to form water, evolves at 0° 29,000 units, and at 2000° (in consequence of the great rise in the specific heat of H_2O vapour from 0° to 2000°) 25,300; hence the heat of combination of H,Cl is greater than that of $\frac{1}{2}(\text{H}_2, \text{O})$ at 2000°, although less at 0°, at constant volume. In the explosions of hydrogen and oxygen, and of hydrogen and chlorine, in closed vessels there appears to be little or no dissociation of HCl or of H_2O at 2000°.

At p. 84 of this volume of the 'Ann. Chim.' Berthelot questions the validity of Avogadro's hypothesis and its applicability in particular

to chlorine and iodine, and prefers interpreting the diminishing density of both at very high temperatures by admitting these to be among numerous exceptions to Boyle's and Gay-Lussac's laws; 'there exists,' he says, p. 88, 'no valid reason for preferring, in the definition of temperatures, the indications of an air-thermometer to those of a chlorine-thermometer.' Now Sir W. Thomson¹ had shown that Carnot's function affords a foundation for a system of thermometry not dependent on special properties of some individual substance, but derivable from the properties of any substance whatever; and in conjunction with Joule published a series of investigations 'On the Thermal Effects of Fluids in Motion'² in which the authors arrived at a means of estimating temperatures on an absolute scale.

The definition given³ shows the principle on which the absolute system of thermometry is founded, by which temperatures are measured on 'the thermodynamic scale'; 'if any substance whatever, subjected to a perfectly reversible cycle of operations, takes in heat only in a locality kept at a uniform temperature, and emits heat only in another locality kept at a uniform temperature, the temperatures of these localities are proportional to the quantities of heat taken in or emitted at them in a complete cycle of the operations.'

From the experiments of Joule and Thomson, in which gases, *e.g.*, air (hydrogen; and carbon dioxide) was made to pass through a porous plug at various pressures, the change of temperature being observed, results were obtained by means of which a formula was deduced, giving the absolute temperature in terms of the temperature by the air-thermometer, and a table of corrections for temperatures from 0° C. up to 300° C. by which these air-thermometer temperatures might be converted into temperatures on the thermodynamic scale; the correction not exceeding, within this range of temperatures, half a degree on either scale whether for air at constant pressure or for air at constant volume.

Relation of Volume to Temperature—Solids and Liquids.

The rates of expansion of bodies in the solid and liquid states are very much smaller in general than in the gaseous state; this rule does not always hold, however, for liquids under the critical point when subjected to great pressures, as shown first by Thilorier for CO₂, the expansion of which in the liquid state under the conditions specified exceeds that of gaseous CO₂.

Solids.

For solids a very large number of results, sufficiently accurate for the purpose at least of drawing an inference of a general kind, were obtained by a number of experimenters about the end of last century and the beginning of this, showing that the *coefficients* of linear expansion of a large number of metals and alloys, and of glass, between 0° and 100° lie in general between 10⁻⁵ and 3 × 10⁻⁵; to these have been added results got by Dulong, Regnault, Kopp, for metals and other elements, for varieties of glass, and for a number of minerals for this temperature-range, and for higher temperatures in some cases; by Playfair and Joule for a number of crystalline compounds; ⁴ by Pfaff,⁵ and by others.

¹ *Camb. Phil. Soc. Proc.* June 5, 1848; and *Phil. Mag.* Oct. 1848.

² *Phil. Trans.* 1853, 1854.

³ *Ibid.* 1854, p. 351.

⁴ *C. S. J.* 1, 1849, p. 121.

⁵ *Jahresb.* 1858, p. 7.

The general result of these data is that solids in general expand very slowly indeed with rise of temperature, at least between 0° and 100° , but as the temperature-limit is increased so as to include higher and higher temperatures the rate of expansion in general increases; if the coefficient of linear expansion remained constant a unit length at 0° would become $1 + at$, where t is the coefficient of linear expansion, the cubical expansion being approximately $1 + 3at$, in which $3a$ is the coefficient of cubical expansion; or if we determine the coefficient of cubical expansion a that of linear expansion is $\frac{a}{3}$. But in general it is necessary to add a term in t^2

to express with sufficient accuracy the results of experiments.

Although many most accurate determinations have been made in recent times on the expansion of solids the results are not connected with any general laws, as in the case of the expansion of gases with rise of temperature.

Liquids.

Mercury.—The absolute expansion of *mercury* was determined by Dulong and Petit and their results given on p. 136, 'Ann. Chim.' (2), 7, 1818. Regnault, using Dulong and Petit's general method with improvements, made an extensive series of determinations of volumes at 0° and 350° , and for every interval of 10° between these limits, with the coefficient of expansion at each temperature and the mean coefficient between that temperature and 0° C.¹ At temp. 100° the true coefficient is given as 0.00018305 by misprint for .00018405.²

By means of the absolute expansion of mercury it is easy to find the expansion of a thermometer-tube or other similar glass vessels in which the expansions of liquids are observed, so that from the apparent expansion of the liquid in the *dilatometer*, as such an instrument is called, the true expansion may be determined. This is of fundamental importance for the determination of the expansions of liquids. For results obtained by Bosscha and Wüllner see 'Jahresb. f. Chem.' 1874, p. 70.

Water.—Feltz³ gives an account of experiments by Rossetti (professor at the University of Padua) on the maximum density and the dilatation of distilled water; for the temperature of maximum density Rossetti finds 4.07° , agreeing very closely with H. Kopp's value 4.08° ⁴ and differing from 4.00° given by Despretz,⁵ and from 3.92° given by Pierre.⁶ The above-named and other experimenters gave tables for the volumes and densities of water at temperatures up to 100° C. and below 0° ; Sorby⁷ and Mendelejeff⁸ gave results for water above 100° ; and Hirn⁹ for a number of other liquids, chiefly organic, up to and above their ordinary boiling-points, and in the case of water up to 200° . In the case of water the rate of expansion is more rapid the higher the temperature above (about) 4° ; and below this, in the unstable condition of water remaining liquid below its ordinary freezing-point it expands as temperature sinks; in other words, at 4° water has its maximum density, the densities diminishing from 4° to -10° , and from 4° to 200° . For further references

¹ *Mém. de l'Acad.* t. xxi. 1847, p. 271.

³ *Ann. di Chim.* (4), 10, 1867, p. 461.

⁵ *Ann. Chim.* (2), 70, 1839, pp. 24, 47, 48.

⁷ *Phil. Mag.* (4), 18, 81.

⁹ *Ann. Chim.* (4), 10, p. 32; and 11, 1867, p. 5.

² See Watts' *Dict.* iii. p. 56.

⁴ *Pogg. Ann.* 72, 1847, p. 48.

⁶ *Ibid.* (3), 15, 1845, p. 348.

⁸ *Pogg. Ann.* 119, 1863, p. 1.

as to the relation of volume to temperature for liquids generally see footnote.¹

The more or less successful attempts of Kopp and of Schröder to find relations connecting the volumes of liquid compounds at their boiling-points, with volumes of their component atoms, were based on the idea that liquids should be comparable among one another at their boiling-points (or at points equidistant from these).

Volume and Temperature. Liquids—Recent Investigations.

Ramsay² made a number of determinations by a new and ingenious method in which the liquid was heated to the temperature of its boiling-point in a small glass vessel from which, by the expansion of the liquid, drops of it overflowed, as the temperature rose, into a larger vessel surrounding it. This latter vessel had a small portion of the liquid to be examined, which was kept boiling vigorously by a flame under it, so that the inner vessel was kept constantly surrounded by the vapour at the boiling-point of its own liquid. By this arrangement the density of a volatile liquid at its boiling-point is determined.

Thorpe³ made a most extensive series of determinations of a large number of liquids for temperatures at intervals between 0° and over 100° (air-thermometer), every precaution being taken to secure against sources of error, the results being expressed by equations of the form $V=1+at+bt^2+ct^3$, where V is the volume at temperature t .

To find a Simple Relation between V and t for Liquids.

The question arises whether—out of all the abundant and accurate material at hand as the result of experiments made on large numbers of liquids at such a range of temperature for each liquid that its expansion may be expressed generally with great accuracy in terms of the temperature by formulæ like that just written—it is not possible to find some simple approximate expression for the expansion which could be applied to each liquid by giving to a constant in the expression a number corresponding to each. In respect of the expansion of gases such an expression is supplied by Gay-Lussac's law, which is an ideal law to which bodies conform in the gaseous state, and is such that bodies in the ideal gaseous state expand equally for equal increments of temperature. In respect of liquids, as will be seen at once by inspecting tables of volumes of bodies in this state, the expansion is very obviously different for different liquids. Any expression, therefore, for their expansion must involve some constant which is special to each.

Bosscha⁴ has proposed $V_t = V_0 \times e^{at}$ in which a is a constant characterising each liquid. Avenarius⁵ proposed another formula; and others before these dates have made attempts to find simple formulæ. In

¹ Despretz, *Ann. Chim.* (2), 73, 1840, p. 5. Pierre, *Ann. Chim.* (3), 15, 1845, p. 325; 19, p. 193; 20, p. 5; 21, 1847, p. 336; 31, p. 118; 33, 1851, p. 119. Drion, *Ann. Chim.* (3), 56, 1859, p. 5. Andréef, *Ann. Chim.* (3), 56, 1859, p. 317. H. Kopp, *Pogg. Ann.* 72, pp. 1 and 223. *Liebig's Ann.* 94, p. 257; 95, p. 307; 96, pp. 153 and 303. Elsässer, *L. Ann.* 218, p. 302.

² *C. S. J. Trans.* 1879, p. 463, and 1881, p. 49.

³ *Ibid.* 1880, pp. 141, 327.

⁴ *Pogg. Erg.* 5, 1871, p. 276.

⁵ *Bull. Ak. Petersb.* 24, 1878, p. 525.

abstracts published in the 'Fortschr. der Physik' since 1845 will be found attempts in this direction.

Mendelejeff's Relation between V and t for Liquids.

Mendelejeff¹ proposes the formula $V = 1/\sqrt{1 - kt}$, similar to Gay-Lussac's formula for gases, but in which k is a specific constant for each liquid; and substantiates this as an approximate formula by applying it to the volumes given by Thorpe for liquids at various temperatures, 10°, 30°, 60°, and in some cases 150°. Arranging 47 liquids studied by Thorpe in order of their rates of expansion with rise of temperature, from the least to the most expansible, an inspection of the figures is sufficient to suggest at once the idea that all expand in a similar manner, and that the difference between their expansions is one of scale only. This is shown by Mendelejeff by taking the expansion for mercury as calculated by him from Regnault's results in the form $V = 1 + 10^{-3} \cdot 1801T + 10^{-7} \cdot 2T^2$, in which T is any temperature of the mercury. Comparing the expansion of mercury with that of PBr_3 , one of the least expansible of the liquids given in the table, and with nitric peroxide N_2O_4 , the most rapidly expanding liquid of those given, Mendelejeff shows that 46·8°, 93·7°, 140·9°, 189·1° are temperatures T at which the volumes of the mercury (vol. at 0° = 1) are the same as are the volumes of PBr_3 at temperatures t such that T/t is 4·68, 4·68, 4·69, 4·72. So for comparison of the volumes of mercury and nitrogen peroxide at temperatures T and t respectively, he finds for mercury at temperatures 43·6°, 86·5°, 129·7°, 174·6° the same volumes as nitrogen peroxide has at temperatures 5°, 10°, 15°, 20° respectively, so that in this case T/t has the values 8·72, 8·65, 8·65, 8·70, showing that phosphorus tribromide expands 4·7 times more strongly than mercury, and nitrogen peroxide 8·7 times more strongly than mercury, but in qualitative respect the expansion of these as well as other liquids is on a uniform plan.

As the density of a mass is inversely as its volume, if we take the density of a liquid at 0° as 1, the density $D = 1 - kt$ at the temperature t ; hence $dD/dt = -k$ (or if density is D_0 at 0°, $D = D_0(1 - kt)$, and $dD/dt = -kD_0$). This result is remarkably confirmed by some specific gravity determinations, by Miss E. K. Gutkowska in Mendelejeff's laboratory in 1881, of some American kerosene (petroleum). At 0°, 16°, 32°, 48° the specific gravities found were ·8056, ·7940, ·7824, ·7708, whence an equal difference ·0116 for equal temperature-intervals; here $\frac{dD}{dt} = \frac{·0116}{16} = -·000725$. Similar results were obtained for Baku petroleum.²

Mendelejeff remarks that he found in 1860³ that the coefficient of change of density of liquids varied more simply than the coefficient of change of volume; and that this, combined with his investigations from 1880 to 1883 (*loc. cit.*) of the products of distillation of Baku petroleum in which he was obliged to find the change of density with changing temperature, induced him to consider all liquids in reference to changes of density rather than volume in the first place, and that he thus arrived at the law of expansion $V = 1/\sqrt{1 - kt}$.

¹ *C. S. J.* 1884, p. 126.

² *Russ. Phys. Chem. Soc. Journ.* 1883, p. 189.

³ *L. Ann.* 114, 165.

The author finds that liquids near their boiling-point show some deviation in their rates of expansion from those calculated from the above formula, in the sense that the observed expansion is greater than that calculated; *e.g.*, the volume of PBr_3 , B.P. 173° , is found at 160° to be 1.1562; the calculated value ($k=0.00841$) is 1.1555; on the other hand *in one case*, that of a paraffin melting at 38° , Beilby has¹ shown that the change in its specific gravity with temperature is from 38° to 60° quite constant; $\frac{dD}{dt} = -0.00727$; the deviations of volatile

liquids from perfect accordance with the law expressed by the formula are nearly always small, but near the boiling-point quite appreciable; and for different liquids the deviations are of different sign; if we consider Mendelejeff's equation as expressing the ideal form of expansion for liquids by analogy with Gay-Lussac's expression for expansion of gases, then the deviations from the ideal form will be greater, the *less* the density of the liquid, the *greater* the cohesion (the value a^2), the *less* the molecular weight, *i.e.*, the less the vapour-density. Water has a small molecular weight and very great cohesion, the molecular weight being the smallest for all common liquids; these facts, taken in conjunction with the small difference between the temperatures at which liquid water changes its state of aggregation to the solid and gaseous respectively, account for the anomalies in the expansion of water; for which, in fact, the equation does not hold, the values of k found within different temperature-ranges being quite different. No other liquid shows so rapid a rate of expansion from 4° .

On p. 132, in a footnote, Mendelejeff refers to a paper by him in which he has shown a dependence of coefficient of expansion of *gases* on the molecular weight; this coefficient *increases* with increasing molecular weight. He draws special attention to the case of chlorine, which, therefore, has a large coefficient of expansion: this fact, he says, should be taken into account in regard to the alleged dissociation of the chlorine molecule.

Thorpe and Rücker on the Relation of k to Critical Temperature.

In the paper immediately following Mendelejeff's (*loc. cit.* p. 135), Thorpe and Rücker discuss the formula given by Mendelejeff in connection with Van der Waals' theories. The result of this paper is to show a simple relation connecting k , Mendelejeff's *determinator* of expansion, with the critical temperature of the liquid.

In the Leipzig edition (1881) of Van der Waals' dissertation on the continuity of the gaseous and liquid conditions, on p. 128, he states two general relations, which show that temperatures and pressures are *corresponding* temperatures and pressures for two different bodies when they are such that the ratio of the absolute temperature in the case of one body to the absolute critical temperature of that body is the same as this ratio for the other body; for when the pressure, volume of liquid, volume of saturated vapour for the two bodies at these two temperatures are compared, the ratios of these pressures and volumes are found also to be in the same ratio to their values at the critical temperature—the same, that is, for both bodies. *Corresponding* conditions for two

¹ *C. S. J.* 1883, *Trans.* 338.

² *C. R.* Feb. 14, 1876.

bodies—not solid—are therefore conditions under which, in the above sense, temperature, pressure, and volume correspond; the boiling-points at any pressure are not, therefore, points at which bodies are to be expected to correspond in physical properties, and the principle of Kopp's method and that of others for comparing bodies as to molecular volumes or molecular heats is in this particular not strictly correct.

On page 152 of Van der Waals' 'Continuity, &c.,' the following conclusion is stated: 'The coefficients of expansion of individual bodies under corresponding conditions (of temperature, &c.) are inversely proportional to the absolute critical temperatures of the bodies'; in which, from the context, it is seen that by the coefficient of expansion of volume v at absolute temperature T is meant $\frac{1}{v} \frac{dv}{dT}$, in which $\frac{dv}{dT}$ is the *partial* differential coefficient, being rate of variation at temperature T with the temperature only and without alteration of pressure.

Hence for any pair of corresponding temperatures the values of $\frac{1}{v} \frac{dv}{dT}$ are to each other inversely as the absolute critical temperatures of the two bodies; and therefore if T_1 is this temperature for one of the bodies, $\frac{1}{v} \frac{dv}{dT} \times T_1 = C$, a quantity which is the same for each body. Now Mendelejeff's formula may be written $1/v = 1 - k(T - 273)$;

whence
$$\frac{1}{v^2} \frac{dv}{dT} = k;$$

and
$$\frac{1}{v} \frac{dv}{dT} = k / (1 - k \cdot \overline{T - 273});$$

therefore
$$\frac{1}{v} \times \frac{dv}{dT} \times T_1 = k T_1 / (1 - k \cdot \overline{T - 273});$$

therefore
$$1 - k(T - 273) = k T_1 / C;$$

and
$$\frac{1}{C} = (1 + 273k) / k T_1 - T / T_1.$$

But C must be independent of the individual body, and dependent only on the ratio T/T_1 ; and k is dependent *not* on T but on the body and therefore on T_1 . These conditions are satisfied if

$$1 + 273k = akT_1 \quad . \quad . \quad . \quad . \quad (a)$$

so that $\frac{1}{C} = a - T/T_1$, a being an absolute numerical constant. We thus

have an equation connecting a , k , and T_1 which, when the value of a is known, will give Mendelejeff's k in terms of the absolute critical temperature of the body. This equation (a) may be put in this form:—

$$1/k = aT_1 - 273;$$

from which
$$1/k - (T - 273) = aT_1 - T;$$

so that
$$1/v = k(1/k - t) = k(aT_1 - T).$$

Hence the density of a given liquid is directly proportional to the result of subtracting the absolute temperature from a times the absolute critical temperature of the body.

To determine the value of a we have then to find a number of bodies

which, in the liquid state, conform to Mendelejeff's law with sufficient accuracy, and of which the critical temperatures also are known; if the values of a so found are nearly equal we have a strong confirmation of the relation between k , a , and T_1 expressed in equation (α).

The relation between the volumes at t° and 0° (ordinary scale, air-thermometer) is that

$$\frac{v_t}{v_0} = \frac{aT_1 - 273}{aT_1 - T};$$

whence, if $v_0=1$,

$$a = \frac{Tv_t - 273}{T_1(v_t - 1)},$$

the equation by which the values of a may be obtained.

The authors give a number of tables of values of t or $(T-273)$ and v_t for different liquids, for which in each table the critical temperatures have been determined by some one observer, together with the value of a in each case. The table annexed—Table 1, p. 138—in which the critical temperatures have been determined for all the bodies by Sajotschewsky,¹ is a good illustration:—

Substance	t	v_t	T_1	a
Ethyl chloride	10	1.0160 P.	455.6	1.993
Ether	30	1.0483 K.	463.0	1.996
Benzene	80	1.1064 K.	553.6	1.996
Ethyl formate	50	1.0735 K.	503.0	1.995
Ethyl acetate	70	1.1040 K.	512.8	1.981
Methyl acetate	50	1.0733 K.	502.8	1.999
Chloroform	60	1.0818 T.	533.0	2.001

The letters P, K, T indicate that the expansions were determined by Pierre, Kopp, Thorpe. The mean value of a is found to be 1.995, which nearly agrees with each individual value.

Other tables are given, in which critical temperatures are made use of which had been found by Ramsay² and Pawlewski.³ The result of all the determinations is to show that a differs from 2 by a very small fraction. For a perfect liquid (*i.e.*, where k is constant) we have, at constant pressure—

$$\frac{v_t}{v_0} = \frac{2T_1 - 273}{2T_1 - T}; \text{ for perfect gases } \frac{v_t}{v_0} = \frac{T}{273}.$$

From equation (α) we have now—

$$1/k = 2T_1 - 273 (\beta)$$

a formula by means of which, in the case of a volatilisable liquid generally, the critical temperature can be calculated from observations on its 'expansion' as a liquid.

On page 144 is given a table of the observed absolute critical temperatures of the bodies in the table cited, and by side of these the calculated critical temperatures. The correspondence is so close that it is worth while to reproduce the table here.

¹ *Wied. Beibl.* 1879, p. 741.

² *Proc. Roy. Soc.* 31, 194.

³ *Ber.* 15, 1882, p. 2450; 16, p. 2633.

Absolute Critical Temperatures.

	Observed	Calculated	Difference
Ethyl chloride	455·6	455·2	- 0·4
Ethyl oxide	463·0	463·8	+ 0·8
Benzene	553·6	553·8	+ 0·2
Ethyl formate	503·0	502·9	- 0·1
Ethyl acetate	512·8	509·3	- 3·5
Methyl acetate	502·8	503·9	+ 1·1
Chloroform	553·0	534·8	+ 1·8

It is noticeable, too, that the errors fall in both directions.

Objections by MM. Bartoli and Stracciati.

In the course of a study of the physical properties of American petroleum (from Pennsylvania) MM. Bartoli and Stracciati¹ criticise the propositions of Mendelejeff on the volumes of liquids and their expansion by heat, and the deductions of Thorpe and Rücker from Van der Waals' and Mendelejeff's conclusions.

Mendelejeff's 'very interesting memoir' is resolved by these authors into three propositions:—

(A) Any two liquids which dilate equally between (say) 0° and 10° will dilate equally between 0° and t° ; and if the dilatation of one liquid is greater or less than the other liquid between 0° and 10°, it will also be greater or less between 0° and t° .

(B) Let $V_0, V_1, V_2, \dots, V_n$ be the volumes of a liquid at temperature 0°, t_1, t_2, \dots, t_n ; then, if another liquid has the same volumes at temperatures 0°, t'_1, t'_2, \dots, t'_n , we shall have—

$$\frac{t'_1}{t_1} = \frac{t'_2}{t_2} = \frac{t'_3}{t_3} = \dots = \frac{t'_n}{t_n}.$$

(C) The volume V_t of a liquid at temperature t is expressed (in terms of the volume at 0° as unit) by the equation $V_t = 1 / \sqrt{1 - kt}$.

They proceed to say that proposition (A) can only be taken as an approximation, and that 'it is easy to see' that it is deduced from the formula of Van der Waals.

Now Mendelejeff says,² 'Just as for gases the expression $V = 1 + kt$ applies only to a first approximation, or to a so-called ideal gas, so does the expression $V = (1 - kt)^{-1}$ apply for liquids only to a first approximation, namely, to 'ideal liquids,' giving in a foot-note his idea of the characteristics of an ideal liquid. Mendelejeff has not claimed more for his formula and his general conclusions than that they are approximate.

Again, 'it is easy to see' that Mendelejeff's result, as embodied in A, is deduced from the formula of Van der Waals may mean that *it is not easy to show*; if these authors had shown this they would have given a theoretical confirmation of a result of Mendelejeff's experience.

Again, they object that if proposition (B) is true, then in the formula which expresses accurate determinations of expansions of many liquids, viz., $V_t = 1 + at + bt^2 + ct^3 + dt^4$ we should have $a = b/a = c/b = d/c = k$; relations which are not verified: this would be a fatal objection if Mendelejeff

¹ *Ann. Chem. Ph.* (6), 7, 1886 p. 334.

² *C. S. J. Trans.* 45, 1884, p. 131.

maintained that his results were rigidly accurate; but as they are only approximate the objection falls to the ground.

Again, they give a table for the dilatations of water and other liquids which Hirn had studied at a pressure of 11·5 metres of mercury; and deduce from these tables, by means of Mendelejeff's formula, the value of k for water, from 100° to 200° ; for alcohol, from 50° to 200° ; for ether, from $21\cdot55^\circ$ to $133\cdot66^\circ$; and for (essence of) terebenthene from 40° to 160° .

The value of k for each substance in these determinations they find not to be constant but to vary with t , increasing as t rises; now the first example chosen is that of water, which even below 100° Mendelejeff finds to be a quite remarkable exception in being far removed from an ideal liquid; and with regard to the other examples (to which are added in this paper of Bartoli and Stracciati, ammonia, nitrous oxide, carbon dioxide, and ethyl chloride), it may be remarked that in Mendelejeff's paper, p. 131, there is this foot-note:—'A subject for further experimental investigation would be the solution of the question, in what manner and how much the expansion of volatile liquids is changed at different pressures. I should like to submit this theoretically important question to an experimental solution.'

The Continuity of the Gaseous and Liquid States.

In nature we find no substance which is an ideal gas or an ideal liquid; however nearly a body may conform to either of these ideal states within certain limits there are always deviations from such conformity outside those limits; so that volatilisable liquids, which in one direction tend to obey Mendelejeff's law within certain limits of temperature, in the other direction will, in general, under suitable conditions, tend to conform with Gay-Lussac's law. There is, however, in all cases a more or less considerable range of intermediate conditions in which the expansion of the body is not even in approximate conformity with either law.

Andrews¹ showed by experiments on various bodies that, when a condensible body is in the state of vapour, there exists a temperature—the critical temperature—at and above which no amount of pressure could make any appearance of discontinuity in the body acted on: no meniscus could be observed indicative of the separation of the body—*e.g.*, CO_2 —into two distinct portions of different densities; above the critical temperature there is, as shown by graphic representation of the experimental results, a *continuous* curve for each temperature.² Below the critical temperature a sufficient pressure produces a meniscus, indicating a separation of the body into a heavier and lighter portion; and generally, at temperatures below the critical, the diagram representing the variation of volume with pressure showed a portion of the line as straight during the compression so long as the less dense upper portion was visible; after this the curve shows a rapid increase of pressure with given decrease of volume. The whole line of pressure-volume consists, roughly speaking, at these lower temperatures of two curves joined by a straight line. Above the critical temperature there is perfect continuity; below it, discontinuity; above, the relation between p and v (t constant) could conceivably be expressed by an equation representing the continuous curve;

¹ *Phil. Trans.* ii. 1869, p. 575.; and 1876, p. 421.

² *Ibid.* 1869, p. 575.

and a single equation might give a relation between p , v , and t , which would apply to all pressures and volumes, and to temperatures above the critical point. Yet from the discontinuity at lower temperatures this equation would hardly seem applicable throughout.

In 1871¹ James Thomson suggested that the isothermal curves are not really but only apparently discontinuous, and that their true form is such that in place of the straight part there is a curved part continuous with the rest, and situated partly on one side and partly on the other of the straight part.²

The transition from the gaseous to the liquid state, in this view of James Thomson, is gradual, regular, and continuous for each temperature; and the idea of finding a mathematical relation between p , v , and t for all temperatures may be realised. Such perfectly general equations have been given by Van der Waals, Clausius, and others; but however approximately these formulæ represent certain sets of experiments, none seem to have been proved to have the generality required.

Less general relations we have, as Boyle's, Gay-Lussac's, and Mendelejeff's laws; a law stated by Amagat as applicable to fluids under great pressure: $p(v-a) = \text{const.}$ [*Ann. Chim. Ph.* [5], 22, 1881, p. 395]; and another by Amagat for high temperatures or low pressures: $p = c(t - t_0)$ [*Ann. Chim. Ph.* [5], 28, 1883, pp. 505, 506], and [*C. R.* 94, 1882, p. 847].

General Equations for p , v , and T .

The general equations of Van der Waals, Clausius, and others, though not yielding results fully in accordance with all the experiments for bodies in the state of liquid or of gas or vapour by Amagat and others, give so close an agreement through large ranges in cases to which they have been applied that each of them must be looked upon as a tolerably close approximation; the most important of these equations are:

$$p v = R T - \frac{c}{T v}; \text{ Rankine.}^3$$

$$(p+r)(v-\psi) = R T; \text{ Hirn.}^4$$

$$p v = R T \left(1 - \frac{B_t}{v}\right); \text{ Recknagel.}^5$$

$$\left(p + \frac{a}{v^2}\right)(v-b) = R T;$$

$$\text{or, } p = R \frac{T}{v-b} - \frac{a}{v^2}; \text{ Van der Waals.}^6$$

$$p = R \frac{T}{v-a} - \frac{c}{T(v+\beta)^2}; \text{ Clausius.}^7$$

$$\frac{p}{RT} = \frac{1}{v-a} - \frac{A T^n - B}{(v+\beta)^2}; \text{ Clausius.}^8$$

¹ *Proc. Roy. Soc.* 1871, No. 130.

² *Maxwell's Theory of Heat*, 4th ed. p. 125.

³ *Phil. Trans.* 1854, p. 336.

⁴ *Théo. Méc. Chaleur*, 2nd edit. t. i. p. 195; 3rd edit. t. ii. p. 211.

⁵ *Pogg. Ann. Ergbd.* t. v. p. 563; and t. cxlv. 1872, p. 469.

⁶ Leipzig edit. '*Die Continuatät*,' 1881, p. 125.

⁷ *Wied. Ann.* 9, 1879, p. 127.

⁸ *Ibid.* 14, 1881, pp. 279, 692.

These equations are to be found in the articles by Clausius, in 'Wied. Ann.' referred to; and in 'Ann. Chim.' 5, 30, 1883, pp. 358 and 433, in which Clausius' articles are translated.

Another equation is given by Sarrau,¹ as a modification of Clausius':

$$p = \frac{RT}{v-a} - \frac{Ke^{-\tau}}{(v+\beta)^2}$$

Ramsay and Young's Isochoric Lines.

In the 'Philosophical Magazine' for May and August 1887 is published Part VI. of a series of papers by Ramsay and Young on Evaporation and Dissociation. In this part, from very copious data extending over large ranges of pressure, temperature, and volume, a relation is deduced from the isotherms for ether, carbon-dioxide, methyl alcohol, and ethyl alcohol, from which the following conclusion is drawn:²—'The relation between the pressures and temperatures of a liquid or gas at constant volume is expressed by the equation $p=bT-a$, where p is the pressure in millimetres, T the absolute temperature, and a and b are constants. The values of these constants depend on the nature of the substance and on the volume. It follows from this that if a diagram be constructed to express the relations of pressure, temperature, and volume of liquids and gases, where pressure and temperature form the ordinates and abscissæ, the lines of equal volume are straight.' These lines are called isochors.

From very numerous data obtained by themselves for ether, and published in 'Phil. Trans.' 1886, p. 10, the authors found series of values of p and t° , from which it was seen that for each volume v of a gram of the substance the lines passing through points, in which p and t were taken as ordinates and abscissæ, were, at least approximately, straight. The volumes in the case of ether ranged from 1.9 cc. to 300 cc.; the pressures from 860 mm. to 52,700 mm.; and the temperatures from 50° to 280° C. For each isochor the value of $\frac{dp}{dt}$ (or b) was found by finding the whole difference of pressure through the largest range of temperature; and the value of a by taking the mean of the values for different points on each isochor. The isochor constructed by drawing the line $p=bT-a$ was found to agree wonderfully well throughout with the points found by experiment; the equation for each being verified by deducing from the series of isochors thus found the isotherms; these calculated isothermal lines were found to give results agreeing very closely indeed with actual observation.

Clausius³ had drawn attention to the fact that the line of observed vapour-pressures must cut James Thomson's curve in half, so that the volume above the line is equal to that below it. Now the equation $p=bT-a$ represents the whole series of isochors for ether by putting for b and a their values for each volume; and the calculated isothermal lines pass close to the observed points on them; but for values of v corresponding to the sinuous part of each isothermal, the value of p can be calculated from the equation; this part of the curve can be traced by means of the equation, assuming that the relation $p=bT-a$ applies to the part of the curve on which we have no observations as well as to the

¹ *C. R.* ci. 1885, p. 1145.

² *Phil. Mag.* May 1887, p. 436.

³ *Wied. Ann.* 9, 1879, p. 127; *Ann. Chim.* 5, 30, 1883, p. 381.

remainder. Ramsay and Young devised a method for constructing the horizontal line (line of equal pressures on Andrews' diagram corresponding to the vapour-pressure for any temperature), and obtained these lines for the various isothermal lines so accurately dividing the volumes into equal parts that it was found that the vapour-pressures thus indicated agreed with those of experiment within 1 per cent. This is a remarkable confirmation of the accuracy with which $p=bT-a$ represents lines of equal volume.

Similar results were obtained for CO_2 , and for methyl alcohol and ethyl alcohol; and the equation $p=bT-a$ was confirmed as a remarkably accurate representation of the lines of equal volume for these bodies in the gas-liquid state.

For acetic acid and for nitric peroxide the isochoric lines were not straight, but were curved in such a way that points on them for high temperatures were on nearly straight lines, which would be isochors for the formulæ $\text{C}_2\text{H}_4\text{O}_2$ and NO_2 , supposing that compounds with these formulæ in the gas-liquid state behaved as alcohol and ether do; it is noticeable that in the gaseous state acetic acid and nitric peroxide do not attain constant vapour-densities till they have been heated considerably above their boiling-points. It must be observed, however, that this is a matter of degree; and so far as acetic acid is concerned, there is as yet hardly sufficient reason for supposing that acetic acid forms a true polymer. The case of nitric peroxide is, perhaps, a case of polymerism in which we have two distinct chemical substances, NO_2 and N_2O_4 : there are, in fact, distinct physical differences between nitric peroxide at a low and a high temperature.

On the Nature of Liquids.

In a paper on this subject¹ Ramsay and Young bring forward a number of considerations from researches of their own,² among which is a series of determinations of densities of the *saturated* vapours of alcohol and acetic acid; in both these cases the vapour-density, at high temperatures, becomes abnormally great: thus, for alcohol at temperature about 250° the pressure is 32,000 mms., and the vapour-density of the saturated vapour 45, the normal being 24 from the formula; for acetic acid at 250° and 15,000 mms. the saturated vapour-density is 55. But there is this difference between the two cases: the vapour-density at saturation diminishes continually with alcohol till it becomes normal, *i.e.*, 24 at about 20° —similar results to these were got for ether. The case of acetic acid is quite different; for, although at temperatures above 150° the saturated vapour-density continually increases with rise of temperature, and this vapour-density sinks as temperature falls to 150° , yet, as the temperature falls below 150° , the vapour-density begins to increase again, till at 20° it is the same as at about 270° ; nor does it become normal, although at 20° the pressure is only a few millimetres, and the vapour-density 59 nearly corresponds to 60 for $(\text{C}_2\text{H}_4\text{O}_2)_2$; but the nature of the curve of vapour-densities of acetic acid at saturation does not suggest a limit at this point.

Ramsay and Young argue thus with respect to acetic acid: High temperatures are favourable to chemical decomposition, or dissociation of complex molecules; and we therefore have no reason for assigning to

¹ *Phil. Mag.* Feb. 1887.

² *Phil. Trans.* 1886, Part I.

acetic acid on the score of its saturation vapour-densities at the higher temperatures any essentially different molecular arrangement than we do to alcohol and ether. Now, for these latter bodies, the vapour-densities at saturation are at *low* temperatures normal, *i.e.*, normal under conditions of temperature more favourable to complex molecules: Seeing that complex molecules of alcohol are not formed at low temperatures, *à fortiori* they are not at the higher temperatures; there is no reason, seeing that at the higher temperatures alcohol and acetic acid behave similarly, for supposing that acetic acid has other than a normal molecular constitution at higher temperatures: But there remains the peculiarity of acetic acid, that its saturation vapour-density below 150° increases continually. The pressure being relieved, we should expect, as in the case of alcohol, that as the pressure diminishes with the temperature the vapour-density would get smaller till it is normal. There must, therefore, for temperatures below 150°, be, in the case of acetic acid (also in that of nitric peroxide, which is similar), some cause (different from the mere approximation of the molecules by pressure, which at high temperatures accounts for the high vapour-densities at saturation) operating to increase the density. This can be no other than a *chemical* cause, and is probably due to the combination of some of the molecules by pairs, or, perhaps, partly into more complex molecules.

There are other arguments besides the one put forward here; and for these, and for the light thrown by the analogy of the behaviour of the dissociating compounds, the original paper must be seen. The general result from all the considerations adduced is, that for *stable* substances the difference between the liquid and the gaseous state is not one of kind but of degree; that the phenomena accompanying the vaporisation of a single stable body in the liquid state presents no evidence, from the study of the vapour, in favour of the existence of complex molecules in the liquid; that, on the other hand, in the cases of acetic acid and nitric peroxide, there is evidence of the formation of complex molecules in the vaporous and in the liquid forms of these bodies; the complex molecules corresponding in some respects to molecules of an unstable, dissociable body.

The difference between the gaseous and the liquid condition of a stable body is thus referred to the greater approximation to each other of the gaseous molecules, and to the consequent increase in their attraction for one another, which is known as cohesion.

There is no doubt of the wonderful accuracy with which the equation $p = bT - a$ expresses the results of experiment for four of the bodies examined, *viz.*, ether, methyl- and ethyl-alcohols, and CO_2 ; and of the considerable deviation of the results of experiments from the predictions of this formula in the cases of nitric peroxide and acetic acid, and probably for formic acid and other bodies. The explanation given above of the differences between these two sets of cases involves the separation of bodies into two classes, to one of which the equation applies accurately, and to the other not at all.

Perhaps it will be found that even here it is a question of degree and not of kind; that bodies differ from one another in reference to the degree to which they conform to the rule expressed by the above equation in the gas-liquid state; that there is, in fact, a perfect gas-liquid state, as there is a perfectly gaseous state; and that many bodies can be

found which conform almost perfectly to the gas-liquid condition, others less perfectly, while others again deviate from it in a very marked manner.

Molecular Weight of Nitric Peroxide by Raoult's Method—Ramsay.

Raoult has of late years,¹ by a long series of investigations, succeeded in perfecting a method by which the molecular weights may, in a large number of cases, be determined by observations of the degree of temperature by which the freezing-point, either of water or of some other substance, is lowered by the solution of a given quantity of the solvent.

In the case of acetic acid as the solvent, the freezing-point of this, when perfectly anhydrous and pure, is $16\cdot68^\circ$; dissolve in a given weight of acetic acid a known small quantity of the substance whose molecular weight is required; observe the melting-point of the acetic acid with the addition of this substance; it will be found lower than $16\cdot68^\circ$; note the difference; and assuming, as we may, that the lowering is proportional to the small quantity of the substance dissolved, calculate the lowering of the freezing-point for the solution in acetic acid of 1 part in 100 parts of the acid; this amount multiplied by the molecular weight in almost all cases in which the molecular weight is known is 39. This is called by Raoult the molecular depression for acetic acid; assuming now, in any case, the molecular depression to be 39, it is seen that by noting the depression produced by a given small weight of a substance in acetic acid the molecular weight of the substance can be determined.

Ramsay has applied this method² to find the molecular weight of nitric peroxide at about 16° , by dissolving small weighed quantities of the liquid in acetic acid, and finds in a series of experiments that the molecular weight of the peroxide is always near 92; and that the relative number of molecules of the peroxide in a given volume of acetic acid may be decreased from 8.97 to 0.92 without materially altering the molecular weight; no dissociation therefore of N_2O_4 takes place on dilution.

Experiments giving Points on the James Thomson Sinuous Curve.

Experiments have been repeatedly made in reference to the anomalous condition of a liquid when in certain circumstances it can be raised in temperature above, and often considerably above, its boiling-point without entering into ebullition. This state of a liquid has been the subject of special examination by Donny,³ by Dufour,⁴ and by Gernez.⁵ In the case of some experiments of this kind there is not only the liquid but the vapour above the liquid at a temperature above the boiling-point of the liquid, while the pressure of this vapour hardly exceeds the atmospheric pressure, and no liquid distils. These are cases where for the temperature (above the boiling-point) the pressure of the vapour is less than the vapour-pressure normally belonging to that temperature. We have here, therefore, points on that part of the sinuous curve which is convex to the axis of volumes. Such a point, as Ramsay and Young

¹ *Ann. Chim. Ph.* [5], 20, 1880; 28, 1883; and [6], 2, 1884; 4, 1885; 8, 1886. The *Agenda du Chimiste* for 1888 contains a summary of the principles and practice of M. Raoult's method by himself, p. 475.

² *C. S. J.* June, 1888, p. 621.

³ *Ann. Chim. Ph.* [3], 16, 1846, p. 167.

⁴ *Ibid.* [3], 68, 1863, p. 370; [4], 6, 1865, p. 104; and 16, 1869, p. 470.

⁵ *Ibid.* [5], 4, 1875, p. 335; and 7, 1876, p. 113.

have shown, can be obtained at constant temperature by diminishing pressure, a case of which is a point on the isothermal, for 181.4° , of alcohol.¹ Other examples are methyl alcohol, liquid SO_2 , liquid NH_3 , heated with their vapour to temperatures considerably above the temperature at which the vapour-pressure is, in the static method, in equilibrium with the atmospheric pressure² (this Report, 1886, p. 13).

Points on the upper part of the sinuous curve—concave to the axis of volumes—are points at which the pressure is in excess of the vapour-pressure for a given temperature; these points are reached in cases where a space is supersaturated with vapour. In 'Nature,' March 1, 1880, Mr. John Aitken gives an abstract of a paper read by him at the Royal Society of Edinburgh on February 6 the same year. In this remarkable paper, 'On the Number of Dust Particles in the Atmosphere,' he shows that when an expansion by a stroke of the piston of an air-pump is made in the air saturated with moisture in the receiver, a fog is formed by the dust particles acting as nuclei to small droplets of the water precipitated on them through slight loss of heat and lowering of temperature consequent on expansion against pressure; but that if the air be by filtration through cotton-wool freed from the greater part of the dust particles, after allowing the fog produced by the stroke of the piston to subside, subsequent fogs so produced will at length become slighter, until a small stroke (and then a larger stroke as the operation is repeated) ceases to produce a fog or any deposition of water in the liquid state; the air is thus to a greater or less extent supersaturated with aqueous vapour. If all the air-dust has settled, some points on the upper part of an isothermal curve of water are thus obtained, at which the pressure is greater than the vapour-pressure of water at that temperature.

All points on this sinuous curve represent unstable states of equilibrium, so that if the stroke of the piston is made with a jerk a copious shower is produced in the dust-free air.

Properties of Bodies for which $p=bT-a$.

Professor G. F. Fitzgerald³ discusses the 'thermodynamic properties of substances whose intrinsic equation is a linear function of the pressure and temperature.' The intrinsic equation is the equation $p=bT-a$, in which a and b are functions of the volume only; and the conclusions he draws are the following:—

(1) The specific heat of the substance at constant volume is independent of the pressure.

(2) The internal energy of the substance is the sum of two terms, of which one is independent of the pressure, and the other independent of the temperature.

(3) The entropy of the substance is the sum of two terms, of which one is independent of the pressure, and the other independent of the temperature.

Isopycnics.

The above name is given by Wroblewski⁴ for lines representing the relation between pressure and temperature when the density is kept

¹ *Phil. Trans.* 1886, Part I. plate 3.

² *Reg. Mém.* t. xxvi. p. 645.

³ *Proc. Roy. Soc.* 42, 1887, p. 50.

⁴ *Wiener Monatsheft f. Chemie*, 1886, p. 383; and *Wied. Ann.* 29, 1886, p. 428.

constant. These lines are obviously the same as Ramsay and Young have investigated; for if the density of a given mass is constant, its volume is constant. Isopyknic lines are therefore isochoric lines, and Wroblewski is attacking precisely the same problem as Ramsay and Young have apparently brought to a successful conclusion for several widely different substances by means of their own laborious and skilful experiments. Wroblewski calculates their data by means of Sarrau's equation, which, however well it may apply to portions of the data for CO_2 , is not to be taken as a rigorously proved theorem which can enable one to dispense with direct experiment. A criticism of Wroblewski's method and conclusion is given by Ramsay and Young in 'Philosophical Magazine,' 23, 1887, p. 547.

Compressibility of Liquids.

Amagat, in the course of his examination of the effect of pressure on gases, found¹ for the gases he examined, including CO_2 for low temperatures as for high, when the pressure is very great, the following relation $p(v-a) = \text{constant}$; this relation holds good very approximately at ordinary temperatures, whether at these temperatures the compression condenses the gas to a liquid or not—whether or not the temperature is above or below the critical point. The higher the temperature the higher the pressure required beyond which the above relation holds; but at ordinary temperatures the pressure need not exceed from 400 to 500 atmos.; the constant a for all pressures above a certain number of atmos. and for the volumes corresponding varies with the gas or liquid and with the temperature.

Amagat's results, however, were obtained for gases mostly, and for CO_2 at temperatures not very much below their critical points. The problem is not the same when we take the case of water, mercury, or other liquids, the compressibility of which is slight, and for which the compression is usually measured by a special instrument, a piezometer.

In a previous paper² Amagat made a special investigation into the effect of variation of temperature on the compression of a variety of liquids, among them ethyl—chloride, bromide, oxide; methyl—and ethyl—acetates, methyl alcohol, ethyl alcohol, amyl alcohol, some paraffins; benzene, chloroform, carbon bisulphide, and acetone; the pressures not being greater than 37 atmos., the minimum temperature for each body being about 11° – 13° , and the maximum about 100° .

Again, Amagat has made recently³ a special investigation into the compressibility of water, and in particular into the effect of compression on the point of maximum density. In some respects water behaves quite differently from all other liquids. Thus, as the pressure increases the coefficient of expansion *increases*, more and more slowly at higher pressures, but, at pressures up to and beyond 200 atmos., rather rapidly; at about 3,000 atmos. the coefficient of expansion ceases to increase, and, probably, at higher pressures, it diminishes, as is the case with other liquids. Between two given pressures the compressibility *diminishes* as the temperature rises, contrary to the behaviour of other liquids.

Meanwhile, as pressure is continuously increased, the point of maximum density is lowered till at 200 atmos. it is nearly 0° ; at 700 atmos. it

¹ *Ann. Chim. Ph.* 22, 1881, pp. 319-397.

² *Ibid.* 5, 11, 1877, p. 520.

³ *C. R.* 104, 1887, p. 1159; 105, 1887, p. 1120; and *C. S. J. Abs.* 1887, p. 695, and 1888, p. 215.

is below 0° . No liquid besides water showed in Amagat's experiments any sign of a point of maximum density; the peculiarities associated with this point in the case of water seem to cease at pressures above 3,000 atmos., and water at higher pressures behaves like other liquids; the liquids examined were ether; methyl, ethyl, propyl, and allyl alcohols, ethyl chloride, bromide, and iodide, carbon bisulphide, and phosphorous chloride.

Solidification of Liquids by Pressure.

Of the many liquids subjected to great pressure, Amagat¹ had not succeeded in solidifying one; at last the compound C_2Cl_4 was found to solidify at a great pressure, the temperature of solidification rising with increase of pressure; the temperature of solidification is the freezing-point of the liquid and the melting-point of the solid; in the exceptional case of water, which *expands* on freezing, the melting-point of ice was expected by theory and found by experiment to be *lowered* by pressure; in the case C_2Cl_4 , the temperature of solidification, which at atmospheric pressure is much below 0° , rises with increased pressure as Amagat found, the solid having a very distinct crystalline structure. The following are among Amagat's results for pressures and freezing-points of this body:—

Pressure in atmos.	. . .	210; 620; 900; 1,160
temperature	. . .	$-19^{\circ}5$; 0° ; 10° ; $19^{\circ}5$

Benzene solidified at 22° under about 700 atmos. Amagat considers it not improbable that every liquid has a 'critical' temperature of solidification—*i.e.*, one above which no pressure, however great, will convert the liquid into a solid.

Compressibility of Solids and Liquids.

The general discussion of this problem up to his time, and experiments by himself on the compressibility of water, mercury, and of glass, brass, and copper, are given by Regnault.² In Tait's 'Properties of Matter' (1885) there is an historical account, including and supplementing that by Regnault, a critical discussion of theory and experiment on the subject, and of advances in it made since Regnault's time.

The reader interested in this part of the subject cannot do better than consult this excellent summary by Professor Tait.

References are here given to papers by Oersted, Perkins, Colladon, and Sturm, Poisson, Aimé, before Regnault's researches; also to Wertheim, Grassi; to a paper by Cailletet, and one by Pagliani and Vicentini.

To these must be added papers by Voigt, Röntgen and Schneider, Braun, and Tait.³

¹ *C. R.* 105, 1887, p. 165; *Phil. Mag.* 24, 1887, p. 446; *C. S. J. Abs.* 1887, p. 1013.

² *Mém. de l'Acad.* 21, p. 429.

³ Oersted, *Ann. Chim.* 2, 21, 1822, p. 99; 22, 1823, p. 192; 28, 1828, p. 326; *Mem. Roy. Soc. Copenhagen.* Perkins, *Phil. Trans.* 1820; *Ann. Chim.* 2, 16, 1821, p. 321; 23, 1823, p. 410. Colladon and Sturm, *Ann. Chim.* 2, 36, 1827, pp. 113, 225; *Mém. des Étrangers*, 1, 5. Aimé, *Ann. Chim.* 3, 8, 1843, p. 257. Wertheim, *Ann. Chim.* 3, 23, 1848, p. 52. Grassi, *Ann. Chim.* 3, 31, 1851, p. 437. Cailletet, *C. R.* 75, 1872, p. 77. Pagliani and Vicentini, *Sulla Compressibilità dei Liquidi*, Torini, 1884. Voigt *Wied. Ann. Ergbd.* 7, p. 214. Röntgen and Schneider, *Wied. Ann.* 1886–1888, 29,

In a paper by Tait, of Dec. 1887, the ultimate loss of volume of water under infinite pressure is estimated at about 25 p.c.; in a paper of March 5, 1888, the same author finds the compressibility of lead-glass per atmosphere as $\cdot 0_527$; and the increase of compressibility per degree Centigrade as $\cdot 0_72$.

Melting-points—Carnelley and Carleton-Williams.

In the application of heat to solid bodies which are not decomposed by heat at the temperatures employed, the effect after reaching a certain temperature is that the body will change its state, either by liquefying or volatilising; or both effects may take place together, especially in a case such as that of iodine, where there is not a great interval between the point of liquefaction, or melting-point, and the boiling-point.

Both of these points, however, are dependent on external pressure; the effect of pressure on the boiling-point is very considerable compared with the effect on the melting-point, which is in general hardly appreciably altered by a great alteration of pressure. But whether a substance shall volatilise without melting depends on the external pressure.

The experiments of Carnelley are concerned with the melting-points of bodies which melt at atmospheric pressure; a multitude of cases of inorganic bodies, chiefly compounds, have been determined with great care and accuracy, and the experiments and results published in a number of papers in the 'Trans. of the Chem. Soc.'¹ and in papers contributed to the 'Phil. Mag.' and the 'Proc. Roy. Soc.'

In many cases a knowledge of Carnelley's melting-points makes it possible to determine within moderate limits the boiling-point of a body when this is high, without recourse to an air-thermometer; this is done by finding two bodies, near to one another in their melting-points, one of which is and the other is not fused in the vapour of the boiling substance. This is, in fact, the method which was used by Carnelley and Carleton-Williams² for the approximate determination of the boiling-points of some salts and other bodies. By establishing relations connecting the melting-points with the atomic weights in the case of elements³ and of compounds, Carnelley has predicted melting-points of bodies which had not been determined, and found a very fair agreement between the calculated and the afterwards-observed temperatures.

A noteworthy example of this is in the cases of beryllium chloride and bromide, the melting-temperatures of which they observed and found to agree⁴ well enough with what they should be if calculated for the formulæ BeCl_2 , BeBr_2 , but to be enormously too high for the formulæ BeCl_3 , BeBr_3 , or for these formulæ doubled. It is evident from this example that Carnelley's method is an additional and valuable aid towards deciding between proposed formulæ of metallic chlorides and bromides, and so between two proposed numbers for the atomic weight of an element and the molecular weight of a compound.

p. 165; 31, p. 1000; 33, p. 644. Braun, *Wied. Ann.* 30, p. 250; 32, p. 504; 33, p. 239; *C. S. J.* 1887, *Abs.* p. 436. Tait, *Proc. Roy. Soc.* 1883, Dec. 1887 and March 1888; *Nature*, Jan. and March 1888.

¹ *C. S. J.* 1876, p. 489; 1878, p. 273; 1879, p. 563; 1880, p. 125; 1884, p. 409.

² *Ibid.* 1878, p. 281; and 1879, p. 563.

³ *Proc. Roy. Soc.* No. 197, 1879, p. 190.

⁴ *Phil. Mag.* Nov. 1879, p. 371; *Proc. Roy. Soc.* 1879, vol. xxix. 190.

Effects of Pressure—Solids.

The effects of great pressure on solid bodies in the state of powder have been examined by Spring in a series of investigations extending over several years, accounts of which have been published from time to time.¹

The bodies being taken in the state of powder, and the apparatus used being capable of exerting a pressure of about 10,000 atmos., experiments were made on various bodies, elementary and compound. The effects may be classed under two heads, mechanical and chemical.

As to the mechanical effects, the following metals—*lead, bismuth, tin, zinc, aluminium, copper, antimony*—taken in the form of powder or filings, when subjected to pressures up to 6,000 atmos., were completely welded into a homogeneous mass of the specific gravity of the metals in block, sometimes with crystalline fracture, but with no trace of powder or filings visible; spongy *platinum* gave a block with shining metallic surface exhibiting a dull fracture, and perfect union was not obtained at any pressure; similarly with amorphous carbon; while graphite powder was welded at 5,500 atmos. into a compact mass of solid graphite. Similar results in general were obtained with metallic oxides, sulphides, salts, *e.g.*, chlorides, bromides, iodides, sulphates, nitrates, carbonates, thiosulphates, phosphates, and on other bodies; with most of these, though not with all, the welding process took place, although in not a few cases the welding was incomplete. It was found in subsequent experiments that welding requires time, and that the completion of a welding process was favoured by several conditions, such as amount of pressure, the time during which pressure was applied, and temperature, a rise of temperature favouring the process. A substance difficult to weld was found, on breaking it up, to be most imperfectly coherent in the interior; and on powdering it again and renewing the pressure again and again the welding can be made complete. Generally, the harder the substance the more difficult it is to weld it; if a body exist in allotropic modifications—as, *e.g.*, sulphur—the effect of pressure is to produce a coherent mass having specific gravity equal to that of the densest variety. The welding of a powder is in some respects analogous to the liquefaction of a gas by pressure; the particles of the powder are brought into closer contact and within each other's sphere of cohesion, and then unite like drops of water. Although the temperature is hardly raised in the experiments, some metals at very high pressures flow and ooze out of the joints of the apparatus. It will sometimes happen that no welding takes place at a very high pressure, but on still further increasing the pressure the process is effected.

As to the formation of alloys by pressure, it was found that Woods' metal was formed by submitting to a pressure of 7,500 atmos. a mixture of filings of bismuth, cadmium, and tin in the required proportions. Rose's alloy of lead, bismuth, and tin was obtained in a similar manner.

¹ *Wied. Ann.* [5], 22, 170; *Bull. Acad. Belg.* 1880 [2], 49, 323; *Abs. Jahr. f. Min.* 1882, 1, R. 42; *Ber.* 1882, pp. 15, 595, *Ber.* 1883, pp. 16, 324, 999, 2723; *Ber.* 1884, 17, pp. 1215, 1218; *Bull. Soc. Chim.* 44, p. 166; 46, p. 299; *Ber.* 1885, 18, R. 597; *Ber.* 1886, R. 728; *Ber.* 1887, 20, R. 358; *Zeitschr. f. phys. Chem.* 1, 231. And abstracts in *C. S. J.* 1881, p. 498; 1882, pp. 273, 921; 1883, pp. 650, 904; 1884, pp. 256, 949, 959; 1887, p. 332.

Ordinary brass was got with difficulty by repeatedly submitting a mixture of zinc and copper filings to great pressure.

Spring lays down the rule that 'matter assumes that condition which corresponds to the volume it is made to occupy.' Thus when two bodies can by their union or interaction produce one of less volume or greater density, this will be produced by great pressure; and he explains by this the readiness with which Woods' and Rose's alloys are formed as contrasted with the formation of brass by great pressure. At 6,500 atmos. arsenides of lead, copper, and silver are formed from the elements in the same way; and the following sulphides, viz., of Mg, Zn, Fe', Cd, Bi, Pb, Ag, Cu, Sn, and Sb, by repeated compressions. Spring found that the extent to which the formation of sulphide is carried in this process depends on time as one condition; by the lapse of time alone more of the sulphur and metal combining to form more of the sulphide.

Chemical Actions by intense Pressure.—Solids.

A dry intimate mixture of sodium carbonate and barium sulphate being submitted to intense pressure, double decomposition occurs to a considerable extent. A double decomposition also occurs under similar circumstances with a mixture of dry powdered sodium sulphate and barium carbonate; and when the resulting compressed cylinder was again powdered and submitted to intense pressure, and the process repeated several times, the substance being maintained for some time under pressure, the formation of barium sulphate increased to about 80·5 per cent., which seemed to be the limit.

The Transition-point.

J. H. Van 't Hoff calls by the name 'transition-point' that constant temperature at which a chemical change can begin and continue, and compares it to the melting-point of a solid in its theoretical relations. Thus, if there is a transition-point in a chemical action, this point must be dependent on the pressure in such a manner that if the change is accompanied by decrease of volume, as in the melting of ice, the transition-temperature should be *lowered* by increased pressure. As an example, Van 't Hoff and Spring take the case of a double acetate of calcium and copper.¹ At ordinary pressures the double-salt, which is blue, is decomposed into its component salts at 75°, and this change is accompanied by diminution of volume, as in the melting of ice. Therefore increase of pressure should lower the transition-point, and therefore promote the formation at a lower temperature than 75° of the separate salts from the double salt. Now the cupric acetate by itself is green, and the transition can therefore be observed by the change of colour. At 6,000 atmos., and temp. 16°, the finely powdered double acetate became a marble-like crystalline mass, but showed no sign of decomposition; at 40° a quantity of the mass liquefied; on relieving the pressure it became all solid, the dark blue had changed for the most part to green, and there was found a coating of copper round the sides of the containing vessel. At 50° the action was more rapid. It was found also that the decompo-

¹ *Bull. Acc. Belg.* 49, 344; *Zeitschr. f. phys. Chem.* 1, 227; *C. S. J. Abs.* 1888, p. 341; *Rec. trav. chim.* 6, 91; *Ber.* 1887, *R.* 276, 311.

sition could take place at ordinary temperatures by the application of sufficient pressure during a sufficiently long time.

In a further communication, Van 't Hoff¹ mentions that at his suggestion Spring had subjected the double acetate to high pressures at varying temperatures, and adds that by prolonging at 16° the pressure of 6,000 atmos. evidence of decomposition is readily recognisable. Van 't Hoff points out that determinations of the minimum pressure required to produce reactions of this kind, together with measurements of the resulting changes of volume, will make it possible to express in kilogram-metres the absorption of energy involved in the reaction, and conversely the liberation of energy resulting from the reverse change.

Report of the Committee, consisting of Sir F. J. BRAMWELL, Mr. E. A. COWPER, Mr. G. J. SYMONS, Professors G. H. DARWIN and EWING, Mr. ISAAC ROBERTS, Mr. THOMAS GRAY, Dr. JOHN EVANS, Professors LEBOUR, PRESTWICH, HULL, MELDOLA, and JUDD, and Mr. J. GLAISHER, appointed for the purpose of considering the advisability and possibility of establishing in other parts of the country observations upon the prevalence of Earth Tremors similar to those now being made in Durham.

DURING the past year a good deal has been done in the way of devising, constructing, and testing new forms or modifications of old forms of earth-tremor-registering instruments. Professor Milne in Japan and Dr. Holden, of the Lick Observatory in California, have instituted systems of earthquake observations, the former employing instruments of various kinds, chiefly of his own invention, and the latter using Professor Ewing's duplex seismograph. Professor Ewing has, however, recently been engaged in materially improving this instrument and also in perfecting a cheaper time-recording apparatus with a special view to numerous observers stationed in many parts of the country. He has also quite recently brought out a new sensitive electric seismoscope. Mr. E. A. Cowper has described at the present meeting of the Association yet another seismoscope, of entirely new construction, specially adapted for recording vertical motion. The North of England Institute of Mining and Mechanical Engineers have continued the series of observations on the coast of Durham at Marsden, and have now three instruments at work there, including a form of cheap recorder constructed from the designs of Mr. M. Walton Brown. That institute has issued an elaborate preliminary report on these instruments (1888).

An important observing station, with adequate funds, promises to be instituted by Mr. C. Davison and Professor Poynting at Birmingham.

Considering that so much is being done with the object of securing suitable forms of instruments, and that these investigations are still incomplete in many ways, the Committee feel that it would be premature for them to select and recommend any special recorder at present. They wish, however, to emphasise the view that, whilst carefully finished, highly sensitive, and necessarily expensive seismoscopes made to record

¹ *Ber.* 20, *R.* 311, 1888; *Rec. trav. chim.* 6, p. 137; *C. S. J. Abs.* 1888, p. 404.

with as much accuracy as possible the time, form, and intensity of each set of tremors are very desirable, and indeed indispensable, yet only a comparatively small number of such instruments would be required in a general scheme of seismographical observatories. Such instruments, moreover, could only be used with effect in carefully selected situations, and otherwise under very special conditions. On the other hand, comparatively rough, *cheap*, and easily used instruments, which could do little more than afford fairly accurate time-records, would be required in large numbers, and must form a most important portion of such a scheme.

Under these circumstances the Committee are glad to hear that the observations and trials of instruments above referred to are being continued in the north of England and elsewhere. They trust that special attention will be paid to the question of suitability in selecting the localities and, generally speaking, in considering all the local conditions of the observing stations.

Earth-tremors appear to be of frequent occurrence, and should be recorded, but the Committee propose to take no immediate action. Next year they hope to be in a position to present a report containing definite recommendations. In asking to be reappointed they hope that Mr. M. Walton Brown, who has conducted the observations in Durham, may be added to the Committee.

The Relations between Sliding Scales and Economic Theory.

By L. L. PRICE, M.A.

[A communication ordered by the General Committee to be printed *in extenso* among the Reports.]

THE treatment which I have ventured to give in this paper to the subject I have chosen—the Relations between Sliding Scales and Economic Theory—will, I am afraid, appear at the outset to be confined within very narrow and definite limits. It will seem to involve nothing more than an inquiry into the connection which exists, or may exist, between a practical expedient adopted with some success in some few industries for the regulation of wages, and that limited—although contentious—part of theoretic economics which is concerned with the determination of the rate of wages. And, narrow and definite as these limits may appear, I propose to circumscribe the subject still further; for not only do I intend in the main to limit my consideration of sliding scales to their employment in the regulation of wages, but I purpose also to confine it for the most part to the form in which they have, as a matter of actual fact, been employed. By sliding scales, then, I mean in the main certain expedients which have been adopted in the coal and iron industries as the result of an agreement between two opposing combinations of masters on the one hand and of men on the other, in accordance with which fluctuations in wages have followed, we may almost say automatically, on changes in the selling prices of the coal and iron. And by economic theory I mean for the most part that theory which is known by the name—partial and erroneous as may be its application—of the abstract or deductive method. Within these narrow and definite limits I propose to examine the nature of the relations between sliding scales and economic theory.

And yet, narrow and definite as are the limits I have prescribed, the subject almost of necessity presents some points of wider interest and of larger importance than might at first be supposed. It necessarily involves the examination from an economic standpoint of the nature and consequences of those combinations which seem to be occupying, and to be destined to occupy, a more and more prominent position in the industrial world as time moves on. For the adoption and the continued observance of a sliding scale appear to presuppose some sort of organised representation on either side; and organised representation is but another name for combination.

The subject, again, almost of necessity compels the consideration of some of the chief changes which have taken place in the economic theory of wages, as it appears to have been conceived by Ricardo, and as it is now generally accepted. And, lastly, it has certainly some indirect bearing on the relation between economic theory and practice.

If I may be permitted to do so, I should like to preface my examination of the question by a brief account of the circumstances which originally induced me to attempt it. Some months ago there appeared in the pages of a periodical—the name of which would, I imagine, be of little or no interest to the members of the Section, and I therefore withhold—two able and indulgent criticisms on certain views I had ventured to put forward in a recent publication¹ on the subject of this paper. These criticisms led me to reconsider the attitude I had adopted with some little care, and it is the general results of that reconsideration which I venture now to submit; and I have given this explanation in order to afford some excuse at the outset for the egotistic form which the paper will take.

The first of these critics—who, I may remark in passing, was a strenuous adherent of what I suppose we must call the ‘historical’ method—observed that the work he was criticising, which contained these views, was the ‘outcome of common sense working upon historical and statistical material *unaided*² by economic theory.’ The other critic, who lent his support rather to the abstract or deductive method, rejoined that the ‘*neglect*’² of that theory was the ‘one grave defect’ of the book. Now, it appeared to me, perhaps not unnaturally, that both these criticisms were wrong. It seemed to me that it was impossible to discuss with adequate completeness the facts and the principles of sliding scales ‘unaided’ by economic theory; and on the other hand I hoped that I had not been guilty of the unpardonable sin, as it would seem to me, of the ‘neglect’ of that theory. I was firmly of opinion, in opposition to my first critic, that such knowledge of theory as I might have possessed had ‘appreciably helped’ me in the discussion of sliding scales; that it had ‘supplied’ me with ‘points of view;’ that it had given me ‘guidance in the arrangement of material;’ and that the ‘facts of real life and the theories of economists’ had not ‘been kept, as it were, in two separate compartments of’ my ‘mind.’ And yet I could not agree entirely with my other critic when he asserted that ‘Political Economy does supply the principle’ on which an arbitrator should act, or a sliding scale proceed; and that that principle was that he or it should endeavour to award such wages as would be obtained if ‘combination on either side were absent.’ This criticism indeed appeared to me to be nearer the truth, as I held it, than the other, but I did not think that it had entirely

¹ *Industrial Peace.*

² The italics are my own.

succeeded in reaching it. And so I was led to reconsider the attitude I had originally adopted.

And here I am afraid that I can only explain my meaning and define my attitude by quoting the three passages in the book to which my critics referred where the relation of economic theory to methods of industrial conciliation is considered. Nor will these quotations be irrelevant to the strict subject of this paper, the relation of that theory to sliding scales: for, on the one hand, the starting-point of a scale must almost necessarily be an agreement obtained by conciliatory methods—by conciliation that is, or arbitration; and, on the other, the principle which has as a matter of fact, I believe, been invariably taken as the basis of a scale in industrial matters—the concurrent variation of wages and prices—is also the principle to which recourse has generally been had at boards of conciliation or courts of arbitration.

The first of these passages occurred at a place¹ where the nature of what I had ventured to call 'irregular negotiations' between masters and men in industrial disputes was examined. The passage ran in these terms: 'Nor, be it noticed, does there seem to be any economic standard which can be called into requisition in such disputes, for, as Professor Sidgwick has pointed out, where two combinations meet one another, political economy is perforce silenced.'

In the second and longest passage² it was argued that the 'principle' on which an arbitrator should act in adjusting industrial disputes 'could hardly be supplied by Political Economy.' . . . 'As Jevons has shown in his "Theory of Political Economy," in all bargains about a single *indivisible* object'—and I lay special stress, for reasons which will appear later, upon the word *indivisible*—'there may arise a "deadlock" because neither party can read the mind of the other, and discern the exact length to which it is prepared to go in pushing demands or accepting concessions. Nor indeed, did they possess the gift of clairvoyance, would the problem be necessarily solved. For even then there might be no definite point fixed in the mind of either. After alluding to this passage in his "State in Relation to Labour," he' (*i.e.*, Jevons) 'proceeds to point out that the existence of *indivisible* combinations in trade disputes'—and here again I would emphasise the word *indivisible*—'usually reduces them to a bargain of this "indeterminate" nature. To avoid a strike it may be the interest of either party to relinquish, or at least to relax, its demands; but theoretic economics cannot resolve the problem. It is, in mathematical phraseology, "indeterminate."'

The third and last passage occurred³ where the introduction into a sliding scale of such elements as the cost of materials and the state of the labour market was under consideration. 'From an economic point of view indeed,' it was argued, 'there is considerable reason for having regard to them, but it is the traditions of the trade which are of the greatest importance. For the existence of combinations on either side banishes, as we have noticed, to a very great extent all economic considerations, so far at least as the determination of the exact basis of the settlement is concerned.' And then, later on in the same paragraph, it was urged that 'the negotiations into which' the two parties 'enter can hardly be reduced to a question of pure economics, nor is there any economic touchstone which can be brought into requisition to decide the

matter.' And then the next paragraph began with these words:—'In a certain sense, indeed, it may be said that the regulation of wages by selling prices does rest upon an economic basis, however the particular details of that basis may be arranged.'

These, then, are the three passages to which my critics seemed to refer; and I should be inclined to summarise the argument to which they were intended to give expression in some such way as this. What I maintained was that, while the general nature of the principle on which a sliding scale may be based or an arbitrator proceed may, and indeed must, possess an economic complexion, yet the particular application of that principle—the special relation between wages and prices adopted as the starting-point of a scale—is not strictly determinable by economic theory. A treatise on sliding scales cannot then, it seems to me, be written 'unaided,' as one of my critics declares, by economic theory; and yet it is none the less true to maintain—in opposition to my other critic—that 'theoretic economics' cannot resolve the problem involved in the determination of the *exact* basis of a scale.

For what is the fundamental assumption of 'theoretic economics'? The answer which would, I imagine, be at once returned to this question would be, that the fundamental assumption of almost any scheme of theoretic economics is competition. That competition, indeed, may be hindered in its action by qualifying circumstances—by the *vis inertia* of custom or some other obstacle; but we may nevertheless maintain that the hypothesis which presents itself at the outset before these qualifying circumstances are taken into consideration—the hypothesis which is revealed in the last analysis when these circumstances have been successively abstracted—is, undoubtedly, pure competition. The term 'competition,' however, stands in need of fuller explanation; for, for the purposes of 'theoretic economics,' it seems to me that the objects or interests about which the competitive forces play must be, in theory at least, susceptible of continuous subdivision. This is what I meant when I followed Jevons in arguing that 'the existence of *indivisible* combinations in trade disputes usually 'reduced' them to a bargain of 'an indeterminate nature.'

The proposition just laid down seemed to me to admit of more than one easy and simple test. We might take, for instance, Jevons' own conception of 'final utility.' Few economists, I imagine, would deny that that conception is now an accepted part of economic theory, and that it is one of the most fertile conceptions of modern economics. There are signs of its extension—along with the increasing amalgamation of the theory of exchange with that of distribution—from the theory of exchange of material commodities to that of exchange of services. It has been applied to the determination of interest; and it may, I suppose, be said to be connected with the theory of rent. But it cannot, I imagine, be accepted, save on the assumption enforced by Jevons himself,¹ that 'more or less of a commodity' can 'be had down to infinitely small quantities.'

Take once more the law of Diminishing Return—the overthrow of which would, as Cairnes once pointed out,² involve the rewriting of the greater part of economic theory—and what do you find? Here again the

¹ *Theory of Political Economy* (2nd edition), p. 130.

² *Logical Method* (2nd edition), p. 36.

assumption seems to me to be fundamental that 'doses' of capital and labour—to use the elder Mill's suggestive expression—can be applied to the cultivation of land in infinitely small quantities, and that the returns to those doses, when a certain point of cultivation has been reached in a certain stage of civilisation, diminish also *cæteris paribus* by infinitely small degrees.

Or take again—though I do not lay much stress on this—one variety of what I may perhaps call the application of the 'graphic method' to economics. It seems to me—though I speak, I confess, with some hesitation—to be impossible to represent, as some economists have done with conspicuous success, economic theorems by geometrical curves unless we assume the possibility of division into infinitely small quantities.

This possibility, in fact, is the underlying basis of any theory of competition, and in the final analysis of any such theory it cannot fail to appear. The theory may indeed be only hypothetically true; although for my part I must confess that I am inclined to believe that it is a more accurate and serviceable representation of fact than is sometimes maintained. The conditions, again, of the hypothesis must always be remembered; and it may be the case in some instances that the quantities into which the commodity or service is capable of division may only be infinitely small in comparison with the great mass of the commodity or service under consideration. But this possibility does not prevent the theory from being hypothetically true; nor, on the other hand, does it obviate its failure to apply in its entirety to cases where this capacity of infinite divisibility is lacking.

One of these cases occurs whenever a combination of sellers meet a combination of buyers. The commodity or service offered by either party in exchange for that supplied by the other is *ex hypothesi* whole and indivisible. There may indeed possibly be—as we shall endeavour to illustrate later—a maximum as well as a minimum limit beyond which it may respectively be the interest of neither party to go. But no theory of competitive economics—based as it is on the possibility of infinite subdivision—will enable you to determine the precise point between these two limits at which it is for the joint interest of the two parties to stop; for the commodities or services they are exchanging are, by the very terms of the existence of the combinations, incapable of that infinite subdivision. On the one side you have, roughly speaking, in the case of a sliding scale a combined mass of labour offered for sale; on the other, you have a combined mass of remuneration, be it expressed in terms of nominal or real wages or earnings—and by the very conditions of the combinations, neither of these two masses is capable of infinite divisibility. If a combination of buyers alone, or a combination of sellers alone existed, this capability might indeed be impaired, but it would not be paralysed. The one commodity or service offered in exchange would retain it, and the other would lose it. And hence it is, I suppose, that Professor Sidgwick has discussed¹ as a part of economic theory the action of monopoly or combination. But the combination he considers is, as he himself expresses it, only one-sided; and the combinations in connection with a sliding scale, which we are now discussing, are found on both sides. And yet the existence of these combinations seems, we must remember, to be a necessary condition of successful conciliation, or arbitration, or sliding

¹ *Principles of Political Economy*, Book II ch x.

scales ; for there must be organised representation on either side if there is to be any authoritative or binding agreement, and organised representation is but an alternative expression for combination.

Nor does my critic seem to me to succeed in showing a way of escape from this conclusion ; and, if I might be allowed to put my own interpretation upon his language, and to supply the missing parentheses, I imagine that the difference between us might be reduced to the narrowest limits, even if it did not disappear altogether. Let me quote his words:—‘As a matter of fact,’ he argues, ‘political economy does supply the principle—which is, that the arbitrator should endeavour to award such wages as would be obtained if combination on either side were absent. If he fixes them appreciably above or below this level, economic theory shows that his award will have very soon to be revised. So, too, economic theory shows that if a sliding scale has the effect of making the wages paid under it differ much from competitive wages it must break down.’

Now, looking at the matter for a moment from a practical standpoint—although, indeed, I freely confess that for the immediate purposes of this discussion this mode of regarding the question is chiefly important for the side-light it may throw upon the theoretical aspect—but adopting for the moment this practical standpoint, I am afraid that my critic’s argument does not carry us very far. For where, let me ask, is the unhappy arbitrator to discover this ideal standard ? If he confines his consideration within the limits of the two organisations which are represented before him, he manifestly can discover no such standard. He cannot arrive at anything save a particular relation between wages and prices, which is held by both parties to be fair ; and the fact that they both consist of combinations whose express purpose is to secure better terms than could be obtained by individual competition, establishes a strong presumption against the belief that any standard could have become traditional which was determined merely by the influences affecting competitive wages. Nor, for the very same reason—and of this point the history of industrial conciliation supplies more than one striking and instructive illustration—will they be inclined to accept an appeal to the standard of wages prevailing outside the limits of their own, or at least of some, combination ; for by doing this they would virtually nullify the *raison d’être* of their own organisation.

Nor, indeed, is it possible for the arbitrator himself to penetrate, as it were, beneath the stratum of combination and to reach that of pure competition. Within the limits of the combinations before him he cannot do this ; for he cannot strip off so much and declare that what is left is what would be the case ‘if combination on either side were absent.’ He cannot, in fact, isolate the competitive wage from the action and interaction of the two combinations. The rate of wages is the result—to use a metaphor with which students of logic are familiar—of chemical rather than mechanical action, and the effects of the causes are intermixed.

Nor, again, can he succeed in this aim by having recourse to the labour market outside these limits ; for he cannot really pass beyond the influence of the forces originating within them. The so-called competitive market itself must be influenced by the action of the combinations. If you have a strong buyer and a strong seller—and what are combinations but strong buyers and sellers ?—at any particular time in a market, they will, for good or for evil, affect the market price ; and if the permanent condition of affairs be that of a strong buyer confronting a strong seller,

they will, for good or for evil, exercise a permanent influence on the market price, however wide the area of the market be. And a 'market,' in the economic sense, we must remember, may cover a very large area.

This conclusion conducts naturally to the consideration of the question from the point of view which is at present of the most immediate importance to us—that of theoretic economics. And here I am prepared—and the previous course of the argument has, I think, tended to this result—to accept my critic's opinion, subject to my own interpretation and commentary. I readily allow that, if an arbitrator fixes wages at too great a distance above or below a competitive 'level,' in time the action of what we may perhaps call *external* competition—modified, indeed, and retarded by combination—will bring about a reversal of his decision. I do not see, indeed, how he is to ascertain this competitive 'level' save by examining into the past history or present condition of a market—be it within or be it outside of the limits of the organisations represented before him—where combinations have influenced wages. Nor do I think that it would be easy to determine the exact distance which would be 'appreciable' enough to upset his award. But, subject to these reservations—the latter of which is, I admit, more important from the practical than from the theoretical point of view—I accept my critic's conclusion. And in the same way it may be the case—and I for one would not question it—that 'if a sliding-scale has the effect of making the wages paid under it differ much from competitive wages it must break down.' But here again it is true—from the standpoint alike of theory and of practice—that these 'competitive wages' themselves will be influenced by the reflex action of the two powerful combinations; and that the exact amount of difference which, for the purposes we are now considering, ought to be characterised as 'much' would be hard to determine.

The truth, as I conceive it, may be expressed in some such way as this: combinations cannot entirely free themselves from competitive influences, any more than competition can nullify the presence and action of combinations. Competition prescribes, as I think, at any particular time in a market what I will follow Roscher in calling a maximum and a minimum limit to wages; but 'theoretic economics,' based as they are on two-sided, or at any rate on 'one-sided,' competition, cannot determine the exact point between these two limits at which two combinations will, or should, agree on a price. 'The existence,' then, 'of combinations on either side' does, as I have argued, 'banish' 'to a very great extent'—and I must add myself, though my critic does not in his quotation from me, this qualifying expression—it does banish 'to a very great extent' all economic considerations, *so far at least*—and here, again, I would emphasise the addition of this qualifying clause—'so far at least as the exact basis of a settlement is concerned.'

I do not intend to maintain, as my critic seems to imagine that I do, that 'by means of arbitration and conciliation and sliding scales the wages paid in a trade can be somehow or other removed from the arena of competition;' but I do maintain that it is impossible to determine by any theory, based, and based essentially, on the unrestrained freedom of any fresh combatant to enter the lists or of anyone already within the arena to withdraw—it is impossible to determine by any such theory the exact issue of the contest when, in place of this unrestricted freedom, you have the comparatively rigid and unvarying forces of two rival combinations.

Metaphors, however, are proverbially liable to break down at some important point; and therefore I will, at the risk of trespassing upon the patience of the Section, endeavour to make my meaning plain by an examination of the general nature of the change which has, I think, passed over the theory of wages in modern economics. The old theory of Ricardo¹—so much maligned and so often misunderstood—was, I imagine, so far true that, looking at the matter chiefly from what I may call a statical point of view, and remembering that Ricardo used the term ‘profits’ in what would now be regarded as a loose and inexact sense—making allowance for this, and looking at the matter chiefly from the statical standpoint—if you had a definite total amount of wealth produced, and a definite share of that total were taken for the landlords in rent, the remainder would be all that could be divided between the capitalists and the labourers, and if wages gained profits must lose. Looking at the matter, then, in this way, it would not be difficult to obtain from Ricardo an idea of what I will call the ‘competitive’ maximum limit of wages. That limit would consist in the amount of wealth left when the capitalists had secured the rate of profits prevailing in the country—the rate that is prescribed by the return yielded by the land on the margin of cultivation to the capital and labour applied to it.² Nor, again, would it be easy even now to discover any other ‘competitive’ minimum limit, as I will call it, than that presented in Ricardo’s idea of the cost of production of labour.

Wherein, then, we may ask, did he fail? He failed in neglecting to lay stress on the causes which might extend the maximum limit. Nay, he rather looked forward—and we cannot in fairness say that this pessimistic forecast was unwarranted by the circumstances of the times when the law of Diminishing Return seemed to be applying to England with terrible reality—he rather looked forward to a contraction than to an extension of the maximum limit. Neither he nor Malthus—as M. Leroy-Beaulieu has insisted with characteristically French epigrammatic force³—were ‘geographers.’ Their horizon—so far at least as the future was concerned—was to a great extent bounded by the circumstances of their own country, and it was in a large degree on those circumstances that they founded their generalisations of the future.

In the second place, Ricardo may be said, on the whole, to have failed by neglecting to give sufficient emphasis—and to repeat the emphasis from time to time at each successive stage in the argument—to the elasticity of the expressions, ‘the cost of production of labour’ and ‘the average rate of profits.’ It was, I suppose, to a large extent in consequence of this that he failed to examine the distance by which, at any particular time and in any particular condition of the labour market,

¹ So far, indeed, as Ricardo can strictly be said to have *formulated* any definite and complete theory of wages.

² And so Ricardo may really be said to agree with later writers in finding the maximum limit to wages in the productivity of industry, however much he may differ from them in the narrowness and rigidity with which he may have conceived that limit. It must, of course, be admitted that it would perhaps be more accurate to represent him as limiting profits by wages rather than wages by profits; but the statement in the text may nevertheless be regarded as consistent with the *broad* outlines of his reasoning.

³ I am not sure that we ought not to add ‘with characteristically French exaggeration,’ for M. Leroy-Beaulieu appears in some passages to betray a slight tendency to exaggerate the deficiencies of the older economists.

the extreme point of the maximum limit might be parted, as Roscher has shown, from the extreme point of the minimum, and the causes which might contribute to bring wages further away from the one extreme and nearer the other. He identified, in short, the maximum and the minimum; and this is not misleading when we consider only the question of 'natural,' or, as we should now call them, 'normal' wages. But it is misleading to give so rigid a character as a rapid perusal of Ricardo might easily suggest to this identified maximum and minimum; and, with the exception of some brief passages, he did not examine at all into the causes affecting what we may term 'market wages.'

A later and more comprehensive analysis—assisted in its turn by the altered and altering circumstances of the times—has endeavoured to supply these deficiencies. It has shown how the maximum may be extended as civilisation advances, as invention and knowledge progress, as distribution itself reacts on production by increasing the efficiency of labour, and generally aiding in the augmentation of wealth. It has replaced the suggested rigidity of the Ricardian conceptions by elasticity; and it has also investigated the causes of market wages as distinct from, and yet connected with, normal or natural wages. It has shown how the strength the workmen have gained by the aid of public sympathy and of legal enactment has affected both the market and the normal wages, and has elevated alike what we have called the competitive minimum and the competitive maximum limit. And it has also shown—and this is, perhaps, the most important point for us—how the power of combination has enabled them to raise wages in the market at any particular time from the extreme of the minimum towards the extreme of the maximum. They have become strong sellers, and they have secured the advantage which will always accrue to strong sellers in a market. They have not emancipated themselves from the influence of competition; but they have retarded and modified its action.

In time, no doubt, the influence of competition would effect—as Ricardo, confining his examination almost exclusively to normal wages, held that it did—an identification between the competitive maximum and the competitive minimum limit. But the reflex action of the market wages might cause this identification to be made at a higher or a lower point in the area covered by these two elastic expressions. It might raise the old minimum nearer to a new maximum; it might depress the old maximum nearer to a new minimum. And—as Marx in his discussion of the iron law of wages has shown, although strangely enough he has neglected to draw the natural inference from his argument—it would take time to do this; and during the interval the market influences would bring about many fluctuations in market wages, while the moment the identification had taken place—nay, even while it was going on—new market influences would be at work producing new fluctuations. The identification, then, is theoretical, and refers to normal wages; and the theory of market wages allows us to suppose at any particular time in any particular market an interval between the lowest possible point of the competitive minimum and the highest possible point of the competitive maximum. The minimum, in short, which is to be found, as it was in Ricardo's time, in the cost of production of labour, is an elastic idea, and may cover a wide area; and the maximum, which is also to be found, as it was in Ricardo's time, in the average rate of profits, is also an elastic idea, and may also cover a wide area. There is nothing, then, to prevent

us from supposing that in the labour market at any particular time—and still more so in any particular trade—there may be what we may call a competitive maximum and a competitive minimum limit of wages—the former lying at the point where more wages would mean such a low rate of profit that there would be a pressing danger that the requisite business management and enterprise would fail to appear and the requisite capital cease to be forthcoming, and the latter being found in a similar way at the point where more profits would mean such a low rate of wages that there would be an imminent prospect that labour of the requisite efficiency would not be available. Nor are we debarred from examining the causes which may influence the fluctuation of market wages between these two points, and the market wages, we must remember, will in their turn exercise a reflex influence on normal wages.

Our combination of workmen, then, enjoys the advantages of a strong seller in the market, and within the competitive minimum they may be conceived to have set up, as it were, a minimum limit of their own. Were they not confronted by a rival combination of masters they might conceivably have made this minimum coincide with the competitive maximum. But they are confronted by this combination, which in its turn endeavours to set up, as it were, a maximum limit of its own within the competitive maximum. Were it unopposed it might, in the same way as the combination of the men, effect a coincidence between this maximum and the competitive minimum. But as the case stands neither of the two combinations is unopposed. Neither of the two can secure the terms which it might otherwise have obtained. A compromise is inevitable, and on the one side or the other a greater or less concession must be made. The point at which the agreement is effected will lie between what we have called the competitive minimum and the competitive maximum—understanding by these terms the extreme points of the area covered by the elastic expressions ‘the cost of production of labour’ and ‘the average rate of profits.’ But it will probably coincide with neither of the two; and no theory of pure competition, based as it essentially is on the possibility of infinite subdivision, will enable you to determine at what precise point between these two extreme competitive limits the two combinations, dealing as they are *ex hypothesi* with commodities or services incapable of infinite subdivision, will come to an agreement and effect an exchange. All that you can safely infer is that the point of agreement will not lie outside these limits, unless indeed—though this is not an impossible supposition—either of the two parties is blind to its economic interests.

I have endeavoured to reply to the argument advanced, as I think, erroneously by one of my critics; and I believe that, without undue presumption, I may claim to have answered the other by implication. For while I have tried to show that theoretic economics cannot determine the exact basis of a scale, I have, I think, incidentally indicated the reasons for my opinion that they may have something to say about the general character of that basis. Combinations are, as we have seen, in some degree subject to the influence of competition, which prescribes the extreme limits within which they act; and it is probable, therefore, that economic theory, based as it is on competition, may not be entirely foreign to a treatise on sliding scales, based as they are on combination.

The fundamental principle, indeed, of a scale—the concurrent varia-

tion of wages and prices—is an economic principle; and I do not know myself how it can be satisfactorily or completely investigated without the aid of economic theory. And so, looking at sliding scales, as I have done throughout this paper, as they have been employed in the regulation of wages alone, I have endeavoured to show¹ that the practice hitherto followed in connection with their construction and operation is ‘in a measure in accord’ with the modern economic theory of wages. I do not think, indeed, that it is at present possible to effect a complete reconciliation between the economic theory of wages and the factors entering into the determination of a scale; but I do think that, if we make such allowance for the consequences resulting from the presence of rival combinations as the previous course of the argument has indicated, our emphasis would rather be laid on the points of agreement than on the points of difference.

For there is—and we cannot ignore it—the broad fact of a concurrent variation of wages and prices. That is an element common both to the scale and to the theory. It is true that the prices in the theory are in the present or the future, while the prices in the scale are in the past; that the former are, as I have said elsewhere,² ‘realisable,’ while the latter are realised. But this difference arises from a practical necessity, which may surely be regarded as one of those conditions which generally attach to the putting of theory into practice, but do not on that account make the theory untrue to the practice. You must ascertain the variation that has taken place in prices before you can determine what variation should be made in wages; and your particular practical mechanism for ascertaining prices does not allow you to do so until they have actually been realised. The fundamental principle, then, on which the sliding scale and the theory of wages alike are based, is not affected by this difference; nor is it—if the period of ascertaining the prices be frequent—a difference of any great magnitude. And here it is relevant to add that, in the iron trade at least, the competitive forces on which the theory of wages rests have, as a matter of actual fact, been adduced and accepted as a reason for the more frequent ascertainment of prices.

It is true, again, that the economic theory of wages takes into account the question of the supply of labour and the demand for its services, and that this element is not explicitly recognised in a sliding scale. But here again the difference is in reality less considerable than might be imagined, and is only such as the previous course of the argument in this paper might lead us to expect. The economic theory of wages is based on competition, and the sliding scale on combination. But, as we have already seen, combinations are not entirely emancipated from the influences of competition; and it may fairly be argued that, as a matter of actual fact, competition is implicitly, if it is not explicitly, taken into account in the construction and operation of a scale.

In the construction this is the case, for the basis from which a scale starts is, as Professor Munro has said, ‘historically’ connected³ with competitive influences, so far as they have not been modified by combination. The general basis, again, is only the centre of a number of particular local arrangements, which in their turn start from a time when competitive influences were at work through the medium of combination, pre-

¹ *Industrial Peace*, p. 94.

² *Ibid.*

³ *Sliding Scales in the Coal Industry*, p. 19.

scribing what we have ventured to call a maximum and a minimum limit to wages.

Nor are the facts different from this when we turn our attention to the operation of a scale ; for, should particular local circumstances conspicuously alter, the intervention of the joint committee of masters and men might be solicited to alter the particular local arrangements without interference with the average wage which forms the basis of a scale ; and should the general circumstances of the trade themselves conspicuously alter, or those of the labour market, experience has shown that the basis originally adopted in the scale may be liable, and that more than once, to readjustment.

Nor must we forget that in some trades—and especially in such trades as the coal and iron mining industries, where the selling price is the sole or paramount consideration—variations in prices may be taken as a tolerably adequate index of the demand and correct price for labour in those particular trades. And this is likely to be the case in a still higher degree, on account of the fact that the combinations present material hindrances to the entrance of outside competitors into the market, and thus the supply side of the question is in a large degree robbed of its importance and the supply becomes stereotyped.

Where, indeed, the cost of the raw material is an appreciable and fluctuating element, the index afforded by variations in prices becomes deficient. But here I can only remark that the inclusion of changes in the cost of the raw materials among the various factors entering into the determination of a scale may be a matter of time, and may introduce an added complexity, but is certainly in no way incompatible with its essential characteristics. We are indeed only too liable to forget, on the one hand, that sliding scales possess considerable elasticity, so much so that their complete reconciliation with economic theory, *if we allow for the presence of the combinations on which they rest in industrial matters*, is at least conceivable ; and on the other that they are as yet in their infancy, and may develop in a manner and degree that it would be folly to attempt to anticipate. They may possibly be reconciled with more completeness to economic theory, and they may also help to modify that theory. There is no doubt that they do present the spectacle of two combinations expressly recognising, and endeavouring to facilitate in its operation, a fundamental principle of competitive economics—the concurrent variation of wages and prices ; and there is also no doubt that where you have a scale regulating wages there you have two combinations influencing the conditions of the competitive market in such a way that no theory of pure competition will enable you to determine the exact point at which they will agree on a price. The starting-point then of a scale is arbitrary ; its general working is the exemplification of an economic principle.

And it is, we must not forget, a principle of great importance. To satisfy, indeed, all the conditions that economic strictness would require, it ought, perhaps, to be elaborated in some such way as Professor Marshall has pointed out.¹ But, presented as it is in its broad and, if you like, unscientific form, had it met with general recognition I think that it is scarcely too great presumption to infer that no Royal Commission would be sitting at present to investigate the ‘recent changes in the

¹ *Industrial Peace*, Preface, pp. xx.–xxii.

relative values of the precious metals; that the adjustment of wages to lower gold prices would have taken place automatically, and that we should not now be hearing of supposed or real bounties to Indian spinners and manufacturers of cotton and growers and sellers of wheat.

And this leads me to consider one general point in conclusion. The sliding scale is indeed in its infancy, and only affects a minority of workmen. It has been applied with success to those industries alone where it can be applied with the least complexity; and the fact that it has not been recognised, save in a very partial manner, in the cotton trade—and yet the regulation of wages by lists in that trade is, as any student of the exhaustive report submitted to this Section last year will admit, by no means free from complexity—ought to render us very chary in venturing upon any rash prophecy of its more extended adoption. It may, however, and I think that it will, be extended in the future; but, even as it is, it may perhaps be regarded as significant of wider and more important changes. It is based, as we have seen, on combinations, and the action of combinations, as we have also seen, undoubtedly exercises an influence on the competitive market. Is it then quite fanciful to regard the adoption of the sliding scale as part of a growing collectivist tendency in economic society?

And here we must be careful to avoid over- and under-statement alike. We must remember, on the one hand, how large is the sphere occupied by competition in the construction and the operation of a scale; and, on the other, we must not minimise the significance of the fact that two powerful combinations meet one another and agree on a joint policy. I am not one of those who think that society will ever be organised on one comprehensive plan. I do not believe in the dull and stagnant uniformity of one unvarying method of production universally prevalent. As in the past so in the future there will, I think, be almost multitudinous variety. But I do believe that there is more than one sign—and that among these we may include the regulation of wages by sliding scales—that the extreme individualism which has been attributed, not without exaggeration, to the economic organisation of the early part of this century is giving way, here a little and there a little, to collectivist influences. I do believe that methods of collective action, be it that of the State, be it that of private corporations and associations and combinations, may occupy a larger and a more explicitly recognised place in the future economy of society than they have done in the immediate past.

I am not afraid of this tendency, because I think that its enemies and its advocates alike have exaggerated its proportions and projects. It will not, I believe, any more than the sliding scale has done, emancipate itself from competition, but it will utilise and modify it. It will not, any more than the sliding scale, overthrow economic theory, but it may supplement it and correct it; and economists, whether historical or deductive, will, I believe, devote as much and as fruitful patience and acumen to the study and analysis of society as it is influenced perhaps in a larger degree by this collectivist tendency, as they have done to society as it was influenced perhaps in a larger degree by the individualist tendency. They will be ready to correct their theory by the study of facts, and to assist their study of facts by the help of theory, as the best representatives of either school have done, if not explicitly, at least implicitly, in the past.

Index-numbers as illustrating the Progressive Exports of British Produce and Manufactures. By STEPHEN BOURNE, F.S.S.

[A communication ordered by the General Committee to be printed *in extenso* among the Reports.]

A PAPER read at the Aberdeen Meeting of 1885 endeavoured to show the 'Use of Index-numbers in the Investigation of Trade Statistics,' and set forth in several forms the comparisons which might thus be made between the exports of 1883 and previous years. The publications of the Board of Trade since that date enable similar calculations to be made for the four later years, and it is thought that these figures may be interesting as an addendum to those then produced. The materials then used were wholly drawn from the official tables and did not extend to the imports, which are generally susceptible of being so treated; nor does the present inquiry travel beyond the range of that paper.

The method then adopted was to fix upon 1,000, 100, 10, or 1, as the index for 240,000,000*l.*, the whole value of the British exports of 1883, and to split this up into so many numbers as there were specified articles the values of which made up this sum of 240,000,000*l.* Thus cotton yarn, having been exported to the value of 13,500,000*l.*, had for its index-number 56; and in like manner every other article comprised in the total of 1,000. Such a set of figures if prepared for other years—that is, taking 1,000 to represent 240 millions of money—would show at a glance the progress of the export trade for any number of years either backwards or forwards for which the requisite data were available.

But value alone is no evidence of the extent of our trade, since prices differ greatly in one year from others; and hence the volume of such exports can only be brought into the requisite proportion to the whole of its own or other years, by reducing the weights and measurements to a common standard or properly altering the index-number.

This is done by considering the price of each article in 1883 to be the unit 1, and that for other years to be more or less than this by the proportion in which it differs. Thus cotton yarn in that year was 12·25*d.* per pound, that for 1887 10·88*d.*, and reckoning the former to be 1, the latter is between ·89 and ·90. Now if we wish to convert the value of the 1887 export, viz., 11,400,000*l.*, the index-number for which is 47, into the equivalent in volume which at the price of 1883 the value of 1887 would have procured, we divide 47 by ·89 to find 53 as its index to compare with that of the former year.

Pursuing a similar course for all the articles of which the quantities and the prices are specified in the accounts, and assuming that those for which these particulars are not attainable should be in the same ratio as those which are so distinguished, we get an index-number for the whole which represents the difference in the extent of our trade as regards quantity. With these materials it can also be shown at a glance wherein the several articles and the several years correspond to or differ from each other.

The first of the following tables sets forth in detail the method of comparison between 1883 and 1887. The second condenses the figures of the five years into the index-numbers for classes of goods; and the corresponding indices calculated at the prices of 1887.

A. British Goods exported in 1887 compared with those of 1883.

1883				1887				
Articles	Aver. Price	Value of Exports		Aver. Price	Value of Exports	Index-numbers		
		In million £'s	Index No.			Value	Price	Volume
Alkali. . . cwt.	6·12s.	2·12	9	5·66s.	1·74	7	·92	8
Anls., horses . . ea.	55·62 <i>l.</i>	·41	2	57·85 <i>l.</i>	·55	2	1·04	2
Arms, fire . . . "	27·40s.	·36	1	34·75s.	·22	1	1·27	1
Gunpowder . . lb.	5·83 <i>d.</i>	·38	2	6·46 <i>d.</i>	·26	1	1·11	1
Bags . . . doz.	5·16s.	1·14	5	4·07s.	·66	3	·79	4
Beer . . . brl.	79·82s.	1·82	8	76·14s.	1·68	7	·96	7
Books . . . cwt.	9·55 <i>l.</i>	1·17	5	8·81 <i>l.</i>	1·18	5	·92	6
Butter . . . "	139·58s.	·21	1	112·81s.	·16	1	·81	1
Candles . . doz. lbs.	6·72s.	·15	1	4·66s.	·18	1	·70	1
Cement . . . cwt.	2·31s.	·93	4	1·94s.	·98	4	·84	5
Cheese . . . "	84·15s.	·06	—	79·26s.	·06	—	·94	1
Coals . . . ton	9·35s.	10·65	44	8·32s.	10·17	42	·90	48
Cordage . . . cwt.	51·05s.	·44	2	45·67s.	·37	2	·90	2
Cotton yarn . lb.	12·25 <i>d.</i>	13·51	56	10·88 <i>d.</i>	11·38	47	·89	53
" manfd.								
plain yd.	2·61 <i>d.</i>	34·15	142	2·27 <i>d.</i>	32·81	137	·87	158
printed "	3·62 <i>d.</i>	20·83	87	3·17 <i>d.</i>	18·93	79	·88	90
mixed "	5·81 <i>d.</i>	·55	2					
" stockings doz.	3·28s.	·54	2	—	·44	2	—	2
" thread. lb.	3·27s.	2·36	10	2·92s.	2·98	12	·89	15
Fish, herrings. brl.	29·73s.	1·43	6	20·62s.	1·05	5	·70	7
Glass, plate .sq. ft.	1·42s.	·26	1	1·12s.	·26	1	·80	1
" flint . cwt.	44·94s.	·34	1	48·64s.	·24	1	1·08	1
" common "	9·27s.	·36	2	9·45s.	·39	2	1·02	2
Hats . . . doz.	21·50s.	1·14	5	19·08s.	1·14	5	·90	6
Leather . . . cwt.	9·34 <i>l.</i>	1·64	7	8·79 <i>l.</i>	1·34	6	·94	7
" boots dz. prs.	60·10s.	1·54	6	57·94s.	1·75	7	·96	8
Jute yarn . . lb.	3·05 <i>d.</i>	·27	1	2·32 <i>d.</i>	·23	1	·76	1
" manfs. . yd.	2·64 <i>d.</i>	2·50	10	2·02 <i>d.</i>	2·06	8	·78	10
Linen yarn . lb.	14·36 <i>d.</i>	1·06	4	13·77 <i>d.</i>	·94	4	·96	4
" manfs.								
white ...yd.	6·95 <i>d.</i>	4·41	18	6·07 <i>d.</i>	3·86	16	·87	18
printed... "	7·80 <i>d.</i>	·21	1	6·12 <i>d.</i>	·21	1	·78	1
sail cloth "	11·73 <i>d.</i>	·17	1	11·01 <i>d.</i>	·14	1	·94	1
" thread . lb.	2·61s.	·29	1	2·48s.	·35	1	·95	1
Iron, old . . ton	3·47 <i>l.</i>	·34	1	2·86 <i>l.</i>	·83	3	·82	3
" pig . . . "	52·14s.	4·08	17	47·26s.	2·74	11	·91	12
" bar . . . "	7·06 <i>l.</i>	2·03	8	5·50 <i>l.</i>	1·45	6	·78	8
" railroad "	6·19 <i>l.</i>	6·01	25	4·56s.	4·62	19	·73	26
" wire . . . "	14·80 <i>l.</i>	·93	4	13·58 <i>l.</i>	·63	3	·90	3
" sheet . . . "	10·12 <i>l.</i>	1·48	6	9·06 <i>l.</i>			·90	3
" galvanised "	15·18 <i>l.</i>	1·75	7	11·75 <i>l.</i>	3·31	14	·77	15
" hoop . . . "	7·77 <i>l.</i>	·67	3	6·06 <i>l.</i>			·78	3
" tinned . . . "	17·47 <i>l.</i>	4·71	20	13·56 <i>l.</i>	4·79	20	·77	26
" cast . . . "	12·97 <i>l.</i>	4·62	19	11·16 <i>l.</i>	4·12	17	·85	20
" steel, wrght. "	19·10 <i>l.</i>	1·40	6	—	2·09	9	—	13
" " mfs. "	42·70 <i>l.</i>	·58	2	29·93 <i>l.</i>	·41	2	·70	3
Copper ingots . cwt.	3·38 <i>l.</i>	1·14	5	2·26 <i>l.</i>	·97	4	·67	6
" yellow								
metal. "	2·99 <i>l.</i>	1·18	5	2·08 <i>l.</i>	·70	3	·70	4
" other kinds "	3·87 <i>l.</i>	1·24	5	2·58 <i>l.</i>	·99	5	·66	7

A. *British Goods exported in 1887 compared with those of 1883—continued.*

Articles	1883			1887					
	Aver. Price	Value of Exports		Aver. Price	Value of Exports	Index-numbers			
		In million £'s	Index No.			Value	Price	Volume	
Brass . . . cwt.	4·47 <i>l.</i>	·43	2	3·75 <i>l.</i>	·34	1	·84	1	
Lead . . . ton	14·07 <i>l.</i>	·55	2	13·75 <i>l.</i>	·61	2	·98	2	
Tin . . . cwt.	4·88 <i>l.</i>	·52	2	5·48 <i>l.</i>	·54	2	1·12	2	
Zinc . . . „	13·89 <i>s.</i>	·10	—	13·91 <i>s.</i>	·15	1	1·	1	
Oil-seed . . . gal.	1·85 <i>s.</i>	1·86	8	1·67 <i>s.</i>	1·57	7	·90	8	
Paper . . . cwt.	2·15 <i>l.</i>	1·28	5	1·74 <i>l.</i>	1·48	6	·81	8	
Salt . . . ton	12·84 <i>s.</i>	·65	3	12·82 <i>s.</i>	·52	2	1·	2	
Silk, Brd. stfs. yd.	3·26 <i>s.</i>	1·25	5	4·15 <i>s.</i>	1·37	6	1·27	8	
Soap . . . cwt.	22·96 <i>s.</i>	·45	2	19·98 <i>s.</i>	·45	2	·87	2	
Spirits . . . gal.	5·93 <i>s.</i>	·81	3	6·70 <i>s.</i>	1·04	4	1·13	4	
Sugar . . . cwt.	21·40 <i>s.</i>	1·24	5	13·19 <i>s.</i>	·47	2	·62	3	
Wool . . . lb.	12·71 <i>d.</i>	1·03	4	11·25 <i>d.</i>	·92	4	·88	5	
„ yarn . . . „	23·41 <i>d.</i>	3·27	14	23·73 <i>d.</i>	3·97	17	1·01	17	
„ cloth . . . yd.	38·30 <i>d.</i>	7·35	31	40·04 <i>d.</i>	9·85	41	1·04	40	
„ flannels . . . „	14·82 <i>d.</i>	·84	3	12·27 <i>d.</i>	·96	4	·89	5	
„ stuffs . . . „	9·94 <i>d.</i>	7·69	32	8·87 <i>d.</i>	6·95	29	·83	35	
„ carpets . . . „	28·24 <i>d.</i>	1·26	5	24·26 <i>d.</i>	1·31	5	·86	6	
Total specified articles . . . }	—	170·14	706	—	158·86	662	—	775	
Total unenumerated do. . . }	—	69·66	294	—	62·55	260	—	287	
		239·80	1·000	—	221·41	922	—	1,062	

B. *Exports of British Produce and Manufactures for the five years ending with 1887, in Index-numbers on the Basis of 1883, viz., 1,000 representing 240,000,000*l.* with those numbers as they would have been at the prices of 1883 (the black figures being at 1883 prices).*

—	1883	1884		1885		1886		1887	
Cottons	299	285	294	262	283	271	304	278	318
Linen and Jute	36	36	39	31	35	32	37	32	36
Woollens	89	97	98	95	98	98	102	100	109
Chief Textiles	424	418	431	388	416	401	443	410	463
Coals	44	45	46	44	46	41	46	43	48
Iron	118	102	112	90	107	91	115	104	135
Other Metals	21	20	22	19	23	17	22	18	23
Chief Minerals	183	167	180	153	176	149	183	165	206
Others specified	99	98	100	102	108	98	108	87	106
All other goods	294	288	299	245	267	237	268	260	287
Total goods	1,000	971	1,010	888	967	885	1,002	922	1,062

	Actual values.		At 1883 prices.	
	Index No.	£	Index No.	£
1883 .	1,000 =	239,799,473	1,000	240,000,000
1884 .	971 =	233,025,242	1,010	242,500,000
1885 .	888 =	213,044,500	967	232,000,000
1886 .	885 =	212,432,754	1,002	240,500,000
1887 .	922 =	221,414,186	1,062	253,000,000
Average .	933 =	223,943,231	1,008	242,000,000

Although the object of this paper is rather to show the plan adopted and to add to the details of the former paper those relating to subsequent years; it would lack the interest to which the subject, if not the method, is entitled, were there to be no allusion to the results at which we are thus enabled to arrive. Comparing then the figures of the year last ended with those of 1883, which has been adopted as a standard, we find that, starting with 1,000 as the index-number to represent the total exports of the former year, 922 will be that for 1887, because the export of that year fell short of those in 1883 by 7·8 per cent.; but that having regard to the quantities of the several articles exported during last year and the higher prices which prevailed in 1883, we must make additions to most of them, which will bring the index up to 1,062, and, therefore, that instead of the volume of trade having diminished in the proportion which the value taken alone would indicate, it has increased by 6·2 per cent. beyond that of 1883. In fact, that had the goods we thus sold in 1887 been parted with in 1883 they would have realised 253,000,000*l.* instead of but 221,000,000*l.*; in other words, that our trade in this particular branch has been larger by $\frac{42,000,000}{221}$, or 19 per cent., more than it appears to be, if we take value alone as our guide.

Treating the intermediate years in the same way, 1886 is increased by $\frac{28}{212}$, or 13·2 per cent.; 1885, $\frac{19}{213}$, or 9 per cent.; and 1884 $\frac{9\cdot5}{233}$, or 4·1 per cent., the actual index-numbers for the values from 1883 being in the series of

$$1,000 : 971 : 888 : 885 : 922 ;$$

those for volume :

$$1,000 : 1,010 : 967 : 1,002 : 1,062 ;$$

and carrying the comparison further back it was shown in the Aberdeen Paper that, whilst the value series for the years 1883, 1879, 1875, 1873, and 1865 were 1,000 : 798 : 931 : 1,063 : 695, those for volume were 1,000 : 798 : 739 : 727 : 460; thus giving an accurate gauge of the conditions as to total volume as well as to total value for the four years since 1883 and four selected ones between that year and 1865. The same comparison may be made at sight with any single article either in relation to itself for previous years or as to its relative importance to others in one or many years.

Looking down the list of articles enumerated in the published accounts it may be seen how much of our manufacturing power expended upon the production of goods for export is so spent upon each one, and wherein the variations in the volume as contrasted with the value have consisted. Grouping together all the textiles and all the metals and throwing all the others into a third, we learn that the value of textiles is represented by the index 410, the volume by 463, a difference of 12·4 per cent.; that of metals

and minerals, including of course coal, the indices are 165 and 206, a difference of 23·1 per cent.; whilst the whole stands at 922 and 1,062, or 10·85 per cent., thus showing the relative proportions of the two most important branches of our national industries, and the degrees in which they have varied in the one year from the other. It must be remembered always, however, that a vast variety of articles into which the materials are converted when finished, as, for instance, apparel from cotton and hardware from iron, are included in the unenumerated because we have no facts as to the alterations either of quantity or price.

Another branch of the inquiry, even as regards the export trade, would require similar figures and calculations for the imports of the raw materials in which we work. These are widely different in the case of the two principal branches, for almost all of those enumerated with textiles are of foreign production, whilst those employed in the metal industries are chiefly from native sources. To select for illustration the one class of cotton goods, of which the chief constituent is of foreign growth. Cottons altogether have an index-number of 278 out of 922 for value, and one of 318 out of 1,062 for volume. The imports of cotton wool (after deducting the quantity sent away again in its original condition) are indicated by 143 for value and 166 for volume, which are very nearly one-half of the whole export figures. The index for prices is almost exactly the same, namely, ·86 or ·87, showing that there must have been a fall in the labour or other elements of the cost of production in the same ratio as in that of the raw material.

These particulars are not singled out as proofs of the progress the country has been making—for that would require a much more detailed examination—but as instances in which the method of reduction into index-numbers facilitates inquiry and exemplifies its results. For whilst as regards each individual article or material its own figures furnish the best means of comparison, it is only, as is well known to all inquirers, by getting some common basis that we can effect the necessary additions, deductions, or combinations without which it is not possible that the whole should be shown or general conclusions established.

The Friction of Metal Coils.

By PROFESSOR HELE SHAW and EDWARD SHAW.

[A communication ordered by the General Committee to be printed *in extenso* among the Reports.]

COIL friction has long been used as a powerful means of communicating or retarding motion. Even where only a partial coil is employed, as in the case of leather or rope belting and flexible metal brake bands, the frictional resistance to be obtained by small pressures is very considerable; but where several complete convolutions are used, the effects to be produced are unlimited. Thus a rope, half a turn of which is taken round a post, will enable a man at one end to sustain a force three times as great at the other; but the resistance is multiplied three times for each half-turn, so that in four or five turns a resistance of several hundred tons might be obtained, and the result only limited by the ultimate tenacity of the rope. On first thoughts, it would not be obvious that,

with the exception of flexible metal bands and wire rope, metal could be employed in coil friction. In exactly similar circumstances this certainly could not be done; but suppose the conditions to be altered, and the metal coil to be only used under circumstances which do not require it to be unwound, as is done with rope, then the properties of coil friction may also be taken advantage of if the coil is sufficiently flexible for the purpose. It is true that metal is inferior in frictional resistance to rope, but this advantage may easily be obviated by using a greater number of coils, whereas the much higher tensional strength and durability of metal point to many valuable applications. The chief applications, which have been made with more or less success, have been in connection with clutches and brakes, and the principle of operation is very simple. The metal coil is either wound round a shaft or the sleeve of a pulley, or else it is contained within a cylinder attached to either. One end, which will always be referred to in the present paper as the 'tail,' is by some means or other brought into frictional contact with the shaft, sleeve, or cylinder, and is thus carried round if the surface be in motion, or retarded if the coil itself be in motion and the surface at rest. The attachment of the 'head' of the coil prevents its following the tail until a considerable tension is put upon the whole coil. Thus, if the coil encloses the shaft or sleeve, it is made to wind up upon the shaft, becoming of less internal diameter and taking a frictional grip throughout its whole length; but if, on the contrary, it is enclosed in a cylinder, it is made to unwind, and so expand. In either case the result is the same, and a force of any required magnitude may be transmitted by this means. In order to illustrate this action, a piece of apparatus has been devised by the authors which may interest those who have never seen any example of the power of metal coil friction. A weight of 56 lbs. is raised by a drum and handle. The shaft—1 in. in diameter—to which the drum is attached, passes through its bearing in the frame, and is attached to the head of a metal coil of iron wire $\frac{1}{8}$ in. in diameter. The coil encloses a sleeve carried by the frame, and the tail of the coil is free. As long as this is the case the whole weight of the 56 lbs. has to be sustained by means of the handle; but if a weight of 10 oz. is now suspended to the tail, a grip is obtained throughout the coil, by means of which the weight is sustained, which from the difference of leverage is equivalent to a force at the head of the coil of 200 lbs. The load has in this way been increased at a previous trial until the head of the coil was torn off without adding to the weight at the tail. If the small weight is raised, the load falls; but its fall is instantly checked by releasing the small weight again. To show the effect of the number of convolutions various coils are substituted, and it is seen that when there are only four coils instead of eight, an increased weight, many times as great, is required to sustain the load. The effect of simply twisting the tail of the coil is very remarkable, as may be ascertained by means of the small wire coils now passed around the room. In this case it is not necessary to hang any weight at all upon the tail itself; and the self-sustaining action of the coil, which permits perfectly unconstrained motion in one direction but instantly checks any motion in the other, is very striking. This effect is still more strikingly exhibited by means of the experimental apparatus. The tail of the small coil is twisted so as to just touch the shaft with a slight pressure. The load is then raised, and no resistance whatever is felt from the coil as long as the handle is being turned in the correspond-

ing direction; but immediately the handle is released and the weight tends to fall, the coil comes into operation, and grips the shaft with a force which not only prevents the weight from falling, but also resists the further load now applied, the two being together equivalent to a total pull of nearly 1,000 lbs. upon the coil. The important applications of this kind of action in self-sustaining hoists, silent feed motions, and for other purposes, are obvious.

Coming to the applications of metal coil friction which have been proposed, we find that in 1877 Mr. Rider, an American, devised the friction clutch shown in Fig. 1. In this clutch a cone sleeve, A, is moved

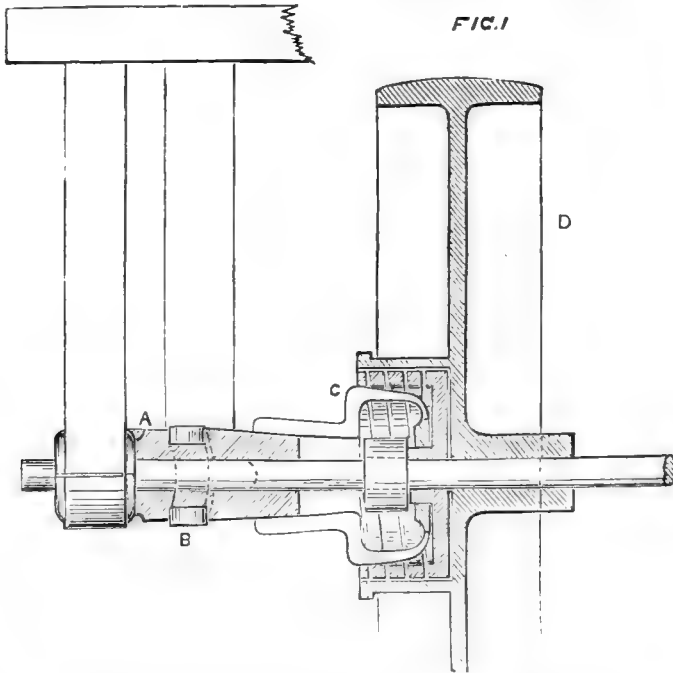

by means of a lever acting at B, and so throws open a split cone lever, C, and wedges out the tail of the coil against the cylinder in which it is enclosed. The coil, which is revolving, is thus unwound, and so presses upon the inner surface of the cylinder, which it carries round, and with it the pulley to which it is attached. Fig. 2 shows an application of the converse and most usual case, in which the coil winds up and closes upon a shaft or sleeve which it surrounds. This friction clutch was invented by Mr. Sterling in 1882, and its action is easily understood. A sleeve, A, carries along one end of a toggle joint B, and so pushes out the end of the lever C, and thus presses the tail end of the coil. The coil consequently tightens upon the boss of the pulley D, and carries it round. There is also an example of wire rope coil friction shown at E, Fig. 2. An arrangement has been recently devised by M. Gambaro, a French engineer, and applied as a brake to a crab winch. The same inventor has proposed a system of continuous railway brakes on this principle. Professor Osborne Reynolds has also applied metal coil friction in an ingenious arrangement for turning the valve rods of the experimental steam engine at Owens College, thus enabling the governor to be the means of almost instantly altering the position of the slides, thus regu-

lating the admission of steam. Those who have seen this arrangement at work must have been struck by the suddenness and force with which the coil comes into action. Notwithstanding these and other applications of coil friction, the actual amount of knowledge on the subject, at any rate in a published form, is very small, and the accepted theory of

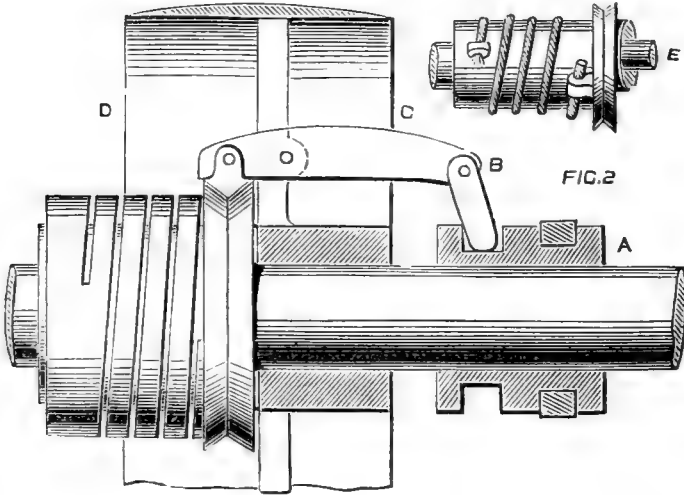

ordinary coil friction, which takes no account of the comparative rigidity of the coil, is not directly applicable in the case under discussion. Mr. Edward Shaw, in attempting to make use of metal coils, found various practical difficulties and apparently anomalous results, which led the authors to think it worth while to make some experiments bearing upon certain features in the application of this form of coil friction.

Form of coil.—The first points to be considered are those of the requisite form and dimensions of coil; for it is obvious that while sufficient strength is required at the head of the coil to resist a considerable force, the tail need not be of similar section. It is not merely waste of metal to have the section uniform, but the want of flexibility thus entailed seriously impairs the efficiency of the coil. Fig. 3 will illustrate this point, in which *a* shows the section of a coil which has been adopted by one or two inventors, whilst *b* is a section of the coil reduced in thickness, but of uniform width. This has the disadvantage of being too broad at the tail, and the quantity of lubricant getting under such a surface prevents the initial grip taking place so readily. Fig. 3 *c* shows a very efficient form in which the advantage of smaller space (the number of convolutions being the same as in *b*) and more sudden initial grip are insured. A very good form of coil is that shown in *d*, in which the last coil or two are circular in section. M. Gambaro and Professor Reynolds have both employed coils of decreasing width and thickness. With regard to the diameter of the coil, this, where perfect flexibility is assumed, is a matter of no importance, except as regards the obvious effect upon the leverage at which the resistance acts. With metal coils the case is different, as the larger the diameter the more readily the surface comes to its bearing for a given cross section, and with a given initial clearance the comparative distortion is less the greater the radius of curvature. In order to have the internal surface of true cylindrical form, several coils were

rigidly held and bored out, some even being afterwards scraped to a bearing. It was, however, found that there was no necessity for such refinement, as after a very brief period coils simply made by twisting a

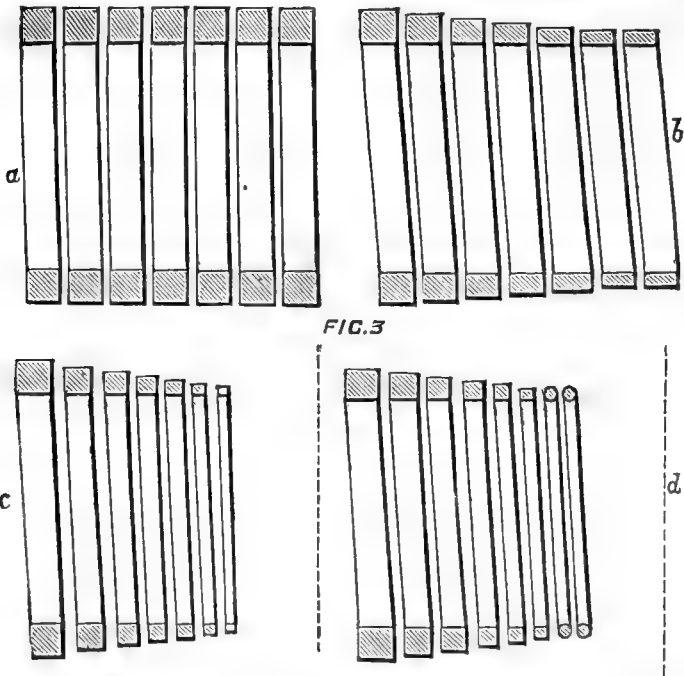

taper rod round a turned cylinder found their own bearing, and were quite as effective as those which had been bored out.

Relation between force and resistance.—Of the coils exhibited, those lettered *a*, *b*, *c*, and *d* had sections corresponding to those similarly lettered in Fig. 3. These four coils have been experimented upon by means of the apparatus shown in Fig. 4. On the face-plate of a lathe were fixed cylinders upon which the coils fitting loosely were successively

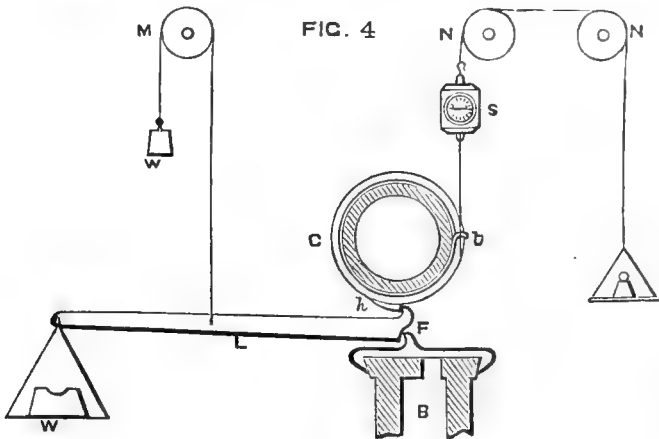

placed. The head *h* of the coil *C* was prevented from revolving by means of a lever *L* having a fulcrum at *F* attached to the lathe bed *B*. The lever *L* is counterweighted by means of a scale-pan *W* hanging over a

pulley M, and the loads which are placed in the larger scale-pan W thus have an effect just twenty times as great upon the head of the coil. The tail of the coil t was attached to a delicate spring balance, S, which in turn was suspended by a cord passing over pulleys, N N. By exerting a greater or less force on this cord any required tangential pressure could be brought to bear upon the tail.

(a) Coil a consists of seven convolutions of $\frac{1}{2}$ in. square cast steel, and therefore not being very flexible, was made a good fit upon the cylinder; but notwithstanding this a pull of no less than 25 pounds was required to raise the weight of the lever, which was equivalent to a force of 140 pounds at the head of the coil. The result of increasing the pull on the tail is shown below:—

F	.	.	25	37	41	43	47	51	55	59	63	67	70
R	.	.	140	240	260	300	310	350	410	480	520	660	700

F = force on tail in pounds. R = resistance on head in pounds.

These results, which are not very uniform, and point to the evil of using rigid coils, were obtained with dry surfaces. The effect of lubricating the surfaces always appeared to be the reverse of what might be expected; thus, in the present case, a pull of only 32 lbs. instead of 37 lbs. was sufficient when lubricant was freely applied to overcome a load of 240 lbs., 37 lbs. replacing 55 lbs. and balancing 410 lbs., 49 lbs. replacing 70 lbs. and balancing 700 lbs.

(b) Coil b of wrought iron, consisting of eight convolutions of $\frac{1}{2}$ in. \times $\frac{3}{8}$ in. tapering to $\frac{1}{4}$ in. \times $\frac{1}{8}$ in. required only a force of 3 lbs. to make it lift the lever; but having once done this, the grip upon the surface was absolute, and apparently sufficient to raise the maximum pull that could safely be applied, which was 4,000 lbs. The only effect of lubrication was to make the gripping action more sudden and violent.

(c) Coil c of steel, consisting of eight convolutions tapering from $\frac{3}{4}$ in. square to $\frac{3}{8}$ in. square section, gave the following uniform series of results:—

F	.	.	4 $\frac{1}{2}$	5	5 $\frac{1}{2}$	6	6 $\frac{1}{2}$	7	7 $\frac{1}{2}$	8	8 $\frac{1}{2}$	9	9 $\frac{1}{2}$	10
R	.	.	140	220	300	380	460	540	620	700	780	860	940	1020

F and R having the same values as before.

When the lubricant was used, the results, though not quite so uniform, did not differ greatly from the above, but were again slightly less, showing that lubrication makes the action more effective.

(d) Coil d , consisting of ten convolutions of $\frac{3}{8}$ in. square wrought iron, tapering to $\frac{1}{16}$ in. round steel, behaved exactly in the same way as coil b , but the effect was more marked, and 1 lb. on the tail resulted in an absolute and complete grip of the whole coil.

Influence of velocity.—The effect of change of velocity of the moving surfaces was very surprising, the general result of decrease of velocity being to enable a small force on the tail to put the coil into operation. This was not merely the case when the coil was revolving and the result of centrifugal force acting to keep the coil from contact, but was just as marked when the shaft or sleeve rotated and the coil remained at rest. Again, the chief effect of change of velocity seemed to be felt with coils similar to a and b on the diagram, in which the broad surfaces seem to hold the lubricant more than the narrow ones. In experimenting upon coil c it was found that with a surface velocity of 15 ft. a minute 3 $\frac{1}{2}$ lbs. at

the tail produced a force of 140 lbs. at the head, whereas at 180 ft. per minute $5\frac{1}{2}$ lbs. was required to obtain the same result. With a very short coil of section *c*, having only five convolutions, the sleeve inside the coil could be rapidly revolved, with no apparent resistance; but directly the speed was reduced below a certain limit, the coil gripped with its full force. It may be that further experiments in this direction will throw some light on frictional resistance at high velocities.

The foregoing results, which are a brief *résumé* of the experiments upon the four typical coils, at first appear to be contradictory. Two of the coils behave in a very different manner to the other two. Thus, with *a* and *c*, after allowing for the stiffness of the spring, the experiments agree with the usual theory, which assumes that the forces at the two ends of the coil are directly proportional to each other when the arc of contact and coefficient of friction are constant, as was the case in the experiment. This is not so evident with the former of the two, in which the stiffness of the coil and the manner in which it acted prevented very accurate results being obtained. With the latter it is easy to see that an equation of the form

$$F = kR + m$$

represents the results, *F* being the force on the tail, *R* being the resistance on the head, while *k* and *m* are constants. The exact value of *m* is 3.625, this being a measure in lbs. of the stiffness of the spring, since when the resistance is zero, *m* is equal to the force on the tail in lbs., and it will be seen that for each increase of $\frac{1}{3}$ lb. on the tail there must be an increased resistance of 80 lb. on the head. With the coils *b* and *d* there is no such proportion between the two effects, but when once the coil comes into operation the grip is sudden and absolute. The explanation is found by reference to the dimensions of the coils themselves, when it will be seen that the section towards the tail in the case of *b* and *d* is much less than that in the case of *a* and *c*; thus, when the initial resistance in the latter case to closing the coil due to its stiffness is overcome, the bearing is continuous, and the force then on the tail is probably far in excess of that which would be required to even tear off the head of the coil. It will thus be evident that on attempting to make use of metal coils for practical purposes two distinct modes of operation are available, which, although so very different, can be obtained by merely varying the relation between the number of convolutions and cross section of the coil. Where a definite ratio is required between force and resistance, then the number of coils must be reduced or the cross section towards the tail increased; but if small constant force only is available to put into operation, whatever be the resistance at the head, then the convolutions must be sufficiently numerous and the tail end of the coil sufficiently flexible. The objection to the former is that any variation in the coefficient of friction makes a considerable difference in the result; but in the latter case, where the force required to start the coil is so extremely small, some effective means of releasing the grip when it reaches a certain definite amount would enable such coils to be effectively applied for purposes such as clutches and brakes.

NOTE.—In the discussion which followed the reading of the paper, various suggestions were made to account for the peculiar effect of the lubricant in increasing the effective action of the coil. The authors, upon further consideration, believe the true reason to be as follows. At times,

when running dry, it was noticed that the application of the load produced a vibratory effect, which was sometimes so great as to make itself evident by auditory means. This vibration in all probability always existed, to a greater or less extent, throughout the experiments as long as no lubricant was used, and would be quite enough to account for the diminished power of the coil considering the great resistance it had to overcome, and would explain the more effective action resulting from the application of the lubricant, which no doubt prevented such vibration taking place. Certainly no vibration caused by alternate gripping and release of the tail of the coil was ever noticed when lubricant was being used between the surfaces in contact.

—————

*Sur l'application de l'analyse spectrale à la mécanique moléculaire
et sur les spectres de l'oxygène. Par Dr. J. JANSSEN.*

[A communication ordered by the General Committee to be printed *in extenso* among the Reports.]

L'ANALYSE spectrale constitue l'une des méthodes les plus fécondes d'investigation dont le physicien puisse disposer pour l'étude de la constitution des corps, soit au point de vue chimique, soit au point de vue de la mécanique moléculaire.

Jusqu'ici l'analyse spectrale a été principalement appliquée à la détermination de l'espèce chimique.

Nous nous proposons de montrer dans ce travail qu'elle est non moins féconde pour l'étude des questions de mécanique moléculaire.

Les études suivantes sur les spectres de l'oxygène dans leurs rapports avec les densités de ce gaz sont un essai tenté dans cette direction.

1. *Laboratoire et instruments d'expérience.*—La disposition du lieu et des bâtiments à l'observatoire de Meudon a permis la création d'un laboratoire qui a environ 100 mètres de long et contient tous les instruments nécessaires pour l'étude des gaz sous de grandes épaisseurs et de hautes pressions et notamment :

Un tube en fer et deux en acier doublé de cuivre rouge, ayant 60 mètres de long et pouvant supporter une pression de 200 atmosphères.

De nombreux tubes de longueurs et de diamètres variés permettant d'étudier les gaz sous des pressions qui dans des cas spéciaux peuvent aller au delà de 1,500 atmosphères.

Il y a lieu de signaler une balance pouvant peser 40 kilogrammes à un centigramme près. Cette balance permet de déterminer la densité d'un gaz indépendamment des pressions et par la seule considération des poids. Le tube, contenant le gaz sous pression, est équilibré sur la balance. On fait sortir le gaz, on rétablit l'équilibre par des poids marqués, ce qui fait connaître le poids du gaz sorti, et ce poids combiné avec la capacité du tube préalablement déterminée (après les corrections nécessaires) permet de conclure la densité.

Les sources de lumière employées dans le laboratoire sont la lumière de Drummond, la lumière électrique, la lumière solaire.

2. *Spectres de l'oxygène.*—Ces études devaient commencer par l'oxygène. Ce gaz, en effet, par les phénomènes de modifications moléculaires qu'il présente, notamment celle qui donne lieu à l'ozone, paraissait être le

gaz qui promettait les résultats les plus intéressants pour une étude de structure moléculaire par l'analyse spectrale.

Au moment où j'ai commencé ces études en 1885 M. Egoroff était occupé à vérifier si les groupes A et B du spectre solaire appartenaient effectivement, comme il l'avait soupçonné, au gaz oxygène.

Malgré les facilités que me donnaient les moyens puissants dont je disposais, j'ai tenu à lui laisser poursuivre cette étude commencée, estimant qu'on n'a pas le droit de toucher à un sujet abordé par un auteur tant que cet auteur manifeste l'intention de poursuivre ses études. Ces habitudes de délicatesse scientifique ne sont pas malheureusement assez suivies.

Les premières études sur le gaz oxygène ont été faites avec le tube en fer de 60 mètres, fermé à ses extrémités par des glaces doublées. La lumière employée fut la lumière de Drummond (becs multiples disposés en ligne verticale). Le faisceau est rendu parallèle avant son entrée dans le tube et à sa sortie il est concentré sur la fente du spectroscopie.

Variation apparente des spectres avec la pression.

Le groupe B du spectre solaire commence à être nettement perceptible avec 2 atmosphères d'oxygène. Le groupe A commence à l'être beaucoup plus tôt.

Ces groupes se développent naturellement en intensité avec l'augmentation de pression.

Bandes obscures.—Mais de 6 à 12 atmosphères on voit apparaître un phénomène spectral nouveau : ce sont des bandes obscures estompées, paraissant très difficilement résolubles.

La première se montre près de D du côté du violet.

Une seconde entre C et D.

Une troisième près de F du côté du violet.

On peut en développer d'autres par l'augmentation de pression, mais nous considérerons seulement ces trois bandes d'absorption pour le moment. Voici la position de ces bandes (il faut remarquer qu'elles augmentent de largeur et d'intensité avec la pression et l'épaisseur de gaz traversé, suivant la loi générale de ces phénomènes).

Bande du rouge, 0^m.632 à 0^m.622.

Bande du jaune près de D, 0^m.580 à 0^m.572.

Bande du bleu près de F, 0^m.482 à 0^m.478.

Il paraissait d'abord singulier qu'un gaz donnât naissance à des bandes paraissant très-semblables à celles que donnent les corps solides ou liquides, et en outre, que ces bandes fussent associées, dans le même corps, à un autre système de raies, comme B, A ; aussi ces bandes singulières ont-elles attiré notre attention tout d'abord, et avons-nous cherché à faire une étude approfondie de la question de principe qu'elles soulevaient.

Il fallait avant tout démontrer qu'elles appartenaient bien au gaz oxygène, et qu'elles n'étaient point dues à la présence de vapeurs ou gaz étrangers, produits soit dans la préparation de l'oxygène, soit dans les opérations qui ont pour but de le comprimer. Nous avons alors préparé l'oxygène par des moyens variés : par le chlorate de potasse, en purifiant et desséchant avec soin le gaz produit ; par l'oxyde de mercure ; par l'eau oxygénée, etc. Les bandes ont toujours persisté. Nous avons ensuite institué une expérience propre à montrer la non-intervention des carbures d'hydrogène dans la production du phénomène.

Le gaz oxygène, au sortir de la pompe, et avant son entrée dans le tube en expérience, était forcé de passer dans une couronne formée par

un tube capillaire de cuivre rouge, couronne qui était portée à la température du rouge vif.

Dans ces conditions l'oxygène subissait l'action d'une très haute température capable de décomposer complètement les carbures d'hydrogène qu'il eût pu contenir. Or, les bandes ont encore fait leur apparition aux mêmes pressions.

Nous avons encore voulu nous démontrer par une expérience directe que l'action des pompes n'intervient pas dans la production des bandes.

Aux deux extrémités du tube de 60 mètres on a branché des tubes flexibles mettant ces extrémités en communication, au moyen de robinets, avec la pompe foulante.

Ces dispositions prises, on a foulé dans le tube 6 atmosphères d'oxygène de manière que la bande de D fut aussi faible que possible quoique encore perceptible.

La pompe alors fut mise en action; elle prenait le gaz à une extrémité du tube pour le faire rentrer par l'autre extrémité.

Dans cette opération la pression dans le tube de 60 mètres n'augmentait pas, puisque ce tube empruntait à lui-même le gaz que la pompe lui envoyait; les bandes ne pouvaient donc pas augmenter en intensité du fait de l'augmentation de la pression.

Mais si l'action de la pompe eût été capable d'intervenir dans la production des bandes, l'expérience l'eût mise infailliblement en évidence, puisque cette action pouvait être continuée aussi longtemps qu'on voulait. Or, après six heures d'action de la pompe, les bandes présentaient le même aspect qu'au début de l'expérience.

Les bandes sont donc indépendantes de l'action des pompes.

En résumé :

Les bandes persistent quelle que soit la provenance de l'oxygène employé. Elles ne peuvent être attribuées ni à la présence de carbures d'hydrogène qui auraient échappé aux moyens de purification du gaz, ni à une action inconnue mais possible de la pompe.

Les motifs pour les attribuer à l'action de l'oxygène prenaient donc déjà une grande force. Cependant, comme l'oxygène fait partie de l'atmosphère terrestre, on devait, avant de considérer la question comme résolue, examiner les circonstances de la production des bandes dans leurs rapports avec l'atmosphère.

Or, de ce côté, surgissait une grande difficulté.

En effet, l'oxygène contenu dans l'atmosphère terrestre, représentant environ la cinquième partie du poids de cette atmosphère, équivaut à une couche gazeuse de 1,500 mètres environ de hauteur à la pression d'une atmosphère ou de 250 mètres à 6 atmosphères.

L'action de l'atmosphère, d'après ces données, devrait donc être plus que quadruple de celle du tube de 60 mètres.

Comment se fait-il que le spectre solaire aux environs de midi et même quand le soleil est assez loin du méridien ne présente aucune des bandes en question ?

Cette considération ne laissait que deux alternatives : ou d'admettre que l'action qui produisait les bandes suivait une loi différente de celle acceptée jusqu'ici, c'est-à-dire, celle de la proportionnalité au produit de l'épaisseur gazeuse traversée par la densité du gaz, ou bien que des gaz étrangers et actifs n'avaient pas été éliminés.

Les précautions prises pour écarter toute action possible des corps étrangers m'ont paru assez complètes pour chercher ailleurs la cause du phénomène.

J'ai alors varié mes expériences avec des tubes de longueurs différentes, chargés de gaz à des pressions variables.

Ces expériences m'ont conduit en effet à soupçonner une influence particulière de la pression et par suite de la densité sur la production du phénomène.

Pour mettre nettement en évidence cette influence de la densité, j'ai institué l'expérience suivante. A côté du tube de 60 mètres a été placé un tube de 20 mètres de même diamètre et pouvant être mis en rapport avec lui par des prismes à réflexion totale.

La lumière de la source traversait le tube de 60 mètres, se réfléchissait deux fois, pénétrait alors dans celui de 20 mètres et était analysée à la sortie de celui-ci.

Les choses ainsi disposées, on fit le vide dans le tube de 60 mètres et on foula au contraire de l'oxygène dans celui de 20 jusqu'à ce que les bandes commençassent à se montrer. Il a fallu pour cela 12 atmosphères. Ceci fait, on ouvrit le robinet de communication entre les deux tubes. L'oxygène se répandit dans le tube de 60 mètres et se partagea entre les deux tubes. La pression tomba à 3 atmosphères et *les bandes disparurent complètement.*

Cette expérience mettait nettement en évidence l'influence de la densité.

En effet, dans la seconde phase de l'expérience le faisceau lumineux avait traversé une quantité de matière gazeuse équivalente à celle de la première phase, puisque, si la densité était devenue quatre fois plus faible, l'épaisseur gazeuse était quatre fois plus grande. La disparition des bandes ne pouvait donc être attribuée qu'à l'abaissement de la pression, qui n'était pas compensée par une augmentation proportionnelle de l'épaisseur gazeuse traversée.

Cette influence particulière de la densité nettement mise en évidence, il restait à trouver la loi suivant laquelle elle agissait.

On institua alors une série d'expériences dans lesquelles on fit varier tout à la fois la longueur des tubes et la pression du gaz. Mais pour donner une base précise à ces expériences on adopta comme point où la force d'absorption est toujours la même le moment où une bande est *naissante*, c'est-à-dire, commence à être perceptible lorsque le spectre est *en mouvement.*

Ce moment de la naissance d'une bande n'est évidemment qu'un phénomène relatif qui dépend de l'intensité lumineuse, de la sensibilité de l'œil, etc. On s'est attaché à conserver ces conditions sensiblement les mêmes dans les expériences.

Ceci posé, voici un premier tableau où sont résumés les expériences sur l'apparition de la bande près de D quand la longueur des tubes varie :—

Longueur des tubes	Pression sous laquelle la bande est naissante	Pression calculée d'après le produit de l'épaisseur par la densité <i>e</i> ⁶
mètres	atm.	
60	6	6
20	10-12	18
5	23	72
1.47	38	240
0.75	50-55	480
0.42	70-75	858

La première colonne contient les longueurs des tubes contenant l'oxygène, la deuxième les pressions sous lesquelles la bande près de D est naissante. La troisième contient les pressions qui eussent dû être observées si la loi du produit de l'épaisseur gazeuse par la densité régissait le phénomène.

On voit que l'écart entre les nombres de cette troisième colonne et ceux de la seconde se prononce dès les premières expériences et que quand la longueur du tube tombe au-dessous d'un mètre il est énorme.

La loi du produit de l'épaisseur par la densité ou par la première puissance de la densité est donc insoutenable.

On voit de suite que ce doit être une puissance n de la densité supérieure à la première qui doit permettre de représenter le phénomène.

Soit donc F la force en question, δ la densité du gaz et e l'épaisseur gazeuse traversée; on aura $F=e\delta^n$. Et pour deux expériences dans lesquelles les épaisseurs seront e' et e'' et les densités δ' et δ'' on aura $e'\delta'^n=e''\delta''^n$.

Pour obtenir la valeur de n prenons les logarithmes :

$$\log e' + n \log \delta' = \log e'' + n \log \delta'' ;$$

$$\text{d'où } n = \frac{\log e'' - \log e'}{\log \delta' - \log \delta''}.$$

Il faut maintenant substituer dans cette équation les valeurs de e' , e'' , δ' , δ'' pour deux expériences bien choisies.

Nous prendrons celles qui se rapportent aux termes extrêmes de notre série, ce qui donne plus de chances d'exactitude; ce sont les expériences avec le tube de 60 mètres et celui de 0^m.42.

On a alors :

$$n = \frac{\log 60 - \log 0.42}{\log 72 - \log 6} = \frac{2.1549020}{1.0731070} = 2.008.$$

Ainsi $n=2$.

Il est même bien remarquable que cette valeur se trouve déterminée avec une précision aussi considérable.

Pour démontrer que cette valeur de n est bien celle qui répond à l'expression du phénomène, nous avons calculé qu'elles devraient être, pour les expériences précitées, les densités correspondant à une valeur de n plus grande ou plus petite d'un dixième d'unité, ce qui conduit au tableau suivant :—¹

Longueur des tubes	Pressions observées	Densités calculées suivant $e\delta^{1.9}$	Densités calculées suivant $e\delta^2$	Densités calculées suivant $e\delta^{2.1}$
m.	atm.			
60	6	6	6	6
20	10-12	10.7	10.4	10.1
5	23	22.2	20.7	19.6
1.47	38	42.2	38.3	35.1
0.75	50-55	60.1	53.6	48.0
0.42	70-75	81.7	71.7	63.7

On voit que pour les pressions élevées les différences entre les den-

¹ On donne ici les pressions observées, parce que c'est par le moyen des manomètres qu'on a commencé ce travail. Les densités déterminées par la méthode des pesées seront données plus tard.

sités calculées par les formules $e\delta^{1.9}$ et $e\delta^{2.1}$ et l'observation se prononcent assez pour qu'on doive les rejeter.

C'est donc bien la formule $e\delta^2$ qui représente le phénomène, c'est-à-dire, que l'action du gaz oxygène pour les bandes (nous avons donné les nombres pour la bande près de D, mais les autres bandes étudiées conduisent à la même loi) est, pour une même épaisseur, proportionnelle au carré de la densité.

Armé de cette connaissance de la loi, nous allons reprendre l'étude de l'atmosphère terrestre, non-seulement afin de voir si la difficulté qui nous avait arrêtés se trouve levée, mais même pour y chercher une confirmation de la loi.

Cherchons d'abord, d'après la loi du carré de la densité, quelle soit l'action de l'atmosphère sur un faisceau de lumière qui la traverse normalement.

Soit A B une colonne d'air considérée dans l'atmosphère; $m m'$ une tranche infiniment mince à la hauteur H; δ la densité de l'atmosphère en ce point.

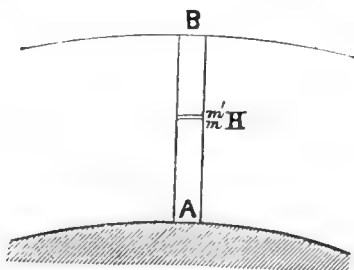

La force d'absorption F aura pour différentielle

$$dF = -\delta^2 dH.$$

Mais la densité δ est proportionnelle à la pression barométrique h ou à $\delta = Kh$

$$\text{et } dF = -K^2 h^2 dH.$$

Cette équation intégrée, de $h=0$ à $h=760$ et en remarquant que $K = \frac{1}{760}$ et prenant $dH = -18336 \log e \frac{dh}{h}$, conduit à la valeur

$$F = 3981^m.$$

Mais ce résultat suppose l'atmosphère entièrement formée d'oxygène à la densité de l'air; l'oxygène n'en représente que le cinquième, ou plutôt le 0.208, dont le carré est 0.043; il faut multiplier par ce nombre et on a $F = 172^m$.

Ainsi l'action de l'atmosphère sur un faisceau qui la traverse normalement équivaut à celle d'une colonne d'oxygène de 172 mètres environ à la pression d'une atmosphère.

Or, notre tube de 60 mètres commençant à donner les bandes à la pression de 6 atmosphères est équivalent d'après la loi du carré à $60 \times 6^2 = 2160$ mètres d'oxygène à la même pression, c'est-à-dire, que le tube équivaut dans ces conditions à plus de douze fois l'action de l'atmosphère.

Nous avons maintenant l'explication péremptoire de l'absence des bandes dans le spectre solaire pendant le milieu de la journée.

Mais quand le soleil est abaissé sur l'horizon ses rayons traversent alors des épaisseurs atmosphériques qui peuvent devenir considérables et équivaloir et au delà les actions naissantes constatées dans nos tubes.

On retrouve, en effet, dans le spectre du soleil levant ou couchant, les bandes que nous avons décrites, et quand l'astre est à l'horizon, et surtout quand il est au-dessous, plusieurs de ces bandes acquièrent une extrême intensité.

Le spectre solaire en présente d'autres qui appartiennent également à l'oxygène, mais la présente étude ne porte que sur les trois bandes dont nous avons parlé et dont la considération est suffisante pour asseoir la loi.

Puisque l'atmosphère dans des circonstances favorables peut donner naissance au phénomène dont nous cherchons la loi, nous devons la faire pour en obtenir une nouvelle confirmation—confirmation qui sera précieuse parce qu'elle regarde les basses pressions, depuis la densité nulle jusqu'à un cinquième d'atmosphère environ.

Dans ce but nous avons institué une série d'observations du spectre solaire soit par l'examen optique, soit par la photographie.

Ces études ont été poursuivies à Meudon, aux Alpes, et à l'observatoire du Pic du Midi.

La bande du rouge et celle du jaune près de D sont déjà nettement visibles quand le soleil est à plusieurs degrés au-dessus de l'horizon. Celle du bleu près de F demande une épaisseur atmosphérique traversée beaucoup plus grande. Je l'ai obtenue photographiquement et assez forte au Pic du Midi avec le soleil abaissé d'un à deux degrés au-dessous de l'horizon.

Pour la vérification précise de la loi il faut calculer d'abord par une formule générale les actions subies d'après cette loi par un rayon lumineux qui traverse l'atmosphère suivant une direction déterminée, et chercher ensuite quel angle le rayon doit faire avec la verticale pour subir une action équivalente à celle, par exemple, du tube de 60 mètres chargé d'oxygène à 6 atmosphères, lequel donne, comme on sait, la bande de D naissante.

Cette hauteur du soleil déterminée, il faut obtenir une série de spectres solaires comparables à ceux des tubes et correspondant à des hauteurs progressives et déterminées du soleil, et dans cette série chercher la hauteur pour laquelle la bande en question est évanouissante.

Cette recherche a été faite, mais les calculs ne sont pas encore terminés; nous pouvons dire seulement que la loi y trouve une nouvelle confirmation.

Mais cette loi a reçu dernièrement une confirmation inattendue d'une expérience sur l'oxygène liquide de M. Olszewski, si cette expérience est exacte. M. Olszewski, en liquéfiant l'oxygène, a annoncé qu'il avait constaté la présence des bandes dont j'ai annoncé l'existence avec une épaisseur de liquide de 7 millimètres environ. Or, si nous admettons, comme on le fait généralement, pour la densité de l'oxygène liquide une densité très voisine de celle de l'eau, nous trouverons que cette densité serait 695 fois plus grande que celle de l'oxygène à la densité correspondante à une atmosphère.

On a en conséquence :

$$60 \times \bar{6}^2 = x \cdot \bar{695}^2$$

$$x = \frac{60 \cdot \bar{6}^2}{\bar{695}^2} = 0^m \cdot 0045 ;$$

c'est-à-dire, que la bande de D serait naissante pour une épaisseur de 4.5^{mm} d'oxygène gazeux ayant cette densité.

Or, si la bande est naissante pour $4\frac{1}{2}$ mm elle doit être accusée pour 7mm, et c'est ce que M. Olszewski annonce avoir trouvé.

Dans ce travail nous avons parlé seulement de la bande près de D, mais la loi en question se vérifie également pour les bandes du rouge et du bleu que nous avons considérées

Ainsi cette loi se trouve actuellement vérifiée depuis une densité nulle de l'oxygène jusqu'à celle qui égale celle de l'eau, c'est-à-dire, entre les termes les plus extrêmes qu'on puisse considérer.

Le groupe de la raie B qui se résout en raies paraît suivre, au contraire, la loi générale de la proportionnalité du produit de l'épaisseur traversé par la densité.

Nous nous en sommes assurés jusqu'à 100 atmosphères.

Il convient de faire remarquer les horizons que cette loi nouvelle du carré ouvre en analyse spectrale et en mécanique moléculaire. Pour nous elle ne représente que le début des études qui auront pour objet la constitution moléculaire des corps par les actions que ces corps exercent sur la lumière quand on les soumet à l'action de forces variées.

Pour l'oxygène notamment elle nous fait soupçonner que la constitution moléculaire de ce corps n'est pas simple et qu'il y a lieu de faire de nouvelles recherches à cet égard.

TRANSACTIONS OF THE SECTIONS.

TRANSACTIONS OF THE SECTIONS.

SECTION A.—MATHEMATICAL AND PHYSICAL SCIENCE.

PRESIDENT OF THE SECTION—Professor G. F. FITZGERALD, M.A., F.R.S.

THURSDAY, SEPTEMBER 6.

The PRESIDENT delivered the following Address:—

THE British Association in Bath, and especially we here in Section A, have to deplore a very great loss. We confidently anticipated profit and pleasure from the presence in this chair of one of the leading spirits of English science, Dr. Schuster. We deplore the loss and we deplore the cause of it. It is always sad when want of strength makes the independent dependent, and it is doubly sad when a life's work is thereby delayed; and to selfish humanity it is trebly sad when, as in this case, we ourselves are involved in the loss. And our loss is great. Dr. Schuster has been investigating some very important questions. He has been studying electric discharges in gases, and he has been investigating the probably allied question of the variations of terrestrial magnetism. We anticipated his matured pronouncements upon these subjects, and also the advantage of his very wide general information upon physical questions, and the benefit of his judicial mind while presiding here.

As to myself, his substitute, I cannot express how much gratified I feel at the distinguished honour done me in asking me to preside. It has been one of the ambitions of my life to be worthy of it, and I will do my best to deserve your confidence; man can do no more, and upon such a subject 'the less said the soonest mended.'

I suppose most former occupants of this chair have looked over the addresses of their predecessors to see what sort of a thing was expected from them. I find that very few had the courage to deliver no address. Most have devoted themselves to broad general questions, such as the relations of mathematics to physics, or more generally deductive to inductive science. On the other hand, several have dealt each with his own speciality. On looking back over these addresses my attention was specially arrested by the first two past presidents of this section, whose bodily presence we cannot have here. They were presidents of Section A in consecutive years. In 1874 Provost Jellett occupied this chair, and in 1875 Professor Balfour Stewart occupied it. Both have gone from us since the last meeting of this Association. Each gave a characteristic address. The Provost, with the clearness and brilliancy that distinguished his great intellect, plunged through the deep and broad questions surrounding the mechanism of the universe, and with impassioned earnestness claimed on behalf of science the right to prosecute its investigations until it attains, if it ever does attain, to a mechanical explanation of all things. This intrepid honesty to carry to their utmost the principles of whose truth he was convinced, the utter abhorrence of the shadow of double dealing with truth, was eminently characteristic of one whom all, but especially we of Trinity College,

Dublin, will long miss as a lofty example of the highest intellectual keenness and honesty, and mourn as the truest-hearted friend, full of sympathy and Christian charity. In 1875 Professor Stewart gave us a striking example of the other class of address in a splendid exposition of the subject he did so much to advance, namely, solar physics. He brought together from the two great storehouses of his information and speculation a brilliant store, and displayed them here for the advancement of science. Him, too, all science mourns. Though, from want of personal acquaintance, I am unequal to the task of bringing before you his many abilities and great character, you can each compose a fitting epitaph for this well-known great one of British science. In this connection I am only expressing what we all feel when I say how well timed was the royal bounty recently extended to his widow. At the same time the niggardly recognition of science by the public is a disgrace to the enlightenment of the nineteenth century. What chancellor or general with his tens of thousands has done that for his country and mankind that Faraday, Darwin, and Pasteur have done? The 'public' now are but the children of those who murdered Socrates, tolerated the persecution of Galileo, and deserted Columbus.

In a presidential address on the borderlands of the known delivered from this chair the great Clerk Maxwell spoke of as an undecided question whether electro-magnetic phenomena are due to a direct action at a distance or are due to the action of an intervening medium. The year 1888 will be ever memorable as the year in which this great question has been experimentally decided by Hertz in Germany and, I hope, by others in England. It has been decided in favour of the hypothesis that these actions take place by means of an intervening medium. Although there is nothing new about the question, and although most workers at it have long been practically satisfied that electro-magnetic actions are due to an intervening medium, I have thought it worth while to try and explain to others who may not have considered the problem what the problem is and how it has been solved. A presidential address such as this is not for specialists; it is for the whole section; and I would not have thought of dealing with this subject only that its immediate consequences reach to all the bounds of physical science, and are of interest to all its students.

We are all familiar with this, that when we do not know all about something there are generally a variety of explanations of what we do know. Whether there is anything of which there are in reality a variety of explanations is a deep question which some have connected with the Freedom of the Will, but which I am not concerned with here. A notable example of the possibility of a variety of explanations for us is recorded in connection with an incident said to have occurred in the neighbouring town of Clifton, where a remarkable meteorological phenomenon, as it appeared to an observing scientist, was explained by others as a bull's-eye lantern in the hands of Mr. Pickwick. Another kind of example is the old explanation of water rising in a pump, that 'Nature abhors a vacuum,' as compared with the modern one. Nowadays, when we know as little about anything, we say, 'It is the property of electricity to attract.' This is really little or no advance on the old form, and is merely a way of stating that we know a fact but not its explanation. There are plenty of cases still where a variety of explanations is possible. For example, we know of no *experimentum crucis* to decide whether the people I see around me are conscious or are only automata. There are other questions which have existed, but which have been experimentally decided. The most celebrated of these are the questions between the caloric and kinetic theories of heat, and between the emission and undulatory theories of light. The classical experiments by which the case has been decided in favour of the kinetic theory of heat and the undulatory theory of light are some of the most important experiments that have ever been performed. When it was shown that heat disappeared whenever work appeared, and *vice versâ*, and so the caloric hypothesis was disproved; when it was shown that light was propagated more slowly in a dense medium than in a rare, the sciences of light and heat were revolutionised. Not but that most who studied the subject had given their adhesion to the true theory before it was finally decided in

general estimation. In fact, Rumford and Davy's experiments on heat, and Young and Fresnell's experiments on light had really decided these questions long before the erroneous views were finally abandoned. I hope that science will not be so slow in accepting the results of experiment in respect of electro-magnetism as it was in the case of light and heat. Rowland's experiment proving an electro-magnetic action between electric charges depending on their absolute and not relative velocities has already proved the existence of a medium relative to which the motion must take place, but the connection is rather metaphysical and is too indirect to attract general attention. The importance of the striking experiments was that they put the language of the wrong hypothesis out of fashion. Elementary text-books that halted between two opinions, and, after the manner of text-books, leant towards that enunciated in preceding text-books, had all perforce to give prominence to the true theory, and the whole rising generation began their researches from a firm and true standpoint. I anticipate the same results to follow Hertz's experimental demonstration of a medium by which electro-magnetic actions are produced. Text-books which have gradually been invoking lines of force, in some respects to the aid of learners and in others to their bewilderment, will now fearlessly discourse of the stresses in the ether that cause electric and magnetic force. The younger generation will see clearly in electro-magnetic phenomena the working of the all-pervading ether, and this will give them a firm and true standpoint for further advances.

And now I want to spend a short time in explaining to you how the question has been decided. An illustrative example may make the question itself clearer, and so lead you to understand the answer better. In colloquial language we say that balloons, hot air, &c., rise because they are light. In old times this was stated more explicitly, and therefore much more clearly. It was said that they possessed a quality called 'levity.' 'Levity' was opposed to 'heaviness.' Heaviness made things tend downwards, levity made things tend upwards. It was a sort of action at a distance. At least it would have required such a hypothesis if it had survived until it was known that heaviness was due to the action of the earth. I expect levity would have been attributed to the direct action of heaven. It was comparatively recently in the history of mankind that the rising of hot air, flames, &c., was attributed to the air. Everybody knew that there was air, but it was not supposed that the upward motion of flames was due to it. We now know that this and the rising of balloons are due to the difference of pressure at different levels in the air. In a similar way we have long known that there is an ether, an all-pervading medium, occupying all known space. Its existence is a necessary consequence of the undulatory theory of light. People who think a little but not much sometimes ask me, 'Why do you believe in the ether? What's the good of it?' I ask them, 'What becomes of light for the eight minutes after it has left the sun and before it reaches the earth?' When they consider that they observe how necessary the ether is. If light took no time to come from the sun there would be no need of the ether. That it is a vibratory phenomenon, that it is affected by matter it acts through—these could be explained by action at a distance very well. The phenomena of interference would, however, require such complicated and curious laws of action at a distance as practically to put such a hypothesis out of court, or else be purely mathematical expressions for wave-propagation. In fact, anything except propagation in time is explicable by action at a distance. It is the same in the case of electro-magnetic actions. There were two hypotheses as to the causes of electro-magnetic actions. One attributed electric attraction to a property of a thing called electricity, to attract at a distance, the other attributed it to a pull exerted by means of the ether, somewhat in the way that air pushes balloons up. We do not know what the structure of the ether is by means of which it can pull, but neither do we know what the structure of a piece of indiarubber is by means of which it can pull, and we might as well ignore the indiarubber, though we know a lot about the laws of its action, because we do not know its structure, as to ignore the ether because we do not know its structure. Anyway, what was wanted was an experiment to decide between the hypothesis of direct action at a distance and of action by means of a medium.

At the time that Clerk Maxwell delivered his address no experiment was known that could decide between the two hypotheses. Specific inductive capacity, the action of intervening matter, the delay in telegraphing, the time propagation of electro-magnetic actions by means of conducting material—these were known, but he knew that they could be explained by means of action at a distance, and had been so explained. Waves in a conductor do not necessarily postulate action through a medium such as the ether. When we are dealing with a conductor and a thing called electricity running over its surface, we are, of course, postulating a medium on or in the conductor, but not outside it, which is the special point at issue. Clerk Maxwell *believed* that just as the same air that transmits sound is able by differences of pressure—*i.e.*, by means of its energy per unit volume—to move bodies immersed in it, so the same ether that transmits light causes electrified bodies to move by means of its energy per unit volume. He believed this, but there was no experiment known then to decide between this hypothesis and that of direct action at a distance. As I have endeavoured to impress upon you, no *experimentum crucis* between the hypotheses is possible except an experiment proving propagation in time either directly, or indirectly by an experiment exhibiting phenomena like those of the interference of light. A theorist may speak of propagation of actions in time without talking of a medium. This is all very well in mathematical formulæ, but, as in the case of light, we must consider what becomes of it after it has left the sun and before it reaches the earth, so every hypothesis assuming action in time really postulates a medium whether we talk about it or not. There are some difficulties surrounding the complete interpretation of some of Hertz's experiments. The conditions are complicated, but I confidently expect that they will lead to a decision on most of the outstanding questions on the theory of electro-magnetic action. However, there is no doubt that he has observed the interference of electro-magnetic waves quite analogous to those of light, and that he has proved that electro-magnetic actions are propagated in air with the velocity of light. By a beautiful device Hertz has produced rapidly alternating currents of such frequency that their wave-length is only about two mètres. I may pause for a minute to call your attention to what that means. These waves are propagated three hundred thousand kilomètres in a second. If they vibrated three hundred thousand times a second the waves would be each a kilomètre long. This rate of vibration is much higher than the highest audible note, and yet the waves are much too long to be manageable. We want a vibration about a thousand times as fast again with waves about a mètre long. Hertz produced such vibrations, vibrating more than a hundred million times a second. That is, there are as many vibrations in one second as there are seconds—in a day? No, far more. In a week? No, more even than that. The pendulum of a clock ticking seconds would have to vibrate for four months before it would vibrate as often as one of Hertz's vibrators vibrates in one second. And how did he detect the vibrations and their interference? He could not see them; they are much too slow for that; they should go about a million times as fast again to be visible. He could not hear them; they are much too quick for that. If they went a million times more slowly they would be well heard. He made use of the principle of resonance. You all understand how by a succession of well-timed small impulses a large vibration may be set up. It explains many things, from speech to spectrum analysis. It is related that a former Marquess of Waterford used the principle to overturn lamp-posts; his ambition soared above knocker-wrenching. So that it is a principle known to others besides scientific men. Hertz constructed a circuit whose period of vibration for electric currents was the same as that of his generating vibrator, and he was able to see sparks, due to the induced vibration, leaping across a small air-space in this resonant circuit. The well-timed electrical impulses broke down the air-resistance just as those of my Lord of Waterford broke down the lamp-post. The combination of a vibrating generating circuit with a resonant-receiving circuit is one that I spoke of at the meeting of the British Association at Southport as one by which this very question might be studied. At the time I did not see any feasible way of detecting the induced resonance; I did not anticipate that it could

produce sparks. By its means, however, Hertz has been able to observe the interference between waves incident on a wall and the reflected waves. He placed his generating vibrator several wave-lengths away from a wall, and placed the receiving resonant circuit between the generator and the wall, and in this air-space he was able to observe that at some points there were hardly any induced sparks, but at other and greater distances from his generator they reappeared to disappear again in regular succession at equal intervals between his generator and the wall. It is exactly the same phenomenon as what are known as Lloyd's bands in optics, which are due to the interference between a direct and a reflected wave. It follows hence that, just as Young's and Fresnell's researches on the Interference of Light prove the undulatory theory of optics, so Hertz's experiment proves the ethereal theory of electro-magnetism. It is a splendid result. Henceforth I hope no learner will fail to be impressed with the theory—hypothesis no longer—that electro-magnetic actions are due to a medium pervading all known space, and that it is the same medium as the one by which light is propagated, that non-conductors can, and probably always do, as Professor Poynting has taught us, transmit electro-magnetic energy. By means of variable currents energy is propagated into space with the velocity of light. The rotation of the earth is being slowly stopped by the diurnal rotation of its magnetic poles. This seems a hopeful direction in which to look for an explanation of the secular precession of terrestrial magnetism. It is quite different from Edlund's curious hypothesis that free space is a perfect conductor. If this were true, there would be a pair of great antipoles outside the air, and terrestrial magnetism would not be much like what it is, and I think the earth would have stopped rotating long ago. With alternating currents we *do* propagate energy through non-conductors. It seems almost as if our future telegraph cables would be pipes. Just as the long sound waves in speaking tubes go round corners, so these electro-magnetic waves go round corners if they are not too sharp. Professor Lodge will probably have something to tell us on this point in connection with lightning conductors. The silvered glass-bars used by surgeons to conduct light are exactly what I am describing. They are a glass, a non-conducting, and therefore transparent, bar surrounded by a conducting, and therefore opaque, silver sheath, and they transmit the rapidly alternating currents we call light. There would not be the same difficulty in utilising the energy of these electro-magnetic waves as in utilising radiant heat. Having all the vibrations of the same period we might utilise Hertz's resonating circuits, and in any case the second law of thermodynamics would not trouble us when we could practically attain to the absolute zero of these, as compared with heat, long period vibrations.

We seem to be approaching a theory as to the structure of the ether. There are difficulties from diffusion in the simple theory that it is a fluid full of motion, a sort of vortex sponge. There were similar difficulties in the wave theory of light owing to wave propagation round corners, and there is as great a difficulty in the jelly theory of the ether arising from the freedom of motion of matter through it. It may be found that there is diffusion or it may be found that there are polarised distributions of fluid kinetic energy which are not unstable when the surfaces are fixed; more than one such is known. Osborne Reynolds has pointed out another, though in my opinion less hopeful, direction in which to look for a theory of the ether. Hard particles are abominations. Perhaps the impenetrability of a vortex would suffice. Oliver Lodge speaks confidently of a sort of chemical union of two opposite kinds of elements forming the ether. The opposite sides of a vortex ring might perchance suit, or maybe the ether, after all, is but an atmosphere of some infra-hydrogen element: these two latter hypotheses may both come to the same thing. Anyway we are learning daily what sort of properties the ether must have. It must be the means of propagation of light; it must be the means by which electric and magnetic forces exist; it should explain chemical actions and, if possible, gravity.

On the vortex-sponge theory of the ether there is no real difficulty by reason of complexity why it should not explain chemical actions. In fact, there is every reason to expect that very much more complex actions would take place at distances

comparable with the size of the vortices than at the distances at which we study the simple phenomena of electro-magnetism. Indeed, if vortices can make a small piece of a strong elastic solid we can make watches and build steam engines and any amount of complex machinery, so that complexity can be no essential difficulty. Similarly the instantaneous propagation of gravity, if it exists, is not an essential difficulty, for vortices each occupy all space, and they act on one another simultaneously everywhere. The theory that material atoms are simple vortex rings in a perfect liquid otherwise unmoving is insufficient, but with the innumerable possibilities of fluid motion it seems almost impossible but that an explanation of the properties of the universe will be found in this conception. Anything purporting to be an explanation founded on such ideas as 'an inherent property of matter to attract,' or building up big elastic solids out of little ones, is not of the nature of an ultimate explanation at all; it can only be a temporary stopping-place. There are metaphysical grounds, too, for reducing matter to motion and potential to kinetic energy.

These ideas are not new, but it is well to enunciate them from time to time, and a presidential address in Section A is a fitting time. Besides all this it has become the fashion to indulge in quaint cosmical theories and to dilate upon them before learned societies and in learned journals. I would suggest, as one who has been bogged in this quagmire, that a successor in this chair might well devote himself to a review of the cosmical theories propounded within the last few years. The opportunities for piquant criticism would be splendid.

Returning to the sure ground of experimental research let us for a moment contemplate what is betokened by this theory that in electro-magnetic engines we are using as our mechanism the ether, the medium that fills all known space. It was a great step in human progress when man learnt to make material machines, when he used the elasticity of his bow and the rigidity of his arrow to provide food and defeat his enemies. It was a great advance when he learnt to use the chemical action of fire; when he learnt to use water to float his boats and air to drive them; when he used artificial selection to provide himself with food and domestic animals. For two hundred years he has made heat his slave to drive his machinery. Fire, water, earth, and air have long been his slaves, but it is only within the last few years that man has won the battle lost by the giants of old, has snatched the thunderbolt from Jove himself and enslaved the all-pervading ether.

The following Report and Papers were read:—

1. *Fourth Report of the Committee for promoting Tidal Observations in Canada.*—See Reports, p. 27.

2. *On the Behaviour of Water under great Provocation from Heat.*
By Professor W. RAMSAY, F.R.S.

3. *On the Proof of the Logarithmic Law of Atomic Weights.*
By Dr. G. JOHNSTONE STONEY, F.R.S.

4. *On the Oscillations of a Rotating Liquid Spheroid and the Genesis of the Moon.* By A. E. H. LOVE, B.A.

Riemann's investigations of the motion of a liquid ellipsoid¹ contain the condition of stability of the form of steady motion, usually referred to as 'Maclaurin's spheroid,' when the liquid is perfectly inviscid. The equation for the critical value of the eccentricity of the spheroid is—

$$e(3 + 4e^2) \sqrt{1 - e^2} = (3 + 2e^2 - 4e^4) \sin^{-1}e,$$

¹ *Abh. Kön. Ges. Wiss. Göttingen*, 1860.

or, taking the notation of Thomson and Tait, in which $(1+f^2)(1-e^2)=1$, the critical value of f is nearly equal to 3.14. If f be greater than this value, the motion is unstable. Also M. Poincaré¹ has proved the statement of Thomson and Tait that the motion is secularly unstable for any degree of viscosity, however small, when f exceeds 1.39457, and he has shown that it is thoroughly stable for all displacements when f is less than this value.

In this paper Riemann's equations of motion are applied to find the small oscillations of a perfectly inviscid spheroidal mass of liquid, rotating as if rigid about its polar axis, whose direction is fixed in space, the displacement contemplated being of such a kind that the bounding surface remains ellipsoidal. It appears that there are two periods of oscillation, viz.: if $n/2\pi$ be the frequency, we have either

$$n^2 = 16\pi\gamma\rho(3+f^2) - 2\omega^2(3+8f^2+f^4)/(3f^2+f^4);$$

$$\text{or} \quad n^2 = 24\pi\gamma\rho(1+f^2)/(3+f^2) - \omega^2(1+f^2)(27+18f^2-f^4)/(3+f^2)^2,$$

where ρ is the density of the spheroid, ω the angular velocity, and γ the constant of gravitation. In these ω and f are connected by the condition of steady motion, viz.:—

$$(3+f^2)\tan^{-1}f = f(3 + \omega^2 f^2 / 2\pi\gamma\rho).$$

These values of n vary very little for different small values of ω , so that for a spheroid rotating in any period longer than about three hours the period varies very nearly inversely as the square root of the density.

The determination of these periods of oscillation has an important bearing on the question of the origin of the moon. Professor Darwin in his paper on the 'Precession of a Viscous Spheroid and the Remote History of the Earth'² saw reason to reject Laplace's hypothesis that the moon separated from the earth as a ring because the angular velocity was too great for stability. In the light of Riemann's and Poincaré's researches, above referred to, it is clear that, when the density is not less than 3, and the period of rotation longer than three hours, the motion is certainly stable. According to Professor Darwin, the period of rotation of the earth-moon system when the two bodies formed a single rotating mass may be estimated at something between two and six hours (more probably between two and four hours),³ so that, even allowing for continued contraction of the two cooling bodies, and remembering that the present mean density of the moon is about 3.7, it seems highly improbable that Laplace's hypothesis as to instability can be correct. Professor Darwin suggested as one alternative that possibly the spheroid might have a period of free oscillation not far removed from the semi-diurnal tidal period, in which case the solar tides would be of enormous height, and we should not then have to make additional demands on the lapse of time with a view to the consolidation of the ring-moon into one body.

Now it is shown in this paper that with a density of 5.67 the longer period is very nearly equal to $1\frac{1}{2}$ hours, while with a density of 3 this period is very nearly equal to two hours, whatever the rate of rotation may be, provided that it is not faster than once in three hours; so that, if the period of rotation ever came to be between three and four hours, the density may easily have been such as to make the period of free oscillation very nearly identical with that of the semi-diurnal solar tides. Thus the possibility of Professor Darwin's guess is confirmed.

5. Waves in a Viscous Liquid.⁴ By A. B. BASSET, M.A.

The propagation of waves in a viscous liquid was first considered by Professor Stokes,⁵ who showed that when the viscosity is small, and the depth of the liquid

¹ *Acta Mathematica*, vii. 1885.

² *Phil. Trans.* 1879.

³ 'On the Secular Changes in the Elements of the Orbit of a Satellite,' § 22, *Phil. Trans.* 1880.

⁴ The original paper is published in the author's treatise on *Hydro-dynamics*, vol. ii. §§ 519-523.

⁵ *Trans. Camb. Phil. Soc.* vol. ix.

so great that it may be treated as infinite, the motion is represented by a harmonic function whose amplitude diminishes as the time increases. Professor Stokes' result was obtained by means of the dissipation function; and the object of the present paper is to solve the problem by a direct process, which possesses the advantage of furnishing a result which is applicable to highly viscous as well as to slightly viscous liquids, and also to solve the same problem when the depth of the liquid is finite.

In order to solve the problem of deep sea waves we must find a solution, representing wave motion, of the equation

$$\nabla^2(\nabla^2 - \nu^{-1}d/dt)\psi = 0 \quad . \quad . \quad . \quad . \quad . \quad (1)$$

where ψ is Earnshaw's current function, and which also satisfies the conditions that the tangential and normal stresses at the free surface are zero. Measuring the axis of x in the direction of propagation of the waves, we assume that x and t enter in the form of the exponential factor e^{imx+kt} , and the principal object of the investigation is to find the equation for determining k . This equation is

$$k^2 + 4m^2k\nu + gm + 4m^4\nu^2 - 4m^3\nu^2a = 0 \quad . \quad . \quad . \quad (2)$$

where

$$a^2 = m^2 + k/\nu \quad . \quad . \quad . \quad . \quad . \quad (3)$$

When ν is small, as in the case of water,

$$k = -2m^2\nu \pm \sqrt{(4m^4\nu^2 - gm)} \quad . \quad . \quad . \quad . \quad (4)$$

$$= -2m^2\nu \pm in \quad . \quad . \quad . \quad . \quad (5)$$

approximately, where $n^2 = gm$; which represents a train of waves whose velocity of propagation is slightly less than $(g\lambda/2\pi)^{1/2}$, and whose modulus of decay is $\lambda^2/8\pi^2\nu$, where λ is the wave length.

If, however, ν is large, we shall obtain

$$k/\nu = -m^2 \times .92 \quad . \quad . \quad . \quad . \quad . \quad (6)$$

approximately, which shows that the value of k is real and negative; hence the motion is non-periodic, and rapidly subsides.

When the depth of the liquid is finite and equal to h , the equation for k is a rather complicated transcendental one, which is expressible in the form of a determinant of four rows. If, however, ν is small, it is reducible to a quadratic whose roots are

$$k = -2m^2\nu \pm i(mg \tanh ml)^{1/2} \quad . \quad . \quad . \quad . \quad (7)$$

which is the approximate solution of the problem.

This represents a train of waves whose velocity of propagation is

$$(g\lambda/2\pi \cdot \tanh 2\pi h/\lambda)^{1/2},$$

and whose modulus of decay is $\lambda^2/8\pi^2\nu$.

6. On a Hydrostatic Balance.¹ By J. JOLY, M.A., B.E.

7. On the Meldometer. By J. JOLY, M.A., B.E.

This is an apparatus enabling mineralogists to compare the melting-points of minerals and observe their behaviour at very high temperatures. It is applicable for dealing with very small quantities of bodies. The apparatus consists essentially of a ribbon of thin platinum, about 4 cm. long by 3 mm. wide, clamped in two forceps with attached binding screws, so that a current from a small storage cell, or two or three Grove's cells, may be passed through it. The apparatus rests on the stage of the microscope, the fragments of mineral being laid on the platinum strip and observed with a one-inch objective. A resistance, of simple construction, which can be set to automatically diminish or increase at any desired rate is placed

¹ An account of this apparatus appears in the *Philosophical Magazine* for September 1888, p. 26.

in circuit. As this resistance diminishes the temperature of the strip rises, so that the operator may confine his attention to the observation of the bodies on the platinum hob, while they are being exposed to a temperature gradually increasing up to that of the melting-point of platinum. Quartz is melted by this apparatus, and orthoclase caused to boil. Many substances are decomposed displaying characteristic phenomena. It reveals that the order of melting-points set forth in von Kohell's scale is incorrect.

Another form of the apparatus, not yet completed, will permit, it is hoped, of an approximate estimation of the temperature of the platinum hob at any moment.

8. *Electro-calorimetry.* By Professor WILLIAM STROUD, B.A., D.Sc.,
and W. W. HALDANE GEE, B.Sc.

During the year experiments have been continued both at Owens College, Manchester, and Yorkshire College, Leeds, with the null method described at the last British Association meeting. Important improvements have been effected in the details of the method and apparatus used. The calorimeters are now made in the form of barrels closed by screw plugs which effectually prevent leakage and loss by evaporation. For agitation of the contents of the calorimeters paddles and plungers worked by electro-motor or clockwork have been entirely discarded in favour of the simple method of rocking or shaking by hand the calorimeters themselves. For the heating coils platinoid wire has been found the best, each coil being formed of a number of strands of fine wire well insulated by silk and paraffin. Experiments made with the bolometer have shown that, compared with the thermo-pile, it is greatly inferior to the latter for the purpose of ascertaining the equality of temperature of the calorimeters. A number of determinations have been made which confirm the accuracy of the method.

9. *On Figures produced by Electric Action on Photographic Dry Plates.*¹
By J. BROWN.

A rapid bromide photographic dry plate is laid film side up on a sheet of metal in connection with one terminal of a good induction coil. A wire from the other terminal is brought down on the centre of the film. A single discharge from the coil is given, and the plate developed in the usual way.

If the wire touching the film be the negative pole, a beautiful figure with branches carrying palm-like fronds is produced; if positive a number of irregular branches of a quite different character accompanied by a quantity of light radiating irregular tracery extending beyond the darker branches.

If the discharge take place with the two poles of the coil touching the uncoated side of the plate, other figures are produced by the electricity induced on the film, the positive and negative differing both from each other, and from those given as described above by the discharge on the film.

If a coating of tinfoil be placed on each side of the plate, after the manner of a Franklin's pane, that on the film having letters cut out like a stencil plate, the result after electrification of the foils and development is a dark irregular marking round the edge of the stencil plate foil on the film, including the edges of the cut-out parts, apparently produced by a discharge from the edge, together with irregular blotchings, apparently corresponding to wrinkles in the foil. If a piece of gutta-percha tissue be placed between the foil and the film, the effect is much the same. If four thicknesses intervene there is only irregular blotching without any appearance of the outline of the letters cut in the foil.

These last effects, together with some peculiarities of the figures produced by the discharge on the film itself, appear to show that the figures are produced, partly at least, by a direct action of the electricity on the film without the intervention of light or purely photo-chemical causes as usually understood. Further

¹ *Phil. Mag.* Dec. 1888.

investigation may show that we have here a new kind of experimental evidence on the relations of electricity and light.

10. *Comparison of Gassner's Dry Cells with Leclanché's.*

By WM. LANT CARPENTER.

Two Gassner's cells were examined, the round form having an E.M.F. of 1.317^v and an internal resistance of 0.205^ω, the measurements of flat form being 1.52^v and 0.700^ω. The E.M.F.'s were measured by Law's condenser method, and the internal resistance by Kempe's method, the shunt employed being 1^ω.

The resistance of a ringing bell, measured by the reproduced deflection method, was found to be 20^ω. The two dry cells and a No. 2 size Leclanché were separately circuited for 168 hours through 20^ω, and observations of the potential differences were made at frequent intervals. Similar observations were made during the recovery from the polarisation thus produced, and the results were plotted in curves, which were exhibited. The round dry cell was circuited through 3^ω for 5½ hours, the potential differences and internal resistances being measured at intervals so that the current might be calculated.

From the results obtained it appeared that the round form of dry cell polarised less than a No. 2 Leclanché, but took longer to recover when the circuit was opened, and its internal resistance was considerably lower, but that the flat form polarised in most cases more than a No. 2 Leclanché, and had the same internal resistance.

11. *On the Intensity of Magnetisation of soft Iron Bars of various lengths in a uniform Magnetic Field.* By A. TANAKADATÉ.

Experiments were made on bars for which the ratio of length to diameter varied from 13 to 32; the bars were subjected to different strengths of magnetising fields, and the magnetic moments thereby acquired were measured, the mean intensity of magnetisation being then calculated. The results agreed with those of Professor Ewing on bars, for which the above ratio varied from 50 to 300.

Mention is made also of some experiments by the author in 1883 wherein a magnetic field of constant strength was used to act on a mass of iron that was varied by steps. The mass consisted of iron wires, which were varied in number. With a field of 46 C.G.S. units the magnetometer deflection was sensibly proportional to the number of wires up to 10; as the number of wires was increased the ratio of deflection to number diminished, the maximum deflection practically occurring with 25 wires, no greater deflection occurring with 41 wires. When the wires numbered more than 10, some of them would be thrown out of the bundle, requiring pressure to keep them in the solenoid, though the whole bundle could with care be so placed that no wire would jump out. Each wire was obviously in an unstable state of equilibrium, being under the action of opposed forces, one from the solenoid tending to throw it out, and the other from its fellow wires tending to eject it.

FRIDAY, SEPTEMBER 7.

The following Papers were read:—

1. *Recent Progress in the Use of Concave Gratings for Spectrum Analysis.*
By Professor H. A. ROWLAND.
2. *Is the Velocity of Light in an Electrolytic Liquid influenced by an Electric Current in the direction of propagation?* By Lord RAYLEIGH, LL.D., Sec. R.S.—See Reports, p. 341.

3. *On the Measurement of the Length of Electro-magnetic Waves.*

By Professor OLIVER J. LODGE, F.R.S.

The author has been endeavouring to manufacture light by direct electric action without the intervention of heat, utilising for the purpose Maxwell's theory that light is really an electric disturbance or vibration.

The means adopted is the oscillatory discharge of a Leyden jar whose rate of vibration has been made as high as 100 million complete vibrations per second.

The waves so obtained are about three yards long, and are essentially light in every particular except that they are unable to affect the retina. To do this they must be shortened to the hundred-thousandth of an inch. All that has yet been accomplished, therefore, is the artificial production of direct electrical radiation differing in no respect from the waves of light except in the one matter of length.

The electrical waves travel through space with the same speed as light, and are refracted and absorbed by material substances according to the same laws. It only wants to be able to generate waves of any desired length in order to entirely revolutionise our present best systems of obtaining artificial light by help of steam engines and dynamos, which is a most wasteful and empirical process.

The author measures the waves by converting them into stationary ones by the interference of direct and reflected pulses at the free ends of a long pair of wires attached as appendages to a discharging Leyden-jar circuit. The circuit and its appendages are adjusted till a recoil kick observed at the far end of the wires is a maximum, and the length of each resonant wire is then taken to be half a wave-length. The length so measured agrees with theory.

4. *On the Impedance of Conductors to Leyden-jar Discharges.*

By Professor OLIVER J. LODGE, F.R.S.

In the course of a series of experiments on the theory of lightning-conductors the author had devised an arrangement for testing the electromotive force necessary for sending a given discharge through a given conductor, and thus for comparing the obstruction or impedance which various conductors offered to such discharges.

The results were compared with the general theory of Clerk Maxwell and Lord Rayleigh, and were such as entirely to confirm that theory, although at first sight they were paradoxical and surprising.

The apparent resistance was some hundred thousand times greater than would have been obtained for steady currents; and for very high frequencies of alternates, say over a million per second, it was almost independent of the diameter and quite independent of the material of the rod used. In fact, the ordinary laws of conduction fail utterly and a new condition of things obtains.

Iron carries off Leyden-jar discharges quite as well as copper, and apparently in some cases even better. All but this last anomaly are susceptible of complete explanation in the light of the theory of Maxwell and Lord Rayleigh and Mr. Oliver Heaviside, and the experiments verify that theory.

5. *A simple hypothesis for Electro-magnetic Induction of incomplete circuits, with consequent equations of Electric Motion in fixed homogeneous or heterogeneous solid matter.* By Professor Sir WILLIAM THOMSON, LL.D., F.R.S.

1. To avoid mathematical formulas till needed for calculation consider three cases of liquid¹ motion, which for brevity I call Primary, Secondary, Tertiary, defined as follows: Half the velocity in the Secondary agrees numerically and directionally with the magnitude and axis of the molecular spin at the corresponding point of the Primary; or (short, but complete statement) *the velocity in the Secondary is twice the spin in the Primary*; and (similarly) *half the velocity in the Tertiary is the spin in the Secondary*.

¹ I use 'liquid' for brevity to signify incompressible fluid.

2. In the Secondary and Tertiary the motion is essentially without change of density, and in each of them we naturally, therefore, take an incompressible fluid as the substance. The motion in the Primary we arbitrarily restrict by taking its fluid also as incompressible.

3. Helmholtz first solved the problem—Given the spin in any case of liquid motion, to find the motion. His solution consists in finding the potentials of three ideal distributions of gravitational matter having densities respectively equal to $1/4\pi$ of the rectangular components of the given spin; and, regarding for a moment these potentials as rectangular components of velocity in a case of liquid motion, taking the spin in this motion as the velocity in the required motion. Applying this solution to find the velocity in our Secondary from the velocity in our Tertiary, we see that the three velocity components in our Primary are the potentials of three ideal distributions of gravitational matter, having their densities respectively equal to $1/4\pi$ of the three velocity components of our Tertiary. This proposition is proved in a moment,¹ in § 5 below, by expressing the velocity components of our Tertiary in terms of those of our Secondary, and those of our Secondary in terms of those of our Primary, and then eliminating the velocity components of Secondary so as to have those of Tertiary directly in terms of those of Primary.

4. Consider now, in a fixed solid or solids of no magnetic susceptibility, any case of electric motion in which there is no change of electrification, and therefore no incomplete electric circuit; or, which is the same, any case of electric motion in which the distribution of electric current agrees with the distribution of velocity in a case of liquid motion. Let this case, with velocity of liquid numerically equal to 4π times the electric current density, be our Tertiary. The velocity in our corresponding Secondary is then the magnetic force of the electric current system;² and the velocity in our Primary is what Maxwell³ has well called the 'electro-magnetic momentum at any point' of the electric current system; and the rate of decrease per unit of time, of any component of this last velocity at any point, is the corresponding component of electro-motive force, due to electro-magnetic induction of the electric current system when it experiences any change. This electro-motive force, combined with the electrostatic force, if there is any, constitutes the whole electro-motive force at any point of the system. Hence by Ohm's law each component of electric current at any point is equal to the electric conductivity multiplied into the sum of the corresponding component of electrostatic force, and the rate of decrease per unit of time of the corresponding component of velocity of liquid in our Primary.

5. To express all this in symbols let (u_1, v_1, w_1) , (u_2, v_2, w_2) , and (u_3, v_3, w_3) denote rectangular components of the velocity at time t , and point (x, y, z) of our Primary, Secondary, and Tertiary. We have (§ 1)—

$$u_2 = \frac{dw_1}{dy} - \frac{dv_1}{dz}, \quad v_2 = \frac{du_1}{dz} - \frac{dw_1}{dx}, \quad w_2 = \frac{dv_1}{dx} - \frac{du_1}{dy} \quad . \quad . \quad . \quad (1)$$

$$u_3 = \frac{dw_2}{dy} - \frac{dv_2}{dz}, \quad v_3 = \frac{du_2}{dz} - \frac{dw_2}{dx}, \quad w_3 = \frac{dv_2}{dx} - \frac{du_2}{dy} \quad . \quad . \quad . \quad (2)$$

Eliminating u_2, v_2, w_2 from (2) by (1), we find—

$$u_3 = \frac{d}{dx} \left(\frac{du_1}{dx} + \frac{dv_1}{dy} + \frac{dw_1}{dz} \right) - \left(\frac{d^2 u_1}{dx^2} + \frac{d^2 u_1}{dy^2} + \frac{d^2 u_1}{dz^2} \right); \quad \&c. \quad . \quad . \quad (3)$$

But by our assumption (§ 2) of incompressibility in the Primary—

$$\frac{du_1}{dx} + \frac{dv_1}{dy} + \frac{dw_1}{dz} = 0 \quad . \quad . \quad . \quad . \quad (4)$$

Hence (3) becomes—

$$u_3 = -\nabla^2 u_1, \quad v_3 = -\nabla^2 v_1, \quad w_3 = -\nabla^2 w_1 \quad . \quad . \quad . \quad (5)$$

¹ From Poisson's well-known elementary theorem $\nabla^2 \nabla = -4\pi\rho$.

² *Electrostatics and Magnetism*, § 517 (postscript) (c).

³ *Electricity and Magnetism*, § 604.

where, as in Article xxvii. (November 1846) of my Collected Mathematical and Physical Papers (vol. i.)—

$$\nabla^2 = \frac{d^2}{dx^2} + \frac{d^2}{dy^2} + \frac{d^2}{dz^2} \quad \dots \quad (6)^1$$

This (5) is the promised proof of § 3.

6. Let now u, v, w denote the components of electric current at (x, y, z) in the electric system of § 4; so that—

$$4\pi u = u_3 = -\nabla^2 u_1; \quad 4\pi v = v_3 = -\nabla^2 v_1; \quad 4\pi w = w_3 = -\nabla^2 w_1 \quad (7)$$

which, in virtue of (4), give—

$$\frac{du}{dx} + \frac{dv}{dy} + \frac{dw}{dz} = 0 \quad \dots \quad (8)$$

Hence the components of electro-motive force due to change of current being (§ 5)—

$$-\frac{du_3}{dt}, \quad -\frac{dv_3}{dt}, \quad -\frac{dw_3}{dt},$$

are equal to—

$$4\pi \nabla^{-2} \frac{du}{dt}, \quad 4\pi \nabla^{-2} \frac{dv}{dt}, \quad 4\pi \nabla^{-2} \frac{dw}{dt} \quad \dots \quad (9)$$

and therefore if Ψ denote electrostatic potential, we have, for the equations of the electric motion (§ 5)—

$$u = \frac{1}{\kappa} \left(\nabla^{-2} \frac{du}{dt} - \frac{d\Psi}{dx} \right); \quad v = \frac{1}{\kappa} \left(\nabla^{-2} \frac{dv}{dt} - \frac{d\Psi}{dy} \right); \quad w = \frac{1}{\kappa} \left(\nabla^{-2} \frac{dw}{dt} - \frac{d\Psi}{dz} \right). \quad (10)$$

where κ denotes $\frac{1}{4}\pi$ of the specific resistance.

7. As Ψ is independent of t , according to § 4, we may, conveniently for a moment, put—

$$u + \frac{d\Psi}{\kappa dx} = \alpha; \quad v + \frac{d\Psi}{\kappa dy} = \beta; \quad w + \frac{d\Psi}{\kappa dz} = \gamma \quad \dots \quad (11)$$

and so find, as equivalents to (10)—

$$\frac{d\alpha}{dt} = \nabla^2(\kappa\alpha); \quad \frac{d\beta}{dt} = \nabla^2(\kappa\beta); \quad \frac{d\gamma}{dt} = \nabla^2(\kappa\gamma) \quad \dots \quad (12)$$

The interpretation of this elimination of Ψ may be illustrated by considering, for example, a finite portion of *homogeneous* solid conductor, of any shape (a long thin wire with two ends, or a short thick wire, or a solid globe, or a lump, of any shape, of copper or other metal homogeneous throughout), with a constant flow of electricity maintained through it by electrodes from a voltaic battery or other source of electric energy, and with proper appliances over its whole boundary, so regulated as to keep any given constant potential at every point of the boundary; while currents are caused to circulate through the interior by varying currents in circuits exterior to it. There being no *changing electrification* by our supposition of § 4, Ψ can have no contribution from electrification within our conductor; and therefore throughout our field—

$$\nabla^2 \Psi = 0 \quad \dots \quad (13)$$

which, with (8) and (11), gives—

$$\frac{d\alpha}{dx} + \frac{d\beta}{dy} + \frac{d\gamma}{dz} = 0 \quad \dots \quad (14)$$

Between (12) and (14) we have four equations for three unknown quantities. These *in the case of homogeneousness* (κ constant) are equivalent to only three, because in this case (14) follows from (12) provided (14) is satisfied initially, and the proper surface condition is maintained to prevent any violation of it from supervening.

¹ Maxwell, for quaternionic reasons, takes ∇^2 the negative of mine.

But unless κ is constant throughout our field, the four equations (12) and (14) are mutually inconsistent; from which it follows that our supposition of unchangingness of electrification (§ 4) is not generally true. An interesting and important practical conclusion is, that when currents are induced in any way, in a solid composed of parts having different electric conductivities (pieces of copper and lead, for example, fixed together in metallic contact), there must in general be changing electrification over every interface between these parts. This conclusion was not at first obvious to me; but it ought to be so by anyone approaching the subject with mind undisturbed by mathematical formulas.

8. Being thus warned off heterogeneity until we come to consider changing electrification and incomplete circuits, let us apply (10) to an infinite homogeneous solid. As (8) holds through all space according to our supposition in § 4, and as κ is constant, (13) must now hold through all space, and therefore $\Psi = 0$, which reduces (10) to—

$$u = \frac{1}{\kappa} \nabla^{-2} \frac{du}{dt}; \quad v = \frac{1}{\kappa} \Delta^{-2} \frac{dv}{dt}; \quad w = \frac{1}{\kappa} \nabla^{-2} \frac{dw}{dt} \quad . \quad . \quad (15)$$

These equations express simply the known law of *electro-magnetic* induction. Maxwell's equations (7) of § 783 of his 'Electricity and Magnetism,' become in this case—

$$\mu \left(4\pi C + K \frac{d}{dt} \right) \frac{du}{dt} = \nabla^2 u, \text{ \&c.} \quad . \quad . \quad . \quad (15')$$

which cannot be right, I think, according to any conceivable hypothesis regarding electric conductivity, whether of metals, or stones, or gums, or resins, or wax, or shellac, or india-rubber, or gutta-percha, or glasses, or solid or liquid electrolytes; being, as seems to me, vitiated for complete circuits by the curious and ingenious, but as seems to me not wholly tenable hypothesis which he introduces, in § 610, for incomplete circuits.

9. The hypothesis which I suggest for incomplete circuits, and consequently varying electrification, is simply that the components of the electro-motive force due to electro-magnetic induction are still $4\pi \nabla^{-2} du/dt$, &c. Thus, for the equations of motion, we have simply to keep equations (10) unchanged, while not imposing (8), but instead of it taking

$$'v',^2 \left(\frac{du}{dx} + \frac{dv}{dy} + \frac{dw}{dz} \right) = \frac{d}{dt} \nabla^2 \Psi = -\rho \quad . \quad . \quad . \quad (16)$$

where ρ denotes 4π times the electric density at time t , and place (x, y, z) , and 'v' denotes the number of electrostatic units in the electro-magnetic unit of electric quantity. This equation expresses that the electrification of which Ψ is the potential, diminishes and increases in any place according as electricity flows more out than in or more in than out. We thus have four equations, (10) and (16), for our four unknowns, u, v, w, Ψ ; and I find simple and natural solutions, with nothing vague or difficult to understand, or to believe when understood, by their application to practical problems, or to conceivable ideal problems, such as the transmission of ordinary or telephonic signals along submarine telegraph conductors and land lines, electric oscillations in a finite insulated conductor of any form, transference of electricity through an infinite solid, &c. &c. This, however, does not prove my hypothesis. Experiment is required for informing us as to the real electro-magnetic effects of incomplete circuits; and, as Helmholtz has remarked, it is not easy to imagine any kind of experiment which could decide between different hypotheses which may occur to anyone trying to evolve out of his inner consciousness a theory of the mutual force and induction between incomplete circuits.

6. On the Transference of Electricity within a Homogeneous Solid Conductor. By Professor Sir WILLIAM THOMSON, LL.D., F.R.S.

Adopting the notation and formulas of my previous paper, and taking ρ to denote 4π times the electric density at time t , and place (x, y, z) , we have—

$$-\rho = \nabla^2 \Psi = 'v'^2 \int \left(\frac{du}{dx} + \frac{dv}{dy} + \frac{dw}{dz} \right) dt \dots (17)$$

and, eliminating u, v, w, Ψ by this from (10), we find, on the assumption of κ constant,

$$\kappa \frac{d}{dt} \nabla^2 \rho = \frac{d^2 \rho}{dt^2} - 'v'^2 \nabla^2 \rho \dots (18)$$

The settlement of boundary conditions, when a finite piece of solid conductor is the subject, involves consideration of u, v, w , and for it, therefore, equations (17) and (12) must be taken into account; but when the subject is an infinite homogeneous solid, which, for simplicity, we now suppose it to be, (18) suffices. It is interesting and helpful to remark that this agrees with the equation for the density of a viscous elastic fluid, found from Stokes's equations for sound in air with viscosity taken into account; and that the values of u, v, w , given by (17) and (10), when ρ has been determined, agree with the velocity components of the elastic fluid if the simple and natural enough supposition be made that viscous resistance acts only against change of shape, and not against change of volume without change of shape.

For a type-solution assume—

$$\rho = A E^{-qt} \cos \frac{2\pi x}{a} \cos \frac{2\pi y}{b} \cos \frac{2\pi z}{c} \dots (19)$$

and we find, by substitution in (18)—

$$q^2 - \frac{\kappa}{L^2} q + \frac{'v'^2}{L^2} = 0 \dots (20)$$

where—

$$L^2 = 1 / 4\pi^2 \left(\frac{1}{a^2} + \frac{1}{b^2} + \frac{1}{c^2} \right) \dots (21)$$

Hence, by solution of the quadratic (20) for q —

$$q = \frac{1}{2} \frac{\kappa}{L^2} \left\{ 1 \pm \sqrt{1 - \frac{4'v'^2 L^2}{\kappa^2}} \right\} \dots (22)$$

[In the communication to the Section numerical illustrations of non-oscillatory and of oscillatory discharge were given.]

7. *Five Applications of Fourier's Law of Diffusion, illustrated by a Diagram of Curves with Absolute Numerical Values.* By Professor Sir WILLIAM THOMSON, LL.D., F.R.S.

1. Motion of a viscous fluid.
2. Closed electric currents within a homogeneous conductor.¹
3. Heat.
4. Substances in solution.

¹ This subject is essentially the 'electro-magnetic induction' of Henry and Faraday. It is essentially different from the 'diffusion of electricity' through a solid investigated by Ohm in his celebrated paper 'Die Galvanische Kette mathematisch bearbeitet,' Berlin, 1827; translated in Taylor's 'Scientific Memoirs,' vol. ii. part viii., 'The Galvanic Circuit investigated Mathematically,' by Dr. G. S. Ohm. In Ohm's work electro-magnetic induction is not taken into account, nor does any idea of an electric analogue to inertia appear. The electro-motive force considered is simply that due to the difference of electrostatic potential in different parts of the circuit, unsatisfactorily, and even not accurately, explained by what, speaking in his pre-Greenian time, he called 'the electroscopic force of the body,' and defined or explained as 'the force with which the electroscope is repelled or attracted by the body;' the electroscope being 'a second movable body of invariable electric condition.'

5. Electric potential in the conductor of a submarine cable.¹

1. Fourier's now well-known analysis of what he calls the 'linear motion of heat' is applicable to every case of diffusion in which the substance concerned is in the same condition at all points of any one plane parallel to a given plane. The differential equation of diffusion,² for the case of constant diffusivity κ , is—

$$\frac{dv}{dt} = \kappa \frac{d^2v}{dx^2}$$

where v denotes the 'quality' at time t and at distance x from a fixed plane of reference. This equation stated in words is as follows:—Rate of augmentation of the 'quality' per unit of time is equal to the diffusivity multiplied into the rate of augmentation per unit of space of the 'quality.'

The meaning of the word 'quality' here depends on the subject of the diffusion, which may be any one of the five cases referred to in the title above.

2. If the subject is motion of a viscous fluid, the 'quality' is any one of three components of the velocity, relative to rectangular rectilinear co-ordinates. But in order that Fourier's diffusional law may be applicable we must either have the motion very slow, according to the special definition of slowness in Article xcvi. below; or the motion must be such that the velocity is the same for all points in the same stream-line, and would continue to be steadily so if viscosity were annulled at any instant. This condition is satisfied in laminar flow, and more generally in every case in which the stream-lines are parallel straight lines. It is also satisfied in the still more general case of stream-lines, coaxial circles with velocity the same at all points at the same distance from the axis. Our present illustration, however, is confined to the case of laminar flow, to which Fourier's diffusional laws for what he calls 'linear motion' (as explained above in § 1) is obviously applicable without any limitation to the greatness of the velocity in any part of the fluid considered (though with conceivably a reservation in respect to the question of stability³). In this case the 'quality' is simply fluid velocity.

3. If the subject is electric current in a non-magnetic metal, with stream-lines parallel straight lines, the 'quality' is simply current-density, that is to say, strength of current per unit of area perpendicular to the current. The perfect mathematical⁴ analogy between the electric motion thus defined, and the corresponding motion of a viscous fluid defined in § 2 was accentuated by Mr. Oliver Heaviside in the 'Electrician,' July 12, 1884; and in the following words in the 'Philosophical Magazine' for 1886, second half-year, p. 135: 'Water in a round pipe is started from rest and set into a state of steady motion by the sudden and continued application of a steady longitudinal dragging or shearing force applied to its boundary. This analogue is useful because everyone is familiar with the setting of water in motion by friction on its boundary, transmitted inward by viscosity.' Mr. Heaviside well calls this analogue 'useful.' It is, indeed, a very valuable analogy, not merely in respect to philosophical consideration of electricity, ether, and ponderable matter, but as facilitating many important estimates, particularly some relating to telephonic conductors and conductors for electric lighting on the 'alternate-current' system. In a short article to be included in volume iii. of my collected papers, which I hope will soon be published, I intend to describe a generalisation, with, as will be seen, a consequently essential modification of this analogy, by which it is extended to include the mutual induction between conductors separated by air or other

¹ This subject belongs to the Ohmian electric diffusion pure and simple, worked out by aid of Green's theory of the capacity of a Leyden jar (see 'Mathematical and Physical Papers,' vol. ii., art. lxxiii.).

² See 'Mathematical and Physical Papers,' vol. ii., art. lxxii.

³ See 'Stability of Fluid Motion,' § 28 *Philosophical Magazine*, August 1887.

⁴ It is essentially a mathematical analogy only; in the same sense as the relation between the 'uniform motion of heat' and the mathematical theory of electricity, which I gave in the *Cambridge Mathematical Journal* forty-six years ago, and which now constitutes the first article of my 'Electrostatics and Magnetism,' is a merely mathematical analogy.

insulators, and currents in solids of different conductivity fixed together in contact.

4. If the subject is heat, as in Fourier's original development of the theory of diffusion, the 'quality' is temperature.

5. If the subject is diffusion of matter, the 'quality' is density of the matter diffused, or deviation of density from some mean or standard density considered. It is to Fick, thirty-three years ago demonstrator of anatomy, and now professor of physiology in the University of Zurich, that we owe this application of Fourier's diffusional theory, so vitally important in physiological chemistry and physics, and so valuable in natural philosophy generally. When the substance through which the diffusion takes place is fluid, a very complicated but practically important subject is presented if the fluid be stirred. The exceedingly rapid progress of the diffusion produced by vigorous up-and-down stirring, causing to be done in half a minute the diffusional work which would require years or centuries if the fluid were quiescent, is easily explained; and the explanation is illustrated by the diagram of curves, § 7 below, with the time-values given for sugar and common salt. Look at curve No. 1, and think of the corresponding curve with vertical ordinates diminished in the ratio of 1 to 40. The corresponding diffusion would take place for sugar in 11 seconds, and for salt in 3½ seconds. The case so represented would quite correspond to a streaky distribution of brine and water or of syrup and water, in which portions of greatest and least salinity or saccharinity are within half a millimetre of one another. This is just the condition which we see, in virtue of the difference of optic refractivity produced by difference of salinity or of saccharinity, when we stir a tumbler of water with a quantity of undissolved sugar or salt on its bottom. If water be poured very gently on a quantity of sugar or salt in the bottom of a tumbler with violent stirring up guarded against by a spoon, the now almost extinct Scottish species called 'toddy ladle' being the best form, or better still a little wooden disc which will float up with the water; and if the tumbler be left to itself undisturbed for two or three weeks, the condition at the end of 17×10^5 seconds (20 days) for the case of sugar, or 5.4×10^5 seconds (6 days) for salt, will be that represented by No. 10 curve in the diagram.

6. If the subject be electricity in a submarine cable, the 'quality' is electric potential at any point of the insulated conductor. It is only if the cable were a straight line that x would be (as defined above) distance from a fixed plane: but the cable need not be laid along a straight line; and the proper definition of x for the application of Fourier's formula to a submarine cable is the distance along the cable from any point of reference (one end of the cable, for example) to any point of the cable. For this case the diffusivity is equal to the conductivity of its conductor, reckoned in electrostatic units, divided by the electrostatic capacity of the conductor per unit length insulated as it is in gutta-percha, with its outer surface wet with sea water, which, in the circumstances, is to be regarded as a perfect conductor. For demonstration of this proposition see vol. ii., art. lxxiii. (1855) of my collected papers.

7. EXPLANATION OF DIAGRAM SHOWING PROGRESS OF LAMINAR DIFFUSION.

In each curve—

$$\frac{1}{10} NP = \frac{2}{\sqrt{\pi}} \int_0^{2x/i} dq. e^{-q^2},$$

where x denotes the number of centimetres in ON , and i the 'curve-number.' The curves are drawn directly from the values of the integral given in Table III. appended to De Morgan's article 'On the Theory of Probabilities,' 'Encyclopædia Metropolitana,' vol. ii. pp. 483-84.

NP denotes the 'quality' (defined below)

{ at distance = ON from initial surface or interface,
and at time equal in seconds to ['curve-number']² divided by sixteen times the diffusivity in square centimetres per second.

Subject of Diffusion	'Quality' represented by $\frac{1}{10} NP$
Motion of a viscous fluid	Ratio of the velocity at N to the constant velocity at O
Closed electric currents within a homogeneous conductor	Current-density
Heat	Ratio of temperature <i>minus</i> mean temperature to mean temperature
Substance in solution	Ratio of density <i>minus</i> mean density to mean density
Electric potential in the conductor of a submarine cable	Ratio of potential at N to constant potential at end O

EXAMPLES.

'Curve-number'	Time in seconds	Case of Diffusion
1	27056	Zinc sulphate through water.
1	25720	Copper sulphate through water.
1	17000	Sugar through wood.
1	5400	Common salt through water.
5	1180	Heat through wood.
5	118	Laminar motion of water at 10° Cent.
5	30	Laminar motion of air.
5	7·1	Heat through iron.
5	1·31	Heat through copper.
		Electric current in a homogeneous non-magnetic conductor:
10	·0488	Copper,
10	·0040	Lead,
10	·0038	German silver,
10	·0023	Platinoid.
1,000,000,000	2·15	Electric potential in the Direct U.S. Atlantic Cable.

8. *On Flux and Reflux of Water in Open Channels or in Pipes or other Ducts.*
By Professor JAMES THOMSON, LL.D., F.R.S.

In the autumn of 1872 I was staying at a place named Castlerock, on the north coast of Ireland, between the mouth of the Bann river and the entrance to Lough Foyle. There was an extensive sandy beach there, lashed by the great waves of the Atlantic Ocean. At a part of that beach a small river or stream flowed to the sea; but the sandy beach had been thrown up as a bank, at about high-tide level, obstructing what might have been the direct outfall course for the stream into the sea, and causing the stream to turn to its right and to flow eastward for some distance along the back of that sandy bank before finding an opening for flow out to the sea. Thus, at the back of the bank, a little estuary was formed, along which, when the tide was down, the stream would have for a considerable length a nearly level bed, and into which, when the tide was up, the sea-water entered so as to fill it up to various depths according to the height of the sea-surface.

I happened to be watching with interest the motions of the water in this little

estuary at a time when a considerable depth of water (such as a few feet depth along its mid-channel) was maintained in it by the height of the sea-water outside, and when the slow rising and sinking of the ocean-waves was producing in the estuary a flux and reflux on a small scale like that of the tidal flow in large estuaries.¹ The motions of the water being indicated by numerous little pieces of sea-weed carried in suspension, I noticed that the water at or very close to the channel-bed reversed its landward or seaward flow always much earlier than did the main body of the water in the channel, less affected by contiguity to the bed. The phenomenon being noticed, the reason at once became apparent. The lamina contiguous to the bed, or channel-face, would be always hindered, by the frictional resistance of that face, from getting into so great a velocity, either seaward or landward, as that which would be attained to by the main body of the water. Then, when the water at the sea-end of the estuary was raised in level, by the arrival of an ocean-wave, so as to give a gravitational propulsive influence tending to cause the water to flow landward along the estuary, the main body of the water, in virtue of its inertia with seaward momentum, would continue to flow for some time seaward, flowing as it were uphill;² while the frictionally restrained lamina at the channel-face, being nearly devoid of inertial tendency seaward, would readily yield to the landward gravitational propulsive influence due to the landward surface declivity of the water in the estuary.

Exactly a like explanation, *mutatis mutandis*, is applicable to the case of reversal of the flow from having been landward to its becoming seaward. The channel-face lamina makes its reversal of flow, just as in the other case, *earlier* than does the main body of the water, and for like reason.

It may now further be noticed that precisely corresponding phenomena would present themselves in the flux and reflux of water in a pipe, if, for instance, the pipe were connecting two cisterns, and a plunger were kept oscillating upwards and downwards in one of them so as to cause the alternating flow through the pipe. The phenomena might be very interestingly manifested in an open trough connecting two cisterns, arrangements being made, by a plunger or otherwise, for causing flux and reflux along the trough, and the motions of the water being indicated by small visible particles in suspension in the water or by the dropping in of granules of aniline dye.

It may now be worthy of remark that the hydraulic principle brought into notice in the present paper, in respect to flux and reflux along channels, is closely allied to, and is in some respects identical with, the leading principle set forth in previous papers by myself on the flow of water round bends in rivers, &c. In that case the frictionally resisted and retarded lamina in contiguity with the channel-face, or bed, flows transversely (or rather obliquely) across the channel towards the inner bank of the bend, impelled inwards by gravitational propulsive influence (that is, downhill as it were), while the main body of the stream, flowing quicker in the bend, exerts centrifugal force outwards, or tends inertially out towards the outer bank. The papers here referred to on Flow of Water round Bends in Rivers, &c., are to be found in the 'Proceedings of the Royal Society' for May 1876; in the British Association Report for the Glasgow Meeting, 1876, Section A, page 31 of Transactions of the Sections; in the 'Proceedings of the Royal Society,' 1877, No. 182, page 356; and in the 'Proceedings of the Institution of Mechanical Engineers,' August 1879, p. 456. Also some other important cases in which like principles of fluid motion come into play (in Whirlwinds &c.) are adduced in a paper by myself in the British Association Report for the Montreal Meeting, 1884, Section A, p. 641.

¹ The period of these oscillations may be about from ten to twenty seconds, as I have been informed that Professor Stokes has found, by observations on that coast, that the period from one wave to the next, in the large Atlantic waves there, is at most about seventeen seconds.

² Or, in more precise terms, flowing from a place of lower to a place of higher free-level.

SATURDAY, SEPTEMBER 8.

The following Papers and Report were read:—

DEPARTMENT FOR LIGHT AND ELECTRICITY.

1. *Sur l'application de l'analyse spectrale à la mécanique moléculaire et sur les spectres de l'oxygène.* By Dr. J. JANSSEN.—See Reports, p. 547.
-
2. *On the Absorption Spectrum of Oxygen.*¹ By Professors LIVEING, F.R.S., and DEWAR, F.R.S.

The authors describe the absorption spectrum given by oxygen at various pressures up to 165 atmospheres in a tube, fitted with quartz ends, 1·6 metre long, and at pressures from one to ninety atmospheres in a tube 18 metres long. They confirm generally the results of Egoroff and Janssen, and add some new facts with regard to the absorptions in the more refrangible part of the spectrum.

Of all the absorptions Fraunhofer's A required the least amount of oxygen to produce it in sufficient intensity to be seen, and B came next. All the other absorptions in the visible region seem to be represented, but with less intensity, amongst the telluric bands of the solar spectrum. Neither carbonic acid gas nor nitrous oxide gave any visible absorption. A could not be resolved into lines, because the expansion of the lines with increased density of the oxygen obliterated the interspaces. The rapid increase in the strength of the bands with increasing pressure of the gas accords with Janssen's law that the intensity of the unresolvable absorptions varies as the square of the density of the gas.

With the shorter tube at high pressures the authors found that the absorption of ultra-violet rays beyond λ 2665 was complete, while with the longer column the complete absorption extended much lower, to about λ 3360.

Remarkable effects were observed to arise from variations of density in the gas, the tube becoming quite opaque through internal reflexions when it was heated at one or two points or when gas at high pressure was entering the tube rapidly.

-
3. *The Spectra of Meteorites compared with the Solar Spectrum.*
By J. NORMAN LOCKYER, F.R.S.

-
4. *On the Harmonic Series of Lines in the Spectra of the Elements.*
By Professor CARL RUNGE.

Similar to the formula found by Mr. Balmer, of Zurich,² in 1885 for the wave-lengths of thirteen lines of the hydrogen spectrum there exist, as Professor Kayser and I have found, formulas for the groups of lines of other elements, which Professors Liveing and Dewar have called 'harmonic series of lines,' and which they have compared to the series of overtones emitted by a vibrating elastic body.

The formulas have the form

$$\text{wave-length} = \frac{1}{a + bn^{-1} + cn^{-2}},$$

$$\text{or wave-length} = \frac{1}{a + bn^{-2} + cn^{-4}},$$

where a , b , c are constants and n assumes consecutive values of the series of entire numbers. I give an example of a series of eight lines in the spectrum of lithium observed by Liveing and Dewar:—

¹ For full details see *Phil. Mag.* Sept. 1888, and *Chem. News*, vol. lviii. p. 163.

² *Wiedemann's Annalen*, 25, pp. 80–87.

Wave-length = $\frac{1}{4341.4 + 186.5n^{-1} - 11635n^{-2}}$ millimeter				
n	Wave-lengths		Difference	Remarks
	Calculated	Observed		
3	3232.0	3232.0	0.0	The wave-lengths are given in Angström's units; that is, 10^{-7} millimeters.
4	2741.0	2741.0	0.0	
5	2562.0	2561.5	-0.5	
6	2474.7	2475.0	+0.3	
7	2425.2	2425.5	+0.3	
8	2394.3	2394.5	+0.2	
9	2373.7	2373.5	-0.2	
10	2359.2	2359.0	-0.2	

Living and Dewar give 0.3 Angström's units as their probable error. According to that the formula might be absolutely correct. However, our other formulas do not agree quite so well with the observations. They contain series of lines in the spectra of thallium, potassium, sodium, tin, zinc, and magnesium. As the spectrum defines an element, so the constants of the formula may be said to define the element. Possibly they will be found to be in some connection with the atomic weight.

5. *A Vortex Analogue of Static Electricity.*

By Professor W. M. HICKS, M.A., F.R.S.

Consider two bodies in contact placed in an infinite fluid, and with a vortex filament the ends of which are one on one surface, the other on the other. If now the surfaces be separated from one another, there will be formed at the point where they separate a hollow vortex filament stretching from one to the other, with rotation equal and opposite to that of the original filament. As the bodies are moved apart these filaments will not in general take up a position of rest. If the strength of the original filament be very great, or if there be several of them, the resulting hollow vortex will, through instability, split up into a number of smaller ones.

If the resulting number be very large they will ultimately take up some position of stable equilibrium. What the distribution in this case will be I cannot say, but the following is one state of equilibrium and probably, although I have not proved it, a stable one. The two sets of filaments will be mixed up with each other, and each will distribute itself according to the same law as the distribution of lines of force between the two bodies supposed equally and oppositely electrified.

In the case of the original filaments, as the surfaces are further and further separated, their sections become smaller and smaller. This is, however, not the case with the hollow filaments. Their section depends only on the pressure of the fluid and their circulation, and as these remain constant the areas of their section also remain so. In such a hollow vortex the pressure inside sinks to zero. Consequently the portion of the surface on which it abuts experiences a diminution of pressure, a diminution which is the same at all distances. The two bodies are therefore attracted. Moreover, as the two bodies separate further, the distribution of the filaments being the same as that of electrical lines of force, and the diminution of pressure for each line being constant, it follows that the force between the two bodies follows precisely the same laws as the force between the two bodies supposed equally and oppositely electrified. It can be shown that the effect of the original filaments is similar, the diminution of pressure being half as large again as for the hollow vortices.

If another surface be brought into the presence of the others, some of the

filaments would abut on this. These would break off, and rearrange themselves so that some of the filaments would end on it and an equal number start from it.

Call those ends of the filaments positive at which the rotation, looked at *from* the surface on which they abut, is right-handed; and those ends negative at which the rotation is left-handed. The two ends of any filament will then always be of opposite name.

The analogy with electrical action is then close. Two bodies, A B, brought in contact touch in innumerable points, owing possibly to the different states of motion of the ether at their surfaces; a state of equilibrium is set up, consisting of a kind of sifting of vortex motion already subsisting, so that on the whole more lines go from A to B than *vice versa*. This is *E.M.F. of contact*. Separate the bodies; one has a number of positive ends of hollow filaments, and the other an equal number of negative ends. *The bodies are equally and oppositely electrified*. The forces in the hydrodynamical case and in its electrical analogue follow the same laws.

Bring into the field another surface C; the filaments rearrange themselves as mentioned above, the negative and positive ends abutting on C being equal. *This is induced electricity*.

If the surface C consist of a large number of small unconnected surfaces, the filaments will arrange themselves in some manner depending on the sizes and distances of the unconnected parts, the field will be disturbed in a similar way to that in an electric field into which a different dielectric is placed. This is the analogue of a non-uniform specific inductive capacity. So far the ground is pretty safe. The succeeding remarks must be regarded as speculative.

Return to the case of the two separated surfaces A and B; what will happen if they be connected by a third surface—say, to fix our ideas—a long, narrow cylinder or wire? It is not so easy to say certainly what the exact rearrangement will be. It would seem very probable that the hollow filaments near the wire would at once be replaced by circulation round the wire. In this case the solid filaments must rotate as a whole round it, while at the same time, although this has not been proved, they will contract, their ends move along until they come together, form a ring and get mixed up in the surrounding fluid. This would correspond to the *current of discharge*. But notice that if this is so the fluid outside the wire rotates round the wire while a stationary state is being reached, and, as we know that the field round a current is a magnetic field, it follows that the *analogue of a magnetic field is a flow along the magnetic lines of force*.

It may, however, be further necessary that these streams must contain vortex filaments moving with the fluid, their axes at every point being perpendicular to the lines of force there.

If the field is determined by the flow of fluid independently of the vortex motion it is not easy to see the hydrodynamical analogue of the induction of currents when, say, a wire moves across a uniform magnetic field. If, however, the vortex filaments as above are a necessary adjunct, it is conceivable how a movement of the wire across the lines of flow and amongst the filaments produce an instantaneous disarrangement which will travel through the vortical fluid with the velocity of propagation of transverse vibrations in a vortical fluid. That is in the ether as Sir W. Thomson has shown with the velocity of light.

It is difficult to see any analogue to the rotation of the plane of polarisation of light by a magnetic field.

6. *On a Diffusion Photometer.* By J. JOLY, M.A., B.E.

This photometer in its original form was brought before the British Association in 1885 by Professor Fitzgerald for the author. The improved form, made of translucent glass, is now shown. A full account will be found in the 'Philosophical Magazine,' July 1886, p. 26.

7. *Third Report of the Committee on Electrolysis.*—See Reports, p. 339.

DEPARTMENT FOR MATHEMATICS AND GENERAL PHYSICS.

I. *On Centres of Finite Twist and Stretch.*
 By Professor R. W. GENESE, M.A.

Given two directly similar figures $ABC\dots, A'B'C'\dots$ in a plane; it is known that one may be transformed into the other by a twist about a certain point I , and a proper stretch from that point. But it will be seen that the transformation may be effected by an equal twist about any point O in the plane (so as to bring AB parallel to $A'B'$) followed by a stretch from a different centre S , or equally well by a stretch from S followed by a twist round a proper point O' not coincident with O . It would seem worth while to consider the relations between the centres.

FIG. 1.

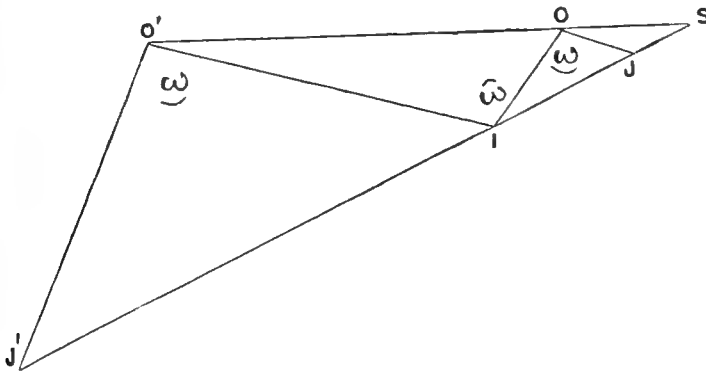

Let I be brought to J by the twist ω round O ; then it must be brought back by the stretch from S . Thus it is clear that for a given twist and stretch the triangle OIS is of constant species.

Similarly if I be brought by the stretch first to J' it must be brought back by the rotation about O' .

It is at once seen that (1) S, O, O' are collinear, (2) SO' is the stretched position of SO , (3) IO, IO' are equally inclined to SI and are to each other as $SO : SO'$, so that O' is the position of O after the first twist and stretch.

If we start again with two symmetrically similar figures, one may be transformed into the other by a half turn about any axis in the plane, together with a twist and stretch from the proper centre, and the relation between the axis and the centre might be worth investigation. For the present paper, however, it suffices to observe that by taking an axis parallel to the bisector of the angle between two corresponding sides the twist may be avoided; it is not difficult to show that the locus of the stretch-centres for axes parallel to this axis is a straight line at right angles to it. In the case in which the stretch-centre is on the half-turn axis, the locus and axis form two remarkable straight lines which should bear the name of the illustrious mathematician Bellavitis who first noticed them.

FIG. 2.

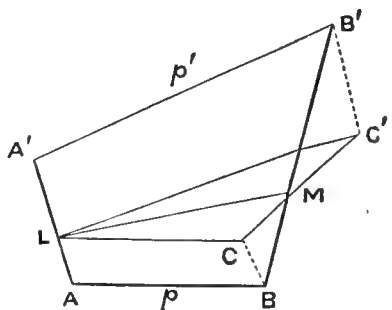

Their existence may be briefly demonstrated, thus :

Let $AB = p, A'B' = p'$ be corresponding sides, and let AA', BB' be divided at L, M so that $AL : LA' = p : p' = BM : MB'$. Then LM shall be equally inclined to p, p' .

Complete the parallelograms $BALC, B'A'LC'$. Then, since $BC : B'C' = p : p' = BM : MB', CC'$ passes through M ; and $CM : MC' = p : p' = LC : L'C'$; therefore LM is equally inclined to $LC, L'C'$.

A similar demonstration holds if L_1, M_1 be the points dividing AA', BB' externally in the ratio $p : p'$. The lines LM, L_1M_1 intersecting at right angles at S (see fig. 3), and $\{A'LAL_1\}$ being harmonic, we see that SL bisects the angle ASA' and similarly BSB' . And $SA : SA' = AL : LA' = p : p'$. Thus AB may be transformed into $A'B'$ by a half-turn round LM with a stretch from S .

Again, AB may be otherwise transformed into $A'B'$, thus: let the circum-circles EAA', EBB' (E being the intersection of $AB, A'B'$) meet in I ; then $IAB, IA'B'$ are directly similar and a twist round and stretch from I suffices. From this property I , as well as S , lies on the circles described on LL_1, MM_1 as diameters.

Now let ML meet AB in $O, A'B'$ in O' . Then AB may be changed into $A'B'$ by a twist round O followed by a stretch from S , or by a stretch from S followed by a twist round O' , the twist in all cases being the angle $AEA' = \omega$. Hence, angle $OIO' = \omega$, and E, O, I, O' are concyclic; hence, EI bisects angle OIO' , and, from previous reasoning IS bisects the same angle externally; therefore EIS is a right angle.

Again, let L_1M_1 meet $AB, A'B'$ at Q, Q' . Then Q comes to Q' on the half-turn and stretch. Whence $QIQ' = \omega$, and E, Q', Q, I are concyclic. Also $QIS = \frac{1}{2}QIQ' = \frac{1}{2}\omega = QOS$. Therefore I lies on the circle OSQ , i.e., on OQ as diameter; and similarly on the circle $O'SQ'$.

FIG. 3.

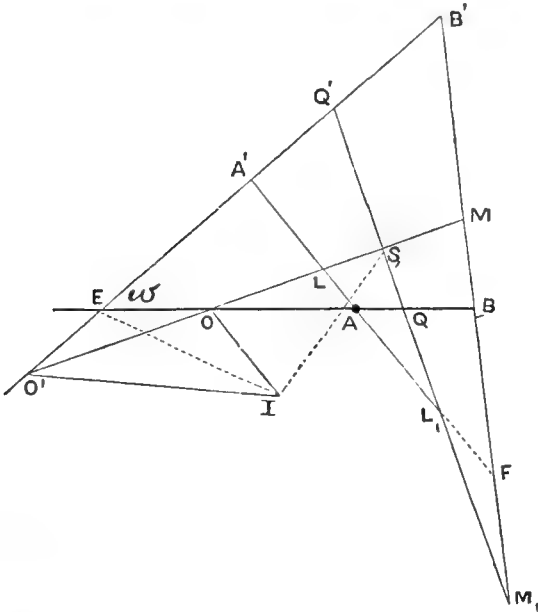

A particular case is worthy of notice. If A, B, B', A' be concyclic the point S coincides with the intersection of $AB', A'B$, and it is then also the centre for the transformation of AA' into BB' . Then the angle SIF is a right angle, and I is the foot of the perpendicular from S on EF .

2. On Recurring Decimals and Fermat's Theorem.

By Professor R. W. GENESE, M.A.

Let 9_r denote the number formed of r digits, each being 9; and let 9_m be the smallest such number exactly divisible by a given prime number $p > 5$. Then $\frac{1}{p}$

gives rise to m recurring decimals, and any proper fraction with p for denominator must give the same number of decimals. For if, say, $\frac{a}{p}$ gave fewer places, it could be converted into a fraction with denominator of form 9_r , r being less than m , in which case p would divide 9_r , contrary to the hypothesis above.

Now in the conversion of $\frac{a}{p}$ into m recurring decimals there are m different remainders, say $b, c, d \dots a$; then the m fractions $\frac{b}{p}, \frac{c}{p}$, &c., give rise to the same cycle of digits. Thus the fractions $\frac{1}{p}, \frac{2}{p}, \frac{3}{p}$, &c., $\frac{p-1}{p}$ must be capable of arrangement in groups, m at a time, giving the same cycle:

$$\begin{aligned} \text{i.e. } m \text{ is a factor of } p-1 \\ \therefore 9_m \quad \text{''} \quad \text{''} \quad 9_{p-1} \\ \therefore p \quad \text{''} \quad \text{''} \quad 9_{p-1} \\ \text{i.e. of } 10^{p-1} - 1. \end{aligned}$$

Repeating the reasoning in a different scale of notation we have Fermat's theorem: the radix must clearly be prime to p , otherwise the fraction $\frac{1}{p}$ would give rise to pure as well as recurring decimals.

In connection with recurring decimals a curious property may be noticed of the equivalent to $\frac{1}{81}$, viz., $\cdot 012345679$ (nine different digits out of the usual ten), the 8 being absent. If we multiply this by a number less than 81, and prime to it, a similar result holds, the absent digit being the defect of the multiplier from the next greater multiple of 9, thus:

$$\begin{aligned} \frac{8}{81} &= \cdot 09876543\dot{2}, 1 \text{ absent} \\ \frac{4}{81} &= \cdot 04938271\dot{6}, 5 \quad \text{''} \\ \frac{7}{81} &= \cdot 08641975\dot{3}, 2 \quad \text{''} \\ \frac{28}{81} &= \cdot 34567901\dot{2}, 8 \quad \text{''} \quad = 4 \times 9 - 28. \end{aligned}$$

Hence a new, so-called, recreation. If the number 012345679 be multiplied by a single digit, and the digits only of the product be given in any order, the multiplier can be detected.

3. *On the Relations between Orbits, Catenaries, and Curved Rays.*
By Professor J. D. EVERETT, F.R.S.

If the same curve be regarded—

I. As the orbit of a particle under a force of intensity P directed to a fixed point.

II. As the curve assumed by a string under a force of magnitude F per unit length, opposite in direction to P .

III. As the path of a curved ray of light in a medium in which the absolute index of refraction μ is a function of distance from the common centre of the forces P and F .

Then, in passing from point to point of the curve, the ratio of P to F will vary directly as μ .

In fact, from the well-known formulæ

$$vp = h, Tp = C, \mu p = A, P = \frac{h^2}{p^3} \frac{dp}{dr}$$

(in which p denotes the perpendicular from the common centre on the tangent, v the velocity in the orbit, T the tension of the string, and $h, C,$ and A constants), together with the additional formula (proved in my edition of ‘Todhunter’s Statics’).

$$F = \frac{C}{p^2} \frac{dp}{dr},$$

we have

$$\frac{P}{F} \propto \frac{1}{p} \propto v \propto T \propto \mu.$$

If, instead of supposing the three curves identical, we suppose them similar and similarly placed with respect to the centres in question, the above results will obviously remain true.

Further, instead of supposing the forces central, and the index a function of distance from centre, let us make the more general supposition that, at corresponding points of the orbit and the string, the forces P and F are parallel and opposite, and that, at the corresponding point of the curved ray, the direction of most rapid increase of μ is the same as the direction of P ; then we have the following equations, in which ϕ denotes the angle between the direction of F and the tangent drawn in the direction of increasing s .

$$P \cos \phi = - \frac{d}{ds} \frac{v^2}{2} \dots \dots \dots (1) \quad P \sin \phi = \frac{v^2}{\rho} \dots \dots \dots (2)$$

$$F \cos \phi = - \frac{dT}{ds} \dots \dots \dots (3) \quad F \sin \phi = \frac{T}{\rho} \dots \dots \dots (4)$$

$$\frac{d \log \mu}{dr} \cos \phi = \frac{d \log \mu}{ds} \dots \dots \dots (5) \quad - \frac{d \log \mu}{dr} \sin \phi = \frac{1}{\rho} \dots \dots \dots (6)$$

$$\text{From (1) and (2), } \cot \phi = - \rho \frac{d \log v}{ds};$$

$$\text{,, (3) and (4), } \cot \phi = - \rho \frac{d \log T}{ds};$$

$$\text{,, (5) and (6), } \cot \phi = - \rho \frac{d \log \mu}{ds}.$$

Equating the three values of $\cot \phi$, we have

$$\frac{d \log v}{ds} = \frac{d \log T}{ds} = \frac{d \log \mu}{ds}.$$

Hence the logarithms of v, T and μ change by equal amounts; that is,

$$v \propto T \propto \mu.$$

$$\text{From (2) and (4), } \frac{P}{F} = \frac{v^2}{T}. \text{ But } \frac{v}{T} \text{ is constant;}$$

$$\therefore \frac{P}{F} \propto v \propto T \propto \mu.$$

The proportionality of v, T and μ can be proved without the calculus by regarding the three curves as the limit of three similar polygons.

In the first polygon a particle moves along the sides under no forces, but is acted on by impulsive forces at the corners.

The second polygon is a polygon of string kept tight by forces applied at the corners, the lines of action of these applied forces being parallel to the impulses in the first polygon, but opposite to them in direction.

The third polygon is the path of a ray which undergoes refraction at each corner by passing out of one uniform medium into another uniform medium; and

the normals to the surfaces of junction of the media are parallel to the impulses in the first polygon or to the applied forces in the second.

The angles of the three polygons are thus similarly divided by the lines which are drawn one at each angle. Call the two parts into which one of the angles is divided α and α' , one being acute and the other obtuse.

In the first polygon, since the component velocity perpendicular to the impulse remains unchanged, we have

$$v \sin \alpha = v' \sin \alpha',$$

v and v' denoting the velocities before and after an impulse.

In the second polygon, since the applied force at any corner is balanced by the two tensions T, T' of the two portions of string which meet there, we have

$$T \sin \alpha = T' \sin \alpha'.$$

In the third polygon the law of sines in refraction gives

$$\mu \sin \alpha = \mu' \sin \alpha'.$$

Hence we have

$$\frac{v}{v'} = \frac{T}{T'} = \frac{\mu}{\mu'} = \frac{\sin \alpha'}{\sin \alpha}.$$

The changes in $v, T,$ and μ are therefore proportional when we pass from any side to the next.

4. On the Stretching of Liquids.

By Professor A. M. WORTHINGTON, *M.A., F.R.A.S.*

The author described the three methods that have been employed by previous observers to subject a liquid to tension. These are:—

- (1) *The barometer tube method*, by which Professor Osborne Reynolds had succeeded in subjecting mercury to a tension of five or six atmospheres due to its own weight.
- (2) *The centrifugal method*, devised by the same observer, and by means of which he had subjected water to a pull of about five atmospheres (72.5 lbs. per square inch); while the author had succeeded in reaching with alcohol a tension of 7.9 atmospheres, or 116 lbs. per square inch, and with strong sulphuric acid a tension of 11.8 atmospheres, or 173.4 lbs. per square inch.
- (3) *The method of cooling*, discovered by Berthelot, and described by him, 'Ann. de Chimie' xxx. (1850): Sur la dilatation forcée des liquides.

In this method a liquid deprived of air by boiling nearly fills a very strong closed glass tube. On slight heating it expands and fills the whole tube, compressing the residual air, which dissolves under the increasing pressure and finally disappears. The liquid may now be greatly cooled, but remains extended, filling the whole tube, of which at last it lets go its hold with a violent 'click,' and the bubble of residual air and vapour reappears.

By this means Berthelot succeeded in stretching water by about $\frac{1}{20}$ of its whole volume, alcohol by about $\frac{1}{93}$, and ether by about $\frac{1}{69}$; and the author learns that Berthelot's experiments were repeated with even higher results by Mr. Creelman in Professor Tait's laboratory in Edinburgh.

Reasons were given for believing that the rupture is in no case due to the limit of the cohesion having been reached, but rather to the imperfect adhesion of the liquid to the walls of the vessel, owing to the presence of air, either in a film or in microscopic cavities. The effect of long boiling is to get rid of this adherent air, and the apparent increase in the cohesion is to be attributed rather to this cause than the liberation of air from solution.

The author then described the form of apparatus arrived at after many trials, by which the tension of the liquid and the extension produced by it could be simultaneously measured.

The tension was ascertained from the enlargement due to the pull of the liquid on the ellipsoidal bulb of a thermometer sealed into the containing vessel.

By means of this instrument (exhibited), for the construction of which the author had to thank his friend Mr. Charles F. Casella, he had already in a first trial succeeded in subjecting alcohol to a pull of fifteen atmospheres, or 223 lbs. to the square inch, with an extension that appeared to be about $\frac{1}{200}$ of the whole volume, or about three times what would have been expected had the coefficient of extensibility been the same as that of compressibility. This result, however, which depends on a single measure, when the apparatus, unfortunately, broke under the great strain upon it, requires further confirmation.

Measures of this kind afford an experimental determination of points in the unstable portion of the isothermal curve of a substance passing from liquid into vapour, which portion lies, as the author pointed out in a paper on 'The Surface Forces in Fluids,'¹ below the line of zero pressure, and not as indicated in Andrews' diagram, reproduced in Maxwell's 'Heat.'

The experimental proof that tensional stress within a mass of liquid is necessarily accompanied by a corresponding strain, is, in the author's opinion, an important point in the theory of surface tension, since it shows that the diminution of density or extension of the surface liquid, which can be shown to be a necessity of the equilibrium at the surface, is sufficient to account for the surface being a seat of energy. It becomes, in fact, unnecessary to ascribe to the energy any other form than that in which it exists in stretched matter.

5. *A new Sphere Planimeter.*² By Professor HELE SHAW, *M.Inst.C.E.*

The want has long been felt of some instrument for measuring areas which, while possessing the accuracy of the Amsler planimeter, would have the great advantage of giving a reading by means of a pointer moving over a dial face of such magnitude as to obviate the use of a vernier. The author, four years ago, brought forward a class of sphere integrator, under the name of sphere and roller mechanism, in which, by employing the rolling of two surfaces in contact with each other, instead of the combined slipping and rolling of the Amsler type of instrument, a satisfactory solution of the problem appeared to have been attained. Various forms of these integrators were thoroughly tested, but with unsatisfactory results, inasmuch as they always gave a slight error of variable amount, and it has since been found by means of specially designed experiments that the universally accepted principle of rolling contact relied upon in their design did not hold in practice under the particular conditions in which it was there applied. The sphere planimeter which was exhibited for the first time really belongs to the Amsler class of integrator, though resembling in external appearance the author's previous instrument above referred to, since one essential feature of it is a sphere.

The instrument consists of a bent bar, one end of which forms the fixed centre, upon the surface containing the area to be measured. The other end is jointed to a frame which guides a sphere by means of four rollers, the centres of these rollers being carried upon small rigid brackets. The frame which supports the dial is continued by means of a bar, at the end of which is a pointer which is passed round the perimeter of the figure to be integrated. Upon the spheres rests a small measuring roller or integrating wheel, the axis of which carries the recording index and a pinion.

This pinion gears with a wheel ten times as large, working on the back of the dial, by means of which higher readings are recorded. Undue pressure between the measuring roller and the sphere is prevented by means of the roller which is attached to the bar.

The proof of the theory of the action of the instrument was then given, and the author concluded by pointing out that the action of the sphere is simply to transmit the motion of the roller, and therefore so long as no slipping takes place on the surface of the paper beneath the record is given with the same degree of accuracy

¹ *Phil. Mag.*

² Published *in extenso*, *Engineering*, Sept. 21.

as with the Amsler planimeter, but with the important advantage of a large dial reading, there being only the simple difference that the pointer must in the sphere planimeter be moved in the opposite direction round the perimeter of the figure to be measured.

One feature of interest in the instrument is the use of the four guiding rollers, which are in contact with the great circle of the sphere formed by the intersection of the horizontal plane through its centre, and thus allow the sphere to turn without resistance *in any direction*. To this end the rollers are carried in brackets, and do not exert any pressure upon the sphere, but just keep it in position in the frame. They are pivoted on very fine centres, and they are of steel with polished edges, so that even when the sphere is moving in a direction causing its axis of rotation to pass through one of these edges, the motion of the sphere is not appreciably retarded by frictional resistance. Hence the planimeter is found to be correct up to the limit of accuracy to which records can be read on the dial face.

6. *On Composition of Sensation and Notion of Space.*¹ By L. DE LA RIVE.

Notion of space is admitted to result from the association of our muscular activity with the perception of visual or tactile sensation. On the other hand, sensation of colour is a function of three variables, and muscular sensation is supposed to be also a function of three variables. Then the three dimensions of space are subjective.

A theoretical law of composition or synthesis of sensation is found to be the law of composition of forces. The principle applied to is—*consciousness of two simultaneous sensations is consciousness of the ratio of their intensities*, of which the well-known law of Fechner is a consequence. The differential equation of cosine is obtained by considering the variation of intensity, which, being eventually positive or negative, gives rise to a quadruple field of specific variation continuous with itself. The repetition numbered by 2^2 for the double synthesis is by 2^3 for the treble in the case of the eight solid right angles composing the whole ternary specific field, and would be 2^4 for a hypothetical quadruple synthesis.

The muscular sense is supposed to have its nervous organ composed of all the nervous fibres of an organ of mobility (the ocular globe, the arm) and the corresponding nervous centre. According to the law of composition, the exercise of muscular sense produces the notion of *subjective spherical space* thus defined; *the notion of the field of straight directions from a centre together with the notion of a length from the centre*. Hence the assertion that this notion is the muscular sense has in its favour: First, each sense gives us a peculiar notion; muscular sense is not apparent as others because the quality it teaches to endow the external world with is looked at as an absolute quality. Secondly, the fact of the blind possessing the notion of geometrical space with the same thoroughness as the seeing shows that the notion is neither visual nor tactile, but muscular.

Association of a permanent cause of external sensation, or entity, with the species in the ternary subjective field which, when acting, leaves undisturbed the external perception is the localisation of the cause. Hence the formation of *monocular space*. Any muscular sensation of the ocular globe is a rotation round an axis, and the rotation round the direction of the luminous ray leaves undisturbed the direct vision. A retinian angular field is produced by a similar process.

A process of formation of *tactile space* is analysed in the case of a schematical arm, with the humerus acting in the same manner as the ocular globe, and the elbow giving by the variable angle of its articulation a variable radius to the spherical surface described by the hand. The passage from a tactile point to another with a minimum of sensation is given by a constant species in the ternary field. Hence the geometrical definition of the straight line. Definition of parallels is given by assimilating any tactile point to the centre. The hypothesis of subjectivity of geometrical space may perhaps call the attention.

¹ Published *in extenso* in the *Mémoires de la Société de Physique et d'Histoire Naturelle de Genève*, 1888.

MONDAY, SEPTEMBER 10.

The following Reports and Papers were read :—

1. *Third Report of the Committee for inviting Designs for a good Differential Gravity Meter.*—See Reports, p. 72.

2. *Fourth Report of the Committee for considering the best means of Comparing and Reducing Magnetic Observations.*—See Reports, p. 28.

3. *Third Report of the Committee appointed to co-operate with the Scottish Meteorological Society in making Meteorological Observations on Ben Nevis.*—See Reports, p. 49.

4. *Modern Views about Hurricanes, as compared with the Older Theories.*
By HON. RALPH ABERCROMBY, F.R.Met.Soc.

The old conception of a hurricane was that of a circular-shaped eddy, round which the wind blew in circles; the whole system was not supposed to be connected with any surrounding trade-wind or monsoon, and the idea that a hurricane changes its shape, as well as its depth and intensity during its progress, was never thought of.

Modern research shows that a hurricane is really an oval eddy, and that the vortex, or centre of the wind rotation, is not in the geometrical centre of the oval, but usually nearer one edge or other of the depression. The former is a very simple, the latter a very difficult conception; nevertheless, such are the facts, as the author has proved by an examination of hurricanes on 60 different days.

The wind blows as a spiral of variable incurvature round the vortex, not round the centre of the oval. The general sense of the rotation is counter-clockwise in the Northern, clockwise in the Southern Hemisphere; but the amount of incurvature varies in different parts of the oval for a number of reasons. As a rule, in all hurricanes, the incurvature is less in front than in rear of the vortex.

A hurricane is also always changing its shape, so that the oval lies sometimes in one way, and sometimes quite in a different direction; while sometimes the vortex is displaced towards one side of the oval one day and towards quite another side on the next.

The path of the hurricane is not in a regular line, for the vortex sways about, and sometimes even describes a loop.

For all these reasons, no rule is possible for determining absolutely the bearing of the vortex by observations on board a single ship; whereas it used to be stated positively that facing the wind the vortex bore 8 points—at right angles—to the right in the Northern, and to the left in the Southern Hemisphere.

We can only say now that, when fairly within the storm-field and facing the wind, the vortex will be to the right and a little to the rear; that is, from 8 to 12 points to the right of the wind in the Northern Hemisphere; and to the left and a little to the rear; that is, from 8 to 12 points to the left of the wind in the Southern Hemisphere. If the wind blew exactly in a circle round a circular hurricane the vortex would always bear 8 points to the right or left according to the Hemisphere, and the rule to take 8 to 12 points is simply allowing for the effects of variable incurvature.

The above rule does very well for a first approximation to the bearing of the vortex, but greater precision can be attained in certain circumstances. If the condition indicate that a ship is nearly in front of the vortex, the bearing of the vortex will probably not be much more than 8 points to the right or left, according to the Hemisphere, because, as before mentioned, the incurvature is very small in

front of a hurricane. Great care must be taken not to apply this rule to an increasing trade with a falling barometer, as will be explained hereafter.

In the rear of a hurricane, on the contrary, the vortex may bear 12 or even more points to the right or left of the wind, because the wind is very much incurved in that part of a hurricane. A ship should therefore always then lie-to till the barometer begins to rise and the weather to improve, otherwise she will probably run right into the vortex. She might easily scud 10 knots, while the hurricane might not be advancing more than 5 miles an hour, so that it is very easy to catch up the vortex. The discovery of this great incurvature is one of the most important modern developments of the subject.

It used to be thought that if the wind increased in force, without changing in direction, with a falling barometer, a ship must necessarily be in the line of progression of the vortex, and that she should run at once. This was owing to the idea that a hurricane was an isolated disturbance.

Now we know that if it is only the usual trade-wind which increases without changing in direction, and with a falling barometer, a ship should lie-to till the mercury has fallen at least 6-10ths of an inch before she runs as a last resource. Modern research has proved that a hurricane is usually imbedded in some prevailing trade or monsoon, and that there is therefore a belt of intensified trade-wind outside the true storm-field. This belt is always on the side of the hurricane furthest from the equator. A ship in this belt experiences an increasing trade without change of direction, and with a falling barometer, though she may be far away from the line of progression of the vortex. She would equally experience an increasing and unchanging wind with a falling barometer, if she were in the line of progression; but as there is no means of knowing whether she is in the line of progression, or only in the belt of intensified trade, the empirical rule says: 'Lie-to till the mercury has fallen 6-10ths of an inch before beginning to run.'

The old rules for finding which semicircle of a hurricane a ship may be in, and the old rules for heaving-to in either Hemisphere, are all proved to be both true and valuable by modern research. These rules remain as follows: Facing the wind in both Hemispheres, if the wind changes by the right, the ship is in the right-hand semicircle, and she should heave-to on the starboard tack. If the wind changes by the left, she is in the left semicircle, and should heave-to on the port tack. If circumstances compel her to run, she should keep the wind well on the starboard quarter in the North Hemisphere, and well on the port quarter in the South Hemisphere.

It is much to be regretted that the examination papers of the Board of Trade for master and mates are painfully behind the modern standards of knowledge, and that in these matters the Germans and other nations are now ahead of England. The whole knowledge which is required in our merchant service is contained in six questions, and a candidate is expected to say that the centre bears 8 points, or perhaps a little more, from the direction of the wind, while no notice is taken either of the small incurvature in front or of the great incurvature in rear, or of the belt of intensified trade, where the usual indications of being exactly in front of the vortex fail.

No one should blame the master of a ship for not following the established rules without the closest investigation, for, as Piddington says, 'absolute rules are all nonsense,' and much depends on the capabilities of a ship, and on the ever-varying conditions of a heavy cross sea.

-
5. *Report of the Committee appointed to arrange an investigation of the Seasonal Variations of Temperature in Lakes, Rivers, and Estuaries in various parts of the United Kingdom.*—See Reports, p. 326.
-

6. *On the Temperature of some Scottish Rivers.*

By HUGH ROBERT MILL, D.Sc., F.R.S.E.

Observations were carried on in a number of rivers in different parts of Scotland, with the result that from January to July 1888 the variations of temperature were practically identical; all the curves showing a series of well-marked maxima and minima exactly coincident in date and approximately equal in amplitude, although the actual temperature varied for each stream. The maxima appear to characterise periods of high air-temperature and slight rainfall over Scotland generally, the minima periods of low air-temperature and considerable precipitation. The temperature of the water in the Aray, the one stream of the west coast examined, was always lower than that of the air; but over the east coast rivers the air-temperature was more extreme, and frequently fell below that of the water.

7. *On the recent Magnetic Survey of Japan.*

By PROFESSOR CARGILL G. KNOTT, D.Sc., F.R.S.E.

This survey was carried out during the summer months of 1887, the expenses of the expedition being wholly borne by the Imperial University.

The object was to obtain, within as short a time as possible, a general survey of the whole of Japan. The work was accomplished by two parties, known as the Northern and Southern Parties. The Northern party was under my own charge, and its route may be roughly described as a cycle of that part of Japan which lies to the east and north of a line drawn from Fujiyama north-west to the peninsula of Noto. Mr. Tanakadate took charge of the Southern party, whose stations all lay to the west of the line just described. The Northern party took observations at four stations in the Island of Ezo, and the Southern party made a trip to Korea and obtained a series of valuable measurements in the neighbourhood of Pusan.

The Northern party were equipped with a complete set of instruments of the usual Kew pattern—the dip circle used being one which was kindly loaned by the Kew Committee of the Royal Society. The chronometer was checked daily by sextant observations. The Southern party used Mr. Tanakadate's own form of electro-magnetic declinometer (described 'Proc. R. S. E.' 1884-6), which was also fitted up for the measurement of the horizontal force by the ordinary method of sines. The theodolite, whose base was an essential part of Mr. Tanakadate's declinometer, served in its usual form for taking the transits and altitudes necessary for rating the chronometer and finding the true meridian.

Generally speaking, the magnetic features of Japan present great irregularities, a fact which the highly volcanic condition of the country would lead us to expect. The south-western portion of the main island, with the adjacent islands fringing the Inland Sea, presents fairly uniform magnetic features. The regions where the greatest disturbances exist are (1) the great central mountain region to the north and north-west of Fujiyama, and (2) the region included between the 38th and 40th parallels of latitude.

The general characteristics of the iso-magnetic lines corresponding to the observations made are as follows:—The lines of equal dip, of equal horizontal force, and of equal total force are approximately straight, while the lines of equal declination are distinctly parabolic or hyperbolic, approximating very closely to the general form of the main island. Out of the eighty-one stations at which complete observations were carried out, a selection of fifty was made; and the values of the magnetic elements at these selected stations were combined by the method of least squares according to the usual mode. Linear expressions in latitude and longitude were assumed for the dip, horizontal force, and total force; and, for the particular case of the declination, a term was added in the square of the longitude. The latitude and longitude co-ordinates were referred to the mean station (36° 30' N. lat.; 137° 9' E. long.).

The mean formulæ so obtained are as follows:— ϕ and λ being the latitude and

longitude co-ordinates, referred to the mean station, and measured in minutes of arc; and θ , H , F , δ being respectively the dip, the horizontal force, the total force, and the declination.

$$\begin{aligned}\theta &= 50^\circ 28' \cdot 6 + (1 \cdot 141 \phi - \cdot 1556 \lambda)' \\ H &= \cdot 29482 - \cdot 0000617 \phi - \cdot 0000117 \lambda \\ F &= \cdot 46407 + 000094 \phi - \cdot 000045 \lambda \\ \delta &= 4^\circ 53' \cdot 3 + (\cdot 241 \phi - \cdot 109 \lambda - \cdot 000231 \lambda^2)'\end{aligned}$$

The horizontal and total forces are measured in C.G.S. electro-magnetic units, and the declination is west.

From these expressions we may find the quantities u and r for the mean station:— u being the angle between a given iso-magnetic line drawn eastward, and the longitude line drawn northward, and r being the rate of change of the given element per kilometre of distance measured in a direction perpendicular to the iso-magnetic line. The values of u and r for the several quantities are given in the subjoined table, together with the value of the element at the mean station:—

	Mean Value	u	r
Dip	50° 28' · 6	80° 23' · 6	0' · 626
Horizontal force	· 29484	103° 14' · 9	· 000034
Total force	· 46407	59° 16' · 5	· 000059
Declination	4° 53' · 3	29° 19' · 6	0' · 149

Regarding the secular changes in the elements very little can be definitely said. If we admit the accuracy of Ino's observation of eighty years ago, that the needle pointed true geographical north at that time, then the mean secular change during these eighty years will be about 3'·7 per annum. Gauss's numbers give 1° 46' W. as the value of the declination at the mean station of the present survey. Taking fifty years as the interval between Gauss's epoch and now, we get again about 3'·7 as the mean annual rate of change of the declination in Japan. Recent observations, however, do not bear out this conclusion. Thus, if we compare (as far as comparison is possible) the observations made in the summer of 1887 with those made during the autumn and winter months of 1882 and 1883 by Messrs. Sekino and Kodari at their numerous but not very well distributed stations, we find no evidence of any well-marked secular change of the declination during the interval in question. There are indications, however, of changes in the other elements, namely, an average decrease of 2' per annum in the dip, an increase of nearly 0·1 per cent. in the horizontal force, and a decrease of fully 0·1 per cent. in the total force.

The full details of the survey are given in the second volume of the 'Journal of the College of Science, Imperial University, Japan.'

8. On Reading Electrically Meteorological Instruments distant from the Observer.¹ By J. JOLY, M.A., B.E.

An instrument placed in a distant observatory may on this system be controlled by three wires communicating with the home station. The principle on which a reading is obtained is, briefly, as follows. The instrument is in circuit with a rheotome at the home station. One contact on the rheotome corresponds to a movement over a definite distance of a travelling limb on the distant instrument, the limb being actuated by an electro-magnet. In the case of the barometer or thermometer, for example, the travelling limb carries a metallic pin through a definite distance at each make, starting from a known zero position, till finally the pin makes contact with the mercury in the instrument, when a needle in the home station is deflected. The position or level of the mercury is thus easily computed from the reading of the rheotome or number of interruptions effected. The

¹ *Proc. Royal Dublin Society*, vol. iv. new series, p. 158.

mechanism to be attached to each instrument is very simple. A thermometer fitted with it gives satisfactory results.

An arrangement whereby an indefinite number of instruments may be controlled by one light cable of three wires is proposed. It has not, however, been practically tested.

9. *On the Mechanical Conditions of a Swarm of Meteorites, and on Theories of Cosmogony.* By Professor G. H. DARWIN, F.R.S.

10. *On some accurate Charts of Kew Corrections for Mercury Thermometers.* By W. N. SHAW, M.A.

An English thermometer (Hicks, No. 79915) graduated in the stem to $0^{\circ} \cdot 2$ C. was compared at Kew in the ordinary way in December 1880 to $0^{\circ} \cdot 1$ C. at each fifth degree between 0° and 35° . In January 1882, through the kindness of Mr. G. M. Whipple, Superintendent of the Kew Observatory, it was compared at each degree and the readings were estimated to the hundredth of a degree. A similar comparison was carried out in the same way in April 1888. The errors from true (Kew standard) temperature are plotted and the points joined to facilitate interpolation. For the two sets of more accurate comparisons the curves are smoothed within the limits of possible errors of observation. These two curves are drawn on the same sheet with the plotting of the original comparison and the juxtaposition makes it easy to compare the curves. During the interval from January 1882 to April 1888 the zero had risen $0^{\circ} \cdot 1$ C., and, on the usual assumption, the two corresponding curves should run parallel to each other at a distance representing that difference of temperature. The general similarity of the two curves is very fairly exhibited in the diagram, and affords evidence of accuracy and trustworthiness of the comparisons upon which Mr. Whipple and his staff are to be congratulated. A slight divergence from parallelism is, however, clear, as the curves get gradually wider apart as the temperature rises, the difference at 30° being $0^{\circ} \cdot 17$ C., whereas at 2° it is $0^{\circ} \cdot 1$ C. The original rougher comparison epitomises the more accurate ones in a very striking manner.

Similar results follow from charts for two other English thermometers by Hicks and for two German thermometers by Geissler. But the divergence from parallelism is not shown in the charts of two thermometers by Negretti, nor of two by Casella, the curves in these four cases running very nearly parallel, although there were changes of zero of $0^{\circ} \cdot 35$ F. and $0^{\circ} \cdot 2$ F. respectively. In the case of the German thermometers there was no appreciable change of zero in the interval. It would appear that the divergence from parallelism is due to the nature of the glass employed in the construction of the instruments.

11. *On an Apparatus for determining Temperature by the Variation of Electrical Resistance.* By W. N. SHAW, M.A.

This apparatus is designed to measure to a high degree of accuracy the mean temperature of a large burette in a water-bath. A Wheatstone quadrilateral is formed by joining the ends of a platinum wire about 30 inches long (resistance about 11 ohms) to those of a platinum-silver wire BCDA. The platinum wire is bare and the alloy is silk covered, $\cdot 007$ inch in diameter; its resistance is 13.5 ohms per metre. At A, C and B, D respectively battery and galvanometer wires are soldered; the lengths of the wires are so arranged that for some temperature near 15° C. there is a perfect balance indicated in the bridge. The wires are laid in parallel lengths and disposed upon a strip of pure india-rubber, about three-quarters of an inch wide, in the manner indicated in the figure. The india-rubber is painted with a solution of india-rubber in benzene and a second strip, similarly painted, is laid down upon it and the wires are thus completely enclosed; the strip contains 18 inches at each end beyond the junctions of leading wires, so that

the whole length of strip is about $5\frac{1}{2}$ feet, and from the two ends the galvanometer and battery leads respectively project.

A very flexible quadrilateral is thus obtained in the form of a ribbon, which can be wrapped round any apparatus whose temperature is required.

Since the two wires, which together form the quadrilateral, have different temperature coefficients, there is no balance except for one particular temperature; but the balance can be restored by shunting either the wire AB or the arm BC by connecting a resistance-box in a suitable manner with the projecting leads. The resistance of the shunt required to produce a balance can be employed to indicate the temperature when the instrument has once been graduated. The graduation of the apparatus exhibited was made for the author at the Cavendish Laboratory

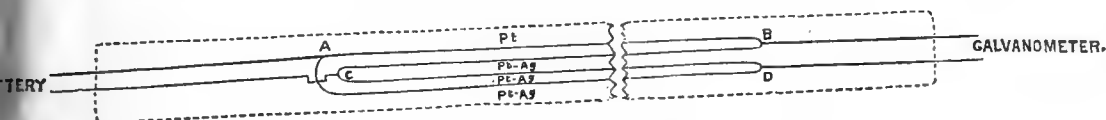

by Mr. J. W. Capstick, demonstrator at University College, Dundee. The ribbon was wound round a metal cylinder, and the whole immersed in ice or water, and a number of readings of the shunt taken at different temperatures between 0° and 28° C. The conductivity of the shunt at different temperatures is very nearly represented by a straight line cutting the zero line at the neutral point $15\cdot16^{\circ}$ C. The maximum divergence from the straight line corresponds to the temperature difference of a fifth of a degree between 0° and $15\cdot16^{\circ}$ and to about a tenth of a degree between $15\cdot16^{\circ}$ and 28° . In the graduation the temperatures are referred to the Kew standard by means of mercury thermometers previously compared at Kew. The temperature can be read with a suitable galvanometer to about the 500th of a degree.

12. *Fourth Report of the Committee on Standards of Light.*
See Reports, p. 29.

TUESDAY, SEPTEMBER 11.

The following Papers and Report were read:—

1. *Joint Discussion with Section G on Lightning-conductors.*

The PRESIDENT called upon Mr. W. H. Preece, F.R.S., and Professor Oliver J. Lodge, F.R.S., to open a joint discussion with Section G on Lightning-conductors.

Mr. PREECE said it was a most remarkable thing that if they wanted to know much about atmospheric electricity and its effects they had to go back to the works of Benjamin Franklin 140 years ago. Scarcely anything had been done in this direction since then. Up to the year 1881 there was not even a code of rules extant in this United Kingdom to guide people in protecting their buildings from the destructive effects of atmospheric electricity. It was proposed in 1878 to establish a conference of various societies to discuss the effects of atmospheric electricity and to form a code of rules for the erection of lightning-conductors.

At the York meeting of the Association in 1881 a report was adopted; it was then published, and was one of the most admirable works that had ever been collated on atmospheric electricity and its effects.

Now that report was divided into three parts. In the first part was discussed the purpose which a lightning-conductor was intended to serve. In the second part there was a statement of those features in the construction and erection of the lightning-conductors respecting which there had been, or was, a difference of opinion, and the final decision of the Conference thereupon. In the third part

there was drawn up a code of rules for the guidance of those who erected these conductors. He might say that that report itself was most decisive and it was most important. He could not help reading out to them, because it would form the basis of a good deal that would be said that day, how they defined a lightning-conductor:—‘A lightning-conductor fulfils two functions. It facilitates the discharge of the electricity to the earth, so as to carry it off harmlessly, and it tends to prevent disruptive discharge by silently neutralising the conditions which determine such discharges in the neighbourhood of the conductor. To effect the first object a lightning-conductor should offer a line of discharge more nearly perfect and more accessible than any other offered by the materials or contents of the edifice we wish to protect. To effect the second object the conductor should be surmounted by a point or points; fine points and flames have the property of slowly and silently dissipating the electrical charges; they in fact act as safety-valves. If all these conditions be fulfilled, if the points be high enough to be the most salient features of the building, no matter from what direction the storm-cloud may come, be of ample dimensions and in thoroughly perfect electrical connection with the earth, the edifice with all that it contains will be safe, and the conductor might even be surrounded by gunpowder in the heaviest storm without risk of danger. All accidents may be said to be due to a neglect of these simple elementary principles. The most frequent sources of failure are conductors deficient either in number, height, or conductivity, bad points or bad earth connections.’ The paragraph ended with this most decisive and clear assertion, an assertion that he was there to defend, and that was that there was ‘no authentic case on record where a properly constructed conductor failed to do its duty.’

Now here they had defined the functions of a conductor, and lest it should be thought that they neglected the teachings of modern theorists he thought it was only right to point out that they asserted in the Report of the Lightning-rod Conference, ‘We will assume the conductivity of equal lengths and weights of iron in the case of steady currents of electricity’; and further on they asserted ‘that the suddenness of lightning discharge modifies the conductivity.’ Now that report, he might say, was signed by Professor Grylls Adams, Professor Ayrton, Latimer Clark, E. E. Dymond, Carey Forster, D. E. Hughes, Peter Lewis, W. H. Preece, G. J. Symons and John Wychgrove. He had a great deal of experience in the performance of lightning-protectors. He personally had under his supervision at that present moment 500,000 lightning-conductors, and fixed throughout the offices of this country they had their apparatus protected by about 30,000 or 40,000 lightning-protectors. Professor Oliver Lodge was selected to deliver lectures at the Society of Arts. If all the vaticinations of Oliver Lodge were true, the work of this Committee and the work of the last 140 years would be useless; no lightning-protector could possibly protect and no discharge could possibly be led to earth.

Now those were strong assertions. He thought that Professor Oliver Lodge had in his papers before the Society of Arts, and in his paper published in the ‘Phil. Mag.,’ committed certain fallacies that it was now his (Mr. Preece’s) duty to bring before them. Now in the first place Professor Lodge assured them that a lightning-rod formed a part of a flash. Well it did not. Nobody had ever seen, to his knowledge, a flash of lightning strike a conductor. The function of a lightning-conductor was to prevent the possibility of its being struck by a flash, and if it were struck by an infinitesimal part of a flash, then he said that lightning-protector was not a lightning-protector; it had some defect in its construction that had to be remedied. But suppose it did. Then the lightning-protector would form but a very small portion indeed of the path of the lightning discharge from the cloud to the earth. A great deal depended upon the height of the thunder clouds. They saw in text-books ridiculous assertions about the length of lightning flashes. Well, now, who could measure the length of a lightning flash? There had been several extremely accurate measurements of the height of thunder clouds. In South Africa Dr. Mann measured, and his measurements made the height 650 feet. But the most accurate measurements had been made by M. Lacoïn, a Frenchman in charge of the Ottoman telegraphs in Constantinople, and there he made the height of a cloud, therefore the length of a flash, about 325 feet. Well, they had those two measurements,

accurate measurements, he believed; and during the past summer, amongst the mountains of North Wales, he saw several thunder clouds, and those thunder clouds seemed at a height of about 500 feet, and he felt almost certain that the length of our flashes of lightning did not average more than 500 feet. In consequence of the researches of Sir William Thomson and also the measurements made by Dr. Warren De La Rue and Hugo Müller the striking distance across the layer of air for steady currents in one direction was pretty well known. It was something like 30,000 volts per centimetre. Now if a flash of lightning were 500 feet long and it varied directly as the striking distance, then Oliver Lodge's measurements given in his papers would be fairly accurate. But there was every reason to believe that the striking distance did not vary directly as the distance, especially for alternate currents that were modifying their conceptions in every direction of the action of electricity. There was a Mr. Acheson in America who had been making some very careful observations on the striking distance across air when currents were produced by transformers; and there he made out that the striking distance varied not directly as the electromotive force, but as the cube of the electromotive force. If that be so then it would follow that the electromotive force forcing a current of electricity through the air and producing a flash was very much less than they hitherto had considered it. And again a flash of lightning always went along a path that had been prepared for it. All photographs, as they would see presently, gave indications that wherever lightning flowed there some preparation had been made for its approach.

Next there was an assumption which he considered a fallacy, and that was that a flash of lightning was instantaneous. Now they all knew experiments that were made to show revolving wheels; the spokes of the revolving wheel suddenly appeared before them whenever a spark passed, and they most of them believed that a flash of lightning was really instantaneous. There was no proof of its instantaneity. What they knew was that the flash was merely a flash of light that indicated the path. How long that flash lasted they could not tell. But there were dark and invisible flashes, if they might so call them. There were dark and invisible charges of electricity, and there were cases on record where people had been struck and killed underneath trees where no light of any kind whatever had been seen. But he argued on the non-instantaneity of lightning flashes from their effects on telegraph wires. Now of course we had spread all over this country an enormous network of telegraph wires. Whenever a lightning flash took place anywhere some wire was sure to be affected somewhere, and wherever lightning took place it might not hit the wire. It sometimes did. Whether it did or whether it did not, it did not apparently make very much difference in the effects observed. But there they always got currents of sensible duration. For instance, on board ships, ships had often been struck, especially when their lightning-protectors were a little defective, and there invariably it had been observed—or rather he should not say invariably, but frequently it had been observed—that compasses were turned about, and they went playing about wherever the ship passed through an electric storm. Now it was quite impossible that the compass of a ship which had a very slow rate of vibration could be deflected or turned round unless there was a considerable duration in the flash. However that was a point on which the photographs taken gave a considerable amount of information, and during the discussion he hoped that Mr. Abercromby would give them a sight of some of those beautiful photographs that he had collected.

Now he went to perhaps the hardest nut of all in the questions before them to discuss—one that he approached with a certain amount of diffidence because it was supported by very high authorities, and that was the assertion that a flash of lightning was oscillatory in its character; that was, that it did not flow straight from the cloud to the earth and disperse; that it went slashing backwards and forwards, somebody said a million times in a second; but he was not going to discuss that—at any rate that that flash went flying backwards and forwards with considerable frequency. Now he might say at once that that assertion of the oscillatory character of a lightning flash was based more on mathematical reasoning than it was on absolute observation. Well, he was not going to say much on the

mathematical part of the question, first, because he did not think it would interest them, and secondly because he did not think he was quite equal to it himself.

He thought that this theory, beautiful as it was, of the oscillatory character of a lightning flash must be received with great caution. Now there were several facts against the theory. There is no doubt whatever that electro-magnets are powerfully excited for a sensible duration by lightning flashes. They knew that needles were magnetised and demagnetised; they knew that electrolysis could be produced by lightning flashes. He had pointed out to them that the mariner's compass was caused to fly about. Sounds were produced. He had stood in the telegraph office and he had heard distinctly letters of the alphabet signalled by a flash of lightning.

Three oscillations were required to make the letter 'R.' He had heard the letter 'C' which involved four currents. There was a case on record in the A B C instrument of Wheatstone of the letter 'G' having been made. Now the letter 'G' required eight alternations to be made in order to be recorded. And there were other effects. Hence he said that those durable effects on telegraphs were contrary to the oscillatory theory of the flash, unless the frequency of those oscillations were very small indeed; and he said that there were very great doubts as to whether it was true for lightning flashes. It might be true for condensers; it might be true for Leyden jars; but they were not dealing with Leyden jars; they were dealing with flashes of lightning, which if they were analogous to anything in a Leyden jar they were analogous to the bursting of the dielectric, and not to the external discharge where oscillations might occur. Of course they had in a Leyden jar the dielectric, with its charges of positive and negative electricity on each side of it in a considerable state of mechanical stress; and when that stress was suddenly removed, as it was by a spark, then it was not difficult to conceive that there might be mechanical oscillations in the dielectric; but he could not conceive that those took place in a flash of lightning which burst through a mere layer of air. Speaking once more upon oscillations he must mention to them that they had evidence, distinct evidence, of slow oscillations in a flash of lightning; and he thought the photographs would also give them some evidence of that. But Professor Elihu Thomson, in America, a very remarkable observer and one of the ablest men on the other side of the Atlantic, had recently, during a thunderstorm, by wagging his head about or wagging his glass about, seen six distinct flashes pass exactly over the same path. They had other evidence in favour of slow oscillations, but at present they had no evidence whatever of those rapid oscillations, and if they did not exist then the whole of Professor Oliver Lodge's ingenious theory fell to the ground.

On this point he could not help reading just one little quotation from Faraday's researches, who showed how when a spark flew across an air-space the whole of the electricity disappeared. He said: 'The ultimate effect is exactly as if the metallic wire had been put into the place of the discharging particles, and it does not seem impossible that the principles and action in both cases may hereafter prove to be the same.' He thought that that statement of Faraday had a most important bearing on the theory of electricity.

He would deal with another and extremely important point that Oliver Lodge had raised, and one of immense value. Mr. Lodge had given some very beautiful experiments indeed to prove his case. He took two Leyden jars and they were charged with a Holtz machine.

Now there were many objections to this self-induction theory. There was no doubt whatever that Professor Lodge, in this inquiry, had started an entirely new and fresh hare, which they, as electricians, were bound to hunt up, and follow, and kill. He felt satisfied that Professor Lodge was on the brink of some discovery in connection with static electricity. He did not think his explanations were right. He did not believe in the influence that he assumed of self-induction.

As a fact 'self-induction' is used in innumerable senses and in different ways. Professor Lodge himself, with all his care, could not avoid speaking of this self-induction in various ways.

Now, as he had said, Professor Lodge had made a discovery—he (Mr. Preece)

did not know what it was, but in being possessed of this mania he might call it self-induction—he had had self-induction before his eyes and seen nothing else, and consequently had not studied Professor Poynting's paper to the advantage that one would expect. If he had studied Professor Poynting's paper (who shows that energy passed through the dielectric and not through the conductor) he might have applied that principle to his experiments and proved with equal satisfaction to himself that the peculiar effects that he produced were due to something or other in the dielectric. But he was not sure that he would not find on further inquiry into the matter that there was something between the dielectric and the conductor. They knew that a conductor in contact with a dielectric in contact with air was subject to an electromotive force. They knew when a row of people, for instance, were collected together and a spark was passed through them those who suffered were the two end ones. There were several instances on record where horses had been ranged in a row, and the two extreme horses had been killed and the intermediate ones not touched. That showed that there must be some effect between the surface of the terminals and the air, of which at present they were ignorant. He thought that that was a point that deserved experiments. Wires could be obtained coated with various dielectrics. He could supply Professor Lodge, if that gentleman would continue his experiments, with any quantity of wire covered with gutta-percha, with paraffin, or with any other compound that was in the market. Then, again, there was nothing analogous to the transformation of energy in those experiments of Professor Lodge. Let his explanation be absolutely true; let there be self-induction in those alternative currents—he could not conceive from analogy of any single effect of self-induction that would cause the electromotive force between those two balls to increase from 100,000 to 140,000 volts. They had to account for a great increase of electromotive force. Professor Lodge indicated in his paper at Section A on Friday that a spark of one inch at a distance of three yards increased to (he thought) fourteen inches. There they had an increase of electromotive force that would be something like an increase from 100,000 volts to 1,000,000 volts, and they could not account for that by any known phenomenon connected with self-induction.

Well, those points, he thought, rather tended to shake one's confidence in the oscillatory character of lightning, and in the influence of self-induction in determining the efficacy of lightning-protectors.

The next fallacy of Professor Lodge that he wished to touch was one where he asserted that a lightning-protector protected no area whatever. If a lightning-protector raised above that building did not protect an area around and about that building, what earthly use was there in a lightning-protector? Well, they knew from evidence in the Report of the Lightning-rod Conference that areas were protected, and he had in a paper in the 'Philosophical Magazine' worked that out in a way that he thought could scarcely be controverted. Again Professor Lodge asserted that extended points were needless. Well, their Report on the Conference said that extended points were necessary. Of course those two opinions were diametrically opposed to each other. The Conference placed their stand upon the experience of the past, and Professor Lodge placed his stand upon his mathematical assumptions.

Next as to iron. Professor Lodge advocated iron now; so did he. But he found on November 3, 1887, in 'Nature'—only last November—Professor Lodge says: 'A lightning-conductor should not be a round rod, but a flat strip, or a strand of wires with the strands as well separated as convenient, and though I have not mentioned the special effect of iron I may as well say here that iron is about 90,000 times worse than copper.'

He had said something about mathematical developments, and he thought that one of the serious errors committed by those who relied on mathematical developments was that of hasty generalisation.

He had always held the belief that they would sooner or later trace an electric current to be a mere vibration, a mere oscillation of the molecules that composed the mass of their conductors. He carried out in Dr. Warren De La Rue's laboratory a series of the most brilliant experiments with his great battery deflagrating

pieces of wire, and those pieces of wire were laid flat between white paper, and the result of the deflagration showed upon that white paper. There they had a distinct indication of waves—that the passage of the current through the conductor burst in the form of waves. Professor Hughes, one of their best experimenters, one of the most marvellous men with his fingers, had been working steadily together with himself. The notion that they had gone upon was that in order to account for heat, in order to account for light, in order to account for electricity, and in order to account for the difficult *crux* of the whole question of the duality of electricity, they would have to prove that the result of the motion in an electric current was spiral, that it was of the character of a right- and left-handed screw. So that when they had it going in one direction there was positive electricity, and when it was going in the other direction there was negative electricity. He threw that out as a suggestion which deserved to be worked out.

He said, in conclusion, that he had done all that he possibly could to prove that the position taken up by the Lightning-rod Conference was the true one. He had shown Professor Lodge's conclusions to be in some respects fallacious. No doubt Professor Lodge would say that they were not. He (Mr. Preece) felt satisfied of this, that whether the result of the discussion were to establish the truth of the position taken up by the Lightning-rod Conference, or whether Oliver Lodge were right, at any rate the discussion would have had this advantage, that it would bring to their minds what they were all anxious to see—the true theory of electricity.

Professor OLIVER LODGE said he must in the first place confess that he had nothing whatever like the experience of Mr. Preece to base his statements upon. There was not at present even a lightning-conductor to the college in Liverpool with which he happened to be associated. He had asked them to put one, but lightning-conductors at present seemed to be so expensive that the answer he generally got was that it is cheaper to insure.

It was perfectly true that if his views were correct very few buildings are effectively and thoroughly protected at the present time; but then, also, if they were correct, lightning-conductors would in the future be bought for, he was going to say, as many shillings as they are now bought for pounds; but, at any rate, they will become much cheaper; and that of itself would be no slight advantage if, of course, they are equally effective.

Mr. Preece began by saying that there is no authentic case on record of a properly constructed conductor failing to do its duty. He had read carefully that report of the Lightning-rod Conference to which Mr. Preece drew attention, and there he found a large number of entire failures. There was one very noteworthy one which was often quoted—a brass rod, an inch thick, on a steeple in Italy, which was smashed all to pieces and the spire destroyed, the flash being seen, he believed, by a number of people. There is a heap of other cases. In his lectures this spring he quoted, as the best protected building in the world, the Hôtel de Ville at Brussels, on which M. Melsens had spent so much time and trouble. It was elaborately protected; it was protected by innumerable conductors with admirable earths made in a variety of ways, bristling with points all over the top—everything being carried out in the most approved style, regardless of expense. But in the month of June that building was struck, and it was set on fire. The fire was put out. He was sorry he did not know more particulars. The particulars had not been published, but he thought they ought to be published, because that was a building the protection of which had had books written about it. M. Melsens himself wrote a book about it. It should be very instructive to find out, when a thoroughly protected building was struck, how and why it was done, and what damage was done, and all about it. But he did not think, although he spoke from a limited experience, apart from reading, that it could be said that existing conductors never fail.

Then Mr. Preece had a hit at him where he admitted he had the advantage. Mr. Preece quoted an entirely erroneous statement which he made. But he (the speaker) had not introduced that as a statement of a mathematical calculation or anything; it was the merest parenthesis thrown in, and it was very hastily done. Of course

one ought not to do those things, but still if one wrote much one was very apt at some time or other to make very hasty statements. When the Society of Arts asked him to give a lecture on lightning-conductors he thought to himself, 'Yes, I will tell them about induction,' because he knew that the Lightning-rod Conference had not called attention to that nor yet to magnetic inertia or whatever they called it. He had happened to write a paper which appeared, he thought, in 'Nature'—he did not know where the quotation made by Mr. Preece came in—and in that paper having referred to the magnetic permeability of the two metals, copper and iron, he had stated that iron was 90,000 times worse than copper. He went on to say, therefore, that although iron was cheaper it was more difficult to melt, had a higher specific heat, and in a variety of ways was better than copper, yet in regard to this electro-magnetic inertia it was enormously worse. But before actually giving those lectures, on again making a few experiments, to his surprise, he found that, so far from being worse, it was often rather better—that iron, even a thin wire of iron, carried off the discharge better than a thick wire of copper. He did not press the point that iron is better than copper, and he had never said that copper has more self-induction than iron—that would be a mad thing to say. It might happen for some reason or other that the copper obstructed the current more than the iron, but he preferred to say that they are just equal.

Now Mr. Preece said that the function of a lightning-conductor is to prevent a flash from striking the conductor; that is to say, that a lightning-conductor never ought to be struck or it fails. But they are struck because they get melted. Yet at the beginning sentence Mr. Preece said that they never failed. He did not know which of these statements was to be taken as correct. If a lightning-conductor can prevent a flash from occurring by its repellent action well and good, but he had shown in those lectures that there are cases where a point has no protective action whatever, when a point could be struck by a thick and heavy flash. There were other cases where the point acts with a brush or fizz and neutralises the electric charge without a flash. They could not always do it. And so the lightning-rod has two functions, one is to be repellent if it can and the other is to carry off a flash when it cannot help receiving it. But they must remember that a flash, at least that the electric charge, has a certain amount of energy, and that has to be dissipated somehow. It was not a question of a certain quantity of electricity to be conducted to earth and then there was an end of it. There must be a certain amount of energy, they must dissipate it somehow, and they could not expect to *hocus-pocus* it out of existence by saying they could conduct it down to the earth. The quicker they tried to conduct it down to the earth the more searching and ramifying disturbances they were likely to get. It might be better to let it trickle down slowly by using a moderately bad conductor than to rush it with extreme vehemence down a good conductor; just as it would be safer to let a heavy weight suspended in a dangerous position down slowly rather than let it drop as quickly as possible.

Concerning the length of flashes he wished he had any information, but he had none; it was one of those things which their friends, the meteorologists, must determine for them. It was very important to know the length of a flash. He had found it stated in books that flashes were a mile long and perhaps more. Mr. Preece thought they were only 500 feet long. That was a matter of fact which could be investigated, but of which he had no direct first-hand information. Whether the spark-length is proportional to distance or not he would say that the experiments with oscillating currents to which Mr. Preece referred were conducted with alternating dynamos between points. Now the area of cloud and the area of earth below it are not points, they are flat.

There the law did not seem to hold, but then it ought not to hold, so that would be all right. But between flat surfaces it ought. The spark-length ought to increase with a difference of potential between the two flat surfaces. At the same time if there were points on the earth's surface big enough and which in any fashion could act as points, then of course it would not hold. But the oscillating current did not apply as regarded the length of the spark because until the discharge occurs there is no oscillation—it is a mere static charge. It is exactly like

the coats of a Leyden jar which are preparing to spark into one another and which do spark into one another when the difference of potential rises to a certain maximum and the area is broken down.

Concerning the duration of flashes, that again was a point on which much valuable work might be done by meteorologists and photographers. He had seen lightning flashes which certainly appeared to last two or three seconds. He could not imagine that it was one flash which was doing that; he thought it was a series of multiple flashes succeeding one another very rapidly. But whether they lasted long or not there was no necessary argument that they were not oscillatory. The fact that they deflect a compass needle does not prove anything about it, and does not prove anything concerning their duration either because a ballistic galvanometer is deflected by a momentary kick—a momentary blow given to a thing can deflect it, the blow having ceased long before the motion has ceased which it produced. But there is a difficulty which Mr. Preece did very well to advert to, and that is the magnetising power of a lightning flash. He thought that was the strongest point Mr. Preece had adduced. A flash magnetises steel bars, deranges the magnetism of a ship's compass, and conspicuously produces magnetic effects. Now an oscillating current ought not to produce these effects. An oscillating current with decaying amplitude is used by Professor Ewing to demagnetise steel, not to magnetise it. It ought not to magnetise, but it does magnetise them; therefore how can it be a current of this kind? But then the same difficulty would be felt with a Leyden jar discharge. The Leyden jar discharge is also oscillatory, certainly oscillatory because it has been seen to be spiral; the sparks have been analysed in a revolving mirror, and yet it magnetises steel needles when sent round them. He did not understand that point himself, but he hoped that Lord Rayleigh might say something about it. Mr. Preece was quite right in saying that the whole theory depends upon the oscillations. What he (Professor Lodge) had done, as far as the theory was concerned, was merely to call attention to these oscillations (which were well known in the case of Leyden jar discharges and of which the mathematics had been worked out) and to point out that they applied also to lightning which he thought had not been much noticed.

What the energy of a flash is he did not know. He wished there were some means of determining it; it would be very important to determine the energy of a flash. He would now say a word as to whether lightning was likely to be oscillatory or not—this question of what the resistance or friction has to do with the energy of the capacity which is discharged. The smaller the capacity the more likely it is to be oscillatory—the bigger the electro-magnetic inertia the more likely it is to be oscillatory. Now the capacity discharged in a flash is small. He said it was small for this reason, that the quantity of electricity discharged is not great. It was well known that the quantity of electricity concerned in a lightning flash was small. The quantity of electricity then existing in the portion of the cloud that is discharged is a small quantity, but the potential of it is enormous. It is able to spark 500 feet, possibly a mile—whatever it is able to spark it does spark. That meant an enormous potential. Now when they had a very small quantity raised to an enormous potential that meant that the capacity could not be great, capacity being the ratio of the two. There was no reason for supposing that the capacity of a condenser discharge in a lightning flash is anything bigger than a Leyden jar's, or in a micro-Farad, or things of that sort. He would mention as being perhaps interesting that the radiation of the waves produced by a micro-Farad condenser discharging from a coil of self-induction one seohm, as Professors Ayrton and Perry called it—he preferred to call it a 'quod'—the waves produced by that discharge—the ether waves, waves of light—if it is oscillatory will be 1,200 metres long. They had nothing like that capacity discharging in a Leyden jar, which has a capacity only, as he guessed it, of 10 metres electro-static units. Mr. Preece had promised to supply him with covered wire in order to repeat these experiments on the alternative path. He would have the greatest pleasure in taking advantage of it.

Then there was the theory of protection of area. Mr. Preece said, 'If it does not protect the area what is the good of it?' Well, but that was not an argument

proving that it did protect an area. He knew Mr. Preece's theory about the protection of areas because it had been published in the 'Phil. Mag.' The area, as Mr. Preece knew, was so extremely small that he thought they might almost give it to him without much argument.

Even then they would not be safe. Now why did he object to such a bit of protection as that? He objected to it mostly because he thought that areas of protection directed one's attention to side issues, to a thing which it is better not to think about because there is no certain area of protection as one could show in this way. Take another rod completely enclosed in this area of protection and bring it up near to the lightning-conductor. Now if area of protection has any meaning, that rod ought be protected; but he said that when a lightning flash—this was merely an assertion—strikes that conductor they would most likely, almost certainly, get a spark down the second rod, and it would take its share in operating to convey the current. Therefore that is not protected. If a man holds a lightning-conductor when a flash passes down it he will most likely be killed; and if it passed through—well, he did not know about gunpowder because gunpowder got blown about. It did not matter about the earth—about that being a good earth and this being a bad earth—still the same effect will occur; a spark is likely to occur if the distance be not too great. He said that that is so because he had made experiments in the laboratory after this fashion among others: he took a rod (which might be as thick as they pleased) a yard long and put it in circuit with a Leyden jar discharge, sending discharges through the rod. He then took a Wollaston platinum wire or any other wire, as fine as possible to make the contrast greater, and arranged it so as to make a kind of tapping circuit; if then the bottom end was arranged so as to be in contact with the rod and then let the top end be an eighth of an inch away or a sixteenth of an inch away, then they would have a splendid conductor, better than any lightning conductor ever was. They would have no trouble about earth; they would have close to it a little tapping circuit, the Wollaston wire which they could hardly see. It seemed absurd for any portion of the discharge to leave this conductor to jump across the sixteenth of an inch and to make for the little strip of wire. Nevertheless a portion of it did and from every spark that went to the conductor a side branch went to that little wire.

There was one point where Mr. Preece might have attacked him, but where he did not think that gentleman had made out the full strength of his case, namely, the question, What are the conditions of a flash? He (Professor Lodge) had assumed that a flash behaved like experiments in a laboratory, but it was a question whether a cloud discharge was of this kind. A cloud is not like a conductor; it consists of globules of water separated from one another by interspaces of air; it may be compared to a Spangle jar; when a Spangle jar discharges you have no guarantee that the whole of it discharges, it discharges in a slowish manner. It may be that there was with a cloud first a bit of a discharge and then another bit, and so on; so that there might be a kind of dribbling of the charge out of it, and they might therefore fail to get these oscillatory and sudden rushes. At the same time he did not think that they could always guarantee doing this, and it would not be safe in arranging for protectors to protect for only one case and that the easiest. They must provide for the possibility of a sudden and actual discharge. Still the conditions of actual lightning were to be met by observing lightning, and not by experiments in the laboratory. Thus they had the momentum of one spark exciting others; he was sure there were multiple flashes. There was a photograph which Mr. Abercromby had with him, and which he hoped would be shown to the meeting, where the flash is breaking the air down in all directions at once. It was most extraordinary the way in which there seemed to be a rod set up in the air so that one flash began and the whole thing smashed up in all directions. There was a point there which could only now just be called attention to, namely, the light of one spark assisting others to form. A spark of an induction coil here would be able to start the spark of another induction coil up in the gallery merely by its light; if it was closer it would do better but it would do it at a very considerable distance. When they came to consider the very bright light of a lightning flash

this effect must have very important consequences. He thought there was no doubt that once a flash occurs the light of it must make all conductors in the neighbourhood, all the air in the neighbourhood, very easily able to break down, and so may give rise to a multiplicity of flashes from all the neighbouring points. That was why he said areas of protection were misleading; if one flash caused a lot of others they had better not have the one if they could help it. Therefore he said, do not run up these great long rods to attract flashes near powder magazines or anywhere where it is dangerous, but try to avoid them if you can. If there must be a flash they must be very careful indeed to have all the other conductors arranged so that sparks along them do not matter, because if one occurred they were very likely to get the other.

The Hon. R. ABERCROMBY said he wished to be allowed to contribute to the discussion some facts which had been brought out by looking at about 90 photographs of lightning flashes in different parts of the world which had been collected by a Committee of the Royal Meteorological Society, of which he had acted as secretary. A few of the most remarkable of the photographs he had brought with him for the inspection of the meeting. In doing so he proposed to confine his remarks to such facts only as bore on the discussion they were having that morning, instead of ranging over the whole theory of lightning flashes.

The first point was, is there any evidence in the photographs of a duplication of flashes, that is, of one flash following rapidly after another? He thought the answer to that must be that there is no certain evidence. He had a very remarkable photograph with him, which might at first seem rather to negative that.

Here there was one very bright flash. In one place there were no less than three lines which were sorts of doubles of that bright line. In another part of the same picture they had a thin flash with another flash exactly parallel to it, only a little bit fainter. For reasons which it was difficult to give without a close inspection of the original picture, there was reason to suppose that that effect was due to a secondary reflection from the back of the glass. Although he was far from denying the alleged phenomenon, he thought they had often seen flashes come very nearly after each other, yet so far there is no photographic evidence of a flash coming exactly along the same path; but there is most decisive evidence of the tendency of flashes to be parallel to each other. He now exhibited a most magnificent photograph which had just been sent to the Committee from Massachusetts. In that instance the whole air is filled with threads of lightning coming down like the roots of a tree from the sky. He thought it was very much a question where the area of protection would be when the whole air seemed to be pouring lightning down upon you. There were other photographs in which appeared two or three flashes apparently following pretty much in the same path. Then, connected with this, there is the inveterate tendency of a lightning flash to ramify. Sometimes they got in a photograph a comparatively smooth line; at other times it was like that photograph which he had already shown the meeting. The main flash seems to throw out threads in every sort of direction. That would be observed in an influence machine; instead of a spark always coming from one to the other, they very often saw it begin to go off at right angles, and then jump away to the other.

Connected with that there was one thing of which he had not been able to find any notice in any of the discussions or publications on lightning-conductors, and that is, what is the effect of rain or cloud on the passage of electricity? All laboratory experiments are taken, of course, in dry air, but every experimenter knew that the dust in a laboratory has a very considerable effect on the discharge of static electricity. His impression was that when lightning comes down through rain or hail, or even through cloud, the continuity of what are called potential surfaces, and all that sort of thing, must be very much disturbed. The Committee of the Royal Meteorological Society had collected for this year of very frequent thunderstorms an enormous amount of material relating to them, including cases where much damage had been done to buildings. So much did he believe in the disturbance he had mentioned that when the Committee met again he should suggest to them to send out a circular with the object of finding out, if possible,

whether the buildings were struck during rain or when it was not raining. He was not quite sure but that they might learn something in that way.

There was another point which had been alluded to upon which photography he thought gave very conclusive evidence; that is, that lightning flashes are by no means as instantaneous as they are usually supposed to be. First of all, most people had seen lightning flashes which to their eyes appeared to last some time; but the evidence of the eyes in bright light is a little doubtful, as there are always subjective effects on the retina. They had a large number of photographs bearing upon this point, and he had brought with him a very good specimen. Lightning does not jump from the cloud to the air, but it goes meandering about in the air. It meanders about in the air without very much rhyme or reason, and flies about in a very eccentric manner. He thought it was perfectly certain that lightning, when it was tying knots like that, could not be going with anything which in ordinary parlance might be called an instantaneous speed. Of course there is no such thing really as instantaneity. Besides the ordinary flashes of lightning, some people had seen and everybody had read about what has been called a globular discharge of lightning, in which a ball of light, about the size of a cricket ball, goes dancing slowly down the street and eventually discharges. It is perfectly certain that between that very slow discharge and the quicker discharges which were ordinarily spoken of as flashes of lightning there must be intermediate rates of discharge. There was one point bearing upon this question of the non-instantaneity of a flash which had been adduced as evidence, but which the photographs in the possession of the Committee did not confirm. In fully half of the photographs the lightning does not cover the plate as a streak, but it is more or less of a banded nature, something like a ribbon. It had been suggested that this apparent motion that way might have been due to a shaking of the camera. There was evidence, —although he could not describe it verbally, it was easy to see it—to show that, and he could not think that that evidence of the slowness of flashes was not correct. Only yesterday their distinguished visitor, Dr. Janssen, made a suggestion to him which he thought furnished additional evidence of the fact. One of their most remarkable photographs, besides showing three white flashes on the picture, has a black flash; that was a very curious thing. They very early got the idea that that must be due to the inversion of the photograph, which sometimes took place from over-exposure. Photographers knew very well that, instead of white coming out as white, it came out black. It was a well-known peculiarity of plates and developers, and so on, but they were brought to a stand by the idea that this photograph was the only one instance that they had got, and if it should be over-exposure they would have a great many over-exposed. Dr. Janssen made to him the very valuable suggestion that that might be the evidence, not of a peculiarly bright flash which over-exposed the plate, but of a slow moving flash which moved so long that the plate was over-exposed. Of course it was impossible to say much from one case. He thought it was a remarkably brilliant idea, and he only brought it before them as a possible confirmation of what they were certain of from other things.

Then the only other point upon which he would like to speak was not connected with the photographs, but was a point upon which he would speak as a meteorologist, that was with reference to some remarks of Mr. Preece about the height of lightning clouds. He had no doubt that Mr. Preece might have seen it over a sufficient amount of country. The flashes might come from a cloud only 500 feet high, but that was a very low cloud, and in the majority of cases they certainly came from very much greater heights. In that one particularly that he had already alluded to, from the scale of the picture he was perfectly certain that the height of that cloud was considerably over 500 feet. At the same time he might mention that there was hardly a case of lightning much over 7,000 feet. When they got on the side of mountains much over that he would not like to say too precisely, but certainly a very moderate height, they always saw lightning below it. Electrical disturbance of this kind was confined certainly to the lower 10,000 feet of the atmosphere. In connection with the practical bearing of that he might mention that in Norway they had two kinds of thunderstorms. One occurred in

the summer, he believed, when the lightning clouds were high, and they got very little damage done; on the contrary, in winter time the thunderstorm clouds were very low, and the churches were very frequently struck. That, he thought, was all that he need say.

Lord RAYLEIGH said he had no special experience whatever of lightning-conductors, and could only speak from a general knowledge of electricity, no doubt to be applied in this case to very peculiar circumstances, so that everything that stood upon a merely *à priori* foundation should be put forward with very great diffidence. He must say, however, that Professor Lodge's experiments had seemed to him to be likely to have most important practical applications to lightning-conductors. He could not see how experiments dealing with the thing of all others most like lightning that could be produced in the laboratory could fail to have such an application. Professor Lodge asked one question and he thought mentioned his (Lord Rayleigh's) name in connection with it, as to how it could happen that an oscillatory electric current, that was, say, an alternate electric current beginning at a finite magnitude and gradually dying away, could produce magnetising effects such as they well knew that in some cases it did; and he instanced the very opposite behaviour, of slowly dying away alternating currents in the experiments of Professor Ewing and of others, in which such an arrangement was precisely the one adopted in order to get rid of even the last traces of magnetism. The question was a difficult one certainly, and he had intended in fact to make some experiments upon it himself; but he was inclined to think that the explanation might perhaps be sought in a case very much akin to the one with which they were now dealing, namely, that of the magnetic steel needle which was magnetised, say, by the discharge of a Leyden jar flowing through a spiral involving the needle. He said the needle itself was a conductor of finite dimensions, and that during the very rapid passage, and he had no doubt in some cases alternations of electric current through the spiral, there were induced in the magnet itself, in the steel needle itself, which ultimately became a magnet, circumferential currents, which circumferential currents would first, at any rate, protect the interior of the iron from the direct magnetising action of the enveloping helix. They must think not only of the action of the oscillating current in the helix upon the various parts of the steel needle, but also of the action of the currents developed in the steel needle itself. He believed it had been well ascertained that at different depths in such a steel needle they would very often find different degrees and even different directions of magnetisation. It seemed to him possibly that if that was thoroughly followed out they would be better able to understand what was certainly the fact, that a current that was certainly alternating and gradually dying away did nevertheless produce and leave behind it the effect of strong magnetisation.

There was only one other point that had occurred to him which it would be necessary to mention in connection with the development of atmospheric electricity, and he would like very much to hear any meteorologists present express their views upon it. He was reading only the other day a pamphlet by Professor Swankey, a man who had done very good work in other departments of science, in which he developed the theory that atmospheric electricity was due to the friction between water and ice. There was no doubt that many clouds (cirrous clouds he believed nearly always) were ice clouds, and not water clouds. Dr. Swankey's view was that at a certain level in the atmosphere ice clouds and water clouds could meet; and that under those circumstances this friction might occur; and his view was that the atmospheric electricity was the result of such friction. He quoted experiments by Faraday on the friction of ice and water, which had a positive result. But that was, perhaps, not the main question before them. He would rather hear from some more experienced and practical men, who had been at work on lightning-conductors especially, any instances of the kind that Professor Lodge asked for of actual failures of lightning-conductors. It seemed to him that it was only by actual experience of the lightning-conductors that the question could ever be finally settled. The laboratory experiments might be most important as suggestions, but he thought no one would wish finally to adopt any

system or to change any system of lightning protection without actual experience upon a large scale.

Sir WILLIAM THOMSON said: In respect to the very central difference between Mr. Oliver Lodge and Mr. Preece, he might say he thought Mr. Oliver Lodge was in the American stage with reference to judging the functions of inertia, and Mr. Preece rather in the English stage. They call it 'keeping our station' in England, but the Americans called it 'keep going ahead.' These are the two functions of inertia to prevent anything from getting into motion, and when in motion to keep it going; and both those functions were plain in this electrical influence. He could not but think that if Mr. Lodge continued his work he would find the explanation of the very great discovery that he has made, namely, that iron wire affords a better discharger, or an easier path in the circumstances Mr. Lodge had minutely defined, than does copper. He hoped Mr. Lodge would pursue the investigation, keeping the circumstances in all respects as similar as possible—comparing, for instance, a thin iron wire with a thin lead or brass wire of precisely the same ohmic conductivity. He knew that that gentleman had done a good deal already, but a good deal more might need to be done, and all that could be done by experiment could be done in a very easy investigation. The other point Dr. Oliver Lodge very importantly accentuated, namely, that the energy must be got quit of somehow and somewhere—it must be got quit of either in the conductor or elsewhere. If got quit of in the conductor, then there must be energy to melt the conductor, and it might be a positive advantage to have quasi-inertia to keep it oscillating for a time instead of volatilising the conductor in an instant. He did not hazard that in the slightest degree as an explanation, but it was certainly something that must be taken into account in connection with the experimental result which Mr. Lodge had put before them.

It was interesting to hear about the number of horses placed in a row, the first and last of the row being killed and the others not touched by a lightning discharge, which seemed to pass through them all. A very common lecture-room experiment was to give a Leyden jar shock to a hundred or two hundred students sitting on the benches, making them all join hands. He had no doubt that those students next to the ends of the line experienced the shock much more potently than those in the middle of the line. There was one very marked influence here, and that was want of perfect insulation; but there was another—self-induction. Self-induction was now in the air—they thought of nothing else in fact—and some of them thought of self-induction incessantly in these matters. He thought that the extent of self-induction might be tried, and that it would be a very interesting experiment. He thought they must also try this same experiment with as nearly as possible similar insulation with a number of people spreading out in a large circle. Then the self-induction would be much more influential in causing the discharge not to keep through the line of comparatively good conducting bodies. Take the case of persons ranged in a row taking an electrical shock; if the row is zigzag then self-induction will not have the same tendency to cause the lightning discharge to leave the line of the best conductors as it will have if the conducting bodies are placed in a wide circuit. Then he believed the imperfect insulation of standing on the floor would be much more potent, and he should expect that those who were in the middle of the row would experience a shock much less in the case of standing in a wide circle than in the case of standing on similarly good conducting material in a zigzag row. At all events that would be an experiment worth repeating.

Mr. Preece had spoken of the impossibility of conceiving of the enormous augmentation of potential in these actions. Take the word inertia which Mr. Preece used and the judiciousness of which he fully agreed with and apply it to the steam hammer and the hydraulic ram. They applied a comparatively gentle force to a steam hammer until it produced an exceedingly intense action at the blow. Take a hydraulic ram again, the well-known analogue for getting up a high potential by self-induction in an electric circuit, and he thought they would see that Professor Lodge's explanation of the phenomena he had brought before them was altogether valid and not very difficult to work out in detail.

Exceedingly interesting questions had been put and remarks made in respect to

the oscillatory discharge in ordinary lighting in respect to the duration of the discharge and in respect to the multiple flashes. He thought that Mr. Oliver Lodge had distinguished these more or less from one another. There might be a slow discharge. Mr. Abercromby had referred to a ball of lightning running about down the street, and so on. There was a curious description in Arago which Professor Tait credited (although he must say for himself that he scarcely credited it) so far as to quote in a lecture he gave at Glasgow some time ago, which described a ball of lightning as coming in at the window, running about amongst the people, and brushing up against their legs as if a kitten was about, and after that going out up the chimney. This slow discharge by ball lightning had been described very graphically by many people. He had never seen any description so minute as that of Arago's, which he must repeat he scarcely believed. He thought in respect to the duration that what Mr. Abercromby had called attention to was probably the true explanation. When people see a ball, as it were, passing along the floor, going up the wall and out at the window, he believed it was altogether a physiological affair. They had been looking in some direction or other when the flash came; at the instant that the flash came there was an intense action on the centre of the retina, especially if they chanced to see the flash in the sky; naturally after such a startling incident the eyes are moved and the person after seeing the flash looks about to see what has happened—looks on the floor, looks along the wall, looks up at the window, and a spot of light follows, so that he believed this marvellous ball of lightning could be seen by every person present going out of any window that he happened to look out of.

He thought Mr. Preece was perfectly right in speaking of the multiplicity of flashes of lightning. That gentleman gave some unmistakable experimental and observational evidence which agreed altogether with what he (Sir William Thomson) had noticed. The first time he distinctly remembered noticing it was in the year 1840, at Frankfort, where he had the pleasure of seeing a great many thunderstorms. He then remarked what he did not remember noting before, namely, triple and quadruple flashes frequently, but at such short intervals of time that one could not but think they were somehow connected, and yet at certainly long enough intervals of time to allow him quite distinctly to see that they were not one flash but several flashes. It was impressed upon him then, and had been since—because he had incessantly seen them since—that, as Mr. Abercromby had said, it did not appear to be a repeated repetition of flash along one and the same course, but a succession of connected flashes—a sort of breaking down all over the line—all over the place. One flash causes ever so many others: it is something like setting up a set of toy bricks or soldiers—tumble down one of them and there is a commotion all along the line, with a very sensible time interval. He thought something must be allowed for sound in this case. The light of one flash tends to produce another flash. If there is a flash just ready to take place between two knobs here, a flash there will cause it to pass, according to an experiment which Professor Schuster had given in his work, which had been a great deal referred to. As for the fact of lightning tending for the moment to make air more easily broken by the flash, it seemed that the very fine vibrations in light actually put the air into a more disruptive condition, or rather a condition that is more easily disruptive than air which is not agitated by light. That would not account for the time interval between the different flashes which were spoken of by Mr. Preece, and which he had himself repeatedly noticed. He thought there must be something in the velocity of sound—the velocity of the propagation of sound in the air. It seemed not improbable—he would not say improbable, for the first flash does produce certainly a tremendous disturbance in the air—a tremendous disruption of air probably causing a very perfect vacuum in the place of the flash and the shaking together of the air. He thought they could not account for it otherwise than by supposing a crack in the air suddenly filling up and producing an exceedingly sharp elastic disturbance. It is quite possible that that elastic disturbance coming at a time nearly equal to the ordinary velocity of sound to another place where they are in a state of high tension, ready to break down, causes it to break down. Thus it may be that one flash causes considerable numbers of others to spark at an interval of a quarter of a second, or

half a second, or one second from its initiation. This was a thing that might be experimented upon. Referring now to the photographs he observed that there was a great multiplicity of flashes shown in one of them. There were three flashes on one photograph, and one a great distance at the side—he supposed a mile or so at the side the distance probably would be. Query: Were they simultaneous? Perhaps Mr. Abercromby might say.

Mr. ABERCROMBY: We have no evidence; the photographs were sent to us without any particulars.

Sir WILLIAM THOMSON, continuing, said that the subject was always a most interesting one, but as it was now coming within the range of experimental investigation (which it could not be before the photographing of flashes of lightning was practised) he thought it would be worth while now to make experiments distinctly to ascertain whether such a group of flashes as that is or is not simultaneous.

There are some interesting points with regard to the magnetisation of steel needles by a helix in which there are electric oscillations which have been spoken of by Lord Rayleigh. If he remembered right Riess experimented on the subject some time prior to 1854. Riess (if he remembered right—and he was pretty sure he did remember right in this respect) found that when a Leyden jar was discharged through an insulated wire wound up in a helix in the ordinary way steel needles are sometimes magnetised in the direction that would be expected and sometimes in the contrary direction. He believed, as Lord Rayleigh had said, that experimenters have actually found differences of direction of magnetisation in different individuals of a group or bundle of steel wires thus actuated, thus exposed to this kind of magnetising action. If they had a very powerful current going in one direction, a current of half that strength going in the opposite direction, a current of a quarter the original strength going in the first direction, and so on, then they might expect the medium to be left magnetised by the current going in that one direction extending to the last time it had magnetising force enough to reverse the magnetism of the needle. So that he thought by experimenting upon Riess' old experiment with the same degree of electric magnetic inertia in different successive cases but different degrees of resistance, and therefore different rates of extinction of the oscillation, probably full explanation and investigation of them might be made, and they would understand how it might be magnetised in one direction and in the opposite direction. He was afraid that he was occupying too much time, but there was just what seemed to him rather an important point with reference to the protection of buildings. It was rather disturbing to find that a lightning-rod has so little protecting power as Professor Lodge had pointed out to have been proved by experiments. With reference to this distinction between iron and copper he would like to ask Mr. Preece whether he had experimental evidence of any superiority of copper. It was an exceedingly difficult question, but Mr. Preece had told them that his experience generally is that lightning-conductors are efficacious whether they are copper or iron conductors. There are certainly a great many iron conductors and he (Sir William Thomson) did not know of any experiment which proved that they were less efficient. On that he could not say anything certain at the present time. As Professor Lodge himself had pointed out, experiment after experiment must be gone through before they could say which it would be safer to recommend for lightning, whether iron or copper. There was one point upon which iron has greatly the advantage, that is, that it takes a great deal more heat to melt it. If they were to compare the cost of iron and copper they would have four or five times as great a mass of iron for a given sum. Take also the higher melting-point of iron and then they would see that for the same expense upon a lightning-conductor they would allow for the consumption of a great deal more energy within itself without destroying it by using iron than by using copper; but then the question of self-induction bearing on magnetisation must be considered before they could say for certain that in all circumstances an iron lightning-conductor is as safe as a copper one. He thought that the one moral, the one conclusion, which could be drawn from all this was, that a sheet-iron house with sheet-iron roof and sheet-iron walls and sheet-iron floor is the very safest place that we can possibly be in, or that gunpowder can possibly be in, in a

thunderstorm. Here he might say something which was perhaps absolutely wrong, but he would hazard it. The subject was full of pitfalls, and one could scarcely open one's mouth without putting one's foot in it in speaking of self-induction of magnetisation of iron and of discharge, but he would venture to do so. He would say that the magnetisability of the iron seems in this case rather to prevent the danger—rather to prevent the current coming into the inside than to facilitate its coming into the inside. He thought he might quite safely say this, that within an iron funnel—a long vertical iron funnel say—and within a copper vertical funnel the interior would be protected in the case of the iron funnel by the magnetic susceptibility of the iron; whereas in the interior of the copper funnel there would be no such protection, although in each case there would be a very potent protection from the conductivity of the metal. However, he thought that with what Dr. Lodge had put before them they knew quite enough about iron to say that an iron building will be as safe as safe can be—as safe as science can make it. He thought it was rather an important thing for powder magazines that the rule should be no lightning-conductors at all, but iron roof, iron walls, iron floor: wooden boards over the floor naturally to prevent people setting fire to the gunpowder by walking over sheet iron, but a complete surrounding of iron; and then that might be placed on a dry granite rock, it might be placed on glass, it might be placed on anything they pleased, it might be placed over water—no matter what the surroundings are, the interior will be safe. He thought that was a somewhat important practical conclusion that might safely be drawn from these electrical oscillations and mathematical calculations of which they had heard so much.

Professor ROWLAND, referring to Professor Lodge's experiment and the photographs exhibited by Mr. Abercromby, said the question seemed to be whether that experiment actually represented the case of the lightning. For himself he was very much disposed to think that it did not. In Professor Lodge's experiment the whole of the circuit between the condensers was a material of copper and iron, whereas in the case of the lightning the greater portion of the flash was in the air, and therefore it might be an entirely different phenomenon in the case of the lightning from what it was in the case of Professor Lodge's experiment. Furthermore, he was not entirely disposed to think that the length of the spark was an index of the resistance of the conductor in that case, for the reason that they did not know what the length of the spark was when there was an oscillating electro-motive force acting on it. He was not disposed to say that the discharge would take place at the first moment; there might be considerable oscillation, and finally the air might break down. The oscillation might take place before the spark went, in which case the length of the spark might not be an index altogether of what they might call the temporary resistance of the conductor to the passage of the spark, and the presence of iron might change the time of the oscillation in some way, so that it might give a different length of spark in that case from what it did in the copper. But he thought the fact should be remembered that in the case of the lightning the greater portion of the spark was in the air which was a very bad conductor, and that therefore the discharge of the lightning might not be oscillatory, but might be of the nature of a swing, in which case a solid conductor or a conductor of copper would probably be worse than that of iron. With regard to the photographs he noticed many curious phenomena, which he thought should be guarded against. He was happy to say that the best one exhibited, which might form the text of his remarks on the rest of them, was an American photograph, in which case they had the whole plate exposed and the lightning in the centre of it. He did not suppose that all those flashes were taken at once, but that, as Sir William Thomson had remarked, the plate might have been exposed some time and have several discharges upon it. As he looked at that he noticed near the centre the lines of discharge were perfectly sharp. As he wandered off towards the edge he saw some phenomena which were very similar to those that he saw upon those other photographs, which therefore he would say were due to the astigmatism of the lens. For instance, some sparks were merely an astigmatic image of the true fact, and in the corners and off on the side he saw sparks which were very similar.

M. DE FONVIELLE (who spoke in French) said he was sorry that he had the honour to be called upon to give his opinion on that occasion, as he arrived in the room late, but he would try to glance at some of the speeches that he had heard from so many distinguished electricians. Sir William Thomson said most eloquently that Mr. Preece was taking the English side of the question, and Mr. Lodge the American side, but he must say that Sir William Thomson had taken the French side and had proposed a revolutionary system which consisted in the building of iron houses. He took the liberty, though a Frenchman, to disagree with the great electrician and to stand with his friend Mr. Preece as an English Conservative of lightning-conductors. Lord Rayleigh said that mathematicians and physicists should unite together, but he supposed that he would agree with him in remarking that Mr. Preece was realising that alliance in a very remarkable manner, as on the one hand he was dealing with a large number of experiments and observations of nature, and on the other his application of statistics, or rather his calculation of probabilities, belonged to one of the highest branches of mathematics. The experiments done in laboratories differed from those which were presented by nature in regard to their size. On the previous day in that very hall his friend M. Janssen had proved by his observations on the action of oxygen on light that in many phenomena there was a coefficient behind varying according to the square or higher power. They might suppose that in electricity the law might relate accordingly to some unknown power, so they must wait for observations of natural phenomena from the clouds. They were so much more bound to wait because photography was now coming to their help, and it was impossible to say what were the powers he referred to until they had seen what photography could do. He would advise the meeting to delay its opinion until the time when his countrymen had erected in Paris the Eiffel Tower, which would be the most extraordinary lightning-conductor in existence, being a thousand feet high, and which would supply unprecedented means for observation and experiments. He must, moreover, state that Paris was practically free from calamities produced by lightning because they had a sufficient number of lightning-rods erected according to the principles so admirably advocated by Mr. Preece. That was strong evidence that Mr. Preece was in the right direction, altogether irrespective of any mathematical or physical question.

Professor GEORGE FORBES said:—Let them keep before their minds in this discussion what the question was which they wished to determine. The question had arisen from Mr. Lodge having come with those experiments to prove that the views of the Committee on Lightning-rods were erroneous. The Committee on Lightning-rods had come to a definite conclusion to make a recommendation that copper should be used for the lightning-rods, and Dr. Lodge had come to say that if iron was not better it certainly was as good; and that was the question which had to be decided. Now Professor Rowland had already said that it was not quite certain that the experiments which Dr. Lodge had brought forward were perfectly conclusive on this point. No one could fail to be enormously impressed with the beauty and the value of those experiments from a scientific point of view; but he thought that it was quite a fair position for Mr. Preece to take up to say that at present they had not proved the fact that the conclusions of the Committee on Lightning-rods ought to be given up. He would illustrate what he meant in this way. They had heard once of Professor Lodge's experiments very clearly put before them in which they had an alternative path either of copper or of iron. Previous to those experiments most persons would have expected that the copper would have been a better conductor for the alternative path. Professor Lodge assured them as the result of his experiments that copper was not the better but was probably the worse of the two.

Now he wished to show them the reason why he thought they were not fully able to accept that experiment as sufficing to abolish copper rods for their lightning-conductors. It was this. In the experiment Professor Lodge had used two condensers, and he had used a special case in which there were two sparks produced beside the alternative path. He asked Professor Lodge to tell them what was the result. He had doubtless tried the experiment when the experiment was

performed in a much smaller way, and more resembling the conditions which existed in an actual phenomenon. Suppose instead of using those two condensers they used the two poles of the Holtz machine, or instead of having two pairs of knobs suppose they used only one pair of knobs. They might connect the poles of the Holtz machine, if they pleased, with a large battery of Leyden jars, and they would get all the better effect. The arrangement then was that they got a spark between the two knobs of the Holtz machine. They connected that by an alternative path and then they tested to see at what distance it was just possible for a spark to take place. He wanted to ask Professor Lodge when that experiment was being performed whether an iron alternative path or a copper alternative path was the better. The circumstances seemed to him to more resemble the circumstances in nature than the arrangement which he had described in his experiment; and he thought the conclusion was that the copper alternative path was the better, which would be an argument in favour of Mr. Preece's view.

Sir JAMES DOUGLASS said the few remarks that he had to make upon this matter were in relation to his experience with a large number of conductors in exposed stations now extending over about forty years. He might say that his experience was comforting to the Committee. His experience was with lighthouse towers; and there they had been following out for nearly the last fifty years the advice of Faraday entirely. For protecting a lighthouse he advised them to start with the base of a metallic lantern. The conductors were of an inch and a half by three-quarters half round; that was to say, the half of an inch-and-a-half copper bar; they were carried down the interior of the tower, on the internal walls of the tower, with branches from all metal work in the tower. The earth was obtained by a copper plate 2 feet 6 inches square, buried at a distance of 15 feet from the tower and about 12 feet from the surface, generally securing damp contact. At exposed stations at sea the bar was carried down to about 8 or 10 feet below low-water spring tides so as to be always immersed in the wave. He might say that during forty years perhaps seven or eight accidents had occurred, but no accidents of a serious nature; and in all cases when an accident had occurred they had been able to discover that it was due to a defect in the conductor. Generally it had been found due to a mechanic who had been about the station who had disconnected the conductor and had not properly connected it again. Therefore those were points which he felt confident were to be got over by more rigid inspection, and more rigid inspection was now being carried out. He for one would feel that he would be perfectly safe in any tower where this system was carried out, and where the conductors were properly looked after. Having them carried down in the interior of the building they had every opportunity of inspecting them, and he rarely visited a lighthouse but what he inspected every connection up and down, and generally tested the conductor with a common linesman's instrument from top to bottom.

There was one practical point on the question of iron *versus* copper, and it was this, the rapid corrosion of iron compared with copper. It was quite possible with an iron conductor in an exposed station, where they were subject to such a corrosion, no matter what their sectional area might be, if they visited that station in the course of seven or eight years they would find very little of that conductor left. He had known bars of large diameter corroding at the most rapid rate possible in this country, and of course it was much more rapid in hotter climates. He only introduced that as a considerable fact of experience with conductors in exposed stations.

There was one point that he had omitted to mention, and it was comforting to Mr. Preece that during forty years where those conductors had been carried out on towers in contact with dwellings only one case of accident had occurred to surrounding dwellings, and there it was due to the imperfection of the conductor in the tower. The mischief was caused to the dwelling by the imperfection of the conductor in the tower; it was not a case of the dwelling being struck from the outside.

Mr. SYDNEY WALKER, speaking from the point of view of the practical engineer, said:—Upon the question of iron or copper for practical purposes, he should

certainly say that iron would not be as good as copper, because, as Sir James Douglass had pointed out, iron would not stand. It was not only a question of the weather, but at the top of a chimney—for instance, at the top of a factory chimney—the bricks are red-hot; and in the case of iron works and other places anybody who examined the top of an iron works chimney would see some material there, some chemical deposit from the chimney, and he did not think that any iron conductor could live in the face of that, otherwise he would say that there is no difference between one and the other.

Mr. BROWN (of Belfast) suggested that if one were to use a revolving camera successive flashes in the same path would be separated on the plate, and it would be easy to calculate the time interval, knowing the rate at which the camera was revolving. He had used a revolving camera himself for the purpose of registering, and he might say from his experience that it would be quite easy to determine the tenth of a second. In order to investigate the other question as to successive flashes in different paths, that could easily be done by setting up one stationary camera to photograph the thing in the ordinary way, having a secondary camera revolving on a vertical axis, and comparing the photographs.

Mr. SYMONS said he ought perhaps to offer some apology for speaking on this subject, but the fact was that it was a thing to which he had devoted his attention for considerably over thirty years. In fact, as far back as 1859 he was present at a discussion on lightning-conductors, the one at which Sir William Thomson made the very remark which had been referred to that day. He dared say Sir William would remember the remark on that occasion, that when he suggested to the Glasgow manufacturers to set up lightning-conductors they all said it was 'cheaper to insure.' Lord Rayleigh said it was desirable to get the evidence of practical men. He had nothing to do with the construction or the erection of lightning-conductors, but all his life it had been a hobby of his own to investigate every accident that he could possibly hear of involving damage by lightning; and in that way he had got, he supposed, experience which was certainly not theoretical, but it was possibly of some value. Then eventually, when it came to be a question of drawing up this code of lightning-conductors, he was one of the Committee, and they did him the honour of making him Secretary, and the consequence was he had had a great deal of evidence brought before him; and he must say that the impression left upon his mind as the result of the whole of his experience was precisely in accordance with that of Sir James Douglass, namely, that, as far as they could judge, if people would only put up conductors precisely in accordance with their rules, fulfilling all those conditions, those conductors were absolutely safe. He had not a shadow of hesitation in saying so. He admitted that accidents had happened now and then to buildings which had conductors, but a reasonable explanation of every one of those accidents to the best of his knowledge was forthcoming. They all knew how very much easier it was to produce destructive criticism than constructive criticism. Professor Lodge's experiments (and he yielded to no one in appreciation of him as an experimenter) were simply laboratory experiments after all, and it seemed to him that what they wanted was something on an infinitely larger scale. He was not going to suggest how they could make artificial lightning, so that they might deal with the actual thing itself, although he must say that the idea had often occurred to him that a great deal of information upon the subject could be obtained, if upon the summit of some of those hills which they knew were most frequently struck, a series of interrupted conductors were put up on tall masts where the lightning would presumably strike, and would strike of course without risk to human life, and they might thus learn a good deal more than they knew at the present time. He certainly did feel most desirous on the one hand that if possible a lightning-conductor should be cheapened and rendered more generally accessible; but on the other hand that they should not simply on the strength (as he said before) of those laboratory experiments allow to go forth from this great Association that there was any uncertainty in the protection of the public buildings throughout the country. It seemed to him that a very serious responsibility attached to those who would make a suggestion of that nature. They had experience, not only in this

country, but, as M. de Fonvielle had said, in France; they had it in Germany; they had it in Austria and in the United States on an enormous scale; and tens of thousands were erected and millions sterling had been invested in the subject, and he must say that it was with considerable hesitation that he would hear it go forth from that room that simply on the strength of some laboratory experiments all that had been done was to be regarded as almost worse than useless. The discussion had already gone on so long that he should be sorry to enter into many of the points upon which he had made some notes; but there were two or three upon which he should certainly like just very briefly indeed to say two or three words.

He had forgotten who it was; but one of the speakers made, he thought, very justifiable allusion to Arago's remarks about the ball of lightning rubbing against his trousers; but as to the existence of ball lightning, or some phenomenon of slow lightning, he had heard of it from so many hundreds of persons in all parts of the country and in all countries of the globe, irrespective of having on one or two occasions seen it himself, that he could not dispute its existence. As for understanding it, he did not. He remembered quite well the experiments that were made—he was not electrician enough to say whether they were correct or not—but experiments were made at one of the meetings of the Society of Telegraph Engineers by Mr. Varley in which he produced something closely analogous to the phenomenon of ball lightning. How far that was or was not the exact thing it was not for him to say.

Then with respect to iron conductors. First of all there was, as Sir James Douglass said, the question of oxidation. He should be told, 'Oh, it can be galvanised.' But he knew enough of galvanised iron to know that galvanised iron was not an everlasting material by any means. And then another thing was, as had been well pointed out, that the gases coming out from many of our factories were seriously injurious. With respect to the area of protection, he knew that there was a little bit of chaff about that diagram, but he did know also that he was within the mark in saying that hundreds of cases had been investigated and that there was not, as regards the area of protection laid down in the report of the Lightning-rod Conference, in the whole world more than two instances, and those were a little bit doubtful, in which anything had been struck within that area of protection. The attacks all round were alarming. One would be afraid to go to church in a thunder storm because the conductor on the top of the church would not protect you. Up to the present time there was not a single case of a church having been struck which was protected with a good and efficient conductor. Churches were struck every year. What happened? Sometimes, as one of their friends said, the bottom of the conductor was let into a paving stone. Away in South Wales, at the Cathedral of St. Asaph, they had a conductor laid into a pickle bottle. Of course if people went into that they would see that it was stupidity to allow a country blacksmith to put them up. There was such a thing as a properly made lightning-conductor. His friend Mr. Preece, in spite of all his attention (and he did work thoroughly hard upon that report) had not thoroughly mastered the report itself. The report suggested that what was called the upper terminal—that was the extreme top—should consist of a blunt point surrounded at about six inches below the top by a small ring from which very sharp needle-points should project. The idea of the Conference in designing that upper terminal was (he was afraid he did not use proper electrical language because, as he said before, he was not an electrician) that the acute points, the very sharp needle-points down below, were to disperse the electricity and act as a preventive; but if a disruptive discharge occurred, if the cloud came up so rapidly that the points could not get the potential down fast enough, and a disruptive discharge came upon the conductor, the absolute top of the conductor was nearly round. And the object of that was this, that if a disruptive discharge fell upon a sharp point it invariably melted it. Just going back to one point with respect to the small wires he felt quite aghast for this reason, that he had been in a dozen of houses which had been struck by lightning, and almost the first thing that was found was that the bells went wrong, and the fact was this, that the lightning as a rule got into the bell-wires; it dispersed them in dust, as a brown mark all round the walls of the room and every

wire was gone. If the old-fashioned conductors as thick as his fingers were to be replaced by something analogous to bell wires he wondered what was to happen after the first flash.

MR. TRUEMAN WOOD wanted to say one word about two of the photographs. The so-called black flash, the dark flash, whatever that was, it certainly was not the result of over-exposure, as had been suggested, because the white flash, which was presumably on that theory less exposed, overrode the black one. Whereas, of course, if the black part was a part of the plate which had received most exposure, the black one would show over the white one. In that other photograph there was an exactly similar dark line which was evidently the result of reflection from the back of the lens, and therefore he thought there could not be the least doubt that this so-called dark flash was really the result of reflection from the other flashes.

THE PRESIDENT: I think, gentlemen, we have now had a great deal of information brought before us, and in order to finish up I will ask in the first place Lord Rayleigh to make a short statement about the black flash, and then I will ask Mr. Lodge to give a reply, and then Mr. Preece will have the opportunity of finishing up with his remarks.

LORD RAYLEIGH said he would repeat the suggestion that Professor Stokes once made. He did not think it had ever appeared in print, and he was not quite sure whether he ought now to mention it, but he was encouraged by Sir William Thomson to do so. He thought there was no doubt, as Mr. Wood had said, that the appearance of the black flash did not suggest that over-exposure was the explanation. Professor Stokes' view was this, he thought that under the influence of a flash the atmospheric gases of oxygen and nitrogen were combined so as to produce considerable quantities of the oxides of nitrogen; that those oxides of nitrogen formed therefore along the line of the flash were highly opaque to the invisible rays at the upper limit of the spectrum to which most of the photographic action was due, and that then when another flash occurred, illuminating the background of the cloud to hide the place where the first flash had been, the mark of the first flash was depicted as a black line on account of its opacity to the general light of the background.

PROFESSOR OLIVER LODGE said so many things had been remarked and so much might be said even that had not been commented upon that one must exercise caution in what one mentions. He must, however, say a few words that had been suggested by the remarks of the various speakers. Mr. Walker and Mr. Symons and also Mr. Preece originally had spoken as if he (Professor Lodge) had especially attacked the report of the Lightning-rod Conference. That he had not done. He had made great use of the report of the Lightning-rod Conference; he thought that they had done a very valuable piece of work. They had collected together all manner of details of destructions and of failures of lightning-rods. The whole of the report was bristling with failures of lightning-rods, so that he was at a loss to understand—no, he did understand how it is. They said that a 'properly constructed' lightning-rod never fails, because whenever a thing fails they always say there is something the matter with it. They generally say bad earth; but why a thing ought to have such an extraordinarily good earth he never could tell. What is the difference between one end of the conductor and the other? They stuck three points at this end and they wanted a lot of rods at that end. Suppose it was reversed; why they would have the rods in the sky and the points down below. Why should one end have to be treated so very carefully and the other end be left to itself? As far as protection is concerned three points at the top and the three points at the bottom ought to do equally well. Of course it might be inconvenient to have the ground ploughed up, and you might have the ground and water-pipes broken if you have not good earth. He said they ought to have a good deep earth. Flashes ought not to spit off from the conductor to the gas apparatus, nor to explode gunpowder, nor run along gas-pipes and play the fool dancing along any part above the earth. It did not do that because it met with obstruction and impedance—he did not care what they call it, a spurious resistance—they might use the word resistance if they liked, but it was not what they ordinarily called resistance, it was like inertia. It was like having to move

a great weight ; there is no resistance to its motion, you may knock it about with a hammer and expect it to fly to the other end of the room, but it does not move, although you may knock the hammer to pieces and do a great deal of damage to it. That was the kind of obstruction that was met with in the lightning-conductor. As regarded the failures of properly constructed lightning-conductors he wanted to know from Mr. Symons (there would be plenty of opportunities for continuing this discussion in print) why had M. Melsen's Hôtel de Ville at Brussels got set on fire by a lightning flash? because if anything is well protected and admirably and thoroughly protected according to orthodox principles that building was safe. He (Professor Lodge) thought it was protected too. When he spoke of its not being completely safe he did not mean, and he never thought of meaning, that lightning-conductors are of no use. They are of very much use, but they may occasionally and he believed do occasionally fail. M. de Fonvielle spoke of the great experience Mr. Preece had had and also of the great experience that they had had in Paris with all manner of conductors ; for lightning-posts and things like that they did not fail much. But then a lightning-post and an obelisk and a lighthouse even are the easiest possible things to protect ; there is just the one column and if you stick one protector down there is not much chance of its splitting, or of its doing much damage to anything else. In the Monument of London the handrail of the staircase, he believed, is the lightning-conductor ; he did not know what it would feel like when it was struck ; he dared say it had been struck, probably in the night when nobody was there, but he believed it had not been damaged in the least bit. It was not much use to protect powder magazines and houses where there is escaping gas. If the lightning flash went down near a leaden gas-pipe it would very likely fuse the pipe, and they would have the house burnt down. They might not know that the house had been struck, but they would wake up in the morning and find themselves burnt.

Professor Forbes asked him to say why he did not use one pair of knobs instead of two pairs of knobs to try the experiment with. If Professor Forbes tried the one pair of knobs he would find that he could not perform the experiment at all ; there must be two pairs of knobs somewhere.

With these oscillating currents, which are of extremely great frequency (there are something like a million a second), it is only the outer surface that is obstructed. It is due to the space surrounding the conductor, and it is not due to the material of the conductor. It is the tube of the conductor that flies ; therefore the conductor does not get magnetised at all, whether iron or copper ; the thing does not care about its permeability, its magnetic properties, or its conductivity much. The current is very great even from an ordinary Leyden jar ; the current produced when discharging is about 3,000 ampères. The current in a lightning flash is, no doubt, enormous ; he should think a million ampères for the time it lasts. That it is very great is shown by the heating powers and the destructive powers that it has, only the duration is so extremely small. Hence it is that the impedance is so very great, because there was a certain amount of ohms, and then there was a tremendous current, and so they got the tremendous difference of potential at the end and the liability to spit off. Seeing that only the outer surface conducts, what is the good of the inside of the rod? It may have to conduct the heat away, and so prevent the heating, or it may not have time to do that ; probably there is no particular good in it, but if they were going to have a tube they had better have a flat tube, and it was also better to have a strand of separated wires or have a series of wires about the size of telegraph wires. Mr. Preece knew very well that the iron lightning-conductors on the telegraph posts protected them, and a house would be protected in a similar way, and chiefly by putting a great number of common galvanised wires up. That was his view, but it was not authoritative. If what he said was authoritative, and would be sent forth as a statement made in that room, of course he would hold his tongue ; but of course one simply said that which one thinks at the time. It is found that all the failures of lightning-conductors are due to the spitting off, are due to this high potential, are due to the impedance of it, the obstruction of it—to the fact that it does not conduct so easily as they would expect it to do, and not due to the melting of it. Mr. Symons, in his Lightning-

rod Conference Report, gives in Appendix K a list of conductors which had been melted by the flash, and he apologises for the shortness of the list. No apology was necessary, for they very seldom got melted, and if they were to analyse those Mr. Symons gave they would find in every case that the upper terminals had been melted (as they might have expected) and not the full length of the conductor. There was only one case, and that was of a bell-wire. When bell-wires were used then they were melted, but he did not want wires to be put up which were of the thickness of bell-wires.

Iron buildings, as Sir William Thomson had said, are practically safe for powder magazines. They are the safest things that could be made, but even with them some little care must be taken; the iron must be in absolutely good connection all through. If there is a gap left anywhere there may be a spark at that gap. When an iron building is struck they might have the electricity surging about in all directions, and they might get sparks in the most unexpected places and for the most apparently ridiculous reason. The gap might be only half an inch long or a quarter of an inch long, but that would be quite sufficient to light the gas and do all the damage. It was that danger in the case of gas and in powder magazines of having gaps only a quarter of an inch long, and they might get them where they least expected them.

As regards the possible effect of sound waves he would just call attention to one little experiment which was not his at all—it was first made by Dr. Guthrie, but it had been called attention to at the Physical Society afresh and independently by Mr. Cooke, he thought. They took a discharging Leyden jar, which, as he had often said, gives ether waves of a calculable length. Now this modification of the experiment had been made by his friend Mr. Chattock. That gentleman took a little tube like a resonant tube, sprinkled powder in it, and when the spark crossed near the mouth of that tube it was drawn into it like the ripples in the sand, indicating that a longitudinal wave had done that. These longitudinal waves were extremely short, about a millimetre in length. Sound waves are practically one-millionth of a light wave. That was evidence of the oscillation. The spark is subject to longitudinal waves due to vibration sound waves, about a millimetre long, which throw the sand into ripples. It may be those longitudinal sound waves of which Sir William Thomson spoke which may from some action or other precipitate a response in the neighbourhood, though no doubt there are other causes too.

Mr. PREECE said he would not occupy their time much, because there would be other occasions when the points at difference between them would be argued. He might say they had dwindled down to a very small thing indeed. As regarded the question of iron and copper, in answer to Sir William Thomson, most, in fact all, of those lightning-protectors of which he had actual experience were of iron, and he had always been, as most of them knew who had read the reports he had written, a great advocate of iron. He thought the use of copper to the extent to which it was used introduced a needless expense into the erection of lightning-protectors. His own impression was that every private house could be thoroughly protected, according to the recommendations of this Lightning-rod Conference, for at most a pound. Anybody could buy a coil of stranded iron rope, and if they took an iron rope about a quarter of an inch in diameter, with the finial Mr. Symons had referred to, he believed that they could safely protect their houses with lightning-protectors for a few shillings, instead of now, where copper was employed, indulging in the expenditure of a few pounds.

The PRESIDENT said he was sure they had all heard with very great pleasure this discussion that had taken place, and it was with very great diffidence indeed that he felt called upon by his position as President rather than by any desire to do so to say a few words in summing up what seemed to him the result of the discussion. He was glad to say that he had had no experience of lightning. It was not an agreeable thing to have anything to do with. However it was most closely allied—there was no doubt about it—to static electricity, which he had heretofore looked upon as one of the most beautiful but useless adaptations of nature, and he hoped now that these experiments with what had been called static electricity would gain fresh interest from the practical applications that

might be likely to be derived from it. It was very important to observe that there were a number of experiments that had taken place, especially in connection with some tramway lines, with telegraph instruments and with telephones with effects that had taken place at terminal stations at considerable distances from the lightning which required to be investigated, and about which they knew very little, and which had not been considered very much.

Mr. PREECE said he meant to point out what Professor Fitzgerald was now saying, that they had had experience in their telephone exchanges and in their electric light installations where there was a mere metallic conductor, and their experience was that in practice it was exactly what Professor Fitzgerald now referred to, and it was a most interesting point.

The PRESIDENT said he thought they were all very much obliged to Professor Lodge for his experiment, because heretofore he thought there had been little or no experimental observation of this particular point, and it was a very important thing to them, especially if telephones were likely to become of use on a large scale, that during thunder storms, if they could possibly do it, they should protect people from injurious effects owing to the presence of the thunder storm, perhaps at a considerable distance from the person that was using the telephone. It was very analogous, it seemed to him, to Professor Lodge's experiments, and they were very much to the point in that connection. He was inclined to think that the experiment that Professor Lodge had performed was not exactly analogous and in many ways was not at all analogous to a lightning flash. Mr. Preece had called attention to a fact that a lightning flash was very much more like a discharge between the plates of a condenser, much more like the breaking down of the insulation in a Leyden jar when it burst through the glass. Mr. Lodge's experiments had not been on the effect of putting a point upon one of the plates of the air-condenser, and if he did make some experiments on it, he thought it would be found there would be a considerable diminution of sparks.

Professor LODGE: If you have read my paper you will find those experiments have been made too.

The PRESIDENT said he was afraid he had not studied the thing completely, but the experiments that were alluded to that day were not exactly analogous.

Professor LODGE: No.

The PRESIDENT, continuing, said he thought it would have been well if they had been told of experiments which were exactly analogous. There was a question with respect to the alternation of currents, and he would call Mr. Preece's attention to this, that even though there might not be millions of alternations per second a great many of the effects of the alternating current would be produced by an extremely sudden current of very short duration. A great many of them would be produced by a single sudden discharge of a millionth of a second. It might be that some of them would not, but a great number of the effects would be, and he thought also a great number of effects would be produced similar to those that Professor Hertz had observed, where at a distance from a spark he had observed electro-magnetic effects. Those might also cause electro-magnetic effects in the inside of the house, due to a spark of electricity occurring outside the house. He would like to make one other remark. The globular lightning might possibly be due to the dissociation of the molecules of the air, if there be a region of the air in which there were atoms going about by themselves, combining among themselves and producing an illuminating part of the air, the original dissociation of the atoms having been produced by some electrical action.

In conclusion, he thought the principal thing for them to pay attention to was that 'prevention is better than cure.' As M. de Fonvielle had reminded them, there was very little doubt but that the presence of a very considerable number of lightning-conductors undoubtedly affords a great deal of protection to the area within which they exist. M. de Fonvielle had remarked that in the city of Paris they hardly ever had any accidents from lightning. So that it is very desirable that if possible the whole country should be covered with lightning-conductors in order that they might have as many points as possible, and thus, as far as they could, prevent the occurrence of lightning. There was no doubt that when a flash

occurred it was extremely disagreeable, and that they had better take example by the old rule that 'absence of body' is better than 'presence of mind' and avoid being near a flash if they could.

He did not think there was any doubt, quite independent of any experiments of Mr. Lodge's, that, as a matter of experience, lightning-conductors have protected buildings, whatever the explanation of it is, nor that there was any doubt that we have been right on the whole in our methods of erecting conductors. Perhaps there are improvements possible; perhaps we might be able to protect ourselves from those unfortunate discharges that occur in telephones, and so forth; but, as a whole, lightning-conductors have been a great protection to mankind from danger by lightning. That is undoubtedly the result of our experience.

2. *On the Burning by Lightning of a Magnet on a Generating Dynamo at the Waterfall on the Bush River, County Antrim, belonging to the Giant's Causeway and Portrush Electric Railway and Tramway Company.* By ANTHONY TRAILL, LL.D., M.D.

I happened last month to be travelling on this line in a thunderstorm. The electric car was going well, at about twelve miles an hour, when I observed that the main power of the current suddenly left us, and we were with difficulty able, at a very reduced speed, to finish our journey. On arriving at Bushmills I drove up to the waterfall, on the river Bush, where the electric station is situated, and there found that one of the magnets of the five-ton dynamo (Elwell-Parker) had become short-circuited, the series wire and shunt wire having been fused into each other, and the thick ply of all insulating material burnt up. The turbine-driver stated that just at the moment of a heavy thunderclap there was a tremendous flash of lightning all through the room, and the rupture of the magnet took place at that instant.

On a former occasion during a thunderstorm there was great consternation both in the generating-room, where there were great flashes on the brushes of the dynamo which were burned, and on the car, which was travelling on the line, where the lightning seemed to play all round the car for some moments, and especially to flash on the brushes and about the starting commutator which puts on or cuts off the current from the car. The driver of the car was so alarmed as to stop the car and jump off, but no injury was done to the car or to the motor apparatus in it.

Query: Should lightning-conductors be placed at the generating-station and along the main line?

3. *Analyse chronométrique des Phénomènes électriques lumineux.*
Par Dr. J. JANSSEN.

Le principe du revolver photographique proposé par l'auteur en 1874 à propos du Passage de Vénus, et qui a été appliqué depuis si heureusement par M. Marey à l'analyse des mouvements du vol des oiseaux, peut donner également la solution de divers problèmes de physique et de mécanique, et notamment celui où l'on se propose d'analyser les circonstances de la propagation des phénomènes lumineux dans les étincelles électriques, les décharges, la foudre, etc.

L'appareil consiste en une chambre photographique portant deux objectifs de même ouverture et foyer. L'un des objectifs donne les images sur un disque animé d'un mouvement de rotation rapide et portant une pellicule photographique sensible. L'autre objectif donne les images sur une pellicule semblable mais fixe.

Quand l'appareil est en mouvement on en excite l'étincelle, ou bien si les étincelles se succèdent d'elles-mêmes on découvre un instant les objectifs.

Deux images se forment ainsi, l'une sur le disque fixe, et celle-ci est l'image normale, tandis que celle du disque mobile sera plus ou moins déformée si le phénomène ne s'est pas produit assez instantanément pour ne pas être influencé par le mouvement.

La comparaison de cette dernière image avec l'image normale conduira à reconnaître et à mesurer le temps écoulé pendant la production successive des diverses parties de l'étincelle.

On n'a exécuté encore que quelques expériences. Elles ont été faites sur des étincelles produites avec une bobine de Rhumkorff; et déjà on a pu constater que dans la production des étincelles à plusieurs branches partant d'un même pôle la production des diverses branches n'est pas simultanée mais successive.

Pour une même étincelle même la manifestation du phénomène lumineux donne lieu à des circonstances singulières sur lesquelles nous aurons à revenir.

Ces expériences seront poursuivies. Elles seront appliquées notamment à l'étude des phénomènes de la foudre.

4. *Report of the Committee for constructing and issuing Practical Standards for use in Electrical Measurements.*—See Reports, p. 55.

5. *On Standards of Electrical Resistance.* By R. T. GLAZEBROOK, F.R.S.

6. *On the C.G.S. Units of Measurement.* By W. H. PREECE, F.R.S.

It is suggested that the unit of work equivalent to 10^7 ergs be called the *Joule*, as proposed by Sir William Siemens. We should then have these relations:—

One joule = 10^7 ergs = .24 calorie (gramme-water degree).

One watt = one joule per second = .24 calorie per second.

One calorie = 4.2 joules = 42000000 ergs.

One British thermal unit (pound-water degree Fahr.) = 1058 joules = 252 calories.

The inconvenience of making the volt 10^8 units instead of 10^9 C.G.S. units, the very rough approximation of the legal ohm, and the necessity for some unit magnetic field are considered, and it is recommended that the standard of pure copper should be redetermined, for Matthiessen's standard is known to be wrong.

7. *Electrometric Determination of 'v.'*

By Professors Sir W. THOMSON, F.R.S., AYRTON, F.R.S., and PERRY, F.R.S.

WEDNESDAY, SEPTEMBER 12.

The following Reports and Papers were read:—

1. *Report of the Committee for considering the desirability of introducing a Uniform Nomenclature for the Fundamental Units of Mechanics.*—See Reports, p. 27.

2. *Second Report on our Experimental Knowledge of the Properties of Matter.* By P. T. MAIN, M.A.—See Reports, p. 465.

3. *On the Mechanical Arrangements of the Analytical Engine of the late Charles Babbage, F.R.S.* By Major-General H. P. BABBAGE.

The object of this paper is to give some idea of the mechanical contrivances employed to govern and control the analytical engine of Charles Babbage. It is scarcely possible to give in a short space a full abstract of what is already very condensed. Those who desire further information are referred to a volume of

about 400 pages now in the press at Messrs. Clowes & Sons', Ltd., containing nearly all that has been published relating to the calculating machines of Charles Babbage.

The paper sketches the origin of the engine in 1833-4 and describes the chief means employed to direct it. 1st. The cards which have been already more or less described. 2nd. The principle of 'chain,' by which any possible contingency among many may be provided for. There is a movable block for each event anticipated, which on the occurrence of the event is moved into a certain position; a lever or arm is made to act, so that when the movable block is in that position it is moved and passes on the motion to something else, effecting whatever change may be desired in the mechanism. If the block is not in that position, the lever moves in vain. This arrangement is applicable to one or to many events. The shape of the block may be varied to suit different purposes. This principle is used to put various parts of the engine into and out of gear automatically. It is also used in anticipating carriage, which is described at some length, showing how by the use of 'chain' every possible case of carriage in n figures may be mastered and the whole effected simultaneously, the mechanism indeed presenting to the eye a sort of picture of each combination as it occurs. A double camb is explained, which is extensively used for producing intermittent motion required at fixed times.

The frequent use of counting apparatus of sorts for recording and regulating the various trains of motion is mentioned, and the advisability of making these trains as short as possible and taking a fresh start from the motive power is urged. Various other details are more or less alluded to or discussed.

The notations and drawings (of which there is a full list in the forthcoming volume) are mentioned, and the system of 'mechanical notation' used by the inventor (see Proceedings of B. A. for 1855 at Glasgow) is mentioned; an instance of its practical utility is given, and its being taught in art and technical schools is recommended.

As regards the report of the Committee presented to the B. A. in 1878, it is urged that the powers of the analytical engine are not limited to the production of a 'single numerical result,' but can follow the mathematician wherever he can point the way, and that its processes (including division) are not tentative except so far as the mathematician makes them. Some further objections are made to certain points in the report, which, considering the improbability of the engine ever being constructed, may be here passed over. It is admitted that the scope and powers of the design may be very considerably restricted, with the result of leaving a machine which would still be excessively useful and which would inevitably lead the way to further progress.

It may here be stated that a piece of machinery working to 29 places of figures, and embodying the anticipating carriage, was shown during the meeting to several who desired to see it. The anticipating carriage works perfectly, and was much admired by those who saw it.

4. *On a Modification of Maxwell's Equations of Electromagnetic Waves.*
By Professor H. A. ROWLAND.

5. *On a Photographic Image of an Electric Arc Lamp, probably due to Phosphorescence in the Eye, and on some Photographs of an Eclipse of the Moon.* By FRIESE GREENE.

The eye was exposed to a 2,000 candle lamp, the current was switched off, and a sensitive plate was immediately held before the eye. Some of the plates afterwards showed a minute picture of the glowing carbons.

Photographs of the moon were also exhibited which had been taken by what was practically a Newtonian telescope without a lens.

6. *On the Errors of the Argument of Statistical Tables.*

By JOSEPH KLEIBER.

The object of the paper is to show that statistical tables and generally tables giving the result of observations on two covariable quantities are *not invertible*, the values of the function not corresponding exactly to the values of the argument as indicated in the table. The correction to be applied to the argument for the inversion of the table may be calculated by very simple formulæ. If we have a table giving a series of values of y for equidistant values of x , and we take for unity the distance between two consecutive values of x , then the true value of an argument x_i is represented by the integral

$$\int_{x_i - \frac{1}{2}}^{x_i + \frac{1}{2}} xf(x)dx \quad . \quad . \quad . \quad . \quad (1)$$

$f(x)$ being the probability curve of x , which may be approximately found by considering the distribution of the number of cases, when x had given values x_1, x_2, \dots . If we have, for instance, n_1 cases of x being equal to x_i , and the total number of observations = n , then

$$n_i = n \int_{x_i - \frac{1}{2}}^{x_i + \frac{1}{2}} f(x)dx \quad . \quad . \quad . \quad . \quad (2)$$

From a series of values of n a parabolical expression for $f(x)$ may be calculated by means of the formula (2), and this expression being substituted in (1) gives with sufficient accuracy the required correction.

Ex.—In the simplest case of three observations being given, corresponding to the arguments $y = -1, 0, 1$, and the number of cases of $x = -1, 0, 1$, being respectively n_{-1}, n_0, n_1 , we find for the correction of the value $x = 0$ the formulæ

$$\frac{1n_1 - n_{-1}}{8n_1 + n_0 + n_{-1}}$$

if we have for $f(x)$ a linear expression, and

$$\frac{1}{24} \frac{n_1 - n_{-1}}{n_0}$$

if $f(x)$ is represented by a parabola of the second order; and similar formulæ may be found for higher orders of parabolæ and larger numbers of arguments. The paper will be prepared for publication in the 'Philosophical Magazine.' Examples of application to meteorological tables will be given in the 'Meteorologische Zeitschrift.'

7. *On Geometry of Four Dimensions.* By EDWARD T. DIXON.

In this paper the author begins by pointing out that the principles of geometry of four or any number of dimensions might be worked out analytically, even if they could not be interpreted. He then proceeded to explain how it was possible either to conceive a fourth independent direction or to graphically interpret geometry of four dimensions without this conception by regarding the density of a solid as a geometrical dimension analogous to length. Thus mass became a geometrical dimension as well as length, area, and volume, and any equation in four variables might be graphically represented by a solid body of varying density.

8. *A Suggestion from the Bologna Academy of Science towards an agreement on the Initial Meridian for the Universal Hour.* By Dr. CÆS. TONDINI DE QUARENGHI.

In a letter dated June 18, 1879, to the Secretary of State for the Colonies, and relating to the choice of the initial meridian for the universal hour, Sir G. B.

Airy, Astronomer Royal of Greenwich said: 'Nearly all navigation is based on the Nautical Almanack, which is based on Greenwich observations and referred to Greenwich meridian. . . . But I, as Superintendent of the Greenwich Observatory, entirely repudiate the idea of founding any claim on this.' Unfortunately this advice has not been listened to, and though, to use Dr. Struve's expression in his Report on the Washington Conference of 1884, 'a law relative to the unification of time notation is of less relative importance to the navigator,' the preference there given to Greenwich was almost exclusively based on the argument disclaimed by Sir G. B. Airy.

A comparison more or less derogatory to the Paris Observatory was also, unfortunately, transparent; which, of course, could not fail to be unfavourably resented. The result was that France, which had propounded the principle of neutrality or internationality, abstained from voting. The same did Brazil. Now, as it has been there remarked, any resolution passed without the consent of France would not answer the scope of the Conference.

That things are now no more advanced than before the Washington Conference is proved by the very message of the President of the United States to the Congress, dated January 9, 1888, recommending the Government 'to take action to *approve* the resolutions passed in 1884 and to invite the Powers to accede to them.' They are, consequently, not approved yet, nor have the Powers acceded yet to them.

Moreover, the delegates of the 26 Powers there represented declared, from the very beginning, that their presence there was only *ad referendum*, and could not in any way bind their respective Governments. What *these* consequently really think on the subject is unknown, and they are still at liberty of giving or refusing their adhesion. Other Governments not represented at Washington, say Roumania and China, may claim a right to give an opinion, which may equally result either in diminishing or increasing the opposition.

On the other hand, the urgency of the unification of time is every day more keenly felt, and Mr. Sandford Fleming, its fervent promoter, can now safely rely on general opinion. 'All sciences,' says again Dr. Struve, 'are in common interested in it,' and he expresses even the hope that 'it might be arranged to come to pass in 1890.'

Finally the simultaneous use of more than one initial meridian is acknowledged not to be without some advantage for science, as stated in M. Caspari's Report for the French 'Commission de l'Unification des longitudes et des heures' (August 1884). It cannot, for instance, be denied that they offer a means of controlling and securing the correctness of 'Ephemerides.'

For all these reasons, and to prevent the unification of time being indefinitely postponed for want of agreement on the initial meridian, the Bologna Academy of Science submits to the British Association the following suggestion contained in a Note of theirs recently addressed to all scientific bodies represented at the festivals of the eighth centenary of the Bologna University in June last, viz.—

'That, navigators and astronomers being at liberty to go on using their own initial meridians, another truly international meridian be chosen for all other purposes for which the unification of time is required. That, moreover, since the Jerusalem meridian has already the suffrages of scientific authorities, its appropriateness to serve as the universal initial meridian be seriously taken into consideration.'

SECTION B.—CHEMICAL SCIENCE.

PRESIDENT OF THE SECTION—Professor W. A. TILDEN, D.Sc., F.R.S., F.C.S.

THURSDAY, SEPTEMBER 6.

The PRESIDENT delivered the following Address:—

A PART of the duty which devolves upon the President of a Section of the British Association consists in delivering an address, and the knowledge that a pretty full liberty of choice is permitted in regard to the selection of a subject is the only source of comfort which serves to alleviate the onerous nature of the task.

It seemed to me that the time is gone by when an attempt to review progress over the whole field of chemical science is likely to be useful or even possible, and an account of what is being done within the narrow limits of those parts of the science to which I have been able to give special attention would be ill-adapted to the character of a speech addressed to the members of the Section collectively. The fact that at the last meeting of the Association a Committee was appointed to inquire into the methods at present adopted for teaching chemistry suggested that, as I had not been able to accept an invitation to join this Committee, I might make use of this opportunity for contributing to the discussion. The first report of the Committee will be received with much interest by the Section. As might be expected, it embodies the expression of many varieties of opinion.

The existence of chemistry as a department of science not merely requiring the observation of facts that are to be made useful, but seeking in the accumulated stores of observation to discover law, is a thing of comparatively recent growth. How chemistry arose out of alchemy I need not remind you, but the connection between the study of chemistry and that of medicine, and the maintenance of this connection down to even the present generation, is illustrated by the fact that a large number of men who have become eminent as chemists began their career in the surgery or the pharmacy. Black, Davy, Berzelius, Wollaston, Wöhler, Wurtz, Andrews, and W. A. Miller began by the study of medicine, whilst Scheele, H. Rose, and the great names of Liebig and Dumas are to be found in the long roll of those who received their earliest notions of chemistry in the pharmaceutical laboratory. Chemistry has been gradually emancipated from these associations with enormous advantage to both sides. So long as technical purposes alone were held in view a scientific chemistry could not exist, but no sooner did the study take an independent form and direction than multitudes of useful applications of the facts discovered became apparent.

It is only within a comparatively few years, however, that universities, in this country at least, have ceased to deal with chemistry as a kind of poor relation or humble follower of medicine, and have permitted her to emerge from the cellars of a museum or school of anatomy and have given her a commodious dwelling in the fair light of day.

In the old time such instruction in chemistry as was given in the universities and mining or technical schools seems to have taken the form of lectures read by the professor, and access to a laboratory for practical manipulation seems to have been a high privilege accorded only under exceptional circumstances to the few. We are told, for example, that when Liebig went to Paris in 1823 he applied to

Gay-Lussac for practical instruction at first without success, and that admission to the laboratory of the *École Polytechnique* was ultimately granted him only through the intervention of Von Humboldt.

In a great many cases the student of chemistry must have been almost entirely dependent upon private study, though books were scarce and materials more costly than now. Davy, for example, seems to have had no instruction whatever previous to his appointment as assistant to Dr. Beddoes at the Pneumatic Institute at Bristol.

Doubtless, therefore, the recollection of his own early difficulties when seeking instruction contributed largely to influence Liebig in the establishment of the laboratory in the University of Giessen, and in the adoption of the principles which guided his teaching there. For the first time in the history of chemistry students met not merely to listen to the discourse of a professor concerning his own experiments and conclusions, but to examine for themselves the basis of the theories taught, to learn the processes of analysis, and by independent investigation to extend the boundaries of existing knowledge.

The fame of the new school spread fast and far, and soon men from every part of the civilised world assembled to share in the advantages offered. The influence of the new method can be estimated when we reflect that nearly all the now passing generation of chemists in England and America obtained the greater part of their training in Liebig's laboratory; and as a large number of them have been teachers, it may be assumed that they transplanted into their own countries the methods they had learnt from the great German master.

It was not till 1846, long after the school at Giessen had risen into fame, that in England a sense of our deficiencies in respect to provision for teaching chemistry was felt strongly enough to lead to the establishment of a college of chemistry. At that time the Professor of Chemistry at Oxford was also Professor of Botany. At Cambridge it was thought praise and boast enough that the occupant of the chair of chemistry had, during more than thirty years, frequently resided at the University and every year gave a course of lectures. The Jacksonian professorship was not then, as now, in the possession of a chemist. University College, London, had at this period a very distinguished man in the chair of chemistry, but it was only in 1848 that a commodious laboratory was provided by public subscription, raised in commemoration of the services of Dr. Birkbeck in promoting popular education. In that year Fownes was appointed to co-operate with Graham in the work of teaching, though his premature death soon after left but little time for the fulfilment of the rich promise of his earlier years. At Manchester John Owens had died in 1846, leaving the bulk of his estate for the purpose of establishing a university in Manchester, but as yet the Owens College was not.

The foundation of the College of Chemistry in 1846 was therefore an event of supreme importance in the history of chemical teaching in this country; and though at the time some dissatisfaction was expressed at the choice of the professor selected to direct the work, who, though a distinguished pupil of Liebig, was not an Englishman, all British chemists now concur in believing the choice to have been a most fortunate one. The great majority of my contemporaries having begun, continued, or ended their studies in Oxford Street, they and all who have come under Dr. Hofmann's teaching know how vast was his capacity for work and how marvellous was the power he possessed of communicating his own enthusiasm to his pupils.

Since the time of which I have been speaking the means of instruction in science in England have multiplied enormously. In University College, London, founded in 1828, and in Owens College, Manchester, founded in 1851, not only have chairs of chemistry existed from the first, but they have been occupied by a succession of chemists of the highest eminence. But long after 1846 the whole of the serious teaching of scientific chemistry was accomplished at the College of Chemistry, and it was nigh upon twenty years before the Manchester school began to attract considerable notice.

In 1872-3 the movement set in which has resulted in the erection of colleges for higher instruction at a number of important English and Welsh towns. These,

together with the pre-existent Queen's Colleges in Ireland and the Universities of more ancient foundation in the three kingdoms, are for the most part provided with pretty good laboratories and a competent staff. We have also the Normal School of Science and the Institute raised by the City and Guilds of London at South Kensington, and its Associate College at Finsbury. England is therefore at the present time as well provided with *places* of instruction for the study of chemistry as any country in the world.

And a very large proportion of the professors or heads of the chemical schools in the colleges and universities of the United Kingdom have shown by their own activity in research that they are qualified to give instruction of the highest kind, and are ready to train young chemists in the art as well as in the theory of their subject.

It is therefore no longer true that a student desiring to become a scientific chemist must needs choose between a single institution in London and another in Manchester, or must seek the instruction which he cannot get at home in the laboratory of a foreign university. As an element in a liberal education the position of chemistry is also considerably in advance of what it was twenty years ago.

It is nevertheless true that increased opportunities for study, a considerable supply of capable teachers, and an enormous body of students have not produced such an amount of original investigation, or even of accurate analytical work, as might reasonably be expected. A full and complete explanation of all the influences which contribute to this result would be difficult; but I think the apparent inactivity of the chemical schools in this country is not generally the fault of the professors, but is chargeable in the main to the ignorance, and partly to the indifference, of the public. There exists as yet no intelligent feeling in favour of learning, nor indeed in favour of any sort of education, unless there is expectation of direct returns in the form of obvious practical results. It is this which animates the present popular movement in favour of so-called 'technical' education. That part of the attention of the nation which can be spared from the contemplation of Irish affairs is concentrated upon the problem of how to make every little boy learn the rudiments of chemistry, whether he likes it or not, whilst there are comparatively few people interested in the question of how to provide means and instruction for those who are capable and desirous of attaining to a mastery of the subject. Moreover, the public have not yet grasped this truth, that, so far as chemistry is concerned, it is of very little consequence to the great metallurgical and chemical industries whether the workpeople do or do not know a little chemistry, though it is important that they should be intelligent enough to obey orders. What is wanted is that every manufacturer and manager should himself be an accomplished engineer and chemist, trained to observe, to reason, and to solve problems for himself.

In the case of chemistry this absence of sentiment in favour of concentration and thoroughness, and the demand for superficiality, if only it can be had wholesale, tells in a variety of ways. The governing bodies who control the various colleges and universities, and the public generally, cannot understand that good and useful work is being done unless it can be shown in the form of passes at examinations. Though I most firmly believe in the necessity for examinations, serious mischief begins when they are regarded as the end itself, and not as mere incidents in the student's career towards the end, which should be knowledge.

In respect to chemistry this is the disadvantage which attends the operation of such a system as that of the Science and Art Department or of any system under which certificates in connection with individual subjects are granted on easy terms. Especial objection I also feel to such expressions as 'advanced,' used in reference to a particular stage, so commonly misunderstood as they are by the student and his friends, and operating against his further progress.

Reflect also upon the fact that there are only two or three colleges in this country which can boast of more than one professor of chemistry. In nearly all cases one man is called upon to discharge the duty of teaching classes both elementary and advanced, in pure and applied chemistry, inorganic and organic, theoretical and practical. This is a kind of thing which kills specialism, and

without specialists we can have not only no advance, but no efficient teaching of more than rudiments.

That teachers ought to engage in research at all is by no means clear to the public and to those representatives of the public who are charged with the administration of these new institutions. This was illustrated very painfully a few years ago by the conditions under which professors were engaged at a certain college founded, according to the declaration of its promoters, 'by the people for the people,' wherein it was announced in round terms that original research was not wanted, as the college was 'for the good of the many and not for the advantage of the few.' This example of ignorance is only remarkable by reason of its audacity. Probably many people hold a similar view, though few are bold enough to declare it.

Without going far into the discussion of the general question, which is a large one, I may perhaps be allowed to offer a few remarks for the consideration of any of my audience who may perchance incline towards that opinion.

It is only when a teacher occupies himself with research that the most complete guarantee is given that he is interested in his subject and that he is a learner. A popular mistake consists in regarding a professor as a living embodiment of science—complete, infallible, mysterious—whereas in truth he is, or ought to be, only a senior student who devotes the greater part of his time to extending and consolidating his own knowledge for the benefit of those who come to learn of him, not only what lies within the boundaries of the known, but how to penetrate into the far greater region of the unknown. Moreover, the man who has no intellectual independence and simply accepts other people's views without challenge is pretty certain to make the stock of knowledge with which he sets out in life do service to the end. That one may be fitted to form a sound judgment concerning new theories he must be familiar with the methods by which progress is accomplished. The work of investigation then reacts beneficially upon the work of teaching; that is why teachers should be encouraged, nay even required, to investigate, and not because their discoveries may haply prove to be practically useful.

Of course it may be said that there have been distinguished investigators who could not teach, but the converse is not true; every teacher who has attained to eminence as a teacher, who has drawn men after him, who has founded a school of thought, and has left his mark upon his generation, has been an industrious worker in research of some kind. All teachers cannot be expected to reach the same high standard, but this is the ideal after which all must strive, or fail utterly.

The fact that there is as yet little demand among schoolmasters for high attainments in chemistry is another reason why so little is accomplished in the chemical schools. Here again the public is really to blame. It is disgraceful that in all classes of schools, even where chemistry is supposed to be taught, there are but few places where serious employment is found for the well-trained chemist. I could point to several schools, which claim the position of first-rate, where chemistry is taught by masters who have never studied the subject at all, but who are, I suppose, allowed the traditional 'ten minutes' start' with the book. Would the head-masters of such places dare to employ a person to teach mathematics who did not know the first four rules of arithmetic, or another to teach Latin who had not even got through the accidence? I fancy not. This, however, is without exaggeration the exact parallel of the position in which chemistry is placed in the majority of schools. I have heard the excuse that there is a lack of competent teachers. Of course the demand and the supply will react upon each other. When you offer a reasonable stipend, reasonable accommodation for teaching effectively, reasonable leisure for the master's own studies, and a position on the staff not inferior to that of the classical and mathematical masters, I believe that then, but not till then, there will be as many good school teachers of chemistry as there are of other subjects.

I could point to other prominent schools where the chemistry and other branches of science are taught by a peripatetic South Kensington teacher, who arrives weekly with his box of tricks. Not long ago I was invited to distribute the

prizes given in connection with the evening classes in a town not far from Birmingham, and I took the opportunity of advising the teachers present on the occasion to read. One of them said to me afterwards, 'When do you suppose I can read? I am engaged in going round to my schools from nine in the morning till ten at night.' People of this kind do the greater part of the so-called science teaching sustained by the Science and Art Department, and the worthy town councillors and committees who employ them think that these are the people who are going to help the British manufacturer in his struggle against foreign competition under the guidance of the highly trained chemists from the German universities. This would be ludicrous if it were not so very serious.

There is an opportunity at the present time of correcting some of these mistakes, but no advantage is being taken of it. I refer now to the 'technical schools' which are springing up everywhere. There may be a few competent teachers of chemistry employed in some of them, but I find it difficult to think of many examples. The sort of person who is put in charge of these places is usually a schoolmaster, who is allowed, sometimes even after his appointment, to get a short course of qualitative analysis in order to enable him to obtain a certificate which will entitle him to earn grants from the Science and Art Department.

And manufacturers are much to blame. Instead of employing trained chemists the greater number of those who want chemical assistance are satisfied to engage the services of boys who have been to an evening class for a winter or two.

The difficulty of finding a satisfactory career in connection with the subject also accounts for the fact which I fear must be admitted, that chemistry does not attract its due share of the intellect of the nation. Clever young men can usually do better at the law, in medicine, or in commerce than in teaching chemistry or in manufactures in which chemical skill is applicable. So badly educated are many of the young men who commence the study with professional objects in view that it is quite impossible to teach them anything beyond routine analysis, if so much.

I heard lately from a friend of mine a story of a young groom in his employ who cannot read or write, and who declines to be taught to read on the ground that, considering himself pretty smart, he is afraid that 'learning might dull him.' This idea seems to be rather prevalent among certain classes of people, but I can assure those who wish to be chemists that some familiarity with the rule of three, and such a command of English as will enable them to understand words of more than one syllable, will be no obstacle to the acquisition of chemical knowledge.

Three years has hitherto been regarded as the normal period for study. The question arises, Can a young man, previously well educated, expect to become an accomplished chemist, competent to apply his knowledge usefully, by giving the whole of his time to study during *three years*? I believe not.

By reason of the enormous development of the science the position of the student of chemistry is nowadays very different from what it was thirty years ago. Since that time we have not only got a few new elements, a matter of small importance in itself, but new views of the nature of the elements and of their mutual relations. This could hardly have come about but for the recognition of the law of Avogadro as a fundamental principle, upon which we rely as the ultimate criterion by which the true distinction between so-called equivalent weights and molecular ratios has been established. By the gradual evolution of ideas having reference successively to the electro-chemical relations of elements and compounds, the theory of types, and atomicity or valency, we have arrived at notions of chemical constitution based upon the hypothesis of the orderly linking together of atoms. Thirty years ago isomerism had scarcely attracted notice, and carbon compounds were only just beginning to be arranged in homologous series. The general use at the present day of the language of the molecular kinetic theory shows how deeply this theory influences our ideas of the internal constitution of matter. Within the period referred to dissociation has been studied and a vast body of thermo-chemical data have been accumulated. And although the larger portion of the results of this work still await interpretation, dynamical ideas of chemical action are now generally accepted. We have also new methods of investigation, including spectroscopic analysis with all its vast train of results.

When I began chemistry many of these subjects and others had not been heard of. Of course we had our difficulties, and I well remember the puzzles met with in the endeavour to refer compounds to their appropriate types, also the consternation caused in the student's mind and the confusion in his note-book by the successive changes in the atomic weights of carbon, oxygen, sulphur, and the metals. But on the whole there was much less to learn.

It has always been thought essential that a student of chemistry should have some knowledge of physics. It is now more than ever necessary that this knowledge should be extensive, sound, and based upon a good foundation of mathematics. Thirty years ago a hundred pages of Fownes contained all that was thought necessary, but no one nowadays could be satisfied with that. It is now asserted that a young chemist who expects to find a career in industrial chemistry should also have learnt drawing, and more important still that he should have a good general knowledge of mechanics, steam, and building construction. I suppose everyone will agree in adding French and especially German. You see how the requirements expand.

The inference from all this is that it now takes longer to make a chemist than formerly. This is a point of considerable practical importance.

My estimate that a well-educated and intelligent young man will now require five years for the study of chemistry and accessory subjects before he is likely to be of much use will not appear extravagant.

Here one may remark that in order to become a chemist it is before all things necessary to study chemistry. If the greater part of a student's time is to be taken up with other things it is not very clear how this is to be done.

A reform all round is wanted. The mathematics, modern languages, and drawing properly belong to the antecedent school period, and I believe the Institute of Chemistry would greatly promote the interests of the profession if it would impose upon candidates for the Associateship not only a three years' course of training with an examination in practical chemistry at the end, but a severe examination in mathematics, in the English, French, and German languages, and perhaps drawing before matriculation or registration.

A consideration of the present position of the student of chemistry leads naturally to a review of the methods of teaching the subject. Speaking broadly, I suppose nearly all professional chemists who have had the advantage of systematic training have, up to the present time, passed through very much the same kind of course. This consists, as everybody knows, very largely of analytical work, qualitative and quantitative, preceded or followed by the preparation of a number of definite chemical compounds, besides practice in certain very necessary physical determinations, *e.g.*, relative density of solids, liquids, and gases, melting-points, boiling-points, and so forth. There seems now to be a disposition in some quarters to depart from this time-honoured curriculum in favour of a course in which the student is early engaged in some semblance of investigation, and in which he is encouraged to attack difficult problems, which from their fundamental importance offer considerable temptation. I venture to express a hope that this will not be carried too far. Already we are in danger of losing the art of accurate analysis. One constantly meets with young chemists who are ready enough to discuss the constitution of benzene, but who cannot make a reliable combustion. And according to my own experience attempts at research among inexperienced chemists become abortive more frequently in consequence of deficient analytical skill than from any other cause.

One modification I should gladly see generally adopted. I think an unnecessary amount of time is often spent upon qualitative mineral analysis, and an acquaintance with the properties of common and important carbon compounds ought to be acquired at an early stage. Quantitative work might with advantage be taken up much sooner than usual. By that, however, I mean serious work in which good methods are used and every effort made to secure accuracy. I do not believe in the use of rough methods because they are easy; the use of such leads the student to be satisfied with approximations, which after all he will learn soon enough is all that is possible to man. I am very glad to know that I have the

support of one of my predecessors in this chair (Sir Henry Roscoe), whose opinion will carry far greater weight than mine in deprecating premature efforts to engage students in research.¹

But though it does not appear to me to be wise to encourage beginners, without sufficient experience or manipulative skill, to attempt original work, one of the best possible exercises preparatory to original work is to select suitable memoirs, and not only to read them but to work conscientiously through the whole of the preparations and analyses described, following the instructions given. Many of Dr. Hofmann's papers afford excellent examples. So also do the writings of Dr. Perkin and Dr. Frankland, besides those of many other chemists which could easily be selected by the teacher.

An intelligent student, possessing the requisite preliminary knowledge, would obtain much instruction by repeating the work contained in such papers as the following, for example:—Emerson Reynolds on the missing Sulphur Urea ('J. Chem. Soc.' 1869—i.); Fittig and Tollens on the Synthesis of Hydrocarbons of the Benzol Series (Liebig's 'Annalen,' 1864, cxxxi. 303); L. Claisen and Pupils on the introduction of Acid Radicles into Ketones, &c. ('Berichte,' xx.); Lawson and Collie on the action of Heat on Salts of Tetramethyl-Ammonium ('J. Chem. Soc.' June 1888); Thorpe and Hambly on Manganic Trioxide ('J. Chem. Soc.' March 1888); besides many others, including papers on analytical processes. To such as these there might subsequently be added the determination of an atomic weight on the model of one of the best masters, as a discipline which could not fail to be impressive, and full of instruction.

When chemistry is taught, not with professional or technical objects in view, but for the sake of educational effects, as an ingredient in a liberal education, the primary object is to make the pupil observe and think. But with young students it is very important to proceed slowly, for chemistry is really a very difficult subject at first, owing to the variety of strange materials with uncouth names. To reason from particulars to generals is for the unpractised always a difficult process, and in chemistry this is specially the case. With young students it is, in my experience, preferable to adopt a somewhat dogmatic style, which should of course be exchanged for a more cautious one as the pupil proceeds.

Thus the law of Avogadro can only be given at first as a recognised physical law, without much explanation, since the full apprehension of the evidence upon which it rests can only be secured at a late stage of the learner's progress. There is of course great advantage in the use of an inductive method if only it is employed judiciously. Otherwise the result is only confusion.

A number of papers, pamphlets, and text-books have lately appeared, professing to teach the principles of the science practically and by new methods. Most of these turn out, upon inspection, to be very old methods indeed, but there is a small residue of distinctly original character which are sure to attract, as they deserve, considerable attention. The systems I refer to provide a series of problems which the pupils are called upon to solve. According to this plan the student is not allowed peaceably to examine the properties of oxygen or sulphur which he now sees for the first time. He must weigh, and measure, and observe, and then infer. All this coming at once upon the head of a beginner seems to me to be well fitted to drive him to despair.

I well remember the first experiment in chemistry I ever made. It consisted in dissolving zinc in diluted sulphuric acid in an evaporating dish, lighting with a match the bubbles of hydrogen as they rose, and afterwards leaving the solution to crystallise. I was about sixteen, and the bubbles of gas as well as the crystals I afterwards got interested me very much. If at that time I had been made to weigh the zinc and acid, and measure the hydrogen with the object of answering some question about the composition of zinc and hydrogen sulphates, I should have been pretty much in the position of a boy ignorant of geometry shut up with the propositions of Euclid and ordered to give the demonstrations.

I think when we recall such a fact as that Priestley, who discovered oxygen in 1774, failed to the end of his days to understand the process of combustion, and

¹ See Address to Section B, Montreal meeting.

actually wrote, in 1800, a pamphlet in defence of 'phlogiston,' we ought not to be surprised when young people, though born a century later, fail to perceive at once the full significance of facts to which they are introduced for the first time. At the outset you cannot reasonably expect a young student both to observe accurately and infer justly. These two things must be kept separate at first, and for this reason among others I believe that attempts to make young students verify for themselves the fundamental propositions of chemistry will not be successful. One has only to trace the origin of one's own convictions in reference to any important fact or principle to perceive that they very seldom spring into existence suddenly, but almost always commence in vagueness and hesitation, acquiring consistency and solidity only as the result of accumulated experience.

I will not pretend to determine what may be included within the wide circle of the functions of the British Association; but I think I cannot be mistaken in assuming that the advancement of science is dependent in no small degree upon the provision for the efficient teaching of science. I have traced an outline of what has been done in the past, and have endeavoured to show in what respects I think we are deficient at the present time. No matter how ardent may be the aspirations, how earnest the endeavours of the few, progress will be slow unless they are sustained by the sympathy of the many. On one principle the public must surely insist, that only those shall be allowed to teach who know.

The following Reports and Papers were read:—

1. *Report of the Committee for the investigation of the action of Light on the Hydracids of Halogens in presence of Oxygen.*—See Reports, p. 89.

2. *Second Report of the Committee on the Bibliography of Solution.*
See Reports, p. 54.

3. *Second Report of the Committee for investigating the Nature of Solution.*
See Reports, p. 93.

4. *Second Report of the Committee for investigating the Influence of Silicon on the properties of Steel.*—See Reports, p. 69.

5. *On the Study of Mineralogy.* By T. STERRY HUNT, LL.D., F.R.S.

§ 1. Our knowledge of the inorganic kingdom, as seen in this earth, may be comprehended under geography, geology and mineralogy; the latter in its wider sense including all non-organised forms of matter, with their whole dynamical¹ (physical) and chemical history. In didactic language, however, mineralogy is limited to the study of native species, and includes a knowledge alike of their external characters and their chemical relations. The so-called natural-history method in mineralogy, disregarding these latter, is based exclusively on specific

¹ We use the words dynamics and dynamical in the sense in which they are employed by Thomson and Tait in their treatise on *Natural Philosophy*, wherein all those manifestations of force which are neither chemical nor vital (biotic), including, besides ordinary motion, the phenomena of sound, temperature, radiant energy, electricity and magnetism, are embraced under the general title of dynamics, corresponding to what in popular language is designated Physics. Other eminent students of our time have sanctioned this use of the term dynamics, in which they were to a certain extent anticipated by Berzelius, who in 1842 included electricity, magnetism, light and heat—all of which he regarded as affections of matter, and compared their phenomena with those of sound—under the common term of Dynamides. (See Hunt, *Mineral Physiology and Physiography*, p. 13.)

gravity, hardness, optical characters, texture and structure, including crystallisation; while the chemical method regards the results of chemical analysis alone, and mixed methods consider these in connection with crystallisation, and even endeavour to take into account other physical characters. The defects of all the methods hitherto devised are obvious, and no system of classification can be complete which does not assign a value and a place to all characters whatsoever. There exists in the nature of things such an interdependence of these that a true natural system can exclude none. To the establishment of such a system, a clearer view of the nature and relations of physical and chemical phenomena than that generally received will materially aid us.

§ 2. Matter is susceptible of changes of volume of two kinds:—(1) Those produced from without, by variations of temperature and of pressure, which changes are constant and regular. Effecting no essential alteration in species, they may be called *extrinsic* or, as the result of external dynamic agencies, *mechanical* changes. (2) Those which have been described as due to 'internal disturbances,' which effect specific alterations in character. These constitute *chemical* or what may be called *intrinsic* changes, and differ from the last in that, instead of being constant and regular, they are periodic and subordinated to definite and unforeseen relations of volume. Intrinsic changes of volume in matter connote chemical as distinguished from dynamical processes. In chemical union we have intrinsic contraction or condensation (variously designated as interpenetration, compenetration, identification, integration, unification); and in chemical decomposition, intrinsic expansion or division. These changes may be either homogeneous, involving one species of matter, or heterogeneous, involving two or more species. The first includes so-called polymerisation and depolymerisation, which may be described as homogeneous intrinsic union and homogeneous intrinsic division; constituting what we have called collectively *chemical metamorphosis*. Those intrinsic changes which involve two or more species we have included under the title of *chemical metagenesis*; the process being one of heterogeneous intrinsic union or of heterogeneous intrinsic division. In the former, intrinsic contraction involves volumes of unlike species, and in the latter, intrinsic expansion resolves a species into two or more unlike species. The relations to volume of all such changes are most simple and evident in the case of gases and vapours; but the same laws of intrinsic contraction and expansion by volumes apply alike to gases and to the liquid and solid species formed by their condensation. In all of these chemical changes temperature and pressure play an important part, and beyond certain limits the extrinsic or dynamic changes thereby produced themselves provoke chemical changes. These in their turn are accompanied by thermic changes, the study of which is the object of thermo-chemistry.

§ 3. All chemically stable forms of matter may theoretically, by sufficient elevation of temperature, assume, even under the greatest pressure, a gaseous condition; the more or less dense polymeric vapours thus produced being subject to intrinsic expansion or depolymerisation on diminution of pressure. By reduction of temperature these pass, as may be seen under favourable conditions, through successive polymerisations, or processes of intrinsic contraction, into liquid (or solid) species; the passage from the vapour to the liquid being apparently continuous. The ideal gas is wholly obedient to the dynamic influence of pressure, according to Boyle's law, to which the ideal solid is wholly indifferent. These ideal forms are, however, constant only within certain limited ranges of temperature and pressure, beyond which even the so-called permanent gases become liquid or solid by intrinsic changes.

The regularity of the extrinsic variations in volume for gases and vapours, within certain known limits, enables us for such bodies to determine their specific gravity, for which purpose atmospheric air at 0° and 760 mm. is taken as unity. If for this we substitute hydrogen gas (represented as $H_2 = 2.0$), the lightest body known, at the same temperature and pressure, the specific weight of an equal volume of any given vapour or gas, calculated for this standard temperature and pressure, is its equivalent weight, or in the language of the popular hypothesis, the molecular weight of the species. Extending the same method from normal gases

and vapours to polymeric vapours, and thence to liquids and solids, and remembering that none of these forms are stable beyond certain ranges of temperature and pressure, we proceed to determine the specific gravity of all such bodies in terms of the same gaseous unit; the number thus obtained being for each body its equivalent weight. We thus find, as has long been suspected, that the equivalent (or so-called molecular) weights of liquid and solid species are exceedingly elevated. That of water, a litre of which at 100° (its temperature of formation under a pressure of 760 mm.) weighs 958.78 grams, corresponds to 1192 volumes of water vapour at standard temperature and pressure ($H_2O = 17.96$) condensed into a single volume; or to $1192 \times 17.96 = 21,408$, approximately 21,400. Representing by p the empirical equivalent weight, which is really the specific gravity on the hydrogen basis ($H_2 = 2.0$), and by d the specific gravity taking water = 21,400 as unity, we obtain by the formula $p \div d = v$, the reciprocal of the coefficient of the condensation which takes place in the passage of a normal gaseous species, by intrinsic contraction or polymerisation, into the liquid or solid species, the specific gravity of which we have determined by comparison with water.

§ 4. The reciprocal number thus got is, as we shall show, one of great significance. In determining the specific weight of any given liquid or solid species, the fact of prime importance is not simply its specific gravity as compared with water, but the relation of the value thus determined to the equivalent weight, or, in other words, to its specific gravity on the hydrogen basis. It is not d , nor yet p , but the relation $p : d$, as expressed by v . In the case of volatile species the true value of p may be known, but for the comparison of fixed solids, as oxyds, carbonates, and silicates, we deduce from the received formulas an arbitrary value for p by dividing the value calculated therefrom by twice the number of oxygen portions. Thus for MgO , $p = 40 \div 2$; for SiO_2 , $p = 60 \div 4$; for Al_2O_3 , $p = 102 \div 6$; for $SiMg_2O_4$, $p = 140 \div 8$; for $CCaO_3$, $p = 100 \div 6$. For metalline minerals, including metals, and their compounds with S, Se, Te, As, Sb, Bi, the value assumed for p is that got by dividing the empirical equivalent weight by the sum of the valencies.

While the specific gravity of liquid and solid species is represented by d , the hardness, infusibility and insolubility or resistance to chemical change are, for related species, directly as the condensation, or inversely as the value of v . This may be seen in comparing colourless ordinary phosphorus, $v = 17.2$, with the metalloidal form, $v = 13.2$; the isomeric silicates, meionite, $v = 6.5$, and zoisite, $v = 5.3$; or calcite, $v = 6.2$, with dolomite, chalybite and diallogite, $v = 5.2$, and with magnesite and smithsonite, $v = 4.7$; for aragonite, $v = 5.55$. These examples will serve to show the relations between sensible characters and chemical constitution, the interdependence of which must be taken into account in a natural system of mineralogical classification. The differences in hardness and in solubility of the different species just named are familiar to chemists. The behaviour of native silicates with fluorhydric acid, lately studied by J. B. Mackintosh, illustrates in a striking manner the relations between condensation and solubility.

§ 5. The successive forms imposed upon matter give us the order in which such a system of mineralogy should be built up. First, the form which we may call the *chemical form* of the species, either elemental or compound, due to the unknown stochiogenic process, or to subsequent chemical metagenesis. Second, what may be called the *mineralogical form*, which involves the greater or less intrinsic contraction (polymeric condensation) of the normal chemical species—often gaseous or volatile but frequently unknown to us—and the assumption by it of a liquid or solid state, having greater or less specific gravity, hardness, fixity and insolubility, and being metallic or non-metallic, colloidal or crystalline. Third, the *crystalline form*, being the geometric shape assumed by the crystalline individual, which connotes a certain structure, apparent in the cleavage, the varying hardness, and the thermic, optical and electrical relations, of the crystal, but is, notwithstanding its value in determinative mineralogy, the least essential or most accidental form of the mineral species. The significance involved in the note of metallicity is very apparent when we consider the metallic and non-metallic conditions of selenium and of phosphorus, the similar dual conditions of the sulphids of mercury and antimony, the non-metallic and sparry characters of the native sulphids of zinc,

cadmium and arsenic, and the singular metallic character assumed by the complex tungstates or Tungstometalloids, known as tungsten bronzes. These, with the not less remarkably complex soluble tungstates or Tungstosalinoids, and the native tungstic species, make the Tungstates one of the most instructive orders known.

§ 6. The author has elsewhere proposed to divide the mineral kingdom into four classes, including (1) Metalline, (2) Oxydised, (3) Haloid, (4) Pyricaustate (combustible or fire-making) species. Each of these classes is again divided into orders, tribes, genera and species. In the first class a single order includes two sub-orders and nine tribes, named (1) Metalloideæ; (2) Galenoideæ, including three sub-tribes corresponding to sulphur, selenium and tellurium compounds; (3) Bournonoideæ; (4) Pyritoideæ; (5) Smaltoideæ; (6) Arsenopyritoideæ; (7) Spatometalloideæ; (8) Sphaleroideæ; (9) Proustoideæ; each tribe including one or more genera. Again, in the second class are grouped under different orders, Oxyds, Silicates, Carbonates, Borates, Sulphates, Phosphates, Tungstates, &c. Three sub-orders of silicates include protoxyd, protoperoxyd and peroxyd silicates; among peroxyd bases being reckoned aluminic, ferric, manganic, chromic, bismuthic, and also, for special reasons, zirconic oxyd. Recognising in each sub-order various types designated Hydrospathoid, Spathoid, Adamantoid or gem-like, Phylloid or micaceous, and Porodic or colloidal; the tribes may be named Pectolitoid, Willemoid, Amphiboloid, Talcoid, Ophitoid, Zeolitoid, Feldspathoid, Granatoid (garnet-like) Micoid, Pinitoid, Perzeolitoid, Eulytoid, Topazoid, Pyrophylloid and Argilloid. Soluble saline species in any order are referred to a salinoid type, as Borosalinoid, Tungstosalinoid. The extension of this system to the Haloid and Pyricaustate classes is easy, and has been elsewhere explained.

The work of arranging in genera and species, with a Latin binomial nomenclature, and the determination for each species of the value of v , is now nearly completed for the first two classes; and the whole will probably soon appear, with a proper introduction, as a Systematic Mineralogy, to be followed by a Descriptive Mineralogy. The general principles here set forth are discussed at length in the author's 'Mineral Physiology and Physiography' (Boston, 1886), pp. 279-401, where, in a chapter entitled 'A Natural System in Mineralogy,' will be found an examination of the constitution and relations of the known natural silicates arranged in tribes, and tabulated, with the calculated values of v , and a new quantivalent chemical notation. See farther, a paper on 'The Classification and Nomenclature of Metalline Minerals,'¹ discussing Class I., in the 'Proceedings of the American Philosophical Society' for May 4, 1888, reprinted in the 'Chemical News' of August 10 and 17; also the author's 'New Basis for Chemistry,' 2nd edition (Boston, 1888), where, in chapters vii. and xiv. many points in the proposed mineralogical classification are elucidated.

6. *On the Logarithmic Law and its Connection with the Atomic Weights.*
By Dr. G. JOHNSTONE STONEY, F.R.S.

7. *On Dissociation.*² By the Rev. A. IRVING, D.Sc., B.A.

The author refers to the paper on this subject which he read before Section B at the Birmingham meeting in 1886. Further work has furnished confirmatory evidence in support of the theory then propounded. From a number of experiments recently made, visible evidence has been obtained of the direct dissociation of the hydrocarbons of coal-gas. The deposition of amorphous carbon takes place in contact with pumice-fragments at temperatures ranging from dull red heat up to the incipient fusion-temperature of the hardest Bohemian glass. Along with carbon some sulphur is also deposited. We have thus a visible confirmation of

¹ An abstract of this paper, printed in the programme of the Royal Society of Canada, without revision or correction by the author, will also be found in the *Chemical News* for June 29, 1888.

² Published *in extenso* in the *Chemical News*, No. 1505, September 28, 1888.

the theory put forward two years ago in the two cases of the hydrocarbons and the sulphur compounds of coal-gas; the cause of the deposition of 'gas-carbon' is explained, and the operations of the same physical principles is believed to have been the origin (for the most part) of the graphite which abounds (in places) in the (archæan) primitive crystalline rocks. Reference is made to the presence of hydrocarbons in heads of comets and of carbon in meteorites.

8. *On Closed-chain Formulæ.* By J. E. MARSH, B.A.

9. *On Van't Hoff's Hypothesis and the Constitution of Benzene.*
By J. E. MARSH, B.A.¹

FRIDAY, SEPTEMBER 7.

The following Papers were read:—

1. *Discussion on the Chemical Problems presented by Living Bodies, opened by Professor MICHAEL FOSTER, Sec.R.S.*

2. *On the Atomic Weight of Oxygen.*
By ALEXANDER SCOTT, M.A., D.Sc., F.R.S.E.

After giving a brief historical sketch of the work which had been done to determine with the greatest possible accuracy the atomic weight of oxygen—that of hydrogen being taken as the unit—the author pointed out amongst other sources of error that the presence of air to the extent of only $\frac{1}{5000}$ of the volume of hydrogen used would be sufficient to raise the value 15.96 deduced from Dumas' experiments to 16.00. Similarly with regard to Regnault's ratio of the densities originally given as 15.96 also, but shown by applying the correction proved necessary by Lord Rayleigh when recalculated by Crafts to be only 15.91, the presence of $\frac{1}{2500}$ of air by volume in the hydrogen would be alone sufficient to account for this being so far below 16, to say nothing of the traces of water vapour and sulphur dioxide also most probably present.

The recent work of Professor J. P. Cooke and Mr. Richards, as well as the re-determination of the ratio of the densities of the gases by Lord Rayleigh, have tended to remove the value for the atomic weight of oxygen further from 16 instead of raising it, the corrected number of Professor Cooke being 15.869. Lord Rayleigh's ratio of the densities being 15.884, and if we take 1.998 : 1 as the ratio of the volumes in which hydrogen and oxygen combine to form water, we get from it 15.90 as the atomic weight of oxygen.

The author then described his latest experiments on the ratio of the combining volumes of hydrogen and oxygen and pointed out that the volume of hydrogen required seemed to decrease when it was continuously evolved from the same vessel, four consecutive experiments with hydrogen from the electrolysis of dilute hydrochloric acid with zinc amalgam giving

H	O	Total Impurity	Date
2.001	: 1	$\frac{1}{8776}$	May 2, 1888
1.999	: 1	$\frac{1}{4500}$	May 5, "
1.998	: 1	$\frac{1}{18170}$	May 5, "
1.995	: 1	$\frac{1}{21575}$	Aug. 31, "

¹ Published *in extenso* in *Phil. Mag.* November 1888.

The hydrogen seemed to be quite free from every trace of hydrochloric acid, but the continuous variation of the ratio seems to point to the presence of some impurity at present undetected but which seems to be gradually eliminated as the gas in the last case is the purest. The lower the value for the hydrogen volume gives of course a higher value for the atomic weight of oxygen.

The author concluded by remarking that it was still premature to conclude that the atomic weight of oxygen was below 16, as almost all the errors in both Dumas' and Regnault's methods could only lower the number, very few raise it.

3. *The Incompleteness of Combustion in Explosions.*

By Professor H. B. DIXON, *F.R.S.*, and H. W. SMITH, *B.Sc.*

The authors found that when a mixture of two volumes of hydrogen and one volume of oxygen was exploded in a long tube an explosive residue was left unburnt which could be collected and exploded.

The percentage of explosive residue found depended partly on the surface of the vessel in contact with the gas; in a narrow tube 4.5 mm. in diameter nearly 2% of electrolytic gas remained unburnt, while in an iron cylinder 100 mm. in diameter about 5% of electrolytic gas remained unburnt.

The same phenomenon of incomplete combustion was observed in the case of moist carbonic oxide and oxygen.

4. *A new Gas Analysis Apparatus.* By W. W. J. NICOL, *M.A., D.Sc.*

This apparatus consists of a measuring tube and laboratory vessel of the same diameter placed side by side in an outer jacket of water. The two tubes are connected by U-shaped capillaries at top and bottom. The upper capillary is furnished with an ordinary three-way stopcock which communicates with a cup on the top through which gas or various reagents may be introduced or expelled through a siphon tube. The lower capillary has also a three-way tap, which is, in addition, bored longitudinally, by means of which communication can be established between either the laboratory tube or the measuring vessel and one or other of two movable reservoirs, one of which during use is always level with the top of the apparatus, the other being at the bottom. The apparatus is intended to supply the want of a quick method, comparable in the way of accuracy with the well-known method of Bunsen.

5. *The Determination of Vapour-densities at High Temperatures and under Reduced Pressure.* By Dr. WILLIAM BOTT, *F.C.S.*

About a year ago a method was described by the author for the determination of vapour-densities by accurately measuring the increase of pressure caused by the volatilisation of a weighed quantity of substance in a calibrated vessel connected with a mercury pressure-gauge and heated in the manner employed in Hofmann's method. The determinations by this method could be made at any pressure required, but we must refer to the original paper ('Ber.' xx. 916) for the details. Now the range of temperatures at which the original method can be used is naturally a limited one from the plan of heating adopted. By slightly altering the apparatus and the *modus operandi*, however, this objection can be overcome, and the apparatus may be heated in an open bath, or even in a furnace in the manner adopted by Victor Meyer. The original apparatus (see 'Ber.' xx. 916) is made shorter, with a bulb about 30 ctm. by 4.5 ctm., corresponding to 450 cc. capacity. The remainder of the apparatus remains unaltered, excepting that a stopcock is inserted between the gauge and the vessel, so that communication can be shut off at any time. This having been done at the commencement of the determination, the initial temperature of the apparatus (*viz.*, the ordinary temperature) is noted, and from this and the known capacity of the vessel the volume of air calculated which it contains. The apparatus is then heated till constant, and

the expansion up to that point determined by collecting and measuring the air expelled on heating. From this volume the temperature is again calculated. Communication with the gauge is then made and the apparatus quickly exhausted as far as may be thought requisite. The remainder of the operation is the same as in the old method already referred to, the density being found from the formula

$$d = \frac{s}{0.00008958 \left[\frac{C - CP}{P_1} \left(\frac{P}{760(1 + 0.00367t^0)} \right) \right]}$$

(s = substance; C = capacity of apparatus; P = initial pressure; P_1 = final pressure; t^0 = temperature during experiment.)

The main objection to the above method might lie in the fact that its accuracy decreases with the pressure employed (see original paper, 'Ber.' xx. 916). Experiments having been made to find a more direct method, the following arrangement was found to answer all requirements. A large Victor Meyer's apparatus, with a bulb 30 ctm. long by 4.5 ctm. diameter, is used, fitted with a detachable top-piece, communicating with a barometer tube and a large measuring tube about 40 ctm. long by 3 ctm. diameter, and connected with a mercury reservoir. The apparatus is heated till constant, exhausted as far as may be requisite, and the reservoir so adjusted that the measuring tube is completely filled with mercury. The pressure, as shown by the barometer tube, is then noted, substance introduced, and the surplus pressure generated is removed by lowering the reservoir till the gauge again registers the initial pressure. The volume of gas in the measuring tube is then determined, and from it the density calculated as in Victor Meyer's method. Neither the temperature of the bath nor the exact capacity of the apparatus need be known. The results are accurate.

An apparatus like the above, only made of suitable material, and slightly adapted to suit special requirements, might be used for the study of dissociation at very high temperatures and varying pressures.

6. *On Photographing Hydrogen and Chlorine Bulbs by aid of the Flash of Light which caused their Explosion.* By Professor P. PHILLIPS REDSON, D.Sc.

The notices which have appeared in 'Nature' (vol. xxxvii. p. 576; vol. xxxviii. p. 15) of C. du Bois Raymonde's successful attempt to photograph the expanded pupil of the eye by a flash of magnesium suggested to my mind the experiment of attempting to photograph a glass bulb containing a mixture of equal volumes of hydrogen and chlorine, which, as is well known, combines with explosive violence and consequent shattering of the bulb when exposed to the flash of magnesium light.

At my suggestion, Mr. Saville Shaw, demonstrator in chemistry at the Durham College of Science, Newcastle-upon-Tyne, undertook the experiment, with the result (as shown in the accompanying photograph) that a clearly defined image of the bulb can be obtained, although the bulb itself is shattered by the explosion.

The method of procedure was as follows. An empty bulb similar to the one to be exploded was clamped in a stand and accurately focussed in gaslight. The room was then completely darkened, the empty bulb replaced by one containing the mixed gases, and after uncovering the lens combination was induced by the ignition of a mixture of magnesium dust and potassium chlorate placed close to the bulb. In this way two bulbs have been photographed, one of which is exhibited. It will be seen on close examination that, whilst the outline of the bulb itself is perfectly clear, it is fainter than the jagged stem which was left unbroken, and consequently exposed for a much longer time than the bulb. A small mirror was attached to the bulb with the intention of reflecting the light into the camera. The result, however, shows that this was quite unnecessary, and the only effect of this arrangement has been its reproduction in the photograph.

It is proposed to make further experiments in this direction, which may perhaps throw some light on the question of photo-chemical induction.

7. *On the Formation of Crystals of Calcium Oxide and Magnesium Oxide in the Oxyhydrogen Flame.* By J. JOLY, M.A., B.E.

Lime cylinders which have been in use for some time in the production of the lime-light will be found to have undergone alteration in structure in the immediate vicinity of the part played on by the flame, becoming lustrous and crystalline. With the lens it is seen that the reflecting faces are squares. By playing on a small heap of fragments of pure lime with the oxyhydrogen flame larger and very distinct cubes are easily produced. The crystals are very evidently formed by sublimation. They build upon the rough surface of the lime in arborescent growths of cubes and cubo-octahedrons, having a common orientation. They are limpid or milky, very lustrous, showing a plated structure on the cube face and appear to offer a greater resistance to hydration than the amorphous substance. In the polariscope they are optically inactive. Up to the present CaO seems to have only been crystallised from the nitrate (Brügelmann).

In a similar manner, but with more difficulty, minute transparent cubes of magnesium oxide may be prepared from the amorphous substance.

SATURDAY, SEPTEMBER 8.

The following Report and Paper were read:—

1. *Report of the Committee on the present methods of teaching Chemistry.*
See Reports, p. 73.

2. *Chemistry as a School Subject.* By the Rev. A. IRVING, D.Sc., B.A.

The author expressed some doubt as to the means adopted by the committee appointed last year for dealing with this matter in our public schools, and strongly urged considerable addition to the committee of men who, as science-masters, have first-hand knowledge of the facts. Speaking from a personal experience of some twenty years, both as a schoolmaster and as a teacher of science, he deprecated any attempt by syllabus or otherwise to fetter the freedom of action which every real educator knows to be one of the first conditions of fruitful educational work. The high educational value of experimental science alone considered tells us that this must be our guiding principle in dealing with chemistry as a school-subject; we must not aim at making all our boys professional chemists; we must defer in this matter to the higher educational law expressed in the formula, '*Mens sana in corpore sano.*' The slur cast indiscriminately upon the public schools in a paper read last year was repudiated, and the practical inapplicability to the necessary conditions of school-work of many suggestions contained in that paper was pointed out. The alleged sterility of English chemical science was referred rather to a divorcement in the past between the laboratory-worker and the higher culture of the country, and it was maintained that the remedy lies mainly in the recognition of the true importance of the subject by the older universities, with a further development of the professoriate, which (with the healthy rivalry of numbers) is the true secret of the working productiveness in science of the German as compared with the English academical system. It was suggested that the committee would do well to select a fairly large number of real contributors to the science in the last quarter of a century and attempt to arrive inductively from the facts of their individual biographies at some general conclusions as to what intellectual antecedents and environment seemed to enter most essentially into the *genesis* of the scientific chemist; while the strongest possible appeals should be made to the ancient universities to lead public opinion, especially the governing-bodies of our public schools, to recognise genuine work in science and proved capacity in

educational work as constituting equal claims with mere 'scholarship' in the appointment of head masters.

Some recent depreciations of qualitative analysis were remarked upon, analysis rationally taught being held to be a good mental discipline available for class-teaching, and a sort of stock on which might be engrafted a great deal of theoretical as well as experimental teaching, the work of the lecture-room and the exercises of the laboratory being made each to supplement the other. With the cry that the great difficulty is the want of good text-books the author has no sympathy; experimental science can only be really taught by men who are independent of such extraneous aids. The common notion that experimental science is a 'refuge for the destitute' in intellectual matters was strongly denounced as an absurd fallacy, the admission of which is nothing more nor less than the practical surrender of our position to the 'classical' and 'mathematical' men who make up the majority of the staff of every public school.

The author dealt with the 'objects,' 'difficulties,' and 'methods' of teaching chemistry; but on these points many of his suggestions had been already put forward in the committee's printed report.

The remainder of the paper dealt with examinations, and various suggestions were made as to how these might be improved, so as to discourage the mere exercise of the faculty of receptivity for examinational purposes, and to place examiners who had been brought into touch with scientific research and had had the spirit of inquiry awakened in them at a greater advantage than at present.

MONDAY, SEPTEMBER 10.

The following Papers were read:—

1. *Discussion on Valency, opened by Professor H. E. ARMSTRONG, F.R.S.*
2. *Evidence of the Tetravalency of Oxygen derived from the Constitution of the Azonaphthol-Compounds. By Professor R. MELDOLA, F.R.S., F.C.S., F.I.C.*¹

The author commenced by pointing out the differences between the azo-derivatives of *a*-naphthylamine and *a*-naphthol as compared with the corresponding azo-compounds of the *β*-series. The *a*-derivatives have all the properties of amidoazo- or oxyazo-compounds, and show in all their reactions the presence of NH₂ or HO. The *β*-compounds, on the other hand, not only differ from the others in physical properties, such as melting-point and crystalline form, but in their chemical properties they show much less distinctly the presence of NH₂ and HO. They are diazotisable only with much difficulty, and the insolubility of the oxy-compounds in aqueous alkalis appears to indicate the absence of hydroxyl.

The author next proceeded to review the different formulæ which had been proposed for the compounds of the *β*-series, the first attempt to represent these on a different type to the *a*-compounds having been made by Liebermann (I.), himself (II.), and Zincke (III.):—

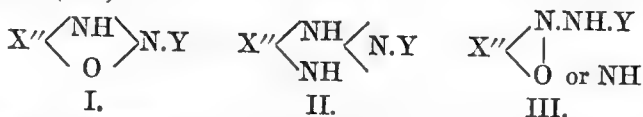

Since these were suggested in 1883-4 evidence has been accumulated which the author considered as being distinctly unfavourable to the proposed formulæ. It has been found by Nietzki and Goll, and by Zincke himself, that the azo-deriva-

¹ Published *in extenso* in the *Phil. Mag.* Nov. 1888.

tives of β -naphthylamine can be diazotised and the diazo-salts converted into the corresponding oxy-compounds by the usual reaction.

The author and F. J. East have recently found that the nitrobenzeneazo- β -naphthylamines can be converted into the corresponding β -naphthyl-acetates by heating them with acetic acid and adding sodium nitrite. Weinberg has shown also that benzeneazo- β -naphthol can be ethylated, and the author and F. J. East have shown that this and other β -naphtholazo-derivatives can be acetylated. The reduction products of the ethyl and acetyl derivatives tend to show that the alkyl or acetyl is not attached to the N-atom, as would be required by Zincke's hydrazone formula or by Liebermann's formula, but further investigation in this direction is considered necessary, and is being undertaken in the author's laboratory.

The author next pointed out that although the results of the most recent experiments thus appeared to favour a return to the old formulæ—

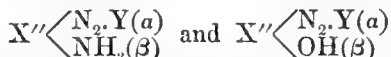

the non-phenolic character of the β -oxy-compounds and the other differences shown by these and the β -amido-compounds when compared with those of the α -series, must still be considered as evidence of a different constitution. To express this difference in the case of the orthoamidoazo-compounds it is suggested that the N : N-group and the NH_2 , being in the ortho-position, interact with the formation of a closed chain, and the author proposes for these and the analogous oxy-compounds the general formulæ—

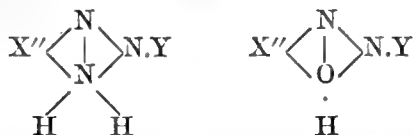

The first of these expressions shows the relationship of the orthoamidoazo-compounds to the azimides of Griess into which (or into isomeric substances) they can be converted, as shown by Zincke, by the action of oxidising agents, the latter simply removing two atoms of hydrogen and leaving

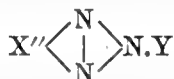

The same formula explains the difficultly diazotisable character of the compounds, their feebly basic properties, and the formation of ortho-diamines by reduction.

The second formula, in which oxygen is represented as tetravalent, appears to accord with the general properties of the β - or ortho-oxyazo-compounds. Thus it is seen that the replaceable hydrogen atom is attached to the oxygen, but is not in the hydroxylic state, as the oxygen forms one atom in a closed ring. This may be the explanation of the non-phenolic character of these compounds. With reference to the tetravalency of oxygen the author called attention to Friedel's compound $(CH_3)_2O.HCl$, as well as to the general arguments based on the position of the element in the periodic system.

3. *The Theory of Solution.*¹ By T. STERRY HUNT, LL.D., F.R.S.

The author began by a brief statement of Mendeléef's views on solution, as put forth since 1886 and resumed in the latter's recent paper on the compounds of ethylic alcohol and water, presented to the Chemical Society of London in 1887. In this it is maintained that the products of the dilution with water of bodies like alcohol and sulphuric acid include several distinct chemical compounds, with greater or less proportions of water, which compounds may in some cases be separated as definite crystalline solids by reduction of temperature. Their presence is also made evident by the study of the relation of the specific gravity to the cen-

¹ Published *in extenso* in the *Chemical News* for Sept. 28, 1888.

tesimal composition of the dilute alcohol or acid. The author noted further the confirmation of these views by the subsequent studies of Crompton on the electrical conductivity of diluted sulphuric and other acids, and of solutions of the hydroxyds of potassium and sodium, as well as to the able discussion of these results lately published by Professor H. E. Armstrong.

He then proceeded to recall his own contributions to the theory of solution, dating from 1853, in which he has affirmed the chemical nature of solution, and especially his essay entitled *Thoughts on Solution and the Chemical Process*, in the 'Chemical Gazette' for 1855. It was therein maintained not only that solution is a chemical process, but that 'all chemical union is nothing else than solution. The uniting species are, as it were, dissolved in each other, for solution is mutual;' and subsequently that 'the type of the chemical process is found in solutions, from which it is possible, under changed physical conditions, to regenerate the original species.' After giving an analysis of the paper of 1855, its conclusions are resumed under the following heads: 1. The conception that in the process of aqueous solution there are formed definite compounds with water, accompanied by all the phenomena of chemical union. 2. That in these compounds of a single proportion of a salt or other species with many proportions of water there are clearly defined limits beyond which the further addition of water gives rise (A) to decomposition involving a new arrangement of the elements of the previously united bodies (double decomposition), or (B) to simple admixtures of one definite solution, or liquid species, with another less dense solution, or with water. 3. That these compounds are separable in a solid state by changes of temperature and (theoretically at least) in a liquid state, by the influence of gravity. 4. That liquidity is but an accident of solution, since it is a state depending on temperature and on pressure, which state may be assumed by all species, whether elemental or compound.

The author then proceeded to notice his later treatment of the subject in his 'New Basis for Chemistry,' and especially in the second (revised and augmented) edition (Boston, 1888). Therein are considered the cryohydrates of Guthrie, and the remarkable liquid compounds of salts with small quantities of water, got by Tilden and Shenstone at high temperatures under pressure. He further notes the evidences of the integral vaporisation of solutions above the critical point, under pressure, observed by Hannay and Hogarth, and the previous separation of some of these at high temperatures into lighter and denser layers. Earlier observations of similar separations, and the recent studies of Traube and Neuberg on the differentiation by gravity of various saline solutions in dilute alcohol, are also noticed. All of these facts are considered as illustrations of the theory of solution so long maintained by the author, which, at least so far as aqueous solutions are concerned, is now adopted by Mendeléef.

4. *The Composition of Copper-Tin Alloys.* By A. P. LAURIE.

Experiments by Lodge, Roberts-Austen, &c., have shown that the physical properties of these alloys point to the existence of two compounds, Cu_3Sn and Cu_4Sn .

In testing the E.M.F. of these alloys in constant voltaic cells the author finds a change of E.M.F. corresponding to the formula CuSn , and by suitable arrangements has succeeded in eating out the excess of free tin in an alloy, leaving the compound Cu_3Sn behind.

5. *The Composition of the ancient Roman Mortar from the London Wall.* By JOHN SPILLER, F.C.S.

With the view of collecting fresh evidence as to the chemical union of lime and silica by long contact, the author had examined a sample of ancient Roman mortar taken from the section of old London Wall recently laid bare in St. Martin's-le-Grand.

From the fact that a large quantity (11 per cent.) of silica could be dissolved out readily by caustic soda, and there being a deficiency of carbonic acid without

any evidence of free caustic lime, the author considered he was justified in drawing the inference that silicate of lime was present, this body being the result of direct combination between lime and sand in the course of many centuries.

Samples of a London mortar about a hundred years old and another of recent date contained 1.1 per cent., or less, of soluble silica, that is, only one-tenth of the amount now actually found in the Roman mortar analysed.

For full particulars of composition and analytical details see the 'Chemical News' of October 19, 1888, p. 189.

6. *On the Rate of Solution of Copper in Acids.* By V. H. VELEY, M.A.

From time to time accounts of experiments have been published on the rate of solution of metals in acids. In most cases a piece of metal of more or less regular surface is placed at the bottom of a suitable vessel, dilute acid poured thereon, and the rate measured at which the hydrogen or other gas is evolved. It is obvious that the measured result is one of very mixed causes, the separate effect of which has not been duly taken into account. Thus the rate at which hydrogen is given off from redistilled zinc and dilute sulphuric acid will depend *inter alia* on (i) the surface of metal exposed; (ii) the concentration of the acid; (iii) the rate of diffusion of the solution of salt formed in the acid liquid. Of these only (i) can be approximately constant, while (ii) and (iii) are indeterminable variables.

The author has made a series of experiments on the rate of solution of spheres of electrolytic copper, made from one block, in solutions of potassium bichromate acidulated with sulphuric acid under such conditions that not only are fresh surfaces of the copper continually exposed, but also the dissolving liquid in the immediate vicinity of the metal continually renewed. At the end of definite intervals of time the loss in weight of the sphere is determined, and the alteration in area calculated by a measurement of the axes of the sphere. The mass dissolved per unit area is taken as the measure of the rate of solution.

As a preliminary step it was ascertained that, under the same conditions, different spheres of copper dissolved at the same rate.

Experiments thus far have shown that the difference of the logarithm of the factor $\frac{M}{A}$ ($M = \text{mass}$, $A = \text{area}$) is constant for a constant difference of temperature.

But, apparently, the value of this factor is proportional only within certain limits to the concentration; thus, although with greater or less concentration the mass dissolved is greater or less, yet this variation proceeds *per saltum*, and not in direct proportion, even though a large excess of dissolving reagents was in all cases used.

The rate of solution is also dependent upon the rate of movement of the metallic sphere in the acid; throughout the experiments this has been kept constant by various mechanical arrangements.

7. *Recovery of the Ammonia and Chlorine in the Ammonia-soda Process.* By F. BALE.

If ammonium chloride be volatilised, and its vapour passed over or through heated metallic oxide, at a temperature of 400° C. or higher, the ammonia which is evolved is partially decomposed in its passage over the heated oxide, and this to the extent of from 25 to 50 per cent. of the ammonia evolved.

If, however, the ammonium chloride be intimately mixed in powder with metallic oxide in powder, as the oxide of manganese (which I prefer), and the mixture then gradually heated, the ammonia is gradually and completely evolved at a temperature of 130° C. to 325° C. without the loss mentioned above by the method of volatilisation of the ammoniac chloride. Most of the ammonia is here evolved between 130° and 200° C.

In this method of mixtures, if the temperature of the residue left after the evolution of the ammonia be kept below 350° C. and cold and dry air be passed

over it, no chlorine is evolved at this temperature, but residual ammonia and moisture may be completely driven out of the retort on stirring the mixture. If the temperature be now raised to 350°C ., the chlorine begins to be slowly evolved on the passage of dry air, when the oxide used has been manganese; and the percentage yield of chlorine by the peroxides of manganese is about one and a half time that of any monoxide. Sesquioxides (M_2O_3) are unsuitable for this purpose, as they yield one-third less ammonia, the other third being decomposed into nitrogen and hydrogen.

The method of volatilisation of the ammoniac chloride means a high temperature, which means again a loss of ammonia and other disadvantages. By the method of mixtures a low temperature is employed, the ammonia saved, the chlorine fully evolved, and atmospheric air may be used to expel residual ammonia and steam remaining in the retort; and if the temperature be kept below 350°C . air may be passing through the retort during the whole operation for the ammonia, thus removing the ammonia and steam as formed, and preventing loss of ammonia and the formation of hydrochloric acid when chlorine is required.

Oxides of the heavy metals, and the alkaline earths and salts formed from these, may be used for this purpose with more or less advantage. There is one oxide, however, which appears superior to all others, viz., the oxides of manganese which are not sesquioxide. These oxides (Mn_3O_4 and MnO_2) evolve ammonia at a low temperature. From 130°C . to 200°C . most of the ammonia is evolved, and at 325°C . is completely evolved by these oxides. The percentage yield of chlorine by these oxides is one and a half time that of the monoxide of nickel and others. For these and other reasons I think they will hold their place in the new process as they have in the old process of Leblanc.

Peroxides of the composition M_3O_4 , MO_2 may be used with advantage both for the evolution of the ammonia, and afterwards for the chlorine on the passage of air, and for the evolution of the hydrochloric acid on the passage of steam at the low temperature employed.

The workman would keep the temperature below 350°C . during the evolution of the ammonia, which may be done by a mercurial thermometer placed in the door of the retort. Other heavy oxides, salts, &c., require a much higher temperature for the evolution of the ammonia and chlorine.

When all the chlorine or hydrochloric acid is evolved, the residue is equivalent when reduced to the oxide with which we started, and will give the equivalent of ammonia as at first when heated with ammoniac chloride, and from this point the round of operations goes on continually.

The apparatus required would be a Stourbridge fire-clay retort, or other suitable furnace or retort, heated by gas or preferably by a self-feeding coke furnace. These retorts may be worked in series and connected with pipes leading to the ammonia-absorbing plant, the hydrochloric condensing chambers, and the bleaching powder chambers. They should also be connected with an exhaustor or blower for the passage through them of air or steam when chlorine or hydrochloric acid was required.

The residual oxides left after the complete evolution of the chlorine or hydrochloric acid would need washing at intervals from common salt and when manganese has been the oxide used; they exist chiefly as sesquioxide of manganese, and before the charge of ammoniac chloride is added they must be reduced. This may be done by heating them with charcoal or small coal, or, better, by passing the gases from the coke or other furnace used over them, when they will no longer decompose the ammonia when used for the next round of operations.

The lime now used is thus saved, the ammonia and chlorine fully recovered, and reagents for this purpose recovered for use over and over again continually; and this at no other cost than the labour and fuel employed (which is small) and the wear and tear of retorts.

By this development of the ammonia-soda process the old process of Leblanc has lost its last remaining prop.

TUESDAY, SEPTEMBER 11.

The following Report and Papers were read:—

1. *Third Report of the Committee for investigating Isomeric Naphthalene Derivatives.*—See Reports, p. 96.

2. *Note on the Molecular Weight of Caoutchouc and other Colloids.*
By Dr. J. H. GLADSTONE, F.R.S., and W. HIBBERT, F.I.C.

While investigating the chemical and physical properties of caoutchouc the authors had endeavoured to determine by Raoult's method its molecular weight when dissolved in benzene. They found it to be extremely high, although the numbers obtained for caoutchene and hevene (substances of the same ultimate composition) agreed fairly well with what might be anticipated from the formulæ $C_{10}H_{16}$ and $C_{20}H_{32}$. They had subsequently examined the aqueous solutions of other colloid bodies, viz., gum arabic, caramel, albumen, and ferric hydrate, with the result in each case that the molecular weight as determined by Raoult's method is very high. No great reliance was placed upon the actual figures obtained, but they were sufficient to corroborate the conclusion arrived at by Graham long ago, that 'the equivalent of a colloid appears to be always high.'

3. *On some new Silicon Compounds.*
By Professor J. EMERSON REYNOLDS, M.D., F.R.S.

The following substances were exhibited and shortly described:—

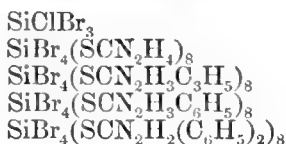

and



4. *On some new Thiocarbamide Compounds.*
By Professor J. EMERSON REYNOLDS, M.D., F.R.S.

The following substances were exhibited and shortly described:—

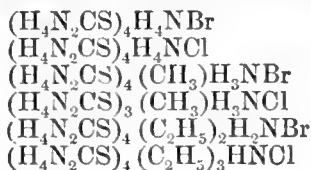

and the trithiocarbamide derivative



5. *Proposed International Standards to control the Analysis of Iron and Steel.* By Professor J. W. LANGLEY.

It is well known that the results of chemical analysis will differ slightly with the methods employed and with the personal peculiarities of the operator. This latter might be called the 'personal equation' of the analyst. These causes of variation become of great importance in all investigations where minute quantities of foreign

bodies have to be sought in large amounts of a compound or mixture, such as are all samples of commercial iron and steel. In this class of analyses the percentages of carbon and phosphorus may be as low as 0.15 per cent. and 0.01 per cent. respectively, and yet these small amounts will have quite marked effects in the steel which contains them.

In order to bring about a greater uniformity of analysis in the countries which are the principal producers and users of iron and steel, it is proposed to prepare a quantity of samples which shall be absolutely identical and to distribute them to properly qualified analysts in those countries, who will then analyse them and will interchange reports of their results with each other.

By the above plan there will be in each country participating in the work a quantity of metal identical with that in the other countries, and which has been analysed with the utmost care by a considerable body of chemists, so that its composition may be said to be known authoritatively and beyond dispute, and which will thus constitute international standards.

The standards so obtained will serve two important purposes. First, they will show, in the course of their preparation, the relative agreement in processes and results habitually arrived at by the chemists of different countries. Second, these standards being distributed to certain custodians, it may be possible to furnish small portions of them to chemists who may make application for the purpose of checking their individual work and obtaining a measure of their accuracy. Also, as new analytical methods are constantly being invented, it will be of great advantage to have a standard metal on which to test them.

The details of the best method of securing the above ends should be the work of a committee.

Professor Hermann Wedding, of Berlin, and Professor Richard Åkerman, of Stockholm, and myself have already considered the general plan, and have given provisional assent to it and to the following suggestions:—

First. The analysis shall be made for total carbon and for phosphorus. This is all which it is advisable to demand, but other elements may be added at the wish of any analysts for the samples in their hands only.

Second. The samples shall be of the following composition (or temper) in carbon, as nearly as is practicable.

Carbon = 1.3% 0.8% 0.4% 0.15%

and all the other elements shall be kept down to the customary proportions for steel of medium quality.

Third. The samples shall be in the form of drillings, uniformly and carefully mixed, and quantities not less than forty kilogrammes for each temper: this would mean not less than 160 kilos. for the whole.

Fourth. These samples shall be equally divided and sent under seal to properly accredited persons in Sweden, Germany, England, and the United States.

Fifth. The analyses shall be made in each country independently, and the report of the results obtained shall be sent to each of the proper representatives of the other countries participating in this plan.

Sixth. If there should be an important disagreement in these reports it shall then be the duty of the parties to this agreement to appoint an international committee to whom the whole subject shall be referred. If, however, the reports differ only slightly then the average of all the reports shall be deemed the true composition of the international iron and steel standards.

6. *On the Action of Light on Water Colours.*

By ARTHUR RICHARDSON, Ph.D.

In this paper the author discusses the effect of light on colours, and draws attention to the very important part played by moisture in assisting their decomposition. Unstable colours are divided into two groups:—

1st. Those which bleach by oxidation under the combined influence of light, 1888.

air, and moisture. 2nd. Those on which light exerts a reducing action, which is independent of the air, and in some cases takes place in the absence of moisture.

Cadmium yellow, cadmium orange, king's yellow, crimson lake, and indigo are placed in the first group; these are bleached by light, under the conditions above stated, but are permanent in an atmosphere of carbon dioxide, or in dry air. The colours of the second group include Prussian blue, vermilion, chrome yellow, &c. Prussian blue fades slowly in moist air—much more readily, however, in an atmosphere of carbon dioxide; but it is permanent in dry air. Mixed with cadmium yellow, Prussian blue gives a green which is very sensitive to light if moisture is present: permanent, however, in dry air. Vermilion is shown to fade in dry and moist air; also in an inert atmosphere like carbon dioxide. With cadmium yellow, vermilion forms an orange which blackens in moist air in a few hours, though in dry air light is without action on it. The author condemns as unsafe those pigments which fade in dry air, and shows that the greater number of paints are stable in sunlight, provided moisture is absent.

7. *Further Researches on the Pyrocresols.* By Dr. WILLIAM BOTT, F.C.S., and J. BRUCE MILLER, F.I.C.

In a paper submitted to the Chemical Section of the Association last year by Professor Schwarz and W. Bott the properties and a number of derivatives of the three isomeric pyrocresols, $C_{15}H_{14}O$, were described. Since then experiments have been made to ascertain the precise chemical nature of the reduction products of α -pyrocresol. The products just referred to had been found to consist of a mixture of paraffins, and a hydrocarbon, $C_{15}H_{32}$, had been isolated from them.

The reductions both with hydriodic acid and zinc dust have been repeated on a larger scale and at a lower temperature, with a view of obtaining an intermediate compound of an aromatic nature. No such product could, however, be obtained, the reaction invariably giving rise to formation of paraffins only. The investigation of these paraffins is not yet completed, but we expect to be able to publish the details before long, as well as the results of further study regarding the replacement of the oxygen atom in pyrocresol by chlorine by means of phosphorus pentachloride. The present paper only treats of a number of new derivatives of α -pyrocresol which have been prepared during the course of the main investigation.

Trichlor- α -pyrocresol, $C_{15}H_{11}Cl_3O$, is obtained by the protracted action of chlorine upon a solution of α -pyrocresol in chloroform or carbon tetrachloride and repeatedly recrystallising the product from boiling benzene. It forms a white bulky mass consisting of very fine needles, which under the microscope are resolved into pretty and characteristic aggregates of thin, transparent, flat prisms or bars. The substance is insoluble in water, alcohol, ether, acetic acid; more soluble in chloroform and carbon tetrachloride, and readily soluble in boiling benzene. The melting-point is exceptionally high, but cannot be exactly determined, as the body melts very gradually, first showing signs of fusion about 225° .

Tetra-amido- α -pyrocresol oxide, $C_{15}H_8(NH_2)_4O_2$, has been prepared by reduction with tin under pressure of tetra-nitro- α -pyrocresol oxide suspended in a mixture of glacial acetic and hydrochloric acid. It is a greenish yellow powder, slightly soluble in water, sparingly soluble in alcohol and ether, and almost insoluble in benzene. The salts are soluble in water, and with sodium hypochlorite give a dark reddish-brown coloration. A double platinum chloride has also been prepared. The melting-point appears to lie considerably above 300° .

The amido-compound can be diazotised and the diazo salts obtained react with phenols. Experiments in this direction were made with oxy-quinoline, resorcin, thymol salicylic acid, cresol, phenol, α - and β -naphthol. The derivative obtained with β -naphthol has been examined more closely and would represent the first colouring matter obtained from pyrocresol. It is obtained by adding an alkaline solution of β -naphthol to a diazotised acid solution of the amido-compound and forms a dark red precipitate insoluble in water but soluble in ether, alcohol, chloroform, and benzene. With strong sulphuric acid it gives a very characteristic and beautiful reaction, dissolving in the concentrated acid with a deep, greenish

blue colour, which upon gradual dilution with water slowly changes to a red, the colouring matter being reprecipitated in red flakes by excess of water. Although insoluble in water it is slightly soluble in dilute sulphuric and also in acetic acid, and silk may be dyed a fine crimson shade in baths acidified with these acids. If the colouring matter is dissolved in strong sulphuric acid and a single drop of concentrated nitric added to the solution the colour immediately changes from a dark blue to a claret shade. The latter reaction and the behaviour of the sulphuric acid solution upon diluting with water are two equally characteristic and delicate tests.

The action of alkaline-reducing agents, viz., of sodium ethylate and methylate, sodium amalgam and ammonium sulphide in alcoholic solution upon tetra-nitro- α -pyrocresol oxide, gives rise to the formation of varying quantities of amido- and of azo-compounds. The action of ammonium sulphide is particularly interesting. If a small quantity of the nitro-compound is heated with alcohol and a few drops of ammonium sulphide, the supernatant liquid assumes a reddish-brown colour, and upon the addition of hydrochloric acid and warming a red precipitate is formed, insoluble in water, but soluble in chloroform, alcohol, ether, benzene, and acetone with a reddish-violet colour. It is practically insoluble in carbon disulphide, and thus may be separated from any admixture of sulphur. With strong sulphuric acid it yields a yellowish solution, and upon diluting the colouring matter separates unchanged as a red precipitate. It dyes silk a reddish shade, but only in strongly acid baths.

By protracted treatment of the nitro-compound with excess of alcoholic ammonium sulphide a solution is obtained which with hydrochloric acid no longer yields a red colour. On adding water a yellow precipitate is formed, insoluble in hydrochloric acid, slightly soluble in cold water, and a little more soluble in hot water, the hot aqueous solution dyeing silk a fine yellow. The colouring matter is only slightly soluble in alcohol, ether, chloroform, and almost insoluble in benzene.

We have not had sufficient time to determine the composition of the red and yellow colouring matters which have only quite recently been prepared. From their mode of formation it would appear that the red body is an azoxy- or else oxyazo-derivative, whilst the yellow substance would be azo-pyrocresol oxide; still this is a mere conjecture, and their composition may turn out to be of a more complex nature.

It is proposed to apply the above reactions to the β - and γ -isomerides of pyrocresol, and, by sulphonating or otherwise, to prepare the colouring matters in a pure and soluble condition, and to study their special qualities as dyes. Experiments are also in progress to obtain direct nitro-substitution products of the pyrocresols, of which only the nitrated oxides are known, and to prepare the phenols corresponding to the sulphonic acids.

Of nitrated derivatives of the pyrocresols only the tetra-nitro-compounds of the respective oxides had been obtained, no intermediate product being known. A dinitro- α -pyrocresol oxide, $C_{15}H_{10}(NO_2)_2O_2$, has, however, been lately prepared by treating α -pyrocresol oxide with cold concentrated nitric acid and extracting the product with boiling alcohol to remove unaltered oxide. It forms yellowish-white crystals melting at about 235° .

The main work being still progressing, little can be added to the views expressed in the previous paper on the structure of the pyrocresols. The fundamental question as to the position of the oxygen atom in the molecule of pyrocresol, $C_{15}H_{11}O$, thus still remains open. An argument in favour of the existence of the carbonyl group in the molecule of α -pyrocresol at least might be found in the formation of the reduction product $C_{15}H_{32}$; but we have formerly stated our reasons against this supposition. Still adhering to the belief that α -pyrocresol contains the oxygen atom linked to two carbon atoms, the production of the compound $C_{15}H_{32}$ necessitates the assumption of a closed ring instead of two separate chains; thus:

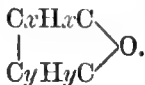

SECTION C.—GEOLOGY.

PRESIDENT OF THE SECTION—Professor W. BOYD DAWKINS, M.A., F.R.S.,
F.G.S., F.S.A.

THURSDAY, SEPTEMBER 6.

The PRESIDENT delivered the following Address:—

IN taking the chair occupied twenty-four years ago in this place by my honoured master, Professor Phillips, I have been much perplexed as to the most fitting lines on which to mould my Address. It was open to me to deal with the contributions to our knowledge since our last meeting in Manchester in such a manner as to place before you an outline of our progress during the last twelve months. But this task, difficult in itself, is rendered still more so by the special circumstances of this meeting, attended, as it is, by so large a number of distinguished geologists, assembled from nearly every part of the world for the purposes of the Geological Congress. It would be presumptuous of me, in the presence of so many specialists, to attempt to summarise and co-ordinate their work. Indeed, we stand too near to it to be able to see the true proportions of the various parts. I will merely take this opportunity of offering to our visitors, in the name of this section and of English geologists in general, a hearty welcome to our shores, feeling that not only will our science be benefited enormously by the simplification of geological nomenclature, but that we ourselves shall derive great advantage by a closer personal contact than we have enjoyed hitherto.

Our science has made great strides during the last twenty-four years, and she has profited much from the great development of her sisters. The microscopic analysis of the rocks has opened out a new field of research, in which physics and chemistry are in friendly rivalry, and in which fascinating discoveries are being made almost day by day as to metamorphism, and the crushing and shearing forces brought to bear upon the cooling and contracting crust while the earth was young. The deep-sea explorations have revealed the structure and the deposits of the ocean abysses, and the depths supposed to be without life, like the fabled deserts in the interior of Africa, are now known to teem with varied forms glowing with the richest colours. From a comparison of these deposits with the stratified rocks we may conclude that the latter are marginal, and deposited in depths not greater than 1,000 fathoms, or the shore end of the Globigerina ooze, and most of them at a very much less depth, and that consequently there is no proof in the geological record of the ocean depths having ever been in any other than their present places.

In North America the geological survey of the Western States has brought to light an almost unbroken series of animal remains, ranging from the Eocene down to the Pleistocene Age. In these we find the missing links in the pedigree of the Horse, and sufficient evidence of transitional forms to cause Professor Flower to restore to its place in classification the order Ungulata of Cuvier. These may be expected to occupy the energies of our kinsmen on the other side of the Atlantic for many years, and to yield further proof of the truth of the doctrine of evolution. The use of this word reminds me how much we have grown since 1864, when evolution was under discussion, and when biological, physical, and geological

laboratories could scarcely be said to have existed in this country. Truly may the scientific youth of to-day make the boast—

Ἡμεῖς μὲν πατέρων μὲν ἀμείνονες εὐχομεθ' εἶναι—

‘We are much better off than our fathers were,’ while we, the fathers, have the poor consolation of knowing that when they are fathers their children will say the same of them. There is reason to suppose that our science will advance more swiftly in the future than it has in the past, because it has more delicate and precise methods of research than it ever had before, and because its votaries are more numerous than they ever were.

In 1864 the attention of geologists was mainly given to the investigations of the later stages of the Tertiary Period. The bent of my pursuits inclines me to revert to this portion of geological inquiry, and to discuss certain points which have arisen during the last few years in connection with the classificatory value of fossils, and the mode in which they may be best used for the co-ordination of strata in various parts of the world.

The principle of homotaxy, first clearly defined by Professor Huxley, has been fully accepted as a guiding principle in place of synchronism or contemporaneity, and the fact of certain groups of plants and animals succeeding one another in a definite order, in countries remote from each other, is no longer taken to imply that each was living in the various regions at the same time, but rather, unless there be evidence to the contrary, that they were not. While, however, there is a universal agreement on this point among geologists, the classificatory value of the various divisions of the vegetable and animal kingdoms is still under discussion, and, as has been very well put by my predecessor in this chair at Montreal, sometimes the evidence of one class of organic remains points in one direction, while the evidence of another class points in another and wholly different direction as to the geological horizon of the same rocks. The Flora, put into the witness-box by the botanist, says one thing, while the Mollusca or the Vertebrata say another thing in the hands of their respective counsel. There seems to be a tacit assumption that the various divisions of the organic world present the same amount of variation in the rocks, and that consequently the evidence of every part of it is of equal value.

It will not be unprofitable to devote a few minutes to this question, premising that each case must be decided on its own merits, without prejudice, and that the whole of the evidence of the flora and fauna must be considered. We will take the flora first.

The cryptogamic flora of the later Primary rocks shows but slight evidence of change. The forests of Britain and of Europe generally, and of North America, were composed practically of the same elements—Sigillaria, Calamites, and conifers allied to the Ginkho—throughout the whole of the Carboniferous (16,336 feet in thickness in Lancashire and Yorkshire) and Devonian rocks, and do not present greater differences than those which are to be seen in the existing forests of France and Germany. They evidently were continuous both in space and time, from their beginning in the Upper Silurian to their decay and ultimate disappearance in the Permian Age. This disappearance was probably due to geographical and climatic changes, following the altered relations of land to sea at the close of the Carboniferous Age, by which Secondary plants, such as *Voltzia* and *Walchia*, were able to find their way by migration from an area hitherto isolated. The Devonian formation is mapped off from the Carboniferous, and this from the Permian, but to a slight degree by the flora, and nearly altogether by the fauna. While the fauna exhibits great and important changes, the flora remained on the whole the same.

The forests of the Secondary Period, consisting of various conifers and cycads, also present slight differences as they are traced upwards through the Triassic and Jurassic rocks, while remarkable and striking changes took place in the fauna, which mark the division of the formations into smaller groups. As the evidence stands at present, the cycads of the Lias do not differ in any important character from those of the Oölites or the Wealden, and the *Salisburia* in Yorkshire in the Liassic Age is very similar to that of the Island of Mull in the Early Tertiary, and to that (*Salisburia adiantifolia*) now living in the open air in Kew Gardens.

Nor do we find evidence of greater variation in the dicotyledonous forests, from their first appearance in the Cenomanian stage of the Cretaceous rocks of Europe and America, through the whole of the Tertiary Period down to the present time. In North America the flora of the Dakota series so closely resembles the Miocene of Switzerland that Dr. Heer had no hesitation in assigning it in the first instance to the Miocene Age. It consists of more than one hundred species, of which about one-half are closely allied to those now living in the forests of North America—sassafras, tulip, plane, willow, oak, poplar, maple, beech, together with *Sequoia*, the ancestor of the giant redwood of California. The first Palms also appear in both continents at this place in the Geological record.

In the Tertiary Period there is an unbroken sequence in the floras, as Mr. Starkie Gardner has proved, when they are traced over many latitudes, and most of the types still survive at the present day, but slightly altered. If, however, Tertiary floras of different ages are met with in one area, considerable differences are to be seen, due to progressive alterations in the climate and altered distribution of the land. As the temperature of the Northern Hemisphere became lowered the tropical forests were pushed nearer and nearer to the equator, and were replaced by plants of colder habit from the northern regions, until ultimately, in the Pleistocene Age, the Arctic plants were pushed far to the south of their present habitat. In consequence of this Mr. Gardner concludes that 'it is useless to seek in the Arctic regions for Eocene floras as we know them in our latitudes, for during the Tertiary Period the climatic conditions of the earth did not permit their growth there. Arctic fossil floras of temperate and therefore Miocene aspect are in all probability of Eocene age, and what has been recognised in them as a newer or Miocene facies is due to their having been first studied in Europe in latitudes which only became fitted for them in Miocene times. When stratigraphical evidence is absent or inconclusive, this unexpected persistence of plant types or species throughout the Tertiaries should be remembered, and the degrees of latitude in which they are found should be well considered before conclusions are published respecting their relative age.'

This view is consistent with that held by the leaders in botany, Hooker, Dyer, Saporta, Dawson, and Asa Gray—whose recent loss we so deeply deplore—that the North Polar region is the centre of dispersal, from which the deciduous Dicotyledons spread over the Northern Hemisphere. If it be true—and I, for one, am prepared to accept it—it will follow that for the co-ordination of the subdivisions of the Tertiary strata in various parts of the world the plants are uncertain guides, as they have been shown to be in the case of the Primary and Secondary rocks. In all cases where there is a clash of evidence, such as in the Laramie lignites, in which a Tertiary flora is associated with a Cretaceous fauna, the verdict in my opinion must go to the fauna. They are probably of the same geological age as the deposit at Aix-la-Chapelle.

I would remark further, before we leave the floras behind us, that the migration of new forms of plants into Europe and America took place before the arrival of the higher types in the fauna, after the break-up of the land at the close of the Carboniferous period, and after the great change in geography at the close of the Neocomian. The Secondary plants preceded the Secondary vertebrates by the length of time necessary for the deposit of the Permian rocks, and the Tertiary plants preceded the Tertiary vertebrates by the whole period of the Upper Cretaceous.

Let us now turn to the fauna.

Professor Huxley, in one of his many addresses which have left their mark upon our science, has called attention to the persistence of types revealed by the study of Palæontology, or, to put it in other words, to the singularly little change which the ordinal groups of life have undergone since the appearance of life on the earth. The species, genera, and families present an almost endless series of changes, but the existing orders are for the most part sufficiently wide, and include the vast series of fossils without the necessity of framing new divisions for their reception. The number of these extinct orders is not equally distributed through the animal kingdom. Taking the total number of orders at 108, the number of extinct orders

in the Invertebrata amounts only to 6 out of 88, or about seven per cent., while in the Vertebrates it is not less than 12 out of 40, or 30 per cent. These figures imply that the amount of ordinal change in the fossil Vertebrates stands to that in the Invertebrata in the ratio of 30 to 7. This disproportion becomes still more marked when we take into account that the former had less time for variation than the latter, which had the start by the Cambrian and Ordovician Periods. It follows also that as a whole they have changed faster.

The distribution of the extinct orders in the animal kingdom, taken along with their distribution in the rocks, proves further that some types have varied more than others, and at various places in the geological record. In the Protozoa, Porifera, and Vermes there are no extinct orders; among the Coelenterates one: the Rugosa; in the Echinodermata three: Cystideans, Edriasterida, and Blastoidea; in the Arthropoda two: the Trilobita and Eurypterida. All these, with the solitary exception of the obscure order Rugosa, are found only in the Primary rocks. Among the Pisces there is none; in the Amphibia one; the Labyrinthodonts ranging from the Carboniferous to the Triassic Age. Among the Reptilia there are at least six of Secondary age: Plesiosauria, Ichthyosauria, Dicynodontia, Pterosauria, Theriodontia, Deinosauria; in the Aves two: the Saururæ and Odontornithes, also Secondary. In the Mammalia the Amblypoda, Tillodontia, Condylarthra, and Toxodontia represent the extinct orders—the three first Early Tertiary, and the last Pleistocene. It is clear therefore that, while the maximum amount of ordinal variation is presented by the Secondary Reptilia and Aves, all the extinct orders in the Tertiary are Mammalian.

If we turn from the extinct orders to the extinct species, it will also be found that the maximum amount of variation is presented by the plants, and all the animals, excepting the Mammalia, in the Primary and Secondary Periods.

The general impression left upon my mind by these facts is that, while all the rest of the animal kingdom had ceased to present important modifications at the close of the Secondary Period, the Mammalia, which presented no great changes in the Secondary rocks, were, to quote a happy phrase of Professor Gaudry, 'en pleine évolution' in the Tertiary Age. And when, further, the singular perfection of the record allows us to trace the successive and gradual modifications of the Mammalian types from the Eocene to the close of the Pleistocene Age, it is obvious that they can be used to mark subdivisions of the Tertiary Period, in the same way as the reigns of kings are used to mark periods in human history. In my opinion they mark the geological horizon with greater precision than the remains of the lower members of the animal kingdom, and in cases such as that of Pikermi, where typical Miocene forms, such as Deinotheria, are found in a stratum above an assemblage of marine shells of Pleiocene age, it seems to me that the Mammalia are of greater value in classification than the Mollusca, some of the species of which have been living from the Eocene down to the present day.

Yet another important principle must be noted. The fossils are to be viewed in relation to those forms now living in their respective geographical regions. The depths of the ocean have been where they are now since the earliest geological times, although continual geographical changes have been going on at their margins. In other words, geographical provinces must have existed even in the earlier geological periods, although there is reason to believe that they did not differ so much from each other as at the present day. It follows from this that the only just standard for comparison in dealing with the fossils, and especially of the later rocks, is that which is offered by the fauna and flora of the geographical province in which they are found. The non-recognition of this principle has led to serious confusion. The fauna, for example, of the Upper Sivalik Formation has been very generally viewed from the European standpoint and placed in the Miocene, while, judged by the standpoint of India, it is really Pleiocene. A similar confusion has followed from taking the Miocene flora of Switzerland as a standard for the Tertiary flora of the whole of the Northern Hemisphere.

It now remains for us to see how these principles may be applied to the co-ordination of Tertiary strata in various parts of the world. In 1880 I proposed a classification of the European Tertiaries, in which, apart from the special cha-

racteristic fossils of each group, stress was laid on the gradual approximation of various groups to the living Mammalia. The definitions are the following:—

DIVISIONS.	CHARACTERISTICS.
1. Eocene, or that in which the higher Mammalia (Eutheria) now on the earth were represented by allied forms belonging to existing orders and families. Oligocene.	Extinct orders. Living orders and families. No living genera.
2. Miocene, in which the alliance between fossil and living Mammals is closer than before.	Living genera. No living species.
3. Pleiocene, in which living species of Mammals appear.	Living species few. Extinct species predominant.
4. Pleistocene, in which living species of Mammals preponderate.	Living species abundant. Extinct species present. Man present.
5. Prehistoric, or that period outside history in which Man has multiplied exceedingly on the earth and introduced the domestic animals.	Man abundant. Domestic animals present. Wild Mammals in retreat. One extinct Mammal.
6. Historic, in which the events are recorded in history.	Records.

These definitions are of more than European significance. The researches of Leidy, Marsh, and Cope prove that they apply equally to the Tertiary strata of North America. The Wasatch Bridger and Uinta strata contain representatives of the orders Cheiroptera and Insectivora, the sub-orders Artio- and Perissodactyla, and the families Vespertilionidæ and Tapiridæ; but no living genera.¹ The Mammalia are obviously in the same stage of evolution as in the Eocenes of Europe, although there are but few genera, and no species common to the two.

The White River and Loup Fork Groups present us with the living genera *Sciurus*, *Castor*, *Hystrix*, *Rhinoceros*, *Dicotyles*, and others; but no living species, as is the case with the Miocenes of Europe. In the Pleiocenes of Oregon the first living species appear, such as the Beaver, the Prairie Wolf, and two Rodents (*Thomomys clusius* and *T. talpoides*), while in the Pleistocene river deposits and caves, from Eschscholtz Bay in the north to the Gulf of Mexico in the south, there is the same grouping of living with extinct species as in Europe, and the same evidence in the glaciated regions that the Mammalia occupied the land after the retreat of the ice.

If we analyse the rich and abundant fauna yielded by the caves and river deposits both of South America and of Australia, it will be seen that the Pleistocene group in each is marked by the presence of numerous living species in each, the first being remarkable for their gigantic extinct Edentata, and the second for their equally gigantic extinct Marsupials.

The admirable work of Mr. Lydekker allows us also to see how these definitions apply to the fossil Mammalia of India. The Miocene fauna of the lower Sivaliks has yielded the living genera *Rhinoceros* and *Manis*, and no living species.

The fauna of the Upper Sivaliks, although it has only been shown, and that with some doubt, to contain one living Mammal, the Nilghai (*Boselaphus tragocamelus*), stands in the same relation to that of the Oriental Region, as that of the Pleiocenes of Europe to that of the Palæarctic Region, and is therefore Pleiocene.

¹ The genus *Vesperugo* has not been satisfactorily determined.—Cope, *Report of Geol. Survey of the Territories. Tertiary Vertebrata*, I., 1884.

And lastly, the Narbada formation presents us with the first traces of Palæolithic Man in India in association with the living one-horned Rhinoceros, the Nilghai, the Indian Buffalo, two extinct Hippopotami, Elephants, and others, and is Pleistocene.

It may be objected to the Prehistoric and Historic divisions of the Tertiary Period that neither the one nor the other properly falls within the domain of Geology. It will, however, be found that in tracing the fauna and flora from the Eocene downwards to the present day there is no break which renders it possible to stop short at the close of the Pleistocene. The living plants and animals were in existence in the Pleistocene Age in every part of the world which has been investigated. The European Mollusca were in Europe in the Pleiocene Age. The only difference between the Pleistocene fauna, on the one hand, and the Prehistoric, on the other, consists in the extinction of certain of the Mammalia at the close of the Pleistocene Age in the Old and New Worlds, and in Australia. The Prehistoric fauna in Europe is also characterised by the introduction of the ancestors of the present domestic animals, some of which, such as the Celtic shorthorn (*Bos longifrons*), sheep, goat, and domestic hog, reverted to a feral condition, and have left their remains in caves, alluvia, and peat-bogs over the whole of the British Isles and the Continent. These remains, along with those of Man in the neolithic, bronze, and iron stages of culture, mark off the Prehistoric from the Pleistocene strata. There is surely no reason why a cave used by palæolithic Man should be handed over to the geologist, while that used by men in the Prehistoric Age should be taken out of his province, or why he should be asked to study the lower strata only in a given section, and leave the upper to be dealt with by the archæologist. In these cases the ground is common to geology and archæology, and the same things, if they are looked at from the standpoint of the history of the earth, belong to the first, and, if from the standpoint of the history of Man, to the second.

If, however, there be no break of continuity in the series of events from the Pleistocene to the Prehistoric ages, still less is there in those which connect the Prehistoric with the period embraced by history. The historic date of a cave or of a bed of alluvium is as clearly indicated by the occurrence of a coin as the geological position of a stratum is defined by an appeal to a characteristic fossil. The gradual unfolding of the present order of things from what went before compels me to recognise the fact that the Tertiary Period extends down to the present day. The Historic Period is being recorded in the strata now being formed, exactly in the same way as the other divisions of the Tertiary have left their mark in the crust of the earth, and history is incomplete without an appeal to the geological record. In the masterly outline of the destruction of Roman civilisation in Britain the historian of the English Conquest was obliged to use the evidence, obtained from the upper strata, in caves which had been used by refugees from the cities and villas; and among the materials for the future history of this city there are, to my mind, none more striking than the proof, offered by the silt in the great Roman bath, that the resort of crowds had become so utterly desolate and lonely in the ages following the English Conquest as to allow of the nesting of the wild duck.

I turn now to the place of Man in the geological record, a question which has advanced but little since the year 1864. Then, as now, his relation to the glacial strata in Britain was in dispute. It must be confessed that the question is still without a satisfactory answer, and that it may well be put to 'a suspense account.' We may, however, console ourselves with the reflection that the River-drift Man appears in the Pleistocene strata of England, France, Spain, Italy, Greece, Algiers, Egypt, Palestine, and India along with Pleistocene animals, some of which were pre-glacial in Britain. He is also proved to have been post-glacial in Britain, and was probably living in happy, sunny, southern regions, where there was no ice, and therefore no glacial period, throughout the Pleistocene Age.

It may further be remarked that Man appears in the geological record where he might be expected to appear. In the Eocene the Primates were represented by various Lemuroids (*Adapis*, *Necrolemur*, and others) in the Old and New Worlds. In the Miocene the Simiadæ (*Dryopithecus*, *Pliopithecus*, *Oreopithecus*) appear in Europe, while Man himself appears, along with the living species of Mammalia, in the Pleistocene Age, both in Europe and in India.

The question of the antiquity of Man is inseparably connected with the further question: 'Is it possible to measure the lapse of geological time in years?' Various attempts have been made, and all, as it seems to me, have ended in failure. Till we know the rate of causation in the past, and until we can be sure that it has been invariable and uninterrupted, I cannot see anything but failure in the future. Neither the rate of the erosion of the land by sub-aërial agencies, nor its destruction by oceanic currents, nor the rate of the deposit of stalagmite or of the movement of the glaciers, have as yet given us anything at all approaching a satisfactory date. We only have a sequence of events recorded in the rocks, with intervals the length of which we cannot measure. We do not know the exact duration of any one geological event. Till we know both, it is surely impossible to fix a date, in terms of years, either for the first appearance of Man or for any event outside the written record. We may draw cheques upon 'the bank of force' as well as 'on the bank of time.'

Two of my predecessors in this chair, Dr. Woodward and Professor Judd, have dealt with the position of our science in relation to Biology and Mineralogy. Professor Phillips in 1864 pointed out that the later ages in Geology and the earlier ages of mankind were fairly united together in one large field of inquiry. In these remarks I have set myself the task of examining that side of our science which looks towards History. My conception of the aim and results of Geology is, that it should present a universal history of the various phases through which the earth and its inhabitants have passed in the various periods, until ultimately the story of the earth, and how it came to be what it is, is merged in the story of Man and his works in the written records. Whatever the future of Geology may be, it certainly does not seem likely to suffer in the struggle for existence in the scientific renaissance of the nineteenth century.

The following Papers were read:—

1. *Further Note on the Midford Sands.*¹ By HORACE B. WOODWARD, F.G.S.

[Communicated by permission of the Director-General of the Geological Survey.]

The term Midford Sands, introduced in 1871 by Professor Phillips, has been accepted by many geologists because it avoided the confusion that had arisen from the use by some authorities of the term Inferior Oolite Sands, and by others of Upper Lias Sands.

At Midford the upper portion of the Inferior Oolite (zone of *Ammonites Parkinsoni*) rests directly on the Sands, whereas in other parts of Somersetshire, in Dorsetshire and Gloucestershire, the lower portion of the Inferior Oolite (comprising the zones of *A. Humphriesianus* and *A. Murchisonæ*) is present above the Sands. In the absence of palæontological evidence, it has been questioned whether the Midford Sands are really equivalent to the Sands in other parts of the south-west of England. Hence other local names, e.g., the Yeovil and Bridport Sands, and the Cotteswold Sands, have been introduced.

Regarding the zone of *Ammonites opalinus* and the Gloucestershire Cephalopoda-bed as a portion of the Cotteswold Sands, there is no doubt about their correlation with the Sands of Bridport and Yeovil. Two species of *Ammonites* (*A. striatulus* and *A. aalensis*) have been obtained by the Rev. H. H. Winwood from the Midford Sands. The latter of these species was recorded by myself, on the authority of Mr. Etheridge, in 1876, but its occurrence has been overlooked. More recently I have seen in the William-Smith Collection in the British Museum an *Ammonite* from the Coal-canal at Midford; and this has been identified by Mr. Etheridge and Mr. R. B. Newton as very near to, if not identical with, *A. Levesquei*, a species recorded by Dr. Lycett from the Gloucestershire Cephalopoda-bed. These species show that the Midford Sands belong to the same general horizon as the Sands of Gloucestershire and Dorsetshire, so that there is no adequate

¹ A previous Note on the Midford Sands was published in the *Geol. Mag.* 1872, p. 513.

reason for discarding the name Midford Sands. If the beds near Bath have not proved so fossiliferous as those in other localities, there is no reason why they should remain so; for in Dorsetshire there are many sections where the beds appear barren, in close proximity with other exposures that yield an abundant fauna.

2. *The Relations of the Great Oolite to the Forest Marble and Fuller's-earth in the South-west of England.* By HORACE B. WOODWARD, F.G.S.

[Communicated by permission of the Director-General of the Geological Survey.]

The southerly attenuation of the Great Oolite, and its absence in Dorsetshire, have been generally attributed to lateral changes in the strata—it being considered that the Great Oolite is mainly replaced by Forest Marble (which has been stated to increase in thickness southwards), and perhaps in part by the Fuller's-earth.

In Gloucestershire the Great Oolite and Forest Marble are so interblended that there is no real line of demarcation. At Bradford-on-Avon this is not the case: the surface of the Great Oolite, with its clusters of *Apiocrinus*, indicates a pause in deposition, and we have locally a good line of division between this formation and the Bradford Clay, which is a subordinate portion of the Forest Marble. Southwards the Bradford Clay horizon extends to the Dorsetshire coast, but the Great Oolite is no longer found, and we see no evidence of the Crinoid growth *in situ*. The estimated thickness of the Forest Marble in Dorsetshire has been much exaggerated, and the evidence furnished by the persistence of the Bradford Clay is opposed to the view that the Great Oolite is replaced in any way by the Forest Marble.

In Oxfordshire and Gloucestershire the Great Oolite and the Stonesfield Slate merge downwards into the Fuller's-earth with no marked stratigraphical division, and this is the case as far as Lansdown, near Bath. Northwards the Fuller's-earth is much attenuated, and near Chipping Norton it rests on a higher stage of the Inferior Oolite than we find in the Cotteswold Hills, as if in the former area the conditions attending the deposition of Inferior Oolite lingered longer. Rarely do we find any interblending of Inferior Oolite and Fuller's-earth; indeed, we sometimes find indications of local pauses in deposition, marked by annelide burrows, &c. So that on stratigraphical grounds the Fuller's-earth is more intimately connected with the Great Oolite than with the Inferior Oolite.

In Dorsetshire the Fuller's-earth series attains its greatest development in this country, and is separable into Upper and Lower clayey divisions with an intermediate bed of Fuller's-earth Rock. These divisions may be traced northwards to Lansdown and Slaughtford, near Bath, where the Fuller's-earth Rock is present in an attenuated form, and where the Upper Fuller's-earth merges into the base of the Great Oolite.

It is therefore clear that the mass of the Great Oolite is not represented in the Fuller's-earth series of Dorsetshire, although its lower beds may be partially replaced by the Upper Fuller's-earth. The mass of the Great Oolite, therefore, either wedges out abruptly south of Bradford-on-Avon, or has been to some extent denuded. On the whole, it appears probable that the Great Oolite has been denuded—the erosion being local and contemporaneous so far as the Great Oolite series is concerned. The structure of the Forest Marble, with its clay-galls, its current-bedded limestones made up of broken shells and oolitic grains (the latter sometimes in a sandy matrix), favours the notion that it may have been largely derived from previous accumulations; and this opinion was suggested by Dr. Sorby from a microscopical study of some of the beds.

The organic remains of the Fuller's-earth include many species common to the Inferior Oolite and many common to the Great Oolite. Of seventy-two species, obtained during the course of the Geological Survey, fifty-eight are known also in the Great Oolite and forty-two in the Inferior Oolite, a number being common to the two formations. The palæontological evidence therefore coincides with the

stratigraphical, that the Fuller's-earth on the whole is more intimately connected with the Great Oolite than with the Inferior Oolite. For convenience of classification it should therefore be placed with the Great Oolite series.

3. *Note on the Portland Sands of Swindon and elsewhere.*
By HORACE B. WOODWARD, F.G.S.

[Communicated by permission of the Director-General of the Geological Survey.]

Attention was drawn to some fresh sections at Swindon and these confirmed the sequence made out by Professor J. F. Blake from somewhat scattered data. The sandy beds that yield the Swindon Stone were originally grouped as 'Portland Sands,' but they clearly belong to the Portland Stone division, as pointed out by Mr. Blake. The basement bed here and at Aylesbury consists of a conglomeratic band containing lydites, a few quartz pebbles, and some derived fossils. The true Portland Sands occur below, and are about 60 feet thick. The sequence is as follows:—

	feet	
Portland Stone, with lydite bed at base and in upper part of clay beneath.		
Portland Sands. {	3. Blue and brown clay	19
	2. Sandy calcareous rock. Oyster-bed with small acuminate oyster	8
	1. Greenish and yellowish sands with huge concretionary masses of calcareous sandstone. The sands merge downwards into	30 to 40
Kimmeridge Clay.		

Comparing the sequence with that at Aylesbury, worked out by Mr. Hudleston, we find the Portland Stone with lydite bed at base resting on the Hartwell Clay. This clay, like the Blue and brown clay (No. 3.) at Swindon, was originally taken to be Kimmeridge Clay, but the former has been shown to be on the horizon of the Middle Portlandian of French geologists; and there is no doubt, on stratigraphical and palæontological grounds, that the clays of Swindon and Hartwell are on the same approximate horizon, and that both belong to the Portland Sands. We have not clear evidence of the sequence beneath the Hartwell Clay at Aylesbury; but a deep well at Stone, in that neighbourhood, showed the presence beneath the Portland Stone of Blue clay, Limestone, Dark sand, and then Blue clay again—this last-named bed being, no doubt, the true Kimmeridge Clay, although detailed measurements are wanting.

Doubtless there is some inconvenience in a term like Portland Sands, when it includes prominent beds of clay like those of Swindon and Hartwell, and when the Portland Stone of Swindon is so largely represented by sand. We might employ the terms Upper and Lower Portlandian were it not that on the Continent a three-fold division has been adopted, and the Lower Portlandian embraces beds that in this country cannot be separated from the Kimmeridge Clay. The Middle Portlandian, as before mentioned, represents our Portland Sands and Hartwell Clay; and Professor Blake has applied the term Bolonian to these Middle and Lower Portlandian beds. On stratigraphical grounds it does not appear possible for us to adopt that term, and on the whole the following grouping appears best adapted for the English strata:—

Upper Portland Beds—Portland, Tisbury and Swindon Stone.

Lower Portland Beds—Portland Sands and Hartwell Clay.

It is true that at Swindon and Hartwell the Lower Portland Beds are more intimately connected, on stratigraphical grounds, with the Kimmeridge Clay than with the Upper Portland Beds; but this is not the case on the Dorsetshire coast, where no conglomeratic band has been met with at the base of the Portland Stone.

4. *On Local Geological Photography.* By OSMUND W. JEFFS.

In this paper the author suggests the desirability of taking steps to secure the formation of a collection of photographic views illustrating the geological features of each county.

Isolated attempts to record local geological features of importance have been made by several provincial societies, amongst others by the Leicester Literary and Philosophical Society, Liverpool Geological Society, Belfast Naturalists' Field Club, Chester Society of Natural Science, the Geological Society of Yorkshire, the Croydon Microscopical and Natural History Society, &c. ; but there is need for some systematic scheme to secure uniformity of action in every district in England.

This could best be done by the appointment under this Association (which is in touch with all centres of scientific activity in the United Kingdom) of officers in each county charged with the arrangement of details and superintendence of local photographic surveys in their respective districts. The results obtained would be duly preserved, recorded, and catalogued by a central officer of the Association, who would give facilities for the purchase and exchange of views.

It is important that the date, name of photographer, and full descriptive details (accompanied by explanatory sketches when necessary) be attached to every picture taken. The suggestions made in the paper are for consideration, and subject to such modification as may be arranged by the Committee or the Officers of Section C.

Photographic records of sections and of other geological features and physiological phenomena are not only invaluable as aids to class-teaching and geological instruction generally, but they will serve to preserve for future reference the details of many exposures of strata and other important landscape features which in course of time, by natural and other agencies, are in danger of becoming obliterated.

5. *Further Notes on the Origin of the Crystalline Schists of Malvern and Anglesey.* By CHARLES CALLAWAY, D.Sc., M.A., F.G.S.

At the meeting of the Association in 1887 the author noticed that in the Malvern Hills the foliation was *zonal*. The igneous rocks, as a shear zone was approached, acquired a parallel structure, and where the zone was penetrated by granite veins hornblende was converted into black mica. In Anglesey also some of the schists resulted from the shearing of igneous rocks, and it was suggested as probable that the limestones of the Older Archæans were endogenous deposits derived from the decomposition of the adjacent rocks.

Subsequent work in the field and cabinet confirmed and enlarged the above results. At Malvern some new shear zones were examined. At one locality diorite interlaced with vertical granite-veins passed, within the breadth of a yard, into a banded gneiss, with a dip of 70°. Both granite and diorite exhibited progressive shearing and mineral change. The granite (binary) passed through the usual stages into muscovite gneiss. These seams were interbanded with a dark schist, consisting mainly of hornblende crystals flattened out, white mica and black mica.

A large series of observations showed that when a complex of granite and diorite was sheared, mica was produced in both. In the diorite either biotite was formed from the hornblende, or muscovite replaced soda-lime felspar. Sometimes both micas were generated in the diorite.

Injection schists were sometimes formed by *infiltration*. Granite and diorite were in contact. Shearing was progressive towards the granite and into it. The diorite near the junction went largely to chlorite and iron-oxide. These passed into the cracks of the crushed granite, and as the latter was progressively sheared they retained their place between the folia of quartz and felspar. Thus a chlorite gneiss was formed. Black mica was sometimes generated in the chlorite, especially round opaque dots (? iron-oxide).

The mica (? sericite) schist of the western spur of Ragged Stone Hill was formed

from diorite. The chemical change was greatest where the shearing reached its maximum. In an intermediate stage the rock was a sort of grit, consisting of parallel seams of felspar fragments immersed in chlorite. Much lime was liberated as carbonate. The percentage of silica rose during the process of schist-making from forty-seven to sixty-five.

In Anglesey additional evidence for the conversion of felsite to mica-schist had been procured. At Porth Nobla a felsitic rock passed into hälleflinta, which, by shearing, graduated into schists. The granite of Llanfaelog was intrusive in these and other adjacent rocks. The author's time-succession in the older schists of Anglesey could not, of course, be regarded as more than a mineral succession in the light of the new views of metamorphism. The case was different with the Newer Archæan (? Pebidian) series, in which there was a passage between the hypometamorphic slates and true crystalline schists, the foliation of the latter coinciding with the bedding, which was clearly indicated by bands of grit.

6. *Sketch of the Geology of the Crystalline Axis of the Malvern Hills.* By CHARLES CALLAWAY, D.Sc., M.A., F.G.S.

This ridge was composed of rocks which had originally been eruptive, but in places they had undergone such important structural and chemical changes that they might fairly be called 'metamorphic.' The original rocks were diorite (several varieties), epidiorite, a binary granite, and felsite. The principal rocks of secondary origin were muscovite gneiss, biotite gneiss, hornblende gneiss, and mica schists, some of these schists being *simple* (formed from one kind of rock), while others were *injection* schists (formed out of veined masses).

In the North Hill massive diorites predominated, but a gneissic structure was frequently produced by pressure. The mass, which culminated in the Worcestershire Beacon, consisted of diorites with intrusive granite. The granite veins in diorite, accompanied by shearing, gave rise to various gneisses. At the Wych there was a chlorite gneiss, which was a sheared granite, into which chlorite from decomposed diorite had infiltrated. Between here and the Wind's Point the rock was mainly diorite with granite veins, occasionally compressed and sheared. The Herefordshire Beacon was of similar composition, but its eastern spurs consisted of felspathic rocks, some of which, according to Mr. Rutley, were perlitic felsites. These rocks were probably of Uriconian (Newer Archæan) age, and might perhaps be correlated with the Pebidian of Dr. Hicks.

Granite in masses formed the northern end of Swinyard's Hill; near the southern end it was sheared into mica gneiss, and at the southern extremity, in association with diorite, it formed injection schist. Midsummer Hill was mostly diorite. Ragged Stone Hill was a complex mixture of diorite, granite, felsite, and epidiorite. At the south-eastern spur felsite was sheared into mica schist, while the south-western spur mainly consisted of a mica schist, which could be traced into a diorite. This schist was overlain unconformably by the Hollybush Sandstone (Cambrian). The bulk of the Malvern crystalline rocks were Older Archæan. The Malvern axis was thus seen to furnish many interesting facts bearing on the origin of the crystalline schists.

7. *Archean Characters of the Rocks of the Nucleal Ranges of the Antilles.* By Dr. PERSIFOR FRAZER.

During a visit this year to the south-eastern part of the island of Cuba, the speaker had made some examinations of the rocks which form the nucleus of the spurs of the Sierra Maestra, and there is strong reason to believe of the axial range of the entire island and of Jamaica, Santo Domingo, Puerto Rico, and the Windward Islands as well. From the field observations there made, and an examination of the specimens under the microscope, it seems highly probable that these rocks, instead of being igneous extrusions of the Tertiary period and later, are in reality of much earlier date, and may not be entirely volcanic.

The considerations which support this view are—

1. Microscopic analysis shows immense alteration to have taken place, and consequently a very long period to have elapsed.

2. The complexity of the congeries of rocks forbids the hypothesis of their having been derived from one mass. Where this congeries, therefore, is unconformably adjacent to the Tertiary, there can be no reasonable doubt that the crystalline rocks are the elder. This point of view was suggested by Mr. Teall, who would consider the argument valid also for the contact with the Cretaceous, and perhaps older series. It is difficult to see why it should not hold equally good for the contact between these crystalline and the Paleozoic rocks as made out by De Castro near Cienfuegos, &c.

3. The characters of the several associated rocks are those which one finds united in very many Archean regions throughout the world.

4. The products of alteration of these rocks are similar to those which one finds in the districts just alluded to.

5. The chemical peculiarities of the iron ores found in contact with these rocks are similar to those which one finds in the ores of the Archean regions, both in the low percentage of phosphorus and in the pyrite and (more sparingly) chalcopyrite disseminated through the ore, and in other respects.

6. If this nuclear mass had been forced up from the earth's interior in a state of igneous fusion there would not be now (as there are) abundant traces of stratification and structure, implying an original sedimentation.

7. If this mass had resulted from volcanic outflow there must have been contact phenomena, and changes induced on the surfaces of the rocks with which it was brought in contact. No such contact alteration has been observed between these rocks and those of either the Paleozoic, Mesozoic, or Cenozoic groups which in different localities meet them.

8. The direction of the range, considered as a whole, lends support to the hypothesis that it is a fork of the Andes which, diverging from the main axis in Guatemala, traverses the peninsula of Yucatan, and in a symmetrical curve sweeps through the highlands of Cuba and Jamaica, Hayti, Puerto Rico, the Windward Islands, and the N.E. coast of Venezuela. This rim of high land once enclosed the Caribbean as another Mediterranean Sea.

9. The shapes of the hills of this range, produced by weathering, are not those usually visible in regions of volcanic, but rather of metamorphic rocks.

The rocks which furnished the basis for the above conclusions are all, or nearly all, alteration products. In some cases they appeared to be the results of a series of metamorphoses, some of their constituents seeming to pass through cycles of change, ending in the mineral with which the alteration began after a number of intermediate stages. The rocks are Diabases or Diorites, with Epidote, Porphyritic Dolerites, which resemble and have been taken for Syenites; Garnet rock; Actinolite; Felsite and Orthofelsite Porphyry, like that of the South Mountain of South-eastern Pennsylvania, of St. David's Head in Wales, and elsewhere. To these are added Pyrite, and iron ores and crystalline limestone. Copper and manganese ores are not rare, but their relations to the rocks under consideration have not been made out.

NOTE.—A number of the first petrologists of Europe who have examined their slides are disposed to consider the specimens of not later than Paleozoic age, while none are willing to deny that they *may* be earlier.

8. *On a Specimen of Quartz from Australia and Three Specimens of Oligoclase from North Carolina exhibiting curious Optical Properties.*
By Dr. PERSIFOR FRAZER.

Mr. George F. Kunz, Gemmist for Tiffany & Co., of New York city, and reporter on the precious stones of the United States for the United States Geological Survey, desires through me to call attention to these minerals, on the curious optical properties of which a preliminary note appears in the 'American Journal

of Science' for September. Further investigations will be published in succeeding numbers of this journal. The Oligoclase presents an appearance like that seen in devitrified glass, where numbers of small star-like masses appear in the transparent matrix. The quartz, which unfortunately has been superficially polished, exhibits twin structure when viewed along the axis ∞ P, the alternate parts of the twin being differentiated by smoky and clear quartz.

In the interior a singular segregation of foreign matter has taken place along the plains of twinning, but in such a manner as to mark the outline of a hexagonal or ditrigonal pyramid.

FRIDAY, SEPTEMBER 7.

The following Report and Papers were read:—

1. *Sixteenth Report on the Erratic Blocks of England, Wales, and Ireland.*
See Reports, p. 101.

2. *On a High Level Boulder-clay in the Midlands.*
By Dr. H. W. CROSSKEY, F.G.S.

3. *On the Extension of the Bath Oolite under London, as shown by a Deep Boring at Streatham.* By W. WHITAKER, B.A., F.R.S.

The attempts to get water from beds deep underground in and near London have done much to reveal the geological structure of that district, and to prove what was before only the theory of the geologist to be a fact, namely, that along part of the valley of the Thames the regular succession of the formations is broken by the occurrence of a mass of older rocks, rising up so as, in some cases, to come next beneath the Gault.

This has been brought about by the underground extension eastward of the great line of disturbance, of which so much is seen at the surface in the west of England, in the great saddleback of the Mendips, in the trough of the South Wales Coal-field, and in the bringing in of coal-fields under Jurassic formations.

Whether the Bath waters have anything to do with this disturbance I cannot say, but we have not yet succeeded in tapping them under London.

Not the least interesting result of the set of experiments in deep boring has been the discovery of beds of Jurassic age in two of the borings, at Meux's Brewery and at Richmond. These beds, though comparatively thin, can be referred with safety to the lower division of the series, or that which is so well developed round Bath, both from their character and from their fossils.

A boring now being made by the Southwark and Vauxhall Water Company at Streatham, a southern part of London, has passed through the following formations, and then, at the depth of 1,081½ feet, has passed at once into Jurassic limestone:—

Tertiary beds	feet
Chalk	241½
Upper Greensand	623
Gault	29
	188

This limestone is hard, compact, for the most part of coarsely oolitic structure and with small fragments of shells. It is almost exactly like some of the Forest Marble of Wiltshire, so much indeed that specimens from the two can hardly be distinguished.

As it is in the two other borings nearest to Streatham that Jurassic rocks, also referred to the Forest Marble, have been found, we may fairly infer the existence of

a continuous sheet of these rocks from the central part of London for some miles southward. How far south we cannot say. We can, however, limit the northerly extension, as in the northern part of London and beyond no Jurassic beds have been found. On the east, too, along the valley of the Thames, they soon end off, though they may extend far beneath the broad tract of the Weald, and perhaps also under some of the bordering chalk tract.

The object of the various borings alluded to has been to get water from the Lower Greensand, which formation comes next beneath the Gault at the outcrop on the south, right through Surrey and Kent. The borings have, however, proved that it thins out underground northward, not reaching so far as London.

The only chance, therefore, of getting water from this formation near London seems to be by tapping some older formation which may come into contact with the Lower Greensand in some part of its underground course, and may be permeable enough to receive and to carry off some of its water. The Jurassic limestone as yet found at Streatham is too compact for this, but the boring will be continued for awhile in the hope of reaching beds of looser texture.

Should the Company, however, feel compelled to abandon the work, it is to be hoped that some means may be taken to carry it on as a scientific experiment, in order to find out what formation comes beneath the Jurassic beds, which, in the two borings that have pierced them, are succeeded by red sandstones and marls of doubtful age, or by undoubted Devonian rocks. We have now another chance of solving an important problem, the question whether Coal Measures occur along the valley of the Thames.

NOTE.—Since this paper was read the boring has been carried through the Jurassic beds, which are only $38\frac{1}{2}$ feet thick, and has entered a set of compact calcareous sandstones, grey and greenish grey, mottled with maroon-colour, probably with beds of clay (specimens of which are not brought up by the boring-tool). These beds are like those of Richmond and of doubtful age—New Red or Old Red?

4. *On the Lower Carboniferous Rocks of Gloucestershire.*

By E. WETHERED, F.G.S., F.C.S., F.R.M.S.

In Gloucestershire there are two coalfields, namely, that of the Bristol and Forest of Dean. The Carboniferous Limestone Series of Gloucestershire were long ago divided by Sir H. De La Beche as follows :

UPPER MIXTURE OF SANDSTONES.

	Clifton feet	Forest of Dean feet
Marls and Limestones	400	146
Central Portion	1,438	480
Lower Shales	500	165
	2,338	791

The author has proposed some detailed alterations with regard to the Bristol coalfield which are stated in the 'Quarterly Journal of the Geological Society' for 1888, p. 187, but the above divisions have been generally accepted under the terms Lower Limestone Shales, Carboniferous Limestone, and Upper Limestone Shales. Professor Hull has given a classification of the Carboniferous Series throughout the country ('Quart. Journ. Geol. Soc.' 1877), based on the various stages which occurred during the deposition of the rocks. The author supports the principle of that classification, and is of opinion that the Lower Carboniferous rocks of Gloucestershire might be correlated with the same formation in the north of England. If this could be done it might be possible to adopt terms for the respective stages which would apply to the north and south of England, and thus avoid the complication of terms now in use.

The author then recited the stages which occur in the Carboniferous Limestone of Gloucestershire. Above the Old Red Conglomerate there appears a series of 1888.

sandy beds which are best developed in the Forest of Dean. These consist of micaceous green shales, and red purple and yellow sandstones. Some are calciferous and readily effervesce when treated with acid. No fossils have been found, but quartz pebbles occur in some of the beds.

The strata just referred to pass up into limestone and shales, the so-called Lower Limestone Shales. In the Forest of Dean the limestones are largely made up of the valves of *Ostrococha*, among which the following have been determined: *Kirkbya variabilis*, *K. plicata*, *Cytherella extuberata*, *Bythocypris sublunata*, and *Darwinula berniciana* (^p). Among the other fossils which are numerous may be mentioned *Athyris Royssii*, *Rhynchonella pleurodon*, *Encrinites* and *Polyzoa*. Among the latter the following have been determined: *Rhabdomeson gracile*, Phill., and *Fenestella tuberculocarinata*, Ether. Junr. In the Lower Limestone Shales of the Bristol coalfield Ostracoda are not so plentiful, though in some beds the valves of these small Crustacea are numerous. *Rhynchonella pleurodon*, *Athyris Royssii*, *Productus*, *Spirifera* Crinoids and *Polyzoa* occur. At Clifton the Lower Shales are followed by a crinoidal limestone known as the Black Rock, which is about 490 feet thick, and is not represented in the Forest of Dean. The Black Rock series are followed by seventy feet of Dolomite, and then by about 100 feet of white oolitic limestone which the author regards as the true base of the Middle or Carboniferous Limestone. The author has grouped the Lower Limestone Shales with the Black Rock under the term Lower Limestones, and he considers the stage to occupy the horizon of the Tuedian and Calciferous series of the north of England and Scotland. As to the sandy beds which lie between the Old Red Conglomerate and Lower Limestone Shales the author regards them as the equivalent of the lower portion of the Transitional series of Phillips and the Calciferous of Scotland. The true upper limits of the Old Red Sandstone should be drawn at the Old Red Conglomerate.

As to the Middle Limestone there can be no doubt that it is the equivalent of the Carboniferous Limestone as generally understood, but the latter term the author thinks objectionable, and he would term the whole series Carboniferous Limestone. The Middle Limestone is largely made up of *Foraminifera* and *Calcisphaera*, but corals, polyzoa, crinoids, and shells occur, sometimes in quantity. In the Forest of Dean the Middle Limestone is extensively dolomitised.

Coming to the Upper Limestones; at Clifton it is difficult to draw the line at which the series should commence, as there is little alteration in the structure from that of the Middle Limestones. Corals are more numerous, coarse oolitic beds appear, and the beds become mixed with millstone grit. In the Forest of Dean the upper stage is well and clearly defined by two characteristic limestones known as the 'Crease' and 'Whitehead.' The former of these has become partially crystallised, but in some beds *Productus* is numerous, and also *Calcisphaera*.

The millstone grit is about 900 feet thick in the Bristol coalfield, and is a hard, slightly pink-coloured quartzite. In the Forest of Dean it is about 270 feet, and is a loose yellow red and mottled sandstone made up of well-rounded grains of quartz. The lowest beds are argillaceous and contain remains of *Lepidodendra*.

5. On the Tytherington and Thornbury Section. By the Rev. H. H. WINWOOD, F.G.S.

The author gave a short description of the section between Tytherington and Thornbury which members of the Association had an opportunity of visiting on the Saturday excursion. Beginning at Mr. Hardwicke's quarry, close to the Tytherington Station, the Carboniferous Limestone is seen rising sharply from the Gloucestershire Coal-field, followed by the whole series of beds of this formation, Upper, Middle, and Lower in descending order, until the Old Red Sandstone and Conglomerate appear at the Thornbury end. The chief points to be noticed in the Section are: (1) the 'Firestone' beds to be seen near the top of the quarry, dense siliceous beds marking the gradual coming in of the Millstone Grit. (2) The reversed fault bringing the fine-grained yellow beds of the Dolomitic Conglomerate similar to the

so-called Magnesian Limestone at Clevedon, against the Carboniferous Limestone, causing rolls and fractures for the space of some 500 feet, when the latter formation appears again, but now with the Dolomitic Conglomerate, everywhere resting horizontally on its upturned and denuded edges. (3) The cropping up of the 'Bryozoa' bed just before the last tunnel, giving a definite horizon for the correlation of this section with that at the Avon gorge. (4) The appearance at the base of the section of the Old Red Conglomerate with the coarse Dolomitic Conglomerate, containing pebbles of white quartz, Old Red Sandstone and Limestone, resting on its edges and with difficulty to be distinguished from the latter. (5) The reappearance at the end of the cutting of the same fine-grained yellow limestones divided by bands of shale and clay lying horizontally on the coarse Conglomerate beneath.

6. *The Northern Section of the Bristol Coal-field.*

By HANDEL COSSHAM, M.P., F.G.S.

After some general remarks on the character of the Bristol Coal-field, and its more complicated geological features, the author referred to the opinions of the principal geologists who have described the district, and recalled attention to his paper on a mistake in the geological maps of this Coal-field (read at the Bath meeting of the British Association in 1864).

He then drew attention to certain remarkable faults found in the Bristol Coal-field, with explanations of the same; and observed that they furnished illustrations of lateral pressure rather than of vertical movement.

He gave some account of the upheaval of the Mendip Hills, Broadfield Down, &c., subsequent to the formation of the Coal-field: alluding to the rent in the Palæozoic strata which forms the Severn valley, and to the severance of the Coal-fields of South Wales, Dean Forest and Bristol. A remarkable discovery was made by him, in 1884, of a great overthrust fault, the effect of which has been to double the known coal resources on the western side of the Bristol Coal-field. His observations threw some light on the complicated geological section of the Avon gorge, and on the future of the Bristol coal supply.

7. *Some Points of Interest in the Geology of Somerset.*

By W. A. E. USSHER, F.G.S.

[Communicated by permission of the Director-General of the Geological Survey.]

Three subjects were put forward as worthy of attention, and demanding a solution.

First. The position of the Carboniferous Limestone patches in the Coal-Measure area at Vobster and Luckington.

Secondly. The borderland between the Devonian and Culm Measures and the rocks of Old Red Sandstone and Carboniferous (proper) type.

Thirdly. The relations of the Lower Devonian beds in West Somerset.

In the first place, he suggested a thrust-fault through the Mendip axis carrying its upper portion northward so that the upward continuation of the Limestone on the north side of the Mendips should be shifted to the position indicated by the Vobster patches, the relations of these patches to the Coal Measures beneath and around being subsequently affected by step faults. This alternative hypothesis seemed to him more simple than Mr. H. B. Woodward's faulted anticlinal curves, and was merely put forward as a tentative hypothesis.

In the second place the author deprecated absolute correlations of divisions of Devonian and Carboniferous beds, whilst accepting the philosophical aspects of the general correlations of the late Professor Jukes and of Professor Hull. He considered that the area in which both types occurred side by side deserved primary attention. The relative position of the Cannington Park (Carboniferous) Limestone to the Middle Devonian rocks of the Quantocks and the Cannington and other inliers, supposed to be Middle Devonian, was given, as also the position of the

nearest Upper Devonian rocks and Culm Measures. From the strike of the Upper Devonian rocks he considered that they would be found under the Trias of the Vale of Taunton, and might trend northward under the Bridgewater Levels, till cut off by fault or unconformity bringing on the Carboniferous beds of normal type.

He believed a very careful comparison of the relations of the Belgian Lower Carboniferous and Upper Devonian rocks with the Culm Measures and Upper Devonian rocks of Devon and Somerset would throw much light on the question.

Lastly, brief allusion was made to the absence of the Lynton beds east of Luccot Hill, and to the possibility of their occurrence, as also of the presence of Foreland grits in the north of the Quantocks.

SATURDAY, SEPTEMBER 8.

The following Papers and Report were read:—

1. *Comparison of the principal Forms of Dinosauria of Europe and America.*
By Professor O. C. MARSH.

2. *The Evolution of the Mammalian Molar Teeth to and from the Tritubercular Type.*¹ By HENRY FAIRFIELD OSBORN.

Out of 82 species of mammals from the lowest Eocene of America (Puerco), all but four have *tritubercular* superior molars. From this type it is demonstrated that the molars of many of the Marsupialia of the Carnivora, Insectivora, Lemuroidea and Primates, Ungulata, &c., are derived, by the addition of cusps. To this type it is demonstrated that the molars of the Triassic and Jurassic mammalia lead. It is a central type.

The history of each of the cusps can be traced in all the mammals in which the molars have passed through the tritubercular stage. A nomenclature is therefore proposed as follows: the *protocone*, for the cusp which represents the primitive reptilian cone; the *para* and *metacones*, for the cusps on either side of this. These rotate inwards in the lower jaw and outwards in the upper jaw, to form the tritubercular type. In the lower molars a heel is next formed, the *hypoconid*, this leads to the formation of the intermediate cusps upon the upper molars, the *para* and *metaconules*. Finally the heel is formed upon the upper molars, the *hypocone*, completing the sextitubercular crown.

These stages of evolution are also named as follows: *protodont*, primitive reptilian crown stage; *triconodont* stage, with the large central and two lateral cones; *tritubercular* (Cope); *sevitubercular*, the parent ungulate type with six tubercles, and the *quadritubercular*. The lower molars pass more rapidly through the *tritubercular* to the *tubercular-sectorial* (Cope) and *quadritubercular* stages.

The development of the cusps is believed to be, in a measure, mechanical (Lamarck, Ryder, Cope): *a*. New cusps appear at points of vertical interference between upper and lower molars; *b*. Cusps take new shapes as a result of horizontal interference between upper and lower molars.

Not all mammalia are believed to have acquired this type. Those which have not are believed to have become extinct, this type having favoured the lines which acquired it. At any one period we find *progressive*, *conservative*, *central* and *persistent* types of molars, standing at various stages of the *tritubercular* evolution.

3. *On the Gigantic Size of some Extinct Tertiary Mammalia.*
By Professor A. GAUDRY.

The author drew attention to the very large size attained by some of the mammalia in later geological times, and instanced especially the skeleton of *Elephas*

¹ Published *in extenso* in the *American Naturalist*, December 1888.

primigenius in the Paris Museum, which is nearly five metres in height and which is exceeded by a specimen at St. Petersburg. The great *Dinotherium* of Pikerimi in Greece, found by Professor Gaudry himself, is of greater size still. The author expressed his satisfaction at finding that among British palæontologists there were now several who devoted themselves to the vertebrate as well as to invertebrate remains.

4. *Note on the Relation of the Percentage of Carbonic Acid in the Atmosphere to the Life and Growth of Plants.* By the Rev. A. IRVING, D.Sc., B.A., F.G.S.

The author refers to the discussion raised recently on this question in the pages of the 'Geological Magazine.' In order to test the hypothesis adopted by Professor Prestwich, three series of observations have been made during the past summer on plants exposed, under similar physical conditions, to atmospheres of different compositions. The evidence obtained all points in one direction, and goes to show that, with an increase of the percentage of carbonic acid up to about that of the free oxygen present, the vigour of plant life and growth is also increased, so long as the plants are freely supplied at their roots with water, as we have good reason to suppose was the case with the vascular cryptogams from which the carbonised materials of the coal-measures are for the most part derived. The author further considers the theory as throwing some light upon a certain stage of development of life upon the earth in later palæozoic time; the great development of plant growth in the carboniferous age having served as the means of storage of carbon in the earth's lithosphere, and thus purified the atmosphere so as to render it fit for the development of air-breathing forms of life in the Mesozoic Age.

5. *On the Occurrence of a Boulder of Granitoid Gneiss or Gneissoid Granite in the Halifax Hard-bed Coal.* By JAMES SPENCER. With a note by Professor T. G. BONNEY.

Many years ago, before the great importance of these boulders found in coal-beds was recognised, a fine specimen was found in the Hard-bed coal at Dam Head Pit, Shibdendale, near Halifax. It was a white hard rock streaked with small patches of a darker hue, almost as round as an orange, and about as large, and most highly polished. Having had my attention again called to these boulders by the discovery of quartzite boulders in the Black-bed coal at Leeds, two of them having been sent to me to prepare slices for examination under the microscope, I have been on the look-out for specimens from our local coal-beds, and was very fortunate to meet with one (in the spring of the present year 1888), which came from Shibden Head Pit, near Halifax. The boulder is of a greyish colour, four inches in length by about two and a half inches square. The angles have been worn off and the faces smoothed and polished, and afterwards transversely striated, the striæ being most probably due to slickensiding in the coal rather than to glaciation. It may be of use to note the exact locality and horizon in which the boulder was found. It came from the hard-bed coal at a depth of about 150 yards from the surface, and from under the north side of a hill called Barehead, in Shibdendale, near Halifax. The round boulder above mentioned came from the same bed, and from under the south side of the same hill, the two places being about half a mile apart. The geological horizon of the Hard-bed coal lies at about 60 to 70 yards above the rough rock, the uppermost member of the Millstone Grit series.

After preparing thin slices and examining them under the microscope, it was evident that the specimens presented a different structure from either of those from the Black-bed coal.

Professor T. G. Bonney, D.Sc., LL.D., F.R.S., &c., to whom a specimen had been sent, kindly describes it as follows:—'The boulder is one of unusual interest.

It is not a quartzite but a granitoid gneiss or gneissoid granite, probably derived from some mass of Pre-Cambrian age.

'The specimen practically consists of two minerals, quartz and felspar. The former occurs in grains of irregular outline, sometimes associated, and often joined, as it were sewn together, by microcrystalline quartz, which also occasionally extends into small patches. Numerous small enclosures give it a dusty look; many are empty cavities, some contain fluids.

'The felspar also occurs in grains of roundish to rather irregular outline, also often associated. It is much decomposed, but some is probably orthoclase, and microcline can be distinctly recognised. Parts occasionally are blackened by clustered granules. Without destroying the slide I cannot say whether these are iron oxide or some carbonaceous material which has infiltrated. As its presence has no important significance I have thought it needless to ascertain its precise nature, but believe it probably of secondary origin. Rather roundish grains of quartz are occasionally included in the felspar, as is common in old granitoid gneisses. I note a very little flaky viridite. It is possible that the gneissoid structure is due to mechanical deformation of a granite, but if so reconsolidation has been complete. The structure, in short, recalls a type of rock which is exceedingly common among gneissoid rocks which are universally admitted to be much older than any part of the Cambrian, and which is, so far as my experience goes, exceedingly rare, if not altogether wanting in any rock of Palæozoic or later date.'

6. *The Caverns of Luray.* By the Chevalier R. E. REYNOLDS.

These famous caverns are situated near the crest of a limestone hill of Silurian Limestone, near Luray Court House, in the valley of the South Shenandoah, Virginia, U.S.A. The valley is bounded on the east by the Blue Ridge Mountains, and on the west by the Massanutton range, the caverns lying equidistant from each. They were discovered in 1880, during which year the Smithsonian Institution sent out a scientific commission for the purpose of exploring and reporting on the same. The writer was a member of this commission.

The caverns—several distinct ones united by engineering operations—are similar to others found in limestone regions. They are mostly the result of erosion; one only—the Ramble, a plateau 500 feet long by 300 wide—resulting from displacement of the adjacent strata.

The predominating features are chambers, galleries, chasms, cascades, lakes, springs, and enormous columns.

The drapery is multiform in character, and many examples are highly ornate, a few being absolutely unique. The several styles or patterns will be named in the order of their growth.

Human remains have been found, but the character of their environment proves them to be of Indian origin. From the depth of the travertine which enclose them they appear to have been imprisoned for nearly a thousand years. The bones that are now visible consist of the right femur, the lower jaw, a rib, the segment of a clavicle, and a few teeth detached from the superior max. They appear to have belonged to a female of seventeen or eighteen years, the sex and age being determined by anatomical structure, ossification and dentition.

Columns.—Millions of them; some are 100 feet in circumference, and others 100 feet in height.

Stalactites.—They are very numerous and both single and compound, the latter forming 'sheet drapery' a hundred feet long and equally as wide.

Stalagmites.—Less numerous than the above, as much of the drip from the stalactites is converted into travertine.

Helictites.—Stalactites, usually small, which have ceased to enlarge vertically, their drip being diverted by polar influence and capillary attraction. The result is a horizontal, or obliquely perpendicular growth, in utter defiance of the 'Law of Newton.'

Travertine.—The result of a drip too excessive to permit the growth of stalag-

mites. The acidulous water spreads over the floor, rapid evaporation takes place, the calcite or carbonaceous residuum forming loose granular tufa or sinter, which slowly indurates in the form of compact travertine of variable depths.

Calc-Spar.—Found in abundance, tons of it having been removed by dynamite while levelling obstructions and battering doorways through intervening walls. The crystals are of the usual rhomboidal form.

Cucumbers.—Oblong convoluted objects found in the Coral Spring, and originating from nuclei.

Pearls.—Mechanical formation similar to the above, but differing in size and probably in material.

The collection of objects and photographs is sufficiently large to convey a fair idea of the several growths found in the caverns, and the characteristic appearance of the same *in situ*.

The writer's memoir on this subject embraces a vast amount of information on the early or incipient growth of stalactites, some of which is believed to be wholly original. He is also engaged in studying the ratio of stalagmitic growth in the Atlantic coast caverns. The result now obtained shows that the vertical growth of stalagmite is one inch in forty years. The growth of stalactites is nearly twice as fast, or one inch in twenty years. The glasses exhibited show the following:—

(1) The small glass, two years' deposit of carbonate under a medium drip.

(2) The goblet, three years' deposit under a constant, heavily-impregnated calcareous drip.

The caverns embrace a circuit of seven miles.

The specimens exhibited to the British Association for the Advancement of Science are the products of Luray and Weyer's caves. The polished sections are from Luray. They consist of stalagmites and stalactites—primary, compound, and drapery.

7. *Report on the rate of Erosion of the Sea Coasts of England and Wales.*
See Appendix, p. 802.

MONDAY, SEPTEMBER 10.

The following Papers and Reports were read:—

1. *The Volcanoes of the Two Sicilies.* By TEMPEST ANDERSON, M.D., B.Sc.

The author has recently visited the volcanoes of Naples, the Lipari Islands and Sicily, including Vesuvius, Stromboli, Vulcano, and *Ætna*, and taken photographs of their craters and some of their lava streams, and other most important parts, in order to obtain a record of their present condition which may be available for comparison in case of future eruptions. Some of these photographs were shown as projections on a screen by means of a lime-light lantern.

The summit of Vesuvius presents a sort of plain, consisting of the lava of 1872, in the north-eastern portion of which is the great crater excavated by the eruption of 1885, now nearly filled up by matters ejected since that time. A small secondary crater on the north-east part of its floor emits white vapour and occasional showers of red-hot pasty lava. An instantaneous photo of one of these explosions showed many of these up in the air.

Different lava streams exhibit different characteristics. The lava of 1872 was very quick flowing. Its surface is covered with angular masses of scoriæ with sharp edges, and it is still devoid of vegetation.

On the other hand, that of 1858 was pasty and slow moving. Its surface presents rounded bosses with curious contortions, almost like great coils of ropes. It is now beginning to weather and support a few tufts of vegetation.

The island of Stromboli, one of the Lipari Islands, consists of a great volcanic

cone standing out of the deep water of the Mediterranean and rising about 3,000 feet above its surface. The north side has been partly breached, so that the active crater is now on the side of the mountain, about two-thirds of the way up. Explosions take place constantly from it at intervals of a few minutes, or occasionally longer. The ejected materials partly fall back into the crater and partly roll down the steep slope, or *schiarà*, into the sea. The details of crater itself are constantly changing. A photo taken on May 17 showed two small cones on its floor, one of which constantly emitted clouds of vapour, while the other was that from which the explosions proceeded.

2. *Notes on the late Eruption in the island of Vulcano.* By TEMPEST ANDERSON, M.D., B.Sc., and H. J. JOHNSTON-LAVIS, M.D., F.G.S.

Both authors have visited the island of Vulcano, the former during the month of May of this year, and the latter just one year before. Both have photographed the principal points of interest; those of the latter were exhibited at the last meeting of the Association, and Dr. Anderson's are now shown before the meeting by aid of the lantern.

The island of Vulcano, so far as we can trace back its geological history, came into existence and was chiefly built up of a cone composed of doleritic lavas and related products. This large cone, traversed by radial dykes, some solid and some hollow, indicating the existence at one time of parasitic cones, was eventually destroyed by one or more explosive eruptions, and by truncating it very low, aided by subsequent denudation, reduced it to an irregular table-land. On this plain a fresh eruption took place, giving rise to small scoria cones and lava streams, some of which are basalts very rich in olivine.

This was followed by an eccentric explosive eruption, drilling a large crater out of the northern part and edge of this plain, and along this axis the present active cone of Vulcano was built up. This cone seems to have been formed at first of basic rocks, like that composing the main mass of the island, but subsequently highly acid products were erupted, composed of very acid pumices and lava streams of obsidian, very spherulitic in the interior. Lastly, still further north of this is the triple cone of Vulcanello, which, perched upon its own platform of lavas, constitutes an almost circular peninsula joined to the rest of the island by a narrow low neck of land. There is every reason to believe that Vulcanello has almost, if not entirely, been built up by eruptions of doleritic lavas and derivatives during the historic period, though at present only slight warm emanations of steam occur from a few cracks.

The main crater of Vulcano has also been in gentle solfataric activity from time to time, interrupted by paroxysmal eruptions. In its solfataric state the bottom and sides get more or less covered by sublimations of sulphur, boric acid, realgar, &c., whilst some distant rocks afford at present, and have from Roman times afforded, many varieties of the alums. For many years the sulphur and boric acid were collected for commercial purposes, but from the competition of Asia Minor and California the latter product has been neglected, and the English company who own the property have converted much of the island, described by Spallanzani a century ago as totally barren, into a rich vine, fig, and broom plantation, including more than 20,000 of vine plants.

The second of the authors described in 'Nature,' of this summer, the state in which he found the Lipari group of volcanoes in June 1887, and the first of the authors noticed no important difference three months since.

In 1886 a slight eruption cleared out the bottom of the crater of Vulcano, and since that time the crater has never 'entered into its former quiescent condition' to which the residents on the island are accustomed.

Mr. Narlian, whose villa is within a few hundred yards from the crater, very narrowly escaped with his and his children's lives. The following is the substance of his letter, and is, we think, quite worthy of being put on record:—

Lipari, August 30, 1888.

MY DEAR DR. JOHNSTON-LAVIS,—I have your kind note of 22nd inst. and will give you a short account of the strange doings of our old friend the crater of Vulcano.

On the 3rd inst. we had an outburst in the crater with stones, flames, thunder (regular lightnings). It was strong enough to throw stones of considerable size to the sides of the mountain. This lasted perhaps ten to fifteen minutes and then ended. After some time we began to have, at the interval of every twenty to thirty minutes, a great rush of thick smoke, and lasting some ten to twelve minutes at a time. We had often seen such eruptions during the twelve to thirteen years I have been on this island, and I hoped it would end like former eruptions. Towards evening, however, these rushes of smoke, steam, and ashes (which used to be projected into the air to about twice the height of the mountain) had completely ceased. As the night approached the leading fumarole (which was very active, giving off an offensive smell for months before the event) had begun to show a *clear high flame*, much paler than the flames produced by the burning of wood, and somewhat greenish or bluish. This phenomenon, together with the sudden stopping of the smoke, was evidently not a good omen. Consequently, I spent all the night dressed on a sofa in the drawing-room. Towards morning I was overpowered by sleep, and went to the little bedroom which looks towards the mountain, rested on the bed, and soon was sound asleep. Shortly afterwards I was awakened by a *tremendous din* which can hardly be described. As I jumped up from my bed I felt stones falling on the roof as hail—such cannonading going on—I understood what was the matter—ran to the opposite room, where I had made my children sleep that night. They were also up in consequence of an indescribable noise of thunder, rush of gases, flames, falling of huge boulders, rocks, &c. I took them to the drawing-room, but as soon as the door was opened a big stone *red hot* (all these stones are quite red with heat) fell through the roof, ceiling, and floor a few yards from us, smashing all, setting fire to everything. Now I took my children back to the bedroom, which looks on to the verandah, and tried to gain the terrace by that side. The house doors were shivering and shaking so that it was a difficult matter to open the doors. At last I succeeded, but before we were out in the verandah another stone fell at *our feet*, was smashed to fragments, and burned the feet and legs of my boys. Now we passed through the verandah, regained the house at the top of the stairs; here another stone fell very near us (none of these stones were less than 2 feet in diameter). This last stone (which is the fourth that struck the house including the one that fell on the ceiling of my bedroom while in bed) has nearly blocked our way out with the rubbish that it brought from the roof. We passed through over the heap of rubbish and were now out in the open to the north of the house. By this time (not many minutes after all) the whole place was lighted up, woods, grass, buildings, hedges—all was on fire; the huge boulders and stones were literally raining everywhere about us—what confusion! Natali, the faithful boy, had by this time come to the help of my little boys—we all began to run to Vulcanello and away from the dreadful thundering mountain. All the means of communication we possessed at Vulcano consisted in an old, half-broken 20-foot boat, and a lighter, both of which the men in their panic and mad despair had taken away with them, leaving us on the sands of Vulcanello. Towards noon, however, boats of rescue reached us from Lipari, and we thus ended one of the most eventful days of our life. How we escaped death I do not know.

On revisiting the spot I saw the whole plains below the mountain, to the distance of $1\frac{1}{2}$ mile, specially the neighbourhood of the house and the men's habitations, *literally* covered with boulders and rocks of all sizes, which had imbedded themselves in the ground to various depths. The most huge of them is near the well of the house, which is not less than 10 *yards* in diameter, and is some 10 to 11 feet deep in the ground. This is about $\frac{3}{4}$ of a mile from the crater. Another, of nearly equal dimensions, is on the shore near the Quarantana at the end of the bay of the Levante! Rocks of 1 yard in diameter are as plentiful as can be as far as the middle of Vulcanello, near the Punta Samossa! We have to thank God for going unhurt through this '*hail storm*'!

After this awful calamity, which has caused me so much loss, the crater has recommenced the rushes of steam, ashes, &c. This was a time of comparative diminution of activity, which had lasted for some days. Soon, however, it began the old game of throwing stones, boulders, ashes, &c., every two or three minutes, in all directions. No doubt many of these boulders are 10 to 15 yards across, and are projected as far as the sea, but often fall back into the crater itself. This state of things is continuing incessantly and uninterruptedly, causing further damage and frightening everybody.

During the last three or four days the noise of the thunder and eruption is so loud that from Lipari (at the distance of six miles) it would be impossible to distinguish it from a prolonged thunderstorm.

Yours truly,
A. E. NARLIAN.

In this letter we have a clear, unexaggerated account of the eruption that is well worthy, from its analogy, of being placed side by side with the renowned epistle of Pliny the younger to Tacitus. Until it is possible to examine the *primary or essential* ejectamenta the characters of the eruption seem to be, with slight doubt, of an intermediate stage between a paroxysmal and explosive eruption. The irregularity in the puffs of smoke and ejections of stones indicated that, as from time to time the crumbling sides of the crater blocked the vent, eruptive energy was for greater or less intervals suppressed until stored up energy or increased tension overcame the obstacle.

Another point of interest was the presence of flames, which are so rare in volcanoes, but have repeatedly been seen in this one. These are the result, no doubt, of the kindling of the sulphur deposited on the cooler parts around the fumaroles, which gets lighted by the hot stones and gases. The peculiar tint is in all probability due to the presence of boric acid (green) and sulphides of arsenic (grey blue). In fact a year ago the stones in the immediate neighbourhood of the great fumarole were covered by a boiling varnish of mixed realgar and sulphur, and when the latter author of this paper moved the stones, the outrush of steam bespattered those standing near with pearls of this compound. No doubt this presence of arsenic had increased of late and given rise to the special odour spoken of by Mr. Narlian.

One of us hopes soon to visit Vulcano and report more fully upon this late eruption.

3. *Report on the Volcanic Phenomena of Vesuvius and its neighbourhood.*
See Reports, p. 320.

4. *On the Conservation of Heat in Volcanic Chimneys.*
By H. J. JOHNSTON-LAVIS, M.D., F.G.S.

In various publications the author has endeavoured to enunciate the laws and explain the phenomena of the absorption of water by volcanic magmas and the liberation of the same. One group, however, of the phenomena were somewhat neglected, and it is to these that reference will now be made.

One who daily follows the phenomena of an active volcano such as Stromboli, Vesuvius, and others of the same type, cannot but be struck with the fact that the enormous evolution of watery and other vapours does not suffice to reduce the temperature of the magma to the point of solidification.

By carefully following the details of the varying activity of the above-mentioned volcanoes, which we will choose as our types, the matter becomes comprehensible. There is little doubt that all igneous magmas are originally in a vitreous condition, and that the passage from that state to a crystalline one must be accompanied by the evolution of an enormous amount of heat, just as occurs in the passage from the liquid state of water to the solid ice. Were the magma composed of a single chemical compound, we should expect that it would remain at a fixed temperature from the commencement of crystallisation to the complete

solidification as the result of that process. This would not be the case in the lava in a volcanic chimney, in which we should expect that the temperature would fall by steps, remaining fixed as long as any definite mineral species was crystallising, and would then drop to the crystallising temperature of the next species, again remaining for a certain time fixed. What these temperatures should be we do not know until the crystallising temperature of each rock-forming species is known. It must be remarked that the simple fusion point of any mineral is no indication of the temperature of the crystallising of a given mineral from a magma; for, in the former case we have to deal with a simple physical process, whereas in the latter it is often a chemical one. This is illustrated well in the case of orthoclase and augite, which both crystallise before leucite, which can only be explained by a chemical reaction taking place in the magma.

This process I take to be dependent upon a magma open to the atmosphere, by which the alkaline chlorides break up, the HCl being liberated and the free alkalis combining with the silica and alumina of the basic iron glass. Part of the iron separates as magnetite and part combines with the HCl and escapes in the vapour as chloride, always accompanied by some of the alkaline chlorides.

In fact, it seems an almost impossible task, the determining theoretically or even practically the temperature of solidification of a lava.

However, a clear comprehension of what has been said demonstrates how the supply of heat is kept up for a long time in the volcanic chimney, and the varying activity resulting therefrom. We have good reason to suppose that in our type of volcanoes there comes to the surface a uniform quantity of magma in a given time, although the extrusion may be more or less rhythmical, due to tidal and other agencies. Let us suppose that the magma has been so long simmering in the chimney that by volatilisation of steam, &c., it begins to become pasty. In that condition the escape of vapour from the lower part of the magma in the chimney cannot go on, and consequently the fall of temperature is arrested, although crystallisation may go on for some time, so that the temperature of the lava rises. Meanwhile more water is being dissolved or taken up by the magma, and, in consequence of this and the rise of temperature, the tension of the magma increases until it overcomes the resistance of the pasty magma choking the upper part of the chimney. There occurs a more or less strong paroxysmal eruption, in which, from the excess of water and the higher temperature there will result a tendency to the issue of the magma in a fragmentary condition, and this will approach more or less the scoriaceous or even pumiceous character. This is what is constantly occurring at Stromboli and even at Vesuvius, but in the latter it is much modified by the lateral oozing of lava, the effect of which I propose to treat of elsewhere.

In fine, we must conclude that the calorific capacity of the original vitreous magma must be very great, although its temperature may not be very high, and that its heat energy under favourable conditions may keep up the temperature for a long time. This would be the case in a volcanic chimney when solidification was taking place by crystallisation instead of cooling as a glass—a similar condition, in fact, to what we observe in the solidification of melted sulphur and other vitreous materials.

5. *Note on a Mass containing Metallic Iron found on Vesuvius.*

By H. J. JOHNSTON-LAVIS, M.D., F.G.S.

In the year 1882, during an excursion that I made on the slopes of Vesuvius to the N.W. of Camaldoli della Torre, a rusty-looking block about the size of a human head was met with loose on the surface. I was provided with a hammer sufficiently powerful to break up the usual size of ejected blocks, but on striking the mass in question, much to my astonishment, it persistently refused to break. A near examination revealed the fact that the spot where the blows had been delivered was malleable, and had been beaten out into scales. By a little manœuvring the block was eventually split up into various pieces.

The surface was rough and irregular, showing no patina of any kind, and was much rust-stained. The mass is principally composed of a dark grey vesicular

rock, with many scattered white glassy spots up to two millimetres in diameter. There are also many patches of buff, more spongy-looking rock passing into the surrounding grey mass. Scattered through the stony part are large masses of metallic iron, which in one section is 9 centimetres long by $1\frac{1}{2}$ in the broadest part. From eight to ten grammes of the metal were employed for a search after nickel and cobalt, but only gave faint traces of the former metal. A polished surface etched afforded no signs of Widemanstätten figures.

There being much doubt in my mind as to whether we had to deal with an artificial product or iron of volcanic or meteoric origin, I thought it safest to place it in the hands of some competent authority, and therefore sent one of the best fragments to Mons. Stanislas Meunier, who kindly promised to investigate the matter. From pressure of more important matters this investigation was delayed until last month, when my eminent friend published a short account in 'Le Naturaliste,' April 15, 1888. His chemical researches agree with mine, as also do his microscopical, from which he describes the matrix as 'well-defined crystals enclosed in a vermiculated paste which encloses here and there a few opaque globules'; some of the crystals he considers to be oligoclase. There were also very regular rectangular and rather large hyalin crystals.

He very justly observes that if this mass is not an artificial product it is of considerable scientific interest. For over two years we had not corresponded, and the appearance of Mons. Meunier's paper rather took me by surprise, for had I known of my friend's intention of publishing his observations, I should have supplied him with further and more recent facts that have come to my knowledge, which to my mind render it very probable that we have to deal with an artificial product.

Against the supposition of this mass being of artificial origin we have its appearance and structure, which is not at all like what one usually sees amongst slags; secondly, there are no furnaces in the neighbourhood; thirdly, the piece is unique of its kind in the locality; and lastly, its mode and reason of transport were not obvious when I found it.

During the last two years I have met with, in the same neighbourhood, sandstone the surface of which is vitrified apparently by artificial heat, besides a mass of ordinary slag enclosing some fragments of half-baked limestone. In the next place I have been able to discover its mode of transport, which is worthy of description, as explaining the occurrence of many other rocks not belonging to Vesuvius, but common in the neighbourhood, such as Piperno, yellow tuff, Travertine, Nocerine tuff, Castellamare limestone, &c., the latter being exceedingly common, and all are more frequently met with in or near quarries of Vesuvian lava. The iron specimen also was not very far from some of the largest quarries on the mountain. In this neighbourhood all the carts for the transport of paving stones of Vesuvian lava have a frame consisting of two long poles balanced on two high wheels and prolonged into the shafts.

The carter, after having delivered his load, gets on his cart to ride back to the quarry, and to counterbalance his own weight on the front of the cart he places one or more stones at the tail about equal to his own weight. He naturally takes what is most handy, hence the great abundance of limestone blocks which are left in heaps along the sides of all the roads for repairing them when required. On the carter's arrival at or near the quarry these ballast stones are thrown away. The presence of these furnace products on the slopes of Vesuvius I account for by their having been brought from the ports of Torre del Greco or Torre Annunziata, where probably they had been thrown out from the ballast of some ship. At any rate, it seems justifiable to consider this iron of artificial origin until we have some more substantial grounds for considering such masses of natural origin.

In conclusion I wish to thank Mons. Stanislas Meunier for the trouble he has taken in the matter, and to express my regret for not having furnished him with further evidence, which I certainly should have done if I had known the matter had not dropped.

6. *Note on the Occurrence of Leucite at Etna.*
By H. J. JOHNSTON-LAVIS, M.D., F.G.S.

Some years since, whilst on a visit to Etna, my attention was drawn to some superficially placed tufts of a chocolate to a coffee-brown colour. In these tufts, near the Casa del Bosco, are observable included pieces of scoriaceous lava which to the naked eye are evidently leucitic; that mineral occurring in large well-formed crystals attaining to some millimetres in diameter, and brilliantly white as the result of fairly advanced kaolinisation. In consequence of this change the rock is excessively friable and, therefore, difficult to sectionise. A section of it, however, was exhibited at the meeting and also two photo-micrographs therefrom. In these it will be seen that kaolinisation has extended along the fracture planes of the leucites, whilst the beautifully formed pyroxene crystals are unaltered and the triclinic feldspars are fairly in a normal condition. The base is a microlitic network of feldspar and pyroxene, together with beautiful minute cubes and octahedra of magnetite, rendering the substance intervening between the crystals almost opaque even in thin sections. The pyroxene is often enveloped in a casing of leucite, as at Vesuvius, Roccamonfina, &c., confirming what I have asserted in other places, namely, that leucite is one of, if not the latest mineral to crystallise.

I regret that I have not the opportunity of investigating the question of the origin and age of this rock more completely, as on writing to my friend Professor O. Silvestri, inquiring if leucite had yet been encountered at Etna, I received a categorical answer in the negative, which, coming from such an authority, must be taken as conclusive as to the rarity of leucitic rocks being produced from Etna.

The discovery of this mineral at Etna is what one would have looked for, knowing as we do its wide distribution in nearly all the other late basic volcanoes of Italy.

7. *Note on some recent Investigations into the Condition of the Interior of the Earth.*¹ By Professor E. W. CLAYPOLE, B.A., D.Sc., F.G.S.

The difficulty of this great problem in geology was referred to in this paper as a reason for the slow progress made toward its complete solution, and the indirect nature of the evidence was also quoted as a source of uncertainty.

The chief element upon which reliance can be placed is the now seldom disputed datum that the earth must in all these inquiries be regarded as a heated body in cold space subject to laws of radiation as yet imperfectly understood.

Reference was then made to the recent investigations of Mr. C. Davison, Mr. T. M. Reade, Rev. A. Fisher, and Professor G. Darwin, claiming to prove that the following deductions from this datum have been established:—

- (a) That below 400 miles the cooling, and consequently the contraction, are imperceptible.
- (b) That the cooling, and consequently the contraction, reach their maximum at the depth of seventy-two miles.
- (c) That at the depth of five miles the contraction from cooling exactly equals the diminution of space due to the descent of the shell at that depth ensuing from the total vertical contraction of all the layers below it.

This layer at the depth of five miles has, therefore, been termed 'the layer of no strain,' being liable neither to extension nor compression, because the space is exactly sufficient for its diminished bulk.

The layer of 'no strain' is placed by one of the authors above named at the depth of five miles, and in a neutral zone between the bent and crushed strata above it and the compressed and horizontally extended strata below it. It is consequently impossible that any disturbance can occur in the layer of 'no strain.'

Yet in some parts of the earth, and notoriously in the Appalachian region of North America, strata have been forced up from a depth greatly exceeding this limit.

¹ Published in the *American Geologist* (Minneapolis, Minnesota) for June and July 1888.

Beds are now exposed which, at the time of their folding, lay fully eight miles below the surface, and must, therefore, have been far below this neutral zone, which was then (at the end of the Palæozoic Age) less than five miles deep.

Similar facts might be adduced from other parts of the world, and it is therefore difficult to avoid the conclusion that the layer in question has been placed too near the surface, though of the actual existence of such a zone, after a careful study of these investigations, scarcely a doubt can be entertained.

It should further be urged, as another difficulty lying in the way of the implicit reception of the numerical conclusions of the mathematicians, that if the layer of 'no strain' lie at the depth stated, all seismic foci must be situated at less depth. Many of them doubtless are so, but that of the great Neapolitan earthquake of 1857 was placed by Mr. Mallet at the depth of seven miles, and that of the Charleston earthquake of 1886 at the depth of twelve miles. Without pledging ourselves to exactness in these figures, it is somewhat difficult to reconcile them with those of the mathematician.

Little doubt can be entertained that an actual and existing state of things has been revealed by the mathematicians, needing, however, the joint action of themselves and the physicists in order to adjust its details.

8. *On the Causes of Volcanic Action.* By J. LOGAN LOBLEY, F.G.S.

After citing recent opinion as to the absence of an adequate explanation of the causes of volcanic action, the author showed that the accumulation of knowledge of the controlling facts of volcanic phenomena and the amount of attention which had been given to the question placed the subject on firmer grounds, and made the finding of a satisfactory solution of the problem now more probable.

The difficulty of the question lay in the great number of facts and the apparent conflict of many of them.

It was, in the first place, necessary that the leading and controlling facts should be recognised and kept in view. With this object a compendium or concise statement of forty-five such facts was given, followed by a brief review of the various theories that had been advanced from Lemery's in 1700 to Prestwich's in 1886, with in each case numerical references to the facts in the compendium which were in the author's opinion at variance with the respective hypotheses.

The author's own conclusions were then submitted, which are briefly as follows:—

A. That the primary cause of the formation of lava is the internal heat of the globe inducing chemical action in subterranean regions where the materials and conditions are both favourable.

That since the fusion-point of temperature of solids is raised by extreme pressure, conditions for chemical action may be changed from unfavourable to favourable by the removal or relief of vertical pressure by lateral or tangential pressure.

That certain substances are fusible at low or moderate temperatures, and that thus at very moderate depths chemical action may be locally commenced that will extend until sufficient heat is produced to effect rock-fusion.

B. That the cause of the ejection of lava from its source, and its rise in the volcanic tube is the increase of bulk consequent upon the change from the solid to the fluid state, aided by the formation of potentially gaseous compounds by chemical reactions among the original materials of the magma.

That the ascent of the lava in the volcanic tube may be affected by the weight of the atmosphere and by lunar attractive influence, and that therefore a volcanic vent is a thermometer, and, secondarily, a barometer and heliometer¹ combined.

C. That the explosive effects of volcanic eruptions are altogether secondary, and are due to the access of sea and land water, by percolation through cool rocks, to fissures up which lava is ascending.

That this water, when converted into steam, opens, by its expansive power,

¹ From ἑλκυσίς - εἶωσ = attraction.

rents that admit large flows of sea-water to the lava, occasioning the formation of vents and the greater explosive phenomena of eruptions.

The formation of the actual surface volcano and the determination of its position is therefore due to the sea, near which volcanoes are almost always situated.

Emissions of lava without explosive effects are from volcanic tubes to which large flows of water have not obtained admittance, and, on the other hand, purely explosive eruptions, without lava-flows, are caused by water reaching lava which fails to rise to the surface of the earth.

The various forms of volcanoes the author considered could be explained by these views, which opposed:—

1. An infra-crust common central source of lava.
2. The passage of lava through 30 miles of rocks, and consequently through any greater thickness.
3. The ejection of lava from its source by vertical pressure.
4. The ejection of lava from its source by super-heated steam or 'potential steam' force.
5. The passage of water through highly-heated rocks, either by fissures or by capillary transmission.
6. The accumulation or the presence of water at volcanic foci.
7. A primogeneal 'water substance.'
8. The importance of land surface water.

The author had given much thought during many years to volcanology, and had made personal observations of volcanic activity; and whether his views were approved or not he would be glad if they elicited facts and opinions that would further a solution of the problem. He thought a discussion on the subject would not be inappropriate at the city of Bath, famous as it was for thermal waters deriving their heat from what might be termed, according to his views, a volcanic focus, but in this case one from which only benefit to mankind was received.

9. *Eighth Report on the Earthquake and Volcanic Phenomena of Japan.*
See Reports, p. 422.

10. *On the recent Volcanic Structure of the Azorean Archipelago.*
By OSBERT H. HOWARTH.

The object of the author's notes upon the relation of the Azorean group to the other islands of the West Atlantic is to indicate a line of inquiry by which some approximation may be made to the intervals separating the great eruptive changes; and determining any modifications in the type of flora during that important succession of volcanic products which has been evolved since the Upper Miocene period assigned to the islands generally. A field for such inquiry seems to be offered by the present phase of action in the Furnas district, in the eastern centre of St. Michael's, where existing activity is associated with some of the oldest formations in the series. The author has traced in that valley a series of beds of vegetable origin dating back from the most recent changes, immediately connected with the present boiling-spring area, to a period antecedent to the formation of the Furnas Valley itself. The intermediate intervals of repose are now represented by peaty beds and subaqueous vegetable deposits, interstratified with the successive lava streams, tuffs, and pumice-beds of various dates, within and prior to the historical period. From the more recent of these, buried trunks and branches have been obtained which represent the intervals of recent eruptions; while in one of the older tuffs, underlying nearly the whole series at that portion of the islands, a tree (probably an *Erica*) has been found, presumably *in situ*, and offering possibilities of a subjacent soil for examination, which would be contemporaneous with the earliest vegetation of the island.

11. *Report of the Earth Tremor Committee.*—See Reports, p. 522.

SUB-SECTION C.

1. *The Watcombe Terra-Cotta Clay.* By W. A. E. USSHER, F.G.S.

[Communicated by permission of the Director-General of the Geological Survey.]

The Lower Trias Conglomerates at Watcombe rest upon about 20 feet of sandstones made up of comminuted slate; these are succeeded by red marly and shaly clay, cut off by fault at the south boundary of Watcombe Combe, but reappearing on the south side of the intervening faulted mass of conglomerate, in Petitor Combe, where the beds of marl and clay are apparently at a lower horizon than those of Watcombe, and they are interstratified with sandstones made up of comminuted slate. They rest on broken limestone, through which the red mud has permeated. The junction-beds are in places local masses of breccia.

The series above described is visible nowhere else on the coast, but has been traced inland by the author to Kingskerswell and Torre. Its character changes in this westerly extension, the sandstones often assuming the aspect of a fine breccia, and the clay becoming an indurated mudstone, brecciated in places. About 40 feet of these beds are exposed in a large pit near the Torquay Cemetery, where they are faulted against Devonian slates. Beds on this horizon, apparently, consisting of clay and loam with gravelly detritus dispersed throughout, occupy the slopes of the Dacombe Valley, near Kingskerswell on the east. In the Wellington Co.'s (Thomas) pits a small mass of porphyrite occurs in the sands and loams which there constitute the upper part of this series. Towards Torre Station the Watcombe clays pass under breccia and conglomerate; red marl and shaly clay occur in the railway cutting.

To the north of Kingskerswell the Watcombe clays do not appear to have extended far, as the conglomerate and breccia of the overlying beds rest on the Devonian rocks bordering the estuary of the Teign.

To the south and west of Torre and in the Paignton area no lithological equivalent to the Watcombe clays has been observed. But it is quite possible that contemporaneous deposition took place in these districts; the components of the Lower Trias exhibiting such frequent local variation that no great faith can be placed in the maintenance of lithological distinction on definite horizons.

The Watcombe clays, however, may be the oldest Triassic rock in South Devon, and may have attained a much greater development to the eastward of the present coast, although restricted within narrow limits in their westerly extension.

The author concluded by adhering to the classification he had propounded for the Triassic rocks of the south-western counties, and saw no reason to alter the position therein assigned to the Watcombe clay.¹

2. *Second Report on the 'Manure' Gravels of Wexford.*

See Reports, p. 133.

3. *Beds exposed in the Southampton New Dock Excavation.*

By T. W. SHORE, F.G.S., F.C.S.

The beds described in this paper have been exposed during the progress of an excavation of eighteen acres for the purposes of a deep-water dock at Southampton. The site of the excavation is at the junction of the tidal rivers Itchen and Test in the Southampton water, the area excavated having previously been covered with tidal water to a depth varying from 12 to 17 feet. The excavation has brought to light the succession of beds to a depth varying from 36 to 42 feet below the surface of the alluvium over this area. From 5 to 17 feet of tidal alluvium lay at

¹ In a paper by Mr. Appleton 'On Economic Geology of Devon' (*Trans. Dev. Assoc. for 1875*, p. 241), an analysis of the Watcombe clay, by Dr. Percy, is given.

the top, which contained within it and on its surface abundance of the marine shells *Cardium edule*, *Buccinum undatum*, *Purpura lapillus*, *Murex arenaceus*, *Tellina Balthica*, *Tapes decussata*, *Litorina litorea*, *Trochus cinerareus*, *Hydrobia ulvæ*, *Lucina borealis*, species of *Scrobicularia*, *Rissoa*, *Nassa*, *Mytilus*, and others.

Beneath the tidal alluvium over the greater part of the area, peat was found in thickness varying from 2 to 14 feet, being thickest towards the Itchen side of the excavation, and as a rule thinnest on the Test side. At the Test side of the excavation, and dipping sharply towards the Itchen under the thick peat on this side—at one time a dark line of peat parallel with the present course of the Itchen, and on a level with the gravel terrace, could be seen stretching out into the estuary towards the junction of the river channels. The colouring matter of a green sand found in the gravel just below the alluvium has been examined and analysed by Mr. J. Brierly, public analyst for Southampton.

The Bracklesham beds lying beneath the gravel were found to be largely composed of green sand or green sandy clay coloured with glauconite, below which a dark clay was met with. On the Itchen side of the excavation, where the gravel is comparatively thin and occurs beneath very thick peat, the Bracklesham clay just below the gravel was found to be dark-coloured. Some remarkably large sand pipes, very fine specimens of *Venericardia planicosta*, *Turritella sulcifera*, and large pieces of pyritised wood, have been found in the Bracklesham beds, the compact sandy clays of which showed some well-marked joint planes discoloured by infiltration and oxidation. About fifty species of Bracklesham mollusca have up to the present time been found.

The loss of cattle and the native ponies of the New Forest during wet seasons in the deep New Forest bogs at the present time, appears to explain the occurrence of animal remains in the peat.

Some Neolithic remains were found in the peat, consisting of dark-coloured flint flakes, such flint chips being met with on one occasion all lying within a few feet of each other, the site probably marking the spot where a Neolithic worker had fashioned his implement. A very fine specimen of a round hammer-stone was also found in the peat about twenty feet below the surface of the alluvium, the hammer being $3\frac{3}{4}$ inches in diameter, and having a circular hole $1\frac{3}{4}$ inches in diameter at the sides, and $\frac{7}{8}$ inch in diameter in the middle. It weighs 1 lb. 9 oz., and is made of fine greywether sandstone, and is one of the finest of its kind recorded as having been found in England.

The gravel beneath the peat was found partly in ridges with thick peat between the ridges, but this character did not extend far. A great part of the area after the removal of the upper beds presented the appearance of a gravel terrace, the gravel lying highest on the north-western part of the excavation; the alluvium was found to rest on gravel, peat being absent.

The peat was found to contain within it extensive beds or pockets of shell marl or fresh-water tufa containing abundance of shells of land and fresh-water species—*Limnea peregra*, *Limnea stagnalis*, *Limnea palustris*, several species of *Helix* and *Planorbis*, *Pisidium amnicum*, *Bithinia tentaculata*, *Hydrobia ventrosa*, and *Valvata piscinalis*. The tufa much resembled large patches of a similar kind, which occur just below the surface of the alluvial meadow land in both the river valleys from ten to twenty miles higher up the streams.

The peat contained much bog-oak, with large trunks *in situ*, and remains of beech, hazel, birch, fir, and apparently the bog myrtle, heaths, bracken-fern, sedge, and bulrush.

The animal remains found in this peat comprised the horn cores and parts of the skull of *Bos primigenius*—one a very fine specimen, described by the author of the paper in the 'Geological Magazine' for November 1887—many bones of the *Bos*, and many horns and bones of *Cervus elephas*. Some bones of a small variety of horse were previously found in this peat, from which was also obtained the tusk of a boar and some bones of the hare.

4. *Fossil Arctic Plants from the Lacustrine Deposit at Hoxne, in Suffolk.*
By CLEMENT REID, F.G.S., and H. N. RIDLEY, M.A., F.L.S.

Near the village of Hoxne, close to the northern border of Suffolk, and about five miles east of Diss, lies the well-known lacustrine deposit from which Palæolithic implements were obtained more than ninety years ago. This deposit has been so well described that it may seem presumptuous to imagine that there is still anything new to say about it. But it so happens that every observer up till now has studied the deposit either from an archaeological or from a geological point of view. No one has paid special attention to the character of the associated plants, or to the climatic conditions which these plants indicate.

This deposit was described in 1797 by John Frere, and afterwards, in 1860, by Professor Prestwich, who gave numerous details and showed that the lacustrine deposit rests in a hollow in the Boulder Clay.

The following is an abstract of the section given by Professor Prestwich :—

SECTION IN SOUTH-WEST CORNER OF HOXNE BRICKFIELD.

	Feet
a. Surface soil	1 to 2
b. Brown and greyish clay, not calcareous. Two flint imple- ments. Bones of <i>Bos</i>	10 to 12
c. Yellow sub-angular flint gravel. <i>Elephas</i>	½ to 1
d. Bluish and grey calcareous clay, in places very peaty. Wood and vegetable remains. Land and freshwater shells. Deer, horse, elephant	3 to 4
e. Gravel like c, but smaller	1 to 2
f. Calcareous grey clay, more or less peaty, with freshwater shells (bored to 17 feet, but no bottom was reached)	17

The mollusca, to which the authors added two or three unrecorded species, are all forms having a wide range. The plants obtained from bed *d* throw more light on the climatic conditions. They include twenty-seven flowering plants, one *Chara*, and ten mosses. The specimens are chiefly seeds and fruits, with leaves of willow and birch and wood of yew. The mosses are all fragments of the stem with leaves attached. The list of species shows that the flora was an Arctic one corresponding in many features to that of Iceland. The presence of *Betula nana*, *Salix polaris* and *S. myrsinites* is sufficient to show this. The latter Sallow has not been hitherto recorded as fossil, but its leaves are the bilberry-like foliage mentioned by Professor Prestwich. *Salix polaris* is now only known from very high arctic latitudes, but it is well known as a fossil in glacial and post-glacial deposits. The mosses which Mr. Mitten has identified for us have also an arctic or alpine facies. *Acroceratium sarmentosum* is now an inhabitant of the higher mountains of Killarney and Scotland, as well as the arctic regions. The Cornel is represented by a single large seed, differing somewhat from the common form and perhaps a variety.

The larger part of the plants represented are aquatic or marsh plants, and nearly all are plants still occurring in high latitudes at the present day; but the Yew, Bur-reed, Cornel, and *Potamogeton trichoides* are absent from the arctic regions.

The flora thus suggests the approach of a warmer climate following a cold one, so that the arctic flora had not entirely gone by the time that the more temperate one had begun to come.

5. *Report on an ancient Sea Beach near Bridlington Quay.*
See Reports, p. 328.

6. *On the Origin of Oolitic Texture in Limestone Rocks.*
By Professor H. G. SEELEY, F.R.S.

The author believed that oolitic texture might originate in many ways. It was stated to be found in limestones and iron ores of Silurian, Devonian, and Carboniferous age, but to be most characteristic of the inferior and great oolite,

coralline oolite, and Portland oolite. Experiment has shown that a pseudomorph of carbonate of lime may be obtained when carbonate of soda is acted upon by chloride of lime; and he thought that many oolitic grains were pseudomorphs. In the magnesian limestone grains of dolomite present all the characters of oolite. In the carboniferous limestone it is common for large foraminifera to be the nuclei of oolitic grains so as almost to justify the view of Dr. W. B. Carpenter that oolites are foraminiferal limestones where the foraminifera are coated with calcite. In the secondary oolites nuclei are less frequent, and often include several grains of sand. It is difficult to account for a pellet of sand acting as a nucleus, but the author believed the interpretation of Dr. Sorby to be satisfactory with a single nucleus. The author attributed the small size of the grains to the small transporting power of the current which is assumed to have formed them by rolling.

Almost all limestones are of organic origin, and the author drew attention to the close resemblance of the internodal grains of the nullipores to grains of oolite as furnishing a further explanation of oolitic texture. These grains show a concentric structure as well as a radiated tubular structure, which would favour the recrystallisation such as commonly occurs.

TUESDAY, SEPTEMBER 11.

The following Papers and Reports were read:—

1. *Notes of some Researches on the Fossil Fishes of Chiavòn, Vicentino (Stratum of Sotzka, Lower Miocene).* By Professor FRANCESCO BASSANI.

These fossiliferous Marls were first discovered by Baron Zigno in 1852, who referred them to the Lower Miocene, since which time Heckel, Heer, Molon, Bayan, and Messrs. Liroy, Suess, Sauvage, Hébert, Munier-Chalmas, Stur, Friedrich, and Staub have studied their fauna and flora.

The abundant materials here investigated were derived from many public and private museums, and represent plants and animals, amongst which are a few crustaceans badly preserved, very few insects, many beautiful fish, two bones of birds, and some amphibia.

The plants were described by Massalongo and Roberto di Visiani, the insects by Omboni and Heckel, Kner, and Messrs. Steindachner and de Zigno have occupied themselves with the Ichthyolites. At this epoch the fish-fauna of Chiavòn was represented by seventeen species, of which only six were figured, as follows:—

- | | |
|---|---|
| <ol style="list-style-type: none"> 1. <i>Galeodes priscus</i>, Heckel (not fig.). 2. <i>Myliobates Claronis</i>, Zigno (fig.). 3. <i>Myliobates leptacanthus</i>, Zigno (fig.). 4. <i>Clupea breviceps</i>, Heck. (not fig.). 5. <i>Meletta gracillima</i>, Heck. (not fig.). 6. <i>Alausa latissima</i>, Heck. (not fig.). 7. <i>Engraulis longipinnis</i>, Heck. (not fig.). 8. <i>Engraulis brevipinnis</i>, Heck. (not fig.). 9. <i>Chanos brevis</i> (Heck.) Kner St. (fig.)
(<i>Albula brevis</i>, Heck.). | <ol style="list-style-type: none"> 10. <i>Chanos Zignoi</i> (Heck.) Kner St. (fig.) (<i>Albula Zignoi</i>, Heck.—<i>Alb. lata</i>, id.). 11. <i>Smerdis analis</i>, Heck. (not fig.). 12. <i>Smerdis aduncus</i>, id. (not fig.). 13. <i>Smerdis minutus</i>, Ag. (not fig.). 14. <i>Gerres Massalongi</i>, Heck. (not fig.). 15. <i>Caranx ovalis</i>, id. (fig.). 16. <i>Caranx rigidicaudus</i>, id. (fig.). 17. ? <i>Mene</i> (not fig., not descr.). |
|---|---|

My researches have augmented in a notable manner the number of species, which now amounts to fifty-eight, as may be seen from the following table. This shows, at the same time, their tropical and marine characters.

EUICHTHYES.

PALAEICHTHYES.

CHONDROPTERYGII.

Fam. Galacidae.

Gen. GALEOCERDO, Müller et Henle.

1. *Galeocерdo priscus* (Heck.), Zigno.
(*Galeodes priscus*, Heck.).

Gen. MYLIOBATES, Duméril.

2. *Myliobates Clavonis*, Zigno.
3. *Myliobates leptacanthus*, id.

TELEOSTEI.

ARTHROPTERI.

PHYSOSTOMI.

Fam. Scopelidae.

Gen. SCOPELOIDES, Wettstein.

4. *Scopeloides Nicolisi*, n. sp.

Fam. Clupeidae.

Gen. CLUPEA, Linneo.

5. *Clupea breviceps*, Heck.
6. *Clupea latissima*, id.
(*Alausa latissima*, id.).
7. *Clupea gracillima*, Heck.
(*Meletta gracillima*, id.).
8. *Clupea sagorensis*, Steind.
9. *Clupea sagorensis*, St. var. *arcuata*
Kner (*Clupea arcuata*, Kner).
10. *Clupea* cfr. *lanceolata*, Meyer.
11. *Clupea inflata*, Vukot.
12. *Clupea Ombonii*, n. sp.
13. *Clupea Grandonii*, n. sp.
14. *Clupea*, sp.

Gen. ENGRAULIS, Cuvier.

15. *Engraulis longipinnis*, Heck.
16. *Engraulis brevipennis*, id.

Gen. CHANOS, Cuvier.

17. *Chanos Zignoi* (Heck.) Kner et St.
(*Albula Zignoi*, Heck.—*Alb. lata*, id.).
18. *Chanos brevis* (Heck.) Kner et St.
(*Albula brevis*, Heck.).

ANARTHROPTERI.

HAPLOPTERI.

Fam. Gobiidae.

Gen. GOBIUS, Lacép.

19. *Gobius*, sp.

ACANTHOPTERI.

PHARYNGOGNATHI.

Fam. Labridae.

Gen. LABRUS, Artedi.

20. *Labrus Agassizi*, Heckel.

ACANTHOPTERIS. STR.

Fam. Cottidae.

Gen. *Lepidocottus*, Sauvage.

21. *Lepidocottus aries* (Ag.), Sauvg.
(*Cottus aries*, Ag.).
22. *Lepidocottus elongatus*, n. sp.

Fam. Percidae.

Gen. LATES, Cuvier.

23. *Lates macropterus*, n. sp.

Gen. LABRAX, Cuvier.

24. *Labrax* cfr. *Neumayri*, Kramb.

Gen. SMERDIS, Agass.

25. *Smerdis analis*, Heck.
26. *Smerdis aduncus*, id.
27. *Smerdis minutus*, Ag.
28. *Smerdis Taxramelli*, n. sp.

Gen. GERRES, Cuvier.

29. *Gerris Massalongi*, Heck.

Gen. APOGON, Lacépède.

30. *Apogon Krambergeri*, n. sp.

Gen. ANTHIAS, Cuv.

31. *Anthias* cfr. *stiriacus* (Rolle) Bass.
(*Serranus? stiriacus*, Rolle).

Gen. SERRANUS, Cuv.

32. *Serranus rudis*, n. sp.
33. *Serranus*, sp.

Fam. Sparidae.

Gen. SPARNODUS, Ag.

34. *Sparnodus Moloni*, n. sp.
35. *Sparnodus intermedius*, n. sp.
36. *Sparnodus*, sp.

Gen. PAGRUS, Cuv.

37. *Pagrus Meneghini*, n. sp.

Gen. CHRYSOPHRYS, Cuv.

38. *Chrysochrysis Zignoi*, n. sp.
39. *Chrysochrysis Scacchii*, n. sp.

Fam. Scomberidae.

Gen. ORCYNUS, Cuv.

40. *Orcynus medius*, n. sp.

Gen. SCOMBER, Cuv.

41. *Scomber* cfr. *antiquus*, Heck.

Gen. CYBIUM, Cuv.

42. *Cybiium*, sp.

Gen. MENE, Lacép.

43. *Mene oblonga* (Ag.), Zigno, var. *pusilla*, n. var.

Fam. *Carangidae*.

Gen. CARANX, Cuv.

44. *Caranx ovalis*, Heckel.
45. *Caranx rigidicaudus*, id.

Gen. LICHIA, Cuv.

46. *Lichia Stoppanii*, n. sp.
47. *Lichia lata*, n. sp.

Gen. AMPHISTIUM, Ag.

48. *Amphistium dubium*, n. sp.

Fam. *Squamipennidae*.

Gen. SCATOPHAGUS, Cuv.

49. *Scatophagus Capellinii*, n. sp.
50. *Scatophagus affinis*, n. sp.

Gen. HOLACANTHUS, Cuv.

51. *Holacanthus Piovenorum*, n. sp.

Gen. PYGAEUS, Ag.

52. *Pygaeus aff. Coleanus*, Ag.
53. *Pygaeus* *cf.* *oblongus*, id.
54. *Pygaeus Zignoi*, n. sp.

Fam. *Sciaenidae*.

Gen. ODONTEUS, Ag.

55. *Odonteus* *cf.* *sparoides*, Ag.

Fam. *Sphyraenidae*.

Gen. SPHYRAENA, Blainv.

56. *Sphyraena* *cf.* *bolcensis*, Ag.
57. *Sphyraena intermedia*, n. sp.

Fam. *Palaeorhynchidae*.

Gen. PALAEORHYNCHUS, Bl.

58. *Palaeorhynchus* *cf.* *glaronensis*, Bl. *emend.*, Wettst.

An examination of this list shows that the Chiavòn fauna includes no Ganoids, and is constituted of Chondropterygeans and Teleosteans. The first are represented by two families, with two genera and three species. The second comprehend the Arthropteri and the Anarthropteri; the former with two families, four genera, and fifteen species; the latter with eleven families, twenty-six genera, and forty species. The whole are therefore comprehended in fifty-eight species, distributed in thirty-two genera and fifteen families.

Comparing the fish-fauna of Chiavòn with twenty-one other analogous deposits of Europe, I have come to the conclusion that they are in age Aquitanian, or belong, like the strata of Sotzka, to the base of the Lower Miocene.

(The original memoir, and the figures which accompany it, will be published in the 'Atti della R. Accad. delle Scienza Fische e Matematiche di Napoli.')

2. *Sixth Report on the Fossil Phyllopora of the Palaeozoic Rocks.*
See Reports, p. 173.

3. *Report of the Committee for investigating the Flora of the Carboniferous Rocks of Lancashire and West Yorkshire.*—See Reports, p. 150.

4. *On an Ichthyosaurus from Mombasa, East Africa, with Observations on the Vertebral Characters of the Genus.* By PROFESSOR H. G. SEELEY, F.R.S.

The author described two cervical vertebræ of an Ichthyosaurus from low-lying country nine miles N.W. of Mombasa, brought to this country by Mr. New, a missionary, and submitted to the author by Mr. Harris, F.G.S. The specimens are from the cervical region, and differ in no way from such as occur in the English Secondary clays. They are probably of Lower Secondary age. The vertical height is 73 millimetres, the transverse width is 77 mm., and the antero-posterior length is 34 mm. The author finds that the ratio of height to width and of height to length, is a good means of distinguishing vertebræ in different species, and that, when it is determined for each region of the body, it forms and furnishes a valuable datum for defining a species on vertebral characters. The

author specified the vertebral characters which should be observed, as size, number in the several regions, proportions of centrum in each region, proportions of vertebrae to limb bones and to the skull.

5. *A Comparison of the Cretaceous Fish-fauna of Mount Lebanon with that of the English Chalk.* By A. SMITH WOODWARD, F.G.S., F.Z.S.

No detailed comparison having hitherto been instituted between the Cretaceous fish-fauna of Mount Lebanon and that of the English chalk, which belongs to a well-determined horizon, the author has undertaken a general survey of the genera, with the result that the two faunas are proved to have more forms in common than hitherto supposed. The Selachian fishes are scarcely comparable, *Notidanus* and *Squatina* being the only genera as yet recognised in the two formations, although the English teeth named *Lamna rhapsiodon* seem to belong to the shark named *Rhinognathus*; on the whole, those of Mount Lebanon exhibit the most modern facies, all traces of Hybodont Sharks and of *Ptychodus* being wanting. Chimæroids are unknown at Mount Lebanon, but abundantly met with in the English Chalk. Among Ganoids there are representatives of the Pycnodonts both in the Lebanon (*Palæobalistum*, *Cocodus*, *Xenopholis*) and in England (*Cælodus*), but no identical genera can yet be recognised. Rhombic-scaled Ganoids are rare in the English Chalk (*Lophiostomus*, *Aeorhombolepis*), and unknown in Mount Lebanon; traces of Acipenseroids also occur in the former, but have not been discovered in the latter; and at least one Crossopterygian genus occurs plentifully in England (*Macropoma*), while no uncertain remains have been detected in the Syrian beds. *Belonostomus*, however, is common to the two formations, one species having been described from Mount Lebanon under the name of *Rhinellus laniatus*.

Of Physostomous Teleosteans, the great early families represented in the Chalk of England and the Upper Cretaceous of North America by *Portheus*, *Ichthyodecetes*, *Protosphyæna* and *Pachyrhizodus*, are quite unknown in the deposits of Mount Lebanon; but in the latter locality *Enchodus* is abundant, having been described under the synonym of *Eurygnathus*, and this is accompanied by a closely-allied genus, *Eurypholis*, only differing in the possession of a few dermal scutes. The English *Pomognathus* may also be regarded as represented at Mount Lebanon, for the so-called *Phylactocephalus* merely differs in the presence of extremely delicate minute scales, which would not be preserved in a matrix of the nature of the Chalk; and *Aspidopleurus* (Mount Lebanon) possesses scutes indistinguishable from the detached examples long known in the English Chalk under the name of *Prionolepis*. *Dercetis*, also, is met with abundantly in the Syrian beds, being described under the synonym of *Leptotrachelus*. Among Elopine Clupeoids, some undescribed forms occur in the English Chalk, and one from Mount Lebanon has been erroneously assigned to the genus *Chupea* ('*C. Lewisii*'); and the supposed Salmonoid, *Osmeroides*, is common to the two formations, though inferior in size at the last-named locality. In the Syrian deposits, however, there are many more specialised Physostomi, such as *Cheirothrix*, *Spaniodon*, *Opistopteryx*, *Rhinellus*, *Scombroclupea*, *Diplomystus*, and *Chupea*, of which no traces appear to be discoverable in collections of English Chalk fossils. Among Physoclystous Teleosteans but few genera are common to the two formations under comparison. *Hoplopteryx*, with perhaps *Beryx*, represents the Berycidæ in both localities; but only a single imperfect specimen from the English Chalk can yet be assigned to any higher type, namely, *Platax* (?) *nuchalis*. At Mount Lebanon more specialised Physoclysti are numerous, as *Platax*, *Imogaster*, and *Pycnosterinx*; although to the latter have been erroneously assigned certain extraneous forms, including at least one well-marked Berycoid, the so-called *Pycnosterinx Lewisii*.

The conclusion is thus arrived at, that in those respects in which the Lebanon fish-fauna differs from that of the English Chalk, it exhibits greater specialisation. Considered alone, therefore, it is distinctly of a more modern type than the latter, although the beds in which it occurs are regarded, from other evidence, as being of Turonian age.

6. *On Bucklandium diluvii*, König, a Siluroid Fish from the London Clay of Sheppey. By A. SMITH WOODWARD, F.G.S., F.Z.S.

In his well-known 'Icones Fossilium Sectiles,' pl. viii., No. 91, König figures a remarkable fossil from the London clay of Sheppey, which is mentioned in the text as not certainly determinable, but generally regarded, by the anatomists who have examined it, as pertaining to some type of lizard. This specimen is preserved in the British Museum, and the author has determined that it is truly the imperfect head and pectoral arch of a Siluroid. The roof of the skull is preserved almost as far forwards as the middle of the frontals; the pectoral arch is in position, though slightly bent backwards; and the mass of ankylosed anterior vertebræ, with the basioccipital, is displaced downwards and thrown beneath the clavicles. All the bones are remarkably strong, and the exposed surfaces are ornamented with large tubercles. The head must have been originally somewhat deeper than broad, and the roof exhibits no flattening, but is strongly arched from side to side. Posteriorly, the supraoccipital projects in the usual manner, probably to meet a dermal plate upon the nape; and the post-temporal element seems to be merged with the bones of the postero-lateral angles of the cranium. It is impossible to determine the family-position of the genus in the usual manner, but the skulls of the West African *Auchenoglanis* and *Synodontis* appear to approach the fossil most closely. The provisional name of *Bucklandium diluvii* may be retained; and the fish is interesting as being the earliest undoubted Siluroid hitherto discovered.

7. *On the Origin of Graphite in the Archæan Rocks, with a Review of the alleged Evidence of Life on the Earth in Archæan Time.* By the Rev. A. IRVING, D.Sc., B.A., F.G.S.

Attention is drawn to the occurrence of carbon in meteorites and its supposed evidence of the pre-existence of vegetation, reference being made to the recent experiments of Mr. Lockyer. Möbius, Etheridge, Dr. Sterry Hunt, Dr. Dawson, and Dr. Geikie are referred to as having adopted a similar argument or else admitted the presence of graphite to be evidence in that direction. References are made to the writings of Credner and Von Hauer as to its actual occurrence in the archæan gneisses and schists. The general assumption of the *phytogenic origin* of graphite which has hitherto prevailed is found to derive no support from the specimens preserved in the national collection at South Kensington, since their structures can all be explained on mechanical principles. The only direct evidence of phytogenic origin is its occurrence in *later rocks* as an extreme carbonisation-product, but this clearly is no proof of such an origin for the archæan.

Other ways are then considered in which elementary graphitic carbon is produced without the intervention of organic life, such as

- (1) In the case of pig-iron.
- (2) The reduction of CO₂ by the alkali-metals and by magnesium, and the reduction of hydrocarbons by chlorine.
- (3) The dissociation of hydrocarbons by the spark-stream and by the contact-action of heated solid surfaces.

The last-mentioned process is conclusively demonstrated by the experimental results obtained during the last three months in the author's laboratory, carbon being copiously deposited from the hydrocarbons of common coal-gas by the simple contact-action of red-heated fragments of pumice (cf. the author's paper 'On Contact-action' read before Section B).

The known conditions under which acetylene, marsh-gas, and some more complex hydrocarbons can be formed synthetically were referred to, as well as the spectroscopic evidence of the existence of hydrocarbons in the heads of some comets. Such conditions probably obtained when the minerals of the archæan gneisses were formed by primary paramorphism from a state of dry fusion. It is therefore maintained that the necessarily phytogenic origin of archæan graphite is a pure assumption, and can no longer be urged in proof of archæan organic life.

On the question of *animal life* the author takes his stand on the results of Möbius's investigations, which cannot be explained away, and considers that it is impossible to accept such slender evidence as has been produced of the organic origin of *Eozöon canadense* in the face of the overwhelming physical evidence (general and particular) against it.

The assumption by Sterry Hunt that the great beds of *iron-oxides* in the archæan rocks point to the pre-existence of vegetation, is shown to be without foundation; ferric oxide being the direct product of the combustion of iron-vapour in oxygen, and magnetic oxide the product of the reaction of steam on iron at high temperatures.

The *unfossiliferous limestones* (as well as the *quartzites* of the archæan and earlier Cambrian can be explained on purely chemical and physical principles, which are known and demonstrable; and there is no need here for the intervention of the agency of living organisms.

The sum of the whole matter is that we have no tangible and trustworthy evidence whatever of the existence on this globe of organic life in archæan time.

8. On some Devonian Cephalopods and Gasteropods.

By the Rev. G. F. WHIDBORNE, M.A., F.G.S.

The following new species occur at Woulborough or Lummaton, or, in the case of some of the Gasteropods, at Chudleigh: *Goniatites obliquus*, a large shell with open umbilicus, flat sloping sides and narrow flat back; *G. psittacinus*, a small tumid shell with closed umbilicus, rounded whorls, slightly curved sutures; *G. nuciformis*, with minute umbilicus and much broader back than the preceding; *G. aratus*, a flatter shell with small umbilicus and marked with four angulated sulci; *G. pentangularis*, with open spire, inner whorls ribbed, and section of whorls pentagonal; *G. Hughesii*, large and flat with closed umbilicus, evenly rounded back and minutely striated surface; *Cyrtoceras Leei*, a large curved conoidal form with more irregular and dilate lamellæ than *C. fimbriatum*, Ph.; *C. pulcherrimum*, unlike *C. reticulatum*, Ph., in having tubercles on the shoulder instead of ribs; *C. Vicarii*, having a broader section and much fewer tubercles than the last; *C. praeclarus*, more involute and elliptical than the last, with wider mouth and oblique ridges crossed by distant striæ; *C. majestica*, large and smooth, with oval mouth, narrow chambers and imperfect spire; *Hercoceras inornatum*, differing from *H. subtuberculatum*, Sandb., in being smooth; *Orthoceras hastatum*, more conical and with fewer annulæ than *O. tubicinella*, Ph.; *O. Vicarii*, differing from *O. pulchellum*, F.A.Rö., in being round and not oval in section; *O. comatum*, which is *O. tubicinella*, Sandb., not Ph.; *Phragmoceras vasiformis*, which is rather less convex than Ph. subpyriforme, Mii.; *Ph. unguatum*, small and more arched than *C. cornucopiæ*, Sandb.; *Ph. Marri*, conical and transversely flattened, approaching *G. Conradi*, Barr.; *B. mundus*, with broad grooved keel and very transverse kidney-shaped mouth; *Euomphalus fenestralis*, which has a depressed spire with three ridges cancellated by numerous rings; *Pl. perversa*, a large sinistral shell, unlike *Pl. expansa* in having spiral striæ, a deeper suture, more convex whorls; *Pl. victrix*, which has an elevated spire, angulated whorls, central sinus band and a few spiral striæ; *Pl. fortilineata* = *Pl. imbricata*, M'Coy, not F.A.Rö.; *Pl. Chudleighensis*, separated from the preceding, having its spiral ridges crenulated and the sinus band much higher; *Littorina devonica*, having the general shape of *Purpura lapillus*, with eight spiral rows of tubercles which are largest near the suture; *Monodonta archon*, very large and trochiform with flat base and sides, linear suture and oblique growth lines; *Phorus philosophus*, with a low spire, wide umbilicus, and convex whorls bearing fragments of broken shells; *Macrocheilus tumescens*, a much more globular form than *M. subcostatus*, Schlot; *Turbo Pengelli*, unlike *T. subangulosus*, d'A. & de V., in its wider flatness above the shoulder; *Loxonema sculariodes*, very elongate, with its convex whorls crossed by discontinuous varices; *H. duplisulcata*, differing from *H. tenuisulcata* in possessing a series of subsidiary striæ; *Acroculia columbina*, a wide depressed form with fine waving longitudinal markings; *Melo-*

ptoma cordata, like *M. pileus*, Ph., but with loftier umbo and more angulated mouth; and *Chiton papilio*, which comes midway between *Ch. corrugatus*, Sandb., and *Ch. sagittalis*, Sandb.

The above are accompanied by *Orthoceras Oceani*, d'Orb. (= *O. cinctum*, Ph.), *O. tenuistriatum*, Mii., *O. subfusiforme*, d'A. & de V., *O. regulare*, Mii., *O. subannularis*, Mii., *B. lineatus*, Goldf. (= *B. striatus*, Ph.), *P. bifida*, Sandb. (= *B. Woodwardii*, Ph.), *Eu. serpula*, de Kon., *Eu. planorbis*, d'A. & de V., *Eu. lævis*, d'A. & de V., *Eu. rota*, Sandb., *Eu. decussatus*, Sandb., *Eu. germanus*, Ph. sp., *Eu. catenatus* (= *Eu. serpens*, Ph., Pal. Foss., fig. 172, f. and g. only), *Pl. D'Orbiguiana*, d'A. & de V., *Pl. subclathrata*, Sandb., *Pl. Lonsdalii*, d'A. & de V., *Pl. delphinuloides*, Schlot., *Pl. calculiformis*, Sandb., *Pl. trochooides* (= *Pl. monilifera*, Ph. Pal. Foss.), *Pl. distinguenda* (= *Pl. aspera*, Ph. Pal. Foss.), *N. deformis* Iow., *N. piligera*, Sandb., *T. multispira*, Sandb., *L. purpura*, d'A. & de V., *L. subcostata*, d'A. & de V., *Scalaria antiqua*, Mii., *M. subcostatus*, Schlot. (= *M. arcuatus*, Ph., and *M. elongatus*, Ph. *Scoliostoma textatum*, Ph. sp., *Sc. gracile*, Sandb., *Holopella tenuicostata*, Sandb., *H. tenuisulcata*, Sandb., *H. piligera*, Sandb., *A. multiplicata*, Giebel, and *A. proava* Eichw.

9. On some Devonian Crustaceans.

By the Rev. G. F. WHIDBORNE, M.A., F.G.S.

Besides four or five species of trilobites and two ostracods already described from Woulborough and Lummaton, *Bronteus granulatus* (Goldf.) has occurred there, and the following new species:—*Pratus batillus*, which differs from *P. bohemicus*, Barr., in having a flatter glabella, more anterior eyes and longer cheek spines; *P. subfrontalis*, which differs from *P. frontalis*, Barr., in having a much squarer glabella; *P. audax*, which is like *P. cornutus*, Sandb., but without a perpendicular area in front of the glabella; *Cyphaspis ocellatus*, like *C. ceratophthalmus*, Sandb., but with long sabre-like cheek spines; *Lichas devonianus*, differing from *L. Haueri*, Barr., in having a wider head, larger eyes, surrounded with tubercles, and a more arched neck; *Acidaspis Robertsii*, with narrower side cheeks than the Bohemian type; *A. Hughesii*, having a bilobed tail surrounded by a flat border bearing aciculate spines; *Entomis peregrinus*, distinguishable from *E. pelagicus*, Barr., by the absence of a defined nodule; and *Bactropus decoratus*, dissimilar from *B. longipes*, Barr., in being much smaller and more coarsely striated.

The *Cheirurus* found at Lummaton is not *Ch. articulatus*, Mii., but a new species, *C. Pengellii*, differing from the former by having a shorter front lobe of the glabella.

10. On some Fossils of the Limestones of South Devon.

By the Rev. G. F. WHIDBORNE, M.A., F.G.S.

From the three localities of Woulborough, Lummaton, and Chudleigh, about 334 species are known, of which 104 are common to the two former places, and five occur in all three. Among these are *Orthis distorta*, Barr.; *Pterinea Wormii*, F. A. Rö., Pt. ala. Barr., *A. rudis* Ph., *A. plicatellus* (= *P. plicatus*, Ph., Pal. Fos.), *A. Cybele*, Barr., *A. consolans*, Barr., *P. lateralis*, Sow., *Hoplomytilus crassus*, Sandb., *Megalodon obliquus* (= *M. carinatus*, Ph., not Goldf.), *Pl. Vilmarensis*, d'A. and de V. *Pl. pugnans* (= *Pl. minax*, Ph.; Pal. Foss.), *H. interscapularis*, Ph. (including *H. depressus*, Aust.), *H. macrotatus*, Aust. (= *H. tuberculatus*, Ph. not Mill.), *H. ornatus*, Goldf., *Pl. fritillus*, Wiet. and Zieker., *H. Vicarii* (= *H. pentangularis*, Ph. not Mill.), *Pl. quintangulus* (= *Pl. pentangularis*, Aust. not Mill.), and *Rh. crenatus*, Goldf.? *Receplaculites* sp. and *Serpula*? *semiplicatus* Sandb.; and also the following, which are new: *Pterinea obovata*, a small deep species, like *Pt. texturata*, Ph., but without concentric lamellæ; *Pt. placida*, flatter and more angulated than the last, and with more distant ribs than *A. urbana*, Barr.; *Pt. dilatata*, which is larger and wider and with fewer and more distant ribs than the preceding, crossed by crowded growth lines; *Pt. crenatissima*, a longer shell with very anterior umbo,

and covered with fine granulated lines crossing minute rays; *Pt. bellula*, a species like *Pt. fasciculata*, Goldf., but with few alternating ribs crossed by distant zigzag striæ; *Aviculopecten hirundella*, separated from *Pt. texturata* by its shorter hinge line and finer reticulation (the right valve has transverse marks similar to those of *Pt. ala*. Barr.) *A. aviformis*, a flat recurved shell much produced and rounded behind, with very small umbo and wings; *A. comma*, similar to the preceding, but much smaller and with reticulated surface; *A. gracillimus*, a flat, elongate, sub-equilateral form, with minute umbo, notched anterior ear and close alternating ribs; *Mytilus Robertsii*, which is more ovoid and less produced in the postero-superior region than *M. dimidiatus*, Goldf.; *M. stultus*, a short, squarish form, with fine concentric striæ and a few stronger ones; *M. pinnoides*, which is shorter and has a more direct umbo than *M. uncinatus*, Eichw.; *Myalina elliptica*, a smooth, convex ovoid shell, differing from *Unio castor*, Eichw., in its more incurved umbo, and less dilate wings; *Megalodon columbinus*, separated from *M. carinatus*, Goldf., by its finer, regular plaits, more terminal umbo, and the contour of its elevated keel; *M. ? prominens*, larger than the last, and with coarser wavy plaits, loftier and more projecting umbo, and more oblique anterior margin; *Ctenodonta ? lepida*, a small, flat, transverse shell, which is narrower and more convex anteriorly than *P. modiolaris*, F. A. Rö.; *Cardiomorpha ? polita*, a flat, oblique species, unlike *A. damnoniensis*, Ph., in its smoothness and its shorter hinge-line; *Cypricardia neglecta*, with fewer, stronger ribs and more definite wing than *M. scalaris*, Ph., *C. guttata*, with fewer plaits and rounder indentations than *C. crenistria*, Sandb.; *C. ensiformis*, a much flatter and wider shell than *C. neglecta*, and with more and finer plaits; *Edmondia ? dubia*, a large, wide convex shell, with a recurved anterior umbo, deep area and close, indistinct, bifurcating growth, lines; *Hexacrinus perarmatus*, with calix, like *H. macrotatus*, Aust., but covered with sharp, regular, non-confluent tubercles; *H. microglypticus*, with a convex calix, very long basals, and fine ornamentation; *Platycrinus aberrans*, with trilobed attachment, elongate calix, three squarish basal, four or five long radials, intercalated with one large and one small subsidiary anal; *Haplocrinus decipiens*, a minute crinoid, having a short calix with an elevated conical summit, with key-shaped grooves for the arms; *Tricelocrinus ? Leei*, with shorter limbs and shallower excavations than *T. Woodmani*, Mate and Worthen; and *Serpula ? devonica*, a long, straight, smooth, and cylindrical tube.

SUB-SECTION C.

1. Mineralogical Evolution. By T. STERRY HUNT, LL.D., F.R.S.

In a paper read by the author in 1887, before the Geological Section of the British Association for the Advancement of Science, on The Elements of Primary Geology, it was said that 'the transformation of the primitive igneous material of the earth's crust through the action of air and water, aided by internal heat, presents a mineralogical evolution not less regular, constant, and definite in its results than the evolution apparent in the organic kingdoms.'¹ The details of this complex evolutionary process, as explained by what the writer has named the crenitic hypothesis, have been elsewhere set forth at length, on more than one occasion, and involve the whole chemical history of the various mineral species which enter into the constitution of rock-masses, but especially their relations to subterranean changes under the influence of heated water, and to atmospheric action. As we have pointed out, the transformation of basalt into the hydrous porodic body known as palagonite, and the subsequent partial conversion of this into a crystalline zeolite, as described by Bunsen, furnishes a significant illustration of the process under consideration.

The stability of silicated species under atmospheric influences is very variable,

¹ *Transactions*, p. 704; also *Geological Magazine*, November 1887.

some being readily decomposed, and others very permanent; the indifference or chemical resistance, moreover, increasing with the hardness or mechanical resistance. These two qualities vary, for species of analogous constitution, directly as their condensation; while for species of similar condensation and hardness, the chemical indifference increases as alumina takes the place of the ordinary protoxyd-bases, lime, magnesia, ferrous oxyd, and alkalies—a fact readily explained by the comparative insolubility of alumina and aluminous silicates in atmospheric waters. The less partial action of dilute fluorhydric acid on the various silicates shows more clearly than the atmospheric process, the relation of condensation to chemical indifference. This relation may be made evident by a few examples. The condensation being inversely as the so-called atomic volume, we find that when calculated by a simple formula (elsewhere given by the author) for all silicates and oxyds this value, represented by $v (= p \div d)$ for the various feldspars and scapolites, for nephelite, iolite, and petalite, equals 6·8–6·2; for the muscovitic or non-magnesian micas, 5·9–5·6; for garnet, epidote, zoisite, and the various tourmalines, 5·4–5·3; for staurolite and spodumene, 4·9; and for andalusite, topaz, fibrolite, and cyanite, 5·0–4·5, approximately. Comparing with these the common protoxyd-silicates, we find for wollastonite and willemite, $v = 6·6$; for amphibole, 5·9; for pyroxene and enstatite, 5·5; for chrysolite, 5·4–5·3; and for phenakite, 4·6. In the sub-aërial decay of crystalline rocks, while felspars and scapolites among aluminiferous silicates are kaolinised, the micas, notwithstanding their laminated structure, are much less readily changed, and garnet, epidote, tourmaline, andalusite, and topaz are found unaltered, with the quartz, corundum, spinel, cassiterite, and magnetite left behind by the decay of the felspathic rocks—a process in which even amphibole, pyroxene, and chrysolite share. ‘The greater stability of those [silicates] which belong to the more condensed types is shown in their superior resistance to decay, and is thus of geological significance.’

While the above are examples of the varying resistance to the atmospheric influences of carbon dioxyd and water combined, other changes less well known take place in silicates by the subterranean action of watery solutions, where a greater insolubility determines the formation of certain softer hydrated magnesian and aluminous species by epigenesis from harder and more condensed species. The production of these epigenic products, as was said in 1885, is due to their ‘chemical stability under the circumstances,’ and it was added, ‘The constancy in composition and the wide distribution of pinite show that it is a compound readily formed and of great stability. Such being its character, it might be expected to occur as a frequent product of the aqueous changes of other and less stable silicates. It is met with in veinstones in the shape of crystals of nephelite, iolite, scapolite, felspars, and spodumene, from each of which it is supposed to have been formed by epigenesis. Its frequent occurrence as an epigenic product is one of the many examples to be met with in the mineral kingdom of the law of “the survival of the fittest.” It is, however, difficult to assign such an origin to beds of this [described as dysyntribite and parophite], which are probably the results of original deposition or of diagenesis.’

Mr. E. A. Ridsdale, who during the present year (1888) has done good service by publishing a suggestive essay called ‘Notes on Inorganic Evolution,’ speaks of the production and conservation of more stable species, as above described, as a gradual ‘selection of inert forms,’ and further, as ‘a survival of the most inert.’ But as inertness consists in stability, and in fitness to resist alike the chemical and the mechanical agencies which destroy other species, it is evident that his phraseology is but another statement of the formula of ‘the survival of the fittest.’

The great principle of the change of the mineral matters which existed in former conditions of our planet, into other forms more stable under the altered conditions of later ages, is but an extension to the mineral kingdom of the laws already recognised in astronomical and biological development. As was written in 1884, ‘That a great law presided over the development of the crystalline rocks was from the first my conviction, but until the confusion which a belief in the miracles of metamorphism, metasomatism, and vulcanism had introduced into geology had been dispelled, the discovery of such a law was impossible.’ To this we may add

that 'the great successive groups of stratiform crystalline rocks mark necessary stages in the mineralogical evolution of the planet'; and that the principles which we have elsewhere laid down will help us 'to recognise the existence and the necessity of an orderly lithological development in time.' The reader who desires to follow the questions here raised will find them discussed in the author's 'Mineral Physiology and Physiography, (Boston, 1886), at much length in chapters V., VI., VII., and VIII., and further noticed in the Appendix, p. 688, where will be found references to previous pages here cited.

2. *Report on the Microscopic Structure of the Older Rocks of Anglesey.*
See Reports, p. 367.

3. *On a probable Cause of Contortions of Strata.*
By CHARLES RICKETTS, M.D., F.G.S.

The amount of compression to which the crust of the earth would be subjected as the effect of subsidence, by the presence of faults and other causes, as well as by the secular cooling of its mass (Rev. O. Fisher, 'Phil. Mag.,' Jan. 1888), is too inconsiderable to develop the great contortions and foldings certain strata have undergone.

When accompanied by cleavage, the distortion of contained fossils and the displacement of included rock fragments (the flat sides lying parallel to the cleavage planes), indicate that the change occurred whilst the clay deposits were in an unconsolidated or plastic condition.

It is suggested that these flexures may be dependent on irregular pressure, caused by the local distribution of larger and heavier particles on accumulations of unconsolidated muddy deposits, in a similar manner to what may be demonstrated by spreading layers of clay of various colours, dried and reduced to powder, in a trough; when, on the admission of water, the clay has become plastic, sand is heaped on some special part and extra weight applied, which in the experiment is necessary. The heavier substance subsides into the plastic mass, and at the same time the clay beds are squeezed outwards, causing the layers underneath to be formed into films, which are still continuous with those on the sides, though these are rendered considerably thicker than in their original state and are curved into folds, even to reversal of the beds, representing on a small scale what are frequently met with in stratified rocks. The experiment so coincides with natural phenomena that it is reasonable to expect it will prove to be a true and frequent cause of the contortions of strata.

4. *On the Temperature at which Beryl is decolorised.*¹
By J. JOLY, M.A., B.E.

Experiments on some translucent green and yellow beryls from Glencullen, Co. Dublin, show that these beryls are almost entirely deprived of colour when exposed for one hour to a temperature of 357° C., i.e., the temperature of boiling mercury at atmospheric pressure. The loss of colour takes place whether the beryls are out of contact with the air or not. It was found further that exposure to a temperature of 230° C. for the space of 30 hours effected a marked loss of colour. In all cases the crystals retain their translucency. They have shown no signs of regaining colour during a lapse of three years since the date of the experiments.

The author suggests that this observation may bear on the history of the containing granite subsequent to the formation of beryl if the colour of the latter be regarded as indicating a major limit to the changes of temperature experienced by the rock.

¹ *Proc. Royal Dublin Soc.* vol. v. p. 51.

5. *On the Occurrence of Iolite in the Granite of County Dublin.*¹

By J. JOLY, M.A., B.E.

Iolite, not previously noticed in Irish granite, has been found by the author in the granite of Glencullen. It occurs as a microscopical but abundant inclusion in a substance of felspathic nature which is to be found interpenetrating prisms of beryl. Its presence is confined, apparently, to the felspar so intermixed with beryl. The iolite is in twelve-sided basal prisms, showing the faces *I*, *i-1*, *i-3*, *i-1*, *O*, in size up to 0.1 mm. in length, transparent, colourless viewed singly, and presenting a vivid and beautiful object in the polarising microscope. Characteristic features are the basal angles of 150°, 120° or 60°; its generally symmetrical extinction on elongated rectangular sections and the transverse cleavage on such sections. A foliation or plating on *O*, and an oblique twining line parallel to *I*, are also frequently met with. Occasionally the crystals occur in radiating groups. Enclosures are rare, generally glass.

6. *An Igneous Succession in Shropshire.*

By W. W. WATTS, M.A., F.G.S.

The author described the succession of Igneous Rocks in the Shelve and Corndon district in Shropshire.

1. There is a series of Andesitic ashes, interbedded at two principal horizons in the Ordovician sequence. These have a percentage of silica varying from 66-60.

2. Then come three sets of intrusive masses. *a.* Andesites (59-54 per cent. of silica). These are intruded into Ordovician rocks, and never touch the Silurian of the district. *b.* Dolerites (51-48 per cent. of silica) which are post-Silurian in date. *c.* Picrites (41-34 per cent. of silica) of later date. These are undoubtedly rocks intermediate in age and composition, but it is difficult to be quite sure of this where the differences in composition are so slight. One, however—the dolerite of Llanfawr—is a very basic dolerite, coming between the normal dolerites and picrites. In minerals a similar transition is to be noted. The Andesites are rich in Hypersthene, the Dolerites rather richer in Augite, while Olivine and Brown Mica come in in the Picrites. The author believed, though he had no means of certainly proving it, that the felspars became more basic in the more basic rocks, but certainly there were *different* felspars in some of the different members of the series. Another curious point was that the mineral aggregates in glomeroporphyritic Andesites are practically pieces of the ophitic dolerites. The determination of the specific gravities of these rocks gave a similar sequence, the least dense rocks having been erupted first and the denser last. Each of the eruptive rocks occurred in laccolites along the main anticlinal line of the district and also in dykes and along fault lines.

7. *Fourteenth Report on the Circulation of Underground Waters.*

See Reports, p. 145.

8. *A List of Works referring to British Mineral and Thermal Waters.*

By W. H. DALTON.—See Appendix, p. 859.

¹ *Proc. Royal Dublin Soc.* vol. v. p. 65.

SECTION D.—BIOLOGY.

PRESIDENT OF THE SECTION.—W. T. THISELTON-DYER, C.M.G., M.A., B.Sc.,
F.R.S., F.L.S.

THURSDAY, SEPTEMBER 6.

The PRESIDENT delivered the following Address:—

BEFORE we commence the formal business of the Section, I propose to invite your attention to several points which have suggested themselves to me from a consideration of the present position and progress of the study of botany in this country.

It is not so very long ago that at English universities, at least, the pursuit of botany was regarded rather as an elegant accomplishment than as a serious occupation. This is the more remarkable because at every critical point in the history of botanical science the names of our countrymen will be found to occupy an honourable place in the field of progress and discovery. In the seventeenth century Hooke and Grew laid the foundations of the cell theory, while Millington, by discovering the function of stamens, completed the theory of the flower. In the following century Morison first raised ferns from spores, Lindsay detected the fern prothallus, Ray laid the foundations of a natural classification, Hales discovered root-pressure, and Priestley the absorption of carbon dioxide and the evolution of oxygen by plants. In the early part of the present one we have Knight's discovery of the true cause of geotropism, Daubeny's of the effect upon the processes of plant-life of rays of light of different refrangibility, and finally, the first description of the cell-nucleus by R. Brown. I need not attempt to carry the list through the last half-century. I have singled out these discoveries as striking landmarks, the starting-points of important developments of the subject. It is enough for my purpose to show that we have always had an important school of botany in England, which has contributed at least its share to the general development of the science.

I think at the moment, however, we have little cause for anxiety. The academic chairs throughout the three kingdoms are filled, for the most part, with young, enthusiastic, and well-trained men. Botany is everywhere conceded its due position as the twin branch with zoology of biological science. We owe to the enlightened administration of the Oxford University Press the possession of a Journal which allows of the prompt and adequate publication of the results of laboratory research. The excellent work which is being done in every part of the botanical field has received the warm sympathy of our colleagues abroad. I need only recall to your recollection, as a striking evidence of this, the remarkable gathering of foreign botanists, which will ever make the meeting of this Association at Manchester a memorable event to all of us. The reflection rises sadly to the mind that it can never be repeated. Not many months, as you know, had passed before the two most prominent figures in that happy assemblage had been removed from us by the inexorable hand of death. In Asa Gray we miss a figure which we could never admit belonged wholly to the other side of the Atlantic. In technical botany we recognised him as altogether in harmony with the methods of work and standard of excellence of our own most distinguished taxonomists. But, apart from this, he

had that power of grasping large and far-reaching ideas, which, I do not doubt, would have brought him distinction in any branch of science. We owe to him the classical discussion of the facts of plant distribution in the Northern Hemisphere, which is one of the corner-stones of modern geographical botany. He was one of the earliest of distinguished naturalists who gave his adhesion to the theory of Mr. Darwin. A man of simple and sincere piety, the doctrine of descent never presented any difficulty to him. He will remain in our memories as a figure endowed with a sweetness and elevation of character which may be compared even with that of Mr. Darwin himself.

In De Bary we seem to have suffered no less a personal loss than in the case of Gray. Though, before last year, I do not know that he had ever been in England, so many of our botanists had worked under him that his influence was widely felt amongst us. And it may be said that this was almost equally so in every part of the civilised world. His position as a teacher was in this respect probably unique, and the traditions of his methods of work must permanently affect the progress of botany, and, indeed, have an even wider effect. This is not the occasion to dwell on each of his scientific achievements. It is sufficient to say that we owe to him the foundations of a rational vegetable pathology. He first grasped the true conditions of parasitism in plants, and not content with working out the complex phases of the life-history of the invading organism, he never lost sight of the conditions which permitted or inhibited its invasion. He treated the problem, whether on the side of the host or of the parasite, as a whole, as a biological problem, in fact, in the widest sense. It is this thorough grasp of the conditions of the problem that give such a peculiar value to his last published book, the 'Lectures on Bacteria,' an admirable translation of which we owe to Professor Balfour. To this I shall have again to refer. I must content myself with saying now, that in this and all his work there is that note of highest excellence which consists in lifting detail to the level of the widest generality. To a weak man this is a pitfall, in which a firm grasp of fact is lost in rash speculation. But when, as in De Bary's case, a true scientific insight is inspired by something akin to genius, the most fruitful conceptions are the result. Yet De Bary never sacrificed exactness to brilliancy, and to the inflexible love of truth which pervaded both his work and his personal intercourse we may trace the secret of the extraordinary influence which he exerted over his pupils.

As the head of one of the great national establishments of the country devoted to the cultivation of systematic botany, I need hardly apologise for devoting a few words to the present position of that branch of the science. Of its fundamental importance I have myself no manner of doubt. But as my judgment may seem in such a matter not wholly free from bias, I may fortify myself with an opinion which can hardly be minimised in that way. The distinguished chemist, Professor Lothar Meyer, perhaps the most brilliant worker in the field of theoretical chemistry, finds himself, like the systematic botanist, obliged to defend the position of descriptive science. And he draws his strongest argument from biology. 'The physiology of plants and animals,' he tells us, 'requires systematic botany and zoology, together with the anatomy of the two kingdoms: each speculative science requires a rich and well-ordered material, if it is not to lose itself in empty and fruitless fantasies.' No one, of course, supposes that the accumulation of plant specimens in herbaria is the mere outcome of a passion for accumulating. But to do good systematic work requires high qualities of exactitude, patience, and judgment. As I attempted to show on another occasion, the world is hardly sensible of the influence which the study of the subject has had on its affairs. The school of Jeremy Bentham has left an indelible mark on the social and legislative progress of our own time. Mill tells us that 'the proper arrangement of a code of laws depends on the same scientific conditions as the classifications in natural history; nor could there,' he adds, 'be a better preparatory discipline for that important function than the principles of a natural arrangement, not only in the abstract, but in their actual application to the class of phenomena for which they were first elaborated, and which are still the best school for learning their use.' He further tells us that of this Jeremy Bentham was perfectly

aware, and that his 'Fragment on Government' contains clear and just views on the meaning of a natural arrangement which reflect directly the influence of Linnæus and Jussieu. Mill himself possessed a competent knowledge of systematic botany, and therefore was well able to judge of its intellectual value. For my part, I do not doubt that precisely the same qualifications of mind which made Jeremy Bentham a great jurist, enabled his nephew to attain the eminence he reached as a botanist. As a mere matter of mental gymnastic, taxonomic science will hold its own with any pursuit. And, of course, what I say of botany is no less true of other branches of natural history. Mr. Darwin devoted eight or nine years to the systematic study of the *Cirripedia*. 'No one,' he himself tells us, 'has a right to examine the question of species who has not minutely described many.' And Mr. Huxley has pointed out, in the admirable memoir of Mr. Darwin which he has prepared for the Royal Society, that, the acquirement of an intimate and practical knowledge of the process of species-making . . . 'was 'of no less importance to the author of the "Origin of Species" than was the bearing of the Cirripede work upon the principles of a natural classification.'

At present the outlook for systematic botany is somewhat discouraging. France, Germany, and Austria no longer possess anything like a school in the subject, though they still supply able and distinguished workers. That these are, however, few, may be judged from the fact that it is difficult to fill the place of the lamented Eichler in the direction of the Botanic Garden and Herbarium at Berlin. Outside our own country, Switzerland is the most important seat of general systematic study to which three generations of De Candolle have devoted themselves. The most active centres of work at the moment are, however, to be found in our own country, in the United States, and in Russia. And the reason is, in each case, no doubt the same. The enormous area of the earth's surface over which each country holds sway brings to them a vast amount of material which pre-emptorily demands discussion.

No country, however, affords such admirable facilities for work in systematic botany as are now to be found in London. The Linnean Society possesses the Herbarium of Linnæus; the Botanical Department of the British Museum is rich in the collections of the older botanists; while at Kew we have a constantly increasing assemblage of material, either the results of travel and expeditions or the contributions of correspondents in different parts of the empire. A very large proportion of this has been worked up. But I am painfully impressed with the fact that the total of our available workers bears but a small proportion to the labour ready to their hands.

This is the more a matter of concern, because for the few official posts which are open to botanists at home or abroad a practical knowledge of systematic botany is really indispensable. For suitable candidates for these one naturally looks to the universities. And so far, I am sorry to say, in great measure one looks in vain. It would be, no doubt, a great impulse to what is undoubtedly an important branch of national scientific work if fellowships could occasionally be given to men who showed some aptitude for it. But these should not be mere prizes for undergraduate study, but should exact some guarantee that during the tenure of the fellowship the holder would seriously devote himself to some definite piece of work. At present, undoubtedly, the younger generation of botanists show a disposition to turn aside to those fields in which more brilliant and more immediate results can be attained. Their neglect of systematic botany brings to some extent its own Nemesis. A first principle of systematic botany is that a name should denote a definite and ascertainable species of plant. But in physiological literature you will find that the importance of this is often overlooked. Names are employed which are either not to be found in the books, or they are altogether misapplied. But if proper precautions are taken to ascertain the accurate botanical name of a plant, no botanist throughout the civilised world is at a loss to identify it.

But precision in nomenclature is only the necessary apparatus of the subject. The data of systematic botany, when properly discussed, lend themselves to very important generalisations. Perhaps those which are yielded by the study of

geographical distribution are of the most general interest. The mantle of vegetation which covers the surface of the earth, if only we could rightly unravel its texture, would tell us a good deal about geological history. The study of geographical distribution, properly handled, affords an independent line of attack upon the problem of the past distribution of land and sea. It would probably never afford sufficient data for a complete independent solution of the problem; but it must always be extremely useful as a check upon other methods. Here, however, we are embarrassed by the enormous amount of work which has yet to be accomplished. And unfortunately this is not of a kind which can be indefinitely postponed. The old terrestrial order is fast passing away before our eyes. Everywhere the primitive vegetation is disappearing as more and more of the earth's surface is brought into cultivation or, at any rate, denuded of its forests.

A good deal, however, has been done. We owe to the indomitable industry of Mr. Bentham and of Sir Ferdinand Mueller a comprehensive flora of Australia, the first large area of the earth's surface of which the vegetation has been completely worked out. Sir Joseph Hooker, in his retirement, has pushed on within sight of completion the enormous work of describing so much of the vast Indo-Malayan flora as is comprised within British possessions. To the Dutch botanists we owe a tolerably complete account of the Malayan flora proper. But New Guinea still remains botanically a *terra incognita*, and till within the last year or two the flora of China has been an absolute blank to us. A committee of the British Association (whose report will be presented to you) has, with the aid of a small grant of money, taken in hand the task of gathering up the scanty data which are available in herbaria and elsewhere. This has stimulated European residents in China to collect more material, and the fine collections which are now being rapidly poured in upon us will, if they do not overwhelm us by their very magnitude, go a long way in supplying data for a tentative discussion of the relations of the Chinese flora to that of the rest of Asia. I do not doubt that this will in turn explain a good deal that is anomalous in the distribution of plants in India. The work of the committee has been practically limited to Central and Eastern China. From the west, in Yunnan, the French botanists have received even more surprising collections, and these supplement our own work in the most fortunate manner. I have only to add for Asia Boissier's 'Flora Orientalis,' which practically includes the Mediterranean basin. But I must not omit the invaluable report of Brigade-Surgeon Aitchison on the collections made by him during the Afghan Delimitation Expedition. This has given an important insight into the vegetation of a region which had never previously been adequately examined. Nor must I forget the recent publication of the masterly report by Professor Bayley Balfour on the plants collected by himself and Schweinfurth in Socotra, an island with which the ancient Egyptians traded, but the singularly anomalous flora of which was almost wholly unknown up to our time.

The flora of Africa has been at present but imperfectly worked up, but the materials have been so far discussed as to afford a tolerably correct theory of its relations. The harvest from Mr. Johnston's expedition to Kilimanjaro was not as rich as might have been hoped. Still, it was sufficient to confirm the conclusions at which Sir Joseph Hooker had arrived, on very slender data, as to the relations of the high-level vegetation of Africa generally. The flora of Madagascar is perhaps, at the moment, the most interesting problem which Africa presents to the botanist. As the rich collections, for which we are indebted to Mr. Baron and others, are gradually worked out, it can hardly be doubted that it will be necessary to modify in some respects the views which are generally received as to the relation of the island to the African continent. My colleague, Mr. Baker, communicated to the York Meeting of the Association the results which, up to that time, he had arrived at, and these subsequent material has not led him to modify. The flora as a whole presents a large proportion of endemic genera and species, pointing to isolation from a very ancient date. The tropical element is, however, closely allied to that of Tropical Africa and of the Mascarene Islands, and there is a small infusion of Asiatic types which do not extend to Africa. The high-level flora, on the other hand, exhibits an even closer affinity with that temperate flora the ruins of which

are scattered over the mountainous regions of Central Africa, and which survives in its greatest concentration at the Cape.

The American botanists at Harvard are still systematically carrying on the work of Torrey and Gray in the elaboration of the flora of Northern America. The Russians are, on their part, continually adding to our knowledge of the flora of Northern and Central Asia. The whole flora of the North Temperate Zone can only be regarded substantially as one. The identity diminishes southwards and increases in the case of the Arctic and Alpine regions. A collection of plants brought us from high levels in Corea by Mr. James might, as regards a large proportion of the species, have been gathered on one of our own Scotch hills.

We owe to the munificence of two English men of science the organisation of an extensive examination of the flora and fauna of Central America and the publication of the results. The work, when completed, can hardly be less expensive than that of the results of the 'Challenger' voyage, which has severely taxed the liberality of the English Government. The problems which geographical distribution in this region present will doubtless be found to be of a singularly complicated nature, and it is impossible to overestimate the debt of gratitude which biologists of all countries must owe to Messrs. Godman and Salvin when their arduous undertaking is completed. I am happy to say that the botanical portion, which has been elaborated at Kew, is all but finished.

In South America, I must content myself with referring to the great 'Flora Brasiliensis,' commenced by Martius half a century ago, and still slowly progressing under the editorship of Professor Urban at Berlin. Little discussion has yet been attempted of the mass of material which is enshrined in the mighty array of volumes already published. But the travels of Mr. Ball in South America have led him to the detection of some very interesting problems. The enormous pluvial denudation of the ancient portions of the continent has led to the gradual blending of the flora of different levels with sufficient slowness to permit of adaptive changes in the process. The tropical flora of Brazil, therefore, presents an admixture of modified temperate types which gives to the whole a peculiar character not met with to the same degree in the tropics of the old world. On the other hand, the comparatively recent elevation of the southern portion of the continent accounts, in Mr. Ball's eyes, for the singular poverty of its flora, which we may regard indeed as still in progress of development.

The botany of the 'Challenger' expedition, which was also elaborated at Kew, brought for the first time into one view all the available facts as to the floras of the older oceanic islands. To this was added a discussion of the origin of the more recent floras of the islands of the Western Pacific, based upon material carefully collected by Professor Moseley and supplemented by the notes and specimens accumulated with much judgment by Dr. Guppy. For the first time we were enabled to get some idea how a tropical island was furnished with plants and to discriminate the littoral element due to the action of oceanic currents from the interior forest almost wholly due to frugivorous birds. The recent examination of Christmas Island by the English Admiralty has shown the process of island flora-making in another stage. The plants collected by Mr. Lister prove, as might be expected, to be closely allied to those of Java. But the effect of isolation has begun to tell; and I learn from my colleague, Professor Oliver, that the plants from Christmas Island cannot be for the most part exactly matched with their congeners from Java, but yet do not differ sufficiently to be specifically distinguished. We have here, therefore, it appears to me, a manifest case of nascent species.

The central problem of systematic botany I have not as yet touched upon: this is to perfect a natural classification. Such a classification, to be perfect, must be the ultimate generalisation of every scrap of knowledge which we can bring to bear upon the study of plant affinity. In the higher plants experience has shown that we can obtain results which are sufficiently accurate for the present without carrying our structural analysis very far. Yet even here, the correct relations of the Gymnosperms would never have been ascertained without patient and minute microscopic study of the reproductive processes. Upon these, indeed, the correct classification of the Vascular Cryptogams wholly depends, and generally, as we

descend in the scale, external morphology becomes more and more insecure as a guide, and a thorough knowledge of the minute structure and life history of each organism becomes indispensable to anything like a correct determination of its taxonomic position. The marvellous theory of the true nature of Lichens would never have been ascertained by the ordinary methods of examination which were held to be sufficient by lichenologists.

The final form of every natural classification—for I have no doubt that the general principles I have laid down are equally true in the field of zoology—must be to approximate to the order of descent. For the Theory of Descent became an irresistible induction as soon as the idea of a natural classification had been firmly grasped.

In regard to flowering plants we owe, as I have said, the first step in a natural classification to our own great naturalist John Ray, who divided them into Monocotyledons and Dicotyledons. The celebrated classification of Linnæus was avowedly purely artificial. It was a temporary expedient, the provisional character of which no one realised more thoroughly than himself. He, in fact, himself gave us one of the earliest outlines of a truly natural system. Such a system is based on affinity, and we know of no other explanation of affinity than that which is implied in the word, namely, common parentage. No one finds any difficulty in admitting that, where a number of individual organisms closely resemble one another, they must have been derived from the same stock. I allow that, in cases where external form is widely different, the conclusion to one who is not a naturalist is by no means so obvious. But in such cases it rests on the profound and constant resemblance of internal points of structure. Anyone who studies the matter with a perfectly open mind finds it impossible to draw a line. If genetic relationship or heredity is admitted to be the explanation of affinity in the most obvious case, the stages are imperceptible, when the evidence is fairly examined, by which the same conclusion is inevitable, even in cases where at the first glance it seems least likely.

This leads me to touch on the great theory which we owe to Mr. Darwin. That theory, I need hardly say, was not merely a theory of descent. This had suggested itself to naturalists in the way I have indicated long before. What Mr. Darwin did was to show how by perfectly natural causes the separation of living organisms into races which at once resemble and yet differ from one another so profoundly came about. Heredity explains the resemblance; Mr. Darwin's great discovery was that variation worked upon by natural selection explained the difference. That explanation seems to me to gather strength every day and to continually reveal itself as a more and more efficient solvent of the problems which present themselves to the student of natural history. At the same time I am far from claiming for it the authority of a scientific creed or even the degree of certainty which is possessed by some of the laws of astronomy. I only affirm that as a theory it has proved itself a potent and invaluable instrument of research. It is an immensely valuable induction; but it has not yet reached such a position of certitude as has been attained by the Law of Gravitation, and I have myself, in the field of botany, felt bound to protest against conclusions being drawn deductively from it without being subjected to the test of experimental verification. This attitude of mine, which I believe I share with most naturalists, must not, however, be mistaken for one of doubt. Of doubt as to the validity of Mr. Darwin's views I have none; I shall continue to have none till I come across facts which suggest doubt. But that is a different position from one of absolute certitude.

It is therefore without any dissatisfaction that I observe that many competent persons have, while accepting Mr. Darwin's theory, set themselves to criticise various parts of it. But I must confess that I am disposed to share the opinion expressed by Mr. Huxley, that these criticisms really rest on a want of a thorough comprehension.

Mr. Romanes has put forward a view which deserves the attention due to the speculations of a man of singular subtlety and dialectic skill. He has startled us with the paradox that Mr. Darwin did not after all put forth, as I conceive it was his own impression he did, a theory of the origin of species, but only of adaptations.

And inasmuch as Mr. Romanes is of opinion that specific differences are not 'even generally' adaptive, while those of genera are, it follows that Mr. Darwin only really accounted for the origin of the latter, while for an explanation of the former we must look to Mr. Romanes himself. For my part, however, I am altogether unable to accept the premises, and therefore fail to reach the conclusion. Specific differences, as we find them in plants, are for the most part indubitably adaptive, while the distinctive characters of genera and of higher groups are rarely so. Let anyone take the numerous species of some well-characterised English genus, for example *Ranunculus*; he will find that one species is distinguished by having creeping stems, one by a tuberous root, one by floating leaves, another by drawn-out submerged ones, and so on. But each possesses those common characters which enable the botanist almost at a glance, notwithstanding the adaptive disguise, to refer them to the common genus *Ranunculus*. It seems to me quite easy to see, in fact, why specific characters should be usually adaptive, and generic not so. Species of any large genus must, from the nature of things, find themselves exposed to any but uniform conditions. They must acquire, therefore, as the very condition of their existence, those adaptive characters which the necessities of their life demand. But this rarely affects those marks of affinity which still indicate their original common origin. Probably these were themselves once adaptive, but they have long been overlaid by newer and more urgent modifications. Still Nature is ever conservative, and these reminiscences of a bygone history persist; significant to the systematic botanist as telling an unmistakable family story, but far removed from the stress of a struggle in which they no longer are called upon to bear their part.

Another episode in the Darwinian theory is, however, likely to occupy our attention for some time to come. The biological world now looks to Professor Weissmann as occupying the most prominent position in this field of speculation. His theory of the continuity of the germ-plasm has been put before English readers with extreme lucidity by Professor Moseley. That theory, I am free to confess, I do not find it easy to grasp clearly in all its concrete details. At any rate, my own studies do not furnish me with sufficient data for criticising them in any adequate way. It is, however, bound up with another theory—the non-inheritance of acquired characters—which is more open to general discussion. If with Weissmann we accept this principle, it cannot be doubted that the burden thrown on natural selection is enormously increased. But I do not see that the theory of natural selection itself is in any way impaired in consequence.

The question, however, is, are we to accept the principle? It appears to me that it is entirely a matter of evidence. It is proverbially difficult to prove a negative. In the analogous case of the inheritance of accidental mutilations Mr. Darwin contents himself with observing that we should be 'cautious in denying it.' Still I believe that, though a great deal of pains has been devoted to the matter, there is no case in which it has been satisfactorily proved that a character acquired by an organism has been transmitted to its descendants; and there is, of course, an enormous bulk of evidence the other way.

The consideration of this point has given rise to what has been called the new Lamarckism. Now Lamarck accounted for the evolution of organic nature by two principles—the tendency to progressive advancement and the force of external circumstances. The first of these principles appears to me, like Nägeli's internal modifying force, to be simply substituting a name for a thing. Lamarck, like many other people before him, thought that the higher organisms were derived from others lower in the scale, and he explained this by saying that they had a tendency to be so derived. This appears to me much as if we explained the movement of a train from London to Bath by attributing it to a tendency to locomotion. Mr. Darwin lifted the whole matter out of the field of mere transcendental speculation by the theory of natural selection, a perfectly intelligible mechanism by which the result might be brought about. Science will always prefer a material *modus operandi* to anything so vague as the action of a tendency.

Lamarck's second principle deserves much more serious consideration. To be perfectly fair we must strip it of the crude illustrations with which he hampered

it. To suggest that a bird became web-footed by persistently stretching the skin between its toes, or that the neck of a giraffe was elongated in the perpetual attempt to reach the foliage of trees, seems almost repugnant to common sense. But the idea that changes in climate and food—*i.e.* in the conditions of nutrition generally—may have some slow but direct influence on the organism seems, on a superficial view, so plausible that the mind is very prone to accept it. Mr. Darwin has himself frankly admitted that he thought he had not attached sufficient weight to the direct action of the environment. Yet it is extremely difficult to obtain satisfactory evidence of effects produced in this way. Hoffmann experimented with much pains on plants, and the results were negative. And Mr. Darwin confessed that Hoffmann's paper had 'staggered' him.

Organic evolution still, therefore, seems to me to be explained in the simplest way as the result of variation controlled by natural selection. Now both these factors are perfectly intelligible things. Variation is a mere matter of everyday observation, and the struggle for existence which is the cause, of which natural selection is the effect, is equally so. If we state in a parallel form the Lamarckian theory, it amounts to a tendency controlled by external forces. It appears to me that there is no satisfactory basis of fact for either factor. The practical superiority of the Darwinian over the Lamarckian theory is, as a working hypothesis, immeasurable.

The new Lamarckian school, if I understand their views correctly, seek to re-introduce Lamarck's 'tendency.' The fact has been admitted by Mr. Darwin himself that variation is not illimitable. No one, in fact, has ever contended that any type can be reached from any point. For example, as Weissmann puts it, 'under the most favourable circumstances a bird can never become transformed into a mammal.' It is deduced from this that variation takes place in a fixed direction only, and this is assumed to be due to an innate law of development, or, as Weissmann has termed it, a 'phyletic vital force.' But the introduction of any such directive agency is superfluous, because the limitation of variability is a necessary consequence of the physical constitution of the varying organism.

It is supposed, however, by many people that a necessary part of Mr. Darwin's theory is the explanation of the phenomenon of variation itself. But really this is not more reasonable than to demand that it should explain gravitation or the source of solar energy. The investigation of any one of these phenomena is a matter of first-rate importance. But the cause of variation is perfectly independent of the results that flow from it when subordinated to natural selection.

Though it is difficult to establish the fact that external causes promote variation directly, it is worth considering whether they may not do so indirectly. Weissmann, like Lamarck before him, has pointed out, as others have also done, the remarkable persistence of the plants and animals of Egypt; and the evidence of this is now even stronger. We owe, at Kew, to the kindness of Dr. Schweinfurth, a collection of specimens of plants from Egyptian tombs which are said to be as much as 4,000 years old. They are still perfectly identifiable, and, as one of my predecessors in this chair has pointed out, they differ in no respect from their living representatives in Egypt at this day. The explanation which Lamarck gave of this fact 'may well,' says Sir Charles Lyell, 'lay claim to our admiration.' He attributed it, in effect, to the persistence of the physical geography, temperature, and other natural conditions. The explanation seems to me adequate. The plants and animals, we may fairly assume, were, 4,000 years ago, as accurately adjusted to the conditions in which they then existed as the fact of their persistence in the country shows that they must be now. Any deviation from the type that existed then would either, therefore, be disadvantageous or indifferent. In the former case it would be speedily eliminated, in the latter it would be swamped by cross-breeding. But we know that if seeds of these plants were introduced into our gardens we should soon detect varieties amongst their progeny. Long observation upon plants under cultivation has always disposed me to think that a change of external conditions actually stimulated variation, and so gave natural selection wider play and a better chance of re-establishing the adaptation of the organism to them. Weissmann explains the remarkable fact that organisms may for thousands of years reproduce themselves unchanged by the principle of the

persistence of the germ-plasm. Yet it seems hard to believe that the germ-plasm, while enshrined in the individual whose race it is to perpetuate, and nourished at its expense, can be wholly indifferent to all its fortunes. It may be so, but in that case it would be very unlike other living elements of organised beings.

I am bound, however, to confess that I am not wholly satisfied with the data for the discussion of this question which practical horticulture supplies. That the contents of our gardens do exhibit the results of variation in a most astonishing degree no one will dispute. But for scientific purposes any exact account of the treatment under which these variations have occurred is unfortunately usually wanting. A great deal of the most striking variation is undoubtedly due to wide crossing, and these cases must, of course, be eliminated when the object is to test the independent variation of the germ-plasm. Hoffmann, whose experiments I have already referred to, doubts whether plants do as a matter of fact vary more under cultivation than in their native home and under natural conditions. It would be very interesting if this could be tested by the concerted efforts of two cultivators, say, for example, in Egypt and in England. Let some annual plant be selected, native of the former country, and let its seed be transmitted to the latter. Then let each cultivator select any variations that arise in regard to some given character; set to work, in fact, exactly as any gardener would who wanted to 'improve' the plant, but on a preconceived plan. A comparison of the success which each obtained would be a measure of the effect of the change of the environment on variability. If it proved that, as Hoffmann supposed, the change of conditions did not affect what we may call the rate of variation, then, as Mr. Darwin remarks in writing to Professor Semper, 'the astonishing variations of almost all cultivated plants must be due to selection and breeding from the varying individuals. This idea,' he continues, 'crossed my mind many years ago, but I was afraid to publish it, as I thought that people would say, "How he does exaggerate the importance of selection!"' From an independent consideration of the subject I also find my mind somewhat shaken about it. Yet I feel disposed to say with Mr. Darwin, 'I still *must* believe that changed conditions give the impulse to variability, but that they act *in most cases* in a very indirect manner.'

Whatever conclusions we arrive at on these points, everyone will agree that one result of the Darwinian theory has been to give a great impulse to the study of organisms, if I may say so, as 'going concerns.' Interesting as are the problems which the structure, the functions, the affinity, or the geographical distribution of a plant may afford, the living plant in itself is even more interesting still.

Every organ will bear interrogation to trace the meaning and origin of its form and the part it plays in the plant's economy. That there is here an immense field for investigation there can be no doubt. Mr. Darwin himself set us the example in a series of masterly investigations. But the field is well-nigh inexhaustible. The extraordinary variety of form which plants exhibit has led to the notion that much of it may have arisen from indifferent variation. No doubt, as Mr. Darwin has pointed out, when one of a group of structures held together by some morphological or physiological *nexus* varies, the rest will vary correlatively. One variation then may, if advantageous, become adaptive, while the rest will be indifferent. But it appears to me that such a principle should be applied with the greatest caution, and from what I have myself heard fall from Mr. Darwin, I am led to believe that in the later years of his life he was disposed to think that every detail of plant structure had some adaptive significance, if only the clue could be found to it. As regards the forms of flowers an enormous body of information has been collected, but the vegetative organs have not yielded their secret to anything like the same extent. My own impression is that they will be found to be adaptive in innumerable ways which at present are not even suspected. At Kew we have probably a larger number of species assembled together than are to be found anywhere on the earth's surface. Here, then, is ample material for observation and comparison. But the adaptive significance will doubtless often be found by no means to lie on the surface. Who, for example, could possibly have guessed by inspection the purpose of the glandular bodies on the leaves of *Acacia sphaerocephala* and on the pulvinus of *Cecropia peltata* which Belt in the one case, and Fritz Müller in the other have

shown to serve as food for ants? So far from this explanation being farfetched, Belt found that the former 'tree is actually unable to exist without its guard,' which it could not secure without some attraction in the shape of food. One fact which strongly impresses me with a belief in the adaptive significance of vegetative characters is the fact that in almost identical forms they are constantly adopted by plants of widely different affinity. If such forms were without significance one would expect them to be infinitely varied. If, however, they are really adaptive, it is intelligible that different plants should independently avail themselves of the same appliances and expedients.

Although this country is splendidly equipped with appliances for the study of systematic botany, our universities and colleges fall far behind a standard which would be considered even tolerable on the Continent in the means of studying morphological and physiological botany or of making researches in these subjects. There is not at the moment anywhere in London an adequate botanical laboratory, and though at most of the universities matters are not quite so bad, still I am not aware of any one where it is possible to do more than give the routine instruction or to allow the students, when they have passed through this, to work for themselves. It is not easy to see why this should be, because on the animal side the accommodation and appliances for teaching comparative anatomy and physiology are always adequate and often palatial. Still less explicable to me is the tendency on the part of those who have charge of medical education to eliminate botanical study from the medical curriculum, since historically the animal histologists owe everything to botanists. In the seventeenth century, as I have already mentioned, Hooke first brought the microscope to the investigation of organic structure, and the tissue he examined was cork. Somewhat later, Grew, in his 'Anatomy of Plants,' gave the first germ of the cell-theory. During the eighteenth century the anatomists were not merely on a hopelessly wrong tack themselves, but they were bent on dragging botanists into it also. It was not till 1837, a little more than fifty years ago, that Henle saw that the structure of epithelium was practically the same as that of the *parenchyma plantarum* which Grew had described 150 years before. Two years later Schwann published his immortal theory, which comprised the ultimate facts of plant and animal anatomy under one view. But it was to a botanist, Von Mohl, that, in 1846, the biological world owed the first clear description of protoplasm, and to another botanist, Cohn (1851), the identification of this with the sarcode of zoologists.

Now the historic order in discovery is not without its significance. The path which the first investigators found most accessible is doubtless that which beginners will also find easiest to tread. I do not myself believe that any better access can be obtained to the structure and functions of living tissues than by the study of plants. However, I am not without hopes that the serious study of botany in the laboratory will be in time better cared for. I do not hesitate to claim for it a position of the greatest importance in ordinary scientific education. All the essential phenomena of living organisms can be readily demonstrated upon plants. The necessary appliances are not so costly, and the work of the class-room is free from many difficulties with which the student of the animal side of biology has to contend.

Those, however, who have seriously devoted themselves to the pursuit of either morphological or physiological botany need not now be wholly at a loss. The splendid laboratory on Plymouth Sound, the erection of which we owe to the energy and enthusiasm of Professor Ray Lankester, is open to botanists as well as to zoologists, and affords every opportunity for the investigation of marine plants, in which little of late years has been done in this country. At Kew we owe to private munificence a commodious laboratory in which much excellent work has already been done. And this Association has made a small grant in aid of the establishment of a laboratory in the Royal Botanic Garden at Peradeniya, in Ceylon. It may be hoped that this will afford facilities for work of the same kind as has yielded Dr. Treub such a rich harvest of results in the Buitenzorg Botanic Garden in Java.

Physiological botany, as I have already pointed out, is a field in which this

country in the past has accomplished great things. It has not of late, however, obtained an amount of attention in any way proportionate to that devoted to animal physiology. In the interests of physiological science generally, this is much to be deplored; and I believe that no one was more firmly convinced of this than Mr. Darwin. Only a short time before his death, in writing to Mr. Romanes on a book that he had recently been reading, he said that the author had made 'a gigantic oversight in never considering plants; these would simplify the problem for him.' This goes to the root of the matter. There is, in my judgment, no fundamental biological problem which is not exhibited in a simpler form by plants than animals. It is possible, however, that the distaste which seems to exist amongst our biologists for physiological botany may be due in some measure to the extremely physical point of view from which it has been customary to treat it on the Continent. It is owing in great measure to the method of Mr. Darwin's own admirable researches that in this country we have been led to a more excellent way. The work which has been lately done in England seems to me full of the highest promise. Mr. Francis Darwin and Mr. Gardiner have each in different directions shown the entirely new point of view which may be obtained by treating plant phenomena as the outcome of the functional activity of protoplasm. I have not the least doubt that by pursuing this path English research will not merely place vegetable physiology, which has hitherto been too much under the influence of Lamarckism, on a more rational basis, but that it will also sensibly react, as it has done often before, on animal physiology.

There is no part of the field of physiological botany which has yielded results of more interest and importance than that which relates to the action of ferments and fermentation; and I could hardly give you a better illustration of the purely biological method of treating it. I believe that these results, wonderful and fascinating as they are, afford but a faint indication of the range of those that are still to be accomplished. The subject is one of extreme intricacy, and it is not easy to speak about it briefly. To begin with, it embodies two distinct groups of phenomena which have in reality very little which is essential in common.

What are usually called ferments are perhaps the most remarkable of all chemical bodies, for they have the power of effecting very profound changes in the chemical constitution of other substances, although they may be present in very minute quantity; but—and this is their most singular and characteristic property—they themselves remain unchanged in the process. It may be said without hesitation that the whole nutrition of both animals and plants depends on the action of ferments. Organisms are incapable of using solid nutrient matter for the repair and extension of their tissues; this must be first brought into a soluble form before it can be made available, and this change is generally brought about by the action of a ferment. Animal physiology has long been familiar with the part played by ferments, and it may be said that no small part of the animal economy is made up of organs required either for the manufacture of ferments or for the exposure of ingested food to their action. It may seem strange at first sight to speak of analogous processes taking place in plants. But it must be remembered that plant nutrition includes two very distinct stages. Certain parts of plants build up, as everyone knows, from external inorganic materials substances which are available for the construction of new tissues. It might be supposed that these are used up as fast as they are formed. But it is not so; the life of the plant is not a continuous balance of income and expenditure. On the contrary, besides the general maintenance of its structure, the plant has to provide from time to time for enormous resources to meet such exhausting demands as the renewal of foliage, the production of flowers, and the subsequent maturing of fruit.

In such cases the plant has to draw on an accumulated store of solid food which has rapidly to be converted into the soluble form in which alone it is capable of passing through the tissues to the seat of consumption. And I do not doubt for my part that in such cases ferments are brought into play of the same kind and in the same way as in the animal economy. Take such a simple case as a potato tuber. This is a mass of cellular tissue, the cells of which are loaded with starch. We may either dig up the tuber and eat the starch ourselves or we may leave it in

the ground, in which case it will be consumed in providing material for the growth of a potato-plant next year. But the processes by which the insoluble starch is made available for nutrition are, I cannot doubt, closely similar in either case.

When we inquire further about these mysterious and all-important bodies, the answer we can give is extremely inadequate. It is very difficult to obtain them in amount sufficient for analysis or in a state of purity. We know, however, that they are closely allied to albuminoids and contain nitrogen in varying proportion. Papain, which is a vegetable ferment derived from the fruit of the papaw, and capable of digesting most animal albuminoids, is said to have the same ultimate composition as the pancreatic ferment and as peptones, bodies closely allied to proteids; the properties of all three bodies are, however, very different. It seems clear, nevertheless, that ferments must be closely allied to proteids, and, like these bodies, they are, no doubt, directly derived from protoplasm.

I need not remind you that, unlike other constituents of plant tissues, protoplasm, as a condition of its vitality, is in a constant state of molecular activity. The maintenance of this activity involves the supply of energy, and this is partly derived from the waste of its own substance. This 'self-decomposition' of the protoplasm liberates energy, and in doing so gives rise to a number of more stable bodies than protoplasm. Some of these are used up again in nutrition; others are thrown aside and are never drawn again into the inner circle of vital processes. In the animal organism, where the strictest economy of bulk is a paramount necessity, they are promptly got rid of by the process of excretion. In the vegetable economy these residual products usually remain. And it is for this reason, I may point out, that the study of the chemistry of plant-nutrition appears to me of such immense importance. The record of chemical change is so much more carefully preserved; and the probability of our being able to trace the course it has followed is consequently far more likely to be attended with success.

This preservation in the plant of the residual by-products of protoplasmic activity no doubt accounts for the circumstance which otherwise is extremely perplexing—the profusion of substances which we meet with in the vegetable kingdom to which it is hard to attribute any useful purpose. It seems probable that ferments, in a great many cases, belong to the same category. I imagine that it is in some degree accidental that some of them have been made use of, and thus the plant has been able to temporarily lock up accumulations of food to be drawn upon in future phases of its life with the certainty that they would be available. Without the ferments the key of the storehouse would be lost irretrievably.

Plants, moreover, are now known to possess ferments, and the number will doubtless increase to which it is difficult to attribute any useful function. Papain, to which I have already alluded, abounds in the papaw; but it is not easy to assign to it any definite function; still less is it easy, on teleological grounds, to account for the rennet ferment contained in the fruits of an Indian plant, *Withania coagulans*, and admirably investigated by Mr. Sheridan Lea.

Having dwelt so far on the action of ferments, we may now turn to fermentation and that other kind of change in organic matter called 'putrefaction,' which is known to be closely allied to fermentation. Ferments and fermentation, as I have already remarked, have very little to do with one another; and it would save confusion and emphasise the fact if we ceased to speak of ferments but used some of the alternative names which have been proposed for them, such as *zymases* or *enzymes*.

The classical case of fermentation, which is the root of our whole knowledge of the subject, is that of the conversion of sugar into alcohol. Its discovery has everywhere accompanied the first stages of civilisation in the human race. Its details are now taught in our text-books; and I should hardly hope to be excused for referring to it in any detail if it were not necessary for my purpose to draw your attention more particularly to one or two points connected with it.

Let us trace what happens in a fermenting liquid. It becomes turbid, it froths and effervesces, the temperature sensibly increases; this is the first stage. After this it begins to clear, the turbidity subsides as a sediment; the sugar which

the fluid at first contained has in great part disappeared, and a new ingredient, alcohol, is found in its place.

It is just fifty years ago that the great Dutch biologist Schwann made a series of investigations which incontrovertibly demonstrated that both fermentation and putrefaction were due to the presence of minute organisms which live and propagate at the expense of the liquids in which they produce as a result these extraordinary changes. The labours of Pasteur have confirmed Schwann's results, and—what could not have been foreseen—have extended the possibilities of this field of investigation to those disturbances in the vital phenomena of living organisms themselves which we include under the name of 'disease,' and which, no one will dispute, are matters of the deepest concern to every one of us.

Now, at first sight, the conversion of starch into sugar by means of diastase seems strikingly analogous to the conversion of sugar into alcohol. It is for this reason that the phenomena have been so long associated. But it is easy to show that they are strikingly different. Diastase is a chemical substance of obscure composition it is true, but inert and destitute of any vital properties, nor is it affected by the changes it induces. Yeast, on the other hand, which is the active agent in alcoholic fermentation, is a definite organism; it enormously increases during the process, and it appears to me impossible to resist the conclusion that fermentation is a necessary concomitant of the peculiar conditions of its life. Let me give you a few facts which go to prove this. In the first place, you cannot ferment a perfectly pure solution of sugar. The fermentible fluid must contain saline and nitrogenous matters necessary for the nutrition of the yeast protoplasm. In pure sugar the yeast starves. Next, Schwann found that known protoplasmic poisons, by killing the yeast-cells, would prohibit fermentation. He found the same result to hold good of putrefaction, and this is the basis of the whole theory of antiseptics. Nor can the action of yeast be attributed to any ferment which the yeast secretes. It is true that pure cane-sugar cannot be fermented, and that yeast effects the inversion of this, as it is called, into glucose and lævulose. It does this by a ferment which can be extracted from it, and which is often present in plants. But you can extract nothing from yeast which will do its peculiar work apart from itself. Helmholtz made the crucial experiment of suspending a bladder full of boiled grape-juice in a vat of fermenting must; it underwent no change; and even a film of blotting-paper has been found a sufficient obstacle to its action. We are driven, then, necessarily to the conclusion that in the action of 'ferments' or zymases we have to do with a chemical—*i.e.* a purely physical process; while in the case of yeast we encounter a purely physiological one.

How, then, is this action to be explained? Pasteur has laid stress on a fact which had some time been known, that the production of alcohol from sugar is a result of which yeast has not the monopoly. If ripening fruits, such as plums, are kept in an atmosphere free from oxygen, Bérard found that they, too, exhibit this remarkable transformation; their sugar is converted appreciably into alcohol. On the other hand, Pasteur has shown that, if yeast is abundantly supplied with oxygen, it feeds on the sugar of a fermentible fluid without producing alcohol. But, under the ordinary circumstances of fermentation, its access to oxygen is practically cut off; the yeast, then, is in exactly the same predicament as the fruit in Bérard's experiment. Sugar is broken up into carbon dioxide and alcohol in an amount far in excess of the needs of mere nutrition. In this dissociation it can be shown that an amount of energy is set free in the form of heat equal to about one-tenth of what would be produced by the total combustion of an equivalent amount of grape-sugar. If the protoplasm of the yeast could, with the aid of atmospheric oxygen, completely decompose a unit of grape-sugar, it would get ten times as much energy in the shape of heat as it could get by breaking it up into alcohol and carbon dioxide. It follows, then, that to do the same amount of growth in either case, it must break up ten times as much sugar without a supply of oxygen as with it. And this throws light on what has always been one of the most remarkable facts about fermentation—the enormous amount of change which the yeast manages to effect in proportion to its own development.

There are still two points about yeast which deserve attention before we dismiss

it. When a fermenting liquid comes to contain about 14 per cent. of alcohol, the activity of the yeast ceases, quite independently of whether the sugar is used up or not. In other cases of fermentation the same inhibiting effect of the products of fermentation is met with. Thus lactic fermentation soon comes to an end unless calcium carbonate or some similar substance be added, which removes the lactic acid from the solution as fast as it is formed.

The other point is that in all fermentations, besides what may be termed the primary products of the process, other bodies are produced. In the case of alcoholic fermentation the primary bodies are alcohol and carbon dioxide; the secondary, succinic acid and glycerine. Delpino has suggested that these last are residual products derived from that portion of the fermentible matter which is directly applied to the nutrition of the protoplasm.

Yeast, itself the organism which effects the remarkable changes on which I have dwelt, is somewhat of a problem. It is clear that it is a fungus, the germs of which must be ubiquitous in the atmosphere. It is difficult to believe that the simple facts, which are all we know about it, constitute its entire life history. It is probably a transitory stage of some more complicated organism.

I can only briefly refer to putrefaction. This is a far more complex process than that which I have traced in the case of alcoholic fermentation. In that nitrogen is absent, while it is an essential ingredient in albuminoids, which are the substances which undergo putrefactive changes. But the general principles are the same. Here, too, we owe to Schwann the demonstration of the fact that the effective agents in the process are living organisms. If we put into a flask a putrescible liquid such as broth, boil it for some time, and during the process of boiling plug the mouth with some cotton-wool, we know that the broth will remain long unchanged, while if we remove the wool putrescence soon begins. Tyndall has shown that, if we conduct the experiment on one of the high glaciers of the Alps, the cotton-wool may be dispensed with. We may infer, then, that the germs of the organisms which produce putrefaction are abundant in the lower levels of the atmosphere and are absent from the higher. They are wafted about by currents of air; but they are not imponderable, and in still air they gradually subside. Dr. Lodge has shown that air is rapidly cleared of suspended dust by an electric discharge, and this, no doubt, affords a simple explanation of the popular belief that thunderous weather is favourable to putrefactive changes.

Cohn believes that putrefaction is due to an organism called *Bacterium Termo*, which plays in it the same part that yeast does in fermentation. This is probably too simple a statement; but the general phenomena are nevertheless similar. There is the same breaking down of complex into simpler molecules; the same evolution of gas, especially carbon dioxide; the same rise of temperature. The more or less stable products of the process are infinitely more varied, and it is difficult, if not impossible, to say, in the present state of our knowledge, whether in most cases they are the direct outcome of the putrefactive process, or residual products of the protoplasmic activity of the organisms which induce it. Perhaps, on the analogy of the higher plants, in which some of them also occur, we may attribute to the latter category certain bodies closely resembling vegetable alkaloids; these are called ptomaines, and are extremely poisonous. Besides such bodies, bacteria undoubtedly generate true ferments and peculiar colouring matters. But there are in most cases of putrefaction a profusion of other substances, which represent the various stages of the breaking up of the complex proteid molecule, and are often themselves the outcome of subsidiary fermentations.

These results are of great interest from a scientific point of view. But their importance at the present moment in the study of certain kinds of disease can hardly be exaggerated. I have already mentioned Henle as having first found the true clue to animal histology in the structure of plants. As early as 1840 the same observer indicated the grounds for regarding contagious diseases as due to living organisms. I will state his argument in the words of De Bary, whose 'Lectures on Bacteria,' the last work which we owe to his gifted hand, I can confidently recommend to you as a luminous but critical discussion of a vast mass of difficult and conflicting literature.

It was, of course, clear that contagion must be due to the communication of infectious particles or contagia. These contagia, although at the time no one had seen them, Henle pointed out, 'have the power, possessed, as far as we know, by living creatures only, of growing under favourable conditions, and of multiplying at the expense of some other substance than their own, and therefore of assimilating that substance.' Henle enforced his view by comparison with the theory of fermentation, which had then been promulgated by Schwann. But for many years his views found no favour. Botanists, however, as in so many other cases, struck on the right path, and from about the year 1850 steady progress, in which De Bary himself took a leading part, was made in showing that most of the diseases of plants are due to parasitic infection. The reason of this success was obvious: the structure of plants make them more accessible to research, and the invading parasites are larger than animal contagia. On the animal side all real progress dates from about 1860, when Pasteur, having established Schwann's theory of fermentation on an impregnable basis, took up Henle's theory of living contagia.

The only risk now is that we may get on too fast. To put the true theory of any one contagious disease on as firm a basis as that of alcoholic fermentation is no easy matter to accomplish. But I believe that this is, notwithstanding a flood of facile speculation and imperfect research, slowly being done.

There are two tracts in the body which are obviously accessible to such minute organisms as bacteria, and favourable for their development. These are the alimentary canal and the blood. In the case of the former there is evidence that every one of us possesses quite a little flora of varied forms and species. They seem for the most part, in health, to be comparatively innocuous; indeed, it is believed that they are ancillary to and aid digestion. But it is easy to see that other kinds may be introduced, or those already present may be called into abnormal activity, and fermentative processes may be set up of a very inconvenient kind. These may result in mere digestive disorder, or in the production of some of those poisonous derivatives of proteids of which I have spoken, the effect of which upon the organism may be most disastrous.

The access of bacteria to the blood is a far more serious matter. They produce phenomena the obvious analogy of which to fermentative processes has led to the resulting diseases being called zymotic. Take, for example, the disease known as 'relapsing fever.' This is contagious. After a period of incubation, violent fever sets in, which lasts for something less than a week, is then followed by a period of absence, to be again followed in succession by one or more similar attacks, which ultimately cease. Now you will observe that the analogy to a fermentative process is very close. The period of incubation is the necessary interval between the introduction of the germ and its vegetative multiplication in sufficient numbers to appreciably affect the total volume of the blood. The rise in temperature and the limited duration of the attack are equally, as we have seen, characteristic of fermentative processes, while the bodily exhaustion which always follows fever is the obvious result of the dissipation by the ferment organisms of nutritive matter destined for the repair of tissue-waste. During the presence of this fever there is present in the blood an organism, *Spirochæte Obermeieri*, so named after its discoverer. This disappears when the fever subsides. It is found that if other individuals are inoculated with blood taken from patients during the fever attack, the disease is communicated, but that this is not the case if the inoculation is made during the period of freedom. The evidence then seems clear that this disease is due to a definite organism. The interesting point, however, arises, why does the fever recur, and why eventually cease? The analogy of fermentation leads to the hypothesis that, as in the case of yeast, the products of its action inhibit after a time the further activity of the *Spirochæte*. The inhibiting substance is, no doubt, eventually removed partially from the blood by its normal processes of depuration, and the surviving individuals of *Spirochæte* can then continue their activity, as in lactic fermentation. With regard to the final cessation of the disease, there are facts which may lead one to suppose that in this as in other cases sufficient of the inhibiting substance ultimately remains in the organism to protect it against any further outbreak of activity on the part of the *Spirochæte*.

Here we have an example of a disease which, though having a well-marked zymotic character, is comparatively harmless. In Anthrax, which is known to be due to *Bacillus anthracis*, we have one which is, on the contrary, extremely fatal. I need not enter into the details. It is sufficient to say that there is reason to believe that the *Bacillus* produces, as one of those by-products of protoplasmic destruction to which I have already alluded, a most virulent poison. But the remarkable thing is that this *Bacillus*, which can be cultivated externally to the body, if kept at a heightened temperature, can be attenuated in its virulence. It drops, in fact, the excretion of the poison. It is then found that, if injected into the blood, it does no mischief, and, what is more extraordinary, if the *Bacillus* in its most lethal form is subsequently introduced, it too has lost its power. The explanation of the immunity in this case is entirely different to that which was suggested by a consideration of the facts of relapsing fever. The researches of Metschnikoff have led to the hypothesis that in the present case the white blood-corpuscles destroy the *Bacillus*. When they first come into contact with these in their virulent form they are unable to touch them. But if they have been educated by first having presented to them the attenuated form, they find no difficulty in grappling with the malignant. This is a very remarkable view. I should not have put it before you had there not been solid reasons for regarding the idea of the education of protoplasm with scientific respect. The plasmodia of the myxomycetes, which consist of naked protoplasm, are known to become habituated to food which they at first reject, and the researches of Beyerinck on the disease known as 'gumming' in plants have apparently shown that healthy cells may be taught, as it were, to produce a ferment which otherwise they would not excrete.

If Metschnikoff's theory be true, we have a rational explanation of vaccination and of preventive inoculation generally. It is probably, however, not the only explanation. And the theory of the inhibitive action upon itself of the products of the ferment-organism's own activity is still being made the basis of experiment. In fact, the most recent results point to the possibility of obtaining protection by injecting into the blood substances artificially obtained entirely independent of the organisms whose development they inhibit.

It is impossible for me to touch on these important matters at any greater length, but I doubt if the theory of fermentation, as applied to the diseases of organisms, has as yet more than opened its first page. It seems to me possible that, besides the rational explanation of zymotic diseases, it may throw light on others where, owing to abnormal conditions, the organism, as in the case of Bérard's plums, is itself the agent in its own fermentative processes.

And now I must conclude. I have led you, I am afraid, a too lengthy and varied a journey in the field of botanical study. But to sum up my argument. I believe I have shown you that at the bottom of every great branch of biological inquiry it has never been possible to neglect the study of plants; nay, more, that the study of plant-life has generally given the key to the true course of investigation. Whether you take the problems of geographical distribution, the most obscure points in the theory of organic evolution, or the innermost secrets of vital phenomena, whether in health or disease, not to consider plants is still, in the words of Mr. Darwin, 'a gigantic oversight, for these would simplify the problem.'

The following Reports and Papers were read:—

1. *Report of the Committee for exploring the Flora of the Bahamas.*
See Reports, p. 361.

2. *Second Report of the Committee for taking steps for the establishment of a Botanical Station at Peradeniya, Ceylon.*—See Reports, p. 421.

3. *Report of the Committee for continuing the preparation of a Report on our present knowledge of the Flora of China.*—See Reports, p. 420.

4. *A Lily Disease.* By Professor H. MARSHALL WARD, F.R.S.

5. *On the Morphology of the Pitcher of Nepenthes.*
By Professor BOWER, F.L.S.

6. *On Adelphotaxy: an undescribed Form of Irritability.*
By Professor MARCUS M. HARTOG, D.Sc., M.A.

In *Achlya*, a genus of Saprolegniæ, the zoospores lie in the sporange before liberation closely appressed together, with their long axes parallel, instead of showing the rotatory hustling movements of other species. In liberation, instead of separating and swimming off, each on its own account, they remain near the mouth of the sporange, each in turn edging its way in between those that have already escaped with its narrower flagellate (anterior end inwards). They thus form a hollow sphere, each zoospore rotating round its long axis (radial to the sphere) before encysting in its place. The only explanation that will fit these phenomena is that these zoospores are endowed with a peculiar irritability in virtue of which they tend to place themselves close together side by side, with their long axes parallel. This irritability is only exerted at a short distance; for, if a zoospore be pushed as little as its long diameter away, whether by accident or design, it fails to find its place, but swims off to and fro, instead of rotating *in situ*, before encysting.

In a critical review, now in the press, of a paper by Rothert, I have given the name '*adelphotaxy*' to this form of irritability, consisting in the tendency of spontaneously motile cells to assume definite positions with regard to their fellows.

Leaving aside the kindred question of tissue-formation and the processes in the embryo-sac of Phanerogams, adelphotaxy is of rare occurrence in the Vegetable Kingdom. Two good instances occur in the Chlorophytes. In *Pediastrum* the contents of each cell of the flat disc break up into 16 (or 32) zoospores, which swarm in the cell, and then unite edge to edge to form a new disc. So in each cell of a *Hydrodictyon* the many thousand zoospores unite end to end to form a new network with hexagonal meshes.

In many of the Myxomycetes the plasmodia aggregate together before fructification to form the compound masses termed æthalia; possibly even the very formation of plasmodia may be regarded as a mode of adelphotaxy.

We may perhaps go a step further and ascribe the parallel or converging courses of *Fungus hyphæ* to form mycelium strings, fruit bodies, and pseudo-parenchyma as extreme cases of adelphotaxy.

I think this principle affords a ready explanation of many cases of cellular aggregation in the animal embryo, and the formation of the spermatophores of many animals, notably Limicolous Worms.

The relations of sexual and isogamous union of gametes to adelphotaxy are obvious; for, though in some cases of sexual union chemotaxy has been shown by Pfeffer to be involved in bringing the active gamete from a distance, that will not cover the actual fusion of the two cells.

ZOOLOGICAL DEPARTMENT.

1. *Report of the Committee for reporting on the present state of our knowledge of the Zoology and Botany of the West India Islands, and taking steps to investigate ascertained deficiencies in the Fauna and Flora.*—See Reports, p. 437.
-

2. *Report of the Committee to arrange for the occupation of a Table at the Zoological Station at Naples.*—See Reports, p. 150.
-
3. *Report of the Committee for making arrangements for assisting the Marine Biological Association Laboratory at Plymouth.*—See Reports, p. 94.
-
4. *Report of the Committee for continuing the Researches on Food-Fishes at the St. Andrews Marine Laboratory.*—See Reports, p. 141.
-
5. *Report of the Committee on the Migration of Birds.*—See Reports, p. 146.
-

6. *On the Irruption of Syrrhaptus paradoxus.*

By Professor NEWTON, M.A., F.R.S.

The author began by observing that 25 years before, almost to a day, he had made a communication with the very same title to the Section at Newcastle, and had then been bold enough to anticipate a recurrence of the irruption of which he then treated, a full account of which appeared in 'The Ibis' for 1864. After briefly pointing out the peculiarities of this singular form of bird, and tracing what was known of its early history, especially of its appearance in Europe prior to the first great irruption of 1863, he proceeded to notice the two small and less known visitations of 1872 and 1876. In the former of these it had only been observed in two localities—one on the coast of Northumberland, the other on that of Ayrshire—in both cases in the month of June, though in neither was any specimen procured. In the latter (1876) it was observed in three localities—one being near Winterton, in Norfolk (in May), another near Modena, in Italy (in June), and the third in the county Wicklow, in Ireland (in October). The irruption of the present year had been on a scale at least as large as that of 1863, if not larger—certainly the number of observations was greatly in excess. It had also taken place fully a month earlier. From the information at present in his possession it had extended further to the southward—in Italy to Orvieto, and in Spain (which country had been for the first time reached) to the Albufera of Valencia; and to the westward—to Belmullet, in the county Mayo; but at present it seemed to have fallen short as regards its northern limits, though very possibly time would prove that localities quite as far towards the north as on the former occasions (the Nord Fjord, in Norway, and the Færoes) had been attained. The limits of all the irruptions from 1859 to 1888 were shown on a map, and in this way it was evident that the general direction of all was practically identical. The discovery of the 'radiant point' (which might be assumed to be beyond the Caspian Sea) was very desirable, and on this matter the author hoped trustworthy information might be received from Russian observers. With regard to the causes which had led to these extraordinary movements, he wished to express himself cautiously; but their apparent regularity inclined him to think that they were not due to any 'convulsion of Nature,' as some persons supposed, but rather, as he had before suggested, to the natural overflow of a redundant population. When more complete information had been obtained he hoped to treat this irruption at length in 'The Ibis' for the year 1889 in some such way as he had treated that of 1863.

7. *Remarks on some Teleostean Ova, and their Development.*

By J. T. CUNNINGHAM, B.A., F.R.S.E.

The ovum of *Solea vulgaris* has a diameter of 1.46 to 1.47 mm. Its perivitelline space is small. There are a large number of very minute oil-globules aggregated in irregular groups on the surface of the yolk, at first mostly near the

edge of the blastoderm, later chiefly at the sides of the embryo. There is a single layer of separate vitelline masses, at first beneath the blastoderm, later forming a superficial layer over the whole yolk.

Neither the *Solea*, sp. A, nor *Solea*, sp. B, of Raffaele ('Mitt. Zool. Stat. Neapel,' Bd. viii.) is the ovum of *Solea vulgaris*.

The ovum of *Solea variegata* has a diameter of 1.36 mm. The oil-globules are separate and not united in groups, and they are larger than in *Solea vulgaris*; otherwise the ova of the two species are similar. No. 1 of Raffaele's 'specie indeterminate' is probably the ovum of *Solea variegata*.

The ovum of *Pleuronectes microcephalus* has a diameter of 1.36 to 1.37 mm. The yolk is perfectly homogeneous, the perivitelline space small. The larva, which hatches in seven, eight, or nine days, has a multicolumnar notochord, the mouth not open, the rectum in contact with the yolk. Chromatophores, black and yellow in colour, are present over the sides of the body, in the median fin fold, and on the surface of the yolk.

The ovum of the mackerel is 1.22 mm. in diameter; the perivitelline space is small; the yolk has a single large oil-globule, which is at first movable, but afterwards fixed beneath the posterior end of the embryo. Black chromatophores develop on the body of the embryo and on the deeper surface of the oil-globule, and others of a green colour behind the eye and on the side of the embryo above the oil-globule.

It was suggested that there is a close connection between the presence of one or more oil-globules in a pelagic ovum and the abundance of oil in the body of the parent. The pilchard is oily, and its ovum has an oil-globule; the herring is less oily, and its ovum is without that structure.

It was argued that the space round the heart is a part of the body cavity, continuous posteriorly with the lateral body cavities; while the space between the yolk-sac and the yolk, with which the heart is in open communication, corresponds to the vitelline veins in those Teleostean ova where the latter exist. This venous space seems to be the segmentation cavity continued and remaining open throughout development; at the same time the cavity has been altered morphologically when the heart develops by the appearance of mesoblastic cells on the surface of the periblast, these cells being the dendritic chromatophores on the surface of the yolk visible in the living larva, but not to be traced in transverse sections. Thus Ryder ('U.S. Fish Commissioners' Report' for 1882) was wrong in calling the space round the heart the pericardium, and the venous space both segmentation cavity and body cavity; while Shipley ('Quart. Journ. Mic. Sci.' 1887) gives an account of the parts in *Petromyzon* which closely agrees with the above description of them in Teleostei, the differences being that he found no mesoblastic cells on the surface of the yolk in *Petromyzon*, and found that the coelem had not developed in the lateral mesoblast posterior to the heart at the time that it had developed an anterior ventral portion around that organ.

FRIDAY, SEPTEMBER 7.

The following Papers were read:—

PHYSIOLOGICAL DEPARTMENT.

1. *On the Physiological Bearing of Waist-belts and Stays.*
By Professor ROY, M.D., F.R.S., and J. G. ADAMI, M.A.

In the course of an investigation upon the work of the heart in health and in disease, certain facts were observed by the authors which throw not a little light upon the physiological bearing of waist-belts and girdles. By means of an instrument devised by them—a Cardiometer—they have been enabled to register very

accurately the changes of volume in, and the amount of blood propelled by, the heart in a given time under varying conditions. Experimenting upon the dog, they found that even slight compression of the abdomen caused an increase in volume of the heart, and that with this a greatly increased amount of blood passed through the heart in a given time, the increase being often thirty or even forty per cent. more in some cases. These phenomena can be explained without difficulty. The abdominal vessels are capable of containing all, and more than all, the blood in the organism. Slight compression of the abdomen will, without disturbing the arterial supply, drive out from the abdominal veins and venous capillaries a large amount of blood; and this blood so driven out will, as long as the compression continues, be of use for the other regions of the body—for the brain, muscles, &c.

Now the functional activity of any organ depends directly upon its blood-supply. With increase in the arterial blood-supply of any part, other things being equal, the activity and power of work of that part increases. It is to be noted further that the abdominal walls in front and at the sides are formed of soft, and more or less elastic, tissues. In health pressure is, by means of the muscles contained in these walls, exerted upon the abdominal contents, and can be therefore put upon the abdominal veins and venous capillaries. This physiological compression of the abdominal contents is rendered more powerful by the use of a waist-belt. Here, then, we have an explanation of the extensive use of some form or other of waist-belt by all nations who have passed beyond the stage of absolute barbarity.

The waist-belt is of use and has constantly been used in cases of sudden and great exertion, and in those cases where, through want of tone of the abdominal wall, it becomes necessary to counteract the tendency to a useless storing up of blood in the abdomen; and, lastly, and most frequently, by those in perfect health, by bringing more blood into the service of the brain and muscles to conduce to an increase of mental and muscular activity. Thus, for instance, is to be explained, on the first ground, the employment of tight belts by gymnasts and modern athletes. This use has been recognised from the earliest times. Thus in 2 Kings xviii. 46 (and elsewhere), where Elijah is said to 'gird up his loins,' the word for girding up is, we are informed by Professor Robertson Smith, best rendered *fortiter constrinxit*—tightly constricted. Similarly the Greek expression for an active man—*εὐζωvos*, well-girt—arose from a like conception. The Romans had a corresponding phrase, and eventually among all these nations—as among the Arabs of the present day—a loose girdle or belt when in public places was looked upon as a sign of want of vigour, and, indeed, of dissolute habits.

If the history of girdle-wearing by women be inquired into it will be found that the women of ancient Egypt, Greece, Rome, and indeed of all the more or less civilised races, employed habitually one or two, or even three, girdles placed higher up or lower down on the body (not necessarily worn simultaneously).

We are therefore brought to conclude that among women some form of waist-belt has been found advantageous. The modern corset is an article of apparel which may be said to be evolved from two separate belts—the waist-belt proper and the band over the lower ribs, the *στροφίον* of the Greeks, employed to preserve the figure. These in the course of time have become combined, and now are worn not only by the well-to-do, but by the poorest in every European country. Moderate constriction does no harm; extreme constriction is not only absurd but dangerous, inasmuch as instead of promoting exercise and activity it does the reverse, and, while causing pressure upon the veins, affects the arteries also, and disturbs the blood-supply of the abdomen and lower extremities as well. The pressure upon the abdomen should be capable of alteration according to circumstances, and should be slight after meals, when digestion is going forward and a full abdominal circulation is required.

The authors are emphatically not advocates of tight-lacing, nor is their paper written in order to urge the universal use of belts and stays. Their desire has been to point out that the widely-spread habit of wearing some form or other of waist-band, which may almost be termed an instinct, has a physiological basis, and is not of purely æsthetic origin; and, further, that there are periods at which,

within certain limits, rightly constructed abdominal bands are of use, and are not an abuse. They have not touched upon the *pathology* of abdominal constriction, this subject not being in the scope of their paper.

ZOOLOGICAL DEPARTMENT.

1. *Some Remarks on the Instincts of Solitary Wasps and Bees.*
By Sir JOHN LUBBOCK, Bart., F.R.S.

2. *Restoration of Brontops Robustus, from the Miocene of America.*
By Professor O. C. MARSH, Ph.D., LL.D.

The largest mammals of the American Miocene were the huge *Brontotheridæ*, which lived in great numbers on the eastern flanks of the Rocky Mountains, and were entombed in the fresh-water lakes of that region. They were larger than the *Dinocerata* of the Eocene, and nearly equalled in size the existing elephant. They constitute a distinct family of perissodactyles, and were more nearly allied to the rhinoceros than to any other living forms.

The deposits in which their remains are found have been called by the author the Brontotherium beds. They form a well-marked horizon at the base of the Miocene. These deposits are several hundred feet in thickness, and may be separated into different subdivisions, each marked by distinct genera or species of these gigantic mammals.

The author has made extensive explorations of these Miocene lake-basins, and has secured the remains of several hundred individuals of the *Brontotheridæ*, which will be fully described in a monograph, now well advanced towards completion, to be published by the United States Geological Survey. The atlas of sixty lithographic plates is already printed, and the author submitted a copy to the Section. The last plate of this volume is devoted to a restoration of *Brontops robustus*, one-seventh natural size, and a diagram enlarged from this plate to natural size was also exhibited.

The skeleton represented in this restoration is by far the most complete of any of the group yet discovered. It was found by the author in Dakota in 1874, and portions of it have been exhumed at different times since, some of the feet bones having been recovered during the past year. It is a typical example of the family, and shows well the characteristic features of the genus and species which it represents.

The most striking feature of the restoration here given, aside from the great size of the animal, is the skull. This is surmounted in front by a pair of massive prominences, or horn-cores, which are situated mainly on the frontal bones. The nasals contribute somewhat to their base, in front, and the maxillaries support the outer face. These elevations, or horn-cores, vary much in size and shape in the different genera and species. They are always very small in the females.

The general form of the skull and lower jaw is well shown in the figure. The prominent occipital crest, the widely expanded zygomatic arches, and the projecting angle of the lower jaw are all characteristic features. In general shape the skull resembles that of *Brontotherium*, but may be readily distinguished from it by the dental formula, which is as follows:—

$$\text{Incisors } \frac{2}{1}; \text{ canines } \frac{1}{1}; \text{ premolars } \frac{4}{4}; \text{ molars } \frac{3}{3}.$$

The presence of four premolars in each ramus of the lower jaw is a distinctive feature in this genus. This character, with the single well-developed lower incisor, marks both the known species.

The number of teeth varies in the different genera. The form of the teeth, especially in the molar series, is more like that in *Chalicotherium* and *Diplacodon*

than in any other known forms. The teeth in the allied genus *Brontotherium* have already been figured and described by the author.

The vertebræ are somewhat similar to those of the existing rhinoceros. In the present genus, *Brontops*, the neural spines of the dorsal vertebræ are elevated and massive. There are four sacral vertebræ in this genus, and in the known species the tail is short and slender, as in the individual here described.

The ribs are strong and massive. The sternal bones are compressed transversely. The exact form of the first one is not known with certainty, and is here restored from the rhinoceros. This is the only important point left undetermined in the restoration.

The fore limbs are especially robust. The humerus has its tuberosities and ridges very strongly developed, and the radius and ulna have their axes nearly parallel. There are four well-developed digits in the manus, the first being entirely wanting.

The pelvis is very wide, and transversely expanded, as in the elephant. The femur is long, and has the third trochanter rudimentary. The tibia and fibula are quite short. The calcaneum is very long, and the astragalus is grooved above. There are only three digits in the pes, the first and fifth having entirely disappeared.

Diplacodon of the Upper Eocene is clearly an immediate ancestor of the *Brontotheriidae*, while *Palæosyops* and *Limnohyus* of the Middle Eocene are on the more remote ancestral line. The nearest related European form is the Miocene *Chalicotherium*. No descendants of the *Brontotheriidae* are known.

Menodus, *Megacerops*, *Brontotherium*, *Symborodon*, *Menops*, *Titanops*, and *Allops* all belong to the family *Brontotheriidae*, and their relation to the genus here described, and to each other, will be fully discussed in the monograph to which reference has already been made.

3. *Heredity in Cats with an extra Number of Toes.*

By E. B. POULTON, M.A.

4. *On the Nature of the Geological Terrain as an important factor in the Geographical Distribution of Animals.* By HANS GADOW, M.A., Ph.D.

The observations concern the geographical distribution of all the species of Amphibia and Reptiles in the Iberian Peninsula, with special reference to Portugal. The number of different species amounts to 38, whilst the localities from which these species are recorded number about 800.

The method adopted—with a view of finding out a possible interdependence between geological terrain and occurrence of species—was the following: The various species and localities were arranged in five groups, which latter represent the most typical sorts of terrain in the Peninsula, viz.: Palæozoic; granite and other igneous rocks; new red sandstone; mesozoic limestones, including the cretaceous deposits; and, lastly, tertiary terrain, the latter being overlaid with sandy soil chiefly.

The proportionate areas of these five classes of terrain were given in percentage of the area of the whole country.

The most reliable conclusions could be drawn from Portugal, since this country had been extensively visited by the author on four different occasions. The following conclusions refer to Portugal only; it may, however, be especially stated that these results agree closely with those drawn from the whole peninsula. The distribution of the Reptiles exhibits features different from that of the Amphibia.

Concerning Amphibian Life.—The most favourable terrain is that of red sandstone; then follows granitic terrain, then tertiary, palæozoic, and lastly mesozoic limestone. Granitic terrain is more than six times more favourable than palæozoic, and three times more favourable than tertiary terrain. Limestone is as a rule almost detrimental. Palæozoic terrain is about seven times less favourable than red sandstone, and not half so good as tertiary terrain.

Concerning Reptilian Life.—By far the best terrain is that of red sandstone; then follows mesozoic limestone, granite, tertiary, and lastly palæozoic terrain. Granite is more than two times better than palæozoic, nearly equal to jurassic and cretaceous, and slightly better than tertiary terrain. Palæozoic terrain is many times less favourable than that of red sandstone and nearly three times worse than jurassic and cretaceous grounds.

The effect of the nature of the various sorts of terrain upon the whole flora and the healthiness of the country is remarkable.

An interesting fact is also this, that most of the snakes which frequent the sterile jurassic and palæozoic rocks are lizard-eaters, whilst the two species of *Tropidonotus* are nearly absent.

It was found that altitude, annual mean temperature, or the annual amount of rainfall by far less influence the distribution of Reptiles and Amphibia in the peninsula than the nature of the soil. High and long granitic ranges of mountains may in many cases afford no obstacle to the spreading of certain creatures, whilst other terrain, like limestone—although perhaps forming low and narrow tracts only—may act as a most effective barrier.

In conclusion, the wish is expressed that similar data, referring to other countries, may be forthcoming to enable us to verify and to correct the conclusions made in this paper. For the present they cannot be anything but suggestions, which, however, may, with more material to work with, prove capable of wider application.

5. *On the Natural History of Christmas Island.*

By J. J. LISTER, M.A., F.Z.S.

Her Majesty's surveying vessel 'Egeria' reached Christmas Island on Friday, September 30, 1887.

In the distance the sides of the island were seen to rise moderately steeply, and a shallow saddle in the middle ended in two low, rounded elevations, one of which was the summit, near the western end. On nearer approach the whole island was seen to be uniformly covered with bush, except where the bare face of a line of inland cliffs appeared. The general physical features of the island are treated of in Captain Aldrich's report.¹ The greatest length is 12 statute miles. It rises from deep sea. Soundings of over 1,000 fathoms were obtained at five points round the island, all within four miles of shore. Its volcanic origin is proved by the presence of lumps of 'compact olivine basalt and basalt tuff' at the foot of a cliff, and of a bed of 'altered volcanic stones' near the summit.² No volcanic rock was, however, found *in situ*. The surface formation of the parts of the island explored is limestone. This rock forms the summit, 1,195 feet above the sea, and covers the sides, broadening out at successive elevations into terraces which rise one above another on the sides of the island. The rock is traversed by vertical fissures which isolate tall pinnacles often 12 or 20 feet in height. The surface is weathered into irregular hollows and sharp projecting points. From the base of the lowest inland cliff a gradual slope leads to the sea, terminating in a shore cliff from 15 to 60 feet in height. This has a vertical face and is much underworn by the waves. In some places, where the sides slope less steeply into deep water, beds of live coral are seen.

The geological history of the island appears to be shortly as follows. The summit of a submarine volcanic mass has been slowly elevated above the sea to a height of nearly 1,200 feet, and, as it has passed through the zone of lime-forming organisms in shallow water, these have invested it with a cap of limestone. The upheaval has been arrested at intervals and allowed the formation of reefs which have since been elevated and form the terraces on the sides. At the projecting headlands, where the chief stress of the ocean currents fell, the reefs have grown less than in the intervals between them, and since their elevation the action of the

¹ Report on Christmas Island (Indian Ocean), H.M.S. 'Egeria.' 1887. Captain P. Aldrich, R.N.

² *Loc. cit.* p. 15.

waves has been greatest at these points; hence we find that at the headlands the terraced slopes are replaced by a single abrupt descent.

Captain Wharton points out that the raised reefs forming the summit of Christmas Island are the highest that are known in the world.

No sign of any stream was seen. The rain sinks at once into the porous limestone rock and reaches the sea by underground channels. Widely-spread littoral plants fringe the shores, *Hibiscus tiliaceus*, *Tournefortia argentea*, and *Scævola kanigii* being abundant. Within the line of shore plants the high bush begins. Many of the trees attain 200 feet in height. Several kinds of epiphytes were found, among which a new species of *Hoya* was conspicuous.

The following vertebrate animals were observed (those marked with an asterisk are peculiar to the island):—

MAMMALS.

- **Pteropus natalis*. (Thomas.)
- A small insectivorous Bat (not obtained), *Sorex* (sp.)
- **Mus macleari*. (Thomas.)
- **Mus*, n. sp.

BIRDS

- **Merula erythropleura*. (Sharpe.)
- **Zosterops*, n. sp.
- **Collocalia*, n. sp.
- **Carpophaga whartoni*. (Sharpe.)
- **Chalcophaps*, n. sp.
- **Urospizias*, n. sp.
- **Ninox*, n. sp.
- Totanus hypoglossis*. (Linn.)
- Charadrius geoffroyi*. (Wagler.)
- Ardea jugularis*. (Forster.)
- Sula*, 2 sp.
- Fregeta aquila*. (Linn.)
- Phaethon flavirostris*. (Brandt.)
- Phaethon phœnicurus*. (Gm.)

REPTILES.

Lizards.

- **Lygosoma nativitatis*. (Blgr.)
- **Ablepharus*, n. sp.
- Gymnodactylus marmoratus*. (Kuhl.)
- **Gecko*, n. sp.

Snakes.

- **Typhlops exocoeti*. (Blgr.)

Turtles.

- Chelonia virgata*.

No Amphibia were found.

Eleven kinds of Molluscs are known, seven of which were discovered during the visit of the 'Egeria.' Five out of the eleven have been found by Mr. E. A. Smith to be peculiar to the island.

The examination of the insects has not yet been completed.

Birgus latro (Linn.)—The large land crab was very abundant.

Though the collections are, from the shortness of the visit, necessarily imperfect, the following conclusions as to the nature of the Christmas Island fauna appear to be justified.

First—Its poverty. Situated 190 miles from the nearest part of the rich Malay Archipelago, it contains, as far as is at present known, only five kinds of Mammals,

seven of land birds, four of lizards, and one snake. This seems to show that the island has been stocked by what may be called accidental means.

Secondly—Its peculiarity. Of the mammals, three out of the five are certainly peculiar, as are all the land birds, though some approach their allies on the archipelago very closely, and four out of the five reptiles. A considerable though not so high a degree of peculiarity has been found among the invertebrate forms.

Thirdly—As to the affinities. What conclusions are to be drawn as to the affinities of the fauna and flora when viewed as a whole cannot be certainly determined until the examination is complete. The birds, however, appear to be allied to those of the Austro-Malay region.

SATURDAY, SEPTEMBER 8.

The Section did not meet.

MONDAY, SEPTEMBER 10.

The following Reports and Papers were read:—

1. *Report of the Committee for aiding in the maintenance of the establishment of a Marine Biological Station at Granton, Scotland.*—See Reports, p. 319.

2. *Report of the Committee on the Development of the Oviduct in certain fresh-water Teleostei.*—See Reports, p. 338.

3. *On certain Adaptations for the Nutrition of Embryos.*
By F. W. OLIVER.

4. *On the Development of the Bulb in Laminaria bulbosa.*¹
By C. A. BARBER.

A brief description was given of a mature plant. In such a plant three parts are distinguishable. The bulb; the stalk, upon whose modifications special stress was laid; and the lamina. The bulb is merely a part of the stalk curiously altered. After a short historical summary, the development of the bulb was described in detail. It arises as a ridge upon the stalk below the lamina: this ridge grows outwards and forms a shelf-like process, which very soon curves downwards all around. A bell-shaped organ is thus formed from whose edges numerous hapteres are developed: after these hapteres have appeared, successive circles of these processes are developed in ascending order upon the expanding hollow bulb. A few points were noticed in the histology of the plant. The epidermis seems to be the only region in which active cell-division takes place. Increase in size in all parts, even at the ridge, seems to be largely dependent on increase in size of the cells. Increase in thickness is also dependent on the great thickening of the walls of the cells. This occurs especially in the elongated cells of the central strand of tissue. From these latter are sent out numerous protrusions into their thick mucilaginous walls. The protrusions thus formed penetrate in all directions, and form the so-called 'hyphal tissue.' The formation of new cells by budding seems to take place in a somewhat different form in the cortical cells of the older stalk. The epidermal cells usually appear to

¹ Published in full in *Annals of Botany*.

contain one nucleus: in other cells usually several nuclei appear: in the larger ones as many as thirty or forty may frequently be counted. In some of the inner cells of the cortex each nucleus is surrounded by a crowd of chromatophores.

There appears to be an absence of hyphal tissue in the stalk below the ridge. The cells of the hapteres are parenchymatous; they are of two kinds, larger and smaller cells alternating in such a manner that the larger cells appear to be surrounded and separated by the smaller. There is in the hapteres no strand of conducting tissue; in this respect the hapteres resemble those of *Podostemaceæ*. Numerous multicellular root-hairs are developed from the part of the haptere in contact with the substratum. This is due to the outgrowth of epidermal cells. The formation of sporangia takes place in exactly the same way; and these bodies occur on the inside as well as the outside of the hollow bulb.

The difference between *L. bulbosa* and allied species is seen as well in the formation of the bulb and stalk as in the position of the sporangia. The shedding of the lamina does not appear to be recorded for *L. bulbosa*.

The differentiation of the stalk is primarily due to the necessity of supporting the huge lamina. The cylindrical stalk of young specimens points to the descent of the species from a form more nearly allied to that of other *Laminarias*, where the stalk is still rounded. It is not easy to assign a definite reason for the departure of the stalk from its cylindrical form.

There are in this species a great amount of morphological differentiation and complicated attempts at adaptation. There does not appear to be the same amount of histological differentiation. It has not been possible to examine old specimens; but, so far as material extends, no zones of secondary thickening have been met with, neither have any mucilage-ducts been observed: the development of sieve-hyphæ is not at all well marked. Finally, the huge size of the cells and their numerous nuclei, and the increase in size by the growth of cells rather than their division, seem to point to a low stage of histological differentiation.

5. *On Pachytheca, a Silurian Alga of doubtful Affinities.*¹

By C. A. BARBER.

Pachytheca was described by Sir J. D. Hooker in 1853, and has, since then, received the attention of many eminent botanists. Two excellent slides have been obtained, and Sir Joseph Hooker requested the author to make drawings and descriptions for publication in the 'Annals of Botany,' offering himself to write a general historical and descriptive introduction. The historical portion was read before the Association by the permission of Sir Joseph Hooker, and the author then made a few remarks on the structure exhibited in the two slides.

There are three zones in the specimens. An outer cortical portion of radiating filaments; a central portion, consisting of a clear matrix, penetrated in different directions by filaments; and a zone of spherical bodies separating the cortex from the central part.

In the cortex the radiating filaments are divided by transverse walls; therefore the Alga does not belong to the Siphonææ. On the transverse walls are freely developed the callus-like thickenings or 'stoppers' found in *Oscillaria*, *Nostoc*, &c., and characteristic of the Floridææ. The filaments branch in a few cases, and the branching is similar to that of *Cladophora*: this removes the Alga from the group *Cyanophyceæ*.

In the centre the filaments are also divided by transverse walls. The stoppers and the branching have not yet been observed.

In tracing the filaments from the cortex, they usually appear to pass between the spherical bodies; and in one case they appear to arise by branching from one of the spherical bodies. In tracing the filaments from the centre, they appear to enter the spaces between the spherical bodies, and to pass between the bars which are present in these interspaces.

The large spherical bodies are of dubious nature. In one of the sections, which

¹ Published in full in *Annals of Botany*.

seems to pass through the spherical plant at some distance from its centre, there appear to be three or four rows of spherical bodies; and these are separated by well-defined interspaces of irregular form. This seems to indicate that the spherical bodies are not merely the interspaces between the radiating filaments. In the same section certain of the spherical bodies send out protrusions towards the cortex, thus becoming flask-shaped. In the other section, which appears to be cut through the centre of the plant, there is only one circle of these bodies. They have a well-defined inner wall, but appear to taper outwards towards the cortex. Between any two spherical bodies there are bars stretching across the intervening space, reminding one of the bars of *Caulerpa*, or such as are formed between the larger cells of *Furcellaria*. In one case there seems to be a connection between the spherical bodies and the radiating filaments: usually these filaments appear to pass between the spherical bodies.

Having regard to the facts mentioned, there seems to be no theory which can be accepted. More specimens must be obtained showing structure.

There are several possible explanations. The central and radiating filaments may or may not be continuous. The spherical bodies may be true cells, or they may be the interspaces between the filaments. If the central filaments are not continuous with the cortical, the former are probably parasitic. There may finally be present such a body as one of the segments of *Cymopolia*, the central part being penetrated by a parasitic alga.

6. *On the Plant-remains discovered by Mr. W. M. Flinders Petrie in the Cemetery of Hawara, Lower Egypt.*¹ By PERCY E. NEWBERRY.

The author called attention to the importance of this discovery to botanical science, and briefly reviewed the species of plants determined by him among the ancient remains. The condition which these plants were still in was wonderful, for, although they had lain eighteen or twenty centuries in the earth, the author had succeeded in preparing, by placing the remains in cold or warm water, a series of specimens which were as satisfactory for the purposes of science as any gathered at the present day. He had examined these plant-remains, but had been unable to detect, except in two or three instances, any peculiarities in the plants from the graves which were absent in the existing species. The author exhibited a series of specimens to illustrate his paper.

The following is a list of the ancient Egyptian plants found by Mr. W. M. Flinders Petrie in the cemetery of Hawara, Lower Egypt. Those marked with an asterisk have before been authenticated by specimens from the ancient tombs.

<i>Nymphæa cærulea</i> , Sav.*	<i>Acacia arabica</i> , Willd.*
<i>Nelumbium speciosum</i> , Willd.	<i>Rosa sancta</i> , Richars.
<i>Matthiola librator</i> , L.	<i>Pyrus domestica</i> , L.
<i>Zilla myagroides</i> , Forsk.	<i>Prunus persica</i> , Bth. and Hook.
<i>Lychnis cœli-rosa</i> , L.	<i>Myrtus communis</i> , L.
<i>Tamarix nilotica</i> , Ehrenb.	<i>Lawsonia inermis</i> , L.*
<i>Hibiscus</i> , sp.?	<i>Punica granatum</i> , L.*
<i>Elæocarpus serratus</i> , L.	<i>Epilobium hirsutum</i> , L.*
<i>Linum humile</i> , Mill.*	<i>Cucumis sativus</i> , L.
<i>Balsamodendron myrrha</i> , Nees (Resin).	<i>Lagenaria vulgaris</i> , L.*
<i>Vitis vinifera</i> , L.*	<i>Galium tricornæ</i> , With.
<i>Vitis vinifera</i> , L., v. <i>corinthiaca</i> , L.	<i>Coriandrum sativum</i> , L.*
<i>Medicago denticulata</i> , L.*	<i>Torilis infesta</i> , L.
<i>Trifolium alexandrinum</i> , L.	<i>Chrysanthemum coronarium</i> , L.*
<i>Cicer arietinum</i> , L.	<i>Centaurea depressa</i> , M. Bieb.*
<i>Vicia Faba</i> , L.*	<i>Gnaphalium luteo-album</i> , L.
<i>Lens esculenta</i> , Mœnch.	<i>Mimusops Schimperii</i> , Hochst.*
<i>Pisum sativum</i> , L.	<i>Olea europea</i> , L.*
<i>Pisum arvense</i> , L.*	<i>Olea europea</i> , L., v. <i>nubica</i> , Schwnf.

¹ Published *in extenso* in Mr. W. M. Flinders Petrie's *Hawara* (Field & Tuer, London).

Cordia Myxa, L.
Styrax Benzoin, Dry. (Resin).
Cuscuta arabica, L.
Solanum Dulcamara, L.
Origanum Marjorana, L.
Celosia argentea, L.
Rumex dentatus, L.*
Laurus nobilis, L.
Ficus sycomorus, L.*
Juglans regia, L.
Juniperus phœnicia, L.*

Pinus Pinea, L.*
Narcissus tazetta, L.
Phoenix dactylifera, L.*
Hyphæne thebaica, Mart.*
Cyperus papyrus, L.*
Scirpus maritimus, L.
Imperata cylindrica, L.
Saccharum egyptiacum, Willd.
Avena strigosa, Schreb.
Triticum vulgare, L.*
Hordeum vulgare, L.*

7. *Abnormal Ferns, Hybrids, and their Parents.*¹

By E. J. LOWE, F.R.S., and COLONEL JONES.

It is not intended by anything said in this paper that the exertion of others in the same field shall be ignored; the authors only wish to record their personal experience, the labour of a number of years.

More than thirty years ago experiments were commenced, and twenty-one years ago a paper was read by Mr. Lowe, 'On Hybrid Ferns,' at the Dundee meeting of the British Association. The subject was at that time in its infancy, and none of the botanists there present, with the exception of the late Professor Balfour, thoroughly believed in these crosses. The late Mr. Clapham, who had given the subject careful investigation for some years, only became convinced by seeing a series of examples in 1879 of crosses of *Athyriums*, in which were spores of the varieties *Victoriae* and *Proteoides*, which series was taken to the British Association at Sheffield.

About fifteen years ago the endeavour was made to cross *Polystichum aculeatum* with *Polystichum angulare*, and when the seedlings had become mature (seven years afterwards) it was at all events apparent to one of the authors that this cross had been accomplished, but only in five examples out of a thousand seedlings. The object was to obtain a narrow cruciate variety of *Polystichum aculeatum*, a copy in *Polystichum aculeatum* of the narrow cruciate variety *Wakeleyanum* of *Polystichum angulare*, for as yet this was a desideratum.

Polystichum angulare, var. *Wakeleyanum*, was sown together with a dense fronded variety of *Polystichum aculeatum* known as 'densum.' In 1884 specimens and a short paper were sent to the Linnean Society, but even this was not sufficient to remove the doubts of botanists; but a year later a letter from Sir Joseph Hooker stated that the crossing of ferns was then an acknowledged fact.

This hybrid, with its parents, together with the offspring of the hybrid, have been exhibited at the Bath Floral Fête amongst other specimens of botanical interest to Section D.

Colonel Jones, who is joint author with Mr. Lowe, has had (though starting a little later) great experience in the crossing of ferns, and has obtained coincident results. The instances of crossing have now accumulated to such an extent as to preclude the possibility of any further doubt on the subject.

To produce these results, however, great care is necessary that the germination of the spores should be very general and also simultaneous.

The clear proof of the reality of the crossing of varieties lies in the fact of the production of plants, either bearing a character intermediate between those of the plants sown, or combining the two characters.

A remarkable fact in connection with these crosses being the frequent transference of the character by one variety to another, this even applies to variegation. It will be seen in the example of the cruciate hybrid of *Polystichum aculeatum* that it is a marked copy of the cruciate form of *Polystichum angulare*, one of the parents selected with the object of obtaining a cruciate *Polystichum aculeatum*. Instead of the usual gradual process, the form was obtained at once. This applies

¹ This paper is to be published *in extenso* in *Annals of Botany*, with illustrations.

equally in the case of the polydactylous forms of *Polystichum angulare*, and in the variegated forms of *Scolopendrium vulgare*.

As examples there have been selected experiments made with varieties of *Athyriums*, *Scolopendriums*, and *Polystichums*. Several hundred examples might have been shown, but a few of each is ample illustration.

EXAMPLE 1.—*Athyrium*.

The following varieties were sown together: *Victoriae*, *multifidum*, *Jonesii*, *Craigii*, *uncum*, *Harrisæ*, *cruciatum*, *Proteoides*, *tortile*, *reflexum*, *laciniatum*, and *grammicon*. The result has been several hundred intermediate forms, some very interesting.

EXAMPLE 2.—*Scolopendrium*.

In this experiment the varieties were: *Crispum* (rarely fertile), *Victoriae*, *marginatum*, *undulatum*, *digitatum*, *ramo-cristatum*, *laceratum*, and a variegated *crispum*. The result has been various intermediate forms, a number of which are variegated; for instance, the variegation in the *crispum* has passed into a crested form, the colour and not the shape being altered.

EXAMPLE 3.—*Polystichum*.

The attempt was made to so transfer the polydactylous character of certain forms of *Polystichum angulare* to other forms of *Polystichum angulare*, which, though preserving the normal outline and distinct individuality, were not polydactylous.

The forms used were Mr. Padley's polydactylous form from the vale of Avoca, and Colonel Jones's Hampshire form. The polydactylous character has now been successfully transferred to the forms known as *decompositum*, *acutilobum*, *divisilobum*, *frondosum*, *alatum*, *lineare*, *congestum*, *inæquale-variegatum*, and others. The polydactylous character of *Polystichum angulare* has also been transferred to *Polystichum aculeatum*.

There are now four clearly established cases in which the characters of distinct forms of *Polystichum angulare* have been transferred to *Polystichum aculeatum*. Hitherto the varieties of *Polystichum aculeatum* have been very few, so that now a new field for exertion is open, the results of which it is difficult to over-estimate, for the robust constitution of *Polystichum aculeatum* enables it to thrive in climates in which *Polystichum angulare* would soon perish.

The interest in the varieties of British ferns ought to increase now the crossing of varieties has become an acknowledged fact, not only on account of the extreme beauty of many of the crosses already effected, but also that, however beautiful, it may be confidently asserted that these are as nothing to what will be accomplished when exhaustive experiments, guided by tasteful and judicious selection, shall have been made. Though much will depend on such selection, there will always be enough left to the element of chance to keep up the interest.

The prospect of these endless combinations may be likened to the combinations in bell-ringing, where the changes in the ringing of twelve bells amount to 40 millions. The immense field of inquiry that can be opened up in these investigations can scarcely be conceived. The number of forms to be obtained is past all conception, and, like as the discovery of one truth is the stepping-stone to the discovery of even greater truths, so every new form that is raised enables the raiser, or those following in his footsteps, to produce countless other combinations.

8. *Preliminary Note on the Functions and Homologies of the Contractile Vacuole in Plants and Animals.* By Professor MARCUS M. HARTOG, D.Sc., M.A.

Through the practice of regarding botany and zoology as essentially distinct studies, the solution of many an interesting problem in the one domain is long missed, because the known facts that afford a clue when properly applied have

been worked out only in the other, and are contained in records never likely to be consulted in reference to the given problem. Thus, the 'contractile vacuole' is an organ that exists in both kingdoms: the question of protoplasmic vacuolation, of which this is a particular case, has only been really studied by the vegetable physiologist; and yet in the minute plant-cells which possess this organ it is too small for the study of the mechanism of its work: this study has been successfully carried out by zoologists on the larger Ciliata and Heliozoa, in ignorance, however, of the known facts that explained the reason of its working. Thus the botanists had forged a key of the right pattern, but too big to open the locks in their own domain, while fitting that of which the zoologists had described the wards and tumblers. In this preliminary publication I shall only put the key into the lock, reserving original observations for a complete paper.

I. *Distribution*.—One or more contractile vacuoles occur in all naked plant zoospores, with scarcely a recorded exception, whether mastigopod or myxopod, whether Algal, Fungal (Saprolegnieæ, Peronosporæ, Chytridieæ), or Myxomycete. They occur in all fresh-water Protozoa when in the active state, though not when encysted; they are, however, absent from those that live in the perivisceral fluid or blood of living hosts from the Radiolaria, and possibly other marine forms.

II. *Position and Mechanism*.—They are vacuoles in the protoplasm, usually peripheral; they contract to disappearance at regular intervals; in favourable cases (Actinosphærium, many Ciliata) they are seen on contraction to discharge their contents into the water. In a few cases they are known to be reservoirs filled gradually by the almost continuous influx from plasmatic canals, which are invisible from this very reason, only starting into sight normally during the momentary pause when, owing to the contraction of the vacuole, their liquid contents have time to accumulate and distend them.

Now, if a specimen of sufficient size, say a *Paramecium*, be placed under certain unfavourable conditions (among which is deficiency of oxygen), we find that the contractile vacuoles contract less perfectly and at longer intervals; the plasmatic canals become persistently visible and enlarged; the whole animal becomes dropsical; its thin cuticle bursts, and its protoplasm, no longer protected by the 'Hautschicht' and cuticle, and exposed directly to the water, disintegrates into 'diffluence.'

Again, if a vegetable cell be wounded in water and its protoplasm passes out, it rounds off and surrounds itself with a Hautschicht; then vacuoles appear inside; these enlarge enormously and finally burst; the protoplasm so exposed without a Hautschicht to the water disintegrates into diffluence, just like the Ciliate whose contractile vacuole works inefficiently. This pathological vacuolation and diffluence do not occur if to the water there be added a sufficiency of sugar, saltpetre, glycérine, or other innocuous osmotic substance; and when the protoplasm has the power of excreting a complete cellulose wall, as in *Vaucheria*, the incipient vacuolation is arrested on the formation of the wall.

The explanation of both series of facts is the same, as worked out by a series of botanists from Von Mohl to De Vries:—

Protoplasm contains in its interstices substances of high osmotic value; its outer layer at least, while freely pervious to water, is slightly if at all pervious to these substances even in solution. Hence, when protoplasm is immersed in water, cavities or vacuoles form in its substance containing solutions of these substances, which continue to enlarge by attraction of water from without; the enlargement produces a tension which De Vries and others have by various methods determined to be at least 3 atmospheres, and which may reach 15 atmospheres. Now, naked protoplasm has very little toughness, it yields readily to the increasing tension and to the expansion of the vacuole, and finally bursts and disintegrates. On the other hand, cellulose and chitinous cyst-walls are sufficiently tough to resist; and equilibrium is attained when, after a certain amount of stretching, the elasticity of the wall balances the tension of the vacuoles due to osmosis.

If, however, in the absence of a tough wall, the vacuole, instead of extending indefinitely and bursting irregularly, (a) opens by a minute pore, (b) contracts regularly as it expels its contents, (c) closes up simultaneously with the completion

of their expulsion, no part of the inner protoplasm is exposed directly to the water; and we have a mechanism which expels regularly the plasmatic juice or cell-sap when over-diluted and over-abundant, and which prevents the destruction of the protoplasm by bursting and diffuence. This is the mechanism of the contractile vacuole, which is thus a physiological necessity to the naked cell living in water like the kidney is to the multicellular animal organism.

I will add one unpublished observation to the well-known facts here brought together. Two sporanges of *Saprolegnia* opened at an early stage of the partial segregation of the protoplasm into masses. Part of the protoplasm in each slowly escaped and aggregated into rounded masses. The first discharged masses underwent the usual pathological changes and diffuence; the later masses (from both sporangia) had already acquired the power of forming contractile vacuoles possessed by the zoospores; the numerous small vacuoles appeared and contracted regularly, lines of separation formed and deepened, and the masses divided into zoospores which separated and swarmed, just like the protoplasm which remained in the sporange, though more slowly. This observation seems to afford a crucial test of the truth of the thesis that the contractile vacuole has the function of preventing excessive vacuolation and diffuence of naked cells in water.

The following is a brief summary of the points on which the above thesis rests:—

1. All naked protoplasmic bodies living in fresh water have at least one contractile vacuole.

2. The possession of this is quite independent of the systematic position of the organism.

3. The vacuole loses its contractility on the formation of a strong cell-wall or cyst and may even disappear.

4. It is absent from Gregarinida and Opalinia, and the *Radiolaria* which inhabit saline liquids.

5. When, owing to morbid conditions, the efficiency of the contractile vacuole is impaired, excessive vacuolation and diffuence ensue.

6. Conversely, as soon as contractile vacuoles appear the tendency to excessive vacuolation and diffuence is arrested.

It may be suggested that the perforations of the nephridial cells in Vermes and embryonic mollusks, and of the epiblastic gland-cells of Vermes and Arthropods, are due to the persistence of the contractile vacuole, the opening of which has become permanent, while its contractility has been superseded in the kidneys at least by other arrangements. Even the goblet-cells of mucous epithelia may possibly be traced to this origin.

9. *On the Contrivances for the Seed Protection and Distribution in Blumenbachia Hieronymi, Urban.* By W. GARDINER.

ZOOLOGICAL DEPARTMENT.

1. *On Locusts in Cyprus.* By S. BROWN.

The author gave a brief description of the habits of the common Cyprus locusts (*Stauronotus crociatus*) and of the system which has been successfully employed for their destruction in Cyprus. These insects have from time immemorial been the scourge of the island, and as, under Turkish rule, little was done to keep them down, their ravages formed probably the chief agency in reducing what was once a fertile and flourishing island to a condition of comparative desolation. Successful efforts were, however, made by the Turkish Government from 1862 to 1870 for the destruction of the locusts, and in the latter year the island was so far rid of them that for some time no injury was sustained by the crops. But the Government

relaxed its exertions and the locusts again bred and multiplied, until, by the time of the British occupation in 1878, they had so increased as to cause anxiety for the future. Acting under local advice, the Government attempted to keep them down by collecting and destroying their eggs. This operation was continued for three years on a vast scale, involving a heavy outlay, but without success, for, although this method was attempted on a scale almost without precedent, the locusts continued to increase with alarming rapidity, until in 1882 they swarmed throughout the plains, and in spite of various attempts to destroy them the damage sustained by crops was very great, and probably did not fall short of 80,000%, or from 15 to 20 per cent. of the value of the crops on the infested area.

In 1883 and 1884 operations against the locusts were limited exclusively to attacking them in the crawling stage by the apparatus known as the Cyprus system of screens. These were formed of canvas and were stretched across the line of march, so that the onward progress of the locusts was arrested, and they were then diverted into pits carefully trapped, from which there was no escape. By the operations of these two years the power of the locusts was so effectually destroyed that no damage whatever has been sustained by the crops during the past five years; and although it is still necessary to watch the locusts and prevent their increase, this is now done at a comparatively small annual outlay—and their numbers have so steadily decreased year by year as to warrant the hope of their final extermination.

In submitting this paper to the Association the author was influenced by the hope that some of its members might be able to throw light on problems which (although they have received from him considerable attention) he has been unable hitherto to solve in a definite and satisfactory manner. The chief of these are:—

1. The rate of increase and the number of eggs deposited by different varieties of locusts.
2. How is it that some varieties possess the migratory instinct in an eminent degree, while others closely allied in outward form appear to be altogether devoid of it?
3. What are the laws that determine the direction of the march or flight of migratory locusts?

2. *On the Fauna of the Firth of Clyde.* By W. E. HOYLE, M.A.

3. *On a Deep-sea Tow Net.* By W. E. HOYLE, M.A.

4. *On some Points in the Natural History of the Coral Fungia.*
By J. J. LISTER, M.A., F.Z.S.

The coral fungia is abundant in shallow water on the reefs of the island of Mahé in the Seychelles Islands. Many examples of the fixed stocks were obtained. These show the disc in all stages of growth, from the young stocks with six primary septa conspicuous, to the stage in which separation of the disc takes place by absorption in a plane which is situated where the stalk is beginning to widen out into the disc.

The disc, when set free, has a scar on its under surface, exposing a section of the thecal wall, septa, trabeculæ and the soft tissues investing them. Calcareous matter is subsequently deposited over this, obliterating the scar.

A similar section is exposed on the summit of the stalk. From this a new disc is formed by growth of the septa and other structures. An early stage was obtained in which delicate fluted laminæ had been formed on the edges of the septa just projecting above the scar surface. These grow higher and higher and a new thecal wall is built up just within the margin of the thecal wall of the stalk, and thus a new disc is produced. This again is set free, when it is fully formed, at a plane above that at which the first disc was separated; and the repetition of the process gives rise to the jointed appearance of the stalk.

In many stocks the soft tissues invest the exterior of the stalk down to its base. The fully-grown discs were producing free swimming larvæ during the month of March.

5. *On the Echinodermata of the Sea of Bengal.*
By PROFESSOR F. JEFFREY BELL, M.A., Sec. R.M.S.

I am able to make an addition of some interest to the report on the Echinoderms of Ceylon which I communicated to the British Association in 1885. Collections of great interest have been made at Mergui by Dr. John Anderson, F.R.S., and at his instigation at the Andamans, while Mr. E. Thurston, Superintendent of the Madras Museum, has lately made a rather large collection at Tuticorin. If we add to the species collected at these stations those which have been noted by others, we find that the whole number of species found in the Bay of Bengal is 149. This is a considerable advance on the fifty-one specimens which, three years ago, I reported from Ceylon. The additions have not all, of course, been made since then, but the more important are due to the collections of Anderson, the Sarasins, and Thurston. If we compare the lists of forms with those given in the 'Alert Report,' we find much to support the view there held, that there is in the Indo-Pacific area an intertropical Echinoderm fauna. Within the Bay of Bengal it is not possible to show that this doctrine is erroneous, but an examination of the Persian Gulf would afford an excellent test, and it is much to be wished that such an examination might be made. It may be confidently predicted that some interesting examples of the modification of common Indo-Pacific species would be discovered therein.

TUESDAY, SEPTEMBER 11.

The following Papers and Reports were read:—

1. *Discussion on Coral Reefs.*

Mr. W. T. THISELTON-DYER, President of the Biological Section, said:—We have met this morning in conjunction with our colleagues from the Geological Section to consider a question which at the present moment is very deeply attracting the interest not merely of biologists but of geologists—the vexed question which has been raised with respect to the origin of coral islands and coral reefs. One of the earliest researches of the late Mr. Darwin was a memoir upon the origin of these islands, and in it he was disposed to attribute them in great measure to the subsidence of the land upon which they were ultimately formed. I will not anticipate the statement of the reader of the paper as to the points of difference between Mr. Darwin's views and those which are now held, but it was in consequence of the explorations of H.M.S. 'Challenger' that a series of facts were brought before the scientific world which in some degree made it extremely probable that Mr. Darwin's views did not form the only explanation to which these curious phenomena are susceptible. A very distinguished individual has thought fit to bring before the scientific world the preposterous assertion that we are leagued together in a conspiracy of silence with the object of suppressing the progress of scientific truth. I cannot pretend that that assertion has influenced us in holding this discussion to-day. It so happens that we have the presence of two distinguished scientific men who have had opportunities of examining these questions for themselves; they will state their views, and you will judge for yourselves in which direction you are inclined to think the ultimate solution of the problem may be found. At any rate I think I may claim that our minds are absolutely open, and that we attribute no weight to the authority of tradition, however eminent. The only thing we really want to know is what is the conclusion that commends itself to our minds with the greatest probability, and which is based on the largest number of ascertained facts.

Dr. SYDNEY J. HICKSON, who was then called upon to read his paper on 'Theories of Coral Reefs and Atolls,' said before commencing his paper that he held it to be the duty of the opener of a discussion such as this first of all to explain the phenomena about which discussion was to take place and then state as impartially as possible the different views held to explain the phenomena. The object of the discussion was, if possible, to arrive at the truth, and not to run any particular theory. Thus he would endeavour to state as impartially as possible the different views which had been put forward to explain the presence of atolls and barrier reefs, and, although he could not help indicating in his opening remarks the view which he was inclined to hold himself, he would endeavour to postpone the reasons for his prejudice in favour of that view to a subsequent part of the discussion. He hoped none of the gentlemen who followed him would consider that his mind was so prejudiced that they would not be able to convince him that he was wrong in the view he took. Mr. Hickson then proceeded to read his paper, the principal points in which were illustrated by maps and diagrams.

At the close of Dr. Hickson's paper the PRESIDENT said they would all agree with him that they must tender their hearty thanks to Dr. Hickson for his very admirable address. If he found any fault with it, it would be that in relation to their conference it had been of a too judicial and well-balanced character, that he had rather taken the sting out of anything like an animated controversy. They must admire the fair way in which Dr. Hickson had brought forward the arguments for and against in this controversy. It would be difficult to attack him, for he had avoided controversial matter by presenting both sides in a very fair manner. For his own part, being a botanist, and knowing very little indeed about coral islands, his mind was perfectly open in the matter. If he might venture to throw out a suggestion with regard to the arguments of future speakers, he might say he was struck with the anxiety of those who attacked Mr. Darwin's views, whilst asserting that no considerable amount of subsidence of the earth's crust had taken place, to go very largely into the correlative action, as it seemed to him, of elevation. If they admitted that portions of the earth's crust had been elevated 500 or 600 feet, it appeared to him that other portions of the earth might be correspondingly depressed. The President then invited discussion.

Professor BOYD DAWKINS said he thought they were particularly fortunate that morning in having that subject brought before the two Sections which were so closely connected as Sections C and D, for if on the one hand Section D had to deal with the history of life on the earth at the present time, Section C had to regard those changes which were revealed in the history of the earth by the study of the various forms which had lived. And the question of coral reefs might be said to stand absolutely on the frontiers which divide the province of Section C from that of Section D. He certainly felt that the Chairman had, to a very large extent, by his remarks, anticipated one of those points which certainly had, to his mind, very great force in this matter. It certainly seemed to him, as a student of the history of the earth, that it was wholly impossible for them to allow that any great movements of elevation could have taken place in a given area without acknowledging the correlative movements of depression; and when they knew that there were large portions of the Pacific and some other oceans which undoubtedly bore evidences of elevation, it seemed, in the very nature of things, that there must be some traces of subsidence. It was quite impossible for him to imagine that the one operation should go on without the other, and as a matter of fact from their geological record they must look upon the surface of the earth as being in a continual state of movement up and down, and the state of the ocean as a stable, even, and regular level. He thought the discussion would direct their attention to the rival merits of the two theories—that which was started by Mr. Darwin more than fifty years ago, and which was known as the subsidence theory; and the other theory which had been placed before them, which he might term the minus-subsidence theory. It seemed to him that the latter was not capable of being entirely ignored. As he took it, corals would live on whatever they could find to perch themselves upon and develop coral reefs within the limits of coral growth, and if the centre of the land is depressed, in the nature of things, corals

will grow more on the outside than on the inside, for the reasons advanced in the address which had opened the discussion. He failed to grasp that there was any antagonism whatever between the two views. The points raised in the opening address were, for the most part, points which had been proved over and over again by the series of observations made by Professor Agassiz and recently published. He failed to see that the minus-subsidence theory was really applicable to the formation of all coral reefs, and he observed, the care with which the gentleman who had brought the subject before them that morning had stated that atolls and barrier reefs might be made without subsidence. Of course they might. And he felt sure that if Mr. Darwin were there that day he would have been amongst the first to realise that the theory which he sketched out was capable of modification by the advance of knowledge and the extension of research. Such then was the main point which occurred to him to bring before them in that discussion. He felt that he was unable to impart into it any matters of controversial interest. And he doubted whether Mr. Murray would venture to assert that there were no reefs which had been formed on the Darwinian hypothesis, and he felt sure none of his disciples would be rash enough to say that all these observations made during the last few years could be said not to modify the views held so many years ago. There was, however, one other point he would like to mention. He felt equally with Professor Hickson the difficulty of accounting for the existence of atolls by what he might call the carbonic-acid or erosion theory. So far as he understood this theory, it largely depended upon the amount of coral in the water and upon the area upon which the attack was made. In the case of atolls, so far as he knew, most of them were without any of those scourings which would allow of material being carried away in solution by the action of carbonic acid. Of course the action might go on to a considerable extent, the action was going on incessantly, so that in place of having large, thick masses of perfectly recognisable coral you find masses of limestone scarcely to be distinguished for the most part from some of those reefs.

Mr. BOURNE followed with a paper, in which he upheld the arguments of Mr. Hickson.

Dr. EVANS said he was present as a member of Section C, and not as one who had paid any particular regard to the formation of coral reefs. He came there for instruction, and he had received it, and the general result was that, whether land was rising or falling—and they as geologists knew that a see-saw action was going on in different parts of the world—they knew it was possible for these coral reefs at all events to be formed. Where there was a supply of food, there the corals would thrive, and where there was a single nucleus there would be a gradual extension in all directions. The difficulty had been to account for the ring-shape of the atolls, and there had been little brought forward that day to satisfactorily account for that phenomenon. It might be doubted whether they were able to account for the action of the carbonic acid in the water; but they had been told that all the reefs were exposed to that action. To his mind this was due to another and different cause which had not been brought before them, viz., to the rainfall in the districts in which these coral islands and atolls are situated. He thought he was right in stating that, as a rule, water more or less fresh was to be found at a certain depth in almost all the islands. That water must have come from the surface in the shape of rain. Rain falling on vegetable matter would become charged with carbonic acid and would dissolve the rock on which it fell. He thought they might fairly assume that the continual process of fresh water falling upon the coral and finding its way out into the sea in a different condition, being charged with carbonate of lime, would account for the rottenness of the centre of the islands and the formation of lagoons within them. That was an element which he thought should not be left out, and as it had not been cited in the discussion he thought it but right to bring it before them.

The CHAIRMAN said that from a botanical point of view he rather distrusted any general theory that coral islands were of no great antiquity. The botanical evidence, so far as it went, did not very strongly support Mr. Bourne's argument.

Professor SEELEY observed that, when Dr. Hickson laid before them his clear statement of the views held with regard to coral reefs, he opened with expressing

a hope that he should convert them to his own views before he had finished, and when he (Professor Seeley) turned to the end of the address he found that Dr. Hickson's own view was that he was an adherent of the views of Dr. Murray. If it was possible for the subject to have been stated in so impartial a manner as it appeared to have been by Dr. Hickson, and for Dr. Hickson to be an adherent of the views of Dr. Murray, he (Professor Seeley) would like Dr. Hickson, in his reply, to lay before them the evidence which so weighed with him as to convince him of the truth of Dr. Murray's views rather than the views of Mr. Darwin. When he remembered the circumstances under which Mr. Darwin commenced the study of coral reefs he found there was one very remarkable determining influence which gave Mr. Darwin very exceptional opportunities for forming views upon this subject. Mr. Darwin told them that he had been spending the previous autumn in North Wales, studying the processes of the upheaval and depression of the earth, and he had told them how on touching upon every shore he found records of the changes in progress all over the surface of the globe. Therefore when he came to study the problems of the distribution of life on the surface of the earth at the present time he was not attacking any problem which had previously engaged his attention, but judging whether they were true. And the conclusion he arrived at was that there was no link wanting in the evidence to unite the past methods of bringing coral reefs into existence and those which govern their distribution at the present day. The great merit, as it seemed to those who, like himself, had been occupied in expounding the views of Mr. Darwin was that as new knowledge had come before them from various researches they had learnt prophecies of the upheaval of fringing reefs which were unknown in detail to Mr. Darwin; and as Semper made known his views they learnt that there was an object of exceptional modification to the views which Mr. Darwin put forward, which were in no way antagonistic to those views but were a fitting illustration of the general truth of the views of Mr. Darwin—truth which admitted of exceptional conditions of modification where the requisite conditions were present. When these views came to be stated again, appealing to mankind, they said boldly, 'We do not regard this as a novelty or revelation, or as a new basis of science to be honoured.' And why? Because it did not do for them what Mr. Darwin's view had done—given us the method of research and connected with the past geology of the earth the phenomena of the present day. All we could see in these views were exceptional conditions of coral growth, which could be harmonised with the views which Mr. Darwin had already formulated. When the objection is raised that Mr. Darwin had not fully stated this and various facts brought before us with the view of contesting what is, perhaps, found in popular text-books as an exposition of the views of Mr. Darwin, it was very much like fighting a shadow and views which were in existence long before the views which Mr. Murray brought before them. It is stated that no coral reef is known which is more than 25 fathoms in thickness. Probably no geologist knew of any reef of more than that thickness, and he knew the conditions of the growth of coral were not favourable to extreme thickness, for it was battered up by the waves and the fragments scattered about, so that the continuity of coral growth upwards was hindered. Therefore under these and various other circumstances which come under practical observation in the study of the geological structure of our country and make us acquainted with the different distribution of coral reefs he failed to see anything in the arguments brought before them at present which would lead them to see in the new views brought forward by Mr. Murray evidence which would lead them to overthrow those given by Mr. Darwin.

Mr. HARMER observed that Professor Hickson in criticising the origin of lagoons assumed that the rim of the coral would grow more actively than the centre. Was that really the case? They could understand that the rim of the atoll would cut off supplies of food, and if there were any great differences noticeable in submerged atolls they could understand that the outside conditions of growth were more favourable than those on the inside. If, however, they had a perfectly flat table-land would there be any difference—would not the coral in the centre be able to get as much oxygen and food as that at the edge? The opponents of Mr. Darwin were ready to admit any amount of elevation, whilst they were not

ready to believe in subsidence. These opponents of Mr. Darwin's views were bound to bring forward cases in which atolls were formed in connection with cases of elevation. It was necessary for them to show that elevation had taken place in cases where atolls had been formed. The President of Section C had pointed out that elevation must be compensated for by subsidence. Was it not a fact that in a volcanic district elevation often took the form of isolated peaks on which coral work could commence, and that these would be diffused over a larger area and only affect the deep sea, so that it would not so much affect the growth of coral as the elevation which gives rise to the formation of these peaks?

Dr. MILL said they must all very much regret the absence of Mr. Murray and Dr. Guppy, the latter of whom was on his way to Christmas Island. He only desired to express on Mr. Murray's behalf the gratification which he was sure he would have felt had he been present to see how fully it was understood by the members of both Sections that his theory was not really antagonistic to Mr. Darwin's, but simply pointed out facts observed by himself and others. Mr. Murray's theory of coral islands was only part of a much wider theory which was formulated by the researches of the 'Challenger.' Mr. Murray referred more particularly to the action of life and to the action of sea-water in dissolving carbonate of lime, *i.e.*, dead carbonate of lime. The observations of the 'Challenger' and other vessels in deep sea tended to show that in the greatest depths of oceans there was no carbonate of lime, but instead of that there was a red clay. The water, however, contained more carbonate of lime in solution than that in any other part of the oceanic area. This suggested to Mr. Murray that the organisms in falling towards the bottom had their shells gradually dissolved by their passage to the deep sea. In shallower depths the organisms fall more or less. These banks are formed more readily in shallow water. Mr. Murray supposes that the coral is not the only worker, and he prefers to call these islands organic islands. Dr. Guppy found an upheaval bed closely resembling the red clay upon which the coral was growing. One question which was really of importance was, 'Is it possible that there is sufficient carbonate of lime to supply these great coral deposits?' That matter was being tested by a series of laboratory experiments, and this research was somewhat difficult to carry out. It is being tested by means of feeding a number of hens with food containing no carbonate of lime. On testing the shells of the eggs it has been found that they have in them more carbonate of lime than they have received, which shows that other processes are able to produce carbonate of lime.

Mr. POULTON wished to know whether there was no explanation that would destroy, as a means of argument, the theory that volcanic action was necessary to areas of elevation. He noticed that no data had been given as to the relative thickness of coral. He also wanted to know whether, if these movements of the earth going up and down went on, it were not possible for an atoll to be formed and then upheaved—whether atolls might not be formed by depression and afterwards elevated. Dr. Hickson had pointed out that small atolls probably arose from small peaks and then grew outwards. Mr. Bourne had pointed out that they would grow in the direction of the currents by which food would be conveyed to them, and that they rested on very small bases. The question was whether this would be really and physically possible.

The PRESIDENT said he was afraid that the time had come when they must bring this interesting discussion to a close. They would, he thought, agree, from the speeches they had heard, that scientific men as a whole did not show any marked disposition to plead one another's views. The fact was that the condition of mind which scientific men exhibited was the best guarantee for the gradual evolution of truth. They were charged by the Duke of Argyll with having entered into a conspiracy of silence; but he appealed to those present that morning and asked them whether they could see a shadow of ground for the making of such an accusation.

Dr. HICKSON observed that as the time was so late he would endeavour to make his concluding remarks as short as possible. Mr. Poulton had asked if volcanoes were always found on areas of elevation. That question was really

rather difficult to answer. As far as they knew, volcanoes were only found on areas of elevation, but they might be found on areas of subsidence; but, as Darwin had pointed out, the evidence of the subsidence sank beneath the sea and out of sight. In regions he had investigated the land was slowly but certainly being elevated. As to the thickness of the limestone there was a very great thickness below the upraised reefs, but upon that point they required further information. Mr. Poulton had alluded to the explanation he gave about the formation of the reefs. The difficulty they had to contend with was that in addition to atolls they found coral islands without the centre lagoon. In the second place they must suppose that in some cases the reef had come to the surface as a solid rock and gradually grown outwards where the submarine peak is larger and in the submarine table-lands when the reef before it reaches the surface has the form of an atoll. Mr. Harmer had asked if it was probable that the corals would grow more rapidly and better upon the rim of a submarine table-land than in the centre. The evidence which Mr. Bourne had brought forward tended to show that where there was a rush of water corals would grow much more favourably. In the Tizard Bank and the banks in the China seas the rims were to be found covered with a luxuriant growth of coral, and in the centre there was none. Regarding Professor Seeley's remarks he (Dr. Hickson) was sorry if he did not make himself quite clear in his opening words. He did not intend to say that he hoped he should convert anyone to his views, and he believed he said distinctly that his object would be to elicit the truth, and that, although he could not help his own views being evident, he did not wish to try to convert anybody to them. He protested against Professor Seeley's suggestion that he had only given them the text-book ideas of Darwin's theory. He had carefully considered the subject from every source, and he had given what he thought a fair statement in a short time of Mr. Darwin's views. Professor Seeley also said that the new views did not seem to give the connection between the geological evidence of coral reefs and the processes actually going on. He maintained that the new views did this, whilst Darwin's views did not. Mr. Darwin most distinctly stated that coral reefs only grew on coral peaks, and here we now have examples to the contrary which are consistent with Mr. Murray's theory and not with the Darwinian. The suggestion which Dr. Evans had made respecting the action of rain-water was very valuable. In reference to the remarks made by the President of Section C, he would observe that his reason for suggesting this discussion was because Darwin's most eminent pupils would not admit that coral reefs had been formed in any other way than that suggested by Darwin. His most eminent disciple distinctly stated in his reply to Mr. Murray's views that the Darwinian theory remained true of all these atolls—in other words, that where you find an atoll and barrier reef you have *ipso facto* a proof of subsidence. It seemed to him that recent researches tended to show that the presence of the two did not form proof of subsidence. They might have been formed by subsidence, but they might also have been formed in another way. It was because Mr. Darwin's eminent pupil would not concede the point which Mr. Dawkins did that he asked for this discussion. There were two points on which Mr. Darwin was wrong, first, in supposing that all the atolls and barrier reefs were formed by subsidence and in that way only; and thus the map which he gave showing areas of elevation and depression would need modification. He did not mean to say that they would need to wipe out all the blue and substitute red, but there were certain parts marked blue which must be in future marked red. The second point was that coral reefs do not only grow upon volcanic peaks, but that they may grow upon foraminiferous shells.

2. *Second Report of the Committee on the Physiology of the Lymphatic System.*—See Reports, p. 363.

3. *Contributions to the Anatomy of the Tubificidæ.*
By F. E. BEDDARD, M.A., F.Z.S.

4. *On the Flora of Madagascar.* By the Rev. R. BARON.

The London Missionary Society, in whose service the author is engaged in the island of Madagascar, encourages its missionaries, by a distinct clause in its Regulations, to take up some special study as a relaxation from the usual routine of missionary life. He has been led, for various reasons, to give a portion of his time to the study of botany, and gives this morning a brief abstract of a somewhat lengthy paper on the flora of Madagascar, which he has compiled from numerous notes and observations made during several years past.

He need not here enter into detail in regard to the size and physical structure of Madagascar. Suffice it to say that the island is nearly four times the size of England and Wales. The great mountain-chain of the country, which in its highest point reaches to about 8,500 feet, runs in a longitudinal direction probably for 700 or 800 miles, but is much nearer to the east than to the west coast. The eastern half of the island, speaking roughly, consists of crystalline schists, specially gneiss invaded by granitic and basaltic bosses and masses, with numerous recently extinct volcanoes. These schists possess all the characters of Archæan rocks, and probably are such for the most part, though it is not unlikely that they are commingled with highly metamorphosed Cambrian or other palæozoic rocks. The western half of the island seems to be composed mainly of secondary and Tertiary rocks, and chiefly those of the Jurassic, Cretaceous, and Eocene systems.

A considerable part of the island is covered by primeval forest. On the eastern side there is a forest which extends probably 800 miles from north to south almost, if not entirely, without a break, and which, according to some, is continued round the island in a complete or almost complete ring, a statement which I imagine requires verification. In the western part of the island there are undoubtedly extensive forests running in a northerly and southerly direction, but how far these are continuous is not yet known. The forest in the eastern part of the island is probably from 60 to 80 miles wide in its greatest breadth, and occupies fully two-fifths, if not one half, of the total eastern area. If we take into account the whole of the island, probably about one-eighth part of it is covered with trees.

It is grievous to relate, however, that the forests of Madagascar are being destroyed in the most ruthless and wholesale manner by the natives. Every year thousands of acres of country are cleared, the trees being burned to the ground, and that for no other purpose than to provide ashes as manure for a mere handful or two of beans or a few cobs of Indian corn. The author once came across a passage which had been cut through the forest for a long distance for no other purpose than to allow space for the dragging of a tombstone which had been quarried in the neighbourhood. To make this road no fewer than about 25,000 trees had been cut down! Again, in getting planks for building purposes from the forests, there is most extravagant waste of timber. A tree is felled, and the native woodmen, not having saws, set to work with their hatchets on each side of it until the timber is reduced to the required thickness, and thus each tree, however large, supplies but a single plank. It is truly lamentable to see how, in these and other ways, the Malagasy forests, containing, as they do, valuable timber, are being consigned to destruction.

There are now known in Madagascar about 3,440 species of flowering plants, so that it may probably be said that the great bulk of the plants found in the island has been discovered. Of these so large a proportion as four-fifths or probably more are endemic. The list below shows the number of species in the Orders most largely represented, and their percentage of the total flora.

If we include the ferns, they would stand second on the list with a percentage of 8.4.

The author has long been convinced that the flora of Madagascar may be divided into three Regions. These Regions run in a longitudinal direction, following approximately the longer axis of the island. It is proposed to call them Eastern, Central, and Western (see Map). Of the 1,977 species of plants whose localities have been determined there are—

Common to the three Regions	73
„ „ Eastern and Central	142
„ „ Western and Central	59
„ „ Eastern and Western	89

The table (exhibited) shows the Orders most largely represented and their percentage of the total flora of the respective Regions.

In this table the following facts are prominent. In the Eastern Region the two most abundantly represented Orders are Filices and Leguminosæ, but the former are in proportion to the latter as much as 5 to 2. It will be noticed that Filices do not appear in the second or third column at all, the reason being that there is not sufficient data for determining their relative position. Possibly they might occupy the third or fourth place. Neither, for the same reason, do the Gramineæ appear in the third column. In the Western Region the Leguminosæ stand at the head of the list, and this order is followed by Euphorbiacæ, but the difference between the two is very great, the proportion being more than 5 to 1. The table shows that 24·6 per cent. of the flora of the Western Region consists of Leguminosæ. The Compositæ form only 3 per cent. of the flora. In the Central Region, on the other hand, the Compositæ stand head of the list, with a percentage of 12·2. Rubiaceæ do not appear in the column representing the Western Region at all. They, in fact, only form about 2 per cent. of the flora. The Eastern, Central, and Western Regions therefore might, if we take the most largely represented Orders into account, be fairly called the Fern Region, the Composite Region, and the Leguminous Region respectively.

That the flora of the Central Region should differ widely from the floras of the Eastern and Western Regions is accounted for by the great elevation above the sea of the central part of the island. But how are we to explain the existence of so great a difference between the floras of the Eastern and Western Regions, occupying, as they do, the same latitudinal and altitudinal positions, for of the 1,355 plants found in the Eastern and Western Regions only 89 are common to both? The explanation is believed to be simple. The central elevated plateau of the island, which runs from north to south, is undoubtedly of very great antiquity, having existed not improbably from palæozoic times, and has therefore always formed a barrier between the floras of the Eastern and Western Regions. The floras therefore, even if they were formerly similar, have had abundance of time to become differentiated in character; and if they were originally different, they have been kept, by the existence of the mountain barrier, distinct to the present day.

In another paper of a much more extensive character than the present one, the author has entered into detail in regard to the character of the three Regions. He will not, however, go into particulars here. One thing, however may be mentioned of a somewhat interesting character. In the higher portions of the Central Region there are some half-dozen plants whose distribution is remarkable. Of these one is a violet, which is also found at the height of 10,000 feet in Fernando Po and 7,000 feet in the Cameroons in West Africa, almost under the equator, and also in the mountains of Abyssinia. A geranium has a similar distribution, so have *Caucalis melanantha*, *Drosera ramentacea*, and *Lonchitis occidentalis*, which appear also on the mountains of Angola and Guinea, and *Agauria salicifolia* in Réunion, the Cameroons, and the high land about Nyassa. *Sanicula europæa* 'occurs in Central Madagascar, the mountains of Abyssinia, the Cape, 4,000-7,000 feet in the Cameroons, 4,000 feet in Fernando Po, and is widely spread through Europe and other parts of the north temperate zone.' *Cyanotis nodiflora* finds a home in Angola and Central Madagascar. These facts point plainly to the existence of a former cold (or temperate) climate within the tropics, followed by a warmer period, when these temperate plants, in order to maintain an existence, were compelled to retreat up the mountains, where they remain to the present day.

In considering the flora of Madagascar as a whole, one of the first things that strikes one is that the island must be of immense antiquity. About four-fifths of

the species and a seventh of its genera of plants are peculiar to the island. And this is as it should be; the genera have for the most part survived the untold ages that have elapsed since their first appearance, while the species have been subjected to enormous modification. Such a very large amount of specific differentiation seems to point in the clearest manner to long isolation. The antiquity of the island is also abundantly evidenced by the remarkable character of its fauna, a subject, however, which need not be discussed here. At what period the island was connected with the adjacent continent it is impossible to state with certainty, but, as has been remarked elsewhere, as nummulitic limestone occurs on a great part of the west coast of Madagascar, there seems to have been probably no land connection in Eocene times; and as the inroad of the higher forms of mammals into South Africa from the Euro-Asiatic continent probably took place, as Mr. Wallace shows, in later Miocene or early Pliocene times, Madagascar must have been cut off from the mainland at least previous to the later Pliocene period, as the absence of such mammals in the island proves. This would allow time for the migration of the mammals to South Africa, which would not unlikely keep pace with the gradual lowering of the temperature going on in the Northern Hemisphere. This also would explain the existence of a comparatively cold period succeeded by a warm one, during which, or some part of which, Madagascar must have been joined to the mainland, for it is now well known that in the Northern Hemisphere in Tertiary time there was a gradual lowering of the temperature from that of a tropical to a temperate or even a cold climate. This being of course reversed in the Southern Hemisphere, we should have a cold period followed by a warm one. It seems probable, therefore, that Madagascar was joined to the African continent during some part or parts or the whole of the Miocene (including Oligocene) or early Pliocene period.

5. *On the Effects of the Weather of 1888 on the Animal and Vegetable Kingdoms.* By E. J. LOWE, F.R.S.

First, attention must be drawn to the extraordinary mortality amongst birds and the fearful increase in the number of slugs and insect pests during the present spring and summer near Chepstow. At Shirenewton at the present time there is not a redbreast, wren, goldcrest, coal-tit, marsh-tit, longtailed-tit, nutbatch, creeper, night jar, lesser spotted woodpecker, redcrest, grey wagtail, redstart, blackcap, white-throat, or red-pole, although usually they are all common. There are scarcely any examples of land-rail, water-ouzel, thrush, missel-thrush, dunnoek, whinchat, garden-warbler, siskin, linnet, or swallow, although these are also usually common in this district. Amongst birds those that seem to be of an average number are the crow, rook, jackdaw, magpie, jay, sparrow-hawk, swift, skylark, moor-hen, starling, and blackbird.

Usually birds are so abundant here that, without nets, cherries, strawberries, raspberries, currants, and gooseberries are all devoured by them. This year there has been no necessity for nets, as the fruit has been untouched by birds, or rather there have been no birds to eat it.

The long deep snow in February destroyed many birds, but this does not account for the absence of so many summer birds. Only four or five swallows can be seen at one time, and only a solitary land-rail has been heard.

During the last two or three weeks there has been an increase in the number of the following birds: blackbird, willow-warbler, chaffinch, sparrow, great-tit, blue-tit, spotted flycatcher, swallow, martin, and dunnoek. It may be mentioned that in June a pair of sand-grouse settled close to the cricket-ground in Shirenewton Park, but they were not seen again.

Usually there is an increase in the number of slugs and insect pests after a cold winter, and this year that increase has been enormous; seedling plants, vegetables, and flowers have been destroyed wholesale, and great damage has been done to the wheat, grass, and other agricultural crops, but what has been most noticeable is the destruction by caterpillars of all the leaves of the oak. Thousands

of oaks have been without a leaf, bare like winter, and now they are only just coming into leaf again. The damage to the oaks has extended for miles round here. Amongst destructive slugs the greatest increase has been in *Helix aspersa*, *H. rufescens*, *H. hispida*, *Zonites alliarius*, *Z. cellaria*, *Vittrina pellucida*, *Limax maximus*, *L. agrestis*, *Arion ater*, *A. empiricorum*, and *Amalia marginata*. There has also been an increase in *Testacella haliotideia* and *T. Maugei*.

Earwigs, woodlice, ants, and butterflies and beetles of numerous species have been unusually abundant, but there are no wasps and very few moles. Snakes and adders have also been numerous.

Toads and frogs deposited vast quantities of eggs, as usual, in the sheet of water in Shirenewton Park, but not a single tadpole resulted, nor did the eggs swell. The water-newt has also been much less abundant.

Early sown peas were twenty-one weeks before they were fit for the table, and all fruit has been very late, many gooseberries are not yet ripe, and currants are still abundant. Pears are scarcely swelling. Nuts are, however, an enormous crop. The hay crop has been the latest ever known, and much (September 3) has yet to be harvested.

The above, together with the great snow in February and early drought, followed by heavy continuous rains, that from May 1 to August 31 yielded here $16\frac{1}{4}$ inches of water, and also the long continuance of cold weather, has made this an exceptional year so far, and a great contrast to the warm summer of 1887.

6. *The Odoriferous Apparatus of the Blaps mortisaga* (Coleoptera).

By Professor GUSTAVE GILSON.

It is well known that many insects of the *Pimelids* family give out a characteristic odour. I remarked that this odour is much stronger in the *Blaps* than in other genera of the same family, as, for instance, the *Pimelia* and the *Apis* that I had observed in Italy. I tried to discover what might be the cause of this difference, and I am now able to state that there exists a special highly developed apparatus.

This apparatus is composed of two cylinders, which unite to form, under the genital organs, a very short tube opening at the lower part of the last intersegmental space of the abdomen. Each cylinder is a sac, the walls of which are covered with a great number of whitish lobes.

This sac is a receptacle where the secretion produced by the lobes is accumulated.

This secretion is an oil in which swims a considerable number of crystalline yellow needles.

I have not yet been able to get a sufficient quantity of this substance to make a chemical analysis.

The lobes are constituted by large cells, arranged as a sort of epithelium within a bag, formed of a very thin membrane.

These lobes are by no means real glandular tubes, because each secretory cell communicates directly with the surface of the common receptacle by a tiny canal. They are simple agglomerations of unicellular glands, analogous to those we find in the inner surface of the shell of many insects, especially in the vicinity of the genital organs. Since Leydig first described this kind of cell, many writers have remarked them in various species. I may mention Claus, Nussbaum, Forel, and Schiemenz. The latter found these elements grouped in lobes rather similar to those I speak of, in certain salivary glands of bees.

However, as the descriptions are not sufficiently detailed, I made a closer examination of them in the *Blaps*, where they present several peculiarities hitherto unmentioned so far as I have been able to learn.

Each cell contains an apparatus producing the odorous oil.

This apparatus itself is made up of four distinct parts:—

1. A radiating vesicle.
2. A central ampulla.
3. An excretory canal.
4. A sheath for the canal.

The vesicle is terminated by a membrane which has a dotted appearance. It contains filaments radiating from the ampulla.

These filaments pass through the membrane and become the radiating filaments of the protoplasm.

The ampulla is but a dilatation at the end of the tube.

The tube itself has a thin wall, but a solid and elastic one, and a very narrow hole.

The sheath is a formation analogous to the vesicle; it has also a membrane and radiating filaments. It varies much in length; sometimes short, sometimes very long, and rolled up in the protoplasm.

Towards the lower part it narrows gradually, and finally it becomes one with the tube itself.

A question now arises: what is the morphological significance of these productions?

To my mind it is quite clear that the membrane of the vesicle of the ampulla and of the tube are analogous to the nuclear membrane and to other productions which arise in the cell by a condensation of the protoplasmic reticulum.

The radiating filaments are nothing but radial fibres of the reticulum, which have become more regular and stronger.

It is very interesting to compare these cells with similar elements found dispersed in the abdominal region of other insects; as, for instance, in the *Carabus catenulatus*.

Two forms of cell with canal are present.

In one set the canal is in direct contact with the protoplasm from end to end. In the other, which are of spheroidal form, the end of the canal is furnished with a radiating vesicle similar to that of the *Blaps mortisaga*.

These three forms are types of three stages of development of the unicellular gland.

In the first there is only a canal in which are inserted directly the radiating filaments of the protoplasm. In the second the protoplasm around the extremity of the canal forms a radiating vesicle, but there is no sheath. And in the third we have the sheath, which is a formation analogous to the vesicle.

The odoriferous cell of the *Blaps mortisaga* represents the most complex type of the unicellular gland and one of the most complicate forms of the living cell.

7. *Report of the Committee on Provincial Museums.*—See Reports, p. 124.

8. *The effect of various substances (chiefly members of the aromatic series of organic compounds) upon the rate of secretion and constitution of the Bile.* By W. J. COLLINS, M.D., M.S., B.Sc. (Lond.), F.R.C.S.

The paper details the results of a research undertaken at the suggestion of Dr. Lauder Brunton, being part of the larger subject of the relation between chemical constitution and physiological action. The work of other experimenters in the same field is reviewed. The methods of collecting the bile are discussed and decided in favour of the formation of temporary biliary fistulæ. This was adopted in all the experiments detailed. The animals employed were guinea-pigs. The substances experimented with were—*Benzene, Toluene, Aniline, Toluene Diamine, Benzoic Acid, Phenol, Sodid Salicylate, Hydroquinone, Resorcin, Pyrocatechin, Ethyl-Ammonium Iodide, and Ipecacuanha*. The collected bile, both before and after the subcutaneous injection of the drug, was analysed so far as the estimation of its water, solids, and ash in every case. *Toluene* appeared to be the most decisive cholagogue of those experimented with, both as regards rate of secretion and increase of biliary solids eliminated. Experimental trials of this drug upon man have served to corroborate this conclusion.

SECTION E.—GEOGRAPHY.

PRESIDENT OF THE SECTION—Colonel Sir C. W. WILSON, R.E., K.C.B., K.C.M.G.,
D.C.L., F.R.S., F.R.G.S.

THURSDAY, SEPTEMBER 6.

The PRESIDENT delivered the following Address :—

On opening the present session of the Geographical Section of the British Association I cannot refrain from alluding to the last occasion, now nearly a quarter of a century ago, upon which it met in this city. The chair was then filled by one to whom I, in common with others of the younger generation of that day, must ever owe a deep debt of gratitude for many kindly words of advice and encouragement. Then, as now, popular interest centred in Africa, and Sir Roderick Murchison, on taking the chair, was accompanied by a group of distinguished African explorers. Some amongst us may remember the enthusiastic greeting accorded to Livingstone, and the heartfelt sorrow caused by the announcement that the gallant, chivalrous officer, whose name will ever live in history as the discoverer of the sources of the Nile, had been cut off in the fulness of his strength and vigour.

The African travellers of the present day have shown the same pluck, the same perseverance, the same disregard of personal risk and comfort as their predecessors. One African traveller, a distinguished officer of the German army, who hoped to have been with us, has this year been awarded the highest honour which the Royal Geographical Society can confer—its gold medal. Lieut. Wissman, who possesses all Livingstone's indomitable courage, his constancy of purpose, and his kindly feeling towards the natives, has twice crossed Africa, in its widest extent, without firing a shot in anger. He returned recently to Europe, filled, like the great English traveller, with indignation at the atrocities perpetrated by the Arabs on the blacks; and eager to find means, if such there be, of putting an end to, or at least mitigating, the unspeakable horrors of the slave trade. He is now organising an expedition which has the double object of opening up the territory in Eastern Africa that falls within the sphere of German influence, and of bearing relief to Emin Pasha. In both enterprises we may heartily wish him 'God speed!'

The light thrown upon the interior of the Dark Continent is the most striking feature of geographical exploration during the last twenty-five years; and it is really the outcome of the last eleven years, for it was only in 1877 that Mr. Stanley, by his remarkable journey, gave a new continent to the world. If Sir Roderick Murchison were now alive he would feel more than gratified at results which have been so largely due to his initiative. I propose, presently, to return to the interesting subject of Africa; but I would first draw attention to the influence which the natural features of the earth's surface have had, and are still having, in conjunction with other causes, on the trade routes and commercial relations between the West and the East, and more especially with India.

The great civilisations of high antiquity appear to have risen and expanded in four riverain districts; Chinese in the basins of the Hoang Ho and the Yang-tse-

Kiang; Hindu in those of the Indus and the Ganges; Chaldæan and Assyro-Babylonian in those of the Tigris and Euphrates; and Egyptian in that of the Nile. India is separated from China, on the one hand, by rugged, lofty mountain ranges, and the high-lying plateau of Thibet; and from Mesopotamia, on the other, by the Suleiman Mountains and the Perso-Afghan plateau. Intercommunication between these early seats of man's activity must, therefore, have been of slow growth. From Mesopotamia, on the contrary, there is easy access to the Nile basin by way of Syria and Palestine, and there are indications of traffic between these districts at a very remote period. Enquiry into the causes which first led to intercommunication and into the means by which it was effected is needless. Desire of gain, lust of power, were as much a part of human nature in the earliest ages as they are now. The former induced the pioneers of commerce to feel their way across trackless deserts, and to brave the hidden dangers of the sea; and for nearly three hundred years it led gallant men to seek a way to the wealth of India through the ice-laden seas of the Arctic region. The latter brought the great empires of Assyria and Egypt into hostile conflict, and carried Alexander to the banks of the Oxus and the Indus; and it is largely answerable for the land-hunger of European states in our own generation.

Nations rise, fall, and disappear, but commerce extends in ever-widening circles, and knows no limits. Efforts are constantly being made to discover and open up new fields of commercial activity and to connect the great centres of commerce by quicker and shorter trade routes. The earliest traffic was conducted by land; men travelled together in caravans for mutual protection, and rested where food and water were to be obtained; at the most important of these halting places cities were founded. As trade extended it became necessary to carry goods through independent tribes or countries which often insisted on retaining the transit trade in their own hands, and this led to the rise of cities at points convenient for the transfer of loads and the exchange of the commodities of one country for those of another. Generally speaking this early overland trade was co-extensive with the geographical limit of the camel. Next in order to land traffic came that by water, first on rivers, then on the sea; and cities naturally sprang up at places on the coast where the merchandise brought down the rivers in boats could, conveniently and safely, be transferred to galleys or ships suitable for coasting. After a knowledge of the monsoons had been acquired men began to trust themselves to the open sea; the ships were improved, and a system was established under which voyages were made, with great regularity, at certain seasons of the year so that advantage might be taken of the periodic winds. Increased knowledge of the globe, improvements in the art of shipbuilding, and the invention of the steam-engine have gradually led to the ocean traffic of the present day, conducted by large steamers which, regardless of wind and tide, follow the most direct course from one point to another. The trade routes of the world are subject to two great modifying influences, one physical, the other political. The inland trade of India, for instance, can only reach Central Asia and the West by way of Herat or Bamian; caravan roads across the deserts of Asia and Africa must follow lines of springs or wells; climatic conditions render all Polar routes impracticable; and the removal of a physical obstacle, by the construction of the Suez Canal, is now causing a remarkable redistribution of the channels of commerce. So too disturbance of traffic by war, or its designed destruction by conquerors; and great political changes such as the establishment of the Persian Empire, the rise of Rome, the disruption of the Roman Empire, and the advent of the Arabs to power in Western Asia, divert trade from its accustomed routes and force it into new channels, to the ruin of some cities and states and the enrichment of others. The general tendency of trade so diverted is to seek, where possible, a maritime route, for water transport is not only less costly but less liable to interruption than land transport.

India, partly from its geographical position, partly from the character of its people, has always played a passive rôle in commerce, and allowed the initiative in commercial enterprise to rest with the West. The greatest advantages have always been derived from the possession of the trade between the East and the West, and, from a

remote period, the nations of the world have contended for this rich prize. One state after another has obtained and lost the prize; England now holds it, but if she is to keep what she has obtained there must be a far closer study than there has hitherto been, of geography and terrestrial phenomena in their relation to commerce. Trade between the East and the West may be divided into three periods: the *first*, during which the limits of Oriental commerce were the eastern and south-eastern shores of the Mediterranean, closed with the foundation of Carthage about 800 B.C.; the *second*, or Mediterranean, period ended in the fifteenth century; the *third*, or Oceanic period, has lasted to the present day. In the first period there were two principal lines of traffic; the southern sea route following the coast line, and the northern land route traversing Asia in its whole extent from east to west. There are indications of communication between China and the West so early as 2698 B.C.; and in 2353 B.C. an embassy arrived in China from a country which is supposed to have been Chaldæa. There is also an early notice of caravan traffic in the company of Ishmeelites, bearing spicery, and balm, and myrrh to Egypt, to whom Joseph was sold (Gen. xxxvii. 25-28.) The earliest maritime people to appreciate the value of trade between the East and West were, apparently, those living along the south coast of Arabia. Happily situated between the Persian Gulf and the Red Sea, and separated by vast deserts from the great nations of Asia, the Sabæans were free from those alternations of industry and war which are so unfavourable to commercial pursuits; for centuries they possessed the commerce of India, and they became famous for their opulence and luxury. Sabæan ships visited Ceylon and the Malabar coast, and Sabæan merchants supplied Indian goods to Mesopotamia and Syria, as well as to Egypt and Ethiopia. The ships trading to the Persian Gulf discharged their cargoes near the mouth of the Euphrates; whence the traffic passed partly by river, partly by land, to the coast towns of Syria and Palestine, and through the Syrian and Cilician gates to Mazaca (*Kaisariyeh*) and Pterium (*Bogharzewi*); from the last place Indian goods found their way to Sardis and Sinope. The ships visiting the Red Sea landed goods at Elath, at the head of the gulf of Akabah, for carriage by land to Tyre and Sidon, and on the western shores of the Red Sea for transmission to Merœe, Thebes, and Memphis. At the same time silks from China, and gems from India, were carried overland to Chaldæa and Assyria; and Bactra (*Balkh*), 'the mother of cities,' rose and flourished at the central point of the transit trade. Egypt, with no timber for shipbuilding, a distrust of all foreigners, especially when they came by sea, and a settled dislike of maritime pursuits amongst her people, long neglected the opportunities afforded by her favourable geographical position. Tyre, Sidon, and other Phœnician towns, reached by easy roads from the Euphrates and the Red Sea, and from their situation commanding the Mediterranean, became centres of distribution for Indian goods; and the Phœnicians, gradually extending their operations to the Red Sea, traded with the ports of southern Arabia, and even ventured to the shores of India. It was in this first period that the Jewish kingdom reached its widest extent. During the long wars of David's reign the Jews obtained possession of the land routes over which the rich products of India were carried to Tyre and Sidon; and Solomon did all in his power, by building Tadmor in the Wilderness (*Palmyra*), by improving the port of Elath, and by carrying out other great works, to protect and facilitate the transit trade from which such large profits were derived. The Jews do not appear to have been the actual carriers, but many of them no doubt, following the example of their merchant-king, engaged in commercial pursuits, and wealth poured into the kingdom so that silver was made to be as stones in Jerusalem.

In the early portion of the second period the commercial prosperity of the Phœnicians reached its culminating point. Their colonies dotted the shores of the Mediterranean, and their ships passed the 'Pillars of Hercules' to Great Britain and the western shores of Africa, and floated on the waters of the Red Sea, the Persian Gulf, and the Indian Ocean. The sea-borne trade of the known world was in their hands; wealth flowed into their cities, and in the markets of Tyre tin from Cornwall and amber from the Baltic were exposed for sale with the silks, gems, and spices of the far-distant East. The decline of Phœnicia dates from the

establishment of the Persian Empire in the sixth century B.C., and after the capture of Tyre by Alexander its commerce gradually passed into the hands of the Greeks. The Persian policy of closing the Persian Gulf to commerce forced the Indian traffic along the land routes. Babylon, which had become the emporium of Eastern trade, declined, whilst Susa and Ecbatana were enriched by the transit trade which passed through them and crossed the whole extent of the empire to the Mediterranean ports. The policy of Alexander was to secure the carrying and distribution trade of the world to the Greeks; and with this object he founded Alexandria, and intended, had he lived, to restore Babylon to her former splendour. Ptolemy, his successor in Egypt, used every means in his power to draw trade to Alexandria, and the new city soon rose to opulence and splendour. The Greek merchants obtained their Indian goods from the Arab traders whom they met in the ports of southern Arabia; they landed them at Myos Hormos and Berenice on the western shore of the Red Sea, carried them by camel across the desert, and floated them down the Nile and by canal to Alexandria, whence they were distributed to the neighbouring parts of Africa and the coasts of the Mediterranean. This trade route remained unaltered until Egypt became a Roman province. Another stream of commerce passed by way of the Persian Gulf to Seleucia on the Tigris, and thence, partly by water and partly by land, through Aleppo to Antioch and Seleucia at the mouth of the Orontes; and a third followed the ancient highway from Central Asia to the ports of the Euxine and Ægean Seas.

After the rise of Rome all trade routes were directed upon the imperial city, which became a centre of distribution for the merchandise of the East. The Greeks still monopolised the sea-borne trade; and those of Egypt, recognising the advantage of their geographical position, took the direct trade to India into their hands, and extended their voyages to Kattigara, the port of the Sinæ (Chinese), in the gulf of Tongking. Alexandria became the commercial capital of the Roman Empire, the distributing centre of the world for Indian and Asiatic goods, and a place of such wealth that one of the merchants is said to have been able to maintain an army. At the same time the old ports of Tyre, Beirût, Antioch, Ephesus, Byzantium, and Trebizonde maintained their position as *termini* of the land traffic. The extent of the intercourse between the East and the West during the Roman Empire is shown by the embassy of the Seres (Chinese) to Rome in the reign of Augustus, and by the several embassies to China, which followed that sent by Marcus Aurelius in 166 A.D., until the Arab Empire interposed; as well as by the fact that in the time of Pliny the Roman imports from Asia each year were valued at 100 million sesterces (about 800,000*l.*). Trade followed well-established routes, which remained in use, with but slight modification, till the fifteenth century. There were three principal lines of communication through Central Asia, all leading from China across the desert of Gobi. The northern ran to the north of the Thien Shan by Lake Balkash to the Jaxartes (*Syr Darya*); the central passed along the southern slopes of the Thien Shan and crossed the mountains by the Terek Pass to Samarcand and the Oxus (*Amu Darya*); and the southern passed over the Pamir and through Badakhshan to Balkh. The northern route apparently went on from the Jaxartes, through Khiva, to the Caspian, which it crossed, and then ran on to the Black Sea. Even at this early period trade filtered round the northern shores of the Caspian, and later, during the Middle Ages, there was a well-established trade route in this direction through Khiva to Novgorod and the Baltic, by which the northern countries received Indian goods. From the Oxus region, reached by the central and southern lines, there were two routes to the West. One passed through Merv, crossed the Caspian, ascended the Araxes to reach Artaxates and Trebizonde, or to descend the Phasis (*Rion*) to Poti, and then coasted the shores of the Black Sea to Byzantium. The other also passed through Merv, and, running along the northern frontier of Persia, reached the shores of the Black Sea through Artaxates, or continued on through Mesopotamia, Syria, and Asia Minor to Byzantium. The land trade from India passed through the Bamian Pass to Balkh, and through Kandahar and Herat to Merv or Sarrakhs to join the great stream of Central Asian traffic. The greater portion of the carrying trade on these long lines was in the hands of the people dwelling between the Jaxartes and the Oxus,

who had their centre at Samarcand; and these Sogdians, or Asi as they are called in the Chinese annals, fearing lest they should lose the profit on the transit trade, threw every obstacle in the way of direct communication between China and the Roman Empire. The difficulties which thus interrupted the land traffic gave an impetus to the trade by sea, and so benefited Alexandria and the cities in the Persian Gulf. The sea trade at this time was carried by way of the Persian Gulf and the Red Sea. In the first case the cargoes were landed at some port on the Euphrates or Tigris, whence the goods were carried by river and caravan up the valleys of those rivers and then through Syria to Beirût and Antioch, and through Asia Minor to Ephesus, Smyrna, Constantinople, and Samsûn. In the second case the merchandise was landed either near Suez, whence it was conveyed by caravan, canal, and river to Alexandria, and at a later date to Pelusium; or at the head of the Gulf of Akabah for transport to Syria and Palestine. The sea trade was to a great extent a coasting trade, and it appears to have been shared by the Greeks and the Arabs, and perhaps by the Chinese, whose junks were to be seen at Hira, on the Euphrates, in the fifth century.

On the disruption of the Roman Empire the Byzantines, with their capital situated on the confines of Europe and Asia, naturally became the intermediaries between the East and the West, and they retained this position until the maritime towns of Italy, France, and Spain became sufficiently strong to engage in direct trade with the Mediterranean ports to which the produce of the East found its way. Until the seventh century the Sassanians held the lines of communication by land, and they did all they could to prevent Eastern produce from being carried over any other roads than those passing through their territory or by any other hands than theirs. In the sixth century they allowed an exchange of produce between the East and the West to take place at only three points: Artaxates for goods arriving from Central Asia; Nisibis for those from Central Asia and by the Tigris route; and Callinicum (*Rakka*) for those coming by way of the Persian Gulf and the Euphrates. Justinian attempted to free Oriental commerce from its dependence on the Sassanians by opening up new trade routes. The Sogdian silk merchants passed, outside of Persian territory, round the north end of the Caspian to meet those of Byzantium on the shores of the Sea of Azov and the Black Sea; the products of India were obtained from Ethiopian traders at Adulis, on the Red Sea; and Greek navigators, taking advantage of the monsoons, sailed direct from the southern end of the Red Sea to the Malabar coast and Ceylon.

In the seventh and eighth centuries the Arabs overran the whole of Central Asia, and the carrying trade by sea and by land passed into their hands. Profound modifications were thus introduced into the commercial intercourse between the East and the West. All land traffic from the East was directed upon Baghdad, which became the distributing centre whence goods were despatched by the ancient trade routes to the West, and which almost rose to the splendour of Babylon. On the sea the Arabs regained their old reputation; they sailed direct from the Red Sea to Cape Comorin, and from Ceylon to the Malay Peninsula, and extended their voyages to Kanpu on a delta arm of the Yang-tse-Kiang; they established factories in the Indian Ocean, and, in the eighth century, were so numerous in Canton as to be able to attack and pillage that city. Their only rivals were the Chinese, whose junks visited the Euphrates and Aden, and brought silks and spices to the Malabar coast to be there exchanged for the raw material and manufactures of the West.

The Eastern produce brought by the Arabs to the ports of the Mediterranean was conveyed to Europe by the merchants of Venice, Genoa, Pisa, and other towns, who also traded to Constantinople and the Black Sea. Venice from its geographical position was well adapted to be the intermediary between the East and Central Europe, and even before the rise of Islam a large share of the carrying trade of the Mediterranean had fallen into its hands through the apathy and luxurious indolence of the Byzantines. It is unnecessary to trace the rise of Venice or discuss the impetus given by the Crusades to commercial intercourse between the East and Western Europe; it will be sufficient to note that in the first quarter of the

fifteenth century the carrying trade of the Mediterranean was wholly in the hands of the Venetians, and Venice had become the distributing centre for all Europe. Venetian fleets, well guarded by war galleys, sailed at stated times for Constantinople and the Black Sea; for Syria and Egypt; for France; for Spain and Portugal, and for Holland. From the ports in those countries, as well as from Venice herself, the products of the East were carried inland over well-defined trade routes, and cities such as Pavia, Nürnberg, and Bruges, the emporium of the Hanseatic League, rose to importance as *entrepôts* of Eastern commerce.

The victorious advance of the Turks, the fall of Constantinople, the piracy in the Mediterranean, and the termination of all intercourse with China on the decline of the Mongol dynasty in the fourteenth century, combined with other circumstances to turn men's minds towards the discovery of a more convenient way to the East. India was the dream of the fifteenth-century merchant, and how to reach it by a direct sea voyage was the problem of the day. The problem was solved when Vasco de Gama reached the shores of India on May 20, 1498; and its solution was due to the wise policy of a great-grandson of Edward III., Prince Henry of Portugal, 'the Navigator,' who unfortunately died before success was attained. The discovery of the Cape route was no mere accident, but the result of scientific training, deep study, careful preparation, and indomitable perseverance. Prince Henry having determined to find a direct sea route to India, invited the most eminent men of science to instruct a number of young men who were educated under his own eye, and in a few years he made the Portuguese the most scientific navigators in Europe. The successful voyage of Vasco de Gama soon produced important results; the saving in freight by the direct sea route was enormous, and when it became generally known that the products of the East could be obtained much cheaper in Lisbon than anywhere else, that city became the resort of traders from every part of Europe. From Lisbon Indian commodities were carried to Antwerp, which soon became the emporium of Northern Europe. By these changes the trade of Venice was almost annihilated, and Lisbon became the richest commercial city in Europe. The Venetians had endeavoured to confine commerce within its existing limits, and to keep to the trade routes then in use. They had never made any attempt to enlarge the sphere of nautical and commercial enterprise, and the consequence was that their ablest seamen, imbued with the spirit of adventure, took service in the Western States. When the Cape route was discovered, instead of attempting to secure a share in the direct sea trade, they entered into an alliance with the Sultan of Egypt to crush the Portuguese, and built a fleet for him at Suez, which was defeated by Almeida in 1508. After this defeat the trade of Venice soon passed away.

Since the discovery of the Cape route there has been one long struggle for the possession of the commerce of India; who should be the carriers and distributors of Indian commodities was for more than two and a half centuries a much contested point amongst the maritime nations of the West. At first there seems to have been a general acquiescence in the claim of the Spaniards and Portuguese to a monopoly of the southern sea-routes, and this led to those heroic efforts to find a north-east or north-west passage to India which have so greatly added to our geographical knowledge. Failure in this direction was followed by attempts to reach India by the Cape in the face of the hostile attitude of Spain and Portugal. The mighty events which in turn transferred wealth and commerce from Lisbon to Antwerp, Amsterdam, and the banks of the Thames are matter of history, and it is scarcely necessary to say that at the close of the Napoleonic wars England remained undisputed mistress of the sea, and had become not only the carrier of all ocean-borne traffic, but the distributing centre of Indian goods to the whole world. A period of keen competition for a share in the commerce of India has again commenced amongst the states of Europe, and symptoms of a coming change in the carrying and distributing trade have been increasingly apparent since Africa was separated from Asia, nearly twenty years ago, by the genius of M. de Lesseps.

The opening of the Suez Canal, by diverting trade from the Cape route to the Mediterranean, has produced and is still producing changes in the intercourse

between the East and the West which affect this country more nearly, perhaps, than any other European state. The changes have been in three directions.

First. An increasing proportion of the raw material and products of the East is carried direct to Mediterranean ports, by ships passing through the Canal, instead of coming, as it once did, to England for distribution. Thus Odessa, Trieste, Venice, and Marseilles are becoming centres of distribution for Southern and Central Europe, as Antwerp and Hamburg are for the North; and our merchants are thus losing the profits they derived from transshipping and forwarding Eastern goods to Europe. It is true that the carrying trade is still, to a very great extent, in English hands; but should this country be involved in a European war the carrying trade, unless we can efficiently protect it, will pass to others, and it will not readily return. Continental manufacturers have always been heavily handicapped by the position England has held since the commencement of the century, and the distributing trade would doubtless have passed from us in process of time. The opening of the Canal has accelerated the change, to the detriment of English manufactures, and consequently of the national wealth; and it must tend to make England less and less each year the emporium of the world. We are experiencing the results of a natural law that a redistribution of the centres of trade must follow a rearrangement of the channels of commerce.

Second. The diversion of traffic from the Cape route has led to the construction of steamers for special trade to India and the East through the Canal. On this line coaling stations are frequent, and the seas, excepting in the Bay of Biscay, are more tranquil than on most long voyages. The result is that an inferior type of vessel, both as regards coal-stowage, speed, endurance, and seaworthiness has been built. These 'canal wallahs,' as they are sometimes called, are quite unfitted for the voyage round the Cape, and should the Canal be blocked by war or accident they would be practically useless in carrying on our Eastern trade. Since the Canal has been deepened they have improved, for it has been found cheaper to have more coal-stowage, but they are still far from being available for the long voyage round the Cape. Had the Canal not been made a large number of fine steamers would gradually have been built for the Cape route, and though the sailing ships which formerly carried the India and China trade would have held their own longer, we should by this time have had more of the class of steamer that would be invaluable to us in war time, and our trade would not have been liable, as it is now, to paralysis by the closing of the Canal.

Third. Sir William Hunter has pointed out that, since the opening of the Canal, India has entered the market as a competitor with the British workman; and that the development of that part of the empire as a manufacturing and food-exporting country will involve changes in English production which must for a time be attended by suffering and loss. Indian trade has advanced by rapid strides, the exports of merchandise have risen from an average of 57 millions for the five years preceding 1874 to 88 millions in 1884, and there has been an immense expansion in the export of bulky commodities. Wheat, which occupied an insignificant place in the list of exports, is now a great staple of Indian commerce, and the export has risen since 1873 from $1\frac{3}{4}$ to 21 million hundredweight. It is almost impossible to estimate the ultimate dimensions of the wheat trade, and it is only the forerunner of other trades in which India is destined to compete keenly with English and European producers.

The position in which England has been placed by the opening of the Canal is in some respects similar to that of Venice after the discovery of the Cape route; but there is a wide difference in the spirit with which the change in the commercial routes was accepted. Venice made no attempt to use the Cape route, and did all she could to prevent others from taking advantage of it; England, though by a natural instinct she opposed the construction of the Canal, was one of the first to take advantage of it when opened, and so far as the carrying trade is concerned she has hitherto successfully competed with other countries.

It is only natural to ask what the result of the opening of the Panama Canal will be. To this it may be replied that the Canal, when completed as a maritime canal, without locks, will promote commercial intercourse between the eastern and

western coasts of America; will benefit merchants by diminishing distances and reducing insurance charges; and possibly divert the course of some of the trade between the East and the West; but it will produce no such changes as those which have followed the construction of the Suez Canal.

The increasing practice of the present day is for each maritime country to import and carry the Indian and other commodities it requires, and we must be prepared for a time when England will no longer be the emporium of Eastern commerce for Europe, or possess so large a proportion as she now does of the carrying trade. So great, however, is the genius of the English people for commercial enterprise, and so imbued are they with the spirit of adventure, that we may reasonably hope loss of trade in one direction will be compensated by the discovery of new fields of commercial activity. The problem of sea-carriage has virtually been solved by the construction of the large ocean steamers which run direct from port to port without regard to winds or currents; and the only likely improvement in this direction is an increase of speed which may possibly rise to as much as thirty knots an hour. The tendency at present is to shorten sea-routes by maritime canals; to construct canals for bringing ocean-going ships to inland centres of industry; and to utilise water carriage, wherever it may be practicable, in preference to carriage by land. For a correct determination of the lines which these shortened trade routes and great maritime canals should follow, a sound knowledge of geography and of the physical condition of the earth is necessary; and instruction in this direction should form an important feature in any educational course of commercial geography. The great problem of the future is the inland carrying trade, and one of the immediate commercial questions of the day is—who is to supply the interiors of the great continents of Asia and Africa, and other large areas not open to direct sea traffic? Whether future generations will see

‘The heavens fill with commerce, argosies of magic sails,
Pilots of the purple twilight, dropping down with costly bales,’

or some form of electric carriage on land, may be matter for speculation; but it is not altogether impossible to foresee the lines which inland trade must follow, and the places which must become centres of the distributing trade, or to map out the districts which must, under ordinary conditions, be dependent upon such centres for their supply of imported commodities. The question of supplying European goods to one portion of Central Asia has been partially solved by the remarkable voyage of Mr. Wiggins last year, and by the formation of the company of the ‘Phoenix Merchant Adventurers.’ Mr. Wiggins started from Newcastle-on-Tyne for Yeniseisk, the first large town on the Yenesei, some 2,000 miles from the mouth of that river and within a few hundred versts of the Chinese frontier. On the 9th October, 1887, he cast anchor and landed his cargo in the heart of Siberia. The exploit is one of which any man might well be proud, but in Mr. Wiggins’s case there is the additional merit that success was the result of conviction, arrived at by a strict method of induction, that the Gulf Stream passed through the Straits into the Kara Sea, and that its action, combined with that of the immense volume of water brought down by the Obi and Yenisei, would free the sea from ice and render it navigable for a portion of each year. The attempts of England to open up commercial relations with the interior of Africa have too often been marked by want, if not open contempt, of geographical knowledge, and by a great deficiency of foresight; but the competition with Germany is forcing this country to pay increased attention to African commerce, and the formation of such companies as the British East African Company, the African Lakes Company, and the Royal Niger Company is a happy omen for the future.

Another branch of the subject to which attention may be briefly directed is the fact that it is becoming increasingly evident that manufactures cannot profitably be carried on at a distance from the source of the raw material and the destination of the products. In India, for instance, where the first mill for the manufacture of cotton yarn and cloth was set up in 1854, there are now over 100 cotton and jute mills with 22,000 looms and 2,000,000 spindles; and similar changes are taking place elsewhere.

I am afraid that I have frequently travelled beyond the sphere of geography. My object has been to draw attention to the supreme importance to this country of the science of commercial geography. That science is not confined to a knowledge of the localities in which those products of the earth which have a commercial value are to be found, and of the markets in which they can be sold with the greatest profit. Its higher aims are to divine, by a combination of historical retrospect and scientific foresight, the channels through which commerce will flow in the future, and the points at which new centres of trade must arise in obedience to known laws. A precise knowledge of the form, size, and geological structure of the globe; of its physical features; of the topographical distribution of its mineral and vegetable products, and of the varied forms of animal life, including man, that it sustains; of the influence of geographical environment on man and the lower animals; and of the climatic conditions of the various regions of the earth, is absolutely essential to a successful solution of the many problems before us. If England is to maintain her commanding position in the world of commerce she must approach these problems in the spirit of Prince Henry the Navigator, and by high scientific training fit her sons to play their part like men in the coming struggle for commercial supremacy. The struggle will be keen, and victory will rest with those who have most fully realised the truth of the maxim that 'knowledge is power.'

I may add that if there is one point clearer than another in the history of commerce it is this:—that when a state cannot effectually protect its carrying trade in time of war, that trade passes from it and does not return. If England is ever found wanting in the power to defend her carrying trade, her fate will only too surely, and I might almost say justly, be that of Venice, Spain, Portugal, and Holland.

I will now ask you to turn your attention for a few moments to another subject—Africa. In 1864 Sir Roderick Murchison alluded to the great continent in the following terms: 'Looking at the most recent maps of Africa, see what enormous *lacunæ* have to be filled in, and what vast portions of it the foot of the white man has never trodden.' It was then impossible to give a general sketch even of the geography of Equatorial Africa. Tanganyika and Nyassa had been discovered, and Speke and Grant had touched at a few points on the southern, western, and northern shores of the Victoria Nyanza; but we were still in ignorance of the drainage and form of the immense tract of country between the Tanganyika Lake and the Zambesi; and the heart of Africa, through which the mighty Congo rolls, was as much unknown to us as the centre of America was to our ancestors in the middle of the sixteenth century. There are now few school-boys who could not give a fairly accurate sketch of the geography of Central Africa; and a comparison of the maps published respectively in 1864 and 1888 will show how rapidly the *lacunæ* of which Sir Roderick complained are being filled in. There is still much to be done, and it is precisely in one of the few blank spots left on our maps that the man who may well be called the Columbus of Africa has so mysteriously disappeared. The discovery of the course of the Congo by Stanley has been followed by results not unlike those which attended the discovery of America by Columbus. In the latter part of the nineteenth century Africa has become to Europe what America was in the sixteenth century. Events march more rapidly now than they did then, and the efforts of the maritime nations of Europe to secure to themselves some portion of African territory and some channel through which they can pour their products into Central Africa are rapidly changing the condition of the Dark Continent.

The roads over which the land trade of Equatorial Africa now passes from the coast to the interior are mere footpaths, described by Professor Drummond in his charming book 'Tropical Africa' as being 'never over a foot in breadth, beaten as hard as adamant, and rutted beneath the level of the forest bed by centuries of native traffic. As a rule these footpaths are marvellously direct. Like the roads of the old Romans, they run straight on through everything, ridge and mountain and valley, never shying at obstacles, nor anywhere turning aside to breathe. Yet within this general straightforwardness there is a singular eccentricity and indirectness in detail. Although the African footpath is on the whole a bee-line, no

fifty yards of it are ever straight. And the reason is not far to seek. If a stone is encountered no native will ever think of removing it. Why should he? It is easier to walk round it. The next man who comes that way will do the same. . . . Whatever the cause, it is certain that for persistent straightforwardness in the general, and utter vacillation and irresolution in the particular, the African roads are unique in engineering.' No country in the world is better supplied with paths; every village is connected with some other village, every tribe with the next tribe, and it is possible for a traveller to cross Africa without once being off a beaten track. The existence nearly everywhere of a wide coast plain with a deadly climate, and the difficulties attending land transport in a country where the usual beasts of burden, such as the camel, the ox, the horse, and the mule, cannot be utilised, will probably for many years retard the development of the land trade. On the other hand, the Congo with its wide-reaching arms, the Niger, the Nile, the Zambesi, the Shiré, and the great lakes Nyassa, Tanganyika, and the Victoria and Albert Nyanzas offer great facility for water transport, and afford easy access to the interior without traversing the pestilential plains. Already steamers ply on most of the great waterways—each year sees some improvement in this respect; and a road is in course of construction from Lake Nyassa to Tanganyika which will tend, if Arab raiders can be checked, to divert inland traffic from Zanzibar to Quilimane, and will become an important link in what must be one of the great trade routes in the future. It is possible, I believe, with our present knowledge of Africa, and by a careful study of its geographical features, to foresee the lines along which trade routes will develop themselves and the points at which centres of trade will arise; but I have already detained you too long, and will only venture to indicate Sawákin, Mombasa, Quilimane, or some point near the mouth of the Zambesi, and Delagoa Bay, as places on the east coast of Africa which, from their geographical position, must eventually become of great importance as outlets for the trade of the interior.

The future of Africa presents many difficult problems, some of which will no doubt be brought to your notice during the discussion which, I trust, will follow the reading of the African papers; and there is one especially—the best means of putting an end to slave-hunting and the slave-trade—which is now happily attracting considerable attention. It is surely not too much to hope that the nations which have been so eager to annex African soil will remember the trite saying that 'property has its duties as well as its rights,' and that one of the most pressingly important of the duties imposed upon them by their action is to control the fiends in human form who, of set purpose, have laid waste some of the fairest regions of the earth, and imposed a reign of terror throughout Equatorial Africa.

The following Papers and Report were read:—

1. *Le Canal de Panama.*¹ Par F. DE LESSEPS.

2. *Meteorological Conditions of the Red Sea.*
By Lieut.-General STRACHEY, F.R.S.

3. *Sea Temperatures in the neighbourhood of Cape Guardafui.*²
By Lieut.-General STRACHEY, F.R.S.

4. *The Salinity of the Clyde Sea Area.*³
By HUGH ROBERT MILL, D.Sc., F.R.S.E.

The observations made by the staff of the Scottish Marine Station on the Clyde sea area during the years 1886 and 1887 show that the salinity of the bottom

¹ Published in the *Proceedings of the Royal Geographical Society*, Oct. 1888.

² *Ibid.* Nov. 1888.

³ Published *in extenso* in the *Transactions of the Royal Society of Edinburgh*.

water changes comparatively little with the season, always diminishing slightly from the sea towards the head of the various lochs. The surface water also freshens close to the shore and towards the upper part of the lochs; but its salinity at any time depends largely on the actual rainfall and on the height and steepness of the surrounding mountain walls, being sometimes quite fresh and freezing in severe frosts. The saltiest surface water was almost invariably found near the Otter Spit in Loch Fyne fifty miles from the open sea; the tidal current moving from deep to shallow water carries up the saltier lower layers. Wind currents produce even more striking effects. When a gale blows *down* a loch, the saltiest surface water is found at the head, even though a stream enters in the immediate neighbourhood, in the position where normally it is freshest. This is in consequence of the upwelling of salt water from beneath to replace the surface layers driven away by the wind, and fully confirms Mr. Murray's theory (suggested by temperature observations) of the circulation of water in enclosed basins. Following are the average results of from eight to fourteen observations at a few selected stations spread over two years, the density being that at 60° F. (15.56° C.).

Station	Surface	Bottom	Depth
			fathoms
Mull of Cantire	1.02536	1.02540	60
South of Arran	1.02459	1.02503	25
Off Brodick	1.02444	1.02522	80
Off Skate Island	1.02446	1.02508	106
Outside Otter Spit, Loch Fyne	1.02461	1.02497	35
Off Strachur	1.02226	1.02458	75
Head	1.01435	1.02427	15
Head of Loch Strivan	1.02153	1.02465	12
Off Dunoon	1.02325	1.02476	50
Head of Loch Long	1.01945	1.02440	10
Mouth of Gareloch	1.02223	1.02407	20
Head	1.02238	1.02338	10

5. *Sea Temperatures on the Continental Shelf.*¹

By HUGH ROBERT MILL, D.Sc., F.R.S.E.

The name 'continental shelf' is applied to the shallow and gradually sloping ground from the sea-margin out to the 100-fathom line, beyond which the descent to abysmal depths is abrupt. The British Islands rest on one of the widest continental shelves in the world, and the present paper summarises observations made by the author on its western edge. The observations were carried out at the request of the Fishery Board for Scotland on board H.M.S. 'Jackal' in July and August 1887, and consisted of lines of serial temperature soundings from the north-west coast of the island of Lewis seawards to beyond the 100-fathom line. This portion of the continental shelf is terraced, and the slope varies in different places. It is broken by the long Flannan bank and the small circular bank of St. Kilda, and grooved by several deeper channels. The *form* of the curves of vertical distribution of temperature and the direction of the isotherms in the temperature sections show that the water reaching the seaward edge of the shelf from the ocean consists normally of a layer more than twenty-five fathoms deep at a uniform temperature of 56°, resting on a mass of water at a temperature of 48° or 49°. The action of waves partially mixes the two layers, and they were found separated by a zone about fifteen fathoms thick, in which the temperature changed rapidly with depth. The prevailing westerly wind and eastward tidal current produced changes in this typical arrangement of layers in exact relation with the configuration of the sea-bed. The warm layer, meeting no resistance from in-

¹ Published *in extenso* in the *Scottish Geographical Magazine*, Oct. 1888.

equalities on the bottom, flows on to the shore, and tends to accumulate there, flowing back as an undercurrent, and so giving a deeper layer of warm water or a wider zone of mixture near the land. The effect of a bank is different: the colder mass of water runs up the slope, reducing the thickness of the warm layer over the bank and maintaining a lower temperature on the other side.

The chief conclusion arrived at is that the temperature of sea-water depends little on local air-temperature, but mainly on the configuration of the sea-bottom and the direction of the currents caused by tide and wind. The observations on salinity bear out these conclusions.

6. *Perspective Maps and Common Maps.*
By ARTHUR W. CLAYDEN, M.A., F.G.S.

The author called attention to the inaccuracy essential to all maps, and to the great distortion which may occur in maps of large areas like those of continents or oceans. Notice was especially drawn to the comparative uselessness of the scale of miles usually attached to such maps. It was suggested that for elementary educational purposes such maps could be advantageously replaced by others drawn in true perspective, as a better notion would thereby be given of the true figure of the earth and the relative proportions of its chief features.

7. '*Little Russia.*'¹ By E. DELMAR MORGAN, F.R.G.S.

The region known as 'Little Russia' has no definite landmarks; some place its centre at Kharkof, others at Poltava, but at these cities I was referred to Kief, and at Kief to Luof, or Lemberg, in Austrian Galicia, if I wished to acquaint myself with the so-called Little Russian movement. Anyone wishing to study the country thoroughly should visit all these places, make some stay in the country, and read the voluminous literature on the subject. My claim to be considered an authority rests only on a few weeks passed this summer in Kharkof, Poltava, and Kief, and short excursions in each of those provinces.

Kharkof is a rising city, a Russian Chicago, with a university, founded about eighty years ago, and a select literary circle. The prevailing feeling at Kharkof is that Moscow must be considered as the mother of Slav nationalities, however much like a stepmother she may behave. This is attributable to the large admixture of great Russians in the population and the material prosperity everywhere apparent. At Kharkof, Little Russians gradually lose their distinctive characteristics and language.

At Kharkof there is a summer theatre at which national plays are acted in the Little Russian language, every attention being paid to the exact reproduction of the dress, customs, &c., of this people. From Kharkof I made an expedition to the monastery of 'Sviatiye Gori,' the 'Holy Hills,' on the right bank of the Donets. I reached it on the anniversary of its first abbot, Arsenius, and found a great number of pilgrims assembled there from various parts of Russia. This monastery ranks next to the Pecherski Lavri of Kief in importance in southern Russia. The general appearance of the country is that of a cultivated boundless plain, with occasional mounds or kurghans rising above the surface to a height of 50 or 60 feet. These are the burial-places of the earlier nomadic inhabitants, according to recent investigations.

Poltava, my next halting-place, is situated on heights overlooking the Vorsklo. Notwithstanding its dreary and somewhat dilapidated appearance it is the heart of Little Russia, and its associations carry one back to the most stirring events in the history of that nationality. I made an excursion from Poltava to Count Kochubey's estate and thence to Oposhnia, where the home industries, especially pottery, leather-dressing, &c., are important. The whole of Poltava and its neighbouring provinces are overrun by Jews, much to the injury of the inhabitants. On the way to

¹ Published *in extenso* in the *Scottish Geographical Magazine*, Oct. 1888.

Sorotchnitsi, in the valley of the Psiol, I visited a Stundist, one of a sect which is likely to cause no little trouble to the Government, the measures hitherto taken against them having defeated their object.

The Little Russians are a finer race than the Great Russians; they are enterprising colonists, and the charge of laziness made against them is unfounded. Their social and political tendencies are different from those of the Great Russians. Whereas these favour communal tenure and the patriarchal family life, Little Russians are all for individualising property and severing the family tie. In earlier times their *gromada*, answering to the *Mir* of Great Russia, freely discussed local affairs. The present aristocracy of landowners is descended from the Hetmans and other officers of Cossacks who were in power at the time of the rebellion against Poland in the seventeenth century and their union with Russia, or Muscovy as it was then called.

8. *Third Report of the Committee appointed for the purpose of drawing attention to the desirability of prosecuting further research in the Antarctic Regions.*—See Reports, p. 316.

FRIDAY, SEPTEMBER 7.

The following Papers were read:—

1. *Explorations on the Chindwin River, Upper Burmah, in 1886–87.*¹
By Colonel WOODTHORPE, R.E.

2. *A new Route from India to Tibet.*¹ By Captain W. J. ELWES.

3. *Russian Topographical Surveys.* By E. DELMAR MORGAN, F.R.G.S.

4. *Notes on the Geography of the Region from the Nile to the Euphrates as known to the ancient Egyptians.*² By the Rev. HENRY GEORGE TOMKINS.

No route was so important in the most ancient times as the great drift-way from the Persian Gulf to the Nile mouths by way of the Orontes valley, Coele-Syria and Palestine, or of Damascus and across the Jordan. The Egyptians were the greatest of primæval geographers, and have preserved for us on a profuse scale their records. Narratives of conquest, tribute-lists, despatches and private letters, and many other memorials have come down as our materials; and none are more interesting than the *cuneiform* tablets lately found at Tel-el-Amarna in Upper Egypt.

The results of examination are not yet fully available, but we are quickly filling up the map of all the country from the Egyptian eastern frontier to the banks of Euphrates for the ages before the conquest of Joshua.

From the fortified border of the Delta three routes led eastwards and northwards across the desert. 1. From Tanis (Zoan) by Pelusium along the coast. 2. From the Wâdy Tumilat, the ancient road rediscovered by the Rev. F. W. Holland. 3. The way of the Red Sea, represented by the present Hajj road.

The Etham of the Exodus was not any *Khetam*, but the Atima of the papyri, probably the el Adâm mentioned by the Rev. Greville Chester between Pelusium

¹ Published in the *Proceedings of the Royal Geographical Society*.

² Published *in extenso* in the *Quarterly Statement of the Palestine Exploration Fund*.

and Daphnæ (Tahpanhes). Seti I. has given us his military route, with its fortified watering stations in the desert, to the stronghold of Kanāna south of Hebron.

A very important place, besieged and taken after the expulsion of the Hyksôs by Aahmes the founder of the XVIII. dynasty, is Sharuhen, now Tel-esh-Sheriâh, north-west of Beersheba. It used to be thought that the Egyptian armies avoided the mountain masses of Palestine. But a careful examination of the Karnak tribute-lists leads to quite a different conclusion.

The coast route was deflected far inland by a dense and impracticable forest, haunted by brigands, between Joppa and Carmel. But the hill-country was brought under the military control of Egypt by the great kings of the eighteenth dynasty.

The names of the tribute-lists are to a great extent identical with the Biblical names in the book of Joshua, &c., and many of them occur in Assyrian annals, and the greater part may be found not greatly altered as the present local names. Askalon, Joppa, Gaza, Megiddo, were Egyptian garrisons.

The great fords of the Jordan were covered by military posts on the east side, and the great route down into Arabia was secured.

Tabor and Merom and Laish were points of note. The fords of Jordan, and the Litāny (Nazana) are mentioned, and the Nabr-el-Kelb bears its own monumental testimony to the conquerors.

The Lebanon supplied its cedar and pine timber to the Pharaohs, who had garrisons there.

Along the southern Nahr-el-Kebir (Eleutherus) a great route led to the Orontes and its fortress Kadesh in the land of the Amorites.

The Orontes valley is full of names which we meet in Egyptian tribute-lists and narratives of campaigns, and several occur near Antioch and in the Taurus.

The northern list of Thothmes III. furnishes 230 names, besides 119 in the Palestine list.

Very careful examination now shows that at least 20 of the northern names as along the Euphrates, including Pethor (of Balaam), Karkemish, and Kirkesion, and three important fortified towns renowned in the Egyptian campaigns, Anukie (Anukas of Procopius, refortified by Justinian); Hurenkal; and Inuā (perhaps Haragla or Herakleh and Einya, both on the Euphrates).

The land of Naharina extended east and west of the Euphrates, as we learn from Egyptian texts, but in the cuneiform tablets of Tel-el-Amarna it is identified with the land of Mitāni between the Euphrates and the Khabûr river. These tablets show us that the Pharaohs Amenhotep III. and IV. (Khu-en-aten) were overlords of Assyria and Babylonia, and this agrees well with the principal places on both sides of the Euphrates being included in the tribute-list of Thothmes III. A list of Euphratean names will illustrate this, reaching from above Bir-ejik to some 100 miles below Kirkesion, including positions on the east side commanding great passages of the river. Further eastward it is not proposed to go in the present paper. But the inclusion of Damascus and other places on the great route across the Jordan near Beth-shan, and the old Hajj road towards Arabia, in the lists of Thothmes is thoroughly congruous with such substantial conquest as we have now ascertained. This was the old line of march of Kedorla'omer in the days of Abraham, and in the list of Thothmes we find the same memorials in the Ono-rapha which preserves the name of the Rephaim, and Ashtaroth where these people were smitten, and perhaps Hum is the Ham (חם), where the Zuzim were likewise smitten by the old Êlamite suzerain. Now the tables had been turned, and Egypt was lord of the Euphrates.

The Egyptians, for all their appliances of easy life, were a very enterprising people, and highly trained both as conquerors and administrators, and were continually forced to supply their needs from foreign lands and to defend themselves by keeping their enemies in order.

These things help to account for the thorough knowledge which they had of the geography between their own Nile and the great river Euphrates, which we are able to ascertain by Biblical and Assyrian and classic records, and by the innumerable names still fresh on the lips of the inhabitants.

The successful studies of Mariette, de Rougé, Brugsch, de Saulcy, Maspero, Conder, and others should but stimulate us, both scholars and travellers, to more perfect methods and more exhaustive results.

5. *Remarks on Mr. Tomkins' Paper.*¹ By Major CONDER, R.E.

The questions raised have been discussed for twenty years. Mr. Tomkins' geographical discoveries in Northern Syria have added to our knowledge. The races and towns known to Egyptians enable us to carry back the history and geography of Syria to 1600 B.C. The portraits of Asiatics on the monuments enable us to distinguish the races. One of these was Semitic—as shown by the geographical names. The other was Turanian—as shown by similar information. The details of personal appearance agree with this distinction, which explains the statements of the Bible as to the population of Palestine.

The geographical position of the Kheta in various ages was discussed. In Abraham's time it was as far south as Hebron, but in 1340 B.C. only in the north. The Kheta were Tartars, as shown by physical type and names of chiefs. The influence of this Turanian population on Semites as shown by language was pointed out.

Lenormant, treating on the geographical distribution of the Turanians, says they are akin to the Akkadians. He states them to have spread all over Asia Minor. Geographical nomenclature provides one of the safest methods of tracing race.

6. *Recent Explorations East of the Jordan.*
By Captain A. M. MANTELL, R.E.

The portions of eastern Palestine which have been recently explored are three in number, viz., five hundred square miles surveyed by Major Conder, R.E., to the north-east of the Dead Sea, and two portions of 450 and 240 square miles respectively near the sea of Galilee, surveyed by Herr Schumacher. The principal points were fixed with the theodolite and a triangulation linked with that of western Palestine. Detail was filled in with the prismatic compass and altitudes of subsidiary points fixed by means of the aneroid barometer. At the same time information was collected as to the Arab tribes and their history, and ruins, dolmens, &c., were measured up and sketched. Some difficulty was experienced in ascertaining the names of places, but still more in spelling them with correct Arabic letters.

About thirty Biblical sites have been recently recovered, including Mount Peor and Bamoth Baal.

Some time was spent at Ammân, a city abounding in Roman ruins. The Muhammedan remains are less important, but include a Sassanian building which throws light on early Moslem architecture. Rabboth Ammon is now occupied by a colony of Circassians.

'Arâk el Emir and the ruined palace of Hyrcanus were also sketched and photographed. They are found to agree very well with Josephus' description. Several hundred dolmens were observed, plans and sections being taken of the best preserved; those in Moab seem to be sacrificial not sepulchral. A number of menhirs were discovered, and plans were made of several large ancient stone enclosures. The latter are often imitated at the present day on a small scale. Tombs are surrounded by circular enclosures, at which the Bedowy prays and makes his offerings.

Two groups of the stone pillars called 'Serâbit' and several disc stones were also found.

Herr Schumacher's work in the Jaulân and Haurân was executed while surveying the country for a railroad to Damascus. He has drawn up geographical gazetteers of the various districts. Through his work the ancient Kokaba has been discovered. He has also fully described some of the underground cities.

¹ Published in the *Quarterly Statement of the Palestine Exploration Fund.*

In addition to the above he has surveyed and written a pamphlet on the ancient Pella.

Herr Schumacher has examined numerous dolmens, and come to the conclusion that they are sepulchral in their origin.

A large part of eastern Palestine still remains to be surveyed; a work which ought to be carried out at the first opportunity.

7. *Jerusalem: Nehemiah's Wall and the Royal Sepulchres.*
By GEORGE ST. CLAIR, F.G.S.

The topography of ancient Jerusalem has been difficult to make out, and the site of the sepulchres of the kings of Judah remains unknown. But the problem has been simplified by recent excavations, with which the writer has a professional acquaintance. We now for the first time know the contours of the rock and the features of hill and valley before the 80 ft. of *débris* began to accumulate.

The Akra of the Maccabees being identified, it is seen how, by the recorded filling up of the Asmonean valley, the two parts of the Lower City became joined into one *crescent*, lying with its concave side towards the Upper City, according to the description of Josephus.

The investigations of Sir Charles Warren show that the temple must be placed on the summit of Moriah, with Solomon's palace south-east of it, leaving a vacant square of 300 ft. where now we have the S.W. corner of the Haram area.

From the S.E. corner of the Haram enclosure extends the wall of Ophel, discovered by Warren, running 76 ft. to the south, then bending towards the south-west. Further, it is found that from the Gate of the Chain, in the west wall of the Haram enclosure, a causeway, with complicated structures, extends westward towards the Jaffa Gate.

Having this groundwork we may proceed to place the walls:—

The third wall, built by Agrippa, does not concern us.

As regards the second wall, it suffices for the present purpose to adopt the line of Herr Conrad Schick.

The first wall was the wall of the Upper City. On the northern side it ran from the Jaffa Gate to the Haram wall. The uncertainty has been about its southern portion. The author gives, on a diagram, the line he has been led to adopt, and then shows that it corresponds in detail with the descriptions in the Book of Nehemiah. Taking Nehemiah's night survey, then the consecutive allotments of work assigned to those who repaired the walls, and, thirdly, the points successively reached and passed by the processionists when the walls were dedicated, it is shown that every mention of a gate or a tower, the number and the order of salient and re-entering angles, and every other note of locality, exactly agree with the course of the walls as suggested.

This course, moreover, involves the least possible variation from the present line of walls, and that more in the way of addition than of deviation.

The hypothesis, commending itself as true, by corresponding minutely with Nehemiah's descriptions, by tallying exactly with other Biblical references, and by meeting all the requirements of the case, has this important practical bearing, that it indicates the site of the royal sepulchres, of the stairs of the City of David, of 'the gate between two walls,' &c., and shows incontestably that Zion was the eastern hill.

SATURDAY, SEPTEMBER 8.

The Section did not meet.

MONDAY, SEPTEMBER 10.

The following Papers were read:—

1. *Tunis since the French Protectorate.*¹
By Colonel Sir LAMBERT PLAYFAIR, K.C.M.G.

The system of government adopted is totally different to that of Algeria, which may be styled 'Colonisation de luxe.' No state assistance of any kind is given, not an immigrant has been imported, not an acre of Arab land has been confiscated, and the whole civil charges borne by France do not exceed 6,000*l.* a year.

A very short time ago the interior of the country was practically a *terra incognita*; now it is being rapidly opened out to European enterprise, and it promises soon to rival Algeria in what must always be the principal industry of North Africa, viticulture.

Commerce also has increased in a notable manner, but the beautiful and characteristic arts of the country appear to be in a state of decadence.

It is impossible to speak of Tunis and be silent regarding the most eminent Frenchman there, Cardinal Lavigerie, Archbishop of Carthage and Primate of Africa, who, by the great work he has carried out, has earned the reputation of ranking almost the highest amongst the prelates of his Church. He has now been sent by the Sovereign Pontiff to preach a crusade against the nameless horrors of the African slave trade in every capital of Europe. The Cardinal's aim is first to awaken the public conscience to the enormity of the wrong which is being daily perpetrated, and which is rapidly desolating one of the fairest portions of the earth's surface, and so to prepare the way for any remedy which His Holiness may have to suggest; and which, coming from him, might well be accepted by every Christian nation in Europe, Catholic and Protestant alike.

2. *The Commercial Future of Central Africa.*¹ By Sir FRANCIS DE WINTON.

3. *Bechuanaland and the Land of Ophir.*² By the Rev. JOHN MACKENZIE.

4. *The Transvaal, or South African Republic.* By P. H. FORD.

5. *The Cameroons.*³ By H. H. JOHNSTON.

6. *Dr. Livingstone and Lake Bangweolo.* By E. G. RAVENSTEIN.

7. *Notes from the Atlas Mountains.* By JOS. THOMSON.

8. *Akkas and Dwarfs in Southern Morocco.* By R. G. HALIBURTON.

9. *Through Kakongo.* By Q. E. DENNETT.

¹ Published *in extenso* in the *Proceedings of the Royal Geographical Society*, Nov. 1888.

² Published in the *Proceedings of the Royal Geographical Society*, Nov. 1888.

³ Published in the *Scottish Geographical Magazine*, Oct. 1888.

TUESDAY, SEPTEMBER 11.

The following Papers were read :—

1. *Photographic and Photozincographic Processes employed in the Ordnance Survey.* By Colonel J. H. BOLLAND, R.E.

2. *Note on Geographical Terminology.*¹ By H. J. MACKINDER, M.A.

3. *The River of Joseph, the Fayum and Raian Basins.*
By COPE WHITEHOUSE, M.A.

The map exhibited (scale 1 in 50,000) is the result of surveys made during 1887-8, under the immediate direction of the Egyptian Government. In conformity with instructions drawn up by Colonel Western, R.E., Director-General of Works, Messrs. Lieurnur and Beychalier, of the Public Works Department, were occupied from November, 1887, to March, 1888. The results are in entire conformity with the observations heretofore presented, and demonstrate the accuracy of the sketch-map made by Captain Surtees, and the five previous lines of levels run by Mr. Stadler and Major Shahn in the various expeditions of Mr. Cope Whitehouse. The area of the Raian Basin at the contour of 30 metres (high Nile) is 686 sq. kilom., or about 180,000 acres. Its eastern extension—the Wadi Lulu—is separated from the Gharaq Basin of the Fayum by a long narrow bank of hard clay and soft conglomerate, covered with blackish sand, 1,000 to 2,000 metres in width. Another small basin, the Wadi Safir, connects with the Gharaq basin at level + 26 m., and the Raian Basin connects with the same depression at + 25 m. The names of *Lulu* (the Pearl) and *Safir* (the Sapphire) have been given to these basins, in view of their future use as the gate, and preliminary reservoir, when the Wadi *Raian* (irrigation) is filled and utilised as an escape for the Nile Flood and an impounding reservoir for the season of drought. The engineering details are stated in the paper in the Engineering Section. The similarity of shape with the Lake Moeris of the Ptolemaic maps is more fully developed. The Wadi Muellah—a depression in the desert to the S.E., about 30 kilometres long and 6 kilometres wide—is separated from the Raian Basin by sandhills and rock, at a mean level of 50 m. A narrow strip, 8 kilometres long and $1\frac{1}{4}$ wide, lies about 5 metres below high Nile. The southern extremity of the valley has no connection with the Nile below + 100 m. It never, therefore, served as a channel for the Nile, but the distance is not sufficient to preclude a subterranean conduit.

The survey of the Fayum has not been completed, but it is hoped that contours will be run during the coming season around the north of the lake, and the exact height of the various ruins determined. It is now beyond cavil or dispute that the narrow passage at el-Lahun, with its dyke about 3 kilometres long and 10 metres high, is the only channel of communication at the level of high Nile between the great crevice which connects the watershed of Central Africa with the eastern Mediterranean and these depressions. The area of the Fayum at this level may be put at 2,500 square kilometres (1,000 square miles), and the Raian at 680 square kilometres (250 square miles); this surface of 3,180 square kilometres (1,250 square miles) was one vast sheet of water before the dyke at el-Lahun was established, not later than B.C. 1,400. The heavy alluvial deposits of the Fayum prove that the communication was uninterrupted for a long period within historic times. There are similar deposits in the Wadi Raian. Over 100 square miles are 70 metres (200 ft.) below the level of the Mediterranean. The basins, together or separately, are perfectly adapted to control the alternate flood and drought. The Raian basin is, however, sufficient, and the Fayum appears to have been fully reclaimed at a very early period, and again, in the Roman age, as it

¹ Published in the *Proceedings of the Royal Geographical Society*, Nov. 1888.

should be in the future. There is no question that the Arabic traditions are well founded. This is also the Pithom of the mediæval Jews and Copts, and the Auaris-Heroopolis of Manetho and the Seventy. It is a geographical problem of great importance, whose solution has been largely facilitated by the minute and accurate topography due to these protracted and laborious researches.

4. *Mission to El-Wedj.* By Captain CONYERS SURTEES.

El-Wedj is a port on the east coast of the Red Sea, used by the Egyptian pilgrims returning from Medina. In 1887 Turkish troops occupied the fort which commands the harbour. The author of this paper, temporarily seconded to the Egyptian army, was sent by the Egyptian Government to report upon the general condition of the region. Accompanied by an Egyptian officer and Mr. Cope Whitehouse, he inspected the New Fort, the Old Hill Fort of the ninth century, the alleged gold mines, a sulphur mountain, Roman remains in the Wadi Hamz, rock-hewn inscriptions, and encampments of various tribes. Photographs were exhibited, and the strategic and commercial importance of the district discussed. The whole of Egypt in Arabia east of the Gulf of Akaba has now been formally transferred to Turkey. The author is of the opinion that there is no auriferous quartz in this neighbourhood, but that petroleum does exist, and that the valleys might be occupied by a considerable population, if proper efforts were made to encourage permanent settlements.

5. *Notes on Topographic Maps produced by the United States Geological Survey.*¹ By G. K. GILBERT.

6. *On Pahang, an Independent State in the Malayan Peninsula.*
By W. BARRINGTON D'ALMEIDA.

7. *Formosa: Characteristic Traits of the Island and its Aboriginal Inhabitants.*² By GEORGE TAYLOR.

8. *On the general adoption of the Gregorian Calendar in relation with that of the universal hour.* By Dr. CÆS. TONDINI DE QUARENGHI.

The *Bologna Academy of Science* has, by a special memoir to all scientific bodies represented at the festivals of their centenary in June last, lately submitted to the consideration of the whole scientific world the importance and urgency of finally putting an end to a rather illusory situation, as that exemplified by the fact that the many conferences and congresses assembled for arriving at the unification of time have hardly resulted in anything more than mere aspirations and exchange of ideas.

The main difficulties opposing the realisation of that most important desideratum of science are two: the want of agreement on the starting-point for fixing the unity of time, that is, on the *initial meridian*, and the want of agreement as to the notation and subdivisions of the year—in other words, the want of agreement on the *calendar*. The question of the initial meridian belongs to Section A; here I will say a few words concerning the unification of the calendar.

Let us suppose that, in compliance with the message of the President of the United States, dated January 9 last, to the Congress of Washington, steps were actually and successfully taken to secure the execution of the resolutions of the Washington Conference; that all Powers had already subscribed to the following

¹ Published in the *Proceedings of the Royal Geographical Society*, Nov. 1888.

² *Ibid.*

article of the conference:—‘*The universal day is to be a mean solar day, is to begin for all the world at the moment of mean midnight of the initial meridian,*’ and that they should agree to begin with that midnight which is, for us, between December 31, 1888, and January 1, 1889. If this happens, but without anything having been said concerning the month and year according to which the first universal day is to be dated, will that first *universal* day be January 1, 1889? or December 20, 1888 (Orthodox Calendar)? or the 28th Rebi II., 1306 (Mahomedan Calendar)? or the 28th of Tebeth, 5649 (Jewish Calendar)? or the 30th of the 11th moon of the 25th year of the 76th sexagesimal cycle (Chinese Calendar)? If the first would-be *universal* day is all this at the same time, it will be anything but *universal*, and so poor a result, after so many more or less international congresses and conferences, as a day called universal, but belonging to calendars local, national, and quite particular, and named by them, would really suggest what a Frenchman would say: ‘*Le jeu ne valait pas la chandelle.*’

They make Russia responsible for the situation. One remark only. In 1872 the Japanese Government ordered that the Chinese Calendar should be superseded by our common Gregorian, and the difficulties which Japan had to encounter were certainly not inferior to those which Russia may advance; however the reform was carried on in Japan without the least disturbance. Now, no one single Russian would confess the impossibility for Russia to do what has been successfully done by Japan. How, then, is the behaviour of Russia to be explained? In a reply to a communication recently read to the Paris Geographical Society on the Chinese Calendar, General Tcheng-Ki-tong, the representative of China, gave us the cue of the riddle. His reply was much more an excuse for the delay of Russia than an apology for the maintenance of the Chinese Calendar. ‘The Gregorian Calendar,’ he said, ‘is far from realising the idea of what science may expect. Why, then, should we hasten to adopt a calendar which Europe will soon, in all probability, be obliged to modify?’

It is this strange current rumour concerning our calendar which offers a *pretext* to delays. Russian statesmen and scientific men know very well what to think of it; they are, moreover, fully aware that England, who had too prominent a part in determining Japan to adopt our calendar, would never have advised that Government ‘to adopt a calendar which Europe will soon, in all probability, be obliged to modify.’ But ultra-Slavophiles still use that prejudice for their purposes.

Now, I have reasons for believing that Russia is far from being unwilling that the last pretext of ultra-Slavophiles be publicly discussed, and that a strong current of opinion should loudly call for the abolition of an incorrect calendar. I received, at any rate, strong encouragements even from men of high position in Russia, and a letter, bearing from its source more than a merely private character, pointed out to me what Russia had done for the unification of the hour, thus giving me to understand that, by supporting that unification, Russia had already taken an indirect but mighty initiative in the correction of her calendar.

Before concluding, I beg to make a general remark. The unification of the calendar is only possible if urged within wise limits, that is, for purposes scientific or concerning the welfare of humanity, and in *mere scientific and international relations*. Let, then, every people be at liberty to go on using, in internal matters, their own national calendar, provided it be a correct one. Do we not use two calendars, the one lunar for our movable feasts and religious purposes, and the other solar for all other purposes? This custom indicates the line to be taken with nations attached to their calendar chiefly from religious feelings.

In concluding, if, by your kind and powerful support, you were to give in a few months to the unification of the calendar, *within the said wise limits*, a stronger impulse than the Bologna Academy of Science might be able to do in ten years, neither I nor the said academy would feel envious, but only thankful, and would sincerely rejoice in your well-deserved glory before the whole world.

SECTION F.—ECONOMIC SCIENCE AND STATISTICS.

PRESIDENT OF THE SECTION—The Right Hon. Lord BRAMWELL, LL.D., F.R.S.,
F.S.S.

THURSDAY, SEPTEMBER 6.

The President delivered the following Address:—

It gives me great pleasure to meet you here to-day as President of this Section. Forgive me if I trouble you with a purely personal reason—it is that my brother, Sir F. Bramwell, is President of this Association. That is a great distinction, of which he ought to be and is proud, and one in the enjoyment of which I am proud and glad to see him.

There is another reason, not so purely personal, though somewhat so. At a meeting of this Association nine years ago it was said—and in this Section—not that Political Economy was dead, but that it had never lived—that there never was such a science. This was an awful shock to me, who for nearly two-thirds of a century have been trying to learn something about it, and who have considered, and do consider, that there is no branch of knowledge more important than that of the truths of Political Economy. The argument attracted a good deal of notice, but for my own part I confess I never understood it. It was said that Political Economy was not an independent science, but a branch of one more extensive. It seemed to me as bad an argument as one which should say that ornithology was no science because it was only a part of natural history.

Whether Political Economy can be classed under some title comprehending it and other sciences, I know not. Perhaps 'Sociology' would do. But, whether it can or cannot, it is equally a science, equally a collection of truths relating to a particular subject which constitute the knowledge of that subject.

The truth is that Political Economy is not only a science, but a necessary science when men have formed themselves into a society. What will be the best way to add to the wealth of a society must be a subject of study by that society which will lay down rules—that is to say, make laws for the purpose—and this is Political Economy. Adam Smith was not the first Political Economist, though well called the father of those rules which now prevail. But rules for the purpose existed before him, the great objection to them being that most of them were wrong. There was a law that the dead should be buried in woollen. The object was the encouragement of sheep-breeding, and the reasons given were such as would be given nowadays in support of any proposal of protection or bounty for the agriculturist or grazier. Let us see. The most important of our industries is that which works the land. It employs great capital and much labour. If people are buried in woollen, wool will rise in price, sheep will be bred, mutton will be cheaper, and so on. So laws were made for fixing wages—laws were made against regrating and forestalling, which, as Adam Smith points out, were laws against providence and thrift—laws which would have made a criminal of Joseph, who saved in the seven abundant years, and showed himself sounder as an economist than our ancestors were.

Then think of the usury laws. All usury was thought wrong on religious

grounds. But in Henry the Eighth's time 10 per cent. was allowed, not because that was right and 11 per cent. wicked, but because it was supposed that trade would be injured if more than that percentage could be taken for interest. The percentage has been gradually lowered till forty or fifty years ago, when sound economical reasons prevailed, the usury laws were repealed, and now any amount can be taken. Mr. Henry George, however, of whom you may have heard, thinks all usury wrong. He calls himself an economist; perhaps rightly. If he is, he is a bad one.

You cannot deny that these were economical laws because you think them wrong. There are now free-traders and fair-traders—one is right, the other wrong. I think I know which is which, but I suppose each party would call itself economical, and could only be said not to be by the other because it was not right in its notions. So also, I suppose, the homœopathists and the allopathists are both doctors, both professors of the science of medicine, though one at least is wrong, perhaps both.

It may be said that all the instances I give are instances of erroneous economy. True. The good Political Economy of those times was abstinence from legislation—the cases where people were not meddled with. Buckle said, very truly, that the good done by modern legislation was the repeal of the old. But let us see a little of the good that right opinions on Political Economy have brought about.

It has made the workman a free man. He may employ himself in any work which he can get trusted to him. He may demand any wages he thinks right, refuse to work for less, and get all he can. He is no longer, by the mischievous laws of settlement, almost confined to the parish where he was born. He may go to any part of the kingdom in search of work. He is no longer subject to punishment for joining with his fellows to better his condition. He may combine with them, and agree that they will, as a body, refuse to work unless their wages are raised or other demands complied with. His doing so is no crime, provided he does not violate the freedom and rights of others.

Then look to capital. The capitalist may employ his capital as he thinks fit—in home trade or foreign trade, in using it himself, in lending it to others. He may join with others on the ordinary terms of private partnership, or in joint stock corporate partnership, with liability limited or unlimited, as he thinks fit.

But as to the goodness of following right economical rules, I say, 'circumspect.' Look around! They have been more studied and more followed here than anywhere else. Compare this country with any other. Look at its greatness, its wealth, the comfort of its people, of all classes, as compared with other countries. I do not deny our natural advantages, our mineral wealth, our admirable situation, and, mostly, the bodily and mental condition of our people. But they would have been comparatively wasted under bad economic laws. I may be told that the United States of America beat us for wealth and general prosperity, as to which I will only say that they are cultivating only their best land. We are driven to our worst. And, further, that their best writers and reasoners support very different economic laws from those which prevail there.

I say, then, Political Economy is as old as society, and exists of necessity, and is most important; for on the goodness or badness of the rules its professors believe in to a great extent depends the happiness of society. I believe its rudiments should be taught to all, and I believe that learning them would not be difficult.

For what is it when truly understood? Man has desires and wants, and therefore a disposition to gratify them, and has also a pleasure in an active life and in attaining his objects. But he has also a desire for repose, and his power of work is limited. Bearing these things in mind, Political Economy inquires what are the best ways for man to attain these objects. It is not necessary that the student should master all the ingenious and elaborate definitions in which writers on Political Economy delight. I have in my mind a book, very clever and very profound, which I can't read. It is very subtle, but not practical, and after a few pages I get bewildered. Value, wealth, capital, labour, currency, and other things are refined on to weariness, in spite of the talent exhibited.

It is a singular thing that another most important matter is very much dealt with in a like way. One would suppose that any educated person would like to have some acquaintance with the laws of his country—certainly that Englishmen would, as they are proud of their laws, and they are responsible for them. For, if wrong, the power to alter them is with those they rule. But a similar argument is used—‘The law is so dry.’ I deny it. No doubt, if you have to learn how to serve a writ, and how many days a defendant has before he need plead, and so on, it is dry and wearisome enough. But if the study is not of the practice of the law, but of its broad, general principles, it is quite otherwise. Of the four volumes of ‘Blackstone’s Commentaries,’ three, to my mind, are most agreeable reading. These general principles should be taught as a part of ordinary education. So of Political Economy—it has been called a dismal science. I never could read ten pages of him who so called it. It has been called inhuman and unfeeling. The same epithets might as well be applied to ‘Euclid’s Elements,’ or to a treatise on baking or brewing. Indeed, much more reasonably, for Political Economy lays down those rules which will procure the greatest amount of enjoyment.

The governing precepts of Political Economy are few. In my judgment, its main one is ‘*Laissez faire*’—‘let be.’ As M. Molinara says, ‘*Notre évangile se résume en quatre mots—“Laissez faire, laissez passer.”*’ Leave everyone to seek his own happiness in his own way, provided he does not injure others. Govern as little as possible. Meddle not, interfere not, any more than you can help. Trust to each man knowing his own interest better, and pursuing it more earnestly than the law can do it for him. I believe this maxim will justify most of the rules that right economists have laid down—let your people buy in the cheapest and sell in the dearest markets. That enjoins free trade. For the trader, whether he buys at home or abroad, seeks the cheapest market. If a duty is put on the foreign article to protect the home producers, the trader is interfered with. The consumer is interfered with. The law says he shall not consume that which he can get at the lowest price—that the producers, the capitalists, and the labourers shall not employ their capital and labour as they would if left to themselves; shall not produce something they could exchange with the foreigner for something he can produce more cheaply than they; shall not buy of him, and so shall lose him as a customer, and so, not being able to employ the capital and labour on what he would take, therefore must employ it in some other way.

I say this is one of the most important precepts of Political Economy. It is plain and simple—a broad, intelligible principle; and so are all the leading truths of economic teaching.

But it is not my intention to treat further on the science generally. One subject, on which I wish to say a few words particularly, is Socialism. I once said to Mr. Newmarch, known to many of you as a most able man, ‘I am a bit of a Socialist.’ He said, ‘Yes; every right-minded man has a tendency that way.’ Our reasons were the same. It is impossible not to have a doubt or misgiving whether it is right that one man should have in an hour as many pounds sterling as another has in a year; whether one man should suffer the extreme of misery and privation, and another have every, not only necessity, but superfluity. It is a truth hard to believe; but I am satisfied that it is a truth. The great object of a society in this matter should be to make what the Americans call the largest pile—the greatest quantity to be distributed and consumed. I do not say that a more equal division than exists is not desirable, but I say that in the attempt to bring it about by law the pile will be reduced. If you gave an equal share to each, do you suppose—can anyone suppose—that each would work as hard as he does now? A man would know that the lazy and idle would indulge themselves at his expense if he worked. He would feel he had a sort of right to do the same, and he would do it. I repeat what I have said, that when men are as honest as the bees we may have Socialism or Communism—not till then. As to the argument or assertion that all men are equal and have equal rights, it is untrue, and absurdly untrue. It is equivalent to saying that all men are equally strong, equally industrious, equally clever. Why should not the more industrious man be better off than the less industrious? No reason can be given. But, if that is

true of industry, why is it not true of strength and cleverness? They are natural gifts, as well as the love of work. Natural rights are talked of. Nonsense! Natural rights may exist when man is in a state of nature. What they may be, I know not. But when man is in a social state his rights are what the law gives him; and if the law is wise it will give him all he can get. Poverty and misery shock us, but they are inevitable. They could be prevented if you could prevent weakness, and sickness, and laziness, and stupidity, and improvidence; not otherwise. To tell the weak, the lazy, and the improvident that they should not suffer for their faults and infirmities would but encourage them to indulge in those faults and infirmities. If it is said that poverty and misery may exist without fault in the sufferer, it is true. But it is but rarely that they do, and the law cannot discriminate such cases. To attempt to remedy the disparity of conditions would make the well-off poor, the poor not well off. Socialism is not good for man till man himself is better.

Not that I think that Socialism would be better even than our present state. Nothing could compensate for the loss of the pleasure and excitement of struggling for the good of ourselves and of those dear to us, unless, indeed, we could feel an equal pleasure in working for the hive. But then we should be something different from what we are.

Private charity may be useful, not in indiscriminate gifts and doles—soup kitchens, coals, flannel, and clothes given to all who apply—but in careful relief, given in no case that is not investigated and seen to be deserving of help. All charity is mischievous which is given to those who ask merely because they ask and say they are in want. In this way, by careful and discriminate charity, the man of wealth with Mr. Newmarch's socialist tendency may do good and relieve his conscience.

But besides this Socialism—the Socialism of the streets, well so called by Mr. Crofts, who gives a clear account of it—this Communism—there is a mischievous disposition abroad which is continually urging on Parliament—and Parliament is too ready in agreeing to—invasions of private liberty and of private property. It is quite certain that the number of orders we are under has vastly increased. It is very clear also that private property is not regarded with as much respect as it was. Everything that is said or written against it is listened to with favour. The land particularly is attacked. Mill's 'unearned increment' is quoted as justifying taxation, as though, when private property in land was established, it did not, as in reason it did, include all increment, earned or unearned. The legal proposition of Mr. Joshua Williams that all land in this country is held of the Crown or other lord, and so the absolute property is not in the owner, is quoted to justify taking away all property in it. My old friend would have been horrified at the ridiculous and erroneous conclusion drawn from what he said. It is quite true. But all it means is this—that if a man dies intestate and without heirs, his land escheats to the Crown or other lord; so do his horse and his watch. We are not so bad as Mr. George, who has the audacity to suggest that land should practically be taken from its owners without compensation—on this principle, that their ownership was always a wrong, and they should not be compensated for being stopped doing wrong. Is it credible? Two men have saved a competency for their old age. One has bought railway stock, another land. Both have trusted to the law. The one is to have his land taken from him because he is a wrongful owner; the other is to keep his railway stock! This is approved of by some who call for the 'nationalisation of the land.' The best thing to be said in their favour is that they attach no definite idea to the words. They don't know what they mean.

Another remarkable instance of this attack on property in land is the desire to tax what are called ground-rents. I think this is the result of want of knowing better. A man has three pieces of land of the same size, situation, value. On one he builds a house at a cost of 1,000*l.* and lives in it; on another he builds a house at a cost of 1,000*l.* and lets it at a rack rent of 65*l.*, putting the annual value of his land at 15*l.*; the third he lets to a tenant at 5*l.* a year for fifty years on the terms that the tenant lays out 1,000*l.* in building a house. He, the landowner, gives up

10*l.* a year because he will have the house at the end of fifty. The tenant is willing to build the house and give it up at the end of fifty years, because for those fifty years he will have land for 5*l.* a year which is worth 15*l.* Can any human being give a reason why any one of these three houses, or their owners and occupiers in respect of them, should pay more taxes or rates than any other of them?

Then we have the enfranchisement of leaseholds. As you are to have a paper read on this, I will say no more than that you do not compensate a man when you take from him what he would rather keep as a matter of business than have what you give him—not if it is twenty shillings for his sovereign.

I regret to say that these schemes and ideas receive encouragement from Parliament. I was told by a gentleman, than whom there is no better authority, when the Manchester Ship Canal Company was unable to raise capital, that it was owing to the distrust that existed among capitalists that their property was not safe—a distrust, I regret to say, well justified. The water companies of London were entitled to charge according to the real annual value of the houses supplied. An Act was passed at the instance of a private member that the charge should be on the rated value, which is very commonly five-sixths of the real value. It was passed by some who knew no better, by others who did, not without a blush; but it was 9,000*l.* a year loss to one company. In this last Session the following was done. If the railway companies do not make a tariff of maximum charges satisfactory to the Board of Trade, that Board may make one. In the Government Bill it was provided that their tariff should be 'just and reasonable.' It was objected that they might think something less than their right by statute would be just and reasonable. So it was suggested that these words should be added, 'equivalent to their existing rates.' This was adopted. I need say nothing more in its favour than that Lord Selbourne approved it. This was in the Lords. The Commons struck out the words 'equivalent to their existing rates.' The Lords acquiesced. The ever-ready Marquis gave as a reason or excuse or answer that Parliament would not adopt the new rates unless they were equivalent. But why did the Commons object to the words except to provide a power to alter the rates to what will not be equivalent?

I say property and freedom of action are not held in the respect they were and ought to be. It is to combat this that the Liberty and Property League has been established, and has struggled under their able Chairman and their indefatigable Secretary.

The following specimens of proposed interference with property and freedom of contract may interest you:—A Bill to give everyone a right of access to mountain or uncultivated moorland for recreation or study. A Bill that, notwithstanding any agreement to the contrary, a tenant may obtain compensation for *improvements* done against the landlord's consent. A Bill to compel an employer to give his servants holidays without deduction from wages. Another Bill to let a tenant *improve* without and against his landlord's consent and opinion, and against their agreement. A Bill that a colliery tenant may, *notwithstanding any agreement to the contrary*, have his lease extended if he has been unable to work owing to depressed state of trade. A Bill that everybody may fish in rivers which are highways or along which there is a right of passage. A Bill that property may be taken for labourers' dwellings without payment of compensation for loss of trade, profits, goodwill, &c. Another similar Bill, but one year's profits allowed. A Bill which may shortly be described as one to introduce into Scotland the mischief of the Irish Land Acts. A Bill that lessees of mines in Cornwall, *notwithstanding any agreement to the contrary*, may remove buildings. A Bill giving general right in Wales and Monmouth to go on lands for recreation, winberry gathering, scientific inquiry, sketching, or antiquarian research. A Bill that in every execution against the goods of a household necessary furniture to the value of 20*l.* shall be exempt. In these cases rights of property and freedom of contract are violated.

Just one word as to Protection and Fair Trade. I have said of 'Fair Trade' that it is a taking phrase; but really it is unmeaning. Does a foreign nation tax our goods for the sake of revenue? What is there unfair in that? Does it do so

because it is unwise enough to believe in protection? Again, what is there unfair in that? Is it unfair to sell to us and not buy? Why? There is no deception. We will not buy of you; we do not compel you to sell to us. If you do, it is because it suits you. But let us drop the words and look at the substance. If, by not buying of the foreigner, we could make him buy of us, there might be some reason in our refusal to buy. When a case of that sort is shown it will be worth considering. Till then, if we buy of those who will not buy of us, it is because it suits us, as they say. Why? Because we get the thing we want when otherwise we should go without or get it dearer. Remember, we must pay for it; and to pay for it we must produce something else, which it is worth our while to make, and change for it—I do not mean change specifically. We deal with the world. From parts we get gold and silver. With them, with goods, with what is owing to us, we pay those who do and those who do not buy of us. A friend said: 'Dear me, our imports are 350,000,000*l.*, our exports only 230,000,000*l.*,' or whatever was the figure. I said, 'I wish we could get them for less.' Is protection to be argued over again? There is not a reason that can be given for it that would not be equally good for protecting tariffs between London and Southwark.

There is one more particular subject I wish to speak on. It is certain that the wonderful labour-saving inventions of modern times have diminished the manual labour required by society. If the food, clothing, and habitations of mankind are got and constructed with less labour, fewer labourers are required. Of course, I know the well-recognised truth that man's wants and wishes are never more than supplied. But everything in this world is relative, and, though every one might like more than he has, yet his wants diminish as his havings increase. Happily, one good result of this saving of labour has been a diminution of the hours of work, an increase of leisure, one of the good things desired by mankind. But there is always a risk that, if work does not increase and workmen do, the competition among them will diminish their rewards. Another thing to be remembered is that our mineral wealth—certainly our coal—is diminishing. Further, that foreign competition increases; we have taught others how to rival us. I do not prophesy our decadence; I have the greatest confidence in my countrymen. But I do think there are considerations which should make us rejoice if our population did not increase as fast as it has done. I am glad to think that the rate of increase in the last few years has not been as great as it was formerly. No doubt a great increase of population is in one sense a cause of rejoicing. It shows a prosperous condition of things, and adds to the strength of the State. But it inevitably *tends* to a lowering of wages and a lowering of the standard of comfort in the labouring classes. It may be, and in this country has been, counteracted by other circumstances, but there is that tendency. I never sympathise with the exultation at our increase in population compared with the French. I think it very doubtful if they do not show more foresight and thrift than do our people. It is sad to see the improvident marriages of boys and girls without a shilling, or a chair or table. Of course, it is a charming thing for a man after his work to go to his home, find his comfort has been cared for by an affectionate wife, and have his children to play with, and I believe that such a man is more likely to keep out of mischief and out of the public-house; the attraction there is less, and he feels his responsibility for those dear to him. But the home should be a comfortable one for him, and this it will not be in the case of the improvident marriages I mention. I do sincerely think that they are earnestly to be deprecated, especially at the present time, and I am glad to think they are diminishing.

I will not trouble you further. I daresay there are many among you who do not share my love for Political Economy. I have endeavoured not to weary you, but to place before you some leading principles and considerations. I believe and repeat that correct opinions on the subject are most important, and that the acquisition of them is neither difficult nor repulsive.

The following Papers were read :—

1. *On Mining Royalties and their effect on the Iron and Coal Industries.*
By Professor W. R. SORLEY.

§ 1. *Historical.*—Local customs still existing in various parts of England and Wales point to a condition of things in which extensive rights to the working of minerals were possessed by the inhabitants of mining districts. But English law favoured the extension of the rights of private property at the expense both of such communal rights and the claims of the sovereign, till possession of the surface became the best *primâ facie* claim to possession of the minerals underneath, and the legal maxim was adopted, *Cujus est solum, ejus est usque ad cælum, et deinde usque ad inferos*. The same tendency to private ownership was checked or reversed in most European countries by the French Mining Law of 1791 (re-enacted in 1810), which nationalised the minerals, and allowed of their being worked only on concession from the State.

§ 2. *Descriptive.*—The exhaustion of mines by working induces the private owner or landlord to charge the lessee or worker of the minerals (1) a royalty or tonnage-rent on the quantity of mineral removed; (2) a fixed or certain rent, to provide against the amount of his royalties falling below that sum; and, in some cases, (3) rents for instroke or outstroke, shaft, and wayleave, also calculated on the tonnage or royalty principle. An estimate of the amount of these rents and account of their variations can hardly be given in an abstract.

§ 3. *Incidence of Royalties: Opinions of the Trade.*—The following summary may, I think, be taken as fairly representing the views of those engaged in the trade who have expressed their opinions on the subject:—

(1) That royalties, being a fixed money payment for quantity of output, are heaviest just when trade is depressed and prices low;

(2) That English trade is at a disadvantage in competing with foreign countries where there is little or no royalty to pay;

(3) That it is unfair for the landlord's rent to remain undiminished when the wages of workmen are being reduced, and the profits of the employer disappear; and even—a platform sentiment—that it is unjust for the landlord to claim any share of the minerals under his land, seeing he did not put them there.

§ 4. *Economic Theory of Royalties.*—The theory of mine rents is usually treated by economists as on a par with that of agricultural rents (Ricardo's 'Works,' p. 45, Bagehot's 'Economic Studies,' p. 127), though attention may be drawn to the fact that the mine is exhausted by working. Now, if the rent of a mine is determined in the same way as that of a farm, rent will not enter into the price of the product at all, so that its abolition would not cheapen coal and iron, but only enrich certain mining lessees, while its nationalisation would not affect the mining industry any more than the confiscation of any equal amount of other property would. But farm-rents and mine-rents have to be treated differently, owing to the fact that the farm is not exhausted by workmanlike cultivation, whereas the mine is exhausted by being worked. Thus, when the economist says of agricultural rent (1) that the 'worst land' cultivated (expenses of production on which determine the price of the product) pays no rent, or (2) that the produce yielded by the last application of capital and labour to the soil (that application which the farmer is only just induced to make) pays no rent, the same cannot be affirmed of mines. (1) The 'worst mine' worked does pay a rent, because it is not indifferent to the landlord whether his property be disfigured, and a possible future source of income exhausted. (2) The produce of the 'last application' of capital and labour to the mine pays the same royalty per ton as any other portion of the yield. The theory still holds, that the price of the product is determined, in the long run, by its expenses of production in the least advantageous circumstances, *i.e.* in the 'worst mine.' But this worst mine pays a rent or royalty which therefore enters into price. This royalty paid by the 'worst mine' may be called the *minimum royalty*, and is a part of expenses of production. Any royalty higher than this, in so far as it is higher, does not affect price, but is a payment from tenant to landlord for the exceptional advantages of a particular mine.

§ 5. *Economic Theory and the Facts of Trade.*—A minimum royalty, such as the above, seems to be discoverable. The materials at my command lead me to suppose that the minimum royalty (the smallest met with in cases sufficiently important to determine the result) is in this country about 4*d.* a ton for both coal and ironstone. And, although day by day in actual trade, it is not the expenses of production on the worst mines that fix the price, and it is rather prices that determine what mines can continue working; yet, in this way, the expenses of production on the worst mines which keep going become a measure of prices: these expenses include the minimum royalty, and the minimum royalty is thus a factor in price.

§ 6. *Effect of Royalties on International Competition.*—Even 4*d.* a ton on the raw material will add considerably to the price of a product such as pig-iron—will probably amount to about 1*s.* 8*d.* a ton on Cleveland pig. Hence there is ground for the assertion that royalties put England at a disadvantage in competing with foreign countries. Yet there is a certain illusoriness about the so-called ‘no-royalty’ system abroad. It is not true that royalties are entirely absent in the cases of our great competitors, France, Germany, and Spain. (1) In these countries certain dues are paid to the State—almost nominal in Spain, 2 per cent. of gross value of output (of coal) in Germany, 5 per cent. of net produce (coal or ironstone) in France. Further, in certain districts of Germany, old seigniorial rights still exist, and in France a *redevance tréfoncière* has to be paid to the owner of the surface. In most cases this is of merely nominal amount, but in other cases it is a tonnage rent, and, in some districts (*e.g.* the coal mines in the basin of the Loire), is as much as 4½*d.* to 6¾*d.* a ton. (2) A concession gives absolute ownership to the concessionaire, who may, and often does, sublet the working of the mines at a royalty. For instance, the Orconera Co. pays a heavy royalty to the original concessionaire for the famous Bilbao mines. Perhaps this subletting at a royalty is commoner in the case of the richer mines, and does not occur in the poor. If so, English mining industry will be more heavily burdened than continental by the excess of its minimum royalty over the State and other dues paid abroad. Further, it is to be noted that it is not the smaller royalties that account for the recent success of the German iron trade, but the discovery of a process of conversion into steel which can be applied to the German iron.

§ 7. *Proposed Reforms.*—The complete subversion of the present system is sometimes proposed. It could be carried out in either of two ways: either by the abolition of mining rents and royalties, or by their nationalisation. The latter would enrich the national exchequer without specially affecting mining industry; the former would reduce prices by the amount of the minimum royalty, and so stimulate demand, and would make a present to existing lessees of the remainder of the royalties they have contracted for. It would thus favour the lessees of good mines at the expense of the lessees of poor mines, and lead to a new distribution of trade (remove, for example, the coal trade of Northumberland and Durham to South Wales). For this reason (apart from weightier political objections) such a measure seems undesirable. The real grievances of our present system rather appear to be in (*a*) the royalty payment remaining the same while prices fall; (*b*) the high certain rents and the limitation of time for working ‘shorts’; and (*c*) the tonnage charges made for instroke and outstroke, shaft, and wayleave. In the last class of cases the tonnage principle is out of place. The owner of a way (or of a royalty next to a mine which may not be worked by shaft) has an advantage of position which enables him to obtain a monopoly price. There is no pretence of fairness in the contract which exacts a penny a ton (amounting, in the case referred to, to 600*l.* a year) for leave to draw stone under a field forty yards wide. Considering the national importance of the mining industry, and the way in which it is burdened by such charges, Parliamentary interference would seem as allowable here as when it compels the sale of land to a railway company at a valuation. A remedy for the two former grievances might be carried through without affecting prejudicially the interests of landlords, but it is doubtful whether anything but the coercion of an Act of Parliament will secure its adoption. The reforms in the royalty system which thus seem to be called for would be effected by a law enacting—

(1) that instroke or outstroke, shaft, and wayleave rents should be granted at a fair valuation of the land occupied or damaged, or of the injury done to the ventilation, drainage, &c., of the mine;

(2) that in all future leases—

(a) there should be no restriction put on the time for working shorts;

(b) the royalty charged should be a percentage of the value of the output.

No mining court would be necessary for carrying out such reforms; nor does there seem to be, in the defects of the present system, any sufficient reason for transferring the assessment of royalties from private agreement to the decision of such a court.

2. *The Relations Between Sliding Scales and Economic Theory.*

By L. L. PRICE, M.A.—See Reports, p. 523.

3. *On Wage Statistics and Theories.* By JAMES MAVOR.

This paper (1) describes briefly past and current theories of wages; (2) illustrates the course of wages by reference to American and English statistics; (3) recounts the leading causes of wage fluctuations; (4) offers analysis of existing method of distribution of the product; (5) points out resulting criticism of current theories of wages; and (6) attempts classification of proposals for effecting changes in the current method of the distribution of the product among the contributories to production.

4. *The Growth of American Industries and Wealth.*

By MICHAEL GEORGE MULHALL, F.S.S.

The development of the United States in ten principal items since 1850 has been as follows:—

	1850	1860	1870	1880	1888	Increase since 1850 (per cent.)
Population	100	136	167	213	270	170
Commerce	100	214	208	477	415	315
Agriculture	100	162	189	293	352	252
Manufactures	100	186	312	421	508	408
Wealth	100	227	369	614	780	680
Steam-power	100	225	325	527	785	685
Shipping	100	156	151	158	174	74
Railways	100	340	585	1,035	1,680	1,580
Banking	100	190	470	795	1,018	918
Education	100	140	164	232	306	206
Total	1,000	1,976	2,940	4,770	6,288	5,298

The foregoing table is according to the census reports from 1850 to 1880, and estimates for 1888.

In order to arrive at the working-power, we allow 300 foot-tons daily for each male between fifteen and sixty years, 200 for each female, 3,000 for each living horse, and 4,000 for each horse power of steam. The result is as follows:—

	Millions of foot-tons daily	
	1850	1880
Human	3,160	6,850
Horse	12,990	31,090
Steam	6,440	33,740
Total	22,590	71,680

At present the aggregate of energy reaches 90,000 millions of foot-tons daily, which is more than the collective force of the United Kingdom and France.

Measuring each of the principal industries by the number of hands, we find the increase as follows:—

	1850	1880	Increase
Agriculture . . .	3,311,000	7,671,000	130 per cent.
Manufactures . . .	958,000	2,733,000	184 „
Trades, &c. . . .	2,923,000	6,988,000	140 „
Housekeeping . . .	3,362,000	8,956,000	168 „
Total	10,554,000	26,348,000	150 „

But the increase of hands is by no means a fair measure of the growth of the above industries.

1st. As regards agriculture, the grain crop rose from 867 million bushels in 1850 to 2,697 millions in 1880, an increase of 211 per cent. The production of meat rose from two million tons to three and a half millions. The value of agricultural and pastoral products rose from 213 millions sterling to 562 millions sterling, viz. :—

	Millions sterling	
	1850	1880
Grain	94	293
Meat	44	88
Cotton	19	67
Sundries	56	114
Total	213	562

The assessed value of farms and stock rose from 937 millions in 1850 to 2,973 millions sterling in 1880, being an average increase of 147. per head per annum on the mean number of persons engaged in all manner of agricultural or pastoral pursuits.

2nd. As for manufactures, the value of merchandise produced rose from 212 millions in 1850 to 1,117 millions sterling in 1880. But the values in 1880 were artificially enhanced 25 per cent. by the protective tariff, and therefore the real value in 1880 was only 893 millions sterling, showing an increase of 321 per cent.

3rd. Commerce, that is, imports and exports (not including bullion), rose from 65 millions to 310 millions sterling. The shipping trade has, however, fallen away, the American carrying power being now less than the British, whereas in 1850 it was greatly in excess, viz. :—

	Carrying-power, Tons	
	United States	British
1850	5,640,000	3,955,000
1886	9,820,000	22,770,000

The United States, meantime, have made great progress in railways, possessing at present 151,090 miles, against 9,000 in 1850.

Banking business has multiplied tenfold, the total of banking capital and deposits in 1883 showing 754 millions sterling against 74 millions in 1850.

INCREASE OF WEALTH.

This has been greater than the growth of industry, and four and a half times more than the increase of population. The census returns show—

	Millions £ sterling
1850	1,484
1860	3,361
1870	5,003
1880	9,077

The increase in thirty years averaged 253 millions sterling per annum, or 50 per cent. over the accumulations of Great Britain or France. It averaged 14 $\frac{1}{2}$ per worker, or 7 $\frac{1}{2}$ per inhabitant, yearly over the whole period. The accumulation of thirty years showed—

	Millions £
By Americans	6,230
„ Irish settlers	471
„ German „	374
„ Other „	518
	7,593

The components of this increase of wealth in thirty years, according to the census returns, were—

	Millions £
Farms	2,036
Railways	981
Factories	472
Houses, &c.	4,104
Total	7,593

The accumulations averaged 7 $\frac{1}{2}$ per annum per inhabitant in the decade ending 1860, less than 5 $\frac{1}{2}$ (4·7) in that ending 1870, and over 9 $\frac{1}{2}$ (9·2) in that ending 1880.

The census for 1890 will probably show a population of 66 millions, with an aggregate energy of nearly 100,000 millions, for foot-tons daily, and an accumulated wealth of 14,000 millions sterling, figures never before applicable to any nation in the world.

5. *Somersetshire Cider.* By JOHN HIGGINS.

Economic science cannot confer a greater benefit on the county of Somerset than by indicating the direction in which sound scientific methods can be brought to bear on the natural products of the district.

The old 'rule of thumb' methods, as they are called, have grown out of the experience and thought of generations of workers. And it not infrequently happens that what looks like superstitious observance of old ways turns out to be in real accordance with the soundest science.

Economic science, with its handmaiden, recorded statistics, steps in to examine accurately the work we do; to separate the sound, good rules of work from the clumsy, irrational ones; to point out the course leading to real improvements; and to record what has been done in these directions for our future guidance.

In the short paper submitted it is not claimed that any finished scientific improvements in the making and storing of cider are brought forward. The more humble office of the writer is the description of the old-fashioned ways, of showing improvements which the experience of years has suggested to him, and of asking that the attention of practised chemists and others may be brought to bear on the cider industry of Somerset, in the hope that *light*, and if possible by all means *sweetness*, may be thrown upon and added to our west country beverage.

The writer shortly describes the making of cider as practised in Somerset, its qualities, the fermentation and development of aroma, its alcoholic strength, and the malic and acetic acids and fusel oil found in it.

The probable sources of the natural yeast cells, and methods suggested for the cultivation of pure yeast cells on the lines indicated by Hansen of Copenhagen and M. Pasteur, are touched upon.

The statistics of the subject can only be slightly handled, since no reliable data exist upon which accurate calculations can be made.

It is hoped that under the new Minister of Agriculture there may be better data in the near future.

6. *Agricultural, Commercial, Industrial, and Banking Statistics.*
By WM. BOTLY, M.R.A.S.E.

Comparative statistics are given of the leading features of industries and interests above mentioned, showing the high position occupied by the United Kingdom as compared with other nations. It is shown that the capital of the United Kingdom employed in banking was, in 1882, 840,000,000*l.*, or 29,000,000*l.* more than the amount so employed by France, Germany, Austria, and Russia combined, and that Great Britain has nearly 10 per cent. of her national wealth engaged in banking.

FRIDAY, SEPTEMBER 7.

The following Papers were read:—

1. *An Analysis of the Current Conception of State Socialism.*
By Professor HENRY SIDGWICK, M.A.

The present tendency of opinion is towards increased interference of Government. The results of this are often lumped together and referred to 'State-Socialism,' as opposed to 'Individualism,' or *Laisser Faire*—the principle that 'individuals if secured from interference can take better care of their own interests than Government can for them.'

My present object is to distinguish different issues that are liable to be confounded in this opposition.

I. A great deal of recent extension of governmental interference is really individualistic in principle; its aim is the more effective protection of individuals from mischief to person or estate caused by action of other men, intentionally or carelessly.

Most individualists recognise that it is the duty of Government to prevent this kind of mischief; and it is easy to see how the progress of civilised states brings new occasions for interfering in this way, either

- (a) From new or increased dangers due to the closer massing of human beings and the more complicated relations which development of industry and civilisation bring with it; or
- (b) Increased insight into such dangers; or
- (c) New knowledge of possible remedies due to progress of science.

Illustration—Sanitary interference.

II. Even when Governmental interference, actual or proposed, cannot be based on the individualistic principle, it does not necessarily imply a denial of the proposition that 'the individual is the best guardian of his own interest'; but only of the quite different proposition that 'the common welfare is best attained by each seeking his own interest intelligently.'

This latter proposition I hold to be largely true; but there are many exceptional cases, as I pointed out two years ago at Birmingham—*e.g.*:

- (1) Where the individual cannot adequately appropriate and sell the utility he might render to society; or
- (2) Where the process of sale is wasteful of time and labour; or
- (3) Where a business tends to become a monopoly, since a monopolist may often get better pay for less service; or
- (4) Where uniformity of action or inaction is specially important.

Much of the actual industrial intervention of Government is justified on one or other of these grounds—*e.g.* regulation of forests, fisheries, management of conveyance and communication, currency, provision of gas and water.

Is all this to be called Socialistic, when its aim is to benefit the community as a whole, not one class at the expense of another? Certainly 'Socialistic' is often understood to imply a design of benefiting the poor at the expense of the rich.

No doubt much expenditure of public funds in modern states has apparently this latter object—*e.g.* on education and poor relief.

III. Here, however, the distinction is important between

- (1) Taking A's products to supply B's needs;
- (2) Equalising opportunities of productive labour—*e.g.* by State-aided education.

This latter is defensible on individualistic principles as rather increasing than diminishing stimulus to self-help. Still, it is urged, this equalisation costs money. A's products have to be taken to enable B to produce more, and this is contrary to natural justice. But it is fair to answer that on the principle of individualism, it is only the appropriation of the results of labour, not of natural resources, that is absolutely justifiable; and that, by the actual appropriation of natural resources—however practically inevitable—the propertied classes have diminished the opportunities of the unpropertied to an extent that justifies a demand for compensation; and that State-aid to education, emigration, &c., regarded as an attempt to give this compensation, is not anti-individualistic if the taxation it involves does not seriously diminish the inducements to labour and thrift of the persons taxed.

IV. Public poor relief must be admitted to be socialistic in case (1), though its bad effects are materially reduced by the workhouse system.

Here, again, a distinction seems needed in comparing compulsory poor rates with compulsory insurance. It is disputed which interferes most with the liberty of the individual. Perhaps we may say that the latter involves greater *political* interference, the former greater *economic* interference.

2. *The Transition to Social Democracy.* By G. BERNARD SHAW.

INTRODUCTORY.

The Mediæval Order of custom and rule. Its disablement by the growth of commerce and by the industrial revolution. Modern Political Economy and the abandonment of industry to competition. Discovery of the nature of economic rent. Modern Socialism. The practical transition involved in its adoption. The political conditions of that transition. Democracy the complement of Socialism. Social Democracy. Agitation for effecting a change at once by violence. Practical necessity for a gradual transition.

PROGRESS OF THE TRANSITION UP TO THE PRESENT TIME.

Starting-point—the Reform Bill of 1832 and the abolition of the old Poor Law. The resultant social pressure. Its effects—the Income Tax and the Factory Acts. Free Trade and Emigration. The gold discoveries and the period of prosperity. The pressure relieved. Apparent successes of 'self-help,' and collapse of Social-Democratic agitation. The Reform Bill of 1867. Successes of State enterprise—the Post Office and the Education Act. End of the period of prosperity and return of the pressure. Revival of Socialism.

THE FUTURE.

Completion of the Transition.

Starting-point—the Reform Bill of 1884. The remaining practical steps to the consummation of Democracy—(1) to perfect the constitution of the Democratic State; (2) to adapt its machinery to the organisation of industry. Why these steps will be taken. The agitation for the municipalisation of urban rents. Impossibility of permanently resisting it. Its reinforcement by the Land Nationalisation movement and the demand for a Progressive Income Tax. The weak point in these schemes. State organisation of industry inseparable from State custody of rent. The point at which this will begin—the *fighting-point* of the transition. Effect of exportation of capital on the labour market. The unemployed and the local authorities. The extension of municipal enterprise to general industry. Its

methods of acquiring capital, land, ordinary labour, and managerial ability. Economic reaction of these methods. Municipal advantages in competition, extending even to the destruction of rents both of land and ability. Gradual extinction of the proprietary class. Relation of the municipalities to the central government. Consummation of Social Democracy.

3. *The Tendency of Competition to result in Monopoly.*

By Professor FOXWELL.

4. *Associative Economics applied to Colonisation.* By W. L. REES.

The question of emigration is daily becoming more important to Great Britain.

The yearly increase of her population and the serious diminution in the numbers of labourers employed in agriculture, as well as the severe competition of foreign manufactures, render it necessary that some provision should be made to transplant the unemployed to the Colonies for the purpose of settlement upon the waste lands.

In olden times migration took place either by nations or by communities. In the Middle Ages by communities only, which system, under the name of special settlements, has been largely practised till the present time, although individual emigration has in modern days become greatly predominant. The large majority of those to whom emigration is now necessary are unable thus to leave the United Kingdom by reason of poverty. They are also unwilling by reason of fear of the sea and the unknown land, and of being obliged to recommence life among strangers without any certainty of help or success.

They are for the most part unfit also; they do not possess the energy, courage, aptitude, and self-reliance necessary to make successful colonists, such as belonged to the earlier and bolder men who have raised new Englands in the outlying parts of the empire.

Nor are the circumstances which surround immigrants in these days so favourable to individual settlement as of old. The available land near the harbours and centres of population is all gone. Employment is not so plentiful as in earlier days, and the operation of our present economic laws is causing the reproduction to some extent in most of the Colonies of the difficulties which harass older countries.

The only method of colonisation likely to be successful is the associative or co-operative method, by associations registered under the Joint Stock Companies Act, in which the capitalist, the labourer or producer, and the consumer or purchaser should be joined together as partners:—

The capitalist to receive a moderate interest and a share of profits and increased values;

The labourer, including all employed by the association, to receive wages or salary and a share of the profits and increased values;

The consumer or purchaser to receive his goods and a share of the profits and increased values.

The capital would be secured upon the property, and expended in making it productive, and therefore of value.

Production to be on a large scale, and markets secured, either through the co-operative bodies now existing or others formed upon the same lines.

Going in companies to a certain destination upon certain and constant employment, only dependent upon good behaviour, and with a certainty of sharing in profits, the future would look bright enough, and hope would give fresh life and vigour.

This plan of colonisation would open many avenues for the utilisation of idle lands by idle labour; would relieve the ratepayers from much, if not all, of the poor-rates; would increase commerce, strengthen the Colonies, produce fresh wealth,

give a practical imperial federation, and point out a practical system of co-operation between Capital and Labour which might ultimately confer safety and comfort upon civilised society.

5. *On the Statistics of Examination.*¹
By PROFESSOR F. Y. EDGEWORTH, M.A., F.S.S.

The object of this paper is to estimate the error incident to a large aggregate of marks at a competitive examination in several subjects. Error is defined as deviation from that Mean towards which the average marking of numerous competent critics would tend.

Among the sources of error are: I. The fact that there is a *minimum sensibile* in our perception of degree of merit. II. The idiosyncrasy or personal equation of the examiner affecting (1) particular answers, (2) the scale of marks in any subject. III. The negligence of examiners.

The extent of the several errors is estimated by means of statistical data. Compounding the items according to the rules of the Calculus, the writer finds a 'probable error' of 2 per cent. (corresponding to a possible error of more than 6 per cent.) in the aggregate of marks according to which candidates are classed at an examination of a kind now prevalent.

That is the error in appreciating the work done at the examination. A further error is incurred in taking that work as a sample of the candidate's real proficiency. Upon a certain mechanical hypothesis, a part of this latter error can be estimated by the Calculus of Probabilities. Adding this error to the previous account, we may infer that the number of candidates displaced—that is, not obtaining a prize when they ought, or obtaining one when they ought not—is likely to be about 30 out of a total of 1,000 examined.

The following recommendations are based on statistical grounds: (1) The order of merit within the Honours Class should be abandoned whenever the difference between the marks of the discriminated candidates is less than the 'probable error' incident to those figures. (2) It might be expedient that the examiners should at first scrutinise only *half* the answers of each candidate, wherever the purpose of the examination would be subserved by obtaining a rough preliminary indication of the order of merit. (3) In order that the importance assigned to each subject may be free from accidental oscillation, it would be allowable to assume that the average proficiency of a large number of candidates in any subject is, from year to year, constant (just as the average height is); and, therefore, that the mean of the marks in that subject should be the same every year. If the average of the marks given to a number of candidates by any examiner differ from the figure which may have been prescribed for the mean, those marks should be reduced to the normal scale. The practice of basing the standard upon the answering of the most proficient candidate is objectionable. (4) For a certain purpose it might be theoretically desirable to combine the marks in different subjects, not by simple addition, but by taking their geometrical mean.

SATURDAY, SEPTEMBER 8.

The following Papers were read:—

1. *The Revenue System of the United States.*² By ALBERT SHAW, Ph.D.

The United States enters upon the current fiscal year with an interest-bearing debt reduced below \$1,000,000,000. In 1865 the bonded debt was approximately \$2,400,000,000. Sixty per cent. of the principal has been wiped out, and 75 per

¹ Published *in extenso* in the *Journal of the Royal Statistical Society*, Sept. 1888.

² Published in the *Contemporary Review*, Nov. 1888.

cent. of the yearly interest-charge has disappeared. The rapid debt payment has now been brought to a halt by the cancellation of all matured obligations and the high premiums commanded by the outstanding bonds, about one-fourth of which become payable at the Government's option in 1891, while the remainder do not mature until 1907.

Before the war the U.S. Government was depending upon customs' duties for its revenue. Fluctuations of trade subjected the public income to inconvenient variations, and the need of a second principal source of income was obvious. The heavy cost of the Civil War compelled the creation of an elaborate system of internal taxation—including excise, income, stamp, banking, and other taxes. The outgoings of the four war years aggregated \$3,350,000,000. Current revenues contributed about \$730,000,000 towards this sum, of which the larger half came from the internal taxes. After the war the unpopular income-tax was abolished, and by gradual remissions the 'internal revenue system' was reduced to the proportions of an excise-tax upon spirits, tobacco, and fermented liquors, which produces nearly two-thirds as much revenue as is derived from the customs.

The annual surplus income exceeds \$100,000,000. In the fiscal year 1886-7 there were called in and cancelled \$125,000,000 of matured bonds, drawing 3 per cent. interest. Less than \$34,000,000 of this class of bonds remained to be paid in the year 1887-8. They were soon extinguished, and the country was embarrassed by the accumulation in the Treasury of large sums of the circulation medium. The stringency was relieved by the deposit of Government funds with banks throughout the country, and by the purchase on public account in open market, at high premiums, of about \$45,000,000 of the unmatured bonds, half of them being bought at an average price of more than 125.

It is agreed that the volume of revenue ought to be reduced at once. This would be an easy thing to accomplish if advantage were not taken of the situation by those desiring to force a reform of the revenue system. The reduction of surplus revenue should be accomplished first upon a plan that would secure unanimous consent. Then the question of tariff and revenue reform could be properly taken up. The current discussion is likely to end in a measure that will merely reduce revenue without affecting the essential character of the revenue system.

The Federal Government is to be regarded as practically restricted to indirect sources of taxation, other sources being in the hands of the States and municipal corporations. The main dependence for revenue must continue to be a tariff upon imports. Good financiering also requires the maintenance of the excise system as a supplemental source of income.

There seems little reason to believe that in arranging the tariffs of the future the protection principle will be abandoned, however much the existing duties may be revised and modified. The pending Mills' Bill places a few articles, chiefly crude materials for manufactures, upon the free list, and reduces the average rate of duty upon the remaining articles of the tariff-list from about 47 per cent. to about 42 per cent.—by no means a revolutionary proposal.

The tariff should be revised by an impartial, permanent Commission, acting in the light of information to be supplied by exhaustive and thoroughly scientific statistical inquiries. Until such investigations are made, the real operation and effect of the American system, whether as a system of taxation or as a system of protection, can only be a matter of opinion and assertion; it cannot be a matter of demonstration.

2. *On the Distribution of the Licences proposed to be transferred in aid of Local Expenditure.* By R. H. INGLIS PALGRAVE, F.R.S., F.S.S.

This paper is based on the statements respecting the licences dealt with by the Local Government Bill of this year contained in the Memorandum, dated June 21, 1888, prepared by the Local Government Board. The licences referred to were those on publicans and all other licences for retailing beer, spirits, wine, &c., and also those on carriages, male servants, armorial bearings, &c.

The licences on game dealers, tobacco dealers, appraisers, auctioneers, house

agents, pawnbrokers and plate dealers, which are also stated in the Memorandum, are not included in the tables given in this paper, as it was not possible to apportion them in a satisfactory way between the two heads of expenditure which are the subject of the present investigation.

The Author has taken the amounts raised under the two general heads mentioned above, in each of the municipal boroughs and counties of cities included in the statement—all of which, with the exception of York, Exeter, Lincoln, Chester, Gloucester, Worcester, and Canterbury, had populations exceeding 50,000 at the last Census. These places were forty-nine in number. In the case of one, West Ham, the investigation could not be carried out in the same manner as the others, as the published returns do not supply the value of the assessment.

The method of investigation followed in the paper is to compare the amounts raised by the two different descriptions of licences, which may roughly be taken to indicate the expenditure of the working classes and of the wealthier classes of the population respectively, both with the numbers of the population by whom it is presumed these duties are paid, and with the wealth of each place as indicated by the assessment value—the object desired being to ascertain whether the incidence of these duties is in any way uniformly distributed over the country. The facts, as indicated by the tables annexed to the paper, indicate that this is far from being the case.

Thus, taking the maximum amount contributed by the publicans' licences, in proportion to population, in the place where these duties are the heaviest, namely, Nottingham, at 100; the minimum, in the place where they are the lightest, namely, Wolverhampton, is 26. The same results, nearly, are shown when these duties are compared with the assessable value. Taking the maximum, in Norwich, also at 100, the minimum, in Salford, is 24.

The results of the carriage, &c., licences are even more unequal, comparing these in the same manner with the population, and the maximum, in Worcester, at 100, the minimum, at South Shields, is 2. Comparing these same duties with the assessable value, and taking the maximum, at Chester, at 100, the minimum, at Salford, is 7.

The inference which may be drawn from this inquiry is, that the incidence of these taxes is far from being uniform over the whole of the country, and the advisability of further investigation into the question of the incidence of taxation becomes obvious. The amounts dealt with in the present paper are, comparatively speaking, small, and a wider inquiry is desirable.

3. *The Standard, or Basis, of Taxation.* By CLAIR J. GRECE, LL.D.

The thesis to be upholden is that neither capital nor income, but expenditure—that is to say, destructive expenditure—is the right standard, or basis, for fiscal computation, and the abstract of the memoir was as follows:—

The contributions of the various members of the State to its burdens, or charges, must be unequal. This fact is apparent from the inequality of the means and resources of the contributories, and is, indeed, implied in the very term *taxation*, or assessment; for, were the contributions all alike, it would be a payment, but it could not properly be called a *tax*. From this palpable inequality of resources in the contributories has probably proceeded the common and erroneous opinion, to which even the clear and penetrating mind of Adam Smith would appear to have yielded, that the contributions should be proportional to the means or resources of the contributories. Combined with this opinion another principle has been industriously at work, that many members of society are in the possession of means largely in excess of their rational needs, and that this excess may be legitimately drawn upon for the purposes of the State, a principle which finds its expression nowadays in the demand for graduated imposts upon successions and upon incomes. But the principle to be established is that, in apportioning the burdens of the State among the contributories' rights, the diversity and the inequality of means and resources should be disregarded as impertinent. The

proper principle is that *each contributory should give to the State in the proportion in which he receives from the State*; and this proportion is not, as would at the first aspect appear just, to be calculated either upon the still *fluid means*, or incomes, of the contributories, or upon their *means solidified*, and stored up as *capital*. What the citizen receives from the State is the *fruition*, or enjoyment, of his means or resources under the State's guarantee; but the perception of income, whether in the shape of wages, of profit, or of rent, is not its *fruition*, or enjoyment. To illustrate the meaning, let us reduce the problem to its simplest terms, and suppose two members only of a political society, and that the labour of both is equally valuable, which means that their contributions to the aggregate of the means of enjoyment are equal. Let one, A, consume as fast as he produces, while the other, B, forbears from consuming a moiety. A has under the State guarantee double the fruition that B has. The burden of proof now lies upon whosoever should assert that their contributions to the State burdens should be alike. It would perhaps be maintained that, notwithstanding the actual inequalities of fruition, the potential, or facultative, fruition of both was equal, that it was open to B to *consume*, and by consumption to *enjoy* equally with A. But, through the abstinence of B, another party, C, comes upon the scene. B by his abstinence has afforded the means of enjoyment to C; and C, too, is a member of the political society, and should therefore be a contributory to its burdens. But if the whole contribution to the State had already been rendered by A and B, C would escape the burden altogether. This is the *reductio ad absurdum* of the taxation of income. The taxation of destructive expenditure—that is, of consumption—entails no absurdity; but A, whose production and consumption equal each other; B, whose production exceeds his consumption; and C, whom we may treat abstractedly as a pure consumer, all contribute in the proportion of their fruition or enjoyment under the State guarantee.

But, if the contributions to the State ought not to be measured by the incomes of the respective contributories, still less should they be graduated according to their accumulated capitals. Capital is deposited, or solidified, income. Its end is the generation of enlarged fluent income; and income, whether original, that is, generated by labour alone, or derivative, that is, generated by labour in conjunction with capital, is *not the end*, but the *means* to the *end*, the end being over the fruition, or *enjoyment*, in the eventual expenditure of the income. By introducing capital we import another term, but a term which, in the order of causation, precedes income, as income precedes consumption, or fruition. The order is (a) capital, (b) income, (c) expenditure, (d) consumption or fruition. By imposing a tax upon income you strike in the wrong place; but by taxing capital you strike still further from the mark. Only by assessing taxation upon consumption—that is, upon the destructive expenditure by the members of the political society—do you collect the contributions from the parties who ought to contribute, and in their due proportions. That the characters which have been assigned severally to A, B, and C may be filled in successive acts of the drama of society by the same persons, or by persons succeeding to the same rights, makes no difference to the argument. The frugal B may be followed by a spendthrift heir, who dissipates B's accumulations. The spendthrift would then, under a properly adjusted scheme of taxation, become the contributory to the State charges in the proportion of his fruition, or of his destructive expenditure.

The State machine is not concerned to promote or foster either accumulation or expenditure. Accumulation means, virtually, enjoyment postponed, or deferred; while consumption is enjoyment in act; and the function of the State is to guarantee the enjoyment and to maintain its neutrality between the present, or actual, and the postponed, or deferred. But it is only by assessing its burdens in the proportion of the destructive expenditure of the members of the political society that it maintains its neutrality. By taxing income it imposes equal burdens upon A the spendthrift and B the accumulator, unduly strengthening the motives actuating A, and equally unduly weakening those actuating B—that is to say, *encouraging present* at the cost of *deferred* enjoyment; whereas, by taxing A and B according to their consumption or destructive expenditure, A contributes in the pro-

portion of his fruition under the State guarantee, B also in the proportion of his, and C, the postponed or deferred enjoyer, contributes his quota, when the stage of enjoyment is reached.

4. *The Suitability of Small Towns for Factory Industries.* By RUSSELL R. TANNER.

The limitations of the paper.

I. *The Employer's Position.*—Among the disadvantages are: Inability to suddenly increase the staff and so meet unexpected or urgent requirements. Distance prevents so close a watch on the pulse of the market. The cost of carriage a constant drain on profits. There is a tendency to get behind the times and miss opportunities and improvements. To correct this, constant watchfulness needed. Among the advantages are: The considerable value of a man's personal integrity as a negotiable article. Low rents and wages and the consequent reduction in the cost of production and warehousing. Less temptation to speculate on rising or falling prices and consequent freedom from anxiety and worry. The deviations in prices smaller, and the mental strain attending both rises and falls in prices less marked. Greater influence over employes. A more serious thing to lose a situation from bad conduct in a small town. Better discipline can be maintained, and consequently more work done.

II. *The Employe's Position.*—The so-called disadvantage of lower wages a chimera. Real wages compared with nominal wages. Allotments, decrease of illness. Longer working capacity taken into account. Other advantages are: Working rooms more healthy. House rents low, so that everyone can afford a house. Temptations less powerful. Less liability to loss of situation, hands being hard to replace, short hours are worked by preference.

III. *Advantages Common to All.*—Improved health, consequent increase in earning power. Classes less sharply divided; great benefits result from this. The standard of living lower. The constant travelling avoided. Recreations more rational. Life carried on at a lower pressure. Increase of neighbourly feeling. Example more potent for good, less potent for evil. Increased self-respect. Conclusion.

MONDAY, SEPTEMBER 10.

The following Reports and Papers were read:—

1. *Second Report of the Committee on the method of ascertaining and measuring Variations in the Value of the Monetary Standard.*—See Reports, p. 181.
2. *Index Numbers as illustrating the Progressive Exports of British Produce and Manufactures.* By STEPHEN BOURNE, F.S.S.—See Reports, p. 536.
3. *Report of the Committee on the Statistical Data available for determining the amount of the Precious Metals in use as Money in the Principal Countries, the chief forms in which the Money is employed, and the amount annually used in the Arts.*—See Reports, p. 219.
4. *An Examination into the Reasons of the Price of Wheat Rising or Falling contemporaneously with the Variation in the Value of Foreign Currencies.* By W. J. HARRIS, F.S.S.

This paper commences with a preamble demonstrating the effect on prices and production in a hypothetical case of a new country being discovered with iron as its

precious metal and wheat as its most easily-produced article of export. Mr. Harris attempts to show that, if the coinage in such a country were open to all comers, the cost of wheat to an importing country like England (which has an unlimited supply of iron at a very small cost of production) would be very little beyond the freight and insurance. He argues that in such a case the merchants would have an enormous profit, and that the effect produced would be a rise of price, and consequently a great impulse to production of wheat in the new country, and a gradual fall in the price of wheat in England until no other exporting country could afford to compete.

He points out, however, that if the coinage of the iron were restricted by the Government of the new country, and, in fact, kept in the hands of that Government, the main part of the profit on export would remain in the hands of the new country, and that the exchange of commodities would only take place to the extent of the actual requirements of the people, thereby limiting the growth of wheat to what they would require in other goods and to the amount of fresh coinage which the Government might allow.

Following this hypothetical preamble, Mr. Harris compares the circumstances of the United States, where the Government keeps coinage entirely in its own hands, and those of India, where the coinage and the consequent inflation of currency is open to all. He arrives at the conclusion that there is a real premium on production in India to the extent of the fall in value of silver, whereas there exists no such premium in the United States. Then, taking the case of Russia, a paper currency country, he attempts to show that she has superior chances of production as compared with India. In fact, that so much as the paper rouble is depreciated beyond the price of its silver representation, so great is the premium to the grower of Russian wheat over and above any premium which the Indian grower may enjoy. The paper leads to the conclusion that any important legislation which raised the value of silver would in no way necessarily affect the value of the Russian currency, whereas it would affect the value of the Indian rupee, and that we might see the trade of India to a large extent transferred to Russia and other countries where the currencies were independent of the value of metals with an unvarying mercantile value.

5. *The Effects on Indian Exports of the Fall in the Gold Price of Silver.*

By L. C. PROBYN.

The paper states that the gold price of silver has fallen from 60½*d.* in 1871 to 42*d.* an ounce at the present time, and alludes to the encouragement thus said to have been given to the competition of Indian with English produce and manufactures. It is then shown that the great flow of silver to India, and the general rise in silver prices, which Mr. Bagehot and others predicted would result from a fall in silver, and which they thought would give a great stimulus to the Indian export trade, have not occurred. The exports of the 18 years between April 1, 1870, and March 31, 1888, are then examined, two tables being prepared showing the figures of the first and last years of the period, and the increases and decreases in the quantities and values of the 13 principal articles of export in each of the intervening years. It is first shown that the actual increase in values is not so great as in the 17 years preceding 1870-71, though a much higher average annual increase might have been expected. An examination is then made of the growth of the total value of the trade during each five consecutive years, which shows that the greatest growths have occurred in periods of comparative steadiness in the price of silver. The principal articles are then examined in detail, and no indication is found that the exports of cotton, seeds, rice, jute, hides, indigo and coffee have been stimulated by the fall in silver.

The views of Mr. Barbour, Mr. O'Connor, and Mr. Waterfield are then briefly stated, and the author's disagreement on some points shortly described. The paper then examines in detail the circumstances of the export trade of wheat, tea, cotton twist, piece goods, and gunny-bags. While attributing the development of the wheat trade in a great measure to the extension of Indian railways, and the cheap

ocean freights, the author disagrees with the contention that the price of wheat has been reduced in Europe by appreciation of gold alone, and thinks that it has been in part brought about by the competition of Indian wheat, which was rendered possible by the favourable circumstances detailed, but which received a fresh stimulus from the fall in the gold value of silver. He ascribes the development of the tea trade to the favourable circumstances in which this industry is placed in India, and to the stimulus given to it by the high gold prices formerly ruling, and thinks that the only effect of the fall in the gold value of silver on it has been to enable the industry to be carried on at the low prices which have resulted from increased production and Chinese competition, and which would otherwise have been unremunerative. While admitting the advantageous conditions which attend the manufacture in India of cotton twist and piece goods and gunny-bags, he explains why he considers these exports have received a stimulus from the fall in the gold value of silver. He then states his general conclusions that, though the export of certain articles has been stimulated, the export trade of India has not on the whole benefited by the fall in the gold value of silver.

6. *On Statigrams, with some suggestions for Greater Uniformity in Comparative Graphics.* By the Rev. J. F. HEYES, M.A., F.C.S., F.R.G.S.

1. The word *diagram* is very loosely used. It is best confined to mathematical and physical science. It is proposed to use the word *statigram* (first put forward in the author's letter in 'Nature' for 1885, p. 597) when graphical statistics of the usual approximate and varying values are being given.

2. The word *graph*, both as a noun and a verb, will be found conveniently short and explicit. Thus a page of figures may be *graphed*, and the resulting *graph* or *graphs* will exhibit a line or curve giving maximum information with minimum trouble. These *graphs* are now becoming well known and popular. They are not necessarily *curves*, so this latter word may thus be given a more restricted and suitable use. As part of the wider science of *Graphics* the whole subject is named *Statigraphy*.

3. It would be convenient to agree upon the use of the co-ordinates. The horizontal line, as far as possible, should, for instance, mark years in preference to the vertical one. In this way the *marriage graph* for the last ten years would be seen to fall in a way corresponding to the diminished rate.

4. It would be convenient to agree to use, whenever possible, *graph paper* (ruled faintly in small squares), with the co-ordinates marked at *standard distances*, say either $\frac{1}{4}$ inch or $\frac{1}{2}$ cm. The half-centimetre distance is much to be preferred, and would, if regularly adopted in international statistics, facilitate comparisons and tend to prevent mistakes. It is also convenient for printed books. In any case the metric system is preferable.

5. In the study of so complex subjects as Geosophy and Sociology all small suggestions which are likely to help are worthy of consideration. These names and the proposed uniformity would, it is believed, help the advancement of science, especially with those who are not mathematicians.

7. *Reasons for a Quinquennial Census.*
By G. B. LONGSTAFF, M.A., M.B., F.R.C.P.

In order to expedite the publication of the results of the census of 1891, as much of the work as possible should be done beforehand; to facilitate this the Bill should be introduced into Parliament in 1889.

The census should be the work of a permanent census sub-department of the General Register Office, which, when not occupied in taking the quinquennial census, would be greatly reduced in numbers; the small permanent staff would, in the intervals, supply all estimates of populations and make special inquiries for Royal Commissions, Select Committees, and Government departments. The work would

thus be better done, and the regular operations of the General Register Office would not be interfered with as at present.

A census is taken every five years by France and Germany, by Queensland and New Zealand. The rapid growth of population in this country and the acknowledged dependence of representation upon population demand that we should have more frequent, and therefore more exact, information.

For instance, the New Local Government Act makes several towns 'county boroughs' on the assumption that on June 1, 1888, they had populations of upwards of 50,000, whereas it is impossible to say, with any approach to certainty, what their populations really were on that day.

The recent inquiry into the immigration of foreign paupers into England to a great extent failed, owing to the want of information less than seven years old.

An exact knowledge of the population is mainly useful as a basis for the calculation of birth-rates and death-rates. In England much money is expended on the calculation and publication of these in the various reports of the Registrar-General and the Medical Officers of Health. These reports are of great value in impressing the need of sanitary improvements on the people and the sanitary authorities, but they lose much of their value from the uncertainty as to the basis upon which such statistics must be built, viz., an exact knowledge of the population. Experience has proved that the official estimates and the census numbers often differ by 10 per cent. in either direction, and sometimes by 15 or even 22 per cent. The Registrar-General himself is ceasing to put any trust in the official estimates of populations, as shown by recent weekly and quarterly reports.

There is reason to believe that, mainly owing to unusually large emigration, the population of the whole United Kingdom was, in April, 1886, or five years after the census, between 400,000 and 500,000 *less* than the official estimate; an error of $1\frac{1}{4}$ per cent.; in smaller areas the errors are often, proportionately to the whole, very much greater.

These errors in the estimation of the population may involve an error of two or three per thousand in the death-rate, so that elaborate calculations made with a view of correcting errors due to differences in age and sex, and constitution of the population, are thrown away.

The cost of a census being 123,000*l.*, it would not be a great burden upon such a rich country to take one every five years instead of every ten.

The author, therefore, urged the British Association to press upon the Government, by memorial or deputation, the desirability of forming a permanent census sub-department, and taking a census every five years.

TUESDAY, SEPTEMBER 11.

The following Papers and Report were read:—

1. *Leasehold Enfranchisement.*
By CHARLES HARRISON.

The author submits this paper on 'Leasehold Enfranchisement' in view of the vital importance which, he considers, the subject bears in relation to the social and economic problems involved in the grave questions of the 'Housing of the Working Classes,' and the reform of the existing Land Laws; and also in view of the many misconceptions entertained by certain sections of the public as to the proposed enfranchisement of leaseholds, being neither more nor less than a communistic violation of freedom of contract, and a socialistic confiscation of the rights of property in private ownership.

The importance of the questions discussed by the author can scarcely be rated too high; it is demonstrated by the fact that a committee of the House of Commons appointed to inquire into the question of Town Holdings in all its various

branches has sat through three consecutive sessions, taking evidence from all parts of the kingdom, and that its labours are still unended.

The author has traced the origin and growth of the system of granting leasehold interests in land through successive stages of legal history; the cause and effect of the Restraining Statutes of Elizabeth; and he has shown that practically the whole of the land on which the metropolis has been developed was formerly held by the Crown, by bodies ecclesiastic and corporate, or by a few of the great historical families, and that it was all but impossible for any private person to acquire a freehold interest in land either in London or its immediate vicinity, prior to the nineteenth century. He argues that as the land was in the hands of these monopolists who could and did dictate such terms as they thought fit, the population, as it increased, was bound to submit to them, and that therefore there could not have been any freedom of contract between contracting parties. Ergo, as there has not been any freedom of contract in the development of the leasehold system, there cannot be any communistic violation of freedom of contract in abolishing it.

The author also deals with the pernicious effect of Private Bill Legislation on property in London, and regards it as one of the main factors in the growth of the present short leasehold system in and around the metropolis.

He points out that between 1700 and 1750 twenty-one separate private Acts of Parliament were passed conferring leasing powers on owners of land in and around the metropolis; and that between 1750 and 1800 no less than fifty-eight further private estate Acts were passed for the same purpose. These Acts were obtained without any discussion as to their public policy. Areas of land, sometimes larger than the old City of London, were dealt with by a single private Act of Parliament; and by this means Parliament enabled tenants for life to deal with settled property in a way unauthorised by the original settlements. Formerly tenants for life could not lease for longer terms than twenty-one years; and it was even considered waste to pull down a house, however ruinous its condition might be, for the purposes of improving or rebuilding it, and no tenant for life had power to do so. In like manner, the bishops and prebends went to Parliament and obtained powers to lease their property, and thus helped to build up the London leasehold system.

The author contrasts the disadvantages of this system of leasing land with the advantages of the freehold fee-farm and chief-rent systems customary in Bath and Bristol and the great majority of towns throughout England, and he says that what is good for all England must be good for the metropolis.

He states the machinery proposed to be put in motion for the enfranchisement of leaseholds, and explains that full compensation is to be paid to the ground landlord for the reversion dependent on the expiration of the lease. The 12 and 13 Vict. c. 105 (Ireland) conferred upon lessees the right of acquiring the fee-simple of the property leased by them, provided the lease is perpetually renewable. The Conveyancing Act of 1881 gives power to a tenant to purchase the reversion where no money rent is reserved; and in the same way it is proposed by the Leaseholds Enfranchisement Bill to give power to a tenant to purchase the reversion where a money rent is reserved, provided the tenant has an unexpired term of a certain number of years.

The author strongly denounces the evils and hardships of the London leasehold system, and advocates the freehold system as being the most perfect of all known systems of land tenure; or, in the alternative, the fee-farm or rent-charge system, such as is now, and has been for centuries past, customary in the city of Bath and the adjoining city of Bristol.

2. *Report of the Committee for continuing the Inquiries relating to the Teaching of Science in Elementary Schools.*—See Reports, p. 164.

3. *The Industrial Education of Women abroad and at home.*
By E. J. WATHERSTON.

4. *Irishwomen's Industries.* By Miss HELEN BLACKBURN.

The industries at present existing amongst women in Ireland are eminently cottage industries. Cottage industries, not requiring large capital, are peculiarly fitted to the condition of the country; moreover, they suit the tastes of the people and the scattered nature of their dwellings. Ireland, therefore, presents a specially favourable field for such industries; but to preserve those already existing, and to develop them further, much is needed in the way of skilled direction and organisation of trade arrangements.

The years of the famine of 1846-48 first drew public attention in any marked degree to the capacities of Irishwomen's fingers, and the results the needle produced in those calamitous days were truly astonishing. Of the numerous centres of work then organised, many have long wholly disappeared, while of those that remain the most firmly established are in the North, where the work is in the hands of large commercial firms, and thus secure of a permanent market.

It is true that in Belfast, the chief factory town of Ireland, the majority of women workers are employed in the mills, while box-making and tobacco factories, and a few other lesser industries, employ some; nevertheless, of the 4,000 women estimated to be employed in shirt and collar making, a quarter are estimated to do the work at home, and in and round Londonderry, which is the centre of the shirt-making trade, a larger proportion. Hemstitching handkerchiefs is stated to employ 20,000 women, and these, together with numbers employed in sewed muslin and embroidery, bring work into every cottage over the greater part of Ulster.

But in the rest of Ireland the centres now at work are too dependent on private effort. They have mostly been started since the years of distress of 1880-81; thus, to name a few, the knitting industries of Valencia Island, Athea, and the Rosses were started in 1880, 1883, and 1884. The revival going forward in the lace-work of Munster dates from the Cork Exhibition of 1883, when the Convent Lace Schools awoke to the necessity of improvement in design, and the revival manifested itself with marked success in the renaissance of Limerick lace. The revival of pillow lace-making in Mayo; the Clonmel Industrial Association; the straw bottle-envelope factory in Galway; and the Association for Promoting Silk Cultivation in the South of Ireland,—all have arisen within the last four years.

To tell of what has been done is to remind ourselves of how much more is needed to be done to make these openings of lasting duration. The efforts already made by various ladies have overcome some of the initial difficulties, chief of which is the lack of precision and punctuality. These ladies have set the women on the way to habits of industry and cleanliness; but the numbers employed must remain comparatively few until the industries thus laboriously started are made independent of the precariousness of private endeavour. For this they need permanent teaching power, organised channels of distribution, means of knowing how to adapt their work to the demands of the market, as well as how to get it there. Nor do these needs apply only to the cottage centres. The jute and brush factories of Galway, which already employ many women—partly in the factory, partly in work done at home—might employ more. Glove-making, once a well-marked skilled trade for women in Ireland, is susceptible of revival; jam-making, now on the increase, is a trade in which women are chiefly employed, and which brings with it the correlative industry of fruit-growing. The cottagers of the wilds of Galway are beginning to find out that there is an outside demand for the home-spun, home-dyed flannels characteristic of the district.

The new City of Dublin Technical Schools admit women, so does the Belfast School of Science and Technology. The Munster Dairy School in Cork and the Glasnevin Dairy School, co. Dublin, are doing good work. But these are not enough; they may teach teachers, but classes are wanted everywhere. Here the movement towards technical teaching in the convent schools is worthy of note; nothing can better show that there is a healthy movement at work than the way in which the Convents of the Sisters of Mercy are beginning to start cookery and dairy classes. The importance of this may be realised when we reflect that there is not a town

of any size in Ireland in which these earnest and energetic women have not a school.

Even in respect to butter-making, the capabilities of the country have never been properly drawn out, much less in the cultivation of early poultry, early flowers, and early vegetables. Rapid transit once arranged, an immense and unsuspected amount of produce now running to waste might be utilised, and garden ground now idle turned to profit.

We often hear of the hopelessness of cottage work as against machinery, but the iron hand can never come up with the skilled hand of nerve and muscle in taste, delicacy, and variety of workmanship. The three urgent needs of Ireland to-day, to enable its domestic industries to flourish, are:—

1. Technical teaching power, for the exercise of which surplus workhouses and convent schools afford facilities.

2. Organised means of distribution, such as the Home Industries' Association in Dublin is endeavouring to establish.

3. Arrangements for rapid transit of perishable produce. These three points demand the careful consideration of all who wish to see possibilities of home industry opened out to Irishwomen of every rank and degree.

5. *Education: a Chapter of Economics.* By T. W. DUNN, M.A.

1. There are no technical schools in Bath. The educational work does not differ from that of most places. Need here, as elsewhere, of ladders to help promising boys from primary to secondary schools. The bearing of such an arrangement on economics. 'Tools to the hands of him that can use them.'

2. The subject is General—the Influence of Education on the Production of Wealth. The Theory of Education is still in the stage of discussion in which inquirers differ.

3. Of the elements of production, labour, or the labourer, alone directly concerned.

4. Wider sense of labour: 'hands,' 'managers.'

5. Tendency to undue subordination of general to technical education. Mischievous consequence in schools and in industries.

6. What the labourer has in common with other labourers is due to general, what he has in difference to technical, training.

7. Industrial organisation based upon what labourers have in common. First a man, then a workman.

8. Illustration. Fishermen, single and co-operative.

9. How far increase of production due to improved character and skill. Vast improvement to be expected from good faith in workmen and a sense of common interest.

10. Men of science propound lopsided theories of education. Philosopher or man of general culture alone to legislate.

11. Children work for work's sake, or *play*; boys work in order that they may work, or *learn*; men work that they may get, or *produce*.

12. Primary schools teach assiduity, or patient persistence in routine and mutual concession or the social faculty. Immense value of these qualities. These schools repress energy and are unfavourable to the artistic spirit. Play, or work for its own sake, and the spirit of play in learning, alone teaches the passion for excellence. This is seen in the fine arts. Hence the importance attached to organised games in secondary schools. Hence, too, the radical unfitness of utilitarian subjects for education and the necessity of distinguishing between education and apprenticeship. Digging and gymnastics, land surveying and mathematics. 'Commercial certificates.'

13. The sciences as subjects of school education. Language and literature the reservoir of traditional and accumulative culture and knowledge, as well as the instrument and cement of social organisation and co-operation.

14. Industrial order, a picnic from which we all tend to draw out only what we put in.

6. *L'organisation et la statistique de l'enseignement technique secondaire en Italie.* By Signor BONGHI.

Je regrette, messieurs, de devoir vous communiquer ces quelques notes sur l'organisation et la statistique de l'enseignement technique secondaire en Italie dans une langue qui n'est ni la vôtre ni la mienne ; mais j'y suis forcé, ne sachant pas prononcer assez bien la vôtre, et la mienne n'étant pas assez généralement comprise. Mais puisqu'il en est ainsi, je n'aurai garde de trop compter sur votre patience ; et je me limiterai à toucher seulement les points les plus importants de mon sujet, pour que vous ayez une juste idée de l'état de cette partie de l'instruction publique dans mon pays, et je laisserai de côté tout ce qui peut s'y rattacher dans l'enseignement élémentaire et dans l'enseignement supérieur, ainsi que les instituts nautiques.

L'idée d'écrire sur ce sujet le mémoire, dont j'extrais les notes que je vous lis, m'est venue l'année passée en assistant à Manchester aux conférences et discussions de la section économique de cette Association. On y a beaucoup parlé d'instruction technique, et dans cette occasion l'Italie a été très souvent citée par les orateurs, qui reprochaient au gouvernement anglais de n'avoir rien fait jusqu'à présent pour l'instruction technique, ni en forme de subside ni en forme d'organisation obligatoire d'écoles appropriées, comme il a pourtant fait pour l'instruction élémentaire. On paraissait croire que ce qui manquait ici se trouvât en Italie parfaitement organisé et développé. Or, ceci n'est pas tout à fait vrai.

Nous avons en Italie un code d'instruction publique qui date de 1859. Il n'a pas été discuté et voté par les chambres, mais conçu et publié par le ministère du temps qui en avait eu ou croyait d'en avoir eu le pouvoir. Or, dans ce code on règle l'instruction qu'on y appelle technique, comme les autres. On y établit que l'instruction technique soit donnée dans une école technique—1^{er} degré—et dans un institut technique—2^d degré, et aux deux degrés en trois ans. La dépense en est partagée en différentes proportions entre l'Etat, la commune et la province ; et le gouvernement a le droit de fonder l'une ou l'autre de ces institutions scolastiques dans les communes qui se trouvent en certaines conditions. La loi, pourtant, n'a pas été parfaitement exécutée, par des raisons que je dois omettre ici ; et le fait est, qu'il y a actuellement en Italie 141 écoles techniques gouvernementales, avec 13 mille élèves presque, et 49 instituts gouvernementaux avec 5,500 élèves. Mais en outre il y a 102 écoles techniques communales avec 8,400 élèves, et 18 instituts provinciaux avec 1,200 élèves. Ce sont des écoles ou des instituts que les communes ou les provinces soutiennent à leurs frais, sans y être obligées par la loi. Je donne les chiffres de 1886-87, car il n'y a pas de statistique plus récente.

Ainsi il paraîtrait qu'on soit fondé à croire que l'organisation de l'instruction technique est parfaitement développée en Italie, et que les orateurs qui en proposaient l'exemple au gouvernement anglais avaient parfaitement raison. Mais au contraire le fait est, que la loi de 1859, qui a établi les institutions dont je viens de vous parler, a appelé technique une instruction qui ne l'est pas, et qui ne s'appelle ainsi ni chez vous ni partout ailleurs. L'instruction qu'elle a appelée technique est plutôt une instruction professionnelle, si vous voulez appeler ainsi une instruction qui n'est pas classique, c'est-à-dire qui n'apprend ni le grec ni le latin, qui met à leur place deux langages modernes, et qui a pour but de fournir des aptitudes et des connaissances nécessaires à tous ceux qui veulent ou doivent se contenter d'emplois ou de professions de moindre valeur et importance que celles auxquelles on arrive par les études supérieures ou universitaires. Ce but nous le trouvons à présent très imparfaitement atteint par les deux institutions de la loi de 1859 ; et rien ne nous paraît plus urgent que de les transformer.

Ainsi quant à ces deux institutions, nous ne pouvons être proposés pour modèle. L'instruction que nous appelons technique ne mérite ce nom qu'exceptionnellement dans un très petit nombre d'instituts, où une des sections dans lesquelles les instituts se partagent s'est développée dans un sens vraiment technique. Pour tout le reste, l'instruction que la loi a appelée technique n'est qu'une instruction professionnelle qui ne nous paraît pas à nous-mêmes assez bonne ou utilement distribuée.

L'école et l'institut, dont je vous ai parlé, sont gouvernés par le ministère de l'instruction publique, mais pendant un certain temps c'est le ministère de l'agriculture et du commerce qui les a gouvernés. Le changement de dépendance vous prouve ce que je viens de vous dire sur leur caractère. Parce qu'elles se nommaient techniques, le ministère de l'agriculture et du commerce les réclamait ; parce qu'au fond elles ne le sont pas, le ministère de l'instruction publique les a reprises. Une fois que le ministère de l'agriculture et du commerce en a été privé, il a développé, plus vigoureusement qu'il n'avait fait jusqu'alors, un enseignement qui est vraiment technique en dehors de l'école et de l'institut, improprement ainsi dits. Si l'on croyait pourtant que la distinction de compétence entre les deux ministères soit tout à fait claire et parfaite, et qu'il n'arrive pas qu'il y ait des doubles emplois dans les créations scolastiques de l'un et de l'autre, on se tromperait. Je crois que, dans l'intérêt du budget et d'une organisation simple et forte, il vaut mieux que tout ce qui est instruction publique, de quelque genre que ce soit, jusqu'où on croit nécessaire que l'Etat s'en mêle, dépende d'un seul ministère. C'est ce que m'a appris l'expérience de mon pays.

En attendant, voici comment le ministère de l'agriculture et du commerce a développé une instruction vraiment technique. Il en distingue trois sortes : l'instruction agricole, l'instruction d'arts et métiers, l'instruction d'art appliqué à l'industrie.

Seulement la première est réglée par une loi, très récente d'ailleurs, car elle date de 1885.

Cette loi établit trois genres d'écoles agricoles : écoles pratiques générales, écoles pratiques spéciales et stations agraires. Dans les dernières on n'enseigne pas : le directeur expérimente, essaye, étudie, donne des conseils. Dans les écoles pratiques on apprend ou la science et l'art de la cultivation de la terre en général ou surtout la science et l'art d'une culture particulière. Le gouvernement peut en établir une par province. L'Italie pourrait en avoir 74 : elle en a 27, mais pas toutes sur le même type ni du même coût. Le nombre des élèves qui les ont fréquentées dans l'année 1886-87, et qui vivent la plupart dans des collèges annexés à l'école, n'a pas surpassé le millier. La dépense de l'école et du collège est partagée entre l'Etat, la commune et la province.

Passons aux écoles d'arts et métiers et d'art appliqué à l'industrie. Elles ne sont pas réglées par une loi, comme je viens de le dire. Le gouvernement en a présenté une, mais elle n'a pas été votée et ne sera pas votée de sitôt. Jusqu'à présent ces écoles ont été créées par acte du pouvoir exécutif, résultat ou de la pensée même du ministre ou de l'influence d'un membre du parlement ou de l'initiative de quelques citoyens. Le parlement s'y est associé en accordant dans le vote annuel du budget les sommes que le gouvernement, par une convention avec la commune ou la province où l'école se fondait, avait mises à sa charge.

De cette manière on a jusqu'à présent fondé en Italie 144 écoles de différents types et dénominations, et ayant pour objet différents arts, avec des cours de jour ou de soir, pour hommes et pour femmes. Elles sont fréquentées par presque 20,000 élèves. On fonde de pareilles écoles tous les ans ; ainsi le nombre en va toujours augmentant.

Ces écoles, qui ont été fondées en différents temps, mais toutes depuis trop peu de temps pour en apprécier les bienfaits, ont pourtant dû exercer quelque influence dans ce réveil des industries artistiques qui s'est vu en Italie pendant les dernières quinze années, et que vous avez pu apprécier et vous avez apprécié avec tant de bienveillance à l'Exposition Italienne à Londres. Mais il faut ajouter que ce réveil est dû aussi en grande partie au réveil national, par lequel chaque citoyen italien et par conséquence chaque ouvrier a senti renaître dans son esprit le goût de l'ancien art de son pays, et diminuer le goût de l'imitation d'un art étranger, surtout de l'art français. L'ouvrier italien s'est trouvé plus hautement, plus profondément inspiré par l'art exquis, d'une si suprême élégance et pureté, du quinzième et du seizième siècle. Le développement de l'école technique a été plutôt l'effet que la source de ce mouvement ; mais certainement elle l'a aidé et elle l'aide. C'est tout ce qu'on peut ou doit en attendre.

7. *Agricultural Education.* By Professor JAMES LONG.

Agricultural prosperity will return with the advance of agricultural education.
The farmer's son of to-day trained at a commercial school.

The son of the Continental farmer has a choice of numerous agricultural schools of different grades.

The agricultural classes deficient in their knowledge of the principles of agriculture.

Admitted that agricultural education requires State aid: what does the present system do under the Science and Art Department?

6,578 students at 332 schools.

4,266 students examined and 3,583 passed, earning a grant of 3,123*l*.

The three years' course for the associateship chiefly includes a knowledge of certain sciences—chemistry, physics, astronomy, biology, geology, mineralogy, mechanics—the agricultural course only coming in one term of the third year.

Astonishment of the authorities that only one student has attempted to take it.

In the last year, eight teachers had attended the thirty-eight weeks' course, and thirty-one the three weeks' course, at a cost of 907*l*.

Suggestion as to a central normal school and farm.

The children in rural schools to have the option of two extra subjects, of which agriculture should be one.

In particular districts special subjects applicable to those districts should be more fully taught, such as dairying, fruit-growing, hop-growing, bee-keeping.

Subjects under the head of agriculture, taught at the rural schools, should be most comprehensive, although elementary.

Weekly night-schools for the pupils who have left the rural schools.

Free scholarships to district schools of agriculture.

Establishment of five district agricultural schools for England and Wales. Each to have, in addition, a special course; two for dairying, one for horticulture (including fruit-growing and preserving, and market gardening); one for biology and botany, and one for forestry.

Free scholarships from the district to the central agricultural school.

Exhibitions from the central school, to enable students to travel abroad.

Travelling lecturers.

8. *Economy in Education and in Writing.* By EIZAK PITMAN.

A million pounds yearly are wasted by the present method of teaching reading in our elementary schools, which might be saved by the use of phonetic reading books; and a hundred million hours yearly are wasted in writing by those who speak the English language.

There are five million children in the common schools of the country. Their first occupation is to learn to read, and they spend, at the lowest reckoning, eight hours per week in gaining a certain amount of reading power during the first four years of their school life. An equal degree of proficiency might be gained by using phonetically printed books during the first *two* years' schooling, and by reading in the present books afterwards.

The annual cost of our elementary schools is five million pounds. The proportion of this sum spent in teaching reading is a little more than one-third. From seven to ten hours, according to the Education Code, are required to be thus occupied out of a total attendance of twenty hours per week. Say that on an average eight hours per week are devoted to reading. The cost of teaching reading alone to these five million children is, therefore, two million pounds. One half of this sum would be saved by the use of an alphabet containing a letter for each sound in the language. As reading is now taught, the sound or pronunciation of every word has to be learned independently of the names of the letters that compose it; and generally in spite of the names or sounds of the letters. But by the use of letters that make up the sound of a word certainty and celerity in the art of

reading take the place of doubt and difficulty; and what is now an irksome task to both teacher and pupil would become a delightful pastime.

Our present style of writing is 'cumbersome in the last degree, and unworthy of these days of invention.' By the use of phonetic shorthand the time spent in writing is reduced to one-fourth, and the writing is as legible as longhand. On a very moderate computation there are a million persons out of the hundred millions who speak the English language that occupy, on an average, one hour a day in writing, or three hundred hours in the working days of a year. This amounts to three hundred million hours in the course of a year. Three-fourths, or say one-third, of this time would be saved by the use of shorthand. Reckoning twelve hours as a working day, above twenty-seven thousand years are annually lost to the world by our slow and tedious method of writing.

The phonetic alphabet for teaching reading and the shorthand alphabet were then exhibited.

WEDNESDAY, SEPTEMBER 12.

The following Papers were read:—

1. *The Malthusian Theory.* By EDWIN CHADWICK, C.B.

When Malthus wrote his book on the 'Pressure of Population on the Means of Subsistence,' the population of England was ten millions, and in the manufacturing districts the wages were low, and the prices of provisions were high. Take Lancashire: the wages given at the commencement of the cotton manufactures were not more than five shillings per head of the cotton mill workers, man, woman, and child; that is to say, if there were three workers in a cottage, the aggregate wages they received were not more than fifteen shillings per week. In agriculture, in Scotland, Adam Smith states that the wages for adult workers at that period were eightpence a day. The wages now in Lancashire average seventeen shillings per head of the mill workers, and in a cottage of three—man, woman, and child—the wages may amount to 2*l.* 10*s.* per week. The agricultural wages in the highly cultivated districts in Scotland are now about 1*l.* per week for the man, 6*s.* for the woman, and 4*s.* for the boy, besides a good cottage and other advantages. Now it may be stated as an economical principle, that the fact of an artisan being employed at wages denotes that over and above his own means of subsistence, he earns enough to yield a profit to the capitalist who employs him, and the continued advance of wages denotes a continued diminution of the pressure of that population on the means of subsistence. And this has been going on, as in Lancashire, with the increasing introduction of labour-saving machinery.

At the beginning of the century, the spinning of a pound of cotton cost 1*s.*; it now costs $\frac{1}{2}$ *d.*, and there is now paid the highest amount of wages with the lowest cost of production of any in Europe. The population in Lancashire has increased from half a million to three millions and a half, and it is going on increasing; whilst the death rate has been considerably reduced. A Cabinet minister is reported to have stated in a recent speech: 'The vast questions connected with population have to be considered. It is growing at a rate which I do not like to cite, but you know Professor Huxley's estimate. Are we taking measures to deal with that population in an intelligent and far-sighted way? I venture to think that we are taking very few precautions, if any. And when you come to think what that question of population involves, you must see that it is one which will force itself on our attention in a very unmistakable way before long. In the first place, it forces on us the great question of the land of this country, which remains limited, while the population knows no limit to expansion.' This quietly assumes the limited cost of production, and the limited amount of the production. Sir Robert Kane, in his work on the 'Industrial Resources of Ireland,' declares that the cultivable land of that country is capable of a threefold

production greater than is now obtained from it, but that the landlords of Ireland are generally incompetent from want of skill to obtain it by labour-saving machinery. In England, it is in evidence that the labour-saving machinery in use in agriculture is not so productive by one-half, as the like machinery in use in the United States. And yet in England, the yield, say, of wheat, is double what it is in France or in Germany, and according to the examinations of the late Mr. Jenkins, the owner of land in *petite culture* works twice as hard for this reduced produce and for half the wages of a well-paid labourer in England. In Germany, the produce of every sort is one-half what it is in England. In England, however, more than half the land that would be largely improved for profitable production by drainage, is as yet undrained. Of the possible augmentation of production in England by high culture it may be stated, that whilst the common production is as one, the high production of market garden culture is as three and a half, whilst the liquefied manure culture, as set forth by De Candolle as the future of agriculture, by giving food and water at the same time, is as five. And yet in the metropolis, prepared plans for the distribution of fresh sewage have been set aside, and the fresh sewage which would yield the milk of 200,000 cows, is thrown into the river Thames in a condition of putridity, to its gross pollution.

It may be mentioned as an incident in analogy with the course of population in Lancashire, that in Norfolk, where the greatest amount of labour-saving machinery has yet been introduced, the agricultural population appears rather to have increased.

Now, in regard to the doctrine of the assumed natural check of pestilence to increase of population. In the investigation on the subject of Poor Law Relief, I found that in the healthy agricultural districts the intervals of births, where the mothers suckled their own children, was about two years, and that where there was a family of eight children, the eldest would be sixteen years of age, the second fourteen, and the third twelve, capable of earning their own subsistence. In the depressed districts, on the other hand—the slums of the metropolis, more heavily ravaged by epidemics—the intervals of births were only one year, the conceptions taking place immediately after each birth. Extended experience shows that, except in such extraordinary pestilences as the Black Death, ordinary pestilences do not diminish population, but only leave it weakened. This may be exemplified from India and elsewhere. As health and the duration of life is advanced, the proportion of births appears to be rather diminished, as with the well-to-do classes. To sum up, it is shown that where wages increase, the pressure of population on the means of subsistence is diminished; that, instead of the cost of the production of land being fixed, it is generally reducible largely by science and machinery, whilst the amount of produce may be everywhere augmented, and that mostly in the regions of *petite culture*; that, instead of pestilence being the natural check to population, it does not diminish that pressure, but serves to weaken population and diminish its productive power, and increase the pressure of population on the means of subsistence.

I cannot descry the limits of a further advance of prosperity in this country with a further increase of population. I expect it will be found with a fifth or a fourth more of population. And then as to external relief. It is declared by a French authority that only one-sixth part is yet inhabited of the cultivable parts of the world. Mr. Justice Cunningham declares that in India 'there are still 79 millions of cultivable acres not utilised, and the rate of produce might be increased so as to provide for an additional population of 400 millions.' Mr. Bence Jones succeeded to an estate in Ireland when the wages were 3*d.* a day and the rental 10*s.* an acre. He advanced the wages to 2*s.* a day, and the valued rental to 40*s.* per acre, and was proceeding to advance still further at the time of his death. But scarcely an instance was known of a similar advance in all Ireland. In France and Germany a similar augmentation of production is proved to be practicable.

2. Dairy Industry. By GEORGE GIBBONS.

3. *Amendments founded on Experiences submitted for the Local Government Bill.* By EDWIN CHADWICK, C.B.

Extended Functions of the County Councils.—In great part the local administrations of all sorts are now occupied by members who are concerned in contracts for supplies. If the Committee on the Poor Law Relief had been carried further, this might have been shown in evidence. Dr. Mouat might have been called as a witness, and he would have shown, in respect to the supplies for the metropolis, that he had examined them twice, and he might have given in tables showing the extraordinary variations in the prices of supplies, and have given reasons for the conclusion that these variations were mainly variations in jobbing commonly at the expense of qualities. Of the children under the administration of the poor-law, only one-third are in the large district schools; two-thirds of them are kept under an inferior administration in the union houses, where they are mixed up and made familiar with the ways of old and depraved paupers. But the consents of the guardians are necessary to the creation of the superior district establishments freed from such influences, and that are more economical as well as superior in results. It is perfectly well known that the refusal to the formation of the district institutions is based on the interest in the retention of the patronage of supplies. To counteract this, and also for superior economy, it is proposed as an amendment that the County Boards should be charged with the exclusive power of making contracts for supplies of provisions and materials for the whole of the public institutions within the county. This would give the benefit of a superior intendment, better qualities of supplies, and the economy of wholesale prices. It would give a means of distributing employment in the different institutions—clothing in one, bakeries, &c., in others. The superior administration in Paris, where the whole of the supplies for the hospitals and other public institutions are under one intendment, and well organised intendment, may serve as a contrast with the conditions found by Dr. Mouat, and flagrantly displayed in the divers vestries of London. But this provision, shifting the contracts, would largely influence the new local administrations throughout the country. It would tend to clear them effectively of the jobbing interests, and to give a new and pure start to the new local administration.

Remedies against Jobbing Appointments.—One great vice of the present local administration is the inveterate habit of jobbing the appointments. This is in distinct contravention of early principles of securities provided in poor-law administration against this evil, but which have extensively fallen through. The remedy available for the local appointments is the principle of testing them by competitive examinations, and this remedy is now sought to be introduced in the United States. It has there been applied to about one-fifth of the public appointments, and has worked so well that it is contended for general application. The Honourable Mr. Seth Low, late Mayor of Brooklyn, states that it has been applied there not only to policemen, but to labourers who are officially employed. The extension of the practice to high officers is now being contended for in France as a remedy for the great political corruption there. An example of the application of the principle may be taken from the County Grand Juries of Ireland. At Dublin competitive examinations are conducted by the Scientific Board of Works, and on any vacancy occurring in the county surveyorships some half-dozen of the leading competitors are presented to the grand juries for their choice of one. A scientific administration is thus secured for the roads of Ireland. Field-Marshal Sir John Burgoyne, who served there, has shown that, under this administration, there is a saving at least of one horse out of five, as compared with the roads as commonly administered in England. In Ireland the cost of maintaining the superior road is 20*l.* a mile per annum. In England the cost of the main road per annum is as much as 38*l.* per mile, with the exception of some parts where a consolidation has been effected by Mr. Thomas Codrington, the scientific Inspector of the Local Government Board. It is submitted as an amendment that with the exception of those who have already undergone competitive examination, such as the Royal Engineers and others,

future local appointments shall be made from successful competitors in examinations by the Civil Service Commissioners for the Empire.

Reduction of Electoral Expenses.—As the Local Government Bill now stands, with the procedure for the elections at polling-booths, the same as in the boroughs, it will frequently involve expenses as great as those of elections to Parliament, and will exclude many fitting candidates. The results at the elections by the polls for the School Board of London have been such as to exclude the most fitting specialists in education, and to admit grossly ignorant and ill-qualified persons. The expense to the ratepayers of this system, which gives the returns generally to minorities and to ignorance or to jobbery, it will be found would suffice to defray the expenses of a superior board of specialists giving their undivided and constant attention in harmony with the latest improved educational principles, whose value would receive general recognition from Parliament as well as from the public at large.

Out of 1,398 contested elections for guardians which took place in 1874-75, it appeared from a return to the House of Lords that there were only seven complaints, scarcely more than 1 per cent. of the electors, of which four of the complaints were adjudged to be well founded. On comparison of these results with the election of members of Parliament, the complaints of false returns on account of bribery, corruption, or intimidation at each dissolution were upwards of 20 per cent. of the elections, and it was notorious that they would have been far more numerous but for the enormous expense of prosecuting the petitions. In the case of the house-to-house collection of votes the petitions are made and examined and determined gratis. It is assumed that the ballot is incompatible with the house-to-house collection of voting papers. This is a fallacy. House-to-house collections of ballots for candidates are practised by charitable associations. An open envelope containing a balloting paper is transmitted by post to the elector, who takes out the paper, marks his candidate, returns the paper into the envelope, closes it, and sends it back to the returning officer under some safe method, which might be by postal delivery and collection under securities of registered letters.

Let it be considered what is the practice of elections in the great civil business of the country; what would be their stability if, as in political life, they were made dependent on the decisions of the hundreds who may be got to meetings, as against the thousands who cannot be got to attend them, but whose voices are brought to the poll by the house-to-house collection of votes as proxies. The plurality of voting is objected to, but, in respect to landed property, the fact is omitted to be observed that on the average two-thirds of rent represents capital in buildings, steadings, roads, hedges, &c. Now where is any objection raised to plurality of votes proportioned to holdings of shares in all commercial institutions? It is proposed that at all events candidates shall be allowed to call for a preliminary test ballot as by way of a show of hands, or by show of collected papers, to be distributed by the post, in such form as the Local Government shall regulate, containing a balloting paper, such as are in use by private societies. All parties would frequently abide by this preliminary test, which need not cost more than a registered letter.

A Completed Imperial Police Force.—In local agricultural associations the eligibility of an imperial police force is fully recognised exclusively of the grounds of its adoption as a great reserve military force, and as a means of repression without bloodshed, and as an economy of military force which has been fully explained.

4. *The Vital and Commercial Statistics of Bath.* By F. NORFOLK.

5. *Old Age and Sickness Assurance for the Mercantile and Professional Classes.* By F. NORFOLK.

SECTION G.—MECHANICAL SCIENCE.

PRESIDENT OF THE SECTION—W. H. PREECE, F.R.S., M.INST.C.E.

THURSDAY, SEPTEMBER 6.

The PRESIDENT delivered the following Address:—

'CANST thou send lightnings, that they may go, and say unto thee, Here we are?' were pregnant words addressed to Job unknown centuries ago. They express the first recorded idea in history of the potentiality of electricity to minister to the wants of mankind. From Job to Franklin is a long swing in the pendulum of time. It was not until that American philosopher brought down atmospheric electricity by his kite-string in 1747, and showed that we could lead it where we willed, that we were able to answer the question addressed to the ancient patriarch. Nearly another century elapsed before this mysterious power of Nature was fairly conquered. It has been during this generation, and during the life of the British Association, that electricity has been usefully employed; and it is because I have taken a subordinate position in inaugurating nearly all of its practical applications, that I venture to make the developments of them the text of my address to this section.

People are singularly callous in matters affecting their own personal safety; they will not believe in mysteries, and they ridicule or condemn that which they do not understand. The Church itself set its face against Franklin's 'impious' theories, and he was laughed to scorn by Europe's scientific sons; and even now, though commissions composed of the ablest men of the land have sat and reported on Franklin's work in England, France, and nearly every civilised nation, the public generally remains not only ignorant of the use of lightning conductors, but absolutely indifferent to their erection, and, if they are erected, certainly careless of their proper maintenance. I found in a church not very far from here the conductor leaded into a tombstone, and in a neighbouring cathedral the conductor only a few inches in the ground, so that I could draw it out with my hand. Although I called the attention of the proper authorities to the absolute danger of the state of affairs, they remained in the same condition for years.

Wren's beautiful steeple in Fleet Street, St. Bride's, was well-nigh destroyed by lightning in 1764. A lightning rod was fixed, but so imperfectly that it was again struck. In July last (1887) it was damaged because the conductor had been neglected, and had lost its efficiency.

As long as points remain points, as long as conductors remain conductors, as long as the rods make proper connection with the earth, lightning protectors will protect; but if points are allowed to be fused, or to corrode away; if bad joints or faulty connections are allowed to remain; if bad earths, or no earths, exist, protectors cease to protect; and they will become absolute sources of danger. Lightning conductors, if properly erected, duly maintained, and periodically inspected, are an absolute source of safety; but if erected by the village blacksmith, maintained by the economical churchwarden, and never inspected at all, a loud report will some day be heard, and the beautiful steeple will convert the churchyard into a new geological formation.

We have not yet acquired that mental confidence in the accuracy of the laws that guide our procedure in protecting buildings from the effects of atmospheric electrical discharges which characterises most of the practical applications of electricity. Some of our cherished principles have only very recently received a rough shaking from the lips of Professor Oliver Lodge, F.R.S., who, however, has supported his brilliant experiments by rather fanciful speculation, and whose revolutionary conclusions are scarcely the logical deduction from his novel premises. The whole subject is going to be thoroughly discussed at this meeting.

We are now obtaining much valuable information about the nature of lightning from photography. We learn that it does not, as a rule, take that zigzag course conventionally used to represent a flash on canvas. Its course is much more erratic and sinuous, its construction more complicated, and pictures have been obtained of *dark* flashes whose *raison d'être* has not yet been satisfactorily accounted for. The network of telegraph wires all over the country is peculiarly subject to the effects of atmospheric electricity, but we have completely mastered the vagaries of lightning discharges in our apparatus and cables. Accidents are now very few and far between.

The art of transmitting intelligence to a distance beyond the reach of the ear and the eye, by the instantaneous effects of electricity, had been the dream of the philosopher for nearly a century, when in 1837 it was rendered a practical success by the commercial and far-sighted energy of Cooke, and the scientific knowledge and inventive genius of Wheatstone. The metallic arc of Galvani (1790) and the developments of Volta (1796) had been so far improved that currents could be generated of any strength, the law of Ohm (1828) had shown how they could be transmitted to any distances, the deflection of the magnetic needle by Oersted in 1819, and the formation of an electro-magnet by Ampère and Sturgeon, and the attraction of its armature had indicated how those currents could be rendered visible as well as audible.

Cooke and Wheatstone in 1837 utilised the deflection of the needle to the right and the left to form an alphabet. Morse used the attraction of the armature of an electro-magnet to raise a metal style to impress or emboss moving paper with visible dots and dashes. Steinheil imprinted dots in ink on the different sides of a line on paper, and also struck two bells of different sound to affect the ear. Bréguet reproduced in miniature the actual movements of the semaphore then so much in use in France; while others rendered practical the favourite idea of moving an indicator around a dial, on which the alphabet and the numerals were printed, and causing it to dwell against the symbol to be read—the A, B, C instrument of Wheatstone in England, and of Siemens in Germany. Wheatstone conceived the notion of printing the actual letters of the alphabet in bold Roman type on paper—a plan which was made a perfect success by Hughes in 1854.

At the present moment the needle system of Cooke and Wheatstone, as well as the A, B, C dial telegraph, are very largely used in England on our railways and in our smaller post offices. The Morse recorder and the Hughes type-printer are universally used on the Continent; while in America the dot and dash alphabet of Morse is impressed on the consciousness through the ear by the sound of the moving armature striking against the stops that limit its motion. In our larger and busier offices the Morse sounder and the bell system, as perfected by Bright, are largely used, while the press of this country is supplied with news which is recorded on paper by ink dots and dashes at a speed that is almost fabulous.

Sir William Thomson's mirror—the most delicate form of the needle system—where the vibratory motions of an imponderable ray of light convey words to the reader, and his recorder, where the wavy motion of a line of ink spirted on paper by the frictionless repulsion of electricity performs the same function, are exclusively employed on our long submarine cables.

Bakewell in 1848 showed how it was possible to reproduce facsimiles of handwriting and of drawing at a distance, and in 1879 E. A. Cowper reproduced one's own handwriting, the moving pen at one station so controlling the currents flowing on the line wire that they caused a similar pen to make similar motions at the other distant station. Neither of these plans, the former beautifully developed by

Caselli and d'Arlincourt, and the latter improved by Robertson and Elisha Gray, has yet reached the practical stage.

The perfection of telegraphy has been attained by that chief marvel of this electrical age—the speaking telephone of Graham Bell. The reproduction of the human voice at a distance, restricted only by geographical limits, seems to have reached the confines of human ingenuity; and though wild enthusiasts have dreamt of reproducing objects abroad visible to the naked eye at home, no one at the present moment can say that such a thing is possible, while in face of the wonders that have been done no one dare say that it is impossible.

The commercial business of telegraphy, when our thoughts and wishes, orders and wants, could be transmitted for money, was inaugurated in this country by the establishment of the Electric Telegraph Company in 1846, and until 1870 it remained in the hands of private enterprise, when it was purchased by the Government, and placed under the sole control of the Postmaster-General. It has been the fashion to decry the terms of purchase of the various undertakings then at work by those who have not understood the question, and by those who, being politically opposed to the Government in power at the time, saw all their acts, not only through a glass darkly, but through a reversing lens. A business producing 550,000*l.* per annum was bought at twenty years' purchase, and that business has now increased to 2,000,000*l.* per annum. 6,000,000 messages per annum have increased to 53,400,000.

Every head post office has been made a telegraph office, every village of any size has its wire; messages which used to cost 1*s.* 6*d.* are now sent for 6*d.*; a tariff which was vexatious from its unfair variation is now uniform over the United Kingdom, and no one can justly complain of error or delay in the transmission of their messages. Silly complaints are sometimes inserted in the press, of errors which the most elementary knowledge of the Morse alphabet would detect, and little credit is given to the fact that the most perfect telegraph is subject to strange disturbances from terrestrial and atmospheric causes which admit sources of error beyond the control of the telegraphist. A flash of lightning in America may cause an extra dot in Europe, and *mine* may become *wine*. An earthquake in Japan may send a dash through France, and *life* would become *wife*. A wild goose flying against a telegraph wire might drive it into momentary contact with another wire, and *sight* might become *night*. Everyone should know his Morse alphabet, and people should learn how to write. Nine-tenths of the errors made are due to the execrable caligraphy of the present day. As a matter of fact, in ninety-nine cases out of a hundred, the telegraphist delivers to the editor of a newspaper 'copy' far more accurate than the first proof of his own leader submitted by the printer. The quantity of news transmitted is enormous, on an average 1,538,270 words are delivered per day. The recent convention in Chicago, when the Republican party of the United States nominated their candidate for the presidency, created so much business that every American paper has chronicled this big thing as unique. 500,000 words were sent on one night; but we in England, when Mr. Gladstone introduced his celebrated Home Rule Bill on April 8, 1886, sent from the Central Telegraph Office in London 1,500,000 words.

The growth of business has led to vast improvement in the carrying capacity of the wires. Cooke and Wheatstone required five wires for their first needle instrument to work at the rate of four words per minute. One wire can now convey six messages at ten times the speed. The first Morse apparatus could work at about five words a minute; we now transmit news at the rate of 600 words a minute. Even in 1875 it was thought wonderful to transmit messages to Ireland at 80 words a minute. When I was recently in Belfast I timed messages coming at the rate of 461 words a minute. Duplex working—that is, two messages travelling on the same wire at the same time in opposite directions, the invention of Gintl, of Vienna—is now the normal mode of working; Edison's quadruplex is common; and the Delany system of multiplex working is gradually being introduced, by which six messages are indiscriminately sent in either direction on one wire. The telegraphic system of England has been brought to the highest pitch of perfection. We have neither neglected the inventions of other countries, nor have we been chary of exercising

inventive skill ourselves, and we have received our full meed of that reward which is always freely bestowed on a British Government official, neglect and abuse.

All parts of the civilised world are now united by submarine cables. The 'Times' every morning has despatches from every quarter of the globe, giving the news of the previous day. 110,000 miles of cable have been laid by British ships, and nearly 40,000,000*l.* of British capital have been expended by private enterprise in completing this grand undertaking. A fleet of 37 ships is maintained in various oceans to lay new cables and to repair breaks and faults—faults that arise, among other causes, from chafing on coral reefs, ships' anchors, the onslaught of insects, and earthquakes. The two cables connecting Australia and Java were recently simultaneously broken by an earthquake.

The politician, unmindful of the works of the engineer, is apt to apply to the credit of his own proceedings the growing prosperity of the world. The engineer, however, feels that steam and electricity in his hands have done more to economise labour, to cheapen life, to increase wealth, to promote international friendship, to alleviate suffering, to ward off war, to encourage peace, than all the legislation and all the verbosity of the politician.

The railways of this country are entirely dependent for the conduct of their traffic on the telegraph, and the security of their passengers is mainly due to the working of the block system. A railway, say between London and Bath, is broken up into certain short sections, and only one train is allowed on one section at one time. The presence, motion, and departure of trains are announced and controlled by electric signals, and the outdoor signals are governed by these electric signals. There are few more interesting places to visit than a well-equipped signal-box on one of our main railways. The signalman is able to survey the lines all around and about him by aid of his electric signals; he can talk by telegraph or by telephone to his neighbours and his station-master; he learns of the motion of the trains he is marshalling by the different sounds of electric bells; he controls his outdoor signals by the deflection of needles, or the movement of miniature semaphores; he learns the true working of his distant signals by their electrical repetition; machinery governs and locks every motion he makes, so that he cannot make a mistake. The safety of railway travelling is indicated by the fact that while in the five years ending 1878 thirty-five people were killed annually from causes beyond their own control, in the five years ending 1887 the average has been reduced to sixteen. One person is killed in 35,000,000 journeys made by train. Wherever we are dependent on human agency we are subject to human error, and a serious accident very recently at Hampton Wick has shown how the most perfect machinery may be rendered valueless to protect life when perversity, thoughtlessness, or criminality enter as factors into the case.

At the meeting of the Association in Plymouth in 1877, I was able for the first time in this country to show the telephone at work. Since then its use has advanced with giant strides. There are probably a million instruments at work now throughout the civilised world. Its development has been regularly chronicled at our meetings. As far as the receiving part of the apparatus is concerned, it remains precisely the same as that which I brought over from America in 1877; but the transmitter, since the discovery of the microphone by Hughes in 1878, has been entirely remodelled. Edison's carbon transmitter was a great step in advance; and the modern transmitters of Moseley, Berliner, D'Arsonval, De Jongh, leave little to be desired. The disturbances due to induction have been entirely eliminated, and the laws regulating the distance to which speech is possible are so well known that the specification of the circuit required to connect the Land's End with John o'Groat's by telephone is a simple question of calculation. A circuit has been erected between Paris and Marseilles, 600 miles apart, with two copper wires of 6½ gauge, weighing 540 lbs. per mile, and conversation is easily maintained between those important cities at the cost of three francs for three minutes. One scarcely knows which fact is the more astounding—the distance at which the human voice can be reproduced, or the ridiculously simple apparatus that performs the reproduction. But more marvellous than either is the extreme sensitiveness of the instrument itself, for the energy contained in one heat

unit (gramme-water-degree) would, according to Pellat, maintain a continuous sound for 10,000 years.

The influence which electric currents exert on neighbouring wires extends to enormous distances, and communication between trains, and ships in motion, between armies inside and outside besieged cities, between islands and the mainland, has become possible without the aid of wires at all, by the induction which is exerted through space itself. On the Lehigh Valley Railway, in the United States, such a system of telegraphing without wires is in actual daily use.

The conduct of telephonic business in England is still in the hands of those who hold the patents, and who maintain a most rigid monopoly. These patents have only a short period to run, and when they expire we may expect to find that England will not occupy the very retired position she holds now as a telephone country. Stockholm has more subscribers than London; there are 15,000 subscribers in and about New York; while the number in London is only 4,851.

Electric lighting has become popular, not alone from the beauty of the light itself, but from its great hygienic qualities in maintaining the purity and coolness of the air we breathe. The electric light need not be more brilliant than gas, but it must be more healthy. It need not be cooler than a wax candle, but it must be brighter, steadier, and more pleasant to the eye. In fact, it can be rendered the most perfect artificial illuminant at our disposal, for it can illumine a room without being seen directly by the eye; it can be made absolutely steady and uniform without irritating the retina; it does not poison the air by carbonic acid and carbonic oxide, or dirty the decorations by depositing unconsumed carbon; it does not destroy books or articles of vertu and art by forming water which absorbs sulphur acids; and it does not unduly heat the room.

In the Post Office Central Savings Bank in London it has been found, after two years' experience of electric lighting, that the average amount of absences from illness has been diminished by about two days a year for each person on the staff. This is equivalent to a gain to the service of the time of about eight clerks in that department alone. Taking the cost at the 'overtime' rate only, this would mean a saving in salaries of about 640*l.* a year. The cost of the installation of the electric light was 3,349*l.* and the annual cost of working 700*l.* per annum, say a total annual cost of 1,034*l.* The cost of the gas consumed for lighting purposes was about 700*l.* a year, so that on the whole there was a direct saving of something like 266*l.* a year to the Government, besides the material advantage of the better work of the staff resulting from the improved atmospheric conditions under which their work is done.

The production of light by any means implies the consumption of energy, and this can be measured in *watts*, or the rate at which this energy is consumed. A watt is $\frac{1}{746}$ part of a *horse-power*. It is a very convenient and sensible unit of power, and will in time replace the meaningless horse-power.

One candle light maintained by tallow	absorbs	.	.	124 watts.
"	"	wax	"	. . 94 "
"	"	sperm	"	. . 86 "
"	"	mineral oil	"	. . 80 "
"	"	vegetable oil	"	. . 57 "
"	"	coal gas	"	. . 68 "
"	"	cannel gas	"	. . 48 "
"	"	electricity (glow)	"	. . 3 "
"	"	electricity (arc)	"	. . 5 "

The relative heat generation of these illuminants may be estimated from these figures.

Though the electric light was discovered by Davy in 1810, it was not until 1844 that it was introduced into our scientific laboratories by Foucault; it was not until 1878 that Jablochhoff and Brush showed how to light up our streets effectually and practically; it was not until 1881 that Edison and Swan showed how our homes could be illuminated softly and perfectly. Unpreparedness for such a revolution produced a perfect panic among gas proprietors; inexperience in the use of powerful electric currents resulted in frequent failure and danger; speculation in 1888.

financial bubbles transferred much gold from the pockets of the weak to the coffers of the unscrupulous; hasty legislation in 1882 restricted the operations of the cautious and the wise; and the prejudice arising from all these causes has, perhaps fortunately, delayed the general introduction of electricity; but now legislation has been improved, experience has been gained, confidence is being restored, and in this beautiful town of Bath fifty streets are about to be lighted, and we see everywhere around and about us in our English homes the pure glow lamp replacing filthy gas and stinking oil. The economical distribution of the electric current over large areas is annually receiving a fresh impetus. The expensive systems defined in the Act of Parliament of 1882 have entirely disappeared. Hopkinson in England and Edison in America showed how a third wire reduced the weight of copper needed by 66 per cent. Gaulard and Gibbs in 1882 showed how the conversion of alternate currents of high electromotive force to currents of low electromotive force by simple induction coils would enable a mere telegraph wire to convey sufficient electricity to light a distant neighbourhood economically and efficiently. Lane Fox in 1879 showed how the same thing could be done by secondary batteries; and Planté, Faure, Sellon, and Parker have done much to prove how batteries can be made to solve the problem of storage; while King and Edmunds have shown how the distribution by secondary batteries can be done as economically as by secondary generators. The Grosvenor Gallery Co. in London have proved the practicability of the secondary generator principle by nightly supplying 24,000 glow lamps scattered over a very wide area of London. The glow lamp of Edison, which in 1881 required 5 watts per candle, has been so far improved that it now consumes but $2\frac{1}{4}$ watts per candle. The dynamo, which in the same year weighed 50,000 lbs., absorbed 150 horse-power, and cost 4,000*l.* for 1,000 lamps, now weighs 14,000 lbs., absorbs 110 horse-power, and costs 500*l.* for the same production of external energy; in other words, its commercial output has been increased nearly six times, while its prime cost has been diminished eight times.

The steam-engine has received equal attention. The economy of the electric light when steam is used depends almost entirely on the consumption of coal. With slow-speed low-pressure engines one kilowatt (1,000 watts, $1\frac{1}{3}$ horse-power) may consume 12 lbs. of coal per hour; in high-speed high-pressure triple-expansion condensing engines it need not consume more than 1 lb. of coal per hour. Willans and Robinson have actually delivered from a dynamo one kilowatt by the consumption of 2 lbs. of coal per hour, or by the condensation of 20 lbs. of steam.

There is a great tendency to use small economical direct-acting engines in place of large expensive engines, which waste power in countershafting and belts. Between the energy developed in the furnace in the form of heat and that distributed in our rooms in the form of light there have been too many points of waste in the intermediate operations. These have now been eliminated or reduced. Electricity can now be produced by steam at 3*d.* per kilowatt per hour. The kilowatt-hour is the Board of Trade unit as defined by the Act of 1882, for which the consumer of electric energy has to pay. Its production by gas engines costs 6*d.* per kilowatt-hour, while by primary batteries it costs 3*s.* per kilowatt-hour. The Grosvenor Gallery Company supply currents at 7*d.* per kilowatt-hour; a 20 candle-power lamp consuming 3 watts per candle, and burning 1,200 hours per annum, expends 82,000 watt-hours or 82 kilowatt-hours, and it costs, at 7*d.* per unit, 50*s.* per annum. If the electricity be produced on the premises, as is the case in the Post Office, in the House of Commons, and in many large places, it would cost 20*s.* 6*d.* per annum. I have found from a general average under the same circumstances and for the same light in the General Post Office in London that an electric glow lamp costs 22*s.* and a gas lamp 18*s.* per annum. The actual cost of the production of one candle light per annum of 1,000 hours is as follows:—

	<i>s.</i>	<i>d.</i>
Sperm Candles	8	6
Gas (London)	1	3
Oil (petroleum)	0	8
Electricity, glow	0	9
„ arc	0	1 $\frac{1}{2}$

The greatest development of the electric light has taken place on board ship. Our Admiralty have been foremost in this work. All our warships are gradually receiving their equipment. Our ocean-going passenger ships are also now so illuminated, and perhaps it is here that the comfort, security, and true blessedness of the electric light are experienced.

Railway trains are also being rapidly fitted up. The express trains to Brighton have for a long time been so lighted, and now several northern railways, notably the Midland, are following suit. Our rocky coasts and prominent landfalls are also having their lighthouses fitted with brilliant arc lamps, the last being St. Katharine's Point on the Isle of Wight, where 60,000 candles throw their bright beams over the English Channel, causing many an anxious mariner to proceed on his way rejoicing.

Fontaine showed in Vienna, in 1873, that a dynamo was reversible; that is, if rotated by the energy of a moving machine, it would produce electric currents; or, if rotated by electric currents, it would move machinery. An electric current is one form of energy. If we have at one place the energy of falling water, we can, by means of a turbine and a dynamo, convert a certain portion of the energy of this falling water into an electric current. We transmit this current through proper conductors to any other place we like, and we can again, by means of a motor, convert the energy of the current into mechanical energy to do work by moving machinery, drawing tramcars, or in any other way. We can in this way transmit and utilise 50 per cent. of the energy of the falling water wherever we like. The waste forces of Nature are thus within our reach. The waterfalls of Wales may be utilised in London; the torrents of the Highlands may work the tramways of Edinburgh; the wasted horse-power of Niagara may light up New York. The falls of Bushmills actually do work the tramway from Portrush to the Giant's Causeway, and those of Bessbrook the line from Newry to Bessbrook.

The practicability of the transmission of energy by currents is assured, and the economy of doing this is a mere matter of calculation. It is a question of the relative cost of the transmission of fuel in bulk, or of the transmission of energy by wire. Coal can be delivered in London for 12s. per ton. The mere cost of the upkeep of a wire between Wales and London to deliver the same amount of energy would exceed this sum tenfold. For long distances the transmission of energy is at present out of the question. There can be no doubt, however, that for many purposes within limited areas the transmission of energy by electricity would be very economical and effective. Pumps are worked in the mines of the Forest of Dean, cranes are moved in the works of Easton and Anderson at Erith, lifts are raised in banks in London; water is pumped up from wells to cisterns in the house of Sir Francis Truscott, near East Grinstead; ventilation is effected and temperature lowered in collieries; goods, minerals, and fuel can be transmitted by telpherage.

The transmission of power by electricity is thus within the range of practice. It can be distributed during the day by the same mains which supply currents for light by night. Small industries, such as printing, watch-making, tailoring, boot-making, can be cheaply supplied with power. It is thus brought into direct competition with the distribution of power by steam as in America, or by air-pressure as in Paris, or by high-pressure water as in London; and the relative advantages and economies of each system are simple questions of calculation. When that evil day arrives that our supply of natural fuel ceases, then we may look to electricity to bring to our aid the waste energies of Nature—the heat of the sun, the tidal wave of the ocean, the flowing river, the roaring falls, and the raging storm.

There is a mode of transport which is likely to create a revolution in the method of working tramways. A tramcar carries a set of accumulators which supplies a current to work a motor geared to a pair of wheels of the car. The weight, price, day's work, and life of the accumulator is curiously the same as the weight, price, day's work, and life of horseflesh; but the cost of maintenance, the liability to accident, and the chances of failure are much less. Although very great improvements in batteries have been made, and they are now really practical things, sufficient experience in tramcar working has not yet been obtained to say

that we have reached the proper accumulator. Nor have we yet acquired the best motor and mode of gearing; but very active experiments are being carried out in various countries, and nothing can prevent their ultimate success.

The property, which the electric current possesses, of doing work upon the chemical constitution of bodies so as to break up certain liquid compounds into their constituent parts, and marshal these disunited molecules in regular order according to a definite law upon the surfaces of metals in contact with the liquid where the current enters and exists, has led to immense industries in electro-metallurgy and electro-plating. The extent of this industry may be gathered from the fact that there are 172 electro-platers in Sheffield and 99 in Birmingham. The term electro-metallurgy was originally applied to the electro-deposition of a thin layer of one metal on another; but this is now known as electro-plating.

In 1839 Jacobi in St. Petersburg and Spencer in Liverpool laid the foundations of all we know of these interesting arts. Copper was deposited by them so as to obtain exact reproductions of coins, medals, and engraved plates. The first patents in this country and in France were taken out by Messrs. Elkington of Birmingham, who still occupy the foremost position in the country.

The fine metals, gold and silver, are deposited in thin layers on coarser metals, such as german silver, in immense quantities. Christofle of Paris deposits annually six tons of silver upon articles of use and of art, and if the surfaces so electro-plated were spread out continuously they would cover 140 acres.

The whole of the copper plates used in Southampton for the production of our splendid Ordnance Survey maps are deposited by current on matrices taken from the original engraved plates, which are thus never injured or worn, are always ready for addition or correction, while the copies may be multiplied at pleasure and renewed at will.

Nickel-plating, by which the readily oxidisable metals like iron are coated with a thin layer of the more durable material nickel, is becoming a great industry; the trappings of harness, the exposed parts of machinery, the fittings of cycles and carriages, and innumerable articles of daily use are being rendered not only more durable but more beautiful.

The electro-deposition of iron, as devised by Jacobi and Klein, in the hands of Professor Roberts-Austen, F.R.S., is giving very interesting results. The designs for the coins which were struck at our Mint on the occasion of the Jubilee of the Queen were modelled in plaster, reproduced in intaglio by the electro-deposition of copper, and on these copper moulds hard excellent iron in layers of nearly $\frac{1}{10}$ th of an inch was deposited.

The exact processes of measurement, which have led to such vast improvement in our telegraphic systems, have scarcely yet penetrated into this field of electrical industry, and little is known at present of the exact relations of current and electromotive force with respect to surfaces of contact, rate of deposit, and resistance of liquids. Captain Sankey, R.E., of the Ordnance Survey Department, has done some useful work in this direction.

The extraction of metals from their ores by deposition has received wide application in the case of copper. In 1871 Elkington proposed to precipitate copper electrolytically from the fused sulphide of copper and iron known to the copper smelter as 'regulus.' Thin copper plates were arranged to receive the deposited copper, while the foreign metals, including gold and silver, fell to the bottom of the solution, the process being specially applicable, it was supposed, to regulus containing small quantities of the precious metals.

The electrical purification of copper from impure 'blister copper' or 'blade copper' has also made great progress, and special dynamos are now made which will, with an expenditure of 100 horse-power, precipitate 18 tons of copper per week. The impure metal is made to form the anode in a bath of sulphate of copper, the metal being deposited in the pure form on a thin copper cathode.

It was not very long ago considered very economical to absorb '85 horse-power in depositing one pound of copper per hour, but now the same work can be done with '3 horse-power. Mr. Parker of Wolverhampton has done good work in this direction, and his dynamos in Messrs. Bolton's works have revolutionised this process of purification.

Both at Swansea and Widnes immense quantities of copper, in spite of the restrictive operations of the copper syndicate, are being produced by electro-deposition. Copper steam pipes for boilers are now being built up of great firmness, fine texture, and considerable strength by Mr. Elmore at Cockermonth, by electro-deposition on a rotating mandril in a tank of sulphate of copper. By this process one ton of copper requires only a little more than one ton of coal to raise the requisite steam to complete the operation.

It has been shown that the electrolytic separation of silver from gold by similar methods is perfectly practicable. The value of the material to be dealt with may be gathered from the fact, communicated to the 'Gold and Silver Commission' now sitting, that nearly 90,000,000 ounces of silver are annually produced, and the greater portion of this amount contains sufficient gold to render refining remunerative. Although the old acid process of 'parting' gold and silver remains practically undisturbed, there seems no reason to doubt that in the future electricity will render us good service in this direction as it has already in the purification of copper.

There is not much actual progress to report in the extraction of gold from its ores by electrical agency. The conversion of gold into chloride of gold by the direct, or indirect, action of chlorine is employed on a very large scale in [Grass Valley] California and elsewhere. This fact has led to well-directed efforts to obtain, by electrolytic action, chlorine, which should attack finely divided gold suspended (with the crushed ore) in the solution from which the chlorine was generated, the gold, so converted into soluble chloride, then being deposited on a cathode. The process would seem to be hopeful, but is not as yet a serious rival to the ordinary chlorination method.

In the amalgamation of gold ores much is expected from the possibility of keeping clean, by the aid of hydrogen set free by the electric current, the surfaces of amalgamated plates.

It is well known that the late Sir W. Siemens considered that the electric arc might render good service in the fusion of metals with high melting-points, and he actually succeeded in melting 96 ounces of platinum in 10 minutes with his electrical furnace. The experiments were interrupted by his untimely death, but in the hands of Messrs. Cowles the electric arc produced by 5,000 ampères and 500 horse-power is being employed on a very large scale for the isolation of aluminium (from corundum), which is immediately alloyed (*in situ*) with copper or iron, in the presence of which it is separated.

The heating power of large currents has been used by Elihu Thomson in the United States, and by Bernardos in Russia, to weld metals, and it is said to weld steel without affecting its hardness. It has even been proposed to weld together in one continuous metallic mass the rails of our railways so as to dispense entirely with joints.

The production of chlorine for bleaching and of iodine for pharmaceutical purposes, the economical production of oxygen, are also processes now dependent on the electrolytic effect of the electric current.

It is almost impossible to enumerate the various general purposes to which electricity is applied to minister to our wants, and to add to our comforts. Every one appreciates the thorough efficiency of the trembling electric bell, while all will sooner or later derive comfort from the perennially self-winding electric clock. Correct mean time is distributed throughout the length and breadth of the land by currents derived from Greenwich Observatory. Warehouses and shops are fitted with automatic contact pieces, which, on any undue increase of temperature due to fire, create an alarm in the nearest fire station; and at the corner of most streets a post is found with a face of glass, which on being broken enables the passer-by or the watchful and active policeman to call a fire engine to the exact spot of danger. Our sewers are likely to find in its active chemical agency a power to neutralise offensive gases, and to purify poisonous and dangerous fluids. The germs of disease are attacked and destroyed in their very lairs. The physician and the surgeon trust to it to alleviate pain, to cure disease, to effect organic changes beyond the reach of drugs. The photographer finds in the brilliant rays of the arc lamp a

miniature sun which enables him to pursue his lucrative business at night, or during the dark and dismal hours of a black November fog of London.

We learn from the instructive and interesting advertising columns of our newspapers that 'electricity is life,' and we may perhaps read in the more historical portion of the same paper that by a recent decision of the New York Parliament, 'electricity is death.' It is proposed to replace hanging by the more painless and sudden application of a powerful electrical charge; but those who have assisted at this hasty legislation would have done well to have assured themselves of the practical efficacy of the proposed process. I have seen the difficulty of killing even a rabbit with the most powerful induction coil ever made, and I know those who escaped and recovered from the stroke of a lightning discharge.

The fact that the energy of a current of electricity, either when it flashes across an air space, or when it is forced through high resistance, assumes the form of heat of very high temperature led early to its employment for firing charges of gunpowder; and for many civil, military, and naval purposes it has become an invaluable and essential agent. Wrecks like that of the 'Royal George' at Spithead were blown up and destroyed; the faces of cliffs and quarries are thrown down; the galleries of mines and tunnels are excavated; obstructions to navigation like the famous Hell Gate, near New York, have been removed; time guns to distribute correct time are fired by currents from Greenwich at 1 P.M. In the operations of war, both for attack and defence, submarine mining has become the most important branch of the profession of a soldier and a sailor. Big guns, whether singly or in broadside, are fired, and torpedoes, when an enemy's ship unwittingly is placed over them, are exploded by currents of electricity.

An immense amount of research has been devoted to design the best form of fuse, and the best form of generator of electricity to use to explode them. Gun-tubes for firing consist of a short piece of very fine wire embedded in some easily fusible compound, while the best form of fuse is that known as the Abel fuse, which is composed of a small, compact mass of copper phosphide, copper sulphide, and potassium chlorate. The practice in the use of generators is very various. Some, like the Austrians, lean to the high tension effects of static electricity; others prefer magneto machines; others use the dynamo; while we in England cling with much fondness to the trustworthy battery. Since the electric light has also become such a valuable adjunct to war purposes, it is probable that secondary batteries will become of immense service. The strong inductive effects of atmospheric electricity are a source of great danger. Many accidental explosions of fuses have occurred. An experimental cable with a fuse at one end was laid below low-water mark along the banks of the Thames at Woolwich. The fuse was exploded during a heavy thunderstorm. The knowledge of the causes of a danger is a sure means for the production of its removal, or of its reduction to a minimum. Low tension fuses and metallic circuits reduce the evils of lightning, but have not removed them. Should war unhappily break out again in Europe, submarine mining will play a very serious part, and, paradoxical as it may appear—as has been suggested by the French ambassador, M. Waddington—its very destructiveness may ultimately prove it to be a powerful element of peace.

It seems incredible that, having utilised this great power of nature to such a wide and general extent, we should be still in a state of mental fog as to the answer to be given to the simple question—What is Electricity? The engineer and the physicist are completely at variance on this point. The engineer regards electricity, like heat, light, and sound, as a definite form of energy, something that he can generate and destroy, something that he can play with and utilise, something that he can measure and apply. The physicist—at least some physicists, for it is difficult to find any two physicists that completely agree with each other—regard electricity as a peculiar form of matter pervading all space as well as all substances together with the luminiferous ether which it permeates like a jelly or a sponge. Conductors, according to this theory, are holes or pipes in this jelly, and electrical generators are pumps that transfer this hypothetical matter from one place to another. Other physicists, following Edlund, regard the ether and electricity as identical, and some, the disciples of Helmholtz, consider it as an integral

constituent of nature, each molecule of matter having its own definite charge, which determines its attraction and its repulsion. All attempts to revive the Franklinian, or material theory of electricity, have, however, to be so loaded with assumptions, and so weighted with contradictions, that they completely fail to remove electricity from the region of the mysterious. It is already extremely difficult to conceive the existence of the ether itself as an infinitely thin, highly elastic medium, filling all space and employed only as the vehicle of those undulatory motions that give us light and radiant heat. The material theory of electricity requires us to add to this another incomprehensible medium embedded or entangled in this ether, which is not only a medium for motion, but which is itself moved. The practical man, with his eye and his mind trained by the stern realities of daily experience, on a scale vast compared with that of the little world of the laboratory, revolts from such wild hypotheses, such unnecessary and inconceivable conceptions, such a travesty of the beautiful simplicity of nature.

He has a clear conception of electricity as something which has a distinct objective existence, which he can manufacture and sell, and something which the unphilosophic and ordinary member of society can buy and use. The physicist asserts dogmatically: 'Electricity may possibly be a form of matter—it is not a form of energy.' The engineer says distinctly: 'Electricity is a form of energy—it is not a form of matter; it obeys the two great developments of the present generation—the mechanical theory of heat and the doctrine of the conservation of energy.' There must be some cause for this strange difference of views. It is clear that the physicist and the engineer do not apply the term electricity to the same thing. The engineer's electricity is a real form of energy; the speculative philosopher's electricity is a vague subjective unreality which is only a mere factor of energy and is not energy itself. This factor, like force, gravity, life, must, at any rate for the present, remain unknowable. It is not known what force is; neither do we know what is matter or gravity. The metaphysician is even doubtful as regards time and space. Our knowledge of these things commences with a definition. The human mind is so unimpressionable, or language is so poor, that writers often cannot agree even on a definition. The definition of energy is capacity for doing work. We practical men are quite content to start from this fiducial line, and to affirm that our electricity is a something which has a capacity for doing work; it is a peculiar form of energy. The physicist may speculate as much as he pleases on the other side of this line. He may take the factors of energy, and mentally play with them to his heart's content; but he must not rob the engineer of his term *electricity*. It is a pity that we cannot settle our difference by changing the term. Physicists might leave the term *electricity* to the form of energy, which is an objective reality, and which the ordinary mortal understands; while engineers would be quite content if speculative physicists and enthusiastic mathematicians would call their subjective unreality, their imaginary electrical matter, by some other term. If it be necessary to mentally create some imaginary matter to fulfil the assumptions and abstractions of their mathematical realisations, let them call it *coulombism* or *electron*, and not appropriate the engineer's generic and comprehensive term *electricity*. The engineer finds the motions of existing matter and of the ether quite sufficient to meet all his requirements, and to account for all those phenomena which are called electrical.

It seems paradoxical to assert that two unrealities can form a reality, or that two subjective ideas can become an objective one; but it must be remembered that in all electrical phenomena that which makes them real and objective is derived from without. The motion that renders an electrical phenomenon evident is imparted to it from some other form of energy. The doctrine of the conservation of energy asserts that energy is never destroyed, it is only transformed—work must be done to render it evident. No single electrical effect can be adduced which is not the result of work done, and is not the equivalent of energy absorbed. The engineer's notions of work—something done against resistance—and of power—the rate at which this change of condition is effected—are the keystones to the conception of the character of those great sources of power in nature whose direction to the uses and convenience of man is the immediate profession of those who

generally assemble together in Section G of the British Association to discuss the 'practical application of the most important principles of natural philosophy which has, in a considerable degree, realised the anticipations of Bacon and changed the aspect and state of affairs in the whole world.'

I cannot pretend to have given a survey of all the practical applications of electricity. I have entirely neglected its applications to physical research, its assistance in securing minute and accurate observations, the marvellous precision and delicacy of its measurement. I have but briefly indicated the present area covered by the new and rapidly growing industry. Five million people upon the globe are now dependent on the electric current for their daily bread. Scarcely a week passes without some fresh practical application of its principles, and we seem to be only on the shore of that sea of economy and beneficence which expands with every new discovery of the properties of electricity, and spreads already beyond the mental grasp of any one single worker.

The following Papers were read:—

1. *The Phonograph.* By Colonel G. E. GOURAUD.

2. *The Graphophone.*¹ By HENRY EDMUNDS.

A review of the interesting history of the art of recording and reproducing sound shows that Dr. Hooke in 1681 exhibited some experiments before the Royal Society demonstrating how musical notes and other sounds could be produced by means of toothed wheels rapidly rotated. In 1854 Charles Bourseuil proposed to use two diaphragms, connected by an electric wire, and, by speaking into one of them, reproduce the spoken sounds at any distance in the other. This idea was actually carried out by Philipp Reis five years later. The Phonautograph was patented by Leon Scott in 1857; and Faber constructed a complicated speaking machine which pronounced a few words and sentences most unsatisfactorily. But in 1876 appeared the Bell Telephone, the first really perfect instrument for the transmission of speech. In April, 1877, M. Charles Cros deposited a paper at the Academy of Sciences in Paris on 'A process of recording and reproducing audible phenomena,' in which he proposed to obtain tracings of sound-waves by means of a vibrating membrane. Then, by going over these tracings with a stylus attached to another membrane, the sounds would be reproduced. Consequently, to M. Cros belongs the credit of having suggested a means of mechanically recording and reproducing spoken sounds. Later in the year Mr. Thomas Alva Edison realised this idea in his phonograph. Mr. Edmunds described it in a report to the 'Times' on February 17, 1878. Shortly afterwards Mr. W. H. Preece exhibited at the Royal Institution the first phonograph made in this country under Mr. Edmunds' instructions. This instrument created a great sensation, and glowing anticipations were entertained of its future application, but it was found that its articulation was far too imperfect, and its general performance too crude, to admit of its being used for any practical purpose; and Mr. Edison himself gave it up, applying himself to other work, even allowing his two English patents to lapse. But in 1881, Professor Graham Bell, inventor of the Telephone, with Dr. Chichester A. Bell, and Mr. Charles Sumner Tainter, formed the Volta Laboratory Association in Washington for the purpose of investigating the art of transmitting, recording, and reproducing sound. They conducted many elaborate experiments, and, among other things, sought for and discovered the cause of the failure of the Edison Phonograph. They found that tinfoil, as used in that instrument, was far too pliable for the purpose, as it always had a tendency to pucker, and destroy the symmetry of the sound-waves. They perceived that no good result could be obtained by merely *indenting a pliable material*; it was necessary to *engrave a record in a solid resisting body*; and this discovery enabled them to produce a really practical instrument, which they termed the 'Graphophone.' Instead of tinfoil, Mr. Tainter employed

¹ Printed *in extenso* in *Engineering*, vol. xlv. p. 319.

wax, ploughing out, by means of a vibratory stylus, a narrow undulating groove, which constituted a sound record. When this groove was retraced by another stylus and diaphragm, the original sounds were reproduced with a fidelity undreamed of by those only acquainted with the phonograph. In 1885 the Volta Laboratory Association was dissolved, after performing most important work, and taking out a series of valuable patents.

Mr. Tainter has brought the experience of years to the perfection of the graphophone. The kernel of the invention is the 'recording cylinder,' six inches long by an inch-and-a-quarter broad, formed of cardboard, coated with wax. This is placed in a small lathe and rotated by a treadle in contact with the 'recorder,' which consists of a metal frame supporting a thin mica diaphragm, in the centre of which is a steel point that cuts a narrow groove on the surface of the cylinder, according to the quality and intensity of the sound spoken against it. The recorder is then removed, and replaced by the 'reproducer,' a light feather of steel that travels along the grooves made on the cylinder, and transmits their undulations to a small mica diaphragm, which in its turn communicates its vibrations, as sound-waves, to the ears of the auditor by means of two india-rubber tubes, for Mr. Tainter found it best to reduce the size of the record, and concentrate the sound in this way, on account of the greater distinctness that was thus secured. The manipulation of the graphophone is simplicity itself. It requires no adjustment, no electric motor, no galvanic battery. The foot supplies the motive power, and the machine regulates its own speed by means of an ingenious, but simple governor. Journalists and reporters may dictate their articles and reports, leaving others to transcribe them. The principal of a firm can speak his day's correspondence into the machine, which will repeat it sentence by sentence, to be written down in proper form by pen or typewriter. Or purely verbal communication can be carried on through the post by means of the record cylinders, which are extremely light, although capacious enough to hold one thousand words a piece. All these applications are now in active operation in America, where the graphophone has achieved a great success.

3. *Mechanical Pathology considered in its relation to Bridge Design.*¹

By G. H. THOMSON, *M.Am.S.E.*

After pointing out the applicability of the ordinary terms of medical science in the consideration of mechanical problems the author asks, How many railway bridges are structurally competent to perform the work for which they were erected? How many are being taxed mechanically beyond the limit ever intended? And how many are able to withstand the sometimes rough usage (as in the case of collisions) incidental to railroad operations?

A railway bridge is ordinarily constructed upon the assumption that all the conditions governing its use and life will always remain favourable, and the non-recognition of the fact that an unfavourable combination of circumstances may occur is responsible for many of the deficiencies that occur in practice.

No less than 251 truss railway bridges have failed in the United States and Canada during the ten years ending December 1887 from preventable causes such as are here alluded to, involving in each case the wreck wholly or partially of a train.

The author investigates the causes of these several accidents under different headings. He discusses successively broken axles and wheels, increase of tonnage, power, and speed.

He doubts the utility of laboratory tests as a means of affording thoroughly reliable information in regard to broken axles, and points out that whereas the earliest engine used in America only weighed 0.875 ton per wheel, those now in use weigh eight tons and upwards. Since 1874 the speed of freight trains on the New York Central has increased from fifteen to twenty-five miles per hour, and passenger trains at times attain a maximum speed of no less than 74 miles an hour.

¹ Printed *in extenso* in *Engineering*, vol. xlvii, p. 252.

The author then discusses certain experiments he has made with a view to ascertain the strains that occur in various types of bridge when loads pass over them, and proceeds to describe an extensive series of photographs illustrative of bridge accidents, which were exhibited to the meeting.

In concluding he strongly advocates the use of riveted lattice-bridges instead of pin-connected trusses for railway service up to spans of 250 feet, and gives numerous reasons for preferring them, as well as conditions to be observed in their construction.

4. *A few Arguments in favour of Light or Road Railways.*

By THOS. STEPHEN P. W. D'ALTE SELLON, *Assoc.M.Inst.C.E.*

The author's object in this paper has been to demonstrate that there is no reason why the present tramway system, familiar in most of our principal towns, cannot be made (with some modifications) of exceptional value as feeders to the trunk lines, and as a means of transit for every description of goods and merchandise as well as passengers.

That, by utilising the sometimes considerable waste, so often met with along the side of our country roads, cheap and efficient feeders can be constructed, thereby saving the cost of land purchase or the heavy cost of maintenance if constructed on the road.

For example, a line which has been constructed on this principle and has been working for the last eighteen months, is mentioned as proving how increased facilities make increased traffic, in the fact that it carries the entire population of the whole district once a week besides dealing with the whole of the cartage and delivery of goods to and from the London and North-Western Railway, with which the line is connected, as well as all the parcels and mails.

That, besides the advantages proved by the large patronage it receives, the property in the district, since its opening, has risen 20 per cent. in value, and houses which had long been in want of tenants are now all occupied.

That, as the object of this class of railway is to carry heavy goods and other merchandise that would otherwise be drawn along the road, it is clear that there must be a great saving in the wear and tear of the same as well as a material relief to the road rates which, in some country districts, is a great burthen.

Being a tramway, the working expenses as compared with railways are very small, owing to the absence of stations and station officials, signals and telegraph.

The author is strongly against the construction of this class of light railway to any other gauge but that of the line it feeds, as he affirms that the plea of economy cannot be maintained, and that one of the chief causes of the failure of the Irish Tramway Act, 1883, was the fact that the gauge was fixed at 3 ft., the fallacy of which has been demonstrated by the report of the late Royal Commission on Irish Public Works.

He also points out the great necessity there is for the reform of Private Bill Legislation, there being far too much expense in the introduction of a scheme, *i.e.*, prior to consideration; a mutilated Bill being often accepted by the promoters in consideration of the money already expended.

In these days of progress landowners are urged to thoroughly examine the merits of a scheme before they throw away their money in opposition, as by arrangement with promoters all their objections might easily be overcome.

By a comparison between the ordinary service of a branch line and the ordinary service of a light railway, it is demonstrated by the actual returns of the latter that it is to the interest of all railway managers and railway shareholders to give every facility for the construction of these feeders which must largely increase the value of their properties.

FRIDAY, SEPTEMBER 7.

The following Papers were read:—

1. *The Barry Docks.*¹ By JOHN WOLFE BARRY, *M.Inst.C.E.*

The Barry Docks, which are now approaching completion, are situated on the north shore of the Bristol Channel about 7 miles westward of Cardiff. The site is between Barry Island and the mainland, and the approaches from the sea are very easy. Good anchorage exists eastward of the docks between Barry Island and Sully Island. The docks are, as is the case with other docks on the Bristol Channel, tidal, and thus can only be approached for a few hours at high water. The range of tide in the Bristol Channel is large: at Barry there is a range of 36 feet at ordinary springs and of 19½ feet at ordinary neaps. There is a depth of 25 feet of water at low water of spring tides within 700 yards of the entrance gates of the Barry Docks. The main object of the Barry Docks is for the shipment of South Wales coal, but it is expected that a considerable import trade will also be developed. About 11 millions of tons of coals were shipped at the neighbouring ports of Cardiff and Penarth during the past year. The Barry Docks are connected with the coal-fields by new railways about 27 miles in length which are nearly finished. They have easy gradients, which, on the main line, are not steeper than 1 in 400 against the load. The entrance of the docks is on the east side of Barry Island, which protects it from westerly and south-westerly winds. Against other winds the entrance is protected by two breakwaters composed of rubble protected by 6-ton blocks of stone on the sea-slope. The waterway between the breakwaters is 350 feet and the entrance is 485 yards within the breakwater heads. A channel of that length is to be dredged to the entrance. The entrance is 80 feet wide and has a pair of wrought-iron gates which will be opened and closed by direct acting hydraulic cylinders; it gives access to the basin, which is 600 feet long and 500 feet wide, having an area of 7 acres. Beyond the basin is the dock, which is 3,400 feet long and 1,100 feet wide. This width is divided at the western end of the dock into two arms by a projecting mole. The water area of the dock is about 70 acres. The basin and dock are connected by a passage, which, like the entrance, is 80 feet wide, and has a pair of wrought-iron gates. The basin will be used as a lock, and the water in it will be adjusted to meet the rising tide each day, so that vessels may leave the basin before high water, and, similarly, vessels may enter the basin for some little time after high water. A floating caisson of wrought iron has been provided, which will fit against any of the faces of the entrance or passage in case of necessity. A low-water lock westward of the basin is contemplated. A graving dock, 700 feet long and 100 feet wide, is being made at the north-east corner of the dock. Eastward of this is the timber pond of 24 acres, approached from the dock by a short canal. The total area of water in the dock, basin, and timber pond is upwards of 100 acres. The depth of water at the entrance is 38 feet at high-water spring tides, and 29 feet at high-water neap tides. The following list gives the levels of various parts of the dock and of the tides above a datum line 50 feet beneath Ordnance datum:—

	Above Datum Feet
Ordnance datum	50·00
High water—ordinary <i>spring</i> tides	69·70
Low water	33·60
High water—ordinary <i>neap</i> tides	61·30
Low water	41·70
Mean sea-level at Barry	51·60
Entrance channel	28·00
Sill of entrance	32·00 ²
Sill of passage	32·00 ²

¹ Printed *in extenso* in the *Railway News*, Sept. 15, 1888.

² The sills being in the form of an invert, at the middle point there is three feet more water than the nominal level above given.

	Above Datum Feet
Bottom of basin	30·00
Bottom of dock	30·00
Coping of basin and dock	76·50
Top of breakwaters	78·50

The shipment of coal will take place from eleven high-level coal-tips and four cranes on the north side of the dock, and five low-level tips on the mole, and one tip at the west end of the dock. Space for a larger number of tips exists on the mole and on the south side of the dock and in the basin. Imports will be accommodated on the south and east sides of the dock. All the machinery will be worked by hydraulic pressure from an engine-house and accumulators at the south side of the dock, and two other accumulators on the north side of the dock. The first sod of the dock was cut in November 1884, and it is expected that the docks will be opened at the end of this year or the beginning of 1889. The engineers for the dock works are the author and Mr. T. Forster Brown and Mr. H. M. Brunel; the resident engineer is Mr. John Robinson. The contractor for the dock works is Mr. T. A. Walker. The cost of the dock works will be about 850,000*l.*, including the gates and all the hydraulic and other machinery, electric light, &c.

2. *Plant and Machinery in use on the Manchester Ship Canal.*¹ By LIONEL B. WELLS, *M.Inst.C.E.*

When the Association met at Manchester last year Mr. Leader Williams read a paper giving a general description of the Manchester Ship Canal, and the author proposes to give some account of the means adopted by Mr. T. A. Walker, the contractor, for carrying out the work.

The Canal commences at Eastham, 5 miles above Liverpool, and extends to Manchester, 35½ miles further inland, and is practically a continuous cutting. The Canal is to be more than half as wide again as that of Suez, and, with extensive docks and the deviations of the various railway lines to provide for, the earthwork amounts to about 50 million cubic yards.

The engineer has divided the work into sections, and appointed a resident engineer to each. The contractor divides the work into nine sections; each section is assigned to an agent, with a separate staff of sub-agents and engineers looking to the agent for instructions. To their charge is consigned the plant allotted to each section; they have their own workshops, means of repairing plant, &c. The whole is controlled by an agent-in-chief with head-quarter staff in Manchester; but each section is worked as a separate contract; the individual responsibility of the agent is thus secured by Mr. Walker, and the Canal Company hold Mr. Walker responsible for his contract to complete the whole of the work.

A commencement was made during the winter, and already the progress has been very great, mainly with excavation, and especially on the sections at Eastham and Manchester.

The plant for a contract of such magnitude, to be completed within a limited time, is necessarily great in quantity and of the most improved description. In addition to the usual locomotives, which already number eighty-seven, there are upwards of sixty steam-diggers of various models, some of which were referred to in detail and photographs shown; also new excavating machines were described, which, under the name of the French or German Excavator, for each nation supplies its especial machine, have been for the first time introduced into this country. The action of the machine is that of a bucket-dredger, but instead of being water-borne it is worked on a railway.

Already the excavations exceed a million and a quarter cubic yards a month, and the output is still increasing.

¹ Printed *in extenso* in the *Engineer*, Sept. 21, 1888.

3. *On an improved Canal Lift.*¹ By S. LLOYD.

After referring to the antiquity of river and canal navigation, the author mentions that no effective method of overcoming the difficulty of transferring boats from one level to another was invented till the year 1481, when, by the introduction of canal locks with double gates, a new era in canal construction was introduced, as canal boats, instead of being confined to transit across level plains, could be made to traverse hills and valleys wherever a sufficient supply of water could be obtained.

The author points out that as a rule canals have not a sufficient supply of water to work locks of a capacity to suit the larger class of boats which modern trade renders necessary for economy of transit; but a new era in canal transit may be again inaugurated by the use of hydraulic lifts of the improved type, which experience shows would be desirable, and which it is the object of his paper to describe.

Already three hydraulic canal lifts are in operation, namely, one at Anderton in Cheshire, one at La Louvière in Belgium, and another at St. Omer in France.

In each case the boat is floated into a receptacle full of water, and is raised or lowered in it, the receptacle being supported by a ram fixed vertically beneath it.

With a view to augment the stability of such lifts, it has been proposed to increase the number of points of support of the receptacle by placing more rams and presses under it; but this would not attain the desired result, and would be very expensive, requiring many deep, and therefore costly, foundations.

The improved hydraulic canal lift, of which diagrams are shown, suspends the receptacle between and considerably below the upper part of two hydraulic rams in place of making it rest on the head of one ram.

This new arrangement causes the centre of gravity of the system to be very low down, even below the stuffing-boxes of the hydraulic presses (if desired), and consequently great stability is attained. It not only insures very great stability, but at the same time effects considerable economy in construction.

The heads of the two rams are connected by a cross-girder, to which the receptacle is suspended by ties; and the strong pipes below, which connect the two presses, ensure solidity and perfectly even movement of the receptacle.

By this arrangement the rams have not to descend entirely below ground, so that the wells for the presses are not nearly so deep, and consequently are less costly. Moreover, the rams can be easily lubricated with oil, and all the parts are readily accessible for inspection or replacement.

The advantages of rapidity and economy with which boats of large tonnage may be transferred from one level to another by the means advocated will be apparent.

4. *On the Replenishment of the Underground Waters of the Permeable Formations of England.* By J. BAILEY DENTON, *M.Inst.C.E., F.G.S.*

The author, having long advocated, with the late Sir John Rennie and others, the storage of the surplus rainfall in reservoirs or lakes to be constructed in the higher tributary valleys of our river systems to maintain them in full service, invites attention to the capabilities existing of replenishing at the same time the subterranean supplies of the water-bearing strata by shafts to be sunk down to the line of their saturation.

The author takes the Thames and its basin to illustrate his views, which apply equally to other river systems, and to support his statement as to the decline of the water levels in the chalk, red sandstones, and other formations, he makes reference to the evidence and publications of Clutterbuck, Deacon, Harrison, Braithwaite, and others, who have shown that with a natural inclination towards the outfall the line of saturation in the chalk under London, and in the sandstone at Liverpool, had fallen, more than twenty years back, above fifty feet. The most reliable

¹ Published *in extenso* by the author. (J. Hogg and Sons, London.)

records of meteorologists showing that the average amount of rain falling on the surface of the Thames watershed varies according to position from 25 inches to 28½ inches, he has assumed that 27 inches is the nearest approach to the mean quantity upon which the supply of the Thames system depends. Out of the three and a half million acres constituting approximately the superficial area of the Thames watershed he estimates that one-third represents the aggregate of impervious surfaces consisting of clays, gault, and lias, whilst two-thirds represent in like way the numerous formations and beds of chalk, sandstones and sand-beds, cornbrash and coral rag, and marlstones, the former throwing off the rain, and the latter absorbing and infiltrating nearly all that falls upon it to satisfy vegetation and evaporation and to find discharge by springs at the outcrops.

Of the 27 inches forming the mean average annual rainfall, about two-thirds, or eighteen inches, are evaporated from the surface, whilst of the remaining third 4 inches serve to maintain the river system, and 5 inches pass away as floods and freshets. Instances are numerous in which the year's rainfall exceeds 30 inches, whilst they are very few in which it is less than 20 inches—about three times in twenty years. As the amount of evaporation is nearly a constant figure, and the quantity required to maintain effectually the river system necessarily remains the same under all conditions, the amount of flood or excess water greatly varies. It is sometimes double the average. On the few occasions when the rainfall does not reach 20 inches it is insufficient to satisfy the demands of the river system, and then the river becomes a borrower from the stored supply of the subterranean reservoirs. On such occasions the quantity of water flowing down the river to Kingston has been so reduced as not to reach 300 million gallons in twenty-four hours. The importance and bearing of this fact upon the proposal to replenish the subterranean supply will be appreciated when it is pointed out that the quantity of water supplied daily to the metropolis by the water companies has already exceeded 150 million gallons. Of these 150 millions the river Thames contributes 50 per cent. or 75 millions, which is a quarter of the quantity flowing past Kingston. The Lea furnishes 38 per cent., and deep chalk wells the remainder, or 12 per cent. The quality of deep well waters has become of late years more and more approved. Dr. Edward Frankland, in his classification of potable waters, places deep well waters only second to springs issuing from the outcrops of the same formations. To make good the loss of this superior water the author proposes that whenever the water in the river rises above a certain datum height recognised as the gauge of its full service, the excess shall be diverted out of the river course on to filter-beds formed near at hand. The outlet from these filter-beds would be steined shafts or sumps sunk down to the water-level beneath, and into them the filtered water would pass after it is freed from flocculent matter. The steined shafts would be made water-tight and sealed against all surface contamination. The whole of the 150 million gallons forming the metropolitan supply of the water companies is, with exception of the Kent Company's supply, at present filtered daily through filter-beds varying in depth and character of materials from 3 feet 6 inches to 9 feet deep of sand and other ingredients of different degrees of coarseness, the whole of the beds covering a superficial space rather less than 100 acres in extent. These arrangements having been successfully worked, the same might be adopted in the utilisation and purification of excess or storm waters.

As far back as 1867 the author in his evidence before the 'Royal Commission on Water Supply' pointed out that if towns on the banks of rivers, such as the Thames, the Lea, and their tributaries, were to lift their sewage and foul liquids on to absorbent lands lying 100 to 150 feet above them, they would not only free those rivers from pollution but they would help to maintain their flow with certainty. He specified Luton as a town that could adopt such a mode of disposal with good effect and economy (see Question 1613 of Minutes of Evidence). The author now refers to this case in consequence of the authorities of Luton having adopted the treatment by which they have signally proved the facility with which the sewage of towns may be cleansed by filtration through a deep bed or stratum of porous material. Winchester, Basingstoke, and several other towns situated on the chalk have adopted this mode of sewage disposal without any injurious effect.

The author submits that while such instances testify to the purifying powers of aerated chalk, they afford proof that when superfluous waters are let down into the water-bearing strata from above, they will *pro tanto* spread and naturally raise the line of saturation and the outflow of springs.

5. *The Raiyān Project for the Storage of Nile Flood.*¹

By COPE WHITEHOUSE, M.A.

This paper described a project for impounding a part of the surplus flood of the Nile. A series of surveys show that the Wadi Raiyān is a depression 75 miles to the S.S.W. of Cairo, communicating with the Nile Valley at +26 metres, or a little below high Nile. Except at two narrow passes, it is bounded by precipitous limestone hills rising to +190 metres. The bottom, of sand and clay overlaying rock, sinks to -46 metres. A reservoir formed by putting this valley in communication with the Nile flood would have at +30 metres a surface of 686 sq. kil. (250 square miles), or 686 million square metres, and hold 20,559 million cubic metres. At +20 metres the surface is 550 million square metres, and contents 14,876 million cubic metres. It would yield (without pumping) a net 40 million cubic metres per diem for 100 days, or about the average discharge of low Nile from March to July. It would practically double the summer (Sefi) irrigation of Egypt.

The proposed works are:—

- (a) Cutting through the Myana Col: -3,500 metres long; summit level, +44; bed of canal, +21.8; average, 14 metres; material (hard clay) to be removed, about 75,000 cubic metres for each metre of bed width.
- (b) Dyke skirting desert: depth of water held up, 8 metres; section, 140 square miles; length, 14,500 metres; material (gravel, sand, and earth) to be handled, about 2 million cubic metres.
- (c) Short low cut (1,500 metres); two short banks (500 metres); and a regulator.

The works could be completed within one year, and the Wadi Lulu and Wadi Safir, being detached from the Wadi Raiyān, could be used as small reservoirs until the Raiyān Basin was available. It would require one season to fill the small basins, and three to fill the Raiyān Reservoir.

6. *The Severn Watershed.*² By J. W. WILLIS BUND.

The Severn Watershed, with an area of 4,350 square miles, is the second largest in England and Wales. The water supply within its area is no more than sufficient for the population (1,500,000) and trades of the district.

1. THE PRESENT SOURCE OF SUPPLY.

The Severn, from its source to Beachley, in Gloucestershire, is 158 miles long, and its drainage area of 4,350 square miles, comprises parts of the following ten counties:—Montgomery, Denbigh, Radnor, Salop, Stafford, Northampton, Warwick, Worcester, Hereford, and Gloucester.

The Severn rises in one of the Montgomeryshire spurs of Plynlimon, about 2,000 feet above sea-level. At Llanidloes, 15 miles down, it is only 545 feet above sea-level; at Newtown, 12 miles, 358 feet; at Montgomery, 8 miles, 306 feet; at Welchpool, 8 miles, 270 feet; at Shrewsbury, 32 miles, 179 feet. The fall of the river in the 75 miles of its upper course is 1,821 feet; at the end of the next 30 miles (Bewdley) the fall is 108 feet (179 to 71); at Stourport it is 53 feet; at Worcester, 35 feet. In the next 40 miles, to Framilode, the fall is about

¹ See *Engineering*, vol. xlvi. p. 267.

² Paper published *in extenso* in the *Report of Severn Fishery Board* for 1888.

3 inches a mile, or 9 feet 8 inches. After Framilode, round the Horseshoe bend, it is about 1 foot per mile.

From Llanidloes to Sharpness, 140 miles, at mean sea-level the fall is 545 feet. The tide flows up regularly to Tewkesbury, and a 28-foot tide at Sharpness puts the Navigation Weir at Tewkesbury out of action. This occurs on an average four times a month. The tide runs up to Upton, and on very high tides is still felt at Worcester.

(i) THE SEVERN TO TEWKESBURY.

Area, 640 square miles; rainfall, 20·26. Except about 20 square miles of the Upper Leaddon, which is partly porous, all the rocks of the Lower Severn are superpervious.

(ii) THE AVON.

Falls into the Severn at Tewkesbury; 26 feet above sea-level; 85 miles long, falls 226 feet (252 to 26); drains 1,040 square miles; rainfall, 20·11 inches. Except a patch of pervious rock in the N.E. corner, all of the basin is composed of superpervious rocks.

(iii) MID SEVERN.

Tewkesbury to Shrewsbury, leaving out the Teme; fall, 153 feet (from 179 to 26); drainage area, 1,050 square miles; rainfall, 19·54 inches.

(iv) TEME.

Falls into Severn about 2 miles below Worcester; about 27 feet above sea-level; length, 64 miles; fall, over 500 feet; drainage area, 633 square miles; rainfall, 22·91 inches. The rocks are impervious, 250 square miles; partly pervious, 300 square miles; superpervious, 50 square miles.

(v) UPPER SEVERN.

Shrewsbury to the source, leaving out the Vyrnwy; fall, 1,821 feet (2,000 to 179); length, 75 miles; drainage area, 631 square miles; rainfall, 22·91 inches; impervious rock, 250 square miles; partly porous, 381 square miles.

(vi) VYRNWY.

Falls into Severn at Melverley; 217 feet above sea-level; length, 29 miles; fall, 1,283 feet (1,500 to 217); drainage area, 339 square miles; rainfall, 29·67 inches; impervious rocks, 330 square miles; porous, 5 square miles.

The proportion of rock impervious, partly pervious, superpervious, and pervious throughout the 4,350 square miles of the watershed is as follows:—

	Square miles
Impervious	840
Partly pervious	825
Superpervious	2,100
Pervious	585

The area of high rainfall is almost coextensive with the area of impervious rock.

2. RAINFALL.

Taking the mean annual rainfall by counties, the figures are for 1887:—

	Inches
Montgomeryshire	31·67
Shropshire	23·90
Worcester	19·85
Gloucester	22·18
Hereford	19·53
Stafford	21·19
Warwick	18·42

or for the watershed 22·38 inches.

As to monthly rainfall, September is the wettest month on a 20 years' average at 7 places, 3·38 being the figure. The driest is March, 1·86. As to distribution of rainfall, the N.W. corner of the watershed is wettest, and the rainfall gradually decreases as far as the N.E. corner, 25 to 30 inches. This remains the average, going south, until the Avon watershed is reached, when it does not exceed 20 to 30 inches; and among the Cotswolds it rises to from 25 to 35 inches.

On the west there is a triangular area of high rainfall, of which the Severn, from Llanidloes to Shrewsbury, is the base, and the apex is at Coleford, in the Forest of Dean, and the two sides are the watershed line and the Severn. Over this area the rainfall is from 30 to 40 inches.

Height above sea-level does not seem to be a safe guide to the rainfall in the district, as the following figures from four of the counties will show:—

	Height in feet	Rainfall Average of 3 years
<i>Montgomeryshire—</i>		
Tybrith	595	46·12
Montgomery	550	29·51 ¹
Churchstoke	540	31·52
<i>Shropshire—</i>		
Bishopscastle	720	32·72
Church Stretton	702	30·06
Westbury	700	33·17
<i>Worcestershire—</i>		
Lincombe	62	27·38
Bevere	52	29·07
Diglis	49	26·60
<i>Gloucestershire—</i>		
Westbury-on-Severn	62	31·20
Frampton	42	27·72
Llanthony	39	26·25

3. THE PRESENT SUPPLY AND DEMAND.

Taking the rainfall over the district at 25 inches, roughly, the present demand on the water supply is, primarily, that due to the following population:—

Montgomeryshire	Population
Denbighshire	60,000
Radnorshire	5,000
Shropshire	5,000
Stafford	280,000
Warwick	280,000
Worcester	100,000
Hereford	390,000
Gloucester	20,000
	360,000
Total	1,500,000

Taking the supply at 20 gallons a head per day, including manufacturing purposes, it gives 30,000,000 gallons; Liverpool and what is taken for the Shropshire Union Canal takes 50,000,000 gallons a day; mills, navigation, and to keep up the head of water, 20,000,000 gallons (a very low estimate). So that at the lowest the present demand is 36,500,000,000 gallons a year.

¹ One year only (1885).

The supply is 25 inches on 4,350 square miles. An inch of rain is 14,500,000 gallons to the square mile. The amount is 1,576,875,000,000 gallons.

Deduct from this evaporation and absorption 20 per cent., 5 inches of rainfall; waste by floods 20 per cent., 5 inches rainfall. This amounts to 10 inches, 630,750,000,000 gallons. Add to this 36,500,000,000 gallons (the present daily demand), and the total is 667,250,000,000 gallons. Deduct this from the present supply of 1,576,875,000,000 gallons, and the surplus over the present demand is about 909,625,000,000 gallons.

4. THE RELATION BETWEEN THE RAINFALL AND THE HEIGHT OF THE RIVER.

1. What rainfall in what parts of the watershed is required to produce a flood? Broadly, the rainfall on the east bank in Staffordshire and Worcestershire never causes floods, for—

- (1) The tributaries are too small to bring down the necessary volume of water.
- (2) The porous nature of the rocks.
- (3) The low rainfall.

To produce a flood the Montgomeryshire rainfall is required in addition.

2. Local storms, however violent, produce but small effect on the river.

(a) August 4, 1886, rainfall at Lincombe, 2·43 inches. The height of the river at Diglis and Tewkesbury on the next days was:—

	DIGLIS feet inches		TEWKESBURY feet inches	
August 5	10	3	11	0
„ 6	10	6	11	3
„ 7	12	8	11	0

Besides the Lincombe rainfall on August 4 there had been in Montgomeryshire falls of 1·41 inch at Dolanog, and 1·88 inch at Pennant, and on the 5th 2·00 inches at Llansaintffraid. The water took two days to reach Diglis. The local fall at most raised the river there 3 inches.

On September 19, 1886, there was a fall of 1·68 inch on the Banw, but the Severn at Diglis remained unaffected for the next week at 10 feet 5 inches. Indeed, the height gradually fell. To raise the Severn at Diglis there must be at least ·20 inch of rain over most of Montgomeryshire.

The following figures show the Montgomeryshire rainfall and the height of the Severn at Diglis for 1887, and also the mean rainfall for the counties of Salop and Stafford:—

	Mean Rainfall in Montgomeryshire	Mean Rainfall in Stafford and Salop	Height of Severn at Diglis	
	inches	inches	ft.	ins.
January	2·71	2·69	17	5
February	1·08	·69	13	2
March	1·66	1·54	11	7
April	1·54	1·25	10	10
May	2·08	1·92	10	9
June	1·08	1·63	11	0
July	1·83	1·48	9	7
August	3·89	2·63	9	6
September	3·08	2·32	10	9
October	2·39	2·58	10	2
November	2·42	1·84	12	9
December	4·63	1·84	14	10

The summer rainfall, being mostly storm, produces little effect; the winter, not being merely local, at once makes itself felt. The average height at Diglis is

11 feet 9 inches. To maintain this a rainfall of at least 2 inches a month over the three counties is necessary—that is, over 1,964 square miles, or 56,956,000,000 gallons.

3. This gives some idea of the proper quantity of compensation water. The Liverpool compensation water is 10,000,000 gallons a day, and 1,280,000,000 gallons a year in addition; that is, a total compensation of 930,000,000 gallons a year. This looks a large amount. The Liverpool gathering ground is 36 square miles; an inch of rainfall over that is 532,000,000 gallons. On September 9 and 10, 1886, at three places in Montgomeryshire the rainfall was:—

		Inch	Inch	Inch
September 9		1·01	·19	·90
10		—	1·10	—

The effect of the 3 inches of rain was to raise the Severn at Diglis 4 feet for one day.

4. Rainless periods and the effect on the river.

The following were the rainless periods for 1886 and 1887 at 15 places in the Severn watershed:—

- 1886. February.—Four places, 12 days.
- " Three other places, 11 days.
- March 3 to 15.—Rain only fell on 4 days at 4 places. Except a fall of ·40 inch, the whole fall was only ·04 inch.
- May.—No rain recorded anywhere from 1st to 6th.
- June (from 23rd to July 7).—Only a total of ·08 inch at 3 places.
- August 18 to 31.—Only ·18 inch in the watershed, except at a place in Montgomeryshire, where a storm registered ·27.
- September 13 to 25.—No rain but at a place in Montgomeryshire, 1·68 inch on 1 day.
- 1887. February 6 to 13.—No rain.
- " 13 to 17.—Only ·08 inch.
- March (from February 25 to March 9).—Only ·02 inch on 2 days at different stations.
- April 6 to 20.—No rain registered in watershed.
- June.—No rain registered in watershed between June 8 and July 4.
- July.—No rain from July 30 to August 12.
- August.—No rain from August 20 to 26.
- September 17 to 26.—No rain in watershed.
- October.—Until 8th rain only fell at 2 places in watershed.
- " 15 to 23.—Only rain in 3 places. Total at all, ·09 inch.
- November 12 to 19.—Only ·12 inch at 6 places in watershed.

5. The effect of rainless periods on the height of the river:—

Rainless Period		No. of Days	Difference in Height of River		Height at Beginning and End of Period	
			ft.	ins.	Date	ft. ins.
1885.	July 23 to 31	8	2	0	{ 23	11 6
					{ 31	9 6
	August 12 to 20	8	1	2	{ 12	11 2
					{ 20	10 0
1886.	February 22 to 28	6	1	5	{ 22	13 5
					{ 28	12 0
	March 6 to 14	8	1	0	{ 6	12 0
					{ 14	11 0
	April 28 to May 7	9	0	6	{ 28	11 4
					{ 7	10 10
	June 22 to July 7	15	0	9	{ 22	11 0
					{ 7	10 3
	August 21 to September 1	11	0	6	{ 21	10 4
					{ 1	9 10
	December 15 to 21	6	12	3	{ 15	27 4
					{ 21	15 1

Rainless Period	No. of Days	Difference in Height of River		Height at Beginning and End of Period	
		ft.	ins.	Date	ft. ins.
1887. February 5 to 16	11	7	2	{ 5 16	18 10 11 8
„ 24 to March 9	13	0	9	{ 24 9	11 9 11 0
April 5 to 21	16	1	0	{ 5 21	11 3 10 3
June 8 to July 4	26	2	4	{ 8 4	11 10 9 6
July 18 to 24	6	—	—	{ 18 24	9 6 9 6
„ 30 to August 12	12	0	3	{ 30 12	9 6 9 3
August 20 to 26	6	0	2	{ 20 26	9 8 9 6
September 17 to 26	9	0	9	{ 17 26	10 7 9 10

The figures seem to show that when the lowest level is reached, continuance of rainless periods has not much effect on the river. But, besides the mere absence of rain, so many other matters have to be taken into account that a deduction is impossible.

SATURDAY, SEPTEMBER 8.

The following Papers were read :—

1. *On Rolling Seamless Tubes from Solid Bars or Ingots, by the Mannesmann Process.*¹ By FREDERICK SIEMENS.

The author refers to the circumstance that steel and toughened glass, though specially suitable, on account of their high qualities and strength, for use in the arts, have been somewhat neglected owing to the difficulty of welding and cutting them. Attention is next drawn to the combination of strength with lightness which the tubular form admits of, and to the extensive use of tubes in construction which is likely to follow from a simple means of producing them. The different kinds of rolls hitherto employed which are classed as the longitudinal, circular and intermediate, are passed in review, and the process which forms the subject of the paper is then described.

In the Mannesmann Process, a certain relation between longitudinal and rotary motion is maintained, so adjusted for each material to be worked that a twist is imparted to the fibre resulting in great strength and toughness of the manufactured product. The following is the mode of manufacture: A bar is placed between conoidal rolls, where the diameter and therefore the velocity are least, and is gradually drawn forward into contact with those portions of the rolls which travel more and more rapidly. The rolls are so set that the space left between them for the passage of the bar decreases slightly, so as to cause a certain amount of material to be shifted. The action of the rolls preventing this material from being taken from the outside of the bar, it is consequently drawn from the interior, a hollow being first produced and then a tube.

A mandril may be employed to finish and smooth the interior and to enlarge

¹ Printed *in extenso* in *Engineering*, vol. xlv. p. 291.

the diameter of the tube. That the mandril is not required in the manufacture is proved by stopping the action of the rolls while the bar is passing through them, and breaking off the bar where the hollow is just commencing to form; the metal inside is found to be crystalline and bright, as before being cut there is a vacuum within the hollow, no air, of course, entering during the process of manufacture.

Specimens of tubes made out of Siemens open-hearth steel, which material is specially suitable for the purpose, were exhibited at the meeting; these show how the tube in the centre commences by a fracture of the metal, which widens out, and also the twist of the fibre having the appearance of a rope, which assists in giving the tubes their great toughness and resisting power.

2. *Gaseous Fuel.*¹ By J. EMERSON DOWSON, *M.Inst.C.E.*

At the York Meeting of the Association in 1881 the author explained an apparatus for making cheap heating-gas by passing steam and air through incandescent fuel. Since then the apparatus has been considerably improved, and the gas made in it has been much used, not only for driving engines but for heating in many industrial processes. The composition of the gas necessarily depends somewhat on the quality of the coal used and on the condition of the fire; the average composition is much the same, whether the gas is made at the rate of 1,000 cubic feet per hour in a small generator or at the rate of 15,000 cubic feet per hour in a large one. In 1881 it was necessary for gas engines to use five volumes of this generator gas for one of ordinary lighting-gas to develop the same power: since then some important modifications have been made in the Otto engines, and it is now necessary to use only four volumes. In 1881 only one engine of $3\frac{1}{2}$ horse-power had been worked with the author's gas, but since then a large number of engines have been worked with it, one indicating over 80 horse-power. For more than four years Messrs. Crossley, the English makers of the Otto engines, have used this gas exclusively at their works for an average power of 150 horse-power, and after a careful trial extending over thirty-five weeks they have found that the fuel consumption was only 1.3 lb. per indicated horse-power per hour. At these large works there is no chimney except for the blacksmiths' shop. Returns sent by eleven users of Otto engines working regularly in different places with the author's gas, and averaging 35 horse-power each, show an average fuel consumption of about 1.3 lb. per indicated horse-power per hour, which is less than half that required for the best steam engines of equal power. The results of other tests are given, and, seeing that all have been obtained under practical working conditions, the record is certainly satisfactory. Many letters have also been received testifying to the ease with which the gas plant can be managed.

The author considers himself justified in saying that gas-power is now fairly launched in competition with steam-power, and he thinks with the late Professor Fleeming Jenkin that eventually the former will to a great extent supersede the latter. The author also thinks it tolerably sure that even better results than those already recorded will be obtained when an engine is really designed to give the best effect with generator gas. It is well known that in the Otto engines each new charge of gas is diluted with a portion of the products of combustion from the previous charge, and this answers very well for ordinary lighting-gas. But as generator gas, such as the author's, has only about one-fourth the explosive power of the other gas, it is a disadvantage to dilute it with products of combustion, and he feels confident that sooner or later makers of engines will find it expedient to design all engines of large power specially for cheap generator gas. The best fuel to use for making the gas is anthracite, as it does not yield tar or other condensable products, and does not cake in the generator. Ordinary gas-coke can also be used with certain precautions.

Several instances are given of the use of this gas for heating of various kinds. At the Gloucester County Asylum it has been used daily for about five years. All the kitchen-work for the staff and inmates is done with it, and there is no

¹ Printed *in extenso* in *Scientific News*, Sept. 1888. Also by the author.

ordinary fire in the kitchen; about three hundred quartern loaves are baked with the gas every day at a cost of about one shilling only for fuel. The gas is also used for two 12 horse-power (nom.) Otto engines, which pump water and drive a dynamo for electric lighting. This gas is used on a large scale at the cocoa works of Messrs. Van Houten & Son, Messrs. Cadbury, and Messrs. Russ-Suchard & Co. Messrs. Onderwater & Co. of Dordrecht use it for heating the drying-chambers in their starch works. Messrs. Guittet of Herblay have for some years used it for making varnish, and they not only effect a considerable economy, but they avoid all risk of fire, which is a great consideration in varnish works. This gas is also used by the Société Nestlé for soldering their condensed-milk tins, and more recently it has been adopted by Messrs. Huntley, Bourne, & Stevens of Reading not only for soldering but for heating a large number of ovens in which japanned and varnished goods are stored. Messrs. Hillman, Herbert, & Cooper use this gas at their Coventry works and in Germany for brazing with blow-pipes the joints of bicycles and tricycles, as well as for enamelling. On the Continent several firms use this gas for singeing silk yarns and textile fabrics. It is also used by several linen manufacturers in the north of Ireland for stentering, which they formerly did with hot air. The cost of the gas somewhat depends on that of the fuel; but, speaking generally, the equivalent of 1,000 cubic feet of ordinary lighting-gas costs from sixpence to one shilling.

3. *The Shipman Engine.* By W. R. PIDGEON, M.A.

This motor is an automatic petroleum-burning steam engine, and has been designed by Mr. Shipman, of America, for use, either on launches or in houses, where a moderate amount of power is required. One of its essential points is that it is automatic, so that, when once steam has been generated in the boiler, practically no further attention is required beyond that of opening and shutting the steam valve whenever the engine is started or stopped, the fire, speed, and water-feed being so arranged as to attend to themselves.

The engine is simple or compound, as may be best suited to the work it has to perform, and is built upon the same frame as the boiler. This latter is composed of tubes about 18 inches long, which are screwed into a flat oblong chamber at one end and closed at the other, and is fired externally.

Two small aspirators or atomisers, taking steam from the boiler, suck up the petroleum, which is used as fuel, from a chamber below, and drive it into the furnaces in the form of a fine spray. A couple of torches ignite this spray as it passes inwards, and the flames produced by its combustion rush round and among the boiler tubes. The amount of steam and petroleum that is used by the atomisers is regulated by a diaphragm connected to a valve in the steam pipe that supplies them.

This diaphragm is exposed to the steam pressure on the one side, and is held down by a spring, loaded to a certain pressure, on the other, and moves upwards or downwards as the steam exerts more pressure than the spring, or *vice versa*. Its movement is conveyed to the valve by means of a rod, and it thus regulates the amount of steam passing at any moment to the atomisers. In this way the fire is made to vary inversely as the pressure in the boiler, and thus keeps the latter constant.

The petroleum is stored in a tank at any convenient distance from the motor, and is led to it through a pipe having a regulating valve in it. The water in the boiler is kept at a constant level by means of a float, connected to a tap in the suction pipe of the pump. This float is placed in a chamber, which is joined to the top and bottom of the boiler, and rises or falls with the level of the water. The movement is conveyed, through a stuffing-box and by means of levers, to the tap in the suction pipe, which it opens or closes as the water level changes.

The speed of the engine is kept regular by means of a governor, which works directly on to the excentric, and the lubricating of all journals, cylinders, and slides is performed by the ordinary sight-feed lubricators and cups, except that of

the crank-pin, which is effected by means of a centrifugal oiler attached to the crank disc. It may be seen from the foregoing that, when once steam is up, the fires, the water supply, the oiling, and the speed of the engine require no further attention. But, when first starting, a sufficient pressure is required in the boiler to work the atomisers, and for this a hand air-pump is provided. A few strokes of this pump will suffice to start the fires, and it is only necessary to pump slowly for five minutes to raise sufficient pressure of steam to keep them going, fifteen minutes in all being required to get steam up to 100 lbs. per square inch.

As regards the other requirements of small motors, the Shipman engine is compact, not heavy, and simple to understand, so that it neither requires much space, strong foundations, nor a skilled attendant. An engine developing $4\frac{1}{2}$ h.p. on the break uses 4.21 lbs. of petroleum per h.p.; and this, at 7d. per gallon, would give the cost of running at under 3d. per break h.p. per hour.

4. *On the Disengaging of Boats, &c.* By E. J. HILL.

At the meeting of the Association in 1872 the author described a new hook for lowering and disengaging parcels, boats, and other objects, which shortly afterwards was very generally adopted, over 10,000 sets being at present in use.

After having considerable experience of this appliance the author in 1879 designed a simpler form, which may be described as a hook, shaped in the form of a horse's head, working in a link or shackle, and this in its turn has resulted in the form exhibited. One of the principles in view in all three systems is that the hook shall consist of a solid piece of metal, and not be altogether dependent upon the proper working of the parts added to it.

The new hook is a solid piece in the form of the letter G. Through the thick or back part of this G is a slot to admit of a small traverser having a U-shaped recess at one end which passes into the opening of the G, not only filling up the aperture but forming a perfect O. The upper part or actual hook of the G is curved round to such an extent that a ring or hook when engaged is safe to an angle of about 45° , and therefore it is impossible with a fair strain for the traverser to be moved; but, when this strain is taken off, the ring is inclined to fall into the U of the traverser, and of course is easily withdrawn. When it is required to prevent the traverser being moved in the end which projects through the back of the G a slot is made, in which a small flat locking key works. A pin or check is fixed on the traverser to control it in its movements. One of these hooks is fixed at each end of the boat pointing in the same direction, namely, towards the bow. By attaching a piece of wire rope to the two traversers the hooks are made to work simultaneously, as was demonstrated by means of models. This plan can be worked safely in several ways, either by the men in the boat, the coxswain of the same, the officer in charge of the lowering on board the ship, or automatically, in all of which cases the reliability of the working of the hooks is ensured.

The author concludes with a reference to the increased interest now being taken in all matters connected with the saving of life at sea.

5. *The old Orkney Click Mill.* By Professor A. JAMIESON, *M.Inst.C.E.*

The author, during a recent visit to the Orkneys, while inspecting one of the mountain burns that run down to Birsay Loch, came across a specimen of the old Click Mill, said to derive its name from the click-clack noise created by it when at work, which is supposed to have been introduced into these islands several centuries ago by the Norwegians. The interesting points about it are:—(1) It is the only remaining mill of its kind in Orkney; and (2) it is very like the latest and most perfect form of horizontal turbine in general conception and arrangement, for the water comes down near the centre on one side and flows freely away to the tail race. The farmer, Mr. Nicol Folster, stated that the mill had worked in its present position over 100 years. The construction and action of the mill were explained by means of a sketch and explanatory index. It consists of a horizontal

wheel connected direct to the moving or upper millstone by a vertical spindle, thus avoiding much friction.

The author concludes by pointing out how interesting it would be to ascertain whether another specimen of this mill is to be found in the British Isles, and why it has given place to the more complex vertical breast or overshot wheel, to again be reproduced in the most efficient form of turbine?

MONDAY, SEPTEMBER 10.

The following Papers were read:—

1. *On the application of Electricity to the working of a 20-ton Travelling Crane.*¹ By W. ANDERSON, M.Inst.C.E.

One of the travelling cranes in the foundry of the Erith Ironworks was originally constructed to be worked by hand, but preparations had been made to apply wire rope driving at some future time.

The crane is 39' 6" span, and consists of a pair of wrought-iron girders resting on end carriages running on an elevated line of rails. The gearing for hoisting and for longitudinal and cross traverse is secured on to the top of the main girders, the hoisting chain passes from the barrel at one end over a pulley at the other, then back to the pulleys in the cross traversing carriage, which runs between the main girders, through a falling block, and thence to an anchorage under the barrel at the extreme end of the main girders. By this arrangement the crane occupies a moderate height, and the hook can come within three feet of each wall.

The inconveniences and wear attending the employment of rope-driving gear induced the writer to try whether electricity might not be used with advantage. Messrs. Elwell Parker, of Wolverhampton, were communicated with, and these gentlemen undertook to supply the dynamo and a motor suitable for the peculiar requirements of a heavy crane. The dynamo, which was intended to give 50 ampères at 120 volts with 1,200 revolutions, was fixed in the main boiler-house of the works, and was driven by a small horizontal engine by means of a link belt. The leads from the boiler-house up to the conductor in the foundry are of 6 B. W. G. copper wire, while the conductor is formed of an angle-iron bar 2" × 2" × ¼", extending the whole 350-foot length of the shop, and has one face roughly ground and protected from rust by vaseline. The return current travels along one of the rails on which the crane runs. The motor, which is shunt wound, and constructed for 100 volts and 50 ampères, is fixed on the working platform of the crane beside one of the main girders. Its driving spindle carries a steel pinion which gears into a double helical spur wheel keyed on to a shaft which runs longitudinally on the top of the girder, and is connected by nests of three bevil wheels, with friction clutch connections to the three shafts which command the several movements of the crane, the means of using the hand-power being still retained.

Two sets of speeds are arranged for each of the movements, namely:

Hoisting . . .	slow 3·4 feet per minute, fast 10 feet per minute
Cross traverse . . .	" 25 " " " 105 " "
Longitudinal traverse . . .	" 78 " " " 213 " "

To provide against undue strains upon the motor, an automatic magnetic cut-out is fixed on the crane, and for the purpose of varying the power and speed to meet the requirements of the foundry, a set of resistance coils is provided, governed by a special switch by means of which different resistances can be introduced into the armature circuit of the motor, or the current can be cut off altogether, but so that it must be done by steps, and not suddenly. The connection between the motor and the conductors is by means of brushes pressed against them by elastic

¹ Printed *in extenso* in *Engineering*, vol. xlv. p. 268.

attachments. The handles for operating the several movements, the break lever, the switch and the automatic cut-out, are all collected together, so that a single attendant can readily work the crane from one spot.

The crane was set to work in June last, and has continued to act satisfactorily ever since. The advantages are very great in the facility of adaptation, as it is so easy to transmit the power from any point. The main boilers being always under steam, the crane is available at a moment's notice. The duty realised is about 65 per cent. of the power developed in the driving steam-engine. As far as can be judged at present, there is no special wear to apprehend. The conductors act satisfactorily, though a considerable length is in the open air, and the dust, heat, and smoke of the foundry do not appear to affect the working.

When first proposed, the writer was not aware of the existence of any other electric crane, but he has since learned that Messrs. Mather & Platt, of Manchester, have had one working satisfactorily for some time, and that there is one also in France.

Experiments on Electric Foundry Crane, Erith Iron Works, August 1888.

Movement of Crane	Load on Hook	Total Load on Rails	Volts at Dynamo	Ampères in circuit	Watts at Dynamo	Watts at Crane (mean)	Horse-power at Crane (mean)	Speed of Motor. Revolutions per minute	Speed of crane movement. Feet per minute
	tons cwt.	tons cwt.							
Cross Traverse, quick gear	0 0	18 0	120	27	3,240	3,202	3.78	1,166	105.
Long Traverse " " "	0 0	" "	105	48	5,040	4,925	5.81	1,100	201.3
Hoisting " " "	0 0	" "	110	22	2,420	2,398	2.83	1,166	9.92
Cross Traverse " " "	4 12	22 12	98	47	4,606	4,493	5.3	1,100	99.
Long Traverse " " "	" "	" "	86	80	6,880	6,560	7.74	1,050	192.
Hoisting " " "	" "	" "	90	76	6,840	6,551	7.73	1,050	8.92
Cross Traverse " " "	9 11 $\frac{1}{2}$	27 11 $\frac{1}{2}$	130	65	8,450	8,229	9.71	1,166	105.
Long Traverse " " "	" "	" "	115	78	8,970	8,666	10.23	1,116	213.
Hoisting, slow " " "	" "	" "	103	58	5,974	5,806	6.85	1,117	3.27
Cross Traverse " " "	14 2 $\frac{3}{4}$	32 2 $\frac{3}{4}$	112	44	4,928	4,831	5.7	1,166	25.3
Long Traverse " " "	" "	" "	135	38	5,130	5,058	5.97	1,333	89.3
Hoisting " " "	" "	" "	115	73	8,395	8,125	9.59	1,133	3.317
Cross Traverse " " "	19 2 $\frac{3}{4}$	37 2 $\frac{3}{4}$	135	51	6,885	6,752	7.97	1,266	27.5
Long Traverse " " "	" "	" "	130	46	5,980	5,874	6.93	1,250	83.7
Hoisting " " "	" "	" "	98	86	8,428	8,058	9.95	1,016	2.976

2. On recent Developments of the Cowles Aluminium Process.

By R. E. CROMPTON.

It is unnecessary to again describe the earlier stages of the Brothers Cowles' invention of the electric furnace. I confine myself to a description of such parts of the new plant which has been recently put down at Milton, near Stoke-upon-Trent, that I think will be of general scientific interest.

The experience in America at the works at Lockport, Ohio, showed conclusively that great economies were to be expected from increasing the size of the furnaces and the strength of the electric currents employed to work them; but no current larger than 3,000 ampères had been used up to the time that the Milton Works were planned.

Mr. Eugene Cowles came over to England to ascertain whether English makers of dynamo machines were prepared to supply one 60 per cent. larger than Mr. Brush's 'Colossus,' which had been made specially for them in America, and which was then the largest direct current machine in the world. He prepared his specification for a dynamo to give a current of 5,000 ampères at 60 volts, and eventually Messrs. Crompton's designs and tender were accepted.

The works were built near the Milton Station, on the North Staffordshire Railway; the boilers for generating the steam required are of the Babcock Wilcox type, and are provided with mechanical stokers; the steam-engine is of 600 h.p., and is a compound condensing horizontal tandem, made by Messrs. Pollit and

Wigzel of Sowerby Bridge. It is furnished with an exceedingly perfect centrifugal governor, which maintains the speed accurately at seventy-six revolutions in spite of very great fluctuations in the load. The electrical means of stopping the engine have been provided in the shape of Tate's electrical stop-valve, which may be described as an electro-magnet arrangement with the ordinary pushes for completing its circuit, which actuates a steam relay piston set to close the main-stop-valve. The fly-wheel of this engine is twenty feet in diameter and weighs thirty tons, and is geared to the pulley of the dynamo, so that the latter makes five revolutions for each revolution of the engine by rope driving gear consisting of eighteen ropes.

This engine is an extremely fine specimen of a modern steam-engine; it works so silently that a visitor standing in the engine-room with his back to the engine railings at the time the engine is being started, cannot tell whether it is in motion or not. The dynamo at first sight seems very small when compared with the steam-engine driving it, the fact being that it is dwarfed by the enormous fly wheel of the engine; it is only when one stands close to the plummer-block bearings that one realises the great size of the spindle, and of all the parts required to transmit the power to the armature coils.

The author was well aware when designing this machine that the mechanical strains on the spindle, core attachments, and winding were likely to be of an extraordinary nature. The following precautions were therefore adopted, and as events have turned out they have been more than justified. The spindle is of steel, 18 feet long, with three bearings, one being placed on either side of the driving pulley. The diameter is 7 inches in the bearings and 10 inches in the part within the core. This part in the original forging was 14 inches diameter, and was planed longitudinally, so as to leave four projecting ribs or radial bars on to which the core discs are driven, each disc having four key ways corresponding to these ribs. There are about 900 of these discs, the external diameter being 20 inches, and the total length of the core 36 inches. Originally this core was provided with thirty-two driving-teeth made of steel, each tooth riveted to sockets attached to eight of the core discs. It may here be mentioned that, as the working has shown, the strain on these driving-teeth was perilously near their factor of safety; their number has been doubled, so that now the tangential strains are borne by a very considerable percentage of the core discs.

The armature winding consists of 128 copper bars, each seven-eighths of an inch deep, measured radially, by three-eighths wide. These 128 bars are coupled up so as to form thirty-two conductors only; this arrangement has been adopted to avoid the heating from Foucault currents, which with one-and-a-half inch conductors would have been very considerable. The bars are coupled at the ends of the core across a certain chord, according to an arrangement patented by the author and Mr. Swinburne, which consists of crescent-shaped bars so formed that the whole surface is thoroughly exposed to the current of air passing through the armature; they are also somewhat shorter than those usually employed on drum-wound armatures. The bars are insulated by a covering of 'fiburite,' a material which has been recently introduced by Messrs. Crompton, and which will stand a temperature of 160° Cent. for long periods without the least discolouration, softening, or alteration of its mechanical and insulating properties. The commutator is 20 inches long, has sixty-four parts, and in addition to the usual tightening nuts at the two ends, is provided with a third tightening ring at the centre to prevent the tendency of such long commutator strips to spring when worn down thin. The current is collected by eight brushes mounted on a separate ring placed concentric to the commutator, and the current is led away from these brushes by a large number of thin bands of sheet copper strapped together into convenient groups.

The field magnets are of the horizontal double type, and were adopted by the author and Mr. Swinburne after a careful series of experiments, which convinced them that the fashionable single magnet form was very unsuitable for this kind of machine.

As this machine is virtually a series wound machine, the magnet coils each con-

sist of a few turns only of forged copper bars, one-and-a-half inches wide by one inch thick, forged to fit the magnet cores. There is no insulation other than mica wedges to keep the bars from touching the core.

The armature is ventilated by a current of air from a Schiele's fan, driven by a belt from the armature spindle. At 380 revolutions the armature can give 5,000 ampères at 60 volts, and the temperature of the hottest part, which is the end plates next the commutator, never rises beyond 70° Cent. Although this machine was designed to give only 5,000 ampères, yet, electrically speaking, it is capable of doing very much more, and in actual practice it has frequently to stand a current of 8,000 ampères for short periods. But, as will be shown later, when the furnaces are employed to produce ferro-aluminium there are frequently violent oscillations in the current, which would make it unsafe to employ an average current much in excess of 5,000. In fact, as has been stated above, it has been found necessary already to increase the number of driving-teeth in order to provide against the driving strains at the times of maximum current. When the machine was first tried the main circuit was unprovided with a cut-out, and there is no doubt that at this time the armature stood the test more than once of temporary currents exceeding 16,000 ampères. Since that time a safety cut-out has been provided, calculated to fuse at 8,000 ampères; this, probably the largest one that has ever been designed, consists of a framework carrying twelve lead plates, and these fuse at the calculated point in a most satisfactory manner, without any undue detonation or scattering of the molten lead.

Next to the cut-out comes the current indicator, which is simply a solenoid of nine turns through which the whole current passes. The core is attached by chain-gear to the pointers, of which there are two mounted on one spindle. One pointer and dial is placed in the engine-room, and the other in the furnace-room. The gearing of this spindle is calculated so that the range of the instrument up to 8,000 ampères extends over the entire circle of 360 degrees. The construction of the solenoid for this indicator is somewhat novel; it is cut out of a cylinder of cast copper by means of a parting tool in a screw-cutting lathe.

There are two furnace-rooms, each containing six furnaces, and the conductors, after leaving the current indicator, pass right across the two rooms at a height somewhat above the attendants' heads. The current is supplied to the furnaces as follows:—

Each furnace-pit consists of a long trough built of firebrick, the ends being closed by cast-iron pipes through which carbon electrodes are arranged so that they can be moved lengthways to and fro by the attendant in charge. It will be remembered that one of the main features of the Cowles' invention is the use of limed charcoal as a lining for their furnace; they thus obtain a highly refractory non-oxidising lining which is also a non-conductor of electricity, as the lime prevents the particles of carbon fusing together and thus forming a continuous conductor, which would otherwise short circuit the furnace and be consumed under the action of the current, instead of the latter performing its proper duty of maintaining the furnace contents at the required high temperature. The electrodes—each of which consists of nine carbon rods attached to a cast-iron head, mounted on a copper rod passing through the above-mentioned cast-iron pipes—are each provided with flexible copper-wire cable connections, having an attachment sliding along the conductors passing overhead and somewhat behind them. When it is desired to supply the current to any one furnace, the attachments are slid into position opposite it and clamped fast to the conductors; to start the furnace the electrodes are brought together so as to touch, and then separated until the whole of the contents of the furnace between them is an incandescent mass at the required high temperature.

The working of a charge in the furnace is carried out as follows: the bottom of the empty furnace is covered with limed charcoal; the electrodes are brought into position, and a former, or iron box without top or bottom, and of a size determined by the space to be occupied by the charge, is placed in the furnace; the ends of this sheet-iron box are arched out so that it can be dropped over the electrodes; the furnace lining of limed charcoal is then rammed up in the space

between the iron former and the furnace-walls. The space inside the box is filled with the furnace charge, which, when ferro-aluminium is to be produced, consists of a mixture of charcoal, bauxite, and iron-turnings, but when the cupro-aluminium is required granulated copper is substituted for the iron turnings.

When the furnace lining and contents are brought up to the proper level, the iron former is carefully lifted, much as a moulder draws a pattern from the sand; the cover is then luted on to the furnace, and it is ready for the electric current.

This at first is kept down to 3,000 ampères, but as soon as the charge is thoroughly warmed through, and the furnace contents become incandescent throughout, the current is increased to 5,000 ampères, and in about one hour's time the reduction is complete.

The reduced aluminium trickles through the furnace contents, and collects at the bottom below the electrodes, from which in the furnaces last constructed it can be tapped out continuously. Mr. Cowles believes that the temperature of the centre of the furnace is so high that both the reduced aluminium and the metal with which it is to be alloyed are vapourised and combine as a chemical compound when in this condition, being condensed in the upper and cooler part of the furnace, and thence passing down the sides to the bottom.

The working of the furnace when cupro-aluminium is to be produced leaves nothing to be desired; the current can be steadily increased from the commencement, and towards the end of the reduction it is extremely constant, so that the load on the boilers, engine, and dynamo is fairly steady throughout; but when making ferro-aluminium the conductivity of the furnace contents varies through very wide limits, and this brings heavy strains on both the steam-engine and dynamo, which must be met by correspondingly increased strength of parts. The chief feature of the process which strikes a visitor to Milton Works is the small number of men necessary to work the process: two men in the engine and dynamo room, one man at the boilers, and one boy to manipulate the electrodes of the furnaces, are all that are required for the active part of the operation; two labourers can easily charge and re-line the furnaces, and the remaining staff required for melting down, standardising, and casting into ingots the various classes of furnace products is correspondingly small.

From the experience already gained, the author sees no difficulty in designing and constructing engines and dynamos to supply currents of 15,000 or even 20,000 ampères, if such be required, for Cowles' furnaces of enlarged size. The electrical difficulties met with in the construction of this large machine have been comparatively small, whereas the mechanical strains have been unexpectedly great, and must be provided for by extreme solidity and massive construction.

Recent investigations made in America by Mr. W. J. Keep have shown that the use of ferro-aluminium is likely to be enormously extended when its properties in relation to cast-iron are thoroughly understood and appreciated by the engineering world. Mr. Keep is a gentleman who is well known in America, and his statements are entitled to be received with the utmost respect. We already knew in this country that the addition of ferro-aluminium to cast-steel or to ingot iron in such proportion that the finished casting will contain not more than one-thousandth part of aluminium produced extraordinary effects, in some cases reducing the melting-point 300° Cent., and in all cases imparting great fluidity to the metal, thus giving us sharp castings free from blow-holes; but it has remained for Mr. Keep to show us that the addition of an infinitesimally small percentage of aluminium to cast-iron insures perfect castings, freedom from blow-holes, and almost all the ills to which the ironfounder is subject. Mr. Keep's report is so very full that it is impossible to give any *résumé* of it here. I only call attention to it to show the extreme importance that ferro-aluminium is likely to assume in future engineering, and that as far as we know at present the perfected Cowles' furnace is capable of producing the desired material in any quantity and at a moderate cost.

3. *Electric Lighting in America.*¹ By Professor GEORGE FORBES, F.R.S.

The author drew attention to the directions in which this industry has been developed in America. The chief progress in central station work has been in three directions—(1) Arc lighting; (2) incandescent lamps with 3-wire system; (3) incandescent lamps with converters (Gaulard-Gibbs system). The number of arc lamps is now about 300,000. Every city in the States has some streets lighted by arc lamps. The author described the methods of distribution, and gave the reasons for slow progress in this country. There are at present $2\frac{3}{4}$ million incandescent lamps in use in the States. The author described the special features of the central stations, and drew conclusions as to the lessons to be learnt and applied to practice in this country.

4. *On a System of Electrical Distribution.*² By HENRY EDMUNDS.

The problem of the distribution of electricity has considerably occupied the attention of engineers, and several methods are in practical use, which may be classified under two heads—

1.—*Direct supply*, which has the advantages of simplicity, and the employment of currents of low tension; but the disadvantages of requiring large conductors, and being limited to short distances from the source of supply.

2.—*Secondary generators*, which are available over a larger area, and considerably lessen the size of conductors, but, on the other hand, require to be more carefully insulated and protected, to prevent danger to life and property from the high tension alternating currents employed.

Both these systems are dependent upon the regular working of the machinery at the central station; any stoppage plunging a whole district into darkness, to the great annoyance of consumers. To obviate this difficulty, secondary batteries have been suggested, which would act as reservoirs, always leaving a margin to be drawn upon in case of need. After reviewing the attempts which had been made at New York and Colchester to utilise secondary batteries for the distribution of electricity, and pointing out the causes of failure in each case, the 'Edmunds' System of Electrical Distribution, in actual use by the Cadogan Electricity Supply Company in London, is described.

By this system, groups of cells are placed in various portions of the district to be lighted, each group being divided into a given number of sections. If the group be divided into four sections it is arranged that three of these sections shall be sufficient to supply the local demand, while the fourth is being charged by a line from the central station. At given intervals, the section which has been charged is removed from the main charging circuit, and switched into the local one, through which it discharges itself, its place in the charging circuit being taken by one of the other three, which, in its turn, is removed, and replaced by the next, and so on. So each section is kept well charged, the charge never being allowed to fall below a certain point. Thus the great desideratum is achieved, viz., *constant supply*, quite independent of any accident on the line or at the central station. These changes are brought about automatically by an instrument called a 'Distributor,' consisting of a revolving shaft carrying cams which, in their rotation, cause levers to rise and fall, and thus make and break the necessary contacts at the proper intervals. A polarised switch is attached, to prevent the current from entering the cells in the wrong direction, and also a voltage regulator, which keeps the batteries out of the charging main when they are fully charged, and connects them to it when they become exhausted, while a simple form of meter registers the amount of current consumed from day to day.

This system offers many important advantages. The durability of the cells is much increased, owing to the favourable conditions under which they work. The lamps give greater efficiency, through their being always run at an even pressure. The conductors are of moderate dimensions, and do not require to be enlarged

¹ Printed *in extenso* in *Electrical Review*, vol. xxiii. p. 275.

² *Ibid.* vol. xxiii. p. 284.

upon an extension of the work. The tension of the current employed is never high enough to endanger life or property; while the consumer has a reserve of electricity always at command, and is thus relieved from all anxiety regarding any sudden failure of the supply.

5. *The Measurement of Electricity in a House to House Supply.*¹
By W. LOWRIE.

6. *Electric Light applied to Night Navigation upon the Suez Canal.*²
By R. PERCY SELTON.

I. During the commercial crisis extending from 1878 to the early years of the present decade, traffic upon the Suez Canal increased largely. The number of ships passing through the Canal in 1878 was 1,593; this increased to 3,624 vessels in 1885, equal to a gross tonnage of nine million tons.

Increased traffic gave rise to inconveniences and resulted in frequent delays. Shipowners put pressure upon the Canal Company to afford facilities to cope with the increased traffic. In 1885 the average time occupied in passing through the Canal (eighty-seven geographical miles long) amounted to from forty to forty-five hours.

To meet the general demand the Canal Company introduced various improvements, and in the year 1884 commenced experiments to determine the practicability of navigation during the night by means of the Electric Light.

Owing to difficulties incident to the case these experiments occupied two years, resulting in an authorisation issuing from the Canal Company, in December 1885, permitting vessels of war and mail boats to navigate some portion of the Canal if provided with suitable Electric Lights.

In April 1886, the s.s. 'Carthage,' of the Peninsular and Oriental Steam Navigation Company, for the first time made the prescribed passage by night successfully, and was followed shortly by others.

The success of these results encouraged the Canal Company to extend the authorisation to vessels of all classes, and to throw open the whole length of the Canal to them. Thus, in February 1887, this authorisation was made public subject to certain regulations laid down by the Canal Company.

II. The plant to comply with above regulations consists of three essential parts:

1. Dynamo-Generator and engine.
2. Projector Search-Light to throw a beam 1,200 metres ahead of the vessel.
3. Automatic Electric Lamp capable of illuminating a circular area of 200 metres diameter around the vessel.

Accompanying diagrams illustrate the above plant and a vessel so fitted navigating the Canal.

The engine is of Brotherhood's three-cylinder type coupled direct to a Brush Victoria dynamo. The Projector Search-Light, fitted with spherical silvered mirror and diverging lens, is arranged to throw a beam diverging to angle of twenty degrees to a distance of 1,200 metres. The projector is fitted to a platform arranged to accommodate an attendant to manipulate the light, the whole being fixed to the stem of the vessel, forward and close to the water-line.

The automatic lamp is suspended from the masthead and lighted when passing vessels.

III. Figures are adduced to show the development of the Electric Light for this purpose: its advantages, economy, and probable future development are discussed.

¹ Printed *in extenso* in *Electrical Review*, vol. xxiii. p. 308.

² *Ibid.* vol. xxiii. p. 279.

7. *Electricity as applied to Mining.*¹ By FRANK BRAIN.

This paper is written from the mining engineers' standpoint, briefly sketching the known applications of electricity to mine-working up to the present date.

The writer regrets there is very little known to add to what has already been made public. He cannot but express surprise that a power which it is apparent has now passed the range of experiment, and is developing itself economically and efficiently, should not have been made greater use of than appears to have been the case hitherto.

The recommendations of the Mines Commission and the passing of the more stringent Coal Mines Act of 1887 have both stimulated mine managers to inquire into and recognise the advantages of electricity for blasting and lighting. By means of a small hand magneto battery and electric fuzes all the shot-firing in most of the fiery collieries is now done, the explosive used being one of the many lately introduced which, fired by an electric detonator, give off no flame. Dynamo machines at many pits are used for lighting the surface and main roadways of the colliery, and this current has also been used for the purpose of shot-firing, notably at Ynyshir Colliery, Rhondda Valley, South Wales. All the shots are fired in this way simultaneously while every man is out of the pit, thus putting loss of life beyond possibility. This adaptation, it should be said, however, is protected by a patent.

The adoption of the electric lamp in place of the well-known ordinary safety lamp is now very strongly advocated. There are several in the field, notably, the Swan and Pitkin, using secondary batteries, and the Scharschieff, using a primary battery. The South Wales Institute of Engineers, who with other kindred societies have lately had these and other electric lamps before them, have referred the matter to a Special Committee to inquire into and report upon. Several colliery engineers in South Wales are practically testing them—one, Mr. G. W. Wilkinson, of Risca, having several hundreds in daily use. So satisfied is he with their results that an order has been given for a still further number.

The applications of electricity to transmission of power are confined to a few collieries—so far as the writer knows, in Great Britain to three only, viz., Trafalgar Colliery, Forest of Dean; St. John's Colliery, Normanton; and Allerton Main Colliery, near Leeds. At Trafalgar, what was a very small pumping plant, started in December 1882, developed, by May 1887, into three sets of plant, doing the underground pumping of the colliery, and that at a saving of some 500*l.* per annum. At St. John's, a six horse-power set of pumping plant did such excellent work that a 33 horse-power set was put down in March last in another part of the colliery, and has since been in continuous work.

These extensions speak for themselves. In each case the power is conveyed by cables from the dynamo at the surface to the pumps placed at a considerable distance underground. At Allerton Main, very small quantities of water are being dealt with at inaccessible points. The power is supplied to the motors from secondary batteries charged at the surface, and conveyed to the required points in the colliery tubs or carts. A coal-cutter is also being driven by the same method.

On the Continent, underground haulage at Zaukeroda Colliery has been successfully and economically working since 1882, and also at Hohenzollern Colliery since 1884, the cost in each case being much less than by horses.

In America, where electric tramways are now numerous, the writer has been able to obtain particulars of but one application to mining: this is a railway on the same system as the Zaukeroda. The electric locomotive receives the current from an overhead conductor, the return current to the dynamo passing through the rails. It is at Short Mountain Colliery in the Wiconisca mines, and has been working satisfactorily since April 1887.

There has lately been put in operation at Big Bend, on the Feather River, Butte Co., California, the most stupendous set of electric mining plant, so far as the author knows, in existence. A large river has been tapped, and with a fall of three hundred feet it gives hundreds of horse-power by means of Pelton wheels.

¹ Printed in *extenso* in *Electrical Engineer*, vol. ii. (N. S.), p. 310.

These actuate electric generators, from which the currents are sent along a circuit of eighteen miles, driving Sprague motors at fourteen different points where power is required in a mining district for pumping, hoisting, &c.

The falls at Roaring Fork, Grand River, are utilised for driving an electric generator, from which the power is conveyed across country over a mile to Aspen Mines, Colorado, where a 10 horse-power Sprague motor is driving the mine machinery, replacing steam power with considerable economy.

A gold mine in New Zealand has recently been made valuable by transmitting the power from a waterfall two miles away. The conductors, supported on poles, are carried direct over the mountains, two thousand feet intervening between the fall and the mine. Obviously, where water power can be thus applied, the saving as compared with using fuel is considerable, especially in metal or diamond-mining districts, where coal is expensive. The ease with which the power can be conveyed over hill and dale and into the intricacies of the mine is also a factor of no mean importance.

It will be seen from the above how meagre are the results in transmission of power up to the present, and yet in every case where it has been adopted it has proved economically successful.

Possibly in fiery mines some are afraid of the sparks. There is no danger whatever on this head, as all the machinery can be enclosed in an air-tight chamber. It may be that want of familiarity hinders others; they fear to embark capital in plant of which they cannot speak from their own experience.

The failures in the history of electric lighting have no doubt prejudiced some, and they look upon the electric light and all akin to it with suspicion. The writer will be amply repaid if he can by means of this brief paper so interest some mining engineers as to cause them to take up the matter for themselves. He is satisfied that, under many conditions common in colliery working, electricity can and will be applied successfully and economically.

8. *Miners' Electric Safety Lamps.*¹ By NICHOLAS WATTS, *Assoc. M.Inst.C.E.*

After referring briefly to the but partial success attained in modifying miners' oil-lamps to adapt the same to the currents now obtaining in collieries, and noticing the apparent suitability of the incandescent lamp as a substitute, the author described the following miners' portable electric safety lamps, some of which he exhibited:—

The Swan Lamp.—Secondary battery. Four cells grouped together in a block of gutta-percha which is enclosed in a wooden case. The elements are lead oxide and lead. Luminosity, 1 to 1½ candle for ten hours' duration. Weight, 7 lbs. Price, 27s. Cost of maintenance, 3½d. per week. In extensive use in South Wales.

The Schanschieff Lamp.—Single liquid primary battery. Four zinco-carbon cells, the carbon non-porous. The peculiar novelty is the nature of the exciting liquid, which is a solution of the basic sulphate of mercury, about 36 per cent. of the salt being held in solution. The solution is sold at 4s. per gallon, of which 3s. 7d. is allowed for the same quantity of the spent liquid with its solid residue and free mercury precipitated by the cells. Luminosity (with reflector), 2 to 3 candles for nine hours' duration. Weight, about 5 lbs. Price, 30s. Cost of maintenance, 3¾d. per week. Tested at Cannock Chase, Mardy, Merthyr, and elsewhere.

The Pitkin Lamp.—Secondary battery. Four cells. Luminosity (with reflector), 4 to 5 candles for ten hours' duration. The lamp is fitted with a switch and resistance to regulate the expenditure of the electro-motive force, which, if allowed to act without check, would, when the battery was started, destroy the filament. Weight, 8 lbs. Price, 2l. 2s. Used at Llwynypia, Ocean Colliery, Treviky, and elsewhere.

The Walker Lamp.—Primary battery. Three carbon-zinc cells in a strong

¹ Printed in extenso in *Electrical Engineer*, vol. ii. (N. S.), p. 226.

brass cylinder attached to an outer case of brass or copper. The exciting liquid is a mixture of bichromate of potash, nitric acid, and sulphuric acid. Luminosity (with a reflector) sufficient to enable newspaper print to be read at a distance of twelve feet, for ten hours' duration. Weight, 7 lbs. Price, by the gross, 32s. Cost of maintenance, 1*d.* per day.

The Portable Electric Syndicate's Lamp.—Secondary battery. Luminosity (without reflector), 1½ candle for ten hours' duration. Weight, 4¼ lbs. Price, one guinea. The lamp is fitted with an automatic arrangement in connection with the incandescent lamp, whereby if an outer casing of toughened glass be broken the current is cut off to prevent explosion of fire-damp.

The Vaughton Lamp.—Secondary battery. The electrodes are wedged tightly in the cell, rendering the battery so compact that it may be subjected without injury to much rough usage. The lamp weighs 5 lbs. It takes six hours to charge. The working cost is estimated at 1*d.* per day. The electrolyte used is sulphuric acid diluted with eight times its volume of water, and is renewed twice a week. One shilling's worth of acid suffices for 100 lamps for one week. The price is from 25*s.* to 27*s.* 6*d.*

The author concluded by referring to the questions of primary *versus* secondary batteries, and considered the position of the light on the lamp case as not finally settled.

9. *On an Automatic Fire-damp Detector.* By JOSEPH WILSON SWAN, M.A.

At the last meeting of the Association, the author communicated to this Section a description of a fire-damp detector and meter, designed, more especially, to be employed as an appendage to electric safety lamps and exhibited a working model of the combination.

The object of that apparatus was to provide means by which the manager or one of the overseers of a colliery could, by making tests in various parts of a mine, ascertain, with a considerable degree of exactness, whether or no fire-damp is present, and, if it be, in what proportion. That apparatus fulfilled its purpose very well; it was accurate and sensitive, so much so that if only the one-tenth of 1 per cent. of fire-damp existed in the air it was clearly shown.

But it was not sufficiently simple to allow of its being made an adjunct to *every lamp*, nor was it automatic in its action. It therefore appeared desirable, if possible, that these deficiencies should be met or complemented by a *simple* and *automatic* apparatus, suitable for attachment to *every electric safety lamp*, or at least to all those used where gas is likely to be found. Such an apparatus he has the honour to bring under the notice of the members. The primary principle of its action is the same as in Liveing's well-known gas indicator, in which difference of temperature in two similar electrically heated platinum wires (one exposed to the air to be tested, and the other enclosed in a glass tube) is caused by the combustion of fire-damp in contact with the exposed wire.

In Liveing's apparatus the quantity of gas present in the air is estimated by the degree of difference in the luminosity of the two wires.

In my apparatus use is made of the difference of temperature arising in the manner described, but so as to cause movement in a column of mercury, and through that the interruption of the electric current which lights the lamp; therefore the lamp provided with this apparatus goes out just as an ordinary safety lamp does when placed in air contaminated to a certain extent with fire-damp.

In another form of the apparatus, difference of temperature in the indicator wires causes the free ends of a pair of thermoscopic metallic spirals to separate, and by separating to interrupt the electric current which lights the lamp connected with the indicator, and in that way to bring about the extinction of the light.

The new gas detector is therefore distinct from what has hitherto been proposed in its acting automatically upon the lamp, so as to extinguish its light.

It takes the form of a small circular metallic box, fastened upon the outside of the lamp case; the box contains a differential thermometer.

In the first-mentioned form of the apparatus it consists of two glass bulbs (con-
1888.

taining air), united by a U-shaped tube containing mercury in the bend, and having sealed into it two thin platinum wires whose inner ends are in contact with the mercury, one deeply and the other slightly submerged beneath its surface. There passes through the bulbs the two tubes (one open and the other closed), containing the two platinum wires, difference in the temperatures of which determines the action of the apparatus.

The current which passes through the lamp filament traverses also the indicator wires, and the wires in contact with the mercury; it will therefore be easily understood that, in the *absence* of fire-damp, as the wires contained within the thermometer bulbs will be equally hot, there will be no movement of the mercury, and that in the *presence* of fire-damp, as the exposed wire will become hotter than the enclosed wire, the air in the two bulbs will be unequally heated, and consequently the mercury will move away from the hotter bulb, and if its movement is sufficiently great to uncover the end of the least submerged wire, the circuit will be broken, and the light will go out. A switch is provided to enable the broken circuit to be remade, and the lamp lighted after the indication has been given.

The indicating wires are so short as not to consume a large proportion of the energy of the battery. This is the more necessary as it is intended that the current shall continually pass through them during the time the lamp is in use.

The other form of the apparatus to which he referred is similar in principle to that described, but instead of the differential *air* thermometer, use is made in it of a differential *metallic* thermometer, constructed on the principle of Immisch's pocket thermometer. In this case the thermoscopic part of the apparatus consists of a pair of helical tubes of oval section filled with liquid.

The pair of helices are in every respect alike except that one is a right-hand screw and the other a left; they are arranged one over the other with their free ends lightly touching, so as to be in electrical contact with each other.

Variation of temperature, acting equally upon both spirals, does not disturb the contact, but if one helix be heated more than the other, there will be separation of the free ends and breaking of the electrical contact. In adapting these to the purpose of the detector, the enclosed platinum wire is fixed in the axis of one helix, and the open wire in the axis of the other. The electrical connections are so made that normally the current from the lamp battery passes through the lamp, the exposed and enclosed platinum wires, and the helices; and, as in the other form, there is a switch to close the circuit and relight the lamp when it has been extinguished by the action of fire-damp.

The apertures by which the air gains access to the exposed platinum wire are carefully guarded by wire gauze, and they can be closed entirely when, by the going out of the light, there is evidence of the presence of fire-damp.

TUESDAY, SEPTEMBER 11.

The following Papers were read:—

1. *An improved Seismograph.* By E. A. COWPER, M.Inst.C.E.

In order to register the motions of the earth, north, south, east and west, it is of course necessary to have a heavy weight as little as possible affected by the motion of the earth; parallel motions, or 'compound pendulums,' have been used with good effect, but a simpler and more effective plan would be to place a heavy flat weight on a plate of glass with three small 'steel bicycle balls' below, resting on another flat or slightly hollowed plate, so that when the vibrations of the earth ceased, the weight would slowly return to its normal position. In place of glass plates, ground porcelain or metal plates might be used. The weight might be brought back to its normal position by a light pendulum, and then all the plates might be *flat* and of *common plate-glass*. Then two levers, acted on from the centre of gravity of the weight, and multiplying the motions, would register on long strips

of paper the vibrations, north and south, east and west; the paper, of course, being driven by clockwork, and allowed to start as soon as the vibrations of the earth commenced.

Then the vertical vibrations (which have always been the most difficult to obtain a record of) can be very thoroughly ascertained and recorded, by the following simple arrangement.

A light sheet-iron or steel tube, closed at the top like a small 'gasholder,' is inserted in a tank of quicksilver, the centre space inside the 'gasholder' being occupied by an empty tube, so as to reduce the weight of quicksilver very materially; then on exhausting the 'gasholder' with a 'Sprengel pump,' the tank will rise, owing to the pressure of the atmosphere below it, until the column of mercury balances the atmosphere; thus the weight of the tank and mercury in it being in fact supported by the *atmosphere*, and the 'gasholder' being attached to the earth, the 'gasholder' may rise or fall and yet scarcely affect the tank in any way, and a rod from the tank to a multiplying lever, attached to the earth and recording apparatus, will record the vertical vibration on a strip of paper moved by the clockwork.

The clock will be kept always going, but the paper will be started only when there is motion to be recorded.

The attendant, on leaving the apparatus, will throw in a small catch to stop the paper rollers, and the first motion of either of the levers will be made to throw out the said catch, and so start the paper. The clock will be arranged to record time by pricking the paper at certain intervals.

2. *The Friction of Metal Coils.* By PROFESSOR H. S. HELE SHAW
and E. SHAW.—See Reports, p. 540.

3. *Steam Engine Diagrams.*¹ By M. F. FITZGERALD.

Diagrams were exhibited showing the weight of saturated steam present throughout the stroke. In a four-cylinder compound the apparent weight of steam supplied was in the four cylinders—

1st cylinder	. . . 1.47 lb.		3rd cylinder	. . . 1.32 lb.
2nd "	. . . 1.23 "		4th "	. . . 1.24 "

In a Corliss engine re-evaporation took place up to about $\frac{2}{3}$ stroke, when the increase in weight of saturated steam amounted to 47 per cent. of the steam at cut-off.

In two compound pumping-engine diagrams there was in one case an increase, in the other a decrease, in the steam apparently supplied to the second cylinder. An intermediate heater is used in both of these engines.

When the action of the cylinder sides is such as to produce a rise, followed by a fall, in the weight of steam, then at the point where there is neither evaporation nor condensation the proportion of dry steam in mixture present is given (Cotterill, 'Steam Engine Considered as a Heat Engine,' pp. 195-6) by

$x = \frac{T}{1450}$, approximately a half; hence at this point the working substance is known, and theoretically the heat supply of the engine can be inferred from the indicator diagram alone.

During compression the cylinder sides nearly always act in this way, and are practically equivalent to a weight of water equal to that of the steam in clearance.

During lead extremely rapid changes of temperature take place; the rate of transmission of heat to the cylinder surfaces rises as high possibly as 150 heat units per square foot per second, confirming Professor O. Reynolds's experiments on surface condensation, and is much higher than is estimated by Cotterill ('Steam Engine,' pp. 248-9).

¹ Printed in *extenso* in *Industries*, vol. v. p. 333.

4. *The Efficiency of Steam at High Pressures and the Carnot Theorem.*¹By W. WORBY BEAUMONT, *M.Inst.C.E.*

The object of the author of this paper is to show that the Carnot theorem as expressed by the equation $E = \frac{T-t}{T}$ is inapplicable for the calculation of the efficiency of steam as used in a steam-engine cylinder. It is shown that the work done by expanding steam bears no relation to the fall in temperature due to fall in pressure, and that with steam at pressures between 350 lbs. and 50 lbs. per square inch the work done by expansion varies from 692 foot-lbs. to 1,050 foot-lbs. per degree of fall in temperature.

The argument leads to the conclusion that pressures higher than those now used can be very advantageously employed.

When the exchange of heat due to difference in latent heat, total heat, and temperature at the different pressures is taken into account, the difference in favour of the high-pressure steam becomes much greater. An explanation is afforded of the great efficiency of triple stage expansion engines as compared with the lower pressure simple engines. The steam in the steam-engine must be considered with reference to that part of its history which is comprised between its admission to the cylinder and the instant of exhaust, and with reference to the heat used, not to the fall in temperature. By increasing the pressures used, an extra number of stages of expansion may be obtained at a small extra expenditure of heat in the boiler. The difference ΔH between the total heat of steam at 300 lbs. and at 250 lbs. is under five units, but the work done by expansion from 300 lbs. to 250 lbs. is 12,240 foot-lbs. or about 2,400 foot-lbs. per unit of heat employed in raising the pressure from 250 lbs. to 300 lbs. The work done per unit of heat disappearing on expansion for each stage of 50 lbs. is given in a table.

5. *Revolving Sails, or Air-propellers.*² By H. C. VOGT.

If ships could be towed instead of propelled by means of the ordinary propellers, which disturb the stream lines round the ship, a saving on the average of 40 per cent. in coals and engine-power would be gained; the screw especially sucks the sustaining water from the ship, causing its resistance to be augmented in the same proportion; the thrust of the propeller must therefore exceed the net resistance of the ship by this amount. This excess in the resistance can only be reduced by destroying the shape of the ship. Formerly the length of ships was three to four times the breadth, now it is ten times the breadth. Both these proportions cannot be correct, and it must be remembered that the weight of the hull increases with the second power of the length, the middle section remaining unchanged. The screw-propeller increases, further, the change in the trim of the ship when the speed increases, also causing an increased resistance; and this ill-effect can only be counteracted by giving the driving thrust considerably above instead of below the centre of gravity of the ship.

Air-pressure on large canvas areas has been used from time immemorial: the author only proposes to use comparatively small driving areas, radiating from an axis parallel to the keel, and supported between two low pillars. The external appearance of such an air-propeller is similar to that of a screw-propeller; but the wings of the air-propeller are broadest near the circumference, and they are made of thin sheet-steel. Rotated quickly in the elastic air, a rarefaction on the front side of the wings is created, and the consequent difference in pressure constitutes the thrust, which, with a given engine-power, is quite as high as with the common screw in inelastic water. To create such a rarefaction, speed rather than area is required. Take, for instance, the wings of a wild swan, which possess 25-28 times the area of the web feet, while the thrust yielded from the wings is many times that yielded from the web feet. Suppose the horizontal water-resistance when the swan swims fast to be four pounds; when it flies the horizontal resistance may perhaps also be

¹ Paper is published *in extenso* in *Industries*, vol. v. No. 119.

² Printed *in extenso* in *Industries*, vol. v. p. 335.

four pounds, and in addition to this is the weight (35 lbs. for a large wild swan), and this weight is only supported by every downstroke of the wings. The rarefaction on the top side of a wing is produced by the suction from the air-currents passing its rigid fore-edge, just as the rarefaction is produced in a funnel by the wind passing over its edge: a difference in pressure corresponding to 30 lbs. per square foot may occur on windy days. The other important factor in producing a rarefaction on the lee side of a rotating surface is centrifugal force, as explained in the paper. These considerations will serve to explain why the area required for an air-propeller has no connection with the ratio between the specific gravities of air and water, the only means of moving a large quantity of air so as to create a momentum being the rarefaction, or storm centre, in front of the propeller. To create a sufficient rarefaction, the area of an air-propeller ought to be 12-14 times, and the diameter 3-4 times, that of the ordinary water-propeller; but less than this for large vessels, as a natural consequence of the mathematical laws governing these matters. The losses of a propeller in water are—(1) loss by friction; (2) loss by throwing out water in wrong directions; (3) loss by blows. Thanks to the perfect elasticity of air, there will only be the two first-named kinds of losses in that medium. If, for instance, equal weights of air and water moving at the same velocity strike a plane, the pressure from the air will be twice that from the water; and this can also be recognised from the resistance of air, which is about $\frac{1}{400}$ th part of the resistance of water, although the ratio between their specific gravities is $\frac{1}{770}$. An air-propeller is therefore not efficient as a fan, but very efficient as a propeller. If an air-propeller is mounted on a boat and pulled by the power of a man, the boat receives much greater speed than when the same man applies his force in the same boat furnished with a water-propeller. But this difference between the thrusts which a man can yield with an air-propeller and a screw is, of course, not great. The same winds which are useful for ordinary sails are also a gain for rotating sails; that is, 75 per cent. of the winds augments the thrust of an air-propeller, and the energy of the natural wind is taken advantage of when the pitch is changed in accordance with it. When the wind 'straight against' equals the speed of the points of effort of the rotating sails, the thrust of the air-propeller is decreased nearly 60 per cent., or just the same as the thrust of gaff sails is reduced when from having the wind on the beam the course is changed until four points from the wind. Now it happens once a month that a strong wind is actually so straight against the course as to reduce the thrust by 60 per cent. for a propeller with manual power. On a 1,000-ton ship the speed of the points of effort of its air-propeller would be over 150' per second, and no hurricane would be able to reduce its thrust by 60 per cent., and 3.5 points from the hurricane the thrust of the air-propeller would be greater than in a calm. As compared with this the increased resistance caused by the screw is constant.

Details of experiments on a large scale, as well as of the formula for finding the area and speed of an air-propeller, are given in the paper.

6. *A new Sphere Planimeter.* By Professor H. S. HELE SHAW.
See Section A, p. 584.

WEDNESDAY, SEPTEMBER 12.

The following Papers were read:—

1. *Underground Railway Communication in Great Cities.*
By Colonel ROWLAND R. HAZARD.

Perhaps the most important physical problem, growing out of the concentration of great populations in limited areas, is the construction, maintenance, administration, and uses of the public streets. These, absolutely indispensable for purposes

of ordinary traffic, fulfil many other requirements of public necessity or convenience, but should be so constructed as to provide for many others of capital importance, growing out of the multiplying wants incidental to the demands of modern civilisation.

The main thoroughfares of traffic should be reconstructed, substantially upon the plan of superficial subways and galleries, illustrated by a model and sketches shown. Between the lines of curb the substance of the street should be removed to a standard depth of twelve feet, and the excavation so made replaced by four centrally placed subways, the two interior ones being devoted to rapid transit or fast railway trains, operated at great speed between few stations. This form of railway service, essential to economy of time and the proper development of suburban population, is not now performed at all in any great city, the two exterior subways being devoted to 'way' or slow trains, operated rapidly between frequent stations, for the convenience of every district on the line for shopping, and also for supplementing the more rapid long journeys of the express line.

These railways should be operated by electric motors and solid trains, specially devised for the service, and embodying provisions for safety and comfort to a degree which apparently precludes the possibility of serious accident. On either side of these centrally disposed railway subways are placed continuous galleries, calculated for the housing, inspection, replacement, and repair of all pipes and wires of communication, sewers for local service, water mains and supplies, gas mains and service pipes, steam service pipes, pneumatic power, post, parcel, refrigerating and time tubes, electric wires for arc and incandescent lights for street and private use, for power, signals, telegraphs, telephones, &c., and all other essentials or conveniences which are more profitably generated or produced at some central station, and can be distributed or served only through the public domain, overhead or underfoot, and which from the want of such common accommodation are now used—if at all—to a limited extent, at great cost and inconvenience to the authorities, the corporation, and the public.

It is also imperative that the whole subway system should be adequately supplied with fresh air in movement, so that ventilation shall be as perfect as in the best arranged dwellings. This could be effected by closing the railway subways from any communication with the surface of the streets except through the station doorways, and ventilating the stations by shafts supplied with electric exhaust fans, placed in the rear of the entrance buildings, the supply of fresh air being derived from similar shafts placed in the rear of the opposite building; by this means the air of the stations will be absolutely renewed as frequently as required. The railways form open cylinders from station to station, and the trains, being of approximately the same cross-section, constitute loose pistons always moving in the same direction. The effect is the establishment of a ventilating current within the subways dependent for its force upon (1) the approximation of cross-sections, (2) the speed of the trains, and (3) the integrity of the tunnels or subways.

As the products of artificial combustion will be excluded as far as possible, the requirements of ventilation are reduced to a minimum and perfectly performed.

Reference is made to a new material, 'ferflax,' composed of braided steel wire and flax fibre, chemically treated under hydraulic pressure, devised for the wall panels of the subways and for the construction of the railway carriages, a compound building material not unlike horn in character, having a strength and flexibility somewhat exceeding steel wire netting, a toughness approximating to horn, non-fragile and unbreakable by bending, and not liable to shatter under shock.

The necessity for fast intramural travel is illustrated by the fact that the population of the City of New York increased from 1865 to 1885 (twenty years) 50 per cent., while the traffic increased 262 per cent., demonstrating that traffic increases out of all proportion to population; and that the fast travel increases at the expense of the slow is clearly proved by the extraordinary increase on the elevated roads, which for the single year 1887 amounted to the incredible number of 43,853,641 passengers, being 33 per cent. more than the total increase of all lines for the previous year, and actually more than the total increase for that year.

The adoption of this system for the streets of every great city would effect an economic revolution. There would be rapid communication between distant points within the metropolitan areas; there would be rapid communication between frequent stops for the convenience of local traffic and shopping; the streets would be brilliantly lighted by electricity; every house on the line would have access to gas, steam, water, the telephone, telegraph, pneumatic tube, electric light, and compressed air at will. Small industries would flourish because small and cheap power from remote stations would be everywhere available, while the surface of the streets could be maintained in a perfect state, with the minimum of cost, and with complete immunity from disturbance other than for the repair of worn surfaces.

2. *Transmission of Motion and Power.* By J. WALTER PEARSE.

The flexible clutch is the first practical outcome of the mechanical combination devised by M. R. Snyers, of Brussels, and described by the author in a paper on the 'Communication of Motion between Bodies Moving at Different Velocities' during the Manchester meeting of last year. While each of the fibres into which the mass of one of the two bodies is split up acts separately and individually, causing no shock on contact, their sum exerts a considerable mechanical effort. About a dozen flexible clutches and combined fast and loose pulleys are now in operation, transmitting motion to dynamos, emery grinders, spinning machinery, sewing machines, thus preventing that breakage of the beam or arm of the latter which frequently occurs on power being applied in the ordinary manner. The amount of power transmitted is just that for which the clutch or pulley is calculated, the two parts slipping when that power is exceeded by the motor, or on an excess of power being demanded by the machine, this property being useful in cases of letting out power on hire. When, however, a clutch or pulley is of a maximum capacity, any lower amount of power may be transmitted by regulating the degree of penetration of the fibres between the corrugations of the other disc. Experience shows that wear of the fibres, even when there is a considerable amount of slip, is negligible, the corrugated disc being made of softer material; and this fact shows the applicability of the principle to brakes of various kinds, which would exert a retarding force equal to three or four times that employed to apply them, whereas ordinary brake blocks never utilise more than 25 per cent. of the power exerted.

3. *An Annual Winding Clock, with Torsion Pendulum.*¹ By W. H. DOUGLAS.

There is no change whatever in the wheel-work or main spring of an eight-day lever clock except in the balance. The balance is removed, and in its place a *lever* is fixed to the staff carrying the roller pin, which unlocks the lever escapement and receives an impulse at each beat in the usual way, the additional lever imparting impulse to a tooth attached to the pendulum, thus inducing torsion at each beat of the clock. The regulating is effected by increasing the weight of pendulum to make it lose, or decreasing the weight to make it gain; it is also regulated by means of a French sliding curb, moved by a screw to the right or left, as desired, to make it go faster or slower without stopping the clock.

The escapement may be described as a *frictionless pendulum*. The impulse, given direct across the line of centres, as in the chronometer, is independent of oil, and, becoming detached at each beat, the isochronal property of the pendulum is not deranged by friction of any kind whatever.

The cost of manufacture is precisely the same as in producing an eight-day timepiece.

¹ See *Engineering*, vol. xlvi. p. 413.

4. *A new form of Air-compressor for Variable Pressures.*¹

By H. DAVEY, M.Inst.C.E.

This is an air-pump capable of automatically maintaining a constant resistance when pumping against an increasing or decreasing pressure.

One of its applications is that of compressing air for storage purposes.

It is evident that if an ordinary air-pump be made of sufficient capacity to take the full power of the engine employed to drive it at the minimum pressure, it will be too large for the increasing pressure; and, on the other hand, if the pump be made small enough for pumping against the maximum pressure, it will only take up a portion of the power of the engine at the lower pressures.

The problem then is to construct an air-pump which shall work with a constant resistance against increasing and decreasing pressures. It is evident that if the weight of air per stroke of the air-pump could be made to vary inversely with the varying pressures against which the pump works (in proper proportions) then the engine would have a constant resistance, and its full power might be employed during the whole of the operation. This is effected by mechanical means, described and illustrated in the paper. The resistance of the pump governs the engine. The engine runs without a throttle valve and with varying steam pressures at a constant speed, always fully utilising the full power available, and thereby doing the work in the shortest time with the greatest economy of power.

5. *On controlling the direction of Rotation of a Dynamo.* By A. WINTER.

¹ See *Engineering*, vol. xlvi. p. 413.

SECTION H.—ANTHROPOLOGY.

PRESIDENT OF THE SECTION—Lieut.-General PITT-RIVERS, D.C.L., F.R.S.,
F.G.S., F.S.A.

THURSDAY, SEPTEMBER 6.

The PRESIDENT delivered the following Address:—

HAVING been much occupied up to within the last week in my own special branch of anthropology, and in bringing out the second volume of my excavations in Dorsetshire, which I wished to have ready for those who are interested in the subject on the occasion of this meeting, I regret that I have been unable to prepare an address upon a general subject, as I could have wished to do, and am compelled to limit my remarks to matters on which I have been recently engaged. Also, I wish to make a few observations on the means to be taken to promulgate anthropological knowledge and render it available for the education of the masses.

Taking the last-mentioned subject first, I will commence with anthropological museums, to which I have given attention for many years. In my judgment, an institution that is dedicated to the Muses should be something more than a store, it should have some backbone in it. It should be in itself a means of conveying knowledge, and not a mere repository of objects from which knowledge can be culled by those who know where to look for it. A national museum, created and maintained at the public expense, should be available for public instruction, and not solely a place of reference for *savants*.

I do not deny the necessity that exists for museum stores for the use of students, but I maintain that, side by side with such stores, there should in these days exist museums instructively arranged for the benefit of those who have no time to study, and for whom the practical results of anthropological and other scientific investigations are quite as important as for *savants*.

The one great feature which it is desirable to emphasise in connection with the exhibition of archæological and ethnological specimens is evolution. To impress upon the mind the continuity and historical sequence of the arts of life, is, without doubt, one of the most important lessons to be inculcated. It is only of late years that the development of social institutions has at all entered into the design of educational histories. And the arts of life, so far as I am aware, have never formed part of any educational series. Yet as a study of evolution they are the most important of all, because in them the connecting links between the various phases of development can be better displayed.

The relative value of any subject for this purpose is not in proportion to the interest which attaches to the subject in the abstract. Laws, customs, and institutions may perhaps be regarded as of greater importance than the arts of life, but for anthropological purposes they are of less value, because in them, previously to the introduction of writing, the different phases of development, as soon as they are superseded by new ideas, are entirely lost and cannot be reproduced except in imagination. Whereas in the arts of life, in which ideas are embodied in material forms, the connecting links are in many cases preserved, and can be replaced in their proper sequence by means of antiquities.

For this reason the study of the arts of life ought always to precede the study of social evolution, in order that the student may learn to make allowance

for missing links, and to avoid sophisms and the supposition of laws and tendencies which have no existence in reality.

To ascertain the true causes for all the phenomena of human life is the main object of anthropological research, and it is obvious that this is better done in those branches in which the continuity is best preserved.

In the study of natural history, existing animals are regarded as present phases in the development of species, and their value to the biological student depends, not so much on their being of the highest organism, as on the palæontological sequence by which their history is capable of being established. In the same way existing laws, institutions, and arts, wherever they are found in their respective stages of perfection, are to be regarded simply as existing strata in the development of human life, and their value from an anthropological point of view depends on the facilities they afford for studying their history.

If I am right in this view of the matter, it is evident that the arts of life are of paramount importance, because they admit of being arranged in cases by means of antiquities in the order in which they actually occurred, and by that means they serve to illustrate the development of other branches which cannot be so arranged, and the continuity of which is therefore not open to visual demonstration for the benefit of the unlearned.

It is now considerably over thirty years since I first began to pay attention to this subject. Having been employed in experimenting with new inventions in firearms, submitted to H.M. Government in 1852-3, I drew up in 1858 a paper which was published in the 'United Service Journal,' showing the continuity observable in the various ideas submitted for adoption in the army at that time.

Later, in 1867-8 and 9, I published three papers, which, in order to adapt them to the institution at which they were read, I called 'Lectures on Primitive Warfare,' but which, in reality, were treatises on the development of primitive weapons, in which it was shown how the earliest weapons of savages arose from the selection of natural forms of sticks and stones, and were developed gradually into the forms in which they are now used. I also traced the development of the forms of implements of the bronze age and their transition into those of the iron age. These papers were followed by others on the same subject read at the Royal Institution and elsewhere, relating to the development of special branches, such as Early Modes of Navigation, Forms of Ornament, Primitive Locks and Keys, the Distribution of the Bow, and its development into what I termed the *composite* bow in Asia and America, and other subjects.

Meanwhile I had formed a museum in which the objects to which the papers related were arranged in developmental order. This was exhibited by the Science and Art Department at Bethnal Green from 1874 to 1878, and at South Kensington from that date to 1885; and a catalogue *raisonné* was published by the Department, which went through two editions. After that, wishing to find a permanent home for it, where it would increase and multiply, I presented it to the University of Oxford, the University having granted 10,000*l.* to build a museum to contain it. It is there known as the 'Pitt-Rivers Collection,' and is arranged in the same order as at South Kensington. Professor Moseley has devoted much attention to the removal and re-arrangement of it up to the time of his recent, but I trust only temporary illness, which has been so great a loss to the University, and which has been felt by no one connected with it more than by myself; for whilst his great experience as a traveller and anthropologist enabled him to improve and add to it, he has at the same time always shown every disposition to do justice to the original collection. Since Professor Moseley's illness it has been in the charge of Mr. H. Balfour, who I am sure will follow in the steps of his predecessor and former chief, and will do his best to enlarge and improve it. He has already added a new series in relation to the ornamentation of arrow-stems, which has been published by the Anthropological Institute. It appears, however, desirable that the same system should be established in other places, and with that view I have for some time past been collecting the materials for a new museum, which, if I live long enough to complete it, I shall probably plant elsewhere.

Before presenting the collection to Oxford I had offered it to the Government,

in the hope that it might form the nucleus of a large educational museum arranged upon the system of development which I had adopted. A very competent committee was appointed to consider the offer, which recommended that it should be accepted, but the Government declined to do so; one of the reasons assigned being that some of the authorities of the British Museum thought it undesirable that two ethnographical museums should exist in London at the same time; this, however, entirely waives the question of the totally different objects that the two museums (at least that part of them which relates to ethnographical specimens) are intended to serve.

The British Museum, with its enormous treasures of art, is itself only in a molluscous and invertebrate condition of development. For the education of the masses it is of no use whatever. It produces nothing but confusion in the minds of those who wander through its long galleries with but little knowledge of the periods to which the objects contained in them relate. The necessity of storing all that can be obtained, and all that is presented to them in the way of specimens, precludes the possibility of a scientific or an educational arrangement.

By the published returns of the Museum it appears that there has been a gradual falling off in the number of visitors since 1882, when the number was 767,873, to 1887, when it had declined to 501,256. This may be partly owing to the increased claims of bands and switchbacks upon public attention, but it cannot be owing to the removal of the Natural History Museum to South Kensington, as has been suggested, because the space formerly occupied by those collections at Bloomsbury has since been filled with objects of greater general interest, and the galleries have been considerably enlarged.

The Science and Art Department at South Kensington has done much for higher education, but for the education of the masses it is of no more use than the British Museum, for the same reason, that its collections are not arranged in sequence, and its galleries are not properly adapted for such an arrangement. Besides these establishments, annual exhibitions on a prodigious scale have been held in London for many years, at an enormous cost, but at the present time not the slightest trace of these remains, and I am not aware of any permanent good that has resulted from them. If one-tenth of the cost of these temporary exhibitions had been devoted to permanent collections, we should by this time have the finest industrial museum in the world. Throughout the whole series of these annual temporary collections, only one, viz., the American department of the Fisheries Exhibition, was arranged upon scientific principles, and that was arranged upon the plan adopted by the National Museum at Washington. It appears probable from the experience of the present year that these annual exhibitions are on the decline. Large iron buildings have been erected in different places, some of which would meet all the requirements of a permanent museum. The Olympia occupies $3\frac{1}{2}$ acres, the Italian Exhibition as much as 7 acres. There can be little doubt, I think, that the long avenues of potted meats and other articles of commonplace merchandise, which now constitute the chief part of the objects exhibited in these places, must before long cease to be attractive and must be replaced by something else, and in view of such a change I venture to put in a plea for a national anthropological museum upon a large scale, using the term in its broadest sense, arranged stratigraphically in concentric rings upon the plan of the diagram now exhibited. It is a large proposal, no doubt, but one which, considering the number of years I have devoted to the subject, I hope I shall not be thought presumptuous in submitting for the consideration of the Anthropological Section of this Association.

The palæolithic period being the earliest, would occupy the central ring, and having fewer varieties of form would require the smallest space. Next to it the neolithic and bronze age would be arranged in two concentric rings, and would contain, besides the relics of those periods, models of prehistoric monuments, bone caves, and other places interesting on account of the prehistoric finds that have been made in them. After that, in expanding order, would come Egyptian, Greek, Assyrian, and Roman antiquities, to be followed by objects of the Anglo-Saxon, Frankish, and Merovingian periods; these again in developmental outward expansion would be surrounded by mediæval antiquities, and the outer rings of all

might then be devoted to showing the evolution of such modern arts as could be placed in continuity with those of antiquity.

In order that the best objects might be selected to represent the different periods and keep up the succession of forms which would constitute the chief object of the museum, I would confine the exhibition chiefly to casts, reproductions, and models, the latter being, in my opinion, a means of representing primitive arts, which has not yet been sufficiently made use of, but which in my own small local museum at Farnham, Dorsetshire, I have employed to a considerable extent, having as many as twenty-three models, similar to those now exhibited, of places in which things have been found within an area of two miles.

The several sections and rings would be superintended by directors and assistants, whose function it would be to obtain reproductions and models of the objects best adapted to display the continuity of their several arts and periods; and the arts selected for representation should be those in which this continuity could be most persistently adhered to. Amongst these the following might be named:—Pottery, architecture, house furniture, modes of navigation, tools, weapons, weaving apparatus, painting, sculpture, modes of land transport and horse furniture, ornamentation, personal ornament, hunting and fishing apparatus, machinery, fortification, modes of burial, agriculture, ancient monuments, domestication of animals, toys, means of heating and providing light, the use of food, narcotics, and so forth.

Miscellaneous collections calculated to confuse the several series, and having no bearing on development, should be avoided, but physical anthropology relating to man as an animal, might find its place in the several sections.

I have purposely avoided in my brief sketch of this scheme giving unnecessary details. Any cut-and-dried plan would have to be greatly altered, according to the possibilities of the case, when the time for action arrived. My object is to ventilate the general idea of a large anthropological Rotunda, which I have always thought would be the final outcome of the activity which has shown itself in this branch of science during the last few years, and which I have reason to believe is destined to come into being before long. In such an institution the position of each phase of art development shows itself at once by its distance from the centre of the space, and the collateral branches would be arranged to merge into each other according to their geographical positions.

The advantages of such an institution would be appreciated, not by anthropologists and archæologists only. It would adapt itself more especially to the limited time for study at the disposal of the working classes, for whose education it is unnecessary to say that at the present time we are all most deeply concerned. Although it is customary to speak of working men as uneducated, education is a relative term, and it is well to remember that in all that relates to the material arts they have, in the way of technical skill and handicraft, a better groundwork for appreciating what is put before them than the upper classes. That they are able to educate themselves by means of a well-arranged museum, my own experience, even with the imperfect arrangements that have been at my command, enables me to testify. Anything which tends to impress the mind with the slow growth and stability of human institutions and industries, and their dependence upon antiquity, must, I think, contribute to check revolutionary ideas, and the tendency which now exists, and which is encouraged by some who should know better, to break drastically with the past, and must help to inculcate conservative principles, which are urgently needed at the present time, if the civilisation that we enjoy is to be maintained and to be permitted to develop itself.

The next subject to which I would draw your attention is the present working of the Act for the Preservation of Ancient Monuments, with the carrying out of which I have been entrusted during the last five years.

It is unnecessary to speak of the measures that have been taken in other countries which have preceded us in the work of protecting ancient monuments. Their system of land tenure and division of property is different from ours, and the same measures are not equally applicable.

In 1882 a Bill was passed through Parliament known as the Ancient Monuments Act, to enable those who desired to do so, to place the ancient monuments belonging to them, under protection of the Government, and to make it illegal for future owners or others to destroy them : also to enable local magistrates to punish summarily, with a fine of 5*l.* or imprisonment for one month, offences committed under the Act. No power is taken to compel any owner to place his monument under the Act, but provision is made for a small annual expenditure in order to preserve the monuments offered voluntarily by their owners. A schedule of certain monuments was attached to the Act, without the consent of the owners, merely to indicate the monuments to which the Act applied, but these, like any others, had to be voluntarily offered before the Government could accept them. Any other monuments not in the schedule could be accepted, but only after the offer of them had been laid 40 days before Parliament, in order, I presume, that the country might not become charged with the preservation of monuments that were unworthy of protection.

In November 1882, I was asked by Lord Stalbridge, in a complimentary letter, written by desire of the Prime Minister, to undertake the office of Inspector, intimating at the same time that my position as landowner would place me in a favourable position for dealing with other landowners to whom the monuments belonged, and I accepted the post, hoping to render a public service, not, perhaps, sufficiently considering the difficulties that I should have to encounter, and the amount of time that would have to be devoted to it.

A Permissive Act naturally implies that there is some one in the country who desires to make use of it ; whereas, as a fact, no owner has voluntarily offered any monument to be put under the Act, except one to whom I shall refer again presently ; all have had to be sought out and asked to accept the Act, and of the owners of scheduled monuments the larger number have refused.

Sir John Lubbock was chiefly instrumental in passing the Bill through Parliament, although in the condition in which it actually passed it was not his Bill. He had proposed to make the Act compulsory in the case of some of the more important monuments, but the proposal had been overruled on the ground of its being an improper interference with private ownership.

Being a member of the Liberty and Property Defence League, I have lately received a list of 55 measures which have been brought before Parliament in the session of 1888, which that body have thought it desirable to oppose on account of their interference with private property, nearly every one of which would have dealt more hardly with the owners of property than the Ancient Monuments Act would have done had it been made compulsory. But all these measures have been proposed by members of Parliament with the view of catching the votes of particular constituencies, whereas the ancient monuments have no votes to give and very few people to vote for them. Sir John Lubbock had included his own monuments in the original schedule, but finding that the Act in its final form was purely permissive, and not believing, as he told me at the time, that anyone would voluntarily make use of it, naturally being unwilling to put his own property at a disadvantage, by being the only one to come under it, he at first hesitated to sign the deed for their inclusion in the Act, though he did so readily after the adhesion of other owners assured him that he would not stand quite alone.

Finding myself involved in the matter I have done what I could to work it out, and with some success.

The accompanying map of Great Britain (see next page) shows the monuments that I have been the means of obtaining by the consent of their owners.

The Pictish Tower at Mousa in the Shetlands, which is well known to be the best preserved monument of this class in the country, has been included by the owner, Mr. Bruce, and some necessary repairs have been done to it by the Government. In the Orkneys the owners of the scheduled monuments declined to make use of the Act, but they are well looked after. The same applies to the Bass of Inverurie, the Vitriified Fort on the hill of Noath, the pillar stones at Newton, in the Garioch, and the British settlement at Harefaulds, in Lauderdale, which latter, however, is in such ruinous condition that the remains of it are scarcely worth preserving. The Suenos stone near Forres ; the Cairns at Clava, on the banks of

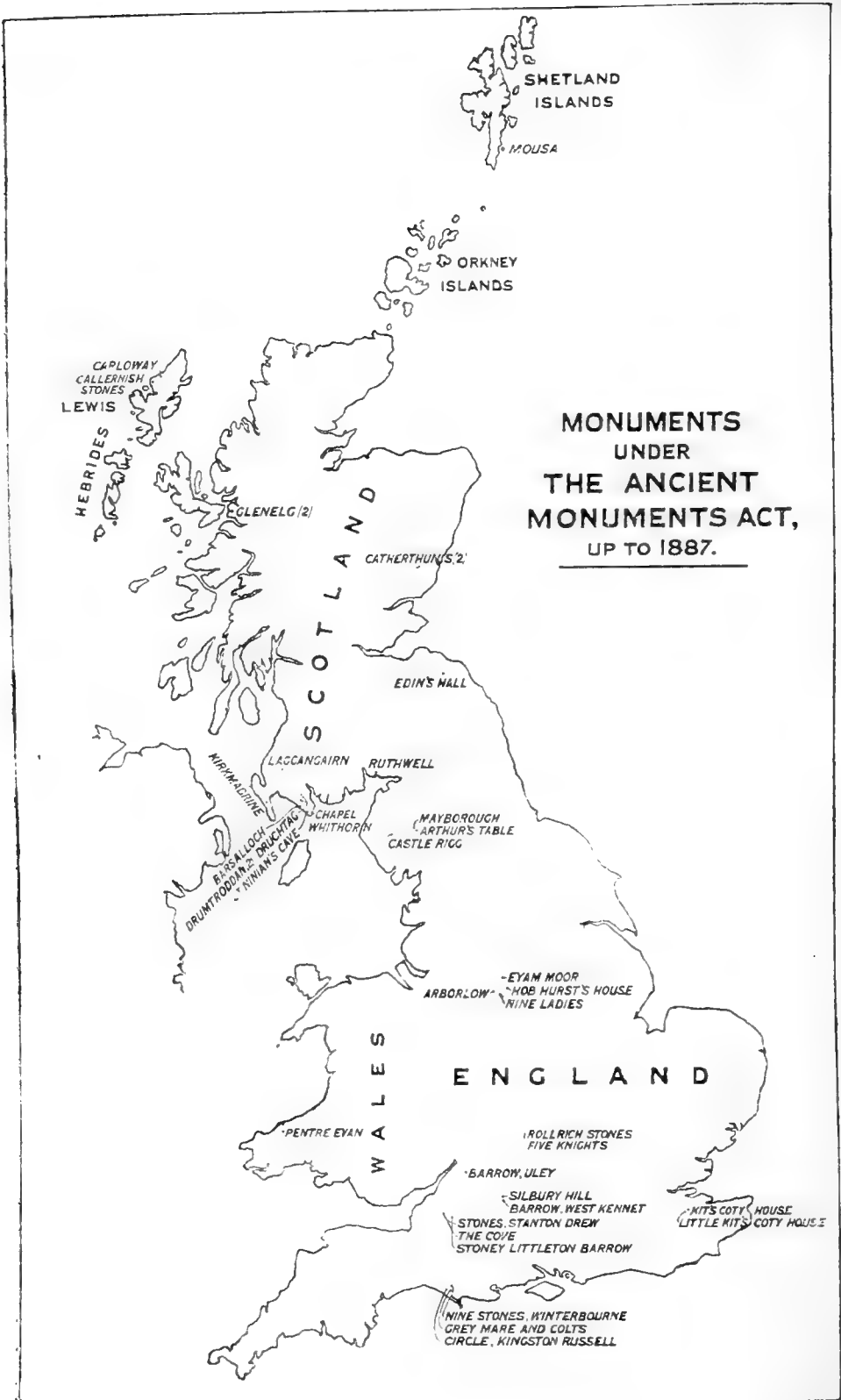

the Nairn; the Cat-stane at Kirkliston; the Burgh of Clickanim, have also been withheld by their owners, but most of them are very well taken care of. The Cairns at Minnigaff were nearly destroyed before they were scheduled, and are not worth preserving. The inscribed stone in St. Vigean's churchyard is preserved in the porch of the church, but it is not included. On the other hand Edin's Hall, the largest and most southern of the remains of the Pictish Towers in Berwickshire, has been included by Mr. J. S. Fraser-Tytler; the Black and White Catherthuns have been added by Miss Carnegie Arbuthnot; both these are large camps having ramparts of stones and earthworks round them, and they are described in General Roy's work. The Pictish Towers at Glenelg have been included by Mr. James Bruce Bailey; they are in a very bad state of repair, and have been propped up by the Government. The inscribed stones at Laggangairn, New Luce, have been included by Lord Stair; they are at a great distance from any road or habitation, and the protection afforded them, beyond the powers contained in the Act, must be regarded as nominal. The Peter's stone, on the road from Wigton to Whithorn, has not been added; it is an important stone, and is in a dangerous position, it has already suffered damage, and it is to be hoped it will be included hereafter. The chapel on the Isle of Whithorn, supposed to be that built by St. Ninian, has been included by Mr. R. Johnstone Stewart; this was not in the schedule. The Pillars of Kirkmadrine have been included by Mrs. Ommaney McTaggart; they are the earliest Christian monuments in the country. I suggested that Government should contribute towards building a small chapel to contain them, which has been done. The Cross at Ruthwell, with its remarkable runes, which were gradually being destroyed and covered with lichen so that its inscription could not be read, has also been added. I suggested that the Government should contribute towards building an annex to the neighbouring church to contain it, which has been done. This was not in the schedule. The cup-marked rock of Drumtrodden, Wigtonshire, has been added by Sir Herbert Maxwell, and Government has granted a certain sum towards building a shed over it to preserve it. It was not in the schedule, but is a good example of its class. Barsalloch Fort, Wigtonshire, the Moat Hill of Druchtag, the Drumtrodden standing stones, Wigtonshire, have also been added by Sir Herbert Maxwell. St. Ninian's Cave, with its early Christian crosses, has been included by Mr. Johnstone Stewart. In the island of Lewis the remarkable standing stones in the form of a cross at Callernish, and the Broch at Carloway, have been added by Lady Matheson. This latter is, next to Mousa, the best Pictish tower in the country. In Cumberland the Stone Circle on Castle Rigg has been put under the Act by Miss Edmondson. In Westmoreland Arthur's Round Table, an earthen circle with a ditch in the interior, and Mayborough, a large circle with an embankment of stones and the remains of a stone circle within, have been included by Lord Brougham. In Derbyshire, Arborlow, a large circle similar to Arthur's Round Table, with the remains of a stone circle, the stones of which are prostrate, and a large tumulus near it, have been added by the Duke of Rutland. Hob Hurst's House, and the Circle on Eyam Moor, which also has a large cairn close to it, have been included by the Duke of Devonshire, and the Nine Ladies, a circle of small stones on Stanton Moor, by Major Thornhill. In Gloucestershire, Uleybury, a long barrow with a well-preserved stone chamber, has been added by Colonel Kingscote. In Oxfordshire the Rollrich stones have been included by Mr. J. Reade. In Kent, Kit's Coty House by Mr. Brassey, which is the remains of a long barrow, the traces of which can be seen, with part of the stone chamber remaining. In Somerset the stone circles at Stanton Drew by Mr. S. B. Coates, and the Cove there by Mr. Fowler; the chambered tumulus at Stoney Littleton by Lord Hylton. In Wiltshire, the long barrow at West Kennet by the Rev. R. M. Ashe, and Silbury Hill by Sir John Lubbock. In Dorsetshire the chambered long barrow, called the Grey Mare and Colts, near Gorwell, by Mr. A. B. Sheridan; the circle of Nine Stones near Bridehead Park by Mr. R. Williams; the stone circle on Kingston Russell Farm by the Duke of Bedford, and in Wales the Pentre Evan cromlech, one of the largest in the country, by Lord Kensington—making in all thirty-six which have been placed under the Act with the consent of their owners. All these and many

others have been surveyed ; plans, drawings, and sections have been made of them, which are contained in the book now upon the table, which is open for the inspection of the members. I hope to publish these shortly. Besides these monuments which are included under the Act, a good deal of useful work has been done by communicating with the owners of other monuments, without using the Act.

I think it speaks well for the landowners that so many should have been willing to accept the Act, considering that few of them take much interest in antiquities. There is not a more public-spirited body in the world than the much-abused landowners of England.

Those who have refused have generally done so on the grounds that they wish to remain responsible for their own monuments, and I think I may say, from my own observations, that there is very little damage to prehistoric monuments going on at the present time. Public opinion has done more than any Act of Parliament could do, and it appears to me that it is generally known throughout the country that any wilful damage to the monuments would be universally condemned.

But it is well to consider the operation of the Act, and how it may be improved. The provision which makes it illegal, ever after, to destroy the monuments that are now placed under the Act by their owners, and to enable magistrates to punish offenders summarily, appears to me excellent and worthy to be retained. But there are defects to which it would be well to give attention. By the present Act the Government are made responsible for all the monuments that are included, which entails expense, and as members of Parliament generally take very little interest in ancient monuments, and the great object of Government must always be to curtail expenditure, additions to the list are not as a rule encouraged.

I last year obtained eleven new monuments, but I was told that this was too many and that some must be omitted, so I selected three of the least important and they have not been included. This, I think, is objectionable, the two provisions of the Act which I have mentioned should be applied as widely as possible. If the provision making Government responsible for the preservation of the whole of them is altered, there will be no inducement on the part of the authorities to reduce the number to be included. At present local archæologists wash their hands of the matter, thinking that there is a Government Inspector whose business it is to look after the monuments. This is a mistake ; the proper function of the Inspector is simply to look after the monuments that are included, and to advise the Commissioners—Not to obtain new monuments for the Act. I have done so because I was charged in a special manner with the organisation and working of the Act on its first introduction, but it is beyond the proper functions of the Inspector. I have done it as a private individual who takes an interest in the subject, and any other private individual may do the same. Moreover, it is impossible for an Inspector to stand sentry over all the monuments that are put under the Act. The police are requested to look after them as well as they can, but damage must occasionally be done which local archæologists are in a better position to ascertain and to remedy, using the provisions of the Act for the purpose.

It may be that my position as a landowner, as Lord Stalbridge said in his letter asking me to take the appointment, may have had some effect in enabling me to persuade some of the other landowners, but you cannot ensure always having a landowner for an Inspector, and it is desirable now to put the Act on a working footing. It is much to be wished that local archæological societies should be made to feel themselves responsible both for the inclusion of monuments under the Act and their preservation afterwards ; the Act arms them with full powers for the purpose if they think proper to use it.

At present no archæological society has rendered any assistance whatever, but Sir Herbert Maxwell, in Galloway, has not only offered his own monuments, he has persuaded his neighbours to do the same. What Sir Herbert Maxwell can do others equally public-spirited can do also, if it is clearly understood that it rests with them to take action in the matter, and I think it should rest with them, because, being local, they can do more than a single Inspector charged with the supervision of the whole of the monuments of Great Britain. I think that the

Government should continue to appropriate a small sum (it is now under 200*l.* a year) to apply to such purposes as may be thought desirable, such as building sheds to preserve the monuments, but that they should not necessarily be held responsible for all the monuments placed under the Act, and that the Bill being a permissive one, it should rest with the public to make use of it or not, as they may think proper. If there is no demand for the preservation of monuments, there is no reason why the country should be saddled with the expense of it. If there is a demand, let those who are interested use the law on the subject as they use any other to prosecute delinquents. I think also, the provision that the new monuments before being included should rest forty days before Parliament, might be advantageously abolished. The First Commissioner, with the practical knowledge of the Inspector, is fully competent to decide upon the monuments to be included. It is evident that if it were desired to save any monument that might be threatened, the forty days would afford ample time to enable the destruction to be carried out before the Act could be applied. With these alterations I think the Act would take root in the country and produce better results. Of one thing, however, I feel certain, that as long as the owner of a monument takes an interest in it he is the best person that the public can look to for the preservation of it.

In conclusion it may perhaps interest the meeting if I say a few words upon the results of my recent excavations on the borders of Dorset and Wilts, upon which I have been at work for the last eight years, the detailed account of which is recorded in the two quarto volumes extending to 541 pages and 159 plates, the last of which is just completed.

I have excavated numerous barrows of the bronze age near Rushmore, about half-way between Salisbury and Blandford. Winkelsbury Camp has been examined and sections cut through the ramparts; an Anglo-Saxon cemetery near it has been dug out, and two Romano-British villages thoroughly explored, the positions of which are shown on the map now exhibited on the walls, a reduced facsimile of which is given on page 835.

In recording these excavations I have acted on the principle that views upon anthropological subjects are constantly on the change, as our imperfect knowledge of the early inhabitants of the country increases, and that when the records of excavations are confined to opinions and results, it is probable that those facts only which coincide with the theories current at the time, receive the prominence they deserve.

The requirements of the future demand that everything should be recorded and tabulated in such a way as to be of easy access hereafter. I have therefore established a system of relic tables in which, without confusing the text and making it unreadable, every object, however small and apparently trivial, is inserted, and the great majority of them are figured in the plates.

It would occupy too much time to enter into details on the present occasion. The result has been to show by a computation from the bones of twenty-eight individuals, found buried in pits in the villages, that the Romanised Britons of this district were an exceedingly small race, having an average stature of not more than 5 feet 2·6 inches for the males, and 4 feet 10·9 inches for the females; that the tallest man was only 5 feet 7·8 inches, and he was an inch and a half taller than the next tallest man.

In head form, the great majority of twenty-six skeletons measured were mesaticephalic and mostly coffin-shaped, but three were hyper-dolichocephalic and two brachycephalic, which shows that the head form approached that of the neolithic, long barrow people, with a probable admixture of either Roman or bronze age types.

The stature is slightly less than that given by Thurnam for the long barrow people of this district, but Dr. Garson informs me that, in a paper which he will read at this meeting, he will show that the height of the Romano-Britons whom I have discovered tallies as nearly as possible with that of some long barrow bones found near Devizes. All are of course shorter than the skeletons of the bronze age, two of which I have found in the same locality, and which are of the usual tall stature and round-headed types of that people.

The Romano-Britons are also considerably shorter than the skeletons of the Anglo-Saxons found in the cemetery at Winkelbury, which are described in my second volume.

The problem, therefore, with respect to these Romanised Britons, appears to be this:—are they the descendants of the long barrow people, and do they owe their small stature to that circumstance, or is their small size to be attributed to their largest men having been drafted away into the Roman legions abroad?

Professor Rolleston examined a number of skeletons from a cemetery at Frilford, which he believed to be Romanised Britons, and found that they were of large size, but in my address to the Royal Archæological Institute at Salisbury, last year, I expressed some doubt about the period of these skeletons, and in a paper since published by Dr. Beddoe, I see that he rejects the evidence of their being Romano-Britons upon the same ground that I had doubted it, and he quotes Barnard Davies and Thurnam for the occurrence of other skeletons of these people of the same or nearly the same stature as those of the villages that I have explored.

We are therefore evidently beginning to accumulate reliable information about these people, whose physical peculiarities are less known to us than any other prehistoric, or rather non-historic, race, that has contributed to the population of this country.

Thurnam showed that the large-sized, round-headed Belgæ probably penetrated no further westward than the borders of the district I am speaking of, and that the bowl barrows and the long barrows of the Stone Age predominated to the westward of it.

Since the present volume of my excavations was in print, I have quite recently made another discovery of considerable interest bearing upon this question.

Bokerley Dyke is an ancient entrenchment which cuts across the Old Roman road from Old Sarum to Badbury Rings. It is an earthwork of considerable magnitude, with a ditch on the north-east side of it. It appears to have originally occupied all the open downland spaces intervening between the ancient woods, which latter probably, by means of felled trees, afforded sufficient defence without earthworks. It extends with its dependencies and detached prolongations more or less all the way from White Sheet Hill on the north-west to Blagdon Hill on the south-east, a distance of about nine miles. Its origin and use have been frequently discussed by archæologists, but no one has hitherto assigned a right date to it. I have now cut two broad sections through it on either side of the Roman road, models of which are exhibited, with the result of proving that it is late Roman, or post-Roman, and is of the same date as the villages, Roman coins to the amount of 500, of late date, extending to Constantinus and Gratianus, and pottery, having been found in both sections, all through the rampart, down to the old surface line. It appears that the dyke had been cut through ground occupied at an earlier date by the Romanised Britons, and that in forming the ditch they threw up the refuse from the habitations to form the bank, including the scattered coins and pottery. A human skeleton of similar character to those found in the villages was also discovered beneath the old surface line in one of the sections, the old surface line being clearly marked over it, showing that it had been buried there before the rampart was thrown over it. From this it appears probable that this dyke was thrown up to defend the Romano-British villages that are situated to the westward or rear of it, from an attack from the east, and that this must in all probability have been done at the time when the Saxon invaders were pressing upon them from the eastward.

This discovery throws a flood of light upon the history of this part of the country at that time, and shows that the Britons must have made a stout defence against their Anglo-Saxon conquerors, sufficient perhaps to account for the apparent pre-dominance of British blood which has been noticed amongst the existing population of the district.

Wansdyke, which runs from a spot not far to the north of the Bokerley Dyke in the direction of Bath, has the same defensive attitude as Bokerley, and the exami-

nation of it, which it is proposed to make, will show whether or not it is of the same period.

The observations of Dr. Beddoe and other physical anthropologists upon the present population of the country show that the people of the South-West of England are, as a rule, shorter and darker than those to the eastward, and my own observations upon the people of this particular district will, when they are systematised, tend to define the area of this ethnical frontier more precisely. It would be a remarkable result if it should hereafter be shown that the physical changes observable in the distribution of the existing population are in any way coincident with these lines of defensive earthworks of the Roman or post-Roman age: and if it should be further shown that the same physical characteristics have persistently belonged to the people of this region ever since the time of the neolithic folk of the long barrows, we shall find ourselves in the presence of anthropological deductions of some value in their bearing on the history of England. I purposely avoid speaking with confidence upon this point, feeling certain that the necessary evidence for deciding the question lies buried in the soil of the district, and will hereafter be unearthed. I shall resume the inquiry as soon as the harvest, if such it can be called this year, is over, but without bias, and with a mind prepared to throw over any preconceived hypothesis, the moment it shows itself to be untenable.

MAP SHEWING THE AREA FORMERLY OCCUPIED BY CRANBORNE CHASE, WITH THE ANTIQUITIES CONTAINED IN IT.



The following Reports and Papers were read:—

1. *Report of the Committee for investigating the effects of different occupations and employments on the Physical Development of the Human Body.*—See Reports, p. 100.

2. *Second Report of the Committee for ascertaining and recording the localities in the British Islands in which evidences of the existence of Prehistoric Inhabitants of the country are found.*—See Reports, p. 289.

3. *The Constitutional Characteristics of those who dwell in large Towns, as relating to Degeneracy of Race.* By G. B. BARRON, M.D., L.R.C.S.E., M.R.C.S., Hon. Surgeon-Major.

The conditions of life and their general surroundings largely influence and materially affect the physical and constitutional characteristics of town dwellers.

The 'vital force,' or 'energy,' of the town dweller is inferior to the 'vital force' of the country man. This is to be found in the general unfitness and incapability of the town dweller to undergo continued violent exertion and the long endurance of fatigue. The various factors at work night and day upon the constitution of the poorer class dwelling in towns develop that form of disease known as tuberculosis and pulmonary consumption. The town man is constitutionally dwarfed, and his life is, man for man, *weaker, shorter, and more uncertain* than that of the country man; and the general tendency of his ailments is of the asthenic type.

I hold the opinion that the deterioration is more in physique, loss of muscular power, attenuation of muscular fibre, loss of integrity of cell structure, and consequent liability to the invasion of disease, *rather than in actual stature of inch measurement.* The true causes are 'bad air' and 'bad habits' of life. My contention is, that it is in the loss of physical tonicity, vital capacity, and vital force, that the degeneracy is found, and not in actual loss of stature. Included in the phrase 'bad air,' I mean bad sanitation and over-crowding.

For thirty years I have been working at this question, and the more I examine it the more I am convinced of the accuracy of my conclusions. Sailors, fishermen, agricultural labourers, and sportsmen are rarely the victims of consumption. The chief cause of consumption is foul air. Air filled with some kinds of dust and other noxious ingredients, produces a form of phthisis, as is seen in the Sheffield knife-grinders, &c. Where people are huddled together in insanitary dwellings, such as are found in the crowded courts and alleys of large towns, they are specially prone to this disease. Experiments made by Dr. Brown-Séquard on animals prove this. The value of fresh air in preventing disease was known to Hippocrates Celsus, Aretæus, and Pliny. The fishermen of the Hebrides and Labrador are specially exempt.

The absence of pure air produces pallor and feebleness of constitutional vigour; the tissues of the human body lose their tonicity and contractile power; the pent-up denizens of courts and alleys in our large towns must necessarily degenerate in physical competency; and their offspring is of feeble type; lowered vitality and impoverished physique is the result.

These observations deal only with those who habitually dwell in towns.

The second factor is 'bad habits of life,' including the non-observance of rules of health, and intemperance, with the various forms of 'impurity.' These tell a sad story by smiting, with devitalising severity, the offspring to the third and fourth generations, as well as the direct victims who indulge in them.

Imperfect feeding, and consequent malnutrition, causes degeneracy to be emphasised. The digestive capacity of the town dweller is not so perfect as that of

the countryman, and he is more liable to suffer from the products of imperfect assimilation. The result often shows itself in the form of the uric acid diathesis and the evils due to that condition, Bright's disease, and allied diseases. The pernicious habit of too much indulgence in tea-drinking is injurious.

It is not the male sex alone we have to consider in this question. The mothers of this part of future England produce an enfeebled offspring, and their development is bad, and they are impaired in physique.

Town children are more quick-witted and artful, and adroit in cunning acquisitiveness; but that does not imply superior intellectual development. It is supposed that rapid growth of the nervous system retards the bodily development. I do not think so.

No satisfactory answer has been supplied to the paramount question, 'Is the town dweller degenerating in stature of inch measurement?' The constant immigration into the towns of country men and women, introducing fresh blood into the old stock by marriage, and thus renovating it, renders the solution of the problem difficult. This is a decided counterpoise to degeneracy. The statistics of the Anthropometric Society rather point to a lowered stature, but they are not conclusive unless they can be applied to pure town dwellers of two or three generations' duration. Mr. Francis Galton measured 9,000 persons, and appears to have established the fact that Cambridge students are rather taller and heavier than the mean population.

As regards the physical impairment or degeneracy of the population of towns in stature, the report of the Anthropometric Committee at the Southport meeting says 'few statistics are in existence which help to throw light on this subject.' The measurements of height and weight of the Factory Commission of 1833, and the report to the Local Government Board of the employment of young persons in factories in 1873, show that there is no appreciable lowering of stature.

The 'Lancet' Commission on the Sweating System discloses a terrible state of things. The daily occupations of town dwellers and their homes and workshops are very insanitary, and must lead to an impoverished condition of the animal economy.

The remedies are Imperial legislation to improve the social conditions of the town dwellers. Insanitary surroundings, over-crowding, uncleanness, impurity, intemperance, must all be swept away. The children must be educated in the pure air of the country. Make the parents sober and moral; give them pure air and plenty of it, and away fly pale faces, dyspepsia, crooked backs (generally resulting from tuberculosis), lowered vitality, stunted development, muscular attenuation, and the imperfect elimination of functional products.

The purely physical side of human nature demands our attention. The instinctive rush of the poorer classes into towns in quest of the means to live has greatly helped to complicate the problem of relief. Hardships of various kinds tend to accentuate their wretchedness, and they seek solace too often in the unhealthy pursuit of unrighteous habits. The problem of poverty has to be reckoned with if the English race in large towns is to retain a fair standard of physical integrity.

4. *The Physique of the Swiss as influenced by Race and by Media.*

By Dr. BEDDOE, F.R.S., V.P.A.I.

The paper was founded on the official recruiting returns. The average stature of Swiss recruits (including the rejected) between the ages of nineteen and twenty is 163.5 cms., or 64.3 inches; the full-grown stature perhaps nearly an inch higher. It is greater, generally speaking, in the districts where French or Romansch is spoken than where the language is Italian or German. From the point of view of race it is highest in the Helveto-Burgundian area, *i.e.* the Jura, contiguous to the French department of the Doubs, where the stature is the highest in France, lowest in the Kelto-Alemannic area, especially around Appenzell, and in the Ober-

land. Weaving and embroidery, which are the chief occupations about Appenzell, St. Gall, &c., may be blamed as productive of degeneration, but watchmaking, in the Jura, does not seem to be so; and the low position of the Oberland, which extends to other points besides stature, is difficult to explain. Goitre seems to have a geological distribution; myopia belongs to the towns, to the highly-educated, to the Germans (readers of German type), to the lacemakers and embroiderers. On the whole, the physical development is healthiest in Nidwalden and Tessin, and it is suggested by the Swiss officials that the diet in these two cantons consists largely of cheese.

5. *On Colour-blindness.* By KARL GROSSMANN, M.D.

The question of colour-blindness, which, when first described 90 years ago, had only the interest of a scientific curiosum, has become one of very great importance in our age of ocean- and railroad-racing.

Still, although everyone, with the exception perhaps of the official authorities, will be of the same opinion as to the danger of employing colour-blind people in posts where coloured signals are to be distinguished, not the same unity exists as to the theories concerning colour-blindness and colour-perception. The old theory of Thomas Young (1802) obtained a new lease by the support of no less a name than Helmholtz; but this theory is fast losing ground against the theory of Hering, who admits two pairs of simple or fundamental colours. A third theory, that of the evolution of the colour-sense, has, as one of its supporters, Mr. W. E. Gladstone. But it has not been considered anything else than a misunderstood Darwinistic deduction, carried out with a great amount of philological knowledge.

Colour-blindness in its typical form is congenital, and, with the very rarest exception, is double-sided: it is either red-green-blindness or blue-yellow-blindness, or total colour-blindness. As red-green-blindness is the usual and most important form, we will consider it exclusively here for simplicity's sake.

The colour-blind individual 'makes mistakes' in distinguishing certain colours. To him the ripe strawberry and its leaves, the blossom of the pomegranate-tree and its foliage, the blush on a rosy cheek and the sky, are three pairs of equal colours. The names given to certain colours by the sufferer may be right or wrong; they do not convey to them the correct notions. A keen perception of dark and light shades exists and often leads to the correct naming of colours. Still, naming is utterly misleading as a rule. Holmgren has therefore modified Seebeck's mode of testing by placing a bundle of coloured skeins before the colour-blind, who has to select to a given shade all those which match. If there be two different colours which appear absolutely alike to the colour-blind, a pattern made of these two colours will appear as of one colour only. On this principle Stilling based his plates, an excellent idea, which, however, fails very often; the reasons will be seen soon.

The author calls two such apparently identical but different fundamental colours 'twin-colours.' Such colours are, for instance, a certain yellow and green. To these two we may find a third fundamental colour, equally identical to the colour-blind, a certain red, thus forming with the two others a set of 'triplet-colours.' He now found that while a certain green and yellow were twin-colours for all his colour-blind patients, the corresponding red was right for some, too dark for others, too light for others again. This he found was due to the way in which the different eyes perceived the spectrum. If the red end of the spectrum was shortened, certain reds appeared darker than to eyes with a normal extension of the spectrum. Dr. Grossmann utilised this by embroidering letters of three colours so as to form on a brownish ground a red letter, say an F, completing it by green in such a manner as to form a B. A red-green-blind eye with normal spectrum will then see a blank ground; while one with a shortened spectrum sees the letter F dark on a lighter ground.

Another difficulty is the variability of the daylight, which affects the different colours in twin combinations to a different degree. Both these reasons explain why Stilling's plates so often fail.

The wool letters, though very nice, handy, and without gloss, are very apt to fade.

In order to get a more uniform light, and also to more readily imitate the signal-lights, patterns were formed of twin-coloured glass, cut into small squares and arranged into mosaic figures, between two plain glasses so as to form a slide which is put into a lantern. These slides are not subject to the variability of daylight, and will never fade. The little squares are hardly destructible.

FRIDAY, SEPTEMBER 7.

The following Papers were read :—

1. *On Human Bones discovered by General Pitt-Rivers at Woodcuts, Rotherley, &c.* By Dr. BEDDOE, F.R.S.

The paper contained a comparison of the Romano-British skulls found at Woodcuts and Rotherley, and of the Anglo-Saxon ones at Winklebury, with remarks on the striking difference in stature between the two former and the latter series. The differences in size (of the skulls) were inconsiderable, and the average cephalic index was about the same in the Romano-Britons and the Saxons, falling just below 75. The elliptic form predominated in the Saxons, the ovoid and coffin-shaped in the Britons. The frontal radius and arc of Busk were larger in the Saxons. In the Britons neolithic forms, pure or mixed, were frequently observed. Dental caries was more frequent in the Britons. The author doubted whether the stature of the Britons was quite so dwarfish as had been supposed; if allowances were made for the soft parts, for the advanced age of some of the individuals, or if they were supposed to have the shortness of limb often found in people of low stature, the male average might even be raised as high as somewhere between 5 ft. 4 in. and 5 feet 5 in. (164 centimetres). In any case, however, the stature was very low, whether compared with that of the Winklebury Saxons (over 5 feet 7), or with the bronze people, or with Davis and Thurnam's long-barrow men. The author inclined to agree with the suggestion of General Pitt-Rivers that the race might have degenerated in stature under the combined influence of oppression, poverty, &c., and of the abstraction, generation after generation, of the taller men for service in the legions.

2. *Human Remains from Wiltshire.*
By J. G. GARSON, M.D., V.P. *Anth. Inst.*

In his important work on 'Excavations in Cranborne Chase, near Rushmore' General Pitt-Rivers has asked the following question regarding the human skeletons he found: 'What race can these people be taken to represent? Are they the survivors of the neolithic population which after being driven westward by successive races of Celts and others continued to exist in the out-of-the-way parts of this region up to Roman times, for which hypothesis the crouched position of the interments and their markedly dolichocephalic or hyperdolichocephalic skulls appear to afford some justification, or are they simply the remnants of a larger race of Britons deteriorated by slavery and reduced in stature by the drafting of their largest men into the Roman legions abroad? In order to throw some light on this important subject, the author has examined several skeletons obtained in various parts of Wiltshire from excavations of barrows containing human remains associated with neolithic implements. Of these neolithic people there seem to have been two varieties; both of these are characterised by having long narrow skulls, but the skull of the one variety differed from that of the other in that, while one is of regularly oval outline, the other has flattened sides which give it a coffin- or pear-shaped appearance. The skulls examined by the author showed

both those varieties to exist in Wiltshire, eight being of the oval form and four of the coffin-shaped variety. General Pitt-Rivers' specimens showed the same varieties to exist, but the oval form to be greatly predominant in numbers. The author found two specimens to be hyperdolichocephalic (Cephalic Index, 65-69), seven dolichocephalic (Index, 70-74), three mesaticephalic (Index, 75-79), and no brachycephalic specimens. Of the specimens excavated by General Pitt-Rivers, three are hyperdolichocephalic, eleven dolichocephalic, ten mesaticephalic, and two brachycephalic. The characters presented by the neolithic skulls showed evidence of the people at that time not being of absolutely pure race. Examination of General Pitt-Rivers' specimens showed that the characters of the skull were identical with those of the early race, though there was evidence that in the interval of time which separated the two sets of interments the people had become, as was to be expected, somewhat more mixed. This fact would account for the greater number of mesaticephalic persons among the skeletons excavated by General Pitt-Rivers, both the Celts and the Romans with whom they came in contact having much rounder heads than themselves, while the brachycephalic skulls found by General Pitt-Rivers proved themselves to be those of Celts or Romans who had been interred with the Britons. Passing to an examination of the long bones of the skeleton, the author found the average stature of the neolithic persons he had examined, estimated from the length of the femur and humerus is, 1,588 mm. (5 ft. 2.5 inches); others, estimated from the radius (consequently not to be so much depended on), averaged 5 ft. 5 inches, the average of the whole being 1,628 mm. (= 5 feet 4 inches), which is the identical average of the skeletons from Woodcuts village. If the statures estimated from the radius be excluded—which, owing to their being much greater than those estimated from other bones, may fairly be done—the average stature of the neolithic Briton and of all the Romano-British people found by General Pitt-Rivers at both villages is exactly the same.

From the characters of the skull and the statures being as nearly as possible identical with those of the early dolichocephalic and neolithic inhabitants of Britain, the author concludes that the human remains obtained from General Pitt-Rivers' excavations are no other than those of the neolithic people who had existed down to Roman times in a comparative state of purity. The evidence of this being the case seemed to him to be corroborated by the fact that down to the present day it is easy to trace remnants of the old Iberian race in various parts of England and Wales, notwithstanding the great interchange of population which has taken place during the present century.

3. *On a Method of investigating the Development of Institutions; applied to Laws of Marriage and Descent.* By EDWARD B. TYLOR, F.R.S.

With the view of applying direct numerical method to anthropology, the writer has compiled schedules of the systems of marriage and descent among some 350 peoples of the world, so as to ascertain by means of a 'method of adhesions' how far each rule co-exists or not with other rules, and what have been the directions of development from one rule to another. As a first test of the results to be obtained by this means, the barbaric custom is examined which forbids the husband and his wife's parents (though on a friendly footing) to speak or look at one another, or mention one another's names. Some seventy peoples practise this or the converse custom of the wife and her husband's relatives being obliged ceremonially to 'cut' one another. On classifying the marriage rules of mankind, a marked distinction is found to lie between those peoples whose custom is for the husband to reside with his wife's family and those where he removes her to his own home. It appears that the avoidance custom between the husband and the wife's family belongs preponderantly (in fourteen cases, as compared with eight computed as likely to happen by chance) to the group of cases where the husband goes to live with the wife's family. This implies a causal connection between the customs of avoidance and residence, suggesting as a reason that the husband, being an interloper in the wife's family, must be treated as a stranger; to use an English idiom expressing the situation, he is not 'recognised.' Other varieties of the custom show similar preponderant

adhesions. Another custom, here called *teknonymy*, or naming the parent from the child, prevails among more than thirty peoples; as an example was mentioned the name of Ra-mary, or Father of Mary, by which Moffat was generally known in Africa. This custom proves on examination to adhere closely to those of residence and avoidance, the three occurring together among eleven peoples, that is, more than six times as often as might be expected to happen by chance concurrence. Their connection finds satisfactory explanation in the accounts given of the Cree Indians of Canada, where the husband lives in his wife's house, but never speaks to his parents-in-law till his first child is born; this alters the whole situation, for though the father is not a member of the family, his child is, and so confers on him the status of 'Father of So-and-so,' which becomes his name, the whole being then brought to a logical conclusion by the family ceasing to cut him. These etiquettes of avoidance furnish an indication of the direction of change in social habit among mankind; there are eight peoples (for instance, the Zulus) where residence is in the husband's family, with the accompanying avoidances, but at the same time avoidance is kept up between the husband and the wife's family, indicating that at a recent period he may have habitually lived with them.

The method of tracing connection between customs is next applied, with the aid of diagrams, to the two great divisions of human society, the matriarchal and the patriarchal, or as the present writer prefers to call them, maternal and paternal systems. In the maternal system descent and inheritance follow the mother's side, and the guardian of the children is the maternal uncle, not the father, whose assertion of parental rights belongs to the paternal system with descent and inheritance on his side. The problem to be solved is, which of the two systems is the more primitive, and to this the present method gives calculable answers, showing that the drift of society has been from the maternal to the paternal system. Thus the law by which the eldest son of an African chief inherits his stepmothers as wives belongs only to the stage where patriarchy is in force, which is consistent with this being the later system; had it been the earlier system the custom would have survived into the midst of matriarchy, where, in fact, it is not found. The custom of the 'couvade,' where at the birth of the child the father is nursed and dieted and otherwise behaves as though he were the mother, is evidence in the same direction. In the maternal stage of society, where the father has hardly any power or position, this farcical proceeding is unknown, but where the paternal relation begins to be more developed, we find it asserted among twenty peoples by the ceremony of couvade, which even lasts on, in eight cases, into the full paternal system, being only just extinct in Europe, where it lingered till the end of last century in the Pyrenees. These several customs are so stratified as to demonstrate that Bachofen, McLennan, Bastian, Morgan, Lubbock, Giraud-Teulon, Wilken, Fison, Howitt, Lippert, Post, have judged rightly, from the evidence before them, in taking the matriarchal system as the earlier, from which the patriarchal gradually arose.

The paper continues with the argument that a chief underlying cause of both systems is still traceable in society. A diagram showing the classification of peoples according to residence showed 65 peoples where the husband attaches himself permanently to the wife's family, 76 where such temporary residence is followed by removal to a paternal home, and 151 where the paternal home is resorted to from the first. The changes brought about by the man's ceasing to be in the hands of his wife's kinsmen, and becoming lord of a household of his own, represent, in fact, the transformation of maternal into paternal society. Among the Pueblo Indians the Hon. J. W. Powell, of the Bureau of Ethnology at Washington, has had the opportunity of watching this change brought about by the necessity of removal of families, for agricultural purposes, from the parent settlement.

By the method of adhesions, examination is next made of the practice of wife-capture, recorded among about 100 peoples, as a hostile act, a recognised and condoned mode of marriage, or a mere formality. The two latter kinds (connubial and formal) only come into existence with the paternal system. It is obvious that this must be so, as the capture of a wife, even in pretence, necessarily involves her passing into the husband's home and authority. The system of exogamy or 'marrying-out,' in which husband and wife must belong to different clans, classes,

or families, does not appear to be derived from the practice of capture, as some 14 peoples, representing so early a stage of the maternal system as to have residence in the wife's family, a state of things which could not have followed from capture, nevertheless already forbid marriage within the clan. With reference to the Rev. Lorimer Fison's argument that the Classificatory System of Relationships described in North America, Hindostan, &c., by the Hon. L. H. Morgan, results directly from exogamy in its Australian form, it is here further shown by a table of adhesions that the closest connection exists between exogamy and this system of relationships, and also with the rule of 'cross-cousin marriage' which in several tribes allows marriage between the children of a brother and sister, but not of two brothers or two sisters. By taking these together, it is found that the list of exogamous peoples of the world may be enlarged to over 100. It appears from the testimony of a number of writers that the rule of exogamy, whatever its precise origin, has from the first been a means of binding together tribes and nations by intermarriages between the clans or groups of which they are composed, and thus resisting the disintegrating effects of quarrels, which would separate in permanent hostility the small isolated communities which endogamy tends to form. A community which marries in has no allies outside; these can only be gained by intermarriage, and savage tribes must again and again have had to face the plain alternative, whether they would marry out or be killed out.

It is evident from the tables that the rules of human conduct are amenable to classification, so as to show by strict numerical treatment their relations to one another. It is only at this point that speculative explanation must begin, guided and limited in its course by lines of fact. In the words of Prof. Bastian, the future of anthropology lies in statistical investigation. The present paper shows that the institutions of man are as distinctly stratified as the earth on which he lives, succeeding one another independently of difference of race and language, by similar human nature acting through necessarily changing conditions of savage, barbaric, and civilised life.

4. *Australian Message-sticks and Messengers.* By A. W. HOWITT, F.G.S.

The use of message-sticks is not universal in Australian tribes, and the degree of perfection reached in conveying information by them differs much. Some tribes, such as the Diéri, do not use the message-stick at all, but make use of emblematical tokens, such as the net carried by the Pinya, an armed party detailed by the Council of Headmen of the tribe to execute its sentences upon offenders. Other tribes, such as the Kurnai, use pieces of wood without any markings. Others, again, especially in Eastern Queensland, use message-sticks extensively, which are often elaborately marked, highly ornamented, and even brightly painted. No messenger, who was known to be such, was ever injured.

The message-stick was made by the sender, and was kept by the recipient of the message as a reminder of what he had to do.

For friendly meetings the messenger of the Kurnai, of Gippsland, carried a man's kilt and a woman's apron hung on a reed; but for meetings to settle quarrels or grievances by a set fight, or for hostile purposes generally, the kilt was hung upon the point of a spear.

Among the Wotjoballük of the Wimmera River in Victoria, the principal man among them prepares a message-stick by making certain notches upon it with a knife. The man who is to be charged with the message looks on, and thus learns the connection between the marks upon the stick and his message. A notch is made at one end to indicate the sender, and probably notches also for those who join him in sending the message. If all the people of a tribe are invited to attend a meeting, the stick is notched from end to end; if part only are invited, then a portion only of the stick is notched; and if very few people are invited to meet or referred to in the verbal message, then a notch is made for each individual as he is named to the messenger.

The messenger carries the stick in a net-bag, and on arriving at the camp to which he was sent, he hands it to the headman at some place apart from the

others, saying to him, 'So-and-so sends you this,' and he then gives his message, referring, as he does so, to the marks on the message-stick.

The author gives an explanation of the method adopted for indicating numbers, which fully disposes of the idea that the paucity of numerals in the languages of the Australian tribes arises from any inability to conceive of more numbers than two, three, or four.

A messenger of death painted his face with pipe-clay when he set out, but did not in this tribe carry any emblematical token.

Among the Wirajuri of New South Wales, when the message was one calling the people together for initiation ceremonies, the messenger carried a 'bull-roarer,' a man's belt, a man's kilt, a bead string, and a white head-band, in addition to the message-stick.

In New South Wales, the Kaiabara tribe use message-sticks cut in the form of a boomerang, to one end of which a shell is tied.

As a rule the notches on a message-stick are only reminders to the messenger of the message he is instructed to deliver, and are unintelligible to a man to whom they have not been explained; but certain notches appear to have a definite meaning and to indicate different classes; and among the Adjadura there is an approach to a fixed rule, according to which these sticks are marked, so that they would convey a certain amount of meaning definitely to an Adjadura headman independently of any verbal message.

5. *Social Regulations in Melanesia.* By the Rev. R. H. CODRINGTON, D.D.

INTRODUCTORY.—The part of Melanesia in view comprises the Northern New Hebrides, the Banks' Islands, Sta. Cruz, and the South-eastern Solomon Islands. The Social Regulations which obtain among the people are described from personal observation, and from information given by natives. A considerable portion of the whole subject is thus in view, and with particular differences there is a general agreement, from which a wider likeness throughout the Melanesian population may be inferred.

The Social Regulations dealt with are only those relating (I.) to *Marriage*, and (II.) to *Property*.

I. SOCIAL REGULATIONS RELATING TO MARRIAGE.

1. The entire arrangement of society depends on the division of the whole people, in every settlement, large or small, into two or more classes, which are exogamous, and in which descent follows the mother. This division comes first of all things in native thought, and all social arrangements are founded upon it. Mankind, to a woman, was divided into husbands and brothers; womankind, to a man, into wives and sisters—at least, on about the same level of descent. Illustration from a story.

2. The members of these divisions are all intermixed in habitation, property, subordination to a chief, and in the well-understood relationship through the father; the divisions, therefore, are not tribes.

3. Examples from two regions—(a) where these divisions are two, as in the Banks' Islands and Northern New Hebrides; (b) where there are more than two, as in Florida, in the Solomon Islands.

(a) 1. Where there are two divisions there is no name to either. In Mota there are two *veve* (distinction); in Lepers' Island two *wai-vung* (bunch of fruit).

2. The divisions are strictly exogamous; irregular intercourse between members of the same is a heinous crime; avoidance of the person and name of father-in-law, &c., is the custom.

3. No communal marriage in practice, or tradition of it; yet a latent consciousness of the meaning of the words used for husband and wife, mother, &c. The story of Qat shows individual marriage. The levirate, and practice of giving a wife to set up a nephew in the world.

4. Descent through the mother makes the close relation of sister's son and mother's brother; the son takes his mother's place in the family pedigree. Certain rights of the sister's son with his uncle. The mother is in no sense head of the family. The bridegroom takes his bride into his father's house, if not into his own.

5. A certain practice of *couvade* prevails.

6. No capture in marriage. Adoption of no importance.

(b) 1. In Florida, in the Solomon Islands, and the neighbourhood, is found an example of four or six divisions, called *kema*. In strict exogamy, descent following the mother, and local and political intermixture, all is the same as in the Banks' Islands. But each *kema* has its name, and each has its *buto*, that which the members of it must abstain from. The names are some local, some taken from living creatures. The *buto* is mostly something that must not be eaten.

2. Question whether totems are present. The bird which giving its name to one *kema* is not the *buto* of it, can be eaten. Comparison from the Island of Ulawa.

3. Exceptional condition of part of Malanta and San Cristoval, in the apparent absence of exogamous divisions of the people, and in descent being counted through the father.

II. PROPERTY AND SUCCESSION.

A. 1. Land is everywhere divided into (1) the Town; (2) the Gardens; (3) the Bush. Of these, the two first are held in property, the third is unappropriated.

2. Land is not held in common—*i.e.*, each individual knows his own; yet it is rather possession and use for the time of what belongs to the family, and not to the individual. A chief has no more property in the land than any other man. Sale of land was very rare before Europeans came; and sale of land by a chief beyond his own piece, no true sale. Example at Saa of the fixed native right of property in land. Abundance makes land of little value.

3. Land reclaimed from the bush by an individual, and the site of a town founded on the garden ground of an individual, has a character of its own.

4. Fruit trees planted by one man on another's land, remain the property of the planter and his heirs. In a true sale the accurate and particular knowledge of property in land and trees is remarkably shown.

5. Personal property is in money, pigs, canoes, ornaments, &c.

B. 1. The regular succession to property is that by which it passes to the sister's son, or to others who are of kin through the mother.

2. But that which a man has acquired for himself he may leave to his sons, or his sons and their heirs may claim. This is the source of many quarrels, the character of a piece of land being forgotten, or disputed by the father's kin.

3. Hence a tendency to succession to the father's property by his sons follows the assertion of paternity, and the occupation of new ground.

4. A man's kin still hold a claim on his personal property, but his sons, who are not his kin, will generally obtain it.

6. *On the Funeral Rites and Ceremonies of the Nicobar Islanders.*

By E. H. MAN.

The author, who during a residence of many years in the Nicobar Islands has made a careful study of the habits and customs of the aboriginal inhabitants as well as of their language, forwards a paper treating in detail of the Nicobarese funeral rites and ceremonies.

The mortuary customs in the central and southern islands differ in many points from those observed by the communities inhabiting the northern portions of the Archipelago: all alike appear to indulge in demonstrations of grief, which amount to almost frenzied extravagance, and which are induced in the majority of mourners less by real sorrow than by the dread entertained of, and desire of conciliating the

disembodied spirit, which is credited with peculiar activity and malevolence immediately after its release.

It is incumbent on all relatives and friends to repair as speedily as possible to the hut where a death has taken place, and those who fail to bring with them the customary offering of white or coloured calico must make a valid excuse to the chief mourner, who would otherwise regard the omission as an insult to be remembered and rendered in kind at the earliest opportunity: these offerings vary in quantity from a few yards to an entire piece, and are, as soon as they are presented, torn into lengths of about two yards and utilised for shrouding the corpse; they must be of new material, and may be of red, blue, white, striped, or checked, but never of *black*, calico.

In most of their funeral appointments the Nicobarese have, it appears, an unexplained preference for uneven numbers; the body must be washed *once, thrice, or five* times; it is laid on a bed or pad of the calico offerings, 30 being used for a headman, and 29 or any less uneven number for persons of minor importance; under the pad are placed 3, 5, or 7 Areca spathes, and these again are kept in position by 5, 7, or 9 swathes or bands of calico: curious-shaped pegs to the number of 7 or 9 are also used to secure the body in the grave in order to prevent its abstraction by a class of evil spirits whose energies are supposed to be directed to this end.

A practice analogous to that of barring the ghost by fire, prevails also in these islands, and a pyre is ignited with firesticks—which are only used on these occasions—at the foot of the hut where the dead is lying for the twofold purpose of keeping the disembodied spirit at a distance and apprising friends approaching or passing in a canoe of the sad occurrence.

Mourners are required to abstain from food from the time of the death until after the prescribed cleansing of the dwelling and personal ablutions and lustration by the *menlūana* or priest-medicine-man on the following day; quids of betel and sips of almost boiling water are the only refreshment permitted during the interval: a set period of abstinence is further observed which varies in duration from one to three or even four years.

There are cemeteries attached to every village, in which each family owns a certain area. The natives of the coast and inland tribes in the Southern group leave their dead undisturbed, but at Car Nicobar, Chowra, Teressa and Bompoké ossuaries are found where, after successive exhumations and re-interments, the remains are deposited. At Car Nicobar mortuary huts are kept exclusively for the reception of the dead prior to their interment, and certain sacrificial acts are performed which are of interest. Throughout the group the memory of the departed is kept alive and their manes propitiated by frequent feasts which are celebrated in their honour.

7. Notes on the Shell-Mounds and Ossuaries of the Choptank River, Maryland, U.S.A. By the Chevalier R. ELMER REYNOLDS.

This paper was accompanied by a series of stone implements and utensils typical of those found during the writer's research in the region named. Specimens of cremated and other osseous remains were also exhibited as a portion of a collection taken from a very interesting communal ossuary in Dorchester County.

Chapter I.—THE BOOK OF LIFE—contains a brief history of the Choptank and Nantëcoke tribes, which were located on the Choptank river. The history of the Choptank tribe was traced from early historic times until the present. Remnants of these people still live in the states of Maryland and Delaware.

Chapter II.—THE SHORES OF TALBAT—locates and describes the present condition of the following shell-mounds on the northern shore of the Choptank.

Oxford, at the mouth of the river; mound covers several acres of ground, with a depth varying from 1 to 3 feet. Shells much decomposed. Implements, hammers, rude axes, arrows, shards of pottery, &c.

Chloras Bay, 2 miles above; mound on shore of bay $\frac{3}{4}$ mile long, and 100 yards wide, 1 to three feet thick; anciently 8 to 14 feet high; shells removed and converted into lime for agricultural purposes. Remains of several ancient pits in which the oysters were steamed with hot stones and water.

Paleo and neo axes and celts, hammer-stones, mullers and pestles, arrows (hunting and war), spears, knives, scrapers, gorgets, fragments of ceremonial weapons, shards of pottery, &c.

Howell's Point, 2 miles above; large mound and shell-field, whose extent could not be determined as the soil was under cultivation. The greatest deposit of shells, 12 to 14 feet. A few rude paleo implements and utensils.

Roadley Manor, 3 miles above; field on eastern shore of Reid's Creek; mound nearly a mile long by 100 or 200 yards wide, greatest depth 3 or 4 feet. Shells decayed. Indian remains ploughed up. Axes of both types, celts, hammers, arrows, spears, knives, and pear-shaped pendant of serpentine and drilled net-sinker.

Bolingbroke Creek, 2 miles east; 15 or 20 acres covered with shells, greatest depth 3 feet. Paleo axes and celts, nuclei, pottery and arrows, spears, knives and scrapers of jasper. Find jasper *in situ* on the shore. Very important archaeological discovery.

Chancellor's Point, 2 miles above; ancient mound 24 feet high. Remains of Indian found buried in the shells. Polished axes, hammers, arrows, spears, knives, pottery, &c.

Goose Point, 2 miles above. Shells 1 to 3 feet deep and cover many acres. Ancient camp on top of mound. Forty years ago the circles where the Indian lodges were pitched could still be traced. Hammers, arrows, pottery, amygdaloid celts fourteen inches in length and superb double-faced polished axes.

'Ingleside.' 2 miles above. Mound short and wide on high shore. Only 1 to 3 feet remaining. Half a million of bushels removed since 1867. Hammers, arrows, pottery and superb double-faced polished axes.

Jamaica Point. 1 mile up the river. Small shell-field in peach orchard. Rude implements. Large mound (remains of) in field beyond. Shells not more than one foot deep. Implements of quartzite and rock crystal.

Outram Manor. 1 mile above. Shell-field in orchard, depth superficial. Many polished axes and arrows, spears, knives, &c., of quartzite, argillite and jasper. Find an abundance of large jasper pebbles on shore. Colour red, yellow, black and variegated. Cleavage excellent.

Bamberg. 2 miles above. 5 to 7 acres covered with shells at a depth varying from 1 to 3 feet. Oblong ungrooved axes, celts, arrows, hammers, pottery and small implements.

Cox's Farm. 1 mile above. A scattering shell-field, polished axes, nuclei, arrows, pottery and flint-chips. The oyster beds cross at this point, and no more mounds are found above. The river now becomes swampy, except at its channel on the opposite shore.

Chapter III.—THE SEPULCHRES OF DORSET.—*The Tomb of the Kings*.—Circular ossuary discovered in Cambridge while building the new jail in 1883. 16 feet in diameter and 7 feet high. Contained the remains of sixteen Indians seated on rocks, facing inward. Probably men of high rank.

Pre-Columbian Necropolis.—At Sandy Hill. Ossuary secondary, communal; remains cremated by eleven fires. Found 16 feet below the surface in the face of a cliff 70 feet high. Over the ossuary was a mound of shells and the remains of an ancient fishing camp. Depth of shells 1 foot.

Ossuary T-shaped, the horizontal bar 15 feet long, 4 feet wide, and 2 feet thick, extending parallel with the river; the upright bar 30 feet long extending rearward into the hill, the other measurements corresponding with transverse portion.

The writer exhumed all of the remains, 300 skeletons.

Crania of much ethnological value, now in possession of the Army Medical Museum.

Among many interesting pathological conditions found are the following:—

1. Cervical vert. of a child of ten years, the spinous process deflected obliquely to the left by traumatic influence.
2. The remains of a pre-natal child.
3. Several segments of the dorsal and lumbar vert. united by extra-osseous deposits. Adult, cause due to old age, disease, or injury.
4. Lower jaw of an adult who died just before being placed in the crematory fire, as shown by the warped condition of the specimen. Coronoid process deflected by heat.
5. Lower third of right femur, showing comminuted fracture, reunion of splintered bones, intraosseous abscesses, suppuration and escape of pus by nearly a dozen circular openings through the bone. Diseased conditions extended for a long time.

SATURDAY, SEPTEMBER 8.

The following Papers and Reports were read :—

1. *Marriage Customs of the New Britain Group.*
By the Rev. BENJAMIN DANKS.

For marriage purposes the people of New Britain are divided into two classes or divisions. No man may marry a woman of his own class. To do so would bring instant destruction upon the woman, and if not immediate death to the man, his life would never be secure; in fact, sexual intercourse between a man and woman of the same class is regarded in the same light as between brother and sister in a Christian community.

As, however, children are of their mother's totem, it is possible for a man to marry his niece, although there is a great repugnance to such unions among the natives.

Preparations for marriage are various. On Duke of York Island, initiation into the secret society which is called Dukduk seems a sufficient preparation (though not absolutely necessary to marriage) for the boys, and there appears to be no needful preparation for the girls.

On New Ireland some girls wear a fringe across their shoulders until they are marriageable. These are the poorer classes. Others are put into cages, in which they remain four or five years without being allowed to go outside the house in which they are confined.

These cages are conical structures about 7 or 8 feet in height, and about 10 or 12 feet in circumference at the bottom and for about 4 feet from the ground, where they taper off to a point at the top. They are made of the broad leaves of the pandanus tree, sewn quite close together so that no light and very little air can enter. On one side is an opening which is closed by a double door of plaited cocoanut tree and pandanus tree leaves. About 3 feet from the ground there is a stage of bamboos which forms the floor. There is only room for the girl to sit or lie down in a crouched position on the bamboo platform, and her feet are never allowed to touch the ground all the time she is confined in the cage. Great marriage-feasts are provided for these girls when they are taken out of the cages.

The author describes some of the customs in connection with the preparation of young men for marriage on the island of New Britain.

Wives are purchased with shell money, and are often married at a very early age. After the price has been decided and paid the girl may be taken away at once to her husband's house, or she may be allowed to remain with her friends for a considerable time.

On Duke of York Island there is generally a marriage-feast of a superior kind when persons of influence are being married. The women of the town and surrounding district prepare a large number of puddings, and many pigs are killed. Many presents are given to the bride in public, which she is expected afterwards to

return privately. A cocoanut is broken over the heads of the pair, and the milk sprinkled upon them. After this there are periodical feasts for a considerable time, the friends of the bride entertaining the friends of the bridegroom and *vice versâ*.

When a man marries a second wife after the death of the first, the female-relatives of the dead wife gather together and are permitted to do as much damage to his property as they can.

A man may have as many wives as he can purchase, but if he cannot afford to buy one, and his credit is low, he may have to remain single.

2. Totem Clans and Star Worship. By GEORGE ST. CLAIR, F.G.S.

The author defines *totem* as the crest of a clan, and enumerates briefly the features of the institution. The origin of Totemism is confessedly obscure, the latest views are unsatisfactory; the author has gathered evidence in favour of a new view, and asks to be heard.

Beginning with a small community which has its camp to guard, and perhaps its religious tabernacle, let us suppose that the eldest son of every mother is liable to military service. The camp is divided, say into four quarters, and the young men serve in turn for a fourth part of the year. In larger tribes the division may be into twelve, the year being already divided into months. The religion of the tribe is astral, like that of the ancient Chaldeans, and the watchers know what constellation is uppermost in the first month, and which in the second month, and so on. If the first band finds the Bull Constellation in high heaven in the dead of night, during its month, it will reverence the Bull; the young men will return to their tents at the month's end and speak of the Bull; they will remember that when the Bull is in the ascendant again they will have to do duty again; and they will come to be known as the Bulls. For the like reason others become goats and scorpions, or kangaroos and blacksnakes, according to the names of the star groups with different peoples.

The Bulls tattoo themselves with the bull crest, and carry it as a military ensign. The goats, the kangaroos, &c., do the like.

The Bull Constellation, or the Bull's-eye Star Aldebaran, is the special god of the clan, and is to be revered. The bull quadruped becomes the earthly representative of the starry deity, and is not to be used as food.

The members of the Bull clan being now known as the Bulls, or designated by the equivalent expression, 'Sons of the Bull,' the Bull is said to be their father; the father of the clan, their great ancestor.

But no sooner is the original tribe thus divided into twelve clans than the danger of disruption is perceived, and to counteract it, the rule or custom of exogamy is introduced.

The author meets the preliminary objection that barbarous tribes would not be advanced enough to frame a religious system upon an astronomical basis; and then proceeds to adduce evidence in support of every step of the process. He finds, in reviewing the number of clans in a tribe, a preponderance of the number four corresponding to the quarters of the year, and the number twelve corresponding to the months, during which service would be performed by the clans in rotation. He shows it to be a natural arrangement that totem clans should be found localised in nomes or districts. The curious connection between totemism and the transmigration of souls is explained by the Egyptian belief that the soul, after death, goes the way of the sun, and consequently passes through the zodiacal constellations one after another, and becomes identified with each in turn.

This stellar origin of totemism goes far to account for the widespread character of the institution. Measures for self-defence would be adopted instinctively by all tribes. The heavens are spread before all, and the moon everywhere divides the year into months.

If the theory be true, it not only explains things which have appeared mysterious, but it indicates fresh lines of inquiry. These are briefly specified in the paper.

3. *The Survival of Corporal Penance.* By OSBERT H. HOWARTH.

The author exhibited specimens of the 'disciplinas' or scourges, the use of which, by way of public penance, still survives in the village of Fenâes d'Ajuda, a remote community on the north coast of St. Michael's, Azores. It is presumably a practice which has been continued in this place without interruption since the first colonisation of the islands by the Portuguese in the Middle Ages, and is still exercised with such extreme severity as occasionally to result in death. The features of the belief associated with self-flagellation are peculiar to the place, and to some extent inconsistent with the teaching of the Roman Catholic Church in modern times. They therefore constitute another evidence that, whereas the public exhibition of this penance was repeatedly suppressed in Europe, even during early times, it has escaped attention and been perpetuated in this one instance up to the present year, when, in consequence of the attention recently drawn to it, steps have been taken by the local authority to ensure its extinction.

4. *Notes on Chest-types.* By Dr. G. W. HAMBLETON.

The observations of another year have completely confirmed the research laid before the Section at the Manchester meeting. It has been found very easy to obtain the best type of chest in young people. But anthropologists will be surprised to learn that the type of chest can, with care, be changed in the same direction in mature age. This the author has seen in the case of a diseased chest in a gentleman aged 37. Between the ages of 25 and 33 he has frequently obtained similar results. Here then are facts showing the direct power of the surroundings in making types.

5. *Third Report of the Committee for investigating the Prehistoric Race in the Greek Islands.*—See Reports, p. 99.

6. *Fourth Report of the Committee for investigating and publishing reports on the physical characters, languages, and industrial and social condition of the North-Western Tribes of the Dominion of Canada.*—See Reports, p. 233.

MONDAY, SEPTEMBER 10.

The following Papers were read:—

1. *Necklaces in relation to Prehistoric Commerce.*
By Miss A. W. BUCKLAND.

The object of this paper is to trace the geographical distribution of various forms of necklaces and beads, as indicating some sort of commercial intercourse between the races among whom they are found either in present use, or among the relics of the past.

Among the ancient cave-dwellers of Europe, teeth of men and animals, bored for suspension and intermixed with shells and pieces of bone, were used as necklaces, and similar necklaces are still worn by savages in almost all parts of the world; but in the Andaman Islands necklaces are made of pieces of human bone, and of bones of animals, not bored, but bound to cords, and wood is sometimes made to imitate bone. The same singular substitution exists in the Admiralty Islands, where also human bones are used as neck ornaments. Necklaces formed of discs of white, purple, and red shell, cut with much care and labour from large sea-shells, are used by natives all over America and across the various groups of the Pacific to Japan,

China, and India, where they are worn by the Nagas. These shell discs, known in America as Wampum, form the money of the Red Indians, and are also used as money by the Solomon Islanders. Similar shell discs are found in ancient graves, not only in America, but in Europe; whilst in Africa, ostrich egg-shell discs of the same size and threaded in the same manner, with pieces of skin substituted for the dark shell, are made and worn by Bushmen, Niam-Niams, and other wild tribes in the interior. Similar ostrich egg-shell discs are found in ancient Egyptian and Etruscan tombs, showing prehistoric intercourse between Etruria and Egypt, or the interior of Africa.

The pendants accompanying these necklaces are almost always teeth or shells cut in the form of teeth. The beads used for necklaces and found among ancient relics are of various substances, such as bone, serpentine, gold, silver, bronze, tin and glass, and are often made so as to represent several discs or beads joined together. Beads of this kind are found in the Swiss Lake dwellings, in Spain, in Britain, in Hissarlik and Mycenæ, and of a later date in Livonia and Abyssinia.

Beads of amber, which formed such an important article of commerce in prehistoric times, are found among relics of the Stone Age, and have also been discovered in tombs belonging to the Bronze Age, in all parts of Europe, in Egypt and India, several trade routes being known, whereby amber found its way from the Baltic to the Mediterranean. Of glass beads the most remarkable are those known as adder's stones, still used as a charm to cure cattle diseases. Beads of this kind of one particular pattern known as chevron beads have been found in various parts of Europe, in Great Britain, in Egypt, in the Pelew Islands, and also in ancient graves in Canada and Peru. Similar glass beads are dug up in Ashantee and highly valued, forming part of the Royal jewels. Beads of the same shape, and from the markings upon them, probably of the same kind, appear adorning the necks of monarchs on the sculptured slabs brought by Layard from Assyria.

There is also a melon-shaped bead of various materials, very widely distributed, being found in ancient graves in Mexico, as well as in Assyria and all over Europe.

Many peculiar glass beads are found in Ireland, resembling those of Egypt and Greece, although perhaps of native manufacture copied from older types, and it may be fairly said that the history of necklaces is the history of commercial intercourse both in prehistoric and in modern times.

2. *The Definition of a Nation.* By J. PARK HARRISON, M.A.

The frequent misuse of the terms 'Nation' and 'Nationality' at the present day appears to be due to the idea that race and language are involved in the definition. This is not the case, excepting in the primary and archaic sense of the word. Johnson's definition is simply 'a distinct people: a kingdom,' but the best definition is that given in the dictionary of the French Academy, viz.—'The *whole* population born or naturalised in a country, and living under the same Government'—irrespective of race and language.

3. *Sun-myths in Modern Hellas.* By J. THEODORE BENT.

The personification of the Sun amongst the peasants of modern Greece compares well with the legends of classical times; his beauty, power, and strength endow him with regal attributes, and he is supposed at night-time to seek his kingdom and live in a palace where his mother tends upon him. We have also the Sun's wife and the Sun's daughter, and can compare the Macedonian legend of Heliojenni with the Homeric myths of Perse and her children Circe and Aietes. The Sun, as messenger, may be compared with the words of the dying Ajax.

The connection between Sun worship and that of the Prophet Elias is very marked in modern Greece. Elias looks after rain, and is the Greek St. Swithin. Churches to him are always found on sites of ancient temples to Apollo. The Macedonian ceremony of Perperouna is referred to, and its connection with other

prayers for rain offered up to St. Elias. In a MS. from Lesbos this idea of union between St. Elias and a power over the elements is clearly shown. Taygetus in Laconia shows too the same connection.

There is a connection between Sun worship and St. George; the *kápa* fires are lit on his day, and the connection is noticeable not only in the islands, but in Macedonia, where a curious swing ceremony is performed on St. George's Day, in honour of the Sun's bride having been swung up to heaven on that day. Also, there is a close connection between St. George and St. John, the universal day for lighting fires on the eve of the summer solstice.

4. *The Ancient Inhabitants of the Canary Islands.*

By J. HARRIS STONE, M.A., F.L.S., F.C.S.

The author stated that the name *Guanche*, though generally used for the old inhabitants of all the seven islands of the Canary group, should properly be only applied to the ancient inhabitants of Teneriffe. The ancient inhabitants of these islands were ignorant of the use of metals, and up to 1402, when the conquest first began, had to all practical intents remained apart from the civilisation of that day. They were a branch of the great Berber race, and probably also a tribe of that white dolicho-cephalic race of cromlech builders which at a very early period swept through Europe. Their connection with the ancient Egyptians was noticeable in many traits and customs. The ornamentations in caves and on pottery which the author had come across in his travels in each island of the archipelago were Egyptian in character. The method of embalming the dead, particularly the practice of removing the entrails by a slit made with the *tabona*, and the wrappings of the corpse, was very similar to that employed by the lower class of Egyptian embalmers. Though the ancient inhabitants of all the islands had so much in common, there were so many specific differences in their languages, manners and customs, that the conclusion was almost forced upon the investigator that they must originally have been peopled by more than one tribe of the same race.

The author had examined a large number of skulls in collections in the islands, and found them very European in contour and general appearance. In a large proportion of those in the collections in the islands he had noticed a peculiar indentation in the frontal bone, usually the left, and to his surprise found that of the twenty-six skulls at the Royal College of Surgeons, no less than fifteen possessed this mark, and of these ten on the left frontal bone.

The ancient inhabitants are now quite extinct as a separate race, but the author in his travels had noticed several traits, manners, and customs of the present inhabitants which were clearly, in his opinion, derived from the old race. The food *gofio* and its method of making and eating; the number of cave dwellings and villages; the still prevalent inter-insular jealousy; the size and great physique of the men of the *Purpurariæ*; the confiding, generous, hospitable character of the *Conejeros*; the use of the vaulting pole; the general absence of bigotry and religious intolerance; the preference to this day of the *Gomeros* to carry baggage on the head; the abomination of butchers; the torchlight fishing; the method of laying-out the dead; the wit of the *Palmeros*; the cleverness with which buildings are constructed with stones without mortar; the honesty of the *Canarios*; the unusual beauty of the peasant women, were points alluded to by the author in illustration of his assertion.

The position of women was considered at some length, the author bringing forward many facts to show that they held a far higher position in the social scale than was usual among ancient nations.

5. *Some Account of the Ancient (præ-Roman) Stronghold of Worlebury, near Weston-super-Mare.* By the Rev. HENRY GEORGE TOMKINS.

Worlebury belongs to a small and highly interesting class of so-called 'British' camps, and in some respects is believed to be unique in England. It has been

minutely described and illustrated by Mr. C. W. Dymond, F.S.A., and the author of this paper, in a work privately printed in 1886, entitled 'Worlebury: an Ancient Stronghold in the County of Somerset,' &c., 4to, with plans and plates. The following account will take principal notice of the rarer features.

1. *Situation*.—On the seaward end of a mountain-limestone ridge running east and west above the town of Weston-super-Mare, Somerset, which lies south of the hill. The ridge, precipitous on the north, slopes away to the south, where many British traces—earthworks, interments, &c.—have been found. The whole hill is about three miles long.

2. *Approaches*.—A gradually ascending oblique way on the south side, entering near the east, and highest, end of the works. An ancient ascent of stone steps leads up on the north side of the hill above Kewstoke, a mile east of the external cattle-enclosure of the camp. Thence the approach is level.

3. *Defensive Works*.—Of very unusual construction. The principal ramparts of dry limestone masonry, complex in structure. A wall built with heart of dry rubble; then on each side lower walls in contact with the central one, the section showing steps or terraces; at the thickest part five or six such walls, forming one very massive work of solid stonework, without mortar and without tool-marks.

Subordinate works, and dry ditches.

Suggestion of stockades considered.

Mr. Dymond's inquiry into analogous works in Wales.

4. *Entrances*.—West, south, north-east.

5. *Pits*, their formation and contents. Some analogous examples. Pottery, weapons, and other relics: stores of corn, &c. Skeletons and detached bones. Remains of animals used for food.

6. *Professor Macalister's report on the skulls*.

7. *General results of inquiry*, and inferences as to the works and the relics.

6. *Celtic Earthworks in Hampshire, in reference to the Density of the Celtic Population.* By T. W. SHORE, F.G.S., F.C.S.

The remains of Celtic earthworks in Hampshire, as in some other English counties, are numerous, as many as forty remaining in a state of preservation more or less complete, and others formerly existed. They are of various kinds and shapes, and where they enclose areas and form the so-called camps they are of very different dimensions. Most of them are hill fortresses, but there are also marsh and peninsular fortresses, and one example exists of a small former insular refuge. The present surroundings of these earthworks are of service in assisting to determine their original uses, for although the woodland features may be changed, the variations in hill and dale, and the geological conditions connected with the dry chalk hills, the chalk streams, and the alluvial meadow-land through which they flow, are the same as in Celtic time.

The camps could scarcely have been permanently inhabited sites, for in Hampshire at least few traces of dwellings, or of articles of domestic use, have been found within them, from which and other circumstances it appears that these untrenched areas were strongholds for defence in case of attack. If this is allowed, then these areas must have had a distinct relationship to the number of people required for their defence and to the population, and their capital or head of cattle, they were intended to shelter. No Celtic or other village community or aggregation of such communities would be likely to construct defensive earthworks larger than their powers of defence; otherwise these works would be a source of weakness. If these considerations are allowed, some approximately accurate inferences concerning the relative density, and perhaps concerning the absolute density, of the Celtic population within reach of the shelter of these camps, may be drawn from their positions and the extent of their intrenchment and areas.

The largest Hampshire camps are placed where large open areas must have existed, and the smallest are forest forts at the present day.

The water supply of the hill fortresses would probably be by dew or cloud

ponds, similar to those which exist in or near them at the present time, and are sufficient for the daily supply of water even in summer for large flocks of sheep. Some of these hill camp sites are capped with the Tertiary debris known as clay with flints resting on chalk, so that as many dew-ponds as might be necessary could be formed.

Walbury, the largest Hampshire earthwork at the north-west corner of the county, is 550 yards from north to south, and 783 yards from east to west, is covered with some clay with flints, and overlooks the Kennet Valley. The people for whom it was a place of refuge must have lived on the northern as well as on the southern side of it. The naturally great open areas of land near it show that a large population could have lived within reach of it, and its great extent shows that it could have afforded shelter for some thousands of people and cattle. From these circumstances and the implements of the later stone period found in and near it, the author thinks that a relatively large population lived round Walbury in Neolithic time. He thinks this population was considerably larger round Walbury than round St. Catherine's Hill, Winchester, because the earthwork at Walbury is much larger than that on St. Catherine's Hill.

There are in the valley of the Test and of its branch, the Micheldever stream, five earthworks, situated at nearly the same distances apart, all of them of about the same size, and having near them areas of open downland and alluvial meadow land, not very dissimilar in extent. From these circumstances the author of the paper considers that the populations living within reach of these earthworks were numerically about the same, and much smaller than the population round Walbury, which is so much greater in area and the extent of its intrenchment.

The peninsular earthwork of Bransbury, at the junction of the Test with the Micheldever stream, is one of much interest, defended by the marshes and by a single line of intrenchment from marsh to marsh. The author is of opinion that Bransbury must have served as a stronghold for a population sufficiently numerous at least to have been able to defend the line of the earthwork.

The author has met with no evidence in Hampshire of the Anglo-Saxon extermination of their Celtic predecessors, but, on the contrary, that county contains evidence in support of the opposite view, viz., that a considerable proportion of the Celts was spared and became blended with the West Saxons. Some early village communities living within easy reach of hill fortresses of defence appear to have continued in a modified condition in early Anglo-Saxon time, that at Burghclere being one, a place which has undoubtedly derived its name from two Celtic earthworks on high hills, having remains of communal fields close to them, and much black earth from a former inhabited site in a valley near them. These earthworks are not far from the 'Seven Barrows' of North Hampshire. A valley which is the only natural pass between the hills for many miles lies between them, and Clere was a tall place as late as the time of the Domesday Survey. A relatively large population, sufficient to defend these earthworks, must have lived in the Clere district, a very ancient clearing in forest land.

The author considers the alodial tax known as *Burh-bote* in Anglo-Saxon time to be an intelligible tax when considered in reference to such a place as Burghclere. Many such alodial obligations existed in the Isle of Wight as late as the date of the Domesday Survey, and appear to have had as early an origin as the earliest fortification at Carisbrook, by the common defence of which the land in the Isle of Wight was long afterwards held. As land gradually ceased to be held in community and became held in severalty, the obligations of local defence would remain as an alodial obligation.

The author considers the measure of the Celtic earthworks to be a measure of the Celtic populations, and to indicate approximately the density of such populations around these fortresses.

TUESDAY, SEPTEMBER 11.

The following Papers were read:—

1. *The Monument known as 'King Orry's Grave' compared with Tumuli in Gloucestershire.* By Miss A. W. BUCKLAND.

The monument known as 'King Orry's Grave,' in the Isle of Man, belongs to the Chambered Long Barrows, described by Thurnam, which are found chiefly in Gloucestershire and Wiltshire, and are always regarded as the earliest of our monuments, being assigned by all antiquaries to the neolithic age.

The points common to all these barrows are the long, somewhat ovate shape of the covering mound, the rudely arched principal chamber, and of the passage leading to it, generally pointing east and west, and the square form of the enclosed chambers. All these are found in 'King Orry's Grave,' which has in addition a singular form of entrance to the principal chamber, of which only a few instances are known. This consists of an elliptical opening cut in two large stones, forming an egg-shaped aperture through which it is possible to creep.

Thurnam supposed that this opening was made to facilitate fresh burials from time to time, but, as in the majority of these long-chambered tumuli, the entrance is through an arch formed of three stones, and in all cases the entrance is carefully covered up and concealed, Miss Buckland suggests that in the case of these ovate openings the burials were probably those of priests, and that the elaborately cut opening symbolised the doctrine of the new birth, of which the egg was, and still is, typical, and which was taught alike by Indian Brahmins, Egyptian priests, and the mystical Druids. The only known openings to tumuli similar to that of 'King Orry's Grave' are three in Gloucestershire, at Rodmarton, Avening, and Leighterton, one in Brittany, and two, the Men-an-Tol, in Cornwall, and that at the Museum of St. Germain, Paris; but in the Men-an-Tol the hole is cut in a single stone. 'King Orry's Grave' has one especial feature—that of a tall monolith, ten feet in height, rising from the mound; whilst in plan it appears to resemble the one at Mané Lud, Brittany, and one at West Kennet, Wiltshire. But according to the description of Oswald it had originally a circle at one end and a crescent at the other, suggestive of sun and moon worship.

In many of the Gloucestershire long barrows cleft skulls have been found, and, from the account given of a similar skull having been found with a skeleton and the bones of a dog buried in the ruins of Peel Cathedral, Miss Buckland suggests that this skeleton may have come originally from one of the chambered tumuli in the island, of which two at least are mentioned besides 'King Orry's Grave,' which is the best known. Thurnam assigns the Gloucestershire tumuli to the Dobuni, but it is evident that the same people built these in the Isle of Man, and the question arises whether they came originally from Gloucestershire through Wales, or from Brittany.

2. *Observations made in the Anthropometric Laboratory at Manchester.*

By GEORGE W. BLOXAM, M.A., and J. G. GARSON, M.D.

Two hundred persons had been examined, of whom 102 were men and 98 women. The average age of the men was 41·7 years, while that of the women was 32·1 years.

There was a marked difference in both sexes between the power of the two eyes.

One case only of absolute colour-blindness had been observed, the subject being a Jew.

The average height of the men was rather more than 68 inches, that of the women about four inches less. The weight averaged 150 lbs. for the men, and some 25 lbs. less for the women.

There was an enormous difference between the chest capacity of the men and that of the women, which could only be accounted for by the female practice of wearing corsets.

3. *On the Early Races of Western Asia.* By Major C. R. CONDER, R.E.

The students of Aryan and Semitic antiquity have found themselves confronted for the last forty years in Western Asia, in Greece, and Italy, by languages and racial types neither Aryan nor Semitic, and showing races whose civilisation is earlier. In three cases these languages are found to be Turanian (in the more limited meaning of the word), viz. Akkadian, Medic, and Etruscan. As regards these languages the study of Akkadian, as it existed about 3000 B.C., shows a grammar nearest to that of Turkic languages and even of the Manchu Tartars, and a vocabulary which has been in great measure recovered, though in part still doubtful, and which, while comparable with Finnic and Ugrian languages, is yet nearest to the Turkic. The language of the Medes known from the inscriptions of Darius, about 500 B.C., has a similar but more advanced grammar, and a vocabulary held by Oppert and others to be nearest the Turkic. The Etruscan, of which the numerals were shown by Dr. Isaac Taylor in 1874 to be Turanian, is also found to compare in grammar and vocabulary with the Akkadian.

The question now raised is whether the early population of Asia Minor and Syria, of which traces are recoverable from various sources, did not belong to the same stock. In Asia Minor, Lenormant believed a Turanian stock to have existed very early, and in Syria this was the belief of the late Dr. Birch, and has been urged by Captain Conder from 1883 onwards.

(1) *As regards Syria.*—The names of towns and persons are recoverable from Egyptian monuments and papyri in 1600 and 1340 B.C. In the south these are mainly Semitic. In the north the country of the Phœnicians and Kheta gives us 200 town names and 20 royal names which are neither Semitic nor Aryan. Comparing these words with Akkadian, and with the living Turkic and Ugrian languages, the author finds that the translation is suitable. Among the personal words, *Tar*, *Sar*, *Lul*, *Nazi*, *Essebu* and *Tarkun* are the most distinctive, and among geographical terms *Tami*, 'building,' *Su*, 'river,' *Tep*, 'hill,' and others are distinctive of the Turkic dialects. From these words it is fairly safe to conclude that a Turanian population inhabited Syria in the earliest historic times akin to the Turks and Turkomans still found in the same region.

In Northern Syria also certain hieroglyphic inscriptions of a very archaic kind are found, which, by general consent of archæologists, have been attributed to the same race; and, by the same general consent, the hieratic character derived from these hieroglyphics is recognisable in the later syllabary generally known as Cypriote or Asianic. This connection was first discovered by Professor Sayce. The author has proposed to treat these syllables as representing Turkic words, and by this means to recover the sounds of the original hieroglyphics of Northern Syria. He finds that by this method it is possible to read the short bi-lingual known as the 'Boss of Tarkondemos.' The words *Ma* and *Ku*, for 'country' and 'king,' which he thus recovered in 1887, though questioned by Dr. Sayce as not being Akkadian, are admitted by other authorities to belong to that language and are widely-spread Turanian words.

The evidence of physiognomy, dress, and religious customs among the Kheta, or Hittites, points to the same conclusion. Their type of face is recognised to be Tartaric or Mongolian, and their adoration of the sun, moon, mountains, clouds, rivers, and the sea is similar to the beliefs of other Turanian peoples, as is their practice of exogamy mentioned in the Bible.

The author further points out that the Kara Khitai, or 'black Khitans,' of Eastern Turkestan—an important people in Central Asia as early as the time of the geographer Ptolemy—possessed a name identical with that of the Kheta. Their language is similar in many words to Akkadian, their religious beliefs and warlike customs resembled those of the Kheta. The pigtailed found to be worn by the latter are also of Tartar origin in China.

(2) *Asia Minor*.—The early 'barbarian' population of Asia Minor is stated by the ancients to have been akin to the Etruscan race. In various parts of Asia Minor hieroglyphics like those of the Hittites are found, and cylinders used as amulets, not unlike the Akkadian cylinders, occur in this region, which have similar hieroglyphic emblems. The syllabary above mentioned as Asianic also exists in these regions, and in the island of Lemnos a text recently discovered proves to be written in a language and character closely similar to the Etruscan. A few words of the Lydian and Carian languages have also come down to us, and among these the author has recognised important Turkic words, such, for instance, as the Carian *Taba* for a 'rock,' and the Lydian *Lailas*, 'tyrant.' The ancient nomenclature of Asia Minor seems to indicate the same connection, as do also the Carian personal names. As an instance, the river Sangarius may be compared with the river Sangari in Manchuria, being one out of many coincidences.

The only alternative to the supposition that a Turkic population once spread over Mesopotamia, Syria, and Asia Minor, is the supposition that these tribes, or some of them, belonged to the Lesghic group in the Caucasus, to which Lenormant proposed to refer the ancient Vannic population. The reason why the author has not accepted this supposition is that the study of this group of languages, though long since proposed, has not led to any satisfactory result, or enabled any student to interpret the sounds of the various languages of Syria and Asia Minor above noticed, or those of the Syrian hieroglyphics, in the manner in which they can be interpreted through the use of the Tartar or Ugrian languages.

The author appends a list of 100 Hittite words recovered from the monuments and compared with Turanian words, and other short lists of Carian, Lydian, Phrygian, and Scythian words of the same class.

4. *Discoveries in Asia Minor.* By J. THEODORE BENT.

During a cruise along the south coast of Asia Minor the author found the sites of three ancient towns and identified them by inscriptions. One in Caria, near a curious little harbour, which apparently was called Kasarea in antiquity, is alluded to by Ptolemy and Pliny as *Κρησσα λιμήν*. Near the mouth of the gulf of Makri, the ancient Telmessus, we found in a hollow basin, surrounded by mountains, the ruins of a town called Lydæ, also incidentally mentioned by Ptolemy, but hitherto undiscovered. Here amongst other remains we found 33 inscriptions, many of them of great local interest, introducing us to a doctor, Aristobulus by name, mentioned by Galen, and to numerous consuls and pro-consuls of Rome who ruled here, and whose names appear in 'Waddington's *Fastes Asiatiques*.' Local offices and dignitaries, family names and customs are referred to on all these inscriptions. About five miles from Lydæ, inland, we came across other ruins—a fortress buried in a thick forest overlooking a lake; and from inscriptions we identified this place as Lissa, but it does not occur in the lists of Lycian towns given by any ancient or modern geographer. At various other known sites we found inscriptions which have not been published.

5. *Notes on the Hyksôs, or Shepherd-Kings of Egypt.*

By the Rev. HENRY GEORGE TOMKINS.

Some accounts of the sources of information on this subject. Chaldæa compared with lower Egypt. Two great streams of migration. Maspero's view of the conquest of Egypt. Forerunners of the Hyksôs. The hordes distinguished from their rulers. Mariette's opinion.

A sketch of the inferences to be derived from:—

(A.) Proper names of the Hyksôs; (B.) Characteristics of their statuary; (C.) Their religion.

- A. 1. Salatis (or Saïtes), compared with Set-Shalit as read on a statue.
2. Bnôn. 3. Pachnan. 4. Apophis, on sphinxes of Sâh and else-

where. Apepi Râ-âa-us, and Apepi Râ-âa-qenen (or -ab-tai). 5. Iannas; Râ-ian or Khian of the Bubastis fragment. His throne-name found on the lion of Baghdad. 6. Staân, Set-an, or An-set, Inferences:

- B. Statuary ascribed to the Hyksôs. Sphinxes of Sâh. Statue from the Fyûm. Ludovisi head. Statuette of the Louvre. Head of Apepi, and throne and legs of Râ-ian or Khian at Bubastis. Characteristics and probable affinity of these works.
- C. Sketch of ascertained points with regard to Set or Sutekh, the god of the Hyksôs and Kheta, and the religious war which ended in the expulsion of the Shepherd-Kings.

Sketch of the struggle between the Theban kings and the Hyksôs; the death of Râ-skenen-ta-âa-qen in battle; the conclusive victory of Aahmes and pursuit of the enemy into Palestine; campaigns of successive Pharaohs of the great eighteenth dynasty, and monumental evidences of Egyptian conquest in Mesopotamia and the Overlordship of Babylonia, including some account of the lately-discovered cuneiform tablets of Tel-el-Amarna.

The retrospective value of these historical and geographical materials in regard to the Hyksôs, their rulers, and what became of them.

The probable relation of these things to the narratives of the Old Testament.

6. *Pelasgians, Etruscans, and Iberians; their relations to the Founders of the Chaldean and Egyptian Civilisations.* By J. S. STUART GLENNIE, M.A.

In the author's paper on 'The Archaian (non-Semitic and non-Aryan) White Races, and their part in the History of Civilisation,' read at the last Manchester Meeting of the British Association, an attempt was made to show that the first civilisations of Chaldea and of Egypt were founded by the action on Dark Races of White Races, neither Aryan nor Semitic; and that the combined results of a great variety of recent researches show that such White Races are an important, and hitherto quite inadequately recognised, element in the ethnology of Asia and of Polynesia, of Africa, of Europe, and of America. It was affirmed, but only very partially proved, that not only in Chaldea and in Egypt, but throughout the world, the civilisations of Semites and of Aryans have been founded on civilisations initiated by some one of these non-Aryan and non-Semitic, or Archaian, White Races. And it is proposed in this paper more fully to prove this proposition with respect to European civilisation, or, in other words, to point out the relations of the pre-Aryan Pelasgians, Etruscans, and Iberians, to the non-Semitic and non-Aryan Stock of White Races to which the founders of the Chaldean and Egyptian civilisations belonged.

It is assumed that we have now sufficient grounds for definitively identifying the Pelasgians and Etruscans with the Pelesta (or Pulista) and Tuirsha of the Egyptian monuments of 1300 B.C., and perhaps also with the Hanebu, or peoples of the North, of 2500 B.C. And the attempt is made to show that, if the Pelesta and Tuirsha, and the peoples either directly or indirectly associated with them, cannot be directly connected with the founders of either the Chaldean or the Egyptian civilisation, yet they belonged, like the initiators of these civilisations, to the non-Semitic and non-Aryan stock of White Races, and the Pelesta, perhaps, even to the Chaldean branch of that stock; and that the appearance of these Northern peoples in the Mediterranean may be connected with that upbreak of the Old Chaldean Empire, and that beginning of the predominance of the Semites of which the first evidence is found in the Kingship of Sargon I. 3800 B.C. The facts are likewise stated which appear to connect the Iberians of Western Europe, from Spain to Scotland, both with the Libyans, or non-Semitic and non-Aryan White Races of Northern Africa, and with the similar White Races of the Caucasus through the evidences of their former settlements in Asia Minor, and otherwise.

The great aim of this, and of connected papers, is, by proof of ethnological relations, to confirm and extend those results of later research which connect

European origins with the civilisations of Western Asia. Hence, the facts having been pointed out that appear to establish the above-indicated ethnological conclusions, some illustrations will be given of the light that may be thrown on the mythologies, traditions, and folk-lore, not only of Greece and of Rome, but also of Western Europe, by thus connecting the Pelasgians, Etruscans, and Iberians with that stock of non-Semitic and non-Aryan White Races to which belonged the founders of the Chaldean and Egyptian civilisations. Hitherto resemblances of the gods, institutions, &c., of different peoples have been ordinarily explained by some theory of 'borrowing.' But the general result of this paper is to show that the resemblances attributed to 'borrowing' are more truly to be attributed to racial immixture. And finally it will be pointed out that the general proof of definite relations between races and civilisations will be an important step towards establishing the laws of man's history.

APPENDIX.

A List of Works referring to British Mineral and Thermal Waters. By W. H. DALTON, F.G.S.

[A communication ordered by the General Committee to be printed *in extenso* in the Report.]

THE following list of some 740 works bearing upon mineral and thermal springs within the area of the British Isles is an extension of one compiled by Mr. Whitaker some years since, and placed by him at my disposal. It included only England and Wales, and I have endeavoured to render it a complete record of the literature of the subject, but have been compelled to take many titles at second hand, verification with the originals being often impracticable. For this reason also the magnitude of independent works is indicated in but very few instances.

I had purposed adding an index of localities, but that this would be too incomplete to be really useful is manifest from the consideration that many titles cover large areas and do not name places fully described in the text.

A similar bibliography of the mineral and thermal springs of the world at large is in preparation, and the manuscript will be at the service of any scientific body or individual willing to publish the whole or any geographical section thereof.

Notification of any omissions will be gratefully accepted.

My best thanks are due to my friends Messrs. G. J. Symons and W. C. Hazlitt and to my former colleagues, Messrs. W. Whitaker and H. B. Woodward, for their numerous and valuable additions and emendations.

ABEL, F. A. On the Composition of Water obtained from the Coal Strata, Bradford Moor, Yorkshire. *Phil. Mag.* ser. 3, vol. xix, pp. 330, 331 [1860].

ABEL, F. A., and THOS. H. ROWNEY. On the Mineral Waters of Cheltenham. *Journ. Chem. Soc.* vol. i, pp. 193-212 [1849]; *Rep. B. Chem. Coll.* 1849, pp. 13-32; *Ann. Chem. Pharm.* bd. lxxix, pp. 246-255 [1849].

ACCUM, F. Analysis of the lately-discovered Mineral Waters at Cheltenham; and also of other Medicinal Springs in its Neighbourhood. *Phil. Mag.* vol. xxxi, pp. 14-28, 81-93, 208-213; vol. xxxii, pp. 57-62 [1808]; and separately, 8vo. London, 1808.

— Analysis of the Chalybeate Spring at Thetford. *Phil. Mag.* vol. liii, pp. 359-365 [1819].

— A Guide to the Chalybeate Spring of Thetford. Pp. 159. 12mo. London, 1819.

ADAM, W. Matlock Bath and its Vicinity.

- ADDISON, W. On the Nature and Properties of the Malvern Water, &c. Pp. 192. 8vo. *London*, 1828.
- AINSWORTH, W. The Scarborough Guide (General Account of Scarborough Spaw Waters, by Dr. W. BELCOMBE). Ed. iii, 16mo. *York*, 1806. Ed. v, 16mo. *Scarborough*, 1812.
- ALDERSON, RALPH. Chemical Analysis and Medical Treatise on the Shap Spaw in Westmoreland. 8vo. *Kendal*, 1825.
- Analysis of Shap Spaw. 8vo. *Kendal*, 1828.
- ALEXANDER, W. Directions for the use of Harrowgate Waters. 8vo. *Edinburgh*, 1773.
- Treatise on the various modes of Bathing, with Analyses of the Mineral Springs of Scarborough. 8vo. 1832.
- ALEXANDER, Dr. W. H. The Horley Green Mineral Water: its new chemical analysis and medical uses. 8vo. *London*, 1840.
- On the Mineral Springs of the Parish of Halifax, geologically considered. *Proc. Geol. Soc. W. Riding Yorkshire*, vol. i, pp. 148–170 [1841].
- ALLEN, B. The Natural History of the Chalybeat and Purging Waters of England. . . . To which are added, Some Observations on the Bath Waters of Somersetshire. 8vo. *London*, 1699. New edition under the title ‘The Natural History of the Mineral Waters of Great Britain.’ 8vo. *London*, 1711.
- ALTHAUS, J. On the Temperature of Mineral Waters. *Edinb. Med. Journ.* vol. vii, pp. 637–641 [1862].
- On Carbonic Acid in Mineral Waters. *Dublin Quart. Journ. Med. Sci.* vol. xxxiii, pp. 75–81 [1862].
- AMES, RICHARD. Islington Wells; or, The Threepenny Academy. A Poem. Pp. 12. 4to. *London*, 1691.
- ANDERSON, Dr. P. Colde Spring of Kinghorne Craig: his admirable and new-tryed properties so far forth as are yet found true by experience. 4to. *Edinburgh*, 1618.
- ANDREE, J. An Account of the Tilbury Water, containing a narrative of the medicinal qualities of this Spring, &c. 8vo. *London*, 1737, 1740, 1764, 1781.
- ANDREWS, Dr. Analysis of the Sulphur Well, Ballynahinch Spa. *Proc. Belfast Nat. Hist. Soc.* Session 1874–75, pp. 86, 87; *Chem. News*, vol. xxxii, p. 65 [1875].
- APJOHN, J. The Spas of Lisdoonvarna, with a report and analysis thereon. Pp. 27. 8vo. *Dublin*, 1856.
- ARBUTHNOT, J. An Historical Account of Peterhead; comprehending its Mineral Wells, &c. 8vo. *Aberdeen*, 1815.
- ARDEN, Dr. J. Treatise on the Saline Springs at Moira, near Ashby-de-la-Zouch. 12mo. *Burton-on-Trent*, 1817.
- ARMSTRONG, JOHN. Practical Illustrations of the Scarlet Fever. . . . Efficacy of Sulphureous Waters in various Complaints. 8vo. *London*, 1818. Ed. ii, 8vo. *London*, 1818.
- ARMSTRONG, W. An Account of Tapping and Closing the Spring of Hot Water, at Mr. Pinch’s Brewery, Bath. 8vo. *Bristol*, 1838.
- ATKINS, J. A Compendious Treatise on the Contents. . . . of Cold and Hot Mineral Springs in general, particularly the celebrated hot waters of Scarborough. 8vo. *London*, 1737.
- ATKINS, JOHN. Treatise on the Scarborough Waters in the ‘Scarborough Miscellany,’ 1832–4.

- ATFIELD, Prof. J. Analysis of the Bath Water.
- AUBRY —. Part of a Letter concerning a Medicated Spring in Glamorgan-shire. *Phil. Trans.* vol. xix (No. 233), p. 727 [1697].
- BABINGTON, Dr. W. Analysis of the Medicinal Waters at Tunbridge Wells. 8vo. *London*, 1792.
- BACCIUS, ANDREAS. De Thermis notabilibus. *Rome*, 1595.
- BAILEY H. W. A Letter to the Committee of the Thetford Mineral Spring Company, with the First Report, &c. 12mo. *Thetford*.
- BAILEY, Dr. WALTER. A Discourse of certain Baths or Medicinal Waters in the County of Warwick, near Newnam Regis. 8vo. *London*, 1587.
- BAINBRIDGE, W. H. Remarks on the Droitwich Saline Springs and Baths, and their Efficacy in curing Disease. Pp. vi, 33. 4to. *Worcester*, 1871.
- The Droitwich Salt Springs: their Medicinal Action and Curative Properties. Pp. 51. 8vo. *Worcester and London*, 1876, 1881.
- Lecture on the progress and success of the Droitwich Brine Baths, delivered at Worcester, September 12, 1877. Pp. 14. 8vo. *Droitwich*, 1877.
- BAKEWELL, R. H. A Visit to Purton Spa, with a short Account of the extraordinary properties and effects of its Sulphated and Bromo-iodated Spring. Pp. 22. 8vo. *London*, 1861.
- BARBER, H. Holywell Spa, Grange, Lancashire: its history, nature, and properties. With directions for drinking the water. Pp. 16. 12mo. *Ulverstone and London*, 1870.
- BARCHINE, —. Treatise on the Waters of Bath.
- BARCLAY, W. Callirhœe, the Nymph of Aberdeen. 8vo. *Edinburgh*, 1615; 8vo. *Aberdeen*, 1670. Reprinted 1799.
- BARKER, J. Treatise on Cheltenham Water, and its great use in the present Pestilential Constitution. 8vo. *Birmingham*, 1786.
- BARLOW, Dr. E. On the Medicinal Efficacy and Employment of the Bath Waters. Pp. 200. 8vo. *Bath*, 1822.
- BARNES, A. Essay on the Virtues and Properties of the Shadwell Spa. 8vo. *London*, 1777.
- BARNES, JOSEPH, and HARRY GRIMSHAW. On a Mineral Water from Humphery Head, near Grange-over-Sands, North Lancashire. *Proc. Lit. Phil. Soc. Manch.* vol. xvi, pp. 62–66 [1878].
- BARNES, J. B. Analysis of a Chalybeate Water in Kensington Gardens. *Pharm. Journ.* vol. xviii, pp. 406–408 [1859].
- BARRATT, JAMES. Analysis of the Water of Holywell, North Wales. *Journ. Chem. Soc.* vol. xii, pp. 52–54 [1860].
- BARRY, Sir E. Observations . . . on the Wines of the Ancients . . . Qualities of Water, and particularly those of Bath. Pp. xii, 479. 4to. *London*, 1775.
- BARTLEY, O. Observations on the Properties of the Saline and Chalybeate Spas at Melksham. 8vo. *Bath*, 1813.
- BARTON, —. Lectures on the Petrifications of Lough Neagh.
- BATTEN, E. C. On the Cause of the Heat of the Bath Waters. *Proc. Somerset. Archæol. Nat. Hist. Soc.* vol. xxii, pp. 52–60 [1877].
- BAYLIES, W. Remarks on Perry's Analysis of the Stratford Mineral Waters, with a short Essay on the same Waters. 8vo. *Stratford-on-Avon*, 1745.
- On the Uses and Abuses of Bath Waters. 8vo. *London*, 1757.

- BEAL, Dr. JOHN. Account of some Sanative Waters in Herefordshire. *Phil. Trans. (Abr.)* vol. i, p. 131 [1666].
- On Vitriolate Water, &c. *Phil. Trans. (Abr.)* vol. ii, p. 132 [1666]
- BECK —. Leamington and the Neighbourhood. Ed. viii. 12mo. *Leamington*, 1847.
- BEDSON, Prof. P. P. On the Composition of Certain Colliery Waters. *Journ. Soc. Chem. Ind.* vol. vi, pp. 712–715 [1887]; vol. vii, p. 13 [1888].
- BESSEY, THOMAS. Analysis of an Aluminous Water. *Pharm. Journ.* vol. ix, pp. 452–454 [1850].
- Analyses of Astrop Wells and Sutton Bog Mineral Waters [1850]. *Pharm. Journ.* vol. x, pp. 293–296 [1851].
- The Lias of Fenny Compton, Warwickshire. *Proc. Warwicksh. Nat. Field Club* [for] 1877, pp. 1–22 [1878]. [Analysis of an Alkaline Spring.]
- BELCOMBE, Dr. W. See AINSWORTH, W.
- BELL, Sir I. L. On the Manufacture of Salt near Middlesborough. (Brine-pumping.) *Proc. Inst. Civ. Eng.* vol. xc, pp. 131–158, pl. 3 [1887].
- BELLON, PETER. The Irish Spaw. 8vo. *Dublin*, 1684.
- BEVIS, J. Experimental Enquiry on the Mineral Waters of Bagnigge Wells, near London. 8vo. *London*, 1760.
- BISSIT, J. Guide to Leamington Priors, containing a brief account of that Celebrated and Fashionable Spa. *London* (?), 1814, 1816.
- BLISS, JOHN. Experiments and Observations on the Medicinal Waters of Hampstead and Kilburn. Pp. 58. 8vo. *London*, 1802.
- BOATE, GERARD. Ireland's Natural History, being a true and ample description of . . . its Springs and Fountains, &c. 1652, 1726, 1755.
- BOND, Dr. F. T. The Geology of Mineral Springs. *Pop. Sci. Rev.* vol. iv, pp. 203–213 [1864].
- BOND, Dr. JOHN. On the Copper Springs in Wicklow, in Ireland. *Phil. Trans. (Abr.)* vol. x, p. 366 [1751].
- BOOTH, A. A Treatise on the Natural and Chymical Properties of Water, and on Various British Mineral Waters. Pp. 196. 8vo. *London*, 1830. Pp. xii, 196. 12mo. *London*, 1838.
- BORLASE, E. Latham Spaw, in Lancashire, with some remarkable cases, and cures effected by it . . . 12mo. *London*, 1670, 1672.
- BOSTOCK, R. The probable Source of Holywell Spring. *Proc. Liverpool Geol. Soc.* Session 9, pp. 65–71 [1868].
- BOYLE, R. Short Memoirs for the Natural Experimental History of Mineral Waters; with Directions as to the usual Methods of trying them, and other useful Remarks and curious Experiments. 8vo. *London*, 1684. Ed. ii, 1685. Latin, 12mo. *London*, 1686.
- BRABAZON, Dr. A. B. The Bath Thermal Mineral Waters. *Bath*.
- BRADSHAW, B. Dictionary of Bathing Places Pp. 410. 8vo. *London*, 1888.
- A Dictionary of Mineral Waters, Climatic Health Resorts, Sea Baths, and Hydropathic Establishments. Ed. i [1883]. Ed. iv, pp. lxxxiii, 408, 18mo. *London*, 1888.
- BRANDE, Prof. W. T. Analyses of two Mineral Waters from Springs in Windsor Great Park. *Quart. Journ. Sci.* vol. xx, p. 264 [1826]: *Phil. Mag.* ser. 2, vol. vi, p. 148 [1829].

- BRANDE, Prof. W. T., and S. PARKES. A Descriptive Account of Mr. Thompson's Laboratory at Cheltenham . . . With a Chemical Analysis of the Waters. *Journ. Sci. Arts*, vol. iii, p. 54-71 [1817].
- BRAYLEY, E. W. On the Existence of Salts of Potash in Brine Springs and in Rock Salt. *Phil. Mag.* ser. 2, vol. v, p. 411-416 [1829].
- BREAREY, C. B. Medical Guide to Scarborough. Ed. iv, 1869.
- BREWERTON, T. L. A Treatise on the Mineral Waters of Askern, &c. 8vo. *Doncaster*, 1818. 8vo. *London*, 1820.
- BROWN, EDWIN. The Geology and the Mineral Waters of Burton-upon-Trent. 8vo. *Burton-upon-Trent*, 1865.
- BROWNE, Dr. Account of the wonderful cures performed by the cold baths, with advice to the water drinkers at Astrope, Nasborough, Guithwaite near Sheffield, and other Spaws. 12mo. 1707.
- BROWNRIFF, Dr. W. Art of making Common Salt, as now practised in most parts of the world, with some Improvements proposed for the Art, for the use of the British dominions. 8vo. *London*, 1748.
- BUCHAN, Dr. WILLIAM. Cautions concerning Cold Bathing and Drinking Mineral Waters; being an additional Chapter to the 9th edition of his Domestic Medicine. 8vo. *London*, 1786.
- BUCKLAND, Rev. Prof. W. On the action of Acidulated Water on the surface of the Chalk near Gravesend. *Rep. Brit. Assoc.* for 1839, *Trans. of Sections*. p. 76.
- BUCKMAN, JAS. Guide to Pitville, with Analyses. 8vo. *Cheltenham*, 1842.
- BUCKMAN, Prof. J. On the Nature and Origin of the Saline Waters of Cheltenham. *Geologist (Moxon's)*, 1843, pp. 146-148.
- BURGESS, Dr. J. Essay on the Waters and Air of Ballyspellan. 1725.
- BURR, T. B. History of Tunbridge Wells. 8vo. *London*, 1766. [Medicinal Waters, p. 70].
- BURTON, T. See WRIGHT, W. T.
- BYFIELD, Dr. T. The Artificial Spaw. 8vo. *London*, 1684.
- A Short and Plain Account of the late-found Balsamick Wells at Hoxdon. 12mo. *London*, 1687.
- C—, Dr. W. W. Hydro-sidereon: or a Treatise of Ferruginous Waters, especially the Ipswich Spaw. 8vo. *London*, 1717.
- CANTON, J. Observations on the Heat of the Bath and Bristol Water. *Phil. Trans.* (Abr.) vol. xii, p. 420 [1762] and vol. lvii, p. 208 [1768].
- CARNELLY, T. Analysis of one of the Trefriw Mineral Waters. *Mem. Lit. Phil. Soc. Manch.* ser. 3, vol. xiv, p. 59 [1874].
- Analysis of one of the Trefriw Mineral Waters. *Mem. Lit. Phil. Soc. Manch.* ser. 3, vol. v, pp. 356-361 [1876].
- CARPENTER, W. L. Notes on Water from the Severn Tunnel Springs. *Rep. Brit. Assoc.* for 1877, p. 511.
- CARRICK, A. Dissertation on the Chemical and Medical Properties of the Bristol Hotwell Water. Pp. 167. 8vo. *Bristol*, 1797.
- and Dr. SYMONDS. The Medical Topography of Bristol. *Trans. Prov. Med. and Surg. Assoc.* vol. ii [1834].
- CARTER, R. On the Mineral Wells at Harrowgate. *Proc. Yorksh. Geol. Soc.* vol. viii, pt. 3, p. 313 [1885].
- CARY, G. S. The Balnea: a description of all the popular watering-places. 12mo. 1799.

- CASTRO, T. DE. On the use and abuse of Mineral Waters in England. (In Italian.) 8vo. *London*, 1756.
- CAUSTON, P. Tunbridgialia. Pp. 24. 4to. *Tunbridge Wells*, 1705. Pp. 12, 8vo. *London*, 1709.
- CAVENDISH, Hon. H. Experiments on Rathbone Place Water. *Phil. Trans.* vol. lvii, p. 92 [1768].
- CAYLEY, Dr. G. Synoptical Tables shewing the Component Parts of the Principal Mineral Waters. 8vo. *Ripon*, 1809.
- CHAMBERS, J. A General History of Malvern, with the more important details of chemical, mineralogical, and statistical information. 8vo. *Worcester*, 1817.
- CHAPMAN, H. Thermæ redivivæ: the City of Bath described, with some observations on those sovereign Waters, both as to the bathing in them, and drinking of them, now so much in use. Pp. 23. 4to. *London*, 1673.
- CHARLETON, Dr. RICE. A Treatise on Bath Waters, wherein are discovered the several Principles of which they are composed, the Causes of their Heat, and the Manner of their Production. 8vo. *Bath*, 1754. 8vo. *London*, 1755.
- Three Tracts on Bath Water. Tract I. A Chymical Analysis of Bath Water. II. An Inquiry into the Efficacy of Bath Water in Palsies. III. History of Hospital Cases. 8vo. *London*, 1775. 8vo. *Bath*, 1774.
- CHEYNE, Dr. GEORGE. Observations concerning the Nature and True Method of Treating the Gout. Together with an account of the Nature and Qualities of the Bath Waters, the manner of using them and the diseases in which they are proper. 8vo. *London*, 1720. Ed. iv, 1722: Ed. v, 1723: Ed. vii, 1728: n. ed. pp. 140. 8vo. *Dublin*, 1754.
- CHRISTISON, Prof. On the Sulphur Springs of Scotland.
- CHURCH, A. H. On the Arsenical Mineral Water of Whitbeck, Cumberland. *Amer. Journ. Dental Sci.* vol. x, pp. 581–583 [1860].
- Ferrous Chloride in a Mineral Water [Harrogate]. *Geol. Mag.* vol. iii, p. 285 [1866].
- CLANNY, Dr. W. R. A History and Analysis of the Mineral Waters at Butterby, near Durham. 12mo. *Durham*, 1807. 12mo. *London*, 1807.
- Observations on the Mineral Waters of Gilsland. 8vo. *Sunderland*, 1816.
- CLAROMONT, C. De Aere, Locis et Aquis Terræ Angliæ . . . Pp. 44, 180. 12mo. *London*, 1672.
- CLIFFORD'S Descriptive Guide of Tunbridge Wells. Ed. iii, pp. x, 180. 12mo. *Tunbridge Wells*, 1822. Ed. (?) 1834.
- CONNELL, ARTHUR. Analysis of a Powerful Chalybeate Water from Vicar's Bridge, near Dollar, in Clackmannanshire. *Edinb. New Phil. Journ.* vol. x, pp. 284–291 [1831].
- CONYBEARE, Rev. W. D., and W. PHILLIPS. Outlines of the Geology of England and Wales. 8vo. *London*, 1822.
- COOPER, J. T. On an Aluminous Chalybeate Spring on the Coast of Sussex [between Newhaven and Rottingdean]. *Ann. Phil.* vol. xiv. pp. 148, 149 [1819].
- CORP, Dr. WILLIAM. An Essay on the Jaundice, in which the propriety

of using the Bath Waters in that Disease, and in some particular affections of the Liver, is considered. 8vo. *Bath*, 1785. Ed. ii, 8vo. *Bath*, 1787.

COUTTS, T. See WOOD, E. T.

CRANE, J. Account of the Nature, Properties, and Uses of the Mineral Waters at Nottingham, near Weymouth, Dorset. 8vo. *Dorchester*, 1780. Pp. 44. 12mo. *London*, 1798.

CRICKITT, R. E. Thermal Springs at Bath and elsewhere. *Proc. Bath Nat. Hist. Club*, vol. i, pp. 85–107; *Geol. Mag.* vol. iv, pp. 174, 175 [1867].

CUBITT, —. Mineral Waters of Ashby-de-la-Zouch and Moira. *Ashby-de-la-Zouch*, 1826. Pp. 90. 12mo. *London*, 1826.

CUFF, C. On the Presence of Iodine, Potash, and Magnesia in the Bath Waters. *Phil. Mag.* ser. 2, vol. vii, pp. 9, 10 [1830].

CUFFE, R. The Woodhall or Iodine Spa, Lincolnshire. Pp. 26. 8vo. *London*, 1867. Ed. iii. pp. 27. 8vo. *London*, 1868.

CURLEY, T. On the Geology of the Llandrindod; its Mineral Springs; and Conglomerate Boulders. *Trans. Woolhope Nat. Field Club* for 1867, p. 28 [1868].

DALTON, W. H. Mineral and other Waters. Pp. 158, 159 of Geology of the South-west part of Lincolnshire . . . *Geological Survey Memoir*, 8vo. *London*, 1885.

DANSON, J. Analysis of the Leasowe Water. *Proc. Hist. Soc. Lanc. Chesh.* sess. ii. p. 260 [1850].

DAUBENY, Dr. C. Memoir on the occurrence of Iodine and Bromine in certain Mineral Waters of South Britain. *Phil. Trans.* vol. cxxi, pp. 223–238 [1830].

— Remarks on Thermal Springs, and their Connexion with Volcanoes. *Edinb. New Phil. Journ.* vol. xii, pp. 49–78 [1831]; *Ann. Chem. Pharm.* bd. iii, pp. 179–201 [1832].

— On the Quantity and Quality of the Gases disengaged from the Thermal Spring which supplies the King's Bath in the City of Bath. *Phil. Trans.* vol. cxxiv, pp. 1–14; *Trans. Roy. Soc.* vol. iii, pp. 258, 259 [1834].

— On Dr. Ure's Paper in the *Phil. Trans.* on the Moira Brine Spring, . . . *Phil. Mag.* ser. 3, vol. vi, p. 321 [1835].

— Report on the Present State of our Knowledge with respect to Mineral and Thermal Waters. *Rep. Brit. Assoc.* for 1836, pp. 1–95: *L'Institut*, t. vi, pp. 219, 220, 235, 236, 271, 272 [1838]; vii, pp. 4–8, 14–16, 36–40, 46–48, 55, 56, 62–64, 91, 92 [1839].

— Letter on a Saline Spring near Oxford. *Trans. Geol. Soc.* ser. 2, vol. v, p. 263 [1837].

— Analysis of the Mineral Spring lately discovered near Oxford [1835]. *Proc. Geol. Soc.* vol. ii, p. 204 [1838].

— [Analysis of a Mineral Spring at Tenbury in Worcestershire]. *Proc. Ashmol. Soc.* no. xviii, pp. 16, 17 [1841].

— On the Thermal Waters of Bath. *Geol. Mag.* vol. i, pp. 230, 231 [1864]; *Rep. Brit. Assoc.* for 1864, *Sections*, p. 27 [1865].

— Réflexions chimico-géologiques sur les Eaux Minérales et leur origine, suggérées par la lecture de deux ouvrages, celui de M. Scudamore, sur les Eaux de Buxton, Matlock, . . . et celui de M. le Dr. G. Bischof, sur les Sources Volcaniques, . . . *Journ. Géol.* t. ii, pp. 113–136 [1830].

- DAVIDSON, S. *History and Properties of Wingate Spaw*. 12mo. *London*, 1792.
- DAVIES, H. *Strangers' Guide through Cheltenham, with an account of the Mineral Waters*. 8vo. 1824.
- *Cheltenham. An account of its Mineral Waters*. 12mo. *Cheltenham*, 1834.
- *A View of Cheltenham, in its Past and Present State*. *London*. Ed. iv of the 'Stranger's Guide through Cheltenham.'
- DAVIS, C. E. *Mineral Baths of Bath*. 1883.
- *The Baths, Ancient and Modern*. Pp. 147–162 of *Handbook to Bath (Brit. Assoc.)*. 8vo. *Bath*, 1888.
- DAVIS, R. H. *Note on the existence of Lithium, Barium, and Strontium in the Medicinal Springs of Harrogate*. *Chem. News*, vol. xiii, pp. 302, 303 [1866].
- *The Imperial Saline Ferruginous Well at Harrogate, its History and Analyses*. *Pharm. Journ.* ser. 2, vol. vii, pp. 458–463 [1866].
- *Monthly Analytical Examinations of the Harrogate Spas*, 1872. *Journ. Chem. Soc.* vol. xxvi, pp. 1089–1092 [1873].
- *The Ancient Alum Well at Harrogate*. *Journ. Chem. Soc.* vol. xxxix, pp. 19, 20 [1881].
- *The Mineral Wealth of Harrogate*. *Proc. Yorksh. Geol. Soc.* vol. viii, pt. 3, p. 357 [1885].
- DAVY, JOHN. *Observations on the Temperature of Springs, Mines and Wells in Cornwall*. *Edinb. Journ. Sci.* vol. iii, pp. 75, 76 [1825].
- DEANE, Dr. E. *Spadacrene Anglica, or the English Spaw Fountaine, being a briefe treatise of the acid or tart Fountaine in the Forest of Knaresborow*. 4to. *London*, 1626; with additions by JOHN TAYLOR, pp. 45. 4to. *York*, 1649; 12mo. *York*, 1654. Reprinted, with additional observations, by M. Stanhope and others, under the title 'Spadacrene Anglica; or, The English Spaw. Being an account of the Situation, Nature, . . . and admirable Cures performed by the Waters of Harrogate, and Parts adjacent.' 8vo. *Leeds*, 1736.
- DE LA BECHE, Sir H. T. *Report on the Geology of Cornwall . . . Geological Survey Memoir*. 8vo. *London*, 1839. (Mineral Springs pp. 517, 518.)
- DENMAN, J. *Observations on the Effects of Buxton Water*. Pp. 164 [1783]. Pp. 144. 8vo. *London*, 1792. Ed. iii, 1793.
- DE RANCE, C. E. *On the Occurrence of Brine in the Coal Measures, with some remarks on Filtration*. *Trans. Manchester Geol. Soc.* vol. xviii, pt. iii, pp. 61–81 [1884]. Discussion, pt. vi, pp. 140–148 [1885].
- and others. *Reports of the Committee for investigating the Circulation of the Underground Waters . . . of England*. *Rep. Brit. Assoc.* 1875–1888 [14 Reports].
- DERHAM, S. *Hydrologia Philosophica; or an Account of Ilmington Waters in Warwickshire*. . . . 8vo. *Oxford*, 1685.
- DERHAM, W. *The Philosophical Experiments and Observations of the late eminent Dr. Robert Hooke and other eminent Virtuosi in his Time*. 8vo. *London*, 1726.
- DESMOULINS, Dr. S. *Letter concerning a Mineral Water at Canterbury*. *Phil. Trans.* vol. xxv, p. 2462, and (Abr.) vol. v, p. 375 [1708].

- DEWAR, J. Note on a Scotch Acidulous Chalybeate Mineral Water at Melrose. *Chem. News*, vol. xxiv, p. 171 [1871]; *Proc. R. Soc. Edinb.* vol. vii, pp. 470, 471; *Pharm. Journ.* ser. 2, vol. ii, p. 727 [1872].
- DIBDIN, Dr. T. F. The History of Cheltenham and its Environs, including an enquiry into the Nature and Properties of the Mineral Waters. 8vo. *Cheltenham*, 1803.
- DICK, THOS. L. An Account of the Aluminous Chalybeate Spring which has lately appeared on the property of Sir Andrew Lauder Dick, Bart., at Fountain Hall, in East Lothian. *Ann. Phil.* vol. viii, pp. 3-13, 341-349 [1816]; xii, pp. 91-101 [1818].
- DODGSON, Dr. T. Practical Observations upon the History, Contents, and Medicinal Properties of Ilkley Fountain. 8vo. *Skipton*, 1830.
- DUNLOP, D. The Philosophy of the Bath . . . 8vo. n.d.
- EDWARDS, C. T. Observations on the Medicinal Properties of the Bladud Spa Water. 8vo. *Bath and London*, 1837.
- EDWARDS, G. F. A Comparative View of the Analysis of the Cheltenham and Melksham Waters. 8vo. *Bath*, 1813.
- ELLIOT, Dr. JOHN. An Account of the Nature and Medicinal Virtues of the Principal Mineral Waters in Great Britain and Ireland, and those most in repute on the Continent, &c. 8vo. *London*, 1781. Ed. ii, 12mo. *London*, 1789.
- ELLIS, R. A Medical Guide to the Principal Health Resorts of Northern England, with new chapters on Whitby . . . Harrogate, &c. Pp. 160. 12mo.
- EVANS, Dr. An Account of Sutton Spa, near Shrewsbury. *Phil. Mag.* vol. xxii, pp. 61-68 [1805].
- EYRE, H. A Brief Account of the Holt Waters, &c. [Wiltshire]. 12mo. *London*, 1731. 8vo.
- FAIRBROTHER, J. E. Shepton Mallet: Notes on its History . . . and Natural Waters. 8vo. 1838.
- FAIRFAX, — Leamington Guide. 8vo. *Leamington*, 1838.
- FAIRLEY, T. Analysis of Water taken from the 'Old Crescent Well,' Harrogate, November 14, 1873. *Chem. News*, vol. xxx, No. 774, p. 151 [1874]
- Analyses of the Water and Gas from Blowing Wells, near North-allerton. *Rep. Brit. Assoc.* for 1881, pp. 601, 602 [1882].
- FALCONER, Dr. R. W. The Bath Mineral Waters in cases of Rheumatism, Sciatica, Gout, &c. Ed. iii, pp. 50. 8vo. *London*, 1860; Ed. iv, pp. 54. 8vo. 1867.
- The Baths and Mineral Waters of Bath [with a List of Authors]. 1857. Ed. iii, 12mo. *London*, 1860. Ed. iv, 1867. Ed. vii, 1881.
- Account of the Bath General, or Mineral Water Hospital. *Bath*, 1864.
- FALCONER, Dr. WILLIAM. An Essay on the Bath Waters; in four parts. With a Prefatory Introduction to the study of Mineral Waters in general. 12mo. *London*, 1770. Ed. ii, 2 vols. 8vo. 1772, 1775; Alt. ed. 8vo. *Bath*, 1790, 1798; Ed. iii. *Bath*, 1807.
- Account of the qualities of the Mineral Water at Middle Hill, near Box, Wiltshire. 8vo. *London*, 1786.
- Efficacy of the Bath Waters in various kinds of Paralytic Disorders. 8vo. *Bath*, 1787.
- Success of Bath Waters in Rheumatic cases. 8vo. *Bath*, 1795.

- FALCONER, Dr. WILLIAM. A Practical Dissertation on the Medicinal effects of the Bath Waters. 8vo. *London*, 1790; Ed. ii, *Bath*, 1798; Ed. iii, 8vo. *Bath*, 1807.
- On the use of Bath Waters in Ischias, or the Disease of Hip Joint. *Mem. Med.* vol. vi, p. 174 [1805].
- A Dissertation on Ischias . . . and on the Use of Bath Waters as a remedy in this complaint. 8vo. *London*, 1805.
- FARADAY, MICHAEL. Note on the Existence of a Nitrate and a Salt of Potash in Cheltenham Water. *Quart. Journ. Sci.* vol. xvii, pp. 178, 179: *Ann. Phil.* ser. 2, vol. vii, p. 393 [1824].
- FARMER, R. Analysis of the Carbonated Chalybeate near Stow (in-the-Wold). 8vo. *Evesham*, 1808; 8vo. *London*, 1809.
- FAUSSET, W. Mineral Springs of Lisdoonvarna, County Clare. Pp. 20. 8vo. *Dublin*, 1867.
- FERRAR, J. History of Limerick from the earliest Records to 1787, with the Charter and an Essay on Castle Connell Spa . . . 8vo. *Limerick*, 1787.
- FISHER, Rev. O. On Supposed Thermal Springs in Cambridgeshire. *Geol. Mag.* vol. viii, p. 42 [1871].
- FLINN, Dr. E. Ireland: its Health Resorts and Watering Places. *London*, 1888.
- FLOYER, Dr. Experimental Inquiry into the Nature and Quality of Bath Water. *London*, 1788.
- FLOYER, Sir J. An Inquiry into the Right Use of the Hot, Cold, and Temperate Baths in England. 8vo. *London*, 1697; Ed. ii, 'Ancient Psychrolusy revived', 1702; Ed. iii, History of Hot and Cold Bathing, Ancient and Modern; with an Appendix by Dr. E. BAYNARD. 8vo. *London*, 1702, 1706, 1709, 1715, 1722 (styled Eds. i-v); Latin, 8vo. *Leyden*, 1699; German, 8vo. *Breslau*, 1729.
- Inquisitio Balnearum Angliæ. Impr. in 'N. Vallerii Tentamina physico-chemica circa Aquas thermales Aquisgranenses.' 8vo. *Leyden*, 1699.
- FORREST, W. H. Report on the Airthrey Mineral Springs, and list of Phænogamous Plants growing in their Vicinity. 8vo. *Stirling*, 1831.
- FORSYTH, J. S. The Natural and Medical Dieteticon . . . Pp. xxiv, 360. 12mo. *London*, 1824.
- FOSBROKE, J. Contributions towards the Medical History of the Waters, and Medical Topography of Cheltenham. 12mo. 1807. (Reprinted, with additions, in the following.)
- FOSBROKE, Rev. T. D. Picturesque and Topographical Account of Cheltenham and its Vicinity, including the Medical History of the Waters by J. FOSBROKE. 8vo. *Cheltenham*, 1826.
- FOTHERGILL, A. On the Nature and Qualities of Cheltenham Waters. 8vo. *Bath*, 1785; 8vo. *Bath*, 1788.
- FOX, ROBERT WERE. Ueber die mit der Tiefe zunehmende Temperatur der Grubenwasser in Cornwall. *Ann. Phys. Chem.* bd. xxi, pp. 171, 172 [1831].
- Some Remarks on the High Temperature in the United Mines. *Rep. Polytechn. Soc. Cornwall*, 1846, pp. 1-3; *Edinb. New Phil. Journ.* vol. xliii, pp. 23-25; xliiii, pp. 99-102 [1847].
- FRANCIS, Capt. W. On the High Temperature of the Water at the

- United Mines. 14 *Ann. Rep. R. Cornwall Polytechn. Soc.* pp. 4-8 [1846]; *Edinb. N. Phil. Journ.* vol. xliii, pp. 102-106 [1847].
- FRANKLAND, Dr. E. and J. C. MORTON. Fifth Report on the Pollution of Rivers. Pollution arising from Mining Operations and Metal Manufactures. 2 vols. fo. *London*, 1875.
- FRANZ, J. C. A. Treatise on Mineral Waters, with reference to the Royal German Spa, Brighton. Pp. 148. 12mo. *London*, 1842.
- FRASER, ALEX. Northern Folk-lore on Wells and Water, with an Account of some Interesting Wells in the neighbourhood of Inverness. Pp. 36. 8vo. *Inverness*, 1878.
- FREEMAN, H. W. The Thermal Baths of Bath. 8vo. *London*, 1888.
- FRENCH, Dr. JOHN. The York-shire Spaw; or a Treatise of four famous Medicinal Wells, viz. The Spaw, or Vitriolic Well; the Stinking, or Sulphur Well; the Dropping, or Petrifying Well; and St. Magnus' Well, near Knaresborough, in Yorkshire. Together with the Causes, Virtues, and Use thereof. 12mo. *London*, 1652, 1654. Ed. ii, *York*, 1654. Reprinted under the title 'A Pocket Companion for Harrowgate Spaw.' 8vo. *Halifax*, 1760.
- GAIRDNER, Dr. M. Essay on the Natural History, Origin, Composition, and Medical Effects of Mineral and Thermal Springs. 8vo. *Edinburgh*, 1832.
- GALLOWAY, R. See MERCK, G.
- GARNETT, Dr. THOMAS. Experiments and Observations on Horley Green Spaw, near Halifax; to which is added a short Account of two other Mineral Waters in Yorkshire. 8vo. *Bradford*, 1790; 8vo. *London*, 1791.
- Experiments and Observations on the Crescent Water of Harrowgate. 8vo. *Leeds*, 1791.
- A Treatise on the Mineral Waters of Harrowgate; containing the History of these Waters, their Chemical Analysis, Medicinal Properties, and plain Directions for their Use. 8vo. *London*, 1792. Ed. ii, 8vo. *Leeds*, 1794, 1804. Ed. v. [1810]. Ed. vii, pp. 224. *Knaresborough*, 1822. Ed. viii [1829].
- Observations on a Tour through the Highlands, . . . a Description of Moffat, and an Analysis of its Mineral Waters. 2 vols. 4to. *London*, 1800. Ed. ii, 1811.
- GEIKIE, Dr. A. Notice of a Saline Water from the Volcanic Rocks of Linlithgow. *Proc. R. Soc. Edinb.* vol. ix, no. 98, pp. 367-371 [1877].
- GEORGE, E. S. Analysis of a Sulphuretted Water from the Northern Part of the Yorkshire Coalfield. *Phil. Mag.* ser. 2, vol. i, pp. 245-248 [1827].
- GIBBES, Dr. G. S. A Chemical Examination of the Bath Waters. *Journ. Nat. Phil. Chem. Arts*, vol. iii, pp. 359-363, 403-405 [1799]; pp. 452-454 [1800].
- The Bath Waters. *Bath and Bristol Mag.* vol. i, pp. 300, 408 [1832].
- Historical . . . Description of Bath, with Observations on the Medicinal Waters. 8vo. *Bath*, n. d.
- A Treatise on the Bath Waters. 8vo. *London*, 1800. Ed. ii, 8vo. *London*, 1803. Ed. ? 1812.

- GIBBES, Dr. G. S. A Second Treatise on Bath Waters. 8vo. *London*, 1803.
- Letter showing that the Bath Waters contain a much greater Portion of Iron than has hitherto been supposed. *Journ. Nat. Phil. Chem. Arts*, ser. 2, vol. xiv, pp. 323, 324 [1806]; *Ann. Phys.* bd. xlii, pp. 347, 348 [1812].
- GIBNEY, W. Medical Guide to the Cheltenham Waters, with observations on their nature and properties. . . . Pp. 162. 18mo. *London*, 1822. Ed. ii, *Cheltenham*, n. d.
- GILBERT, S. Fons Sanitatis; or the healing Spring at Willowbridge, in Staffordshire, found out by Lady Jane Gerard, Baroness of Bromley, published for the common good by Samuel Gilbert, Chaplain to her Honour, and Rector of Quatt. 12mo. *London*, 1676.
- GLADSTONE, Dr. J. H. On the Salts actually present in the Cheltenham and other Mineral Waters. *Rep. Brit. Assoc. for 1856, Sections*, p. 51 [1857].
- GLANVIL, J. Observations concerning the Bath Springs. *Phil. Trans.* vol. iv. (no. 49), p. 977 [1669], and (Abr.) vol. i, p. 361.
- GLOVER, Dr. R. M. On Mineral Waters, their Physical and Medicinal Properties; with descriptions of the different Mineral Waters of Great Britain and the Continent, and directions for their administration. 8vo. *Edinburgh*, 1857. Pp. 375. 8vo. *London*, 1857.
- GODEID, W. Mineral Spring, Shooter's Hill. *London*, 1617.
- GODING. History of Cheltenham from the Earliest Period to the Present Time. 12mo.
- GOODWIN, THOMAS. An Account of the Neutral Saline Waters recently discovered at Hampstead; with Chemical Experiments on their component parts; Observations on their Medicinal Application and Effects in certain Diseases; and on the different modes of Bathing, as an Auxiliary to the drinking of Mineral Waters. 12mo. *London*, 1804.
- GOUGH, J. Observations on the Ebbing and Flowing Well, at Giggleswick, in the West Riding of Yorkshire, with a theory of Reciprocating Fountains. *Mem. Lit. Phil. Soc. Manch.* ser. 2, vol. ii, pp. 354–383; *Journ. Nat. Phil. Chem. Arts*, ser. 2, vol. xxxv, pp. 178–193 [1813].
- GRAHAM, J. The True Nature and Uses of the Bath Waters. 8vo. *Bath*, 1789.
- GRAHAM, THOS. Analysis of the water of three wells at Greenwich and Deptford. *Trans. Inst. Civ. Eng.* vol. v, pp. 203, 204 [1846].
- GRAHAM, TH., and W. B. LORRAIN. Chemical and Medical Examination of the Rothsay Sulphuretted Water. *Glasgow Med. Journ.* vol. iv, pp. 246–248 [1831].
- GRANVILLE, Dr. A. B. The Spas of England and Sea Bathing Places. . . . 3 vols. 8vo. *London*, 1841.
- GRAVES, Dr. ROBERT. An Experimental Enquiry into the Constitutional Principles of the Sulphurous Water at Nottingham, near Weymouth, with Observations relative to its application in the Cure of Diseases. 8vo. *London*, 1792. 8vo. *Sherborne*, 1792.
- GREEVES, A. F. A. Account of the Medical Water of Ilkeston, in the County of Derby, with cases. 8vo. *Nottingham*, 1833.

- GREW, N. *Tractatus de Salis cathartici amaro in Aquis Ebeshamensibus et hujusmodi aliis contenti natura et usu.* 12mo. *London*, 1695.
English transl. by Dr. J. Bridges (with animadversions on a late corrupt transl. by Francis Moulton, chymist). 12mo. *London*, 1697.
- GRIFFITHS, —. *New Historical Description of Cheltenham and its Vicinity.* 2 vols. 8vo. *Cheltenham*, 1826.
— *History of Cheltenham and its Vicinity.* 4to. [1838].
- GRIMSHAW, H., and C. GRIMSHAW. *On the Water of Thirlmere.* *Chem. News*, vol. xxxviii, pp. 216, 217 [1878].
— See BARNES, J.
- GRISENTHWAITE, JOHN. *Reffley Spring: an Epistle in Verse.* 8vo. *Lynn*, 1804.
- GUIDOTT, T. *A Querie concerning Drinking Bath Waters resolved by Eugenius Philander.* *London*, 1673.
— *Observations lately made at Bath.* 4to. *London*, 1674.
— *Discourse of Bath and the Hot Waters there, and on the St. Vincent Rock, near Bristol.* 8vo. *London*, 1676.
— *De Balneis Bathoniensibus.* 1676.
— *De Thermis Britannicis Tractatus: accedunt Observationes Hydrostaticæ Chromaticæ et Miscellanæ unius cujuscumque Balnei apud Bathonium naturam, proprietatem et distinctionem curatius exhibentes.* 4to. *London*, 1681. Ed. ii, 4to. *London*, 1691.
— *A True and Exact Account of Sadlers Wells: or, the New Mineral-Waters lately found out at Islington.* Pp. 8. 4to. *London*, 1684.
— *Observations in Thermas Bathonienses.* 4to. *London*, 1691.
— *The Register of Bath in Two Hundred Observations. . . the famous Hot Wells of Bath.* 8vo. *London*, 1694. Ed. ii [1697].
— *Apology for the Bath; being an Inquiry into the right uses and abuses of the Bath in England.* 8vo. *London*, 1705–1718.
— *A Collection of Treatises relating to the City and Waters of Bath.* 8vo. *Bath*, 1725.
— See JORDEN, E.
- HALES, Dr. S. *Philosophical Experiments on the Sea; with Observations on Chalybeate Water; likewise a Proposal for Cleansing Mud out of Rivers, Harbours, &c.* 8vo. *London*, 1739.
— *Of the Strength of several of the Purging Waters, especially of that of Jessop's Well.* *Phil. Trans. (Abr.)* vol. x, p. 48 [1750].
- HALL, J. See STUBBS, H.
- HALPIN, W. A. *Observations on erroneous statements in Dr. Neale's pamphlet on the Cheltenham Waters.* 8vo. *Cheltenham*, 1820.
- HARDMAN, E. T. *On the Barytes Mines near Bantry.* *Proc. R. Dublin Soc.* ser. 2, vol. i, p. 121. *Journ. R. Geol. Soc. Ireland*, ser. 2, vol. v, pp. 99–103 [1878].
- HARDY, P. D. *Holy Wells of Ireland, containing an authentic account of those various places of pilgrimage.* 12mo. *Dublin*, 1840.
- HARGROVE, E. *The History of the Castle, Town, and Forest of Knaresborough, with an Account of Harrowgate and its Medicinal Waters.* 12mo. *Knaresborough and York*, 1769. Ed. iv [1789]. Ed. v [1798]. Ed. vi [1809]. Ed. ? [1821]. Ed. vii [1832].
- HARMER, F. W. *On some Thermal Springs in the Fens of Cambridgeshire.* *Rep. Brit. Assoc. for 1870, Sections*, p. 74 [1871].
— *The supposed Thermal Springs in Cambridgeshire.* *Geol. Mag.* vol. viii, p. 143 [1871].

- HARRISON, W. J. A Sketch of the Geology of Leicestershire and Rutland. Reprinted from White's History, &c., of the Counties. Pp. 67, 8vo. *Sheffield*, 1877. (Mineral Springs, p. 52.)
- HASTINGS, Dr. C. Illustrations of the Natural History of Worcestershire, with Information on the . . . Geology of the County, including also a short account of its Mineral Waters. Pp. 184, 8vo. *London and Worcester*, 1834.
- On the Salt Springs of Worcestershire (Worcestersh. Nat. Hist. Soc.). *Analyst*, vol. ii, pp. 359–385 [1835]. 8vo *London*, 1835.
- HAWKESLEY, T. Report upon the Boring for Water at Rugby, 1862, with notes on the composition by Dr. W. ODLING. *Rep. Rugby School Nat. Hist. Soc.* for 1874, p. 71 [1875].
- HAWORTH, Dr. S. A Description of the Duke's Bagnio, and of the Mineral Bath and New Spaw thereunto belonging, with an account of the use of sweating, rubbing, bathing, and the Medicinal Vertues of the Spaw. 12mo. *London*, 1683. [The Bagnio was situated at the west end of Long Acre, near Salisbury Stables.]
- HAYWARD, J. W. The Vale of Conway Spa: its nature, property, and uses, mode of administration and season, origin, source, locality, and discovery. Pp. 36. 8vo. *Liverpool*, 1865.
- Guide to Trefriw and the Vale of Conway Spa. Ed. ii, pp. 64. 8vo. *London*, 1872. Ed. iii, pp. 80 [1881].
- HEBNER, O. New Analysis of the Sandrock (I. W.) Mineral Water. *Analyst*, vol. vii, p. 109 [1882].
- HEMMING, Dr. JOHN. The History and Chemical Analysis of the Mineral Water lately discovered in the City of Gloucester; the various Diseases to which it is applicable considered, and the necessary Regulations for Drinking it with success ascertained. 8vo. *London*, 1789.
- HENDERSON, Dr. R. On the General Existence of Iodine in Spring Water. *Phil. Mag.* ser. 2, vol. vii, p. 10–12 [1830].
- HERAPATH, T. J. See HERAPATH, W.
- HERAPATH, W. Analysis of the King's Bath, Bath. *Rep. Brit. Assoc.* for 1836, *Sections*, pp. 70–73 [1837].
- Analyses of the Bath Waters and of the Bristol Hot-well Waters. *Phil. Mag.* ser. 3, vol. xxiv, p. 371 [1844].
- Analysis of a Medicinal Water from the neighbourhood of Bristol [Kingswood]. *Journ. Chem. Soc.* vol. ii, pp. 200–205 [1850].
- Analysis of a Chalybeate Water from the neighbourhood of Brecon. *Chemist*, vol. iii, pp. 145–147 [1851–2].
- HERAPATH, W., and T. J. HERAPATH. Note on the existence of Strontia in the Well-Waters of Bristol. *Quart. Journ. Chem. Soc.* vol. v, pp. 193–194 [1853].
- HERIOT, Captain M. The Bath Waters. *Proc. Bath Field Club*, vol. iii, no. 2, pp. 163–170 [1875].
- The Mineral Spring at Batheaston. *Proc. Bath Field Club*, vol. iii, no. 2, pp. 171–177 [1875].
- The Mineral Waters of Bath. *Proc. Somerset Archæol. Nat. Hist. Soc.* vol. xxii, pp. 47–51 [1877].
- HIGGINS, —. On Castleconnell Water.
- HIGHMORE, Dr. NATHANIEL. Some considerations relating to Dr. Wittie's Defence of Scarborough Spa; concerning a Salt Spring, in

Somersetshire, and a Medicinal Spring in Dorsetshire. *Phil. Trans. (Abr.)* vol. i, p. 419 [1670].

- HILEY, J. S. On the Waters of the Parish of Halifax. *Chemist*, vol. ii, pp. 325–331 [1841].
- HILLARY, W. On the medicinal virtues of Lincomb Spa Water, near Bath. 8vo. *London*, 1742.
- HINDERWELL, T. The History and Antiquities of Scarborough and the Vicinity. 4to. *York*, 1798. Ed. ii. 8vo. *London*, 1811; Ed. iii. 8vo. *Scarborough*, 1832.
- HOFMANN, A. W. Harrogate and its Resources. Chemical Analysis of its Medicinal Waters, with an Appendix on the mode of their Administration by the Committee. Pp. 54. 8vo. *London*, 1855.
- Analysis of the Saline Water of Christian Malford, near Chippenham. *Ann. Chem. Pharm.* bd. cxv, pp. 286–292 [1860]: *Journ. Chem. Soc.* vol. xiii, pp. 80–84 [1861].
- HOFFMANN, F. Experiments and observations upon Mineral Waters, with notes by PETER SHAW. 8vo. *London*, 1731. Ed. ii [1743].
- HOLMES, H. Sunning Hill Wells: or a Practical Inquiry into the action of Iron as a constituent of the blood in health and disease, in connexion with that Chalybeate Spring. Pp. 103. 8vo. *London*, 1851.
- HOME, F. Essay on the contents and virtues of Dunse-Spaw. 8vo. *Edinburgh*, 1751.
- HOPTON, RICHARD. Account of the Eruption of a Burning Spring at Broseley, in Shropshire. *Phil. Trans. (Abr.)* vol. v, p. 680 [1711].
- HORNER, L. Of the Mineral Waters of the Malvern Hills. *Trans. Geol. Soc.* vol. i, pp. 313–316 [1811].
- Account of the Brine Springs at Droitwich. *Trans. Geol. Soc.* vol. ii, pp. 94–109 [1814].
- HORSBURGH, Dr. W. Experiments and Observations upon the Hartfell Spaw [Moffat]. 8vo. *Edinburgh*, 1754.
- HORSLEY, Dr. W. Remarks on the Pitcaithly and Dunbarney Mineral Waters in Perthshire; illustrative of their Composition and Medicinal Properties; founded on accurate Analysis, &c. 12mo. *Edinburgh*, 1814.
- HOULSTON, Dr. THOMAS. An Essay on the Liverpool Spa Water. 8vo. *London*, 1773.
- HOWARD, J. Extract of a Letter giving some Observations on the Heat of the Waters at Bath. *Phil. Trans.* vol. lvii, p. 201 [1768], and (Abr.) vol. xii, p. 419.
- HOWELL, —. Analysis of the Carbonated Chalybeate Well lately discovered at Middleton Hall, near Llanarthney in Carmarthenshire. The Analytical Results by Mr. F. ACCUM. *Phil. Mag.* vol. xxxv, pp. 179, 180 [1810].
- HUDESTON, W. H. Excursion to the West Riding of Yorkshire (Harrogate waters). *Proc. Geol. Assoc.* vol. vii, pp. 420–438 [1882].
- HUGGON, WM. On the Alkaline Waters of Leeds. *Rep. Brit. Assoc.* 1858, pt. 2, pp. 51, 52.
- HULL, Professor E. The Geology of the Country around Cheltenham. Sheet 44 of the Geological Survey. Pp. 98, 8vo. *London*, 1857.
- Salt Water in the Main Coal of Moira. Pp. 67, 68, of Geology of the Leicestershire Coalfield. *Geological Survey Memoir.* 8vo. *London*, 1860.

- HULL, Professor E. On the Occurrence of Brine in the New Red Sandstone Strata at Warrington. *Trans. Manch. Geol. Soc.* vol. xiv, p. 374 [1878].
- HUME, Rev. Dr. A. Notice of certain Mineral Springs at Leasowe. *Proc. Hist. Soc. Lanc. Chesh.* sess. 1, p. 105 [1849].
- HUNT, ROBT. On the Waters from the Mining Districts of Cornwall. *Rep. Trans. R. Polyt. Soc. Cornwall*, 1841, pp. 151–156.
- HUNTER, Dr. A. A Treatise on the Nature and Virtues of Buxton Waters. Ed. iii, 8vo. *London*, 1773. Ed. ? *York*, 1797.
- Lecture on the Sulphur Water of Harrogate. 8vo. *York*, 1806.
- Essay on the Mineral Springs lately discovered at Harrogate, and on the Springs of Thorp Arch and Ilkley. Pp. 134. 8vo. *London*, 1819. Ed. iii, *Knaresborough*, 1834. Ed. v, pp. 206. 12mo. *Knaresborough*, 1838. Ed. ? 1846.
- A Treatise on the Mineral Waters of Harrogate and its Vicinity. Pp. 138. 8vo. *London*, 1830.
- HUNTER, WM. Analysis of the Water drawn from a Well in Fort William at the Depth of 70 feet from the Surface [1806]. *Gleanings Sci.* vol. i, pp. 103–105 [1829].
- HUNTER, W. P. Some Account of the Limestone Rocks and Petrifying Spring at Pounceford, Sussex; with Preliminary Remarks on the Wealden Rocks. *Mag. Nat. Hist.* vol. viii. pp. 597–608; and separately with other papers, 12mo. *Hythe*, 1835.
- HYDE, S. Peakland and the Baths and Climate of Buxton, comprising a full account of the thermal waters, &c. Pp. 76. 12mo. *Manchester* [recent].
- INGRAM, D. An Inquiry into the Origin and Nature of Magnesia Alba, and the Properties of Epsom Waters. 8vo. *London*, 1768.
- JACKSON, Rev. J. On Bath Waters; a Sermon on Ps. ciii. 3. 4to. [1707].
- JACKSON, Dr. W. Some Inquiries concerning the Salt Springs and the Way of Salt-making at Nantwich in Cheshire. Answered. *Phil. Trans.* vol. iv, no. 53, p. 1060, and (Abr.), vol. i, pp. 397, 405 [1669].
- JAMES, CONSTANTIN. Guide pratique aux Eaux Minérales de France . . . quelques mots sur les eaux minérales de l'Angleterre. (Pp. 538–541.) Ed. ii. 8vo. *Paris*, 1852.
- JAMESON, Dr. THOMAS. A Treatise on Cheltenham Waters, and Bilious Diseases; to which are prefixed Observations on Fluidity, Mineral Waters, and Watering Places. 8vo. *London*, 1803. Ed. ii, 8vo. *London*, 1809. Ed. iii, 8vo. *London*, 1814.
- JEPHSON, CHAS. DENHAM ORLANDO. On Variations of Temperature in a Thermal Spring at Mallow [1834]. *Proc. Geol. Soc.* vol. ii, p. 76 [1838].
- JOHNSON, Dr. J. Pilgrimages to the Spas in pursuit of Health and Recreation, with inquiry into the comparative merits of different Mineral Waters, the Maladies to which they are Applicable, and those to which they are Injurious. 8vo. *London*, 1841.
- Excursions to the principal Mineral Waters of England. 8vo. *London*, 1843.
- JOHNSON, Dr. THOMAS. Mercurius Botanicus, &c.; huic accessit de Thermis Bathonicis Tractatus. 12mo. *London*, 1634.
- Thermæ Bathonicæ, sive earum Descriptio, Vires, &c. *London*, 1674. Reprinted 1847.

- JOHNSTONE, Dr. J. Some Account of the Welton Water near Tewkesbury. 8vo. *London and Worcester*, 1787.
- Account of the Medicinal Water near Tewkesbury. 8vo. *Tewkesbury*, 1790.
- JOHNSTONE, W. Analysis of Moffat and Hartfell Spas, collected on October 5 and 12, 1874. *Chem. News*, vol. xxxi, pp. 15, 88 [1875].
- Analysis of the Water of St. Dunstan's Well, Melrose. *Chem. News*, vol. xxxix, pp. 259, 260 [1879].
- Analysis of the Airthrey Springs at Bridge of Allan. *Chem. News*, vol. xxxi. p. 88.
- JONES, Dr. JOHN. The Benefit of the Antient Bathes of Buckstone, which cureth most grievous Sicknesses. 4to. *London*, 1572.
- The Bathes of Bathes ayde . . . 4to. *London*, 1572.
- JONES, J. R. and PRYSE, J. Radnorshire and Breconshire Springs. *Llanidloes*.
- JORDEN, Dr. E. Discourse of Natural Baths and Mineral Waters; wherein first the original of Fountains in general is declared; then the Nature and Differences of Minerals; next the generation of Minerals in the Earth, and lastly of the Nature and Use of Baths, but especially of our Baths at Bath in Somersetshire. 4to. *London*, 1631, 1632, 1633. Ed. iii (Lib. J. St.), with appendix by T. GUIDOTT entitled, An Appendix concerning the Antiquity of Bath, and an Account of the Nature of the Hot Waters there. 8vo. *London*, 1669. Ed. iv, 1673.
- JUDD, Prof. J. W. The Geology of Rutland, &c. (Mineral Springs, pp. 268–270.) *Geological Survey Memoir*. 8vo. *London*, 1875.
- KEDDIE, W. Moffat: its Walks and Wells; and Report on, and Chemical Analysis of, its Mineral Wells, by Dr. J. MACADAM. Pp. 163. 8vo. *Glasgow*, 1854.
- KEIR, P. An inquiry into the Nature and Properties of the Medicinal Waters of Bristol, and their Use in the cure of Chronical Distempers. 8vo. *London*, 1739.
- KENNION, Dr. G. Observations on the Medicinal Springs of Harrowgate. Pp. 31. 8vo. *London*, 1853. Ed. vi, 1869. Ed. vii, enlarged and revised by A. BEALEY. 8vo. *London*, 1870.
- KENTISH, E. Account of Baths and of a Madeira-house at Bristol. Pp. 117. 8vo. *London*, 1814.
- KEOGH, J. *Botanologia Universalis Hibernica* . . . with a treatise on Chalybeate waters, showing their origin, situation, &c. 4to. *Cork*, [1735].
- KIRWAN, R. An Essay on the Analysis of Mineral Waters. 8vo. *London*, 1799.
- KNIGHT, T. The History of the Dorton Chalybeate, near Brill, Bucks. 12mo. *Brill*, 1833. 4to. *Oxford*, 1833.
- KNOX, Dr. A. The Irish Watering Places, &c., with analysis of the principal Mineral Springs, by Sir R. KANE. Pp. 336. 12mo. *Dublin*, 1845.
- The Ballynahinch Mineral Waters. Pp. 47. 12mo. *Belfast*, 1846.
- KYNASTON, J. W. Analysis of the Water of a Spring at Billingborough, Lincolnshire. *Journ. Chem. Soc.* vol. xii, pp. 57–62 [1860].
- LABAT, Dr. A. *Étude hydrologique du Pays de Galles et d'Irlande*. Pp. 31. 8vo. *Paris*, 1872.

- LABAT, Dr. A. *Etude sur la station de Cheltenham (Angleterre)*. Pp. 16. 8vo. *Paris*, 1873.
- LAING, W., M.D. *Account of Peterhead, its mineral well, air, and neighbourhood*. 8vo. [1793].
- *Account of the new cold and warm sea baths at Peterhead, mineral springs, &c.* 8vo. [1804].
- LAMB, H. *Malvern, with observations on the air and waters*. *Malvern*, 1845.
- LAMBE, W. *An Analysis of the Waters of two Mineral Springs at Lemington Priors, near Warwick; including Experiments tending to elucidate the Origin of the Muriatic Acid*. *Phil. Mag.* vol. i, pp. 255–350; *Mem. Phil. Soc. Manch.* vol. v, pp. 174–213 [1798].
- LANKESTER, Dr. E. *An Account of Askern and its Mineral Springs, together with a Sketch of the Natural History of the immediate Neighbourhood*. Pp. 151. 8vo. *London*, 1842.
- *On the Occurrence of Calothrix nivea, and the Infusoria of Sulphureous Waters at Cove, Ireland*. *Rep. Brit. Assoc.* 1843, pt. 2, pp. 77, 78.
- LAYARD, D. P. *An Account of the Somersham Spa*. 8vo. *London*, 1759, 1767.
- LEE, EDWIN. *Account of the most frequented Watering Places on the Continent . . . and an Appendix on the principal Mineral Waters of England*. 12mo. 1834: Pp. 232. 8vo. *London*, 1836.
- *Additional Remarks on the use of English Mineral Springs, especially those of Bath, Cheltenham, and Leamington*. Pp. 20. 8vo. *London*, 1837.
- *The Mineral Springs of England and their curative Efficacy, with Remarks on Bathing . . .* 12mo [1841]. Ed. ii, pp. 212 [1848]. Ed. iii, pp. 280 [1854]. Ed. iv [1859]. Ed. [1863].
- *Brighton and its Sanative Resources, comprising a special reference to the German Spa, &c.* Pp. 120. 8vo. *London*, 1850.
- *Mineral Waters, Climate, &c., of Cheltenham*. Pp. 135. 8vo. *London*, 1851.
- *The Watering Places of England, considered with reference to their Medical Topography*. Ed. iii. 12mo. *London*, 1854.
- LEIGH, C. *Phthisiologia Lancastriensis cui accessit tentamen philosophicum de Mineralibus Aquis in eodem comitatu observatis*. 12mo. *London*, 1694.
- *Exercitationes quinque de Aquis Medicatis, Morbis Acutis, Intermittentibus, Hydrope*. 8vo. *Oxford*, 1697.
- *Natural History of Lancashire and Cheshire and the Peak of Derbyshire*. fo. *Oxford*, 1700.
- LEMPRIERE, WILLIAM. *Report on the Medicinal Effects of an Aluminous Chalybeate Water, lately discovered at Sandrocks, in the Isle of Wight . . .* 8vo. *London*, 1812, 1820. Ed. ii, pp. 67. 12mo. *Newport*, 1827.
- LEWIS, Rev. J. *An Account of the several Strata of Earths and Fossils found in sinking the Mineral Wells at Holt*. *Phil. Trans.* vol. xxxv, no. 403, p. 489 [1728].
- *A Letter giving a farther Account of the Nature and Virtues of the Holt Waters*. *Phil. Trans.* vol. xxxvi, p. 43 [1729].

- LINDEN, D. W. On the Origin, Nature, and Virtues of Chalybeat Waters and Natural Hot Baths, with Remarks and Queries on the Glastonbury Water. 8vo. *London*, 1743. Ed. ii, with Appendix on Seltzer Water. 8vo. *London*, 1748, 1752. Ed. iii, 8vo. *London*, 1755. Ed. 1784.
- Directions for the use of Berry's Shadwell Spa in Sun Tavern Fields, Shadwell. Pp. 16. 8vo. *London*, 1749.
- An Experimental Dissertation on the Nature, Contents, and Virtues of the Hyde-Spaw-Water, near Cheltenham, in Gloucestershire, &c. Pp. 80. 8vo. *London*, 1751.
- On Chalybeat Waters, &c. . . . with Appendix on . . . the Glastonbury Waters. Ed. ii [1752]. Ed. [1755]. Ed. . . . 8vo. *London*, 1758.
- A Treatise on the Three Medicinal Mineral Waters at Llandrindod, in Radnorshire, South Wales, with some Remarks on Mineral and Fossil Mixtures in their Native Veins and Beds; at least as far as respects their Influence on Water. 8vo. *London*, 1756. 8vo. *London*, 1761.
- A Seasonable and Modest Reply to Dr. Lucas' Cursory Remarks on Dr. Sutherland's Treatise on Bath and Bristol Waters; in which Dr. Sutherland's Experiments on . . . Bath Waters are confirmed. 8vo. *London*, 1765. (See LUCAS, Dr. C., and SUTHERLAND, Dr. A.)
- An Experimental and Practical Inquiry into the . . . Properties of the Mineral Water of Llangybi, in Carnarvonshire; . . . Essay on . . . Analysing Mineral Waters. 8vo. *London*, 1767.
- A Medicinal and Experimental History and Analysis of the Hanlys-Spaw Saline, Purgings, and Chalybeate Waters, near Shrewsbury. 8vo. *London*, 1768.
- LIPSCOMB, GEORGE. A Description of Matlock-Bath; with an attempt to explain the Causes of Heat and of the Petrifying Quality of the Springs. . . . Some account of Chatsworth and Kidleston, and the Mineral Waters of Quarndon and Kidleston. 8vo. *London*, 1802.
- LISTER, Dr. Martin. De Fontibus Medicatibus Angliæ. Exercitatio nova et prior. . . . 4to. *York*, 1682. 8vo. *London* (and *Frankfort*), 1684. 12mo. *Leyden*, 1686.
- On the Salt Springs of Worcestershire, Staffordshire, and Cheshire, with speculations respecting Salt, &c. *Phil Trans.* (Abr.), vol. iii, p. 10 [1683].
- Certain Observations of the Midland Salt Springs of Worcestershire, Staffordshire, and Cheshire. *Phil. Trans.* vol. xiv (no. 156). p. 489 [1684].
- LIVINGSTON, —. Account of the Ballston Waters. *Ann. Phil.* vol. x, pp. 442, 443 [1817].
- LOUDON, C. Practical Dissertation on the Waters of Leamington Spa, including the history of the Springs. A new analysis, rules for drinking the Waters, &c. 8vo. *Leamington*, 1828. Ed. ii, 8vo. *London*, 1831. Ed. iii [1851].
- LOWNDES, THOMAS. Brine-Salt improved. 4to. *London*, 1746.
- LUCAS, Dr. CHARLES. An Essay on Waters, in three parts: 1. Of Simple Waters; 2. Of Cold Medicated Waters; 3. Of Natural Baths. 3 vols. 8vo. *London*, 1756–1758. French transl. 8vo. *Liege*, 1765. German transl., by J. C. ZEHER, 3 vols. 8vo. *Altenburg*, 1768–69.

- LUCAS, Dr. CHARLES. An Analysis of Dr. Ruttty's Methodical Synopsis of Mineral Waters. 8vo. *London*, 1757.
- Cursory Remarks on the Method of Investigating the Principles and Properties of the Bath and Bristol Waters: set forth in Attempts. . . . by Dr. A. SUTHERLAND, 8vo. *Bath*, 1764. See LINDEN, Dr. D. W., and SUTHERLAND, Dr. A.
- The Theory and Uses of Baths; with Notes, by Dr. ACHMET. 8vo. *Dublin*, 1772.
- LYELL, Sir C. [Presidential] Address (refers to Thermal Waters). *Rep. Brit. Assoc.* 1864, p. lx-lxv [1865].
- On the Mineral Waters of Bath and other hot springs and their geological effects. *Amer. Journ. Sci.* ser. 2, vol. xxxix, pp. 13-24 [1865].
- LYSONS, Dr. DANIEL. Further Observations on. . . . Bath Waters. . . . 8vo. *Bath*, 1777.
- LYSONS, Rev. D., and S. LYSONS. Magna Britannia; being a concise Topographical Account of the several Counties of Great Britain. 6 vols. 4to. *London*, 1806-1822.
- LYSONS, S. See LYSONS, Rev. D.
- MACADAM, JOHN. Report on, and chemical analyses of, the Moffat Mineral Wells. *Glasgow Med. Journ.* vol. ii, pp. 191-210, 295-321 [1855].
- MCCABE, JAMES. On the Cheltenham Waters and the Diseases in which they are recommended, with Analysis of the Salts and Waters. Pp. 31. 8vo. *Cheltenham*, 1820.
- Directions for drinking the Cheltenham Waters, with a selection of cases illustrating their effects in a great variety of diseases. Pp. 68. 12mo. *Cheltenham*, 1826.
- MACKAILLE, M. Fons Moffatensis: Seu Descriptio topographico-spa-gyrica fontium mineralium Moffetensium in Annandia Scotiæ. 8vo. *Edinburgh*, 1659. English translation, to which is appended a description of the Oily Well at St. Catherine's Chapel, in the parish of Libberton. 12mo. *Edinburgh*, 1664.
- McKENZIE, P. Practical observations on the medical powers of the most celebrated Mineral Waters. Pp. 151. 12mo. *London*, 1819.
- MACKENZIE, Dr. On Mineral Waters and Bathing. 1825.
- McMURTRIE, J. Notes on the occurrence of Salt Springs in the Coal Measures at Radstock. *Proc. Bath Field Club*, vol. vi, p. 84 [1886].
- McPHERSON, Dr. J. Our Baths and Wells: the Mineral Waters of the British Islands. 12mo. *London*, 1871.
- MADAN, P. A Philosophical and Medicinal Essay on the Waters of Tunbridge. 4to. *London*, 1687. [Reprinted in Harleian Miscellanies, vol. i.]
- MAGEW, Dr. On Bristol Water.
- MANBY, G. W. Fugitive Sketches of the History and Natural Beauties of Clifton, the Hot Wells, and Vicinity. 8vo. 1802, 1806, and n. d.
- MANNING, Rev. H. C. An Analysis and brief Account of the Thetford Mineral Waters: translated from the Latin Original of the late Matthew Manning, M.D., of that place. 8vo. *Thetford* [1746].
- MANNING, M. De Aquis Mineralibus. 4to. *London*, 1746.
- MANSON, D. On the Strathpeffer Spa. Pp. 15. 8vo. *Inverness*, 1866.
- On the Sulphur Waters of Strathpeffer, in the Highlands of Ross-shire. Pp. 62. 8vo. *Inverness*, 1869. Ed. ii, pp. 73. 8vo. *London*, 1877. Ed. v, pp. 106.

- MANTELL, Dr. G. A.** *The Geology of Surrey. Brayley's Topographical History of Surrey*, vol. i, p. 121 [1841]. 4to. and 8vo. [An Account of the Rivers and Mineral Springs, p. 165.]
- MAPLET, Dr. JOHN.** *Epistolarum Medicinalium de Thermarum Bathoniensium Effectis Specimen.* Ed. by T. GUIDOTT. 4to. *London*, 1694.
- MAPOTHER, E. D.** *Lisdoonvarna Spa and Sea-side Places of Clare.* Pp. 47. 8vo. *Dublin*, 1871. Ed. ii [1872]. Ed. iii [1876].
- MARCEY, A.** *Chemical Account of the Brighton Chalybeate.* 8vo. *London*, 1805.
- *A Chemical Account of an Aluminous Chalybeate Spring in the Isle of Wight.* *Trans. Geol. Soc.* ser. 1, vol. i, p. 213–248; *Journ. Nat. Phil. Chem. Arts*, ser. 2, vol. xxxii, pp. 52–66, 85–100 [1811].
- MARTIN, —.** *Essay on Castle Connell Water.*
- MARTYN, Professor J.** *An Account of a new Purging Spring discovered at Dulwich in Surrey.* *Phil. Trans.* vol. xli, p. 835 [1744].
- MASKELYNE, N. S.** *Report on the best means of Conveyance of the Bath Mineral Water for a distance of 1,200 yards.* 8vo. *Oxford*, 1853.
- MASON, Rev.** *Letter concerning . . . a burning Well at Brosely.* *Phil. Trans.* vol. xliv (no. 482), p. 370 [1747].
- MAXFIELD, A.** *Observations on the medical virtues of the Beulah Saline Spa, Norwood, and on the disorders in which it is most efficacious, especially those connected with derangement of the digestive organs.* Pp. 82. 8vo. *London*, 1832.
- MEDLEY, Dr. J.** *Tentamen Hydrologicum: or, An Essay upon Matlock-Bath in Derbyshire, &c.* Pp. 92. 8vo. *Nottingham*, 1730.
- MERCK, G., and R. GALLOWAY.** *Analysis of the Water of the Thermal Spring of Bath (King's Bath).* *Phil. Mag.* ser. 3, vol. xxxi, p. 56; *Ann. Chem. Pharm.* bd. lxxiii pp. 318–332 [1847]; *Mem. Chem. Soc.* vol. iii. pp. 262–272 [1848]; *Rep. R. Coll. Chem.* 1849, pp. 1–12.
- MIDDLETON, A.** *A Chemical Analysis of Leamington Waters.* 1808. Ed. ii. 8vo. *Warwick*, 1814, 1843.
- MILES, C. E.** *Mineral Springs.* *Trans. Liverpool Geol. Soc.* vol. iv, pp. 48–59 [1884].
- MILLER, J.** *Practical Observations on Cold and Warm Bathing, and descriptive notices of Watering Places in Britain.* 12mo. *London*, 1821.
- MILLER, Dr. W. A.** *Chemical Examination of a Hot Spring containing Cæsium and Lithium in Wheal Clifford, Cornwall.* *Chem. News*, vol. x, pp. 181, 182; *Min. Smelt. Mag.* vol. vi, pp. 197, 198 [1864]; *Rep. Brit. Assoc. for 1864, Sections*, pp. 35, 36; *Ann. Mines*, sér. 6, t. vii, p. 299 [1865].
- MOLYNEUX, W.** *Burton-on-Trent: Its History, its Waters, and its Breweries.* (Pp. 147–213.) 8vo. *London and Burton*, 1869.
- *On the Occurrence of Aviculopecten . . . in Deposits associated with Seams of Coal containing Salt Water in the Ashby Coal Field.* *Rep. Brit. Assoc.* 1877, *Sections*, pp. 73, 74 [1878].
- MONCRIEFF, W. T.** *Visitor's New Guide to the Spa of Leamington Priors and its Vicinity.* 8vo. *Leamington*, 1818: Ed. ? 1822: Ed. iv. 12mo. 1824: Ed. ? 1830.
- MONRO, Dr. ALEXANDER.** *Remarks on Chalybeate Waters.* *Edinb. Med. Ess.* vol. iii. p. 32 [1734].

- MONRO, DR. ALEX. Treatise on Mineral Waters. 2 vols. 8vo. *London*, 1760.
- MONRO, DR. DONALD. Treatise on Mineral Waters. 2 vols. 8vo. *London*, 1770, 1777.
- On the Sulphureous Mineral Waters of Castle-Leeds and Fairburn, in Ross-shire; and of the Salt Purging Water of Pithcaithly in Perthshire, Scotland. *Phil. Trans.* (Abr.) vol. xiii, p. 271 [1772].
- MOREAU, S. A Tour to the Royal Spa at Cheltenham. 8vo. *Bath*, 1793.
- MORGAN, WILLIAM. Long Ashton; a Poem, in two Parts: descriptive of . . . the Hot Wells, &c. 8vo. *Bristol*, 1814.
- MORTON, J. C. See FRANKLAND, Dr. E.
- MORTON, J. Natural History of Northamptonshire. fo. *London*, 1712.
- MOSSMAN, G. On Scrofula, . . . the effects of Ilkley Spaw (and power of Digitalis). 8vo. *Bradford*, 1792, 1800, 1801.
- MURCH, J. Popular Guide to the use of the Bath Waters. *Bath*.
- MURCHISON, [Sir] R. I. Outline of the Geology of the neighbourhood of Cheltenham, with an account of the Origin of the Mineral Waters. 8vo. *London*, 1834. Ed. ii, by J. BUCKMAN and H. E. STRICKLAND, 1845.
- M[URE] A[NDREW]. ΠΙΔΑΞ ΠΕΤΡΕΙΑ (Pidax Petreia), or the Discovery of St. Peter's Well at Peterhead, in Scotland, showing the admirable virtues thereof against many deplorable diseases. 8vo. *Edinburgh*, 1636.
- MURRAY, Dr. JOHN. An Analysis of the Mineral Waters of Cromlix, near Dunblane, and of Pitcaithly; with general observations on the analysis of Mineral Waters, and the composition of Bath Water and some others [1814]. *Trans. R. Soc. Edinb.* vol. vii, pp. 445-493 [1815]; *Ann. Chim.* t. xcvi, pp. 217-288 [1815]; *Ann. Phil.* vol. vi, pp. 256-269, 347-363 [1815]; *Phil. Mag.* vol. xlvi, pp. 264-278 [1815]; *N. Journ. Pharm. Aerzt. Apoth. Chem.* bd. ii, pp. 387-412 [1818].
- An Analysis of Sea Water; with Observations on the Analysis of Salt Brines [1816]. *Trans. R. Soc. Edinb.* vol. viii, pp. 205-244 [1817]. *Isis Encycl. Zeit.* 1818, pp. 1924-1996; *Phil. Mag.* vol. li, pp. 10-25, 91-95.
- A General Formula for the Analysis of Mineral Waters. *Trans. R. Soc. Edinb.* vol. viii, pp. 259-280; *Ann. Chim.* sér. 2, pp. 159-184; *Ann. Chem. Phys.* bd. xxi, pp. 269-296; *Ann. Phil.* vol. x, pp. 93-98, 169-177 [1817]; *Phil. Chem. Arts*, vol. x, p. 93 [1817]; *N. Journ. Pharm. Aerzt. Apoth. Chem.* bd. ii, pp. 213-247 [1818].
- MURRAY, J. On the Discovery of Iodine and Bromine in the Mineral Waters of England. *Phil. Mag.* ser. 2, vol. vi, pp. 283, 284 [1829].
- MUSGRAVE, Dr. On Bath Water.
- MUSPRATT, Dr. J. S. Some remarks on the Bootle Water. *Pharm. Journ.* vol. ix, p. 564 [1850].
- Report and Analysis of an interesting Spring at the Orrell Colliery, Wigan. *Pharm. Journ.* vol. x, pp. 59, 60 [1851].
- Analysis of the Water of Ben Rhydding, Yorkshire. *Chem. News*, vol. ii, pp. 242, 243 [1860].
- Scarborough Spa. Analysis of the Water of these Mineral Springs. *Chem. News*, vol. vi, p. 278 [1862].

- MUSPRATT, Dr. J. S. Analysis of the Harlow Car Waters, near Harrogate. *Chem. News*, vol. ix, pp. 180, 181 [1864].
- On the Buxton Thermal Spring. *Chem. News*, vol. x, pp. 179, 180 [1864].
- Analysis of the Water of Llandudno, North Wales. *Chem. News*, vol. xi, pp. 14, 15, 35 [1865].
- Analysis of the Montpellier Saline Chalybeate Water. *Chem. News*, vol. xii, p. 37 [1865].
- The Cheltenham Saline Chalybeate Water, Harrogate. *Chem. News*, vol. xii, pp. 83, 215 [1865].
- Discovery of a new Chalybeate at Harrogate. *Chem. News*, vol. xiii, pp. 26, 27 [1866].
- 'Dr. Muspratt's Chalybeates,' in Harrogate. *Chem. News*, vol. xiii, pp. 203, 204, 224, 238, 299 [1866].
- New Analysis of the Montpellier Saline Chalybeate (Kissingen) Water at Harrogate. *Chem. News*, vol. xiv, p. 49 [1866].
- Recent Analysis of the Montpellier Saline Chalybeate (Kissingen) Spring at Harrogate. *Chem. News*, vol. xv, pp. 244, 245 [1867].
- Recent Analysis of the Water of the 'Old Sulphur Well,' Royal Pump Room, Harrogate. *Chem. News*, vol. xviii, pp. 155, 156 [1868].
- Recent Analysis of the 'Hospital Mild Sulphur Spring,' or 'Magnesia Water,' Royal Pump Room, Harrogate. *Chem. News*, vol. xviii, p. 195 [1868].
- Analysis of the Water of the Royal Sulphur Spring, Harrogate. *Chem. News*, vol. xx, pp. 26, 68 [1869].
- MYDDLETON, P. Essay on Gout . . . with Observations on the *modus operandi* of Bath Waters on gouty habits. Ed. iv, pp. 97. 8vo. Bath, 1827.
- MYRTLE, A. S. Practical Observations on the Harrogate Mineral Waters. *Glasgow Med. Journal*, vol. i, pp. 409-425 [1867], pp. 98. 8vo. London, 1867.
- NEALE, A. On the Nature and Properties of the Mineral Waters of Cheltenham. 8vo. London, 1819.
- NEALE, G. Spadacrene Eboracensis, or the Yorkshire Spaws, near Knaresborough. 1740. Inserted in Dr. Short's 'History of Mineral Waters,' q.v. p. 286.
- NESBITT, W. A Medical Guide to the principal Watering Places of Great Britain. 8vo. London, 1802.
- NESSEL, M. Treatise Concerning the Medicinal Waters of the Spa, English and French. 8vo. London, 1714. Ed. ii. 8vo. London, 1715.
- NICHOLS, WILLIAM. God's Blessing on Mineral Waters; a Sermon on John v. 4, preached at the chapel at Tunbridge Wells. 4to. 1702.
- NOAD, Dr. M. Analysis of the Bath Water. *Pharm. Journ.* vol. iii, pp. 526-532 [1844].
- Analysis of the Saline Water of Purton, near Swindon, North Wilts. *Journ. Chem. Soc.* vol. xiv, pp. 43-46 [1862].
- NORTHCOTE, A. B. On the Brine Springs of Worcestershire. *Phil. Mag.* ser. 4, vol. ix, pp. 27-35 [1855].
- On the Brine Springs of Cheshire. *Phil. Mag.* ser. 4, vol. xiv 1888.

- pp. 457–472 [1857]; *Pharm. Journ.* vol. xvii, pp. 475–481 [1858].
- NORTHCOTE, A. B. On the Water of the River Severn at Worcester. *Phil. Mag.* ser. 4, vol. xxxiv, p. 249 [1867].
- NOTT, Dr. JOHN. A Treatise on the Hot-Well Waters near Bristol. Pp. 94. 8vo. London, 1793 and 1797.
- OLIVER, G. The Mineral Springs of the Grand Anticlinal of the West Riding. *Proc. Yorksh. Geol. Soc.* vol. viii. pt. 3, p. 336 [1885].
- OLIVER, W. A Practical Dissertation on Bath Waters, of the Antiquity of Bath and its Waters, the Origin of Springs, of the Ingredients in the Waters, &c. 8vo. London, 1707: other editions, 8vo. London, 1716, 1737, 1747.
- OSANN, Prof. E. *Physikalisch-medicinische Darstellung der bekannten Heilquellen der vorzüglichsten Länder Europas.* II Bde. Pp. xviii, 462; x, 870. 8vo. Berlin, 1829. Ed. ii. III Bde. 8vo. Berlin, 1839–1843.
- OWEN, E. Observations on the Earths, Rocks, Stones, and Minerals for some miles about Bristol, and on the nature of the Hot Well. 12mo. London, 1753–4.
- OWEN, R. An Account of the Nature, Properties, and Uses of all the Remarkable Mineral Waters of Great Britain. Appended to Dr. Russell's 'Dissertation on Sea Water.' 8vo. London, 1769.
- PARKER, W. New Physiological Views, with an Appendix on the Bath Thermal Waters. 8vo. (?) Bath, 1857.
- PARKES, S. See BRANDE, Prof. W. T.
- PARKINSON, C. The Droitwich Brine Springs and Saliferous Marls. *Quart. Journ. Geol. Soc.* vol. xi, pp. 248–256 [1884].
- PAUL, J. D. Shearsby — the Cheltenham of Leicestershire. 8vo. Leicester. n. d.
- PEACOCK, Dr. JOHN. Observations upon the Composition and Uses of the Water at the New Sulphur Baths at Dinsdale, near Darlington. 8vo. London and Newcastle, 1805, 1829.
- PEARSON, Dr. G. Chymical History of the Tepid Springs of Buxton . . . with a chronological relation of the use of Buxton Water from the earliest records, &c. Pp. 327, 227, 2 vols. 8vo. London, 1784.
- Observations and Experiments for investigating the Chymical History of the Tepid Springs of Buxton, &c. . . . 2 vols. 8vo. London, 1784.
- Directions for Impregnating the Buxton Waters with its own and other Gases, and for composing Artificial Buxton Water. 8vo. London, 1784.
- PEARSON, J. A. Reports of cases treated at the Buxton Bath Charity and Devonshire Hospital. Pp. 36. 8vo. 1861.
- PEARSON, WILLIAM. Observations upon some remarkable Wells near the Sea Coast at Bighthelmstone, and other places contiguous. *Journ. Nat. Phil. Chem. Arts*, ser. 2, vol. iii, pp. 65–69 [1802].
- PEILE, H. An Analysis of Shotley Bridge Spa Water. *Journ. Soc. Chem. Ind.* vol. vi, pp. 14, 15 [1887].
- PERCIVAL, T. Essays, Medical and Experimental [Matlock Waters]. 3 vols. 8vo. 1722–1726.
- Experiments and Observations on the Waters of Buxton and Mat-

- lock. *Phil. Trans.* vol. lxxii, p. 455 [1772]. 2 vols. 8vo. London, 1772.
- PERRY, Dr. CHARLES. Inquiry into the nature and principles of the Spaw Waters. 8vo. London, 1734.
- An account of an Analysis made on the Stratford Mineral Waters, comprehending near thirty different experiments. 8vo. Northampton, 1744.
- PETER, J. A Treatise of Lewisham (but vulgarly miscalled Dulwich) Wells in Kent. 12mo. London, 1680–1.
- Dr. Peter's Judgment of Lewisham or Dullidge Water. Broadside, n. d.
- PETTY, Sir W. Some Queries whereby to examine Mineral Waters. *Phil. Trans.* (Abr.) vol. iii, p. 99.
- PHILANDER, E. A Query concerning drinking Bath Water at Bath, resolved. 8vo. London, 1673.
- PHILIP, Dr. A. P. W. Analysis of the Malvern Waters. 8vo. Worcester, 1805. 8vo. Edinburgh, 1806.
- PHILLIPS, Prof. J. The Malvern Hills, &c. *Mem. Geol. Surv.* vol. ii, part i. Springs, p. 17 [1848].
- Note on the Geology of Harrogate. *Quart. Journ. Geol. Soc.* vol. xxi, pp. 232–235 [1865].
- PHILLIPS, J. A. On the Composition and Origin of the Waters of a Salt Spring in Huel Seton Mine, with a chemical and microscopical examination of certain rocks in its vicinity. *Proc. Roy. Soc.* vol. xxi, pp. 132–134; *Phil. Mag.* ser. 4, vol. xlvi, pp. 26–36 [1873].
- Note on the Composition of certain Mine Waters. *Phil. Mag.* ser. 4, vol. xlvi, pp. 164–167 [1874].
- PHILLIPS, R. Analysis of the Hot Springs at Bath. *Phil. Mag.* vol. xxiv, p. 342–361 [1806].
- An Analysis of the Bath Water. 8vo. London, 1806 (? reprint).
- An Analysis of the Salts prepared by Mr. Henry Thompson from the Cheltenham Waters. *Ann. Phil.* vol. xi, pp. 28–31 [1818].
- Analysis of two Sulphureous Springs near Weymouth. *Phil. Mag.* ser. 3, vol. iii, pp. 158, 159 [1833].
- PHIPSON, Dr. T. L. Notes on some Analyses of Waters. *Chem. News*, vol. xl, pp. 1, 2 [1879].
- On some Water from the River Dart, which destroyed fish. *Chem. News*, vol. xl, p. 54 [1879].
- PICKFORD, Dr. Mineral Water at Nottingham. Weymouth, 1821.
- PIERCE, Dr. R. Bath Memoirs, or Observations in Three and Forty Years' Practice at the Bath, what Cures have been there wrought both by Bathing and Drinking these Waters by God's Blessing. 8vo. Bristol, 1697. 8vo. London, 1713.
- PIGGOTT, Dr. G. W. On the Harrogate Spas. 8vo. London, 1853. Ed. ? pp. 280. 12mo. London, 1856. Ed. iv, 1865.
- PILKINGTON, JAMES. The Present State of Derbyshire, with an Account of its most Remarkable Antiquities, Natural History of the Medicinal Waters of Buxton and Matlock, by Dr. ERASMUS DARWIN. 2 vols. 8vo. 1803.
- PINKS, W. J. Clerkenwell, . . . the Clerks' Well . . . 4to. London, 1881.
- PLANCHE, LOUIS ANTOINE. Notice sur les différents Sels de Cheltenham

- usités en Angleterre, et sur les Eaux de Cheltenham. *Journ. Pharm. sér. 2, t. vi, pp. 497–501* [1820].
- PLANT, JAS. Report (to the Local Board of Health) on the Water Supply, for the Town of Hinckley, Leicestershire, from the Underground Sandstones of the Triassic Formation. Pp. 12. 8vo. *Hinckley*, 1879.
- PLATTS, J. C. Analysis of Water from the Roundwood Colliery, Parkgate, near Rotherham. *Journ. Soc. Chem. Ind. vol. vii, pp. 729, 730* [1888].
- PLAYNE, G. F. On the Recent Calcareous Deposits of the Cotteswolds. [Tufa Springs.] *Proc. Cotteswold Nat. Club, vol. vi, pp. 81–89* [1874].
- PLOT, Dr. R. De Origine Fontium. Tentamen Philosophicum. 8vo. *Oxford*, 1685.
- PLUNKETT, W., and L. STUDDERT. Report on the Solid and Gaseous Constituents of the Mallow Spa in the County of Cork. *Proc. R. Irish Ac. ser. 2, vol. i, p. 75* [1877].
- PLUNKETT, W. See STUDDERT, L.
- POSTLETHWAITE, J. The Mineral Springs near Keswick. *Trans. Cumb. Assoc. no. xi. pp. 142–145* [1887].
- POWELL, R. H. Medical Topography of Tunbridge Wells. 12mo. *Tunbridge Wells*, 1846.
- POWNALL, H. Some Particulars relating to the History of Epsom, with the Origin of Horse-racing, the Mineral Waters, &c. 8vo. *Epsom*, 1825.
- PRAT, Dr. E. A short Treatise of Metal and Mineral Waters. 12mo. *London*, 1684.
- A brief account of the rise, progress, and patronage of the Leamington Spa Charity . . . with general rules for drinking the Leamington Waters. 8vo. *Birmingham*, 1812. Republished with additions under the title of ‘A Local and Literary Account of Leamington.’ 1814.
- On the Waters of Tonbridge.
- PRESTWICH, Prof. J. On the Mineral Water discovered in sinking the Artesian Well at St. Clement’s, Oxford, and on certain Geological Inferences suggested by the Character of the Water. *Proc. Ashmolean Soc., 1876*.
- Geology, vol. i, Chemical and Physical. 8vo. *London*, 1886.
- PRICHARD, T. J. L. The Llandrindod Guide, including the Wells of Llandegley and Blaenwdwy. 12mo. *Hay*, n. d.
- The New Guide to Aberystwith. 8vo. *Aberystwith*, 1824.
- PRYOR, R. A. On the supposed Chalybeate Spring at Watford, and on other Medicinal Waters in Herts. *Trans. Watford Nat. Hist. Soc. vol. i, pt. 4, pp. 109–111* [1876].
- PRYSE, JOHN. See JONES, J. R.
- PUGH, R. Bathoniensium et Aquisgranensium Thermarum Comparatio. 12mo. *London*, 1676.
- QUINTON, Dr. J. Practical Observations in Physick, but especially of the Nature of Mineral Waters and Metallick Medicines. 8vo. *London*, 1711.
- De Thermis; or, of Natural and Artificial Baths. 4to. *London*, 1726.
- Treatise of the Mineral Waters, particularly of Bath and Somersetshire. 8vo. *London*, 1733.

- QUINTON, Dr. J. A Treatise of Warm Bath Water, and of Cures made lately at Bath, in Somersetshire. 4to. *Oxford*, 1733-4.
- RADCLIFFE, Dr. C. B. A New Departure in Science. [Notes on Bath Waters.] 8vo. *London*, 1886.
- RANDALL, J. The Burning Well at Broseley. *Geol. Mag.* vol. ii, p. 232 [1865].
- RANDOLPH, Dr. G. Inquiry into the medicinal virtues of Bristol Water, and the indications of cure which it answers. 8vo. *London*, 1745. Ed. 8vo. *London*, 1750.
- Enquiry into the Virtues of Bath Waters. 8vo. *London*, 1752.
- RANSOME, THOS. Analysis of a Saline Spring in a Lead Mine near Keswick. *Mem. Lit. Phil. Soc. Manch.* ser. 2, vol. viii, pp. 399-401 [1848].
- RASTELL, Dr. TH. Account of the Salt Springs and Salt Making at Droitwich, in Worcestershire. *Phil. Trans.* (Abr.) vol. ii, p. 463 [1678].
- An Account of the Salt Waters of Droitwich, in Worcestershire. *Phil. Trans.* vol. xii (no. 142), p. 1059 [1679].
- RAWSON, —. Lichfield Mineral Waters, their History and Influence. 8vo. 1840.
- RELHAN, A. A Short History of Brighthelmston, with Remarks on its Air, and an Analysis of its Waters. 8vo. *London*, 1761, 1829.
- REYNOLDS, THOMAS. Some Experiments on the Chalybeate Water lately discovered . . . at Bromley, in Kent, with Observations on Chalybeate Waters in general, and the most successful method of drinking them. 8vo. *London*, 1756.
- ROBERTSON, W. Analysis of the Water of a Spring on the estate of Tordel, near Inverkeithing, 1829. *Edinb. N. Phil. Journ.*, vol. vii, pp. 99-111 [1829].
- ROBERTSON, W. H. Buxton and its Waters, an Analytical Account of their Medicinal Properties and Effects. Pp. 147. 12mo. *London*, 1838.
- A Guide to the Use of Buxton Waters. Ed. iii. (?) pp. 31. 8vo. *London*, 1846. Ed. xviii, 12mo. *Buxton*, 1874. Ed. ?, pp. 40. 8vo. *London*, 1882.
- A Letter to Dr. Lyon Playfair; being a Medical Commentary on the results of the recent analysis of the Buxton Tepid Water Pp. 19. 8vo. *London*, 1852.
- A Handbook to the Peak of Derbyshire, and to the Use of the Buxton Mineral Waters. 8vo. *London*, 1854.
- ROGER, C. A Week at the Bridge of Allan, comprising an account of Airthrey Spa. 8vo. 1852. Ed. ii. 1858.
- ROSCOE [Sir], H. E. Note on the Existence of Lithium, Strontium, and Copper in the Bath Waters. *Chem. News*, vol. x, p. 158 [1864]; *Rep. Brit. Assoc. for 1864, Sections*, p. 41 [1865].
- ROSE, Dr. HUGH. On the Acid Waters of Croneban.
- ROTUREAU, A. Des Principales Eaux Minérales de l'Europe. 3 t. Allemagne et Hongrie: France: France (suppl.), Angleterre, Belgique, Espagne et Portugal, Italie, Suisse. 8vo. *Paris*, 1858, 1859, 1864.
- ROWNEY, T. H. See ABEL, F. A.
- ROWZEE, Dr. L. The Queene's Welles: that is, a Treatise on the nature and virtues of Tunbridge Water, together with an enumeration of

- the chiefest diseases which it is good for, and against which it may be used, and the manner and order of taking it. Sm. 8vo. London, 1632. Ed. ii, pp. 82. 12mo. [1656] *Harleian Miscell.* vol. viii [1670].
- ROWZEE, Dr. L. Tunbridge Wells: or, a Directory for the Drinking of those Waters. Appendix. Mr. Boyle's Observations upon the Tunbridge Waters. 8vo. London, 1725.
- RUFF, —. History of Cheltenham and its Environs, including an Inquiry into the Nature and Effects of the Mineral Waters. 8vo. Cheltenham, 1803.
- RUSSELL, Dr. R. Dissertation on the Use of Sea-water. 8vo. Oxford, 1753 (see under Anonymous Works, 1755). Ed. ? with An Account of the Nature, Properties, and Uses of all the remarkable Mineral Waters of Great Britain, by R. OWEN. 12mo. London, 1760. Ed. v, 8vo. London, 1769.
- RUTTY, Dr. J. A methodical Synopsis of Mineral Waters, comprehending the most celebrated Medicinal Waters, both cold and hot, of Great Britain, Ireland. . . . 4to. London, 1757. Pp. 478. 8vo. Dublin, 1757. Ed. ? 1761: 4to. 1767.
- Examination of (Lucas's) Analysis of Ruddy on Mineral Waters. 8vo. London, 1758.
- Thoughts on the different Impregnation of Mineral Waters; more particularly on the existence of Sulphur in some of them. *Phil. Trans.* 1759, p. 392.
- Of the Vitriolic Water of Amlwch, in the Isle of Anglesey, with occasional Remarks on the Hartfell Spaw . . . and their Comparison with other Waters of the same class. *Phil. Trans.* vol. li, p. 470 [1761].
- Argument of Sulphur or no Sulphur in Waters discussed, with a comparison of the Waters of Aix-la-Chapelle, Bath, and Bristol, &c. 8vo. Dublin, 1762.
- Natural History of the County of Dublin . . . and of some lately discovered Mineral Waters, particularly the Sulphureous Water at Lucan, and its medicinal virtues, &c. 2 vols. 8vo. Dublin, 1772.
- RYAN, Rev. J. The History of Shotley Spa, and of the Vicinity of Shotley Bridge. 8vo. 1841.
- RYAN, Dr. M. Treatise on the most celebrated Mineral Waters of Ireland, &c., and of the Spa, lately discovered at Brownstown, near Kilkenny. 8vo. Kilkenny, 1824.
- SAINTER, J. D. A Salt Spring in a Coal Mine. *Geologist*, vol. iv, p. 398 [1861].
- SAUNDERS, Dr. W. A Treatise on the Chemical History and Medical Powers of some of the most celebrated Mineral Waters; with Practical Remarks on the Aqueous Regimen. 2 vols. 8vo. London, 1800. Ed. ii, 8vo. [1805].
- SCHMIBSER, J. G. Description of Kilburn Wells, and Analysis of their Water. *Phil. Trans.* vol. lxxxii, p. 115 [1792].
- SCHOFIELD, J. An historical and descriptive Guide to Scarborough. Pp. 192. 8vo. York, 17—.
- SCHWEITZER, EDW. G. Analysis of the Bonnington Water, near Leith. Scotland. *Mem. Chem. Soc.* vol. ii, pp. 201–217 [1843]; *Phil. Mag.* vol. xxvi, pp. 297–314 [1845].

- SCUDAMORE, Dr. C. An Analysis of the Mineral Waters of Tunbridge Wells . . . 8vo. *London*. 1816.
- A Chemical and Medical Report of the Properties of the Mineral Waters of Buxton, Matlock, Tunbridge Wells, Harrogate, Bath, Cheltenham, Leamington, Malvern, and the Isle of Wight. 8vo. *London*, 1820.
- Analysis and medical properties of the Tepid Springs of Buxton, 8vo. *London*, 1833. Ed. iii [1839].
- SEEKAMP, H. [Ipswich Spa—reply to Inquirenda] *East Anglian*, 1814, p. 110.
- See ANON. 1814.
- SENKENBERG, C. H. An Examination of the Cheltenham Mineral Water. *Phil. Trans.* (Abr.) vol. viii, p. 523 [1741]: vol. xli, p. 830 [1744].
- SHADWELL, T. Epsom Wells: A Comedy. 4to. *London*, 1676, 1683.
- SHAPTER, Dr. T. The Climate of the South of Devon and its Influence upon Health. 8vo. *London*, 1842. Ed. ii, 1872. [Springs, pp. 96–98.]
- SHAW, P. Enquiry into the virtues, &c., of the Scarborough Spaw Waters. 8vo. *London*, 1734. Appended to his translation of 'Hoffmann on Mineral Waters.' *London*, 1743.
- [ANONYMOUSLY] A Dissertation on the Contents, Virtues, and Uses of Cold and Hot Mineral Springs; particularly those of Scarborough. 8vo. *London*, 1735.
- SHEBBEARE, J. A new Analysis of the Bristol Waters. 8vo. *London*, 1740.
- SHIERCLIFF, E. Bristol and Hot Wells Guide. . . . 8vo. *Bristol*, 1793.
- SHOBERL, F. Account of the Mineral Waters, Soils, &c., of Surrey and Sussex in vol. xiv of *The Beauties of England and Wales*, 1813.
- SHORT, Dr. R. Περὶ Ψυχροποσίας, Of Drinking Water against our Novelists that prescribed it in England: whereunto is added, Περὶ Θερμοποσίας, Of Warm Drink, and is in Answer to a Treatise of Warm Drink, printed at Cambridge. Pp. xxxii, 173. Sm. 8vo. *London*, 1656.
- SHORT, Dr. T. Memoirs of the Natural History of Medicinal Waters. 8vo. *London*, 1709.
- The Natural, Experimental, and Medicinal History of the Mineral Waters of Derbyshire, Lincolnshire, and Yorkshire, particularly those of Scarborough. . . . 4to. *London*, 1734. 2 vols. [1752].
- An Essay towards a Natural, Experimental, and Medicinal History of the Principle Mineral Waters of Cumberland, Northumberland, Westmoreland, Bishop-prick of Durham, Lancashire, Cheshire, Staffordshire, Shropshire, Worcestershire, Gloucestershire, Warwickshire, Northamptonshire, Leicestershire, and Nottinghamshire, particularly those of Nevill Holt, Cheltenham, Weatherslack, Hartlepool, Astrope, Cartmell, &c. 4to. *Sheffield*, 1740.
- [ANONYMOUS] A General Treatise on various Cold Mineral Waters in England, but more particularly on those at Harrogate, Thorp-Arch, Dorst Hill [Tamworth], Wigglesworth [Ribblesdale, Yorkshire], Nevill-Holt [Leicestershire]. Pp. viii, 248, 8vo. *London*, 1765.

- SHORT, Dr. T. Treatise on the different sorts of Cold Mineral Waters in England. 8vo. *London*, 1766.
- SIGMOND, G. G. De Aquis thermalibus apud Bathonias. 8vo. *Edinburgh*, 1814.
- SIMPSON, Dr. W. Hydrologia Chymica, or the Chymical Anatomy of Scarborough and other Spaws in Yorkshire. 8vo. *London*, 1669.
- Hydrological Essays: or a Vindication of Hydrologia Chymica. Being a further Discovery of the Scarbrough Spaw and of the Sweet Spaw and Sulphur Well at Knaresborough: with a brief Account of the Allom Works at Whitby. 8vo. *London*, 1670.
- Zymologia Physica, . . . with an additional Discourse of the Sulphur Bath at Knaresborough. 8vo. *London*, 1675.
- A Philosophical Discourse of Fermentation . . . Production of many Acidulous or Spaw Waters. Pp. 151. 8vo. 1675.
- The History of Scarbrough Spaw. 12mo. *London*, 1679.
- SKERTCHLY, S. B. J. Supposed Thermal Springs near Chatteris. Pp. 243–246 of the Geology of the Fenland. *Geological Survey Memoir*. 8vo. *London*, 1877.
- SKEYNE, Dr. G. Ane Breif Descriptioun of the qualities and effectis of the well of the woman hill besyde Abirdene (Well of Spa). Pp. 8. 4to. 1580. Reprinted by the Bannatyne Club, 1860.
- SLARE, Dr. FREDERIC. An Examen of the Chalybeate or Spa Waters. *Phil. Trans.* (Abr.) vol. vi, p. 61 [1713].
- SLEIGH, W. W. Treatise on the Waters of Dorton. 8vo. [1824]
- SMITH, A. The Harrogate Medical Guide: a popular and practical Treatise on the Mineral Waters of Harrogate. 8vo. *Ripon*, 1842. Ed. ii, 8vo. *London*, 1847.
- SMITH, H. Treatise on the Mineral Spring, at the New Tonbridge Wells, near Islington, with Rules for Drinking the Waters, &c. 8vo. *London*, 1751. Ed. vii, pp. 36. 8vo. *Islington*, 17—.
- On the use and abuse of Mineral Waters: also Rules necessary to be observed by individuals who visit the Chalybeate Spring of the Old and New Tunbridge Wells. 8vo. *London*, 1760; 8vo. *London*, 1776.
- An Essay on the Nerves, . . . with Observations on Mineral Waters . . . 8vo. *London*, 1794.
- SMITH, J. On the use and abuse of Cheltenham Waters. 8vo. *Cheltenham*, 1786. Ed. ii. 8vo. *Cheltenham*, 1796. Ed. iii. 1800. French transl. by F. Le Breton. 8vo. *Paris*, 1789.
- SMOLLETT, Dr. TOBIAS. An Essay . . . method of using the Mineral Waters of Bath. 4to. *London*, 1752.
- An Essay on the External use of Water, with particular Remarks on the Mineral Waters of Bath. 4to. [1770].
- SMYTH, [Sir] W. W. On the Thermal Water of the Clifford Amalgamated Mines of Cornwall. With an Analysis by Prof. W. A. MILLER. *Mining Smelting Mag.* vol. vi, pp. 193–196; and *Rep. Brit. Assoc.* 1864, *Sections*, p. 70 [1865].
- SOAME, J. Hampstead Wells, or Directions for drinking those Waters. 8vo. *London*, 1734.
- SPENDER, Dr. J. K. The Bath Thermal Waters, historical, social, and medical. 8vo. *Bath*, 1877; *London*, 1878 and 1882.
- The Bath Thermal Waters, and Bath as a Health Resort. Pp. 163–179 of Handbook to Bath (*Brit. Assoc.*). 8vo. *Bath*, 1888.

- SPRANGE, J. Tunbridge Wells Guide. 8vo. *Tunbridge Wells*, 1797.
- SPRY, J. H. Practical Treatise on the Bath Waters, and their effects on Chronic Diseases, with a brief account of the City, Hot Springs, &c. 8vo. *London*, 1822.
- STANHOPE, MICH. Newes out of Yorkshire, or an Account of a journey in the true discovery of Soueraigne Minerall Medicinall Water, near Knaresborough, not inferior to the Spa in Germany. 4to. *London*, 1627.
- Cures without Care . . . by vertue of Minerall Waters neare Knaresborow. 4to. *London*, 1632.
- STEVENS, Dr. J. N. A Treatise on the Medicinal Qualities of the Bath Waters. 8vo. *London and Bristol*, 1758.
- STOKES, A. H. Economic Geology of Derbyshire. *Trans. Chesterfield Inst. Eng.* vol. vi [1878].
- STOOKE, T. S. On a Bore-hole near Hinckley, Leicestershire. *Min. Proc. Inst. Civ. Eng.* vol. xc, pp. 28–32 [1887].
- STRAHAN, A. Warm-springs. Pp. 114–117 of ed. ii. of the Geology of the Carboniferous Limestone . . . of North Derbyshire. Geological Survey Memoir. 8vo. *London*, 1887 (not in ed. i.)
- Mineral Springs. Pp. 208–210 of the Geology of the Country around Lincoln. *Geological Survey Memoir*. 8vo. *London*, 1888.
- STRANGWAYS, C. F. The Harrogate Wells, or the Mineral Waters of Harrogate geologically considered. *Proc. Yorksh. Geol. Soc.* vol. viii, pt. 3, p. 318 [1885].
- A. C. G. CAMERON, and G. BAEROW. The Geology of the Country around Northallerton and Thirsk. (Mineral Springs, pp. 8, 15.) *Geological Survey Memoir*. 8vo. *London*, 1886.
- STUBBS, H. Directions for drinking of the Bath-water, &c.; in 2nd and later ed. of Select Observations on English Bodies of Eminent Persons in Desperate Diseases, by J. HALL. Ed. ii, 8vo. *London*, 1679. Ed. iii [1683].
- STUDDERT, L., and W. PLUNKETT. On the Constituents of the two principal Mineral Waters of Lisdoonvarna, County of Clare. *Proc. R. Irish Ac.* ser. 2, vol. ii, pp. 189–192 [1875].
- STUDDERT, L. See PLUNKETT, W.
- SUTHERLAND, Dr. A. The Nature and Qualities of Bristol Water; . . . with practical reflections on Bath-Waters. . . . 8vo. *Bristol*, 1758.
- An Attempt to ascertain and extend the Virtues of Bath and Bristol Waters by Experiments and Cases. 12mo. *London*, 1764.
- Attempts to revive antient Medical Doctrines. 1. Of Waters in general. 2. Of Bath and Bristol Waters in particular. . . . 2 vols. 8vo. *London*, 1763.
- SWALLOW, ELLEN H. On the occurrence of Boracic Acid in Mineral Waters. *Proc. Boston Nat. Hist. Soc.* vol. xvii, pp. 428–430 [1875].
- TAAFE, —. On the Mineral Spring at Ballyspellan. 1724.
- TAUNTON, JOHN H. Some Notes on the Hydrology of the Cotteswolds and the District around Swindon. [Swindon Mineral Water.] *Proc. Cotteswold Nat. Club*, vol. vi, pp. 52–71 [1887].
- TAVERNER, J. An Essay upon the Witham Spa . . . Pp. 64. 8vo. *London*, 1737.

- TAYLOR, J. Medical Treatise on the virtues of St. Bernard's Well (in Edinburgh). 8vo. *Edinburgh*, 1790.
- THOMAS, J. Practical Observations on Chronic Affections of the Digestive Organs, and on Biliary and Nervous Disorders, with Remarks on Mineral Waters. 8vo. *Cheltenham*, 1820. Ed. ii. Pp. 168. 8vo. *London*, 1821. Ed. iii, 8vo. *London*, 1827.
- THOMAS, J. W. On the Water of Taff's Well [near Cardiff]. *Trans. Cardiff Nat. Soc.* vol. ix, pp. 48-52 [1878].
- THOMPSON, B. The Middle Lias of Northamptonshire. Part iv. The Middle Lias Considered as a Source of Water Supply. General Failure of Deep Springs, . . . *Midl. Nat.* vol. x, pp. 34-41, 55-58, 97-100, 109-113, 175-179, 204-207, 230-236, 250-255, 288-293, 302-305, pts. ii, iii [1887].
- THOMPSON, H. Cheltenham Waters. *Quart. Journ. Sci.* vol. iii, p. 380 [1817].
- THOMPSON, Rev. J. H. Address. On Salt, at the Droitwich Field Meeting . . . (Brine Springs . . .). *Proc. Dudley Geol. Soc.* vol. 3, no. 5, p. 126 [1877].
- The Origin of Salt Springs. *Proc. Dudley Geol. Soc.* vol. 4, no. i, p. 10 [1880].
- THOMSON, Dr. A. Inquiry into the Natural History and Medicinal Virtues of several Mineral Steel Waters. *Edinb. Med. Ess.* vol. ii, p. 48 [1733].
- Inquiry into the Mineral Principles of Montrose Waters. *Edinb. Med. Ess.* vol. iii, pp. 60, 96.
- THOMSON, J. Analysis of the Tunbridge Wells Water. *Journ. Chem. Soc.* vol. x, pp. 223-229 [1858].
- THOMSON, ROBT. DUNDAS. Examination of the Water of the North Well at Scarborough. *Rec. Gen. Sci.* vol. iv, pp. 53, 54 [1836].
- THOMSON, T. Analysis of the Water of Nutshell Spring [near Neilston]. *Rec. Gen. Sci.* vol. iii, pp. 418, 419 [1836].
- THORPE, T. E. Analysis of the Water of the Holy Well, a Medicinal Spring at Humphrey Head, N. Lancashire. *Journ. Chem. Soc.* vol. xxi, pp. 19-25 [1868].
- A Contribution to the History of the Old Sulphur Well, Harrogate. *Phil. Mag.* ser. 5, vol. ii, pp. 50-58 [1876].
- Contributions to the History of the Mineral Waters of Yorkshire. *Journ. Chem. Soc.* vol. xxxix, pp. 497-516 [1881].
- THRESH, Dr. J. C. Chemical Examination of the Buxton Thermal Water. *Journ. Chem. Soc.* vol. xxxix, pp. 388-399, 1881; vol. xli, pp. 117-132 [1882].
- The Orchard Alum Spring, Derbyshire. *Pharm. Journ.* ser. 3, vol. xiii, p. 361; *Chem. News*, vol. xlvi, p. 227 [1882].
- The New Analysis of the Buxton Thermal Water. *Chem. News*, vol. xlvi, pp. 201-204 [1882].
- Buxton as a Health Resort, . . . with a Full Account of its celebrated Mineral Waters. 8vo. *Buxton*, 1883.
- TICHBORNE, C. R. C. On some Peculiarities of the Vartry Water. *Chem. News*, vol. xxxviii, p. 191; *Rep. Brit. Assoc.* for 1877, pp. 517, 518 [1878].
- and P. JAMES. The Mineral Waters of Europe. 12mo. *London*, 1883.
- TILLY, H. Particulars of a Thermal Spring at Wheal Seton Mine in the Parish of Camborne, with a Comparative Table of Analyses of

similar Springs in the United, Balleswidden, Botallack, and Crown Mines. *Rep. Miners' Assoc. Cornw. Dev.* 1872-3, pp. 53-56 [1873].

- TODD, H. An Account of a Salt Spring, and another Medicinal Spring, on the banks of the River Weare or Ware. *Phil. Trans.* vol. xiv (no. 163), p. 726 [1684].
- Account of a Salt Spring in the Bed of the River Wear, in the County of Durham. *Phil. Trans.* (Abr.) vol. iii. p. 78 [1684].
- TONSTALL, Dr. G. Scarbrough Spaw spagyrically anatomized. 12mo. London, 1670.
- TOPLEY, WILLIAM. The Geology of the Weald. (Springs and Mineral Waters, pp. 352-366.) 8vo. London.
- TOURNEFORT, JOSEPH PITTON DE. *Materia Medica*; . . . with an Appendix concerning the Nature and Uses of Mineral Waters. 8vo. [1708.]
- TOVEY, T. Cheltea, a Descriptive Poem, wherein the Genius of the Cheltenham Springs is supposed to Describe the Virtues of the Waters with Walks and Rides in the Vicinity, with Notices of Eminent Characters. 8vo. [1818].
- TREVELYAN [Sir], W. C. Salt Spring of Birtley in Durham. *Edinb. N. Phil. Journ.* vol. xi, p. 389 [1831].
- TRINDER, Dr. W. M. An Inquiry by Experiments into the Properties and Effects of the Mineral Waters in the County of Essex. 8vo. London, 1783.
- Chemical Experiments on the Barnet Well Water. Pp. 14. 8vo. London, 1800.
- The English Olive-Tree . . . Ed. ii, with Analysis of the Barnet Well Water. 8vo. London, 1804, 1812.
- TUNSTALL, J. The Bath Waters, their uses and effects in the cure and relief of various Chronic Diseases. Pp. 144. 8vo. London, 1850. Ed. ii, pp. 167 [1860]. Ed. iii [1864]. Ed. iv, pp. 164 [1867]. Ed. v, pp. 175 [1879].
- TURNER, EDW. On the presence of Iodine in the mineral spring of Bonnington, near Leith. *Edinb. New Phil. Journ.* vol. i, pp. 159-161 [1826].
- TURNER, T. An Analysis of Water from Salt Wells, near Dudley. *Proc. Birmingham Phil. Soc.* vol. iv, p. 38-43 [1884].
- TURNER, Dr. W. A Book of the bath of Bath in England and of the Virtues of the same with diverse other baths most wholesome and effectual both in Almagny and England. [Annexed to the Second Part. of his Herbal.] Fo. *Cologne*, 1562, 1568.
- TYTLER, J. Experiments on Newcastle-on-Tyne Waters. 1760, 1769, 1770
- UNDERHILL, J. *Johannis Subtermontani Thermologia Bristolensis*, or Underhill's short account of the Bristol Hot Well Water, its uses and historical cures. 8vo. *Bristol*, 1703.
- URE, Dr. A. Analysis of the Moira Brine-spring near Ashby-de-la-Zouche, Leicestershire; with Researches on the Extraction of Bromine. *Phil. Trans.* vol. cxxiv, pp. 577-589 [1834].
- Analysis of the Bromine Mineral Spring or Well of Tenbury, Worcestershire. *Pharm. Journ.* vol. viii, pp. 128-130 [1849].
- VENNER, Dr. T. *Via Recta ad Vitam Longam* . . . to which is annexed a Treatise of the famous Baths of Bathe, and on the Waters of

- St. Vincent's Rock, near Bristol. 4to. [1628, 1650, 1660. The Treatise is reprinted in *Harleian Miscell.* t. ii, p. 295.]
- VICARY, T. The Englishman's Treasure, with the true Anatomy of Man's Body; with the rare treasure of the English Bathes, by WILLIAM TURNER, gathered and set forth for the benefit of the poorer sort of people by WILLIAM BREMER; augmented by G. E. **Black Letter.** 4to. London, 1626.
- VOELCKER, Dr. A. On the Proportion of Phosphoric Acid in some Natural Waters. *Rep. Brit. Assoc.* for 1850, *Sections*, p. 63 [1851].
- On the Composition of Purton Saline Water. *Journ. Chem. Soc.* vol. xiv, pp. 46, 47 [1862].
- WADE, W. M. Delineations of the Watering and Sea-bathing places of Scotland, &c. 12mo. Paisley and Edinburgh, 1823.
- WAHLENBERG, Dr. G. Observations on the Heat of Springs. . . . *Ann. Phil.* vol. iv, p. 22 [1814].
- WALCKER, A. Analysis of the Mineral Water of Bath. *Quart. Journ. Sci.* 1829, p. 78-289.
- Analyses of two Mineral Springs in Windsor Forest. *Quart. Journ. Sci.* 1829, pp. 89, 90.
- WALKER, J. Dissertatio Chimica Inauguralis. De Aquâ Sulphureâ Harrowgatensi. 8vo. Edinburgh, 1770.
- An Essay on the Waters of Harrowgate and Thorp-Arch, in Yorkshire. . . . Observations on Mineral Waters in general, and the method of analysing them. 8vo. London, 1784.
- WALKER, T. D. Facts relative to the Medical Properties of the Dimsdale and Croft Sulphur Springs. Ed. iii, 12mo. Darlington, 1835.
- WALL, Dr. J. Experiments and Observations on the Malvern Waters. 8vo. Worcester, 175-. Ed. ii, 8vo. Worcester, 1757. Ed. iii, 8vo. Worcester, 1763. Republished in 'Medical Tracts,' 1760.
- An Essay on the Waters of the Holy Well at Malvern, Worcestershire. *Phil. Trans.* (Abr.) vol. x, p. 673 [1755].
- An Essay on the Waters of the Holy Well at Malvern, Worcestershire. *Phil. Trans.* vol. xlix, pt. 2, p. 459 [1757]. Republished privately 1780.
- On the Good Effects of Malvern Waters, in Worcestershire. *Phil. Trans.* (Abr.) vol. xi, p. 68 [1757].
- Medical Tracts, . . . On Malvern Waters. Published posthumously by Dr. MARTIN WALL. 8vo. Oxford, 1780. This tract republished with Notes by Dr. M. WALL. 8vo. [1806]
- WARING, Dr. E. J. Bibliotheca Therapeutica or Bibliography of Therapeutics, chiefly in reference to articles of Materia Medica, with Critical, Historical, and Therapeutical Notes, and a Bibliography of British Mineral Waters. 2 vols. 8vo. London [1879].
- WARNER, Rev. R. The History of Bath. 4to. Bath, 1801. [Mineral Waters, p. 373.]
- WATERWORTH, Dr. T. L. Account of a Chalybeate Spring in the Isle of Wight. *Ann. Phil.* ser. 1, vol. i, p. 447-450 [1813].
- Letter on the Aluminous Chalybeate Water at Sand Rocks, Isle of Wight. Pp. 28. 12mo. *Isle of Wight*, 1817.
- [WATSON], R. Observations on the Sulphur Wells at Harrogate. *Phil. Trans.* vol. lxxvi, p. 171 [1786].
- Chemical Essays. 12mo. [1789]

- WATSON, W. H. Analysis of Chalybeate Water from a Spring at Sellafield, near Whitehaven. *Chem. News*, vol. xxxii, p. 11 [1875].
- WEATHERHEAD, Dr. G. H. Analysis of the Leamington Spa in Warwickshire, with Remarks on its Uses and Medicinal Qualities. Ed. ii. 8vo. London, 1820.
- An Account of the Royal Beulah Saline Spa at Norwood, Surrey. Pp. 39. 8vo. London, 1832. Ed. v, 1835. Ed. ? 1852.
- WELDON, W. Analysis of a Mineral Water near Dudley, in Worcester-shire. *Journ. Nat. Phil. Chem. Arts*, ser. 2, vol. xxii, p. 266–270 [1809].
- WEST, W. Analysis of a new Sulphur Spring at Harrogate. *Quart. Journ. Sci.* vol. xv, pp. 82–89 [1823].
- Analysis of a newly-discovered Spring at Stanley, near Wakefield. *Quart. Journ. Sci.* vol. ii, p. 21–25 [1827].
- On Mineral Springs and other Waters of Yorkshire (Overflowing Well, Stanley, &c.). *Rep. Brit. Assoc. for 1844, Sections*, pp. 105–112 [1845].
- WESTRUMB, J. F. Observations on Sulphureous Mineral Waters. *Journ. Phil. Chem. Arts*. vol. xviii, p. 40 [1807].
- WHITELEY, R. L. Analysis of the Kissingen Saline Chalybeate Water, 1883 [Harrogate], as compared with Analyses in 1845, 1867, and 1879. *Proc. Yorksh. Geol. Soc.* vol. viii, pt. 3, pp. 366–370 [1885].
- WILLAN, Dr. R. Observations on the Sulphur Water at Croft, near Darlington. 8vo. London, 1782, 1802. Ed. ii (different title), [1786].
- WILLIAMS, A. WYNN. King Arthur's Well, Llanddeiniolen, near Caernarvon: a Chalybeate Spring. 12mo. *Caernarvon*, 1858.
- WILLIAMS, G. A. New Guide to Cheltenham . . . embracing a minute account of the virtues and qualities of its Mineral Waters. 12mo. *Cheltenham*, 1824.
- WILLIAMS, J. On Sea Bathing, and on Baths and Mineral Waters. 12mo. *Portsmouth*, 1820.
- WILLIAMS, R. An analysis, &c., of the medicinal Waters of Llandrindod, in Radnorshire, with observations on the diseases to which they are applicable. Pp. 128. 8vo. London, 1817.
- WILLIAMS, S. An Experimental History of Road Water in Wiltshire. 8vo. London and Bath, 1731.
- WILLIAMS, T. E. Observations on the Properties of the Chalybeate Spring at Caversham, near Reading. 8vo. London (?), 1808.
- WILLIAMSON, Professor A. W. On the Composition of the Gases evolved by the Bath Spring called King's Bath. *Rep. Brit. Assoc. for 1865*, p. 380 [1866].
- WILLICH, A. F. M. A comparative view of the chemical and medicinal properties of the Bristol Hot-well Water. 8vo. London, 1798.
- WILSON, Dr. A. Bath Waters; a Conjectural Idea of their Nature and Qualities; . . . 8vo. London, 1788.
- WILSON, Dr. A. P. See PHILIP, Dr. A. P. W.
- WILSON, Dr. E. Spadacrene Dunelmensis: or a short Treatise of an Ancient Medicinal Fountain or Vitrioline Spaw near the City of Durham. Together with the Constituent Principles, Virtues, and Use thereof. Pp. xxix, 88. 8vo. London, 1675. 12mo.

- WITTIE, Dr. R. Scarbrough Spaw: or a Description of the Nature and Vertues of the Spaw at Scarbrough in Yorkshire. With Historical Relation of Cures. 12mo. *York*, 1660. Ed. ii, 8vo. *York*, 1667.
- Pyrologia Mimica; or an Answer to Hydrologia Chymica of W. Simpson, in Defence of Scarborough Spaw; . . . A Discourse about the Original of Springs. 8vo. *London*, 1669.
- Scarbrough's Spagyrical Anatomizer dissected. 12mo. *London*, 1672.
- Fons Scarburgensis, sive Tractatus de omnis aquarum generis origine et usu; . . . 8vo. *London*, 1678.
- WOOD, EDW. P., and THOS. CUTTS. Analysis of a Mineral Water from Titwood, near Pollockshaws. *Proc. Phil. Soc. Glasgow*, vol. ii, pp. 261, 262 [1847?].
- WOOD, JOHN. Description of Bath . . . its Mineral Waters . . . 2 vols. 8vo. *London*, 1769.
- Description of the Hot Bath at Bath; . . . fo. *London*, 1778.
- WOOD, Dr. LOFTUS. The Valetudinarian's Companion; . . . with the Medical Properties of the Sea, and Mineral Waters of Brighthelmstone. 8vo. *London*, 1782.
- WOODWARD, HORACE, B. Geology of East Somerset and the Bristol Coalfields. *Geological Survey Memoir*. 8vo. *London*, 1876. Thermal and Mineral Springs, pp. 183-186.
- The Noteworthy Springs and Spas of Norfolk. *Trans. Norfolk Nat. Soc.* vol. iii, pp. 318-352 [1882]; pp. 525, 526 [1883]; p. 789 [1884].
- The Geology of the Country around Fakenham, &c. *Geological Survey Memoir*. 8vo. *London*, 1884.
- Account of a Well-sinking made by the Great Western Railway Company at Swindon. *Quart. Journ. Geol. Soc.* vol. xlii, pp. 287-308 [1886].
- The Geology of England and Wales. Ed. ii. 8vo. *London*, 1887. (Mineral Springs, pp. 534-540.)
- WOOLNORTH, J. C. Analysis of the Holy Well water, near Cartmell, Lancashire. *Quart. Journ. Sci.* vol. xviii, pp. 187, 188 [1825].
- WORTHINGTON, JAMES. Experiments on the Spa at Mount Sion, near Liverpool. 8vo. *London*, 1773.
- WRIGHT, W. T., and T. BURTON. Analysis of Woodall Spa. *Journ. Chem. Soc.* vol. xlv, pp. 168-170 [1884].
- WYNTER, Dr. J. Cyclus Metasyncriticus; . . . Medicinal Waters of Bath and Bristol. 8vo. *London*, 1725.
- Of Bathing in the hot baths at Bathe, with regard to Palsie . . . 8vo. *London*, 1728.
- YEATS, G. D. Some Hints on a mode of procuring Soft Water at Tunbridge Wells, and on the danger of the improper Use of its Mineral Springs . . . [1822]. *Quart. Journ. Sci.* vol. xiv, pp. 345-353 [1823].
- YEO, Dr. J. B. Health Resorts and their uses; being Vacation Studies in various health resorts. 8vo.

ANONYMOUS WORKS.

- A LEARNED PHYSICIAN [? Dr. Moreton]. A Brief Account of the virtues of the Famous Well of Astrop, not far from Oxford, of late much frequented by the Nobility and Gentry. Pp. 8. 4to. *London*, 1668.
- A New-year's-gift for Doctor Witty; or the Dissector anatomized: a reply to Dr. Tonstall. 12mo. *London*, 1672.
- A PERSON OF QUALITY. Tunbridge Wells; or A Day's Courtship. A Comedy. Pp. 56. 4to. *London*, 1678.
- A Morning's Ramble; or Islington Wells Burlesqt. fol. *London*, 1684.
- An Exclamation from Tunbridge and Epsom against the New-found Wells at Islington. fol. *London*, 1684.
- On a Medicated Spring at Lancarian, in Glamorganshire. *Phil. Trans.* (Abr.), vol. iv, p. 211 [1697].
- Holt Mineral Waters [Wiltshire]. Fol. *London*, 1700.
- A Rod for Tunbridge Beaus, Bund'l'd up at the request of the Tunbridge Ladies. A Burlesque Poem. Pp. 32. Fol. *London*, 1701.
- Canterbury Wells; a Discourse upon the Mineral Waters lately discovered. 8vo. *London*, 1702.
- An Historical Account of the Cures done by the Mineral Waters at Holt [Wiltshire]; with some short observations concerning its nature, virtues, and the method of using it. 12mo. *Bristol*, 1723. Pp. 16. 12mo. *London*, 1723.
- Account of the Virtues and Method of Taking the Holt-Water [Wiltshire]. 8vo. *London*, 1725.
- An Account of the Tilbury Water, containing a Narrative of the Discovery of the Medicinal Qualities of this Spring, Experiments on the Water, the Manner of Drinking it, and several remarkable Cures. 8vo. [1739].
- A Journey to Landrindod Wells in Radnorshire, with a particular description of those Wells, &c. 8vo. *London*?, 1744. Ed. ii, *London*, 1746.
- The contents, virtues, and uses of Nevil-Holt Spa Water, further proved, illustrated, and explained from experiments and reason. Ed. ii, 8vo. *London*, 1749, with a postscript printed in 1750.
- Wilt thou be made whole? or the virtues and efficacy of the Water of Glastonbury. . . . 8vo. *London*, *Exeter*, and *Oxford*, 1751.
- Experimental Observations on the water of the Mineral Spring, Islington, commonly called New Tunbridge Wells. 8vo. *London*, 1751, 1773.
- A Dissertation on Sea-water . . . together with some practical Hints on drinking the Spaws or any other Medicinal Waters. [Compare R. RUSSELL.] Pp. xvi, 45. 8vo. *London*, 1755.
- Treatise on the nature and virtue of Buxton Waters, by a Physician. 8vo. *London*, 1761.
- A Treatise on the Nature, Properties, &c., of the Waters of Pymont. . . . Also of the Malvern Waters, from Dr. Wall's Observations. 8vo. *London*, 1762.
- A Description of England and Wales, containing a particular Account of each County, with its Mineral Waters. 10 vols. 12mo. *London*, 1769.

- Adam's Well (at Speldhurst), being as circumstantial a history of its original, and the cause of its present improvements, the high esteem it has always been held in as a drinking water, and its salutary effects in the various cases and disorders (herein described and attested) as can at present be produced. 12mo. London, 1780.
- Narrative of the Efficacy of Bath Waters in various kinds of Paralytic Disorders admitted into the Bath Hospital from the end of 1775 to the end of 1785; with particular Relations of 52 Cases, published by order of the Committee, at the Hospital expense. 8vo. London, 1787.
- London in Miniature, being a Description of the Cities of London and Westminster and 40 Miles round, also a Particular Account of the Tower, St. Paul's, and Westminster Abbey. 12mo. 17—. (Dulwich or Sydenham Wells.)
- History of the Mineral Waters of Buxton and other Warm Waters in the Peak of Derbyshire, with a Discourse on Petrifying Waters and Malton Chalybeate. 4to. 17—.
- A Short Account of the Mineral Waters lately found in Canterbury. 4to. London, 17 —.
- The New Bath Guide, giving an Account of the First Discovery of the Waters, &c. 12mo. 1803.
- Guide to all the Watering and Sea Bathing Places, with description of the Lakes, a Tour in Wales, &c. 12mo. [1810].
- Notice of a Chalybeate Spa at Melksham, Wilts. *Phil. Mag.* vol. xlii, p. 145 [1813].
- Inquirenda about Ipswich Spa Waters. *East Anglian*, 1814, p. 60. (From Hydro-sideron. Reply by SEEKAMP, H. *Ibid.* p. 110.)
- Description of the Chalybeate Waters at Canterbury. 8vo. [1814].
- The Bristol Guide, being a complete Ancient and Modern History of the City, the Hot Wells, and Clifton. Ed. iv, 12mo. 1815.
- The Melksham Guide, containing an account of the Spa, &c. 8vo. . . . 1815.
- Historical and Descriptive Account of the Town and Castle of Warwick and of the neighbouring Spa of Leamington. 8vo. *Warwick*, 1815.
- Analysis of the Mineral Waters of Caversham, Berkshire. *Ann. of Phil.* vol. viii, pp. 123, 124 [1816]. [The springs are really in Oxfordshire. W. H. D.]
- Original Bath Guide, considerably enlarged, with an Essay on the Efficiency of the Waters. 8vo. 1817.
- New Buxton Guide; its Medicinal Springs, Hot Baths, &c. 12mo. 1820.
- KI in Scotch Chalybeate. *Edinb. Med. Surg. Journ.* Oct. 1828, p. 448.
- Observations on the Air and Water of Malvern, the Holy Well, St. Ann's, and the Chalybeate Waters of Malvern. 1829.
- Analysis of Bath Water. *Phil. Mag.* ser. 2, vol. vi, p. 148; *Quart. Journ. Sci.* vol. xx, p. 264 [1829].
- Leamington Spa and its Vicinity, with a Dissertation upon the Waters, and a Directory. 12mo. *Leamington*, 1837.
- New Guide to Leamington. *Leamington*, 1839.
- A Brief Account of Hockley Spa, near Southend, Essex; with an Analysis of the Water by R. Phillips. 8vo. *London and Chelmsford*, 1842.

- A short account of the Braceborough Spa Waters. 8vo. *Stamford*, 1852.
- Rambles round Leamington. 1859.
- Islington Wells, an old poem, edited by J. O. Halliwell-Phillips. 1861.
- Industrial Resources of the Tyne, Wear, and Tees. 1863.
- Fifth Report of the Commissioners . . . on the Pollution of Rivers, vol. i. (treats of the composition of mine-waters). fo. *London*, 1874.
- Natural Mineral Waters, their Properties and Uses. Ed. vii, pp. 47. 8vo. *London* [1879].
- The Salt Deposits of Durham. (Notice of Boring.) *Times*, Dec. 26, 1882.
- The Mineral Baths of Bath. 4to. [1883]
- The Bathes of Bath's Ayde in the reign of Charles II., as illustrated by a drawing of the King's and Queen's Bath (signed 1675). 1883.
- Chilcott's New Guide to Clifton and the Hot Wells. 12mo. *Clifton*, n. d.
- Norman May's Guide to Malvern (chap. xi, pp. 136-142, The Malvern Wells). 8vo. *London* and *Malvern*.
- A RESIDENT PHYSICIAN. The Cheltenham Waters; their Nature and Properties.
- The Original Bath Guide, containing an Essay on the Bath Waters. 18mo. *Bath*. n. d.
- The Analysis of Streatham Waters, with experiments on Mineral Waters in general. n. l. n. d.
- Medical Topography of Malvern.
- Excursions round Leamington. n. d.
- Heywood's Tourists' Guide to the Principal Inland Spas of England. Maps and plan. 12mo. [recent].

Report of the Committee, consisting of Mr. R. B. GRANTHAM, Major-General Sir A. CLARKE, Sir J. N. DOUGLAS, Capt. Sir G. NARES, Admiral Sir E. OMMANNEY, Capt. J. PARSONS, Capt. W. J. L. WHARTON, Professor J. PRESTWICH, Messrs. C. E. DE RANCE, E. EASTON, J. B. REDMAN, W. TOPLEY, J. S. VALENTINE, L. F. VERNON-HARCOURT, W. WHITAKER, and J. W. WOODALL, appointed for the purpose of inquiring into the Rate of Erosion of the Sea-coasts of England and Wales, and the Influence of the Artificial Abstraction of Shingle or other material in that Action. C. E. DE RANCE and W. TOPLEY, Secretaries. (The Report edited by W. TOPLEY.)

CONTENTS.

	PAGE		PAGE
A. Report	898	South-eastern Coasts (1856 to 1867). By <i>J. B. Redman</i> . Printed by permission of the War Department :	
B. Memorandum by <i>R. B. Grantham</i> , M.Inst.C.E., F.G.S., Chairman of the Committee	899	1. Sandown Castle, 1856-67	907
C. Notes on the Coast-line from Penarth to Porth Cawl in Glamorganshire. <i>H. B. Woodward</i>	900	2. Sheerness Sea-Defences, 1857	912
D. Notes on the Coast from the Wyre to the Ribble. <i>A. Dowson</i>	904	3. Eastbourne Circular Redoubt Sea-Defences, 1857	918
E. Notes on the Coast of Durham, between the rivers Tyne and Wear. <i>Hugh Bramwell</i>	905	4. Sandown Castle, 1860	923
F. Reports to the War Department and other Government Departments on various parts of the		5. Dover East-Cliff Shore, 1863	927
		6. Sheerness, 1866	930
		7. Isle of Grain	931
		G. Copy of Questions	932

[1 and 5 were printed by the War Department at the dates mentioned ; the others have not hitherto been printed.]

A. Report.

The amount of material at present in the hands of the Committee does not yet warrant the preparation of a formal report with definite recommendations. The southern, eastern, and south-eastern coasts have been fairly well described in previous reports, and these districts are further illustrated in the old reports now printed. Information, however, is still wanted for the western shores of England. It is expected that this want will be supplied during the coming year, and that a final report may then be drawn up.

As the history of coast-changes can only be read by the light of definite information as to the conditions known to have existed at special periods, it is very desirable that the Committee should possess as much of such information as possible. Some important official documents are here printed, but there must be many such in the possession of public departments, harbour commissioners, local authorities, and private landowners. The Committee would be very grateful for copies of these, and indeed for any information bearing upon the subject.¹

¹ Communications for the Committee can be sent to the officers of the British Association, 22 Albemarle Street ; or to the Secretary of the Committee, W. Topley, 28 Jermyn Street, London.

B. Memorandum.

By R. B. GRANTHAM, M.Inst.C.E., F.G.S., Chairman of the Committee.

The British Association Committee have received several reports from a Committee appointed by them upon the effects and power of the sea to erode or otherwise to destroy, or to accumulate land on the coasts of this island.

The Committee have published upwards of forty reports from those who, as engineers, geologists, officers of the Army and Navy, &c., have had special opportunities of observing the changes which are perpetually taking place on the sea-shores.

The inquiries which have, up to the present, been made will be continued upon the south and east coast, and will be extended to the west coasts. They are made by means of printed forms, which the Committee have issued in order to secure uniformity for investigating every change caused by the action of the sea.

The inferences to be drawn from such reports are important, as bearing upon the vexed questions of boundaries of land upon sea-coasts between those vested in the Crown, in lords of manors, and in owners of land; as to the accumulations of shingle and sand-banks, and the frequent shifting of the latter; and also as to the land on the sea-shores where slips occur and entirely change the positions of the frontages, and in many cases totally obliterate them.

Such an inquiry as this by the British Association will, when completed, afford information by which positions on the coasts may be selected for small harbours and fishing ports.

The reports will point out to what extent the removal of shingle has caused, and continues to cause, the constant erosion of the sea-frontages from the land, and will thus indicate the advantage or disadvantage of constructive works.

Mr. Hans Hamilton's interesting and valuable paper, reported in vol. xviii., part 6, of the 'Transactions of the Surveyors' Institution,' enters very fully into the state of the law and the history of the cases, quoting the opinions affecting foreshores, and opinions which have been given in the Courts on the rights and privileges both of the law and the practice of the numerous questions which have been dealt with. A discussion took place upon the paper, in which several members of the Bar joined and gave valuable information as to the powers of the Crown and reputed owners. Others took part in the discussion who had been practically engaged in local investigations in various parts of the kingdom on this subject.

The information in this paper, and the discussion upon it, together with the investigations of the Erosion Committee, will, it is hoped, hereafter form a valuable source from which those engaged in harbour and coast protection may derive much assistance.

I have been induced to prepare this Memorandum in order to point out what should be done by means of the Coast-Erosion Committee under sanction and instigation of the British Association, and the course which might be pursued to form a system of protection to the coast all round the country.

It appears most desirable that advantage should be taken of the results obtained by this Committee, and that attention should be paid to such cases of erosion of the sea-coasts as have been reported on.

The papers hitherto prepared are very valuable ; but they are unconnected, and do not give the means of enabling us to promote a system of protection on all parts of our coasts. It seems essential that the information, to be practically useful, should point out how a connected line of proceeding and operation could be formed to prevent the wearing away of land and the utilisation of the coasts by the formation of harbours of refuge for all kinds of protection of commerce, and local communication for trade and agriculture as well as for navy purposes, and for works for promoting intercourse for remote districts.

Two debates took place in the House of Commons in 1887 upon the question as to the means by which works adapted to this object might be carried out, and under the sanction and direction of the Government.

In the course of the discussion reference was made to a system by which the works should be carried out and conducted. It was stated also in the course of the discussions that it was not intended to cast any censure upon the Public Loan Commissioners, but it was intended to point out and indicate that in the opinion of the House the Harbour Department of the Board of Trade was as well qualified to deal with such questions, and to give a technical opinion of requirements and necessities of certain localities for harbours and public works, for the purposes of trade and other necessities, and for the security and wants of all classes.

Although the foregoing suggestions and remarks refer mainly to harbours, it seems desirable that the question should include large harbours, and shelters and defence works as well. Much benefit would result from the accommodation and protection of the fishing interests as well as from other facilities for trade if properly assisted and promoted.

C. Notes on the Coast-line from Penarth to Porth Cawl, in Glamorganshire.

BY HORACE B. WOODWARD, F.G.S., 1887.

At Penarth headland the cliffs are composed of the following strata :—

	ft.	in.
LOWER LIAS—Marls, limestones, and shales (about)	100	0
RHÆTIC BEDS—Grey marls	15	0
Black shales	20	0
Grey marls (about)	50	0
KEUPER—Red marls.		

The cliffs are nearly vertical and attain a height of 200 feet, the church a little way inland being 234 feet.

The mass of the cliffs is formed of crumbling marl, so that there is a constant falling of material, though on so small a scale that no great difference has been made in the course of the past twenty or thirty years. At the same time these small shoots of marl render it somewhat unsafe for anyone to walk close under the cliffs or to linger there in geological study. The beds occupy a synclinal, slightly faulted in places, and broken and slipped near the pathway between Penarth headland and Penarth.

The beach is made up of fine grains of limestone and pebbles of Red Marl and Lias, also blocks of flat, more or less rolled, slabs of Lias limestone.

The beach slopes somewhat sharply in places, but no 'fulls' are observable. At Penarth headland the cliffs are protected by rocky ledges. The tide here rises from 20 to 22 feet.

At Penarth itself a sea-wall and promenade protect the beach for a short distance. To the south an inclined roadway extends to the summit of the cliffs, and this has been in part formed and protected by a bank of grey marl. The beach here at low tide, for three chains in width, is muddy ; and further seaward, for 6 or 10 chains, it consists of mud and boulders, resting on a platform of Red rocks.

In the railway-cuttings south of Penarth, not far from the cliffs, the lower beds of the Lower Lias have been exposed. It is noteworthy that not only are the beds of limestone much broken up here and there, but the broken-up masses of limestone are waterworn into forms as irregular as flints, although the surface soil is a stiff clay. During the summer of 1887 wide fissures were opened in the ground, cracks extending to a depth of 4 feet; and in this way rain-water would readily find its way through otherwise impervious strata into porous beds below.

North of Lavernock great cracks are formed in dry weather parallel to the cliffs; and these are sources of great weakness, leading to slips and gradual waste of the cliffs.

From Penarth southwards to Lavernock Point the beds shown are the same as in Penarth headland. The cliffs run north and south, facing the east, and while for the most part 50 feet high, they attain a height of 100 feet above the Roundbush Rocks, S.E. of Lower Penarth. They exhibit a synclinal to the south of Penarth, faulted to a small extent in four places. Further on the beds rise in an anticlinal, so that the Red Marls at one point form the entire portion of the low cliff. At Lavernock itself the beds dip sharply to the south, and the Lower Lias limestones and shales form the headland, with ledges of limestone protecting the coast and running out seaward. Alabaster was formerly worked in a 'cave' driven in the Red Marl at the base of the cliffs, about half-way between Penarth and Lavernock; but I was informed in 1887 that it had not been worked for about fifteen years.¹

Rock platforms are shown at low water along the stretch of coast from Penarth headland to Lavernock. At high water the sea ordinarily touches the cliffs at many points, and the headlands are impassable, including a projecting bluff of red marl overlaid by grey marl north of Lavernock. Along this portion of the coast the easterly gales alone produce much effect on the waters and cause damage to the cliffs.

The beach nowhere shows any great thickness of recent accumulations, but for some distance midway between Penarth and Lavernock there is much boulder-shingle at the base of the cliffs, and small patches of local detritus are shown here and there on the shelving rock-platforms. There is a spit of boulder-shingle at Runny Point.

From Lavernock Point the cliffs run south-south-westwards, and immediately west of the point are composed as follows, the heights being 50 feet at the point, and 110 feet further west:—

	ft.	in.
LOWER LIAS—Limestones and shales	25	0
Chiefly grey marls, with here and there stone-		
beds	40	0
Limestones and shales	35	0

The beds occupy a synclinal, the lower beds of limestone, &c., forming bluffs at either end of this stretch of cliffs, the grey Lias marls descending to the beach-level between. Platforms of rock and marl extend seaward for 8 or 10 chains at the foot of the cliffs, near which there is in places an accumulation of boulder-shingle and sand.

By Ball Cottage, south-west of Lavernock, there are reefs of Dolomitic conglomerate, with boulders of this rock on them. In the small bay to the north the beach comprises a little sand in places, but consists mostly of boulders of Liassic, Rhætic, and Triassic rocks, forming one slope. Under the cliffs, about 10 yards of this slope rise above the ordinary high water, then come 2 chains of beach, and reefs of rock (hard grey Rhætic marl) further out. The cliffs here are protected by shrubs.

Along this line of coast the westerly, south-westerly, and southerly gales are all very destructive, and their influence is shown in a marked manner on the trees and shrubs.

Sully Island is composed of red, pale buff and grey Triassic limestones and marls, gently inclined towards the mainland, resting on the upturned beds of the Carboniferous limestone. The severance of this island is due to the more rapid denudation of the Triassic beds, which now at low tide connect the island with the mainland, while the platform of Carboniferous limestone has better withstood the action of the breakers.

Barry Island is largely formed of similar rocks, with also Lower Lias and Rhætic beds. Owing to the recent dock-works it has been connected with the mainland. The Carboniferous limestone has a seaward dip, and forms the two horns or headlands of the island and the promontory just to the west. The severance of the island was owing

¹ See Section in *Proc. Geol. Assoc.* for 1888. Excursion to South Wales, &c., p. 32.

to the denudation of the softer Rhætic beds and Red Marls, which connected the island with the mainland towards the north-east, while northwards and westwards the river channel has been widened by tidal action. The cliffs south of Barry Island rise to a height of about 50 feet. Whitmore Bay, on the same side, between the two headlands, is a beach of sand and shingle at low tide. North of it a little blown sand occurs on the face of the slopes.

From Cold Knap, west of Barry Island, where the Carboniferous limestone is exposed, the cliffs are about 50 feet high. Thence to St. Donat's the general direction of the cliffs is east and west; they are formed of the Lower Lias limestones and shales, but essentially of limestone. The beds have, on the whole, a slight easterly dip; but this is counteracted by numerous small faults, so that the same beds are presented to our view, undulating here and there, and dipping now and again in other directions.

East of Porthkerry the cliffs rise to an elevation of nearly 200 feet, and they attain a similar height on the west. Further on, as far as East Aberthaw, the cliffs are under 100 feet, and in some places not more than 50 feet. At high water the sea washes the cliffs along the greater part of this distance, but for a short extent east of Pleasant Harbour, East Aberthaw, there are wooded cliffs some little distance (about 300 yards) from the high-water mark of ordinary tides. The interval is occupied by alluvium, covered here and there with patches of shingle; beyond is an expanse of shingle, extending another 300 yards to low-water mark. But the shingle is of no great thickness, and is based on mud and Lias rock. Eastwards the coarse shingle stretches along the base of the cliffs over ledges and platforms of Lias.

The alluvium before mentioned indicates that the river Ddaw formerly flowed out to sea further eastward than it does now.

West of the port of Aberthaw there is an expanse of alluvial ground protected by embankments. This is bordered by hillocks of blown sand, and these rise about 20 feet above the shingle beach. Bordering the blown sand there is a ridge of thick shingle, and beyond this, between tide-marks, is an expanse of shingle on mud, with sand here and there.

The shingle consists of rolled pebbles and boulders of blue Lias limestone, and it is these stones which constitute the celebrated Aberthaw lime. All the 'lime' taken away has been shipped in the form of pebbles or boulders, taken preferably between high and low water mark; for these stones are considered to yield a better lime than those heaped up at a higher level, and which have been exposed to the sun's rays, &c. Stones from this latter position are, however, employed locally in the lime-kilns. I was informed in 1887 that fifty or sixty years ago there used sometimes to be about twenty vessels in the harbour loading with beach pebbles. Since the introduction of railways, limes from other districts, such as Harbury, Rugby, &c., have to a great extent diminished the trade at Aberthaw.

The material has travelled from the west, and owing to the encroachments of the sea it has been heaped on to old alluvial ground—portions of the old estuary of the Ddaw. In the blue mud that here covers the platforms of Lias, on both sides of the present river, the occurrence of *Scrobicularia plana* was noticed by Mr. H. W. Bristow. He observed that the mud was from 8 to 10 feet thick in places; and intervening between it and the Lias there is, south-west of Gilston, a bed of white calcareous tufa, with land-shells (*Helix*); a bed which he noticed also at Tresilian, in that case directly under the shingle.

There are no cliffs for some distance west of Aberthaw, not in fact until we approach Summerhouse Point. Thence to Dunraven the cliffs are formed of the Lower Lias limestones, with subordinate layers of clay and shale. They vary in height, attaining a maximum elevation of 235 feet at Whitmore Stairs, between Nash Point and Dunraven, and overhanging in places west of the Summerhouse, where the dip of the strata is seaward.

The beach consists of ledges and platforms of Lias rock, from 150 to 200 yards broad or more, covered here and there by coarse boulder-shingle of Lias rock and occasionally by sand. South-west of Llantwit-Major the Lias strata on the foreshore are much jointed, and the sea works off huge masses of rock; here there is a great bank of boulders. Where the stream from Llantwit flows out to sea a peaty deposit, containing nuts, leaves, and twigs, was noticed by Mr. Bristow. This bed rested on blue clay with *Scrobicularia*, beneath which there was a deposit of tufa. The whole was overlaid by boulders and shingle. Here and there along the coast great falls of the cliff take place; at other points, as at Tresilian, there are caverns, which tend to show that in certain places the cliffs have not recently suffered great destruction.

At St. Donat's large rounded blocks are taken away from the beach, to be used as building-stone and occasionally for lime-burning.

West of St. Donat's there are fine level platforms of rock on the foreshore. Here the cliff follows the strike of the strata, but the ledges naturally vary much along the line of coast, according to the inclination of the strata and the changes in the direction of the coast.

South-east of Nash Point, between the two lighthouses, the cliffs have suffered noteworthy losses by slips and falls of rock. Here, for a short space, a wall has been built to protect the higher lighthouse.

South-east of Dunraven, the ledges and platforms of Lias rock, covered in places by sand, may be seen stretching out rather more than a furlong seawards at low tide. Considerable slips of rock have taken place, and accumulations of tumbled blocks and boulders are to be seen here and there along the foot of the cliffs.

At the Witches' Point, Dunraven, the lowest beds of the Lower Lias are unusually hard and more or less conglomeratic, and they rest irregularly on the upturned edges of the Carboniferous limestone. A prominent headland has been the result, and there are three caverns on the south side of it in the Lias. To the north-west of this headland there is a fine expanse of sand between tide-marks, while the coast is bordered near the Lodge, Dunraven, by very coarse boulder-shingle.

The cliffs in the north-eastern angle of the bay, under Dunraven Castle, show the Lias strata much disturbed and faulted, and here considerable slips take place. I was informed in 1887 that ten or twelve years ago there were caverns here, but no trace of them remains.

From Dunraven, past Southerndown, to Sutton, the cliffs are formed of the ordinary Lias limestones and clays, dipping eastward, but undulating under Southerndown. These beds rest on about 90 feet of hard blue conglomeratic Lias, and hard white and conglomeratic rock, known as the Sutton stone. These lower strata here, as well as south of Dunraven, stand out in massive beds, and offer greater resistance to the breakers than do the ordinary beds of the Lower Lias. They rest irregularly on the Carboniferous limestone; and partly from this fact, and partly owing to great joints and fissures in the rocks, numerous caverns have been excavated by the sea. In one place below West an outlying stack of the Sutton stone, &c., stands out on the foreshore. The cliffs rise rapidly from the beach south-east of Southerndown to an elevation of about 150 feet near West, but decrease again further on to below 50 feet as far as the mouth of the Ogmore. Under Southerndown there are two or three faults where the beds are slightly displaced, and the cliffs stand out in wall-like buttresses.

The Black Rocks, west of Southerndown, are formed of Carboniferous limestone, much fissured, and worn into irregular shapes by the action of the breakers. Both in this rock and in the harder beds of Lias, deep channels, basins, and tiny arches are excavated by the waves dashing over the rocks and then draining off in lines of jointage, &c. Curious honeycombed surfaces are produced in the rocks by the combined action of the breakers and the spray. Here and there little sandy bays occur among the rocks, while more sand and shingle are exposed at low tide near Sutton, the shingle containing pebbles of red and brown Coal-measure grits, as well as pebbles and boulders of Carboniferous limestone: no doubt deriving many stones from the river, which brings material from the South Wales coal-district, while some of the boulders are derived from the Dolomitic conglomerate.

The low cliffs here consist of Carboniferous limestone, with thin and irregular cappings of Lower Lias (white Sutton stone and conglomerate) near the Black Rocks, and irregular masses of Dolomitic conglomerate further on.

Near the mouth of the Ogmore, and on both sides of it, the Carboniferous limestone and Dolomitic conglomerate are smothered up over considerable areas by blown sand. This extends by Candleston Castle and forms the Newton Burrows, which stretch towards Newton Nottage and Porth Cawl. Not far from the mouth of the river is the Tusker Rock, an islet of Carboniferous limestone that is ordinarily exposed at low tide.

D. Notes on the Coast from the Wyre to the Ribble.

By A. DOWSON, 3 Great Queen Street, Westminster.

The part of the coast to which my remarks refer extends from the mouth of the Wyre, near Fleetwood, to the northern side of the estuary of the Ribble, near Lytham.

I am well acquainted with this coast, as I designed and superintended the erection of a pier in the estuary of the Ribble; I also had to prepare evidence relating to the removal of shingle from this district; and I surveyed the northern half of the estuary of the Ribble for the Parliamentary Inquiry with Reference to the Ribble Navigation Act of 1883.

The total length of coast is about 16 miles, Blackpool being situate about half-way. About 11 miles of the coast below Rossall Point lies north and south, but the remainder curves round eastward towards Lytham.

The flood tide runs up the St. George's Channel from the south, past Blackpool on to Fleetwood; but part of it turns off eastward on striking the northern side of the Ribble estuary. Spring tides rise about 28 feet.

The district generally is flat and sandy, the level not being much above high-water mark; but north of Blackpool there are cliffs composed of loose clay, which after the rains and frosts of winter frequently slip. Southward of Blackpool the coast consists of extensive sand-hills varying in height from a few feet to 50 or 60 feet.

The whole foreshore consists of fine sand of very varying widths. Towards high-water mark there is a belt of shingle (largely composed of granite), the pebbles varying in diameter from 6 inches and under.

This stretch of coast being bounded both north and south by a river, the whole supply of shingle (except that washed from its own cliffs) is cast up from the sea on to the shore above Blackpool by westerly gales. It is then caused to travel past Rossall Point to the Wyre by winds from the south, or past St. Anne's towards the Ribble by winds from the north.

This almost ceaseless supply of shingle leads to an immense accumulation at the northern and southern limits, the name of 'Tully Bank' being given to the former, and 'Double Stanner' to the latter. This growth has been going on from time immemorial, as is shown by a large portion of the new watering-place known as St. Anne's, being built on some of the old ridges of shingle, which are nearly 2 miles eastward from where the ridges are now being formed.

At *Rossall Point*, and for about 3 miles south, timber groynes have been erected at frequent intervals. The scouring is, however, very great, and it is only by constant renewals that the sea is kept from encroaching. The bank at the shore ends of the groynes is frequently hollowed out by the waves having been made to run along the sides, and in many cases I have found it easier to pass under the bottom planking of the groynes rather than to walk round by the bank.

The 'Rossall Landmark,' which is an octagonal structure of considerable height, was built by driving timber piles into the beach. In time this beach became so scoured away that, to render the 'Landmark' secure, new piles were driven deeper alongside the old ones, to which they were bolted. At my last visit to this place I found that the second set of piles were themselves being left bare, showing that in spite of all the groynes in the neighbourhood the lowering of the foreshore continued.

A heavy sea embankment built to protect the grounds of Rossall School was also seriously damaged by the sea.

Blackpool was originally a small fishing village, having a large quantity of shingle in front of it, and any damage done by the sea was at once repaired by the person most interested, with the aid of his immediate neighbours.

In course of time a rough stone footing was built to protect the cliff, and from this date the shingle began to be driven away.

The increase in the size of the town led to the making of a sea-wall, or what is locally known as a 'hulking,' by sloping the front of the shore to about an angle of 50 degrees and paving it with stones. This wall was so undermined by the sea that the foundations had to be carried down to a lower level. The sea then had a longer incline up which to run, and of course to rush down again, striking against the beach at the bottom and wearing it away. A second time this wall has been carried lower, with the result that still heavier seas came against its face.

A proof of this is that the surface of the foreshore is now several feet below what

I knew it to be twenty years ago. This was shown by some of the foundation screws of the piles of the pier having been washed bare.

The ordinary cost of keeping the present sea-wall in repair amounts to over 1,500*l.* per annum, in addition to which much loss and anxiety are frequently caused during a heavy storm.

Attempts have been made to replace the shingle driven away by the wall, by erecting timber groynes. The result is that shingle may sometimes be found on their north and sometimes on their south sides, but never during heavy weather can any reliance be placed on an accumulation to assist the sea-wall. The general level of the beach is not in the least raised; the seaward ends of the groynes have deep pools of water around them, and the waves driven along them to their shore ends have struck heavily against the wall and have greatly worn the stonework. It is only by very constant attention that the wall is maintained.

Whilst this damage continues to be done at Blackpool thousands of tons of shingle are driven past it, as before described.

St. Anne's, a new watering-place near the most northern boundary of the estuary of the Ribble, is built on what was a few years ago a rabbit-warren, underlying it being the old shingle ridges before mentioned.

When the town was first laid out a sea-wall, smaller, but of similar outline to the one at Blackpool, was built, much shingle being left between it and the sea. Soon after its erection the shingle began to be driven away, and it became necessary to lower the foundations several feet, as was found to be the case at Blackpool.

Many attempts have been made to protect the wall by groynes constructed of timber, but the invariable result has been to produce an increased scour. I have myself made several attempts, but it was not until I discarded solid groynes and substituted open ones that I met with any really good result.

After various modifications I put up several open groynes at right angles with the wall, their sides or panels being made of wrought-iron gratings, so as to retain the shingle while allowing the water to pass through them freely. These produced a very considerable accumulation of shingle, which after several years still remains there.

Subsequently, during a heavy gale, a considerable length of another portion of the wall was undermined, and, as it was in imminent danger of being washed down, I fixed several open groynes in front of it. The result was that after the next rough tide a large quantity of shingle was trapped. Then, as the groynes became buried, they were lifted up from time to time, so that this part of the beach was raised from 10 to 12 feet above the level which existed when I commenced operations, and the wall has since remained safe.

After this experience the owners of the property were so convinced of the benefit derived from having the open groynes erected that they purchased from me the right to place them along any part of their frontage (about one mile). Having afterwards learnt that they were about to erect a number of short groynes, I pointed out that they would not be likely to attain their object. Short groynes could only lead to the formation of a narrow and steep incline of shingle, whereas they should strive to accumulate a broad, flat incline upon which the waves would break before reaching the sea-wall. They did not, however, carry out this suggestion, so that I fear little good can be expected from these additions.

The foregoing evidence appears to me to show—

(a) That a sea-wall causes the shingle in front of it to be driven away.

(b) That solid groynes, especially if high ones, are most mischievous, as owing to the scour they produce during heavy weather they drive the shingle seawards.

On the other hand, with open groynes it is impossible for the shingle to be driven away, and in practice they have retained it for several years, where it still remains.

E. Notes on the Coast of Durham, between the rivers Tyne and Wear,

By HUGH BRAMWELL, The Whitburn Coal Company, Limited, South Shields.

2. The nature of the coast is as follows:—a. 1½ mile of sand immediately south of the Tyne; 4 miles of limestone cliffs (magnesian limestone Permian); 1 mile of sand, the Whitburn sands; ½ mile of limestone cliffs

- the Roker cliffs; $\frac{1}{2}$ mile of sand, the Roker sands, extending to the Wear.
- b.** Greatest height of cliffs, 80 feet; minimum height of cliffs, 20 feet; average height of cliffs, 40 feet.
- 3.** The coast-line runs roughly north and south.
 - 4.** The prevailing wind is westerly.
 - 5.** The north-east wind is the most important in raising high waves and in the piling up or the travelling of shingle. There is, however, but little shingle, except in the small creeks.
 - 6.** The tidal current 'flows' from the north, and 'ebbs' back to the north. The 'flow' is much the more powerful.
 - 7.** Spring tides range $15\frac{1}{2}$ feet, neap tides range 11 feet. The greatest exposed area is near Whitburn village, where from 200 to 300 yards of foreshore are exposed. Along the cliff-portion of the coast there is deep water to within 100 yards of the cliff.
 - 8.** The area covered by the tide consists of sand at Shields, Whitburn, and Roker; bare rock along the cliff-portion of the coast. A certain amount of shingle accumulates above high-water mark along the cliff-line in the small creeks. There is also an accumulation at the south end of the Whitburn Sands.
 - 9.** Such shingle as there is travels to the south. The amount is undoubtedly larger at the southern portion of the coast-line under notice.
 - 10.** The amount of shingle probably remains constant, or nearly so. It may be increasing at the south end of the coast-line.
 - 12.** The Tyne Commissioners' groynes is the only one built with a view of preventing the movement of shingle, sand, &c.; its object being to prevent the sand filling into the dredged channel of the Tyne. The Tyne Commissioners' south pier extends 1,650 yards (present length) into the sea, and it has caused an accumulation of sand immediately to the south of it. This sand-deposit is not covered by the ordinary high tides, but spring tides, especially if accompanied by north-east winds, rise over it. The Wear Commissioners' old pier, being only 270 yards long, has not led to any appreciable accumulation of sand. A new pier is, however, in course of construction at Roker, to extend some 600 to 800 yards into the sea, which will most probably lead to the piling up of shingle and sand on its north side by preventing their passage to the south.
 - 13.** At South Shields the Tyne Plate Glass Co. remove large quantities of sand, both from above high-water mark (sand-dunes) and also from the more recent accumulation, now only covered by exceptional tides. The sand is used for grinding the sheet glass. A small amount is also removed from the Whitburn Sands, for building purposes, under permission of Sir Hedworth Williamson, the lord of the manor. The Tyne Commissioners have also worked an immense quantity of limestone from quarries on the cliff-line for the construction of piers, &c. The operations have, however, been confined to above high-water mark.
 - 14. a.** The cliff-line is, no doubt, being worn back, being fully exposed to heavy seas from the north and east without any protection whatever, the base of the cliffs being high-water mark. **c.** The limestone, however, being comparatively hard, especially some beds, the wear is very small. After every winter, however, there are numerous falls of stone, due to frost, &c. Estimating that 150 tons of stone fall from the cliffs each year, the average wear of the whole cliff-line would be 1 inch in fifty years. **d.** The Lizards Common, which extended along two miles of the cliff-line, was inclosed in 1718. I have examined the award plan and compared it with the Ordnance Survey of 1854, and find that the loss of land during that period is inappreciable on the plans. A footpath was, however, left along the whole cliff-line, outside the enclosure walls, and in several places the cliff has fallen away, and either carried the path away or rendered it unsafe, and a new path has been made by encroaching on the enclosed land, inside the original line of wall.
 - 16.** No land is being gained, beyond the increase of sand behind the Tyne south pier, which is, however, still subject to inundation.
 - 17.** There are sand dunes at South Shields and at Whitburn. **a.** Locally known as 'bents.' **b.** At Shields they are from 8 to 12 feet in height. At Whitburn their extent and height are very limited. **c.** The Shields dunes were formed before the commencement of the piers, and were probably caused by the tide flowing south, and sweeping past Tynemouth point across the river

mouth, causing a back current from the south (as per sketch). **d.** The sand dunes are not increasing, and they have to a large extent been removed (see **13**), and parts have recently been converted into parks. **e.** The dunes are grass-grown, and the sand does not blow over the adjoining land to any extent.

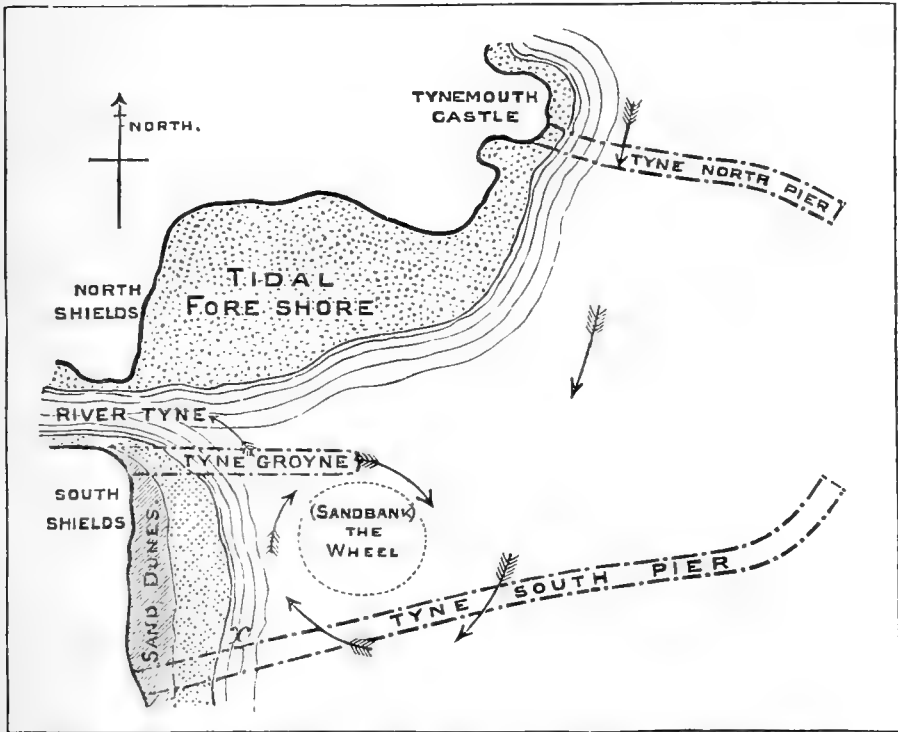

NOTE.—Arrows denote tidal currents before the building of the piers, causing a deposition of sand at x.

19. The Tyne piers completely stop the travel of any shingle from the north to this piece of coast. All the shingle accumulated in the little coves consists of debris from the limestone cliffs and from the boulder clay, which in parts covers the limestone. The north end of the cliff-line is consequently more destitute of it than the south end. The largest accumulation, and, in fact, the only deposit affording any protection to the coast-line, is at the south end of the Whitburn Sands. Near the middle of the Whitburn Sands, at the mouth of a small stream, there are indications of a submerged forest, in the stumps of old trees *in situ*, now below or near high-water mark. These were, however, covered with sand when last I examined the locality.

F. Reports to the War Department and to other Government Departments on Various Parts of the South-eastern Coasts (1856-1867).

By J. B. REDMAN, M.Inst.C.E., F.G.S., F.R.G.S.

(Printed by permission of the War Department.)

1. SANDOWN CASTLE.

The Secretary of State for War to the Mayor of Deal,

War Office, Pall Mall, April 1857.

SIR,—1. On the 4th September last your predecessor addressed to the Secretary of State for War a Memorial of the inhabitants of Deal upon the subject of the danger which is apprehended from the ravages of the sea upon the high shingle beach, which, until recently, has formed a sufficient barrier between the sea and the town of Deal, together with adjacent properties.

2. At the same time communications were received upon the same subject from Mr. Stephen Pritchard and Mr. William Betts, two neighbouring proprietors.

3. From these communications it would seem to be generally admitted that the sea was advancing by degrees upon the land ; and at the same time an opinion was expressed that part of the injurious action was due to the construction of groyne in front of Sandown Castle.

4. An inquiry was thereupon instituted by order of the Secretary of State, by which it would seem that the lowering of the groyne would be of little or no advantage to the security of the neighbouring beach ; but as, at the same time, they seemed to be of little advantage to the Castle itself, the Secretary of State ordered them to be lowered, as was communicated to you in a letter from this Office of the 4th November last.

5. It was pointed out in that letter that it could scarcely ever be possible that the measures taken by one proprietor should be those best calculated for the general interests of the neighbourhood, when all are threatened with the same dangers ; and the Secretary of State expressed his perfect readiness to subordinate the measures taken for the protection of Sandown Castle to any general measures which may be adopted for the protection of the coast.

6. As the Secretary of State did not hear that any such general measures were in contemplation, and as it was a matter of importance to determine what was the best course to adopt with reference to Sandown Castle, his Lordship, after consulting with the Inspector-General of Fortifications, ordered that the subject should be referred to Mr. Redman, a civil engineer of considerable experience in works of this description.

7. Mr. Redman has made a searching investigation into the whole of the circumstances, and has presented a valuable report, which, as it is of equal and, indeed, greater interest to the neighbouring proprietors than to this Department, has been printed for general information.

8. As the present letter will explain the circumstances under which Mr. Redman's report was made, the Secretary of State has directed that it should be printed with the report.

9. Twenty-five copies of the report are herewith transmitted for distribution among the landholders most interested, and additional copies will be forwarded, should you require them.

10. The perusal of this report, and, indeed, the mere inspection of the plan, is sufficient to show that the further maintenance of Sandown Castle must in any case be difficult, and will be quite impossible unless the neighbouring proprietors are willing to incur the expense of general measures for the defence of their respective properties.

11. If those measures are undertaken, the Secretary of State will provide in the Army Estimates for that proportion of the works recommended, which will cover the property of this Department.

12. If they are not undertaken, Sandown Castle will be dismantled, and no future expense incurred on its maintenance.¹ The military value of the Castle is but secondary, and, though interesting from historical recollections, the Secretary of State does not consider he would be justified in incurring the expenditure recommended by Mr. Redman at p. 11 of his report [p. 910] for Sandown Castle itself, as those measures would only be of temporary assistance, and would entail constant additional expenditure as the sea advanced on either flank of the Castle, and would ultimately swallow it up.

13. On the other hand, if the general measures suggested by Mr. Redman at p. 14 [p. 911], or other measures of an equally general character be adopted, there may be a fair chance, not only of maintaining the Castle, but of saving the whole neighbourhood from the peril to which it now seems to be exposed.

The question must now be left to be decided by the landowners, who may obtain a local act for the purpose, or set on foot any other collective action they may think best ; and the Secretary of State hopes that you and they will give him the credit of having endeavoured, to the best of his power, to afford to the neighbours of the War Department property at Sandown Castle as much assistance as it is in his power to afford.

I have the honour to be,

Sir, your obedient Servant,
(Signed)

B. HAWES.

¹ [Carried into effect February 1863.]

Mr. Redman to the Secretary of State for War.

5 New Palace Yard, Westminster, December 20, 1856.

SIR,—In pursuance of the instructions contained in your letters of the 3rd and 14th ultimo, and accompanying memoranda of latter date, I visited Deal from the 25th to 29th ultimo, and for the information of the Secretary of State for War beg to report the result of my inquiries, and what appears to me would be the best plan of defence to adopt to stop the continued encroachments of the sea; in illustration thereof I beg to refer to the accompanying plan and sections, which show the state of the shore north and south of the Castle, and northward to Battery No. 1, during my survey, as also the works I propose should be executed.

On the morning of the 25th ultimo, at high water, with a high tide, and the wind from N.N.W., I found the sea breaking over the Castle, and over the outer brick walls of Battery No. 1, and the Castle moat was full of water, the sea getting through the moat wall on the south side at the termination of the new wall; this was subsequently repaired; at the same time the sea was making a clear breach through the crest of the beach south of the 'Good Intent' public-house, and running into the adjoining fields, and north of the Castle nearly up to Battery No. 1 the sea was over the saltings behind the shingle mole and sand dunes, forming a small lake right up to the adjoining fields, coming in south of Battery No. 1, through two breaches in the crest of the shingle, and flowing round the back of the officers' quarters, or south Tower.

The condition of the shore from the north side of Deal to half-way between the two batteries is very serious, and should there be a continuance of gales from N. and N.E. during the winter, it is difficult to estimate the probable consequences, not only to the property of the War Department, but also to the north side of the town of Deal and the adjoining land.

The inroads made upon the shore between Sandown Terrace and the Castle are so extensive that should a permanent breach occur there, which is not at all improbable, the north side of the town would be threatened as well as the adjoining low lands, or should the wasting of the beach continue, adjoining Battery No. 1, the whole of the low lands up to the line of railway, and even beyond, might be submerged.¹

From the information I have been able to gather, it would appear that the whole of the shore from Sandown to midway between the two batteries has been encroached on by the sea during the last eight years at an alarming rate.² It would appear that at Battery No. 1, only four years back, the line of beach was 40 feet to 50 feet seaward of the battery, and now it is in a line with the back of the gun racers. As the sea has gained on the land, the beach has not only diminished in quantity, but has travelled landward, gaining on the sand-hills, which now in places crop out through the shingle and are washed away by the sea.³ The result of this action is that the upper 'full' of shingle is travelling to the rear of the Castle and Battery, and leaving the groynes, the western ends of which are buried in its progress by this landward recession of the shingle. From the greater prevalence of N.E. winds during the last seven or eight years⁴ on this part of the coast, the leeward motion of the beach has been to the southward; as, however, this mole of shingle travelled originally from the southward, should S.W. winds again predominate to a greater extent the re-accumulation of beach may be looked for, and a motion to the northward, for we find that at Battery No. 2, where at present there is an absence of modern shingle, which almost ceases shortly north of it, there are two 'fulls' of beach after S.W. winds.

There are two deep pools of water behind the beach north of Battery No. 1, which did not exist seven years back; evidence of the encroachment of the sea.

From half-way between the two batteries to Battery No. 2 the mole of shingle appears to have been tolerably stationary for the last eight or nine years, but to the southward the shingle has constantly diminished over the same term of years, and about 20 feet in breadth of beach, according to local evidence, was eaten away at one tide by a breeze from the N.N.W. only a fortnight prior to my visit, the absence of

¹ [This, in effect, took place December 1862.]

² [Beach now gone back 150 feet N. of Castle, February 1863.]

³ [Receded 100 to 150 feet in 6½ years after this, viz., to February 1863.]

⁴ At Ramsgate, from the Harbour Register there, the excess of west winds from 1846 to 1856 has been an average of forty-six days per annum as compared with eighty-five days per annum from 1836 to 1846.

mischief northward being due apparently to the protection afforded by the Isle of Thanet.

During the degradation of this particular length of coast the beach south of Deal at Walmer and Kingsdown appears to have somewhat increased, though not at the same rate as formerly; this at first appears anomalous, but as Kingsdown, where such an extraordinary accumulation of shingle has taken place, is half-way between Dover and Sandown, it appears to have benefited by the motion of shingle from the southward and westward, or from the northward.¹

To show the extreme peril that the lands to which this mole of shingle has hitherto acted as a barrier are now in, it is only necessary to refer to the fact that these formations, in such a situation as this, when in equilibrium, are usually about 10 feet above the range of high water of spring tides; at the end of the esplanade the bank is 11 feet above this level; opposite the mill, 9 feet 9 inches; 500 feet north of the esplanade, 7 feet 8 inches; 800 feet, 7 feet 3 inches; and adjoining the 'Good Intent,' it is only 6 feet 3 inches above this level; north of the Castle the crest is usually from 8 to 9 feet above, until we come to the partial breach at 1,500 feet northwards, where the shingle and sand are only 6 feet above high tides. North of this there are even worse places, being only from 3 to 4 feet above at 1,700 and 2,000 feet northwards; and at one particular place, viz., 2,165 feet north, where there is a sudden dip caused by the breach of 25th ultimo, and the sand-hill cropping through the crest, it is only level with the range of high spring tides, viz., 19 feet above Datum, which figure deducted from those on the crest on plan, will give the relative heights above high water extreme spring tides. South of Battery No. 1 the beach where it has spread over the land is equally low, being only from 2 feet 6 inches to 3 feet above. North of the Battery we find the crest again from 8 to 9 feet above high water.

In reference to the first item of your instructions, viz.:—

'What are the best measures for preserving Sandown Castle from destruction?'

I beg to report that I consider the only effectual way of doing this would be by paving the bays between the groynes with stone, at a slope of about 7 to 1, terminated by a curved face meeting the base of the Castle walls, the margin next the sea to be sheet piled, or protected by a toe of large stones laid in a deep trench. At first it might be sufficient to protect the two bays adjacent to the centre groyne in this way; should no accumulation take place in the north and south bays, an extension of the paving would be necessary; but as I consider these groynes act injuriously by their great height, creating cross eddies and overfalls which sweep out the shingle after it is deposited, I recommend the planks of the north and south groynes being removed to the mean level of the beach north and south of these defences, and the planks of the centre and intermediate groynes to the level of the adjacent shore; the effect of this had best first be tried before encountering the expense of paving; a wall should be erected north of the Castle to the extent of your boundary to check the beach, and this might serve as an example to the landowners, or the revetment should be raised: this is imperatively required, likewise at the Battery, to prevent the beach retreating on the land, which, in travelling westward or landward and southward, at the same time, is heaped up against the walls of the Castle and Battery, and were counter walls, sufficiently high, erected in the directions shown, they would have the effect of driving the shingle seaward of these defences. No permanent benefit would, however, result from this without the wall was made continuous from the Castle to the Battery, and from this latter northward to where the beach is stable or unaffected by this landward motion; for should short lengths only be executed to the limit of the property of your Board, the shingle would drive past, and eventually the ends be undermined, as we now see in operation at the end of the esplanade wall at Sandown, which will shortly render the continuation of this wall imperative unless a re-accumulation of beach hereafter takes place.

A good deal of mischief is done by the sea getting inside the moat, and at low water finding its way out again under the foundations, which in all probability was one of the causes of the failure of the former cross walls. I would recommend (if the material could be readily found) that the moat should be filled to the level of the

¹ The degradation of the shore from St. Margaret's to Dover is almost as remarkable as in the district now under notice.

[February 1863: Notices from Her Majesty's Board of Works now posted against removal, consequent on loss of beach at S. Foreland, Sandown, &c. ? Admiralty Pier, Dover.]

lower embrasures, at which level self-acting tidal-flaps should be introduced in each of the cross walls to allow the water to drain out of the moat at low water, but to shut back against the ingress of the sea.

In the second bay from the north the footings of the north-east tower of the Castle are exposed, and in the third bay the footings of the south-east tower, and a water-worn substratum of hard sand, closely approaching sandstone in appearance, upon which the walls were originally founded, and which may be traced up the coarse vertical joints, and adapting itself to the irregular beds of the stones, precisely similar in character to the serrated edges of the sand dunes that crop out through the beach to the northward.

During the first day of my survey, viz., on the 25th ultimo, from 15 inches to 21 inches in vertical height of this sand were exposed to view at low water, but on the 29th only from 6 inches to 12 inches, from a slight accumulation of shingle having taken place in the interim, arising from the change of wind to the westward.

The paving of the proposed stone slopes should be laid on a bed of concrete or clay to prevent the recoil of the wave drawing away the shore from under the stone-work after getting through the joints, and this should be carried well up to the exposed footings of the Castle walls to prevent the sea having access thereto.

I estimate the cost of these stone slopes, if confined to the two bays north and south of the centre groyne, at 400*l.*, and if extended to the whole distance between the north and south groynes, 800*l.*

As regards the 'probable effect upon the land of the neighbouring proprietors,' I consider that such a system, coupled with a lowering of the Castle groynes, would be beneficial, as allowing a freer passage of the shingle north and south.

In making this survey and report I may, perhaps, have somewhat exceeded the precise limits of my instructions of the 14th ultimo; but looking to the tenor of your first letter of the 3rd ultimo, referring to 'the Coast between Deal and Sandown Castle,' and arriving as I did when the sea had breached the beach, both at Sandown and at Battery No. 1, it appeared to me, viewing the general waste going on over so great a length of coast, that it was impossible to report on the defences of the Castle without having reference to the whole length of the coast affected, and difficult to disconnect the consideration of the works necessary to be carried out for the protection of your defences and those for the adjoining properties, for an abandonment of the Castle would necessitate the construction of a sea-wall in the line of the beach, or the entire abandonment of the present line of coast, for the ground on which the Castle stands has gradually assumed the appearance of an island. Should the degradation of the coast cease, and a prevalence of south-west winds again renew the beach, such a step might be regretted.

As regards the coast from Sandown Terrace to the Castle, the only effectual mode of defence appears to me to be the erection of a sea wall in continuation of the present esplanade wall from the southward: this affects more immediately the Archbishop of Canterbury and the town of Deal.¹

From the Castle to Battery No. 1, should the present waste continue, to preserve the low lands from inundation, I should recommend the erection of counter walls of earth behind the beach, with a stone slope similar to what I propose for the defence of the Castle, and the consideration of this is also a landowners' question; Romney Marsh, formerly protected by a shingle beach and by groynes, is now defended by a stone slope. Such a work might be executed in lengths behind the thinnest and weakest portions of the beach, and the execution of the paving might be deferred until the beach, which would form a barrier as long as it remained, had been carried away and exposed the counter wall; it might eventually be necessary to extend such a wall northward of Battery No. 1, respecting which latter work I would recommend a similar course to what I advise at the Castle, viz., a lowering of the planks of the north and south groynes, and the extension of the latter westward up the crest of the beach, and the entire removal of the whole of the planks of the two intermediate groynes, which, from their direction and form, are not calculated to arrest or retain the shingle: it would also be necessary to construct a timber revetment or wall from the south side of the battery to the west end of the south groyne, and on to the extent of your property.

At Walmer and at the Admiralty premises at Deal notices are exhibited forbidding the removal of shingle, and this should be strictly enforced along the length of coast under consideration. Large quantities appear to be removed for various

¹ [Now flooding with shingle, February 1863.]

purposes, notwithstanding a notice forbidding its removal, in front of the Archbishop of Canterbury's property, and the attention of the authorities at Deal should be called to this pernicious practice.¹

The works I should recommend to be first executed at the Castle, viz., the alterations of the groynes, and the paving of the two centre bays, would probably amount in the aggregate to 450*l.*, and if the moat were partially filled and two sea sluices were added a further sum of 100*l.* would be required.

The works at Battery No. 1, exclusive of sea walls, would cost 100*l.*

Sea walls behind the mole of beach would cost, say, 300*l.* for the Castle frontage, but these would be useless without being continued as the beach retreated.

From the way in which the shingle is now travelling, I consider that no system of groyning will produce any permanent benefit, and would only lead to disappointment.

In the event of a continued recession of the coast-line, and no steps being taken by the landowners for its protection, it may ultimately be necessary to abandon the sea faces at Sandown Castle and Battery No. 1;² but after a very careful consideration of the question, I should recommend the execution of the proposed works in the first instance.³

Before determining on the character or extent of works, it appears necessary to ascertain the views of the adjoining landowners.

As the wind had been blowing for ten days or a fortnight from the southward and westward I again visited the Castle on the 15th instant, and found a large lower 'full' of shingle had been thrown up from Sandown Esplanade to the Castle, and a considerable quantity of shingle had collected in the north and south bays, in the former of which the 'full' of shingle was highest on the south side of the north groyne, showing the motion had been reversed; the beach around these groynes was, however, being quickly drawn away by the change of wind to N.W. on the 14th.

I have the honour to be, Sir,

Your very obedient Servant,

(Signed) J. B. REDMAN.

2. SHEERNESS SEA-DEFENCES.

To Major Jervois, R.E.

5 New Palace Yard, Westminster, S.W., August 20, 1857.

SIR,—On the 3rd instant I was favoured with your instructions from the War Office to survey the sea-wall which bounds the property of the War Department at Sheerness, and to report, for the information of the Secretary of State for War, the mode in which I would recommend the works of renewal of the groynes, which form a part of these defences, should be carried out, and for which a sum had been voted in the Estimates for this year.

I accordingly proceeded to Sheerness on the 5th instant, as you stated it was desirable I should report as early as possible, and from the 5th to the 8th instant carefully examined the coast from Garrison Point on the west to East End Station, eastward, and was furnished by the Commanding Royal Engineer officer (Colonel Montagu) with every information and assistance I could desire.

The prevalent motion of the shingle on this line of coast is from the eastward, the result of which is a very large accumulation, forming a spit on the eastern side of the entrance to the Medway called Garrison Point. This has gone on increasing, as evidenced on the ground by the fact that the glacis of the eastern bastion is now rendered needless as a sea defence from the large accumulation of shingle in front or to seaward of it, and the same remark applies to the glacis round the works at Garrison Point. It appears, from the plans of Sheerness in your possession there, that in 1737 the end of the shingle spit was half a mile east of Garrison Point; and the same plan describes the then termination of the spit as 'growing beach,' and defines the amount that had then recently grown up from the eastward to the west-

¹ [Deal authorities subsequently exhibited notices, also Her Majesty's Board of Works.]

² [This, in effect, is now the case, March 1862.]

³ [Not done. Consequences, retreat 100 feet of beach N. of Castle and flooding in December 1862 of marshes up to the railway.]

ward of this. The shore where now covered with shingle is described all the way to the Medway, as well as the foreshore seaward, as 'ooze.' Here, as the mass of shingle has increased, so has its size, and the usual characteristics of a sea beach, with two distinct 'fulls,' are presented.

The existence of an outer modern 'full' in advance of the old beach is also indicative of the increase of the Point, the western progression of which has amounted to from 2,800 to 3,000 feet in 120 years, viz., from 1737 to 1857, being at the rate of from 23 to 25 feet per annum. On the opposite shore, at Harwich harbour, a similar shingle-formation, called Landguard Point, has progressed in a S.W. direction at the rate of 50 feet per annum during the last twelve years.

Garrison Point appears to have been resorted to for many years for material for concrete for building purposes and for ballast for road-making in the Dockyard and for your Department. From the eastern bastion up to the turnstile a good foreshore of shingle continues, rendering unnecessary the old groynes, which have been allowed to go to decay. From the turnstile to the east end of your property, a frontage of nearly half a mile, are situate the works in question.

At the west end, *i.e.*, just east of the turnstile, from the degradation of the shingle, caused by the groynes being allowed to fall to decay, or from other causes, the sea has been allowed to impinge upon and breach a portion of the stone slope, which has only been partially repaired, and that at a very acute angle. The stone wall, with the exception of this breach, is generally uniform, but the original slope given to it, viz., from 2 to 3 horizontal to 1 vertical, is very steep; the toe or footing is protected by stake piles, which in places are getting undermined, and causing a corresponding settlement of the stone paving from the sea getting into the clay bed and washing it from beneath.

The shingle which is retained by the groynes running out from this wall is usually highest on the east side, showing the prevailing motion. The land ends are rather above the level of high water, and they extend in varying lengths and directions, generally about 120 feet in length, and with an average bearing N.E. by N. by compass; the wind to which the coast is most exposed blowing from the east by compass, and after gales from this quarter large quantities of cement stone pebbles are picked up along the beach, which work up out of the clay shore. The large quantities of oyster-shells on Garrison Point and the beach in front of the east bastion are also indicative of this movement.

The ends of the groynes mark the limit of the shingle, beyond which is a great extent of flat oozy foreland, amounting in breadth to a mile in places at low water of spring tides.

In front of the Royal Hotel is situate a groyne of greater extent, as to length and cross-section, than the others, through which the sewer from the hotel is carried, at the mouth of which, for its protection, is a curved horn. This groyne has promoted a deposit of ooze to the westward; and there is also a small accumulation of shingle, which is, however, entirely local, for westward of it the clay makes its appearance, with little beach to cover it, with the foot of the stone slope projecting above the foreshore.

The stone wall terminates by a rectangular return near the windmill, and there is then a deep recess up to the east end of your property; along this length of 114 yards the groynes have been allowed altogether to go to decay, the shingle has travelled landward, and the sea has gained very much on the shore, shown by the clay cropping out in serrated ridges through the thin beach, which only partially covers it. By a reference to Major Nugent's plan of October last the high-water mark appears coincident, or nearly so, with the shore ends of the groynes, but is now considerably landward of them, from this recession of the shingle. The degradation of the shore would also appear in the then proposition to lengthen these groynes, which are now quite decayed, and the piles of some of which may be lifted out of the shore, being only a few inches therein, showing a lowering of the foreshore on their site of about 3 feet. At the termination of your property at the east end of this bay or recess, and at the west end of Neptune Terrace, there is a very large old groyne of about six parallel rows of stake piles in steps to the westward, filled in with rough Kentish stone. This groyne has caused a local accumulation of shingle eastward of it, where the pebbles are from 4 to 5 feet higher than on the west side; but soon after passing this local accumulation we find the shore to the eastward very much denuded, the clay cropping through in ridges, a very thin medium of beach travelling landward. The shore appears to be lower to the extent of from 5 to 10 feet in places, as evidenced by the way in which it is dished out (leaving pools of water as the tide recedes)

between the land and sea ends of some half-dozen groynes, situate west of the jetty at Cheney House, which have been entirely abandoned and allowed to go to decay by the proprietors of land, who from their promiscuous cartage away of large quantities of beach and sand no doubt very much increase the evil.

Off the jetty is situate a local spit, Cheney Rocks, or, as it is sometimes called, 'China Rocks,' from the neighbourhood of which large quantities are likewise taken.

Eastward of the jetty, to the extent of the system of defence by groynes, the wall is paved on the face and defended by groynes very close together, being only from 10 to 20 yards apart, filled between with 'fulls' of fine shingle. The wall varies very much in direction with a recess just eastward of the jetty; it subsequently takes a direction more landward, is here more regular, and the beach has a better slope. At the eastern end the shore ends of the groynes are nearly level with the top of the wall as well as the beach. Eastward the groynes altogether cease, and we have a mole of shingle up to the preventive station, and thence eastward to the base of the clay cliffs of the island. Assuming two distinct 'fulls,' marking the respective range of springs and neap tides, it appears to have travelled landward a considerable distance during the last five years; it is said also to decrease in quantity. This recession of the shingle-belt has corresponded with the wasting of the clay cliffs of Minster, which is constantly going on, and evidenced at East End by a large amount of undercliff.

Between the shingle-belt at the coastguard station, or 'Ship on Shore' as it is locally called, and the Marsh Wall is a width of saltings, which in the winter time, during spring tides, and with the wind from the northward, is frequently overflowed by the sea, and may hereafter entail more attention on the part of the landowners to this line of wall.

From this general view of the shore, and a reference to the maps in your Department, there would appear to have been a gradual growing up of the shore westward, towards the Point, corresponding with the wasting of the cliff eastward; that advantage has been taken of this to reclaim the slob lands by degrees, some of the walls being in advance of others, and for the protection of these walls of earth the attempt has subsequently been made to secure a permanent protection by arresting the shifting beach by groynes; that this beach to the westward has grown out in advance of, and rendered superfluous, the groynes, and that in places to the eastward it has travelled landward of the groynes, and at intermediate points, from neglecting to keep up the groynes or to arrest the beach in travelling landward, and also from the irregular projections consequent on the want of concerted action, and from promiscuous and ill-judged removal of sand and shingle for building purposes, isolated lengths have suffered very much.

Were my instructions to report what I considered to be the best means of defending this line of coast, I should be disposed to recommend the construction of a sea-wall, or rather the extension of the stone slopes, and the abandonment of any other sea defences in the shape of groynes. This, however, would involve a much larger outlay than is contemplated in the Estimates for the current year, besides which my instructions direct my attention to the question of the best direction for the proposed new groynes. Neither has the cost for maintaining this wall been extravagant, for I find from returns furnished me at Sheerness that the cost from 1822 inclusive to the present time, including the estimated amount for the current year, amounts to 9,324*l.*, which is at the rate of about 267*l.* per annum for thirty-six years.

With the exception of the proposed expenditure this season, that of 1825 appears to have been the heaviest, reaching 1,300*l.*, mainly caused by damage from a high tide, arising in all probability from the upper works being out of repair.

The expenditure for terms of five years appears to be as follows, viz. :—

1822-25	£658 per annum.
1826-33.	(No return. If aught were expended it would raise the rate of annual expenditure accordingly.)
1834-38	£332 per annum.
1839-41	£111 "
1844-48	£220 "
1850-54	£92 "
1850-57	£159 "

The present is therefore apparently an exceptional and reconstructive year.

In construction, all the groynes along this coast are on a uniform local plan, consisting of two parallel rows of small round oak piles driven down about half

their length through the sand and shingle into the clay battering on the outside, their heads inclining inwards towards each other and nearly meeting, the intervening space being filled with rough Kentish ragstone; the piles in the longitudinal direction of the groyne are driven close together. Similar piling is used for protecting the margins of the stone slopes.

Where longer and loftier groynes than usual have been erected for the protection of projecting points, such as the west end of Neptune Terrace, or for a particular purpose, like the hotel-groyne, outer steps have been formed by rows of smaller piles, driven sloping and parallel with the inner piles, and filled in with stone, forming an outer ledge, sometimes constructed to windward, sometimes to leeward, and in the case of the hotel-groyne on both sides. The large groyne at the east end of your property has six parallel rows to leeward; the single and ordinary construction of groyne is generally from 2 to 3 feet above the shore, which is usually 12 inches higher on the east side than on the west. The short groynes have a fall of from 7 to 1 to 10 to 1, *i.e.*, taking the slope of the beach, the larger groynes are at their outer ends correspondingly more easy in inclination, being as much as 30 to 1, and even more corresponding with that of the foreshore.

There are some cases where, from this recession of the shingle, or from the peculiarity of position, like the groyne at the end of Neptune Terrace, the groynes are much higher above the shore. The above, however, is the medium where the wall, shingle-slope, and groynes are in good order; in other cases, as at the east end of these defences, where the shingle has accumulated, the groynes are not much above its surface. The prevailing mode appears to have been to run them out at right angles, or nearly so, to the length of wall they appertain to, and consequently presenting varying angles to the prevailing wind, with spaces or bays between of from one-half to one-fourth their respective length of groyne. In some cases the ends of the groynes have been connected together, with the object of retaining the shingle on the recoil; and in other cases triangles have been formed within the bays by two inner and shorter groynes running out at an acute angle from the roots of the main groynes, and meeting and forming an apex seaward, apparently with the same purpose—*viz.*, to retain the shingle on the return wave. This may be seen at Cheney Point, where, however, these artificial works are so close together—in one case two groynes cross each other at an angle that it becomes almost an artificial slope.

In the two plans proposed for the repairs and extension of your groynes the principles of construction hitherto followed have been adopted, and differ only as to the number, extent, position, and direction of the groynes. The aggregate length of work in each case, and consequent cost, are nearly the same.

The plan proposed by Major Nugent last October recommended the elongation, in certain instances, of existing sound groynes, and the introduction of new intermediate groynes, this view, no doubt, being encouraged by the favourable state of the beach at the eastern end beyond Cheney Point.

In this plan the groynes are nearly parallel to each other, from the east end to the hotel-groyne, and at right angles nearly to the mean line of high water. Those opposite the recess, between Neptune Terrace and the return end of the stone wall near the windmill, are about 53 feet apart on an average, giving bays of about one third the mean projection of the groynes; thence to the hotel-groyne the bays average from 32 to 33 feet in width, or from one fourth to one fifth the projections. Under the lee of the hotel groyne four groynes were proposed to be placed in a radiating position from a common centre, about 90 feet north-east of the outer end of the hotel-groyne, the bays between these groynes having a mean width of 45 feet, or about half the mean length of these radiating groynes, the western one of which would be detached from the shore at a very acute angle in a north-easterly direction. From this point westward to just past the path to Blue Town the groynes are proposed to be placed parallel to the old ones, *i.e.*, at right angles nearly to high-water mark, and to the mean direction of the shingle 'full,' dividing the shore in that extent into No. 15 bays, with a mean width of 37 feet each, equal to one third of length of groynes.

In the plan for the current year, by Colonel Montagu, the length between the road to Blue Town and the east return of the stone wall at the mill is alone considered. The groynes proposed are longer, and the bays wider, than in last year's plan. In order to retain the shingle after it has passed to the westward, the direction given to the new groynes is in two cases more westerly, with an obtuse angle to windward and an acute one to leeward. In a third case, the second from the west end, this direction is reversed; and to aid in promoting deposit, another principle, which has before been adopted on this shore (though not to the same extent), is here called in aid, *viz.*, to

have sea kants more inclined to the westward, but at varying angles; the present groynes are to be strengthened and extended by similar sea kants pointing upwards, with two exceptions, where they point downwards. This form has been adopted with the present hotel-groyne; in effect Colonel Montagu's bays would be much wider than those of his predecessor, but the openings to seaward would be covered or enclosed in a measure by the sea kants. Two new groynes are proposed east of the road to Blue Town and kants to the three existing groynes west of the hotel-groyne, a new groyne between the sixth and seventh groyne west of the N.E. return at the mill and No. 7 kants or elongations along the eastern frontage generally. The absolute length of new groyne work would be less than one-half that proposed in the first plan, but as some of these are treble groynes with two windward ledges, equal in extent of work to rather more than two ordinary groynes, and as a certain portion have one windward ledge, equal to rather more than one and a half common groyne, the absolute length of groyne work, *i.e.*, piling and stonework, will be nearly doubled; so that, considering the larger piles entailed, there would be no great saving in the amount as compared with the plan of last year.

This plan abandons the defence of the east recess, but the first plan would not now meet the requirements of that length without (to carry out its principle of continuous groynes) the addition of six new groynes in lieu of the old ones, which have continued to go to decay, and which are now too far seaward of the shingle to be of service.

I beg now to report, after a careful examination of the shore, and consideration of these plans, that I recommend the erection of three new groynes west of the hotel-groyne, *viz.*, one opposite the end of the road to Blue Town and two others east of this, with intervening spaces or bays of about 125 feet up to the present third groyne west of the hotel-groyne; that these groynes should each be 150 feet in length; that for two-thirds their length—*viz.*, 100 feet—they should bear N.E. by compass, which would be at right angles to the general trend of the shingle at high water between Cheney Point east and Garrison Point west, but presenting a slightly obtuse angle windward—*viz.* 98°—to the immediate length of wall they would front; that the extremities for 50 feet in length should be 45° more westerly in direction, or due north by compass, forming a sea kant; not that I think these kants collect or retain the shingle, but that they assist very materially in raising the foreshore by promoting a deposition of sand and defending the bays under their lee; that the main length of groynes for the straight portion should be laid at a slope of about 10 horizontal to 1 vertical, the south ends or commencements at the top level with high water, spring tides, and that the sea kants should be laid at double the above inclination—*viz.* 20 to 1—kept not more than 18 inches above the foreshore, and the main groyne not more than 3 feet above the mean level of the neighbouring shore; if the above inclination cannot be readily got, one of from 7 to 10 may give that elevation; that these groynes for the centre 50 feet should be formed of four rows of piles and three widths of stone, the eastern ledge thus formed to be 1 foot below the summit of centre width, and the inner or western ledge 2 feet below the same, and that the sea kant should have one outer or N.E. ledge 9 inches from the summit of said kant; that the existing groynes should be repaired where necessary; that the third groyne west of the hotel-groyne should be lengthened to 100 feet, and that its seaward half should be strengthened by a windward ledge, and where the shore is low (but not otherwise) a leeward ledge also, and that it should have a sea kant of 50 feet added to it, constructed the same as those of the new groynes; that the second groyne west of the hotel-groyne should be treated in the same manner; that the first groyne westward of the hotel-groyne should be left as at present with any necessary repairs; that the first groyne east of the hotel-groyne should be lengthened to the mean length of the three eastward in a N.E. direction, with a windward ledge; that the three groynes eastward should be merely repaired and strengthened as before; and that the next groyne eastward and each alternate groyne subsequently should have sea kants bearing north—*viz.* the third, fifth, seventh, and ninth groynes from the eastern groyne at the return in the wall.

The breach in the stone wall commencing about 40 feet east of the road to Blue Town, and extending about 100 yards eastward, should be made good; and I recommend that, as so great a length has been breached, a much easier slope—say double that of the present wall—should be adopted, in order to try its effect on this length; it might be rounded off to meet the present work at the sides, the sea margin to be carried well down under the foreshore and finished with a deep trench and footing of large stones, the large stones being selected for the lower part of the

slope for two-thirds of its width, and the widening of the bank to be done with well-punned clay in thin courses.

In other bays, where the margin of the slope has become undermined, it should receive immediate attention; and in such cases I should recommend the extension of the slope seaward at an easier inclination, to be carried well under the foreshore, with a footing as before described.

In front of the east recess I recommend the construction of one groyne precisely similar in direction and construction to those just described, about 115 feet east of the east return in wall, or one third the frontage of the recess eastward of the east groyne. A good deal of the waste on this portion of the frontage—which, however, can only be regarded as local—has been caused by the great height of the groyne at the end of Neptune Terrace. The effect of the groyne I propose may induce an increase of shingle, but my opinion is that ultimately it will be necessary in future seasons to take further steps for the protection of the east end of your frontage; and I consider that a stone slope immediately behind the shingle, to prevent its retreat further inland from the angle of the present stone slope to the end of the groyne at Neptune Terrace, would be the best remedy.

Before concluding, I beg especially to draw attention to the general condition of this shore, and beg to repeat the remark I made in a recent case where I had the honour of reporting to your Board, that this is to a great extent a landowners' question, and that there are practices going on all along the shore of the most suicidal character, and in some cases quite stultifying the measures taken for defence, arising from each owner merely looking to his individual interest and to the limited frontage under his control, accounting, perhaps, for the irregularity of the walls and varying directions of the groynes. The quarrying of cement-stone on the opposite Essex shore has been loudly complained of in reference to Harwich harbour. The mode in which it is taken from this shore at low water, over the enormous extent then exposed, can hardly be complained of; but the indiscriminate cartage away of shingle and sand from the spit running out at Cheney Point at low water, and along the shore to the westward, cannot be too soon put a stop to; but whilst it is the custom of your Department to remove material from Garrison Point it may be difficult to prevent others to the eastward removing similar material from their frontages. No doubt the removal of shingle from Garrison Point produces less harm, and it has arrived at a point from whence it is desirable it should not extend itself to the westward. I do not, however, think that the manner in which this spit extends itself—similar to other like formations—threatens the Dockyard, for it is increased seaward by parallel ridges or 'fulls,' which would, as they increased, extend themselves eastward, and any abstraction at the western end must, if that view be correct, be a loss eastward.

On the other hand, what is abstracted eastward cannot pass westward, and robs that quarter; so far, it is a relative question of quantity. The two cases are, however, really very different. I understand that the shingle has usually been taken from Garrison Point, where it is highest, largest, and in greatest mass, and consequently least missed; but at Cheney Point, whilst I was there, carts went down at low water and removed material from the shore, where it was most wanted for protection. Great mischief is, no doubt, being done, and this indiscriminate and injudicious mode of removing this material for immediate gain appears to me most hurtful to all interested in the neighbouring foreshores, and even to the prospective advantage of the owner, who, however, if this be a public injury, can, I take it, be stopped in these operations through the Woods and Forests Department. And I may in illustration refer to a recent case at the mouth of the Humber, where, by the indiscriminate removal of pebbles from the Spurn Point, for ballast and other purposes, a breach has ensued, which has resulted in a very heavy expenditure in works, which might have been avoided had attention been drawn to the matter earlier. This particular case attracted considerable attention in the House of Commons in a recent Supply debate.

I feel that, viewing the mere letter of my instructions, this may appear a very lengthy report; but I felt it impossible to give any opinion on the particular subject referred to me without reporting on all the attendant circumstances that must so materially affect an inquiry like this.

Having had surveys of the foreshore placed in my hands, which I verified, to a certain extent, by taking bearings on the ground, as also cross-sections of the beach, I did not consider it necessary to prepare any additional plan, but have merely appended some marginal sketches, which, with a reference to the plan of July 18,

1857, by Colonel Montagu, which I herewith return, together with Major Nugent's plan of October 29, 1856, will be, I think, sufficiently illustrative of my meaning.

I am, Sir,

Your obedient Servant,

(Signed) J. B. REDMAN.

3. EASTBOURNE CIRCULAR REDOUBT SEA-DEFENCES.

To Lieut.-Colonel Owen, R.E.

5 New Palace Yard, Westminster, S.W., December 24, 1857.

SIR,—On the 25th ultimo I was favoured at the War Office with your instructions to report after inspection, for the information of the Secretary of State for War, what, in my opinion, would be the best course to pursue in repairing the damage done to the breakwater at the Circular Redoubt by the gale of October 7 last, and for the future maintenance of this work.

For this purpose I went down to Eastbourne the evening of the 1st instant, and had the opportunity of inspecting these works during the low spring tides of the 2nd and 3rd and the morning of the 4th inst., as well as seeing the effect of the sea upon them, as there was a fresh breeze from the southward and westward, with a heavy sea at high water during the whole time of my visit.

Captain Baillie, who met me on the work on my first inspection and on other occasions, afforded me every information I could desire.

The length of coast under consideration consequent on the projection of Beachy Head bears N.E. and S.W., but I have thought it more convenient to speak generally of the points under consideration as being east or west of each other in reference to the general direction of the south coast unless otherwise specified.

It is hardly necessary for me to dwell at any length on the various evidences there are to show that the sea has continued to encroach for some years past from Beachy Head westward to Langley Point eastward, or how it has resulted from this that the defences at the Circular Redoubt form themselves into a projecting point as the shore has receded east and west of it; very similar in effect to Sandown Castle, on which I had recently the honour of reporting to your Department, all this being clearly shown in Captain Baillie's surveys, with copies of which I was furnished and had with me to aid me in this inquiry.

To the westward, along the frontage of the 'Sea-Houses' at Eastbourne, it has been for some years a contest with the elements, the source of constant outlay, and, from the state in which the foundations of the sea wall are now in, exposed as they have been at low water by the withdrawal of shingle produced by the late easterly gales, this outlay is likely to be very much on the increase, without a re-accumulation of shingle quickly takes place.

In the bay, between the esplanade and the Circular Redoubt, the recession of the shingle is evidenced by the proposed abandonment of the present coastguard station. Immediately west of the Redoubt there is a tolerable 'full' of beach, which, however, has travelled landward, as evidenced by the hardness of the lower slope and thinness of the shingle and amount of sand, and also by the abrasion of the old glacis slope, some of the turf from the serrated edges of which I found lying on the beach below during my first inspections. Nor has the west timber revetment been extended far enough to the westward effectually to guard against this.

On the east side, the recession has been checked by a concrete revetment wall, which appears to have answered the purpose, having been erected half a dozen years back, and the shingle is still seaward of it.

The effect of this land recession is—the continuity of the shingle mole is destroyed, the artificial works for the defence of the Redoubt cutting through it, and there is consequently deeper water immediately in front of them east and west, rendering the collection of shingle in front by groynes more and more difficult, as well as the maintenance of any artificial works, from the increased depth of water.

It appears, from plans belonging to your Department at Eastbourne, that in 1805 the sea at high water was 120 feet seaward of the inside line of the counterscarp-wall, or 250 feet from the centre of the redoubt. In 1808 these dimensions were relatively 90 feet and 223 feet, showing a wasting of the shore of from 27 to 30 feet in three years, equal to from 9 to 10 feet per annum. Referring this comparison to Captain Baillie's survey on the east side of the redoubt the difference would be 238 feet in 49 years, equal to one-half the former degradation, viz., 4½ feet per

annum. On the west side it would be still less, viz., one-third the amount that it is on the east side, viz., $1\frac{1}{2}$ foot per annum. It would thus appear that the recession of the shore line was greater over former terms of years, or that the artificial works at this particular frontage have kept it in check. The effect of the Redoubt and its works is, like that of a groyne, to keep up the shore westward. Were these works abandoned the shore west would recede accordingly.

Surveys by the same authority (Searle) in 1808 show the degradation of the shore as far as Langley Point.

No. 72, Martello Tower, the one adjoining the Circular Redoubt, was removed some years since, consequent upon the encroachments of the sea. No. 71 has apparently been underpinned with stone, and is also protected by a groyne to the leeward as regards the prevailing westerly winds, viz., to the east, which has promoted an extension of the shingle in that immediate neighbourhood. In 1808 high-water mark was 175 feet from the centre of No. 70. It is now 35 feet from it, equal to 140 feet recession, or nearly 3 feet per annum. No. 69 was 195 feet, and is now 50 feet, giving the same amount of degradation; and the old fort between these towers, which was dismantled some sixteen years since, had 50 feet of beach seaward of the most salient angle at high water-mark, which latter is now in a line with its centre, or 140 feet back as before. The degradation of the shore west of the point is also shown by the exposure of about 3 feet of brickwork below the mastic with which these towers were coated two years back.

No. 67, on the other side of the Point, had 170 feet, and has now nearly the same, showing that the degradation is confined to Eastbourne Bay, and ceases on the west side of Pevensey Bay. The east fort had 85 feet on the outside, and has now nearly the same.

No. 66 had 170 feet, and has now 200 feet, showing that there is a local accumulation northward of the point, but this appears to cease to the eastward.

No. 65 had 108 feet, it has now the same; and Nos. 59 and 60 had 150 feet in 1810, and now have much the same.

These facts are sufficient evidence of the continued abrasion of the west shore of Langley Point, which at a former period extended much further westward, as also a much greater distance into the sea. This has had a corresponding effect along the frontage of Eastbourne Bay, but I do not think, on comparing the results with those obtained some ten years since for another purpose, that there is any evidence that the encroachment has been materially on the increase in the neighbourhood of the Redoubt of late years, but, on the contrary, that its rate has rather diminished or been held in check as along the frontage of the town by works of art.

The present low state of the shore in front of the Redoubt appears to be due to the late easterly gales and consequent withdrawal of the shingle. As the latter can, however, only be regarded as a fluctuating medium of defence, it will be well to take the level of the shore as I found it as a datum for laying out any future works. The two west bays I found lower than usual, and Captain Baillie informed me he had never seen them so low as during my visit, and the breastwork was consequently more exposed than when he made his report. I found the west timber revetment at the west end and at the ninth groyne 2 feet above the shingle, at the centre of revetment 6 feet above, and at its east end 5 feet 6 inches above; the south-west angle of the bulwark 3 feet above; the bulwark at the eighth groyne near the west end 5 feet above, at the seventh groyne 6 feet 5 inches above, at the angle at sixth groyne 9 feet 3 inches above, at next angle 8 feet 3 inches, at angle west of fifth groyne 5 feet 6 inches above, and east of fifth groyne 5 feet 3 inches; thence running up eastward to level of bulwark, where it continued to gather during the latter part of my stay, until it stopped and ran over the south-east angle of the bulwark into the next bay.

It appears that usually the west bay revetment and west end of bulwark have a bed of shingle in front, which was, during my inspection, as will be seen above, very low, but was again accumulating. The recent abrasion on the east side is shown by the east groyne being visible, as it is usually buried in shingle. No. 2 groyne is also usually more covered. No. 4 groyne appears usually to have a good supply on each side, but the great accumulation appears usually to cease at the angle here. Captain Baillie proposes a new groyne, but even here it appears that the face of the breastwork is not usually exposed. The most exposed point, as might be expected, is the salient angle at groynes Nos. 6 and 7.

The shore fronting the redoubt may be said to be divided into eight bays by No. 9 groynes, throwing out of consideration the more ancient and dilapidated ones.

East of the artificial works the shore, as before described, and as may be seen by referring to Captain Baillie's survey, recedes suddenly and the crest rises, as in other similar situations, being higher than any accumulation at the Redoubt, as at Sandown and elsewhere. East of No. 1 groyne there are 10 naked piles, the remains, apparently, of an old groyne, exposed by the withdrawal of beach caused by the late easterly gales.

No. 1 groyne is lower than those to the west. It points in a S.S.E. direction, and is well backed up with beach, extending to within a few yards of the end of it.

No. 2 groyne is constructed with an offset, or kant. The landward length bears S. 7° E., and the seaward length S. 5° E. The inclination of this groyne is good, and it has a compact mass of shingle well up to it within 18 inches of the top, extending about 30 feet beyond the kant. Eastward the shingle recedes, and is only just beyond the kant.

No. 3 is an old dilapidated groyne running transversely across the bay between the two kanted groynes (Nos. 2 and 4) in a direction S.S.E., 2½° S. The shore between this and the new groyne (No. 4) was 6 to 7 feet below the latter, which is also constructed with an inclined offset or kant like No. 2, the land length bearing S. 8° E., and the sea length S. 9° E. The effect of this groyne has been to form a local accumulation of shingle, heaped up from 4 feet to 6 feet higher than to leeward, but quickly declining to the westward, as before described, running over the S.E. angle of the bulwark, whilst the return of the latter was 5 feet above the shore to leeward, the margin of the shingle extending to within 30 feet of the kant.

To the eastward of No. 5 groyne the shingle was 5 feet below the bulwark, whilst in the same bay in so short a distance it was running over the top of it at the east side. This groyne bears S.S.E. 1½° S., and had a tolerable 'full' against it 3 feet higher to windward than leeward, but decreasing very much in breadth seaward, the bay east of it being low and bare, composed of fine shingle and sand; the beach in this bay, the widest of all, immediately west of the breach narrows and draws in suddenly with a curve, due to the projection of the breakwater. There are the remains of two old groynes west of No. 5, which I have not numbered, the piles of which are subsequently found running up through the breached work of the breakwater. The stumps of three ancient groynes may also be seen on the foreshore towards low water about the centre of this bay, and similar remains may be traced at top through the beach near the breakwater, standing evidence of the encroachment of the sea.

No. 6 groyne is much decayed. It bears S.S.E. 2½° S. There is a fair amount of shingle against it, but not extending far out seaward. No. 7, which is in better order, extends in a S.S.E. direction, and had beach apparently increasing during my visit about 2 feet higher to windward than leeward.

No. 8 groyne was much ruined; also in a S.S.E. direction. The beach was evidently gathering here again on the morning of the 4th inst., as the west timber revetment and west end of breakwater were then only from 18 inches to 4 feet above the shore, and there was a good supply of shingle in the west bay, and it appeared to be again growing up west of the west groyne No. 9, which bears S.S.E. 2½° S., but which is much out of order, particularly at the end.

The effect of these groynes is, as elsewhere, to cause an accumulation of shingle to windward, as regards the prevailing wind, with a corresponding depression leeward, the shingle sloping down to the west. This is shown in a remarkable degree at the new groyne No. 4, on a line with the east margin of the breakwater, where the beach was 7 feet higher, during my visit, to windward than to leeward; and the two north-east groynes beyond this are much lower than the new groyne.

It would be well to keep up the existing groynes at the landward ends near the breastwork, where they, no doubt, promote a retention of the shingle, but I am not inclined to recommend a great expenditure in extending this system. The site pointed out by Captain Baillie is, no doubt, a good one, if a new groyne be erected; but in that event a length equal to one half that of the new north groyne would, I think, be sufficient. The effect, when the continuity of the natural mole of shingle is destroyed by its own recession and the consequent protrusion of a work of this kind, is that no more than the lower 'full' can be retained, and the beach travels onwards and landward, irrespective of the groynes.

A pier erected northward and eastward of these defences might arrest a large quantity of beach, but would be nearly as costly as maintaining the breakwater, and the works to leeward towards Langley Point might suffer correspondingly. With the problematical results that may be anticipated from any extension of the system of groyning, I am disposed to recommend the maintenance of the breakwater.

I have directed my attention to three modes of protecting this work, viz., by an extension of the system of groynes, the abandonment of the present breakwater, and the construction of an inner sea wall nearer the redoubt, intersecting the counter-scarp wall, and the strengthening and maintaining and extending the present sea face, and am induced to recommend the latter course.

There are, however, it appears to me, serious defects of construction in the present breakwater, and I will first describe the state in which I found it, and what appear to me to be the causes of its failure. These my inspections will enable me to do, as the western or southern half remains entire, and the eastern or northern half has been breached over almost its entire surface, exposing to view the débris of former defences, on which the present have been founded.

The glacis of the redoubt appears formerly to have been formed of shingle and earth coated with clay and grass-grown. As this became abraded by the sea, consequent on the recession of the shingle, a system of defence was adopted known along the coast as 'arming,' faggots being driven down over the surface of the slopes, holding down watlings by means of overlaths. Many of these old and decayed faggots may be seen at the present time in the breach, and this is one of the defects of this work—that succeeding defences have been added and placed above the old ones without removing them or obtaining a sufficiently solid base. As these old works have decayed they have subsided and left vacuities under the modern works. This remark applies to the timber wharfing or bulwark of the apron or breakwater erected so recently as the summer of 1856, formed of whole timber piles 22 feet long, which are now, in places, exposed nearly half their length, driven 4 feet apart alternately in front and to the rear of 4-inch horizontal planking, backed with 4 feet of block concrete, the outer piles being held back to land-tie piles only 4 feet back in the rear of the concrete; and it appears that behind all there is an old timber breastwork. The angular space between the old slope, the outer breastwork, and the surface of the present slope is formed of shingle covered with concrete, which receives the stone paving or brickwork, as it may be. Through this shingle substratum the sea must percolate freely. This is seen now at low water by the great quantity of water running out through the bulwark and gulling out a small run of water across the shore just east of No. 5 groyne, which has previously been penned up after high water in the breached portion. When the general character of the work is considered, the constant infiltration of the sea has been one of the causes operating in producing settlement, in addition to the decay and subsidence of the materials of former works; added to this, the timber breastwork, when exposed to the impact of the sea towards high water by the removal of shingle usually lying against it (which is its present condition, consequent on the late easterly gales), is not of a nature to resist effectually the enormous force brought to bear immediately against it, which, during my visit, caused a sensible vibration through the whole mass of the breakwater, and threw up a column of water about 30 feet high. Where the bulwark projects above the shore, an overfall is created on the receding of the wave, tending to scoop out the shingle. This applies to the east and west ends. Where the shingle is level with the top at the south-east end the sea runs over without breaking. The brickwork forming portions of the slope laid in the summer of 1856 is much worn from the abrasion caused by the shingle dashed against it at high water, and the concrete slope above appears very doubtful, having apparently swelled upwards in places, and sounds quite hollow to the tread. The manner in which the breastwork springs or yields back and then forwards, consequent on the removal of the shingle in front of it, by which the weight of the material of the glacis is brought to bear against it, has been well described in Captain Baillie's report. This produces a loosening of the stones of the slope at the joints, which are subsequently readily removed by the sea. During my visit, by the settlement outwards of the breastwork, the main longitudinal joint between the marginal stones and pitching required pointing, as also some of the main longitudinal joints up the slope; and along the south-west frontage the coping stones had settled vertically, leaving the brick projecting, and which may thus be readily undermined.

Where exposed, the breastwork is being strengthened at the most projecting angles seaward by open piled and braced counterforts, to counteract the tendency it appears to have to settle outwards consequent on the removal of the shingle. The same thing has taken place with the old south timber revetment, which has settled outwards, and is much out of line with an intervening space between it and the concrete backing. It is possible that the free admission of water into the foundation of this work, the paving having close joints, with a homogeneous body below for a

certain depth forming the surface of the slope, has been one cause of its failure, as has been the case in other works where a paved surface not admitting the passage of the sea has been placed on a substratum which does. The result is, a hydrostatic pressure is evolved by the difference of height of the wave outside compared with the level of the water inside, which is comparatively at rest, tending to raise the impermeable work forming the surface of the glacis, which, aiding the wave on the recoil, may be one of the destructive agents at work. In the present case this is to a great extent conjectural, and I am more inclined to think that the settlement of the breastwork and inner work, and the consequent loosening of the surface work receiving the direct impact of the sea, are the more immediate causes of its failure.

The best mode of protecting the Redoubt effectually is the next question, and is, no doubt, a difficult one. The foreland along this shore is not of great extent, and from the way in which it has been deepened in front of the Redoubt, the tide, when once it makes, is soon over its surface, and would quickly gain on any outer works, increasing the difficulty and first cost of construction as well as that of future maintenance.

There are two modes by which the sea defences might be extended: first, by continuing the slope from the top of the bulwark down to the foreshore; and, secondly, by an entire reconstruction; the latter of which courses I beg to recommend, as the present height of the bulwark is so great that to carry out a sea slope from that level would entail a much larger surface and mass of work, and would bring it so near low water as to render it almost impracticable, or else a very steep slope would be required. In carrying out this work it would not be necessary to remove entirely the bulwark, but to pave up to it and to cut off so much of the piles as interfered with the level of the proposed slope. The work seaward of its present extent should be formed of much heavier blocks than those now used, laid dry upon a foundation of broken stone or shingle mixed with tempered clay above; where less influenced by the tide, on concrete. The main groynes should be repaired at their landward ends, as they would form convenient bays for getting in the work, as well as limit the area of damage should breaches hereafter occur.

The sea margin of the elongation of the slope should be formed of still larger stones, stepped down in a trench and founded as before described. To render the sea slope more secure, I propose, in addition, that there should be longitudinal and transverse crosses or walls, as shown in the drawing. These should be founded on work in trenches, as described for the toe or sea margin of the slope. They would have the effect of limiting the area of future breaches. The upper portion of the slope might be continued, as occasion required, to the profile shown in the accompanying section.

In doing this, the remains of old work should be first removed, and I am of opinion that the sea should be allowed to give its own slope to the débris over the breached portion, and that it should be left to settle during the winter, and if the breach extends itself westward such further exposed portions should be treated in the same manner, the interstices to be filled in with broken stone and materials from the old slope, and all old timber and faggots removed; the slope to be then gradually brought up, composed of well-tempered clay, mixed with shingle and broken stone. Shingle itself without such admixture appears to me a most unfit material, from its character, to form the base of such a work of, for, unless in equilibrium or closely confined, it will settle down and run out like water through any outlet formed by a breach or otherwise. The existing groynes should be repaired near the bulwark as far out seaward and as high as the beach usually collects. Any greater extension or elevation appears to me useless.

A small groyne where proposed by Captain Baillie would, in all probability, prove a useful auxiliary, say 90 feet long; but instead of placing the entire length obliquely across the bay, as suggested by Captain Baillie, I propose that for two-thirds its length, viz., 60 feet, it should point S.S.E., and the remaining third, viz., 30 feet, S.S.W., as shown.

The extension of the breakwater beyond the present bulwark I estimate would cost 3,000*l.*; the work above, 2,000*l.*; making a total of 5,000*l.*

I return herewith Captain Baillie's plans and sections (No. 3 sheets). On two of them, descriptive of the Redoubt, I have marked in red the numbers and bearings of the groynes as I have distinguished them, and also the levels of the bulwark above the shore.

I have the honour to be, Sir,

Your very obedient Servant,

(Signed)

J. B. REDMAN.

APPENDIX.

The gale of October 7, which caused the breach in the breakwater, commenced from S.S.E. and veered subsequently to S.S.W., from which quarter it continued the following day. During the rest of the month it blew alternately from the westward and eastward, slightly in excess from the former quarter; but during the month of November there was an unusual amount of easterly winds, and from the middle to the end of the month strong gales from that quarter were experienced.

Since my first inspection of these works the wind has been entirely from the west, the continuous east wind in November accounting for the extreme lowness of the beach during my survey, and the change of wind producing re-accumulation.

4. SANDOWN CASTLE.

To the Secretary of State for War.

5 New Palace Yard, Westminster, S.W., October 11, 1860.

SIR,—Your instructions of August 11 last directed me to report—

First, on the practicability of permanently maintaining the Castle even though it were entirely separated from the shore on either side of it.

Secondly, as to the mode I should propose to adopt for this object; and

Thirdly, as to the probable cost of such an undertaking.

With this view I visited the spot the morning of the 17th ultimo and repeated my inspections the three following days, and was certainly not prepared for the great change that has taken place since I reported four years back, in 1856. In that report I detailed at length the then condition of the shore, illustrated by an accompanying plan from Sandown Esplanade to Battery No. 1.

The beach has continued to retreat and gain on the shore, as this latter is washed away. North of the esplanade and between it and the windmill the edge of the bank that crops through the upper shingle 'full' is now considerably behind the line of the esplanade railings with which it was in a line in 1856. The foreshore northward is thinner, and although the South Castle groyne and timber revetment hold a certain quantity of shingle in check, which, however, was recently scoured away and has since re-accumulated, and is, indeed, as high at the south groyne as in 1856, the condition of the shore northward is altogether altered.

I may state generally that towards the western ends of the groynes the shore has lowered to the following extent: at the south intermediate groyne it is on an average 3 feet lower; at the centre groyne, the western end of which for 30 feet in length next the Castle has disappeared, the shore is 4 to 5 feet lower; at the north intermediate groyne 3 to 6 feet lower; and at the north groyne 8 feet to 13 feet lower. Indeed, this work had been left hanging up, as it were, at its landward end until upset by the fall of the north moat revetment counterscarp wall, the shore being washed away down to the very pile shoes, and the same remark applies to the north timber revetment, from behind which the shingle has been scoured out vertically for a depth of at least from 12 to 15 feet, leaving a clean section of sand-hill 12 feet in height fronting the sea, where formerly existed a shingle mole; and 16 feet in height of the old moat-wall is also exposed.

All the old 'fulls' of beach north of the north groyne are gone; they appear to have gradually decreased for the last three years, but a 'full' of beach level with the top of the north timber revetment, now entirely isolated, existed, it appears, six months past; the mark, indeed, may be seen on the adjoining moat wall, the shore is now 12 feet lower, and what shingle there is, is driven landward. Northward of this, towards Battery No. 1, the degradation of the shore has been almost as remarkable, and the sand 'dunes' now crop for continuous lengths through the shingle mole (which is now much thinner and further inland), and not in isolated patches as described in my report of 1856. The effect of this has been the almost entire destruction of the sea works of Battery No. 1.

The result of this remarkable lowering of the foreshore immediately under the Castle, consequent upon the disappearance of the mole of shingle northwards, has been the continued and increased exposure of the base of that work; and although various attempts have been made to underpin the footings, the main Castle-walls, from numerous appearances therein, appear to have received some amount of injury from the constant percolation of water under the foundations, and the withdrawal therefrom of the same on the recession of the tide causing the loose sand to be drawn away from below the hard crust of sand on which the edifice immediately rests, and

which, on exposure to air and water, by degrees assumes its original character, only showing more plainly the danger to which the structure has been subjected by this continued exposure.

The result of the great recession of the shore north of the Castle before described and delineated on the accompanying plan is that the sea eddies round the building, which at high water forms a kind of point or headland, and the sand is scoured out from under or before the Castle walls: this great decrease in the height of the foreshore has not only induced the permanent loss of beach from its not re-accumulating at a level so much below high water, but the sea also much sooner reaches the Castle walls, rendering the difficulty of construction of any permanent work of defence greater year by year. Another result of the lowering of the shore and loss of the shingle barrier is that the Castle walls are much sooner reached by the tide, longer subject to its influence, and that the footings are gradually more and more undermined, and the sand crust on which they rest exposed in the same degree, and that the body of sand below is more saturated, and a larger amount is withdrawn by the tidal recession. That the sand is highly charged with water under the Castle is shown by the manner in which it pours from under it over the foreshore at low water, and the manner in which it boiled up from under the footings in the trial holes that were sunk for their examination, when none was to be seen coming in from the opposite side. The result of this constant saturation beneath the foundations and withdrawal of water therefrom in such a material as that on which they are founded is evidenced by the numerous fissures in the outer main walls of the building, in the piers therein and in the basement gallery walls; still former fissures existed of considerable standing of which many of the modern ones are merely an extension. Similar indications of settlement may also be traced in the upper embrasures, though these latter may be attributable in a degree to the age of the building and causes producing vibration.

The settlement of the main building is shown by a fissure around the small window in the keep staircase turret; those in the basement walls may be traced all round, and appear worse next the sea. Some are older than others, and have been pointed up some time back. The more recent settlement is shown in places by the breaking of the Caen ashlar stones where the bearing is unequal. The vertical settlement is also shown by the bridge from the ramparts to the door into the principal room of the keep having altered its form; many of these indications are, however, of considerable standing: this may be remarked of the basement, especially on the land side.

There are fissures in the footings of the south revetment or counterscarp wall indicative of settlement and an outward movement similar to that causing the failure of the north wall.

The natural result of the withdrawal of so large a quantity of the sea barrier immediately from the base of the north moat revetment or counterscarp wall has been for the last six months to gradually undermine it from the seaward and to carry the sand away by degrees from under it by the underdraught of water from the moat on the recession of the sea. The wall, which had cracked in various places, fell over in three detached masses, leaving two large breaches for the sea to enter by on the 11th ultimo, just as the brick wall of Battery No. 1 had previously fallen from similar causes.

If the Castle is to be maintained something must be done immediately.

In the first place, I recommend the removal of every remaining timber of the north groyne, north intermediate, and centre groynes, and of the north timber revetment from its present site.

The south intermediate groyne, south groyne, and south timber revetment to be retained for the present, as their removal would entirely alter the condition of the shore southward.

In reference to the above remarks and those that follow, I beg to refer to the plan accompanying my report of 1856, also to the enlarged plan of the Castle and adjoining frontage, showing the proposed works accompanying this report.

I next recommend the immediate construction of a sea barrier across the moat from the outer or N.E. curve of the N.E. tower to the angle in the moat, retaining wall formed by the intersection of the two circular curves therein, such barrier having a N.W. and S.E. direction, and including within it the moat tank or drainage cesspool. It might be formed of the blocks of stone from the fallen north revetment wall, backed with masses of concrete therefrom, and the whole backed up with material procured from the neighbourhood, the pitching of the crest and back slope laid on clay puddle.

As a further precaution, I recommend at the same time the erection of a counter-dam across the opening under the drawbridge to the north of the basement gallery doorway, and near where a similar former work stood, this barrier to be continued along the base of the drawbridge pier or causeway as hereafter described.

The object of the outer dam would be to prevent the sea ranging into the moat as at present, threatening, as it does, to undermine the north side of the N.E. tower, where a height of 4 feet of the compressed or hard sand is now displayed below its exposed base. The north groyne of the drawbridge pier is in the same peril, caused by the indraught of the great body of water at high water of spring tides that there passes under the drawbridge through the narrow opening. The effect of the outer dam would be to arrest the travelling shingle and to cause it to form in front of it instead of being spread over the moat.

The inner or counter-dam under the drawbridge would confine the sea to the northward of it in the event of the failure or leakage of the outer barrier, and would prevent the damage to the south moat revetment or counterscarp wall, now likely to arise from so large a body of water getting behind it. The ill effect of this may now be seen by the quantity of water that pours out on the receding of the tide through the foreshore from under the Castle walls.

A paved watercourse should, I think, be constructed outside the outlet pipe through the south revetment-wall, the scour from which at present is promoting an undermining of the wall.

Coincident with these works I propose that the north timber revetment be retreated and reconstructed against the sand face now exposed by the undermining of the sea.

The broken edge of the north moat wall to be formed to a slope to approximate with that of the outer sea barrier in the moat, and the timber revetment when retreated and faced with stone to form a kind of projecting pier between the two.

The exposed portions of the N.E. tower base, consequent on the failure of the north revetment wall to be underpinned.

The heart of the sea-barrier, of the counterdam, and of the backing of the north revetment, to be formed with clay puddle, the two former to be also furnished with wooden trunks or sluices and self-acting tidal flaps of timber, say 1 foot 6 inches square, hanging outwards to allow of the retreat of any tidal water that might gather behind the same from leakage or the swell from high tides topping them.

A slope or bank of earth to be thrown up against the north side of the drawbridge pier or causeway in continuation of the counterdam and faced with stone. This portion of the work at present is very insecure, the stone ashlar in places being quite honeycombed behind into the backing.

If the Castle is to be maintained, the whole of the above works should, I consider, be immediately executed to make it at all habitable for the approaching winter.

Should the present *statu quo* continue, I apprehend the probable failure of the N.E. main tower and the almost certain fall of the drawbridge pier.

The whole of the above works can, however, as regards the permanent maintenance of the Castle, be only regarded as comparatively temporary in their nature.

Their cost I estimate at 800*l*.

Although I submit herewith a plan which I consider will achieve the object in view, I feel some hesitation in recommending its adoption without first explaining what appear to me inherent defects in the structure to be defended.

The work, looking to the date and character of the masonry, exceeding three centuries of age, composed of small materials, was built more as a landwork, when there was a considerable barrier betwixt it and the sea, than as one to withstand the attacks of the ocean, and was founded somewhat superficially on sand, which, from the stealthy encroachments of the sea, has been undermined by degrees—it is difficult to say to what extent. Not only is the work from these causes somewhat doubtful, but, viewing the continued effects of the sea in its present condition, it will become more so.

If it be determined to maintain it, I propose that hereafter the maintenance of the moat walls and revetments be abandoned, and that the main outer walls of the Castle be entirely surrounded by an enclosing basement wall, to be carried up 18 inches above the sills of the lower or basement embrasures, which would then probably require to be walled up solid, as those at present next the sea now are, or at least on the north and south sides; this level for the top of the enclosing wall would be the range of high spring tides; that this wall above be made nearly parallel to the inclined base of the Castle walls with more projecting courses below, giving it a curve outwards, the foundation carried down to within 4 or 5 feet of low water of

spring tides, that is, vertically 16 feet from its summit; that it be made from 4 feet to 10 feet thick of solid masonry, in large blocks pinned and cramped together as it progressed, and set in hydraulic cement, the largest blocks used in the base with offset courses as shown in the drawing. Such a wall would be considerably below the present base of the enclosing outer walls of the Castle, which it might be made to underpin in places by having projecting corbelled courses carried under and wedged up to the same; it would have to be got in in short lengths, and the excavated face kept sufficiently in advance of the old walls to clear the hard sand crust in front of the same next the sea, and the excavated face below supported by piling, caulked if necessary, as the excavation progressed, to prevent any disturbance of the material below the present walls. The outside of the toe of such encircling wall to be enclosed by another parallel row of sheet piling driven down 12 feet below its base, *i.e.*, 4 feet below the level of low water. Each row of piles to be of rock elm timber, connected by longitudinal wales, and together transversely, as shown, the excavated trench within got out in short lengths and filled with clay puddle and concrete. The greatest care would be requisite not to disturb the ground under the Castle walls.

To avoid this it is, as before stated, proposed to keep the encircling wall at its base, say, 5 feet from the present footings, and pile it at the base on both sides, as shown on the accompanying plan.

The above plan appears to me to present the fewest possible objections out of several that have presented themselves and been considered. To underpin thoroughly the existing walls would be exceedingly costly and difficult, and the driving of piles near them hazardous. By keeping the inner work in advance as above proposed this objection would be obviated, the pile-joints might be caulked, and the areas limited by temporary cross-piling.

This plan would, next the sea, admit hereafter of extension or widening at the base should the shore lower still further, by the addition of another outer row of piling, and stepping down the foundation within the trench so formed, as shown by the dotted lines in the sections.

Or this lowering of the shore might be met by a more economical plan, *viz.*, stone paving on concrete and clay, forming an apron next the sea, as proposed in my report of 1856.

In addition to the main enclosing basement wall, I propose that the moat walls should, on the west or land side, be removed to the level of the sills of the lower embrasures, the chalk hearting therefrom, and the material of the sloped embankment to be used in filling up the moat between the N.W. and S.W. towers, as shown on the plan, maintaining the south revetment walls and the south timber revetment as long as possible, for the reasons before stated, leaving sufficient of the old moat wall standing to form a pier to the drawbridge and a portion of the bank to form an approach to the same, the masonry from the moat walls to be used as a pavement over the surface of the moat so filled in on a bed of clay puddle; the effect of this would be to confine the range of the sea behind the Castle, at present undermining the work on the N. side, where there is now 3 to 4 feet of water at high water of springs, and it would render the basement drier if the above were done; from one-third to one-fourth of the circumference of the proposed main wall of defence might be dispensed with until the sea had made further inroads: this on the assumption that the N. moat barrier and N. timber retreated revetment are maintained, and the shingle forms in front of them; should they not be, the shingle would continue to retreat, and the main enclosing wall must then be made continuous, and any further attempts to maintain the south revetment wall abandoned.

The total cost of the permanent works for the isolated defence of the Castle I estimate at 16,000*l.* If the west side of the enclosing wall be dispensed with and the moat filled I estimate their cost at 12,000*l.* They might be postponed until next summer and until the effect of the more temporary measures first suggested are demonstrated; the immediate execution of these last I consider absolutely necessary for the safety of the Castle.

In order to ascertain that no material change had taken place since my first inspection of the 17th ultimo I again visited the Castle on the 8th instant.

I found that 95 feet of the west portion of the north groyne had been carried away by the sea, and that a further portion of the adjoining counterscarp wall had fallen, and the main fallen masses of the north revetment or counterscarp wall on the east or sea side leaned more over seaward, and that the fissures under the south revetment wall were more open.

I also found the chalk-rubble bottom of the moat behind the breach more gulled

into by the sea, with sand forming over the same, and a beach 'full' thrown up as delineated on the accompanying plan, the crest of which was 18 inches below the sill of the first embrasure east side of the north-east tower, *i.e.*, about 12 inches below high water of spring tides. The partial breach behind the north timber revetment and up to the sand cliff had become filled in a degree with a 'full' of large pebbles collected during the prior two days. The crest of this 'full' was about level with high water of spring tides, and this is the general level of the top of the upper 'full' towards Battery No. 1, so that the shingle mole north of the Castle is now 6 feet to 8 feet lower than in 1856.¹

I have the honour to be, Sir,

Your very obedient Servant,

(Signed) J. B. REDMAN.

5. DOVER EAST-CLIFF SHORE.

H.M. WAR DEPARTMENT AND THE TOWN COUNCIL OF DOVER.

To Lieut.-Colonel Jervois, R.E., Deputy-Inspector of Fortifications.

11 Manchester Buildings, Westminster, S.W., May 7, 1863.

SIR,—In accordance with your instructions of the 14th ultimo, I visited Dover on the 20th, and placed myself in communication with General Stotherd, who lent me a sheet of the Ordnance Survey of the town, with lines showing the degradation produced by the gale of December last upon the East Cliff frontage and the recent ranges of extreme spring tides, as surveyed by his officers, which I have had transferred to the drawing accompanying this report. The General also afforded me every facility in my inquiry, by the production for my inspection of plans and documents at Archcliff Fort, and by his personal explanations of the fullest character. I attended a meeting at noon the same day, summoned by Mr. Knocker, the town clerk, at his offices, consisting of Mr. Worsfold, the Mayor, Captain Noble, Mr. Rees the harbour engineer, and a member of the Town Council, and Mr. Hanvey, the town surveyor. I afterwards inspected the shore accompanied by the last-named gentleman, and again that evening at low water, and also surveyed the condition of the Castle jetty; and the following morning I took the sections (at low water) which accompany this communication, in which I was assisted by Mr. Hanvey and the men at his disposal; from these, and the plan, the general condition of the shore, and the effect of the December gale, will be seen at a glance.

It appeared generally admitted at the above meeting that the Marine Parade and Waterloo Crescent were formerly more exposed than now to the sea from the S.W., the stroke of which has been projected more and more eastward as the Admiralty Pier has been extended seaward, and the East Cliff property has been more exposed of late years from this cause, which has been increased by the recent erection of the harbour jetty, which, by its great height, causes an eddying of the sea eastward, scouring out the shingle forming the natural barrier, and by which the extreme range of the tide at high water, has, from documents placed before me, advanced landward nearly 100 feet from off the centre of Guilford battery to the west side of Arlington House, East Cliff Terrace.

The local 'full' of shingle seen on Section No. 1, and on the plan in front of the esplanade, has gathered there since the gale, said to have travelled from the eastward from the 'full' at the back of the Castle jetty, and of course liable to travel back in an opposite direction.

The harbour stone groyne, or jetty, erected in front of Guilford battery, and now drawing towards completion, takes virtually the position, as respects the harbour frontage, hitherto occupied by the Castle jetty, the same results being traced east of it as to the east of the Castle jetty, as, whatever accumulation of shingle it may tend to promote to the benefit of the harbour frontage west of it, a corresponding sweeping out of the shore may be expected to ensue eastward. This result took place to such an extent during the December gale as to gully out the beach behind

¹ [Mr. Sidney Herbert, then Secretary of War, determined on abandoning the Castle. It was sold, but proved so tough a morsel that it was only lowered down to near ground level. The portion so much written about recently was the mere basement.

On the abutment of the drawbridge was the monogram of the great Cecil, Earl of Burleigh.]

the root or commencement of the groyne, which it threatened to isolate, and which has been hastily continued landwards by a temporary stone wall to check this disposition the sea displayed to get behind the groyne, which, from its position and height (9 feet above H. W. springs), causes an increased action of the sea to leeward, and consequent recession of the high-water line to be met by other works of defence eastward.

It will be seen by the plan that it is only the western portion of the East Cliff property that is immediately affected by the recent encroachment of the sea, the triangular 'full' of shingle held in position by the Castle jetty forming a sea barrier to the terrace from Arlington House eastward; should, however, the recession of the shore in front of Guilford battery continue, no steps being taken to arrest the sea, the apex of this triangular accumulation of shingle abutting on Castle jetty will retreat landward and eastward, the inclined line of high water becoming more and more acute, and the frontage defended by the shingle would necessarily become more limited in extent. The stability of this shingle mole depends entirely on the state of repair of the Castle jetty; and when it is considered that the beach is more than 20 feet higher on one side than on the other, it will be seen that it is a vital question in the inquiry.

The small amount of shingle that lies under the lee of Castle jetty to the eastward was during my inspection—

At the high-water 'full' in a line with the East Cliff houses, from the platform, of the jetty	12 ft.	below it
In line of garden walls of ditto	20 ft. 6 in.	"
Line of esplanade railing	23 ft.	"
End of doubled part of jetty	18 ft.	"
At next offset in ditto	23 ft.	"
End of main jetty	24 ft.	"
From top of lower jetty or groyne at junction with main jetty	18 ft.	"
The crest of the shingle mole on the western side being	5 ft.	above ditto
Or a total difference of level of the beach on the two sides of the jetty of	29 ft.	

Whatever works of defence may be constructed in front of the War Department frontage to render permanent the sea margin there will have the effect of protecting the property eastward by holding in position the eastern shingle mole; but this ultimately must depend entirely on the Castle jetty for its continued stability; with, however, a natural sea barrier 10 feet above high water, any shore work of defence along the immediate frontage of East Cliff Terrace would be one of supererogation.¹

Having regard to the above, and considering the entire frontage of 1,100 feet between the new harbour groyne and the Castle jetty, it is impossible to disconnect the condition of the Castle jetty from the inquiry, nor would a parallel shore work of defence be applicable to the entire frontage; and having regard to the uncertainty attached to the ultimate enclosure of the bay and the extent to which the Admiralty pier may be projected, and looking to the success of the timber revetment in front of the Ordnance property and the prevailing opinion in favour of such a work, I am disposed to recommend the construction of an oak timber revetment or wharf from the new harbour groyne to Arlington House 600 feet in length, to be carried down to the chalk substratum according to Section No. 1 for the western end of 200 feet, the necessity for which will be apparent when the action of the sea eastward of the Castle jetty is studied; the eastern portion, from its being mainly behind the shingle, may gradually diminish in depth, of which Section No. 2 is an average section.

In connection with the above, a complete doubling of the Castle jetty is necessary on its outer or eastern side, from the first offset or end of the portion formerly doubled at the north end, down to the end of the lofty portion of the jetty, 120 feet in length. The low-water groyne, 165 feet long, requires similar treatment on the east side for its entire length, and on the west side for half its length. In addition to this outer doubling, a large proportion of the wales, braces, and ties require renewal, and the stone hearting to be redisposed where settled or fallen out, and the

¹ [When the works for enclosing Dover Bay are carried out this state of things will cease. They were problematical in 1863.]

planking of the main jetty above, on the western side, requires repairing and heightening, to prevent the shingle passing through the top.

When it is considered that the rateable value of the twenty-eight houses in East Cliff Terrace is, as I was informed, from 3,000*l.* to 4,000*l.* per annum, and its estimated value 60,000*l.*, it will be seen who is interested in the safety of the Castle jetty, which, by an arrangement with H.M. Woods, &c., on the information of the town clerk and harbour engineer, appears to be transferred to the East Cliff proprietors, and the Harbour Board relieved from all responsibility as to its maintenance, its successor, the new stone groyne, being regarded now as the east boundary of the harbour frontage, the one-mile frontage of the harbour trust, hitherto measured from the old pier, called Cheeseman's Head, at the west end, now enclosed by and incorporated with the Admiralty Pier to the Castle jetty, now being defined eastward by the new jetty, and the frontage at that end reduced by 1,100 feet.

I have defined by a line from the shore end of the harbour groyne, and terminating opposite the west side of Arlington House, the line I propose for the revetment.

I estimate the cost of this work at	£4,800
Castle jetty repairs	1,700
	£6,500

As it appears, on the information of the Mayor, that the garden wall of No. 1 East Cliff Terrace was washed down when the sea made certain inroads on this part of the coast about forty years back, the December casualty was not unprecedented.

The maintenance of the Castle jetty is quite as, if not more, important than the construction of the revetment, nor should I recommend any steps being taken with the latter without the works of renewal to the Castle jetty are carried out coincidentally therewith.

Should these works in their entirety, from want of concert between the parties interested, not be carried out, in the event of another gale such as that of December recurring, the result in all probability would be the cutting off the sea road communication, not to say the endangering of the western houses of East Cliff Terrace; the result would also probably recur that the harbour authorities would be compelled again to continue to extend their jetty landward; in effect the foreshore may be expected to retreat and to be lowered to the eastward of the harbour jetty, as may be observed at the Castle jetty, and the longer the construction of the sea-works of defence are postponed, so will the difficulty of maintaining the present sea margin be increased as well as the necessity entailed of continuing such works further eastward.¹

Should the works be postponed for any lengthened period and the shore margin be much abraded and the foreshore lowered, it then may become a question whether the construction of a stone sea wall in continuation of the harbour jetty eastward would not be the best plan to adopt for the western end.²

I have the honour to be, Sir,

Your very obedient Servant,

(Signed) J. B. REDMAN.

War Office, June 3, 1863.

SIR,—With reference to your letter, dated April 2, and the reply thereto of the 14th idem respecting the encroachment of the sea at east cliff, Dover, I am directed

¹ [As the revetment was commenced just four years after, without the author of this report being consulted or knowing aught of its details or execution, it is manifest he is in no way responsible for the subsequent results; nor did he authorise or recommend the mode adopted. Had he been so, the last paragraph of this report shows he might have advised a very different mode of procedure.]

He visited Dover in December 1867 for the first time (viz., 4½ years' interval) after making above report, when he found the timber revetment finished. From its great irregularity he doubts if proper land-ties were provided, and now, from the omission of a most important provision—viz., the heavy top paving and other departures from his plan—sufficient reasons appear for its partial failure. Further he has no evidence of the depth of piling or character or mass of concrete backing.]

² [Ultimately done. Since replaced by a stone wall just prior to decease of late town surveyor, Mr. Hanvey.]

by the Secretary of State for War to forward, for the consideration of the Local Board, the report and plan which have been received from Mr. Redman, C.E., and to observe that in the event of Mr. Redman's project meeting the approval of the Town Council, Lord de Grey will be prepared to recommend to the Lords Commissioners of the Treasury that a sum of 1,800*l.*, or about three-elevenths of the whole expense of carrying out that project, shall be paid for from the Army estimates.

The frontage of the whole of the property to be protected is 1,100 feet, that of the War Department being about 300 feet; this proposal will, therefore, be in accordance with the suggestion contained in the letter from this office, dated March 19, 1863.

I am to request the return of the report and plan.

I am, Sir,

Your most obedient Servant,

(Signed) HARTINGTON.

The Town Clerk, Dover.

6. SHEERNESS.

To Lieut.-Colonel Jervois, R.E.

Westminster, S.W., October 31, 1866.

Sir,—In reply to your letter of the 27th instant respecting 'Garrison Point,' I have to report that Colonel Freeth explained to me on the 18th instant, on the spot, the proposal to use the shingle, within certain limits, for filling up the parade of the new fort, and the agent for the contractor for that work attended to point out from whence he proposed to remove shingle.

My attention was directed to the recent accumulation against groynes run out by the contractor and around blocks of stone deposited for the works.

In my report of August 20, 1857, to you on the groynes along the neighbouring shore, I directed attention to the increase of Garrison Point to the westward and that from plans in your possession at Sheerness it appeared that in 1737 the end of the shingle spit was half a mile east of Garrison Point; also that the Point had been resorted to for many years for material for concrete and for roads, &c., for your Department and for the Dockyard.

Taking these facts into consideration, I do not consider that harm would be done by the removal of shingle from the 'fulls' forming the convex horn of the Point, but as the foundations of the fort are only 5 feet below the level of high water of spring tides, it is clear this must be done with great caution. I should recommend that no shingle be removed below the level of high water of neap tides.

It was stated by the contractors' agent that it would not answer their purpose to remove shingle from the eastward of the fort or east of their westernmost groyne on account of transport, so that they would depend entirely on the horn of shingle immediately contiguous to and around the fort.

Within the above limits, viz., from the Gun Wharf to the western groyne and down to the level of high water of neap tides, about 800 yards cube of shingle might be obtained, so that the high-water 'fulls' would have to be renewed six times before the material required would be obtained, as about 5,000 yards are required; but it is fairly argued that the shingle would follow from the eastward as it was removed from the crest, and it is supposed that the requisite material would be thus obtainable in a few months.

The removal should be first from the eastward working westward, so that the travelling shingle would follow on.

The excavation of the shingle should be only in defined and short lengths, say of 20 yards, or about one-fifth of the entire length of the shingle 'horn' on the curve from the Gun Wharf to the west groyne, which is about 110 yards, and the removal of the next length should not be commenced until the sea has begun to repair the breach thus formed with a new 'full'; the wharfing for the support of the contractors' road around the fort forms a protection at its base in the event of the sea passing over the lowered beach at high water of spring tides.

Should the above precautions be taken, I see no objection to the proposition submitted to me.

I am, Sir,

Your obedient Servant,

(Signed) J. B. REDMAN.

7. ISLE OF GRAIN.

*To the Secretary of State for War.*Westminster, S.W., *February 21, 1867.*

SIR,—Acting on instructions from the War Office of August 22 last, accompanied by various plans and sections showing the works in progress at the Isle of Grain and the extent of the encroachment of the sea on the shore, I proceeded to Sheerness on August 27 and made several inspections at low water during the then spring tides. I also again visited the site in October last in reference to borings then in progress, and also again on the completion of the last, to satisfy myself as to the real character of the substratum, respecting which great doubts had been expressed.

In the course of my inquiry I received every assistance from the then commanding R.E. officer at Sheerness, Colonel Freeth, and from the officers at the Isle of Grain fort.

My instructions inform me it is proposed to protect in the most economical manner the foreshore of the property of your Department.

From the plans placed before me and from my inspections I draw the conclusion that the waste of the shore is to a certain extent local, viz., that the material, the London clay and sand and gravel thereon, and the alluvial deposits southwards, are all easily acted on by the sea at high water, and that the material abraded is redistributed upon the foreshore; a comparison of the early plan made for the Board of Ordnance in 1784 with those of the present day shows this, and that the high-water mark is much further inshore and the low-water mark further out. To the north of the fort at the boundary of the property of your Department the sea has gained to the extent of 700 feet and to the eastward of the fort the low-water mark is nearly a corresponding distance further out.

To check this action, I recommend the construction of stone slopes of Kentish rag paving on a bed of concrete, separated into bays by sheet piling, and these again subdivided by lateral piling, as shown on the accompanying drawing.

North and south of the pavement I recommend the construction of two low groynes, as shown at the north end, in a direction N.E. by E. by compass, and that at the south, E.S.E., and two at the north and south ends of the fort frontage, each bearing E.N.E., also opposite the north and south extremities of the battery, that at the north end to bear east by compass, and that at the south to bear E.S.E., viz., six groynes in all.

As regards the frontage of the battery, I do not recommend quite the same treatment as for the rest of the frontage.

For the frontage generally, I consider that the paving should be brought up above high water until it intersects the glacis slopes, and that north and south and between the fort and battery it should be brought up to the level of the adjacent low land or summits of the neighbouring walls, and that the foot or toe of the slopes should be sheet piled, with a deep trench at back for a rough deposit of stone to form an abatement at foot. To the southward this becomes more necessary from the nature of the ground, and the toe will have to be increased in depth more especially corresponding with the frontage of the battery.

Certain borings were taken in 1861, the results of which were placed before me, as also the details of the foundations of the Martello Tower on Grain Spit; from these it was clear that there is following the contour of the hill above a considerable inclination of the London clay to the southward.

Looking to the uncertainty respecting the level of the London clay opposite the battery, I recommended the sinking of two additional boreholes north and south of the battery frontage next the sea, adjacent to and 40 feet west of the two black beacons.

The general result was, at the outer or north beacon for a depth of 35 feet (22 feet below Ordnance datum) nothing but layers of modern alluvion were met with upon a crust of gravel, into which the boring was carried 5 feet, 40 feet in all: this boring was abandoned from the tools failing. At the inner or south beacon similar material was passed through for 45 feet, when blue clay was reached, and bored into for 7 feet 6 inches, a total depth of 52 feet 6 inches.

From the fact that the pipes were drawn before I had the opportunity of examining the strata in the second or south boring, a third was made at my request 320 feet north of the south beacon and in a line with the other two, which proves that the solid London blue clay is 45 feet from the surface of the ground, or 32 feet from Ordnance datum and 26 feet below low water; from the borings of

1861 the inference might have been drawn that it was at a much greater depth, so that the result of these last borings may be looked on as highly satisfactory, and showing the necessity that existed for their being undertaken.

I estimate the cost for defending the entire frontage with stone slopes, &c., as herein proposed, at 30,000*l.*; to put in extra and deeper work at the foot of the stone slope for 400 yards in length in front of the battery will cost 15,000*l.* in addition, making 45,000*l.* total outlay.

I had (for the battery frontage) considered the mode and probable cost of putting in a retaining wall on piles with sheet piling next the sea down to the blue clay, and also a concrete wall got in by means of caissons of iron down to the clay also; but the great depth of the latter and the large cost induce me to recommend the plan shown upon the accompanying drawing, viz., an increased weight of concrete put in in boxes of sheet piling, the front row driven down to the layer of gravel at the north end and to the surface of the clay at and towards the south end: this will involve sheet piling next the sea 25 feet in length for about one-third the frontage and 36 feet for the rest; the back row may be 10 feet shorter; the areas must be subdivided (in progress) by cross rows of piled planking and the concrete got in through the water after the excavation is dredged out.

I have the honour to be, Sir,
Your obedient Servant,
(Signed) J. B. REDMAN.

G. Copy of Questions.

N.B.—Answers to these questions will in most cases be rendered more precise and valuable by sketches illustrating the points referred to.

1. What part of the English or Welsh Coast do you know well?
2. What is the nature of that coast?
 - a. If clifty, of what are the cliffs composed?
 - b. What are the heights of the cliff above H.W.M.? Greatest; average; least.
3. What is the direction of the coast-line?
4. What is the prevailing wind?
5. What wind is the most important—
 - a. In raising high waves?
 - b. In piling up shingle?
 - c. In the travelling of shingle?
6. What is the set of the tidal currents?
7. What is the range of tide?
 - (1) Vertical in feet. (2) Width in yards between high and low water.
 - (a) At spring tide; (b) at neap tide.
8. Does the area covered by the tide consist of bare rock, shingle, sand, or mud?
9. If of shingle, state—
 - a. Its mean and greatest breadth.
 - b. Its distribution with respect to tide-mark.
 - c. The direction in which it travels.
 - d. The greatest size of the pebbles.
 - e. Whether the shingle forms one continuous slope, or whether there is a 'spring full' and 'neap full.' If the latter, state their heights above the respective tide-marks.
10. Is the shingle accumulating or diminishing, and at what rate?
11. If diminishing, is this due partly or entirely to artificial abstraction? (See No. 13.)
12. If groynes are employed to arrest the travel of the shingle, state—
 - a. Their direction with respect to the shore-line at that point.
 - b. Their length.
 - c. Their distance apart.
 - d. Their height—
 - (1) When built.
 - (2) To leeward above the shingle.
 - (3) To windward above the shingle.
 - e. The material of which they are built.
 - f. The influence which they exert.
13. If shingle, sand, or rock is being artificially removed, state—
 - a. From what part of the foreshore (with respect to the tidal range) the material is mainly taken.
 - b. For what purpose.
 - c. By whom—Private individuals. Local authorities. Public companies.
 - d. Whether half-tide reefs had, before such removal, acted as natural breakwaters.
14. Is the coast being worn back by the sea? If so, state—
 - a. At what special points or districts.

- b. The nature and height of the cliffs at those places.
 - c. At what rate the erosion now takes place.
 - d. What data there may be for determining the rate from early maps or other documents.
 - e. Is such loss confined to areas bare of shingle?
- 15.** Is the bareness of shingle at any of these places due to artificial causes?
- a. By abstraction of shingle.
 - b. By the erection of groynes, and the arresting of shingle elsewhere.
- 16.** Apart from the increase of land by increase of shingle, is any land being gained from the sea? If so, state—
- a. From what cause, as embanking salt-marsh or tidal foreshore.
 - b. The area so regained, and from what date.
- 17.** Are there 'dunes' of blown sand in your district? If so, state—
- a. The name by which they are locally known.
 - b. Their mean and greatest height.
 - c. Their relation to river mouths and to areas of shingle.
 - d. If they are now increasing.
 - e. If they blow over the land; or are prevented from so doing by 'bent grass' or other vegetation, or by water channels.
- 18.** Mention any reports, papers, maps, or newspaper articles that have appeared upon this question bearing upon your district (copies will be thankfully received by the Secretaries).
- 19.** Remarks bearing on the subject that may not seem covered by the foregoing questions.

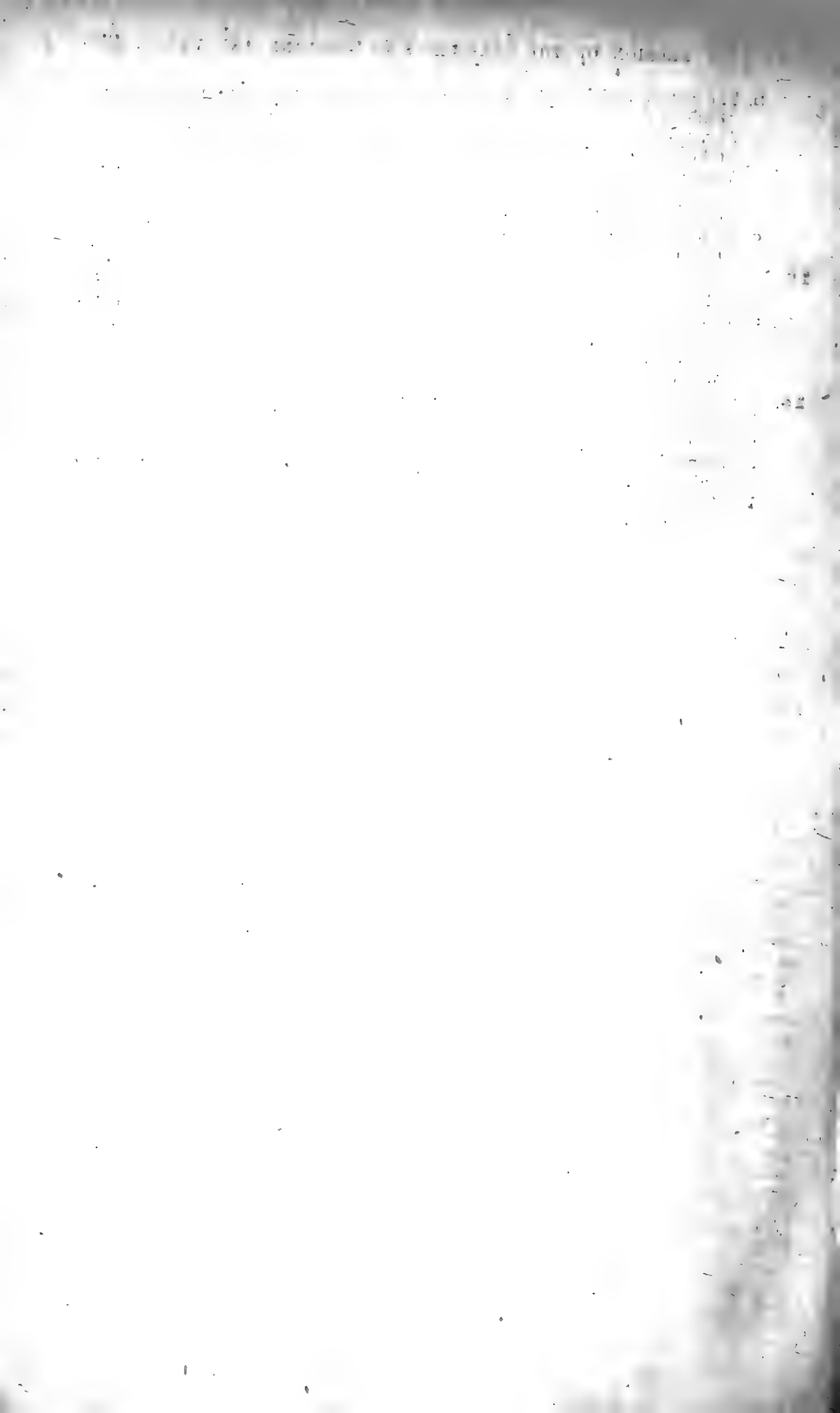

INDEX.

[An asterisk (*) signifies that no abstract of the communication is given.]

- O**BJECTS and rules of the Association, xxvi.
Places and times of meeting, with names of officers, from commencement, xxxvi.
List of former Presidents and Secretaries of Sections, lxiv.
List of evening lectures, lix.
Lectures to the Operative Classes, lxii.
Officers of Sectional Committees present at Manchester, lxiii.
Officers and Council for 1888-89, lxxv.
Treasurer's account, lxvi.
Table showing the attendance and receipts at the annual meetings, lxxviii.
Report of the Council to the General Committee at Bath, lxx.
Committees appointed by the General Committee at Bath: 1. receiving grants of money, lxxiii; 2. not receiving grants of money, lxxvii; other resolutions adopted, lxxx; communications ordered to be printed *in extenso*, lxxxi; resolutions referred to the Council for consideration, and action if desirable, *ib.*
Synopsis of grants of money appropriated to scientific purposes, lxxxii.
Places of meeting in 1889 and 1890, lxxxii.
General statement of sums which have been paid on account of grants for scientific purposes, lxxxiv.
General meetings, xcvi.
- Address by the President, Sir Frederick Bramwell, D.C.L., F.R.S., M.Inst.C.E., 1
- Abercromby (Hon. R.) on arranging an investigation of the seasonal variations of temperature in lakes, rivers, and estuaries, 326; modern views about hurricanes, as compared with the older theories, 586.
Abney (Capt.) on standards of light, 39; on the action of light on the hydracids of halogens in presence of oxygen, 89; on electrolysis in its physical and chemical bearings, 339.
- Absorption spectrum of oxygen, Profs. Liveing and Dewar on the, 576.
Adami (J. G.) and Prof. Roy on the physiological bearing of waist-belts and stays, 704.
Adams (Prof. W. G.) on the desirability of introducing a uniform nomenclature for the fundamental units of mechanics, 27; on the best means of comparing and reducing magnetic observations, 28; on standards of light, 39; on standards for use in electrical measurements, 55.
Adelphotaxy, an undescribed form of irritability, Prof. M. M. Hartog on, 702.
*Africa, central, the commercial future of, by Sir F. de Winton, 745.
Agricultural education, by Prof. J. Long, 776.
Agricultural statistics, by W. Botly, 760.
Air-compressor for variable pressures, a new form of, by H. Davey, 824.
Air-propellers, or revolving sails, by H. C. Vogt, 820.
*Akkas and dwarfs in Southern Morocco, by R. G. Haliburton, 745.
Allman (Prof.) on the researches on food-fishes at the St. Andrews marine laboratory, 141.
American industries and wealth, the growth of, by M. G. Mulhall, 757.
Ammonia-soda process, recovery of the ammonia and chlorine in the, by F. Bale, 638.
Analyse chronométrique des phénomènes électriques lumineux, par Dr. J. Janssen, 615.
Analyse spectrale, sur l'application de l', à la mécanique moléculaire, par Dr. J. Janssen, 547.
Analysis of iron and steel, proposed international standards to control the, by Prof. J. W. Langley, 640.
Analytical engine of the late Charles Babbage, F.R.S., the mechanical arrangements of the, Maj.-Gen. H. P. Babbage on, 616.

- Ancient sea-beach, an, near Bridlington Quay, report on, 328.
- Anderson (Prof. R. J.) on the occupation of the table at the zoological station at Naples, 157.
- Anderson (Dr. T.), the volcanoes of the Two Sicilies, 663.
- and Dr. H. J. Johnston-Lavis on the late eruption in the island of Vulcano, 664.
- Anderson (W.) on the application of electricity to the working of a 20-ton travelling crane, 808.
- Anglesey, the crystalline schists of, Dr. C. Callaway on the origin of, 653.
- , the older rocks of, report on the microscopic structure of, 367.
- Annual winding clock, an, with torsion pendulum, by W. H. Douglas, 823.
- Antarctic regions, third report of the Committee for drawing attention to the desirability of further research in the, 316.
- Anthropological Section, Address by Lieut.-Gen. Pitt-Rivers to the, 825.
- Anthropometric laboratory at Manchester, observations made in the, by G. W. Bloxam and Dr. J. G. Garson, 854.
- Antilles, the nucleal ranges of the, archæan characters of the rocks of, by Dr. P. Frazer, 654.
- Archæan characters of the rocks of the nucleal ranges of the Antilles, by Dr. P. Frazer, 654.
- Archæan time, a review of the alleged evidence of life on the earth in, by Rev. A. Irving, 679.
- Armstrong (Prof. H. E.) on the present methods of teaching chemistry, 73; on isomeric naphthalene derivatives, 96; on the teaching of science in elementary schools, 164; on electrolysis in its physical and chemical bearings, 339; note on Dr. Arrhenius's reply to his criticisms regarding the dissociation theory of electrolysis, 355.
- Armstrong's, Prof., criticisms regarding the dissociation theory of electrolysis, reply to, by S. Arrhenius, 352; note thereon, by Prof. H. E. Armstrong, 355.
- Arrhenius (S.), reply to Prof. Armstrong's criticisms regarding the dissociation theory of electrolysis, 352; note thereon by Prof. H. E. Armstrong, 355.
- Asia, Western, the early races of, by Major C. R. Conder, 855.
- Asia Minor, discoveries in, by J. T. Bent, 856.
- Associative economics applied to colonization, by W. L. Rees, 762.
- *Assurance, old age, and sickness, for the mercantile and professional classes, by F. Norfolk, 780.
- *Atlas Mountains, notes from the, by J. Thomson, 745.
- Atomic weight of oxygen, Dr. A. Scott on the, 631.
- *Atomic weights, the logarithmic law of, Dr. G. J. Stoney on the proof of, 562.
- *—, the logarithmic law and its connection with the, by Dr. G. J. Stoney, 630.
- Australian message-sticks and messengers, by A. W. Howitt, 842.
- Automatic fire-damp detector, J. W. Swan on an, 817.
- Ayrton (Prof.) on standards for use in electrical measurements, 55.
- and Profs. Sir W. Thomson and Perry, electrometric determination of 'r,' 616.
- Azorean archipelago, the recent volcanic structure of the, O. H. Howarth on, 671.
- Babbage (the late Charles, F.R.S.), on the mechanical arrangements of the analytical engine of, by Maj.-Gen. H. P. Babbage, 616.
- Bahamas, the flora of the, report on, 361.
- Baker (J. G.) on the flora of the Bahamas, 361.
- Bale (F.), recovery of the ammonia and chlorine in the ammonia-soda process, 638.
- Balfour (Prof. B.) on the steps taken for establishing a botanical station at Peradeniya, Ceylon, 421.
- Ball (J.) on our present knowledge of the flora of China, 420.
- Ball (Sir R. S.) on the desirability of introducing a uniform nomenclature for the fundamental units of mechanics, 27.
- Ball (Prof. V.) on the provincial museums of the United Kingdom, 124.
- Banking statistics, by W. Botly, 760.
- Barber (C. A.) on the development of the bulb in *Laminaria bulbosa*, 710; on *Pachytheca*, a silurian alga of doubtful affinities, 711.
- Baron (Rev. R.) on the flora of Madagascar, 724.
- Barrington (R. M.) on the migration of birds, 146.
- Barron (Dr. G. B.), the constitutional characteristics of those who dwell in large towns, as relating to degeneracy of race, 836.
- Barry (J. W.), the Barry docks, 795.
- Barry docks, the, by J. W. Barry, 795.
- Bassani (Prof. F.), notes of some researches on the fossil fishes of Chiavòn, Vicentino (stratum of Sotzka, lower miocene), 675.

- Bassett (A. B.), waves in a viscous liquid, 563.
- *Bath, the vital and commercial statistics of, by F. Norfolk, 780.
- Bath oolite, the extension of the, under London, as shown by a deep boring at Streatham, W. Whitaker on, 656.
- Bauerman (H.) on the volcanic phenomena of Vesuvius and its neighbourhood, 320.
- Baynes (R. E.) on the desirability of introducing a uniform nomenclature for the fundamental units of mechanics, 27.
- Beaumont (W. W.), the efficiency of steam at high pressures and the Carnot theorem, 820.
- *Bechuanaland and the Land of Ophir, by Rev. J. Mackenzie, 745.
- Becker (Miss L.) on the teaching of science in elementary schools, 164.
- *Beddard (F. E.), contributions to the anatomy of the Tubificidæ, 723.
- Beddoe (Dr. J.) on the effects of different occupations and employments on the physical development of the human body, 100; the physique of the Swiss as influenced by race and by media, 837; on human bones discovered by Gen. Pitt-Rivers at Woodcuts, Rotherley, &c., 839.
- Beds exposed in the Southampton new dock excavation, by T. W. Shore, 672.
- Bedson (Prof. P. P.) on photographing hydrogen and chlorine bulbs by aid of the flash of light which caused their explosion, 633.
- *Bees and wasps, solitary, the instincts of, Sir J. Lubbock on, 706.
- Bell (A.) on the 'manure' gravels of Wexford, 133.
- Bell (Prof. F. J.) on the echinodermata of the Sea of Bengal, 718.
- Ben Nevis, meteorological observations on, report of the Committee for co-operating with the Scottish Meteorological Society in making, 49.
- Bent (J. T.) on the prehistoric race in the Greek islands, 99; sun-myths in modern Hellas, 850; discoveries in Asia Minor, 856.
- *Benzene, the constitution of, Van't Hoff's hypothesis and, J. E. Marsh on, 631.
- Beryl, the temperature at which it is decolorised, J. Joly on, 684.
- Bidwell (S.) on electrolysis in its physical and chemical bearings, 339.
- Bile, the rate of secretion and constitution of the, the effect of various substances upon, by Dr. W. J. Collins, 728.
- Biological Section, Address by W. T. Thiselton-Dyer to the, 686.
- Blackburn (Miss H.), Irishwomen's industries, 772.
- Blake (Prof. J. F.) on the microscopic structure of the older rocks of Anglesey, 367.
- Blaps mortisaga* (Coleoptera), the odiferous apparatus of the, by Prof. G. Gibson, 727.
- Bloxam (G. W.) on the prehistoric race in the Greek islands, 99; on the effects of different occupations and employments on the physical development of the human body, 100; on the North-western tribes of the dominion of Canada, 233.
- and Dr. J. G. Garson, observations made in the anthropometric laboratory at Manchester, 854.
- **Blumenbachia Hieronymi*, Urban, the contrivances for the seed protection and distribution in, W. Gardiner on, 716.
- Boats, &c., the disengaging of, E. J. Hill on, 807.
- *Bolland (Col. J. H.), photographic and photozincographic processes employed in the Ordnance Survey, 746.
- Bonghi (Signor), l'organisation et la statistique de l'enseignement technique secondaire en Italie, 774.
- Bonney (Prof. T. G.) on the erratic blocks of England, Wales, and Ireland, 101; on the microscopic structure of the older rocks of Anglesey, 367; on a boulder of granitoid gneiss or gneissoid granite in the Halifax hard-bed coal, 661.
- Botly (W.), agricultural, commercial, industrial, and banking statistics 760.
- Bott (Dr. W.), the determination of vapour-densities at high temperatures and under reduced pressure, 632.
- and J. B. Miller, further researches on the pyrocresols, 642.
- Bottomley (J. T.) on standards for use in electrical measurements, 55; on electrolysis in its physical and chemical bearings, 339.
- *Boulder-clay, a high level, in the Midlands, by Dr. H. W. Crosskey, 656.
- Bourne (S.) on the teaching of science in elementary schools, 164; on the best method of ascertaining and measuring variations in the value of the monetary standard, 181; on the statistical data available for determining the amount of the precious metals in use as money, &c., 219; index-numbers as illustrating the progressive exports of British produce and manufactures, 536.
- Bovey (Prof. H. T.) on promoting tidal observations in Canada, 27.

- Bower (Prof.) on the steps taken for establishing a botanical station at Peradeniya, Ceylon, 421; *on the morphology of the pitcher of nepenthes, 702.
- Boynnton (T.) on an ancient sea-beach near Bridlington Quay, 328.
- Boys (C. V.) on the work of the Differential Gravity Meter Committee, 72.
- Brain (F.), electricity as applied to mining, 815.
- Bramwell (Lord), Address to the Section of Economic Science and Statistics by, 749.
- Bramwell (Sir F. J.) on the advisability and possibility of establishing in other parts of the country observations upon the prevalence of earth tremors similar to those now being made in Durham, 522.
- Bridge design, mechanical pathology considered in its relation to, by G. H. Thomson, 793.
- Bristol coal-field, the northern section of the, by H. Cossham, 659.
- British Association and other standard coils, on the permanence of the original standards of resistance of the, by R. T. Glazebrook and T. C. Fitzpatrick, 56.
- British mineral and thermal waters, a list of works referring to, by W. H. Dalton, 859.
- Brontops robustus*, restoration of, from the miocene of America, by Prof. O. C. Marsh, 706.
- Brown (Prof. Crum) on meteorological observations on Ben Nevis, 49; on electrolysis in its physical and chemical bearings, 339.
- Brown (J.) on electrolysis in its physical and chemical bearings, 339; on figures produced by electric action on photographic dry plates, 565.
- Brown (S.) on locusts in Cyprus, 716.
- Buchan (Dr. A.) on meteorological observations on Ben Nevis, 49; on the marine biological station at Granton, 319; on arranging an investigation of the seasonal variations of temperature in lakes, rivers, and estuaries, 326.
- Buchanan (J. Y.) on arranging an investigation of the seasonal variations of temperature in lakes, rivers, and estuaries, 326.
- Buckland (Miss A. W.), necklaces in relation to prehistoric commerce, 849; the monument known as 'King Orry's Grave' compared with tumuli in Gloucestershire, 854.
- Bucklandium diluvii*, König, a siluroid fish from the London clay of Sheppey, A. S. Woodward on, 679.
- Bund (J. W. W.), the Severn watershed, 799.
- Burning by lightning of a magnet on a generating dynamo, Dr. A. Traill on the, 615.
- C.G.S. units of measurement, W. H. Preece on the, 616.
- Callaway (Dr. C.), further notes on the origin of the crystalline schists of Malvern and Anglesey, 653; sketch of the geology of the crystalline axis of the Malvern Hills, 654.
- *Cameroons, the, by H. H. Johnston, 745.
- Canada, tidal observations in, fourth report of the Committee for promoting, 27.
- Canal lift, an improved, S. Lloyd on, 797.
- Canary islands, the ancient inhabitants of the, by J. H. Stone, 851.
- Caoutchouc and other colloids, the molecular weight of, Dr. J. H. Gladstone and W. Hibbert on, 640.
- *Cape Guardafui, sea temperatures in the neighbourhood of, by Lieut.-Gen. Strachey, 738.
- Carbonic acid in the atmosphere, the relation of the percentage of, to the life and growth of plants, Rev. A. Irving on, 661.
- Carboniferous rocks, the lower, of Gloucestershire, E. Wethered on, 657.
- Carnot theorem, the, and the efficiency of steam at high pressures, by W. W. Beaumont, 820.
- Carpenter (W. L.) on the desirability of introducing a uniform nomenclature for the fundamental units of mechanics, 27; on the best means of comparing and reducing magnetic observations, 28; comparison of Gassner's dry cells with Leclanché's, 566.
- and Prof. Balfour Stewart, results of a comparison between the wind values and declination disturbances at the Kew Observatory, 28.
- Carpmael (C.) on promoting tidal observations in Canada, 27; on the best means of comparing and reducing magnetic observations, 28.
- Carruthers (W.) on the flora of the Bahamas, 361; on our present knowledge of the flora of China, 420; on the steps taken for establishing a botanical station at Peradeniya, Ceylon, 421; on the present state of our knowledge of the zoology and botany of the West India islands, and on the steps taken to investigate ascertained deficiencies in the fauna and flora, 437.
- Cash (W.) on the flora of the carboniferous rocks of Lancashire and West Yorkshire, 150; on an ancient sea-beach near Bridlington Quay, 328.

- Catenaries, orbits, and curved rays, Prof. J. D. Everett on the relations between, 581.
- *Cats with an extra number of toes, heredity in, by E. B. Poulton, 707.
- Celtic earthworks in Hampshire, in reference to the density of the Celtic population, by T. W. Shore, 852.
- Centres of finite twist and stretch, Prof. R. W. Genese on, 579.
- Cephalopods and gasteropods, some Devonian, Rev. G. F. Whidborne on, 680.
- Chadwick (E.), the Malthusian theory, 777; amendments founded on experiences submitted for the Local Government Bill, 779.
- *Chemical problems presented by living bodies, discussion on the, 631.
- Chemical Section, Address by Prof. W. A. Tilden to the, 620.
- Chemistry, the present methods of teaching, report on, 73.
- Chemistry as a school subject, by Rev. A. Irving, 634.
- Cherriman (Prof. J. B.) on promoting tidal observations in Canada, 27.
- Chest-types, notes on, by Dr. G. W. Hambleton, 849.
- China, the flora of, report on our present knowledge of, 420.
- *Chindwin river, Upper Burmah, explorations on the, in 1886-87, by Col. Woodthorpe, 741.
- Choptank river, Maryland, U.S.A., notes on the shell-mounds and ossuaries of the, by Chev. R. E. Reynolds, 845.
- Christie (W. H. M.) on the best means of comparing and reducing magnetic observations, 28.
- Christmas Island, the natural history of, J. J. Lister on, 708.
- Chrystal (Prof. G.) on the best means of comparing and reducing magnetic observations, 28; on standards for use in electrical measurements, 55; on the work of the Differential Gravity Meter Committee, 72; on the marine biological station at Granton, 319; on arranging an investigation of the seasonal variations of temperature in lakes, rivers, and estuaries, 326.
- Cider, Somersetshire, by J. Higgins, 759.
- Clarke (Maj.-Gen. Sir A.), on the erosion of the sea-coasts of England and Wales, 898.
- Clarke (W. E.) on the migration of birds, 146.
- Clausius (Prof.), the authorship of electrolytic theory, 346.
- Clayden (A. W.), perspective maps and common maps, 740.
- Claypole (Prof. E. W.) on some recent investigations into the condition of the interior of the earth, 669.
- Cleghorn (Dr.) on the researches on food-fishes at the St. Andrews marine laboratory, 141.
- Cleland (Prof.) on the researches on food-fishes at the St. Andrews marine laboratory, 141.
- Click mill, the old Orkney, by Prof. A. Jamieson, 807.
- Clock, an annual winding, with torsion pendulum, by W. H. Douglas, 823.
- *Closed-chain formulæ, J. E. Marsh on, 631.
- Clyde sea area, the salinity of the, by Dr. H. R. Mill, 738.
- Coal and iron industries, the effect of mining royalties on, by Prof. W. R. Sorley, 755.
- Codrington (Rev. R. H.), social regulations in Melanesia, 843.
- Collins (Dr. W. J.), the effect of various substances upon the rate of secretion and constitution of the bile, 728.
- Colour-blindness, Dr. K. Grossmann on, 838.
- Combustion in explosions, the incompleteness of, by Prof. H. B. Dixon and H. W. Smith, 632.
- Commercial statistics, by W. Botly, 760.
- *Competition, the tendency of, to result in monopoly, by Prof. Foxwell, 762.
- *Concave gratings, recent progress in the use of, for spectrum analysis, by Prof. H. A. Rowland, 566.
- Conder (Major C. R.), remarks on Mr. Tomkins's paper on the geography of the region from the Nile to the Euphrates as known to the ancient Egyptians, 743; on the early races of Western Asia, 855.
- Conduction of alloys and solid sulphides, Dr. J. H. Gladstone and W. Hibbert on the, 347.
- Conservation of heat in volcanic chimneys, Dr. H. J. Johnston-Lavis on the, 666.
- Constitutional characteristics, the, of those who dwell in large towns, as relating to degeneracy of race, by Dr. G. B. Barron, 836.
- Continental shelf, sea temperatures of the, by Dr. H. R. Mill, 739.
- Contortions of strata, a probable cause of, Dr. C. Ricketts on, 684.
- Contractile vacuole in plants and animals, preliminary note on the functions and homologies of the, by Prof. M. M. Hartog, 714.
- Copper, the rate of solution of, in acids, V. H. Veley on, 638.
- Copper-tin alloys, the composition of, by A. P. Laurie, 637.

- Coral fungia, some points in the natural history of the, W. E. Hoyle on, 717.
- Coral reefs, discussion on, 718.
- Cordeaux (J.) on the migration of birds, 146.
- Corporal penance, the survival of, by O. H. Howarth, 849.
- Corresponding Societies Committee, report of the, 255.
- *Cosmogony, on theories of, and on the mechanical conditions of a swarm of meteorites, by Prof. G. H. Darwin, 590.
- Cossham (H.), the northern section of the Bristol coal-field, 659.
- Cowles aluminium process, recent developments of the, by W. Anderson, 809.
- Cowper (E. A.) on the advisability and possibility of establishing in other parts of the country observations upon the prevalence of earth tremors similar to those now being made in Durham, 522; an improved seismograph, 818.
- Creak (Capt.) on the best means of comparing and reducing magnetic observations, 28.
- Cretaceous fish-fauna of Mount Lebanon, a comparison of the, with that of the English chalk, by A. S. Woodward, 678.
- Crompton (R. E.) on recent developments of the Cowles aluminium process, 809.
- Crookes (Mr.) on electrolysis in its physical and chemical bearings, 339.
- Crosskey (Dr. H. W.) on the erratic blocks of England, Wales, and Ireland, 101; on the circulation of underground waters, 145; on the teaching of science in elementary schools, 164; *on a high level boulder-clay in the Midlands, 656.
- Crustaceans, some Devonian, Rev. G. F. Whidborne on, 681.
- Crystalline axis of the Malvern Hills, Dr. C. Callaway on the geology of the, 654.
- Crystalline schists of Malvern and Anglesey, further notes on the origin of the, by Dr. C. Callaway, 653.
- Crystals of calcium oxide and magnesium oxide, the formation of, in the oxy-hydrogen flame, J. Joly on, 634.
- Culverwell (E. P.) on the desirability of introducing a uniform nomenclature for the fundamental units of mechanics, 27.
- Cunningham (D.) on arranging an investigation of the seasonal variations of temperature in lakes, rivers, and estuaries, 326.
- Cunningham (J. T.) on some teleostean ova, and their development, 703.
- Curved rays, orbits, and catenaries, Prof. J. D. Everett on the relations between, 581.
- Cyprus, locusts in, S. Brown on, 716.
- *Dairy industry, by G. Gibbons, 778.
- *D'Almeida (W. B.) on Pahang, an independent state in the Malayan peninsula, 747.
- Dalton (W. H.), a list of works referring to British mineral and thermal waters, 859.
- Danks (Rev. B.), marriage customs of the New Britain group, 847.
- Darwin (Prof. G. H.) on the best means of comparing and reducing magnetic observations, 28; on the advisability and possibility of establishing in other parts of the country observations upon the prevalence of earth tremors similar to those now being made in Durham, 522; *on the mechanical conditions of a swarm of meteorites, and on theories of cosmogony, 590.
- Darwin (H.) on the effects of different occupations and employments on the physical development of the human body, 100.
- Davey (H.), a new form of air-compressor for variable pressures, 824.
- Davis (J. W.) on the prehistoric inhabitants of the British islands, 289; on an ancient sea-beach near Bridlington Quay, 328.
- Dawkins (Prof. W. Boyd) on the erratic blocks of England, Wales, and Ireland, 101; on the work of the Corresponding Societies Committee, 255; on the prehistoric inhabitants of the British islands, 289; Address to the Geological Section by, 644.
- Dawson (Dr. G. M.) on the North-western tribes of the dominion of Canada, 233.
- Dawson (Major H. P.), magnetic disturbances at Fort Rae in 1882-83, 31.
- De Rance (C. E.) on the erratic blocks of England, Wales, and Ireland, 101; on the circulation of underground waters, 145; on the erosion of the sea-coasts of England and Wales, 898.
- Declination disturbances, wind values and, at the Kew Observatory, results of a comparison between the, by Prof. Balfour Stewart and W. L. Carpenter, 28.
- *Deep-sea tow net, W. E. Hoyle on a, 717.
- De la Rive (L.) on composition of sensation and notion of space, 585.
- *Dennett (Q. E.), through Kakongo, 745.
- Denton (J. B.) on the replenishment of the underground waters of the permeable formations of England, 797.
- Development of institutions, on a method of investigating the; applied to laws of marriage and descent, by Dr. E. B. Tylor, 840.
- Dewar (Prof.) on standards of light, 39.

- Dewar (Prof.) and Prof. Liveing on the absorption spectrum of oxygen, 576.
- Dibdin (Mr.) on standards of light, 39.
- Differential gravity meter, a good, third report of the Committee for inviting designs for, in supersession of the pendulum, 72.
- Diffusion photometer, J. Joly on a, 578.
- **Dinosauria* of Europe and America, comparison of the principal forms of, by Prof. O. C. Marsh, 660.
- Discoveries in Asia Minor, by J. T. Bent, 856.
- Disengaging of boats, &c., E. J. Hill on the, 807.
- Dissociation, Rev. A. Irving on, 630.
- Dissociation theory of electrolysis, reply to Prof. Armstrong's criticisms regarding the, by S. Arrhenius, 352; note thereon, by Prof. H. E. Armstrong, 355.
- Dixon (E. T.) on geometry of four dimensions, 618.
- Dixon (Prof. H. B.) on standards of light, 39; on electrolysis in its physical and chemical bearings, 339.
- and H. W. Smith, the incompleteness of combustion in explosions, 632.
- Douglas (W. H.), an annual winding clock, with torsion pendulum, 823.
- Douglass (Sir J.) on standards of light, 39; on the erosion of the sea-coasts of England and Wales, 898.
- Dowson (J. E.), gaseous fuel, 805.
- Dunn (J. T.) on the present methods of teaching chemistry, 73.
- Dunn (T. W.), education: a chapter of economics, 773.
- Dunstan (Prof. W. R.) on the present methods of teaching chemistry, 73.
- *Dynamo, a, on controlling the direction of rotation of, by A. Winter, 824.
- Early races of Western Asia, Major C. R. Conder on the, 855.
- Earth, the interior of the, some recent investigations into the condition of, Prof. E. W. Claypole on, 669.
- Earth tremors, report on the advisability and possibility of establishing in other parts of the country observations upon the prevalence of, similar to those now being made in Durham, 522.
- Earthquake and volcanic phenomena of Japan, eighth report on the, 422.
- Easton (E.), on the erosion of the sea-coasts of England and Wales, 898.
- Echinodermata of the Sea of Bengal, Prof. F. J. Bell on the, 718.
- Eclipse of the moon, some photographs of an, F. Greene on, 617.
- Economic Science and Statistics, Address by Lord Bramwell to the Section of, 749.
- Economic theory, the relations between sliding scales and, by L. L. Price, 523.
- Economy in education and in writing, by E. Pitman, 776.
- Edgeworth (Prof. F. Y.) on the best method of ascertaining and measuring variations in the value of the monetary standard, 181; memorandum on the proposed calculation of index-numbers, 188; on the statistical data available for determining the amount of the precious metals in use as money, &c., 219; on Jevons' method of ascertaining the number of coins in circulation, 224; on the statistics of examination, 763.
- Edmunds (H.), the graphophone, 792; on a system of electrical distribution, 813.
- Education: a chapter of economics, by T. W. Dunn, 773.
- , agricultural, by Prof. J. Long, 776.
- Education and writing, economy in, by E. Pitman, 776.
- Electric action, figures produced by, on photographic dry plates, J. Brown on, 565.
- Electric light applied to night navigation upon the Suez Canal, by R. P. Sellon, 814.
- Electric lighting in America, by Prof. G. Forbes, 813.
- Electric safety lamps for miners, by N. Watts, 816.
- Electrical distribution, a system of, H. Edmunds on, 813.
- Electrical measurements, report of the Committee for constructing and issuing practical standards for use in, 55; on the permanence of the original standards of resistance of the British Association and of other standard coils, 56.
- *Electrical resistance, standards of, R. T. Glazebrook on, 616.
- Electricity, the application of, to the working of a 20-ton travelling crane, by W. Anderson, 808.
- *—, the measurement of, in a house to house supply, by W. Lowrie, 814.
- , the transference of, within a homogeneous solid conductor, Prof. Sir W. Thomson on, 570.
- , static, a vortex analogue of, by Prof. W. M. Hicks, 577.
- Electricity as applied to mining, by F. Brain, 815.
- Electro-calorimetry, by Prof. W. Stroud and W. W. H. Gee, 565.
- Electro-chemical thermo-dynamics, by Prof. Willard Gibbs, 343.
- Electrodes, small, the polarisation of, in dilute sulphuric acid, Dr. F. Richarz on, 350.

- Electrolysis, the dissociation theory of, reply to Prof. Armstrong's criticisms regarding, by S. Arrhenius, 352; note thereon by Prof. H. E. Armstrong, 355.
- Electrolysis in its physical and chemical bearings, third report on, 339.
- Electrolysis of thallium trisulphide, Dr. J. H. Gladstone and W. Hibbert on the, 349.
- Electrolytes, the accuracy of Ohm's law in, Prof. Fitzgerald and F. Trouton on, 341.
- Electrolytic theory, the authorship of, by Prof. Clausius, 346.
- Electro-magnetic induction of incomplete circuits, a simple hypothesis for, with consequent equations of electric motion in fixed homogeneous or heterogeneous solid matter, by Prof. Sir W. Thomson, 567.
- *Electro-magnetic waves, on a modification of Maxwell's equations of, by Prof. H. A. Rowland, 617.
- , on the measurement of the length of, by Prof. O. J. Lodge, 567.
- *Electrometric determination of 'v,' by Profs. Sir W. Thomson, Ayrton, and Perry, 616.
- Ellis (W.) on the best means of comparing and reducing magnetic observations, 28.
- El-Wedj, mission to, by Capt. C. Surtees, 747.
- *Elves (Capt. W. J.), a new route from India to Tibet, 741.
- *Embryos, certain adaptations for the nutrition of, F. W. Oliver on, 710.
- Enseignement technique secondaire en Italie, l'organisation et la statistique de l', by Signor Bonghi, 774.
- Erosion of the sea-coasts of England and Wales, the rate of, and the influence of the artificial abstraction of shingle or other material in that action, report on, 898.
- Erratic blocks of England, Wales, and Ireland, sixteenth report on the, 101.
- Errors of the argument of statistical tables, J. Kleiber on the, 618.
- Eruption, the late, in the island of Vulcano, Drs. T. Anderson and H. J. Johnston-Lavis on, 664.
- Etheridge (R.) on the 'manure' gravels of Wexford, 133; on the fossil phyllopoda of the paleozoic rocks, 173; on the earthquake and volcanic phenomena of Japan, 422.
- Etna, the occurrence of leucite at, Dr. H. J. Johnston-Lavis on, 669.
- Etruscans, Pelasgians, and Iberians: their relations to the founders of the Chaldean and Egyptian civilisations, by J. S. S. Glennie, 857.
- Evans (Dr. J.) on the work of the Corresponding Societies Committee, 255; on the prehistoric inhabitants of the British islands, 289; on the advisability and possibility of establishing in other parts of the country observations upon the prevalence of earth tremors similar to those now being made in Durham, 522.
- Everett (Prof. J. D.) on the desirability of introducing a uniform nomenclature for the fundamental units of mechanics, 27; on standards for use in electrical measurements, 55; on the relations between orbits, catenaries, and curved rays, 581.
- Ewart (Prof.) on the researches on food-fishes at the St. Andrews marine laboratory, 141.
- Ewing (Prof.) on the advisability and possibility of establishing in other parts of the country observations upon the prevalence of earth tremors similar to those now being made in Durham, 522.
- Examination, the statistics of, Prof. F. Y. Edgeworth on, 763.
- Explosions, the incompleteness of combustion in, by Prof. H. B. Dixon and H. W. Smith, 632.
- Factory industries, the suitability of small towns for, by R. R. Tanner, 767.
- *Fauna of the Firth of Clyde, W. E. Hoyle on the, 717.
- Fayum and Raian basins, the, by Cope Whitehouse, 746.
- Fermat's theorem, recurring decimals and, Prof. R. W. Genese on, 580.
- Ferns, abnormal, hybrids, and their parents, by E. J. Lowe and Col. Jones, 713.
- Figures produced by electric action on photographic dry plates, J. Brown on, 565.
- Fire-damp detector, an automatic, J. W. Swan on, 817.
- *Firth of Clyde, the fauna of the, W. E. Hoyle on, 717.
- Fitzgerald (Prof. G. F.) on the desirability of introducing a uniform nomenclature for the fundamental units of mechanics, 27; on standards for use in electrical measurements, 55; on arranging an investigation of the seasonable variations of temperature in lakes, rivers, and estuaries, 326; on electrolysis in its physical and chemical bearings, 339; Address to the Mathematical and Physical Section by, 557.
- and F. Trouton on the accuracy of Ohm's law in electrolytes, 341.

- Fitzgerald (M. F.), steam engine diagrams, 819.
- Fitzpatrick (C. T.) and R. T. Glazebrook on the permanence of the original standards of resistance of the British Association and of other standard coils, 56.
- Fleming (Dr. J. A.) on the desirability of introducing a uniform nomenclature for the fundamental units of mechanics, 27; on standards for use in electrical measurements, 55; on electrolysis in its physical and chemical bearings, 339.
- Flora of China, report on our present knowledge of the, 420.
- Flora of Madagascar, Rev. R. Baron on the, 724.
- Flora of the Bahamas, report on the, 361.
- Flora of the carboniferous rocks of Lancashire and West Yorkshire, report on the, 150.
- Flower (Prof.) on the desirability of further research in the Antarctic regions, 316; on the present state of our knowledge of the zoology and botany of the West India islands, and on the steps taken to investigate ascertained deficiencies in the fauna and flora, 437.
- Flux and reflux of water in open channels or in pipes or other ducts, Prof. J. Thomson on, 574.
- Food-fishes, report of the Committee for continuing the researches on, at the St. Andrews marine laboratory, 141.
- Forbes (Prof. G.) on standards of light, 39; electric lighting in America, 813.
- Forbes (Mr.) on our present knowledge of the flora of China, 420.
- *Ford (P. H.), the Transvaal, or South African Republic, 745.
- Fordham (H. G.) on the erratic blocks of England, Wales, and Ireland, 101; on the provincial museums of the United Kingdom, 124; on the work of the Corresponding Societies Committee, 255.
- *Formosa: characteristic traits of the islands and its aboriginal inhabitants, by G. Taylor, 747.
- Fossil arctic plants from the lacustrine deposit at Hoxne, in Suffolk, by C. Reid and H. N. Ridley, 674.
- Fossil fishes of Chiavòn, Vicentino (stratum of Sotzka, lower miocene), notes of some researches on the, by Prof. F. Bassani, 675.
- Fossil phyllopora of the palæozoic rocks, sixth report on the, 173.
- Fossils of the limestones of South Devon, Rev. G. F. Whidborne on some, 681.
- Foster (Prof. G. C.) on the desirability of introducing a uniform nomenclature for the fundamental units of mechanics, 27; on standards of light, 39; on standards for use in electrical measurements, 55; on electrolysis in its physical and chemical bearings, 339.
- Foster (Prof. M.) on arrangements for assisting the Marine Biological Association laboratory at Plymouth, 94; on the occupation of a table at the zoological station at Naples, 150; on the physiology of the lymphatic system, 363; on the steps taken for establishing a botanical station at Peradeniya, Ceylon, 421.
- Fourier's law of diffusion, five applications of, illustrated by a diagram of curves with absolute numerical values, by Prof. Sir W. Thomson, 571.
- Fowler (G. H.) on the development of the oviduct and connected structures in certain fresh-water teleostei, 338.
- Foxwell (Prof. H. S.) on the best method of ascertaining and measuring variations in the value of the monetary standard, 181; on the statistical data available for determining the amount of the precious metals in use as money, &c., 219; *the tendency of competition to result in monopoly, 762.
- Frankland (Prof.) on electrolysis in its physical and chemical bearings, 339.
- Frazer (Dr. P.), archæan characters of the rocks of the nuclear ranges of the Antilles, 654; on a specimen of quartz from Australia and three specimens of oligoclase from North Carolina exhibiting curious optical properties, 655.
- Friction of metal coils, the, by Prof. H. Shaw and E. Shaw, 540.
- Fundamental units of mechanics, report of the Committee for considering the desirability of introducing a uniform nomenclature for the, and for co-operating with other bodies engaged in similar work, 27.
- Funeral rites and ceremonies of the Nicobar islanders, by E. H. Man, 844.
- Gadow (Dr. H.) on the nature of the geological terrain as an important factor in the geographical distribution of animals, 707.
- Galton (Sir D.) on the circulation of underground waters, 145; on the work of the Corresponding Societies Committee, 255.
- Galton (F.) on the work of the Corresponding Societies Committee, 255.
- Gardiner (J.) on the occupation of the table at the zoological station at Naples, 152.
- *Gardiner (W.) on the contrivances for the seed protection and distribution in *Blumenbachia Hieronymi*, Urban, 716.

- Garnett (Prof. W.) on standards for use in electrical measurements, 55.
- Garson (Dr. J. G.) on the prehistoric race in the Greek islands, 99; on the effects of different occupations and employments on the physical development of the human body, 100; on the work of the Corresponding Societies Committee, 255; human remains from Wiltshire, 839.
- and G. W. Bloxam, observations made in the Anthropometric laboratory at Manchester, 854.
- Gas analysis apparatus, a new, by Dr. W. W. J. Nicol, 632.
- Gaseous fuel, by J. E. Dowson, 805.
- Gassner's dry cells, comparison of, with Leclanché's, by W. L. Carpenter, 566.
- Gasteropods and cephalopods, some Devonian, Rev. G. F. Whidborne on, 680.
- Gaudry (Prof. A.) on the gigantic size of some extinct tertiary mammalia, 660.
- Gee (W. W. H.) and Prof. W. Stroud, electro-calorimetry, 565.
- Genese (Prof. R. W.) on the desirability of introducing a uniform nomenclature for the fundamental units of mechanics, 27; on centres of finite twist and stretch, 579; on recurring decimals and Fermat's theorem, 580.
- Geographical distribution of animals, the nature of the geological terrain as an important factor in the, Dr. H. Gadow on, 707.
- Geographical Section, Address by Col. Sir C. W. Wilson to the, 729.
- *Geographical terminology, note on, by H. J. Mackinder, 746.
- Geography, the, of the region from the Nile to the Euphrates as known to the ancient Egyptians, notes on, by Rev. H. G. Tomkins, 741.
- Geological photography, local, O. W. Jeffs on, 653.
- Geological Section, Address by Prof. W. Boyd Dawkins to the, 644.
- Geological terrain, the nature of the, as an important factor in the geographical distribution of animals, Dr. H. Gadow on, 707.
- Geology of Somerset, some points of interest in the, by W. A. E. Ussher, 659.
- Geometry of four dimensions, E. T. Dixon on, 618.
- *Gibbons (G.), dairy industry, 778.
- Gibbs (Prof. Willard), electro-chemical thermo-dynamics, 343.
- Giffen (R.) on the best method of ascertaining and measuring variations in the value of the monetary standard, 181; on the statistical data available for determining the amount of the precious metals in use as money, &c., 219.
- *Gilbert (G. K.), notes on topographic maps produced by the United States Geological Survey, 747.
- Gilson (Prof. G.), the odoriferous apparatus of the *Blaps mortisaga* (*Coleoptera*), 727.
- Gladstone (Dr. J. H.) on the present methods of teaching chemistry, 73; on the teaching of science in elementary schools, 164; on electrolysis in its physical and chemical bearings, 339.
- and W. Hibbert on the conduction of alloys and solid sulphides, 347; on the electrolysis of thallium trisulphide, 349; on the molecular weight of caoutchouc and other colloids, 640.
- Glaisher (J.) on the circulation of underground waters, 145; on the advisability and possibility of establishing in other parts of the country observations upon the prevalence of earth tremors similar to those now being made in Durham, 522.
- Glazebrook (R. T.) on the desirability of introducing a uniform nomenclature for the fundamental units of mechanics, 27; on standards for use in electrical measurements, 55; on electrolysis in its physical and chemical bearings, 339; *on standards of electrical resistance, 616.
- and T. C. Fitzpatrick on the permanence of the original standards of resistance of the British Association and of other standard coils, 56.
- Glennie (J. S. S.) on the prehistoric race in the Greek islands, 99; Pelasgians, Etruscans, and Iberians; their relations to the founders of the Chaldean and Egyptian civilisations, 857.
- *Gouraud (Col. G. E.), the phonograph, 792.
- Granitoid gneiss or gneissoid granite, the occurrence of a boulder of, in the Halifax hard-bed coal, J. Spencer on, 661; note thereon by Prof. T. G. Bonney, *ib.*
- Grantham (R. B.), on the erosion of the sea-coasts of England and Wales, 898.
- Graphics, comparative, some suggestions for greater uniformity in, by Rev. J. F. Heyes, 769.
- Graphite in the archæan rocks, Rev. A. Irving on the origin of, 679.
- Graphophone, the, by H. Edmunds, 792.
- Gray (T.) on standards for use in electrical measurements, 55; on the earthquake and volcanic phenomena of Japan, 422; on the advisability and possibility of establishing in other parts of the country observations upon the prevalence of earth tremors similar to those now being made in Durham, 522.

- Great oolite, the relations of the, to the forest marble and fuller's-earth in the South-west of England, by H. B. Woodward, 651.
- Grece (Dr. C. J.), the standard, or basis, of taxation, 765.
- Greene (F.) on a photographic image of an electric arc lamp, probably due to phosphorescence in the eye, and on some photographs of an eclipse of the moon, 617.
- Greenhill (A. G.) on the desirability of introducing a uniform nomenclature for the fundamental units of mechanics, 27.
- Gregorian calendar, the general adoption of the, in relation with that of the universal hour, Dr. C. Tondini de Quarenghi on, 747.
- Griffith (G.) on the desirability of introducing a uniform nomenclature for the fundamental units of mechanics, 27.
- Grossmann (Dr. K.) on colour-blindness, 838.
- Haddon (Prof. A. C.) on arrangements for assisting the Marine Biological Association laboratory at Plymouth, 94; on the provincial museums of the United Kingdom, 124; on the occupation of a table at the zoological station at Naples, 150.
- Hale (H.), notes on Rev. E. F. Wilson's report on the Sarcee Indians, 253.
- Haliburton (R. G.) on the North-western tribes of the dominion of Canada, 233; *akkas and dwarfs in Southern Morocco, 745.
- Halliburton (Dr. W. D.) on the physiology of the lymphatic system, 363.
- Hambleton (Dr. G. W.) on the effects of different occupations and employments on the physical development of the human body, 100; notes on chest-types, 849.
- Harcourt (A. G. Vernon) on standards of light, 39; on the present methods of teaching chemistry, 73.
- Harcourt (L. F. Vernon), on the erosion of the sea-coasts of England and Wales, 898.
- Harmonic series of lines, the, in the spectra of the elements, Prof. C. Runge on, 576.
- Harris (W. J.), an examination into the reasons of the price of wheat rising or falling contemporaneously with the variation in the value of foreign currencies, 767.
- Harrison (C.), leasehold enfranchisement, 770.
- Harrison (J. P.), the definition of a nation, 850.
1888.
- Hartley (Prof.) on the action of light on the hydracids of halogens in presence of oxygen, 89; on electrolysis in its physical and chemical bearings, 339.
- Hartog (Prof. M. M.) on the steps taken for establishing a botanical station at Peradeniya, Ceylon, 421; on *adelphotaxy*, an undescribed form of irritability, 702; preliminary note on the functions and homologies of the contractile vacuole in plants and animals, 714.
- Harvie-Brown (J. A.) on the migration of birds, 146.
- Hayward (R. B.) on the desirability of introducing a uniform nomenclature for the fundamental units of mechanics, 27.
- Hazard (Col. R. R.), underground railway communication in great cities, 821.
- Heape (W.) on arrangements for assisting the Marine Biological Association laboratory at Plymouth, 94.
- Hemsley (W. B.), botanical bibliography of the Lesser Antilles, 438.
- Herschel (Prof. A. S.) on the work of the Differential Gravity Meter Committee, 72.
- Heyes (Rev. J. F.) on statigrams, with some suggestions for greater uniformity in comparative graphics, 769.
- Heywood (J.) on the teaching of science in elementary schools, 164.
- Hibbert (W.) and Dr. J. H. Gladstone on the conduction of alloys and solid sulphides, 347; on the electrolysis of thallium trisulphide, 349; on the molecular weight of caoutchouc and other colloids, 640.
- Hicks (Dr. H.) on the prehistoric inhabitants of the British islands, 289; on an ancient sea-beach near Bridlington Quay, 328.
- Hicks (Prof. W. M.) on the desirability of introducing a uniform nomenclature for the fundamental units of mechanics, 27; a vortex analogue of static electricity, 577.
- Higgins (J.), Somersetshire cider, 759.
- Hill (E. J.) on the disengaging of boats, &c., 807.
- Hillhouse (Prof.) on the provincial museums of the United Kingdom, 124.
- Hooker (Sir J. D.) on the desirability of further research in the Antarctic regions, 316.
- Hopkinson (Dr. J.) on standards of light, 39; on standards for use in electrical measurements, 55; on electrolysis in its physical and chemical bearings, 339.
- Hopkinson (J.) on the provincial museums of the United Kingdom, 124;

- on the work of the Corresponding Societies Committee, 255.
- Howarth (O. H.) on the recent volcanic structure of the Azorean Archipelago, 671; the survival of corporal penance, 849.
- Howitt (A. W.), Australian message-sticks and messengers, 512.
- Howorth (H. H.) on the effects of different occupations and employments on the physical development of the human body, 100.
- Hoyle (W. E.) *on the fauna of the Firth of Clyde, 717; *on a deep-sea tow net, *ib.*
- Hughes (Prof. T. McK.) on the erratic blocks of England, Wales, and Ireland, 101.
- Hull' (Prof. E.) on the circulation of underground waters, 145; on the advisability and possibility of establishing in other parts of the country observations upon the prevalence of earth tremors similar to those now being made in Durham, 522.
- Human bones discovered by Gen. Pitt-Rivers at Woodcuts, Rotherley, &c., Dr. Beddoe on, 839.
- Human remains from Wiltshire, by Dr. J. G. Garson, 839.
- Hunt (Dr. T. S.) on the study of mineralogy, 627; the theory of solution, 636; mineralogical evolution, 682.
- Hurricanes, modern views about, as compared with the older theories, by Hon. R. Abercromby, 586.
- Huxley (Prof.) on the desirability of further research in the Antarctic regions, 316.
- Hydracids of halogens, the action of light on the, in presence of oxygen, report on, 89.
- Hydrogen and chlorine bulbs, on photographing, by aid of the flash of light which caused their explosion, by Prof. P. P. Bedson, 633.
- *Hydrostatic balance, J. Joly on a, 564.
- Hyksôs, the, or shepherd-kings of Egypt, notes on, by Rev. H. G. Tomkins, 856.
- Iberians, Pelasgians, and Etruscans: their relations to the founders of the Chaldean and Egyptian civilisations, by J. S. S. Glennie, 857.
- Ichthyosaurus*, an, from Mombasa, East Africa, Prof. H. G. Seeley on, with observations on the vertebral characters of the genus, 677.
- Igneous succession in Shropshire, an, by W. W. Watts, 685.
- Impedance of conductors to Leyden-jar discharges, Prof. O. J. Lodge on the, 567.
- Index-number, an official, memorandum on, 186.
- Index-numbers, the accuracy of the proposed calculation of, memorandum on, by Prof. F. Y. Edgeworth, 188.
- as illustrating the progressive exports of British produce and manufactures, by S. Bourne, 536.
- *India, a new route from, to Tibet, by Capt. W. J. Elwes, 741.
- Indian exports, the effects on, of the fall in the gold price of silver, by L. C. Probyn, 768.
- *Industrial education, the, of women abroad and at home, by E. J. Watherston, 771.
- Industrial statistics, by W. Botly, 760.
- Initial meridian for the universal hour, a suggestion from the Bologna Academy of Science towards an agreement on the, by Dr. C. Tondini de Quarenghi, 618.
- International standards, proposed, to control the analysis of iron and steel, by Prof. J. W. Langley, 640.
- Iolite, the occurrence of, in the granite of co. Dublin, J. Joly on, 685.
- Irishwomen's industries, by Miss H. Blackburn, 772.
- Iron and coal industries, the effect of mining royalties on the, Prof. W. R. Sorley on, 755.
- Irving (Rev. A.) on dissociation, 630; chemistry as a school subject, 634; note on the relation of the percentage of carbonic acid in the atmosphere to the life and growth of plants, 661; on the origin of graphite in the archæan rocks, with a review of the alleged evidence of life on the earth in archæan time, 679.
- Isomeric naphthalene derivatives, third report on, 96.
- Jamieson (Prof. A.), the old Orkney click mill, 807.
- Janssen (Dr. J.) sur l'application de l'analyse spectrale à la mécanique moléculaire et sur les spectres de l'oxygène, 547; analyse chronométrique des phénomènes électriques lumineux, 615.
- Japan, the earthquake and volcanic phenomena of, eighth report on, 422.
- , the recent magnetic survey of, Prof. C. G. Knott on, 588.
- Jeffs (O. W.) on local geological photography, 653.
- Jerusalem: Nehemiah's Wall and the royal sepulchres, by G. St. Clair, 744.
- Jevons' method of ascertaining the number of coins in circulation, Prof. F. Y. Edgeworth on, 224.

- Johnson (Prof. A.) on promoting tidal observations in Canada, 27.
- *Johnston (H. H.), the Cameroons, 745.
- Johnston-Lavis (Dr. H. J.) on the volcanic phenomena of Vesuvius and its neighbourhood, 320; on the conservation of heat in volcanic chimneys, 666; on a mass containing metallic iron found on Vesuvius, 667; on the occurrence of leucite at Etna, 669.
- and Dr. T. Anderson on the late eruption in the island of Vulcano, 664.
- Joly (J.) *on a hydrostatic balance, 564; on the meldometer, *ib.*; on a diffusion photometer, 578; on reading electrically meteorological instruments distant from the observer, 589; on the formation of crystals of calcium oxide and magnesium oxide in the oxyhydrogen flame, 634; on the temperature at which beryl is decolorised, 684; on the occurrence of iolite in the granite of co. Dublin, 685.
- Jones (Col.) and E. J. Lowe, abnormal ferns, hybrids, and their parents, 713.
- Jones (F.) on the present methods of teaching chemistry, 73.
- Jones (Prof. T. R.) on the fossil phyllopora of the palæozoic rocks, 173.
- Jordan, recent explorations east of the, by Capt. A. M. Mantell, 743.
- Judd (Prof.) on the advisability and possibility of establishing in other parts of the country observations upon the prevalence of earth tremors similar to those now being made in Durham, 522.
- *Kakongo, through, by Q. E. Dennett, 745.
- Kew corrections for mercury thermometers, some accurate charts of, W. N. Shaw on, 590.
- 'King Orry's grave,' the monument known as, compared with tumuli in Gloucestershire, by Miss A. W. Buckland, 854.
- Kleiber (J.) on the errors of the argument of statistical tables, 618.
- Knott (Prof. C. G.) on the recent magnetic survey of Japan, 588.
- *Lake Bangweolo and Dr. Livingstone, by E. G. Ravenstein, 745.
- Lamb (Prof.) on the desirability of introducing a uniform nomenclature for the fundamental units of mechanics, 27.
- Laminaria bulbosa*, the development of the bulb in, C. A. Barber on, 710.
- Lamplugh (G. W.) on an ancient sea-beach near Bridlington Quay, 328.
- Langley (Prof. J. W.), proposed international standards to control the analysis of iron and steel, 640.
- Lankester (Prof. Ray) on arrangements for assisting the Marine Biological Association laboratory at Plymouth, 94; on the researches on food fishes at the St. Andrews marine laboratory, 141; on the occupation of a table at the zoological station at Naples, 150; on the development of the oviduct and connected structures in certain freshwater teleostei, 338; on the physiology of the lymphatic system, 363.
- Larmor (J.) on the desirability of introducing a uniform nomenclature for the fundamental units of mechanics, 27; on electrolysis in its physical and chemical bearings, 339.
- Laurie (A. P.), the composition of copper-tin alloys, 637.
- Leasehold enfranchisement, by C. Harrison, 770.
- Lebour (Prof. G. A.) on the circulation of underground waters, 145; on the advisability and possibility of establishing in other parts of the country observations upon the prevalence of earth tremors similar to those now being made in Durham, 522.
- Leclanché's cells, comparison of, with Gassner's dry cells, by W. L. Carpenter, 566.
- Leeds (Dr. A. R.) on the bibliography of solution, 54.
- Lefroy (Gen. Sir J. H.) on the best means of comparing and reducing magnetic observations, 28; on the work of the Differential Gravity Meter Committee, 72; on the North-western tribes of the dominion of Canada, 233.
- *Lesseps (F. de), le canal de Panama, 738.
- Lesser Antilles, botanical bibliography of the, by W. B. Hemsley, 438.
- , zoological bibliography of the, by D. Sharp, 438.
- Leucite, the occurrence of, at Etna, Dr. H. J. Johnston-Lavis on, 669.
- Leyden-jar discharges, the impedance of conductors to, Prof. O. J. Lodge on, 567.
- Licences proposed to be transferred in aid of local expenditure, R. H. Inglis Palgrave on the distribution of, 764.
- Life on the earth in archæan time, a review of the alleged evidence of, by Rev. A. Irving, 679.
- Light, standards of, fourth report on, 39; photometric comparison of candles, the pentane standard, the new pentane lamp, and the amyl-acetate lamp, 41; incandescent platinum, 47.

- Light, the action of, on the hydracids of halogens in presence of oxygen, report on, 89.
- , —, on water colours, Dr. A. Richardson on, 641.
- Light in an electrolytic liquid, is its velocity influenced by an electric current in the direction of propagation? by Lord Rayleigh, 341.
- Light or road railways, a few arguments in favour of, by T. S. P. W. D'A. Sellon, 794.
- Lightning conductors, discussion on, 591.
- *Lily disease, a, by Prof. H. M. Ward, 702.
- Lister (J. J.) on the natural history of Christmas Island, 708; on some points in the natural history of the coral fungia, 717.
- 'Little Russia,' by E. D. Morgan, 740.
- Liveing (Prof.) and Prof. Dewar on the absorption spectrum of oxygen, 576.
- *Living bodies, the chemical problems presented by, discussion on, 631.
- *Livingstone, Dr., and Lake Bangweolo, by E. G. Ravenstein, 745.
- Lloyd (S.) on an improved canal lift, 797.
- Lobley (J. L.) on the causes of volcanic action, 670.
- Local Government Bill, amendments founded on experience submitted for the, by E. Chadwick, 779.
- *Lockyer (J. N.), the spectra of meteorites compared with the solar spectrum, 576.
- Locusts in Cyprus, S. Brown on, 716.
- Lodge (A.) on the desirability of introducing a uniform nomenclature for the fundamental units of mechanics, 27.
- Lodge (Prof. O. J.) on the desirability of introducing a uniform nomenclature for the fundamental units of mechanics, 27; on standards for use in electrical measurements, 55; on electrolysis in its physical and chemical bearings, 339; on the measurement of the length of electro-magnetic waves, 567; on the impedance of conductors to Leyden-jar discharges, *ib.*
- *Logarithmic law, the, and its connection with the atomic weights, Dr. G. J. Stoney on, 630.
- *Logarithmic law of atomic weights, Dr. G. J. Stoney on the proof of the, 562.
- Long (Prof. J.), agricultural education, 776.
- Longstaff (G. B.), reasons for a quinquennial census, 769.
- Love (A. E. H.), on the oscillations of a rotating liquid spheroid and the genesis of the moon, 562.
- Love (E. J.) on electrolysis in its physical and chemical bearings, 339.
- Lowe (E. J.) on the effects of the weather of 1888 on the animal and vegetable kingdoms, 726.
- and Col. Jones, abnormal ferns, hybrids, and their parents, 713.
- *Lowrie (W.), the measurement of electricity in a house-to-house supply, 814.
- Lubbock (Sir J.) on the teaching of science in elementary schools, 164; on the prehistoric inhabitants of the British islands, 289; on the desirability of further research in the Antarctic regions, 316; *on the instincts of solitary wasps and bees, 706.
- Luray, the caverns of, by Chev. R. E. Reynolds, 662.
- Lymphatic system, the physiology of the, second report on, 363.
- McClintock (Sir L.), on the desirability of further research in the Antarctic regions, 316.
- Macfarlane (Dr.) on the provincial museums of the United Kingdom, 124.
- MacGregor (Prof. J. G.) on promoting tidal observations in Canada, 27; on the desirability of introducing a uniform nomenclature for the fundamental units of mechanics, *ib.*
- McIntosh (Prof.) on the researches on food-fishes at the St. Andrews marine laboratory, 141.
- McKendrick (Prof.) on the researches on food-fishes at the St. Andrews marine laboratory, 141; on the marine biological station at Granton, 319.
- *Mackenzie (Rev. J.), Bechuanaland and the Land of Ophir, 745.
- *Mackinder (H. J.), note on geographical terminology, 746.
- Mackintosh (D.) on the erratic blocks of England, Wales, and Ireland, 101.
- McLaren (Lord) on meteorological observations on Ben Nevis, 49.
- McLeod (Prof. H.) on the bibliography of solution, 54; on the present methods of teaching chemistry, 73; on electrolysis in its physical and chemical bearings, 339.
- Madagascar, the flora of, Rev. R. Baron on, 724.
- Magnetic disturbances at Fort Rae in 1882-83, by Major H. P. Dawson, 31.
- Magnetic observations, fourth report of the Committee for considering the best means of comparing and reducing, 28; results of a comparison between the wind values and declination disturbances at the Kew Observatory, by Prof. Balfour Stewart and W. L.

- Carpenter, *ib.*; magnetic disturbances at Fort Rae in 1882-83, by Major H. P. Dawson, 31.
- Magnetic survey of Japan, the recent, Prof. C. G. Knott on, 588.
- Magnetisation of soft iron bars of various lengths in a uniform magnetic field, A. Tankadaté on the intensity of, 566.
- Main (P. T.), second report on our experimental knowledge of the properties of matter with respect to volume, pressure, temperature, and specific heat, 465.
- Malthusian theory, the, by E. Chadwick, 777.
- Malvern, the crystalline schists of, Dr. C. Callaway on the origin of, 653.
- Malvern Hills, the crystalline axis of the, sketch of the geology of, by Dr. C. Callaway, 654.
- Mammalia, some extinct tertiary, the gigantic size of, Prof. A. Gaudry on, 660.
- Mammalian molar teeth, the evolution of the, to and from the tritubercular type, by H. F. Osborn, 660.
- Man (E. H.) on the funeral rites and ceremonies of the Nicobar islanders, 844.
- Manchester ship canal, plant and machinery in use on the, by L. B. Wells, 796.
- Mannesmann process, on rolling seamless tubes from solid bars or ingots by the, by F. Siemens, 804.
- Mantell (Capt. A. M.), recent explorations east of the Jordan, 743.
- 'Manure' gravels of Wexford, second report on the, 133.
- Maps, perspective and common, by A. W. Clayden, 740.
- *—, topographic, produced by the United States Geological Survey, notes on, by G. K. Gilbert, 747.
- Marine Biological Association laboratory at Plymouth, the, report of the Committee for making arrangements for assisting, 94.
- Marine biological station at Granton, Scotland, report of the Committee for aiding in the maintenance of the establishment of a, 319.
- Marriage and descent, the laws of, on a method of investigating, by Dr. E. B. Tylor, 840.
- Marriage customs of the New Britain group, by Rev. B. Danks, 847.
- Marsh (J. E.) *on closed-chain formulæ, 631; *on Van't Hoff's hypothesis and the constitution of benzene, *ib.*
- Marsh (Prof. O. C.), *comparison of the principal forms of *Dinosauria* of Europe and America, 660; restoration of *Brontops robustus*, from the miocene of America, 706.
- Marshall (Prof. A.) on the best method of ascertaining and measuring variations in the value of the monetary standard, 181; on the statistical data available for determining the amount of the precious metals in use as money, &c., 219.
- Marshall (Prof. A. M.) on the provincial museums of the United Kingdom, 124; on the occupation of a table at the zoological station at Naples, 150; on the development of the oviduct and connected structures in certain freshwater teleostei, 338.
- Marten (E. B.) on the circulation of underground waters, 145.
- Martin (J. B.) on the best method of ascertaining and measuring variations in the value of the monetary standard, 181; on the statistical data available for determining the amount of the precious metals in use as money, &c., 219.
- Maskelyne (Prof. N. S.) on the teaching of science in elementary schools, 164.
- Mass, a, containing metallic iron found on Vesuvius, Dr. H. J. Johnston-Lavis on, 667.
- Mathematical and Physical Section, Address by Prof. G. F. Fitzgerald to the, 557.
- Matter, second report on our experimental knowledge of the properties of, with respect to volume, pressure, temperature, and specific heat, 465.
- Mavor (J.) on wage statistics and theories, 757.
- *Maxwell's equations of electromagnetic waves, Prof. H. A. Rowland on a modification of, 617.
- Mécanique moléculaire, sur l'application de l'analyse spectrale à la, par Dr. J. Janssen, 547.
- Mechanical pathology considered in its relation to bridge design, by G. H. Thomson, 793.
- Mechanical Section, Address by W. H. Preece to the, 781.
- Melanesia, social regulations in, by Rev. R. H. Codrington, 843.
- Meldola (Prof. R.) on the present methods of teaching chemistry, 73; on the work of the Corresponding Societies Committee, 255; on the prehistoric inhabitants of the British Islands, 289; on the advisability and possibility of establishing in other parts of the country observations upon the prevalence of earth tremors similar to those now being made in Durham, 522; evidence of the tetravalency of oxygen derived from the constitution of the azonaphthol-compounds, 635.
- Meldometer, J. Joly on the, 564.

- Metal coils, the friction of, by Prof. H. Shaw and E. Shaw, 540.
- *Meteorites, on the mechanical conditions of a swarm of, and on theories of cosmogony, by Prof. G. H. Darwin, 590.
- *—, the spectra of, compared with the solar spectrum, by J. N. Lockyer, 576.
- *Meteorological conditions of the Red Sea, by Lieut.-Gen. Strachey, 738.
- Meteorological instruments distant from the observer, on reading electrically, by J. Joly, 589.
- Meteorological observations on Ben Nevis, report of the Committee for co-operating with the Scottish Meteorological Society in making, 49.
- Microscopic structure of the older rocks of Anglesey, report on the, 367.
- Midford sands, further note on the, by H. B. Woodward, 650.
- Migration of birds, report on the, 146.
- Mill (Dr. H. R.) on arranging an investigation of the seasonal variations of temperature in lakes, rivers, and estuaries, 326; on the temperature of some Scottish rivers, 588; the salinity of the Clyde Sea area, 738; sea temperatures on the continental shelf, 739.
- Miller (J. B.) and Dr. W. Bott, further researches on the pyrocresols, 642.
- Milne (Prof. J.) on the earthquake and volcanic phenomena of Japan, 422.
- Milne-Home (Mr.) on meteorological observations on Ben Nevis, 49.
- Mineral and thermal waters, British, a list of works referring to, by W. H. Dalton, 859.
- Mineralogical evolution, by Dr. T. S. Hunt, 682.
- Mineralogy, the study of, Dr. T. S. Hunt on, 627.
- Miners' electric safety-lamps, by N. Watts, 816.
- Mining royalties and their effect on the iron and coal industries, Prof. W. R. Sorley on, 755.
- Molecular weight of caoutchouc and other colloids, Dr. J. H. Gladstone and W. Hibbert on the, 640.
- Monetary standard, the, variations in the value of, second report on the best method of ascertaining and measuring, 181; memorandum on an official index-number, 186; memorandum by Prof. F. Y. Edgeworth on the accuracy of the proposed calculation of index-numbers, 188.
- Moon, on the genesis of the, and the oscillations of a rotating liquid spheroid, by A. E. H. Love, 562.
- , some photographs of an eclipse of the, F. Greene on, 617.
- More (A. G.) on the migration of birds, 146.
- Morgan (E. D.), 'Little Russia,' 740; *Russian topographical surveys, 741.
- *Morocco, Southern, akkas and dwarfs in, by R. G. Haliburton, 745.
- Mortar, the ancient Roman, from the London Wall, the composition of, by J. Spiller, 637.
- Morton (G. H.) on the circulation of underground waters, 145.
- Moseley (Prof.) on arrangements for assisting the Marine Biological Association laboratory at Plymouth, 94; on the occupation of a table at the zoological station at Naples, 150; on the desirability of further research in the Antarctic regions, 316.
- Mott (F. T.) on the provincial museums of the United Kingdom, 124.
- Muir (Dr.) on the desirability of introducing a uniform nomenclature for the fundamental units of mechanics, 27.
- Muir (P.) on the present methods of teaching chemistry, 73.
- Muirhead (Dr. A.) on standards for use in electrical measurements, 55.
- Muirhead (Dr. H.) on the effects of different occupations and employments on the physical development of the human body, 100; on the prehistoric inhabitants of the British islands, 289.
- Mulhall (M. G.), the growth of American industries and wealth, 757.
- Munro (Dr. R.) on the prehistoric inhabitants of the British islands, 289.
- Murray (G. M.) on the flora of the Bahamas, 361.
- Murray (Dr. J.) on meteorological observations on Ben Nevis, 49; on the desirability of further research in the Antarctic regions, 316; on the marine biological station at Granton, 319; on arranging an investigation of the seasonal variations of temperature in lakes, rivers, and estuaries, 326.
- Nares (Capt. Sir G.) on the desirability of further research in the Antarctic regions, 316; on the erosion of the sea-coasts of England and Wales, 898.
- Nation, the definition of a, by J. P. Harrison, 850.
- Necklaces in relation to prehistoric commerce, by Miss A. W. Buckland, 849.
- Nehemiah's wall and the royal sepulchres, by G. St. Clair, 744.
- *Nepenthes, the morphology of the pitcher of, Prof. Bower on, 702.
- New Britain group, marriage customs of the, by Rev. B. Danks, 847.
- Newberry (P. E.) on the plant-remains discovered by Mr. W. M. Flinders

- Petrie in the cemetery of Hawara, Lower Egypt, 712.
- Newton (Prof. A.) on the migration of birds, 146; on the present state of our knowledge of the zoology and botany of the West India islands, and on the steps taken to investigate ascertained deficiencies in the fauna and flora, 437; on the irruption of *Syrrhaptus paradoxus*, 703.
- Nicholson (Prof. J. S.) on the best methods of ascertaining and measuring variations in the value of the monetary standard, 181; on the statistical data available for determining the amount of the precious metals in use as money, &c., 219.
- Nicobar islanders, the funeral rites and ceremonies of the, E. H. Man on, 844.
- Nicol (Dr. W. W. J.) on the bibliography of solution, 54; on the nature of solution, 93; a new gas analysis apparatus, 632.
- Nile, the region from the, to the Euphrates, notes on the geography of, as known to the ancient Egyptians, by Rev. H. G. Tomkins, 741; remarks thereon by Major Conder, 743.
- Nile flood, the Raiyān project for the storage of, by Cope Whitehouse, 799.
- Niven (Prof. C.) on the work of the Differential Gravity Meter Committee, 72.
- Norfolk (F.), *the vital and commercial statistics of Bath, 780; *old age and sickness assurance for the mercantile and professional classes, *ib.*
- North-western tribes of the dominion of Canada, fourth report on the physical characters, languages, and industrial and social condition of the, 233; report on the Sarcee Indians, by Rev. E. F. Wilson, 242; notes thereon by H. Hale, 253.
- *Nutrition of embryos, certain adaptations for the, F. W. Oliver on, 710.
- Observations made in the anthropometric laboratory at Manchester, by G. W. Bloxam and Dr. J. G. Garson, 854.
- Occupations and employments, different, the effects of, on the physical development of the human body, report on, 100.
- Ohm's law in electrolytes, Prof. Fitzgerald and F. Trouton on the accuracy of, 341.
- Older rocks of Anglesey, report on the microscopic structure of the, 367.
- Oligoclase, three specimens of, from North Carolina, exhibiting curious optical properties, Dr. P. Frazer on, 655.
- Oliver (Prof.) on our present knowledge of the flora of China, 420.
- *Oliver (F. W.) on certain adaptations for the nutrition of embryos, 710.
- Ommanney (Adm. Sir E.), on the desirability of further research in the Antarctic regions, 316; on the erosion of the sea-coasts of England and Wales, 898.
- Oolitic texture in limestone rocks, Prof. H. G. Seeley on the origin of, 674.
- *Ophir, the Land of, and Bechuanaland, by Rev. J. Mackenzie, 745.
- Orbits, catenaries, and curved rays, Prof. J. D. Everett on the relations between, 581.
- *Ordinance Survey, photographic and photozincographic processes employed in the, by Col. J. H. Bolland, 746.
- Orkney cleft mill, the old, by Prof. A. Jamieson, 807.
- Osborn (H. F.), the evolution of the mammalian molar teeth to and from the tritubercular type, 660.
- Oviduct, the, and connected structures in certain fresh-water teleostei, report on the development of, 338.
- Oxygen, evidence of the tetravalency of, derived from the constitution of the azonaphthol-compounds, by Prof. R. Meldola, 635.
- , the absorption spectrum of, Profs. Liveing and Dewar on, 576.
- , the atomic weight of, Dr. A. Scott on, 631.
- Oxygène, les spectres de l', Dr. J. Janssen sur, 547.
- Pachythea*, a silurian alga of doubtful affinities, C. A. Barber on, 711.
- *Pahang, an independent state in the Malayan peninsula, W. B. d'Almeida on, 747.
- Palgrave (R. H. Inglis) on the best method of ascertaining and measuring variations in the value of the monetary standard, 181; on the statistical data available for determining the amount of the precious metals in use as money, &c., 219; on the distribution of the licences proposed to be transferred in aid of local expenditure, 764.
- *Panama, le canal de, by F. de Lesseps, 738.
- Parsons (Capt. J.) on the erosion of the sea-coasts of England and Wales, 898.
- Paterson (Dr. A. M.) on the effects of different occupations and employments on the physical development of the human body, 100.
- Pearse (J. W.), transmission of motion and power, 823.

- Pelasgians, Etruscans, and Iberians : their relations to the founders of the Chaldean and Egyptian civilisations, by J. S. S. Glennie, 857.
- Pengelly (W.) on the prehistoric race in the Greek islands, 99 ; on the erratic blocks of England, Wales, and Ireland, 101 ; on the circulation of underground waters, 145 ; on the prehistoric inhabitants of the British islands, 289.
- Peradeniya, Ceylon, second report on the steps taken for establishing a botanical station at, 421.
- Permanence of the original standards of resistance of the British Association and of other standard coils, R. T. Glazebrook and T. C. Fitzpatrick on the, 56.
- Perry (Prof. J.) on standards for use in electrical measurements, 55.
- *— and Profs. Sir W. Thomson and Ayrton, electrometric determination of 'v,' 616.
- Perry (Prof. S. J.) on the best means of comparing and reducing magnetic observations, 28.
- Petrie, Mr. W. M. Flinders, the plant remains discovered by, in the cemetery of Hawara, Lower Egypt, P. E. Newberry on, 712.
- Phénomènes électriques lumineux, analyse chronométrique des, par Dr. J. Janssen, 615.
- *Phonograph, the, by Col. G. E. Gouraud, 792.
- *Photographic and photozincographic processes employed in the Ordnance Survey, by Col. J. H. Bolland, 746.
- Photographic image of an electric arc lamp, a, probably due to phosphorescence in the eye, F. Greene on, 617.
- Photographing hydrogen and chlorine bulbs by aid of the flash of light which caused their explosion, Prof. P. P. Bedson on, 633.
- Photography, local geological, O. W. Jeffs on, 653.
- Photometer, a diffusion, J. Joly on, 578.
- Phyllopora, the fossil, of the palæozoic rocks, sixth report on, 173.
- Physical Section, the Mathematical and, Address by Prof. G. F. Fitzgerald to, 557.
- Physiology of the lymphatic system, second report on the, 363.
- Pickering (Prof.) on the bibliography of solution, 54.
- Pidgeon (W. R.), the Shipman engine, 806.
- Pitman (E.), economy in education and in writing, 776.
- Pitt-Rivers (Lieut.-Gen.) on the effects of different occupations and employments on the physical development of the human body, 100 ; on the work of the Corresponding Societies Committee, 255 ; Address to the Anthropological Section by, 825.
- Pitt-Rivers, Lieut.-Gen., human bones discovered by, at Woodcuts, Rotherley, &c., Dr. Beddoe on, 839.
- Plant (J.) on the erratic blocks of England, Wales, and Ireland, 101 ; on the circulation of underground waters, 145.
- Plant and machinery in use on the Manchester ship canal, by L. B. Wells, 796.
- Plant-remains discovered by Mr. W. M. Flinders Petrie in the cemetery of Hawara, Lower Egypt, P. E. Newberry on the, 712.
- Plants, the life and growth of, the relation of the percentage of carbonic acid in the atmosphere to, Rev. A. Irving on, 661.
- Playfair (Col. Sir L.), Tunis since the French protectorate, 745.
- Polarisation of small electrodes in dilute sulphuric acid, Dr. F. Richarz on the, 350.
- Portland sands, the, of Swindon and elsewhere, note on, by H. B. Woodward, 652.
- *Poulton (E. B.), heredity in cats with an extra number of toes, 707.
- Poynting (Prof. J. H.) on the desirability of introducing a uniform nomenclature for the fundamental units of mechanics, 27 ; on the work of the Differential Gravity Meter Committee, 72 ; on electrolysis in its physical and chemical bearings, 339.
- Precious metals, the amount of the, in use as money in the principal countries, the chief forms in which the money is employed, and the amount annually used in the arts, report as to the statistical data available for determining, 219 ; memorandum, by Prof. F. Y. Edgeworth, on Jevons' method of ascertaining the number of coins in circulation, 224.
- Preece (W. H.) on standards of light, 39 ; on standards for use in electrical measurements, 55 ; on the C.G.S. units of measurement, 616 ; Address to the Mechanical Section by, 781.
- Prehistoric inhabitants of the British Islands, the localities in which evidences of the existence of, are found, second report of the Committee for ascertaining and recording, 289.
- Prehistoric race in the Greek islands, third report on the, 99.
- Prestwich (Prof. J.) on the erratic blocks of England, Wales, and Ireland, 101 ; on the circulation of underground waters, 145 ; on the advisability and possibility of establishing in other parts of the country observations upon

- the prevalence of earth tremors similar to those now being made in Durham, 522; on the erosion of the sea-coasts of England and Wales, 898.
- Price (L. L.), the relations between sliding scales and economic theory, 523.
- Probyn (L. C.), the effects on Indian exports of the fall in the gold price of silver, 768.
- Provincial museums of the United Kingdom, further report on the, 124.
- Pyrocresols, further researches on the, by Dr. W. Bott and J. B. Miller, 642.
- Quartz, a specimen of, from Australia, exhibiting curious optical properties, Dr. P. Frazer on, 655.
- Quinquennial census, reasons for a, by G. B. Longstaff, 769.
- Raian and Fayum basins, the, by Cope Whitehouse, 746.
- Railway communication, underground, in great cities, by Col. R. R. Hazard, 821.
- Railways, light or road, a few arguments in favour of, by T. S. P. W. D'A. Sellon, 794.
- Raiyān project for the storage of Nile flood, the, by Cope Whitehouse, 799.
- Ramsay (Prof. W.) on the bibliography of solution, 54; on the nature of solution, 93; on electrolysis in its physical and chemical bearings, 339; *on the behaviour of water under great provocation from heat, 562.
- *Ravenstein (E. G.), Dr. Livingstone and Lake Bangweolo, 745.
- Rawson (Sir R.) on the effects of different occupations and employments on the physical development of the human body, 100; on the work of the Corresponding Societies Committee, 255.
- Rayleigh (Prof. Lord) on standards of light, 39; on standards for use in electrical measurements, 55; on electrolysis in its physical and chemical bearings, 339; is the velocity of light in an electrolytic liquid influenced by an electric current in the direction of propagation? 341.
- Recurring decimals and Fermat's theorem, Prof. R. W. Genese on, 580.
- *Red Sea, meteorological conditions of the, by Lieut.-Gen. Strachey, 738.
- Redman (J. B.) on the erosion of the sea-coasts of England and Wales, 898.
- Rees (W. L.), associative economics applied to colonisation, 752.
- Reid (C.) on an ancient sea-beach near Bridlington Quay, 328.
- Reid (C.) and H. N. Ridley, fossil arctic plants from the lacustrine deposit at Hoxne, in Suffolk, 674.
- Reinold (Prof.) on electrolysis in its physical and chemical bearings, 339.
- Revenue system of the United States, the, by Dr. A. Shaw, 763.
- Revolving sails, or air-propellers, by H. C. Vogt, 820.
- Reynolds (Prof. J. E.) on some new silicon compounds, 640; on some new thiocarbamide compounds, *ib.*
- Reynolds (Chev. R. E.), the caverns of Luray, 662; notes on the shell-mounds and ossuaries of the Choptank river, Maryland, U.S.A., 845.
- Richards (Adm. Sir G. H.) on the desirability of further research in the Antarctic regions, 316.
- Richardson (Dr. A.) on the action of light on the hydracids of halogens in presence of oxygen, 89; on the action of light on water colours, 641.
- Richarz (Dr. F.) on the polarisation of small electrodes in dilute sulphuric acid, 350.
- Ricketts (Dr. C.) on a probable cause of contortions of strata, 684.
- Ridley (H. N.) and C. Reid, fossil arctic plants from the lacustrine deposit at Hoxne, in Suffolk, 674.
- River of Joseph, the, the Fayum and Raian basins, by Cope Whitehouse, 746.
- Roberts (C.) on the effects of different occupations and employments on the physical development of the human body, 100.
- Roberts (I.) on the circulation of underground waters, 145; on arranging an investigation of the seasonal variations of temperature in lakes, rivers, and estuaries, 326; on the advisability and possibility of establishing in other parts of the country observations upon the prevalence of earth tremors similar to those now being made in Durham, 522.
- Roberts-Austen (Prof. W. C.) on the influence of silicon on the properties of steel, 69; on electrolysis in its physical and chemical bearings, 339.
- Roscoe (Sir H. E.) on the teaching of science in elementary schools, 164.
- Rotating liquid spheroid, on the oscillations of a, and the genesis of the moon, by A. E. H. Love, 562.
- *Rotation of a dynamo, on controlling the direction of, by A. Winter, 824.
- Rowland (Prof. H. A.), *recent progress in the use of concave gratings for spectrum analysis, 566; *on a modification of Maxwell's equations of electromagnetic waves, 617.

- Roy (Prof.) and J. G. Adami on the physiological bearing of waist-belts and stays, 704.
- Rücker (Prof.) on electrolysis in its physical and chemical bearings, 339.
- Rudler (F. W.) on the prehistoric race in the Greek islands, 99; on the effects of different occupations and employments on the physical development of the human body, 100; on the volcanic phenomena of Vesuvius and its neighbourhood, 320.
- Runge (Prof. C.) on the harmonic series of lines in the spectra of the elements, 576.
- Russell (Dr. W. J.) on the present methods of teaching chemistry, 73; on the action of light on the hydracids of halogens in presence of oxygen, 89.
- *Russian topographical surveys, by E. D. Morgan, 741.
- St. Clair (G.), Jerusalem: Nehemiah's wall and the royal sepulchres, 744; totem clans and star worship, 848.
- Salinity of the Clyde sea area, the, by Dr. H. R. Mill, 738.
- Sanderson (Prof. B.) on the researches on food-fishes at the St. Andrews marine laboratory, 141.
- Sarcee Indians, report on the, by Rev. E. F. Wilson, 242; notes thereon, by H. Hale, 253.
- Schäfer (Prof.) on the physiology of the lymphatic system, 363.
- Schuster (Prof. A.) on the best means of comparing and reducing magnetic observations, 28; on standards of light, 39; on standards for use in electrical measurements, 55; on the work of the Differential Gravity Meter Committee, 72; on electrolysis in its physical and chemical bearings, 339.
- Science, the teaching of, in elementary schools, report on, 164.
- Sclater (Dr. P. L.) on arrangements for assisting the Marine Biological Association laboratory at Plymouth, 94; on the occupation of a table at the zoological station at Naples, 150; on the desirability of further research in the Antarctic regions, 316; on the present state of our knowledge of the zoology and botany of the West India islands, and on the steps taken to investigate ascertained deficiencies in the fauna and flora, 437.
- Scott (Dr. A.) on the atomic weight of oxygen, 631.
- Scottish rivers, on the temperature of some, by Dr. H. R. Mill, 588.
- Sea of Bengal, the echinodermata of the, Prof. F. J. Bell on, 718.
- *Sea temperatures in the neighbourhood of Cape Guardafui, by Lieut.-Gen. Strachey, 738.
- Sea temperatures of the continental shelf, by Dr. H. R. Mill, 739.
- Sea-beach, an ancient, near Bridlington Quay, report on, 328.
- Seamless tubes from solid bars or ingots, rolling, by the Mannesmann process, F. Siemens on, 804.
- Seasonal variations of temperature in lakes, rivers, and estuaries in various parts of the United Kingdom, report of the Committee for arranging an investigation of the, in co-operation with the local societies represented on the Association, 326.
- Sedgwick (A.) on arrangements for assisting the Marine Biological Association laboratory at Plymouth, 94; on the occupation of a table at the zoological station at Naples, 150; on the development of the oviduct and connected structures in certain fresh-water teleostei, 338.
- Seeley (Prof. H. G.) on the origin of oolitic texture in limestone rocks, 674; on an *ichthyosaurus* from Mombasa, East Africa, with observations on the vertebral characters of the genus, 677.
- Seismograph, an improved, by E. A. Cowper, 818.
- Sellon (R. P.), electric light applied to night navigation upon the Suez Canal, 814.
- Sellon (T. S. P. W. D'A.), a few arguments in favour of light or road railways, 794.
- Sensation, composition of, and notion of space, L. de la Rive on, 585.
- Severn watershed, the, by J. W. W. Bund, 799.
- Sharp (D.), zoological bibliography of the Lesser Antilles, 438.
- Shaw (Dr. A.), the revenue system of the United States, 763.
- Shaw (E.) and Prof. H. Shaw, the friction of metal coils, 540.
- Shaw (G. B.), the transition to social democracy, 761.
- Shaw (Prof. H.), a new sphere planimeter, 584.
- and E. Shaw, the friction of metal coils, 540.
- Shaw (W. N.) on the desirability of introducing a uniform nomenclature for the fundamental units of mechanics, 27; on standards for use in electrical measurements, 55; on electrolysis in its physical and chemical bearings, 339; on some accurate charts of Kew corrections for mercury thermometers, 590; on an apparatus for determining temperature by the variation of electrical resistance, *ib.*

- Shell-mounds and ossuaries of the Choptank river, Maryland, U.S.A., notes on the, by Chev. R. E. Reynolds, 845.
- Shenstone (W. A.) on the present methods of teaching chemistry, 73.
- Shipman engine, the, by W. R. Pidgeon, 806.
- Shore (T. W.), beds exposed in the Southampton new dock excavation, 672; Celtic earthworks in Hampshire, in reference to the density of the Celtic population, 852.
- Sicilies, the Two, the volcanoes of, by Dr. T. Anderson, 663.
- Sidgwick (Prof. H.) on the best method of ascertaining and measuring variations in the value of the monetary standard, 181; an analysis of the current conception of State socialism, 760.
- Siemens (F.) on rolling seamless tubes from solid bars or ingots by the Mannesmann process, 804.
- Silicon, the influence of, on the properties of steel, second report on, 69.
- Silicon compounds, some new, Prof. J. E. Reynolds on, 640.
- Sladen (P.) on arrangements for assisting the Marine Biological Association laboratory at Plymouth, 94; on the occupation of a table at the zoological station at Naples, 150.
- Sliding scales and economic theory, the relations between, by L. L. Price, 523.
- Sloan (A. D.) on the occupation of the table at the zoological station at Naples, 153.
- Smith (H. W.) and Prof. H. B. Dixon, the incompleteness of combustion in explosions, 632.
- Smithells (Prof.) on the present methods of teaching chemistry, 73.
- Social democracy, the transition to, by G. B. Shaw, 761.
- Social regulations in Melanesia, by Rev. R. H. Codrington, 843.
- Socialism, State, an analysis of the current conception of, by Prof. H. Sidgwick, 760.
- *Solar spectrum, the spectra of meteorites compared with the, by J. N. Lockyer, 576.
- Solution, the bibliography of, second report on, 54.
- , the nature of, second report on, 93.
- , the theory of, by Dr. T. S. Hunt, 636.
- Solution of copper in acids, the rate of, V. H. Veley on, 638.
- Somerset, some points of interest in the geology of, by W. A. E. Ussher, 659.
- Somersetshire cider, by J. Higgins, 759.
- Sorley (Prof. W. R.) on mining royalties and their effect on the iron and coal industries, 755.
- Southampton new dock excavation, beds exposed in the, by T. W. Shore, 672.
- Space, notion of, and composition of sensation, L. de la Rive on, 585.
- *Spectra of meteorites, the, compared with the solar spectrum, by J. N. Lockyer, 576.
- Spectra of the elements, the harmonic series of lines in the, Prof. C. Runge on, 576.
- Spectres de l'oxygène, Dr. J. Janssen sur les, 547.
- *Spectrum analysis, recent progress in the use of concave gratings for, by Prof. H. A. Rowland, 566.
- Spencer (J.) on the occurrence of a boulder of granitoid gneiss or gneissoid granite in the Halifax hard-bed coal, 661.
- Sphere planimeter, a new, by Prof. H. Shaw, 584.
- Spiller (J.), the composition of the ancient Roman mortar from the London Wall, 637.
- Stallard (Mr.) on the present methods of teaching chemistry, 73.
- Star worship, totem clans and, by G. St. Clair, 848.
- State socialism, an analysis of the current conception of, by Prof. H. Sidgwick, 760.
- Static electricity, a vortex analogue of, by Prof. W. M. Hicks, 577.
- Statigrams, Rev. J. F. Heyes on, with some suggestions for greater uniformity in comparative graphics, 769.
- Statistical tables, the errors of the argument of, J. Kleiber on, 618.
- Statistics, agricultural, commercial, industrial, and banking, by W. Botly, 760.
- , Economic Science and, Address by Lord Bramwell to the Section of, 749.
- *—, the vital and commercial, of Bath, by F. Norfolk, 780.
- Statistics of examination, Prof. F. Y. Edgeworth on the, 763.
- Stays and waist-belts, the physiological bearing of, Prof. Roy and J. G. Adami on, 704.
- Steam at high pressures, the efficiency of, and the Carnot theorem, by W. W. Beaumont, 820.
- Steam engine diagrams, by M. F. Fitzgerald, 819.
- Steel, the influence of silicon on the properties of, second report on, 69.
- Steward (Rev. C. J.) on arranging an investigation of the seasonal variations of temperature in lakes, rivers, and estuaries, 326.
- Stewart (Prof. Balfour) on the best means of comparing and reducing magnetic observations, 28.

- Stewart (Prof. Balfour) and W. L. Carpenter, results of a comparison between the wind values and declination disturbances at the Kew Observatory, 28.
- Stirling (Prof.) on the researches on food-fishes at the St. Andrews marine laboratory, 141.
- Stone (J. H.), the ancient inhabitants of the Canary Islands, 851.
- Stoney (Dr. G. J.) on the desirability of introducing a uniform nomenclature for the fundamental units of mechanics, 27; *on the proof of the logarithmic law of atomic weights, 562; *on the logarithmic law and its connection with the atomic weights, 630.
- Stooke (T. S.) on the circulation of underground waters, 145.
- Strachey (Lieut.-Gen. R.) on the work of the Differential Gravity Meter Committee, 72; on the desirability of further research in the Antarctic regions, 316; *meteorological conditions of the Red Sea, 738; *sea temperatures in the neighbourhood of Cape Guardafui, *ib.*
- Stretching of liquids, Prof. A. M. Worthington on the, 583.
- Stroud (Prof. W.) and W. W. H. Gee, electro-calorimetry, 565.
- Sun-myths in modern Hellas, by J. T. Bent, 850.
- Surtees (Capt. C.), mission to El-Wedj, 747.
- Swan (J. W.) on an automatic fire-damp detector, 817.
- Swiss, the physique of the, as influenced by race and by media, by Dr. Beddoe, 837.
- Symons (G. J.) on the circulation of underground waters, 145; on the work of the Corresponding Societies Committee, 255; on the advisability and possibility of establishing in other parts of the country observations upon the prevalence of earth tremors similar to those now being made in Durham, 522.
- Syrnhaptes paradoxus*, the irruption of, Prof. Newton on, 703.
- Tanakadaté (A.) on the intensity of magnetisation of soft iron bars of various lengths in a uniform magnetic field, 566.
- Tanner (R. R.), the suitability of small towns for factory industries, 767.
- Taxation, the standard, or basis, of, by Dr. C. J. Grece, 765.
- *Taylor (G.), Formosa: characteristic traits of the island and its aboriginal inhabitants, 747.
- Taylor (H.) on standards for use in electrical measurements, 55.
- Teall (J. J. H.) on the volcanic phenomena of Vesuvius and its neighbourhood, 320; on the microscopic structure of the older rocks of Anglesey, 367.
- Teleostean ova, some, and their development, J. T. Cunningham on, 703.
- Teleostei, certain fresh-water, report on the development of the oviduct and connected structures in, 338.
- Temperature, an apparatus for determining, by the variation of electrical resistance, W. N. Shaw on, 590.
- Temperature of some Scottish rivers, Dr. H. R. Mill on the, 588.
- Temple (Sir R.) on the teaching of science in elementary schools, 164.
- Tetravalency of oxygen, evidence of the, derived from the constitution of the azonaphthol-compounds, by Prof. R. Meldola, 635.
- Thallium trisulphide, the electrolysis of, Dr. J. H. Gladstone and W. Hibbert on, 349.
- Thermal and mineral waters, British, a list of works referring to, by W. H. Dalton, 859.
- Thermometers, mercury, some accurate charts of Kew corrections for, W. N. Shaw on, 590.
- Thiocarbamide compounds, some new, Prof. J. E. Reynolds on, 640.
- Thiselton-Dyer (W. T.) on the flora of the Bahamas, 361; on our present knowledge of the flora of China, 420; on the steps taken for establishing a botanical station at Peradeniya, Ceylon, 421; on the present state of our knowledge of the zoology and botany of the West India Islands, and on the steps taken to investigate ascertained deficiencies in the fauna and flora, 437; Address to the Biological Section by, 686.
- Thompson (Prof. S. P.) on electrolysis in its physical and chemical bearings, 339.
- Thomson (G. H.), mechanical pathology considered in its relation to bridge design, 793.
- Thomson (Prof. J.) on flux and reflux of water in open channels or in pipes or other ducts, 574.
- Thomson (Prof. J. J.) on standards for use in electrical measurements, 55; on electrolysis in its physical and chemical bearings, 339.
- Thomson (J. M.) on electrolysis in its physical and chemical bearings, 339.
- *Thomson (Jos.), notes from the Atlas Mountains, 745.
- Thomson (Prof. Sir W.) on the best means of comparing and reducing

- magnetic observations, 28; on standards for use in electrical measurements, 55; on the work of the Differential Gravity Meter Committee, 72; on the desirability of further research in the Antarctic regions, 316; on electrolysis in its physical and chemical bearings, 339; a simple hypothesis for electro-magnetic induction of incomplete circuits, with consequent equations of electric motion in fixed homogeneous or heterogeneous solid matter, 567; on the transference of electricity within a homogeneous solid conductor, 570; five applications of Fourier's law of diffusion, illustrated by a diagram of curves with absolute numerical values, 571.
- *Thomson (Prof. Sir W.) and Profs. Ayrton and Perry, electrometric determination of 'v,' 616.
- *Tibet, a new route from India to, by Capt. W. J. Elwes, 741.
- Tidal observations in Canada, fourth report of the Committee for promoting, 27.
- Tiddeman (R. H.) on the erratic blocks of England, Wales, and Ireland, 101.
- Tilden (Prof. W. A.) on the bibliography of solution, 54; on the influence of silicon on the properties of steel, 69; on the nature of solution, 93; on isomeric naphthalene derivatives, 96; on electrolysis in its physical and chemical bearings, 339; Address to the Chemical Section by, 620.
- Tomkins (Rev. H. G.), notes on the geography of the region from the Nile to the Euphrates, as known to the ancient Egyptians, 741; some account of the ancient (præ-Roman) stronghold of Worlebury, near Weston-super-Mare, 851; notes on the Hyksôs or shepherd-kings of Egypt, 856.
- Tomlinson (H.) on standards for use in electrical measurements, 55.
- Tondini de Quarenghi (Dr. C.), a suggestion from the Bologna Academy of Science towards an agreement on the initial meridian for the universal hour, 618; on the general adoption of the Gregorian calendar in relation with that of the universal hour, 747.
- Topley (W.) on the circulation of underground waters, 145; on the work of the Corresponding Societies Committee, 255; on the erosion of the sea-coasts of England and Wales, 898.
- Totem clans and star worship, by G. St. Clair, 848.
- Traill (Dr. A.) on the burning by lightning of a magnet on a generating dynamo, 615.
- Transmission of motion and power, by J. W. Pearce, 823.
- *Transvaal, the, or South African Republic, by P. H. Ford, 745.
- Traquair (Dr.) on the provincial museums of the United Kingdom, 124; on the researches on food-fishes at the St. Andrews marine laboratory, 141.
- Trimen (Dr.) on the steps taken for establishing a botanical station at Peradeniya, Ceylon, 421.
- Trouton (F.) and Prof. Fitzgerald on the accuracy of Ohm's law in electrolytes, 341.
- *Tubificidæ, contributions to the anatomy of the, by F. E. Beddard, 723.
- Tunis since the French protectorate, by Col. Sir L. Playfair, 745.
- Turner (T.) on the influence of silicon on the properties of steel, 69.
- Twenty-ton travelling crane, the application of electricity to the working of a, by W. Anderson, 808.
- Tylden-Wright (Mr.) on the circulation of underground waters, 145.
- Tylor (Dr. E. B.) on the North-western tribes of the dominion of Canada, 233; on a method of investigating the development of institutions, applied to laws of marriage and descent, 840.
- Tytherington and Thornbury section, Rev. H. H. Winwood on the, 658.
- Underground railway communication in great cities, by Col. R. R. Hazard, 821.
- Underground waters in the permeable formations of England and Wales, the circulation of, and the quantity and character of the water supplied to various towns and districts from these formations, fourteenth report on the, 145.
- Underground waters of the permeable formations of England, the replenishment of the, J. B. Denton on, 797.
- Uniform nomenclature for the fundamental units of mechanics, report of the Committee for considering the desirability of introducing a, and for cooperating with other bodies engaged in similar work, 27.
- United States, the revenue system of the, by Dr. A. Shaw, 763.
- Universal hour, the general adoption of the Gregorian calendar in relation with that of the, Dr. C. Tondini de Quarenghi on, 747.
- , the initial meridian for the, a suggestion from the Bologna Academy of Science towards an agreement on, by Dr. C. Tondini de Quarenghi, 618.
- Ussher (W. A. E.), some points of interest in the geology of Somerset, 659; the Watcombe terra-cotta clay, 672.

- 'v,' electrometric determination of, by Profs. Sir W. Thomson, Ayrton, and Perry, 616.
- *Valency, discussion on, 635.
- Valentine (J. S.) on the erosion of the sea-coasts of England and Wales, 898.
- *Van't Hoff's hypothesis and the constitution of benzene, J. E. Marsh on, 631.
- Vapour densities at high temperatures and under reduced pressure, the determination of, by Dr. W. Bott, 632.
- Veley (V. H.) on the rate of solution of copper in acids, 638.
- Vesuvius, on a mass containing metallic iron found on, by Dr. H. J. Johnston-Lavis, 667.
- Vesuvius and its neighbourhood, the volcanic phenomena of, report on, 320.
- Vogt (H. C.), revolving sails, or air-propellers, 820.
- Volcanic action, the causes of, J. L. Lobley on, 670.
- Volcanic phenomena of Vesuvius and its neighbourhood, report on the, 320.
- Volcanic structure, the recent, of the Azorean archipelago, O. H. Howarth on, 671.
- Volcanoes of the Two Sicilies, the, by Dr. T. Anderson, 663.
- Vortex analogue of static electricity, a, by Prof. W. M. Hicks, 577.
- Vulcano, the late eruption in the island of, Drs. T. Anderson and H. J. Johnston-Lavis on, 664.
- Wage statistics and theories, J. Mavor on, 757.
- Waist-belts and stays, the physiological bearing of, Prof. Roy and J. G. Adami on, 704.
- Walker (Gen. J. T.) on the work of the Differential Gravity Meter Committee, 72; on the desirability of further research in the Antarctic regions, 316.
- Ward (Prof. H. M.) on the steps taken for establishing a botanical station at Peradeniya, Ceylon, 421; *a lily disease, 702.
- *Wasps and bees, solitary, the instincts of, Sir J. Lubbock on, 706.
- Watcombe terra-cotta clay, W. A. E. Ussher on the, 672.
- *Water, the behaviour of, under great provocation from heat, Prof. W. Ramsay on, 562.
- Water colours, the action of light on, Dr. A. Richardson on, 641.
- *Watherston (E. J.), the industrial education of women abroad and at home, 771.
- Watts (N.), miners' electric safety-lamps, 816.
- Watts (W. W.), an igneous succession in Shropshire, 685.
- Waves in a viscous liquid, by A. B. Bassett, 563.
- Weather of 1888, the effects of the, on the animal and vegetable kingdoms, E. J. Lowe on, 726.
- Weldon (W. F. R.) on the flora of the Bahamas, 361.
- Wells (L. B.), plant and machinery in use on the Manchester ship canal, 796.
- West India Islands, report on the present state of our knowledge of the zoology and botany of the, and on the steps taken to investigate ascertained deficiencies in the fauna and flora, 437.
- Western Asia, the early races of, Major C. R. Conder on, 855.
- Wethered (E.) on the circulation of underground waters, 145; on the lower carboniferous rocks of Gloucestershire, 657.
- Wharton (Capt. W. J. L.) on the erosion of the sea-coasts of England and Wales, 898.
- Wheat, an examination into the reasons of the price of, rising or falling contemporaneously with the variation in the value of foreign currencies, by W. J. Harris, 767.
- Whidborne (Rev. G. F.) on some Devonian cephalopods and gasteropods, 680; on some Devonian crustaceans, 681; on some fossils of the limestones of South Devon, *ib.*
- Whipple (G. M.) on the best means of comparing and reducing magnetic observations, 28.
- Whitaker (W.) on the circulation of underground waters, 145; on the work of the Corresponding Societies Committee, 255; on the extension of the Bath oolite under London as shown by a deep boring at Streatham, 656; on the erosion of the sea-coasts of England and Wales, 898.
- White (W.) on the work of the Corresponding Societies Committee, 255.
- Whitehouse (Cope), the river of Joseph, the Fayum and Raian basins, 746; the Raiyān project for the storage of Nile flood, 799.
- Williamson (Prof. A. W.) on the work of the Corresponding Societies Committee, 255.
- Williamson (Prof. W. C.) on the flora of the carboniferous rocks of Lancashire and West Yorkshire, 150.
- Wilson (Col. Sir C. W.), Address to the Geographical Section by, 729.
- Wilson (Dr. D.) on the North-western tribes of the dominion of Canada, 233.

- Wilson (Rev. E. F.), report on the Sarcee Indians, 242; notes thereon by H. Hale, 253.
- Wind values and declination disturbances at the Kew Observatory, results of a comparison between the, by Prof. Balfour Stewart and W. L. Carpenter, 28.
- *Winter (A.) on controlling the direction of rotation of a dynamo, 824.
- *Winton (Sir F. de), the commercial future of Central Africa, 745.
- Winwood (Rev. H. H.) on the Tytherington and Thornbury section, 658.
- *Women, the industrial education of, abroad and at home, by E. J. Watherston, 771.
- Wood (H. T.) on standards of light, 39.
- Woodall (J. W.) on the erosion of the sea-coasts of England and Wales, 898.
- *Woodthorpe (Col.), explorations on the Chindwin river, Upper Burmah, in 1886-87, 741.
- Woodward (A. S.), a comparison of the cretaceous fish-fauna of Mount Lebanon with that of the English chalk, 678; on *Bucklandium diluvii*, König, a siluroid fish from the London clay of Sheppey, 679.
- Woodward (Dr. H.) on the provincial museums of the United Kingdom, 124; on the 'manure' gravels of Wexford, 133; on the fossil phyllopora of the palæozoic rocks, 173; on an ancient sea-beach near Bridlington Quay, 328.
- Woodward (H. B.), further note on the Midford sands, 650; the relations of the great oolite to the forest marble and fuller's-earth in the south-west of England, 651; note on the Portland sands of Swindon and elsewhere, 652.
- Worlebury, the ancient (præ-Roman) stronghold of, near Weston-super-Mare, some account of, by Rev. H. G. Tomkins, 851.
- Worthington (Prof. A. M.) on the stretching of liquids, 583.
- Young (Prof.) on the bibliography of solution, 54.
- Zoological station at Naples, report of the Committee appointed to arrange for the occupation of a table at the, 150; reports to the Committee: by Mr. J. Gardiner, 152; by Mr. A. D. Sloan, 153; by Prof. R. J. Anderson, 157.
-



BRITISH ASSOCIATION FOR THE ADVANCEMENT OF SCIENCE.

Life Members (since 1845), and all Annual Members who have not intermitted their Subscription, receive gratis all Reports published after the date of their Membership. Any other volume they require may be obtained on application at the Office of the Association, 22 Albemarle Street, Piccadilly, London, W., at the following prices, viz.—Reports for 1831 to 1874 (*of which more than 15 copies remain*), at 2s. 6d. per volume; after that date, at two-thirds of the Publication Price. A few sets, from 1831 to 1874 inclusive, may also be obtained at £10 per set.

Associates for the Meeting in 1888 may obtain the Volume for the Year at two-thirds of the Publication Price.

PROCEEDINGS OF THE FIRST AND SECOND MEETINGS, at York and Oxford, 1831 and 1832, *Published at 13s. 6d.*

CONTENTS:—Prof. Airy, on the Progress of Astronomy;—J. W. Lubbock, on the Tides;—Prof. Forbes, on the Present State of Meteorology;—Prof. Powell, on the Present State of the Science of Radiant Heat;—Prof. Cumming, on Thermo-Electricity;—Sir D. Brewster, on the Progress of Optics;—Rev. W. Whewell, on the Present State of Mineralogy;—Rev. W. D. Conybeare, on the Recent Progress and Present State of Geology;—Dr. Pritchard's Review of Philological and Physical Researches.

Together with Papers on Mathematics, Optics, Acoustics, Magnetism, Electricity, Chemistry, Meteorology, Geography, Geology, Zoology, Anatomy, Physiology, Botany, and the Arts; and an Exposition of the Objects and Plan of the Association, &c.

PROCEEDINGS OF THE THIRD MEETING, at Cambridge, 1833, *Published at 12s. (Out of Print.)*

CONTENTS:—Proceedings of the Meeting;—John Taylor, on Mineral Veins;—Dr. Lindley, on the Philosophy of Botany;—Dr. Henry, on the Physiology of the Nervous System;—P. Barlow, on the Strength of Materials;—S. H. Christie, on the Magnetism of the Earth;—Rev. J. Challis, on the Analytical Theory of Hydrostatics and Hydrodynamics;—G. Rennie, on Hydraulics as a Branch of Engineering, Part I.;—Rev. G. Peacock, on certain Branches of Analysis.

Together with Papers on Mathematics and Physics, Philosophical Instruments and Mechanical Arts, Natural History, Anatomy, Physiology, and History of Science.

PROCEEDINGS OF THE FOURTH MEETING, at Edinburgh, 1834, *Published at 15s.*

CONTENTS:—H. G. Rogers, on the Geology of North America;—Dr. C. Henry, on the Laws of Contagion;—Prof. Clark, on Animal Physiology;—Rev. L. Jenyns, on Zoology;—Rev. J. Challis, on Capillary Attraction;—Prof. Lloyd, on Physical Optics;—G. Rennie, on Hydraulics, Part II.

Together with the Transactions of the Sections, and Recommendations of the Association and its Committees.

PROCEEDINGS OF THE FIFTH MEETING, at Dublin, 1835, *Published at 13s. 6d.* (Out of Print.)

CONTENTS:—Rev. W. Whewell, on the Recent Progress and Present Condition of the Mathematical Theories of Electricity, Magnetism, and Heat;—A. Quetelet, *Aperçu de l'Etat actuel des Sciences Mathématiques chez les Belges*;—Capt. E. Sabine, on the Phenomena of Terrestrial Magnetism.

Together with the Transactions of the Sections, Prof. Sir W. Hamilton's Address and Recommendations of the Association and its Committees.

PROCEEDINGS OF THE SIXTH MEETING, at Bristol, 1836, *Published at 12s.* (Out of Print.)

CONTENTS:—Prof. Daubeny, on the Present State of our Knowledge with respect to Mineral and Thermal Waters;—Major E. Sabine, on the Direction and Intensity of the Terrestrial Magnetic Force in Scotland;—J. Richardson, on North American Zoology;—Rev. J. Challis, on the Mathematical Theory of Fluids;—J. T. Mackay, a Comparative View of the more remarkable Plants which characterize the neighbourhood of Dublin and Edinburgh, and the South-west of Scotland, &c.;—J. T. Mackay, Comparative Geographical Notices of the more remarkable Plants which characterize Scotland and Ireland;—Report of the London Sub-Committee of the Medical Section on the Motions and Sounds of the Heart;—Second Report of the Dublin Sub-Committee on the Motions and Sounds of the Heart;—Report of the Dublin Committee on the Pathology of the Brain and Nervous System;—J. W. Lubbock, Account of the Recent Discussions of Observations of the Tides;—Rev. B. Powell, on determining the Refractive Indices for the Standard Rays of the Solar Spectrum in various media;—Dr. Hodgkin, on the Communication between the Arteries and Absorbents;—Prof. Phillips, Report of Experiments on Subterranean Temperature;—Prof. Hamilton, on the Validity of a Method recently proposed by G. B. Jerrard, for Transforming and Resolving Equations of Elevated Degrees.

Together with the Transactions of the Sections, Prof. Daubeny's Address, and Recommendations of the Association and its Committees.

PROCEEDINGS OF THE SEVENTH MEETING, at Liverpool, 1837, *Published at 16s. 6d.* (Out of Print.)

CONTENTS:—Major E. Sabine, on the Variations of the Magnetic Intensity observed at different points of the Earth's Surface;—Rev. W. Taylor, on the various modes of Printing for the Use of the Blind;—J. W. Lubbock, on the Discussions of Observations of the Tides;—Prof. T. Thompson, on the Difference between the Composition of Cast Iron produced by the Cold and Hot Blast;—Rev. T. R. Robinson, on the Determination of the Constant of Nutation by the Greenwich Observations;—R. W. Fox, Experiments on the Electricity of Metallic Veins, and the Temperature of Mines;—Provisional Report of the Committee of the Medical Section of the British Association, appointed to investigate the Composition of Secretions, and the Organs producing them;—Dr. G. O. Rees, Report from the Committee for inquiring into the Analysis of the Glands, &c., of the Human Body;—Second Report of the London Sub-Committee of the British Association Medical Section, on the Motions and Sounds of the Heart;—Prof. Johnston, on the Present State of our Knowledge in regard to Dimorphous Bodies;—Lieut.-Col. Sykes, on the Statistics of the four Collectorates of Dukhun, under the British Government;—E. Hodgkinson, on the relative Strength and other Mechanical Properties of Iron obtained from the Hot and Cold Blast;—W. Fairbairn, on the Strength and other Properties of Iron obtained from the Hot and Cold Blast;—Sir J. Robinson and J. S. Russell, Report of the Committee on Waves;—Note by Major Sabine, being an Appendix to his Report on the Variations of the Magnetic Intensity observed at different Points of the Earth's Surface;—J. Yates, on the Growth of Plants under Glass, and without any free communication with the outward Air, on the Plan of Mr. N. J. Ward, of London.

Together with the Transactions of the Sections, Prof. Traill's Address, and Recommendations of the Association and its Committees.

PROCEEDINGS OF THE EIGHTH MEETING, at Newcastle, 1838,
Published at 15s. (Out of Print.)

CONTENTS:—Rev. W. Whewell, Account of a Level Line, measured from the Bristol Channel to the English Channel, by Mr. Bunt;—Report on the Discussions of Tides, prepared under the direction of the Rev. W. Whewell;—W. S. Harris, Account of the Progress and State of the Meteorological Observations at Plymouth;—Major E. Sabine, on the Magnetic Isoclinal and Isodynamic Lines in the British Islands;—Dr. Lardner, on the Determination of the Mean Numerical Values of Railway Constants;—R. Mallet, First Report upon Experiments upon the Action of Sea and River Water upon Cast and Wrought Iron;—R. Mallet, on the Action of a Heat of 212° Fahr., when long continued, on Inorganic and Organic Substances.

Together with the Transactions of the Sections, Mr. Murchison's Address, and Recommendations of the Association and its Committees.

PROCEEDINGS OF THE NINTH MEETING, at Birmingham, 1839,
Published at 13s. 6d. (Out of Print.)

CONTENTS:—Rev. B. Powell, Report on the Present State of our Knowledge of Refractive Indices, for the Standard Rays of the Solar Spectrum in different media; Report on the Application of the Sum assigned for Tide Calculations to Rev. W. Whewell, in a letter from T. G. Bunt, Esq.;—H. L. Pattinson, on some Galvanic Experiments to determine the Existence or Non-Existence of Electrical Currents among Stratified Rocks, particularly those of the Mountain Limestone formation, constituting the Lead Measures of Alton Moor;—Sir D. Brewster, Reports respecting the Two Series of Hourly Meteorological Observations kept in Scotland;—Report on the subject of a series of Resolutions adopted by the British Association at their Meeting in August 1838, at Newcastle;—R. Owen, Report on British Fossil Reptiles;—E. Forbes, Report on the Distribution of the Pulmoniferous Mollusca in the British Isles;—W. S. Harris, Third Report on the Progress of the Hourly Meteorological Register at Plymouth Dockyard.

Together with the Transactions of the Sections, Rev. W. Vernon Harcourt's Address, and Recommendations of the Association and its Committees.

PROCEEDINGS OF THE TENTH MEETING, at Glasgow, 1840,
Published at 15s. (Out of Print.)

CONTENTS:—Rev. B. Powell, Report on the Recent Progress of discovery relative to Radiant Heat, supplementary to a former Report on the same subject inserted in the first volume of the Reports of the British Association for the Advancement of Science;—J. D. Forbes, Supplementary Report on Meteorology;—W. S. Harris, Report on Prof. Whewell's Anemometer, now in operation at Plymouth;—Report on 'The Motion and Sounds of the Heart,' by the London Committee of the British Association, for 1839-40;—Prof. Schönbein, an Account of Researches in Electro-Chemistry;—R. Mallet, Second Report upon the Action of Air and Water, whether fresh or salt, clear or foul, and at various temperatures, upon Cast Iron, Wrought Iron, and Steel;—R. W. Fox, Report on some Observations on Subterranean Temperature;—A. F. Osler, Report on the Observations recorded during the years 1837, 1838, 1839, and 1840, by the Self-registering Anemometer erected at the Philosophical Institution, Birmingham;—Sir D. Brewster, Report respecting the Two Series of Hourly Meteorological Observations kept at Inverness and Kingussie, from Nov. 1st, 1838, to Nov. 1st, 1839;—W. Thompson, Report on the Fauna of Ireland: Div. *Vertebrata*;—C. J. B. Williams, M.D., Report of Experiments on the Physiology of the Lungs and Air-Tubes;—Rev. J. S. Henslow, Report of the Committee on the Preservation of Animal and Vegetable Substances.

Together with the Transactions of the Sections, Mr. Murchison and Major E. Sabine's Address, and Recommendations of the Association and its Committees.

PROCEEDINGS OF THE ELEVENTH MEETING, at Plymouth,
1841, *Published at 13s. 6d.*

CONTENTS:—Rev. P. Kelland, on the Present State of our Theoretical and Experimental Knowledge of the Laws of Conduction of Heat;—G. L. Roupell, M.D.,

Report on Poisons;—T. G. Bunt, Report on Discussions of Bristol Tides, under the direction of the Rev. W. Whewell;—D. Ross, Report on the Discussions of Leith Tide Observations, under the direction of the Rev. W. Whewell;—W. S. Harris, upon the working of Whewell's Anemometer at Plymouth during the past year;—Report of a Committee appointed for the purpose of superintending the scientific co-operation of the British Association in the System of Simultaneous Observations in Terrestrial Magnetism and Meteorology;—Reports of Committees appointed to provide Meteorological Instruments for the use of M. Agassiz and Mr. M'Cord;—Report of a Committee appointed to superintend the Reduction of Meteorological Observations;—Report of a Committee for revising the Nomenclature of the Stars;—Report of a Committee for obtaining Instruments and Registers to record Shocks and Earthquakes in Scotland and Ireland;—Report of a Committee on the Preservation of Vegetative Powers in Seeds;—Dr. Hodgkin, on Inquiries into the Races of Man;—Report of the Committee appointed to report how far the Desiderata in our knowledge of the Condition of the Upper Strata of the Atmosphere may be supplied by means of Ascents in Balloons or otherwise, to ascertain the probable expense of such Experiments, and to draw up Directions for Observers in such circumstances;—R. Owen, Report on British Fossil Reptiles;—Reports on the Determination of the Mean Value of Railway Constants;—Dr. D. Lardner, Second and concluding Report on the Determination of the Mean Value of Railway Constants;—E. Woods, Report on Railway Constants;—Report of a Committee on the Construction of a Constant Indicator for Steam Engines.

Together with the Transactions of the Sections, Prof. Whewell's Address, and Recommendations of the Association and its Committees.

PROCEEDINGS OF THE TWELFTH MEETING, at Manchester, 1842, *Published at 10s. 6d.*

CONTENTS:—Report of the Committee appointed to conduct the co-operation of the British Association in the System of Simultaneous Magnetical and Meteorological Observations;—Dr. J. Richardson, Report on the present State of the Ichthyology of New Zealand;—W. S. Harris, Report on the Progress of Meteorological Observations at Plymouth;—Second Report of a Committee appointed to make Experiments on the Growth and Vitality of Seeds;—C. Vignoles, Report of the Committee on Railway Sections;—Report of the Committee for the Preservation of Animal and Vegetable Substances;—Dr. Lyon Playfair, Abstract of Prof. Liebig's Report on Organic Chemistry applied to Physiology and Pathology;—R. Owen, Report on the British Fossil Mammalia, Part I.;—R. Hunt, Researches on the Influence of Light on the Germination of Seeds and the Growth of Plants;—L. Agassiz, Report on the Fossil Fishes of the Devonian System or Old Red Sandstone;—W. Fairbairn, Appendix to a Report on the Strength and other Properties of Cast Iron obtained from the Hot and Cold Blast;—D. Milne, Report of the Committee for Registering Shocks of Earthquakes in Great Britain;—Report of a Committee on the construction of a Constant Indicator for Steam-Engines, and for the determination of the Velocity of the Piston of the Self-acting Engine at different periods of the Stroke;—J. S. Russell, Report of a Committee on the Form of Ships;—Report of a Committee appointed 'to consider of the Rules by which the Nomenclature of Zoology may be established on a uniform and permanent basis;—Report of a Committee on the Vital Statistics of Large Towns in Scotland;—Provisional Reports, and Notices of Progress in Special Researches entrusted to Committees and Individuals.

Together with the Transactions of the Sections, Lord Francis Egerton's Address, and Recommendations of the Association and its Committees.

PROCEEDINGS OF THE THIRTEENTH MEETING, at Cork, 1843, *Published at 12s.*

CONTENTS:—Robert Mallet, Third Report upon the Action of Air and Water, whether fresh or salt, clear or foul, and at Various Temperatures, upon Cast Iron, Wrought Iron, and Steel;—Report of the Committee appointed to conduct the Co-operation of the British Association in the System of Simultaneous Magnetical and Meteorological Observations;—Sir J. F. W. Herschel, Bart., Report of the Committee appointed for the Reduction of Meteorological Observations;—Report of the Committee appointed for Experiments on Steam-Engines;—Report of the Committee ap-

pointed to continue their Experiments on the Vitality of Seeds;—J. S. Russell, Report of a Series of Observations on the Tides of the Frith of Forth and the East Coast of Scotland;—J. S. Russell, Notice of a Report of the Committee on the Form of Ships;—J. Blake, Report on the Physiological Action of Medicines;—Report of the Committee on Zoological Nomenclature;—Report of the Committee for Registering the Shocks of Earthquakes, and making such Meteorological Observations as may appear to them desirable;—Report of the Committee for conducting Experiments with Captive Balloons;—Prof. Wheatstone, Appendix to the Report;—Report of the Committee for the Translation and Publication of Foreign Scientific Memoirs;—C. W. Peach, on the Habits of the Marine Testacea;—E. Forbes, Report on the Mollusca and Radiata of the Ægean Sea, and on their distribution, considered as bearing on Geology;—L. Agassiz, Synoptical Table of British Fossil Fishes, arranged in the order of the Geological Formations;—R. Owen, Report on the British Fossil Mammalia, Part II.;—E. W. Binney, Report on the excavation made at the junction of the Lower New Red Sandstone with the Coal Measures at Collyhurst;—W. Thompson, Report on the Fauna of Ireland: Div. *Invertebrata*;—Provisional Reports, and Notices of Progress in Special Researches entrusted to Committees and Individuals.

Together with the Transactions of the Sections, the Earl of Rosse's Address, and Recommendations of the Association and its Committees.

PROCEEDINGS OF THE FOURTEENTH MEETING, at York, 1844, *Published at £1.*

CONTENTS:—W. B. Carpenter, on the Microscopic Structure of Shells;—J. Alder and A. Hancock, Report on the British Nudibranchiate Mollusca;—R. Hunt, Researches on the Influence of Light on the Germination of Seeds and the Growth of Plants;—Report of a Committee appointed by the British Association in 1840, for revising the Nomenclature of the Stars;—Lieut.-Col. Sabine, on the Meteorology of Toronto in Canada;—J. Blackwall, Report on some recent researches into the Structure, Functions, and Economy of the *Araneidea* made in Great Britain;—Earl of Rosse, on the Construction of large Reflecting Telescopes;—Rev. W. V. Harcourt, Report on a Gas-furnace for Experiments on Vitrification and other Applications of High Heat in the Laboratory;—Report of the Committee for Registering Earthquake Shocks in Scotland;—Report of a Committee for Experiments on Steam-Engines;—Report of the Committee to investigate the Varieties of the Human Race;—Fourth Report of a Committee appointed to continue their Experiments on the Vitality of Seeds;—W. Fairbairn, on the Consumption of Fuel and the Prevention of Smoke;—F. Ronalds, Report concerning the Observatory of the British Association at Kew;—Sixth Report of the Committee appointed to conduct the Co-operation of the British Association in the System of Simultaneous Magnetical and Meteorological Observations;—Prof. Forchhammer on the influence of Fucoidal Plants upon the Formations of the Earth, on Metamorphism in general, and particularly the Metamorphosis of the Scandinavian Alum Slate;—H. E. Strickland, Report on the Recent Progress and Present State of Ornithology;—T. Oldham, Report of Committee appointed to conduct Observations on Subterranean Temperature in Ireland;—Prof. Owen, Report on the Extinct Mammals of Australia, and descriptions of certain Fossils indicative of the former existence in that continent of large Marsupial Representatives of the Order Pachydermata;—W. S. Harris, Report on the working of Whewell and Osler's Anemometers at Plymouth, for the years 1841, 1842, 1843;—W. R. Birt, Report on Atmospheric Waves;—L. Agassiz, Rapport sur les Poissons Fossiles de l'Argile de Londres, with translation;—J. S. Russell, Report on Waves;—Provisional Reports, and Notices of Progress in Special Researches entrusted to Committees and Individuals.

Together with the Transactions of the Sections, the Dean of Ely's Address, and Recommendations of the Association and its Committees.

PROCEEDINGS OF THE FIFTEENTH MEETING, at Cambridge, 1845, *Published at 12s.*

CONTENTS:—Seventh Report of a Committee appointed to conduct the Co-operation of the British Association in the System of Simultaneous Magnetical and Meteorological Observations;—Lieut.-Col. Sabine, on some Points in the Meteorology

of Bombay ;—J. Blake, Report on the Physiological Actions of Medicines ;—Dr. Von Boguslawski, on the Comet of 1843 ;—R. Hunt, Report on the Actinograph ;—Prof. Schönbein, on Ozone ;—Prof. Erman, on the Influence of Friction upon Thermo-Electricity ;—Baron Senftenberg, on the Self-registering Meteorological Instruments employed in the Observatory at Senftenberg ;—W. R. Birt, Second Report on Atmospheric Waves ;—G. R. Porter, on the Progress and Present Extent of Savings Banks in the United Kingdom ;—Prof. Bunsen and Dr. Playfair, Report on the Gases evolved from Iron Furnaces, with reference to the Theory of Smelting of Iron ;—Dr. Richardson, Report on the Ichthyology of the Seas of China and Japan ;—Report of the Committee on the Registration of Periodical Phenomena of Animals and Vegetables ;—Fifth Report of the Committee on the Vitality of Seeds ;—Appendix, &c.

Together with the Transactions of the Sections, Sir J. F. W. Herschel's Address, and Recommendations of the Association and its Committees.

PROCEEDINGS OF THE SIXTEENTH MEETING, at Southampton, 1846, *Published at 15s.*

CONTENTS :—G. G. Stokes, Report on Recent Researches in Hydrodynamics ;—Sixth Report of the Committee on the Vitality of Seeds ;—Dr. Schunck, on the Colouring Matters of Madder ;—J. Blake, on the Physiological Action of Medicines ;—R. Hunt, Report on the Actinograph ;—R. Hunt, Notices on the Influence of Light on the Growth of Plants ;—R. L. Ellis, on the Recent Progress of Analysis ;—Prof. Forchhammer, on Comparative Analytical Researches on Sea Water ;—A. Erman, on the Calculation of the Gaussian Constants for 1829 ;—G. R. Porter, on the Progress, present Amount, and probable future Condition of the Iron Manufacture in Great Britain ;—W. R. Birt, Third Report on Atmospheric Waves ;—Prof. Owen, Report on the Archetype and Homologies of the Vertebrate Skeleton ;—J. Phillips, on Anemometry ;—Dr. J. Percy, Report on the Crystalline Flags ;—Addenda to Mr. Birt's Report on Atmospheric Waves.

Together with the Transactions of the Sections, Sir R. I. Murchison's Address, and Recommendations of the Association and its Committees.

PROCEEDINGS OF THE SEVENTEENTH MEETING, at Oxford, 1847, *Published at 18s.*

CONTENTS :—Prof. Langberg, on the Specific Gravity of Sulphuric Acid at different degrees of dilution, and on the relation which exists between the Development of Heat and the coincident contraction of Volume in Sulphuric Acid when mixed with Water ;—R. Hunt, Researches on the Influence of the Solar Rays on the Growth of Plants ;—R. Mallet, on the Facts of Earthquake Phenomena ;—Prof. Nilsson, on the Primitive Inhabitants of Scandinavia ;—W. Hopkins, Report on the Geological Theories of Elevation and Earthquakes ;—Dr. W. B. Carpenter, Report on the Microscopic Structure of Shells ;—Rev. W. Whewell and Sir James C. Ross, Report upon the Recommendation of an Expedition for the purpose of completing our Knowledge of the Tides ;—Dr. Schunck, on Colouring Matters ;—Seventh Report of the Committee on the Vitality of Seeds ;—J. Glynn, on the Turbine or Horizontal Water-Wheel of France and Germany ;—Dr. R. G. Latham, on the present state and recent progress of Ethnographical Philology ;—Dr. J. C. Prichard, on the various methods of Research which contribute to the Advancement of Ethnology, and of the relations of that Science to other branches of Knowledge ;—Dr. C. C. J. Bunsen, on the results of the recent Egyptian researches in reference to Asiatic and African Ethnology, and the Classification of Languages ;—Dr. C. Meyer, on the Importance of the Study of the Celtic Language as exhibited by the Modern Celtic Dialects still extant ;—Dr. Max Müller, on the Relation of the Bengali to the Aryan and Aboriginal Languages of India ;—W. R. Birt, Fourth Report on Atmospheric Waves ;—Prof. W. H. Dove, Temperature Tables, with Introductory Remarks by Lieut.-Col. E. Sabine ;—A. Erman and H. Petersen, Third Report on the Calculation of the Gaussian Constants for 1829.

Together with the Transactions of the Sections, Sir Robert Harry Inglis's Address, and Recommendations of the Association and its Committees.

PROCEEDINGS OF THE EIGHTEENTH MEETING, at Swansea, 1848, *Published at 9s.*

CONTENTS:—Rev. Prof. Powell, A Catalogue of Observations of Luminous Meteors;—J. Glynn, on Water-pressure Engines;—R. A. Smith, on the Air and Water of Towns;—Eighth Report of Committee on the Growth and Vitality of Seeds;—W. R. Birt, Fifth Report on Atmospheric Waves;—E. Schunck, on Colouring Matters;—J. P. Budd, on the advantageous use made of the gaseous escape from the Blast Furnaces at the Ystalyfera Iron Works;—R. Hunt, Report of progress in the investigation of the Action of Carbonic Acid on the Growth of Plants allied to those of the Coal Formations;—Prof. H. W. Dove, Supplement to the Temperature Tables printed in the Report of the British Association for 1847;—Remarks by Prof. Dove on his recently constructed Maps of the Monthly Isothermal Lines of the Globe, and on some of the principal Conclusions in regard to Climatology deducible from them; with an introductory Notice by Lieut.-Col. E. Sabine;—Dr. Daubeny, on the progress of the investigation on the Influence of Carbonic Acid on the Growth of Ferns;—J. Phillips, Notice of further progress in Anemometrical Researches;—Mr. Mallet's Letter to the Assistant-General Secretary;—A. Erman, Second Report on the Gaussian Constants;—Report of a Committee relative to the expediency of recommending the continuance of the Toronto Magnetical and Meteorological Observatory until December 1850.

Together with the Transactions of the Sections, the Marquis of Northampton's Address, and Recommendations of the Association and its Committees.

PROCEEDINGS OF THE NINETEENTH MEETING, at Birmingham, 1849, *Published at 10s.*

CONTENTS:—Rev. Prof. Powell, A Catalogue of Observations of Luminous Meteors;—Earl of Rosse, Notice of Nebulæ lately observed in the Six-foot Reflector;—Prof. Daubeny, on the Influence of Carbonic Acid Gas on the health of Plants, especially of those allied to the Fossil Remains found in the Coal Formation;—Dr. Andrews, Report on the Heat of Combination;—Report of the Committee on the Registration of the Periodic Phenomena of Plants and Animals;—Ninth Report of Committee on Experiments on the Growth and Vitality of Seeds;—F. Ronalds, Report concerning the Observatory of the British Association at Kew, from Aug. 9, 1848 to Sept. 12, 1849;—R. Mallet, Report on the Experimental Inquiry on Railway Bar Corrosion;—W. R. Birt, Report on the Discussion of the Electrical Observations at Kew.

Together with the Transactions of the Sections, the Rev. T. R. Robinson's Address, and Recommendations of the Association and its Committees.

PROCEEDINGS OF THE TWENTIETH MEETING, at Edinburgh, 1850, *Published at 15s.* (Out of Print.)

CONTENTS:—R. Mallet, First Report on the Facts of Earthquake Phenomena;—Rev. Prof. Powell, on Observations of Luminous Meteors;—Dr. T. Williams, on the Structure and History of the British Annelida;—T. C. Hunt, Results of Meteorological Observations taken at St. Michael's from the 1st of January, 1840, to the 31st of December, 1849;—R. Hunt, on the present State of our Knowledge of the Chemical Action of the Solar Radiations;—Tenth Report of Committee on Experiments on the Growth and Vitality of Seeds;—Major-Gen. Briggs, Report on the Aboriginal Tribes of India;—F. Ronalds, Report concerning the Observatory of the British Association at Kew;—E. Forbes, Report on the Investigation of British Marine Zoology by means of the Dredge;—R. MacAndrew, Notes on the Distribution and Range in depth of Mollusca and other Marine Animals, observed on the coasts of Spain, Portugal, Barbary, Malta, and Southern Italy in 1849;—Prof. Allman, on the Present State of our Knowledge of the Freshwater Polyzoa;—Registration of the Periodical Phenomena of Plants and Animals;—Suggestions to Astronomers for the Observation of the Total Eclipse of the Sun on July 28, 1851.

Together with the Transactions of the Sections, Sir David Brewster's Address, and Recommendations of the Association and its Committees.

PROCEEDINGS OF THE TWENTY-FIRST MEETING, at Ipswich, 1851, *Published at 16s. 6d.*

CONTENTS:—Rev. Prof. Powell, on Observations of Luminous Meteors;—Eleventh Report of Committee on Experiments on the Growth and Vitality of Seeds;—Dr. J. Drew, on the Climate of Southampton;—Dr. R. A. Smith, on the Air and Water of Towns: Action of Porous Strata, Water, and Organic Matter;—Report of the Committee appointed to consider the probable Effects in an Economical and Physical Point of View of the Destruction of Tropical Forests;—A. Henfrey, on the Reproduction and supposed Existence of Sexual Organs in the Higher Cryptogamous Plants;—Dr. Daubeny, on the Nomenclature of Organic Compounds;—Rev. Dr. Donaldson, on two unsolved Problems in Indo-German Philology;—Dr. T. Williams, Report on the British Annelida;—R. Mallet, Second Report on the Facts of Earthquake Phenomena;—Letter from Prof. Henry to Col. Sabine, on the System of Meteorological Observations proposed to be established in the United States;—Col. Sabine, Report on the Kew Magnetographs;—J. Welsh, Report on the Performance of his three Magnetographs during the Experimental Trial at the Kew Observatory;—F. Ronalds, Report concerning the Observatory of the British Association at Kew, from September 12, 1850, to July 31, 1851;—Ordnance Survey of Scotland.

Together with the Transactions of the Sections, Prof. Airy's Address, and Recommendations of the Association and its Committees.

PROCEEDINGS OF THE TWENTY-SECOND MEETING, at Belfast, 1852, *Published at 15s.*

CONTENTS:—R. Mallet, Third Report on the Facts of Earthquake Phenomena;—Twelfth Report of Committee on Experiments on the Growth and Vitality of Seeds;—Rev. Prof. Powell, Report on Observations of Luminous Meteors, 1851-52;—Dr. Gladstone, on the Influence of the Solar Radiations on the Vital Powers of Plants;—A Manual of Ethnological Inquiry;—Col. Sykes, Mean Temperature of the Day, and Monthly Fall of Rain at 127 Stations under the Bengal Presidency;—Prof. J. D. Forbes, on Experiments on the Laws of the Conduction of Heat;—R. Hunt, on the Chemical Action of the Solar Radiations;—Dr. Hodges, on the Composition and Economy of the Flax Plant;—W. Thompson, on the Freshwater Fishes of Ulster;—W. Thompson, Supplementary Report on the Fauna of Ireland;—W. Wills, on the Meteorology of Birmingham;—J. Thomson, on the Vortex-Water-Wheel;—J. B. Lawes and Dr. Gilbert, on the Composition of Foods in relation to Respiration and the Feeding of Animals.

Together with the Transactions of the Sections, Colonel Sabine's Address, and Recommendations of the Association and its Committees.

PROCEEDINGS OF THE TWENTY-THIRD MEETING, at Hull, 1853, *Published at 10s. 6d.*

CONTENTS:—Rev. Prof. Powell, Report on Observations of Luminous Meteors, 1852-53;—James Oldham, on the Physical Features of the Humber;—James Oldham, on the Rise, Progress, and Present Position of Steam Navigation in Hull;—William Fairbairn, Experimental Researches to determine the Strength of Locomotive Boilers, and the causes which lead to Explosion;—J. J. Sylvester, Provisional Report on the Theory of Determinants;—Professor Hodges, M.D., Report on the Gases evolved in Steeping Flax, and on the Composition and Economy of the Flax Plant;—Thirteenth Report of Committee on Experiments on the Growth and Vitality of Seeds;—Robert Hunt, on the Chemical Action of the Solar Radiations;—Dr. John P. Bell, Observations on the Character and Measurements of Degradation of the Yorkshire Coast;—First Report of Committee on the Physical Character of the Moon's Surface, as compared with that of the Earth;—R. Mallet, Provisional Report on Earthquake Wave-Transits; and on Seismometrical Instruments;—William Fairbairn, on the Mechanical Properties of Metals as derived from repeated Meltings, exhibiting the maximum point of strength and the causes of deterioration;—Robert Mallet, Third Report on the Facts of Earthquake Phenomena (continued).

Together with the Transactions of the Sections, Mr. Hopkins's Address, and Recommendations of the Association and its Committees.

PROCEEDINGS OF THE TWENTY-FOURTH MEETING, at Liverpool, 1854, *Published at 18s.*

CONTENTS:—R. Mallet, Third Report on the Facts of Earthquake Phenomena (continued);—Major-General Chesney, on the Construction and General Use of Efficient Life-Boats;—Rev. Prof. Powell, Third Report on the present State of our Knowledge of Radiant Heat;—Colonel Sabine, on some of the results obtained at the British Colonial Magnetic Observatories;—Colonel Portlock, Report of the Committee on Earthquakes, with their proceedings respecting Seismometers;—Dr. Gladstone, on the Influence of the Solar Radiations on the Vital Powers of Plants, Part 2;—Rev. Prof. Powell, Report on Observations of Luminous Meteors, 1853-54;—Second Report of the Committee on the Physical Character of the Moon's Surface;—W. G. Armstrong, on the Application of Water-Pressure Machinery;—J. B. Lawes and Dr. Gilbert, on the Equivalency of Starch and Sugar in Food;—Archibald Smith, on the Deviations of the Compass in Wooden and Iron Ships;—Fourteenth Report of Committee on Experiments on the Growth and Vitality of Seeds.

Together with the Transactions of the Sections, the Earl of Harrowby's Address, and Recommendations of the Association and its Committees.

PROCEEDINGS OF THE TWENTY-FIFTH MEETING, at Glasgow, 1855, *Published at 15s.*

CONTENTS:—T. Dobson, Report on the Relation between Explosions in Coal-Mines and Revolving Storms;—Dr. Gladstone, on the Influence of the Solar Radiations on the Vital Powers of Plants growing under different Atmospheric Conditions, Part 3;—C. Spence Bate, on the British Edriophthalma;—J. F. Bateman, on the present state of our knowledge on the Supply of Water to Towns;—Fifteenth Report of Committee on Experiments on the Growth and Vitality of Seeds;—Rev. Prof. Powell, Report on Observations of Luminous Meteors, 1854-55;—Report of Committee appointed to inquire into the best means of ascertaining those properties of Metals and effects of various modes of treating them which are of importance to the durability and efficiency of Artillery;—Rev. Prof. Henslow, Report on Typical Objects in Natural History;—A. Follett Osler, Account of the Self-registering Anemometer and Rain-Gauge at the Liverpool Observatory;—Provisional Reports.

Together with the Transactions of the Sections, the Duke of Argyll's Address, and Recommendations of the Association and its Committees.

PROCEEDINGS OF THE TWENTY-SIXTH MEETING, at Cheltenham, 1856, *Published at 18s.*

CONTENTS:—Report from the Committee appointed to investigate and report upon the effects produced upon the Channels of the Mersey by the alterations which within the last fifty years have been made in its Banks;—J. Thomson, Interim Report on progress in Researches on the Measurement of Water by Weir Boards;—Dredging Report, Frith of Clyde, 1856;—Rev. B. Powell, Report on Observations of Luminous Meteors, 1855-1856;—Prof. Bunsen and Dr. H. E. Roscoe, Photochemical Researches;—Rev. James Booth, on the Trigonometry of the Parabola, and the Geometrical Origin of Logarithms;—R. MacAndrew, Report on the Marine Testaceous Mollusca of the North-east Atlantic and neighbouring Seas, and the physical conditions affecting their development;—P. P. Carpenter, Report on the present state of our knowledge with regard to the Mollusca of the West Coast of North America;—T. C. Eyton, Abstract of First Report on the Oyster Beds and Oysters of the British Shores;—Prof. Phillips, Report on Cleavage, and Foliation in Rocks, and on the Theoretical Explanations of these Phenomena, Part 1;—Dr. T. Wright, on the Stratigraphical Distribution of the Oolitic Echinodermata;—W. Fairbairn, on the Tensile Strength of Wrought Iron at various Temperatures;—C. Atherton, on Mercantile Steam Transport Economy;—J. S. Bowerbank, on the Vital Powers of the Spongiadæ;—Report of a Committee upon the Experiments conducted at Stormontfield, near Perth, for the artificial propagation of Salmon;—Provisional Report on the Measurement of Ships for Tonnage;—On Typical Forms of Minerals, Plants and Animals for Museums;—J. Thomson, Interim Report on Progress in Researches on the Measurement of Water by Weir Boards;—R. Mallet, on

Observations with the Seismometer;—A. Cayley, on the Progress of Theoretical Dynamics;—Report of a Committee appointed to consider the formation of a Catalogue of Philosophical Memoirs.

Together with the Transactions of the Sections, Dr. Daubeny's Address, and Recommendations of the Association and its Committees.

PROCEEDINGS OF THE TWENTY-SEVENTH MEETING, at Dublin, 1857, *Published at 15s.*

CONTENTS:—A. Cayley, Report on the recent progress of Theoretical Dynamics;—Sixteenth and Final Report of Committee on Experiments on the Growth and Vitality of Seeds;—James Oldham, C.E., continuation of Report on Steam Navigation at Hull;—Report of a Committee on the Defects of the present methods of Measuring and Registering the Tonnage of Shipping, as also of Marine Engine-Power, and to frame more perfect rules, in order that a correct and uniform principle may be adopted to estimate the Actual Carrying Capabilities and Working-power of Steam Ships;—Robert Were Fox, Report on the Temperature of some Deep Mines in Cornwall;—Dr. G. Plarr, de quelques Transformations de la Somme $\sum_{i=0}^{-a} \frac{a^i + 1\beta^i + 1\delta^i + 1}{1\epsilon + 1\gamma^i + 1\epsilon^i + 1}$ a étant entier négatif, et de quelques cas dans lesquels cette somme est exprimable par une combinaison de factorielles, la notation $a^i + 1$ désignant le produit des facteurs $a (a+1) (a+2) \&c. \dots (a+t-1)$;—G. Dickie, M.D., Report on the Marine Zoology of Strangford Lough, County Down, and corresponding part of the Irish Channel;—Charles Atherton, Suggestions for Statistical Inquiry into the Extent to which Mercantile Steam Transport Economy is affected by the Constructive Type of Shipping, as respects the Proportions of Length, Breadth, and Depth;—J. S. Bowerbank, Further Report on the Vitality of the Spongiadae;—Dr. John P. Hodges, on Flax;—Major-General Sabine, Report of the Committee on the Magnetic Survey of Great Britain;—Rev. Baden Powell, Report on Observations of Luminous Meteors, 1856–57;—C. Vignoles, on the Adaptation of Suspension Bridges to sustain the passage of Railway Trains;—Prof. W. A. Miller, on Electro-Chemistry;—John Simpson, Results of Thermometrical Observations made at the *Plover's* Wintering-place, Point Barrow, latitude $71^\circ 21' N.$, long. $156^\circ 17' W.$, in 1852–54;—Charles James Hargreave, on the Algebraic Couple; and on the Equivalents of Indeterminate Expressions;—Thomas Grubb, Report on the Improvement of Telescope and Equatorial Mountings;—Prof. James Buckman, Report on the Experimental Plots in the Botanical Garden of the Royal Agricultural College at Cirencester;—William Fairbairn, on the Resistance of Tubes to Collapse;—George C. Hyndman, Report of the Proceedings of the Belfast Dredging Committee;—Peter W. Barlow, on the Mechanical Effect of combining Girders and Suspension Chains, and a Comparison of the Weight of Metal in Ordinary and Suspension Girders, to produce equal deflections with a given load;—J. Park Harrison, Evidences of Lunar Influence on Temperature;—Report on the Animal and Vegetable Products imported into Liverpool from the years 1851 to 1855 (inclusive);—Andrew Henderson, Report on the Statistics of Life-boats and Fishing-boats on the Coasts of the United Kingdom.

Together with the Transactions of the Sections, the Rev. H. Lloyd's Address, and Recommendations of the Association and its Committees.

PROCEEDINGS OF THE TWENTY-EIGHTH MEETING, at Leeds, September 1858, *Published at 20s.*

CONTENTS:—R. Mallet, Fourth Report upon the Facts and Theory of Earthquake Phenomena;—Rev. Prof. Powell, Report on Observations of Luminous Meteors, 1857–1858;—R. H. Meade, on some Points in the Anatomy of the Araneidea or true Spiders, especially on the internal structure of their Spinning Organs;—W. Fairbairn, Report of the Committee on the Patent Laws;—S. Eddy, on the Lead Mining Districts of Yorkshire;—W. Fairbairn, on the Collapse of Glass Globes and Cylinders;—Dr. E. Perceval Wright and Prof. J. Reay Greene, Report on the Marine Fauna of the South and West Coasts of Ireland;—Prof. J. Thomson, on Experiments on the Measurement of Water by Triangular Notches in Weir Boards;—Major-General Sabine, Report of the Committee on the Magnetic Survey of Great Britain;—Michael Connel and William Keddie, Report on Animal, Vegetable, and Mineral Substances imported from Foreign Countries into the Clyde (including the Ports of Glasgow, Greenock,

and Port Glasgow) in the years 1853, 1854, 1855, 1856, and 1857;—Report of the Committee on Shipping Statistics;—Rev. H. Lloyd, D.D., Notice of the Instruments employed in the Magnetic Survey of Ireland, with some of the Results;—Prof. J. R. Kinahan, Report of Dublin Dredging Committee, appointed 1857–58;—Prof. J. R. Kinahan, Report on Crustacea of Dublin District;—Andrew Henderson, on River Steamers, their Form, Construction, and Fittings, with reference to the necessity for improving the present means of Shallow-Water Navigation on the Rivers of British India;—George C. Hyndman, Report of the Belfast Dredging Committee;—Appendix to Mr. Vignoles' Paper 'On the Adaptation of Suspension Bridges to sustain the passage of Railway Trains;'—Report of the Joint Committee of the Royal Society and the British Association, for procuring a continuance of the Magnetic and Meteorological Observatories;—R. Beckley, Description of a Self-recording Anemometer.

Together with the Transactions of the Sections, Prof. Owen's Address, and Recommendations of the Association and its Committees.

PROCEEDINGS OF THE TWENTY-NINTH MEETING, at Aberdeen, September 1859, *Published at 15s.*

CONTENTS:—George C. Foster, Preliminary Report on the Recent Progress and Present State of Organic Chemistry;—Professor Buckman, Report on the Growth of Plants in the Garden of the Royal Agricultural College, Cirencester;—Dr. A. Voelcker, Report on Field Experiments and Laboratory Researches on the Constituents of Manures essential to Cultivated Crops;—A. Thomson, of Banchoy, Report on the Aberdeen Industrial Feeding Schools;—On the Upper Silurians of Lesmahagow, Lanarkshire;—Alphonse Gages, Report on the Results obtained by the Mechanico-Chemical Examination of Rocks and Minerals;—William Fairbairn, Experiments to determine the Efficiency of Continuous and Self-acting Brakes for Railway Trains;—Professor J. R. Kinahan, Report of Dublin Bay Dredging Committee for 1858–59;—Rev. Baden Powell, Report on Observations of Luminous Meteors for 1858–59;—Professor Owen, Report on a Series of Skulls of various Tribes of Mankind inhabiting Nepal, collected, and presented to the British Museum, by Bryan H. Hodgson, Esq., late Resident in Nepal, &c. &c.;—Messrs. Maskelyne, Hadow, Hardwich, and Llewelyn, Report on the Present State of our Knowledge regarding the Photographic Image;—G. C. Hyndman, Report of the Belfast Dredging Committee for 1859;—James Oldham, Continuation of Report of the Progress of Steam Navigation at Hull;—Charles Atherton, Mercantile Steam Transport Economy as affected by the Consumption of Coals;—Warren De La Rue, Report on the present state of Celestial Photography in England;—Professor Owen, on the Orders of Fossil and Recent Reptilia, and their Distribution in Time;—Balfour Stewart, on some Results of the Magnetic Survey of Scotland in the years 1857 and 1858, undertaken, at the request of the British Association, by the late John Welsh, Esq., F.R.S.;—W. Fairbairn, The Patent Laws: Report of Committee on the Patent Laws;—J. Park Harrison, Lunar Influence on the Temperature of the Air;—Balfour Stewart, an Account of the Construction of the Self-recording Magnetographs at present in operation at the Kew Observatory of the British Association;—Professor H. J. Stephen Smith, Report on the Theory of Numbers, Part I.;—Report of the Committee on Steamship Performance;—Report of the Proceedings of the Balloon Committee of the British Association appointed at the Meeting at Leeds;—Prof. William K. Sullivan, Preliminary Report on the Solubility of Salts at Temperatures above 100° Cent., and on the Mutual Action of Salts in Solution.

Together with the Transactions of the Sections, Prince Albert's Address, and Recommendations of the Association and its Committees.

PROCEEDINGS OF THE THIRTIETH MEETING, at Oxford, June and July 1860, *Published at 15s.*

CONTENTS:—James Glaisher, Report on Observations of Luminous Meteors, 1859–60;—J. R. Kinahan, Report of Dublin Bay Dredging Committee;—Rev. J. Anderson, Report on the Excavations in Dura Den;—Prof. Buckman, Report on the Experimental Plots in the Botanical Garden of the Royal Agricultural College, Cirencester;—Rev. R. Walker, Report of the Committee on Balloon Ascents;—Prof. W. Thomson, Report of Committee appointed to prepare a Self-recording Atmo-

spheric Electrometer for Kew, and Portable Apparatus for observing Atmospheric Electricity;—William Fairbairn, Experiments to determine the Effect of Vibratory Action and long-continued Changes of Load upon Wrought-iron Girders;—R. P. Greg, Catalogue of Meteorites and Fireballs, from A.D. 2 to A.D. 1860;—Prof. H. J. S. Smith, Report on the Theory of Numbers, Part II.;—Vice-Admiral Moorsom, on the Performance of Steam-vessels, the Functions of the Screw, and the Relations of its Diameter and Pitch to the Form of the Vessel;—Rev. W. V. Harcourt, Report on the Effects of long-continued Heat, illustrative of Geological Phenomena;—Second Report of the Committee on Steamship Performance;—Interim Report on the Gauging of Water by Triangular Notches;—List of the British Marine Invertebrate Fauna.

Together with the Transactions of the Sections, Lord Wrottesley's Address, and Recommendations of the Association and its Committees.

PROCEEDINGS OF THE THIRTY-FIRST MEETING, at Manchester, September 1861, *Published at £1.*

CONTENTS:—James Glaisher, Report on Observations of Luminous Meteors;—Dr. E. Smith, Report on the Action of Prison Diet and Discipline on the Bodily Functions of Prisoners, Part I.;—Charles Atherton, on Freight as affected by Differences in the Dynamic Properties of Steamships;—Warren De La Rue, Report on the Progress of Celestial Photography since the Aberdeen Meeting;—B. Stewart, on the Theory of Exchanges, and its recent extension;—Drs. E. Schunck, R. Angus Smith, and H. E. Roscoe, on the Recent Progress and Present Condition of Manufacturing Chemistry in the South Lancashire District;—Dr. J. Hunt, on Ethno-Climatology; or, the Acclimatization of Man;—Prof. J. Thomson, on Experiments on the Gauging of Water by Triangular Notches;—Dr. A. Voelcker, Report on Field Experiments and Laboratory Researches on the Constituents of Manures essential to cultivated Crops;—Prof. H. Hennessy, Provisional Report on the Present State of our Knowledge respecting the Transmission of Sound-signals during Fogs at Sea;—Dr. P. L. Sclater and F. von Hochstetter, Report on the Present State of our Knowledge of the Birds of the Genus *Apteryx* living in New Zealand;—J. G. Jeffreys, Report of the Results of Deep-sea Dredging in Zetland, with a Notice of several Species of Mollusca new to Science or to the British Isles;—Prof. J. Phillips, Contributions to a Report on the Physical Aspect of the Moon;—W. R. Birt, Contribution to a Report on the Physical Aspect of the Moon;—Dr. Collingwood and Mr. Byerley, Preliminary Report of the Dredging Committee of the Mersey and Dee;—Third Report of the Committee on Steamship Performance;—J. G. Jeffreys, Preliminary Report on the Best Mode of preventing the Ravages of *Teredo* and other Animals in our Ships and Harbours;—R. Mallet, Report on the Experiments made at Holyhead to ascertain the Transit-Velocity of Waves, analogous to Earthquake Waves, through the local Rock Formations;—T. Dobson, on the Explosions in British Coal-Mines during the year 1859;—J. Oldham, Continuation of Report on Steam Navigation at Hull;—Prof. G. Dickie, Brief Summary of a Report on the Flora of the North of Ireland;—Prof. Owen, on the Psychical and Physical Characters of the Mincopies, or Natives of the Andaman Islands, and on the Relations thereby indicated to other Races of Mankind;—Colonel Sykes, Report of the Balloon Committee;—Major-General Sabine, Report on the Repetition of the Magnetic Survey of England;—Interim Report of the Committee for Dredging on the North and East Coasts of Scotland;—W. Fairbairn, on the Resistance of Iron Plates to Statical Pressure and the Force of Impact by Projectiles at High Velocities;—W. Fairbairn, Continuation of Report to determine the effect of Vibratory Action and long-continued Changes of Load upon Wrought-Iron Girders;—Report of the Committee on the Law of Patents;—Prof. H. J. S. Smith, Report on the Theory of Numbers, Part III.

Together with the Transactions of the Sections, Mr. Fairbairn's Address, and Recommendations of the Association and its Committees.

PROCEEDINGS OF THE THIRTY-SECOND MEETING at Cambridge, October 1862, *Published at £1.*

CONTENTS:—James Glaisher, Report on Observations of Luminous Meteors, 1861-62;—G. B. Airy, on the Strains in the Interior of Beams;—Archibald Smith and F. J. Evans, Report on the three Reports of the Liverpool Compass Committee;—Report on Tidal Observations on the Humber;—T. Aston, on Rifled Guns and Projectiles

adapted for Attacking Armour-plate Defences;—Extracts, relating to the Observatory at Kew, from a Report presented to the Portuguese Government, by Dr. J. A. de Souza;—H. T. Menzell, Report on the Dredging of the Northumberland Coast and Dogger Bank;—Dr. Cuthbert Collingwood, Report upon the best means of advancing Science through the agency of the Mercantile Marine;—Messrs. Williamson, Wheatstone, Thomson, Miller, Matthiessen, and Jenkin, Provisional Report on Standards of Electrical Resistance;—Preliminary Report of the Committee for investigating the Chemical and Mineralogical Composition of the Granites of Donegal;—Prof. H. Hennessy, on the Vertical Movements of the Atmosphere considered in connection with Storms and Changes of Weather;—Report of Committee on the application of Gauss's General Theory of Terrestrial Magnetism to the Magnetic Variations;—Fleeming Jenkin, on Thermo-electric Currents in Circuits of one Metal;—W. Fairbairn, on the Mechanical Properties of Iron Projectiles at High Velocities;—A. Cayley, Report on the Progress of the Solution of certain Special Problems of Dynamics;—Prof. G. G. Stokes, Report on Double Refraction;—Fourth Report of the Committee on Steamship Performance;—G. J. Symons, on the Fall of Rain in the British Isles in 1860 and 1861;—J. Ball, on Thermometric Observations in the Alps;—J. G. Jeffreys, Report of the Committee for Dredging on the North and East Coasts of Scotland;—Report of the Committee on Technical and Scientific Evidence in Courts of Law;—James Glaisher, Account of Eight Balloon Ascents in 1862;—Prof. H. J. S. Smith, Report on the Theory of Numbers, Part IV.

Together with the Transactions of the Sections, the Rev. Prof. R. Willis's Address, and Recommendations of the Association and its Committees.

PROCEEDINGS OF THE THIRTY-THIRD MEETING, at Newcastle-upon-Tyne, August and September 1863, *Published at £1 5s.*

CONTENTS:—Report of the Committee on the Application of Gun-cotton to War-like Purposes;—A. Matthiessen, Report on the Chemical Nature of Alloys;—Report of the Committee on the Chemical and Mineralogical Constitution of the Granites of Donegal, and on the Rocks associated with them;—J. G. Jeffreys, Report of the Committee appointed for exploring the Coasts of Shetland by means of the Dredge;—G. D. Gibb, Report on the Physiological Effects of the Bromide of Ammonium;—C. K. Aken, on the Transmutation of Spectral Rays, Part I.;—Dr. Robinson, Report of the Committee on Fog Signals;—Report of the Committee on Standards of Electrical Resistance;—E. Smith, Abstract of Report by the Indian Government on the Foods used by the Free and Jail Populations in India;—A. Gages, Synthetical Researches on the Formation of Minerals, &c.;—R. Mallet, Preliminary Report on the Experimental Determination of the Temperatures of Volcanic Foci, and of the Temperature, State of Saturation, and Velocity of the issuing Gases and Vapours;—Report of the Committee on Observations of Luminous Meteors;—Fifth Report of the Committee on Steamship Performance;—G. J. Allman, Report on the Present State of our Knowledge of the Reproductive System in the Hydroids;—J. Glaisher, Account of Five Balloon Ascents made in 1863;—P. P. Carpenter, Supplementary Report on the Present State of our Knowledge with regard to the Mollusca of the West Coast of North America;—Prof. Airy, Report on Steam Boiler Explosions;—C. W. Siemens, Observations on the Electrical Resistance and Electrification of some Insulating Materials under Pressures up to 300 Atmospheres;—C. M. Palmer, on the Construction of Iron Ships and the Progress of Iron Shipbuilding on the Tyne, Wear, and Tees;—Messrs. Richardson, Stevenson, and Clapham, on the Chemical Manufactures of the Northern Districts;—Messrs. Sopwith and Richardson, on the Local Manufacture of Lead, Copper, Zinc, Antimony, &c.;—Messrs. Daglish and Forster, on the Magnesian Limestone of Durham;—I. L. Bell, on the Manufacture of Iron in connexion with the Northumberland and Durham Coal-field;—T. Spencer, on the Manufacture of Steel in the Northern District;—Prof. H. J. S. Smith, Report on the Theory of Numbers, Part V.

Together with the Transactions of the Sections, Sir William Armstrong's Address, and Recommendations of the Association and its Committees.

PROCEEDINGS OF THE THIRTY-FOURTH MEETING, at Bath, September 1864, *Published at 18s.*

CONTENTS:—Report of the Committee for Observations of Luminous Meteors;—Report of the Committee on the best means of providing for a Uniformity of Weights

and Measures;—T. S. Cobbold, Report of Experiments respecting the Development and Migration of the Entozoa;—B. W. Richardson, Report on the Physiological Action of Nitrite of Amyl;—J. Oldham, Report of the Committee on Tidal Observations;—G. S. Brady, Report on Deep-sea Dredging on the Coasts of Northumberland and Durham in 1864;—J. Glaisher, Account of Nine Balloon Ascents made in 1863 and 1864;—J. G. Jeffreys, Further Report on Shetland Dredgings;—Report of the Committee on the Distribution of the Organic Remains of the North Staffordshire Coal-field;—Report of the Committee on Standards of Electrical Resistance;—G. J. Symons, on the Fall of Rain in the British Isles in 1862 and 1863;—W. Fairbairn, Preliminary Investigation of the Mechanical Properties of the proposed Atlantic Cable.

Together with the Transactions of the Sections, Sir Charles Lyell's Address, and Recommendations of the Association and its Committees.

PROCEEDINGS OF THE THIRTY-FIFTH MEETING, at Birmingham, September 1865, *Published at* £1 5s.

CONTENTS:—J. G. Jeffreys, Report on Dredging among the Channel Isles;—F. Buckland, Report on the Cultivation of Oysters by Natural and Artificial Methods;—Report of the Committee for exploring Kent's Cavern;—Report of the Committee on Zoological Nomenclature;—Report on the Distribution of the Organic Remains of the North Staffordshire Coal-field;—Report on the Marine Fauna and Flora of the South Coast of Devon and Cornwall;—Interim Report on the Resistance of Water to Floating and Immersed Bodies;—Report on Observations of Luminous Meteors;—Report on Dredging on the Coast of Aberdeenshire;—J. Glaisher, Account of Three Balloon Ascents;—Interim Report on the Transmission of Sound under Water;—G. J. Symons, on the Rainfall of the British Isles;—W. Fairbairn, on the Strength of Materials considered in relation to the Construction of Iron Ships;—Report of the Gun-Cotton Committee;—A. F. Osler, on the Horary and Diurnal Variations in the Direction and Motion of the Air at Wrottesley, Liverpool, and Birmingham;—B. W. Richardson, Second Report on the Physiological Action of certain of the Amyl Compounds;—Report on further Researches in the Lingula-flags of South Wales;—Report of the Lunar Committee for Mapping the Surface of the Moon;—Report on Standards of Electrical Resistance;—Report of the Committee appointed to communicate with the Russian Government respecting Magnetic Observations at Tiflis;—Appendix to Report on the Distribution of the Vertebrate Remains from the North Staffordshire Coal-field;—H. Woodward, First Report on the Structure and Classification of the Fossil Crustacea;—Prof. H. J. S. Smith, Report on the Theory of Numbers, Part VI.;—Report on the best means of providing for a Uniformity of Weights and Measures, with reference to the interests of Science:—A. G. Findlay, on the Bed of the Ocean;—Prof. A. W. Williamson, on the Composition of Gases evolved by the Bath Spring called King's Bath.

Together with the Transactions of the Sections, Prof. Phillips's Address, and Recommendations of the Association and its Committees.

PROCEEDINGS OF THE THIRTY-SIXTH MEETING, at Nottingham, August 1866, *Published at* £1 4s.

CONTENTS:—Second Report on Kent's Cavern, Devonshire;—A. Matthiessen, Preliminary Report on the Chemical Nature of Cast Iron;—Report on Observations of Luminous Meteors;—W. S. Mitchell, Report on the Alum Bay Leaf-bed;—Report on the Resistance of Water to Floating and Immersed Bodies;—Dr. Norris, Report on Muscular Irritability;—Dr. Richardson, Report on the Physiological Action of certain compounds of Amyl and Ethyl;—H. Woodward, Second Report on the Structure and Classification of the Fossil Crustacea;—Second Report on the 'Menevian Group,' and the other Formations at St. David's, Pembrokeshire;—J. G. Jeffreys, Report on Dredging among the Hebrides;—Rev. A. M. Norman, Report on the Coasts of the Hebrides, Part II.;—J. Alder, Notices of some Invertebrata, in connexion with Mr. Jeffreys's Report;—G. S. Brady, Report on the *Ostracoda* dredged amongst the Hebrides;—Report on Dredging in the Moray Firth;—Report on the Transmission of Sound-Signals under Water;—Report of the Lunar Committee;—Report of the Rainfall Committee;—Report on the best means of providing for a Uniformity of Weights and Measures, with reference to the Interests

of Science ;—J. Glaisher, Account of Three Balloon Ascents ;—Report on the Extinct Birds of the Mascarene Islands ;—Report on the Penetration of Ironclad Ships by Steel Shot ;—J. A. Wanklyn, Report on Isomerism among the Alcohols ;—Report on Scientific Evidence in Courts of Law ;—A. L. Adams, Second Report on Maltese Fossiliferous Caves, &c.

Together with the Transactions of the Sections, Mr. Grove's Address, and Recommendations of the Association and its Committees.

PROCEEDINGS OF THE THIRTY-SEVENTH MEETING, at Dundee, September 1867, Published at £1 6s.

CONTENTS:—Report of the Committee for Mapping the Surface of the Moon ;—Third Report on Kent's Cavern, Devonshire ;—On the present State of the Manufacture of Iron in Great Britain ;—Third Report on the Structure and Classification of the Fossil Crustacea ;—Report on the Physiological Action of the Methyl Compounds ;—Preliminary Report on the Exploration of the Plant-Beds of North Greenland ;—Report of the Steamship Performance Committee ;—On the Meteorology of Port Louis, in the Island of Mauritius ;—On the Construction and Works of the Highland Railway ;—Experimental Researches on the Mechanical Properties of Steel ;—Report on the Marine Fauna and Flora of the South Coast of Devon and Cornwall ;—Supplement to a Report on the Extinct Didine Birds of the Mascarene Islands ;—Report on Observations of Luminous Meteors ;—Fourth Report on Dredging among the Shetland Isles ;—Preliminary Report on the Crustacea, &c., procured by the Shetland Dredging Committee in 1867 ;—Report on the Foraminifera obtained in the Shetland Seas ;—Second Report of the Rainfall Committee ;—Report on the best means of providing for a Uniformity of Weights and Measures, with reference to the interests of Science ;—Report on Standards of Electrical Resistance.

Together with the Transactions of the Sections, and Recommendations of the Association and its Committees.

PROCEEDINGS OF THE THIRTY-EIGHTH MEETING, at Norwich, August 1868, Published at £1 5s.

CONTENTS:—Report of the Lunar Committee ;—Fourth Report on Kent's Cavern, Devonshire ;—On Puddling Iron ;—Fourth Report on the Structure and Classification of the Fossil Crustacea ;—Report on British Fossil Corals ;—Report on Spectroscopic Investigations of Animal Substances ;—Report of Steamship Performance Committee ;—Spectrum Analysis of the Heavenly Bodies ;—On Stellar Spectrometry ;—Report on the Physiological Action of the Methyl and allied Compounds ;—Report on the Action of Mercury on the Biliary Secretion ;—Last Report on Dredging among the Shetland Isles ;—Reports on the Crustacea, &c., and on the Annelida and Foraminifera from the Shetland Dredgings ;—Report on the Chemical Nature of Cast Iron, Part I. ;—Interim Report on the Safety of Merchant Ships and their Passengers ;—Report on Observations of Luminous Meteors ;—Preliminary Report on Mineral Veins containing Organic Remains ;—Report on the Desirability of Explorations between India and China ;—Report of Rainfall Committee ;—Report on Synthetical Researches on Organic Acids ;—Report on Uniformity of Weights and Measures ;—Report of the Committee on Tidal Observations ;—Report of the Committee on Underground Temperature ;—Changes of the Moon's Surface ;—Report on Polyatomic Cyanides.

Together with the Transactions of the Sections, Dr. Hooker's Address, and Recommendations of the Association and its Committees.

PROCEEDINGS OF THE THIRTY-NINTH MEETING, at Exeter, August 1869, Published at £1 2s.

CONTENTS:—Report on the Plant-beds of North Greenland ;—Report on the existing knowledge on the Stability, Propulsion, and Seagoing qualities of Ships ;—Report on Steam-boiler Explosions ;—Preliminary Report on the Determination of the Gases existing in Solution in Well-waters ;—The Pressure of Taxation on Real Property ;—On the Chemical Reactions of Light discovered by Prof. Tyndall ;—On Fossils obtained at Kiltorkan Quarry, co. Kilkenny ;—Report of the Lunar Com-

mittee ;—Report on the Chemical Nature of Cast Iron ;—Report on the Marine Fauna and Flora of the South Coast of Devon and Cornwall ;—Report on the Practicability of establishing a ‘Close Time’ for the Protection of Indigenous Animals ;—Experimental Researches on the Mechanical Properties of Steel ;—Second Report on British Fossil Corals ;—Report of the Committee appointed to get cut and prepared Sections of Mountain-Limestone Corals for Photographing ;—Report on the Rate of Increase of Underground Temperature ;—Fifth Report on Kent’s Cavern, Devonshire ;—Report on the Connexion between Chemical Constitution and Physiological Action ;—On Emission, Absorption, and Reflection of Obscure Heat ;—Report on Observations of Luminous Meteors ;—Report on Uniformity of Weights and Measures ;—Report on the Treatment and Utilization of Sewage ;—Supplement to Second Report of the Steamship-Performance Committee ;—Report on Recent Progress in Elliptic and Hyperelliptic Functions ;—Report on Mineral Veins in Carboniferous Limestone and their Organic Contents ;—Notes on the Foraminifera of Mineral Veins and the Adjacent Strata ;—Report of the Rainfall Committee ;—Interim Report on the Laws of the Flow and Action of Water containing Solid Matter in Suspension ;—Interim Report on Agricultural Machinery ;—Report on the Physiological Action of Methyl and Allied Series ;—On the Influence of Form considered in Relation to the Strength of Railway-axles and other portions of Machinery subjected to Rapid Alterations of Strain ;—On the Penetration of Armour-plates with Long Shells of Large Capacity fired obliquely ;—Report on Standards of Electrical Resistance.

Together with the Transactions of the Sections, Prof. Stokes’s Address, and Recommendations of the Association and its Committees.

PROCEEDINGS OF THE FORTIETH MEETING, at Liverpool, September 1870, *Published at 18s.*

CONTENTS :—Report on Steam-boiler Explosions ;—Report of the Committee on the Hæmatite Iron-ores of Great Britain and Ireland ;—Report on the Sedimentary Deposits of the River Onny ;—Report on the Chemical Nature of Cast Iron ;—Report on the practicability of establishing a ‘Close Time’ for the protection of Indigenous Animals ;—Report on Standards of Electrical Resistance ;—Sixth Report on Kent’s Cavern ;—Third Report on Underground Temperature ;—Second Report of the Committee appointed to get cut and prepared Sections of Mountain-Limestone Corals ;—Second Report on the Stability, Propulsion, and Seagoing Qualities of Ships ;—Report on Earthquakes in Scotland ;—Report on the Treatment and Utilization of Sewage ;—Report on Observations of Luminous Meteors, 1869–70 ;—Report on Recent Progress in Elliptic and Hyperelliptic Functions ;—Report on Tidal Observations ;—On a new Steam-power Meter ;—Report on the Action of the Methyl and Allied Series ;—Report of the Rainfall Committee ;—Report on the Heat generated in the Blood in the Process of Arterialization ;—Report on the best means of providing for Uniformity of Weights and Measures.

Together with the Transactions of the Sections, Prof. Huxley’s Address, and Recommendations of the Association and its Committees.

PROCEEDINGS OF THE FORTY-FIRST MEETING, at Edinburgh, August 1871, *Published at 16s.*

CONTENTS :—Seventh Report on Kent’s Cavern ;—Fourth Report on Underground Temperature ;—Report on Observations of Luminous Meteors, 1870–71 ;—Fifth Report on the Structure and Classification of the Fossil Crustacea ;—Report of the Committee appointed for the purpose of urging on Her Majesty’s Government the expediency of arranging and tabulating the results of the approaching Census in the three several parts of the United Kingdom in such a manner as to admit of ready and effective comparison ;—Report of the Committee appointed for the purpose of Superintending the Publication of Abstracts of Chemical Papers ;—Report of the Committee for discussing Observations of Lunar Objects suspected of change ;—Second Provisional Report on the Thermal Conductivity of Metals ;—Report on the Rainfall of the British Isles ;—Third Report on the British Fossil Corals ;—Report on the Heat generated in the Blood during the Process of Arterialization ;—Report of the Committee appointed to consider the subject of Physiological

Experimentation;—Report on the Physiological Action of Organic Chemical Compounds;—Report of the Committee appointed to get cut and prepared Sections of Mountain-Limestone Corals;—Second Report on Steam-Boiler Explosions;—Report on the Treatment and Utilization of Sewage;—Report on promoting the Foundation of Zoological Stations in different parts of the World;—Preliminary Report on the Thermal Equivalents of the Oxides of Chlorine;—Report on the practicability of establishing a 'Close Time' for the protection of Indigenous Animals;—Report on Earthquakes in Scotland;—Report on the best means of providing for a Uniformity of Weights and Measures;—Report on Tidal Observations.

Together with the Transactions of the Sections, Sir William Thomson's Address, and Recommendations of the Association and its Committees.

PROCEEDINGS OF THE FORTY-SECOND MEETING, at Brighton, August 1872, *Published at* £1 4s.

CONTENTS:—Report on the Gaussian Constants for the Year 1829;—Second Supplementary Report on the Extinct Birds of the Mascarene Islands;—Report of the Committee for Superintending the Monthly Reports of the Progress of Chemistry;—Report of the Committee on the best means of providing for a Uniformity of Weights and Measures;—Eighth Report on Kent's Cavern;—Report on promoting the Foundation of Zoological Stations in different parts of the World;—Fourth Report on the Fauna of South Devon;—Preliminary Report of the Committee appointed to Construct and Print Catalogues of Spectral Rays arranged upon a Scale of Wave-numbers;—Third Report on Steam-Boiler Explosions;—Report on Observations of Luminous Meteors, 1871-72;—Experiments on the Surface-friction experienced by a Plane moving through Water;—Report of the Committee on the Antagonism between the Action of Active Substances;—Fifth Report on Underground Temperature;—Preliminary Report of the Committee on Siemens's Electrical-Resistance Pyrometer;—Fourth Report on the Treatment and Utilization of Sewage;—Interim Report of the Committee on Instruments for Measuring the Speed of Ships and Currents;—Report on the Rainfall of the British Isles;—Report of the Committee on a Geographical Exploration of the Country of Moab;—*Sur l'élimination des Fonctions Arbitraires*;—Report on the Discovery of Fossils in certain remote parts of the North-western Highlands;—Report of the Committee on Earthquakes in Scotland;—Fourth Report on Carboniferous-Limestone Corals;—Report of the Committee to consider the mode in which new Inventions and Claims for Reward in respect of adopted Inventions are examined and dealt with by the different Departments of Government;—Report of the Committee for discussing Observations of Lunar Objects suspected of change;—Report on the Mollusca of Europe;—Report of the Committee for investigating the Chemical Constitution and Optical Properties of Essential Oils;—Report on the practicability of establishing a 'Close Time' for the preservation of Indigenous Animals;—Sixth Report on the Structure and Classification of Fossil Crustacea;—Report of the Committee appointed to organize an Expedition for observing the Solar Eclipse of Dec. 12, 1871;—Preliminary Report of a Committee on Terato-embryological Inquiries;—Report on Recent Progress in Elliptic and Hyperelliptic Functions;—Report on Tidal Observations;—On the Brighton Waterworks;—On Amsler's Planimeter.

Together with the Transactions of the Sections, Dr. Carpenter's Address, and Recommendations of the Association and its Committees.

PROCEEDINGS OF THE FORTY-THIRD MEETING, at Bradford, September 1873, *Published at* £1 5s.

CONTENTS:—Report of the Committee on Mathematical Tables;—Observations on the Application of Machinery to the Cutting of Coal in Mines;—Concluding Report on the Maltese Fossil Elephants;—Report of the Committee for ascertaining the Existence in different parts of the United Kingdom of any Erratic Blocks or Boulders;—Fourth Report on Earthquakes in Scotland;—Ninth Report on Kent's Cavern;—On the Flint and Chert Implements found in Kent's Cavern;—Report of the Committee for Investigating the Chemical Constitution and Optical Properties of Essential Oils;—Report of Inquiry into the Method of making Gold-assays; 1888.

—Fifth Report on the Selection and Nomenclature of Dynamical and Electrical Units;—Report of the Committee on the Labyrinthodonts of the Coal-measures;—Report of the Committee appointed to construct and print Catalogues of Spectral Rays;—Report of the Committee appointed to explore the Settle Caves;—Sixth Report on Underground Temperature;—Report on the Rainfall of the British Isles;—Seventh Report on Researches in Fossil Crustacea;—Report on Recent Progress in Elliptic and Hyperelliptic Functions;—Report on the desirability of establishing a ‘Close Time’ for the preservation of Indigenous Animals;—Report on Luminous Meteors;—On the Visibility of the Dark Side of Venus;—Report of the Committee for the Foundation of Zoological Stations in different parts of the World;—Second Report of the Committee for collecting Fossils from North-western Scotland;—Fifth Report on the Treatment and Utilization of Sewage;—Report of the Committee on Monthly Reports of the Progress of Chemistry;—On the Bradford Waterworks;—Report on the possibility of Improving the Methods of Instruction in Elementary Geometry;—Interim Report of the Committee on Instruments for Measuring the Speed of Ships, &c.;—Report of the Committee for Determinating High Temperatures by means of the Refrangibility of Light evolved by Fluid or Solid Substances;—On a Periodicity of Cyclones and Rainfall in connexion with Sunspot Periodicity;—Fifth Report on the Structure of Carboniferous-Limestone Corals;—Report of the Committee on preparing and publishing brief forms of Instructions for Travellers, Ethnologists, &c.;—Preliminary Note from the Committee on the Influence of Forests on the Rainfall;—Report of the Sub-Wealden Exploration Committee;—Report of the Committee on Machinery for obtaining a Record of the Roughness of the Sea and Measurement of Waves near shore;—Report on Science Lectures and Organization;—Second Report on Science Lectures and Organization.

Together with the Transactions of the Sections, Prof. A. W. Williamson’s Address, and Recommendations of the Association and its Committees.

PROCEEDINGS OF THE FORTY-FOURTH MEETING, at Belfast, August 1874, *Published at* £1 5s.

CONTENTS:—Tenth Report on Kent’s Cavern;—Report for investigating the Chemical Constitution and Optical Properties of Essential Oils;—Second Report of the Sub-Wealden Exploration Committee;—On the Recent Progress and Present State of Systematic Botany;—Report of the Committee for investigating the Nature of Intestinal Secretion;—Report of the Committee on the Teaching of Physics in Schools;—Preliminary Report for investigating Isomeric Cresols and their Derivatives;—Third Report of the Committee for collecting Fossils from localities in North-western Scotland;—Report on the Rainfall of the British Isles;—On the Belfast Harbour;—Report of Inquiry into the Method of making Gold-assays;—Report of a Committee on Experiments to determine the Thermal Conductivities of certain Rocks;—Second Report on the Exploration of the Settle Caves;—On the Industrial uses of the Upper Bann River;—Report of the Committee on the Structure and Classification of the Labyrinthodonts;—Second Report of the Committee for recording the position, height above the sea, lithological characters, size, and origin of the Erratic Blocks of England and Wales, &c.;—Sixth Report on the Treatment and Utilization of Sewage;—Report on the Anthropological Notes and Queries for the use of Travellers;—On Cyclone and Rainfall Periodicities;—Fifth Report on Earthquakes in Scotland;—Report of the Committee appointed to prepare and print Tables of Wave-numbers;—Report of the Committee for testing the new Pyrometer of Mr. Siemens;—Report to the Lords Commissioners of the Admiralty on Experiments for the Determination of the Frictional Resistance of Water on a Surface &c.;—Second Report for the Selection and Nomenclature of Dynamical and Electrical Units;—On Instruments for measuring the Speed of Ships;—Report of the Committee on the possibility of establishing a ‘Close Time’ for the Protection of Indigenous Animals;—Report of the Committee to inquire into the economic effects of Combinations of Labourers and Capitalists;—Preliminary Report on Dredging on the Coasts of Durham and North Yorkshire;—Report on Luminous Meteors;—Report on the best means of providing for a Uniformity of Weights and Measures.

Together with the Transactions of the Sections, Prof. John Tyndall’s Address, and Recommendations of the Association and its Committees.

PROCEEDINGS OF THE FORTY-FIFTH MEETING, at Bristol, August 1875, Published at £1 5s. (Out of Print.)

CONTENTS:—Eleventh Report on Kent's Cavern;—Seventh Report on Underground Temperature;—Report on the Zoological Station at Naples;—Report of a Committee appointed to inquire into the Methods employed in the Estimation of Potash and Phosphoric Acid in Commercial Products;—Report on the present state of our Knowledge of the Crustacea;—Second Report on the Thermal Conductivities of certain Rocks;—Preliminary Report of the Committee for extending the Observations on the Specific Volumes of Liquids;—Sixth Report on Earthquakes in Scotland;—Seventh Report on the Treatment and Utilization of Sewage;—Report of the Committee for furthering the Palestine Explorations;—Third Report of the Committee for recording the position, height above the sea, lithological characters, size, and origin of the Erratic Blocks of England and Wales, &c.;—Report of the Rainfall Committee;—Report of the Committee for investigating Isomeric Cresols and their Derivatives;—Report of the Committee for investigating the Circulation of the Underground Waters in the New Red Sandstone and Permian Formations of England;—On the Steering of Screw-Steamers;—Second Report of the Committee on Combinations of Capital and Labour;—Report on the Method of making Gold-assays;—Eighth Report on Underground Temperature;—Tides in the River Mersey;—Sixth Report of the Committee on the Structure of Carboniferous Corals;—Report of the Committee appointed to explore the Settle Caves;—On the River Avon (Bristol), its Drainage-Area, &c.;—Report of the Committee on the possibility of establishing a 'Close Time' for the Protection of Indigenous Animals;—Report of the Committee appointed to superintend the Publication of the Monthly Reports of the Progress of Chemistry;—Report on Dredging off the Coasts of Durham and North Yorkshire in 1874;—Report on Luminous Meteors;—On the Analytical Forms called Trees;—Report of the Committee on Mathematical Tables;—Report of the Committee on Mathematical Notation and Printing;—Second Report of the Committee for investigating Intestinal Secretion;—Third Report of the Sub-Wealden Exploration Committee.

Together with the Transactions of the Sections, Sir John Hawkshaw's Address, and Recommendations of the Association and its Committees.

PROCEEDINGS OF THE FORTY-SIXTH MEETING, at Glasgow, September 1876, Published at £1 5s.

CONTENTS:—Twelfth Report on Kent's Cavern;—Report on Improving the Methods of Instruction in Elementary Geometry;—Results of a Comparison of the British-Association Units of Electrical Resistance;—Third Report on the Thermal Conductivities of certain Rocks;—Report of the Committee on the practicability of adopting a Common Measure of Value in the Assessment of Direct Taxation;—Report of the Committee for testing experimentally Ohm's Law;—Report of the Committee on the possibility of establishing a 'Close Time' for the Protection of Indigenous Animals;—Report of the Committee on the Effect of Propellers on the Steering of Vessels;—On the Investigation of the Steering Qualities of Ships;—Seventh Report on Earthquakes in Scotland;—Report on the present state of our Knowledge of the Crustacea;—Second Report of the Committee for investigating the Circulation of the Underground Waters in the New Red Sandstone and Permian Formations of England;—Fourth Report of the Committee on the Erratic Blocks of England and Wales, &c.;—Fourth Report of the Committee on the Exploration of the Settle Caves (Victoria Cave);—Report on Observations of Luminous Meteors, 1875-76;—Report on the Rainfall of the British Isles, 1875-76;—Ninth Report on Underground Temperature;—Nitrous Oxide in the Gaseous and Liquid States;—Eighth Report on the Treatment and Utilization of Sewage;—Improved Investigations on the Flow of Water through Orifices, with Objections to the modes of treatment commonly adopted;—Report of the Anthropometric Committee;—On Cyclone and Rainfall Periodicities in connexion with the Sun-spot Periodicity;—Report of the Committee for determining the Mechanical Equivalent of Heat;—Report of the Committee on Tidal Observations;—Third Report of the Committee on the Conditions of Intestinal Secretion and Movement;—Report of the Committee for collecting and suggesting subjects for Chemical Research.

Together with the Transactions of the Sections, Dr. T. Andrews's Address, and Recommendations of the Association and its Committees.

PROCEEDINGS OF THE FORTY-SEVENTH MEETING, at Plymouth, August 1877, Published at £1 4s.

CONTENTS:—Thirteenth Report on Kent's Cavern;—Second and Third Reports on the Methods employed in the estimation of Potash and Phosphoric Acid in Commercial Products;—Report on the present state of our Knowledge of the Crustacea (Part III.);—Third Report on the Circulation of the Underground Waters in the New Red Sandstone and Permian Formations of England;—Fifth Report on the Erratic Blocks of England, Wales, and Ireland;—Fourth Report on the Thermal Conductivities of certain Rocks;—Report on Observations of Luminous Meteors, 1876–77;—Tenth Report on Underground Temperature;—Report on the Effect of Propellers on the Steering of Vessels;—Report on the possibility of establishing a 'Close Time' for the Protection of Indigenous Animals;—Report on some Double Compounds of Nickel and Cobalt;—Fifth Report on the Exploration of the Settle Caves (Victoria Cave);—Report on the Datum Level of the Ordnance Survey of Great Britain;—Report on the Zoological Station at Naples;—Report of the Anthropometric Committee;—Report on the Conditions under which Liquid Carbonic Acid exists in Rocks and Minerals.

Together with the Transactions of the Sections, Prof. Allen Thomson's Address and Recommendations of the Association and its Committees.

PROCEEDINGS OF THE FORTY-EIGHTH MEETING, at Dublin, August 1878, Published at £1 4s.

CONTENTS:—Catalogue of the Oscillation-Frequencies of Solar Rays;—Report on Mr. Babbage's Analytical Machine;—Third Report of the Committee for determining the Mechanical Equivalent of Heat;—Report of the Committee for arranging for the taking of certain Observations in India, and Observations on Atmospheric Electricity at Madeira;—Report on the commencement of Secular Experiments upon the Elasticity of Wires;—Report on the Chemistry of some of the lesser-known Alkaloids, especially Veratria and Bebeerine;—Report on the best means for the Development of Light from Coal-Gas;—Fourteenth Report on Kent's Cavern;—Report on the Fossils in the North-west Highlands of Scotland;—Fifth Report on the Thermal Conductivities of certain Rocks;—Report on the possibility of establishing a 'Close Time' for the Protection of Indigenous Animals;—Report on the occupation of a Table at the Zoological Station at Naples;—Report of the Anthropometric Committee;—Report on Patent Legislation;—Report on the Use of Steel for Structural Purposes;—Report on the Geographical Distribution of the Chiroptera;—Recent Improvements in the Port of Dublin;—Report on Mathematical Tables;—Eleventh Report on Underground Temperature;—Report on the Exploration of the Fermanagh Caves;—Sixth Report on the Erratic Blocks of England, Wales, and Ireland;—Report on the present state of our Knowledge of the Crustacea (Part IV.);—Report on two Caves in the neighbourhood of Tenby;—Report on the Stationary Tides in the English Channel and in the North Sea, &c.;—Second Report on the Datum-level of the Ordnance Survey of Great Britain;—Report on instruments for measuring the Speed of Ships;—Report of Investigations into a Common Measure of Value in Direct Taxation;—Report on Sunspots and Rainfall;—Report on Observations of Luminous Meteors;—Sixth Report on the Exploration of the Settle Caves (Victoria Cave);—Report on the Kentish Boring Exploration;—Fourth Report on the Circulation of Underground Waters in the Jurassic, New Red Sandstone, and Permian Formations, with an Appendix on the Filtration of Water through Triassic Sandstone;—Report on the Effect of Propellers on the Steering of Vessels.

Together with the Transactions of the Sections, Mr. Spottiswoode's Address, and Recommendations of the Association and its Committees.

PROCEEDINGS OF THE FORTY-NINTH MEETING, at Sheffield, August 1879, Published at £1 4s.

CONTENTS:—Report on the commencement of Secular Experiments upon the Elasticity of Wires;—Fourth Report of the Committee for determining the Mechanical Equivalent of Heat;—Report of the Committee for endeavouring to procure reports on the Progress of the Chief Branches of Mathematics and Physics;—Twelfth

Report on Underground Temperature;—Report on Mathematical Tables;—Sixth Report on the Thermal Conductivities of certain Rocks;—Report on Observations of Atmospheric Electricity at Madeira;—Report on the Calculation of Tables of the Fundamental Invariants of Algebraic Forms;—Report on the Calculation of Sun-Heat Coefficients;—Second Report on the Stationary Tides in the English Channel and in the North Sea, &c. ;—Report on Observations of Luminous Meteors;—Report on the question of Improvements in Astronomical Clocks;—Report of the Committee for improving an Instrument for detecting the presence of Fire-damp in Mines;—Report on the Chemistry of some of the lesser-known Alkaloids, especially Veratria and Beeberine;—Seventh Report on the Erratic Blocks of England, Wales, and Ireland;—Fifteenth Report on Kent's Cavern;—Report on certain Caves in Borneo;—Fifth Report on the Circulation of Underground Waters in the Jurassic, Red Sandstone, and Permian Formations of England;—Report on the Tertiary (Miocene) Flora, &c., of the Basalt of the North of Ireland;—Report on the possibility of Establishing a 'Close Time' for the Protection of Indigenous Animals;—Report on the Marine Zoology of Devon and Cornwall;—Report on the Occupation of a Table at the Zoological Station at Naples;—Report on Excavations at Portstewart and elsewhere in the North of Ireland;—Report of the Anthropometric Committee;—Report on the Investigation of the Natural History of Socotra;—Report on Instruments for measuring the Speed of Ships;—Third Report on the Datum-level of the Ordnance Survey of Great Britain;—Second Report on Patent Legislation;—On Self-acting Intermittent Siphons and the conditions which determine the commencement of their Action;—On some further Evidence as to the Range of the Palæozoic Rocks beneath the South-east of England;—Hydrography, Past and Present.

Together with the Transactions of the Sections, Prof. Allman's Address, and Recommendations of the Association and its Committees.

PROCEEDINGS OF THE FIFTIETH MEETING, at Swansea, August and September 1880, Published at £1 4s.

CONTENTS:—Report on the Measurement of the Lunar Disturbance of Gravity;—Thirteenth Report on Underground Temperature;—Report of the Committee for devising and constructing an improved form of High Insulation Key for Electrometer Work;—Report on Mathematical Tables;—Report on the Calculation of Tables of the Fundamental Invariants of Algebraic Forms;—Report on Observations of Luminous Meteors;—Report on the question of Improvements in Astronomical Clocks;—Report on the commencement of Secular Experiments on the Elasticity of Wires;—Sixteenth and concluding Report on Kent's Cavern;—Report on the mode of reproduction of certain species of Ichthyosaurus from the Lias of England and Würtemberg;—Report on the Carboniferous Polyzoa;—Report on the 'Geological Record';—Sixth Report on the Circulation of the Underground Waters in the Permian, New Red Sandstone, and Jurassic Formations of England, and the Quantity and Character of the Water supplied to towns and districts from these formations;—Second Report on the Tertiary (Miocene) Flora, &c., of the Basalt of the North of Ireland;—Eighth Report on the Erratic Blocks of England, Wales, and Ireland;—Report on an Investigation for the purpose of fixing a Standard of White Light;—Report of the Anthropometric Committee;—Report on the Influence of Bodily Exercise on the Elimination of Nitrogen;—Second Report on the Marine Zoology of South Devon;—Report on the Occupation of a Table at the Zoological Station at Naples;—Report on accessions to our knowledge of the Chiroptera during the past two years (1878-80);—Preliminary Report on the accurate measurement of the specific inductive capacity of a good Sprengel Vacuum, and the specific resistance of gases at different pressures;—Comparison of Curves of the Declination Magnetographs at Kew, Stonyhurst, Coimbra, Lisbon, Vienna, and St. Petersburg;—First Report on the Caves of the South of Ireland;—Report on the Investigation of the Natural History of Socotra;—Report on the German and other systems of teaching the Deaf to speak;—Report of the Committee for considering whether it is important that H.M. Inspectors of Elementary Schools should be appointed with reference to their ability for examining in the scientific specific subjects of the Code in addition to other matters;—On the Anthracite Coal and Coalfield of South Wales;—Report on the present state of our knowledge of Crustacea (Part V.);—Report on the best means for the Development of Light from Coal-gas of different qualities (Part II.);—Report

on Palæontological and Zoological Researches in Mexico;—Report on the possibility of establishing a 'Close Time' for Indigenous Animals;—Report on the present state of our knowledge of Spectrum Analysis;—Report on Patent Legislation;—Preliminary Report on the present Appropriation of Wages, &c.;—Report on the present state of knowledge of the application of Quadratures and Interpolation to Actual Data;—The French Deep-sea Exploration in the Bay of Biscay;—Third Report on the Stationary Tides in the English Channel and in the North Sea, &c.;—List of Works on the Geology, Mineralogy, and Palæontology of Wales (to the end of 1873);—On the recent Revival in Trade.

Together with the Transactions of the Sections, Dr. A. C. Ramsay's Address, and Recommendations of the Association and its Committees.

PROCEEDINGS OF THE FIFTY-FIRST MEETING, at York, August and September 1881, *Published at £1 4s.*

CONTENTS:—Report on the Calculation of Tables of the Fundamental Invariants of Algebraic Forms;—Report on Recent Progress in Hydrodynamics (Part I.);—Report on Meteoric Dust;—Second Report on the Calculation of Sun-heat Coefficients;—Fourteenth Report on Underground Temperature;—Report on the Measurement of the Lunar Disturbance of Gravity;—Second Report on an Investigation for the purpose of fixing a Standard of White Light;—Final Report on the Thermal Conductivities of certain Rocks;—Report on the manner in which Rudimentary Science should be taught, and how Examinations should be held therein, in Elementary Schools;—Third Report on the Tertiary Flora of the North of Ireland;—Report on the Method of Determining the Specific Refraction of Solids from their Solutions;—Fourth Report on the Stationary Tides in the English Channel and in the North Sea, &c.;—Second Report on Fossil Polyzoa;—Report on the Maintenance of the Scottish Zoological Station;—Report on the Occupation of a Table at the Zoological Station at Naples;—Report on the Migration of Birds;—Report on the Natural History of Socotra;—Report on the Natural History of Timor-laut;—Report on the Marine Fauna of the Southern Coast of Devon and Cornwall;—Report on the Earthquake Phenomena of Japan;—Ninth Report on the Erratic Blocks of England, Wales, and Ireland;—Second Report on the Caves of the South of Ireland;—Report on Patent Legislation;—Report on the Anthropometric Committee;—Report on the Appropriation of Wages, &c.;—Report on Observations of Luminous Meteors;—Report on Mathematical Tables;—Seventh Report on the Circulation of Underground Waters in the Jurassic, New Red Sandstone, and Permian Formations of England, and the Quality and Quantity of the Water supplied to Towns and Districts from these Formations;—Report on the present state of our Knowledge of Spectrum Analysis;—Interim Report of the Committee for constructing and issuing practical Standards for use in Electrical Measurements;—On some new Theorems on Curves of Double Curvature;—Observations of Atmospheric Electricity at the Kew Observatory during 1880;—On the Arrestation of Infusorial Life by Solar Light;—On the Effects of Oceanic Currents upon Climates;—On Magnetic Disturbances and Earth Currents;—On some Applications of Electric Energy to Horticultural and Agricultural purposes;—On the Pressure of Wind upon a Fixed Plane Surface;—On the Island of Socotra;—On some of the Developments of Mechanical Engineering during the last Half-Century.

Together with the Transactions of the Sections, Sir John Lubbock's Address, and Recommendations of the Association and its Committees.

REPORT OF THE FIFTY-SECOND MEETING, at Southampton, August 1882, *Published at £1 4s.*

CONTENTS:—Report on the Calculation of Tables of Fundamental Invariants of Binary Quantics;—Report (provisional) of the Committee for co-operating with the Meteorological Society of the Mauritius in their proposed publication of Daily Synoptic Charts of the Indian Ocean from the year 1861;—Report of the Committee appointed for fixing a Standard of White Light;—Report on Recent Progress in Hydrodynamics (Part II.);—Report of the Committee for constructing and issuing practical Standards for use in Electrical Measurements;—Fifteenth Report on Underground Temperature, with Summary of the Results contained in the Fifteen Reports

of the Underground Temperature Committee;—Report on Meteoric Dust;—Second Report on the Measurement of the Lunar Disturbance of Gravity;—Report on the present state of our Knowledge of Spectrum Analysis;—Report on the Investigation by means of Photography of the Ultra-Violet Spark Spectra emitted by Metallic Elements, and their combinations under varying conditions;—Report of the Committee for preparing a new Series of Tables of Wave-lengths of the Spectra of the Elements;—Report on the Methods employed in the Calibration of Mercurial Thermometers;—Second Report on the Earthquake Phenomena of Japan;—Eighth Report on the Circulation of the Underground Waters in the Permeable Formations of England, and the Quality and Quantity of the Water supplied to various Towns and Districts from these Formations;—Report on the Conditions under which ordinary Sedimentary Materials may be converted into Metamorphic Rocks;—Report on Explorations in Caves of Carboniferous Limestone in the South of Ireland;—Report on the Preparation of an International Geological Map of Europe;—Tenth Report on the Erratic Blocks of England, Wales, and Ireland;—Report on Fossil Polyzoa (Jurassic Species—British Area only);—Preliminary Report on the Flora of the 'Halifax Hard Bed,' Lower Coal Measures;—Report on the Influence of Bodily Exercise on the Elimination of Nitrogen;—Report of the Committee appointed for obtaining Photographs of the Typical Races in the British Isles;—Preliminary Report on the Ancient Earthwork in Epping Forest known as the Loughton Camp;—Second Report on the Natural History of Timor-laut;—Report of the Committee for carrying out the recommendations of the Anthropometric Committee of 1880, especially as regards the anthropometry of children and of females, and the more complete discussion of the collected facts;—Report on the Natural History of Socotra and the adjacent Highlands of Arabia and Somali Land;—Report on the Maintenance of the Scottish Zoological Station;—Report on the Migration of Birds;—Report on the Occupation of a Table at the Zoological Station at Naples;—Report on the Survey of Eastern Palestine;—Final Report on the Appropriation of Wages, &c.;—Report on the working of the revised New Code, and of other legislation affecting the teaching of Science in Elementary Schools;—Report on Patent Legislation;—Report of the Committee for determining a Gauge for the manufacture of various small Screws;—Report on the best means of ascertaining the Effective Wind Pressure to which buildings and structures are exposed;—On the Boiling Points and Vapour Tension of Mercury, of Sulphur, and of some Compounds of Carbon, determined by means of the Hydrogen Thermometer;—On the Method of Harmonic Analysis used in deducing the Numerical Values of the Tides of long period, and on a Misprint in the Tidal Report for 1872;—List of Works on the Geology and Palæontology of Oxfordshire, of Berkshire, and of Buckinghamshire;—Notes on the oldest Records of the Sea-Route to China from Western Asia;—The Deserts of Africa and Asia;—State of Crime in England, Scotland, and Ireland in 1880;—On the Treatment of Steel for the Construction of Ordnance, and other purposes;—The Channel Tunnel;—The Forth Bridge.

Together with the Transactions of the Sections, Dr. C. W. Siemens's Address, and Recommendations of the Association and its Committees.

REPORT OF THE FIFTY-THIRD MEETING, at Southport, September 1883, *Published at £1 4s.*

CONTENTS:—Report of the Committee for constructing and issuing practical Standards for use in Electrical Measurements;—Sixteenth Report on Underground Temperature;—Report on the best Experimental Methods that can be used in observing Total Solar Eclipses;—Report on the Harmonic Analysis of Tidal Observations;—Report of the Committee for co-operating with the Meteorological Society of the Mauritius in their proposed publication of Daily Synoptic Charts of the Indian Ocean from the year 1861;—Report on Mathematical Tables;—Report of the Committee for co-operating with the Scottish Meteorological Society in making Meteorological Observations on Ben Nevis;—Report on Meteoric Dust;—Report of the Committee appointed for fixing a Standard of White Light;—Report on Chemical Nomenclature;—Report on the investigation by means of Photography of the Ultra-Violet Spark Spectra emitted by Metallic Elements, and their combinations under varying conditions;—Report on Isomeric Naphthalene Derivatives;—Report on Explorations in Caves in the Carboniferous Limestone in the South of Ireland;—Report on the Exploration of Raygill Fissure, Yorkshire;—Eleventh Report on the

Erratic Blocks of England, Wales, and Ireland;—Ninth Report on the Circulation of the Underground Waters in the Permeable Formations of England, and the Quality and Quantity of the Water supplied to various Towns and Districts from these Formations;—Report on the Fossil Plants of Halifax;—Fourth Report on Fossil Polyzoa;—Fourth Report on the Tertiary Flora of the North of Ireland;—Report on the Earthquake Phenomena of Japan;—Report on the Fossil Phyllozoa of the Palæozoic Rocks;—Third Report on the Natural History of Timor Laut;—Report on the Natural History of Socotra and the adjacent Highlands of Arabia and Somali Land;—Report on the Exploration of Kilima-njaro and the adjoining mountains of Eastern Equatorial Africa;—Report on the Migration of Birds;—Report on the Maintenance of the Scottish Zoological Station;—Report on the Occupation of a Table at the Zoological Station at Naples;—Report on the Influence of Bodily Exercise on the Elimination of Nitrogen;—Report on the Ancient Earthwork in Epping Forest, known as the ‘Loughton’ or ‘Cowper’s’ Camp;—Final Report of the Anthropometric Committee;—Report of the Committee for defining the Facial Characteristics of the Races and Principal Crosses in the British Isles, and obtaining Illustrative Photographs;—Report on the Survey of Eastern Palestine;—Report on the workings of the proposed revised New Code, and of other legislation affecting the teaching of Science in Elementary Schools;—Report on Patent Legislation;—Report of the Committee for determining a Gauge for the manufacture of various small Screws;—Report of the ‘Local Scientific Societies’ Committee;—On some results of photographing the Solar Corona without an Eclipse;—On Lamé’s Differential Equation;—Recent Changes in the Distribution of Wealth in relation to the Incomes of the Labouring Classes;—On the Mersey Tunnel;—On Manganese Bronze;—Nest Gearing.

Together with the Transactions of the Sections, Professor Cayley’s Address, and Recommendations of the Association and its Committees.

REPORT OF THE FIFTY-FOURTH MEETING, at Montreal, August and September, 1884, *Published at 1l. 4s.*

CONTENTS:—Report of the Committee for considering and advising on the best means for facilitating the adoption of the Metric System of Weights and Measures in Great Britain;—Report of the Committee for considering the best methods of recording the direct intensity of Solar Radiation;—Report of the Committee for constructing and issuing practical Standards for use in Electrical Measurements;—Report of the Committee for co-operating with the Meteorological Society of the Mauritius, in their proposed publication of Daily Synoptic Charts of the Indian Ocean from the year 1861;—Second Report on the Harmonic Analysis of Tidal Observations;—Report of the Committee for co-operating with Mr. E. J. Lowe in his project of establishing a Meteorological Observatory near Chepstow on a permanent and scientific basis;—Report of the Committee for co-operating with the Directors of the Ben Nevis Observatory in making Meteorological Observations on Ben Nevis;—Report of the Committee for reducing and tabulating the Tidal Observations in the English Channel, made with the Dover Tide-gauge, and for connecting them with Observations made on the French Coast;—Fourth Report on Meteoric Dust;—Second Report on Chemical Nomenclature;—Report on Isomeric Naphthalene Derivatives;—Second Report on the Fossil Phyllozoa of the Palæozoic Rocks;—Tenth Report on the Circulation of Underground Waters in the Permeable Formations of England and Wales, and the Quantity and Character of the Water supplied to various Towns and Districts from these Formations;—Fifth and last Report on Fossil Polyzoa;—Twelfth Report on the Erratic Blocks of England, Wales, and Ireland;—Report upon the National Geological Surveys of Europe;—Report on the Rate of Erosion of the Sea-coasts of England and Wales, and the Influence of the Artificial Abstraction of Shingle or other material in that action;—Report on the Exploration of the Raygill Fissure in Lothersdale, Yorkshire;—Fourth Report on the Earthquake Phenomena of Japan;—Report on the occupation of a Table at the Zoological Station at Naples;—Fourth Report on the Natural History of Timor Laut;—Report on the Influence of Bodily Exercise on the Elimination of Nitrogen;—Report on the Migration of Birds;—Report on the Preparation of a Bibliography of certain groups of Invertebrata;—Report on the Exploration of Kilima-njaro, and the adjoining mountains of Eastern Equatorial Africa;—Report on the Survey of Eastern Palestine;—Report of the Committee for defraying the expenses of completing the Preparation of the final Report of the Anthropometric Committee;—Report on the

teaching of Science in Elementary Schools;—Report of the Committee for determining a Gauge for the manufacture of the various small Screws used in Telegraphic and Electrical Apparatus, in Clockwork, and for other analogous purposes;—Report on Patent Legislation;—Report of the Committee for defining the Facial Characteristics of the Races and Principal Crosses in the British Isles, and obtaining Illustrative Photographs with a view to their publication;—Report on the present state of our knowledge of Spectrum Analysis;—Report of the Committee for preparing a new series of Wave-length Tables of the Spectra of the Elements;—On the Connection between Sunspots and Terrestrial Phenomena;—On the Seat of the Electromotive Forces in the Voltaic Cell;—On the Archæan Rocks of Great Britain;—On the Concordance of the Mollusca inhabiting both sides of the North Atlantic and the intermediate Seas;—On the Characteristics of the North American Flora;—On the Theory of the Steam Engine;—Improvements in Coast Signals, with Supplementary Remarks on the New Eddystone Lighthouse;—On American Permanent Way.

Together with the Transactions of the Sections, Lord Rayleigh's Address, and Recommendations of the Association and its Committees.

REPORT OF THE FIFTY-FIFTH MEETING, at Aberdeen, September 1885, *Published at* £1 4s.

CONTENTS:—Report of the Committee for constructing and issuing practical Standards for use in Electrical Measurements;—Report of the Committee for promoting Tidal Observations in Canada;—Fifth Report on Meteoric Dust;—Third Report on the Harmonic Analysis of Tidal Observations;—Report of the Committee for co-operating with the Meteorological Society of the Mauritius in their proposed publication of Daily Synoptic Charts of the Indian Ocean from the year 1861;—Report of the Committee for reducing and tabulating the Tidal Observations in the English Channel, made with the Dover Tide-gauge, and for connecting them with Observations made on the French Coast;—Report on Standards of White Light;—Report of the Committee for co-operating with Mr. E. J. Lowe in his project of establishing a Meteorological Observatory near Chepstow on a permanent and scientific basis;—Report on the best means of Comparing and Reducing Magnetic Observations;—Report of the Committee for co-operating with the Scottish Meteorological Society in making Meteorological Observations on Ben Nevis;—Seventeenth Report on Underground Temperature;—Report on Electrical Theories;—Second Report of the Committee for considering the best methods of recording the direct intensity of Solar Radiation;—Report on Optical Theories;—Report of the Committee for investigating certain Physical Constants of Solution, especially the Expansion of Saline Solutions;—Third Report on Chemical Nomenclature;—Report of the Committee for the Investigation by means of Photography of the Ultra-Violet Spark Spectra emitted by Metallic Elements and their Combinations under varying conditions;—Report of the Committee for investigating the subject of Vapour Pressures and Refractive Indices of Salt Solutions;—Report of the Committee for preparing a new series of Wave-length Tables of the Spectra of the Elements and Compounds;—Thirteenth Report on the Erratic Blocks of England, Wales, and Ireland;—Third Report on the Fossil Phyllopora of the Palæozoic Rocks;—Fifth Report on the Earthquake Phenomena of Japan;—Eleventh Report on the Circulation of Underground Waters in the Permeable Formations of England and Wales, and the Quantity and Character of the Water supplied to various Towns and Districts from these Formations;—Report on the Volcanic Phenomena of Vesuvius;—Report on the Fossil Plants of the Tertiary and Secondary Beds of the United Kingdom;—Report on the Rate of Erosion of the Sea-coasts of England and Wales, and the Influence of the Artificial Abstraction of Shingle or other material in that action;—Report on the occupation of a Table at the Zoological Station at Naples;—Report of the Committee for promoting the Establishment of a Marine Biological Station at Granton, Scotland;—Report on the Aid given by the Dominion Government and the Government of the United States to the Encouragement of Fisheries, and to the Investigation of the various forms of Marine Life on the coasts and rivers of North America;—Report of the Committee for promoting the Establishment of Marine Biological Stations on the coast of the United Kingdom;—Report on recent Polyzoa;—Third Report on the Exploration of Kilima-njaro and the adjoining mountains of Equatorial Africa;—Report on the Migration of Birds;—Report of the Committee for furthering the

1888. 3 s

Exploration of New Guinea by making a grant to Mr. Forbes for the purposes of his Expedition;—Report of the Committee for furthering the Scientific Examination of the country in the vicinity of Mount Roraima in Guiana by making a grant to Mr. Everard F. im Thurn for the purposes of his Expedition;—Report of the Committee for promoting the Survey of Palestine;—Report on the Teaching of Science in Elementary Schools;—Report on Patent Legislation;—Report of the Committee for investigating and publishing reports on the physical characters, languages, and industrial and social condition of the North-Western Tribes of the Dominion of Canada;—Report of the Corresponding Societies Committee;—On Electrolysis;—A tabular statement of the dates at which, and the localities where Pumice or Volcanic Dust was seen in the Indian Ocean in 1883-4;—List of Works on the Geology, Mineralogy, and Palæontology of Staffordshire, Worcestershire, and Warwickshire;—On Slaty Cleavage and allied Rock-Structures, with special reference to the Mechanical Theories of their Origin;—On the Strength of Telegraph Poles;—On the Use of Index Numbers in the Investigation of Trade Statistics;—The Forth Bridge Works;—Electric Lighting at the Forth Bridge Works;—The New Tay Viaduct.

Together with the Transactions of the Sections, Sir Lyon Playfair's Address, and Recommendations of the Association and its Committees.

REPORT OF THE FIFTY-SIXTH MEETING, at Birmingham, September 1886, *Published at £1 4s.*

CONTENTS:—Report on Standards of Light;—Report of the Committee for preparing Instructions for the practical work of Tidal Observation, and Fourth Report on the Harmonic Analysis of Tidal Observations;—Report of the Committee for co-operating with the Scottish Meteorological Society in making Meteorological Observations on Ben Nevis;—Third Report on the best methods of recording the Direct Intensity of Solar Radiation;—Second Report on the best means of Comparing and Reducing Magnetic Observations;—First Report on our Experimental Knowledge of the Properties of Matter with respect to Volume, Pressure, Temperature, and Specific Heat;—Third Report of the Committee for co-operating with Mr. E. J. Lowe in his project of establishing a Meteorological Observatory near Chepstow on a permanent and scientific basis;—Report of the Committee for inviting designs for a good Differential Gravity Meter in supersession of the Pendulum;—Report of the Committee for constructing and issuing practical Standards for use in Electrical Measurements;—Second Report of the Committee for promoting Tidal Observations in Canada;—Report of the Committee for the reduction and tabulation of Tidal Observations in the English Channel, made with the Dover Tide-gauge, and for connecting them with Observations made on the French Coast;—Report of the Committee for preparing a new series of Wave-length Tables of the Spectra of the Elements;—Second Report of the Committee for investigating the subject of Vapour Pressures and Refractive Indices of Salt Solutions;—Second Report of the Committee for investigating certain Physical Constants of Solution, especially the Expansion of Saline Solutions;—Report (provisional) on the influence of the Silent Discharge of Electricity on Oxygen and other Gases;—Report on Isomeric Naphthalene Derivatives;—Report on the Exploration of the Caves of North Wales;—Fourteenth Report on the Erratic Blocks of England, Wales, and Ireland;—Report on the Volcanic Phenomena of Vesuvius and its neighbourhood;—Fourth Report on the Fossil Phyllopoda of the Palæozoic Rocks;—Twelfth Report on the Circulation of Underground Waters in the Permeable Formations of England and Wales, and the Quantity and Character of the Water supplied to various Towns and Districts from these Formations;—Second Report on the Fossil Plants of the Tertiary and Secondary Beds of the United Kingdom;—Report on the Mechanism of the Secretion of Urine;—Report of the Committee for promoting the establishment of a Marine Biological Station at Granton, Scotland;—Report on the occupation of a Table at the Zoological Station at Naples;—Report on the Migration of Birds;—Report of the Committee for continuing the Researches on Food-Fishes and Invertebrates at the St. Andrews Marine Laboratory;—Report on the Depth of the Permanently Frozen Soil in the Polar Regions, its Geographical Limits and relation to the Pole of greatest cold;—Report of the Committee for taking into consideration the Combination of the Ordnance and Admiralty Surveys, and the Production of a Bathy-hypsographical Map of the British Isles;—Report of the Committee for drawing attention to the desirability of further Research in the Antarctic Regions;—Report on the teaching of Science in Ele-

mentary Schools;—Report on the Regulation of Wages by means of Sliding Scales;—Report on the Endurance of Metals under repeated and varying Stresses, and the proper working Stresses on Railway Bridges and other structures subject to varying loads;—Report on the Prehistoric Race in the Greek Islands;—Report of the Committee for investigating and publishing reports on the physical characters, languages, and industrial and social condition of the North-western Tribes of the Dominion of Canada;—Report to the Council of the Corresponding Societies Committee;—Report on Electrolysis in its Physical and Chemical Bearings;—Sixth Report on the Volcanic Phenomena of Japan;—Second Report on the Rate of Erosion of the Sea-coasts of England and Wales, and the Influence of the Artificial Abstraction of Shingle or other Material in that action;—The Modern Development of Thomas Young's Theory of Colour-vision;—On the Explicit Form of the Complete Cubic Differential Resolvent;—On the Phenomena and Theories of Solution;—On the Exploration of the Raygill Fissure in Lothersdale, Yorkshire;—An Accurate and Rapid Method of estimating the Silica in an Igneous Rock:—On some Points for the Consideration of English Engineers with reference to the Design of Girder Bridges;—The Sphere and Roller Mechanism for Transmitting Power;—On Improvements in Electric Safety Lamps;—On the Birmingham, Tame, and Rea District Drainage.

Together with the Transactions of the Sections, Sir J. William Dawson's Address, and Recommendations of the Association and its Committees.

REPORT OF THE FIFTY-SEVENTH MEETING, at Manchester, August and September 1887, *Published at £1 4s.*

CONTENTS:—Third Report of the Committee for promoting Tidal Observations in Canada;—Fourth Report on the best methods of recording the direct Intensity of Solar Radiation;—Report of the Committee for co-operating with the Scottish Meteorological Society in making Meteorological Observations on Ben Nevis;—Fourth Report of the Committee for co-operating with Mr. E. J. Lowe in his project of establishing on a permanent and scientific basis a Meteorological Observatory near Chepstow;—Final Report of the Committee for co-operating with the Meteorological Society of the Mauritius in the publication of Daily Synoptic Charts of the Indian Ocean for the year 1861;—Second Report of the Committee for inviting designs for a good Differential Gravity Meter in supersession of the Pendulum;—Report on the desirability of combined action for the purpose of Translation of Foreign Memoirs;—Report on the Action of the Silent Discharge of Electricity on Oxygen and other Gases;—Report on the Influence of Silicon on the properties of Steel;—Third Report on Standards of Light;—Third Report on certain Physical Constants of Solution, especially the Expansion of Saline Solutions;—Report on the Nature of Solution;—Report on the Bibliography of Solution;—Report of the Committee for making arrangements for assisting the Marine Biological Association Laboratory at Plymouth;—Fifth Report on the Fossil Phyllozoa of the Palæozoic Rocks;—Report on the Migration of Birds;—Report on the Flora and Fauna of the Cameroons Mountain;—Report on the occupation of a Table at the Zoological Station at Naples;—Report of the Committee for aiding in the maintenance of the establishment of a Marine Biological Station at Granton, Scotland;—Report of the Committee for continuing the preparation of a Report on our present knowledge of the Flora of China;—Report on the question of accurately defining the term 'British' as applied to the Marine Fauna and Flora of our Islands;—Report of the Committee for taking steps for the establishment of a Botanical Station at Peradeniya, Ceylon;—Report on the Provincial Museums of the United Kingdom;—First Report on the Disappearance of Native Plants from their Local Habitats;—Report on the Mechanism of the Secretion of Urine;—Report on the Herds of Wild Cattle in Chartley Park and other parks in Great Britain;—Report on the Physiology of the Lymphatic System;—Report on the Depth of Permanently Frozen Soil in the Polar Regions, its Geographical Limits and relation to the present poles of greatest cold;—Report of the Committee for co-operating with the Royal Geographical Society in endeavouring to bring before the authorities of the Universities of Oxford and Cambridge the advisability of promoting the study of Geography by establishing special Chairs for the purpose;—Final Report of the Committee for considering the combination of the Ordnance and Admiralty Surveys, and the production of a Bathy-hypsographical Map of the British Islands;—Report on the teaching of Science in Elementary Schools;—Report on the Prehistoric Inhabitants of the British Islands;—Report of the Committee for editing

a new Edition of 'Anthropological Notes and Queries';—Third Report on the North-Western Tribes of the Dominion of Canada;—Second Report on the Prehistoric Race in the Greek Islands;—Report of the Committee for constructing and issuing practical Standards for use in Electrical Measurements;—Supplement to a Report on Optical Theories;—First Report on the 'Manure' Gravels of Wexford;—Seventh Report on the Volcanic Phenomena of Japan;—Report on the Volcanic Phenomena of Vesuvius and its neighbourhood;—Third Report on the Fossil Plants of the Tertiary and Secondary Beds of the United Kingdom;—Report on the Microscopical Examination of the Older Rocks of Anglesey;—Second Report on Isomeric Naphthalene Derivatives;—Report on the Carboniferous Flora of Halifax and its neighbourhood;—Fifteenth Report on the Erratic Blocks of England, Wales, and Ireland;—Report on the best methods of ascertaining and measuring Variations in the Value of the Monetary Standard;—Second Report on the Cae Gwynn Cave, North Wales;—Report on the Regulation of Wages by means of Lists in the Cotton Industry;—Third Report on the best means of comparing and reducing Magnetic Observations;—Second Report on Electrolysis in its Physical and Chemical Bearings;—Thirteenth Report on the Circulation of Underground Waters in the Permeable Formations of England and Wales, and the Quantity and Character of the Water supplied to various Towns and Districts from these Formations;—Report on the Higher Eocene Beds of the Isle of Wight;—Report on the Endurance of Metals under repeated and varying stresses, and the proper working stresses on Railway Bridges and other structures subject to varying loads;—Report of the Committee for procuring Racial Photographs from the Ancient Egyptian Pictures and Sculptures;—Report of the Corresponding Societies Committee;—On the Vortex Theory of the Luminiferous Æther;—On the Theory of Electric Endosmose and other Allied Phenomena, and on the Existence of a Sliding Coefficient for a Fluid in contact with a Solid;—Gold and Silver: their Geological Distribution and their Probable Future Production;—Recent Illustrations of the Theory of Rent, and their Effect on the Value of Land;—On certain Laws relating to the Régime of Rivers and Estuaries, and on the possibility of Experiments on a small scale;—Experiments on the Mechanical Equivalent of Heat on a large scale;—On an Electric Current Meter.

Together with the Transactions of the Sections, Sir H. E. Roscoe's Address, and Recommendations of the Association and its Committees.

BRITISH ASSOCIATION
FOR
THE ADVANCEMENT OF SCIENCE.

LIST
OF
OFFICERS, COUNCIL, AND MEMBERS,

CORRECTED TO FEBRUARY 1, 1889.

[*Office of the Association:—22 Albemarle Street, London, W.*]

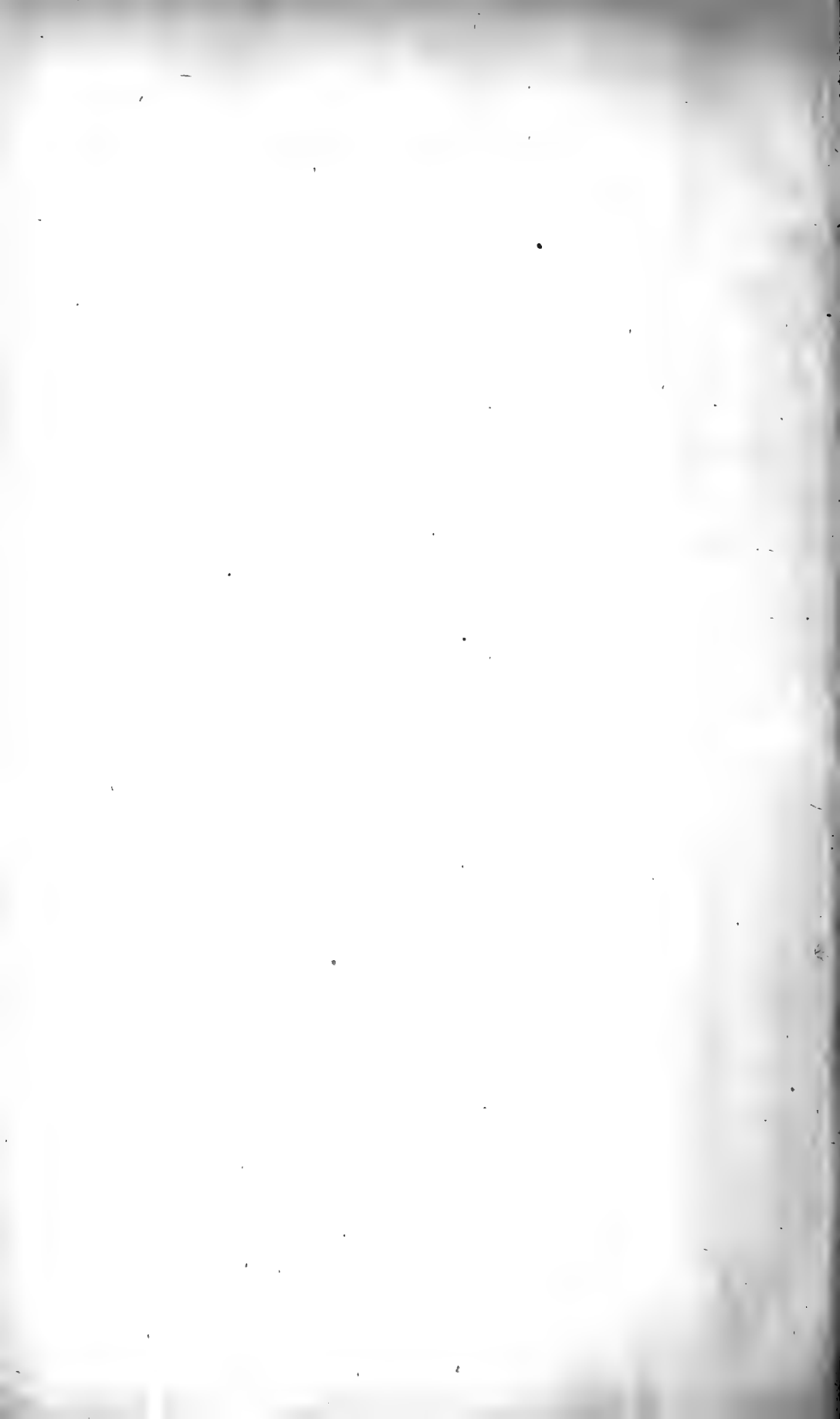

OFFICERS AND COUNCIL, 1888-89.

PRESIDENT.

SIR FREDERICK J. BRAMWELL, BART., D.C.L., F.R.S., M.INST.C.E.

VICE-PRESIDENTS.

The Right Hon. the EARL OF CORK AND ORRERY, K.P., Lord Lieutenant of Somerset.	The Rev. LEONARD BLOMEFIELD, M.A., F.L.S., F.G.S.
The Most Noble the MARQUIS OF BATH.	Professor MICHAEL FOSTER, M.A., M.D., LL.D., Sec.R.S., F.L.S., F.C.S.
The Right Hon. and Right Rev. the LORD BISHOP OF BATH AND WELLS, D.D.	W. S. GORE-LANGTON, Esq., J.P., D.L.
The Right Rev. the BISHOP OF CLIFTON.	H. D. SKRINE, Esq., J.P., D.L.
The Worshipful the MAYOR OF BATH.	Colonel R. P. LAURIE, C.B., M.P.
The Worshipful the MAYOR OF BRISTOL.	E. R. WODEHOUSE, Esq., M.P.
Sir F. A. ABEL, C.B., D.C.L., F.R.S., V.P.C.S.	JEROM MURCH, Esq., J.P., D.L.
The Venerable the ARCHDEACON OF BATH.	

PRESIDENT ELECT.

PROFESSOR WILLIAM HENRY FLOWER, C.B., LL.D., F.R.S., F.R.C.S., Pres.Z.S., F.L.S., F.G.S.
Director of the Natural History Departments of the British Museum.

VICE-PRESIDENTS ELECT.

His Grace the DUKE OF NORTHUMBERLAND, K.G., D.C.L., LL.D., Lord-Lieutenant of Northum- berland.	The Very Rev. the WARDEN of the University of Durlham, D.D.
The Right Hon. the EARL OF DURHAM, Lord Lieutenant of Durham.	The Worshipful the MAYOR OF NEWCASTLE.
The Right Hon. the EARL OF RAVENSWORTH.	The Worshipful the MAYOR OF GATESHEAD.
The Right Rev. the LORD BISHOP OF NEWCASTLE, D.D.	Sir I. LOWTHIAN BELL, Bart., F.R.S., F.C.S., M.Inst.C.E.
The Right Hon. Lord ARMSTRONG, C.B., D.C.L., LL.D., F.R.S.	Sir CHARLES MARK PALMER, Bart., M.P. (<i>nomi- nated by the Council</i>).
	The Right Hon. JOHN MORLEY, LL.D., M.P.

LOCAL SECRETARIES FOR THE MEETING AT NEWCASTLE-UPON-TYNE.

Professor P. P. BEDSON, D.Sc., F.C.S. | Professor J. H. MERIVALE, M.A. | HOWARD PEASE, Esq.

LOCAL TREASURER FOR THE MEETING AT NEWCASTLE-ON-TYNE.

THOMAS HODGKIN, Esq.

ORDINARY MEMBERS OF THE COUNCIL.

ARNEY, Capt. W. De W., C.B., F.R.S.	M'LEOD, Professor H., F.R.S.
BALL, Sir R. S., F.R.S.	MARTIN, J. B., Esq., F.S.S.
BARLOW, W. H. Esq., F.R.S.	OMMANNEY, Admiral Sir E. C.B., F.R.S.
BLANFORD, W. T. Esq., F.R.S.	PREECE, W. H., Esq., F.R.S.
CROOKES, W., Esq., F.R.S.	ROBERTS-AUSTEN, Professor W. C., F.R.S.
DARWIN, Professor G. H., F.R.S.	RÜCKER, Professor E. A., F.R.S.
DOUGLASS, Sir J. N., F.R.S.	SCHÄFER, Professor E. A., F.R.S.
GAMGEE, Dr. A., F.R.S.	SCHUSTER, Professor A., F.R.S.
GEIKIE, Dr. A., F.R.S.	SIDGWICK, Professor H., M.A.
GODWIN-AUSTEN, Lieut.-Col. H. H., F.R.S.	THISELTON-DYER, W. T., Esq., C.M.G., F.R.S.
HENRICI, Professor O., F.R.S.	THORPE, Professor T. E., F.R.S.
JUDD, Professor J. W., F.R.S.	WOODWARD, Dr. H., F.R.S.
LIVEING, Professor G. D., F.R.S.	

GENERAL SECRETARIES.

Capt. Sir DOUGLAS GALTON, K.C.B., D.C.L., LL.D., F.R.S., F.G.S., 12 Chester Street, London, S.W.
A. G. VERNON HARCOURT, Esq., M.A., LL.D., F.R.S., F.C.S., Cowley Grange, Oxford.

SECRETARY.

ARTHUR T. ATCHISON, Esq., M.A., 22 Albemarle Street, London, W.

GENERAL TREASURER.

Professor A. W. WILLIAMSON, Ph.D., LL.D., F.R.S., F.C.S., 17 Buckingham-street, London, W.C.

EX-OFFICIO MEMBERS OF THE COUNCIL.

The Trustees, the President and President Elect, the Presidents of former years, the Vice-Presidents and Vice-Presidents Elect, the General and Assistant General Secretaries for the present and former years, the Secretary, the General Treasurers for the present and former years, and the Local Treasurer and Secretaries for the ensuing Meeting.

TRUSTEES (PERMANENT).

Sir JOHN LUBBOCK, Bart., M.P., D.C.L., LL.D., F.R.S., Pres.L.S.
The Right Hon. Lord RAYLEIGH, M.A., D.C.L., LL.D., Sec.R.S., F.R.A.S.
The Right Hon. Sir LYON PLAYFAIR, K.C.B., M.P., Ph.D., LL.D., F.R.S.

PRESIDENTS OF FORMER YEARS.

The Duke of Devonshire, K.G.	Prof. Stokes, D.C.L., Pres.R.S.	Sir A. C. Ramsay, LL.D., F.R.S.
Sir G. B. Airy, K.C.B., F.R.S.	Prof. Huxley, LL.D., F.R.S.	Sir John Lubbock, Bart., F.R.S.
The Duke of Argyll, K.G., K.T.	Prof. Sir Wm. Thomson, LL.D.	Prof. Cayley, LL.D., F.R.S.
Sir Richard Owen, K.C.B., F.R.S.	Prof. Williamson, Ph.D., F.R.S.	Lord Rayleigh, D.C.L., Sec.R.S.
Lord Armstrong, C.B., LL.D.	Prof. Tyndall, D.C.L., F.R.S.	Sir Lyon Playfair, K.C.B.
Sir William R. Grove, F.R.S.	Sir John Hawkshaw, F.R.S.	Sir Wm. Dawson, C.M.G., F.R.S.
Sir Joseph D. Hooker, K.C.S.I.	Prof. Allman, M.D., F.R.S.	Sir H. E. Roscoe, F.R.S.

GENERAL OFFICERS OF FORMER YEARS.

F. Galton, Esq., F.R.S.	Dr. Michael Foster, Sec.R.S.	P. L. Sclater, Esq., Ph.D., F.R.S.
Dr. T. A. Hirst, F.R.S.	George Griffith, Esq., M.A., F.C.S.	Prof. Bonney, D.Sc., F.R.S.

AUDITORS.

Dr. W. H. Perkin, F.R.S.	Dr. John Evans, F.R.S.	Dr. J. H. Gladstone, F.R.S.
--------------------------	------------------------	-----------------------------

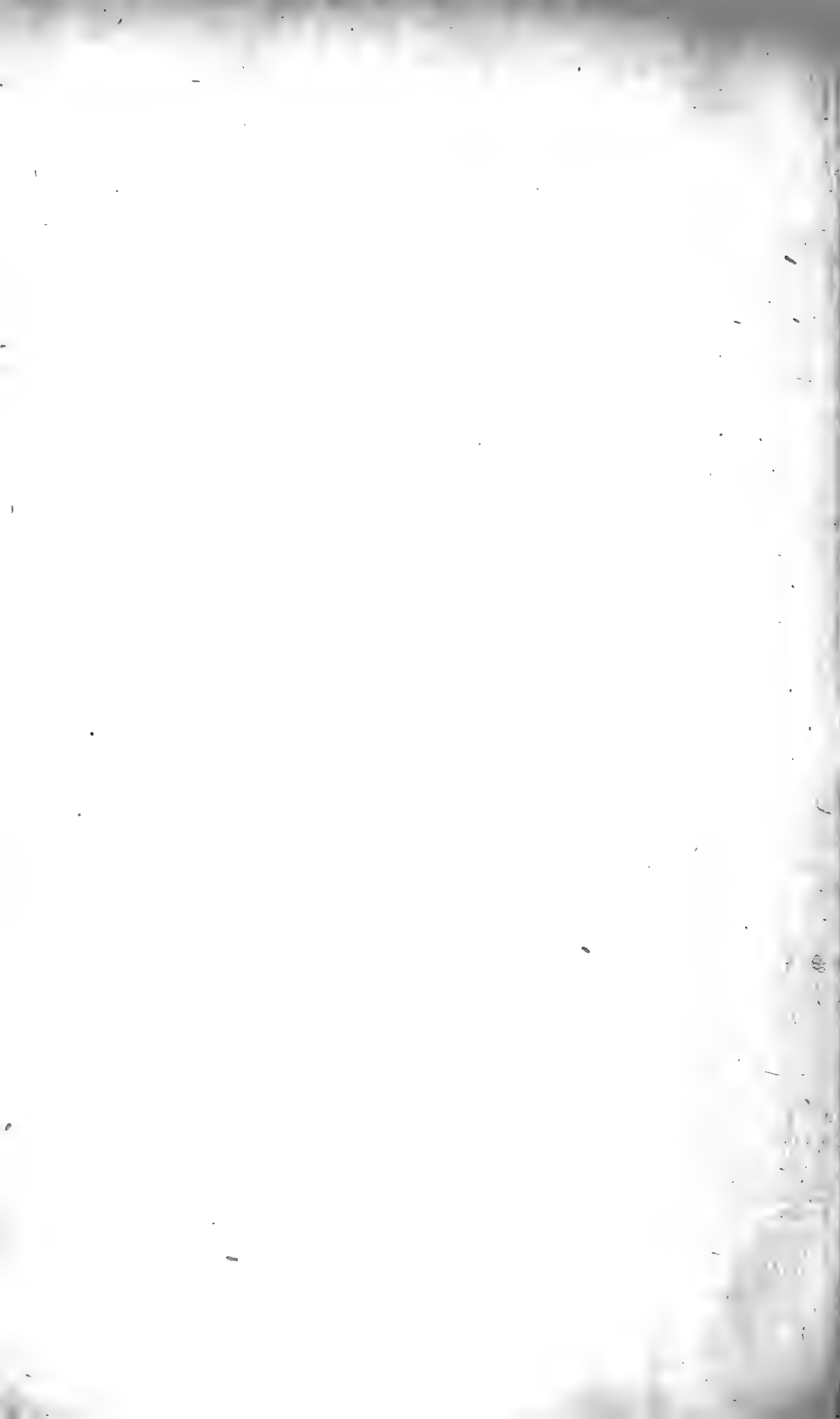

LIST OF MEMBERS

OF THE

BRITISH ASSOCIATION FOR THE ADVANCEMENT OF SCIENCE.

1889.

- * indicates Life Members entitled to the Annual Report.
§ indicates Annual Subscribers entitled to the Annual Report.
† indicates Subscribers not entitled to the Annual Report.
Names without any mark before them are Life Members not entitled to the Annual Report.
Names of Members of the GENERAL COMMITTEE are printed in SMALL CAPITALS.
Names of Members whose addresses are incomplete or not known are in *italics*.
-

Notice of changes of residence should be sent to the Secretary, 22 Albemarle Street, London, W.

Year of
Election.

1887. *Abbe, Cleveland. Weather Bureau, Army Signal Office, Washington, U.S.A.
1881. *Abbott, R. T. G. Quarry Cottage, Norton, Malton.
1887. †Abbott, T. C. Eastleigh, Queen's-road, Bowdon, Cheshire.
1863. *ABEL, Sir FREDERICK AUGUSTUS, C.B., D.C.L., F.R.S., F.C.S., President of the Government Committee on Explosives. Royal Arsenal, Woolwich.
1856. †Abercrombie, John, M.D. 39 Welbeck-street, London, W.
1886. §ABERCROMBY, The Hon. RALPH, F.R.Met.Soc. 21 Chapel-street, Belgrave-square, London, S.W.
1885. *ABERDEEN, The Right Hon. the Earl of, LL.D. 37 Grosvenor-square, London, W.
1885. †Aberdeen, The Countess of. 37 Grosvenor-square, London, W.
1885. †Abernethy, David W. Ferryhill Cottage, Aberdeen.
1863. *ABERNETHY, JAMES, M.Inst.C.E., F.R.S.E. 4 Delahay-street, Westminster, S.W.
1885. †Abernethy, James W. 2 Rubislaw-place, Aberdeen.
1873. *ABNEY, Captain W. DE W., R.E., C.B., F.R.S., F.R.S.E., F.R.A.S., F.C.S. Willeslie House, Wetherby-road, South Kensington, London, S.W.

- Year of
Election.
1886. §Abraham, Harry. 147 High-street, Southampton.
1877. †Ace, Rev. Daniel, D.D., F.R.A.S. Laughton, near Gainsborough,
Lincolnshire.
1884. †Achison, George. Collegiate Institute, Toronto, Canada.
1873. †Ackroyd, Samuel. Greaves-street, Little Horton, Bradford, York-
shire.
1882. *Acland, Alfred Dyke. Oxford.
1869. †Acland, Charles T. D., M.P. Sprydoncote, Exeter.
1877. *Acland, Captain Francis E. Dyke, R.A. School of Gunnery, Shoe-
buryness.
1873. *Acland, Rev. H. D., M.A. Nymet St. George, South Molton, Devon.
1873. *ACLAND, Sir HENRY W. D., K.C.B., M.A., M.D., LL.D., F.R.S.,
F.R.G.S., Radcliffe Librarian and Regius Professor of Medicine
in the University of Oxford. Broad-street, Oxford.
1877. *Acland, Theodore Dyke, M.A. 7 Brook-street, London, W.
1860. †ACLAND, Sir THOMAS DYKE, Bart., M.A., D.C.L., M.P. Sprydon-
cote, Exeter; and Athenæum Club, London, S.W.
1887. §ADAMI, J. G., B.A. New Museums, Cambridge.
1884. †Adams, Frank Donovan. Geological Survey, Ottawa, Canada.
1876. †Adams, James. 9 Royal-crescent West, Glasgow.
- *ADAMS, JOHN COUCH, M.A., LL.D., D.Sc., F.R.S., F.R.A.S., Director
of the Observatory and Lowndean Professor of Astronomy and
Geometry in the University of Cambridge. The Observatory,
Cambridge.
1871. §Adams, John R. 3 Queen's-gate-terrace, London, S.W.
1879. *ADAMS, Rev. THOMAS, M.A., Principal of Bishop's College, Lennox-
ville, Canada.
1877. †ADAMS, WILLIAM. 3 Sussex-terrace, Plymouth.
1869. *ADAMS, WILLIAM GRYLLES, M.A., D.Sc., F.R.S., F.G.S., F.C.P.S., Pro-
fessor of Natural Philosophy and Astronomy in King's College,
London. 43 Notting Hill-square, London, W.
1873. †Adams-Acton, John. Margutta House, 103 Marylebone-road,
London, N.W.
1887. †Adamson, Daniel. The Towers, Didsbury, Manchester.
1879. †Adamson, Robert, M.A., LL.D., Professor of Logic and Political
Economy in Owens College, Manchester. 1 Derby-road,
Fallowfield, Manchester.
1887. §Adamson, Samuel A., F.G.S. 52 Wellclose-terrace, Leeds.
1865. *Adkins, Henry. Northfield, near Birmingham.
1883. §Adshead, Samuel. School of Science, Macclesfield.
1884. †Agnew, Cornelius R. 266 Maddison-avenue, New York, U.S.A.
1887. †Agnew, William. Summer Hill, Pendleton, Manchester.
1884. †Aikins, Dr. W. T. Jarvis-street, Toronto, Canada.
1864. *Ainsworth, David. The Flosk, Cleator, Carnforth.
1871. *Ainsworth, John Stirling. Harecroft, Cumberland.
1871. †Ainsworth, William M. The Flosk, Cleator, Carnforth.
- AIRY, Sir GEORGE BIDDELL, K.C.B., M.A., LL.D., D.C.L., F.R.S.,
F.R.A.S. The White House, Croom's Hill, Greenwich, S.E.
1871. §Aitken, John, F.R.S.E. Darroch, Falkirk, N.B.
- Aitken, Thomas. Ashfield, Fallowfield, Manchester.
- Akroyd, Edward. Bankfield, Halifax.
1884. *Alabaster, H. 22 Paternoster-row, London, E.C.
1886. *Albright, G. S. The Elms, Edgbaston, Birmingham.
1862. †ALCOCK, Sir RUTHERFORD, K.C.B., D.C.L., F.R.G.S. The Athe-
næum Club, Pall Mall, London, S.W.
1861. *Alcock, Thomas, M.D. Oakfield, Sale, Manchester.
- *Aldam, William. Frickley Hall, near Doncaster.

Year of
Election.

1887. †Alexander, B. Fernlea, Fallowfield, Manchester.
 1883. †Alexander, George. Kildare-street Club, Dublin.
 1888. *Alexander, Patrick Y. 8 Portland-place, Bath.
 1873. †Alexander, Reginald, M.D. 13 Hallfield-road, Bradford, Yorkshire.
 1858. †ALEXANDER, WILLIAM, M.D. Halifax.
 1883. †Alger, Miss Ethel. The Manor House, Stoke Damerel, South Devon.
 1883. †Alger, W. H. The Manor House, Stoke Damerel, South Devon.
 1883. †Alger, Mrs. W. H. The Manor House, Stoke Damerel, South Devon.
 1867. †Alison, George L. C. Dundee.
 1859. †Allan, Alexander. Scottish Central Railway, Perth.
 1885. †Allan, David. West Cults, near Aberdeen.
 1871. †Allan, G., M.Inst.C.E. 10 Austin Friars, London, E.C.
 1871. †ALLEN, ALFRED H., F.C.S. 67 Surrey-street, Sheffield.
 1887. *Allen, Arthur Ackland. Overbrook, Kersal, Manchester.
 1879. *Allen, Rev. A. J. C. The College, Chester.
 1887. *Allen, Charles Peter. Overbrook, Kersal, Manchester.
 1888. §Allen, F. J. Mason College, Birmingham.
 1884. §Allen, Rev. George. Shaw Vicarage, Oldham.
 1887. §Allen, John. Kilgrimol School, St. Anne's-on-the-Sea, viâ Preston.
 1878. †Allen, John Romilly. 5 Albert-terrace, Regent's Park, London, N.W.
 1861. †Allen, Richard. Didsbury, near Manchester.
 1887. *Allen, Russell. 2 Parkwood, Victoria Park, Manchester.
 1863. †Allhusen, C. Elswick Hall, Newcastle-on-Tyne.
 *ALLMAN, GEORGE J., M.D., LL.D., F.R.S. L. & E., M.R.I.A., F.L.S., Emeritus Professor of Natural History in the University of Edinburgh. Ardmore, Parkstone, Dorset.
 1887. *Allnutt, J. W. F., B.A. 12 Chapel-row, Portsea, Hants.
 1886. †Allport, Samuel. 50 Whitall-street, Birmingham.
 1887. †Alward, G. L. 11 Hamilton-street, Grimsby, Yorkshire.
 1873. †Ambler, John. North Park-road, Bradford, Yorkshire.
 1883. §Amery, John Sparke. Druid House, Ashburton, Devon.
 1883. §Amery, Peter Fabyan Sparke. Druid House, Ashburton, Devon.
 1884. †Ami, Henry. Geological Survey, Ottawa, Canada.
 1876. †Anderson, Alexander. 1 St. James's-place, Hillhead, Glasgow.
 1878. †Anderson, Beresford. *Saint Ville, Killiney.*
 1888. §Anderson, Bruce. 39 Kempshott-road, Streatham, London, S.W.
 1885. †Anderson, Charles Clinton. 4 Knaresborough-place, Cromwell-road, London, S.W.
 1850. †Anderson, Charles William. Cleadon, South Shields.
 1883. †Anderson, Miss Constance. 17 Stonegate, York.
 1885. *Anderson, Hugh Kerr. Frogna Park, Hampstead, London, N.W.
 1874. †Anderson, John, J.P., F.G.S. Holywood, Belfast.
 1859. †ANDERSON, PATRICK. 15 King-street, Dundee.
 1887. §ANDERSON, Professor R. J., M.D. Queen's College, Galway.
 1880. *ANDERSON, TEMPEST, M.D., B.Sc. 17 Stonegate, York.
 1886. *Anderson, William, M.Inst.C.E. Lesney House, Erith, Kent.
 1880. †Andrew, Mrs. 126 Jamaica-street, Stepney, London, E.
 1883. †Andrew, Thomas, F.G.S. 18 Southernhay, Exeter.
 1880. *Andrews, Thornton, M.Inst.C.E. Cefn Eithen, Swansea.
 1886. §Andrews, William. Gosford Green, Coventry.
 1883. §Anelay, Miss M. Mabel. Girton College, Cambridge.
 1877. §ANGELL, JOHN, F.C.S. The Grammar School, Manchester.
 1886. §Annan, John. Wolverhampton.
 1886. †Ansell, Joseph. 38 Waterloo-street, Birmingham.

Year of
Election.

1878. †Anson, Frederick H. 9 Delahay-street, Westminster, S.W.
Anthony, John, M.D. 6 Greenfield-crescent, Edgbaston, Birmingham.
1868. †Appleby, C. J. *Emerson-street, Bankside, Southwark, London, S.E.*
1886. §Arblaster, Edmund, M.A. The Grammar School, Carlisle.
1870. †Archer, Francis. 14 Cook-street, Liverpool.
1874. †Archer, William, F.R.S., M.R.I.A. 11 South Frederick-street, Dublin.
1884. *Archibald, E. Douglas. Grosvenor House, Tunbridge Wells.
1851. †ARGYLL, His Grace the Duke of, K.G., K.T., D.C.L., F.R.S. L. & E., F.G.S. Argyll Lodge, Kensington, London, W.; and Inverary, Argyleshire.
1884. §Arlidge, John Thomas, M.D., B.A. The High Grove, Stoke-upon-Trent.
1883. §Armistead, Richard. 28 Chambres-road, Southport.
1883. *Armistead, William. 15 Rupert-street, Compton-road, Wolverhampton.
1887. †Armitage, Benjamin. Chomlea, Pendleton, Manchester.
1861. †Armitage, William. 95 Portland-street, Manchester.
1867. *Armitstead, George. Errol Park, Errol, N.B.
1857. *ARMSTRONG, The Right Hon. Lord, C.B., LL.D., D.C.L., F.R.S. Jesmond Dene, Newcastle-upon-Tyne.
1879. *Armstrong, Sir Alexander, K.C.B., M.D., LL.D., F.R.S., F.R.G.S. The Albany, London, W.
1886. §Armstrong, George Frederick, M.A., F.R.S.E., F.G.S., Regius Professor of Engineering in the University of Edinburgh. The University, Edinburgh.
1873. §ARMSTRONG, HENRY E., Ph.D., F.R.S., Sec.C.S., Professor of Chemistry in the City and Guilds of London Institute Central Institution, Exhibition-road, London, S.W. 55 Granville Park, Lewisham, S.E.
1876. †Armstrong, James. Bay Ridge, Long Island, New York, U.S.A.
1884. †Armstrong, Robert B. Junior Carlton Club, Pall Mall, London, S.W.
Armstrong, Thomas. Higher Broughton, Manchester.
1870. †Arnott, Thomas Reid. Bramshill, Harlesden Green, London, N.W.
1853. *Arthur, Rev. William, M.A. Clapham Common, London, S.W.
1886. †Ascough, Jesse. Patent Borax Company, Newmarket-street, Birmingham.
1870. *Ash, Dr. T. Linnington. Holsworthy, North Devon.
1874. †Ashe, Isaac, M.B. Dundrum, Co. Dublin.
1873. †Ashton, John. Gorse Bank House, Windsor-road, Oldham.
ASHTON, THOMAS, J.P. Ford Bank, Didsbury, Manchester.
1887. †Ashton, Thomas Gair, M.A. 36 Charlotte-street, Manchester.
1866. †Ashwell, Henry. Woodthorpe, Nottingham.
- *Ashworth, Edmund. Egerton Hall, Bolton-le-Moors.
1887. †Ashworth, Mrs. Harriet. Thorne Bank, Heaton Moor, near Stockport.
Ashworth, Henry. Turton, near Bolton.
1888. §Ashworth, J. J. 35 Mosley-street, Manchester.
1887. §Ashworth, John Wallwork. Thorne Bank, Heaton Moor, near Stockport.
1887. †Aspland, Arthur P. Werneth Lodge, Gee Cross, near Manchester.
1875. *Aspland, W. Gaskell. Care of Manager, Union Bank, Chancery-lane, London, W.C.
1861. §Asquith, J. R. Infirmary-street, Leeds.

Year of
Election.

1861. †Aston, Theodore. 11 New-square, Lincoln's Inn, London, W.C.
 1872. *ATCHISON, ARTHUR T., M.A. (SECRETARY.) 22 Albemarle-street,
 London, W.
 1858. †Atherton, Charles. Sandover, Isle of Wight.
 1865. *ATKINSON, EDMUND, Ph.D., F.C.S. Portesbery Hill, Camberley,
 Surrey.
 1884. †Atkinson, Edward. Brookline, Massachusetts, Boston, U.S.A.
 1863. *Atkinson, G. Clayton. 21 Windsor-terrace, Newcastle-on-Tyne.
 1887. †Atkinson, Rev. G. C. Goresfield, Ashton-on-Mersey.
 1861. †Atkinson, Rev. J. A. Longsight Rectory, near Manchester.
 1858. *Atkinson, John Hastings. 12 East Parade, Leeds.
 1881. †Atkinson, J. T. The Quay, Selby, Yorkshire.
 1881. †Atkinson, Robert William. Town Hall-buildings, Newcastle-on-
 Tyne.
 1863. *ATTFIELD, Professor J., M.A., Ph.D., F.R.S., F.C.S. 17 Bloomsbury-
 square, London, W.C.
 1884. †Auchincloss, W. S. 209 Church-street, Philadelphia, U.S.A.
 1886. †Aulton, A. D., M.D. Walsall.
 1860. *Austin-Gourlay, Rev. William E. C., M.A. The Rectory, Stanton
 St. John, near Oxford.
 1865. *Avery, Thomas. Church-road, Edgbaston, Birmingham.
 1881. †AXON, W. E. A. Fern Bank, Higher Broughton, Manchester.
 1888. §Ayre, Rev. J. W., M.A. 30 Green-street, Grosvenor-square,
 London, W.
 1877. *AYRTON, W. E., F.R.S., Professor of Applied Physics in the City
 and Guilds of London Institute. Central Institution, Exhibition-
 road, London, S.W.
 *BABINGTON, CHARLES CARDALE, M.A., F.R.S., F.L.S., F.G.S., Pro-
 fessor of Botany in the University of Cambridge. 5 Brookside,
 Cambridge.
 1884. †Baby, The Hon. G. Montreal, Canada.
 Backhouse, Edmund. Darlington.
 1863. †Backhouse, T. W. West Hendon House, Sunderland.
 1883. *Backhouse, W. A. St. John's Wolsingham, near Darlington.
 1887. *Bacon, Thomas Walter. 4 Lyndhurst-road, Hampstead, London,
 N.W.
 1887. †Baddeley, John. 1 Charlotte-street, Manchester.
 1881. †Baden-Powell, Sir George S., C.M.G., M.A., M.P., F.R.A.S., F.S.S.
 8 St. George's-place, Hyde Park, London, S.W.
 1877. †Badock, W. F. Badminton House, Clifton Park, Bristol.
 1883. †Bagruel, P. H. St. Stephen's Club, Westminster, S.W.
 1883. †Baildon, Dr. 65 Manchester-road, Southport.
 1883. *Bailey, Charles, F.L.S. Ashfield, College-road, Whalley Range,
 Manchester.
 1870. §Bailey, Dr. Francis J. 51 Grove-street, Liverpool.
 1887. *Bailey, G. H., D.Sc., Ph.D. Owens College, Manchester.
 1878. †Bailey, John. The Laurels, Wittington, near Hereford.
 1865. †Bailey, Samuel, F.G.S. The Peck, Walsall.
 1855. †Bailey, William. Horseley Fields Chemical Works, Wolver-
 hampton.
 1887. †Bailey, W. H. Summerfield, Eccles Old-road, Manchester.
 1866. †Baillon, Andrew. British Consulate, Brest.
 1878. †Baily, Walter. 176 Haverstock-hill, London, N.W.
 1885. †BAIN, ALEXANDER, M.A., LL.D., Rector of the University of
 Aberdeen. Ferryhill Lodge, Aberdeen.
 1873. †Bain, Sir James. 3 Park-terrace, Glasgow.

Year of
Election.

1885. †Bain, William N. Collingwood, Pollockshields, Glasgow.
*Bainbridge, Robert Walton. 2 Stoke-villas, Exeter.
*BAINES, Sir EDWARD, J.P. St. Ann's Hill, Burley, Leeds.
1858. †Baines, T. Blackburn. 'Mercury' Office, Leeds.
1882. *BAKER, BENJAMIN, M.Inst.C.E. 2 Queen Square-place, Westminster, S.W.
1866. †Baker, Francis B. Sherwood-street, Nottingham.
1886. †Baker, Harry. 262 Plymouth-grove, Manchester.
1861. *Baker, John. The Gables, Buxton.
1881. †Baker, Robert, M.D. The Retreat, York.
1865. †Baker, Robert L. Barham House, Leamington.
1863. †Baker, William. 6 Taptonville, Sheffield.
1875. *Baker, W. Mills. The Holmes, Stoke Bishop, Bristol.
1875. †BAKER, W. PROCTOR. Brislington, Bristol.
1881. †Baldwin, Rev. G. W. de Courcy, M.A. Lord Mayor's Walk, York.
1884. †Balete, Professor E. Polytechnic School, Montreal, Canada.
1871. †Balfour, G. W. Whittinghame, Prestonkirk, Scotland.
1875. †BALFOUR, ISAAC BAYLEY, D.Sc., M.D., F.R.S.L. & E., Professor of Botany in the University of Edinburgh. Inverleith House, Edinburgh.
1883. †Balfour, Mrs. I. Bayley. Inverleith House, Edinburgh.
1878. *Ball, Charles Bent, M.D. 16 Lower Fitzwilliam-street, Dublin.
1835. *BALL, JOHN, M.A., F.R.S., F.L.S., M.R.I.A. 10 Southwell-gardens, South Kensington, London, S.W.
1866. *BALL, Sir ROBERT STAWELL, M.A., LL.D., F.R.S., F.R.A.S., Andrews Professor of Astronomy in the University of Dublin, and Astronomer Royal for Ireland. The Observatory, Dunsink, Co. Dublin.
1878. †BALL, VALENTINE, M.A., F.R.S., F.G.S., Director of the Museum of Science and Art, Dublin.
1833. *Ball, W. W. Rouse, M.A. Trinity College, Cambridge.
1886. §Ballantyne, J. W., M.B. 50 Queen-street, Edinburgh.
1884. †Ballou, Dr. Naham. Sandwich, Illinois, U.S.A.
1869. †Bamber, Henry K., F.C.S. 5 Westminster-chambers, Victoria-street, Westminster, S.W.
1882. †Bance, Major Edward. Limewood, The Avenue, Southampton.
1852. †Bangor, Viscount. Castleward, Co. Down, Ireland.
1879. †Banham, H. French. Mount View, Glossop-road, Sheffield.
1870. †BANISTER, Rev. WILLIAM, B.A. St. James's Mount, Liverpool.
1884. †Bannatyne, Hon. A. G. Winnipeg, Canada.
1884. †Barbeau, E. J. Montreal, Canada.
1866. †Barber, John. Long-row, Nottingham.
1884. †Barber, Rev. S. F. West Raynham Rectory, Swaffham, Norfolk.
1861. *Barbour, George. Bolesworth Castle, Tattenhall, Chester.
1859. †Barbour, George F. 11, George-square, Edinburgh.
1855. †Barclay, Andrew. Kilmarnock, Scotland.
1871. †Barclay, George. 17 Coates-crescent, Edinburgh.
1852. *Barclay, J. Gurney. 54 Lombard-street, London, E.C.
1860. *Barclay, Robert. High Leigh, Hoddesden, Herts.
1876. *Barclay, Robert. 21 Park-terrace, Glasgow.
1887. *Barclay, Robert. Springfield, Kersal, Manchester.
1886. †Barclay, Thomas. 17 Bull-street, Birmingham.
1868. *Barclay, W. L. 54 Lombard-street, London, E.C.
1881. †Barfoot, William, J.P. Whelford-place, Leicester.
1882. †Barford, J. G. Above Bar, Southampton.
1863. *Barford, James Gale, F.C.S. Wellington College, Wokingham, Berkshire.

Year of
Election.

1886. †Barham, F. F. Bank of England, Birmingham.
1860. *Barker, Rev. Arthur Alcock, B.D. East Bridgford Rectory, Nottingham.
1879. †Barker, Elliott. 2 High-street, Sheffield.
1882. *Barker, Miss J. M. Hexham House, Hexham.
1879. *Barker, Rev. Philip C., M.A., LL.B. North Petherton, Bridgewater.
1865. †Barker, Stephen. 30 Frederick-street, Edgbaston, Birmingham.
1870. †BARKLY, Sir HENRY, G.C.M.G., K.C.B., F.R.S., F.R.G.S. 1 Bina-gardens, South Kensington, London, S.W.
1886. †Barling, Gilbert. 85 Edmund-street, Edgbaston, Birmingham.
1873. †Barlow, Crawford, B.A. 2 Old Palace-yard, Westminster, S.W.
1883. †Barlow, J. J. 37 Park-street, Southport.
1878. †Barlow, John, M.D., Professor of Physiology in Anderson's Col-lege, Glasgow.
1883. †Barlow, John R. Greenthorne, near Bolton.
Barlow, Lieut.-Col. Maurice (14th Regt. of Foot). 5 Great George-street, Dublin.
1885. †Barlow, William. Hillfield, Muswell Hill, London, N.
1873. †BARLOW, WILLIAM HENRY, F.R.S., M.Inst.C.E. 2 Old Palace-yard, Westminster, S.W.
1861. *Barnard, Major R. Cary, F.L.S. Bartlow, Leckhampton, Chelten-ham.
1881. †Barnard, William, LL.B. Harlow, Essex.
1868. §Barnes, Richard H. Heatherlands, Parkstone, Dorset.
1884. †Barnett, J. D. Port Hope, Ontario, Canada.
1886. †Barnsley, Charles H. 32^d Duchess-road, Edgbaston, Birmingham.
1881. †Barr, Archibald, B.Sc., Professor of Civil and Mechanical Engineer-ing in the Yorkshire College, Leeds.
1859. †Barr, Lieut.-General. Apsleytoun, East Grinstead, Sussex.
1883. †Barrett, John Chalk. Errismore, Birkdale, Southport.
1883. †Barrett, Mrs. J. C. Errismore, Birkdale, Southport.
1860. †Barrett, T. B. 20 Victoria-terrace, Welshpool, Montgomery.
1872. *BARRETT, W. F., F.R.S.E., M.R.I.A., Professor of Physics in the Royal College of Science, Dublin.
1883. †Barrett, William Scott. Winton Lodge, Crosby, near Liverpool.
1887. §Barrington, Miss Amy. Fassaroe, Bray, Co. Wicklow.
1874. *BARRINGTON, R. M., M.A., LL.B., F.L.S. Fassaroe, Bray, Co. Wicklow.
1874. *Barrington-Ward, Mark J., M.A., F.L.S., F.R.G.S., H.M. Inspector of Schools. Thorneloe Lodge, Worcester.
1885. *Barron, Frederick Cadogan, M.Inst.C.E. Nervion, Beckenham-grove, Shortlands, Kent.
1881. §BARRON, G. B., M.D. Summerseat, Southport.
1866. †Barron, William. Elvaston Nurseries, Borrowash, Derby.
1886. †Barrow, George William. Baldraud, Lancaster.
1887. §Barrow, John. Beechfield, Folly-lane, Swinton, Manchester.
1886. †Barrow, Richard Bradbury. Lawn House, 13 Oampton-road, Edg-baston, Birmingham.
1886. †Barrows, Joseph. The Poplars, Yardley, near Birmingham.
1886. †Barrows, Joseph, jun. Ferndale, Harborne-road, Edgbaston, Bir-mingham.
1862. *BARRY, CHARLES. 15 Pembridge-square, London, W.
1883. †Barry, Charles E. 15 Pembridge-square, London, W.
1875. †Barry, John Wolfe. 23 Delahay-street, Westminster, S.W.
1881. †Barry, J. W. Duncombe-place, York.
1884. *Barstow, Miss Frances. Garrow Hill, near York.

- Year of
Election.
1858. *Bartholomew, Charles. Castle Hill House, Ealing, Middlesex, W.
1858. *Bartholomew, William Hamond. Ridgeway House, Cumberland-road,
Headingley, Leeds.
1884. †Bartlett, James Herbert. 148 Mansfield-street, Montreal, Canada.
1873. †Bartley, George C. T., M.P. St. Margaret's House, Victoria-street,
London, S.W.
1884. †Barton, H. M. Foster-place, Dublin.
1852. †Barton, James. Farndreg, Dundalk.
1887. §Bartrum, John S. 13 Gay-street, Bath.
*Bashforth, Rev. Francis, B.D. Minting Vicarage, near Horn-
castle.
1882. *BASING, The Right Hon. Lord, F.R.S. 74 St. George's-square,
London, S.W.
1876. †Bassano, Alexander. 12 Montagu-place, London, W.
1876. †Bassano, Clement. Jesus College, Cambridge.
1888. *Bassett, A. B., M.A. Chapel Place Mansions, 322 Oxford-street,
London, W.
1866. *BASSETT, HENRY. 26 Belitha-villas, Barnsbury, London, N.
1869. †Bastard, S. S. Summerland-place, Exeter.
1871. †BASTIAN, H. CHARLTON, M.A., M.D., F.R.S., F.L.S. 20 Queen
Anne-street, London, W.
1848. †BATE, C. SPENCE, F.R.S., F.L.S. 8 Mulgrave-place, Plymouth.
1883. †Bateman, A. E. Board of Trade, London, S.W.
1873. *Bateman, Daniel. Wissahickon, Philadelphia, U.S.A.
1868. †Bateman, Frederick, M.D. Upper St. Giles's-street, Norwich.
BATEMAN, JAMES, M.A., F.R.S., F.R.G.S., F.L.S. Home House,
Worthing.
1842. *BATEMAN, JOHN FREDERIC LA TROBE, F.R.S., F.G.S., F.R.G.S.,
M.Inst.C.E. 18 Abingdon-street, London, S.W.
1864. †BATES, HENRY WALTER, F.R.S., F.L.S., Assist.-Sec. R.G.S. 1 Savile-
row, London, W.
1852. †Bateson, Sir Robert, Bart. Belvoir Park, Belfast.
1884. †Bateson, William, B.A. St. John's College, Cambridge.
1851. †BATH AND WELLS, The Right Rev. Lord ARTHUR HERVEY, Lord
Bishop of, D.D. The Palace, Wells, Somerset.
1881. *Bather, Francis Arthur, M.A., F.G.S. 20 Campden Hill-road,
Kensington, London, W.
1836. †Batten, Edmund Chisholm. 25 Thurloe-square, London, S.W.
1869. †Batten, John Winterbotham. 35 Palace Gardens-terrace, Kensington,
London, W.
1863. §BAUERMAN, H., F.G.S. 41 Acre-lane, Brixton, London, S.W.
1867. †Baxter, Edward. Hazel Hall, Dundee.
1867. †Baxter, The Right Hon. William Edward, M.P. Ashcliffe, Dundee.
1868. †Bayes, William, M.D. 58 Brook-street, London, W.
Bayly, John. Seven Trees, Plymouth.
1875. *Bayly, Robert. Torr-grove, near Plymouth.
1876. *BAYNES, ROBERT E., M.A. Christ Church, Oxford.
1887. *Baynes, Mrs. R. E. 3 Church-walk, Oxford.
1887. §Baynton, Alfred. 28 Gilda Brook Park, Eccles, Manchester.
1883. *Bazley, Gardner. Hatherop Castle, Fairford, Gloucestershire.
Bazley, Sir Thomas Sebastian, Bart., M.A. Hatherop Castle,
Fairford, Gloucestershire.
1886. §Beale, C. Lime Tree House, Rowley Regis, Dudley.
1886. †Beale, Charles G. Maple Bank, Edgbaston, Birmingham.
1860. *BEALE, LIONEL S., M.D., F.R.S., Professor of the Principles and
Practice of Medicine in King's College, London. 61 Grosvenor-
street, London, W.

Year of
Election.

1882. †Beamish, Major A. W., R.E. 28 Grosvenor-road, London, S.W.
 1884. †Beamish, G. H. M. Prison, Liverpool.
 1872. †Beanes, Edward, F.C.S. Moatlands, Paddock Wood, Brenchley, Kent.
 1883. †Beard, Mrs. 13 South-hill-road, Toxteth Park, Liverpool.
 1887. †Beaton, John, M.A. 219 Upper Brook-street, Chorlton-on-Medlock, Manchester.
 1842. *Beatson, William. Ash Mount, Rotherham.
 1888. §Beatson, W. B., M.D. 11 Cavendish-place, Bath.
 1855. *Beaufort, W. Morris, F.R.A.S., F.R.G.S., F.R.M.S., F.S.S. 18 Piccadilly, London, W.
 1886. †Beaugrand, M. H. Montreal.
 1861. *Beaumont, Rev. Thomas George. Chelmondiston Rectory, Ipswich.
 1887. *Beaumont, W. J. Angel Hotel, Knutsford.
 1885. §Beaumont, W. W. 163 Strand, London, W.C.
 1871. *Beazley, Lieut.-Colonel George G. 74 Redcliffe-square, London, S.W.
 1859. *Beck, Joseph, F.R.A.S. 68 Cornhill, London, E.C.
 1864. §Becker, Miss Lydia E. 155 Shrewsbury-street, Whalley Range, Manchester.
 1887. *Beckett, John Hampden. Wilmslow Park, Wilmslow, Manchester.
 1860. †BECKLES, SAMUEL H., F.R.S., F.G.S. 9 Grand-parade, St. Leonard's-on-Sea.
 1885. §BEDDARD, FRANK E., M.A., F.Z.S., Prosector to the Zoological Society of London. Society's Gardens, Regent's Park, London, N.W.
 1866. †Beddard, James. Derby-road, Nottingham.
 1870. §BEDDOE, JOHN, M.D., F.R.S. Clifton, Bristol.
 1858. †Bedford, James. Woodhouse Cliff, near Leeds.
 1878. †BENSON, P. PHILLIPS, D.Sc., F.C.S., Professor of Chemistry in the College of Physical Science, Newcastle-on-Tyne.
 1884. †Beers, W. G., M.D. 34 Beaver Hall-terrace, Montreal, Canada.
 1873. †Behrens, Jacob. Springfield House North-parade, Bradford, Yorkshire.
 1874. †Belcher, Richard Boswell. Blockley, Worcestershire.
 1873. †Bell, Asahel P. 32 St. Anne's-street, Manchester.
 1871. §Bell, Charles B. 6 Spring-bank, Hull.
 1884. †Bell, Charles Napier. Winnipeg, Canada.
 Bell, Frederick John. Woodlands, near Maldon, Essex.
 1860. †Bell, Rev. George Charles, M.A. Marlborough College, Wilts.
 1880. †Bell, Henry Oswin. 13 Northumberland-terrace, Tynemouth.
 1862. *BELL, Sir ISAAC LOWTHIAN, Bart., F.R.S., F.C.S., M.Inst.C.E. Rounton Grange, Northallerton.
 1875. †Bell, James, D.Sc., Ph.D., F.R.S., F.C.S. The Laboratory, Somerset House, London, W.C.
 1871. *BELL, J. CARTER, F.C.S. Bankfield, The Cliff, Higher Broughton, Manchester.
 1883. *Bell, John Henry. Dalton Lees, Huddersfield.
 1853. †Bell, John Pearson, M.D. Waverley House, Hull.
 1864. †Bell, R. Queen's College, Kingston, Canada.
 1876. †Bell, R. Bruce, M.Inst.C.E. 203 St. Vincent-street, Glasgow.
 1863. *Bell, Thomas. Oakwood, Epping.
 1867. †Bell, Thomas. Belmont, Dundee.
 1882. †Bell, W. Alexander, B.A. 3 Madeira-terrace, Kemp Town, Brighton.
 1888. *Bell, Walter George, M.A. Trinity Hall, Cambridge.
 1842. Bellhouse, Edward Taylor. Eagle Foundry, Manchester.
 Bellingham, Sir Alan. Castle Bellingham, Ireland.

Year of
Election.

1882. †Bellingham, William. 15 Killieser-avenue, Telford Park, Streatham Hill, London, S.W.
1884. †Bemrose, Joseph. 15 Plateau-street, Montreal, Canada.
1886. §Benger, Frederick Baden. 7 Exchange-street, Manchester.
1885. §BENHAM, WILLIAM BLAXLAND, D.Sc. University College, London, W.C.
1870. †BENNETT, ALFRED W., M.A., B.Sc., F.L.S. 6 Park Village East, Regent's Park, London, N.W.
1836. §Bennett, Henry. Bedminster, Bristol.
1887. †Bennett, James M. St. Mungo Chemical Company, Ruckhill, Glasgow.
1881. §Bennett, John R. 16 West Park, Clifton, Bristol.
1883. *Bennett, Laurence Henry. Bedminster, Bristol.
1881. †Bennett, Rev. S. H., M.A. St. Mary's Vicarage, Bishophill Junior, York.
1870. *Bennett, William. Oak Hill Park, Old Swan, near Liverpool.
1887. †Bennion, James A., M.A. 1 St. James-square, Manchester.
1852. *Bennoch, Francis, F.S.A. 5 Tavistock-square, London, W.C.
1848. †Benson, Starling. Gloucester-place, Swansea.
1870. †Benson, W. Alresford, Hants.
1863. †Benson, William. Fourstones Court, Newcastle-on-Tyne.
1885. *Bent, J. Theodore. 13 Great Cumberland-place, London, W.
1884. †Bentham, William. 724 Sherbrooke-street, Montreal, Canada
1863. †BENTLEY, ROBERT, F.L.S., Professor of Botany in King's College, London. 38 Penywern-road, Earl's Court, London, S.W.
1886. †Benton, William Elijah. Littleworth House, Hednaford, Staffordshire.
1876. †Bergius, Walter C. 9 Loudon-terrace, Hillhead, Glasgow.
1868. †BERKELEY, Rev. M. J., M.A., F.R.S., F.L.S. Sibbertoft, Market Harborough.
1863. †Berkley, C. Marley Hill, Gateshead, Durham.
1886. †Bernard, W. Leigh. Calgary, Canada.
1887. §Berry, William. Harpurhey Cottage, Harpurhey, Manchester.
1870. †Berwick, George, M.D. 36 Fawcett-street, Sunderland.
1862. †Besant, William Henry, M.A., D.Sc., F.R.S. St. John's College, Cambridge.
1865. *BESSEMER, Sir HENRY, F.R.S. Denmark Hill, London, S.E.
1882. *Bessemer, Henry, jun. 5 Palace-gate, Kensington, London, W.
1858. †Best, William. Leydon-terrace, Leeds.
1883. †Betley, Ralph, F.G.S. Mining School, Wigan.
1876. *Bettany, G. T., M.A., B.Sc., F.L.S., F.R.M.S. 33 Oakhurst-grove, East Dulwich-road, London, S.E.
1883. †Bettany, Mrs. 33 Oakhurst-grove, East Dulwich-road, London, S.E.
1880. *Bevan, Rev. James Oliver, M.A., F.G.S. The Vicarage, Vowchurch, Hereford.
1884. *Beverley, Michael, M.D. 54 Prince of Wales-road, Norwich.
1885. †Beveridge, R. Beath Villa, Ferryhill, Aberdeen.
1874. *Bevington, James B. Merle Wood, Sevenoaks.
1863. †Bewick, Thomas John, F.G.S. Suffolk House, Laurence Pountney Hill, London, E.C.
1844. *Bickerdike, Rev. John, M.A. Shireshead Vicarage, Garstang.
1886. §Bickersteth, The Very Rev. E., D.D., Dean of Lichfield. The Deanery, Lichfield.
1870. †Bickerton, A.W., F.C.S. Christchurch, Canterbury, New Zealand.
1888. *Bidder, George Parker. Trinity College, Cambridge.
1885. *BIDWELL, SHELFORD, M.A., LL.B., F.R.S. Riverstone Lodge, Southfields, Wandsworth, Surrey, S.W.

Year of
Election.

1863. †Bigger, Benjamin. Gateshead, Durham.
1882. §Biggs, C. H. W., F.C.S. 1 Bloomfield, Bromley, Kent.
Bilton, Rev. William, M.A., F.G.S. United University Club, Suffolk-
street, London, S.W.
1886. †Bindloss, G. F. Carnforth, Brondesbury Park, London, N.W.
1887. *Bindloss, James B. Elm Bank, Eccles, Manchester.
1884. *Bingham, John E. Electric Works, Sheffield.
1881. †Binnie, Alexander R., F.G.S. Town Hall, Bradford, Yorkshire.
1879. †Binns, E. Knowles, F.R.G.S. 216 Heavygate-road, Sheffield.
1873. †Binns, J. Arthur. Manningham, Bradford, Yorkshire.
1880. †Bird, Henry, F.C.S. South Down, near Devonport.
1866. *Birkin, Richard. Aspley Hall, near Nottingham.
1888. *Birley, Miss Caroline. Seedley-terrace, Pendleton, Manchester.
1887. *Birley, H. K. 13 Hyde-road, Ardwick, Manchester.
1871. *BISCHOF, GUSTAV. 4 Hart-street, Bloomsbury, London, W.C.
1868. †Bishop, John. Thorpe Hamlet, Norwich.
1883. §Bishop, John le Marchant. 100 Mosley-street, Manchester.
1885. †Bissett, J. P. Wyndem, Banchory, N.B.
1886. *Bixby, Captain W. H. War Department, Washington, U.S.A.
1877. †BLACHFORD, The Right Hon. Lord, K.C.M.G. Cornwood, Ivy-
bridge.
1884. †Black, Francis, F.R.G.S. 6 North Bridge, Edinburgh.
1881. §Black, Surgeon-Major William Galt, F.R.C.S.E. Caledonian United
Service Club, Edinburgh.
1869. †Blackall, Thomas. 13 Southernhay, Exeter.
1834. Blackburn, Bewicke. Calverley Park, Tunbridge Wells.
1876. †Blackburn, Hugh, M.A. Roshven, Fort William, N.B.
1884. †Blackburn, Robert. New Edinburgh, Ontario, Canada.
Blackburne, Rev. John, jun., M.A. Rectory, Horton, near Chip-
penham.
1877. †Blackie, J. Alexander. 17 Stanhope-street, Glasgow.
1859. †Blackie, John Stewart, M.A., Professor of Greek in the University
of Edinburgh.
1876. †Blackie, Robert. 7 Great Western-terrace, Glasgow.
1855. *BLACKIE, W. G., Ph.D., F.R.G.S. 17 Stanhope-street, Glasgow.
1884. †Blacklock, Frederick W. 25 St. Famille-street, Montreal, Canada.
1883. †Blacklock, Mrs. Sea View, Lord-street, Southport.
1884. †Blaikie, James, M.A. 14 Viewforth-place, Edinburgh.
1888. §Blaine, R. S., J.P. Summerhill Park, Bath.
1878. §Blair, Matthew. Oakshaw, Paisley.
1883. §Blair, Mrs. Oakshaw, Paisley.
1863. †Blake, C. Carter, D.Sc. 28 Upper Charlton-street, Fitzroy-square,
London, W.
1886. †Blake, Dr. James. San Francisco, California.
1849. *BLAKE, HENRY WOLLASTON, M.A., F.R.S., F.R.G.S. 8 Devonshire-
place, Portland-place, London, W.
1883. *BLAKE, Rev. J. F., M.A., F.G.S. 14 Oxford-street, Nottingham.
1846. *Blake, William. Bridge House, South Petherton, Somerset.
1878. †Blakeney, Rev. Canon, M.A., D.D. The Vicarage, Sheffield.
1886. †Blakie, John. The Bridge House, Newcastle, Staffordshire.
1861. †Blakiston, Matthew, F.R.G.S. Free Hills, Burredon, Hants.
1887. §Blamires, George. Cleckheaton.
1881. §Blamires, Thomas H. Close Hill, Lockwood, near Huddersfield.
1884. *Blandy, William Charles, B.A. 1 Friar-street, Reading.
1869. †BLANFORD, W. T., LL.D., F.R.S., F.G.S., F.R.G.S. 72 Bedford-
gardens, Campden Hill, London, W.
1887. *Bles, A. G. S. Moor End, Kersal, Manchester.

- Year of
Election.
1887. *Bles, Edward J. Moor End, Kersal, Manchester.
1887. §Bles, Marcus S. The Beeches, Broughton Park, Manchester.
1884. *Blish, William G. Niles, Michigan, U.S.A.
1869. *BLOMEFIELD, Rev. LEONARD, M.A., F.L.S., F.G.S. 19 Belmont,
Bath.
1880. †Bloxam, G. W., M.A., F.L.S. 11 Chalcot-crescent, Regent's Park,
London, N.W.
1888. §Bloxam, M. 73 Clarendon-road, Crumpsall, Manchester.
1883. †Blumberg, Dr. 65 Hoghton-street, Southport.
1870. †Blundell, Thomas Weld. Ince Blundell Hall, Great Crosby, Lan-
cashire.
1859. †Blunt, Sir Charles, Bart. Heathfield Park, Sussex.
1859. †Blunt, Captain Richard. Bretlands, Chertsey, Surrey.
1885. §BLYTH, JAMES, M.A., F.R.S.E., Professor of Natural Philosophy in
Anderson's College, Glasgow.
Blyth, B. Hall. 135 George-street, Edinburgh.
1883. †Blyth, Miss Phœbe. 3 South Mansion House-road, Edinburgh.
1887. †Blythe, William S. 65 Mosley-street, Manchester.
1867. †Blyth-Martin, W. Y. Blyth House, Newport, Fife.
1870. †Boardman, Edward. Queen-street, Norwich.
1887. *Boddington, Henry. Pownall Hall, Wilmslow, Manchester.
1884. †Body, Rev. C. W. E., M.A. Trinity College, Toronto, Canada.
1871. †Bohn, Mrs. North End House, Twickenham.
1887. *Boissevain, Gideon Maria. 4 Jesselschade-straat, Amsterdam.
1881. †Bojanowski, Dr. Victor de. 27 Finsbury-circus, London, E.C.
1876. †Bolton, J. C. Carbrook, Stirling.
Bond, Henry John Hayes, M.D. Cambridge.
1883. §Bonney, Frederic, F.R.G.S. Colton House, Rugeley, Stafford-
shire.
1883. §Bonney, Miss S. 23 Denning-road, Hampstead, London, N.W.
1871. *BONNEY, Rev. THOMAS GEORGE, D.Sc., LL.D., F.R.S., F.S.A.,
F.G.S., Professor of Geology in University College, London.
23 Denning-road, Hampstead, London, N.W.
1866. †Booker, W. H. Cromwell-terrace, Nottingham.
1888. §Boon, William. Coventry.
1861. †Booth, James. Elmfield, Rochdale.
1883. §Booth, James. Hazelhurst House, Turton.
1883. †Booth, Richard. 4 Stone-buildings, Lincoln's Inn, London, W.C.
1876. †Booth, Rev. William II. St. Germain's-place, Blackheath, London,
S.E.
1883. †Boothroyd, Benjamin. Rawlinson-road, Southport.
1876. *Borland, William. 260 West George-street, Glasgow.
1882. §Borns, Henry, Ph.D., F.C.S. Friedheim, Springfield-road, Wimple-
don, Surrey.
1876. *Bosanquet, R. H. M., M.A., F.C.S., F.R.A.S. St. John's College,
Oxford.
*Bossey, Francis, M.D. Mayfield, Oxford-road, Redhill, Surrey.
1881. §Bothamley, Charles H. Yorkshire College, Leeds.
1867. §Botly, William, F.S.A. Salisbury House, Hamlet-road, Upper
Norwood, London, S.E.
1887. §Bott, Dr. Owens College, Manchester.
1872. †Bottle, Alexander. Dover.
1868. †Bottle, J. T. 28 Nelson-road, Great Yarmouth.
1887. †Bottomley, James, D.Sc., B.A. 220 Lower Broughton-road, Man-
chester.
1871. *BOTTOMLEY, JAMES THOMSON, M.A., F.R.S., F.R.S.E., F.C.S. 13
University-gardens, Glasgow.

Year of
Election.

1884. *Bottomley, Mrs. 13 University-gardens, Glasgow.
 1876. †Bottomley, William, jun. 6 Rokeley-terrace, Hillhead, Glasgow.
 1883. §Bourdass, Isaiiah. 59 Belgrave-road, London, S.W.
 1883. †BOURNE, A. G., D.Sc., F.L.S., Professor of Zoology in the Presidency
 College, Madras.
 1866. §BOURNE, STEPHEN, F.S.S. Abberley, Wallington, Surrey.
 1884. §BOVEY, HENRY T., M.A., Professor of Civil Engineering and
 Applied Mechanics in McGill University, Montreal. Ontario-
 avenue, Montreal, Canada.
 1888. §Bowden, Rev. G. New Kingswood School, Lansdown, Bath.
 1870. †Bower, Anthony. Bowersdale, Seaforth, Liverpool.
 1881. *BOWER, F. O., F.L.S., Professor of Botany in the University of
 Glasgow.
 1867. †Bower, Dr. John. Perth.
 1856. *Bowly, Miss F. E. 23 Lansdowne-parade, Cheltenham.
 1886. †Bowly, Rev. Canon. 101 Newhall-street, Birmingham.
 1884. †Bowley, Edwin. Burnt Ash Hill, Lee, Kent.
 1880. †Bowly, Christopher. Cirencester.
 1887. §Bowly, Mrs. Christopher. Cirencester.
 1865. §Bowman, F. H., D.Sc., F.R.S.E. Halifax, Yorkshire.
 1863. †Bowman, R. Benson. Newcastle-on-Tyne.
 BOWMAN, Sir WILLIAM, Bart., M.D., LL.D., F.R.S., F.R.C.S.
 5 Clifford-street, London, W.
 1887. §Box, Alfred M. Scissett, near Huddersfield.
 1863. †Boyd, Edward Fenwick. Moor House, near Durham.
 1884. *Boyd, M. A., M.D. 30 Merrion-square, Dublin.
 1887. †Boyd, Robert. Manor House, Didsbury, Manchester.
 1871. †Boyd, Thomas J. 41 Moray-place, Edinburgh.
 1865. †BOYLE, The Very Rev. G. D., M.A., Dean of Salisbury. The
 Deanery, Salisbury.
 1884. *Boyle, R. Vicars, C.S.I. Care of Messrs. Grindlay & Co., 55
 Parliament-street, London, S.W.
 1872. *BRABROOK, E. W., F.S.A. 28 Abingdon-street, Westminster, S.W.
 1869. *Braby, Frederick, F.G.S., F.C.S. Bushey Lodge, Teddington,
 Middlesex.
 1884. *Brace, W. H., M.D. 7 Queen's Gate-terrace, London, S.W.
 1880. †Bradford, H. Stretton House, Walters-road, Swansea.
 1857. *Brady, Cheyne, M.R.I.A. Trinity Vicarage, West Bromwich.
 1863. †BRADY, GEORGE S., M.D., F.R.S., F.L.S., Professor of Natural
 History in the Durham College of Science, Newcastle-on-Tyne.
 2 Mowbray-villas, Sunderland.
 1862. †BRADY, HENRY BOWMAN, F.R.S., F.L.S., F.G.S. 5 Robert-street,
 Adelphi. London, W.C.
 1880. *Brady, Rev. Nicholas, M.A. Rainham Hall, Rainham, Romford,
 Essex, E.
 1864. §BRAHAM, PHILIP, F.C.S. Bath.
 1870. †Braidwood, Dr. 35 Park-road South, Birkenhead.
 1888. §Braikenridge, W. J., J.P. 16 Royal-crescent, Bath.
 1879. †Bramley, Herbert. Claremont-crescent, Sheffield.
 1865. §BRAMWELL, Sir FREDERICK J., Bart., D.C.L., F.R.S., M.Inst.C.E.
 (PRESIDENT.) 5 Great George-street, London, S.W.
 1872. †Bramwell, William J. 17 Prince Albert-street, Brighton.
 1867. †Brand, William. Milnefield, Dundee.
 1861. *Brandreth, Rev. Henry. Dickleburgh Rectory, Scole, Norfolk.
 1885. *Bratby, W. Pott-street, Ancoats, Manchester.
 1852. †BRAZIER, JAMES S., F.C.S., Professor of Chemistry in Marischal
 College and University of Aberdeen.

Year of
Election.

1868. †Bremridge, Elias. 17 Bloomsbury-square, London, W.C.
 1877. †Brent, Francis. 19 Clarendon-place, Plymouth.
 1882. *Bretherton, C. E. 1 Garden-court, Temple, London, E.C.
 1881. *Brett, Alfred Thomas, M.D. Watford House, Watford.
 1866. †Brettell, Thomas (Mine Agent). Dudley.
 1875. †Briant, T. Hampton Wick, Kingston-on-Thames.
 1886. §Bridge, T. W., M.A., Professor of Zoology in the Mason Science College, Birmingham.
 1884. †Bridges, C. J. Winnipeg, Canada.
 1870. *Bridson, Joseph R. Sawrey, Windermere.
 1887. §Brierley, John, J.P. The Clough, Whitefield, Manchester.
 1870. †Brierley, Joseph. New Market-street, Blackburn.
 1886. †Brierley, Leonard. Somerset-road, Edgbaston, Birmingham.
 1879. †Brierley, Morgan. Denshaw House, Saddleworth.
 1870. *BRIGG, JOHN. Broomfield, Keighley, Yorkshire.
 1866. *Briggs, Arthur. Cragg Royd, Rawdon, near Leeds.
 1870. †Bright, H. A., M.A., F.R.G.S. Ashfield, Knotty Ash.
 BRIGHT, The Right Hon. JOHN, M.P. Rochdale, Lancashire.
 1868. †Brine, Captain Lindesay, F.R.G.S. United Service Club, Pall Mall, London, S.W.
 1884. †Brisette, M. H. 424 St. Paul-street, Montreal, Canada.
 1879. †Brittain, Frederick. Taptonville-crescent, Sheffield.
 1879. *BRITTAIN, W. H. Storth Oaks, Ranmoor, Sheffield.
 1878. †Britten, James, F.L.S. Department of Botany, British Museum, London, S.W.
 1884. *Brittle, John R., M.Inst.C.E., F.R.S.E. Farad Villa, Vanbrugh Hill, Blackheath, London, S.E.
 1859. *BRODHURST, BERNARD EDWARD, F.R.C.S., F.L.S. 20 Grosvenor-street, Grosvenor-square, London, W.
 1883. *Brodie, David, M.D. Care of J. G. Johnson, Esq., Southwood-court, Highgate, London, N.
 1865. †BRODIE, Rev. PETER BELLINGER, M.A., F.G.S. Rowington Vicarage, near Warwick.
 1884. †Brodie, William, M.D. 64 Lafayette-avenue, Detroit, Michigan, U.S.A.
 1878. *Brook, George, F.L.S. The University, Edinburgh.
 1880. †Brook, G. B. Brynsyfi, Swansea.
 1881. §Brook, Robert G. Rowen-street, St. Helen's, Lancashire.
 1855. †Brooke, Edward. Marsden House, Stockport, Cheshire.
 1864. *Brooke, Rev. Canon J. Ingham. Thornhill Rectory, Dewsbury.
 1855. †Brooke, Peter William. Marsden House, Stockport, Cheshire.
 1888. §Brooke, Rev. Canon R. E., M.A. 14 Marlborough-buildings, Bath.
 1878. †Brooke, Sir Victor, Bart., F.L.S. Colebrook, Brookeborough, Co. Fermanagh.
 1887. §Brooks, James Howard. Green Bank, Monton, Eccles, Manchester.
 1863. †Brooks, John Crosse. 14 Lorain-place, Newcastle-on-Tyne.
 1887. §Brooks, S. H. Slade House, Levenshulme, Manchester.
 1846. *Brooks, Thomas. Cranshaw Hall, Rawtenstall, Manchester.
 1847. †Broome, C. Edward, F.L.S. Elmhurst, Batheaston, near Bath.
 1887. *Bros, W. Law. Sidcup, Kent.
 1883. §Brotherton, E. A. Fern Cliffe, Ilkley, Leeds.
 1886. §Brough, Joseph. University College, Aberystwith.
 1885. *Browett, Alfred. 14 Dean-street, Birmingham.
 1863. *BROWN, ALEXANDER CRUM, M.D., F.R.S. L. & E., F.C.S., Professor of Chemistry in the University of Edinburgh. 8 Belgrave-crescent, Edinburgh.

- Year of Election.
1867. †Brown, Charles Gage, M.D. 88 Sloane-street, London, S.W.
 1855. †Brown, Colin. 192 Hope-street, Glasgow.
 1871. †Brown, David. 93 Abbey-hill, Edinburgh.
 1863. *Brown, Rev. Dixon. Unthank Hall, Haltwhistle, Carlisle.
 1883. §Brown, Mrs. Ellen F. Campbell. 27 Abercromby-square, Liverpool.
 1881. †Brown, Frederick D. 26 St. Giles's-street, Oxford.
 1887. §Brown, George. Cadishead, near Manchester.
 1883. †Brown, George Dransfield. Henley Villa, Ealing, Middlesex, W.
 1884. †Brown, Gerald Culmer. Lachute, Quebec, Canada.
 1883. †Brown, Mrs. H. Bienz. 26 Ferryhill-place, Aberdeen.
 1884. §Brown, Harry. University College, London, W.C.
 1883. †Brown, Mrs. Helen. 52 Grange Loan, Edinburgh.
 1870. †BROWN, HORACE T. 47 High-street, Burton-on-Trent.
 Brown, Hugh. Broadstone, Ayrshire.
 1883. †Brown, Miss Isabella Spring. 52 Grange Loan, Edinburgh.
 1870. *BROWN, Professor J. CAMPBELL, D.Sc., F.C.S. University College, Liverpool.
 1876. §Brown, John. Edenderry House, Belfast.
 1881. *Brown, John, M.D. 68 Bank-parade, Burnley, Lancashire.
 1882. *Brown, John. Swiss Cottage, Park-valley, Nottingham.
 1859. †Brown, Rev. John Crombie, LL.D., F.L.S. Haddington, N.B.
 1882. *Brown, Mrs. Mary. 68 Bank-parade, Burnley, Lancashire.
 1885. †Brown Miss. *Springfield House, Ilkley, Yorkshire.*
 1886. §Brown R., R.N. Laurel Bank, Barnhill, Perth.
 1863. †Brown, Ralph. Lambton's Bank, Newcastle-on-Tyne.
 1871. †BROWN, ROBERT, M.A., Ph.D., F.L.S., F.R.G.S. Fersley, Rydal-road, Streatham, London, S.W.
 1868. †Brown, Samuel, M.Inst.C.E., Government Engineer, Nicosia, Cyprus.
 1850. †Brown, William, F.R.S.E. 25 Dublin-street, Edinburgh.
 1865. †Brown, William. 41A New-street, Birmingham.
 1885. †Brown, W. A. The Court House, Aberdeen.
 1884. †Brown, William George. Ivy, Albemarle Co., Virginia, U.S.A.
 1879. †Browne, Sir J. Crichton, M.D., LL.D., F.R.S. L. & E. 7 Cumberland-terrace, Regent's Park, London, N.W.
 1866. *Browne, Rev. J. H. Lowdham Vicarage, Nottingham.
 1862. *Browne, Robert Clayton, jun., B.A. Browne's Hill, Carlow, Ireland.
 1872. †Browne, R. Mackley, F.G.S. Redcot, Bradbourne, Sevenoaks, Kent.
 1865. *Browne, William, M.D. Heath Wood, Leighton Buzzard.
 1887. †Brownell, T. W. 6 St. James's-square, Manchester.
 1865. †Browning, John, F.R.A.S. 63 Strand, London, W.C.
 1883. †Browning, Oscar, M.A. King's College, Cambridge.
 1855. †Brownlee, James, jun. 30 Burnbank-gardens, Glasgow.
 1863. *Brunel, H. M. 23 Delahay-street, Westminster, S.W.
 1863. †Brunel, J. 23 Delahay-street, Westminster, S.W.
 1875. *BRUNLEES, Sir JAMES, F.R.S.E., F.G.S., M.Inst.C.E. 5 Victoria-street, Westminster, S.W.
 1875. †Brunlees, John. 5 Victoria-street, Westminster, S.W.
 1868. †BRUNTON, T. LAUDER, M.D., D.Sc., F.R.S. 10 Stratford-place, Oxford-street, London, W.
 1878. §Brutton, Joseph. Yeovil.
 1886. *Bryan, G. H. Trumpington-road, Cambridge.
 1877. †Bryant George. 82 Claverton-street, Pimlico, London, S.W.
 1884. †Bryce, Rev. Professor George. The College, Manitoba, Canada.
 BRYCE, Rev. R. J., LL.D. Fitzroy-avenue, Belfast.
 1859. †Bryson, William Gillespie. Cullen, Aberdeen.

Year of
Election.

1871. §BUCHAN, ALEXANDER, M.A., LL.D., F.R.S.E., Sec. Scottish Meteorological Society. 72 Northumberland-street, Edinburgh.
1867. †Buchan, Thomas. Strawberry Bank, Dundee.
1885. *Buchan, William Paton. Fairyknowe, Cambuslang, N.B.
Buchanan, Archibald. Catrine, Ayrshire.
Buchanan, D. C. 12 Barnard-road, Birkenhead, Cheshire.
1881. *Buchanan, John H., M.D. Sowerby, Thirsk.
1871. †BUCHANAN, JOHN YOUNG, M.A., F.R.S., L. & E. 10 Moray-place, Edinburgh.
1884. †Buchanan, W. Frederick. Winnipeg, Canada.
1883. §Buckland, Miss A. W. 54 Doughty-street, London, W.C.
1886. *Buckle, Edmund W. 23 Bedford-row, London, W.C.
1864. §BUCKLE, Rev. GEORGE, M.A. The Rectory, Weston-super-Mare.
1865. *Buckley, Henry. 27 Wheeley's-road, Edgbaston, Birmingham.
1886. §Buckley, Samuel. 76 Clyde-road, Albert-park, Didsbury.
1884. *Buckmaster, Charles Alexander, M.A., F.C.S. Science and Art Department, South Kensington, London, S.W.
1880. †Buckney, Thomas, F.R.A.S. 53 Gower-street, London, W.C.
1869. †Bucknill, J. C., M.D., F.R.S. E 2 Albany, London, W.
1851. *BUCKTON, GEORGE BOWDLER, F.R.S., F.L.S., F.C.S. Weycombe, Haslemere, Surrey.
1887. †Budenberg, C. F., B.Sc. Buckau Villa, Demesne-road, Whalley Range, Manchester.
1875. §Budgett, Samuel. Cotham House, Bristol.
1883. †Buick, Rev. George R., M.A. Cullybackey, Co. Antrim, Ireland.
1871. †Bulloch, Matthew. 4 Bothwell-street, Glasgow.
1881. †Bulmer, T. P. Mount-villas, York.
1883. †Bulpit, Rev. F. W. Crossens Rectory, Southport.
1865. †Bunce, John Mackray. 'Journal' Office, New-street, Birmingham.
1863. †Bunning, T. Wood. Institute of Mining and Mechanical Engineers, Newcastle-on-Tyne.
1886. †Burbury, S. H. 1 New-square, Lincoln's Inn, London, W.C.
1842. *Burd, John. 5 Gower-street, London, W.C.
1875. †Burder, John, M.D. 7 South-parade, Bristol.
1869. †Burdett-Coutts, Baroness. 1 Stratton-street, Piccadilly, London, W.
1881. †Burdett-Coutts, W. L. A. B., M.P. 1 Stratton-street, Piccadilly, London, W.
1884. *Burland, Jeffrey H. 287 University-street, Montreal, Canada.
1888. §Burne, H. Holland. 28 Marlborough-buildings, Bath.
1883. *Burne, Colonel Sir Owen Tudor, K.C.S.I., C.I.E., F.R.G.S. 57 Sutherland-gardens, Maida Vale, London, W.
1876. †Burnet, John. 14 Victoria-crescent, Dowanhill, Glasgow.
1885. *Burnett, W. Kendall, M.A. The Grove, Kemnay, Aberdeenshire.
1877. †Burns, David. Alston, Carlisle.
1884. †Burns, Professor James Austin. Southern Medical College, Atlanta, Georgia, U.S.A.
1883. †Burr, Percy J. 20 Little Britain, London, E.C.
1887. †Burroughs, Eggleston, M.D. Snow Hill-buildings, London, E.C.
1881. §Burroughs, S. M. Snow Hill-buildings, London, E.C.
1883. *Burrows, Abraham. Greenhall, Atherton, near Manchester.
1860. †Burrows, Montague, M.A., Professor of Modern History, Oxford.
1888. §Burt, John Mowlem. 3 St. John's-gardens, Kensington, London, W.
1888. †Burt, Mrs. 3 St. John's-gardens, Kensington, London, W.
1866. *BURTON, FREDERICK M., F.G.S. Highfield, Gainsborough.
1887. *Bury, Henry. Trinity College, Cambridge.
1878. †BUTCHER, J. G., M.A. 22 Collingham-place, London, S.W.
1884. *Butcher, William Deane, M.R.C.S.Eng. Clydesdale, Windsor.

- Year of
Election
1884. †Butler, Matthew I. Napanee, Ontario, Canada.
 1888. §Buttanshaw, Rev. John. 22 St. James's-square, Bath.
 1884. *Butterworth, W. Greenhill, Church-lane, Harpurhey, Manchester.
 1872. †Buxton, Charles Louis. Cromer, Norfolk.
 1870. †Buxton, David, Ph.D. 298 Regent-street, London, W.
 1883. †Buxton, Miss F. M. Newnham College, Cambridge.
 1887. *Buxton, J. H. 'Guardian' Office, Manchester.
 1868. †Buxton, S. Gurney. Catton Hall, Norwich.
 1881. †Buxton, Sydney. 15 Eaton-place, London, S.W.
 1883. †Buxton, Rev. Thomas, M.A. 19 Westcliffe-road, Birkdale, Southport.
 1872. †Buxton, Sir Thomas Fowell, Bart., F.R.G.S. Warlies, Waltham Abbey, Essex.
 1854. †BYERLEY, ISAAC, F.L.S. Seacombe, Cheshire.
 1885. †Byres, David. 63 North Bradford, Aberdeen.
 1852. †Byrne, Very Rev. James. Ergenagh Rectory, Omagh.
 1883. §Byrom, John R. Mere Bank, Fairfield, near Manchester.
 1875. †Byrom, W. Ascroft, F.G.S. 31 King-street, Wigan.
1863. †Cail, Richard. Beaconsfield, Gateshead.
 1863. †Caird, Edward. Finnart, Dumbartonshire.
 1876. †Caird, Edward B. 8 Scotland-street, Glasgow.
 1861. *Caird, James Key. 8 Magdalene-road, Dundee.
 1875. †Caldicott, Rev. J. W., D.D. The Rectory, Shipston-on-Stour.
 1886. *Caldwell, William Hay. 12 Harvey-road, Cambridge.
 1868. †Caley, A. J. Norwich.
 1857. †Callan, Rev. N. J., Professor of Natural Philosophy in Maynooth College.
 1887. §CALLAWAY CHARLES, M.A., D.Sc., F.G.S. Sandon, Wellington, Shropshire.
 1854. †Calver, Captain E. K., R.N., F.R.S. 23 Park-place East, Sunderland, Durham.
1884. †Cameron, Æneas. Yarmouth, Nova Scotia, Canada.
 1876. †Cameron, Charles, M.D., LL.D., M.P. 1 Huntly-gardens, Glasgow.
 1857. †CAMERON, Sir CHARLES A., M.D. 15 Pembroke-road, Dublin.
 1884. †Cameron, James C., M.D. 41 Belmont-park, Montreal, Canada.
 1870. †Cameron, John, M.D. 17 Rodney-street, Liverpool.
 1881. †Cameron, Major-General, C.B. 3 Driffield-terrace, York.
 1884. †Campbell, Archibald H. Toronto, Canada.
 1874. *CAMPBELL, Sir GEORGE, K.C.S.I., M.P., D.C.L., F.R.G.S., F.S.S. Southwell House, Southwell-gardens, South Kensington, London, S.W.; and Edenwood, Cupar, Fife.
1883. †Campbell, H. J. 81 Kirkstall-road, Talfourd Park, Streatham Hill, S.W.
 Campbell, Sir Hugh P. H., Bart. 10 Hill-street, Berkeley-square, London, W.; and Marchmont House, near Dunse, Berwickshire.
 1876. †Campbell, James A., LL.D., M.P. Stracathro House, Brechin.
 Campbell, John Archibald, M.D., F.R.S.E. Albyn-place, Edinburgh.
1859. †Campbell, William. Dunmore, Argyllshire.
 1862. *CAMPION, Rev. WILLIAM M., D.D. Queen's College, Cambridge.
 1882. †Candy, F. H. 71 High-street, Southampton.
 1888. §Cappel, Sir Albert J. L., K.C.I.E. 14 Harrington-gardens, London, W.
1880. †Capper, Robert. Westbrook, Swansea.
 1883. †Capper, Mrs. R. Westbrook, Swansea.
 1887. †Capstick, John Walton. University College, Dundee.

- Year of Election.
1873. *CARBUTT, EDWARD HAMER. 19 Hyde Park-gardens, London, W.
1883. †Carey-Hobson, Mrs. 54 Doughty-street, London, W.C.
1877. †Carkeet, John. 3 St. Andrew's-place, Plymouth.
1876. †Carlie, Thomas. 5 St. James's-terrace, Glasgow.
- CARLISLE, The Right Rev. HARVEY GOODWIN, D.D., D.C.L., Lord Bishop of Carlisle.
1867. †Carmichael, David (Engineer). Dundee.
1867. †Carmichael, George. 11 Dudhope-terrace, Dundee.
1876. †Carmichael, Neil, M.D. 22 South Cumberland-street, Glasgow.
1884. †Carnegie, John. Peterborough, Ontario, Canada.
1885. *CARNELLEY, THOMAS, D.Sc., Professor of Chemistry in University College, Dundee.
1887. §Carpenter, A., M.D. Duppas House, Croydon.
1884. §Carpenter, Louis G. Agricultural College, Lansing, Michigan, U.S.A.
1871. *CARPENTER, P. HERBERT, D.Sc., F.R.S. Eton College, Windsor.
1854. †Carpenter, Rev. R. Lant, B.A. Bridport.
1872. §CARPENTER, WILLIAM LANT, B.A., B.Sc., F.C.S. 36 Craven-park, Harlesden, London, N.W.
1888. *Carpmael, Alfred. 1 Cophall-buildings, London, E.C.
1884. *Carpmael, Charles. Toronto, Canada.
1867. †CARRUTHERS, WILLIAM, Pres.L.S., F.R.S., F.G.S. British Museum, London, S.W.
1886. †CARSLAKE J. BARHAM. 30 Westfield-road, Birmingham.
1883. †Carson, John. 51 Royal Avenue, Belfast.
1861. *Carson, Rev. Joseph, D.D., M.R.I.A. 18 Fitzwilliam-place, Dublin.
1868. †Carteighe, Michael, F.C.S. 172 New Bond-street, London, W.
1866. †Carter, H. H. The Park, Nottingham.
1855. †Carter, Richard, F.G.S. Cockerham Hall, Barnsley, Yorkshire.
1870. †Carter, Dr. William. 78 Rodney-street, Liverpool.
1883. †Carter, W. C. Manchester and Salford Bank, Southport.
1883. †Carter, Mrs. Manchester and Salford Bank, Southport.
1878. *Cartwright, E. Henry. Magherafelt Manor, Co. Derry.
1870. §Cartwright, Joshua, M.Inst.C.E., Borough Surveyor. Bury, Lancashire.
1884. *Carver, Rev. Canon Alfred J., D.D., F.R.G.S. Lynnhurst, Streatham Common, London, S.W.
1884. †Carver, Mrs. Lynnhurst, Streatham Common, London, S.W.
1883. †Carver, James. Garfield House, Elm-avenue, Nottingham.
1887. †Casartelli, Rev. L. C., M.A., Ph.D. St. Bede's College, Manchester.
1866. †Casella, L. P., F.R.A.S. The Lawns, Highgate, London, N.
1878. †Casey, John, LL.D., F.R.S., M.R.I.A., Professor of Higher Mathematics in the Catholic University of Ireland. 86 South Circular-road, Dublin.
1871. †Cash, Joseph. Bird-grove, Coventry.
1873. *Cash, William, F.G.S. 38 Elmfield-terrace, Saville Park, Halifax.
- Castle, Charles. Clifton, Bristol.
1888. §Cater, R. B. Avondale, Henrietta Park, Bath.
1874. †Caton, Richard, M.D., Lecturer on Physiology at the Liverpool Medical School. 18 Croxteth-road, Liverpool.
1859. †Catto, Robert. 44 King-street, Aberdeen.
1884. *Cave, Herbert. Christ Church, Oxford.
1887. §Cawley, George. 3 Lansdowne-road, Didsbury, Manchester.
1886. †Cay, Albert. Ashleigh, Westbourne-road, Birmingham.
1860. §CAYLEY, ARTHUR, M.A., D.C.L., LL.D., F.R.S., V.P.R.A.S., Sadlerian Professor of Pure Mathematics in the University of Cambridge. Garden House, Cambridge.
- Cayley, Digby. Brompton, near Scarborough.

Year of
Election.

- Cayley, Edward Stillingfleet. Wydale, Malton, Yorkshire.
 1871. *Cecil, Lord Sackville. Hayes Common, Beckenham, Kent.
 1870. †Chadburn, C. H. Lord-street, Liverpool.
 1860. †CHADWICK, DAVID. The Poplars, Herne Hill, London, S.E.
 1842. CHADWICK, EDWIN, C.B. Park Cottage, East Sheen, Middlesex,
 S.W.
 1883. †Chadwick, James Percy. 51 Alexandra-road, Southport.
 1859. †Chadwick, Robert. Highbank, Manchester.
 1883. †Chalk, William. 24 Gloucester-road, Birkdale, Southport.
 1859. †Chalmers, John Inglis. Aldbar, Aberdeen.
 1883. †Chamberlain, George, J.P. Helensholme, Birkdale Park, Southport.
 1884. †Chamberlain, Montague. St. John's, New Brunswick, Canada.
 1883. †Chambers, Benjamin. *Hawkshead-street South, Southport.*
 1883. †CHAMBERS, CHARLES, F.R.S. Colába Observatory, Bombay.
 1883. †Chambers, Mrs. Colába Observatory, Bombay.
 1883. †Chambers, Charles, jun. *The College, Cooper's Hill, Staines.*
 1842. Chambers, George. High Green, Sheffield.
 1868. †Chambers, W. O. Lowestoft, Suffolk.
 *Champney, Henry Nelson. 4 New-street, York.
 1881. *Champney, John E. Woodlands, Halifax.
 1865. †Chance, A. M. Edgbaston, Birmingham.
 1865. *Chance, James T. 51 Prince's-gate, London, S.W.
 1886. *Chance, John Horner. 40 Augustus-road, Edgbaston, Birmingham.
 1865. †Chance, Robert Lucas. Chad Hill, Edgbaston, Birmingham.
 1888. §Chandler, S. Whitty, B.A. Sherborne, Dorset.
 1861. *Chapman, Edward, M.A., F.L.S., F.C.S. Hill End, Mottram, Man-
 chester.
 1884. †Chapman, Professor. University College, Toronto, Canada.
 1877. §Chapman, T. Algernon, M.D. Burghill, Hereford.
 1874. †Charles, John James, M.A., M.D. 11 Fisherwick-place, Belfast.
 1836. CHARLESWORTH, EDWARD, F.G.S. 277 Strand, London, W.C.
 1874. †Charley, William. Seymour Hill, Dunmurry, Ireland.
 1866. †CHARNOCK, RICHARD STEPHEN, Ph.D., F.S.A., F.R.G.S. Junior
 Garrick Club, Adelphi-terrace, London, W.C.
 1886. †Chate, Robert W. Southfield, Edgbaston, Birmingham.
 1883. †Chater, Rev. John. Part-street, Southport.
 1884. *Chatterton, George, M.A., M.Inst.C.E. 46 Queen Anne's-gate, Lon-
 don, S.W.
 1886. §Chattock, A. P. 15 Lancaster-road, Belsize Park, London, N.W.
 1867. *Chatwood, Samuel, F.R.G.S. Irwell House, Drinkwater Park,
 Prestwich.
 1884. †CHAUVÉAU, The Hon. Dr. Montreal, Canada.
 1883. †Chawner, W., M.A. Emmanuel College, Cambridge.
 1864. †CHEADLE, W. B., M.A., M.D., F.R.G.S. 2 Hyde Park-place, Cum-
 berland-gate, London, S.W.
 1887. §Cheetham, F. W. Limefield House, Hyde.
 1887. †Cheetham, John. Limefield House, Hyde.
 1874. *Chermside, Lieut.-Colonel H. C., R.E., C.B. Care of Messrs. Cox &
 Co., Craig's-court, Charing Cross, London, S.W.
 1884. †Cherriman, Professor J. B. Ottawa, Canada.
 1879. *Chesterman, W. Broomsgrove-road, Sheffield.
 CHICHESTER, The Right Rev. RICHARD DURNFORD, D.D., Lord
 Bishop of. Chichester.
 1865. *Child, Gilbert W., M.A., M.D., F.L.S. Cowley House, Oxford.
 1883. §Chinery, Edward F. Monmouth House, Lymington.
 1884. †Chipman, W. W. L. 6 Place d'Armes, Ontario, Canada.
 1842. *Chiswell, Thomas. 17 Lincoln-grove, Plymouth-grove, Manchester.

Year of
Election.

1863. †Cholmeley, Rev. C. H. Dinton Rectory, Salisbury.
 1882. †Chorley, George. Midhurst, Sussex.
 1887. †Chorlton, J. Clayton. New Holme, Withington, Manchester.
 1861. †Christie, Professor R. C., M.A. 7 St. James's-square, Manchester.
 1884. *Christie, William. 13 Queen's Park, Toronto, Canada.
 1875. *Christopher, George, F.C.S. 6 Barrow-road, Streatham Common, London, S.W.
 1876. *CHRISTAL, GEORGE, M.A., F.R.S.E., Professor of Mathematics in the University of Edinburgh. 5 Belgrave-crescent, Edinburgh.
 1870. §CHURCH, A. H., M.A., F.R.S., F.C.S., Professor of Chemistry to the Royal Academy of Arts, London. Shelsley, Ennerdale-road, Kew, Surrey.
 1860. †Church, William Selby, M.A. St. Bartholomew's Hospital, London, E.C.
 1881. †CHURCHILL, Lord ALFRED SPENCER. 16 Rutland-gate, London, S.W.
 1857. †Churchill, F., M.D. Ardrea Rectory, Stewartstown, Co. Tyrone.
 1868. †Clabburn, W. H. Thorpe, Norwich.
 1869. *Clapp, Frederick. Roseneath, St. James's-road, Exeter.
 1857. †Clarendon, Frederick Villiers. 1 Belvidere-place, Mountjoy-square, Dublin.
 1876. †Clark, David R., M.A. 31 Waterloo-street, Glasgow.
 1877. *Clark, F. J. Street, Somerset.
 Clark, George T. 44 Berkeley-square, London, W.
 1876. †Clark, George W. 31 Waterloo-street, Glasgow.
 1876. †Clark, Dr. John. 138 Bath-street, Glasgow.
 1881. †Clark, J. Edmund, B.A., B.Sc., F.G.S. 20 Bootham, York.
 1861. †Clark, Latimer. 5 Westminster-chambers, Victoria-street, London, S.W.
 1855. †Clark, Rev. William, M.A. Barrhead, near Glasgow.
 1883. †Clarke, Rev. Canon, D.D. 59 Hoghton-street, Southport.
 1887. §Clarke, C. Goddard. Folkestone Villa, Elm-grove, Peckham, S.E.
 1865. †Clarke, Rev. Charles. Charlotte-road, Edgbaston, Birmingham.
 1875. †Clarke, Charles S. 4 Worcester-terrace, Clifton, Bristol.
 1886. †Clarke, David. Langley-road, Small Heath, Birmingham.
 Clarke, George. Mosley-street, Manchester.
 1886. §Clarke, Rev. H. J. Great Barr Vicarage, Birmingham.
 1872. *CLARKE, HYDE. 32 St. George's-square, Pimlico, London, S.W.
 1875. †CLARKE, JOHN HENRY. 4 Worcester-terrace, Clifton, Bristol.
 1861. *Clarke, John Hope. 62 Nelson-street, Chorlton-on-Medlock, Manchester.
 1877. †Clarke, Professor John W. University of Chicago, Illinois, U.S.A.
 1851. †CLARKE, JOSHUA, F.L.S. Fairycroft, Saffron Walden.
 Clarke, Thomas, M.A. Knedlington Manor, Howden, Yorkshire.
 1883. †Clarke, W. P., J.P. 15 Hesketh-street, Southport.
 1884. †Claxton, T. James. 461 St. Urbain-street, Montreal, Canada.
 1861. †Clay, Charles, M.D. 101 Piccadilly, Manchester.
 *Clay, Joseph Travis, F.G.S. Rastrick, near Brighouse, Yorkshire.
 1866. †Clayden, P. W. 13 Tavistock-square, London, W.C.
 1850. †CLEGHORN, HUGH, M.D., F.L.S. Stravithie, St. Andrews, Scotland.
 1859. †Cleghorn, John. Wick.
 1875. †Clegram, T. W. B. Saul Lodge, near Stonehouse, Gloucestershire.
 1861. §CLEBLAND, JOHN, M.D., D.Sc., F.R.S., Professor of Anatomy in the University of Glasgow. 2 College, Glasgow.
 1873. †Cliff, John, F.G.S. Nesbit Hall, Fulneck, Leeds.
 1886. †Clifford, Arthur. Beechcroft, Edgbaston, Birmingham.

Year of
Election.

1883. † *Clift, Frederic, LL.D. Norwood, Surrey.*
 1888. § CLIFTON, The Right Rev. the Bishop of, D.D. Bishop's House, Clifton, Bristol.
 1861. *CLIFTON, R. BELLAMY, M.A., F.R.S., F.R.A.S., Professor of Experimental Philosophy in the University of Oxford. Portland Lodge, Park Town, Oxford.
 Clonbrock, Lord Robert. Clonbrock, Galway.
 1878. § Close, Rev. Maxwell H., F.G.S. 40 Lower Baggot-street, Dublin.
 1873. † Clough, John. Bracken Bank, Keighley, Yorkshire.
 1883. *CLOWES, FRANK, D.Sc., F.C.S., Professor of Chemistry in University College, Nottingham. University College, Nottingham.
 1863. *Clutterbuck, Thomas. Warkworth, Acklington.
 1881. *Clutton, William James. The Mount, York.
 1885. § Clyne James. Rubislaw Den South, Aberdeen.
 1868. † Coaks, J. B. Thorpe, Norwich.
 1855. *Coats, Sir Peter. Woodside, Paisley.
 Cobb, Edward. Falkland House, St. Ann's, Lewes.
 1884. § Cobb, John. 29 Clarendon-road, Leeds.
 1864. *Cochrane, James Henry. Elm Lodge, Prestbury, Cheltenham.
 1884. *Cockburn-Hood, J. J. Walton Hall, Kelso, N.B.
 1883. † Cockshott, J. J. 24 Queen's-road, Southport.
 1861. *Coe, Rev. Charles C., F.R.G.S. Fairfield, Heaton, Bolton.
 1881. *COFFIN, WALTER HARRIS, F.C.S. 94 Cornwall-gardens, South Kensington, London, S.W.
 1865. † Coghill, H. Newcastle-under-Lyme.
 1884. *Cohen, B. L. 30 Hyde Park-gardens, London, W.
 1887. § Cohen, Julius B. Hawkesmoor, Wilbraham-road, Fallowfield, Manchester.
 1887. † Cohen, Sigismund. 111 Portland-street, Manchester.
 1876. † *Colbourn, E. Rushton. 5 Marchmont-terrace, Hillhead, Glasgow.*
 1853. † Colchester, William, F.G.S. Springfield House, Ipswich.
 1868. † Colchester, W. P. Bassingbourn, Royston.
 1879. † Cole, Skelton. 387 Glossop-road, Sheffield.
 1876. † Colebrooke, Sir T. E., Bart., F.R.G.S. 14 South-street, Park-lane, London, W.; and Abington House, Abington, N.B.
 1860. † COLEMAN, J. J., F.C.S. Ardarrade, Bearsden, near Glasgow.
 1878. † Coles, John, Curator of the Map Collection R.G.S. 1 Savile-row, London, W.
 1854. *Colfox, William, B.A. Westmead, Bridport, Dorsetshire.
 1857. † Colles, William, M.D. 21 Stephen's-green, Dublin.
 1887. † Collie, Norman. University College, Gower-street, London, W.C.
 1887. † Collier, Thomas. Ashfield, Alderley Edge, Manchester.
 1869. † Collier, W. F. Woodtown, Horrabridge, South Devon.
 1854. † COLLINGWOOD, CUTHBERT, M.A., M.B., F.L.S. 2 Gipsy Hill-villas, Upper Norwood, Surrey, S.E.
 1861. *Collingwood, J. Frederick, F.G.S. 96 Great Portland-street, London, W.
 1865. *Collins, James Tertius. Churchfield, Edgbaston, Birmingham.
 1876. † COLLINS, J. H., F.G.S. 64 Bickerton-road, London, N.
 1876. † Collins, Sir William. 3 Park-terrace East, Glasgow.
 1884. § Collins, William J., M.D., B.Sc. Albert-terrace, Regent's Park, London, N.W.
 1883. † *Collis W. Elliott. 3 Lincoln's-Inn-fields, London, W.C.*
 1868. *COLMAN, J. J., M.P. Carrow House, Norwich; and 108 Cannon-street, London, E.C.
 1882. † Colmer, Joseph G., C.M.G. Office of the High Commissioner for Canada, 9 Victoria-chambers, London, S.W.

- Year of Election.
1884. †Colomb, Capt. J. C. R., M.P., F.R.G.S. Dromquinna, Kenmare, Kerry, Ireland; and Junior United Service Club, London, S.W.
1870. †Coltart, Robert. Aigburth-drive, Sefton Park, Liverpool.
1888. §Commans, R. D. Macaulay-buildings, Bath.
1884. †Common, A. A., F.R.S., F.R.A.S. 63 Eaton-rise, Ealing, Middlesex, W.
1884. §Conklin, Dr. William A. Central Park, New York, U.S.A.
1852. †Connal, Sir Michael. 16 Lynedock-terrace, Glasgow.
1871. *Connor, Charles C. Notting Hill House, Belfast.
1881. †CONROY, Sir JOHN, Bart. Arborfield, Reading, Berks.
1876. †Cook, James. 162 North-street, Glasgow.
1882. †COOKE, Major-General A. C., R.E., C.B., F.R.G.S., Director-General of the Ordnance Survey. Southampton.
1876. *COOKE, CONRAD W. 2 Victoria-mansions, Victoria-street, London, S.W.
1881. †Cooke, F. Bishophill, York.
1868. †Cooke, Rev. George H. Wanstead Vicarage, near Norwich.
Cooke, J. B. Cavendish-road, Birkenhead.
1868. †COOKE, M. C., M.A. 2 Grosvenor-villas, Upper Holloway, London, N.
1884. †Cooke, R. P. Brockville, Ontario, Canada.
1878. †Cooke, Samuel, M.A., F.G.S. Poona, Bombay.
1881. †Cooke, Thomas. Bishophill, York.
1859. *Cooke, His Honour Judge, M.A., F.S.A. 42 Wimpole-street, London, W.; and Rainthorpe Hall, Long Stratton.
1883. §Cooke-Taylor, R. Whateley. Frenchwood House, Preston.
1883. †Cooke-Taylor, Mrs. Frenchwood House, Preston.
1865. †Cooksey, Joseph. West Bromwich, Birmingham.
1888. §Cooley, George Parkin. Cavendish Hill, Sherwood, Nottingham.
1883. †Coomer, John. Willaston, near Nantwich.
1884. †Coon, John S. 604 Main-street, Cambridge Pt., Massachusetts, U.S.A.
1883. †Cooper, George B. 67 Great Russell-street, London, W.C.
1850. †COOPER, Sir HENRY, M.D. 7 Charlotte-street, Hull.
1838. Cooper, James. 58 Pembridge-villas, Bayswater, London, W.
1884. †Cooper, Mrs. M. A. West Tower, Marple, Cheshire.
1868. †Cooper, W. J. *The Old Palace, Richmond, Surrey.*
1846. †Cooper, William White, F.R.C.S. 19 Berkeley-square, London, W.
1884. †Cope, E. D. Philadelphia, U.S.A.
1878. †Cope, Rev. S. W. Bramley, Leeds.
1871. †Copeland, Ralph, Ph.D., F.R.A.S., Astronomer Royal for Scotland and Professor of Astronomy in the University of Edinburgh.
1885. †Copland, W., M.A. Tortorston, Peterhead, N.B.
1881. †Copperthwaite, H. Holgate Villa, Holgate-lane, York.
1863. †Coppin, John. North Shields.
1842. Corbett, Edward. Grange-avenue, Levenshulme, Manchester.
1887. *Corcoran, Bryan. 31 Mark-lane, London, E.C.
1881. §Cordeaux, John. Great Cotes, Ulceby, Lincolnshire.
1883. *Core, Thomas H. Fallowfield, Manchester.
1870. *CORFIELD, W. H., M.A., M.D., F.C.S., F.G.S., Professor of Hygiène and Public Health in University College. 19 Savile-row, London, W.
1884. *Cornwallis, F. S. W. Linton Park, Maidstone.
1885. †Corry, John. Rosenheim, Parkhill-road, Croydon.
1888. §Corser, Rev. Richard K. 12 Beaufort-buildings East, Bath.
1888. §Cossham, Handel, M.P., F.G.S. Weston Park, Bath.
1886. †Cossins, Jethro A. Warwick-chambers, Corporation-street, Birmingham.

Year of
Election.

1883. †Costelloe, B. F. C., M.A., B.Sc. 33 Chancery-lane, London, W.C.
Cottam, George. 2 Winsley-street, London, W.
1857. †Cottam, Samuel. King-street, Manchester.
1874. *COTTERILL, J. H., M.A., F.R.S., Professor of Applied Mechanics.
Royal Naval College, Greenwich, S.E.
1864. †COTTON, General FREDERICK C., R.E., C.S.I. 13 Longridge-road,
Earl's Court-road, London, S.W.
1869. †COTTON, WILLIAM. Pennsylvania, Exeter.
1879. †Cottrill, Gilbert I. Shepton Mallett, Somerset.
1876. †Couper, James. City Glass Works, Glasgow.
1876. †Couper, James, jun. City Glass Works, Glasgow.
1874. †Courtauld, John M. Bocking Bridge, Braintree, Essex.
1834. †Cowan, Charles. 38 West Register-street, Edinburgh.
Cowan, John. Valleyfield, Pennycuick, Edinburgh.
1863. †Cowan, John A. Blaydon Burn, Durham.
1863. †Cowan, Joseph, jun. Blaydon, Durham.
1876. †Cowan, J. B., M.D. 4 Eglinton-crescent, Edinburgh.
1872. *Cowan, Thomas William, F.G.S. Comptons Lea, Horsham.
1886. §Cowan, Mrs. G. R. 9 The Ropewalk, Nottingham.
Cowie, The Very Rev. Benjamin Morgan, M.A., D.D., Dean of
Exeter. The Deanery, Exeter.
1871. †Cowper, C. E. 6 Great George-street, Westminster, S.W.
1860. †Cowper, Edward Alfred, M.Inst.C.E. 6 Great George-street,
Westminster, S.W.
1867. *Cox, Edward. Lyndhurst, Dundee.
1867. *Cox, George Addison. Beechwood, Dundee.
1882. †Cox, Thomas A., District Engineer of the S., P., and D. Railway.
Lahore, Punjab. Care of Messrs. Grindlay & Co., Parliament-
street, London, S.W.
1867. *COX, Thomas Hunter. Duncarse, Dundee.
1888. §Cox, Thomas W. B. The Chesnuts, Lansdown, Bath.
1867. †Cox, William. Foggley, Lochee, by Dundee.
1883. §Crabtree, William, M.Inst.C.E. Manchester-road, Southport.
1884. §CRAIGIE, Major P. G., F.S.S. 6 Lyndhurst-road, Hampstead,
London, N.W.
1876. †Cramb, John. Larch Villa, Helensburgh, N.B.
1858. †Cranage, Edward, Ph.D. The Old Hall, Wellington, Shropshire.
1884. †Crathern, James. Sherbrooke-street, Montreal, Canada.
1887. †Craven, John. Smedley Lodge, Cheetham, Manchester.
1887. *Craven, Thomas, J.P. Merlewood, Chorlton-cum-Hardy, Manchester.
1876. †Crawford, *Chalmond. Ridemon, Crosscar.*
1871. *Crawford, William Caldwell, M.A. 1 Lockharton-gardens, Slate-
ford, Edinburgh.
1871. *CRAWFORD AND BALCARRES, The Right Hon. the Earl of, LL.D.,
F.R.S., F.R.A.S. The Observatory, Dun Echt, Aberdeen.
1883. *Crawshaw, Edward. 25 Tollington-park, London, N.
1870. *Crawshay, Mrs. Robert. Cathedine, Bwlch, Breconshire.
1885. §Creak, Staff Commander E. W., R.N., F.R.S. Richmond Lodge,
Blackheath, London, S.E.
1879. †Creswick, Nathaniel. Chantry Grange, near Sheffield.
1888. §Crew, E. G. 20 Redland-park, Clifton, Bristol.
1876. *Crewdson, Rev. George. St. George's Vicarage, Kendal.
1887. *Crewdson, Theodore. Norcliffe Hall, Styal, Cheshire.
1880. *Crisp, Frank, B.A., LL.B., F.L.S. 5 Lansdowne-road, Notting Hill,
London, W.
1878. †Croke, John O'Byrne, M.A. 12 Plevna-terrace, St. Mary's-road,
Dublin.

Year of
Election.

1859. †Croll, A. A. 10 Coleman-street, London, E.C.
 1857. †Croll, Rev. George. Maynooth College, Ireland.
 1885. †Crombie, Charles W. 41 Carden-place, Aberdeen.
 1885. †Crombie, John. Balgownie Lodge, Aberdeen.
 1885. †Crombie, John, jun. Daveston, Aberdeen.
 1885. †CROMBIE, J. W., M.A. Balgownie Lodge, Aberdeen.
 1885. †Crombie, Theodore. 18 Albyn-place, Aberdeen.
 1887. †Crompton, A. 1 St. James's-square, Manchester.
 1886. †Crompton, Dickinson W. 40 Harborne-road, Edgbaston, Birmingham.
 1887. §Crook, Henry T. 9 Albert-square, Manchester.
 1870. †Crookes, Joseph. Marlborough House, Brook Green, Hammersmith, London, W.
 1865. §CROOKES, WILLIAM, F.R.S., F.C.S. 7 Kensington Park-gardens, London, W.
 1879. †Crookes, Mrs. 7 Kensington Park-gardens, London, W.
 1855. *Cropper, Rev. John. 8 The Polygon, Eccles, near Manchester.
 1870. †Crosfield, C. J. Holmfield, Aigburth, Liverpool.
 1870. *Crosfield, William. Annesley, Aigburth, Liverpool.
 1887. §Cross, John. Beancliffe, Alderley Edge, Cheshire.
 1861. †Cross, Rev. John Edward, M.A. Appleby Vicarage, near Brigg.
 1883. †Cross, Rev. Prebendary, LL.B. Part-street, Southport.
 1868. †Crosse, Thomas William. St. Giles's-street, Norwich.
 1886. †Croskey, Cecil. 117 Gough-road, Birmingham.
 1867. §CROSSKEY, Rev. H. W., LL.D., F.G.S. 117 Gough-road, Birmingham.
 1853. †Crosskill, William. Beverley, Yorkshire.
 1870. *Crossley, Edward, M.P., F.R.A.S. Bemerside, Halifax.
 1871. †Crossley, Herbert. Ferney Green, Bowness, Ambleside.
 1866. *Crossley, Louis J., F.R.M.S. Moorside Observatory, near Halifax.
 1887. *Crossley, William J. Glenfield, Bowdon, Cheshire.
 1883. §Crowder, Robert. Stanwix, Carlisle.
 1882. §Crowley, Frederick. Ashdell, Alton, Hampshire.
 1861. †Crowley, Henry. Trafalgar-road, Birkdale Park, Southport.
 1883. †Crowther, Elon. Cambridge-road, Huddersfield.
 1863. †Cruddas, George. Elswick Engine Works, Newcastle-on-Tyne.
 1885. †Cruikshank, Alexander, LL.D. 20 Rose-street, Aberdeen.
 1859. †Cruikshank, Provost. Macduff, Scotland.
 1888. §Crummack, William J. London and Brazilian Bank, Rio de Janeiro, Brazil.
 1873. †Crust, Walter. Hall-street, Spalding.
 1883. *Cryer, Major J. H. The Grove, Manchester-road, Southport.
 Culley, Robert. Bank of Ireland, Dublin.
 1883. *Culverwell, Edward P. 40 Trinity College, Dublin.
 1878. †Culverwell, Joseph Pope. St. Lawrence Lodge, Sutton, Dublin.
 1883. †Culverwell, T. J. H. Litfield House, Clifton, Bristol.
 1859. †Cumming, Sir A. P. Gordon, Bart. Altyre.
 1874. †Cumming, Professor. 33 Wellington-place, Belfast.
 1861. *Cunliffe, Edward Thomas. The Parsonage, Handforth, Manchester.
 1861. *Cunliffe, Peter Gibson. Dunedin, Handforth, Manchester.
 1882. *Cunningham, Lieut.-Colonel Allan, R.E., A.I.C.E. Brompton Barracks, Chatham.
 1887. §Cunningham, David. Viewbank, Newport, Fife, Scotland.
 1877. *CUNNINGHAM, D. J., M.D., Professor of Anatomy in Trinity College, Dublin.
 1852. †Cunningham, John. Macedon, near Belfast.
 1885. †CUNNINGHAM, J. T., B.A., F.R.S.E. Scottish Marine Station, Granton, Edinburgh.

Year of
Election.

1869. †CUNNINGHAM, ROBERT O., M.D., F.L.S., Professor of Natural History in Queen's College, Belfast.
1883. *Cunningham, Rev. William, B.D., D.Sc. Trinity College, Cambridge.
1850. †Cunningham, Rev. William Bruce. Prestonpans, Scotland.
1885. †Curphey, William S. 268 Renfrew-street, Glasgow.
1884. †Currier, John McNab. Castleton, Vermont, U.S.A.
1867. *Cursetjee, Manockjee, F.R.G.S., Judge of Bombay. *Villa-Byculla, Bombay.*
1857. †CURTIS, ARTHUR HILL, LL.D. 1 Hume-street, Dublin.
1878. †Curtis, William. Caramore, Sutton, Co. Dublin.
1884. †Cushing, Frank Hamilton. Washington, U.S.A.
1883. †Cushing, Mrs. M. Croydon, Surrey.
1881. †Cushing, Thomas, F.R.A.S. India Store Depôt, Belvedere-road, Lambeth, London, S.W.
1854. †Daglish, Robert, M.Inst.C.E. Orrell Cottage, near Wigan.
1883. †Dähne, F. W., Consul of the German Empire. 18 Somerset-place, Swansea.
1887. †Dale, Henry F., F.R.M.S., F.Z.S. Sutgrove, Miserden, Gloucestershire.
1863. †Dale, J. B. South Shields.
1865. †Dale, Rev. R. W. 12 Calthorpe-street, Birmingham.
1867. †Dalglish, W. Dundee.
1870. †DALLINGER, Rev. W. H., LL.D., F.R.S., F.L.S. Ingleside, Newstead-road, Lee, London, S.E.
Dalmahoy, James, F.R.S.E. 9 Forres-street, Edinburgh.
Dalton, Edward, LL.D., F.S.A. Dunkirk House, Nailsworth.
*Dalton, Rev. J. E., B.D. Seagrave, Loughborough.
1862. †DANBY, T. W., M.A., F.G.S. 1 Westbourne-terrace-road, London, W.
1859. †Dancer, J. B., F.R.A.S. Old Manor House, Ardwick, Manchester.
1876. †Dansken, John. 4 Eldon-terrace, Partickhill, Glasgow.
1849. *Danson, Joseph, F.C.S. Montreal, Canada.
1861. *DARBISHIRE, ROBERT DUKINFIELD, B.A., F.G.S. 26 George-street, Manchester.
1883. †Darbshire, S. D., M.D. 60 High-street, Oxford.
1876. †Darling, G. Erskine. 247 West George-street, Glasgow.
1884. †Darling, Thomas. 99 Drummond-street, Montreal, Canada.
1882. †DARWIN, FRANCIS, M.A., M.B., F.R.S., F.L.S. Huntingdon-road, Cambridge.
1881. *DARWIN, GEORGE HOWARD, M.A., LL.D., F.R.S., F.R.A.S., Plumian Professor of Astronomy and Experimental Philosophy in the University of Cambridge. Newnham Grange, Cambridge.
1878. *Darwin, Horace. The Orchard, Huntingdon-road, Cambridge.
1882. †Darwin, W. E., F.G.S. Bassett, Southampton.
1888. §Daubeny, William M. Stratton House, Park-lane, Bath.
1878. †D'Aulmay, G. 22 Upper Leeson-street, Dublin.
1872. †Davenport, John T. 64 Marine Parade, Brighton.
1880. §DAVEY, HENRY, M.Inst.C.E. 3 Prince's-street, Westminster, S.W.
1884. †David, A. J., B.A., LL.B. 4 Harcourt-buildings, Temple, London, E.C.
1870. †Davidson, Alexander, M.D. 2 Gambier-terrace, Liverpool.
1885. †Davidson, Charles B. Roundhay, Fonthill-road, Aberdeen.
1875. †Davies, David. 2 Queen's-square, Bristol.
1870. †Davies, Edward, F.C.S. Royal Institution, Liverpool.
1887. *Davies, H. Rees. Treborth, Bangor, North Wales.
1842. Davies-Colley, Dr. Thomas. Newton, near Chester.

- Year of Election.
1887. †Davies-Colley, T. C. Hopedene, Kersal, Manchester.
1873. *Davis, Alfred. Parliament Mansions, London, S.W.
1870. *Davis, A. S. 6 Paragon-buildings, Cheltenham.
1864. †DAVIS, CHARLES E., F.S.A. 55 Pulteney-street, Bath.
1887. §Davis, David. 55 Berkley-street, Liverpool.
Davis, Rev. David, B.A. Lancaster.
1881. †Davis, George E. The Willows, Fallowfield, Manchester.
1882. §Davis, Henry C. Berry Pomeroy, Springfield-road, Brighton.
1873. *DAVIS, JAMES W., F.G.S., F.S.A. Chevinedge, near Halifax.
1856. *DAVIS, Sir JOHN FRANCIS, Bart., K.C.B., F.R.S., F.R.G.S. Hollywood, near Compton, Bristol.
1883. †Davis, Joseph, J.P. Park-road, Southport.
1883. †Davis, Robert Frederick, M.A. Earlsfield, Wandsworth Common, London, S.W.
1885. *Davis, Rudolf. Castle Howell School, Lancaster.
1886. †Davis, W. H. Hazeldean, Pershore-road, Birmingham.
1886. †Davison, Charles, M.A. 38 Charlotte-road, Birmingham.
1864. *Davison, Richard. Beverley-road, Great Driffield, Yorkshire.
1857. †DAVY, EDMUND W., M.D. Kimmage Lodge, Roundtown, near Dublin.
1869. †Daw, John. Mount Radford, Exeter.
1869. †Daw, R. M. Bedford-circus, Exeter.
1860. *Dawes, John T., F.G.S. Blaen-y-Roe, St. Asaph, North Wales.
1864. †DAWKINS, W. BOYD, M.A., F.R.S., F.G.S., F.S.A., Professor of Geology and Palæontology in the Victoria University, Owens College, Manchester. Woodhurst, Fallowfield, Manchester.
1886. †Dawson, Bernard. The Laurels, Malvern Link.
1885. *Dawson, Major H. P., R.A. 3 Charlton Park-terrace, Old Charlton, Kent.
Dawson, John. Barley House, Exeter.
1884. †Dawson, Samuel. 258 University-street, Montreal, Canada.
1855. §DAWSON, Sir WILLIAM, C.M.G., M.A., LL.D., F.R.S., F.G.S., Principal of McGill University. McGill University, Montreal, Canada.
1859. *Dawson, Captain William G. Plumstead Common, Kent.
1879. †Day, Francis. Kenilworth House, Cheltenham.
1871. †DAY, ST. JOHN VINCENT, M.Inst.C.E., F.R.S.E. 166 Buchanan-street, Glasgow.
1870. *DEACON, G. F., M.Inst.C.E. Municipal Offices, Liverpool.
1861. †Deacon, Henry. Appleton House, near Warrington.
1887. §Deakin, H. T. Egremont House, Belmont, near Bolton.
1861. †Dean, Henry. Colne, Lancashire.
1870. *Deane, Rev. George, B.A., D.Sc., F.G.S. 38 Wellington-road, Birmingham.
1884. *Debenham, Frank, F.S.S. 26 Upper Hamilton-terrace, London, N.W.
1866. †DEBUS, HEINRICH, Ph.D., F.R.S., F.C.S., Lecturer on Chemistry at Guy's Hospital, London, S.E.
1884. §Deck, Arthur, F.C.S. 9 King's-parade, Cambridge.
1887. §Dehn, R. Olga Villa, Victoria Park, Manchester.
1878. †Delany, Rev. William. St. Stanislaus College, Tullamore.
1854. *DE LA RUE, WARREN, M.A., D.C.L., Ph.D., F.R.S., F.C.S., F.R.A.S. 73 Portland-place, London, W.
1879. †De la Sala, Colonel. Sevilla House, Navarino-road, London, N.W.
1884. *De Laune, C. DeL. F. Sharsted Court, Sittingbourne.
1887. †De Meschin, Miss Hannah Constance. Sandycove Castle, Kingstown, Ireland.

Year of
Election.

1870. †De Meschin, Thomas, B.A., LL.D. Sandycove Castle, Kingstown, Ireland.
1873. †Denham, Thomas. Huddersfield.
1884. †Denman, Thomas W. Lamb's-buildings, Temple, London, E.C.
Dent, William Yerbury. Royal Arsenal, Woolwich.
1870. *Denton, J. Bailey. Orchard Court, Stevenage.
1874. §DE RANCE, CHARLES E., F.G.S. 28 Jermyn-street, London, S.W.
1856. *DERBY, The Right Hon. the Earl of, K.G., M.A., LL.D., F.R.S.,
F.R.G.S. 23 St. James's-square, London, S.W.; and Knowsley,
near Liverpool.
1874. *Derham, Walter, M.A., LL.M., F.G.S. 119 Lansdowne-road, Ken-
sington Park, London, W.
1878. †De Rinzy, James Harward. Khelat Survey, Sukkur, India.
1868. †Dessé, Etheldred, M.B., F.R.C.S. 43 Kensington Gardens-square,
Bayswater, London, W.
DE TABLEY, GEORGE, Lord, F.Z.S. Tabley House, Knutsford,
Cheshire.
- *DEVONSHIRE, His Grace the Duke of, K.G., M.A., LL.D., F.R.S.,
F.G.S., F.R.G.S., Chancellor of the University of Cambridge.
Devonshire House, Piccadilly, London, W.; and Chatsworth,
Derbyshire.
1868. †DEWAR, JAMES, M.A., F.R.S. L. & E., F.C.S., Fullierian Professor of
Chemistry in the Royal Institution, London, and Jacksonian
Professor of Natural Experimental Philosophy in the University
of Cambridge. 1 Scroope-terrace, Cambridge.
1881. †Dewar, Mrs. 1 Scroope-terrace, Cambridge.
1883. †Dewar, James, M.D., F.R.C.S.E. Drylaw House, Davidson's Mains,
Midlothian, N.B.
1884. *Dewar, William. 6 Montpellier-grove, Cheltenham.
1872. †Dewick, Rev. E. S., M.A., F.G.S. 26 Oxford-square, London, W.
1884. †De Wolf, O. C., M.D. Chicago, U.S.A.
1873. *DEW-SMITH, A. G., M.A. Trinity College, Cambridge.
1864. *Dickinson, F.H., F.G.S. Kingweston, Somerton, Taunton; and 121
St. George's-square, London, S.W.
1863. †Dickinson, G. T. Claremont-place, Newcastle-on-Tyne.
1887. †Dickinson, Joseph, F.G.S. South Bank, Pendleton.
1884. †Dickson, Charles R., M.D. Wolfe Island, Ontario, Canada.
1881. †Dickson, Edmund. West Cliff, Preston.
1887. §Dickson, H. N. 38 York-place, Edinburgh.
1885. †Dickson, Patrick. Laurencekirk, Aberdeen.
1883. †Dickson, T. A. West Cliff, Preston.
1862. *DILKE, The Right Hon. Sir CHARLES WENTWORTH, Bart., F.R.G.S.
76 Sloane-street, London, S.W.
1877. †Dillon, James, M.Inst.C.E. 36 Dawson-street, Dublin.
1848. †DILLWYN, LEWIS LLEWELYN, M.P., F.L.S., F.G.S. Parkwerne,
near Swansea.
1869. †Dingle, Edward. 19 King-street, Tavistock.
1876. †Ditchfield, Arthur. 12 Taviton-street, Gordon-square, London,
W.C.
1868. †Dittmar, William, LL.D., F.R.S. L. & E., F.C.S., Professor of
Chemistry in Anderson's College, Glasgow.
1884. §Dix, John William H. Bristol.
1874. *Dixon, A. E. Dunowen, Cliftonville, Belfast.
1883. †Dixon, Miss E. 2 Cliff-terrace, Kendal.
1853. †Dixon, Edward. Wilton House, Southampton.
1888. §Dixon, E. T. Messrs. Lloyds, Barnetts, & Bosanquet's Bank, 54
St. James's-street, London, S.W.

Year of
Election.

1886. †Dixon, George. 42 Augustus-road, Edgbaston, Birmingham.
 1879. *DIXON, HAROLD B., M.A., F.R.S., F.C.S., Professor of Chemistry in the Owens College, Manchester.
 1885. †Dixon, John Henry. Inveran, Poolewe, Ross-shire, N.B.
 1887. †Dixon, Thomas. Buttershaw, near Bradford, Yorkshire.
 1885. †Doak, Rev. A. 15 Queen's-road, Aberdeen.
 1885. §Dobbin, Leonard. The University, Edinburgh.
 1860. *Dobbs, Archibald Edward, M.A. 34 Westbourne Park, London, W.
 1878. *DOBSON, G. E., M.A., M.B., F.R.S., F.L.S. Adrigole, Spring Grove, Isleworth.
 1864. *Dobson, William. Oakwood, Bathwick Hill, Bath.
 1875. *Docwra, George, jun. 32 Union-street, Coventry.
 1870. *Dodd, John. Nunthorpe-avenue, York.
 1876. †Dodds, J. M. St. Peter's College, Cambridge.
 Dolphin, John. Delves House, Berry Edge, near Gateshead.
 1851. †Domvile, William C., F.Z.S. Thorn Hill, Bray, Dublin.
 1867. †Don, John. The Lodge, Broughty Ferry, by Dundee.
 1867. †Don, William G. St. Margaret's, Broughty Ferry, by Dundee.
 1887. *Donald, Provost Robert. City Chambers, Dunfermline, Scotland.
 1885. †Donaldson, James, M.A., LL.D., F.R.S.E., Senior Principal of the University of St. Andrews, N.B.
 1882. †Donaldson, John. Tower House, Chiswick, Middlesex.
 1869. †Donisthorpe, G. T. St. David's Hill, Exeter.
 1877. *Donkin, Bryan, jun. May's Hill, Shortlands, Kent.
 1874. †Donnell, Professor, M.A. 76 Stephen's-green South, Dublin.
 1861. †Donnelly, Colonel, R.E., C.B. South Kensington Museum, London, S.W.
 1887. †Donner, Edward, B.A. 4 Anson-road, Victoria Park, Manchester.
 1887. †Dorning, Elias, M.Inst.C.E., F.G.S. 41 John Dalton-street, Manchester.
 1881. †Dorrington, John Edward. Lypiatt Park, Stroud.
 1867. †Dougall, Andrew Maitland, R.N. Scotsraig, Tayport, Fifeshire.
 1871. †Dougall, John, M.D. 2 Cecil-place, Paisley-road, Glasgow.
 1863. *Doughty, Charles Montagu. Care of H. M. Doughty, Esq., 5 Stone-court, Lincoln's Inn, London, W.C.
 1876. *Douglas, Rev. G. C. M. 18 Royal-crescent West, Glasgow.
 1877. *DOUGLASS, Sir JAMES N., F.R.S., M.Inst.C.E. Trinity House, London, E.C.
 1878. †Douglass, William. 104 Baggot-street, Dublin.
 1884. †Douglass, William Alexander. Freehold Loan and Savings Company, Church-street, Toronto, Canada.
 1886. †Dovaston, John. West Felton, Shropshire.
 1883. †Dove, Arthur. Crown Cottage, York.
 1884. †Dove, Miss Frances. St. Leonard's, St. Andrews, N.B.
 1884. †Dove, P. Edward, F.R.A.S., Sec.R.Hist.Soc. 23 Old-buildings, Lincoln's Inn, London, W.C.
 1884. †Dowe, John Melnotte. 69 Seventh-avenue, New York, U.S.A.
 1870. †Dowie, J. Muir. Gollanoll, by Kinross, N.B.
 1876. †Dowie, Mrs. Muir. Gollanoll, by Kinross, N.B.
 1884. *Dowling, D. J. Bromley, Kent.
 1878. †Dowling, Thomas. Claireville House, Terenure, Dublin.
 1857. †DOWNING, S., LL.D. 4 The Hill, Monkstown, Co. Dublin.
 1878. †Dowse, The Right Hon. Baron. 38 Mountjoy-square, Dublin.
 1865. *Dowson, E. Theodore, F.R.M.S. Geldeston, near Beccles, Suffolk.
 1881. *Dowson, Joseph Emerson, M.Inst.C.E. 3 Great Queen-street, London, S.W.
 1887. §Doxey, R. A. Slade House, Levenshulme, Manchester.

- Year of Election.
1883. †Draper, William. De Grey House, St. Leonard's, York.
1868. †DRESSER, HENRY E., F.Z.S. 6 Tenterden-street, Hanover-square, London, W.
1873. §DREW, FREDERIC, F.G.S., F.R.G.S. Eton College, Windsor.
1879. †Drew, Samuel, M.D., D.Sc., F.R.S.E. 10 Laura-place, Bath.
1887. †Dreyfus, Dr. Daisy Mount, Victoria Park, Manchester.
1870. †Drysedale, J. J., M.D. 36A Rodney-street, Liverpool.
1884. †*Du Bois, Henri. 39 Bentick-street, Glasgow.*
1856. *DUCIE, The Right. Hon. HENRY JOHN REYNOLDS MORETON, Earl of, F.R.S., F.G.S. 16 Portman-square, London, W. ; and Tortworth Court, Wotton-under-Edge.
1870. †Duckworth, Henry, F.L.S., F.G.S. Holme House, Columbia-road, Oxtou, Birkenhead.
1888. §Duckworth, Russell, J.P. The Cloisters, Perry-mead, Bath.
1867. *DUFF, The Right Hon. Sir MOUNTSTUART ELPHINSTONE GRANT-, G.C.B., G.C.S.I., F.R.S., F.R.G.S. York House, Twickenham.
1852. †Dufferin and Ava, The Most Hon. the Marquis of, K.P., G.C.B., G.C.M.G., D.C.L., LL.D., F.R.S., F.R.G.S. Clandeboye, near Belfast, Ireland.
1877. †Duffey, George F., M.D. 30 Fitzwilliam-place, Dublin.
1875. †Duffin, W. E. L'Estrange. Waterford.
1884. §Dugdale, James H. 9 Hyde Park-gardens, London, W.
1883. §Duke, Frederic. Conservative Club, Hastings.
1859. *Duncan, Alexander. 7 Prince's-gate, London, S.W.
1866. *Duncan, James. 9 Mincing-lane, London, E.C.
Duncan, J. F., M.D. 8 Upper Merrion-street, Dublin.
1867. †DUNCAN, PETER MARTIN, M.B., F.R.S., F.G.S., Professor of Geology in King's College, London. 6 Grosvenor-road, Gunnersbury, London, W.
1880. †Duncan, William S. 22 Delamere-terrace, Bayswater, London, W.
1881. †Duncombe, The Hon. Cecil. Nawton Grange, York.
1881. †Dunhill, Charles H. Gray's-court, York.
1865. †Dunn, David. Annet House, Skelmorlie, by Greenock, N.B.
1882. §Dunn, J. T., M.Sc., F.C.S. High School for Boys, Gateshead-on-Tyne.
1883. †Dunn, Mrs. 115 Scotswood-road, Newcastle-on-Tyne.
1876. †Dunnachie, James. 2 West Regent-street, Glasgow.
1878. †Dunne, D. B., M.A., Ph.D., Professor of Logic in the Catholic University of Ireland. 4 Clanwilliam-place, Dublin.
1884. §Dunnington, F. P. University of Virginia, Albemarle Co., Virginia, U.S.A.
1859. †Duns, Rev. John, D.D., F.R.S.E. New College, Edinburgh.
1885. *DUNSTAN, WYNDHAM R., M.A., F.C.S., Professor of Chemistry to the Pharmaceutical Society of Great Britain. 17 Bloomsbury-square, London, W.C.
1866. †Duprey, Perry. Woodberry Down, Stoke Newington, London, N.
1869. †D'Urban, W. S. M., F.L.S. 4 Queen-terrace, Mount Radford, Exeter.
1860. †DURHAM, ARTHUR EDWARD, F.R.C.S., F.L.S., Demonstrator of Anatomy, Guy's Hospital. 82 Brook-street, Grosvenor-square, London, W.
1887. †Durham, William. Seaforth House, Portobello, Scotland.
1887. §Dyason, John Sanford, F.R.G.S., F.R.Met.Soc. Boscobel-gardens, London, N.W.
1884. †Dyck, Professor Walter. The University, Munich.
1885. *Dyer, Henry, M.A. 8 Highburgh-terrace, Dowanhill, Glasgow.
Dykes, Robert. Kilmorie, Torquay, Devon.
1869. *Dymond, Edward E. Oaklands, Aspley Guise, Woburn.

Year of
Election.

1868. †Eade, Peter, M.D. Upper St. Giles's-street, Norwich.
 1861. †Eadson, Richard. 13 Hyde-road, Manchester.
 1883. †Eagar, Rev. Thomas. The Rectory, Ashton-under-Lyne.
 1877. †Earle, Ven. Archdeacon, M.A. West Alvington, Devon.
 1833. *EARNSHAW, Rev. SAMUEL, M.A. 14 Beechhill-road, Sheffield.
 1888. §Earson, H. W. P. 11 Alexandra-road, Clifton, Bristol.
 1874. †Eason, Charles. 30 Kenilworth-square, Rathgar, Dublin.
 1871. *EASTON, EDWARD, M.Inst.C.E., F.G.S. 11 Delahay-street, Westminster, S.W.
 1863. †Easton, James. Nest House, near Gateshead, Durham.
 1876. †Easton, John. Durie House, Abercromby-street, Helensburgh, N.B.
 1883. †Eastwood, Miss. Littleover Grange, Derby.
 1887. §Eccles, Mrs. S. White Coppice, Chorley, Lancashire.
 1884. †Eckersley, W. T. Standish Hall, Wigan, Lancashire.
 1861. †Ecroyd, William Farrer. Spring Cottage, near Burnley.
 1858. *Eddison, Francis. Syward Lodge, Dorchester.
 1870. *Eddison, John Edwin, M.D., M.R.C.S. 29 Park-square, Leeds.
 *Eddy, James Ray, F.G.S. The Grange, Carleton, Skipton.
 1887. §Ede, Francis J. Silchar, Cachar, India.
 Eden, Thomas. Talbot-road, Oxton.
 1884. *Edgell, R. Arnold, M.A., F.C.S. Ashburnham House, Little Dean's-yard, Westminster, S.W.
 1887. §Edgeworth, F. Y., M.A., F.S.S., Professor of Political Economy in King's College, London. Savile Club, 107 Piccadilly, London, W.
 1859. †Edmond, James. Cardens Haugh, Aberdeen.
 1870. *Edmonds, F. B. 72 Portsdown-road, London, W.
 1883. †Edmonds, William. Wiscombe Park, Honiton, Devon.
 1888. *Edmunds, Henry. Rhodehurst, Streatham, London, S.W.
 1884. *Edmunds, James, M.D. 8 Grafton-street, Piccadilly, London, W.
 1883. †Edmunds, Lewis, D.Sc., LL.B. 60 Park-street, Park-lane, London, W.
 1867. *Edward, Allan. Farington Hall, Dundee.
 1867. †Edward, Charles. Chambers, 8 Bank-street, Dundee.
 1855. *EDWARDS, Professor J. BAKER, Ph.D., D.C.L. Montreal, Canada.
 1884. †Edwards, W. F. Niles, Michigan, U.S.A.
 1887. *Egerton of Tatton, The Right Hon. Lord. Tatton Park, Knutsford.
 1876. †Elder, Mrs. 6 Claremont-terrace, Glasgow.
 1885. *Elgar, Francis, LL.D., F.R.S.E., Director of H.M. Dockyards. The Admiralty, London, S.W.
 1868. †Elger, Thomas Gwyn Empy, F.R.A.S. Manor Cottage, Kempston, Bedford.
 1863. †Ellenberger, J. L. Worksop.
 1885. §Ellingham, Frank. Thorpe St. Andrew, Norwich.
 1883. †Ellington, Edward Bayzand, M.Inst.C.E. Palace-chambers, Bridge-street, Westminster, S.W.
 1864. †Elliott, E. B. Washington, U.S.A.
 1883. *ELLIOTT, EDWIN BAILEY, M.A. Queen's College, Oxford.
 1872. †Elliott, Rev. E. B. 11 Sussex-square, Kemp Town, Brighton.
 Elliott, John Fogg. Elvet Hill, Durham.
 1879. §Elliott, Joseph W. Post Office, Bury, Lancashire.
 1886. §Elliott, Thomas Henry, F.S.S. Inland Revenue Department, Somerset House, London, W.C.
 1864. *ELLIS, ALEXANDER JOHN, B.A., F.R.S., F.S.A. 25 Argyll-road, Kensington, London, W.

Year of
Election.

1877. †Ellis, Arthur Devonshire. School of Mines, Jermyn-street, London, S.W.; and Thurnscoe Hall, Rotherham, Yorkshire.
1875. *Ellis, H. D. 6 Westbourne-terrace, Hyde Park, London, W.
1883. †Ellis, John. 17 Church-street, Southport.
1880. *ELLIS, JOHN HENRY. New Close, Cambridge-road, Southport.
1864. *Ellis, Joseph. Hampton Lodge, Brighton.
1864. †Ellis, J. Walter. High House, Thornwaite, Ripley, Yorkshire.
1884. †Ellis, W. Hodgson. Toronto, Canada.
1869. †ELLIS, WILLIAM HORTON. Hartwell House, Exeter.
Ellman, Rev. E. B. Berwick Rectory, near Lewes, Sussex.
1887. †Elmy, Ben. Eaton Hall, Congleton, Manchester.
1862. †Elphinstone, H. W., M.A., F.L.S. 2 Stone-buildings, Lincoln's Inn London, W.C.
1883. †Elwes, George Robert. Bossington, Bournemouth.
1887. §Elworthy, Frederick T. Foxdown, Wellington, Somerset.
1870. *ELY, The Right Rev. Lord ALWYNE COMPTON, D.D., Lord Bishop of. The Palace, Ely, Cambridgeshire.
1863. †Embleton, Dennis, M.D. Northumberland-street, Newcastle-on-Tyne.
1884. †Emery, Albert H. Stamford, Connecticut, U.S.A.
1863. †Emery, The Ven. Archdeacon, B.D. Ely, Cambridgeshire.
1886. †Emmons, Hamilton. *Mount Vernon Lodge, Leamington.*
1858. †Empson, Christopher. Bramhope Hall, Leeds.
1866. †Enfield, Richard. Low Pavement, Nottingham.
1884. †England, Luther M. Knowlton, Quebec, Canada.
1853. †English, Edgar Wilkins. Yorkshire Banking Company, Lowgate, Hull.
1869. †English, J. T. Wayfield House, Stratford-on-Avon.
1883. †Entwistle, James P. Beachfield, 2 Westclyffe-road, Southport.
1869. *Enys, John Davis. Care of F. G. Enys, Esq., Enys, Penryn, Cornwall.
1844. †Erichsen, John Eric, LL.D., F.R.S., F.R.C.S., Professor of Surgery in University College, London. 6 Cavendish-place, London, W.
1864. *Eskrigge, R. A., F.G.S. 18 Hackins-hey, Liverpool.
1885. †Esselmont, Peter, M.P. 34 Albyn-place, Aberdeen.
1862. *ESSON, WILLIAM, M.A., F.R.S., F.C.S., F.R.A.S. Merton College, and 13 Bradmore-road, Oxford.
1878. †Estcourt, Charles, F.C.S. 8 St. James's-square, John Dalton-street, Manchester.
1887. *Estcourt, Charles. Vyrnieu House, Talbot-road, Old Trafford, Manchester.
1887. *Estcourt, P. A. Vyrnieu House, Talbot-road, Old Trafford, Manchester.
Estcourt, Rev. W. J. B. Long Newton, Tetbury.
1869. †ETHERIDGE, ROBERT, F.R.S. L. & E., F.G.S., Assistant Keeper (Geological and Palæontological Department) Natural History Museum (British Museum). 14 Carlyle-square, London, S.W.
1888. §Etheridge, Mrs. 14 Carlyle-square, London, S.W.
1883. §Eunson, Henry J. 20 St. Giles-street, Northampton.
1881. †Evans, Alfred. Exeter College, Oxford.
1887. *Evans, Mrs. Alfred W. A. Hillside, New Mills, near Stockport, Derbyshire.
1870. *Evans, Arthur John, F.S.A. 33 Holywell, Oxford.
1865. *EVANS, Rev. CHARLES, M.A. The Rectory, Solihull, Birmingham.
1884. §Evans, Horace L. Moreton House, Tyndall Park, Bristol.
1869. *Evans, H. Saville W. Wimbledon Park House, Wimbledon, Surrey.

- Year of Election.
1861. *EVANS, JOHN, D.C.L., LL.D., Treas.R.S., F.S.A., F.L.S., F.G.S. 65 Old Bailey, London, E.C.; and Nash Mills, Hemel Hempstead.
1883. *EVANS, J. C. Nevill-street, Southport.
1883. *EVANS, Mrs. J. C. Nevill-street, Southport.
1881. †EVANS, Lewis. Llanfyrnach R.S.O., Pembrokeshire.
1876. †EVANS, Mortimer, M.Inst. C.E. 97 West Regent-street, Glasgow.
1885. *EVANS, Percy Bagnall. The Spring, Kenilworth.
1865. †EVANS, Sebastian, M.A., LL.D. Heathfield, Alleyne Park, Lower Norwood, Surrey, S.E.
1875. †EVANS, Sparke. 3 Apsley-road, Clifton, Bristol.
1865. *EVANS, William. The Spring, Kenilworth.
1886. †EVE, A. S. Marlborough College, Wilts.
1871. †EVE, H. Weston, M.A. University College, London, W.C.
1868. *EVERETT, J. D., M.A., D.C.L., F.R.S.L. & E., Professor of Natural Philosophy in Queen's College, Belfast. 5 Prince's-gardens, Belfast.
1880. †EVERINGHAM, Edward. St. Helen's-road, Swansea.
1863. *EVERITT, George Allen, F.R.G.S. Knowle Hall, Warwickshire.
1886. §EVERITT, William E. Finstall Park, Bromsgrove.
1883. †EVES, Miss Florence. Uxbridge.
1881. †EWART, J. COSSAR, M.D., Professor of Natural History in the University of Edinburgh.
1874. †EWART, William, M.P. Glenmachan, Belfast.
1874. †EWART, W. Quartus. Glenmachan, Belfast.
1859. *EWING, Sir Archibald Orr, Bart., M.P. Ballikinrain Castle, Killearn, Stirlingshire.
1876. *EWING, JAMES ALFRED, B.Sc., F.R.S. L. & E., Professor of Engineering in University College, Dundee.
1883. †EWING, James L. 52 North Bridge, Edinburgh.
1871. *EXLEY, John T., M.A. 1 Cotham-road, Bristol.
1884. *EYERMAN, John. Easton, Pennsylvania, U.S.A.
1882. †EYRE, G. E. Briscoe. Warrens, near Lyndhurst, Hants.
Eyton, Charles. Hendred House, Abingdon.
1884. †FAIRBAIRN, Dr. A. M. Airedale College, Bradford, Yorkshire.
1865. *FAIRLEY, THOMAS, F.R.S.E., F.C.S. 8 Newton-grove, Leeds.
1876. †FAIRLIE, James M. Charing Cross Corner, Glasgow.
1870. †FAIRLIE, Robert. Woodlands, Clapham Common, London, S.W.
1886. †FAIRLEY, William. Beau Desert, Rugeley, Staffordshire.
1864. †FALKNER, F. H. Lyncombe, Bath.
1886. †FALLON, T. P., Consul General. Australia.
1883. †FALLON, Rev. W. S. 1 St. Alban's-terrace, Cheltenham.
1877. §FARADAY, F. J., F.L.S., F.S.S. College-chambers, 17 Brazenose-street, Manchester.
1887. †FARMER, Sir James. Hope House, Eccles Old-road, Manchester.
1886. †FARNCOMBE, Joseph, J.P. Lewes.
1879. *FARNWORTH, Ernest. Clarence Villa, Penn Fields, Wolverhampton.
1882. §FARNWORTH, Walter. 86 Preston New-road, Blackburn.
1883. †FARNWORTH, William. 86 Preston New-road, Blackburn.
1885. †FARQUHAR, Admiral. Carlogie, Aberdeen.
1859. †FARQUHARSON, Robert F. O. Haughton, Aberdeen.
1885. †FARQUHARSON, Mrs. R. F. O. Haughton, Aberdeen.
1866. *FARRAR, Ven. FREDERICK WILLIAM, M.A., D.D., F.R.S., Archdeacon of Westminster. St. Margaret's Rectory, Westminster, S.W.
1883. †FARRELL, John Arthur. Moynalty, Kells, North Ireland.
1857. †FARRELLY, Rev. Thomas. Royal College, Maynooth.

Year of
Election.

1869. *Faulding, Joseph. Ebor Villa, Godwin-road, Clive-vale, Hastings.
 1883. §Faulding, Mrs. Ebor Villa, Godwin-road, Clive-vale, Hastings.
 1887. §Faulkner, John. 13 Great Ducie-street, Strangeways, Manchester.
 1886. †Felkin, Robert W., M.D., F.R.G.S. 20 Alva-street, Edinburgh.
 Fell, John B. Spark's Bridge, Ulverstone, Lancashire.
 1864. *FELLOWS, FRANK P., K.S.J.J., F.S.A., F.S.S. 8 The Green, Hampstead, London, N.W.
 1852. †Fenton, S. Greame. 9 College-square; and Keswick, near Belfast.
 1883. †Fenwick, E. H. 29 Harley-street, London, W.
 1876. †Ferguson, Alexander A. 11 Grosvenor-terrace, Glasgow.
 1883. †Ferguson, Mrs. A. A. 11 Grosvenor-terrace, Glasgow.
 1859. †Ferguson, John. Cove, Nigg, Inverness.
 1871. *Ferguson, John, M.A., Professor of Chemistry in the University of Glasgow.
 1867. †Ferguson, Robert M., Ph.D., F.R.S.E. 8 Queen-street, Edinburgh.
 1857. †Ferguson, Sir Samuel, LL.D., Q.C. 20 Great George's-street North, Dublin.
 1854. †Ferguson, William, F.L.S., F.G.S. Kinmundy, near Mintlaw, Aberdeenshire.
 1867. *Fergusson, H. B. 13 Airlie-place, Dundee.
 1883. †Fernald, H. P. Alma House, Cheltenham.
 1883. *Ferne John. Box No. 2, Hutchinson, Kansas, U.S.A.
 1862. †FERRERS, Rev. NORMAN MACLEOD, D.D., F.R.S. Caius College Lodge, Cambridge.
 1873. †Ferrier, David, M.A., M.D., F.R.S., Professor of Forensic Medicine in King's College. 34 Cavendish-square, London, W.
 1882. §Fewings, James, B.A., B.Sc. The Grammar School, Southampton.
 1887. §Fiddes, Thomas, M.D. Penwood, Urmston, near Manchester.
 1875. †Fiddes, Walter. Clapton Villa, Tyndall's Park, Clifton, Bristol.
 1868. †Field, Edward. Norwich.
 1886. †Field, H. C. 4 Carpenter-road, Edgbaston, Birmingham.
 1869. *FIELD, ROGERS, B.A., M.Inst.C.E. 4 Westminster-chambers, Westminster, S.W.
 1887. †Fielden, John C. 145 Upper Brook-street, Manchester.
 1882. †Filliter, Freeland. St. Martin's House, Wareham, Dorset.
 Finch, John. Bridge Work, Chepstow.
 1885. †FINDLATER, JOHN. 60 Union-street, Aberdeen.
 1878. *Findlater, William. 22 Fitzwilliam-square, Dublin.
 1885. †Findlay, George, M.A. 50 Victoria-street, Aberdeen.
 1884. †Finlay, Samuel. Montreal, Canada.
 1887. †Finnemore, Rev. J., F.G.S. 175 Oldham-road, Manchester.
 1881. †Firth, Colonel Sir Charles. Heckmondwike.
 Firth, Thomas. Northwick.
 1863. *Firth, William. Burley Wood, near Leeds.
 1851. *FISCHER, Professor WILLIAM L. F., M.A., LL.D., F.R.S. St. Andrews, N.B.
 1858. †Fishbourne, Admiral E. G., R.N. 26 Hogarth-road, Earl's Court-road, London, S.W.
 1884. *Fisher, L. C. Galveston, Texas, U.S.A.
 1869. †FISHER, Rev. OSMOND, M.A., F.G.S. Harlton Rectory, near Cambridge.
 1873. †Fisher, William. Maes Fron, near Welshpool, Montgomeryshire.
 1879. †Fisher, William. Norton Grange, near Sheffield.
 1875. *Fisher, W. W., M.A., F.C.S. 5 St. Margaret's-road, Oxford.
 1858. †Fishwick, Henry. Carr-hill, Rochdale.
 1887. *Fison, Alfred H., D.Sc. University College, London, W.C.
 1885. †Fison, E. Herbert. Stoke House, Ipswich.

Year of
Election.

1871. *FISON, FREDERICK W., M.A., F.C.S. Eastmoor, Ilkley, Yorkshire.
 1871. †FITCH, J. G., M.A., LL.D. 5 Lancaster-terrace, Regent's Park,
 London, N.W.
 1883. †Fitch, Rev. J. J. Ivyholme, Southport.
 1868. †Fitch, Robert, F.G.S., F.S.A. Norwich.
 1878. †Fitzgerald, C. E., M.D. 27 Upper Merrion-street, Dublin.
 1878. §FITZGERALD, GEORGE FRANCIS, M.A., F.R.S., Professor of Natural
 and Experimental Philosophy. Trinity College, Dublin.
 1885. *Fitzgerald, Professor Maurice, B.A. 37 Botanic-avenue, Belfast.
 1857. †Fitzpatrick, Thomas, M.D. 31 Lower Baggot-street, Dublin.
 1888. *Fitzpatrick, Thomas C. Christ's College, Cambridge.
 1865. †Fleetwood, D. J. 45 George-street, St. Paul's, Birmingham.
 Fleetwood, Sir Peter Hesketh, Bart. Rossall Hall, Fleetwood,
 Lancashire.
 1850. †Fleming, Professor Alexander, M.D. 121 Hagley-road, Birmingham.
 1881. †Fleming, Rev. Canon James, B.D. The Residence, York.
 1876. †Fleming, James Brown. Beaconsfield, Kelvinside, near Glasgow.
 1876. †Fleming, Sandford. Ottawa, Canada.
 1867. §FLETCHER, ALFRED E., F.C.S. 57 Gordon-square, London, W.C.
 1870. †Fletcher, B. Edgington. Norwich.
 1886. †Fletcher, Frank M. 57 Gordon-square, London, W.C.
 1869. †FLETCHER, LAVINGTON E., M.Inst.C.E. Alderley Edge, Cheshire.
 1888. *FLETCHER, LAZARUS, M.A., F.G.S., F.C.S., Keeper of Minerals,
 British Museum (Natural History). Cromwell-road, London,
 S.W.
 1862. §FLOWER, WILLIAM HENRY, C.B., LL.D., F.R.S., F.L.S., F.G.S.,
 F.R.C.S., Director of the Natural History Department, British
 Museum, South Kensington, London. (PRESIDENT ELECT.) 26
 Stanhope-gardens, London, S.W.
 1877. *Floyer, Ernest A., F.R.G.S., F.L.S. Cairo.
 1887. §Foale, William. 3 Meadfoot-terrace, Mannamead, Plymouth.
 1883. †Foale, Mrs. William. 3 Meadfoot-terrace, Mannamead, Plymouth.
 1881. †Foljambe, Cecil G. S., M.P. 2 Carlton House-terrace, Pall Mall,
 London, S.W.
 1879. †Foote, Charles Newth, M.D. 3 Albion-place, Sunderland.
 1879. †Foote, Harry D'Oyley, M.D. Rotherham, Yorkshire.
 1880. †Foote, R. Bruce. Care of Messrs. H. S. King & Co., 65 Cornhill,
 London, E.C.
 1873. *FORBES, GEORGE, M.A., F.R.S. L. & E. 34 Great George-street,
 London, S.W.
 1883. †Forbes, Henry O., F.Z.S., Director of the Canterbury Museum,
 Christchurch, New Zealand.
 1885. †Forbes, The Right Hon. Lord. Castle Forbes, Aberdeenshire.
 1866. †Ford, William. Hartsdown Villa, Kensington Park-gardens East,
 London, W.
 1875. *FORDHAM, H. GEORGE, F.G.S. Châlet Boa Vista, Lausanne, Swit-
 zerland.
 1883. §Formby, R. Formby, near Liverpool.
 1887. †FORREST, JOHN, C.M.G., F.R.G.S. Perth, Western Australia.
 1867. †Forster, Anthony. Finlay House, St. Leonard's-on-Sea.
 1883. †Forsyth, A. R., M.A., F.R.S. Trinity College, Cambridge.
 1884. †Fort, George H. Lakefield, Ontario, Canada.
 1854. *Fort, Richard. Read Hall, Whalley, Lancashire.
 1877. †FORTESCUE, The Right Hon. the Earl. Castle Hill, North Devon.
 1882. §Forward, Henry. 2 St. Agnes-terrace, Victoria Park-road, Lon-
 don, E.
 1870. †Forwood, Sir William B. Hopeton House, Seaforth, Liverpool.

Year of
Election.

1875. †Foster, A. Le Neve. 51 Cadogan-square, London, S.W.
 1865. †Foster, Balthazar, M.D., Professor of Medicine in Queen's College, Birmingham. 16 Temple-row, Birmingham.
 1865. *FOSTER, CLEMENT LE NEVE, B.A., D.Sc., F.G.S. Llandudno.
 1883. †Foster, Mrs. C. Le Neve. Llandudno.
 1857. *FOSTER, GEORGE CAREY, B.A., F.R.S., F.C.S., Professor of Physics in University College, London. 18 Daleham-gardens, Hampstead, London, N.W.
 1845. †Foster, John N. Sandy Place, Sandy, Bedfordshire.
 1877. §Foster, Joseph B. 6 James-street, Plymouth.
 1859. *FOSTER, MICHAEL, M.A., M.D., LL.D., Sec. R.S., F.L.S., F.C.S., Professor of Physiology in the University of Cambridge. Trinity College, and Great Shelford, near Cambridge.
 1863. †Foster, Robert. 30 Rye-hill, Newcastle-upon-Tyne.
 1866. †Fowler, George, M.Inst.C.E., F.G.S. Basford Hall, near Nottingham.
 1868. †Fowler, G. G. Gunton Hall, Lowestoft, Suffolk.
 1888. §Fowler, Gilbert J. Dalton Hall, Manchester.
 1876. *Fowler, John. 4 Kelvin Bank-terrace, Glasgow.
 1882. †FOWLER, SIR JOHN, K.C.M.G., M.Inst.C.E., F.G.S. 2 Queen Square-place, Westminster, S.W.
 1870. *Fowler, Sir Robert Nicholas, Bart., M.A., M.P., F.R.G.S. 137 Harley-street, London, W.
 1884. †Fox, Miss A. M. Penjerrick, Falmouth.
 1883. *Fox, Charles. 28 Glasshouse-street, Regent-street, London, W.
 1883. §Fox, Sir Charles Douglas, M.Inst.C.E. 5 Delahay-street, Westminster, S.W.
 1860. *Fox, Rev. Edward, M.A. Silverdale, Hassocks, Sussex.
 1883. †Fox, Howard, United States Consul. Falmouth.
 1876. *Fox, Joseph Hayland. The Cleve, Wellington, Somerset.
 1860. †Fox, Joseph John. Lordship-terrace, Stoke Newington, London, N.
 1876. †Fox, St. G. Lane. 9 Sussex-place, London, S.W.
 1888. §Fox, Thomas. Court, Wellington, Somerset.
 1886. †Foxwell, Arthur, M.A., M.B. 17 Temple-row, Birmingham.
 1881. *FOXWELL, HERBERT S., M.A., F.S.S., Professor of Political Economy in-University College, London. St. John's College, Cambridge.
 1866. *Francis, G. B. Vale House, Hertford.
 1884. †Francis, James B. Lowell, Massachusetts, U.S.A.
 FRANCIS, WILLIAM, Ph.D., F.L.S., F.G.S., F.R.A.S. Red Lion-court, Fleet-street, London, E.C.; and Manor House, Richmond, Surrey.
 1846. †FRANKLAND, EDWARD, M.D., D.C.L., LL.D., Ph.D., F.R.S., F.C.S. The Yews, Reigate Hill, Surrey.
 1887. *Frankland, Percy F., Ph.D. Royal School of Mines, South Kensington, London, S.W.
 1882. §Fraser, Alexander, M.B. Royal College of Surgeons, Dublin.
 1885. †FRASER, ANGUS, M.A., M.D., F.C.S. 232 Union-street, Aberdeen.
 1859. †Fraser, George B. 3 Airlie-place, Dundee.
 Fraser, James William. 8a Kensington Palace-gardens, London, W.
 1865. *FRASER, JOHN, M.A., M.D. Chapel Ash, Wolverhampton.
 1871. †FRASER, THOMAS R., M.D., F.R.S.L. & E., Professor of Materia Medica and Clinical Medicine in the University of Edinburgh. 13 Drumsheugh-gardens, Edinburgh.
 1859. *Frazer, Daniel. 127 Buchanan-street, Glasgow.
 1871. †Frazer, Evan L. R. Brunswick-terrace, Spring Bank, Hull.
 1884. *Frazer, Persifor, M.A., D.Sc., Professor of Chemistry in the Franklin Institute of Pennsylvania. 201 South Fifth-street, Philadelphia, U.S.A.

- Year of Election.
1884. *FREAM, W., LL.D., B.Sc., F.L.S., F.G.S., F.S.S., Professor of Natural History in the College of Agriculture, Downton, Salisbury.
1860. †Freeborn, Richard Fernandez. 38 Broad-street, Oxford.
1847. *Freeland, Humphrey William, F.G.S. West-street, Chichester.
1877. §Freeman, Francis Ford. 8 Leigham-terrace, Plymouth.
1865. †Freeman, James. 15 Francis-road, Edgbaston, Birmingham.
1880. †Freeman, Thomas. Brynhyfyd, Swansea.
1841. Freeth, Major-General S. 30 Royal-crescent, Notting Hill, London, W.
1884. *Fremantle, Hon. C. W., C.B. Royal Mint, London, E.
1869. †Frere, Rev. William Edward. The Rectory, Bilton, near Bristol.
1886. †Freshfield, Douglas W., Sec.R.G.S. 1 Savile-row, London, W.
1886. †Freund, Miss Ida. Eyre Cottage, Upper Sydenham, S.E.
1887. †Fries, Harold H., Ph.D. 92 Reade-street, New York, U.S.A.
1857. *Frith, Richard Hastings, M.R.I.A., F.R.G.S.I. 48 Summer-hill, Dublin.
1883. †Froane, William. Beech House, Birkdale, Southport.
1887. §Froehlich, The Chevalier. Grosvenor-terrace, Withington, Manchester.
1882. §Frost, Edward P., J.P. West Wrattling Hall, Cambridgeshire.
1883. †Frost, Major H., J.P. West Wrattling Hall, Cambridgeshire.
1887. *Frost, Robert, B.Sc. St. James's-chambers, Duke-street, London, S.W.
1875. †Fry, F. J. 104 Pembroke-road, Clifton, Bristol.
1875. *Fry, Joseph Storrs. 2 Charlotte-street, Bristol.
1884. §Fryer, Joseph, J.P. Smelt House, Howden-le-Wear, Co. Durham.
1872. *Fuller, Rev. A. Pallant, Chichester.
1859. †FULLER, FREDERICK, M.A. 9 Palace-road, Surbiton.
1869. †FULLER, GEORGE, M.Inst.C.E. 71 Lexham-gardens, Kensington, London, W.
1884. †Fuller, William. Oswestry.
1881. †Gabb, Rev. James, M.A. Bulmer Rectory, Welburn, Yorkshire.
1887. †Gaddum, G. H. Adria House, Toy-lane, Withington, Manchester.
- *Gadesden, Augustus William, F.S.A. Ewell Castle, Surrey.
1857. †GAGES, ALPHONSE, M.R.I.A. Museum of Irish Industry, Dublin.
1863. *Gainsford, W. D. *Aswardby Hall, Spilsby.*
1876. †Gairdner, Charles. Broom, Newton Mearns, Renfrewshire.
1850. †Gairdner, Professor W. T., M.D. 225 St. Vincent-street, Glasgow.
- GALBRAITH, Rev. J. A., M.A., M.R.I.A. Trinity College, Dublin.
1876. †Gale, James M. 23 Miller-street, Glasgow.
1863. †Gale, Samuel, F.C.S. 225 Oxford-street, London, W.
1885. *Galloway, Alexander. Tighnault, Aberfeldy, N.B.
1888. §Gallenga, Mrs. Anna. The Falls, Chepstow.
1888. §Gallenga, Mrs. A. A. R. The Falls, Chepstow.
1861. †Galloway, Charles John. Knott Mill Iron Works, Manchester.
1861. †Galloway, John, jun. Knott Mill Iron Works, Manchester.
1875. †GALLOWAY, W. Cardiff.
1887. *Galloway, W. The Cottage, Seymour-grove, Old Trafford, Manchester.
1860. *GALTON, Sir DOUGLAS, K.C.B., D.C.L., LL.D., F.R.S., F.L.S., F.G.S., F.R.G.S. (GENERAL SECRETARY.) 12 Chester-street, Grosvenor-place, London, S.W.
1860. *GALTON, FRANCIS, M.A., F.R.S., F.G.S., F.R.G.S. 42 Rutland-gate, Knightsbridge, London, S.W.
1869. †GALTON, JOHN C., M.A., F.L.S. 40 Great Marlborough-street, London, W.

Year of
Election.

1887. *Galton, Miss Laura Gwendolen Douglas. 12 Chester-street, Grosvenor-place, London, S.W.
1870. §Gamble, Lieut.-Colonel D. St. Helen's, Lancashire.
1870. †Gamble, J. C. St. Helen's, Lancashire.
1872. *Gamble, John G., M.A. Capetown. (Care of Messrs. Ollivier and Brown, 37 Sackville-street, Piccadilly, London, W.)
1888. §Gamble, J. Sykes, F.L.S. Madras.
1877. †Gamble, William. St. Helen's, Lancashire.
1868. †GAMGEE, ARTHUR, M.D., F.R.S., Fullerian Professor of Physiology in the Royal Institution, London. 17 Great Cumberland-place, London, W.
1883. †Gant, Major John Castle. St. Leonard's.
1887. §GARDINER WALTER, M.A. Clare College, Cambridge.
1882. *Gardner, H. Dent, F.R.G.S. 25 Northbrook-road, Lee, Kent.
1882. †Gardner, John Starkie, F.G.S. 7 Damer-terrace, Chelsea, London, S.W.
1884. †Garman, Samuel. Cambridge, Massachusetts, U.S.A.
1862. †GARNER, ROBERT, F.L.S. Stoke-upon-Trent.
1865. †Garner, Mrs. Robert. Stoke-upon-Trent.
1888. §Garnett, Frederick Brooksbank, C.B. 4 Argyll-road, Campden Hill, London, W.
1887. *Garnett, J. W. The Grange, near Bolton, Lancashire.
1882. †Garnett, William, D.C.L., Principal of the College of Physical Science, Newcastle-on-Tyne.
1873. †Garnham, John. Hazelwood, Crescent-road, St. John's, Brockley, Kent, S.E.
1883. §Garson, J. G., M.D. 14 Suffolk-street, Pall Mall, London, S.W.
1874. *Garstin, John Ribton, M.A., LL.B., M.R.I.A., F.S.A. Bragans-town, Castlebellingham, Ireland.
1882. †Garton, William. Woolston, Southampton.
1870. †Gaskell, Holbrook. Woolton Wood, Liverpool.
1870. *Gaskell, Holbrook, jun. Clayton Lodge, Aigburth, Liverpool.
1862. *Gatty, Charles Henry, M.A., F.L.S., F.G.S. Felbridge Place, East Grinstead, Sussex.
1875. †Gavey, J. 43 Stacey-road, Routh, Cardiff.
1875. †Gaye, Henry S., M.D. Newton Abbot, Devon.
1871. †Geddes, John. 9 Melville-crescent, Edinburgh.
1883. §Geddes, John. 33 Portland-street, Southport.
1885. §Geddes, Patrick. 6 James-court, Edinburgh.
1854. †Gee, Robert, M.D. 5 Abercromby-square, Liverpool.
1887. §Gee, W. W. Haldane. Owens College, Manchester.
1867. †GEIKIE, ARCHIBALD, LL.D., F.R.S. L. & E., F.G.S., Director-General of the Geological Survey of the United Kingdom. Geological Survey Office, Jermyn-street, London, S.W.
1871. †Geikie, James, LL.D., F.R.S. L. & E., F.G.S., Murchison Professor of Geology and Mineralogy in the University of Edinburgh. 31 Merchiston-avenue, Edinburgh.
1882. *GENESE, R. W., M.A., Professor of Mathematics in University College, Aberystwith.
1875. *George, Rev. Hereford B., M.A., F.R.G.S. New College, Oxford.
1885. †Gerard, Robert. Blair-Devenick, Cults, Aberdeen.
1884. *Gerrans, Henry T., M.A. Worcester College, Oxford.
1870. *Gervis, Walter S., M.D., F.G.S. Ashburton, Devonshire.
1884. †Gibb, Charles. Abbotsford, Quebec, Canada.
1865. †Gibbins, William. Battery Works, Digbeth, Birmingham.
1874. †Gibson, The Right Hon. Edward, Q.C. 23 Fitzwilliam-square, Dublin.

Year of
Election.

1876. *Gibson, George Alexander, M.D., D.Sc., F.R.S.E., Secretary to the Royal College of Physicians of Edinburgh. 17 Alva-street, Edinburgh.
1884. †Gibson, Rev. James J. 183 Spadina-avenue, Toronto, Canada.
1885. †Gibson, John, Ph.D. The University, Edinburgh.
1887. †Giffen, Robert, LL.D., V.P.S.S. 44 Pembroke-road, London, S.W.
1888. *Gifford, H. J. Bute Arms, Pontydown, South Wales.
1884. †Gilbert, E. E. 245 St. Antoine-street, Montreal, Canada.
1842. †GILBERT, JOSEPH HENRY, Ph.D., LL.D., F.R.S., F.C.S., Professor of Rural Economy in the University of Oxford. Harpenden, near St. Albans.
1883. §Gilbert, Mrs. Harpenden, near St. Albans.
1857. †Gilbert, J. T., M.R.I.A. Villa Nova, Blackrock, Dublin.
1884. *Gilbert, Philip H. 245 St. Antoine-street, Montreal, Canada.
1883. †Gilbert, Thomas. Derby-road, Southampton.
- Gilderdale, Rev. John, M.A. Walthamstow, Essex.
1882. †Giles, Alfred, M.P., M.Inst.C.E. Cosford, Godalming.
1878. †Giles, Oliver. Park Side, Cromwell-road, St. Andrew's, Bristol.
- Giles, Rev. William. Netherleigh House, near Chester.
1878. †Gill, Rev. A. W. H. 44 Eaton-square, London, S.W.
1871. *GILL, DAVID, LL.D., F.R.S., F.R.A.S. Royal Observatory, Cape Town.
1888. §Gill, John Frederick. Douglas, Isle of Man.
1868. †Gill, Joseph. Palermo, Sicily. (Care of W. H. Gill, Esq., General Post Office, St. Martin's-le-Grand, E.C.)
1864. †GILL, THOMAS. 4 Sydney-place, Bath.
1887. †Gillett, Charles Edwin. Wood Green, Banbury, Oxford.
1888. §Gilliland, E. T. 259 West Seventy-fourth-street, New York, U.S.A.
1884. †Gillman, Henry. 79 East Columbia-street, Detroit, Michigan, U.S.A.
1861. *Gilroy, George. Woodlands, Parbold, near Wigan.
1867. †Gilroy, Robert. Craigie, by Dundee.
1887. *Gimingham, Charles H. Stamford House, Northumberland Park, Tottenham, Middlesex.
1867. §GINSBURG, Rev. C. D., D.C.L., LL.D. Holmlea, Virginia Water Station, Chertsey.
1884. †Girdwood, Dr. G. P. 28 Beaver Hall-terrace, Montreal, Canada.
1874. *Girdwood, James Kennedy. Old Park, Belfast.
1884. †Gisborne, Frederick Newton. Ottawa, Canada.
1886. *Gisborne, Hartley. Battleford, Saskatchewan District, Canada.
1883. *Gladstone, Miss. 17 Pembridge-square, London, W.
1883. *Gladstone, Miss E. A. 17 Pembridge-square, London, W.
1850. *Gladstone, George, F.C.S., F.R.G.S. 34 Denmark-villas, Hove, Brighton.
1849. *GLADSTONE, JOHN HALL, Ph.D., F.R.S., F.C.S. 17 Pembridge-square, London, W.
1861. *GLAISHER, JAMES, F.R.S., F.R.A.S. 1 Dartmouth-place, Blackheath, London, S.E.
1871. *GLAISHER, J. W. L., M.A., D.Sc., F.R.S., F.R.A.S. Trinity College, Cambridge.
1883. †Glasson, L. T. 2 Roper-street, Penrith.
1881. *GLAZEBROOK, R. T., M.A., F.R.S. Trinity College, Cambridge.
1887. §Glazier, Walter H., F.C.S. Courtlands, East Molesey, Surrey.
1881. *Gleadow, Frederic. Forth Bridge Works, South Queensferry, N.B.
1870. §Glen, David Corse, F.G.S. 14 Annfield-place, Glasgow.
1859. †Glennie, J. S. Stuart, M.A. West Bank, Wimbledon Common.
1867. †Gloag, John A. L. 10 Inverleith-place, Edinburgh.
- Glover, George. Ranelagh-road, Pimlico, London, S.W.

Year of
Election

1874. †Glover, George T. 30 Donegall-place, Belfast.
Glover, Thomas. 124 Manchester-road, Southport.
1887. †Glover, Walter T. Moorhurst, Kersal, Manchester.
1870. †Glynn, Thomas R., M.D. 62 Rodney-street, Liverpool.
1872. †GODDARD, RICHARD. 16 Booth-street, Bradford, Yorkshire.
1886. †Godlee, Arthur. 3 Greenfield-crescent, Edgbaston, Birmingham.
1887. †Godlee, Francis. 51 Portland-street, Manchester.
1878. *Godlee, J. Lister. 3 New-square, Lincoln's Inn, London, W.
1880. †GODMAN, F. DU CANE, F.R.S., F.L.S., F.G.S. 10 Chandos-street,
Cavendish-square, London, W.
1883. †Godson, Dr. Alfred. Cheadle, Cheshire.
1852. †Godwin, John. Wood House, Rostrevor, Belfast.
1879. §GODWIN-AUSTEN, Lieut.-Colonel H. H., F.R.S., F.R.G.S., F.Z.S.
Shalford House, Guildford.
1876. †Goff, Bruce, M.D. Bothwell, Lanarkshire.
1886. †GOLDSMID, Major-General Sir F. J., C.B., K.C.S.I., F.R.G.S.
3 Observatory-avenue, London, W.
1881. †Goldschmidt, Edward. Nottingham.
1887. †Goldschmidt, Philip. Oldenburg House, Rusholme, Manchester.
1873. †Goldthorp, Miss R. F. C. Cleckheaton, Bradford, Yorkshire.
1884. †Good, Charles E. 102 St. François Xavier-street, Montreal, Canada.
1878. †Good, Rev. Thomas, B.D. 51 Wellington-road, Dublin.
1852. †Goodbody, Jonathan. Clare, King's County, Ireland.
1878. †Goodbody, Jonathan, jun. 50 Dame-street, Dublin.
1884. †Goodbody, Robert. Fairy Hill, Blackrock, Co. Dublin.
1886. †Goodman, F. B. 46 Wheeley's-road, Edgbaston, Birmingham.
1885. †GOODMAN, J. D., J.P. Peachfield, Edgbaston, Birmingham.
1865. †Goodman, J. D. Minories, Birmingham.
1869. †*Goodman, Neville, M.A. Peterhouse, Cambridge.*
1884. §Goodridge, Richard E. W. Oak Bank, Manitoba, Canada.
1884. †Goodwin, Professor W. L. Queen's University, Kingston, Ontario,
Canada.
1883. †Goouch, B., B.A. 2 Oxford-road, Birkdale, Southport.
1885. †Gordon, General the Hon. Sir Alexander Hamilton. 50 Queen's
Gate-gardens, London, S.W.
1885. §Gordon, Rev. Cosmo, D.D., F.R.A.S., F.G.S. Chetwynd Rectory,
Newport, Salop.
1885. †Gordon, Rev. George, LL.D. Birnie, by Elgin, N.B.
1871. *Gordon, Joseph Gordon, F.C.S. Queen Anne's Mansions, West-
minster, S.W.
1884. *Gordon, Robert, M.Inst.C.E., F.R.G.S. Fernhill, Henbury, near
Bristol.
1857. †Gordon, Samuel, M.D. 11 Hume-street, Dublin.
1885. †Gordon, Rev. William. Braemar, N.B.
1887. §Gordon, William John. 21 Catherstone-terrace, London, S.W.
1865. †Gore, George, LL.D., F.R.S. 50 Islington-row, Edgbaston, Bir-
mingham.
1875. *Gotch, Francis, B.A., B.Sc. Holywell Cottage, Oxford.
- *Gotch, Rev. Frederick William, LL.D. Stokes Croft, Bristol.
- *Gotch, Thomas Henry. Kettering.
1873. †Gott, Charles, M.Inst.C.E. Parkfield-road, Manningham, Bradford,
Yorkshire.
1849. †Gough, The Hon. Frederick. Perry Hall, Birmingham.
1857. †Gough, The Right Hon. George S., Viscount, M.A., F.L.S., F.G.S.
St. Helen's, Booterstown, Dublin.
1881. †Gough, Thomas, B.Sc., F.C.S. Elmfield College, York.
1868. †Gould, Rev. George. Unthank-road, Norwich.

- Year of Election.
1888. §Gouraud, Colonel. Little Menlo, Norwood, Surrey.
1873. †Gourlay, J. McMillan. 21 St. Andrew's-place, Bradford, Yorkshire.
1867. †Gourley, Henry (Engineer). Dundee.
1876. †Gow, Robert. Cairndowan, Dowanhill, Glasgow.
1883. §Gow, Mrs. Cairndowan, Dowanhill, Glasgow.
Gowland, James. London-wall, London, E.C.
1873. §Goyder, Dr. D. Marley House, 88 Great Horton-road, Bradford, Yorkshire.
1886. †Grabham, Michael C., M.D. Madeira.
1861. †Grafton, Frederick W. Park-road, Whalley Range, Manchester.
1867. *GRAHAM, CYRIL, C.M.G., F.L.S., F.R.G.S. Travellers' Club, Pall Mall, London, S.W.
1875. †GRAHAME, JAMES. 12 St. Vincent-street, Glasgow.
1852. *GRAINGER, Rev. Canon JOHN, D.D., M.R.I.A. Skerry and Rathcavan Rectory, Broughshane, near Ballymena, Co. Antrim.
1870. †GRANT, Colonel JAMES A., C.B., C.S.I., F.R.S., F.L.S., F.R.G.S.
19 Upper Grosvenor-street, London, W.
1855. *GRANT, ROBERT, M.A., LL.D., F.R.S., F.R.A.S., Regius Professor of Astronomy in the University of Glasgow. The Observatory, Glasgow.
1854. †GRANTHAM, RICHARD B., M.Inst.C.E., F.G.S. Northumberland-chambers, Northumberland-avenue, London, W.C.
1864. †Grantham, Richard F. Northumberland-chambers, Northumberland-avenue, London, W.C.
1887. §Gratrix, Samuel. Alport Town, Manchester.
1881. †Graves, E. 22 Trebovir-road, Earl's Court-road, London, S.W.
1887. †Graves, John. Broomhurst, Eccles Old-road, Manchester.
1881. †Gray, Alan, LL.B. Minster-yard, York.
1864. *Gray, Rev. Charles. The Vicarage, Blyth, Worksop.
1865. †Gray, Charles. Swan Bank, Bilston.
1876. †Gray, Dr. Newton-terrace, Glasgow.
1881. †Gray, Edwin, LL.B. Minster-yard, York.
1859. †Gray, Rev. J. H. Bolsover Castle, Derbyshire.
1887. §Gray, Joseph W., F.G.S. Spring Hill, Wellington-road South, Stockport.
1887. †Gray, M. H., F.G.S. Lessness Park, Abbey Wood, Kent.
1886. *Gray, Robert Kaye. Lessness Park, Abbey Wood, Kent.
1881. †Gray, Thomas, Professor of Engineering in the Rane Technical Institute, Terre Haute, Indiana, U.S.A.
1883. †Gray, Thomas. Spital Hill, Morpeth.
1873. †Gray, William, M.R.I.A. 8 Mount Charles, Belfast.
*GRAY, Colonel WILLIAM. Farley Hall, near Reading.
1883. †Gray, William Lewis. 36 Gutter-lane, London, E.C.
1883. †Gray, Mrs. W. L. 36 Gutter-lane, London, E.C.
1886. †Greaney, Rev. William. Bishop's House, Bath-street, Birmingham.
1883. §Greathead, J. H. 8 Victoria-chambers, London, S.W.
1866. §Greaves, Charles Augustus, M.B., LL.B. 101 Friar-gate, Derby.
1887. †Greaves, H. R. The Orchards, Mill End, Stockport.
1869. †Greaves, William. Station-street, Nottingham.
1872. †Greaves, William. 3 South-square, Gray's Inn, London, W.C.
1872. *Grece, Clair J., LL.D. Redhill, Surrey.
1879. †Green, A. F. 15 Ashwood-villas, Headingley, Leeds.
1887. §Green, Friese. 34 Gay-street, Bath.
1888. §Greene, Joseph R. 17 Bloomsbury-square, London, W.C.
1887. †Greenhalgh, Richard. 1 Temple-gardens, The Temple, London, E.C.
1858. *Greenhalgh, Thomas. Thornydikes, Sharples, near Bolton-le-Moors.

Year of
Election.

1882. †GREENHILL, A. G., M.A., F.R.S., Professor of Mathematics at the Royal Artillery Institution, Woolwich. 3 Staple-Inn, London, W.C.
1881. §Greenhough, Edward. Matlock Bath, Derbyshire.
1884. †Greenish, Thomas, F.C.S. 20 New-street, Dorset-square, London, N.W.
1884. †Greenshields, E. B. Montreal, Canada.
1884. †Greenshields, Samuel. Montreal, Canada.
1887. §Greenwell, G. C., jun. Poynton, Cheshire.
1863. †Greenwell, G. E. Poynton, Cheshire.
1875. †Greenwood, Frederick. *School of Medicine, Leeds.*
1877. †Greenwood, Holmes. 78 King-street, Accrington.
1883. †GREENWOOD, J. G., LL.D., Vice-Chancellor of Victoria University. Owens College, Manchester.
1849. †Greenwood, William. Stones, Todmorden.
1887. §Greenwood, Professor W. H., M.Inst.C.E. Firth College, Sheffield.
1887. *Greg, Arthur. Eagley, near Bolton, Lancashire.
1861. *GREG, ROBERT PHILIPS, F.G.S., F.R.A.S. Coles Park, Buntingford, Herts.
1833. Gregg, T. H. 12 Alexandra-road, Finsbury Park, London, N.
1860. †GREGOR, Rev. WALTER, M.A. Pitsligo, Rosehearty, Aberdeenshire.
1868. †Gregory, Sir Charles Hutton, K.C.M.G., M.Inst.C.E. 2 Delahay-street, Westminster, S.W.
1883. †Gregson, Edward, Ribble View, Preston.
1883. †Gregson, G. E. Ribble View, Preston.
1881. †Gregson, William. Baldersby, Thirsk.
1875. †Grenfell, J. Granville, B.A., F.G.S. 5 Albert-villas, Clifton, Bristol.
1875. †Grey, Mrs. Maria G. 18 Cadogan-place, London, S.W.
1859. †GRIERSON, THOMAS BOYLE, M.D. Thornhill, Dumfriesshire.
1875. †Grieve, David, F.R.S.E., F.G.S. 19 Abercorn-terrace, Portobello, Midlothian.
1878. †Griffin, Robert, M.A., LL.D. Trinity College, Dublin.
1859. *GRIFFITH, GEORGE, M.A., F.C.S. Druries, Harrow.
1870. †Griffith, Rev. Henry, F.G.S. Brooklands, Isleworth, Middlesex.
1884. †Griffiths, E. H. 12 Park-side, Cambridge.
1884. †Griffiths, Mrs. 12 Park-side, Cambridge.
1847. †Griffiths, Thomas. Bradford-street, Birmingham.
1879. †Griffiths, Thomas, F.C.S., F.S.S. Heidelberg House, King's-road, Clapham Park, London, S.W.
1875. †Grignon, James, H.M. Consul at Riga. Riga.
1870. †Grimsdale, T. F., M.D. 29 Rodney-street, Liverpool.
1888. *Grimshaw, James Walter. Australian Club, Sydney, New South Wales.
1884. †Grinnell, Frederick. Providence, Rhode Island, U.S.A.
1881. †Gripper, Edward. Nottingham.
1864. †GROOM-NAPIER, CHARLES OTTLEY. 18 Elgin-road, St. Peter's Park, London, N.W.
- GROVE, The Hon. Sir WILLIAM ROBERT, Knt., M.A., D.C.L., LL.D., F.R.S. 115 Harley-street, London, W.
1863. *GROVES, THOMAS B., F.C.S. 80 St. Mary-street, Weymouth.
1869. †GRUBB, Sir HOWARD, F.R.S., F.R.A.S. 51 Kenilworth-square, Rathgar, Dublin.
1886. §Grundy, John. Park Drive, Nottingham.
1867. †Guild, John. Bayfield, West Ferry, Dundee.
1887. §GUILLEMARD, F. H. H. Eltham, Kent.
- Guinness, Henry. 17 College-green, Dublin.
1842. Guinness, Richard Seymour. 17 College-green, Dublin.

'Year of
Election.

1862. †Gunn, John, M.A., F.G.S. 82 Prince of Wales-road, Norwich.
 1885. †Gunn, John. Dale, Halkirk, Caithness.
 1877. †Gunn, William, F.G.S. Office of the Geological Survey of Scotland, Sheriff's Court House, Edinburgh.
 1866. †GÜNTHER, ALBERT C. L. G., M.A., M.D., Ph.D., F.R.S., Keeper of the Zoological Collections in the British Museum. British Museum, South Kensington, London, S.W.
 1880. §Guppy, John J. Ivy-place, High-street, Swansea.
 1876. †Guthrie, Francis. Cape Town, Cape of Good Hope.
 1883. †Guthrie, Malcolm. 2 Parkfield-road, Liverpool.
 1857. †Gwynne, Rev. John. Tullyagnish, Letterkenny, Strabane, Ireland.
 1876. †GWYTHIER, R. F., M.A. Owens College, Manchester.
1884. †Haanel, E., Ph.D. Cobourg, Ontario, Canada.
 1887. †Hackett, Henry Eugene. Hyde-road, Gorton, Manchester.
 1865. †Hackney, William. 9 Victoria-chambers, Victoria-street, London, S.W.
 1884. †Hadden, Captain C. F., R.A. Woolwich.
 1881. *HADDON, ALFRED CORT, B.A., F.Z.S., Professor of Zoology in the Royal College of Science, Dublin.
 Haden, G. N. Trowbridge, Wiltshire.
 1842. Hadfield, George. Victoria-park, Manchester.
 1888. *Hadfield, R. A. Hecla Works, Sheffield.
 1848. †Hadland, William Jenkins. Banbury, Oxfordshire.
 1870. †Haigh, George. Waterloo, Liverpool.
 *Hailstone, Edward, F.S.A. Walton Hall, Wakefield, Yorkshire.
 1879. †HAKE, H. WILSON, Ph.D., F.C.S. Queenwood College, Hants.
 1875. †Hale, Rev. Edward, M.A., F.G.S., F.R.G.S. Eton College, Windsor.
 1887. †Hale, The Hon. E. J. 9 Mount-street, Manchester.
 1883. †Haliburton, Robert Grant. National Club, Whitehall, London, S.W.
 1872. †Hall, Dr. Alfred. 8 Mount Ephraim, Tunbridge Wells.
 1879. *Hall, Ebenezer. Abbeydale Park, near Sheffield.
 1883. *Hall, Miss Emily. 24 Scarisbrick-street, Southport.
 1881. †Hall, Frederick Thomas, F.R.A.S. 15 Gray's Inn-square, London, W.C.
 1854. *HALL, HUGH FERGIE, F.G.S. Sunnyside, Wavertree, Liverpool.
 1887. †Hall, John. Springbank, Leftwich, Northwich.
 1872. *Hall, Captain Marshall, F.G.S. St. John's, Bovey Tracey, South Devon.
 1885. §Hall, Samuel. 19 Aberdeen Park, Highbury, London, N.
 1884. †Hall, Thomas Proctor. School of Practical Science, Toronto, Canada.
 1866. *HALL, TOWNSHEND M., F.G.S. Pilton, Barnstaple.
 1860. †Hall, Walter. 11 Pier-road, Erith.
 1883. *Hall, Miss Wilhelmina. The Gore, Eastbourne.
 1873. *HALLETT, T. G. P., M.A. Claverton Lodge, Bath.
 1868. *HALLETT, WILLIAM HENRY, F.L.S. Buckingham House, Marine Parade, Brighton.
 1888. §Halliburton, W. D., M.D. 25 Maitland Park-villas, London, N.W.
 Halsall, Edward. 4 Somerset-street, Kingsdown, Bristol.
 1886. †Hambleton, G. W. 76 Upper Gloucester-place, London, N.W.
 1858. *Hambly, Charles Hambly Burbridge, F.G.S. Holmeside, Hazelwood, Derby.
 1883. *Hamel, Egbert D. de. Middleton Hall, Tamworth.
 1885. †Hamilton, David James. 1A Albyn-place, Aberdeen.
 1869. †Hamilton, Rowland. Oriental Club, Hanover-square, London, W.
 1888. *HAMMOND, ANTHONY, J.P. Bath.

Year of
Election.

1851. †Hammond, C. C. Lower Brook-street, Ipswich.
 1881. *Hammond, Robert. Hilldrop, Highgate, London, N.
 1878. †Hanagan, Anthony. Luckington, Dalkey.
 1878. §Hance, Edward M., LL.B. 6 Sea Bank-avenue, Egremont, Cheshire.
 1875. †Hancock, C. F., M.A. 125 Queen's-gate, London, S.W.
 1863. †Hancock, John. 4 St. Mary's-terrace, Newcastle-on-Tyne.
 1861. †Hancock, Walter. 10 Upper Chadwell-street, Pentonville, London, N.
 1857. †Hancock, William J. 23 Synnot-place, Dublin.
 1847. †HANCOCK, W. NEILSON, LL.D., M.R.I.A. 64 Upper Gardiner-street, Dublin.
 1876. †Hancock, Mrs. W. Neilson. 64 Upper Gardiner-street, Dublin.
 1882. †Hankinson, R. C. Bassett, Southampton.
 1884. §Hannaford, E. C. 1591 Catherine-street, Montreal, Canada.
 1859. †Hannay, John. Montcoffer House, Aberdeen.
 1886. §Hansford, Charles. 3 Alexandra-terrace, Dorchester.
 1859. *HARCOURT, A. G. VERNON, M.A., LL.D., F.R.S., F.C.S. (GENERAL SECRETARY.) Cowley Grange, Oxford.
 1886. *Hardcastle, Basil W., F.S.S. Beechenden, Hampstead, London, N.W.
 1884. *Hardcastle, Norman C., M.A., LL.M. Downing College, Cambridge.
 1865. †Harding, Charles. Harborne Heath, Birmingham.
 1869. †Harding, Joseph. Millbrooke House, Exeter.
 1877. †Harding, Stephen. Bower Ashton, Clifton, Bristol.
 1869. †Harding, William D. Islington Lodge, King's Lynn, Norfolk.
 1886. †Hardman, John B. St. John's, Hunter's-lane, Birmingham.
 1872. †Hardwicke, Mrs. 192 Piccadilly, London, W.
 1880. †Hardy, John. 118 Embden-street, Manchester.
 1838. *HARE, CHARLES JOHN, M.D. Berkeley House, 15 Manchester-square, London, W.
 1858. †Hargrave, James. Burley, near Leeds.
 1883. §Hargreaves, Miss H. M. 69 Alexandra-road, Southport.
 1883. †Hargreaves, Thomas. 69 Alexandra-road, Southport.
 1881. †Hargrove, William Wallace. St. Mary's, Bootham, York.
 1876. †Harker, Allen, F.L.S., Professor of Natural History in the Royal Agricultural College, Cirencester.
 1887. §Harker, T. H. Brook House, Fallowfield, Manchester.
 1878. *Harkness, H. W. California Academy of Sciences, San Francisco, California, U.S.A.
 1871. †Harkness, William, F.C.S. Laboratory, Somerset House, London, W.C.
 1875. *Harland, Rev. Albert Augustus, M.A., F.G.S., F.L.S., F.S.A. The Vicarage, Harefield, Middlesex.
 1877. *Harland, Henry Seaton. 8 Arundel-terrace, Brighton, Sussex.
 1883. *Harley, Miss Clara. 4 Wellington-square, Oxford.
 1862. *HARLEY, GEORGE, M.D., F.R.S., F.C.S. 25 Harley-street, London, W.
 1883. *Harley, Harold. 14 Chapel-street, Bedford-row, London, W.C.
 1862. *HARLEY, Rev. ROBERT, F.R.S., F.R.A.S. 4 Wellington-square, Oxford.
 1868. *HARMER, F. W., F.G.S. Oakland House, Cringleford, Norwich.
 1881. *HARMER, SIDNEY F., B.Sc. King's College, Cambridge.
 1882. †Harper, G. T. Bryn Hyfrydd, Portswood, Southampton.
 1872. †Harpley, Rev. William, M.A. Clayhanger Rectory, Tiverton.
 1884. †Harrington, B. J., B.A., Ph.D., Professor of Chemistry and Mineralogy in McGill University, Montreal. Wallbrac-place, Montreal, Canada.

Year of
Election.

1872. *Harris, Alfred. Lunefield, Kirkby-Lonsdale, Westmoreland.
 1888. §Harris, C. T. 4 Kilburn Priory, London, N.W.
 1871. †HARRIS, GEORGE, F.S.A. Iselipps Manor, Northolt, Southall, Middlesex.
 1842. *Harris, G. W., M.Inst.C.E. Mount Gambier, South Australia.
 1884. §Harris, Miss Katherine E. 73 Albert Hall-mansions, Kensington-gore, London, S.W.
 1888. §Harrison, Charles. 20 Lennox-gardens, London, S.W.
 1860. †Harrison, Rev. Francis, M.A. North Wraxall, Chippenham.
 1864. †Harrison, George. Barnsley, Yorkshire.
 1874. †Harrison, G. D. B. 3 Beaufort-road, Clifton, Bristol.
 1858. *HARRISON, JAMES PARK, M.A. 22 Connaught-street, Hyde Park, London, W.
 1870. †HARRISON, REGINALD, M.R.C.S. 51 Rodney-street, Liverpool.
 1853. †Harrison, Robert. 36 George-street, Hull.
 1883. †Harrison, Thomas. 34 Ash-street, Southport.
 1863. †Harrison, T. E. Engineers' Office, Central Station, Newcastle-on-Tyne.
 1886. §Harrison, William. The Horsehills, Wolverhampton.
 1886. †Harrison, W. Jerome, F.G.S. 365 Lodge-road, Hockley, Birmingham.
 1854. †Harrowby, The Right Hon. the Earl of. 39 Grosvenor-square, London, W. ; and Sandon Hall, Lichfield.
 1885. †HART, CHARLES J. 10 Calthorpe-road, Edgbaston, Birmingham.
 1876. *Hart, Thomas. Brooklands, Blackburn.
 1881. §Hart, Thomas, F.G.S. Yewbarrow, Grange-over-Sands, Carnforth.
 1875. †Hart, W. E. Kilderry, near Londonderry.
 Hartley, James. Sunderland.
 1871. †HARTLEY, WALTER NOEL, F.R.S.L. & E., F.O.S., Professor of Chemistry in the Royal College of Science, Dublin.
 1886. §HARTOG, Professor M. M., D.Sc. Queen's College, Cork.
 1887. §Hartog, P. J., B.Sc. 6 Greville-road, London, N.W.
 1870. †Harvey, Enoch. Riversdale-road, Aigburth, Liverpool.
 1885. †Harvey, Surgeon-Major Robert, M.D. Calcutta.
 1885. §Harvie-Brown, J. A. Dunipace, Larbert, N.B.
 1862. *Harwood, John, jun. Woodside Mills, Bolton-le-Moors.
 1884. †Haslam, Rev. George, M.A. Trinity College, Toronto, Canada.
 1882. †Haslam, George James, M.D. Owens College, Manchester.
 1875. *HASTINGS, G. W., M.P. Barnard's Green House, Malvern.
 1886. †Hatherton, The Right Hon. Lord, C.B. Haws Hall, Birmingham.
 1857. †HAUGHTON, Rev. SAMUEL, M.A., M.D., D.C.L., LL.D., F.R.S., M.R.I.A., F.G.S., Senior Fellow of Trinity College, Dublin.
 Trinity College, Dublin.
 1874. †Hawkins, B. Waterhouse, F.G.S. Century Club, East Fifteenth-street, New York, U.S.A.
 1887. *Hawkins, William. 11 Fountain-street, Manchester.
 1872. *Hawkshaw, Henry Paul. 58 Jermyn-street, St. James's, London, S.W.
 *HAWKSHAW, Sir JOHN, M.Inst.C.E., F.R.S., F.G.S., F.R.G.S. Hollycombe, Liphook, Petersfield ; and 33 Great George-street, London, S.W.
 1864. *HAWKSHAW, JOHN CLARKE, M.A., M.Inst.C.E., F.G.S. 50 Harrington-gardens, South Kensington, S.W. ; and 33 Great George-street London, S.W.
 1868. §HAWKSLEY, THOMAS, M.Inst.C.E., F.R.S., F.G.S. 30 Great George-street, London, S.W.

Year of
Election.

1884. *Haworth, Abraham. Hilston House, Altrincham.
 1887. *Haworth, Jesse. Woodside, Bowdon, Cheshire.
 1887. †Haworth, S. E. Warsley-road, Swinton, Manchester.
 1886. †Haworth, Rev. T. J. Albert Cottage, Saltley, Birmingham.
 1863. †Hawthorn, William. The Cottage, Benwell, Newcastle-upon-Tyne.
 1859. †Hay, Sir Andrew Leith, Bart. Rannes, Aberdeenshire.
 1877. †Hay, Arthur J. Lerwick, Shetland.
 1861. *HAY, Admiral the Right Hon. Sir JOHN C. D., Bart., K.C.B.,
 D.C.L., F.R.S. 108 St. George's-square, London, S.W.
 1858. †Hay, Samuel. Albion-place, Leeds.
 1867. †Hay, William. 21 Magdalen-yard-road, Dundee.
 1885. *Haycraft, Professor John Berry, M.B., B.Sc., F.R.S.E. Physiological
 Laboratory, the University, Edinburgh.
 1873. *Hayes, Rev. William A., M.A. Dromore, Co. Down, Ireland.
 1869. †Hayward, J. High-street, Exeter.
 1858. *HAYWARD, ROBERT BALDWIN, M.A., F.R.S. Fishers, Harrow.
 1888. §Hazard, Rowland R. Little Mulgrave House, Hurlingham.
 1879. *Hazlehurst, George S. Rhyl, North Wales.
 1851. §HEAD, JEREMIAH, M.Inst.C.E., F.C.S. Middlesbrough, Yorkshire.
 1869. †Head, R. T. The Briars, Alphington, Exeter.
 1883. †Headley, Frederick Halcombe. Manor House, Petersham, S.W.
 1883. †Headley, Mrs. Marian. Manor House, Petersham, S.W.
 1883. §Headley, Rev. Tanfield George. Manor House, Petersham, S.W.
 1871. †Healey, George. Brantfield, Bowness, Windermere.
 1883. *Heap, Ralph, jun. 1 Brick-court, Temple, London, E.C.
 1861. *Heape, Benjamin. Northwood, Prestwich, near Manchester.
 1883. †Heape, Charles. Tovrak, Oxton, Cheshire.
 1883. †Heape, Joseph R. 96 Tweeddale-street, Rochdale.
 1882. *Heape, Walter, M.A. Northwood, Prestwich, Manchester.
 1877. †Hearder, Henry Pollington. Westwell-street, Plymouth.
 1877. †Heather, William Keep, F.S.A. 195 Union-street, Plymouth.
 1883. †Heath, Dr. 46 Hoghton-street, Southport.
 1866. †Heath, Rev. D. J. Esher, Surrey.
 1863. †Heath, G. Y., M.D. Westgate-street, Newcastle-on-Tyne.
 1884. †Heath, Thomas, B.A. Royal Observatory, Calton Hill, Edinburgh.
 1861. †HEATHFIELD, W. E., F.C.S., F.R.G.S., F.R.S.E. 1 Powis-grove,
 Brighton; and Arthur's Club, St. James's, London, S.W.
 1883. †Heaton, Charles. Marlborough House, Hesketh Park, Southport.
 1886. †Heaton, C. W. Tower House, Belvedere, Kent.
 1886. §Heaton, Miss Ellen. Woodhouse-square, Leeds.
 1865. †Heaton, Harry. Harborne House, Harborne, near Birmingham.
 1884. §Heavside, Rev. George, B.A., F.R.G.S. The Hollies, Stoke Green,
 Coventry.
 1833. †HEAVSIDE, Rev. Canon J. W. L., M.A. The Close, Norwich.
 1888. *Heawood, Edward, B.A., F.G.S. Caius College, Cambridge.
 1888. *Heawood, Percy Y., Lecturer in Mathematics at Durham University.
 30 Old Elvet, Durham.
 1855. †HECTOR, Sir JAMES, K.C.M.G., M.D., F.R.S., F.G.S., F.R.G.S.,
 Director of the Geological Survey of New Zealand. Wellington,
 New Zealand.
 1867. †Hedde, M. Forster, M.D., F.R.S.E. St. Andrews, N.B.
 1869. †Hedgeland, Rev. W. J. 21 Mount Radford, Exeter.
 1882. †Hedger, Philip. Cumberland-place, Southampton.
 1887. *Hedges, Killingworth. 25 Queen Anne's-gate, London, S.W.
 1863. †Hedley, Thomas. Cox Lodge, near Newcastle-on-Tyne.
 1887. §Hembry, Frederick William, F.R.M.S. Sussex Lodge, Sidcup, Kent.
 1867. †Henderson, Alexander. Dundee.

- Year of Election.
1873. *Henderson, A. L. 16 Lee-road, Blackheath, London, S.E.
 1883. †Henderson, Mrs. A. L. 16 Lee-road, Blackheath, London, S.E.
 1880. *Henderson, Captain W. H., R.N. 21 Albert Hall Mansions, London, S.W.
 1876. *Henderson, William. Williamfield, Irvine, N.B.
 1885. †Henderson, William. Devanha House, Aberdeen.
 1856. †HENNESSY, HENRY G., F.R.S., M.R.I.A., Professor of Applied Mathematics and Mechanics in the Royal College of Science for Ireland. Brookvale, Donnybrook, Co. Dublin.
 1857. †Hennessy, Sir John Pope, K.C.M.G., Governor and Commander-in-Chief of Mauritius.
 1873. *HENRICI, OLAUS M. F. E., Ph.D., F.R.S., Professor of Mechanics and Mathematics in the City and Guilds of London Institute. Central Institution, Exhibition-road, London, S.W.
 Henry, Franklin. Portland-street, Manchester.
 1873. Henry, J. Snowdon. East Dene, Bonchurch, Isle of Wight.
 Henry, Mitchell. Stratheden House, Hyde Park, London, W.
 *HENRY, WILLIAM CHARLES, M.D., F.R.S., F.G.S., F.R.G.S., F.C.S. Haffield, near Ledbury, Herefordshire.
 1884. †Henshaw, George H. 43 Victoria-street, Montreal, Canada.
 1870. †Henty, William. 12 Medina-villas, Brighton.
 1855. *Hepburn, J. Gotch, LL.B., F.C.S. Dartford, Kent.
 1855. †Hepburn, Robert. 9 Portland-place, London, W.
 Hepburn, Thomas. Monkbridge, Robinhood-lane, Sutton, Surrey.
 1887. *Herdman, William A., D.Sc., Professor of Natural History in University College, Liverpool.
 1871. *HERSCHEL, ALEXANDER S., M.A., D.C.L., F.R.S., F.R.A.S., Honorary Professor of Experimental Physics in the University of Durham College of Science, Newcastle-on-Tyne. Observatory House, Slough, Bucks.
 1883. †Herschel, Miss F. Observatory House, Slough, Bucks.
 1874. §HERSCHEL, Colonel JOHN, R.E., F.R.S., F.R.A.S. Observatory House, Slough, Bucks.
 1883. †Hesketh, Colonel E. Fleetwood. Meol's Hall, Southport.
 1884. §Hewett, George Edwin. The Leasowe, Cheltenham.
 1883. †Hewson, Thomas. Care of J. C. C. Payne, Esq., Botanic-avenue, The Plains, Belfast.
 1881. †Hey, Rev. William Croser, M.A. Clifton, York.
 1882. †Heycock, Charles T., B.A. King's College, Cambridge.
 1883. §Heyes, John Frederick, M.A., F.C.S., F.R.G.S. 9 King-street, Oxford; and 5 Rufford-road, Fairfield, Liverpool.
 1866. *Heymann, Albert. West Bridgford, Nottinghamshire.
 1879. †Heywood, A. Percival. Duffield Bank, Derby.
 1861. *Heywood, Arthur Henry. Elleray, Windermere.
 1886. §HEYWOOD, Henry. Cardiff.
 *HEYWOOD, JAMES, F.R.S., F.G.S., F.S.A., F.R.G.S., F.S.S. 26 Kensington Palace-gardens, London, W.
 1861. *HEYWOOD, OLIVER, J.P., D.L. Claremont, Manchester.
 1887. †Heywood, Robert. Mayfield, Victoria Park, Manchester.
 Heywood, Thomas Percival. Claremont, Manchester.
 1881. §Hick, Thomas, B.A., B.Sc. Brighton-grove, Rusholme, Manchester.
 1888. §Hickens, James Harvey, M.A., F.G.S. Radley College, Abingdon.
 1875. †HICKS, HENRY, M.D., F.R.S., F.G.S. Hendon Grove, Hendon, Middlesex, N.W.
 1877. §HICKS, Professor W. M., M.A., F.R.S., Principal of Firth College, Sheffield. Firth College, Sheffield.
 1886. §Hicks, Mrs. W. M. Duvhed, Endcliffe-crescent, Sheffield.

Year of
Election.

1884. †Hickson, Joseph. 272 Mountain-street, Montreal, Canada.
 1887. *Hickson, Sydney J., M.A. Downing College, Cambridge.
 1864. *HIERN, W. P., M.A. Castle House, Barnstaple.
 1875. †Higgins, Charles Hayes, M.D., M.R.C.P., F.R.C.S., F.R.S.E. Alfred House, Birkenhead.
 1871. †HIGGINS, CLEMENT, B.A., F.C.S. 103 Holland-road, Kensington, London, W.
 1854. †HIGGINS, Rev. HENRY H., M.A. 29 Falkner-square, Liverpool.
 Hildyard, Rev. James, B.D., F.C.P.S. Ingoldsby, near Grantham, Lincolnshire.
 1885. *Hill, Alexander, M.A., M.B. Grantchester, near Cambridge.
 Hill, Arthur. Bruce Castle, Tottenham, Middlesex.
 1880. †Hill, Benjamin. Cwmdwr, near Clydach, Swansea.
 1883. †Hill, Berkeley, M.B., Professor of Clinical Surgery in University College, London. 66 Wimpole-street, London, W.
 1872. §Hill, Charles, F.S.A. Rockhurst, West Hoathley, East Grinstead.
 1881. §HILL, Rev. EDWIN, M.A., F.G.S. St. John's College, Cambridge.
 1887. †Hill, G. H. Albert-chambers, Albert-square, Manchester.
 1884. †Hill, Rev. James Edgar, M.A., B.D. 2488 St. Catherine-street, Montreal, Canada.
 1857. §Hill, John, M.Inst.C.E., M.R.I.A., F.R.G.S.I. County Surveyor's Office, Ennis, Ireland.
 1871. †Hill, Lawrence. *The Knowe, Greenock.*
 1886. †Hill, M. J. M. 16 Pembury-road, Lower Clapton, London, E.
 1881. †Hill, Pearson. 50 Belsize Park, London, N.W.
 1872. *Hill, Rev. Canon, M.A., F.G.S. Sheering Rectory, Harlow.
 1885. *Hill, Sidney. Langford House, Langford, Bristol.
 1888. §Hill, William. Hitchin, Herts.
 1876. †Hill, William H. Barlanark, Shettleston, N.B.
 1885. *HILLHOUSE, WILLIAM, M.A., Professor of Botany in Mason Science College, Birmingham. 95 Harborne-road, Edgbaston, Birmingham.
 1886. §Hillier, Rev. E. J. Cardington Vicarage, Bedford.
 1863. †Hills, F. C. Chemical Works, Deptford, Kent, S.E.
 1871. *Hills, Thomas Hyde. 225 Oxford-street, London, W.
 1887. †Hilton, Edwin. Oak Bank, Fallowfield, Manchester.
 1858. †HINCKS, Rev. THOMAS, B.A., F.R.S. Stokeleigh, Leigh Woods, Clifton, Bristol.
 1870. †HINDE, G. J., Ph.D., F.G.S. Avondale-road, Croydon, Surrey.
 1883. *Hindle, James Henry. 67 Avenue-parade, Accrington.
 1888. *Hindmarsh, William Thomas. Alnbank, Alnwick.
 1886. †Hingley, Benjamin, M.P. Hatherton Lodge, Cradley, Worcestershire.
 1881. †Hingston, J. T. Clifton, York.
 1884. †HINGSTON, WILLIAM HALES, M.D., D.C.L. 37 Union-avenue, Montreal, Canada.
 1884. †Hirschfelder, C. A. Toronto, Canada.
 1858. †Hirst, John, jun. Dobcross, near Manchester.
 1861. *HIRST, T. ARCHER, Ph.D., F.R.S., F.R.A.S. 7 Oxford and Cambridge Mansions, Marylebone-road, London, N.W.
 1870. †Hitchman, William, M.D., LL.D., F.L.S. 144 Phythian-street, Low Hill, Liverpool.
 1884. †Hoadrey, John Chipman. Boston, Massachusetts, U.S.A.
 Hoare, J. Gurney. Hampstead, London, N.W.
 1881. §Hobbes, Robert George. Livingstone House, 374 Wandsworth-road, London, S.W.
 1864. †Hobhouse, Arthur Fane. 24 Cadogan-place, London, S.W.

Year of
Election.

1864. †*Hobhouse, Charles Parry.* 24 *Cadogan-place, London, S.W.*
 1864. †*Hobhouse, Henry William.* 24 *Cadogan-place, London, S.W.*
 1879. §*Hobkirk, Charles P., F.L.S.* West Riding Union Bank, Dewsbury.
 1887. **Hobson, Bernard, B.Sc.* Tipton Elms, Sheffield.
 1883. †*Hobson, Rev. E. W.* 55 Albert-road, Southport.
 1879. §*Hobson, John.* Tipton Elms, Sheffield.
 1877. †*Hockin, Edward.* Poughill, Stratton, Cornwall.
 1883. †*Hocking, Rev. Silas K.* 21 Scarisbrick New-road, Southport.
 1877. †*Hodge, Rev. John Mackey, M.A.* 38 Tavistock-place, Plymouth.
 1876. †*Hodges, Frederick W.* Queen's College, Belfast.
 1852. †*Hodges, John F., M.D., F.C.S.,* Professor of Agriculture in Queen's College, Belfast.
 1863. **HODGKIN, THOMAS.* Benwell Dene, Newcastle-on-Tyne.
 1887. **HODGKINSON, Alexander.* 18 St. John-street, Manchester.
 1880. §*Hodgkinson, W. R. Eaton, Ph.D., F.R.S.E.,* Professor of Chemistry and Physics in the Royal Artillery College, Woolwich. 75 Vanbrugh Park, Blackheath, London, S.E.
 1873. **Hodgson, George.* Thornton-road, Bradford, Yorkshire.
 1873. †*Hodgson, James.* *Oakfield, Manningham, Bradford, Yorkshire.*
 1884. †*Hodgson, Jonathan.* Montreal, Canada.
 1863. †*Hodgson, Robert.* Whitburn, Sunderland.
 1863. †*Hodgson, R. W.* 7 Sandhill, Newcastle-on-Tyne.
 1865. **HOFMANN, AUGUST WILHELM, M.D., LL.D., Ph.D., F.R.S., F.C.S.* 10 Dorotheen-strasse, Berlin.
 1854. **Holerof, George.* Tyddyn-Gwladis, Ganllwyd, near Dolgelly, North Wales.
 1883. †*Holden, Edward.* Laurel Mount, Shipley, Yorkshire.
 1873. **Holden, Isaac, M.P.* Oakworth House, near Keighley, Yorkshire.
 1883. †*Holden, James.* 12 Park-avenue, Southport.
 1883. †*Holden, John J.* 23 Duke-street, Southport.
 1884. †*Holden, Mrs. Mary E.* Dunham Ladies' College, Quebec, Canada.
 1857. **Holder, Henry William.* Owens College, Manchester.
 1887. **Holdsworth, C. J.* Oxenholme, Westmoreland.
 1879. †*Holland, Calvert Bernard.* Ebbw Vale, South Wales.
 **Holland, Philip H.* 3 Heath-rise, Willow-road, Hampstead, London, N.W.
 1886. †*Holliday, J. R.* 101 Harborne-road, Birmingham.
 1865. †*Holliday, William.* New-street, Birmingham.
 1883. †*Hollingsworth, Dr. T. S.* Elford Lodge, Spring-grove, Isleworth, Middlesex.
 1883. **Holmes, Mrs. Basil.* 5 Freeland-road, Ealing, Middlesex, W.
 1866. **Holmes, Charles.* 59 London-road, Derby.
 1873. †*Holmes, J. R.* Southbrook Lodge, Bradford, Yorkshire.
 1882. **Holmes, Thomas Vincent, F.G.S.* 28 Croom's-hill, Greenwich, S.E.
 1887. §*Holt, Thomas.* Atlas Iron Works, Molesworth-street, Rochdale.
 1875. **Hood, John.* The Elms, Cotham Hill, Bristol.
 1847. †*HOOKE, Sir JOSEPH DALTON, K.C.S.I., C.B., M.D., D.C.L., LL.D., F.R.S., V.P.L.S., F.G.S., F.R.G.S.* The Camp, Sunningdale.
 1865. **Hooper, John P.* Coventry Park, Streatham, London, S.W.
 1877. **Hooper, Rev. Samuel F., M.A.* 39 Lorrimore-square, London, S.E.
 1856. †*Hooton, Jonathan.* 80 Great Ducie-street, Manchester.
 1842. **Hope, Thomas Arthur.* 14 Airlie-gardens, Campden Hill, London, W.
 1884. **Hopkins, Edward M.* 3 Upper Berkeley-street, Portman-square, London, W.

- Year of Election.
1865. †Hopkins, J. S. Jesmond Grove, Edgbaston, Birmingham.
1884. *HOPKINSON, CHARLES. 29 Princess-street, Manchester.
1882. *Hopkinson, Edward, D.Sc. Ireton Bank, Platt-lane, Rusholme, Manchester.
1870. *HOPKINSON, JOHN, M.A., D.Sc., F.R.S. Holmwood, Wimbledon, Surrey.
1871. *HOPKINSON, JOHN, F.L.S., F.G.S., F.R.Met.Soc. 95 New Bond-street, London, W.; and The Grange, St. Albans.
1858. †Hopkinson, Joseph, jun. Britannia Works, Huddersfield.
Hornby, Hugh. Sandown, Liverpool.
1886. †Horne, Edward H. Innisfail, Beulah Hill, Norwood, S.E.
1885. †Horne, John, F.R.S.E., F.G.S. 41 Southside-road, Inverness.
1876. *Horne, Robert R. 150 Hope-street, Glasgow.
1875. *Horniman, F. J., F.R.G.S., F.L.S. Surrey Mount, Forest Hill, London, S.E.
1884. *Horsfall, Richard. Stoodley House, Halifax.
1887. †Horsfall, T. C. Bollin Tower, Alderley Edge, Cheshire.
1856. †Horsley, John H. 1 Ormond-terrace, Cheltenham.
1884. *Hotblach, G. S. Prince of Wales-road, Norwich.
1868. †Hotson, W. C. Upper King-street, Norwich.
1859. †Hough, Joseph, M.A., F.R.A.S. Codsall Wood, Wolverhampton.
1886. †Houghton, F. T. S., M.A. 119 Gough-road, Edgbaston, Birmingham.
1887. †Houldsworth, Sir W. H., Bart., M.P. Norbury Booths, Knutsford.
1858. †Hounsfield, James. Hemsworth, Pontefract.
1884. †Houston, William. Legislative Library, Toronto, Canada.
1883. *Hovenden, Frederick, F.L.S., F.G.S. Glenlea, Thurlow Park-road, West Dulwich, Surrey, S.E.
Hovenden, W. F., M.A. Bath.
1879. *Howard, D. 60 Belsize Park, London, N.W.
1883. §Howard, James Fielden, M.D., M.R.C.S. Sandycroft, Shaw.
1886. §Howard, James L., B.Sc. 20 Oxford-road, Waterloo, near Liverpool.
1887. *Howard, S. S. Llanishen Rise, near Cardiff.
1882. †Howard, William Frederick, Assoc.M.Inst.C.E. 13 Cavendish-street, Chesterfield, Derbyshire.
1883. †Howarth, Richard. York-road, Birkdale, Southport.
1886. †Howatt, David. 3 Birmingham-road, Dudley.
1876. †Howatt, James. 146 Buchanan-street, Glasgow.
1885. §Howden, James C., M.D. Sunnyside, Montrose, N.B.
1857. †Howell, Henry H., F.G.S., Director of the Geological Survey of Scotland. Geological Survey Office, Victoria-street, Edinburgh.
1887. †Howell, J. A. Edward-street, Werneth, Oldham.
1868. †HOWELL, Rev. Canon HINDS. Drayton Rectory, near Norwich.
1886. §Howes, Professor G. B., F.L.S. Science Schools, South Kensington, London, S.W.
1884. †Howland, Edward P., M.D. 211 41½-street, Washington, U.S.A.
1884. †Howland, Oliver Aiken. Toronto, Canada.
1865. *HOWLETT, Rev. FREDERICK, F.R.A.S. East Tisted Rectory, Alton, Hants.
1863. †HOWORTH, H. H., M.P., F.S.A. Derby House, Eccles, Manchester.
1883. †Howorth, John, J.P. Springbank, Burnley, Lancashire.
1883. †Hoyle, James. Blackburn.
1883. †Hoyle, William. Claremont, Bury, Lancashire.
1887. §HOYLE, WILLIAM E., M.A. 32 Queen-street, Edinburgh.
1888. §Hudd, Alfred E., F.S.A. 94 Pembroke-road, Clifton, Bristol.
1888. §Hudson, C. T., LL.D. 6 Royal-crescent, Clifton, Bristol.

- Year of Election.
1835. *HUDSON, HENRY, M.D., M.R.I.A. Glenville, Fermoy, Co. Cork.
1883. †Hudson, Rev. W. C. 58 Belmont-street, Southport.
1867. *HUDSON, WILLIAM H. H., M.A., Professor of Mathematics in King's College, London. 15 Altenberg-gardens, Clapham Common, London, S.W.
1858. *HUGGINS, WILLIAM, D.C.L. Oxon., LL.D. Camb., F.R.S., F.R.A.S. Upper Tulse Hill, Brixton, London, S.W.
1857. †Huggon, William. 30 Park-row, Leeds.
1887. †Hughes, E. G. 4 Roman-place, Higher Broughton, Manchester.
1883. †Hughes, Miss E. P. Newnham College, Cambridge.
1871. *Hughes, George Pringle, J.P. Middleton Hall, Wooler, Northumberland.
1887. §Hughes, John Taylor. Thorleymoor, Ashley-road, Altrincham.
1870. *Hughes, Lewis. Fenwick-court, Liverpool.
1876. *Hughes, Rev. Thomas Edward. Wallfield House, Reigate.
1868. §HUGHES, T. M'K., M.A., F.G.S., Woodwardian Professor of Geology in the University of Cambridge.
1865. †Hughes, W. R., F.L.S., Treasurer of the Borough of Birmingham. Birmingham.
1883. †HULKE, JOHN WHITAKER, F.R.S., F.R.C.S., F.G.S. 10 Old Burlington-street, London, W.
1867. §HULL, EDWARD, M.A., LL.D., F.R.S., F.G.S., Director of the Geological Survey of Ireland and Professor of Geology in the Royal College of Science. 14 Hume-street, Dublin.
- *Hulse, Sir Edward, Bart., D.C.L. 47 Portland-place, London, W.; and Breamore House, Salisbury.
1887. *Hummel, Professor J. J. Yorkshire College, Leeds.
1884. *Humphreys, A. W. 45 William-street, New York, U.S.A.
1878. †Humphreys, H. Castle-square, Carnarvon.
1880. †Humphreys, Noel A., F.S.S. Ravenhurst, Hook, Kingston-on-Thames.
1856. †Humphries, David James. 1 Keynsham-parade, Cheltenham.
1862. *HUMPHRY, GEORGE MURRAY, M.D., F.R.S., Professor of Surgery in the University of Cambridge. Grove Lodge, Cambridge.
1877. *HUNT, ARTHUR ROOPE, M.A., F.G.S. Southwood, Torquay.
1886. †Hunt, Charles. The Gas Works, Windsor-street, Birmingham.
1865. †Hunt, J. P. Gospel Oak Works, Tipton.
1884. †HUNT, T. STERRY, M.A., D.Sc., LL.D., F.R.S. Park Avenue Hotel, New York, U.S.A.
1864. †Hunt, W. Folkestone.
1875. *Hunt, William. Northcote, Westbury-on-Trym, Bristol.
1881. †Hunter, F. W. 4 Westmoreland-road, Newcastle-on-Tyne.
1881. †Hunter, Rev. John. University-gardens, Glasgow.
1884. *Hunter, Michael, jun. Greystones, Sheffield.
1869. *Hunter, Rev. Robert. LL.D., F.G.S. Forest Retreat, Staples-road, Loughton, Essex.
1879. †HUNTINGTON, A. K., F.C.S., Professor of Metallurgy in King's College, London. King's College, London, W.C.
1885. †Huntly, The Most Hon. the Marquis of. Aboyne Castle, Aberdeenshire.
1863. †Huntsman, Benjamin. West Retford Hall, Retford.
1883. *Hurst, Charles Herbert. Owens College, Manchester.
1869. †Hurst, George. Bedford.
1882. †Hurst, Walter, B.Sc. West Lodge, Todmorden.
1861. *Hurst, William John. Drumaness Mills, Ballynahinch, Lisburn, Ireland.
1870. †Hurter, Dr. Ferdinand. Appleton, Widnes, near Warrington.

Year of
Election.

- Husband, William Dalla. The Roost, Miles-road, Clifton, Bristol.
1887. §Husband, W. E. 56 Bury New-road, Manchester.
1882. †Hussey, Captain E. R., R.E. 24 Waterloo-place, Southampton.
1876. †Hutchinson, John. 22 Hamilton Park-terrace, Glasgow.
1868. *Hutchison, Robert, F.R.S.E. 29 Chester-street, Edinburgh.
- Hutton, Crompton. Harescombe Grange, Stroud, Gloucestershire.
1864. *Hutton, Darnton. 14 Cumberland-terrace, Regent's Park, London.
N.W.
1857. †Hutton, Henry D. 17 Palmerston-road, Dublin.
1887. †Hutton, J. A. 29 Dale-street, Manchester.
1861. *HUTTON, T. MAXWELL. Summerhill, Dublin.
1852. †HUXLEY, THOMAS HENRY, Ph.D., LL.D., D.C.L., F.R.S., F.L.S.,
F.G.S. 4 Marlborough-place, London, N.W.
- Hyde, Edward. Dukinfield, near Manchester.
1883. †Hyde, George H. 23 Arbour-street, Southport.
1871. *Hyett, Francis A. Painswick House, Stroud, Gloucestershire.
1882. *I'Anson, James, F.G.S. Fairfield House, Darlington.
- Ihne, William, Ph.D. Heidelberg.
1873. †Ikin, J. I. 19 Park-place, Leeds.
1884. †Iles, George. Windsor Hotel, Montreal, Canada.
1885. †Im-Thurn, Everard F. British Guiana.
1888. *Ince, Surgeon-Major John, M.D. The Mount House, Farningham,
Kent.
1858. †Ingham, Henry. Wortley, near Leeds.
1871. †INGLIS, The Right Hon. JOHN, D.C.L., LL.D., Lord Justice-General
of Scotland. Edinburgh.
1876. †Inglis, John, jun. Prince's-terrace, Dowanhill, Glasgow.
1883. †Ingram, Rev. D. C. Church-street, Southport.
1852. †INGRAM, J. K., LL.D., M.R.I.A., Librarian to the University of
Dublin. 2 Wellington-road, Dublin.
1885. †Ingram, William, M.A. Gamrie, Banff.
1886. §Innes, John. The Limes, Alcester-road, Moseley, Birmingham.
1882. §IRVING, Rev. A., B.A., B.Sc., F.G.S. Wellington College, Woking-
ham, Berks.
1888. §Isaac, J. F. V. Freshford House, Freshford, Bath.
1883. †Isherwood, James. 18 York-road, Birkdale, Southport.
1881. †Ishiguro, Isoji. Care of the Japanese Legation, 9 Cavendish-square,
London, W.
1887. §Ito, Tokutaro. 14 Masagochio, Hongo, Tokio, Japan.
1886. †Izod, William. Church-road, Edgbaston, Birmingham.
1859. †Jack, John, M.A. Belhelvie-by-Whitecairns, Aberdeenshire.
1884. †Jack, Peter. People's Bank, Halifax, Nova Scotia, Canada.
1876. *Jack, William, LL.D., Professor of Mathematics in the University of
Glasgow. 10 The College, Glasgow.
1883. *JACKSON, A. H. College of Pharmacy, Melbourne, Australia.
1879. †Jackson, Arthur, F.R.C.S. Wilkinson-street, Sheffield.
1883. †Jackson, Mrs. Esther. 16 East Park-terrace, Southampton.
1883. †Jackson, Frank. 11 Park-crescent, Southport.
1883. *Jackson, F. J. 1 Morley-road, Southport.
1883. †Jackson, Mrs. F. J. 1 Morley-road, Southport.
1874. *Jackson, Frederick Arthur. Belmont, Lyme Regis, Dorset.
1886. §Jackson, George. Clareen, Higher Warberry, Torquay.
1887. *Jackson, George. 53 Elizabeth-street, Cheetham, Manchester.
1885. †Jackson, Henry. 19 Golden-square, Aberdeen.

Year of
Election.

1866. †Jackson, H. W., F.R.A.S., F.G.S. 15 The Terrace, High-road, Lewisham, S.E.
1869. §Jackson, Moses. The Vale, Ramsgate.
1863. *Jackson-Gwilt, Mrs. H. Moonbeam Villa, The Grove, New Wimbledon, Surrey.
1887. §Jacobson, Nathaniel. Olive Mount, Cheetham Hill-road, Manchester.
1874. *Jaffe, John. Edenvale, Strandtown, near Belfast.
1865. *Jaffray, John. Park-grove, Edgbaston, Birmingham.
1872. †James, Christopher. 8 Laurence Pountney-hill, London, E.C.
1860. †James, Edward H. Woodside, Plymouth.
1886. †James, Frank. Portland House, Aldridge, near Walsall.
1886. *James, Harry Berkeley, F.R.G.S. 16 Ashburn-place, London, S.W.
1863. *JAMES, SIR WALTER, Bart., F.G.S. 6 Whitehall-gardens, London, S.W.
1858. †James, William C. Woodside, Plymouth.
1884. †Jameson, W. C. 48 Baker-street, Portman-square, London, W.
1881. †Jamieson, Andrew, Principal of the College of Science and Arts, Glasgow.
1887. §Jamieson, G. Auldjo. 3 Drumsheugh-gardens, Edinburgh.
1885. †Jamieson, Patrick. Peterhead, N.B.
1885. †Jamieson, Thomas. 173 Union-street, Aberdeen.
1859. *Jamieson, Thomas F., F.G.S. Ellon, Aberdeenshire.
1850. †Jardine, Alexander. Jardine Hall, Lockerby, Dumfriesshire.
1853. *Jarratt, Rev. Canon J., M.A. North Cave, near Brough, Yorkshire.
1870. †Jarrold, John James. London-street, Norwich.
1886. §Jeffcock, Rev. John Thomas. The Rectory, Wolverhampton.
1856. §JEFFERY, HENRY M., M.A., F.R.S. 9 Dunstanville-terrace, Fal-mouth.
1855. *Jeffray, John. Winton House, Kelvinside, Glasgow.
1883. †Jeffreys, Miss Gwyn. 1 The Terrace, Kensington, London, W.
1867. †Jeffreys, Howel, M.A., F.R.A.S. Pump-court, Temple, London, E.C.
1885. §Jeffreys, Dr. Richard Parker. Eastwood House, Chesterfield.
1887. §Jeffs, Osmund W. 12 Queen's road, Rock Ferry, Cheshire.
1881. †JELlicoe, C. W. A. Southampton.
1864. †Jelly, Dr. W. Aveleas, 11, Valencia, Spain.
1873. §Jenkins, Major-General J. J. 16 St. James's-square, London, S.W.
1880. *JENKINS, Sir JOHN JONES. The Grange, Swansea.
1852. †Jennings, Francis M., F.G.S., M.R.I.A. Brown-street, Cork.
1872. †Jennings, W. 13 Victoria-street, London, S.W.
1878. †Jephson, Henry L. Chief Secretary's Office, The Castle, Dublin.
- Jessop, William, jun. Overton Hall, Ashover, Chesterfield.
1884. †Jewell, Lieutenant Theo. F. Torpedo Station, Newport, Rhode Island, U.S.A.
1884. †Johns, Thomas W. Yarmouth, Nova Scotia, Canada.
1884. §Johnson, Alexander, M.A., LL.D., Professor of Mathematics in McGill University, Montreal. 5 Prince of Wales-terrace, Montreal, Canada.
1883. †Johnson, Miss Alice. Llandaff House, Cambridge.
1883. †Johnson, Ben. Micklegate, York.
1871. *Johnson, David, F.C.S., F.G.S. 52 Fitzjohn's-avenue, South Hampstead, London, N.W.
1881. †Johnson, Major E. Cecil. Junior United Service Club, Charles-street, London, S.W.
1883. †Johnson, Edmund Litler. 73 Albert-road, Southport.
1865. *Johnson, G. J. 36 Waterloo-street, Birmingham.
1888. §Johnson, J. G. Southwood Court, Highgate, London, N.

Year of
Election.

1875. †Johnson, James Henry, F.G.S. 73 Albert-road, Southport.
 1872. †Johnson, J. T. 27 Dale-street, Manchester.
 1870. †Johnson, Richard C., F.R.A.S. 19 Catherine-street, Liverpool.
 1863. †Johnson, R. S. Hanwell, Fence Houses, Durham.
 1881. †Johnson, Samuel George. Municipal Offices, Nottingham.
 1887. †Johnson, W. H. Woodleigh, Altrincham, Cheshire.
 1883. †Johnson, W. H. F. Llandaff House, Cambridge.
 1883. †Johnson, William. Harewood, Roe-lane, Southport.
 1861. †Johnson, William Beckett. Woodlands Bank, near Altrincham, Cheshire.
 1883. †Johnston, H. H. Tudor House, Champion Hill, London, S.E.
 1859. †Johnston, James. Newmill, Elgin, N.B.
 1864. †Johnston, James. Manor House, Northend, Hampstead, London, N.W.
 1884. †Johnston, John L. 27 St. Peter-street, Montreal, Canada.
 1883. §Johnston, Thomas. Broomsleigh, Seal, Sevenoaks.
 1884. †Johnston, Walter R. Fort Qu Appele, N.W. Territory, Canada.
 1884. *Johnston, W. H. 6 Latham-street, Preston, Lancashire.
 1885. †Johnston-Lavis, H. J., M.D., F.G.S. Palazzo Caramanico, Chiatomone, Naples.
 1886. †Johnstone, G. H. Northampton-street, Birmingham.
 1864. *Johnstone, James. Alva House, Alva, by Stirling, N.B.
 1876. †Johnstone, William. 5 Woodside-terrace, Glasgow.
 1864. †Jolly, Thomas. Park View-villas, Bath.
 1871. †JOLLY, WILLIAM, F.R.S.E., F.G.S., H.M. Inspector of Schools. St. Andrew's-road, Pollokshields, Glasgow.
 1888. §Jolly, W. C. Home Lea, Lansdown, Bath.
 1888. §Joly, John. 39 Waterloo-road, Dublin.
 1881. †Jones, Alfred Orlando, M.D. Cardigan Villa, Harrogate.
 1849. †Jones, Baynham. Walmer House, Cheltenham.
 1887. †Jones, D. E., B.Sc. University College, Aberystwith.
 1887. †Jones, Francis. Beaufort House, Alexandra Park, Manchester.
 1883. *Jones, George Oliver, M.A. 5 Cook-street, Liverpool.
 1884. †Jones, Rev. Harry, M.A. 8 York-gate, Regent's Park, London, N.W.
 1877. †Jones, Henry C., F.C.S. Normal School of Science, South Kensington, London, S.W.
 1883. †Jones, Rev. Canon Herbert. Waterloo, Liverpool.
 1881. †Jones, J. Viriamu, M.A., B.Sc., Principal of the University College of South Wales and Monmouthshire. Cardiff.
 1873. †Jones, Theodore B. 1 Finsbury-circus, London, E.C.
 1880. †Jones, Thomas. 15 Gower-street, Swansea.
 1860. †JONES, THOMAS RUPERT, F.R.S., F.G.S. 10 Uverdale-road, King's-road, Chelsea, London, S.W.
 1883. †Jones, William. Elsinore, Birkdale, Southport.
 1875. *Jose, J. E. 11 Cressington Park, Liverpool.
 1884. †Joseph, J. H. 738 Dorchester-street, Montreal, Canada.
 1875. *Joule, Benjamin St. John B., J.P. 12 Wardle-road, Sale, near Manchester.
 1842. *JOULE, JAMES PRESCOTT, LL.D., F.R.S., F.C.S. 12 Wardle-road, Sale, near Manchester.
 1847. †JOWETT, Rev. B., M.A., Regius Professor of Greek in the University of Oxford. Balliol College, Oxford.
 1858. †Jowett, John. Leeds.
 1879. †Jowitt, A. Hawthorn Lodge, Clarkehouse-road Sheffield.
 1872. †Joy, Algernon. Junior United Service Club, St. James's, London, S.W.
 1848. *Joy, Rev. Charles Ashfield. West Hanney, Wantage, Berkshire.

- Year of Election.
1883. †Joyce, Rev. A. G., B.A. St. John's Croft, Winchester.
1886. §Joyce, The Hon. Mrs. St. John's Croft, Winchester.
1848. *Jubb, Abraham. Halifax.
1870. †JUDD, JOHN WESLEY, F.R.S., F.G.S., Professor of Geology in the Royal School of Mines. Hurstleigh, Kew.
1883. †Justice, Philip M. 14 Southampton-buildings, Chancery-lane, London, W.C.
1868. *Kaines, Joseph, M.A., D.Sc. 8 Osborne-road, Stroud Green-road, London, N.
KANE, Sir ROBERT, M.D., LL.D., F.R.S., M.R.I.A., F.C.S. Fortlands, Killiney, Co. Dublin.
1888. §Kapp, Gisbert. Stanley Villa, Wimbledon, Surrey.
1887. †Kay, Miss. Hamerlaund, Broughton Park, Manchester.
1859. †Kay, David, F.R.G.S. 19 Upper Phillimore-place, Kensington, London, W.
Kay, John Cunliff. Fairfield Hall, near Skipton.
1883. †Kearne, John H. Westcliffe-road, Birkdale, Southport.
1884. †Keefe, Samuel. Brockville, Ontario, Canada
1884. †Keefe, Thomas Alexander. Port Arthur, Ontario, Canada.
1875. †Keeling, George William. Tuthill, Lydney.
1886. †Keen, Arthur, J.P. Sandyford, Augustus-road, Birmingham.
1878. *Kelland, William Henry. 110 Jernyn-street, London, S.W.; and Grettans, Bow, North Devon.
1887. †Kellas-Johnstone, J. F. 69 Princess-street, Manchester.
1884. †Kellogg, J. H., M.D. Battle Creek, Michigan, U.S.A.
1864. *Kelly, W. M., M.D. 11 The Crescent, Taunton, Somerset.
1885. §Keltie, J. Scott, Librarian R.G.S. 1 Savile-row, London, W.
1887. †Kemp, Harry. 254 Stretford-road, Manchester.
1853. †Kemp, Rev. Henry William, B.A. The Charter House, Hull.
1884. †Kemper, Andrew C., A.M., M.D. 101 Broadway, Cincinnati, U.S.A.
1875. †KENNEDY, ALEXANDER B. W., F.R.S., M.Inst.C.E., Professor of Engineering in University College, London.
1884. †Kennedy, George L., M.A., F.G.S., Professor of Chemistry and Geology in King's College, Windsor, Nova Scotia, Canada.
1876. †Kennedy, Hugh. Redclyffe, Partickhill, Glasgow.
1884. †Kennedy, John. 113 University-street, Montreal, Canada.
1884. †Kennedy, William. Hamilton, Ontario, Canada.
1886. †Kenrick, George Hamilton. Whetstone, Somerset-road, Edgbaston, Birmingham.
Kent, J. C. Levant Lodge, Earl's Croome, Worcester.
1886. §Kenward, James, F.S.A. 280 Hagley-road, Birmingham.
1857. *Ker, André Allen Murray. Newbliss House, Newbliss, Ireland.
1855. *Ker, Robert. Dougalston, Milngavie, N.B.
1876. †Ker, William. 1 Windsor-terrace West, Glasgow.
1881. †Kermode, Philip M. C. Ramsay, Isle of Man.
1884. †Kerr, James, M.D. Winnipeg, Canada.
1887. †Kerr, James. Dunkenhalgh, Accrington.
1883. †Kerr, Dr. John. Garscadden House, near Kilpatrick, Glasgow.
1887. §Kershaw, James. Holly House, Bury New-road, Manchester.
1869. *Kesselmeier, Charles A. Villa 'Mon Repos,' Altrincham, Cheshire.
1869. *Kesselmeier, William Johannes. Villa 'Mon Repos,' Altrincham, Cheshire.
1861. *Keymer, John. Parker-street, Manchester.
1883. *Keynes, J. N., M.A., B.Sc., F.S.S. 6 Harvey-road, Cambridge.

Year of
Election.

1876. †Kidston, J. B. West Regent-street, Glasgow.
 1886. §KIDSTON, ROBERT, F.R.S.E., F.G.S. 24 Victoria-place, Stirling.
 1876. †Kidston, William. Ferniegair, Helensburgh, N.B.
 1885. *Kilgour, Alexander. Loirston House, Cove, near Aberdeen.
 1865. *Kinahan, Sir Edward Hudson, Bart, M.R.I.A. 11 Merrion-square
 North, Dublin.
 1878. †Kinahan, Edward Hudson, jun. 11 Merrion-square North, Dublin.
 1860. †KINAHAN, G. HENRY, M.R.I.A. Geological Survey of Ireland, 14
 Hume-street, Dublin.
 1875. *KINCH, EDWARD, F.C.S. Royal Agricultural College, Cirencester.
 1888. §King, Austin J. Winsley Hill, Limpley Stoke, Bath.
 1872. *King, Mrs. E. M. 34 Cornwall-road, Westbourne Park, London, W.
 1888. *King, E. Powell. Wainsford, Lymington, Hants.
 1883. *King, Francis. Thornhill, Penrith.
 1875. *King, F. Ambrose. Avonside, Clifton, Bristol.
 1871. *King, Rev. Herbert Poole. St. Oswald's College, Ellesmere,
 Salop.
 1855. †King, James. Leverholme, Hurlet, Glasgow.
 1883. *King, John Godwin. Wainsford, Lymington, Hants.
 1870. †King, John Thomson. 4 Clayton-square, Liverpool.
 King, Joseph. Welford House, Greenhill, Hampstead, London,
 N.W.
 1883. *King, Joseph, jun. 44 Well-walk, Hampstead, London, N.W.
 1860. *King, Mervyn Kersteman. 1 Vittoria-square, Clifton, Bristol.
 1875. *King, Percy L. Avonside, Clifton, Bristol.
 1888. §King, Richard. Grosvenor Lodge, Bath.
 1870. †King, William. 5 Beach Lawn, Waterloo, Liverpool.
 1869. †Kingdon, K. Taddiford, Exeter.
 1861. †Kingsley, John. Ashfield, Victoria Park, Manchester.
 1876. §Kingston, Thomas. The Limes, Clewer, near Windsor.
 1875. §KINGZETT, CHARLES T., F.C.S. Trevena, Amhurst Park, London, N.
 1867. †Kinloch, Colonel. Kirriemuir, Logie, Scotland.
 1870. †Kinsman, William R. Branch Bank of England, Liverpool.
 1860. †KIRKMAN, Rev. THOMAS P., M.A., F.R.S. Croft Rectory, near
 Warrington.
 1875. †Kirsop, John. 6 Queen's-crescent, Glasgow.
 1883. †Kirsop, Mrs. 6 Queen's-crescent, Glasgow.
 1870. †Kitchener, Frank E. Newcastle, Staffordshire.
 1886. †Klein, Rev. L. Martial. University College, Dublin.
 1869. †Knapman, Edward. The Vineyard, Castle-street, Exeter.
 1886. §Knight, J. M. Bushwood, Wanstead, Essex.
 1883. †Knight, J. R. 32 Lincoln's Inn-fields, London, W.C.
 1888. §Knott, Cargill G., D.Sc., F.R.S.E. Tokyo, Japan.
 1872. *Knott, George, LL.B., F.R.A.S. Knowles Lodge, Cuckfield, Hay-
 ward's Heath, Sussex.
 1887. *Knott, Herbert. Wharf Street Mills, Ashton-under-Lyne.
 1887. *Knott, John F. Staveleigh, Stalybridge, Yorkshire.
 1887. †Knott, Mrs. Staveleigh, Stalybridge, Yorkshire.
 1887. §Knott, T. B. Ellerslie, Cheadle Hulme, Cheshire.
 1873. *Knowles, George. Moorhead, Shipley, Yorkshire.
 1872. †Knowles, James. The Hollies, Clapham Common, S.W.
 1870. †Knowles, Rev. J. L. 103 Earl's Court-road, Kensington, Lon-
 don, W.
 1874. †Knowles, William James. Flixton-place, Ballymena, Co. Antrim.
 1883. †Knowlys, Rev. C. Hesketh. The Rectory, Roe-lane, Southport.
 1883. †Knowlys, Mrs. C. Hesketh. The Rectory, Roe-lane, Southport.
 1876. †Knox, David N., M.A., M.B., 24 Elmbank-crescent, Glasgow.

Year of
Election.

- *Knox, George James. 29 Portland-terrace, Regent's Park, London, N.W.
1875. *Knubley, Rev. E. P. Staveley Rectory, Leeds.
1883. †Knubley, Mrs. Staveley Rectory, Leeds.
1888. *Kunz, G. F. U. S. Geological Survey, Washington, U.S.A.
1881. †Kurobe, Hiroo. Legation of Japan, 9 Cavendish-square, London, W.
1870. †Kynaston, Josiah W., F.C.S. Kensington, Liverpool.
1865. †Kynnersley, J. C. S. The Leveretts, Handsworth, Birmingham.
1882. †Kyshe, John B. 19 Royal-avenue, Sloane-square, London S.W.
1858. †Lace, Francis John. Stone Gapp, Cross-hill, Leeds.
1884. †Laflamme, Rev. Professor J. C. K. Laval University, Quebec, Canada.
1885. *Laing, J. Gerard. 1 Elm-court, Temple, London, E.C.
1870. †Laird, H. H. Birkenhead.
1870. §Laird, John. Grosvenor-road, Cloughton, Birkenhead.
1882. †Lake, G. A. K., M.D. East Park-terrace, Southampton.
1880. †Lake, Samuel. Milford Docks, Milford Haven.
1877. †Lake, W. C., M.D. Teignmouth.
1859. †Lalor, John Joseph, M.R.I.A. City Hall, Cork Hill, Dublin.
1887. †Lamb, Horace, M.A., F.R.S., Professor of Pure Mathematics in the Owens College, Manchester. Manchester.
1887. †Lamb, James. Kenwood, Bowdon, Cheshire.
1883. †Lamb, W. J. 11 Gloucester-road, Birkdale, Southport.
1883. †LAMBERT, Rev. BROOKE, LL.B. The Vicarage, Greenwich, Kent, S.E.
1884. †Lamborn, Robert H. Montreal, Canada.
1884. †Lancaster, Alfred. Fern Bank, Burnley, Lancashire.
1871. †Lancaster, Edward. Karesforth Hall, Barnsley, Yorkshire.
1886. †Lancaster, W. J., F.G.S. Colmore-row, Birmingham.
1877. †Landon, Frederic George, M.A., F.R.A.S. 59 Tresillian-road, St. John's, S.E.
1883. †Lang, Rev. Gavin. Inverness.
1859. †Lang, Rev. John Marshall, D.D. Barony, Glasgow.
1886. *LANGLEY, J. N., M.A., F.R.S. Trinity College, Cambridge.
1870. †Langton, Charles. Barkhill, Aigburth, Liverpool.
1865. †LANKESTER, E. RAY, LL.D., F.R.S., Professor of Comparative Anatomy and Zoology in University College, London. 45 Grove End-road, London, N.W.
1880. *LANSDELL, Rev. HENRY, D.D., F.R.A.S., F.R.G.S. Care of Mr. Wheldon, 58 Great Queen-street, Lincoln's Inn-fields, London, W.C.
- Lanyon, Sir Charles. The Abbey, White Abbey, Belfast.
1884. †Lanza, Professor G. Massachusetts Institute of Technology, Boston, U.S.A.
1878. †Lapper, E., M.D. 61 Harcourt-street, Dublin.
1886. †Lapraik, W. 9 Malfort-road, Denmark Hill, London, S.E.
1885. †LAPWORTH, CHARLES, LL.D., F.R.S., F.G.S., Professor of Geology and Mineralogy in the Mason Science College, Birmingham. 46 George-road, Edgbaston, Birmingham.
1887. §Larmor, Alexander. Clare College, Cambridge.
1881. †Larmor, Joseph, M.A., Professor of Natural Philosophy in Queen's College, Galway.
1883. §Lascelles, B. P. Harrow.
1870. *LATHAM, BALDWIN, M.Inst.C.E., F.G.S. 7 Westminster-chambers, Westminster, S.W.
1870. †LAUGHTON, JOHN KNOX, M.A., F.R.G.S. 130 Sinclair-road, West Kensington Park, London, W.

- Year of
Election.
1888. §LAURIE, Colonel R. P., C.B., M.P. 35 Eaton-place, London, S.W.
1883. †Laurie, Major-General. Oakfield, Nova Scotia.
1870. *Law, Channell. Ilsham Dene, Torquay.
1878. †Law, Henry, M.Inst.C.E. 9 Victoria-chambers, London, S.W.
1862. †Law, Rev. James Edmund, M.A. Little Shelford, Cambridgeshire.
1884. §Law, Robert. 11 Cromwell-terrace, West Hill Park, Halifax, Yorkshire.
1870. †Lawrence, Edward. Aigburth, Liverpool.
1881. †Lawrence, Rev. F., B.A. The Vicarage, Westow, York.
1875. †Lawson, George, Ph.D., LL.D., Professor of Chemistry and Botany. Halifax, Nova Scotia.
1885. †Lawson, James. 8 Church-street, Huntly, N.B.
1868. *Lawson, M. Alexander, M.A., F.L.S. Ootâcamund, Bombay.
1853. †Lawton, William. 5 Victoria-terrace, Derringham, Hull.
1888. §Layard, Miss Nina F. Turleigh House, near Bradford, Yorkshire.
1856. †Lea, Henry. 38 Bennett's-hill, Birmingham.
1883. *Leach, Charles Catterall. Care of Swan & Leach (Limited), 141 Briggate, Leeds.
1883. §Leach, John. Haverhill House, Bolton.
1875. †Leach, Colonel R. E. Mountjoy, Phœnix Park, Dublin.
1870. *Leaf, Charles John, F.L.S., F.G.S., F.S.A. 6 Sussex-place, Regent's Park, London, N.W.
1884. *Leahy, John White, J.P. South Hill, Killarney, Ireland.
1884. †Learmont, Joseph B. 120 Mackay-street, Montreal, Canada.
1847. *LEATHAM, EDWARD ALDAM, M.P. Whitley Hall, Huddersfield ; and 46 Eaton-square, London, S.W.
1863. †Leavers, J. W. The Park, Nottingham.
1884. *Leavitt, Erasmus Darwin. 604 Main-street, Cambridgeport, Massachusetts, U.S.A.
1872. †LEBOUR, G. A., M.A., F.G.S., Professor of Geology in the College of Physical Science, Newcastle-on-Tyne.
1884. †Leckie, R. G. Springhill, Cumberland County, Nova Scotia.
1883. †Lee, Daniel W. Halton Bank, Pendleton, near Manchester.
1861. †Lee, Henry, M.P. Sedgeley Park, Manchester.
1883. †Lee, J. H. Warburton. Rossall, Fleetwood.
1887. *Lee, Sir Joseph Cooksey. Park Gate, Altrincham.
1884. *Leech, Bosdin T. Oak Mount, Temperley, Cheshire.
1887. †Leech, D. J. Elm House, Whalley Range, Manchester.
1886. *Lees, Lawrence W. Claregate, Tettenhall, Wolverhampton.
1882. †Lees, R. W. Moira-place, Southampton.
1859. †Lees, William, M.A. St. Leonard's, Morningside-place, Edinburgh.
1883. *Leese, Miss H. K. Fylde-road Mills, Preston, Lancashire.
- *Leese, Joseph. Fylde-road Mills, Preston, Lancashire.
1883. †Leese, Mrs. Hazeldene, Fallowfield, Manchester.
1881. †LE FEUVRE, J. E. Southampton.
1872. †LEFEVRE, The Right Hon. G. SHAW, M.P., F.R.G.S. 18 Bryanston square, London, W.
- *LEFROY, General Sir JOHN HENRY, R.A., K.C.M.G., C.B., LL.D., F.R.S., F.R.G.S. 82 Queen's-gate, London, S.W.
- *Lekh, Lieut.-Colonel George Cornwall. High Legh Hall, Cheshire.
1869. †Le Grice, A. J. T'reife, Penzance.
1868. †LEICESTER, The Right Hon. the Earl of, K.G. Holkham, Norfolk.
1861. *Leigh, Henry. Moorfield, Swinton, near Manchester.
1856. †LEIGH, The Right Hon. Lord, D.C.L. 37 Portman-square, London, W. ; and Stoneleigh Abbey, Kenilworth.

Year of
Election.

1886. §Leipner, Adolph, Professor of Botany in University College, Bristol.
47 Hampton Park, Bristol.
1867. †Leishman, James. Gateacre Hall, Liverpool.
1859. †Leith, Alexander. Glenkindie, Inverkindie, N.B.
1882. §Lemon, James, M.Inst.C.E. 11 The Avenue, Southampton.
1863. *LENDY, Major AUGUSTE FREDERIC, F.L.S., F.G.S. Sunbury House,
Sunbury, Middlesex.
1867. †Leng, John. 'Advertiser' Office, Dundee.
1878. †Lennon, Rev. Francis. The College, Maynooth, Ireland.
Lentaigne, Joseph. 12 Great Denmark-street, Dublin.
1887. *Leon, John T. 38 Portland-place, London, W.
1871. †LEONARD, HUGH, F.G.S., M.R.I.A., F.R.G.S.I. St. David's, Mala-
hide-road, Co. Dublin.
1874. †Lepper, Charles W. Laurel Lodge, Belfast.
1872. †Lermit, Rev. Dr. *School House, Dedham.*
1884. §Lesage, Louis. City Hall, Montreal, Canada.
1871. †Leslie, Alexander, M.Inst.C.E. 72 George-street, Edinburgh.
1883. §Lester, Thomas. Fir Bank, Penrith.
1880. †LETCHE, R. J. Lansdowne-terrace, Walters-road, Swansea.
1887. †Leverkus, Otto. The Downs, Prestwich, Manchester.
1887. *Levinstein, Ivan. Villa Newberg, Victoria Park, Manchester.
1879. †Lewin, Colonel, F.R.G.S. Garden Corner House, Chelsea Embank-
ment, London, S.W.
1870. †LEWIS, ALFRED LIONEL. 54 Highbury-hill, London, N.
1884. *Lewis, Sir W. T. The Mardy, Aberdare.
1853. †Liddell, George William Moore. Sutton House, near Hull.
1860. †LIDDELL, The Very Rev. H. G., D.D., Dean of Christ Church,
Oxford.
1887. †Liebermann, L. 54 Portland-street, Manchester.
1876. †Lietke, J. O. 30 Gordon-street, Glasgow.
1887. *Lightbown, Henry. Weaste Hall, Pendleton, Manchester.
1862. †LILFORD, The Right Hon. Lord, F.L.S. Lilford Hall, Oundle, North-
amptonshire.
- *LIMERICK, The Right Rev. CHARLES GRAVES, Lord Bishop of, D.D.,
F.R.S., M.R.I.A. The Palace, Henry-street, Limerick.
1887. †Limpach, Dr. Crumpsall Vale Chemical Works, Manchester.
1878. †Lincolne, William. Ely, Cambridgeshire.
1881. *Lindley, William, M.Inst.C.E., F.G.S. 10 Kidbrooke-terrace, Black-
heath, London, S.E.
1870. †Lindsay, Thomas, F.C.S. Maryfield College, Maryhill, by Glasgow.
1871. †Lindsay, Rev. T. M., M.A., D.D. Free Church College, Glasgow.
Lingwood, Robert M., M.A., F.L.S., F.G.S. 6 Park-villas, Chel-
tenham.
1876. †Linn, James. Geological Survey Office, India-buildings, Edinburgh.
1883. †Lisle, H. Claud. Nantwich.
1882. *Lister, Rev. Henry, M.A. Hawridge Rectory, Berkhamstead.
1888. §Lister, J. J. Leytonstone, Essex, E.
1876. †Little, Thomas Evelyn. 42 Brunswick-street, Dublin.
Littledale, Harold. Liscard Hall, Cheshire.
1881. †Littlewood, Rev. B. C., M.A. Holmdale, Cheltenham.
1861. *LIVEING, G. D., M.A., F.R.S., F.C.S., Professor of Chemistry in the
University of Cambridge. Newnham, Cambridge.
1876. *Liversidge, Archibald, F.R.S., F.C.S., F.G.S., F.R.G.S., Professor
of Chemistry and Mineralogy in the University of Sydney,
N.S.W. (Care of Messrs. Trübner & Co., Ludgate Hill, Lon-
don, E.C.)
1864. §Livesay, J. G. Cromartie House, Ventnor, Isle of Wight.

Year of
Election.

1880. †Llewelyn, John T. D. Penllegare, Swansea.
Lloyd, Rev. A. R. Hengold, near Oswestry.
1842. Lloyd, Edward. King-street, Manchester.
1865. †Lloyd, G. B., J.P. Edgbaston-grove, Birmingham.
*Lloyd, George, M.D., F.G.S. Bryntirion, Berkhamsted, Herts.
1865. †Lloyd, John. Queen's College, Birmingham.
1886. †Lloyd, John Henry. Ferndale, Carpenter-road, Edgbaston, Birmingham.
1886. †Lloyd, Samuel. Farm, Sparkbrook, Birmingham.
1865. *Lloyd, Wilson, F.R.G.S. Myvod House, Wednesbury.
1854. *LOBLEY, JAMES LOGAN, F.G.S., F.R.G.S. 20 Clarges-street, Piccadilly, London, W.
1853. *Locke, John. 133 Leinster-road, Dublin.
1867. *Locke, John. Whitehall Club, London, S.W.
1863. †LOCKYER, J. NORMAN, F.R.S., F.R.A.S. Science Schools, South Kensington, London, S.W.
1886. *Lodge, Alfred, M.A. Cooper's Hill, Staines.
1875. *LODGE, OLIVER J., D.Sc., LL.D., F.R.S., Professor of Physics in University College, Liverpool. 21 Waverley-road, Sefton Park, Liverpool.
1833. †Lofthouse, John. West Bank, Rochdale.
1833. †London, Rev. H. High Lee, Knutsford.
1876. †Long, H. A. Charlotte-street, Glasgow.
1872. †Long, Jeremiah. 50 Marine Parade, Brighton.
1871. *Long, John Jex. 11 Doune-terrace, Kelvininside, Glasgow.
1851. †Long, William, F.G.S. Hurts Hall, Saxmundham, Suffolk.
1883. *Long, William. Thelwall Heys, near Warrington.
1883. †Long, Mrs. Thelwall Heys, near Warrington.
1883. †Long, Miss. Thelwall Heys, near Warrington.
1866. †Longdon, Frederick. Osmaston-road, Derby.
1883. †Longe, Francis D. Coddendam Lodge, Cheltenham.
1883. †Longmaid, William Henry. 4 Rawlinson-road, Southport.
1875. *Longstaff, George Blundell, M.A., M.B., F.C.S., F.S.S. Southfield Grange, Wandsworth, S.W.
1871. §Longstaff, George Dixon, M.D., F.C.S. Butterknowle, Wandsworth, S.W.
1872. *Longstaff, Llewellyn Wood, F.R.G.S. Ridgelsands, Wimbledon, Surrey.
1881. *Longstaff, Mrs. Ll. W. Ridgelsands, Wimbledon, Surrey.
1883. *Longton, E. J., M.D. Lord-street, Southport.
1861. *Lord, Edward. Adamroyd, Todmorden.
1863. †Losh, W. S. Wreay Syke, Carlisle.
1883. *Louis, D. A., F.C.S. 77 Shirland-gardens, London, S.W.
1887. *Love, A. E. H. St. John's College, Cambridge.
1886. *Love, F. F. J., M.A. The University, Melbourne, Australia.
1876. *Love, James, F.R.A.S., F.G.S., F.Z.S. 75 Oval road, Croydon.
1883. §Love, James Allen. 8 Eastbourne-road West, Southport.
1875. *Lovett, W. Jesse, F.I.C. Jessamine Cottage, Thornes, Wakefield.
1867. *Low, James F. Monifieth, by Dundee.
1885. §Lowdell, Sydney Poole. Baldwyn's Hill, East Grinstead, Sussex.
1885. *Lowe, Arthur C. W. Gosfield Hall, Halstead, Essex.
1861. *LOWE, EDWARD JOSEPH, F.R.S., F.R.A.S., F.L.S., F.G.S., F.R.M.S. Shirenewton Hall, near Chepstow.
1884. †Lowe, F. J. Elm-court, Temple, London, E.C.
1886. *Lowe, John Lander. 132 Bath-row, Birmingham.
1850. †Lowe, William Henry, M.D., F.R.S.E. Balgreen, Slateford, Edinburgh.

Year of
Election.

1881. †Lubbock, Arthur Rolfe. High Elms, Hayes, Kent.
 1853. *LUBBOCK, Sir JOHN, Bart., M.P., D.C.L., LL.D., F.R.S., F.L.S.,
 F.G.S. Down, Farnborough, Kent.
 1881. †Lubbock, John B. High Elms, Hayes, Kent.
 1870. †Lubbock, Montague, M.D. 19 Grosvenor-street, London, W.
 1878. †Lucas, Joseph. Tooting Graveney, London, S.W.
 1849. *Luckcock, Howard. Oak-hill, Edgbaston, Birmingham.
 1875. †Lucy, W. C., F.G.S. The Winstones, Brookthorpe, Gloucester.
 1881. †Luden, C. M. 4 Bootham-terrace, York.
 1873. †Lumley, J. Hope Villa, Thornbury, near Bradford, Yorkshire.
 1885. †LUMSDEN, ROBERT. Ferryhill House, Aberdeen.
 1866. *Lund, Charles. Ilkley, Yorkshire.
 1873. †Lund, Joseph. Ilkley, Yorkshire.
 1850. *Lundie, Cornelius. 321 Newport-road, Cardiff.
 1853. †Lunn, William Joseph, M.D. 23 Charlotte-street, Hull.
 1883. *Lupton, Arnold, M.Inst.C.E., F.G.S., Professor of Mining Engineer-
 ing in Yorkshire College. 6 De Grey-road, Leeds.
 1858. *Lupton, Arthur. Headingley, near Leeds.
 1874. *LUPTON, SYDNEY, M.A. The Harehills, near Leeds.
 1864. *Lutley, John. Brockhampton Park, Worcester.
 1871. †Lyell, Leonard, F.G.S. 92 Onslow-gardens, London, S.W.
 1884. †Lyman, A. Clarence. 84 Victoria-street, Montreal, Canada.
 1884. †Lyman, H. H. 74 McTavish-street, Montreal, Canada.
 1884. †Lyman, Roswell C. 74 McTavish-street, Montreal, Canada.
 1874. †Lynam, James. Ballinasloe, Ireland.
 1885. §Lyon, Alexander, jun. 52 Carden-place, Aberdeen.
 1857. †Lyons, Robert D., M.B., M.R.I.A. 8 Merrion-square West, Dublin.
 1878. †Lyte, Cecil Maxwell. Cotford, Oakhill-road, Putney, S.W.
 1862. *LYTE, F. MAXWELL, F.C.S. 60 Finborough-road, London, S.W.
1852. †McAdam, Robert. 18 College-square East, Belfast.
 1854. *MACADAM, STEVENSON, Ph.D., F.R.S.E., F.C.S., Lecturer on
 Chemistry. Surgeons' Hall, Edinburgh; and Brighton House,
 Portobello, by Edinburgh.
 1876. *MACADAM, WILLIAM IVISON. Surgeons' Hall, Edinburgh.
 1868. †MACALISTER, ALEXANDER, M.D., F.R.S., Professor of Anatomy in
 the University of Cambridge. Strathmore House, Harvey-road,
 Cambridge.
 1878. †MACALISTER, DONALD, M.A., M.D., B.Sc. St. John's College, Cam-
 bridge.
 1879. §MacAndrew, James J. Lukesland, Ivybridge, South Devon.
 1883. §MacAndrew, Mrs. J. J. Lukesland, Ivybridge, South Devon.
 1883. §MacAndrew, William. Westwood House, near Colchester.
 1866. *M'Arthur, Alexander, M.P., F.R.G.S. Raleigh Hall, Brixton Rise,
 London, S.W.
 1884. †Macarthur, Alexander. Winnipeg, Canada.
 1884. †Macarthur, D. Winnipeg, Canada.
 1840. MACAULAY, JAMES, A.M., M.D. 25 Carlton-road, Maida Vale,
 London, N.W.
 1840. *MacBrayne, Robert. Messrs. Black and Wingate, 5 Exchange-
 square, Glasgow.
 1884. †McCabe, T., Chief Examiner of Patents. Patent Office, Ottawa,
 Canada.
 1855. †M'Cann, Rev. James, D.D., F.G.S. *The Lawn, Lower Norwood,*
Surrey, S.E.
 1886. †MacCarthy, Rev. E. F. M., M.A. 93 Hagley-road, Birmingham.
 1887. *MacCarthy, James. Bangkok, Siam.

Year of
Election.

1884. *McCarthy, J. J., M.D. Junior Army and Navy Club, London, S.W.
 1884. †McCausland, Orr. Belfast.
 1876. *M'CLELLAND, A. S. 4 Crown-gardens, Dowanhill, Glasgow.
 1863. †M'CLINTOCK, Admiral Sir FRANCIS L., R.N., F.R.S., F.R.G.S.
 United Service Club, Pall Mall, London, S.W.
 1872. *M'Clure, J. H., F.R.G.S. *Chavoire Annecy, Haute Savoie, France.*
 1874. †M'Clure, Sir Thomas, Bart. Belmont, Belfast.
 1878. *M'Comas, Henry. Homestead, Dundrum, Co. Dublin.
 1858. †M'Connell, J. E. Woodlands, Great Missenden.
 1883. †McCrossan, James. 92 Huskisson-street, Liverpool.
 1876. †M'ulloch, Richard. 109 Douglas-street, Blythswood-square,
Glasgow.
 1884. †MACDONALD, The Right Hon. Sir JOHN ALEXANDER, G.C.B., D.C.L.,
 LL.D. Ottawa, Canada.
 1886. §McDonald, John Allen. 6 Holly-place, Hampstead, London, N.W.
 1884. †McDonald, Kenneth. Town Hall, Inverness.
 1884. *McDonald, W. C. 891 Sherbrooke-street, Montreal, Canada.
 1878. †McDonnell, Alexander. St. John's, Island Bridge, Dublin.
 1884. †McDonnell, Mrs. F. H. 1433 St. Catherine-street, Montreal, Canada.
 McDonnell, Hercules H. G. 2 Kildare-place, Dublin.
 1883. †McDonnell, Rev. Canon J. C., D.D. Misterton Rectory, Lutter-
 worth.
 1878. †McDonnell, James. 32 Upper Fitzwilliam-street, Dublin.
 1878. †McDonnell, Robert, M.D., F.R.S., M.R.I.A. 89 Merrion-square
 West, Dublin.
 1884. †Macdougall, Alan. Toronto, Canada.
 1884. †McDougall, John. 35 St. François Xavier-street, Montreal, Canada.
 1881. †Macfarlane, Alexander, D.Sc., F.R.S.E., Professor of Physics in the
 University of Texas. Austin, Texas, U.S.A.
 1871. †M'Farlane, Donald. The College Laboratory, Glasgow.
 1885. †Macfarlane, J. M., D.Sc. 3 Bellevue-terrace, Edinburgh.
 1879. †Macfarlane, Walter, jun. 12 Lynedoch-crescent, Glasgow.
 1884. †Macfie, K. N., B.A., B.C.L. Winnipeg, Canada.
 1854. *Macfie, Robert Andrew. Dreghorn, Colinton, Edinburgh.
 1867. *M'Gavin, Robert. Ballumbie, Dundee.
 1855. †MacGeorge, Andrew, jun. 21 St. Vincent-place, Glasgow.
 1888. §MacGeorge, James. 1 Devonshire-terrace, Kensington, London, W.
 1872. †M'George, Mungo. *Nithsdale, Laurie Park, Sydenham, S.E.*
 1884. †MacGillivray, James. 42 Cathcart-street, Montreal, Canada.
 1884. †MacGoun, Archibald, jun., B.A., B.C.L. 19 Place d'Armes, Mont-
 real, Canada.
 1873. †McGowen, William Thomas. Oak-avenue, Oak Mount, Bradford,
 Yorkshire.
 1885. †Macgregor, Alexander, M.D. 256 Union-street, Aberdeen.
 1884. *MACGREGOR, JAMES GORDON, M.A., D.Sc., F.R.S.E., Professor of
 Physics in Dalhousie College, Halifax, Nova Scotia, Canada.
 1880. †McGregor, William. Kohima Lodge, Bedford.
 1885. †M'Gregor-Robertson, J., M.A., M.B. 400 Great Western-road,
 Glasgow.
 1876. †M'Grigor, Alexander B., LL.D. 19 Woodside-terrace, Glasgow.
 1867. *M'INTOSH, W. C., M.D., LL.D., F.R.S. L. & E., F.L.S., Professor
 of Natural History in the University of St. Andrews. 2 Abbots-
 ford-crescent, St. Andrews, N.B.
 1884. †McIntyre, John, M.D. Odiham, Hants.
 1883. †Mack, Isaac A. Trinity-road, Bootle.
 1884. †Mackay, Alexander Howard, B.A., B.Sc. The Academy, Pictou,
 Nova Scotia, Canada.

Year of
Election.

1885. §MACKAY, JOHN YULE, M.D. The University, Glasgow.
 1873. †MCKENDRICK, JOHN G., M.D., F.R.S. L. & E., Professor of Physiology in the University of Glasgow. The University, Glasgow.
 1883. †McKendrick, Mrs. The University, Glasgow.
 1880. *Mackenzie, Colin. Junior Athenæum Club, Piccadilly, London, W.
 1885. †Mackenzie, J. T. *Glennmuick, Bullater, N.B.*
 1884. †McKenzie, Stephen, M.D. 26 Finsbury-circus, London, E.C.
 1884. †McKenzie, Thomas, B.A. School of Science, Toronto, Canada.
 1883. †Mackeson, Henry. Hythe, Kent.
 1865. †Mackeson, Henry B., F.G.S. Hythe, Kent.
 1872. *Mackey, J. A. 1 Westbourne-terrace, Hyde Park, London, W.
 1867. †MACKIE, SAMUEL JOSEPH. 17 Howley-place, London, W.
 1884. †McKilligan, John B. 387 Main-street, Winnipeg, Canada.
 1887. §Mackinder, H. J., M.A., F.R.G.S. Christ Church, Oxford.
 1867. *Mackinlay, David. 6 Great Western-terrace, Hillhead, Glasgow.
 1865. †Mackintosh, Daniel, F.G.S. 32 Glover-street, Birkenhead.
 1884. †Mackintosh, James B. Consolidated Gas Company, 21st-street, and Avenue A, New York City, U.S.A.
 1886. *Mackintosh, J. B. School of Mines, Fourth Avenue, New York, U.S.A.
 1850. †Macknight, Alexander. 20 Albany-street, Edinburgh.
 1867. †Mackson, H. G. 25 Cliff-road, Woodhouse, Leeds.
 1872. *McLACHLAN, ROBERT, F.R.S., F.L.S. West View, Clarendon-road, Lewisham, S.E.
 1873. †McLandsborough, John, M.Inst.C.E., F.R.A.S., F.G.S. Manningham, Bradford, Yorkshire.
 1885. *M'LAREN, The Right Hon. Lord, F.R.S.E. 46 Moray-place, Edinburgh.
 1860. †Maclaren, Archibald. Summertown, Oxfordshire.
 1873. †MacLaren, Walter S. B. Newington House, Edinburgh.
 1882. †Maclean, Inspector-General, C.B. 1 Rockstone-terrace, Southampton.
 1884. †McLennan, Frank. 317 Drummond-street, Montreal, Canada.
 1884. †McLennan, Hugh. 317 Drummond-street, Montreal, Canada.
 1884. †McLennan, John. Lancaster, Ontario, Canada.
 1862. †Macleod, Henry Dunning. 17 Gloucester-terrace, Campden Hill-road, London, W.
 1868. §M'LEOD, HERBERT, F.R.S., F.C.S., Professor of Chemistry in the Royal Indian Civil Engineering College, Cooper's Hill, Staines.
 1875. †Macliver, D. 1 Broad-street, Bristol.
 1875. †Macliver, P. S. 1 Broad-street, Bristol.
 1861. *Maclure, John William, M.P., F.R.G.S., F.S.S. Whalley Range, Manchester.
 1883. *McMahon, Major-General C. A. 20 Nevern-square, South Kensington, London, S.W.
 1883. †MacMahon, Captain P. A., R.A., Instructor in Mathematics at the Royal Military Academy, Woolwich.
 1878. *M'Master, George, M.A., J.P. Donnybrook, Ireland.
 1862. †Macmillan, Alexander. Streatham-lane, Upper Tooting, Surrey, S.W.
 1884. *Macmillan, Angus, M.D. The Elms, Beverley-road, Hull.
 1888. §McMillan, Robert. 20 Aubrey-street, Liverpool.
 1874. †MacMordie, Hans, M.A. 8 Donegall-street, Belfast.
 1884. †McMurrick, *Playfair. Ontario Agricultural College, Guelph, Ontario, Canada.*
 1871. †M'NAB, WILLIAM RAMSAY, M.D., Professor of Botany in the Royal College of Science, Dublin. St. Lawrence-road, Clontarf, Dublin.

- Year of Election.
1867. †McNeill, John. Balhousie House, Perth.
1883. †McNicoll, Dr. E. D. 15 Manchester-road, Southport.
1878. †Macnie, George. 59 Bolton-street, Dublin.
1887. †Maconochie, Archibald White. Care of Messrs. Maconochie Bros., Lowestoft.
1883. †Macpherson, J. 44 Frederick-street, Edinburgh.
1886. †Macpherson, Lieut.-Colonel J. C., R.E. Ordnance Survey Office, Southampton.
1887. §McRae, Charles, M.A. Science and Art Department, South Kensington, London, S.W.
- *MACRORY, EDMUND, M.A. 2 Ilchester-gardens, Prince's-square, London, W.
1876. *Mactear, James. 16 Burnbank-gardens, Glasgow.
1883. †McWhirter, William. 170 Kent-road, Glasgow.
1887. †Macy, Jesse. Grinnell, Iowa, U.S.A.
1883. †Madden, W. H. Marlborough College, Wilts.
1883. †Maggs, Thomas Charles, F.G.S. Culver Lodge, Acton Vale, Middlesex, W.
1868. †Magnay, F. A. Drayton, near Norwich.
1875. *Magnus, Sir Philip, B.Sc. 48 Gloucester-place, Portman-square, London, W.
1878. †Mahony, W. A. 34 College-green, Dublin.
1869. †Main, Robert. The Admiralty, Whitehall, London, S.W.
1887. †Mainprice, W. S. Longcroft, Altrincham, Cheshire.
1885. *Maitland, Sir James R. G., Bart. Stirling, N.B.
1883. §Maitland, P. C. 136 Great Portland-street, London, W.
- *Malcolm, Frederick. Morden College, Blackheath, London, S.E.
1881. †Malcolm, Lieut.-Colonel, R.E. 72 Nunthorpe-road, York.
1874. †Malcolmsen, A. B. Friends' Institute, Belfast.
1857. †Mallet, John William, Ph.D., M.D., F.R.S., F.C.S., Professor of Chemistry in the University of Virginia, U.S.A.
1887. †MANCHESTER, The Right Rev. the Lord Bishop of, D.D. Bishop's Court, Manchester.
1870. †Manifold, W. H., M.D. 45 Rodney-street, Liverpool.
1885. †Mann, George. 72 Bon Accord-street, Aberdeen.
1888. §Mann, W. J. Rodney House, Trowbridge.
- Manning, His Eminence Cardinal. Archbishop's House, Westminster, S.W.
1878. §Manning, Robert. 4 Upper Ely-place, Dublin.
1864. †Mansel-Pleydell, J. C. Whatcombe, Blandford.
1888. §Mansergh, James, M.Inst.C.E. 3 Westminster-chambers, London, S.W.
1887. *March, Henry Colley. 2 West-street, Rochdale.
1870. †Marcoartu, His Excellency Don Arturo de. Madrid.
1887. §Margetson, J. Charles. The Rocks, Limpley, Stoke.
1883. †Marginson, James Fleetwood. The Mount, Fleetwood, Lancashire.
1887. §Markham, Christopher A., F.R.Met.Soc. Sedgebrook, Northampton.
1864. †MARKHAM, CLEMENTS R., C.B., F.R.S., F.L.S., F.R.G.S., F.S.A. 21 Eccleston-square, London, S.W.
1863. †Marley, John. Mining Office, Darlington.
1888. §Marling, W. J. Stanley Park, Stroud, Gloucestershire.
1888. §Marling, Lady. Stanley Park, Stroud, Gloucestershire.
1881. *Marr, John Edward, M.A., F.G.S. St. John's College, Cambridge.
1888. §Marriott, A. S. Manor Lawn, Dewsbury.
1857. †Marriott, William, F.C.S. 8 Belgrave-terrace, Huddersfield.
1887. †Marsden, Benjamin. Westleigh, Heaton Mersey, Manchester.

- Year of Election.
1887. †Marsden, Joseph. Ardenlea, Heaton, near Bolton.
1842. Marsden, Richard. Norfolk-street, Manchester.
1884. *Marsden, Samuel. St. Louis, Missouri, U.S.A.
1883. *Marsh, Henry. Cressy House, Woodsley-road, Leeds.
1887. §Marsh, J. E., B.A. Oxford.
1870. †Marsh, John. Rann Lea, Rainhill, Liverpool.
1864. †Marsh, Thomas Edward Miller. 37 Grosvenor-place, Bath.
1882. *MARSHALL, A. MILNES, M.A., M.D., D.Sc., F.R.S., Professor of Zoology in Owens College, Manchester.
1881. †*Marshall, D. H. Greenhill Cottage, Rothesay.*
1881. *Marshall, John, F.R.A.S., F.G.S. Church Institute, Leeds.
1881. §Marshall, John Ingham Fearby. 28 St. Saviourgate, York.
1876. †Marshall, Peter. 6 Parkgrove-terrace, Glasgow.
1858. †Marshall, Reginald Dykes. Adel, near Leeds.
1887. §Marshall, William. Thorncliffe, Dukinfield.
1886. *Marshall, William Bayley. 15 Augustus-road, Edgbaston, Birmingham.
1849. *MARSHALL, WILLIAM P., M.Inst.C.E. 15 Augustus-road, Birmingham.
1865. §MARTEN, EDWARD BINDON. Pedmore, near Stourbridge.
1883. †Marten, Henry John. 4 Storey's-gate, London, S.W.
1887. *Martin, Rev. H. A. Laxton Vicarage, Newark.
1848. †Martin, Henry D. 4 Imperial-circus, Cheltenham.
1878. †MARTIN, H. NEWELL, M.A., M.D., D.Sc., F.R.S., Professor of Biology in Johns Hopkins University, Baltimore, U.S.A.
1883. *MARTIN, JOHN BIDDULPH, M.A., F.S.S. 17 Hyde Park-gate, London, S.W.
1884. §Martin, N. H., F.L.S. 85 Osborne-road, Jesmond, Newcastle-on-Tyne.
- *Martineau, Rev. James, LL.D., D.D. 35 Gordon-square, London, W.C.
1865. †Martineau, R. F. Highfield-road, Edgbaston, Birmingham.
1886. †Martineau, R. F. 18 Highfield-road, Edgbaston, Birmingham.
1865. †Martineau, Thomas. 7 Cannon-street, Birmingham.
1886. †MARTINEAU, Sir THOMAS, J.P. West Hill, Augustus-road, Edgbaston, Birmingham.
1875. †*Martyn, Samuel, M.D. 8 Buckingham-villas, Clifton, Bristol.*
1883. †Marwick, James, LL.D. Killermont, Maryhill, Glasgow.
1878. †Masaki, Taiso. Japanese Consulate, 84 Bishopsgate-street Within, London, E.C.
1847. †MASKELYNE, NEVIL STORY, M.A., M.P., F.R.S., F.G.S., Professor of Mineralogy in the University of Oxford. Salthrop, Wroughton, Wiltshire.
1886. †Mason, Hon. J. E. Fiji.
1879. †Mason, James, M.D. Montgomery House, Sheffield.
1876. §Mason, Robert. 6 Albion-crescent, Dowanhill, Glasgow.
1876. †Mason, Stephen, M.P. 9 Rosslyn-terrace, Hillhead, Glasgow.
- Massey, Hugh, Lord. Hermitage, Castleconnel, Co. Limerick.
1885. †Masson, Orme, D.Sc. 58 Great King-street, Edinburgh.
1883. †Mather, Robert V. Birkdale Lodge, Birkdale, Southport.
1887. *Mather, William, M.Inst.C.E. Salford Iron Works, Manchester.
1865. *Mathews, G. S. 32 Augustus-road, Edgbaston, Birmingham.
1861. *MATHEWS, WILLIAM, M.A., F.G.S. 60 Harborne-road, Birmingham.
1881. †Mathwin, Henry, B.A. Bickerton House, Southport.
1883. †Mathwin, Mrs. 40 York-road, Birkdale, Southport.
1865. †Matthews, C. E. Waterloo-street, Birmingham.
1858. †Matthews, F. C. Mandre Works, Driffield, Yorkshire.

Year of
Election.

1885. †MATTHEWS, JAMES. Springhill, Aberdeen.
 1885. †Matthews, J. Duncan. Springhill, Aberdeen.
 1863. †Maughan, Rev. W. Benwell Parsonage, Newcastle-on-Tyne.
 1865. *MAW, GEORGE, F.L.S., F.G.S., F.S.A. Kenley, Surrey.
 1876. †Maxton, John. 6 Belgrave-terrace, Glasgow.
 1864. *Maxwell, Francis. 4 Moray-place, Edinburgh.
 1887. †Maxwell, James. 29 Princess-street, Manchester.
 *Maxwell, Robert Perceval. Finnebrogue, Downpatrick.
 1883. §May, William, F.G.S., F.R.G.S. Northfield, St. Mary Cray,
 Kent.
 1883. †Mayall, George. Clairville, Birkdale, Southport.
 1868. †Mayall, J. E., F.C.S. *Stork's Nest, Lancing, Sussex.*
 1884. *Maybury, A. C., D.Sc. 19 Bloomsbury-square, London, W.C.
 1835. Mayne, Edward Ellis. Rocklands, Stillorgan, Ireland.
 1878. *Mayne, Thomas, M.P. 33 Castle-street, Dublin.
 1863. †Mease, George D. *Lydney, Gloucestershire.*
 1878. §Meath, The Right Rev. C. P. Reichel, D.D., Bishop of. Dundrum
 Castle, Dublin.
 1884. †Mecham, Arthur. 11 Newton-terrace, Glasgow.
 1881. †Meek, Sir James. Middlethorpe, York.
 1871. †Meikie, James, F.S.S. 6 St. Andrew's-square, Edinburgh.
 1879. §Meiklejohn, John W. S., M.D. 105 Holland-road, London, W.
 1887. §Meischke-Smith, W. 31 Plantage, Amsterdam.
 1881. *MELDOLA, RAPHAEL, F.R.S., F.R.A.S., F.C.S., F.I.C., Professor of
 Chemistry in the Finsbury Technical College, City and Guilds
 of London Institute. 6 Brunswick-square, London, W.C.
 1867. †MELDRUM, CHARLES, C.M.G., M.A., F.R.S., F.R.A.S. Port Louis,
 Mauritius.
 1883. †Mellis, Rev. James. 23 Park-street, Southport.
 1879. *Mellish, Henry. Hodsock Priory, Worksop.
 1866. †MELLO, Rev. J. M., M.A., F.G.S. Mapperley Vicarage, Derby.
 1883. §Mello, Mrs. J. M. Mapperley Vicarage, Derby.
 1881. §Melrose, James. Clifton, York.
 1887. †Melvill, J. Cosmo, M.A. Kersal Cottage, Prestwich, Manchester.
 1847. †Melville, Professor Alexander Gordon, M.D. Queen's College, Gal-
 way.
 1863. †Melvin, Alexander. 42 Buccleuch-place, Edinburgh.
 1877. *Menabrea, General Count, LL.D. 14 Rue de l'Elysée, Paris.
 1862. §MENNELL, HENRY T. St. Dunstan's-buildings, Great Tower-street,
 London, E.C.
 1879. §MERIVALE, JOHN HERMAN, M.A., Professor of Mining in the College
 of Science, Newcastle-on-Tyne.
 1879. †Merivale, Walter. *Indian Midland Railway, Sangor.*
 1877. †Merrifield, John, Ph.D., F.R.A.S. Gascoigne-place, Plymouth.
 1880. †Merry, Alfred S. Bryn Heulog, Sketty, near Swansea.
 1863. †Messent, P. T. 4 Northumberland-terrace, Tynemouth.
 1869. †MIALL, LOUIS C., F.G.S., Professor of Biology in Yorkshire College,
 Leeds.
 1886. †Middlemore, Thomas. Holloway Head, Birmingham.
 1865. †Middlemore, William. Edgbaston, Birmingham.
 1881. *Middlesbrough, The Right Rev. Richard Lacy, D.D., Bishop of.
 Middlesbrough.
 1883. §Middleton, Henry. St. John's College, Cambridge.
 1881. †Middleton, R. Morton, F.L.S., F.Z.S. Hudworth Cottage, Castle
 Eden, Co. Durham.
 1886. *Middleton, Robert T. 197 West George-street, Glasgow.
 1886. †Miles, Charles Albert. Buenos Ayres.

Year of
Election.

1881. §MILES, MORRIS. Warbourne, Hill-lane, Southampton.
 1885. §Mill, Hugh Robert, D.Sc., F.R.S.E., F.C.S. 3 Glenorchy-terrace,
 Edinburgh.
 1859. †Millar, John, J.P. Lisburn, Ireland.
 1863. †Millar, John, M.D., F.L.S., F.G.S. Bethnal House, Cambridge-road,
 London, E.
 Millar, Thomas, M.A., LL.D., F.R.S.E. Perth.
 1876. †Millar, William. Highfield House, Dennistoun, Glasgow.
 1876. †Millar, W. J. 145 Hill-street, Garnethill, Glasgow.
 1882. †Miller, A. J. 12 Cumberland-place, Southampton.
 1876. †Miller, Daniel. 258 St. George's-road, Glasgow.
 1875. †Miller, George. Brentry, near Bristol.
 1884. †Miller, Mrs. Hugh. 51 Lauriston-place, Edinburgh.
 1888. §Miller, J. Bruce. Rubislaw Den North, Aberdeen.
 1885. †Miller, John. 9 Rubislaw-terrace, Aberdeen.
 1886. §Miller, Rev. John. The College, Weymouth.
 1861. *Miller, Robert. Cranage Hall, Holmes Chapel, Cheshire.
 1876. *Miller, Robert. 1 Lily Bank-terrace, Hillhead, Glasgow.
 1884. *Miller, Robert Kalley, M.A., *Professor of Mathematics in the Royal
 Naval College, Greenwich, London, S.E.*
 1884. †Miller, T. F., B.Ap.Sc. Napanee, Ontario, Canada.
 1876. †Miller, Thomas Paterson. Cairns, Cambuslang, N.B.
 1868. *MILLS, EDMUND J., D.Sc., F.R.S., F.C.S., Young Professor of
 Technical Chemistry in Anderson's College, Glasgow. 60 John-
 street, Glasgow.
 1880. †Mills, Mansfeldt H. Tapton-grove, Chesterfield.
 1885. †Milne, Alexander D. 40 Albyn-place, Aberdeen.
 1882. *MILNE, JOHN, F.R.S., F.G.S., Professor of Geology in the Imperial
 College of Engineering, Tokio, Japan. Ingleside, Birdhirst Rise,
 South Croydon, Surrey.
 1885. †Milne, J. D. 14 Rubislaw-terrace, Aberdeen.
 1885. †Milne, William. 40 Albyn-place, Aberdeen.
 1867. *MILNE-HOME, DAVID, M.A., LL.D., F.R.S.E., F.G.S. 10 York-
 place, Edinburgh.
 1882. †Milnes, Alfred, M.A., F.S.S. 30 Almeric-road, London, S.W.
 1888. §Milsom, Charles. 69 Pulteney-street, Bath.
 1880. §Minchin, G. M., M.A. Royal Indian Engineering College, Cooper's
 Hill, Surrey.
 1855. †Mirrlees, James Buchanan. 45 Scotland-street, Glasgow.
 1859. †Mitchell, Alexander, M.D. Old Rain, Aberdeen.
 1876. †Mitchell, Andrew. 20 Woodside-place, Glasgow.
 1883. †Mitchell, Charles T., M.A. 41 Addison-gardens North, Kensington,
 London, W.
 1883. †Mitchell, Mrs. Charles T. 41 Addison-gardens North, Kensington,
 London, W.
 863. †Mitchell, C. Walker. Newcastle-on-Tyne.
 1873. †Mitchell, Henry. Parkfield House, Bradford, Yorkshire.
 1885. †Mitchell, Rev. J. Mitford, B.A. 6 Queen's-terrace, Aberdeen.
 1870. §Mitchell, John, J.P. York House, Clitheroe, Lancashire.
 1868. †Mitchell, John, jun. Pole Park House, Dundee.
 1885. †Mitchell, P. Chalmers. Christ Church, Oxford.
 1862. *Mitchell, W. Stephen, M.A., LL.B. 19 Cadogan-street, London, S.W.
 1879. †MIVART, ST. GEORGE, M.D., F.R.S., F.L.S., F.Z.S., Professor of
 Biology in University College, Kensington. 16 Old Quebec-
 street, London, W.
 1884. §Moat, Robert. Spring Grove, Bewdley.
 1885. §Moffat, William. 7 Queen's-gardens, Aberdeen.

Year of
Election.

1864. †Mogg, John Rees. High Littleton House, near Bristol.
 1885. †Moir, James. 25 Carden-place, Aberdeen.
 1861. †MOLESWORTH, Rev. Canon W. NASSAU, M.A., LL.D. Spotland,
 Rochdale.
 1883. §Mollison, W. L., M.A. Clare College, Cambridge.
 1878. †Molloy, Constantine, Q.C. 65 Lower Leeson-street, Dublin.
 1877. *Molloy, Rev. Gerald, D.D. 86 Stephen's-green, Dublin.
 1884. †Monaghan, Patrick. Halifax (Box 317), Nova Scotia, Canada.
 1887. †Mond, Ludwig. 20 Avenue-road, Regent's Park, London, N.W.
 1853. †Monroe, Henry, M.D. 10 North-street, Sculcoates, Hull.
 1882. *Montagu, Samuel, M.P. 12 Kensington Palace-gardens, London, W.
 1872. †Montgomery, R. Mortimer. 3 Porchester-place, Edgware-road,
 London, W.
 1872. †Moon, W., LL.D. 104 Queen's-road, Brighton.
 1884. §Moore, George Frederick. 25 Marlborough-road, Tue Brook,
 Liverpool.
 1881. †Moore, Henry. Collingham, Maresfield-gardens, Fitzjohn's-avenue,
 London, N.W.
 *MOORE, JOHN CARRICK, M.A., F.R.S., F.G.S. 113 Eaton-square,
 London, S.W.; and Corswall, Wigtonshire.
 1854. †MOORE, THOMAS JOHN, Cor. M.Z.S. Free Public Museum, Liver-
 pool.
 1877. †Moore, W. F. The Friary, Plymouth.
 1857. *Moore, Rev. William Prior. The Royal School, Cavan, Ireland.
 1877. †Moore, William Vanderkemp. 15 Princess-square, Plymouth.
 1871. †MORE, ALEXANDER G., F.L.S., M.R.I.A. 3 Botanic View, Glas-
 nevin, Dublin.
 1881. †MORGAN, ALFRED. 50 West Bay-street, Jacksonville, Florida,
 U.S.A.
 1873. †Morgan, Edward Delmar, F.R.G.S. 15 Roland-gardens, London,
 S.W.
 1885. †Morgan, John. 57 Thomson-street, Aberdeen.
 1887. †Morgan, John Gray. 38 Lloyd-street, Manchester.
 1882. §Morgan, Thomas. Cross House, Southampton.
 1878. †MORGAN, WILLIAM, Ph.D., F.C.S. Swansea.
 1867. †Morison, William R. Dundee.
 1883. *Morley, Henry Forster, M.A., D.Sc., F.C.S. University Hall,
 Gordon-square, London, W.C.
 1881. †Morrell, W. W. York City and County Bank, York.
 1880. †Morris, Alfred Arthur Vennor. Wernolau, Cross Inn R.S.O., Car-
 marthenshire.
 1883. †Morris, C. S. Millbrook Iron Works, Landore, South Wales.
 *Morris, Rev. Francis Orpen, B.A. Nunburnholme Rectory, Hayton,
 York.
 1883. †Morris, George Lockwood. Millbrook Iron Works, Swansea.
 1880. †Morris, James. 6 Windsor-street, Uplands, Swansea.
 1883. †Morris, John. 40 Wellesley-road, Liverpool.
 1888. §Morris, J. W., F.L.S. The Woodlands, Bathwick Hill, Bath.
 1880. †Morris, M. I. E. The Lodge, Penclawdd, near Swansea.
 Morris, Samuel, M.R.D.S. Fortview, Clontarf, near Dublin.
 1876. †Morris, Rev. S. S. O., M.A., R.N., F.C.S. H.M.S. 'Garnet,'
 S. Coast of America.
 1874. †Morrison, G. J., M.Inst.C.E. 5 Victoria-street, Westminster,
 S.W.
 1871. *Morrison, James Darsie. 27 Grange-road, Edinburgh.
 1886. †Morrison, John T. Scottish Marine Station, Granton, N.B.
 1865. †Mortimer, J. R. St. John's-villas, Driffield.

- Year of Election.
1869. †Mortimer, William. Bedford-circus, Exeter.
1857. §MORTON, GEORGE H., F.G.S. 209 Edge-lane, Liverpool.
1858. *MORTON, HENRY JOSEPH. 2 Westbourne-villas, Scarborough.
1871. †Morton, Hugh. Belvedere House, Trinity, Edinburgh.
1887. §Morton, Percy, M.A. Iltyd House, Brecon, South Wales.
1886. *Morton, P. F. 10 The Grove, Highgate, London, N.
1868. †MOSELEY, H. N., M.A., LL.D., F.R.S., Linacre Professor of Human and Comparative Anatomy in the University of Oxford. 14 St. Giles's, Oxford.
1883. †Moseley, Mrs. 14 St. Giles's, Oxford.
Mosley, Sir Oswald, Bart., D.C.L. Rolleston Hall, Burton-upon-Trent, Staffordshire.
1878. *MOSS, JOHN FRANCIS, F.R.G.S. Beechwood, Brincliffe, Sheffield.
1876. §MOSS, RICHARD JACKSON, F.C.S., M.R.I.A. St. Aubin's, Ballybrack, Co. Dublin.
1873. *Mosse, George Staley. 13 Scarsdale-villas, Kensington, London, W.
1864. *Mosse, J. R. Conservative Club, London, S.W.
1873. †Mossman, William. Ovenden, Halifax.
1869. §MOTT, ALBERT J., F.G.S. Detmore, Charlton Kings, Cheltenham.
1865. †Mott, Charles Grey. The Park, Birkenhead.
1866. §MOTT, FREDERICK T., F.R.G.S. Birstall Hill, Leicester.
1862. *MOUAT, FREDERICK JOHN, M.D., Local Government Inspector. 12 Durham-villas, Campden Hill, London, W.
1856. †Mould, Rev. J. G., B.D. Fulmodeston Rectory, Dereham, Norfolk.
1878. *Moulton, J. Fletcher, M.A., F.R.S. 74 Onslow-gardens, London, S.W.
1863. †Mounsey, Edward. Sunderland.
Mounsey, John. Sunderland.
1861. *Mountcastle, William Robert. Bridge Farm, Ellenbrook, near Manchester.
1877. †MOUNT-EDGCUMBE, The Right Hon. the Earl of, D.C.L. Mount-Edgumbe, Devonport.
Mowbray, James. Combus, Clackmannan, Scotland.
1850. †Mowbray, John T. 15 Albany-street, Edinburgh.
1887. †Moxon, Thomas B. County Bank, Manchester.
1888. §Moyle, R. E., B.A., F.C.S. The College, Bath.
1886. *Moyles, Mrs. Thomas. The Beeches, Ladywood-road, Edgbaston, Birmingham.
1884. †Moyle, C. E., B.A., Professor of English Language and Literature in McGill College, Montreal. 802 Sherbrooke-street, Montreal, Canada.
1884. †Moyle, Charles E. 802 Sherbrooke-street, Montreal, Canada.
1876. *Muir, John. 6 Park-gardens, Glasgow.
1874. †Muir, M. M. Pattison, M.A., F.R.S.E. Caius College, Cambridge.
1884. *Muir, William Ker. Detroit, Michigan, U.S.A.
1872. †Muirhead, Alexander, D.Sc., F.C.S. Cowley-street, Westminster, S.W.
1871. *MUIRHEAD, HENRY, M.D., LL.D. Bushy Hill, Cambuslang, Lanarkshire.
1876. *Muirhead, Robert Franklin, M.A., B.Sc. Meikle Cloak, Lochwinnoch, Renfrewshire.
1884. *Muirhead-Paterson, Miss Mary. Laurievillie, Queen's Drive, Crosshill, Glasgow.
1883. §MULHALL, MICHAEL G. 19 Albion-street, Hyde Park, London, W.
1883. †Mulhall, Mrs. Marion. 19 Albion-street, Hyde Park, London, W.
1884. *MÜLLER, HUGO, Ph.D., F.R.S., F.C.S. 13 Park-square East Regent's Park, London, N.W.

Year of
Election.

1880. †Muller, Hugo M. 1 Grünanger-gasse, Vienna.
Munby, Arthur Joseph. 6 Fig-tree-court, Temple, London, E.C.
1866. †MUNDELLA, The Right Hon. A. J., M.P., F.R.S., F.R.G.S. 16
Elvaston-place, London, S.W.
1876. †Munro, Donald, F.C.S. The University, Glasgow.
1885. †Munro, J. E. Crawford, LL.D., Professor of Political Economy in
Owens College, Manchester.
1883. *Munro, Robert. Braehead House, Kilmarnock, N.B.
1872. *Munster, H. Sillwood Lodge, Brighton.
1864. †MURCH, JEROM. Cranwells, Bath.
1864. *Murchison, K. R. Brockhurst, East Grinstead.
1855. †Murdoch, James B. Hamilton-place, Langside, Glasgow.
1852. †Murphy, Joseph John. Old Forge, Dunmurry, Co. Antrim.
1884. §Murphy, Patrick. Newry, Ireland.
1887. †Murray, A. Hazeldean, Kersal, Manchester.
1869. †Murray, Adam. 78 Manor Road, Brockley, S.E.
Murray, John, F.G.S., F.R.G.S. 50 Albemarle-street, London, W. ;
and Newsted, Wimbledon, Surrey.
1859. †Murray, John, M.D. Forres, Scotland.
*Murray, John, M.Inst.C.E. Downlands, Sutton, Surrey.
1884. §MURRAY, JOHN, F.R.S.E. Challenger Expedition Office, Edin-
burgh.
1884. †Murray, J. Clark, LL.D., Professor of Logic and Mental and Moral
Philosophy in McGill University, Montreal, 111 McKay-street,
Montreal, Canada.
1872. †Murray, J. Jardine, F.R.C.S.E. 99 Montpellier-road, Brighton.
1863. †Murray, William. 34 Clayton-street, Newcastle-on-Tyne.
1883. †Murray, W. Vaughan. 4 Westbourne-crescent, Hyde Park,
London, W.
1874. §Musgrave, James, J.P. Drumglass House, Belfast.
1861. †Musgrove, John, jun. Bolton.
1870. *Muspratt, Edward Knowles. Seaforth Hall, near Liverpool.
1859. †MYLNE, ROBERT WILLIAM, F.R.S., F.G.S., F.S.A. 7 Whitehall-
place, London, S.W.
1842. Nadin, Joseph. Manchester.
1886. §Nagel, D. H. Trinity College, Oxford.
1876. †Napier, James S. 9 Woodside-place, Glasgow.
1876. *Napier, Captain Johnstone. Laverstock House, Salisbury.
1872. †Nares, Captain Sir G. S., K.C.B., R.N., F.R.S., F.R.G.S. Maple-
road, Surbiton.
1850. *NASMYTH, JAMES. Penshurst, Tunbridge.
1887. §Nason, Professor Henry B., Ph.D., F.C.S. Troy, New York, U.S.A.
1886. §Neale, E. Vansittart. 14 City-buildings, Corporation-street, Man-
chester.
1887. §Neild, Charles. 19 Chapel Walks, Manchester.
1883. *Neild, Theodore. Dalton Hall, Manchester.
1887. §Neill, Joseph S. Claremont, Broughton Park, Manchester.
1887. †Neill, Robert, jun. Beech Mount, Higher Broughton, Manchester.
1855. †Neilson, Walter. 172 West George-street, Glasgow.
1876. †Nelson, D. M. 11 Bothwell-street, Glasgow.
1888. §Nelson, The Right Rev. the Bishop of, D.D. Nelson, New Zealand.
1886. †Nettlefold, Edward. 51 Carpenter-road, Edgbaston, Birmingham
1868. †Nevill, Rev. H. R. The Close, Norwich.
1866. *Nevill, The Right Rev. Samuel Tarratt, D.D., F.L.S., Bishop of
Dunedin, New Zealand.
1857. †Neville, John, M.R.I.A. Roden-place, Dundalk, Ireland.

Year of
Election.

1869. †Nevins, John Birkbeck, M.D. 3 Abercromby-square, Liverpool.
 1842. New, Herbert. Evesham, Worcestershire.
 *Newall, Robert Stirling, F.R.S., F.R.A.S. Ferndene, Gateshead-upon-Tyne.
 1886. §Newbolt, F. G. Edenhurst, Addlestone, Surrey.
 1842. *NEWMAN, Professor FRANCIS WILLIAM. 15 Arundel-crescent, Weston-super-Mare.
 1860. *NEWTON, ALFRED, M.A., F.R.S., F.L.S., Professor of Zoology and Comparative Anatomy in the University of Cambridge. Magdalene College, Cambridge.
 1883. †*Newton, A. W. 7a Westcliffe-road, Birkdale, Southport.*
 1872. †Newton, Rev. J. 125 Eastern-road, Brighton.
 1886. †Newton, William. 18 Fenchurch-street, London, E.C.
 1883. †Nias, Miss Isabel. 56 Montagu-square, London, W.
 1882. †Nias, J. B., B.A. 56 Montagu-square, London, W.
 1867. †Nicholl, Thomas. Dundee.
 1875. †Nicholls, J. F. City Library, Bristol.
 1866. †NICHOLSON, Sir CHARLES, Bart., M.D., D.C.L., LL.D., F.G.S., F.R.G.S. The Grange, Totteridge, Herts.
 1838. *Nicholson, Cornelius, F.G.S., F.S.A. Ashleigh, Ventnor, Isle of Wight.
 1871. §Nicholson, E. Chambers. Herne Hill, London, S.E.
 1867. †NICHOLSON, HENRY ALLEYNE, M.D., D.Sc., F.G.S., Professor of Natural History in the University of Aberdeen.
 1887. *Nicholson, John Carr. Ashfield, Headingley, Leeds.
 1884. §Nicholson, Joseph S., M.A., D.Sc., Professor of Political Economy in the University of Edinburgh. Eden Lodge, Newbattle-terrace, Edinburgh.
 1883. †Nicholson, Richard, J.P. Whinfield, Hesketh Park, Southport.
 1887. §Nicholson, Robert H. Bouchier. 21 Albion-street, Hull.
 1881. †Nicholson, William R. Clifton, York.
 1887. †Nickson, William. Shelton, Sibson-road, Sale, Manchester.
 1885. §Nicol, W. W. J., M.A., D.Sc., F.R.S.E. Mason Science College, Birmingham.
 1878. †Niven, Charles, M.A., F.R.S., F.R.A.S., Professor of Natural Philosophy in the University of Aberdeen. 6 Chanonry, Aberdeen.
 1886. †Niven George. Erkingholme, Coolhurst-road, London, N.
 1877. †Niven, James, M.A. King's College, Aberdeen.
 1874. †Nixon, Randal C. J., M.A. Royal Academical Institution, Belfast.
 1884. †Nixon, T. Alcock. 33 Harcourt-street, Dublin.
 1863. *NOBLE, Captain ANDREW, C.B., F.R.S., F.R.A.S., F.C.S. Elswick Works, Newcastle-on-Tyne.
 1880. †*Noble, John. Rossenstein, Thornhill-road, Croydon, Surrey.*
 1879. †Noble, T. S., F.G.S. Lendal, York.
 1886. §Nock, J. B. Mayfield, Chester-road, Sutton Coldfield.
 1887. †Nodal, John H. The Grange, Heaton Moor, near Stockport.
 1870. †Nolan, Joseph, M.R.I.A. 14 Hume-street, Dublin.
 1882. §Norfolk, F. Elm Villa, Ordnance-road, Southampton.
 1859. †*Norfolk, Richard. Ladygate, Beverley.*
 1863. †NORMAN, Rev. Canon ALFRED MERLE, M.A., D.C.L., F.L.S. Burnmoor Rectory, Fence House, Co. Durham.
 1888. §Norman, George. 12 Brock-street, Bath.
 Norreys, Sir Denham Jephson, Bart. Mallow Castle, Co. Cork.
 1865. †NORRIS, RICHARD, M.D. 2 Walsall-road, Birchfield, Birmingham.
 1872. †Norris, Thomas George. Gorphwysfa, Llanrwst, North Wales.
 1883. *Norris, William G. Coalbrookdale, Shropshire.

Year of
Election.

1881. §North, Samuel William, M.R.C.S., F.G.S. 84 Micklegate, York.
 1881. †North, William, B.A., F.C.S. 28 Regent's Park-road, London, N.W.
 *NORTHWICK, The Right Hon. Lord, M.A. 7 Park-street, Grosvenor-square, London, W.
 NORTON, The Right Hon. Lord, K.C.M.G. 35 Eaton-place, London, S.W.; and Hamshall, Birmingham.
 1886. †Norton, Lady. 35 Eaton-place, London, S.W.; and Hamshall, Birmingham.
 1868. †Norwich, The Hon. and Right Rev. J. T. Pelham, D.D., Lord Bishop of Norwich.
 1861. †Noton, Thomas. Priory House, Oldham.
 Nowell, John. Farnley Wood, near Huddersfield.
 1883. †Nunnerley, John. 46 Alexandra-road, Southport.
 1887. §Nursey, Perry Fairfax. 161 Fleet-street, London, E.C.
 1883. §Nutt, Miss Lilian. Rosendale Hall, West Dulwich, London, S.E.
1882. §Obach, Eugene, Ph.D. 2 Victoria-road, Old Charlton, Kent.
 1878. †O'Brien, Murrough. 1 Willow-terrace, Blackrock, Co. Dublin.
 O'Callaghan, George. Tallas, Co. Clare.
 1888. §O'Connell, Major-General P. 2 College-road, Lansdowne, Bath.
 1878. †O'Connor Don, The. Clonalis, Castlereagh, Ireland.
 1883. †Odgers, William Blake, M.A., LL.D. 4 Elm-court, Temple, London, E.C.
 1858. *ODLING, WILLIAM, M.B., F.R.S., F.C.S., Waynflete Professor of Chemistry in the University of Oxford. 15 Norham-gardens, Oxford.
 1884. †Odlum, Edward, M.A. Pembroke, Ontario, Canada.
 1857. †O'Donnavan, William John. 54 Kenilworth-square, Rathgar, Dublin.
1877. §Ogden, Joseph. 13 Hythe-villas, Limes-road, Croydon.
 1885. †Ogilvie, Alexander, LL.D. Gordon's College, Aberdeen.
 1876. †Ogilvie, Campbell P. Sizewell House, Leiston, Suffolk.
 1885. †Ogilvie, F. Grant, M.A., B.Sc. Gordon's College, Aberdeen.
 1859. †Ogilvy, Rev. C. W. Norman. Baldovan House, Dundee.
 1863. †OGILVY, Sir JOHN, Bart. Inverquharity, N.B.
 *Ogle, William, M.D., M.A. The Elms, Derby.
 1837. †O'Hagan, John, M.A., Q.C. 22 Upper Fitzwilliam-street, Dublin.
 1884. §O'Halloran, J. S., F.R.G.S. Royal Colonial Institute, Northumberland-avenue, London, W.C.
1881. †Oldfield, Joseph. Lendal, York.
 1887. †Oldham, Charles. Syrian House, Sale, near Manchester.
 1853. †OLDHAM, JAMES, M.Inst.C.E. Cottingham, near Hull.
 1885. †Oldham, John. River Plate Telegraph Company, Monte Video.
 1863. †Oliver, Daniel, F.R.S., F.L.S., Professor of Botany in University College, London. Royal Gardens, Kew, Surrey.
 1887. §Oliver, F. W. Royal Gardens, Kew, Surrey.
 1883. †Oliver, J. A. Westwood. Braehead House, Lochwinnoch, Scotland.
 1883. §Oliver, Samuel A. Bellingham House, Wigan, Lancashire.
 1882. §Olsen, O. T., F.R.A.S., F.R.G.S. 116 St. Andrew's-terrace, Grimsby.
 *OMMANNEY, Admiral Sir ERASMUS, C.B., F.R.S., F.R.A.S., F.R.G.S.
 29 Connaught-square, Hyde Park, London, W.
1880. *Ommanney, Rev. E. A. 123 Vassal-road, Brixton, London, S.W.
 1887. §O'Neill, Charles. 72 Denmark-road, Manchester.
 1872. †Onslow, D. Robert. New University Club, St. James's, London, S.W.
 1883. †Oppert, Gustav, Professor of Sanskrit. Madras.
 1867. †Orchar, James G. 9 William-street, Forebank, Dundee.

Year of
Election.

1883. †Ord, Miss Maria. Fern Lea, Park-crescent, Southport.
 1883. †Ord, Miss Sarah. Fern Lea, Park-crescent, Southport.
 1880. †O'Reilly, J. P., Professor of Mining and Mineralogy in the Royal
 College of Science, Dublin.
 1842. ORMEROD, GEORGE WAREING, M.A., F.G.S. Woodway, Teign-
 mouth.
 1861. †Ormerod, Henry Mere. Clarence-street, Manchester; and 11 Wood-
 land-terrace, Cheetham Hill, Manchester.
 1858. †Ormerod, T. T. Brighthouse, near Halifax.
 1835. ORPEN, JOHN H., LL.D., M.R.I.A. 58 Stephen's-green, Dublin.
 1883. †Orpen, Miss. 58 Stephen's-green, Dublin.
 1884. *Orpen, Captain R. T., R.E. 58 Stephen's-green, Dublin.
 1884. *Orpen, Rev. T. H., M.A. Binnbrooke, Cambridge.
 1838. Orr, Alexander Smith. 57 Upper Sackville-street, Dublin.
 1873. †Osborn, George. 47 Kingscross-street, Halifax.
 1887. †O'Shea, L. J., B.Sc. Firth College, Sheffield.
 *OSLER, A. FOLLETT, F.R.S. South Bank, Edgbaston, Birming-
 ham.
 1865. *Osler, Henry F. Cobby Hill, Linthurst, near Bromsgrove,
 Birmingham.
 1869. *Osler, Sidney F. Chesham Lodge, Lower Norwood, Surrey, S.E.
 1884. †Osler, William, M.D., Professor of the Institutes of Medicine in
 McGill University, Montreal, Canada.
 1884. †O'Sullivan, James, F.C.S. 71 Spring Terrace-road, Burton-on-
 Trent.
 1882. *Oswald, T. R. New Place House, Southampton.
 1881. *Ottewell, Alfred D. 83 Siddals-road, Derby.
 1882. †Owen, Rev. C. M., M.A. St. George's, Edgbaston, Birmingham.
 OWEN, Sir RICHARD, K.C.B., M.D., D.C.L., LL.D., F.R.S., F.L.S.,
 F.G.S., Hon. F.R.S.E. Sheen Lodge, Mortlake, Surrey, S.W.
 1888. §Owen, Thomas. 8 Alfred-street, Bath.
 1877. †Oxland, Dr. Robert, F.C.S. 8 Portland-square, Plymouth.
 1883. †Page, George W. Fakenham, Norfolk.
 1883. †Page, Joseph Edward. 12 Saunders-street, Southport.
 1872. *Paget, Joseph. Stuffynwood Hall, Mansfield, Nottingham.
 1884. †Paine, Cyrus F. Rochester, New York, U.S.A.
 1875. †Paine, William Henry, M.D., F.G.S. Stroud, Gloucestershire.
 1870. *PALGRAVE, R. H. INGLIS, F.R.S., F.S.S. Belton, Great Yar-
 mouth.
 1883. †Palgrave, Mrs. R. H. Inglis. Belton, Great Yarmouth.
 1873. †Palmer, George, M.P. The Acacias, Reading, Berks.
 1878. *Palmer, Joseph Edward. Lyons Mills, Straffan Station, Dublin.
 1887. *Palmer, Miss Mary Kate. Kilburn House, Sherwood, Notts.
 1866. §Palmer, William. Kilbourne House, Cavendish Hill, Sherwood,
 Notts.
 1872. *Palmer, W. R. 1 The Cloisters, Temple, E.C.
 Palmes, Rev. William Lindsay, M.A. Naburn Hall, York.
 1883. §Pant, F. J. van der. Clifton Lodge, Kingston-on-Thames.
 1886. †Pant, George A., F.R.S.E. 73 Westfield-road, Edgbaston,
 Birmingham.
 1884. §Panton, Professor J. Hoyes, M.D. Ontario Agricultural College,
 Guelph, Ontario, Canada.
 1883. †Park, Henry. Wigan.
 1883. †Park, Mrs. Wigan.
 1880. *Parke, George Henry, F.L.S., F.G.S. Barrow-in-Furness, Lanca-
 shire.

Year of
Election.

1863. †Parker, Henry. Low Elswick, Newcastle-on-Tyne.
 1863. †Parker, Rev. Henry. Idler-ton Rectory, Low Elswick, Newcastle-on-Tyne.
 1874. †Parker, Henry R., LL.D. Methodist College, Belfast.
 Parker, Richard. Dunscombe, Cork.
 1886. †Parker, Lawley. Chad Lodge, Edgbaston, Birmingham.
 1853. †Parker, William. Thornton-le-Moor, Lincolnshire.
 1865. *Parkes, Samuel Hickling, F.L.S. 6 St. Mary's-row, Birmingham.
 1864. †PARKES, WILLIAM. 23 Abingdon-street, Westminster, S.W.
 1879. §Parkin, William, F.S.S. The Mount, Sheffield.
 1887. §Parkinson, James. Station-road, Turton, Bolton.
 1859. †Parkinson, Robert, Ph.D. West View, Toller-lane, Bradford, Yorkshire.
 1841. Parnell, Edward A., F.C.S. Ashley Villa, Swansea.
 1862. *Parnell, John, M.A. 1 The Common, Upper Clapton, London, E.
 Parnell, Richard, M.D., F.R.S.E. Gattonside Villa, Melrose, N.B.
 1883. †Parson, T. Cooke, M.R.C.S. Atherston House, Clifton, Bristol.
 1877. †Parson, T. Edgcumbe. 36 Torrington-place, Plymouth.
 1865. *Parsons, Charles Thomas. Norfolk-road, Edgbaston, Birmingham.
 1878. †Parsons, Hon. C. A. 10 Connaught-place, London, W.
 1878. †Parsons, Hon. and Rev. R. C. 10 Connaught-place, London, W.
 1883. †Part, C. T. 5 King's Bench-walk, Temple, London, E.C.
 1883. †Part, Isabella. Rudleth, Watford, Herts.
 1875. †Pass, Alfred C. Rushmere House, Durdham Down, Bristol.
 1881. §Patchitt, Edward Cheshire. 128 Derby-road, Nottingham.
 1884. *Paton, David. Johnstone, Scotland.
 1883. *Paton, Henry, M.A. 15 Myrtle-terrace, Edinburgh.
 1884. *Paton, Hugh. 992 Sherbrooke-street, Montreal, Canada.
 1883. †Paton, Rev. William. The Ferns, Parkside, Nottingham.
 1887. †Paterson, A. M., M.D. The Owens College, Manchester.
 1861. †Patterson, Andrew. Deaf and Dumb School, Old Trafford, Manchester.
 1871. *Patterson, A. Henry. 3 New-square, Lincoln's Inn, London, W.C.
 1884. †Patterson, Edward Mortimer. Fredericton, New Brunswick, Canada.
 1863. †Patterson, H. L. Scott's House, near Newcastle-on-Tyne.
 1867. †Patterson, James. Kinnettles, Dundee.
 1876. §Patterson, T. L. Belmont, Margaret-street, Greenock.
 1874. †Patterson, W. H., M.R.I.A. 26 High-street, Belfast.
 1863. †Pattinson, John, F.C.S. 75 The Side, Newcastle-on-Tyne.
 1863. †Pattinson, William. Felling, near Newcastle-upon-Tyne.
 1867. §Pattison, Samuel Rowles, F.G.S. 11 Queen Victoria-street, London, E.C.
 1864. †Pattison, Dr. T. H. London-street, Edinburgh.
 1879. *Patzner, F. R. Stoke-on-Trent.
 1863. †PAUL, BENJAMIN H., Ph.D. 1 Victoria-street, Westminster, S.W.
 1883. †Paul, G., F.G.S. Filey, Yorkshire.
 1863. †PAVY, FREDERICK WILLIAM, M.D., F.R.S. 35 Grosvenor-street, London, W.
 1887. †Paxman, James. Hill House, Colchester.
 1887. *Payne, Miss Edith Annie. Hatchlands, Cuckfield, Hayward's Heath.
 1864. †Payne, Edward Turner. 3 Sydney-place, Bath.
 1881. †Payne, J. Buxton. 15 Mosley-street, Newcastle-on-Tyne.
 1877. *Payne, J. C. Charles. Botanic-avenue, The Plains, Belfast.
 1881. †Payne, Mrs. Botanic-avenue, The Plains, Belfast.
 1866. †Payne, Dr. Joseph F. 78 Wimpole-street, London, W.
 1838. *Paynter, J. B. Hendford Manor House, Yeovil.

Year of
Election.

1886. †Payton, Henry. Eversleigh, Somerset-road, Birmingham.
 1876. †Peace, G. H. Monton Grange, Eccles, near Manchester.
 1879. †Peace, William K. Moor Lodge, Sheffield.
 1885. †Peach, B. N., F.R.S.E., F.G.S. Geological Survey Office, Edinburgh.
 1883. †Peacock, Ebenezer. 8 Mandeville-place, Manchester-square, London, W.
 1875. †Peacock, Thomas Francis. 12 South-square, Gray's Inn, London, W.C.
 1881. *PEARCE, HORACE, F.R.A.S., F.L.S., F.G.S. The Limes, Stourbridge.
 1886. *Pearce, Mrs. Horace. The Limes, Stourbridge.
 1888. §Pearce, Rev. R. J., D.C.L., Professor of Mathematics in the University of Durham. St. Giles's Vicarage, Durham.
 1882. §Pearce, Walter, M.B., B.Sc., F.C.S. St. Mary's Hospital, Paddington, London, W.; and Craufurd, Ray Mead, Maidenhead.
 1884. †Pearce, William. Winnipeg, Canada.
 1886. †Pearsall, Howard D. 3 Cursitor-street, London, E.C.
 1887. §Pearse, J. Walter. Brussels.
 1881. †Pearse, Richard Seward. Southampton.
 1883. †Pearson, Arthur A. Colonial Office, London, S.W.
 1883. †Pearson, Miss Helen E. 69 Alexandra-road, Southport.
 1881. †Pearson, John. Glentworth House, The Mount, York.
 1883. †Pearson, Mrs. Glentworth House, The Mount, York.
 1872. *Pearson, Joseph. Grove Farm, Merlin, Raleigh, Ontario, Canada.
 1881. †Pearson, Richard. 23 Bootham, York.
 1870. †Pearson, Rev. Samuel, M.A. Highbury-quadrant, London, N.
 1883. *Pearson, Thomas H. Golborne Park, near Newton-le-Willows, Lancashire.
 1863. §Pease, H. F. Brinkburn, Darlington.
 1863. †Pease, Sir Joseph W., Bart., M.P. Hutton Hall, near Guisborough.
 1863. †Pease, J. W. Newcastle-on-Tyne.
 1883. †Peck, John Henry. 52 Hoghton-street, Southport.
 Peckitt, Henry. Carlton Husthwaite, Thirsk, Yorkshire.
 1855. *Peckover, Alexander, F.S.A., F.L.S., F.R.G.S. Bank House, Wisbech, Cambridgeshire.
 1888. §Peckover, Miss Alexandrina. Bank House, Wisbech, Cambridgeshire.
 *Peckover, Algernon, F.L.S. Sibald's Holme, Wisbech, Cambridgeshire.
 1885. †Peddle, W. Spring Valley Villa, Morningside-road, Edinburgh.
 1884. †Peebles, W. E. 9 North Frederick-street, Dublin.
 1883. †Peek, C. E. Conservative Club, London, S.W.
 1878. *Peek, William. 16 Belgrave-place, Brighton.
 1881. †Peggs, J. Wallace. 21 Queen Anne's-gate, London, S.W.
 1884. †Pegler, Alfred. Elmfield, Southampton.
 1861. *Peile, George, jun. Shotley Bridge, Co. Durham.
 1878. †Pemberton, Charles Seaton. 44 Lincoln's Inn-fields, London, W.C.
 1865. †Pemberton, Oliver. 18 Temple-row, Birmingham.
 1861. *Pender, Sir John, K.C.M.G. 18 Arlington-street, London, S.W.
 1887. §Pendlebury, William H. Christ Church, Oxford.
 1856. §PENGELLY, WILLIAM, F.R.S., F.G.S. Lamorna, Torquay.
 1881. †Penty, W. G. Melbourne-street, York.
 1875. †Perceval, Rev. Canon John, M.A., LL.D. Rugby.
 1845. †PERCY, JOHN, M.D., F.R.S., F.G.S. 1 Gloucester-crescent, Hyde Park, London, W.

Year of
Election.

- *Perigal, Frederick. Cambridge Cottage, Kingswood, Reigate.
 1886. †Perkin, T. Dix. Greenford Green, Harrow, Middlesex.
 1868. *PERKIN, WILLIAM HENRY, Ph.D., F.R.S., F.C.S. The Chestnuts,
 Sudbury, Harrow, Middlesex.
 1884. †Perkin, William Henry, jun., Ph.D. The Chestnuts, Sudbury,
 Harrow, Middlesex.
 1877. †Perkins, Loftus. Seaford-street, Regent-square, London, W.C.
 1864. *Perkins, V. R. Wotton-under-Edge, Gloucestershire.
 1885. §Perrin, Miss Emily. Girton College, Cambridge.
 1886. †Perrin, Henry S. 31 St. John's Wood Park, London, N.W.
 1886. †Perrin, Mrs. 23 Holland Villas-road, Kensington, London, W.
 Perry, The Right Rev. Charles, M.A., D.D. 32 Avenue-road,
 Regent's Park, London, N.W.
 1879. †Perry, James. Roscommon.
 1874. *PERRY, JOHN, M.E., D.Sc., F.R.S., Professor of Engineering and
 Applied Mathematics in the Technical College, Finsbury. 10
 Penywern-road, South Kensington, London, S.W.
 1883. †Perry, Otley L., F.R.G.S. Bolton-le-Moors, Lancashire.
 1883. †Perry, Russell R. 34 Duke-street, Brighton.
 1870. *PERRY, Rev. S. J., D.Sc., F.R.S., F.R.A.S., F.R.M.S. Stonyhurst
 College Observatory, Whalley, Blackburn.
 1886. †Perry, William. *Hanbury Villa, Stourbridge.*
 1883. §Petrie, Miss Anne S. Stone Hill, Rochdale.
 1883. †Petrie, Miss Isabella. Stone Hill, Rochdale.
 1871. *Peyton, John E. H., F.R.A.S., F.G.S. 5 Fourth-avenue, Brighton.
 1882. †Pfoundes, Charles, F.R.G.S. Spring Gardens, London, S.W.
 1886. §Phelps, Colonel A. 23 Augustus-road, Edgbaston, Birmingham.
 1884. †Phelps, Charles Edgar. Carisbrooke House, The Park, Nottingham.
 1884. †Phelps, Mrs. Carisbrooke House, The Park, Nottingham.
 1886. †Phelps, Hon. E. J. American Legation, Members' Mansions, Victoria-
 street, London, S.W.
 1886. †Phelps, Mrs. Hamshall, Birmingham.
 1863. *PHENÉ, JOHN SAMUEL, LL.D., F.S.A., F.G.S., F.R.G.S. 5 Carlton-
 terrace, Oakley-street, London, S.W.
 1870. †Philip, T. D. 51 South Castle-street, Liverpool.
 1853. *Phillips, Rev. Edward. Hollington, Uttoxeter, Staffordshire.
 1853. *Phillips, Herbert. The Oak House, Macclesfield.
 Phillips, Robert N., M.P. The Park, Manchester.
 1877. §Phillips, T. Wishart. 53 Tredegar-square, Bow, London, E.
 1863. †Phillipson, Dr. 1 Savile-row, Newcastle-on-Tyne.
 1883. †Phillips, Arthur G. 20 Canning-street, Liverpool.
 1862. †Phillips, Rev. George, D.D. Queen's College, Cambridge.
 1887. †Phillips, H. Harcourt, F.C.S. 18 Exchange-street, Manchester.
 1880. §Phillips, John H., Hon. Sec. Philosophical and Archæological
 Society, Scarborough.
 1883. †Phillips, Mrs. Leah R. 1 East Park-terrace, Southampton.
 1883. †Phillips, S. Rees. Wanford House, Exeter.
 1881. †Phillips, William. 9 Bootham-terrace, York.
 1868. †PHIPSON, T. L., Ph.D., F.C.S. 4 The Cedars, Putney, Surrey,
 S.W.
 1884. *Pickard, Rev. H. Adair, M.A. 5 Canterbury-road, Oxford.
 1883. *Pickard, Joseph William. Lindow-square, Lancaster.
 1885. *PICKERING, SPENCER U. 48 Bryanston-square, London, W.
 1884. *Pickett, Thomas E., M.D. Maysville, Mason County, Kentucky,
 U.S.A.
 1870. †Picton, J. Allanson, F.S.A. Sandyknowe, Wavertree, Liverpool.
 1888. *Pidgeon, W. R. 42 Porchester-square, London, W.

Year of
Election.

1871. †Pigot, Thomas F., M.R.I.A. Royal College of Science, Dublin.
 1884. †Pike, L. G., M.A., F.Z.S. 4 The Grove, Highgate, London, N.
 1865. †PIKE, L. OWEN. 201 Maida-vale, London, W.
 1873. †Pike, W. H. University College, Toronto, Canada.
 1857. †Pilkington, Henry M., LL.D., Q.C. 45 Upper Mount-street,
 Dublin.
 1883. †Pilling, R. C. The Robin's Nest, Blackburn.
 Pim, George, M.R.I.A. Brenanstown, Cabinteely, Co. Dublin.
 1877. †Pim, Joseph T. Greenbank, Monkstown, Co. Dublin.
 1884. †Pinart, A. G. N. L. 74 Market-street, San Francisco, U.S.A.
 1868. †Pinder, T. R. St. Andrew's, Norwich.
 1876. †PIRIE, Rev. G., M.A., Professor of Mathematics in the University of
 Aberdeen. 33 College Bounds, Old Aberdeen.
 1884. †Pirz, Anthony. Long Island, New York, U.S.A.
 1887. †Pitkin, James. 56 Red Lion-street, Clerkenwell, London, E.C.
 1888. §Pitman, Eizak. Hazelwood, Warminster-road, Bath.
 1875. †Pitman, John. Redcliff Hill, Bristol.
 1883. †Pitt, George Newton, M.A., M.D. 34 Ashburn-place, South
 Kensington, London, S.W.
 1864. †Pitt, R. 5 Widcomb-terrace, Bath.
 1883. §Pitt, Sydney. 34 Ashburn-place, South Kensington, London, S.W.
 1868. †PITT-RIVERS, Lieut.-General A. H. L., D.C.L., F.R.S., F.G.S.,
 F.S.A. 4 Grosvenor-gardens, London, S.W.
 1872. †Plant, Mrs. H. W. 28 Evington-street, Leicester.
 1869. §PLANT, JAMES, F.G.S. 40 West-terrace, West-street, Leicester.
 1886. †Player, J. H. 5 Prince of Wales-terrace, Kensington, London. W.
 1842. †PLAYFAIR, The Right Hon. Sir LYON, K.C.B., Ph.D., LL.D., M.P.,
 F.R.S. L. & E., F.C.S. 68 Onslow-gardens, South Kensington,
 London, S.W.
 1867. †PLAYFAIR, Lieut.-Colonel Sir R. L., K.C.M.G., H.M. Consul, Algeria.
 (Messrs. King & Co., Pall Mall, London, S.W.)
 1884. *Playfair, W. S., M.D., LL.D., Professor of Midwifery in King's
 College, London. 31 George-street, Hanover-square, London, W.
 1888. §Pleydell, Mansell. Whatcombe, Blandford.
 1883. *Plimpton, R. T., M.D. 23 Lansdowne-road, Clapham-road, London,
 S.W.
 1888. §Plowman, Thomas F. 5 Terrace-walks, Bath.
 1857. †Plunkett, Thomas. Ballybrophy House, Borris-in-Ossory, Ireland.
 1861. *POCHIN, HENRY DAVIS, F.C.S. Bodnant Hall, near Conway.
 1881. §Pocklington, Henry. 20 Park-row, Leeds.
 1888. §Pocock, Rev. Francis. 4 Brunswick-place, Bath.
 1846. †POLE, WILLIAM, Mus.Doc., F.R.S., M.Inst.C.E. Athenæum Club,
 Pall Mall, London, S.W.
 1887. *Poles, A. J. S. Moor End, Kersal, Manchester.
 *Pollexfen, Rev. John Hutton, M.A. Middleton Tyas Vicarage,
 Richmond, Yorkshire.
 Pollock, A. 52 Upper Sackville-street, Dublin.
 1862. *Polwhele, Thomas Roxburgh, M.A., F.G.S. Polwhele, Truro,
 Cornwall.
 1868. †PORTAL, WYNDHAM S. Malshanger, Basingstoke.
 1883. *Porter, Rev. C. T., LL.D. Brechin Lodge, Cambridge-road, South-
 port.
 1874. †Porter, Rev. J. Leslie, D.D., LL.D., President of Queen's College,
 Belfast.
 1886. †Porter, Paxton. Birmingham and Midland Institute, Birming-
 ham.
 1866. §Porter, Robert. Highfield, Long Eaton, Nottingham.

Year of
Election.

1888. §Porter, Robert. Westfield House, Bloomfield-road, Bath.
 1883. †Postgate, Professor J. P., M.A. Trinity College, Cambridge.
 1863. †Potter, D. M. Cramlington, near Newcastle-on-Tyne.
 1887. §Potter, Edmund P. Hollinhurst, Bolton.
 1883. †Potter, M. C., B.A. St. Peter's College, Cambridge.
 Potter, Richard, M.A. 10 Brookside, Cambridge.
 1883. §Potts, John. 33 Chester-road, Macclesfield.
 1886. *Poulton, Edward B., M.A. Wykeham House, Oxford.
 1873. *Powell, Francis S., M.P., F.R.G.S. Horton Old Hall, Yorkshire;
 and 1 Cambridge-square, London, W.
 1887. *Powell, Horatio Gibbs. Wood Villa, Tettenhall Wood, Wolver-
 hampton.
 1883. †Powell, John. Wannarlwydd House, near Swansea.
 1875. †Powell, William Augustus Frederick. Norland House, Clifton,
 Bristol.
 1887. §Pownall, George H. Manchester and Salford Bank, Mosley-street,
 Manchester.
 1887. †Powrie, James. Reswallie, Forfar.
 1855. *Poynter, John E. Clyde Neuk, Uddingston, Scotland.
 1883. †POYNTING, J. H., M.A., F.R.S., Professor of Physics in the Mason Col-
 lege, Birmingham. 385 Hagley-road, Edgbaston, Birmingham.
 1884. §Prance, Courtenay C. Hatherley Court, Cheltenham.
 1884. *Pranker, A. A., D.C.L. Brazenose College, Oxford.
 1869. *PREECE, WILLIAM HENRY, F.R.S., M.Inst.C.E. Gothic Lodge,
 Wimbledon Common, Surrey.
 1888. *Preece, W. L. St. James's-terrace, London-road, Derby.
 1884. *Premio-Real, His Excellency the Count of. Quebec, Canada.
 *PRESTWICH, JOSEPH, M.A., F.R.S., F.G.S., F.C.S. Shoreham, near
 Sevenoaks.
 1884. *Prevost, Major L. de T. 2nd Battalion Argyll and Sutherland
 Highlanders.
 1871. †Price, Astley Paston. 47 Lincoln's-Inn-fields, London, W.C.
 1856. *PRICE, Rev. BARTHOLOMEW, M.A., F.R.S., F.R.A.S., Sedleian
 Professor of Natural Philosophy in the University of Oxford,
 11 St. Giles's, Oxford.
 1872. †Price, David S., Ph.D. 26 Great George-street, Westminster, S.W.
 1882. †Price, John E., F.S.A. 27 Bedford-place, Russell-square, Lon-
 don, W.C.
 Price, J. T. Neath Abbey, Glamorganshire.
 1888. §Price, L. L. F. R., M.A. Oriel College, Oxford.
 1881. §Price, Peter. 12 Windsor-place, Cardiff.
 1875. *Price, Rees. 1 Montague-place, Glasgow.
 1875. *Price, William Philip. Tibberton Court, Gloucester.
 1876. †Priestley, John. 174 Lloyd-street, Greenheys, Manchester.
 1875. †Prince, Thomas. 6 Marlborough-road, Bradford, Yorkshire.
 1883. §Prince, Thomas. Horsham-road, Dorking.
 1864. *Prior, R. C. A., M.D. 48 York-terrace, Regent's Park, London, N.W.
 1846. *PRITCHARD, Rev. CHARLES, D.D., F.R.S., F.G.S., F.R.A.S., Professor
 of Astronomy in the University of Oxford. 8 Keble-terrace,
 Oxford.
 1876. *PRITCHARD, URBAN, M.D., F.R.C.S. 3 George-street, Hanover-
 square, London, W.
 1888. §Probyn, Leslie C. Onslow-square, London, S.W.
 1881. §Procter, John William. Ashcroft, Nunthorpe, York.
 1863. †Proctor, R. S. Summerhill-terrace, Newcastle-on-Tyne.
 Proctor, William. Elmhurst, Higher Erith-road, Torquay.
 1885. †Profeit, Dr. Balmoral, N.B.

- Year of
Election.
1863. †Proud, Joseph. South Hetton, Newcastle-on-Tyne.
1884. *Proudfoot, Alexander. 2 Phillips-place, Montreal, Canada.
1879. *Prouse, Oswald Milton, F.G.S., F.R.G.S. 17 Disraeli-road, Putney, S.W.
1865. †Prowse, Albert P. Whitchurch Villa, Mannamead, Plymouth.
1872. *Pryor, M. Robert. Weston Manor, Stevenage, Herts.
1871. *Puckle, Thomas John. Woodcote-grove, Carshalton, Surrey.
1873. †Pullan, Lawrence. Bridge of Allan, N.B.
1867. *Pullar, Robert, F.R.S.E. Tayside, Perth.
1883. *Pullar, Rufus D., F.C.S. Tayside, Perth.
1842. *Pumphrey, Charles. Southfield, King's Norton, near Birmingham.
1887. §PUMPHREY, WILLIAM. Lyncombe, Bath.
1885. §Purdie, Thomas, B.Sc., Ph.D., Professor of Chemistry in the University of St. Andrews. St. Andrews, N.B.
1852. †Purdon, Thomas Henry, M.D. Belfast.
1860. †PURDY, FREDERICK, F.S.S., Principal of the Statistical Department of the Poor Law Board, Whitehall, London. Victoria-road, Kensington, London, W.
1881. †Purey-Cust, Very Rev. Arthur Percival, M.A., Dean of York. The Deanery, York.
1882. †Purrott, Charles. West End, near Southampton.
1874. †PURSER, FREDERICK, M.A. Rathmines, Dublin.
1866. †PURSER, Professor JOHN, M.A., M.R.I.A. Queen's College, Belfast.
1878. †Purser, John Mallet. 3 Wilton-terrace, Dublin.
1884. *Purves, W. Laidlaw. 20 Stafford-place, Oxford-street, London, W.
1860. *Pusey, S. E. B. Bouverie. Pusey House, Faringdon.
1883. §Pye-Smith, Arnold. 16 Fairfield-road, Croydon.
1883. §Pye-Smith, Mrs. 16 Fairfield-road, Croydon.
1868. §PYE-SMITH, P. H., M.D., F.R.S. 54 Harley-street, W.; and Guy's Hospital, London, S.E.
1879. §Pye-Smith, R. J. 350 Glossop-road, Sheffield.
1861. *Pyne, Joseph John. The Willows, Albert-road, Southport.
1888. §Quin, J. A., J.P. 14 South-parade, Bath.
1870. †Rabbits, W. T. Forest Hill, London, S.E.
1887. §Rabone, John. Penderell House, Hamstead-road, Birmingham.
1860. †RADCLIFFE, CHARLES BLAND, M.D. 25 Cavendish-square, London, W.
1870. †Radcliffe, D. R. Phoenix Safe Works, Windsor, Liverpool.
1887. §Radcliffe, James. 108 Higher King-street, Dukinfield, Cheshire.
1877. †Radford, George D. Mannamead, Plymouth.
1879. †Radford, R. Heber. Wood Bank, Pitsmoor, Sheffield.
- *Radford, William, M.D. Sidmount, Sidmouth.
1855. *Radstock, The Right Hon. Lord. 70 Portland-place, London, W.
1888. §Radway, C. W. 9 Bath-street, Bath.
1878. †RAE, JOHN, M.D., LL.D., F.R.S., F.R.G.S. 4 Addison-gardens, Kensington, London, W.
1854. †Raffles, Thomas Stamford. 13 Abercromby-square, Liverpool.
1887. *Ragdale, John Rowland. Derby-place, Whitefield, Manchester.
1864. †Rainey, James T. St. George's Lodge, Bath.
- Rake, Joseph. Charlotte-street, Bristol.
1863. †RAMSAY, ALEXANDER, F.G.S. 2 Cowper-road, Acton, Middlesex, W.
1845. †RAMSAY, Sir ANDREW CROMBIE, LL.D., F.R.S., F.G.S. 7 Victoria-terrace, Beaumaris.
1884. †Ramsay, George G., LL.D., Professor of Humanity in the University of Glasgow. 6 The College, Glasgow.
1884. †Ramsay, Mrs. G. G. 6 The College, Glasgow.

- Year of
Election.
1861. †Ramsay, John. Kildalton, Argyleshire.
 1884. †RAMSAY, R. A. 1134 Sherbrooke-street, Montreal, Canada.
 1867. *Ramsay, W. F., M.D. Inveresk House, Nevern-road, London, S.W.
 1876. *RAMSAY, WILLIAM, Ph.D., F.R.S., F.C.S., Professor of Chemistry in
 University College, London, W.O.
 1883. †Ramsay, Mrs. 12 Arundel-gardens, London, W.
 1885. †Ramsay, Major. Straloch, N.B.
 1887. †Ramsbottom, John. Fernhill, Alderley Edge, Cheshire.
 1873. *Ramsden, William. Bracken Hall, Great Horton, Bradford Yorkshire.
 1835. *Rance, Henry. St. Andrew's-street, Cambridge.
 1869. *Rance, H. W. Henniker, LL.D. 10 Castletown-road, West Ken-
 sington, London, S.W.
 1865. †Randel, J. 50 Vittoria-street, Birmingham.
 1868. †Ransom, Edwin, F.R.G.S. Ashburnham-road, Bedford.
 1863. §Ransom, William Henry, M.D., F.R.S. The Pavement, Nottingham.
 1861. †Ransome, Arthur, M.A., M.D., F.R.S. Devisdale, Bowdon,
 Manchester.
 Ransome, Thomas. Hest Bank, near Lancaster.
 1872. *Ranyard, Arthur Cowper, F.R.A.S. 25 Old-square, Lincoln's Inn,
 London, W.C.
 Rashleigh, Jonathan. 3 Cumberland-terrace, Regent's Park, London,
 N.W.
 1864. †Rate, Rev. John, M.A. Lapley Vicarage, Penkridge, Staffordshire.
 1870. †Rathbone, Benson. Exchange-buildings, Liverpool.
 1870. †Rathbone, Philip H. Greenbank Cottage, Wavertree, Liverpool.
 1870. §Rathbone, R. R. Beechwood House, Liverpool.
 1874. †RAVENSTEIN, E. G., F.R.G.S. 29 Lambert-road, Brixton, London,
 S.W.
 Rawdon, William Frederick, M.D. Bootham, York.
 1870. †Rawlins, G. W. The Hollies, Rainhill, Liverpool.
 1866. *RAWLINSON, Rev. Canon GEORGE, M.A., Camden Professor of An-
 cient History in the University of Oxford. The Oaks, Precincts,
 Canterbury.
 1855. *RAWLINSON, Major-General Sir HENRY C., K.C.B., LL.D., F.R.S.,
 F.R.G.S. 21 Charles-street, Berkeley-square, London, W.
 1887. †Rawson, Harry. Earlswood, Ellesmere Park, Eccles, Manchester.
 1875. §RAWSON, Sir RAWSON W., K.C.M.G., C.B., F.R.G.S. 68 Corn-
 wall-gardens, Queen's-gate, London, S.W.
 1886. †Rawson, W. Stepney, M.A., F.C.S. 68 Cornwall-gardens, Queen's-
 gate, London, S.W.
 1883. †Ray, Miss Catherine. Mount Cottage, Flask-walk, Hampstead,
 London, N.W.
 1868. *RAYLEIGH, The Right Hon. Lord, M.A., D.C.L., LL.D., Sec.R.S.,
 F.R.A.S., F.R.G.S. Terling Place, Witham, Essex.
 1883. *Rayne, Charles A., M.B., B.Sc., M.R.C.S. 3 Queen-street, Lan-
 caster.
 1865. †Read, William. Albion House, Epworth, Rawtry.
 *Read, W. H. Rudston, M.A., F.L.S. 12 Blake-street, York.
 1870. †READE, THOMAS MELLARD, F.G.S. Blundellsands, Liverpool.
 1884. §Readman, J. B., F.R.S.E. 9 Moray-place, Edinburgh.
 1852. *REDFERN, Professor PETER, M.D. 4 Lower-crescent, Belfast.
 1887. §Redhead, R. Milne. Springfield, Seedley, Manchester.
 1863. †Redmayne, Giles. 20 New Bond-street, London, W.
 1888. §Rednall, Miss Edith E. Ashfield House, Neston, near Chester.
 Redwood, Isaac. Cae Wern, near Neath, South Wales.
 1861. †REED, Sir EDWARD J., K.C.B., M.P., F.R.S. 74 Gloucester-road,
 South Kensington, London, W.

Year of
Election.

1875. †Rees-Mogg, W. Wooldridge. Cholwell House, near Bristol.
 1888. §Rees, W. L. 11 North-crescent, Bedford-square, London, W.C.
 1881. §Reid, Arthur S., B.A., F.G.S. Trinity College, Glenalmond, N.B.
 1883. *REID, CLEMENT, F.G.S. 28 Jermyn-street, London, S.W.
 1876. †Reid, James. 10 Woodside-terrace, Glasgow.
 1884. †Reid, Rev. James, B.A. Bay City, Michigan, U.S.A.
 1887. *Reid, Walter Francis. Fieldside, Addlestone, Surrey.
 1850. †Reid, William, M.D. Cruivie, Cupar, Fife.
 1881. †Reid, William. 19½ Blake-street, York.
 1875. §REINOLD, A. W., M.A., F.R.S., Professor of Physical Science in the Royal Naval College, Greenwich, S.E.;
 1863. §RENALS, E. 'Nottingham Express' Office, Nottingham.
 1885. †Rennett, Dr. 12 Golden-square, Aberdeen.
 1867. †Renny, W. W. 8 Douglas-terrace, Broughty Ferry, Dundee.
 1884. †Retallack, Captain Francis. 6 Beauchamp-avenue, Leamington.
 1883. *Reynolds, A. H. Manchester and Salford Bank, Southport.
 1871. †REYNOLDS, JAMES EMERSON, M.D., F.R.S., F.C.S., M.R.I.A., Professor of Chemistry in the University of Dublin. The Laboratory, Trinity College, Dublin.
 1870. *REYNOLDS, OSBORNE, M.A., LL.D., F.R.S., M.Inst.C.E., Professor of Engineering in Owens College, Manchester. Fallowfield, Manchester.
 1858. §REYNOLDS, RICHARD, F.C.S. 13 Briggate, Leeds.
 1887. §Rhodes, George W. The Cottage, Victoria Park, Manchester.
 1883. †Rhodes, Dr. James. 25 Victoria-street, Glossop.
 1858. *Rhodes, John. 18 Albion-street, Leeds.
 1877. *Rhodes, John. 360 Blackburn-road, Accrington, Lancashire.
 1888. §Rhodes, John George. Beckenham, Kent.
 1884. †Rhodes, Lieut.-Colonel William. Quebec, Canada.
 1877. *Riccardi, Dr. Paul, Secretary of the Society of Naturalists. Via Stimate, 15, Modena, Italy.
 1888. *Richardson, Arthur, M.D. University College, Bristol.
 1863. †RICHARDSON, BENJAMIN WARD, M.A., LL.D., F.R.S. 25 Manchester-square, London, W.
 1861. †Richardson, Charles. 10 Berkeley-square, Bristol.
 1869. *Richardson, Charles. 4 Northumberland-avenue, Putney, S.W.
 1863. *Richardson, Edward. Warkworth, Northumberland.
 1887. *Richardson, Miss Emma. Conway House, Dunmurry, Co. Antrim.
 1882. §Richardson, Rev. George, M.A. The College, Winchester.
 1884. *Richardson, George Straker. Isthmian Club, 150 Piccadilly, London, W.
 1884. *Richardson, J. Clarke. Derwen Fawr, Swansea.
 1870. †Richardson, Ralph, F.R.S.E. 10 Magdala-place, Edinburgh.
 1881. †Richardson, W. B. Elm Bank, York.
 1861. †Richardson, William. 4 Edward-street, Werneth, Oldham.
 1876. §Richardson, William Haden. City Glass Works, Glasgow.
 1886. §Richmond, Robert. Leighton Buzzard.
 1863. †Richter, Otto, Ph.D. 407 St. Vincent-street, Glasgow.
 1868. †RICKETTS, CHARLES, M.D., F.G.S. 18 Hamilton-square, Birkenhead.
 1877. †Ricketts, James, M.D. St. Helen's, Lancashire.
 *RIDDELL, Major-General CHARLES J. BUCHANAN, C.B., R.A., F.R.S. Oaklands, Chudleigh, Devon.
 1861. *Riddell, Henry B. Whitefield House, Rothbury, Morpeth.
 1883. *Rideal, Samuel. Mayow-road, Forest Hill, Kent, S.E.
 1872. †Ridge, James. 98 Queen's-road, Brighton.
 1862. †Ridgway, Henry Ackroyd, B.A. Bank Field, Halifax.
 1861. †Ridley, John. 19 Belsize-park, Hampstead, London, N.W.

Year of
Election.

1884. †Ridout, Thomas. Ottawa, Canada.
 1863. *Rigby, Samuel. Fern Bank, Liverpool-road, Chester.
 1881. *Rigg, Arthur. 71 Warrington-crescent, London, W.
 1883. *RIGG, EDWARD, M.A. Royal Mint, London, E.
 1883. †Rigg, F. F., M.A. 32 Queen's-road, Southport.
 1883. *Rigge, Samuel Taylor, F.S.A. Balmoral-place, Halifax.
 1873. †Ripley, Sir Edward, Bart. Acacia, Apperley, near Leeds.
 *RIPON, The Most Hon. the Marquis of, K.G., G.C.S.I., C.I.E., D.C.L.,
 F.R.S., F.L.S., F.R.G.S. 1 Carlton-gardens, London, S.W.
 1867. †Ritchie, John. Fleuchar Craig, Dundee.
 1855. †Ritchie, Robert. 14 Hill-street, Edinburgh.
 1867. †Ritchie, William. Emslea, Dundee.
 1869. *Rivington, John. Babbicombe, near Torquay.
 1888. §Robb, W. J. Firth College, Sheffield.
 1854. †Robberds, Rev. John, B.A. Battledown Tower, Cheltenham.
 1869. *ROBBINS, JOHN, F.C.S. 57 Warrington-crescent, Maida Vale, London,
 W.
 1878. †Roberts, Charles, F.R.C.S. 2 Bolton-row, London, W.
 1887. *Roberts, Evan. 3 Laurel-bank, Alexandra-road, Manchester.
 1859. †Roberts, George Christopher. Hull.
 1870. *ROBERTS, ISAAC, F.G.S. Kenessee, Maghull, Lancashire.
 1883. †ROBERTS, RALPH A. 23 Clyde-road, Dublin.
 1881. †Roberts, R. D., M.A., D.Sc., F.G.S. Clare College, Cambridge.
 1879. †Roberts, Samuel. The Towers, Sheffield.
 1879. †Roberts, Samuel, jun. The Towers, Sheffield.
 1883. †ROBERTS, Sir WILLIAM, M.D., F.R.S. 89 Mosley-street, Man-
 chester.
 1868. *ROBERTS-AUSTEN, W. CHANDLER, F.R.S., F.C.S., Chemist to the
 Royal Mint, and Professor of Metallurgy in the Royal School
 of Mines. Royal Mint, London, E.
 1883. †Robertson, Alexander. Montreal, Canada.
 1884. *Robertson, Andrew. Elmbank, Dorchester-street, Montreal, Canada.
 1859. †Robertson, Dr. Andrew. Indego, Aberdeen.
 1884. †Robertson, E. Stanley, M.A. 43 Waterloo-road, Dublin.
 1871. †Robertson, George, M.Inst.C.E., F.R.S.E. 47 Albany-street, Edin-
 burgh.
 1883. †Robertson, George H. The Nook, Gateacre, near Liverpool.
 1883. †Robertson, Mrs. George H. The Nook, Gateacre, near Liverpool.
 1876. †Robertson, R. A. Newthorn, Ayton-road, Pollokshields, Glasgow.
 1866. †Robertson, Sir William Tindal, M.D., M.P. 9 Belgrave-terrace,
 Brighton.
 1888. *Robins, E. C. Arts Club, Hanover-square, London, W.
 1886. *Robinson, C. R. 27 Elvetham-road, Birmingham.
 1886. §Robinson, Edward E. 56 Dovey-street, Liverpool.
 1861. †Robinson, Enoch. Dukinfield, Ashton-under-Lyne.
 1852. †Robinson, Rev. George. Beech Hill, Armagh.
 1887. §Robinson, Henry. 7 Westminster-chambers, London, S.W.
 1873. †Robinson, Hugh. 82 Donegall-street, Belfast.
 1887. †Robinson, James. Akroydon Villa, Halifax, Yorkshire.
 1861. †ROBINSON, JOHN, M.Inst.C.E. Atlas Works, Manchester.
 1888. §Robinson, John. Engineer's Office, Barry, Cardiff.
 1863. †Robinson, J. H. 6 Montallo-terrace, Barnard Castle.
 1878. †Robinson, John L. 198 Great Brunswick-street, Dublin.
 1876. †Robinson, M. E. 6 Park-circus, Glasgow.
 1887. §Robinson, Richard. Bellfield Mill, Rochdale.
 1881. §Robinson, Richard Atkinson. 195 Brompton-road, London, S.W.
 1875. *Robinson, Robert, M.Inst.C.E., F.G.S. Beechwood, Darlington.

Year of
Election.

1860. †Robinson, Admiral Sir Robert Spencer, K.C.B., F.R.S. 61 Eaton-place, London, S.W.
1884. †Robinson, Stillman. Columbus, Ohio, U.S.A.
1863. †Robinson, T. W. U. Houghton-le-Spring, Durham.
1888. §Robottom, Arthur. 3 St. Alban's-villas, Highgate-road, London, N.W.
1870. *Robson, E. R. Palace Chambers, 9 Bridge-street Westminster, S.W.
1876. †Robson, Hazleton R. 14 Royal-crescent West, Glasgow.
1855. †Robson, Neil. 127 St. Vincent-street, Glasgow.
1872. *Robson, William. Marchholm, Gillsland-road, Merchiston, Edinburgh.
1885. §Rodger, Edward. 1 Claremont-gardens, Glasgow.
1885. *Rodriguez, Epifanio. 12 John-street, Adelphi, London, W.C.
1872. †RODWELL, GEORGE F., F.R.A.S., F.C.S. Marlborough College, Wiltshire.
1866. †Roe, Thomas. Grove-villas, Sitchurch.
1860. †ROGERS, JAMES E. THOROLD, Professor of Economic Science and Statistics in King's College, London. Beaumont-street, Oxford.
1867. †Rogers, James S. Rosemill, by Dundee.
1883. †Rogers, Major R. Alma House, Cheltenham.
1882. §Rogers, Rev. Saltren, M.A. Gwennap, Redruth, Cornwall.
1883. †Rogers, Thomas Stanley, LL.B. 77 Albert-road, Southport.
1884. *Rogers, Walter M. Lamova, Falmouth.
1886. †Rogers, W. Woodbourne. Wheeley's-road, Edgbaston, Birmingham.
1876. †ROLLIT, Sir A. K., M.P., B.A., LL.D., D.C.L., F.R.A.S., Hon. Fellow K.C.L. Thwaite House, Cottingham, East Yorkshire.
1876. †ROMANES, GEORGE JOHN, M.A., LL.D., F.R.S., F.L.S. 18 Cornwall-terrace, Regent's Park, London, N.W.
1846. †Ronalds, Edmund, Ph.D. Stewartfield, Bonnington, Edinburgh.
1869. †Roper, C. H. Magdalen-street, Exeter.
1872. †Roper, Freeman Clarke Samuel, F.L.S., F.G.S. Palgrave House, Eastbourne.
1881. *Roper, W. O. Eadenbreck, Lancaster.
1855. *ROSCOE, Sir HENRY ENFIELD, B.A., Ph.D., LL.D., D.C.L., M.P., F.R.S., F.C.S. 10 Bramham-gardens, London, S.W.
1883. *Rose, J. Holland, M.A. Aboyne, Bedford Hill-road, Balham, London, S.W.
1885. †Ross, Alexander. Riverfield, Inverness.
1874. †Ross, Alexander Milton, M.A., M.D., F.G.S. Toronto, Canada.
1857. †Ross, David, LL.D. 32 Nelson-street, Dublin.
1887. §Ross, Edward. Marple, Cheshire.
1880. †Ross, Captain G. E. A., F.R.G.S. 8 Collingham-gardens, Cromwell-road, London, S.W.
1872. †Ross, James, M.D. Tenterfield House, Waterfoot, near Manchester.
1859. *Ross, Rev. James Coulman. Baldon Vicarage, Oxford.
1874. †Ross, Rev. William. Chapelhill Manse, Rothesay, Scotland.
1880. †Ross, Major William Alexander. Acton House, Acton, London, W.
1869. *ROSSE, The Right Hon. the Earl of, B.A., D.C.L., LL.D., F.R.S., F.R.A.S., M.R.I.A. Birr Castle, Parsonstown, Ireland.
1865. *Rothera, George Bell. 17 Waverley-street, Nottingham.
1876. †Rottenburgh, Paul. 13 Albion-crescent, Glasgow.
1884. *Rouse, M. L. 343 Church-street, Toronto, Canada.
1861. †ROUTH, EDWARD J., M.A., D.Sc., F.R.S., F.R.A.S., F.G.S. St. Peter's College, Cambridge.
1881. †Routh, Rev. William, M.A. Clifton Green, York.
1861. †Rowan, David. Elliot-street, Glasgow.

Year of
Election.

1883. †Rowan, Frederick John. 134 St. Vincent-street, Glasgow.
 1887. §Rowe, Rev. Alfred W., M.A., F.G.S. Felstead, Essex.
 1881. †Rowe, Rev. G. Lord Mayor's Walk, York.
 1865. §Rowe, Rev. John. Load Vicarage, Langport, Somerset.
 1877. †ROWE, J. BROOKING, F.L.S., F.S.A. 16 Lockyer-street, Plymouth.
 1855. *ROWNEY, THOMAS H., Ph.D., F.C.S., Professor of Chemistry in
 Queen's College, Galway. Salerno, Salthill, Galway.
 1881. *Rowntree, Joseph. 37 St. Mary's, York.
 1881. *ROWNTREE, J. S. The Mount, York.
 1862. †Rowsell, Rev. Evan Edward, M.A. Hambledon Rectory, Godal-
 ming.
 1876. †Roxburgh, John. 7 Royal Bank-terrace, Glasgow.
 1883. †Roy, Charles S., M.D., F.R.S., Professor of Pathology in the Uni-
 versity of Cambridge. Trinity College, Cambridge.
 1885. †Roy, John. 33 Belvidere-street, Aberdeen.
 1888. §Roy, Parbati Churn, B.A. Calcutta, Bengal, India; and University
 Hall, Gordon-square, London, W.C.
 1861. *Royle, Peter, M.D., L.R.C.P., M.R.C.S. 27 Lever-street, Man-
 chester.
 1875. †RÜCKER, A. W., M.A., F.R.S., Professor of Physics in the Royal
 School of Mines. Errington, Clapham Park, London, S.W.
 1869. §RUDLER, F. W., F.G.S. The Museum, Jermyn-street, London, S.W.
 1882. †Rumball, Thomas, M.Inst.C.E. 8 Queen Anne's-gate, London, S.W.
 1884. §Runtz, John. Linton Lodge, Lordship-road, Stoke Newington,
 London, N.
 1887. §Ruscoe, John, F.G.S. Ferndale, Gee Cross, near Manchester.
 1847. †RUSKIN, JOHN, M.A., F.G.S. Brantwood, Coniston, Ambleside.
 1875. *Russell, The Hon. F. A. R. Pembroke Lodge, Richmond Park
 Surrey.
 1884. †Russell, George. Hoe Park House, Plymouth.
 1883. *Russell, J. W. Merton College, Oxford.
 Russell, John. 39 Mountjoy-square, Dublin.
 1852. *Russell, Norman Scott. Arts Club, Hanover-square, London, W.
 1876. §Russell, R., F.G.S. 1 Sea View, St. Bees, Carnforth.
 1886. †Russell, Thomas H. 3 Newhall-street, Birmingham.
 1862. §RUSSELL, W. H. L., B.A., F.R.S. 3 Ridgmount-terrace, Highgate,
 London, N.
 1852. *RUSSELL, WILLIAM J., Ph.D., F.R.S., F.C.S., Lecturer on Chemistry
 in St. Bartholomew's Medical College. 34 Upper Hamilton-
 terrace, St. John's Wood, London, N.W.
 1886. §Rust, Arthur. Eversleigh, Leicester.
 1883. *Ruston, Joseph, M.P. Monk's Manor, Lincoln.
 1871. §RUTHERFORD, WILLIAM, M.D., F.R.S., F.R.S.E., Professor of the
 Institutes of Medicine in the University of Edinburgh.
 1887. §Rutherford, William. 7 Vine-grove, Chapman-street, Hulme, Man-
 chester.
 1881. †Rutson, Albert. Newby Wiske, Thirsk.
 Rutson, William. Newby Wiske, Northallerton, Yorkshire.
 1879. †Ruxton, Rear-Admiral Fitzherbert, R.N., F.R.G.S. 41 Cromwell-
 gardens, London, S.W.
 1875. †Ryalls, Charles Wager, LL.D. 3 Brick-court, Temple, London, E.C.
 1886. †Ryland, F. Augustus-road, Edgbaston, Birmingham.
 1865. †Ryland, Thomas. The Redlands, Erdington, Birmingham.
 1861. *RYLANDS, THOMAS GLAZEBROOK, F.L.S., F.G.S. Highfields, Thel-
 wall, near Warrington.
 1883. *Sabine, Robert. 3 Great Winchester-street-buildings, London, E.C.

- Year of Election.
1883. †Sadler, Robert. 7 Lulworth-road, Birkdale, Southport.
1871. †Sadler, Samuel Champernowne. Purton Court, Purton, near Swindon, Wiltshire.
1885. †Saint, W. Johnston. 11 Queen's-road, Aberdeen.
1866. *St. Albans, His Grace the Duke of. Bestwood Lodge, Arnold, near Nottingham.
1886. §St. Clair, George, F.G.S. 127 Bristol-road, Birmingham.
1887. *SALFORD, the Right Rev. the Bishop of. Bishop's House, Salford.
1881. †Salkeld, William. 4 Paradise-terrace, Darlington.
1857. †SALMON, Rev. GEORGE, D.D., D.C.L., LL.D., F.R.S., Provost of Trinity College, Dublin.
1883. †Salmond, Robert G. The Nook, Kingswood-road, Upper Norwood, S.E.
1873. *Salomons, Sir David, Bart. Broomhill, Tunbridge Wells.
1883. §Salt, Shirley H., M.A. 73 Queensborough-terrace, London, W.
1872. †SALVIN, OSBERT, M.A., F.R.S., F.L.S. Hawksfold, Haslemere.
1887. §Samson, C. L. Carmona, Kersal, Manchester.
1861. *Samson, Henry. 6 St. Peter's-square, Manchester.
1861. *Sandeman, Archibald, M.A. Garry Cottage, Perth.
1876. †Sandeman, David. Woodlands, Lenzie, Glasgow.
1883. †Sandeman, E. 53 Newton-street, Greenock.
1878. †Sanders, Alfred, F.L.S. 2 Clarence-place, Gravesend, Kent.
1883. *Sanders, Charles J. B. Pennsylvania, Exeter.
1884. †Sanders, Henry. 185 James-street, Montreal, Canada.
1872. †Sanders, Mrs. 8 Powis-square, Brighton.
1883. †Sanderson, Surgeon Alfred. East India United Service Club, St. James's-square, London, S.W.
1872. †SANDERSON, J. S. BURDON, M.D., LL.D., F.R.S., Professor of Physiology in the University of Oxford. 64 Banbury-road, Oxford.
1883. †Sanderson, Mrs. Burdon. 64 Banbury-road, Oxford.
- Sandes, Thomas, A.B. Sallow Glin, Tarbert, Co. Kerry.
1864. †Sandford, William. 9 Springfield-place, Bath.
1886. §Sankey, Percy E. Lyndhurst, St. Peter's, Kent.
1886. †Sauborn, John Wentworth. Albion, New York, U.S.A.
1886. †Saundby, Robert, M.D. 83A Edmund-street, Birmingham.
1868. †Saunders, A., M.Inst.C.E. King's Lynn.
1886. †Saunders, C. T. Temple-row, Birmingham.
1881. †SAUNDERS, HOWARD, F.L.S., F.Z.S. 7 Radnor-place, London, W.
1883. †Saunders, Rev. J. C. Cambridge.
1846. †SAUNDERS, TRELAWNEY W., F.R.G.S. 3 Elmfield on the Knowles, Newton Abbot, Devon.
1884. †Saunders, William. London, Ontario, Canada.
1884. †Saunderson, C. E. 26 St. Famille-street, Montreal, Canada.
1887. §Savage, Rev. E. B., M.A. St. Thomas' Parsonage, Douglas, Isle of Man.
1871. §Savage, W. D. Ellerslie House, Brighton.
1883. †Savage, W. W. 109 St. James's-street, Brighton.
1883. †Savery, G. M., M.A. The College, Harrogate.
1872. *Sawyer, George David, F.R.M.S. 55 Buckingham-place, Brighton.
1887. §SAYCE, Rev. A. H., M.A., Deputy Professor of Comparative Philology in the University of Oxford. Queen's College, Oxford.
1884. †Sayre, Robert H. Bethlehem, Pennsylvania, U.S.A.
1883. *Scarborough, George. Holly Bank, Halifax, Yorkshire.
1883. †Scarisbrick, Charles. 5 Palace-gate, Kensington, London, W.
1884. †Scarth, William Bain. Winnipeg, Manitoba, Canada.
1868. §Schacht, G. F. 1 Windsor-terrace, Clifton, Bristol.

Year of
Election.

1879. *SCHÄFER, E. A., F.R.S., M.R.C.S., Professor of Physiology in University College, London. 149 Harley-street, London, W.
1883. †Schäfer, Mrs. 149 Harley-street, London, W.
1888. §Scharff, Robert F., Ph.D., B.Sc. Science and Art Museum, Dublin.
1880. *Schemmann, Louis Carl. Hamburg. (Care of Messrs. Allen Everitt & Sons, Birmingham.)
1888. *Schickle, Rev. C. W., M.A. The Rectory, Langridge.
1842. Schofield, Joseph. Stubley Hall, Littleborough, Lancashire.
1887. †Schofield, T. Thornfield, Talbot-road, Old Trafford, Manchester.
1883. †Schofield, William. Alma-road, Birkdale, Southport.
1885. §Scholes, L. Holly Bank, 19 Cleveland-road, Higher Crumpsall, near Manchester.
1888. §Scholey, J. Cranefield. 30 Sussex-villas, Kensington, London, W.
1887. §Schorlemmer, Carl, LL.D., F.R.S., Professor of Organic Chemistry in the Owens College, Manchester.
1876. †Schuman, Sigismund. 7 Royal Bank-place, Glasgow.
SCHUNCK, EDWARD, Ph.D., F.R.S., F.C.S. Oaklands, Kersall Moor, Manchester.
1873. *SCHUSTER, ARTHUR, Ph.D., F.R.S., F.R.A.S., Professor of Physics in the Owens College, Manchester.
1861. *Schwabe, Edmund Salis. Ryecroft House, Cheetham Hill, Manchester.
1887. †Schwabe, Colonel G. Salis. Portland House, Higher Crumpsall, Manchester.
1847. *SCLATER, PHILIP LUTLEY, M.A., Ph.D., F.R.S., F.L.S., F.G.S., F.R.G.S., Sec.Z.S. 3 Hanover-square, London, W.
1883. *SCLATER, WILLIAM LUTLEY, B.A., F.Z.S. 3 Hanover-square, London, W.
1867. †SCOTT, ALEXANDER. Clydesdale Bank, Dundee.
1881. *Scott, Alexander, M.A., D.Sc. 4 North Bailey, Durham.
1882. †Scott, Colonel A. de C., R.E. Ordnance Survey Office, Southampton.
1878. *Scott, Arthur William, M.A., Professor of Mathematics and Natural Science in St. David's College, Lampeter.
1881. §Scott, Miss Charlotte Angus. Lancashire College, Whalley Range, Manchester.
1885. †Scott, George Jamieson. Bayview House, Aberdeen.
1886. †Scott, Robert. 161 Queen Victoria-street, London, E.C.
1857. *SCOTT, ROBERT H., M.A., F.R.S., F.G.S., F.R.M.S., Secretary to the Council of the Meteorological Office. 6 Elm Park-gardens, London, S.W.
1861. §Scott, Rev. Robert Selkirk, D.D. 16 Victoria-crescent, Downhill, Glasgow.
1884. *Scott, Sydney C. 15 Queen-street, Cheapside, London, E.C.
1869. †Scott, William Bower. Chudleigh, Devon.
1885. †Scott-Moncrieff, W. G. *The Castle, Banff.*
1881. *Scrivener, A. P. Haglis House, Wendover.
1883. †Scrivener, Mrs. Haglis House, Wendover.
1859. †Seaton, John Love. The Park, Hull.
1880. †SEDGWICK, ADAM, M.A., F.R.S. Trinity College, Cambridge.
1880. †SEEBOHM, HENRY, F.L.S., F.Z.S. 6 Tenterden-street, Hanover-square, London, W.
1861. *SEELEY, HARRY GOVIER, F.R.S., F.L.S., F.G.S., F.R.G.S., F.Z.S., Professor of Geography in King's College, London. The Vine, Sevenoaks.
1855. †Seligman, H. L. 27 St. Vincent-place, Glasgow.
1879. §Selim, Adolphus. 21 Mincing-lane, London, E.C.

Year of
Election.

1885. §Semple, Dr. United Service Club, Edinburgh.
 1887. §Semple, James C., M.R.I.A. 64 Grosvenor-road, Rathmines, Dublin.
 1873. †Semple, R. H., M.D. 8 Torrington-square, London, W.C.
 1888. §Senior, Alfred, M.D., Ph.D., F.C.S. Thornfield, Harold-road, London, S.E.
 1858. *Senior, George, F.S.S. Old Whittington, Chesterfield.
 1888. *Sennett, Alfred R., A.M.Inst.C.E. 1 Temple-gardens, London, E.C.
 1870. *Sephton, Rev. J. 90 Huskisson-street, Liverpool.
 1883. §Seville, Miss M. A. Blythe House, Southport.
 1875. §Seville, Thomas. Blythe House, Southport.
 1868. †Sewell, Philip E. Catton, Norwich.
 1888. §Shackles, Charles F. Hornsea, near Hull.
 1883. †Shadwell, John Lancelot. 17 St. Charles-square, Ladbroke Grove-road, London, W.
 1871. *Shand, James. Parkholme, Elm Park-gardens, London, S.W.
 1867. §Shanks, James. Dens Iron Works, Arbroath, N.B.
 1881. †Shann, George, M.D. Petergate, York.
 1869. *Shapter, Dr. Lewis, LL.D. 1 Barnfield-crescent, Exeter.
 1878. †SHARP, DAVID, M.B. Bleckley, Shirley Warren, Southampton.
 Sharp, Rev. John, B.A. Horbury, Wakefield.
 1886. †Sharp, T. B. French Walls, Birmingham.
 *Sharp, William, M.D., F.R.S., F.G.S. Horton House, Rugby.
 Sharp, Rev. William, B.A. Mareham Rectory, near Boston, Lincolnshire.
 1883. †Sharples, Charles H., F.C.S. 7 Fishergate, Preston.
 1870. †Shaw, Duncan. Cordova, Spain.
 1865. †Shaw, George. Cannon-street, Birmingham.
 1881. *SHAW, H. S. HELE, M.Inst.C.E., Professor of Engineering in University College, Liverpool.
 1887. *Shaw, James B. Holly Bank, Cornbrook, Manchester.
 1870. †Shaw, John. 21 St. James's-road, Liverpool.
 1845. †Shaw, John, M.D., F.L.S., F.G.S. Viatoris Villa, Boston, Lincolnshire.
 1887. §Shaw, Saville. College of Science, Newcastle-on-Tyne.
 1883. *Shaw, W. N., M.A. Emmanuel House, Cambridge.
 1883. †Shaw, Mrs. W. N. Emmanuel House, Cambridge.
 1883. †Sheard, J. 42 Hoghton-street, Southport.
 1883. *Shearer, Miss A. M. Bushy Hill, Cambuslang, Lanark.
 1884. †Sheldon, Professor J. P. Downton College, near Salisbury.
 1878. §Shelford, William, M.Inst.C.E. 35A Great George-street, Westminster, S.W.
 1865. †Shenstone, Frederick S. Sutton Hall, Barcombe, Lewes.
 1881. †SHENSTONE, W. A. Clifton College, Bristol.
 1885. †Shepherd, Rev. Alexander. Ecclesmechen, Uphall, Edinburgh.
 1863. †Shepherd, A. B. 17 Great Cumberland-place, Hyde Park, London, W.
 1885. †Shepherd, Charles. 1 Wellington-street, Aberdeen.
 1883. †Shepherd, James. Birkdale, Southport.
 Sheppard, Rev. Henry W., B.A. The Parsonage, Emsworth, Hants.
 1883. §Sherlock, David. Lower Leeson-street, Dublin.
 1883. §Sherlock, Mrs. David. Lower Leeson-street, Dublin.
 1883. †Sherlock, Rev. Edgar. Bentham Rectory, *via* Lancaster.
 1886. †Shield, Arthur H. 35A Great George-street, London, S.W.
 1883. *Shillitoe, Buxton, F.R.C.S. 2 Frederick-place, Old Jewry, London, E.C.
 1867. †Shinn, William C. 4 Varden's-road, Clapham Junction, Surrey, S.W.
 1887. *SHIPLEY, ARTHUR E., M.A. Christ's College, Cambridge.
 1885. †Shirras, G. F. 16 Carden-place, Aberdeen.
 1883. †Shone, Isaac. Pentrefelin House, Wrexham.

Year of
Election.

1870. *SHOOLBRED, JAMES N., M.Inst.C.E., F.G.S. 3 Westminster-chambers, London, S.W.
1888. §Shoppee, C. H. 22 John-street, Bedford-row, London, W.C.
1888. §Shoppee, G. W. 64 Doughty-street, Gray's Inn, London, W.C.
1875. †SHORE, THOMAS W., F.C.S., F.G.S. Hartley Institution, Southampton.
1882. †SHORE, T. W., M.D., B.Sc., Lecturer on Comparative Anatomy at St. Bartholomew's Hospital. 13 Hill Side, Crouch Hill, London, N.
1881. †Shuter, James L. 9 Steele's-road, Haverstock Hill, London, N.W.
1883. †Sibly, Miss Martha Agnes. Flook House, Taunton.
1883. *Sidebotham, Edward John. Erlesdene, Bowdon, Cheshire.
1883. *Sidebotham, James Nasmyth. Erlesdene, Bowdon, Cheshire.
1877. *Sidebotham, Joseph Watson. Erlesdene, Bowdon, Cheshire.
1885. *SIDGWICK, HENRY, M.A., Litt.D., Professor of Moral Philosophy in the University of Cambridge. Hillside, Chesterton-road, Cambridge.
- Sidney, M. J. F. Cowpen, Newcastle-upon-Tyne.
1873. *Siemens, Alexander. 12 Queen Anne's-gate, Westminster, S.W.
1878. †Sigerson, Professor George, M.D., F.L.S., M.R.I.A. 3 Clare-street, Dublin.
1859. †Sim, John. Hardgate, Aberdeen.
1871. †Sime, James. Craigmount House, Grange, Edinburgh.
1862. †Simms, James. 138 Fleet-street, London, E.C.
1874. †Simms, William. The Linen Hall, Belfast.
1876. †Simon, Frederick. 24 Sutherland-gardens, London, W.
1887. *Simon, Henry. Darwin House, Didsbury.
1847. †Simon, Sir John, K.C.B., D.C.L., F.R.S., F.R.C.S., Consulting Surgeon to St. Thomas's Hospital. 40 Kensington-square, London, W.
1866. †Simons, George. The Park, Nottingham.
1871. *SIMPSON, ALEXANDER R., M.D., Professor of Midwifery in the University of Edinburgh. 52 Queen-street, Edinburgh.
1883. §Simpson, Byron R. 7 York-road, Birkdale, Southport.
1887. §Simpson, F. Estacion Central, Buenos Ayres.
1867. †Simpson, G. B. Seafield, Broughty Ferry, by Dundee.
1859. †Simpson, John. Maykirk, Kincardineshire.
1863. †Simpson, J. B., F.G.S. Hedgefield House, Blaydon-on-Tyne.
1857. †SIMPSON, MAXWELL, M.D., LL.D., F.R.S., F.C.S., Professor of Chemistry in Queen's College, Cork.
1883. †Simpson, Walter M. 7 York-road, Birkdale, Southport.
- Simpson, William. Bradmore House, Hammersmith, London, W.
1884. *Simpson, W. J. R., M.D. Town House, Aberdeen.
1887. †Sinclair, Dr. 268 Oxford-street, Manchester.
1874. †Sinclair, Thomas. Dunedin, Belfast.
1870. *Sinclair, W. P., M.P. 19 Devonshire-road, Prince's Park, Liverpool.
1864. *Sircar, The Hon. Mahendra Lal, M.D., C.I.E. 51 Sankaritola, Calcutta.
1865. †Sissons, William. 92 Park-street, Hull.
1879. †Skertchly, Sydney B. J., F.G.S. 3 Loughborough-terrace, Carshalton, Surrey.
1883. †Skillicorne, W. N. 9 Queen's-parade, Cheltenham.
1885. †Skinner, Provost. Inverurie, N.B.
1888. §SKRINE, H. D., J.P., D.L. Claverton Manor, Bath.
1870. §SLADEN, WALTER PERCY, F.G.S., F.L.S. Orsett House, Ewell, Surrey.
1873. †Slater, Clayton. Barnoldswick, near Leeds.

Year of
Election.

1842. *Slater, William. Park-lane, Higher Broughton, Manchester.
 1884. †Slattery, James W. 9 Stephen's-green, Dublin.
 1877. †Sleeman, Rev. Philip, L.Th., F.R.A.S., F.G.S. Clifton, Bristol.
 1884. †Slooten, William Venn. Nova Scotia, Canada.
 1849. †Sloper, George Elgar. Devizes.
 1860. †Sloper, S. Elgar. Winterton, near Hythe, Southampton.
 1867. †Small, David. Gray House, Dundee.
 1887. §Small, E. W. 11 Arthur-street, Nottingham.
 1887. §Small, William. Cavendish-crescent North, The Park, Nottingham.
 1881. †Smallshan, John. 81 Manchester-road, Southport.
 1885. §Smart, James. Valley Works, Brechin, N.B.
 1858. †Smeeton, G. H. Commercial-street, Leeds.
 1876. §Smellie, Thomas D. 213 St. Vincent-street, Glasgow.
 1877. †Smelt, Rev. Maurice Allen, M.A., F.R.A.S. Heath Lodge, Cheltenham.
 1876 †Smieton, James. Panmure Villa, Broughty Ferry, Dundee.
 1876. †Smieton, John G. 3 Polworth-road, Coventry Park, Streatham, London, S.W.
 1867. †Smieton, Thomas A. Panmure Villa, Broughty Ferry, Dundee.
 1857. †Smith, Aquilla, M.D., M.R.I.A. 121 Lower Baggot-street, Dublin.
 1872. *Smith, Basil Woodd, F.R.A.S. Branch Hill Lodge, Hampstead Heath, London, N.W.
 1874. *Smith, Benjamin Leigh, F.R.G.S. Oxford and Cambridge Club, Pall Mall, London, S.W.
 1887. †Smith, Bryce. Rye Bank, Chorlton-cum-Hardy, Manchester.
 1873. †Smith, C. Sidney College, Cambridge.
 1887. *Smith, Charles. 739 Rochdale-road, Manchester.
 1865. †SMITH, DAVID, F.R.A.S. 40 Bennett's-hill, Birmingham.
 1886. †Smith, E. Fisher, J.P. The Priory, Dudley.
 1886. †Smith, E. O. Council House, Birmingham.
 1886. †Smith, Edwin. 33 Wheeley's-road, Edgbaston, Birmingham.
 1866. *Smith, F. C. Bank, Nottingham.
 1887. §Smith, Rev. F. J., M.A. Trinity College, Oxford.
 1855. †Smith, George. Port Dundas, Glasgow.
 1885. †Smith, Rev. G. A., M.A. 91 Fountainhall-road, Aberdeen.
 1860. *Smith, Heywood, M.A., M.D. 18 Harley-street, Cavendish-square, London, W.
 1870. †Smith, H. L. Crabwall Hall, Cheshire.
 1888. §Smith, H. W. Owens College, Manchester.
 1885. †Smith, Rev. James, B.D. Manse of Newhills, N.B.
 1876. *Smith, J. Guthrie. 54 West Nile-street, Glasgow.
 1874. †Smith, John Haigh. 77 Southbank-road, Southport.
 Smith, John Peter George. Sweyney Cliff, Coalport, Iron Bridge, Shropshire.
 1871. †Smith, J. William Robertson, M.A., Lord Almoner's Professor of Arabic in the University of Cambridge.
 1883. †Smith, M. Holroyd. Fern Hill, Halifax.
 1886. *Smith, Mrs. Hencotes House, Hexham.
 1860. *SMITH, PROTHEROE, M.D. 42 Park-street, Grosvenor-square, London, W.
 1837. Smith, Richard Bryan. Villa Nova, Shrewsbury.
 1885. †SMITH, ROBERT H., M.Inst.C.E., Professor of Engineering in the Mason Science College, Birmingham.
 1840. *Smith, Robert Mackay. 4 Bellevue-crescent, Edinburgh.
 1870. †Smith, Samuel. Bank of Liverpool, Liverpool.
 1866. †Smith, Samuel. 33 Compton-street, Goswell-road, London, E.C.
 1873. †Smith, Swire. Lowfield, Keighley, Yorkshire.

Year of
Election.

1867. †Smith, Thomas. Dundee.
 1867. †Smith, Thomas. Poole Park Works, Dundee.
 1859. †Smith, Thomas James, F.G.S., F.C.S. Hornsea Burton, East Yorkshire.
 1884. †Smith, Vernon. 127 Metcalfe-street, Ottawa, Canada.
 1885. *Smith, Watson. 147 High-street, Chorlton-on-Medlock, Manchester.
 1887. §Smith, Dr. Wilberforce. 14 Stratford-place, London, W.
 1852. †Smith, William. Eglinton Engine Works, Glasgow.
 1875. *Smith, William. Sundon House, Clifton, Bristol.
 1876. †Smith, William. 12 Woodside-place, Glasgow.
 1883. †Smithells, Arthur, B.Sc., Professor of Chemistry in the Yorkshire College, Leeds.
 1883. †Smithson, Edward Walter. 13 Lendal, York.
 1883. †Smithson, Mrs. 13 Lendal, York.
 1878. †Smithson, Joseph S. Balnagowan, Rathmines, Co. Dublin.
 1882. †Smithson, T. Spencer. Facit, Rochdale.
 1874. †Smoothy, Frederick. Bocking, Essex.
 1850. *SMYTH, CHARLES PIAZZI, F.R.S.E., F.R.A.S. 15 Royal-terrace, Edinburgh.
 1883. †Smyth, Rev. Christopher. The Vicarage, Bussage, Stroud.
 1874. †Smyth, Henry. Downpatrick, Ireland.
 1878. §Smyth, Mrs. Isabella. Wigmore Lodge, Cullenswood-avenue, Dublin.
 1857. *SMYTH, JOHN, jun., M.A., F.C.S., F.R.M.S., M.Inst.C.E.I. Milltown, Banbridge, Ireland.
 1864. †SMYTH, Sir WARINGTON W., M.A., F.R.S., F.G.S., F.R.G.S., Lecturer on Mining and Mineralogy at the Royal School of Mines, and Inspector of the Mineral Property of the Crown. 5 Inverness-terrace, Bayswater, London, W.
 1888. *Snape, H. Lloyd, D.Sc., Ph.D., F.C.S., Professor of Chemistry in University College, Aberystwith.
 1883. †Snape, Joseph. 13 Scarisbrick-street, Southport.
 1888. §Snell, Albion T. Messrs. Immisch & Co., London.
 1887. †Snell, Bernard J. 5 Park-place, Broughton, Manchester.
 1878. §Snell, H. Saxon. 22 Southampton-buildings, London, W.C.
 1879. *SOLLAS, W. J., M.A., D.Sc., F.R.S.E., F.G.S., Professor of Geology in the University of Dublin. Trinity College, Dublin.
 Sorbey, Alfred. The Rookery, Ashford, Bakewell.
 1859. *SORBY, H. CLIFTON, LL.D., F.R.S., F.G.S. Broomfield, Sheffield.
 1879. *Sorby, Thomas W. Storthfield, Sheffield.
 1888. §Sorley, Professor W. R. University College, Cardiff.
 1886. †Southall, Alfred. Carrick House, Richmond Hill-road, Birmingham.
 1865. *Southall, John Tertius. Parkfields, Ross, Herefordshire.
 1859. †Southall, Norman. 44 Cannon-street West, London, E.C.
 1887. §Sowerbutts, Eli. Market-place, Manchester.
 1863. †Sowerby, John. Shipcote House, Gateshead, Durham.
 1883. †Spanton, William Dunnett, F.R.C.S. Chatterley House, Hanley, Staffordshire.
 1863. *Spark, H. King. Starforth House, Barnard Castle.
 1869. *Spence, J. Berger. 31 Lombard-street, London, E.C.
 1887. §Spencer, F. M. Fernhill, Knutsford.
 1881. †Spencer, Herbert E. Lord Mayor's Walk, York.
 1884. §Spencer, John, M.Inst.M.E. Globe Tube Works, Wednesbury.
 1861. †Spencer, John Frederick. 28 Great George-street, London, S.W.
 1861. *Spencer, Joseph. Springbank, Old Trafford, Manchester.
 1863. *Spencer, Thomas. The Grove, Ryton, Blaydon-on-Tyne, Co. Durham.
 1875. †Spencer, W. H. Richmond Hill, Clifton, Bristol.

- Year of
Election.
1884. *Spice, Robert Paulson, M.Inst.C.E. 21 Parliament-street, Westminster, S.W.
1864. *Spicer, Henry, B.A., F.L.S., F.G.S. 14 Aberdeen Park, High-bury, London, N.
1864. *SPILLER, JOHN, F.C.S. 2 St. Mary's-road, Canonbury, London, N.
1878. §Spottiswoode, George Andrew. 3 Cadogan-square, London, S.W.
1864. *Spottiswoode, W. Hugh, F.C.S. 41 Grosvenor-place, London, S.W.
1854. *SPRAGUE, THOMAS BOND, M.A., F.R.S.E. 26 St. Andrew-square, Edinburgh.
1883. §Spratling, W. J., B.Sc., F.G.S. Maythorpe, 74 Wickham-road, Brockley, S.E.
1853. †Spratt, Joseph James. West-parade, Hull.
1888. §Spreat, John Henry. 1 South-parade, Bath.
1884. *Spruce, Samuel. Beech House, Tamworth.
Square, Joseph Elliot. 147 Maida Vale, London, W.
1877. †SQUARE, WILLIAM, F.R.C.S., F.R.G.S. 4 Portland-square, Plymouth.
- *Squire, Lovell. 6 Heathfield-terrace, Chiswick, Middlesex.
1888. *Stacy, J. Sargeant. 7 and 8 Paternoster-row, London, E.C.
1879. †Stacye, Rev. John. Shrewsbury Hospital, Sheffield.
1858. *STAINTON, HENRY T., F.R.S., F.L.S., F.G.S. Mountsfield, Lewis-ham, S.E.
1884. †Stancoffe, Frederick. Dorchester-street, Montreal, Canada.
1883. *Stanford, Edward, jun., F.R.G.S. Thornbury, Bromley, Kent.
1865. †STANFORD, EDWARD C. C., F.C.S. Glenwood, Dalmauir, N.B.
1837. Staniforth, Rev. Thomas. Storrs, Windermere.
1881. *Stanley, William Ford, F.G.S. Cumberlow, South Norwood, Surrey, S.E.
1883. †Stanley, Mrs. Cumberlow, South Norwood, Surrey, S.E.
Stapleton, M. H., M.B., M.R.I.A. 1 Mountjoy-place, Dublin.
1883. †Stapley, Alfred M. Marion-terrace, Crewe.
1866. †Starey, Thomas R. Daybrook House, Nottingham.
1876. †Starling, John Henry, F.C.S. The Avenue, Erith, Kent.
Staveley, T. K. Ripon, Yorkshire.
1873. *Stead, Charles. Saltaire, Bradford, Yorkshire.
1881. †Stead, W. H. Orchard-place, Blackwall, London, E.
1881. †Stead, Mrs. W. H. Orchard-place, Blackwall, London, E.
1884. †Stearns, Sergeant P. U.S. Consul-General, Montreal, Canada.
1873. †Steinthal, G. A. 15 Hallfield-road, Bradford, Yorkshire.
1887. †Steinthal, S. Alfred. 81 Nelson-street, Manchester.
1887. †Stelfox, John L. 6 Hilton-street, Oldham, Manchester.
1884. †Stephen, George. 140 Drummond-street, Montreal, Canada.
1884. †Stephen, Mrs. George. 140 Drummond-street, Montreal, Canada.
1884. *Stephens, W. Hudson. Lowville (P.O.), State of New York, U.S.A.
1879. *STEPHENSON, HENRY, J.P. Endcliffe Vale, Sheffield.
1881. †Stephenson, J. F. 3 Mount-parade, York.
1870. *Stevens, Miss Anna Maria. 1 Sinclair-road, West Kensington, London, W.
1880. *Stevens, J. Edward. 16 Woodlands-terrace, Swansea.
1886. †Stevens, Marshall. Highfield House, Urmstone, near Manchester.
1878. †Stevenson, Rev. James, M.A. 21 Garville-avenue, Rathgar, Dublin.
1863. *STEVENSON, JAMES C., M.P., F.C.S. Westoe, South Shields.
1887. *Stewart, A. H. Heather-lane, Bowdon, Manchester.
1882. †Steward, Rev. C. E., M.A. The Polygon, Southampton.
1885. †Steward, Rev. Alexander. Heathcot, Aberdeen.
1864. †STEWART, CHARLES, M.A., F.L.S. St. Thomas's Hospital, London, S.E.

Year of
Election.

1885. †*Stewart, David.* 293 *Union-street, Aberdeen.*
 1886. **Stewart, Duncan.* *Kelvinside, Glasgow.*
 1887. §*Stewart, George N.* *Physiological Laboratory, Owens College, Manchester.*
 1875. **Stewart, James, B.A., M.R.C.P.Ed.* *Dunmurry, Sneyd Park, near Clifton, Gloucestershire.*
 1876. †*Stewart, William.* *Violet Grove House, St. George's-road, Glasgow.*
 1867. †*Stirling, Dr. D.* *Perth.*
 1876. †*STIRLING, WILLIAM, M.D., D.Sc., F.R.S.E.,* *Professor of Physiology in the Owens College, Manchester.*
 1867. **Stirrup, Mark, F.G.S.* *Stamford-road, Bowdon, Cheshire.*
 1865. **Stock, Joseph S.* *St. Mildred's, Walmer.*
 1883. **STOCKER, W. R.* *Cooper's Hill, Staines.*
 1854. †*Stoess, Le Chevalier Ch. de W. (Bavarian Consul).* *Liverpool.*
 1845. **STOKES, GEORGE GABRIEL, M.P., M.A., D.C.L., LL.D., Pres. R.S.,* *Lucasian Professor of Mathematics in the University of Cambridge. Lensfield Cottage, Cambridge.*
 1887. †*Stone, E. D., F.C.S.* *The Depleach, Cheadle, Cheshire.*
 1862. †*STONE, EDWARD JAMES, M.A., F.R.S., F.R.A.S.,* *Director of the Radcliffe Observatory, Oxford.*
 1886. †*Stone, J. B.* *The Grange, Erdington, Birmingham.*
 1886. †*Stone, J. H.* *Grosvenor-road, Handsworth, Birmingham.*
 1874. †*Stone, J. Harris, M.A., F.L.S., F.C.S.* *11 Sheffield-gardens, Kensington, London, W.*
 1888. §*STONE, JOHN.* *15 Royal-crescent, Bath.*
 1876. †*Stone, Octavius C., F.R.G.S.* *Springfield, Nuneaton.*
 1883. §*Stone, Thomas William.* *189 Goldhawk-road, Shepherd's Bush, London, W.*
 1859. †*STONE, Dr. WILLIAM H.* *14 Dean's-yard, Westminster, S.W.*
 1857. †*STONEY, BINDON B., LL.D., F.R.S., M.Inst.C.E., M.R.I.A.,* *Engineer of the Port of Dublin. 14 Elgin-road, Dublin.*
 1878. **Stoney, G. Gerald.* *9 Palmerston Park, Dublin.*
 1861. **STONEY, GEORGE JOHNSTONE, M.A., D.Sc., F.R.S., M.R.I.A.* *9 Palmerston Park, Dublin.*
 1876. §*Stopes, Henry, F.G.S.* *Kenwyn, Cintra Park, Upper Norwood, S.E.*
 1883. §*Stopes, Mrs.* *Kenwyn, Cintra Park, Upper Norwood, S.E.*
 1887. †*Storer, Edwin.* *Woodlands, Crumpsall, Manchester.*
 1887. **Storey, H. L.* *Lancaster.*
 1873. †*Storr, William.* *The 'Times' Office, Printing-house-square, London, E.C.*
 1884. §*Storrs, George H.* *Fern Bank, Stalybridge.*
 1859. §*Story, Captain James Hamilton.* *17 Bryanston-square, London, W.*
 1888. §*STOTHERT, J. L., M.Inst.C.E.* *Audley, Park-gardens, Bath.*
 1888. §*Stother, Percy K.* *Audley, Park-gardens, Bath.*
 1874. †*Stott, William.* *Scar Bottom, Greetland, near Halifax, Yorkshire.*
 1871. **STRACHEY, Lieut.-General RICHARD, R.E., C.S.I., F.R.S., Pres.R.G.S.,* *F.L.S., F.G.S.* *69 Lancaster-gate, Hyde Park, London, W.*
 1881. †*Strahan, Aubrey, M.A., F.G.S.* *Geological Museum, Jermyn-street, London, S.W.*
 1876. †*Strain, John.* *143 West Regent-street, Glasgow.*
 1863. †*Straker, John.* *Wellington House, Durham.*
 1882. †*Strange, Rev. Cresswell, M.A.* *Edgbaston Vicarage, Birmingham.*
 1881. †*Strangways, C. Fox, F.G.S.* *Geological Museum, Jermyn-street, London, S.W.*
 **Strickland, Charles.* *21 Fitzwilliam-place, Dublin.*
 1879. †*Strickland, Sir Charles W., K.C.B.* *Hildenley-road, Malton.*
Strickland, William. *French Park, Roscommon, Ireland.*

Year of
Election.

1884. †Stringham, Irving. The University, Berkeley, California, U.S.A.
 1859. †Stronach, William, R.E. Ardmellie, Banff.
 1883. §Strong, Henry J., M.D. Whitgift House, Croydon.
 1867. †Stronner, D. 14 Princess-street, Dundee.
 1887. *Stroud, Professor H. College of Science, Newcastle-on-Tyne.
 1887. *Stroud, William, D.Sc., Professor of Physics in the Yorkshire College, Leeds.
 1876. *STRUTHERS, JOHN, M.D., LL.D., Professor of Anatomy in the University of Aberdeen.
 1878. †Strype, W. G. Wicklow.
 1876. *Stuart, Charles Maddock. High School, Newcastle, Staffordshire.
 1872. *Stuart, Rev. Edward A., M.A. 116 Grosvenor-road, Highbury New Park, London, N.
 1886. †Stuart, G. Morton, M.A. East Harptree, near Bristol.
 1884. †Stuart, Dr. W. Theophilus. 183 Spadina-avenue, Toronto, Canada.
 1888. *Stubbs, Rev. Elias T., M.A. Charlcombe, Bath.
 1885. §Stump, Edward C. 26 Parkfield-street, Moss-lane East, Manchester.
 1879. *Styring, Robert. 3 Hartshead, Sheffield.
 1857. †SULLIVAN, WILLIAM K., Ph.D., M.R.I.A. Queen's College, Cork.
 1883. †Summers, William, M.P. Sunnyside, Ashton-under-Lyne.
 1884. †Sumner, George. 107 Stanley-street, Montreal, Canada.
 1887. †Sumpner, W. E. 37 Pennyfields, Poplar, London, E.
 1888. §Sunderland, John E. Bark House, Hatherlow, Stockport.
 1883. †Sutcliffe, J. S., J.P. Beech House, Bacup.
 1873. †Sutcliffe, J. W. Sprink Bank, Bradford, Yorkshire.
 1873. †Sutcliffe, Robert. Idle, near Leeds.
 1863. †Sutherland, Benjamin John. 10 Oxford-street, Newcastle-on-Tyne,
 1862. *SUTHERLAND, GEORGE GRANVILLE WILLIAM, Duke of, K.G., F.R.S., F.R.G.S. Stafford House, London, S.W.
 1886. †Sutherland, Hugh. Winnipeg, Manitoba, Canada.
 1884. †Sutherland, J. C. Richmond, Quebec, Canada.
 1863. †SUTTON, FRANCIS, F.C.S. Bank Plain, Norwich.
 1881. †Sutton, William. Town Hall, Southport.
 1881. †Swales, William. Ashville, Holgate Hill, York.
 1876. †Swan, David, jun. Braeside, Maryhill, Glasgow.
 1881. §Swan, Joseph Wilson, M.A. Mosley-street, Newcastle-on-Tyne.
 1861. *Swan, Patrick Don S. Kirkcaldy, N.B.
 1862. *SWAN, WILLIAM, LL.D., F.R.S.E., Professor of Natural Philosophy in the University of St. Andrews, N.B.
 1879. †Swanwick, Frederick. Whittington, Chesterfield.
 1883. †Sweeting, Rev. T. E. 50 Roe-lane, Southport.
 1887. §Swinburne, James. Shona, Chelmsford.
 1870. *Swinburne, Sir John, Bart., M.P. Capheaton, Newcastle-on-Tyne.
 1863. †Swindell, J. S. E. Summerhill, Kingswinford, Dudley.
 1885. †Swindells, Miss. Springfield House, Ilkley, Yorkshire.
 1887. *Swindells, Rupert, F.R.G.S. Wilton Villa, The Firs, Bowdon, Cheshire.
 1873. *Swinglehurst, Henry. Hincaster House, near Milnthorpe.
 1858. †SYDNEY, The Right Rev. ALFRED BARRY, Bishop of, D.D., D.C.L. Sydney.
 1883. †Sykes, Alfred. Highfield, Huddersfield.
 1873. §Sykes, Benjamin Clifford, M.D. St. John's House, Cleckheaton.
 1887. *Sykes, George H. 12 Albert-square, Clapham, London, S.W.
 1862. †Sykes, Thomas. Cleckheaton.
 1887. *Sykes, T. H. Cheadle, Cheshire.
 SYLVESTER, JAMES JOSEPH, M.A., D.C.L., LL.D., F.R.S., Savilian Professor of Geometry in the University of Oxford. Oxford.

Year of
Election.

1870. †SYMES, RICHARD GLASCOTT, B.A., F.G.S., Geological Survey of Ireland. 14 Hume-street, Dublin.
1885. †Symington, Johnson, M.D. 2 Greenhill Park, Edinburgh.
1881. *Symington, Thomas. Wardie House, Edinburgh.
1856. *Symonds, Frederick, M.A., F.R.C.S. 35 Beaumont-street, Oxford.
1859. §SYMONS, G. J., F.R.S., Sec.R.Met.Soc. 62 Camden-square, London, N.W.
1883. †Symons, Simon. *Belfast House, Farquhar-road, Norwood, S.E.*
1855. *SYMONS, WILLIAM, F.C.S. 26 Joy-street, Barnstaple.
1886. §Symons, W. H., F.C.S., F.R.M.S. 130 Fellowes-road, Hampstead, London, N.W.
- Synge, Francis. Glanmore, Ashford, Co. Wicklow.
1872. †Synge, Major-General Millington, R.E., F.S.A., F.R.G.S. United Service Club, Pall Mall, London, S.W.
1865. †Tailyour, Colonel Renny, R.E. Newmanswalls, Montrose, N.B.
1877. *TAIT, LAWSON, F.R.C.S. The Crescent, Birmingham.
1871. †TAIT, PETER GUTHRIE, F.R.S.E, Professor of Natural Philosophy in the University of Edinburgh. George-square, Edinburgh.
1867. †Tait, P. M., F.R.G.S., F.S.S. Hardwicke House, Hardwicke-road, Eastbourne.
1883. §Tapscott, R. L. 41 Parkfield-road, Prince's Park, Liverpool.
1878. †TARPEY, HUGH. Dublin.
1861. *Tarratt, Henry W. Moseley, Owl's-road, Boscombe, Bournemouth.
1857. *Tate, Alexander. Longwood, Whitehouse, Belfast.
1870. †Tate, Norman A. 7 Nivell-chambers, Fazackerley-street, Liverpool.
1858. *Tatham, George, J.P. Springfield Mount, Leeds.
1876. †Tatlock, Robert R. 26 *Burnbank-gardens, Glasgow.*
1879. †Tattershall, William Edward. 15 North Church-street, Sheffield.
1886. †Taunton, Richard. Brook Vale, Witton.
1878. *Taylor, A. Claude. North Circus-street, Nottingham.
1884. *Taylor, Rev. Charles, D.D. St. John's Lodge, Cambridge.
- Taylor, Frederick. Laurel Cottage, Rainhill, near Prescott, Lancashire.
1887. §Taylor, G. H. Holly House, 235 Eccles New-road, Salford.
1874. †Taylor, G. P. Students' Chambers, Belfast.
1887. §Taylor, George Spratt, F.C.S. 13 Queen's-terrace, St. John's Wood, London, N.W.
1881. *Taylor, H. A. 25 Collingham-road, South Kensington, London, S.W.
1884. *Taylor, H. M., M.A. Trinity College, Cambridge.
1882. *Taylor, Herbert Owen, M.D. 17 Castlegate, Nottingham.
1887. †TAYLOR, Rev. Canon ISAAC, D.D. Settrington Rectory, York.
1879. †Taylor, John. Broomhall-place, Sheffield.
1861. *Taylor, John, M.Inst.C.E., F.G.S. 29 Portman-square, London, W
1873. †TAYLOR, JOHN ELLOR, Ph.D., F.L.S., F.G.S. The Mount, Ipswich.
1881. *Taylor, John Francis. Holly Bank House, York.
1865. †Taylor, Joseph. 99 Constitution-hill, Birmingham.
1883. †Taylor, Michael W., M.D. Hatton Hall, Penrith.
1876. †Taylor, Robert. 70 Bath-street, Glasgow.
1878. †Taylor, Robert, J.P., LL.D. Corballis, Drogheda.
1884. *Taylor, Miss S. Oak House, Shaw, near Oldham.
1881. †Taylor, Rev. S. B., M.A. Whixley Hall, York.
1883. †Taylor, S. Leigh. Birklands, Westcliffe-road, Birkdale, Southport.
1870. †Taylor, Thomas. Aston Rowant, Tetsworth, Oxon.
1887. †Taylor, Tom. Grove House, Sale, Manchester.

Year of
Election.

1883. †Taylor, William, M.D. 21 Crockherbtown, Cardiff.
 1884. †Taylor-Whitehead, Samuel, J.P. Burton Closes, Bakewell.
 1858. †Teale, Thomas Pridgin, jun. 20 Park-row, Leeds.
 1885. †Teall, J. J. H., M.A., F.G.S. 12 Cumberland-road, Kew, Surrey.
 1869. †Teesdale, C. S. M. Whyke House, Chichester.
 1879. †Temple, Lieutenant George T., R.N., F.R.G.S. The Nash, near Worcester.
 1880. §TEMPLE, Sir RICHARD, Bart., G.C.S.I., C.I.E., D.O.L., LL.D., M.P., F.R.G.S. Athenæum Club, London, S.W.
 1863. †Tennant, Henry. Saltwell, Newcastle-on-Tyne.
 1882. §Terrill, William. 42, St. George's-terrace, Swansea.
 1881. †Terry, Mr. Alderman. Mount-villas, York.
 1883. †Tetley, C. F. The Brewery, Leeds.
 1883. †Tetley, Mrs. C. F. The Brewery, Leeds.
 1887. †Tetlow, T. 273 Stamford-street, Ashton-under-Lyne.
 1882. *Thane, George Dancer, Professor of Anatomy in University College. Gower-street, London, W.C.
 1885. †Thin, Dr. George, 22 Queen Anne-street, London, W.
 1871. †Thin, James. 7 Rillbank-terrace, Edinburgh.
 1871. †THISELTON-DYER, W. T., C.M.G., M.A., B.Sc., F.R.S., F.L.S. Royal Gardens, Kew.
 1835. Thom, John. Lark-hill, Chorley, Lancashire.
 1870. †Thom, Robert Wilson. Lark-hill, Chorley, Lancashire.
 1871. †Thomas, Ascanius William Nevill. Chudleigh, Devon.
 1875. *THOMAS, CHRISTOPHER JAMES. Drayton Lodge, Redland, Bristol.
 1883. †Thomas, Ernest C., B.A. 13 South-square, Gray's Inn, London, W.C.
 1884. †THOMAS, F. WOLFERSTAN. Molson's Bank, Montreal, Canada.
 Thomas, George. Brislington, Bristol.
 1875. †Thomas, Herbert. Ivor House, Redlands, Bristol.
 1869. †Thomas, H. D. Fore-street, Exeter.
 1881. §THOMAS, J. BLOUNT. Southampton.
 1869. †Thomas, J. Henwood, F.R.G.S. Custom House, London, E.C.
 1880. *Thomas, Joseph William, F.C.S. The Laboratory, West Wharf, Cardiff.
 1883. †Thomas, P. Bossley. 4 Bold-street, Southport.
 1883. §Thomas, Thomas H. 45 The Walk, Cardiff.
 1883. †Thomas, William. Lan, Swansea.
 1886. †Thomas, William. 109 Tettenhall-road, Wolverhampton.
 1886. §Thomasson, Yeoville. 9 Observatory-gardens, Kensington, London, W.
 1875. †Thompson, Arthur. 12 St. Nicholas-street, Hereford.
 1887. §Thompson, C. St. Mary's Hospital, London, W.
 1883. †Thompson, Miss C. E. Heald Bank, Bowdon, Manchester.
 1882. †Thompson, Charles O. Terre Haute, Indiana, U.S.A.
 1888. *Thompson, Claude M., M.A., Professor of Chemistry in University College, Cardiff.
 1885. §Thompson, D'Arcy W., B.A., Professor of Physiology in University College, Dundee. University College, Dundee.
 1883. *Thompson, Francis. 1 Avenue-villas, St. Peter's-road, Croydon.
 1859. †Thompson, George, jun. Pitmedden, Aberdeen.
 Thompson, Harry Stephen. Kirby Hall, Great Ouseburn, Yorkshire.
 1870. †THOMPSON, Sir HENRY. 35 Wimpole-street, London, W.
 1883. *Thompson, Henry G., M.D. 8 Addiscombe-villas, Croydon.
 Thompson, Henry Stafford. Fairfield, near York.
 1883. *Thompson, Isaac Cooke, F.L.S., F.R.M.S. Woodstock, Waverley-road, Liverpool.
 1861. *THOMPSON, JOSEPH. Riversdale, Wilmslow, Manchester.

Year of
Election.

1864. †THOMPSON, Rev. JOSEPH HESSELGRAVE, B.A. Cradley, near Brierley Hill.
1873. †Thompson, M. W. Guiseley, Yorkshire.
1876. *Thompson, Richard. Park-street, The Mount, York.
1883. †Thompson, Richard. Bramley Mead, Whalley, Lancashire.
1874. †Thompson, Robert. Walton, Fortwilliam Park, Belfast.
1876. †THOMPSON, SILVANUS PHILLIPS, B.A., D.Sc., F.R.A.S., Professor of Physics in the City and Guilds of London Institute, Finsbury Technical Institute, E.C.
1884. †Thompson, Sydney de Courcy. 16 Canonbury-park South, London, N.
1883. *Thompson, T. H. Heald Bank, Bowdon, Manchester.
1863. †Thompson, William. 11 North-terrace, Newcastle-on-Tyne.
1867. †Thoms, William. Magdalen-yard-road, Dundee.
- Thomson, Guy. Oxford.
1850. *THOMSON, Professor JAMES, M.A., LL.D., D.Sc., F.R.S.L. & E. 2 Florentine-gardens, Hillhead-street, Glasgow.
1868. §THOMSON, JAMES, F.G.S. 3 Abbotsford-place, Glasgow.
1876. †Thomson, James R. Mount Blow, Dalmuir, Glasgow.
1883. †THOMSON, J. J., M.A., F.R.S., Professor of Experimental Physics in the University of Cambridge. Trinity College, Cambridge.
1871. *THOMSON, JOHN MILLAR, F.C.S., Professor of Chemistry in King's College, London, W.C.
1886. †Thomson, Joseph. Thornhill, Dumfriesshire.
1871. †Thomson, Robert, LL.B. 12 Rutland-square, Edinburgh.
1847. *THOMSON, Sir WILLIAM, M.A., LL.D., D.C.L., F.R.S.L. & E., F.R.A.S., Professor of Natural Philosophy in the University of Glasgow. The University, Glasgow.
1877. *Thomson, Lady. The University, Glasgow.
1874. §THOMSON, WILLIAM, F.R.S.E., F.C.S. Royal Institution, Manchester.
1880. §Thomson, William J. Ghyllbank, St. Helen's.
1871. †Thornburn, Rev. David, M.A. 1 John's-place, Leith.
1852. †Thornburn, Rev. William Reid, M.A. Starkies, Bury, Lancashire.
1886. §Thornley, J. E. Lyndon, Bickenhill, near Birmingham.
1887. §Thornton, John. 3 Park-street, Bolton.
1867. †Thornton, Thomas. Dundee.
1883. §Thorowgood, Samuel. Castle-square, Brighton.
1845. †Thorp, Dr. Disney. Lyppiatt Lodge, Suffolk Lawn, Cheltenham.
1881. †Thorp, Fielden. Blossom-street, York.
1871. †Thorp, Henry. Briarleigh, Sale, near Manchester.
1881. *Thorp, Josiah. 159 Field-street, Liverpool.
1864. *Thorp, William, B.Sc., F.C.S. 24 Crouch Hall-road, Crouch End, London, N.
1871. †THORPE, T. E., Ph.D., F.R.S.L. & E., F.C.S., Professor of Chemistry in the Normal School of Science. Science Schools. South Kensington, London, S.W.
1883. §Threlfall, Henry Singleton. 5 Prince's-street, Southport.
1883. †Thresh, John C., D.Sc. The Willows, Buxton.
1868. †THUILLIER, General Sir H. E. L., R.A., C.S.I., F.R.S., F.R.G.S. Tudor House, Richmond Green, Surrey.
1870. †Tichborne, Charles R. C., LL.D., F.C.S., M.R.I.A. Apothecaries' Hall of Ireland, Dublin.
1873. *TIDDEMAN, R. H., M.A., F.G.S. 28 Jermyn-street, London, S.W.
1884. †TIDY, CHARLES MEYMOTT, M.D. 3 Mandeville-place, Cavendish-square, London, W.
1874. †TILDEN, WILLIAM A., D.Sc., F.R.S., F.C.S., Professor of Chemistry and Metallurgy in the Mason Science College, Birmingham. 36 Frederick-road, Birmingham.

Year of
Election.

1873. †Tilghman, B. C. Philadelphia, U.S.A.
 1883. †Tillyard, A. I., M.A. Fordfield, Cambridge.
 1883. †Tillyard, Mrs. Fordfield, Cambridge.
 1865. †Timmins, Samuel, J.P., F.S.A. Hill Cottage, Fillongley, Coventry.
 1876. †Todd, Rev. Dr. Tudor Hall, Forest Hill, London, S.E.
 1887. †Tolmé, Mrs. Melrose House, Higher Broughton, Manchester.
 1857. †Tombe, Rev. Canon. Glenealy, Co. Wicklow.
 1888. §Tomlins, Rev. Henry George. Park Lodge, Weston-super-Mare.
 1864. *TOMLINSON, CHARLES, F.R.S., F.C.S. 7 North-road, Highgate, London, N.
 1887. †Tonge, Rev. Canon. Chorlton-cum-Hardy, Manchester.
 1887. †Tonge, James. Woodbine House, West Houghton, Bolton.
 1865. †Tonks, Edmund, B.C.L. Packwood Grange, Knowle, Warwickshire.
 1865. *Tonks, William Henry. The Rookery, Sutton Coldfield.
 1873. *Tookey, Charles, F.C.S. Royal School of Mines, Jermyn-street, London, S.W.
 1887. †Topham, F. 15 Great George-street, London, S.W.
 1861. *Topham, John, A.I.C.E. High Elms, 265 Mare-street, Hackney, London, E.
 1872. *TOPLEY, WILLIAM, F.R.S., F.G.S., A.I.C.E. Geological Survey Office, Jermyn-street, London, S.W.
 1886. §Topley, Mrs. W. Hurstbourne, Elgin-road, Croydon.
 1875. §Torr, Charles Hawley. 7 Regent-street, Nottingham.
 1886. †Torr, Charles Walker. Cambridge-street Works, Birmingham.
 1884. †Torrance, John F. Folly Lake, Nova Sectia, Canada.
 1884. *Torrance, Rev. Robert, D.D. Guelph, Ontario, Canada.
 1859. †Torry, Very Rev. John, Dean of St. Andrews. Coupar Angus, N.B. Towgood, Edward. St. Neot's, Huntingdonshire.
 1873. †Townend, W. H. Heaton Hall, Bradford, Yorkshire.
 1875. †Townsend, Charles. Avenue House, Cotham Park, Bristol.
 1883. †Townsend, Francis Edward. 19 Aughton-road, Birkdale, Southport.
 1861. †Townsend, William. Attleborough Hall, near Nuneaton.
 1877. †Tozer, Henry. Ashburton.
 1876. *TRAIL, Professor J. W. H., M.A., M.D., F.L.S. University of Aberdeen, Old Aberdeen.
 1883. †TRAILL, A., M.D., LL.D. Ballylough, Bushmills, Ireland.
 1870. †TRAILL, WILLIAM A. Giant's Causeway Electric Tramway, Portrush, Ireland.
 1875. †Trapnell, Caleb. Severnleigh Stoke Bishop.
 1868. †TRAQUAIR, RAMSAY H., M.D., F.R.S., F.G.S., Keeper of the Natural History Collections, Museum of Science and Art, Edinburgh.
 1884. †Trechmann, Charles O., Ph.D., F.G.S. Hartlepool.
 1868. †Trehane, John. Exe View Lawn, Exeter.
 1869. †Trehane, John, jun. Bedford-circus, Exeter.
 Trench, F. A. Newlands House, Clondalkin, Ireland.
 1883. †Trendell, Edwin James, J.P. Abbey House, Abingdon, Berks.
 1884. †Trenham, Norman W. 18 St. Alexis-street, Montreal, Canada.
 1884. §Tribe, Paul C. M. 44 West Oneida-street, Oswego, New York, U.S.A.
 1879. †Trickett, F. W. 12 Old Haymarket, Sheffield.
 1877. †TRIMEN, HENRY, M.B., F.R.S., F.L.S. British Museum, London, S.W.
 1871. †TRIMEN, ROLAND, F.R.S., F.L.S., F.Z.S. Colonial Secretary's Office, Cape Town, Cape of Good Hope.
 1860. §TRISTRAM, Rev. HENRY BAKER, D.D., LL.D., F.R.S., F.L.S., Canon of Durham. The College, Durham.
 1884. *Trotter, Alexander Pelham. 53 Addison Mansions, Blythe-road, West Kensington, London, W.

Year of
Election.

1885. §TROTTER, COUTTS, F.G.S., F.R.G.S. 17 Charlotte-square, Edinburgh.
1887. *Trouton, Frederick T. Trinity College, Dublin.
1869. †Troyte, C. A. W. Huntsham Court, Bampton, Devon.
1885. *Tubby, A. H. Guy's Hospital, London, S.E.
1847. *Tuckett, Francis Fox. Frenchay, Bristol.
1888. §Tuckett, William Fothergill, M.D. 18 Daniel-street, Bath.
Tuke, James H. Bancroft, Hitchin.
1871. †Tuke, J. Batty, M.D. Cupar, Fifeshire.
1887. †Tuke, W. C. 29 Princess-street, Manchester.
1883. †TUPPER, The Hon. Sir CHARLES, Bart., G.C.M.G., C.B., High Commissioner for Canada. 9 Victoria-chambers, London, S.W.
1855. †Turnbull, John. 37 West George-street, Glasgow.
1871. †Turnbull, William, F.R.S.E. Menslaws, Jedburgh, N.B.
1873. *Turner, George. Horton Grange, Bradford, Yorkshire.
1882. †Turner, G. S. 9 Carlton-crescent, Southampton.
1883. †Turner, Mrs. G. S. 9 Carlton-crescent, Southampton.
1888. §Turner, J. S., J.P. Granville, Lansdown, Bath.
1886. *TURNER, THOMAS, A.R.S.M., F.C.S., F.I.C. Mason Science College, Birmingham.
1863. *TURNER, Sir WILLIAM, M.B., LL.D., F.R.S. L. & E., Professor of Anatomy in the University of Edinburgh. 6 Eton-terrace, Edinburgh.
1883. †Turrell, Miss S. S. High School, Redland-grove, Bristol.
1884. *Tutin, Thomas. Weston-on-Trent, Derby.
1884. *Tweddell, Ralph Hart. Provender, Faversham, Kent.
1886. *Twigg, G. H. Church-road, Moseley, Birmingham.
1847. †TWISS, Sir TRAVERS, Q.C., D.C.L., F.R.S., F.R.G.S. 3 Paper-buildings, Temple, London, E.C.
1882. §Tyer, Edward. Horneck, Fitzjohn's-avenue, Hampstead, London, N.W.
1865. §TYLOR, EDWARD BURNETT, D.C.L., LL.D., F.R.S., Keeper of the University Museum, Oxford.
1858. *TYNDALL, JOHN, D.C.L., LL.D., Ph.D., F.R.S., F.G.S., Hon. Professor of Natural Philosophy in the Royal Institution, London. Hindhead House, Haslemere, Surrey.
1883. †Tyrer, Thomas, F.C.S. Garden-wharf, Battersea, London, S.W.
1861. *Tysoe, John. 28 Heald-road, Bowdon, near Manchester.
1888. §Tyzack, Llewellyn Newton. University College, Bristol.
1884. *Underhill, G. E., M.A. Magdalen College, Oxford.
1888. §Underhill, H. M. 7 High-street, Oxford.
1886. †Underhill, Thomas, M.D. West Bromwich.
1885. §Unwin, Howard. Newton-grove, Bedford Park, Chiswick, London.
1883. §Unwin, John. Park-crescent, Southport.
1883. §Unwin, William Andrews. The Briars, Freshfield, near Liverpool.
1876. *UNWIN, W. C., F.R.S., M.Inst.C.E., Professor of Engineering at the Central Institute, City and Guilds of London. 7 Palace-gate Mansions, Kensington, London, W.
1887. †Upton, Francis R. Orange, New Jersey, U.S.A.
1872. †Upward, Alfred. 11 Great Queen-street, Westminster, London, S.W.
1876. †Ure, John F. 6 Claremont-terrace, Glasgow.
1859. †Urquhart, W. Pollard. Craigston Castle, N.B.; and Castlepollard, Ireland.
1866. †Urquhart, William W. Rosebay, Broughty Ferry, by Dundee.
1880. †USSHER, W. A. E., F.G.S. 28 Jermyn-street, London, S.W.
1885. †Vachell, Charles Tanfield, M.D. Cardiff.

Year of
Election.

1887. § Vaizey, J. Reynolds. Broxbourne, Herts.
 1887. *Valentine, Miss Anne. The Elms, Hale, near Altrincham.
 1888. § Vallentin, Rupert. 18 Kimberley-road, Falmouth.
 1884. † Van Horne, W. C. Dorchester-street West, Montreal, Canada.
 1883. *VanSittart, The Hon. Mrs. A. A. 11 Lypiatt-terrace, Cheltenham.
 1886. † VARDY, Rev. A. R., M.A. King Edward's School, Birmingham.
 1868. † Varley, Frederick H., F.R.A.S. Mildmay Park Works, Mildmay-avenue, Stoke Newington, London, N.
 1865. *VARLEY, S. ALFRED. 2 Hamilton-road, Highbury Park, London, N.
 1870. † Varley, Mrs. S. A. 2 Hamilton-road, Highbury Park, London, N.
 1869. † Varwell, P. Alphington-street, Exeter.
 1884. § Vasey, Charles. 112 Cambridge-gardens, London, W.
 1875. † Vaughan, Miss. Burlton Hall, Shrewsbury.
 1883. † Vaughan, William. 42 Sussex-road, Southport.
 1881. § VELEY, V. H., M.A., F.C.S. University College, Oxford.
 1873. *VERNEY, Captain EDMUND H., R.N., F.R.G.S. Rhianva, Bangor, North Wales.
 1883. *Verney, Mrs. Rhianva, Bangor, North Wales.
 Verney, Sir Harry, Bart., M.P. Lower Claydon, Buckinghamshire.
 Vernon, George John, Lord. Sudbury Hall, Derbyshire.
 1883. † VERNON, H. H., M.D. York-road, Birkdale, Southport.
 1864. *VICARY, WILLIAM, F.G.S. The Priory, Colleton-crescent, Exeter.
 1868. † Vincent, Rev. William. Postwick Rectory, near Norwich.
 1883. † Vines, Sydney Howard, M.A., D.Sc., F.R.S., F.L.S., Professor of Botany in the University of Oxford.
 1856. † VIVIAN, EDWARD, M.A. Woodfield, Torquay
 *VIVIAN, Sir H. HUSSEY, Bart., M.P., F.G.S. Park Wern-Swansea; and 27 Belgrave-square, London, S.W.
 1884. † Von Linden, François Hermann. Amsterdam, Holland.
 1886. *Wackrill, Samuel Thomas, J.P. Leamington.
 1860. § Waddingham, John. Guiting Grange, Winchcombe, Gloucestershire.
 1888. § Wadworth, H. A. Devizes, Wiltshire.
 1884. † Wait, Charles E. Professor of Chemistry in the University of Tennessee. Knoxville, Tennessee, U.S.A.
 1886. † Waite, J. W. The Cedars, Bestcot, Walsall.
 1879. *Wake, Bernard. Abbeyfield, Sheffield.
 1870. † WAKE, CHARLES STANILAND. Welton, near Brough, East Yorkshire.
 1884. † Waldstein, Charles, M.A., Ph.D., Director of the Fitzwilliam Museum, Cambridge. Cambridge.
 1873. † Wales, James. 4 Mount Royd, Manningham, Bradford, Yorkshire.
 1882. *Walkden, Samuel. The Thorne, Bexhill, near Hastings, Sussex.
 1885. † Walker, Baillie. 52 Victoria-street, Aberdeen.
 1885. § Walker, Charles Clement, F.R.A.S. Lillieshall Old Hall, Newport, Shropshire.
 1883. § Walker, Mrs. Emma. 14 Bootham-terrace, York.
 1883. † Walker, E. R. Pagefield Ironworks, Wigan.
 Walker, Frederick John. The Priory, Bathwick, Bath.
 1883. † Walker, George. 11 Hamilton-square, Birkenhead, Liverpool.
 1866. † Walker, H. Westwood, Newport, by Dundee.
 1885. § WALKER, General J. T., C.B., R.E., LL.D., F.R.S., F.R.G.S. 13 Cromwell-road, London, S.W.
 1866. *WALKER, JOHN FRANCIS, M.A., F.C.S., F.G.S., F.L.S. 16 Gillygate, York.
 1881. † Walker, John Sydenham. 83 Bootham, York.
 1867. *Walker, Peter G. 2 Airlie-place, Dundee.
 1886. *Walker, Major Philip Billingsley. Sydney, New South Wales.

Year of
Election.

1866. †Walker, S. D. 38 Hampden-street, Nottingham.
 1884. †Walker, Samuel. Woodbury, Sydenham Hill, London, S.E.
 1888. §Walker, Sydney F. 195 Severn-road, Cardiff.
 1887. †Walker, T. A. 15 Great George-street, London, S.W.
 1883. §Walker, Thomas A. 66 Leyland-road, Southport.
 Walker, William. 47 Northumberland-street, Edinburgh.
 1881. *Walker, William. 14 Bootham-terrace, York.
 1883. †Wall, Henry. 14 Park-road, Southport.
 1863. †WALLACE, ALFRED RUSSEL, F.L.S., F.R.G.S. Nutwood Cottage,
 Frith Hill, Godalming.
 1883. §Wallace, George J. Hawthornbank, Dunfermline.
 1887. *Waller, Augustus, M.D. Weston Lodge, 16 Grove End-road, Lon-
 don, N.W.
 1862. †Wallich, George Charles, M.D., F.L.S., F.R.G.S. 26 Addison-road
 North, Notting Hill, London, W.
 1886. †Walliker, Samuel. Grandale, Westfield-road, Edgbaston, Birmingham.
 1883. †Wallis, Rev. Frederick. Caius College, Cambridge.
 1884. §Wallis, Herbert. Redpath-street, Montreal, Canada.
 1886. †Wallis, Whitworth. Westfield, Westfield-road, Edgbaston, Bir-
 mingham.
 1883. †Walmesley, Oswald. Shevington Hall, near Wigan.
 1887. †Walmsley, J. Winton, Patricroft, Manchester.
 1883. †Walmsley, T. M. Clevelands, Chorley-road, Heaton, Bolton.
 1862. †WALPOLE, The Right Hon. SPENCER HORATIO. M.A., D.C.L.,
 F.R.S. Ealing, Middlesex, W.
 1863. †Walters, Robert. Eldon-square, Newcastle-on-Tyne.
 1881. †Walton, Thomas, M.A. Oliver's Mount School, Scarborough.
 1863. †Wanklyn, James Alfred. 7 Westminster-chambers, London, S.W.
 1884. †Wanless, John, M.D. 88 Union-avenue, Montreal, Canada.
 1872. †Warburton, Benjamin. Leicester.
 1887. †Ward, A. W., M.A., Litt.D., Professor of History and English Lite-
 rature in Owens College, Manchester.
 1874. §Ward, F. D., J.P., M.R.I.A. Clonaver, Strandtown, Co. Down.
 1881. §Ward, George, F.C.S. Buckingham-terrace, Headingley, Leeds.
 1879. †Ward, H. Marshall, M.A., F.R.S., F.L.S., Professor of Botany in the
 Royal Indian Civil Engineering College, Cooper's Hill, Egham.
 1874. §Ward, John, F.S.A., F.G.S., F.R.G.S. Lenoxvale, Belfast.
 1887. §Ward, John, F.G.S. 23 Stafford-street, Longton, Staffordshire.
 1857. †Ward, John S. Prospect Hill, Lisburn, Ireland.
 1880. *Ward, J. Wesley. 5 Holtham-road, St. John's Wood, London, N.W.
 1884. *Ward, John William. Newstead, Halifax.
 1883. †Ward, Thomas, F.C.S. Arnold House, Blackpool.
 1887. §Ward, Thomas. Brookfield House, Northwich.
 1882. †Ward, William. Cleveland Cottage, Hill-lane, Southampton.
 1867. †Warden, Alexander J. 23 Panmure-street, Dundee.
 1858. †Wardle, Thomas. Leek Brook, Leek, Staffordshire.
 1884. §Wardwell, George J. Rutland, Vermont, U.S.A.
 1865. †Waring, Edward John, M.D., F.L.S. 49 Clifton-gardens, Maida Vale,
 London, W.
 1887. *Waring, Richard S. Pittsburg, Pennsylvania, U.S.A.
 1878. §WARINGTON, ROBERT, F.R.S., F.C.S. Harpenden, St. Albans, Herts.
 1882. †Warner, F. W., F.L.S. 20 Hyde-street, Winchester.
 1884. *Warner, James D. 199 Baltic-street, Brooklyn, U.S.A.
 1875. †Warren, Algernon. Naseby House, Pembroke-road, Clifton, Bristol.
 1887. §WARREN, Colonel Sir CHARLES, R.E., K.C.B., G.C.M.G., F.R.S.,
 F.R.G.S. 44 St. George's-road, London, S.W.
 1856. †Washbourne, Buchanan, M.D. Gloucester.

- Year of
Election.
1876. † *Waterhouse, A. Willenhall House, Barnet, Herts.*
1875. * *Waterhouse, Lieut.-Colonel J. 40 Hamilton-terrace, London, N.W.*
1870. † *Waters, A. T. H., M.D. 29 Hope-street, Liverpool.*
1875. † *Watherston, Rev. Alexander Law, M.A., F.R.A.S. The Grammar School, Hinckley, Leicestershire.*
1881. § *Watherston, E. J. 12 Pall Mall East, London, S.W.*
1887. † *Watkin, F. W. 46 Auriol-road, West Kensington, London, W.*
1884. † *Watson, A. G., D.C.L. The School, Harrow, Middlesex.*
1867. † *Watson, Rev. Archibald, D.D. The Manse, Dundee.*
1886. * *Watson, C. J. 34 Smallbrook-street, Birmingham.*
1883. † *Watson, C. Knight, M.A. Society of Antiquaries, Burlington House, London, W.*
1867. † *Watson, Frederick Edwin. Thickthorne House, Cringleford, Norwich.*
1885. § *Watson, Deputy Surgeon-General G. A. 4 St. Margaret's-terrace, Cheltenham.*
1882. † *WATSON, Rev. H. W., D.Sc., F.R.S. Berkeswell Rectory, Coventry.*
1873. * *Watson, Sir James. 9 Woodside-terrace, Glasgow.*
1887. † *Watson, J. Beauchamp. Gilt Hall, Carlisle.*
1884. † *Watson, John. Queen's University, Kingston, Ontario, Canada.*
1859. † *WATSON, JOHN FORBES, M.A., M.D., F.L.S. India Museum, London, S.W.*
1863. † *Watson, Joseph. Bensham-grove, near Gateshead-on-Tyne.*
1863. † *Watson, R. S. 101 Pilgrim-street, Newcastle-on-Tyne.*
1867. † *Watson, Thomas Donald. 23 Cross-street, Finsbury, London, E.C.*
1879. * *WATSON, WILLIAM HENRY, F.C.S., F.G.S. Analytical Laboratory, The Folds, Bolton.*
1882. † *Watt, Alexander. 89 Hartington-road, Sefton Park, Liverpool.*
1884. † *Watt, D. A. P. 284 Upper Stanley-street, Montreal, Canada.*
1869. † *Watt, Robert B. E., F.R.G.S. Ashley-avenue, Belfast.*
1888. § *WATTS, B. H. 10 Rivers-street, Bath.*
1875. * *WATTS, JOHN, B.A., D.Sc. Merton College, Oxford.*
1884. * *Watts, Rev. Robert R. Stourpaine Vicarage, Blandford.*
1870. § *Watts, William, F.G.S. Oldham Corporation Waterworks, Pie-thorn, near Rochdale.*
1873. * *WATTS, W. MARSHALL, D.Sc. Giggleswick Grammar School, near Settle.*
1883. § *Watts, W. W., M.A., F.G.S. Broseley, Shropshire.*
Waud, Rev. S. W., M.A., F.R.A.S., F.C.P.S. Rettenden, near Wickford, Essex.
1859. † *Waugh, Edwin. New Brighton, near Liverpool.*
1869. † *Way, Samuel James. Adelaide, South Australia.*
1883. † *Webb, George. 5 Tenterden-street, Bury, Lancashire.*
1871. † *Webb, Richard M. 72 Grand-parade, Brighton.*
1866. * *WEBB, WILLIAM FREDERICK, F.G.S., F.R.G.S. Newstead Abbey, near Nottingham.*
1886. § *Webber, Major-General C. E., C.B. 17 Egerton-gardens, London, S.W.*
1859. † *Webster, John. Edgehill, Aberdeen.*
1834. † *Webster, Richard, F.R.A.S. 6 Queen Victoria-street, London, E.C.*
1882. * *Webster, Sir Richard Everard, Q.C., M.P. Hornton Lodge, Hornton-street, Kensington, London, S.W.*
1884. * *Wedekind, Dr. Ludwig, Professor of Mathematics at Karlsruhe. Karlsruhe.*
1886. † *Weiss, Henry. Westbourne-road, Birmingham.*
1865. † *Welch, Christopher, M.A. United University Club, Pall Mall East, London, S.W.*

- Year of
Election.
1876. *WELDON, W. F. R., M.A. 14 Brookside, Cambridge.
1880. *Weldon, Mrs. 14 Brookside, Cambridge.
1881. †Wellcome, Henry S. First Avenue Hotel, Holborn, London, W.C.
1879. §WELLS, CHARLES A. Lewes; and 45 Springfield-road, Brighton.
1881. †Wells, Rev. Edward, B.A. West Dean Rectory, Salisbury.
1883. †Welsh, Miss. Girton College, Cambridge.
1887. *Welton, T. A. Rectory House-grove, Clapham, London, S.W.
1850. †Wemyss, Alexander Watson, M.D. St. Andrews, N.B.
1881. *Wenlock, The Right Hon. Lord. 8 Great Cumberland-place, London, W.; and Escrick Park, Yorkshire.
Wentworth, Frederick W. T. Vernon. Wentworth Castle, near Barnsley, Yorkshire.
1864. *Were, Anthony Berwick. Hensingham, Whitehaven, Cumberland.
1886. §Wertheimer, J., B.A., B.Sc., F.C.S. 32 Lyddon-terrace, Leeds.
1865. †Wesley, William Henry. Royal Astronomical Society, Burlington House, London, W.
1853. †West, Alfred. Holderness-road, Hull.
1870. †West, Captain E. W. Bombay.
1853. †West, Leonard. Summergangs Cottage, Hull.
1853. †West, Stephen. Hesse Grange, near Hull.
1870. *Westgarth, William. 10 Bolton-gardens, South Kensington, London, S.W.
1882. §Westlake, Ernest, F.G.S. Fordingbridge, Hants.
1882. †Westlake, Richard. Portswood, Southampton.
1882. †Westlake, W. C. Grosvenor House, Southampton.
1863. †Westmacott, Percy. Whickham, Gateshead, Durham.
1875. *Weston, Sir Joseph D. Dorset House, Clifton Down, Bristol.
1864. †WESTROPP, W. H. S., M.R.I.A. Lisdoonvarna, Co. Clare.
1860. †WESTWOOD, JOHN O., M.A., F.L.S., Professor of Zoology in the University of Oxford. Oxford.
1882. §WETHERED, EDWARD, F.G.S. 5 Berkeley-place, Cheltenham.
1884. †Wharton, E. R., M.A. 4 Broad-street, Oxford.
1885. *Wharton, Captain W. J. L., R.N., F.R.S., F.R.G.S. Florys, Prince's-road, Wimbledon Park, Surrey.
1888. §Wheatcroft, William G. 6 Widcombe-terrace, Bath.
1853. †Wheatley, E. B. Cote Wall, Mirfield, Yorkshire.
1866. †Wheatstone, Charles C. 19 Park-crescent, Regent's Park, London, N.W.
1884. †Wheeler, Claude L. 123 Metcalfe-street, Montreal, Canada.
1847. †Wheeler, Edmund, F.R.A.S. 48 Tollington-road, London, N.
1883. *Wheeler, George Brash. Elm Lodge, Wickham-road, Beckenham, Kent.
1878. *Wheeler, W. H., M.Inst.C.E. Boston, Lincolnshire.
1888. §Whelen, John Leman. 73 Fellowes-road, London, N.W.
1883. †Whelpton, Miss K. Newnham College, Cambridge.
1888. *Whidborne, Miss Alice Maria. Charanté, Torquay.
1888. *Whidborne, Miss Constance Mary. Charanté, Torquay.
1879. *WHIDBORNE, Rev. GEORGE FERRIS, M.A., F.G.S. Charanté, Torquay.
1873. †Whipple, George Matthew, B.Sc., F.R.A.S. Kew Observatory, Richmond, Surrey.
1884. †Whischer, Arthur Henry. Dominion Lands Office, Winnipeg Canada.
1887. †Whitaker, E. J. Burnley, Lancashire.
1874. †Whitaker, Henry, M.D. 33 High-street, Belfast.
1883. *Whitaker, T. Saville Heath, Halifax.

- Year of Election.
1859. *WHITAKER, WILLIAM, B.A., F.R.S., F.G.S. Geological Survey Office, Jermyn-street, London, S.W.; and 33 East Park-terrace, Southampton.
1886. †Whitcombe, E. B. Borough Asylum, Winson Green, Birmingham.
1886. †White, Alderman, J.P. Sir Harry's-road, Edgbaston, Birmingham.
1876. †White, Angus. Easdale, Argyleshire.
1886. †White, A. Silva, Secretary to the Royal Scottish Geographical Society, Edinburgh.
1883. †White, Charles. 23 Alexandra-road, Southport.
1882. †White, Rev. George Cecil, M.A. St. Paul's Vicarage, Southampton.
1885. *White, J. Martin. Spring Grove, Dundee.
1873. †White, John. Medina Docks, Cowes, Isle of Wight.
1859. †WHITE, JOHN FORBES. 311 Union-street, Aberdeen.
1883. †White, John Reed. Rossall School, near Fleetwood.
1865. †White, Joseph. Regent's-street, Nottingham.
1869. †White, Laban. Blandford, Dorset.
1884. †White, R. 'Gazette' Office, Montreal, Canada.
1859. †White, Thomas Henry. Tandragee, Ireland.
1877. *White, William. 9 The Paragon, Blackheath, London, S.E.
1883. *White, Mrs. 9 The Paragon, Blackheath, London, S.E.
1886. §White, William. 4 Mecklenburgh-square, London, W.C.
1861. *Whitehead, John B. Ashday Lea, Rawtenstall, Manchester.
1861. *Whitehead, Peter Ormerod. 4 Reformation-street, Fold's-road, Bolton.
1883. †Whitehead, P. J. 6 Cross-street, Southport.
1855. *Whitehouse, Wildeman W. O. 18 Salisbury-road, West Brighton.
1871. †Whitelaw, Alexander. 1 Oakley-terrace, Glasgow.
1884. †Whiteley, Joseph. Huddersfield.
1881. †Whitfield, John, F.C.S. 113 Westborough, Scarborough.
1866. †Whitfield, Samuel. Eversfield, Eastnor-grove, Leamington.
1852. †Whitla, Valentine. Beneden, Belfast.
1857. *Whitty, Rev. John Irwine, M.A., D.C.L., LL.D. 6 Wildwood-grove, North End, Hampstead, London, N.W.
1887. †Whitwell, William. Overdene, Saltburn-by-the-Sea.
1874. *Whitwill, Mark. Redland House, Bristol.
1883. †Whitworth, James. 88 Portland-street, Southport.
1870. †WHITWORTH, Rev. W. ALLEN, M.A. Glenthorne-road, Hammer-smith, London, W.
1888. §Wickham, Rev. F. D. C. Horsington Rectory, Bath.
1865. †Wiggin, Henry, M.P. Metchley Grange, Harborne, Birmingham.
1886. †Wiggin, Henry A. The Lea, Harborne, Birmingham.
1885. †Wigglesworth, Alfred. Gordondale House, Aberdeen.
1881. *Wigglesworth, James. New Parks House, Falsgrave, Scarborough.
1883. †Wigglesworth, Mrs. New Parks House, Falsgrave, Scarborough.
1881. *Wigglesworth, Robert. Harrogate Club, Harrogate.
1878. †Wigham, John R. Albany House, Monkstown, Dublin.
1883. †Wigner, G. W. Plough-court, 37 Lombard-street, London, E.C.
1884. †Wilber, Charles Dana, LL.D. Grand Pacific Hotel, Chicago, U.S.A.
1881. †WILBERFORCE, W. W. Fishergate, York.
1887. †Wild, George. Bardsley Colliery, Ashton-under-Lyne.
1887. *Wilde, Henry, F.R.S. The Hurst, Alderley Edge, Manchester.
1887. †Wilkinson, C. H. Slaithwaite, near Huddersfield.
1857. †Wilkinson, George. Temple Hill, Killiney, Co. Dublin.
1886. *Wilkinson, J. H. Corporation-street, Birmingham.
1879. †Wilkinson, Joseph. York.
1887. *Wilkinson, Thomas Read. The Polygon, Ardwick, Manchester.
1872. †Wilkinson, William. 168 North-street, Brighton.
1869. §Wilks, George Augustus Frederick, M.D. Stanbury, Torquay.

Year of
Election.

1859. † Willet, John, M.Inst.C.E. 35 Albyn-place, Aberdeen.
 1872. † WILLETT, HENRY, F.G.S. Arnold House, Brighton.
 WILLIAMS, CHARLES JAMES B., M.D., F.R.S. 47 Upper Brook-
 street, Grosvenor-square, London, W.
 1861. *Williams, Charles Theodore, M.A., M.B. 47 Upper Brook-street,
 Grosvenor-square, London, W.
 1887. † Williams, E. Leader, M.Inst.C.E. The Oaks, Altrincham.
 1883. *Williams, Edward Starbuck. Ty-ar-y-graig, Swansea.
 1861. *Williams, Harry Samuel, M.A., F.R.A.S. 1 Gorse-lane, Swansea.
 1875. *Williams, Rev. Herbert A., M.A. S.P.G. College, Trichinopoly,
 India.
 1883. † Williams, Rev. H. A. The Ridgeway, Wimbledon, Surrey.
 1857. † Williams, Rev. James. Llanfairinghornwy, Holyhead.
 1888. § Williams, James. Bladud Villa, Entryhill, Bath.
 1887. § Williams, J. Francis, Ph.D. Salem, New York, U.S.A.
 1870. § WILLIAMS, JOHN, F.C.S. 63 Warwick-gardens, Kensington,
 London, W.
 1888. *Williams, Miss Katherine. Llandaff House, Pembroke-vale, Clifton,
 Bristol.
 1875. *Williams, M. B. Killay House, near Swansea.
 1879. † WILLIAMS, MATTHEW W., F.C.S. Queenwood College, Stock-
 bridge, Hants.
 1886. § Williams, Richard, J.P. Brunswick House, Wednesbury.
 Williams, Robert, M.A. Bridehead, Dorset.
 1883. † Williams, R. Price. North Brow, Primrose Hill, London, N.W.
 1869. † WILLIAMS, Rev. STEPHEN. Stonyhurst College, Whalley, Blackburn.
 1883. § Williams, T. H. 2 Chapel-walk, South Castle-street, Liverpool.
 1883. † Williams, T. Howell. 125 Fortess-road, London, N.W.
 1888. § Williams, W. Cloud House, Stapleford, Nottinghamshire.
 1877. *WILLIAMS, W. CARLETON, F.C.S. Firth College, Sheffield.
 1865. † Williams, W. M. Stonebridge Park, Willesden.
 1883. † Williamson, Miss. Sunnybank, Ripon, Yorkshire.
 1850. *WILLIAMSON, ALEXANDER WILLIAM, Ph.D., LL.D., For. Sec. R.S.,
 F.C.S., Corresponding Member of the French Academy. (GENE-
 RAL TREASURER.) 17 Buckingham-street, London, W.C.
 1857. † WILLIAMSON, BENJAMIN, M.A., F.R.S., Professor of Natural Phi-
 losophy in the University of Dublin. Trinity College, Dublin.
 1876. † Williamson, Rev. F. J. Ballantrae, Girvan, N.B.
 1863. † Williamson, John. South Shields.
 1876. † Williamson, Stephen. 19 James-street, Liverpool.
 WILLIAMSON, WILLIAM C., LL.D., F.R.S., Professor of Botany
 in Owens College, Manchester. 4 Egerton-road, Fallowfield,
 Manchester.
 1883. † WILLIS, T. W. 51 Stanley-street, Southport.
 1882. † Willmore, Charles. Queenwood College, near Stockbridge, Hants.
 1859. *Wills, The Hon. Sir Alfred. Clive House, Esher, Surrey.
 1886. † Wills, A. W. Wylde Green, Erdington, Birmingham.
 1886. † Wilson, Alexander B. Holywood, Belfast.
 1885. † Wilson, Alexander H. 2 Albyn-place, Aberdeen.
 1878. † Wilson, Professor Alexander S., M.A., B.Sc. 124 Bothwell-street,
 Glasgow.
 1859. † Wilson, Alexander Stephen. North Kinmundy, Summerhill, by
 Aberdeen.
 1876. † Wilson, Dr. Andrew. 118 Gilmore-place, Edinburgh.
 1874. † WILSON, Colonel Sir C. W., R.E., K.C.B., K.C.M.G., D.C.L.,
 F.R.S., F.R.G.S. Ordnance Survey Office, Southampton.
 1850. † Wilson, Sir Daniel. Toronto, Canada.

Year of
Election.

1876. † Wilson, David. 124 Bothwell-street, Glasgow.
1863. † Wilson, Frederic R. Alnwick, Northumberland.
1847. * Wilson, Frederick. 73 Newman-street, Oxford-street, London, W.
1885. † Wilson, *Brigade-Surgeon G. A. East India United Service Club, St. James's-square, London, S.W.*
1875. † Wilson, George Fergusson, F.R.S., F.C.S., F.L.S. Heatherbank, Weybridge Heath, Surrey.
1874. * Wilson, George Orr. Dunardagh, Blackrock, Co. Dublin.
1863. † Wilson, George W. Heron Hill, Hawick, N.B.
1883. * Wilson, Henry, M.A. Eastnor, Malvern Link, Worcestershire.
1879. † Wilson, Henry J. 255 Pitsmoor-road, Sheffield.
1885. † Wilson, J. Dove, LL.D. 17 Rubislaw-terrace, Aberdeen.
1886. † Wilson, J. E. B. Woodslee, Wimbledon, Surrey.
1865. † WILSON, Rev. JAMES M., M.A., F.G.S. The College, Clifton, Bristol.
1884. † Wilson, James S. Grant. Geological Survey Office, Sheriff Court-buildings, Edinburgh.
1858. * Wilson, John. Seacroft Hall, near Leeds.
WILSON, JOHN, F.R.S.E., F.G.S., Professor of Agriculture in the University of Edinburgh. The University, Edinburgh.
1879. † Wilson, John Wycliffe. Eastbourne, East Bank-road, Sheffield.
1876. † Wilson, R. W. R. St. Stephen's Club, Westminster, S.W.
1847. * Wilson, Rev. Sumner. Preston Candover Vicarage, Basingstoke.
1883. † Wilson, T. Rivers Lodge, Harpenden, Hertfordshire.
1861. † Wilson, Thos. Bright. 4 Hope View, Fallowfield, Manchester.
1887. § Wilson, W., jun. Hillock, Terpersie, by Alford, Aberdeenshire.
1871. * Wilson, William E. Daramona House, Rathowen, Ireland.
1861. * WILTSHIRE, Rev. THOMAS, M.A., F.G.S., F.L.S., F.R.A.S., Assistant Professor of Geology and Mineralogy in King's College, London. 25 Granville-park, Lewisham, London, S.E.
1877. † Windeatt, T. W. Dart View, Totnes.
1886. § Windle, Bertram C. A. 195 Church Hill-road, Handsworth, Birmingham.
1887. † Windsor, William Tessimond. Sandiway, Ashton-on-Mersey.
1886. † Winter, George W. 55 Wheeley's-road, Edgbaston, Birmingham.
1887. § Winton, Colonel Sir F. de, K.C.M.G., F.R.G.S. 24 Tavistock-road, Westbourne Park, London, W.
1863. * WINWOOD, Rev. H. H., M.A., F.G.S. 11 Cavendish-crescent, Bath.
1888. § WODEHOUSE, E. R., M.P. 56 Chester-square, London, S.W.
1883. § Wolfenden, Samuel. Cowley Hill, St. Helen's, Lancashire.
1884. † Womack, Frederick, Lecturer on Physics and Applied Mathematics at St. Bartholomew's Hospital. 68 Abbey-road, London, N.W.
1881. * Wood, Alfred John. 5 Cambridge-gardens, Richmond, Surrey.
1883. § Wood, Mrs. A. J. 5 Cambridge-gardens, Richmond, Surrey.
1863. * Wood, Collingwood L. Freeland, Forgandenny, N.B.
1861. * Wood, Edward T. Blackhurst, Brinscall, Chorley, Lancashire.
1883. † Wood, Miss Emily F. Egerton Lodge, near Bolton, Lancashire.
1875. * Wood, George William Rayner. Singleton, Manchester.
1878. § WOOD, H. TRUMAN, M.A. Society of Arts, John-street, Adelphi, London, W.C.
1883. * WOOD, JAMES, LL.D. Grove House, Scarisbrick-street, Southport.
1881. § Wood, John, B.A., F.R.A.S. Wharfedale College, Boston Spa, Yorkshire.
1883. * Wood, J. H. Woodbine Lodge, Scarisbrick New-road, Southport.
1886. † Wood, Rev. Joseph. Carpenter-road, Birmingham.
1883. † Wood, Mrs. Mary. Ellison-place, Newcastle-on-Tyne.
1883. † Wood, P. F. *Ardwick Lodge, Park-avenue, Southport.*

Year of
Election.

1864. †Wood, Richard, M.D. Driffield, Yorkshire.
 1871. †Wood, Provost T. Barleyfield, Portobello, Edinburgh.
 1850. †Wood, Rev. Walter. Elie, Fife.
 1865. *Wood, William, M.D. 99 Harley-street, London, W.
 1872. §Wood, William Robert. Carlisle House, Brighton.
 *Wood, Rev. William Spicer, M.A., D.D. Higham, Rochester.
 1863. *WOODALL, JOHN WOODALL, M.A., F.G.S. St. Nicholas House,
 Scarborough.
 1884. †Woodbury, C. J. H. 31 Devonshire-street, Boston, U.S.A.
 1883. †Woodcock, Herbert S. The Elms, Wigan.
 1884. †Woodcock, T., B.A. The Old Hall School, Wellington, Shropshire.
 1884. †Woodd, Arthur B. Woodlands, Hampstead, London, N.W.
 1850. *Woodd, Charles H. L., F.G.S. Roslyn House, Hampstead, London,
 N.W.
 1865. †Woodhill, J. C. Pakenham House, Charlotte-road, Edgbaston,
 Birmingham.
 1871. †Woodiwis, James. 51 Back George-street, Manchester.
 1888. *Woodiwiss, Alfred. Fernleigh, Paignton, South Devon.
 1888. *Woodiwiss, Mrs. Alfred. Fernleigh, Paignton, South Devon.
 1872. †Woodman, James. 26 Albany-villas, Hove, Sussex.
 1869. †Woodman, William Robert, M.D. Ford House, Exeter.
 *WOODS, EDWARD, M.Inst.C.E. 6B Victoria-street, Westminster,
 London, S.W.
 1883. †Woods, Dr. G. A., F.R.S.E., F.R.M.S. Carlton House, 57 Houghton-
 street, Southport.
 WOODS, SAMUEL. 1 Drapers'-gardens, Throgmorton-street, London,
 E.C.
 1888. §Woodthorpe, Colonel. Messrs. King & Co., 45 Pall Mall, Lon-
 don, S.W.
 1887. *Woodward, Arthur Smith, F.G.S., F.L.S. 183B King's-road, Chel-
 sea, London, S.W.
 *WOODWARD, C. J., B.Sc. 97 Harborne-road, Birmingham.
 1886. †Woodward, Harry Page, F.G.S. 129 Beaufort-street, London, S.W.
 1866. †WOODWARD, HENRY, LL.D., F.R.S., F.G.S., Keeper of the Depart-
 ment of Geology, British Museum (Natural History), Cromwell-
 road, London, S.W.
 1870. †WOODWARD, HORACE B., F.G.S. Geological Museum, Jermyn-street,
 London, S.W.
 1881. †Wooler, W. A. Sadberge Hall, Darlington.
 1884. *Woolcock, Henry. Rickerby House, St. Bees.
 1877. †Woolcombe, Surgeon-Major Robert W. 14 Acre-place, Stoke,
 Devonport.
 1883. *Woolley, George Stephen. 69 Market-street, Manchester.
 1856. †Woolley, Thomas Smith, jun. South Collingham, Newark.
 WORCESTER, The Right Rev. HENRY PHILPOTT, D.D., Lord Bishop
 of. Hartlebury Castle, Kidderminster.
 1874. †Workman, Charles. Ceara, Windsor, Belfast.
 1878. †Wormell, Richard, M.A., D.Sc. Roydon, near Ware, Hertford-
 shire.
 1863. *Worsley, Philip J. Rodney Lodge, Clifton, Bristol.
 1855. *Worthington, Rev. Alfred William, B.A. Stourbridge, Worcester-
 shire.
 Worthington, Archibald. *Whitchurch, Salop.*
 Worthington, James. Sale Hall, Ashton-on-Mersey.
 1856. †Worthy, George S. 2 Arlington-terrace, Mornington-crescent,
 Hampstead-road, London, N.W.
 1884. †Wragge, Edmund. 109 Wellesley-street, Toronto, Canada.

Year of
Election.

1879. †Wrentmore, Francis. 34 Holland Villas-road, Kensington, London, S.W.
1883. *Wright, Rev. Arthur, M.A. Queen's College, Cambridge.
1883. *Wright, Rev. Benjamin, M.A. The Rectory, Darlaston.
1871. §WRIGHT, C. R. A., D.Sc., F.R.S., F.C.S., Lecturer on Chemistry in St. Mary's Hospital Medical School, Paddington, London, W.
1861. *Wright, E. Abbot. Castle Park, Frodsham, Cheshire.
1857. †WRIGHT, E. PERCEVAL, M.A., M.D., F.L.S., M.R.I.A., Professor of Botany, and Director of the Museum, Dublin University. 5 Trinity College, Dublin.
1886. †Wright, Frederick William. 4 Full-street, Derby.
1884. †Wright, Harrison. Wilkes' Barré, Pennsylvania, U.S.A.
1876. †Wright, James. 114 John-street, Glasgow.
1874. †Wright, Joseph. Cliftonville, Belfast.
1865. †Wright, J. S. 168 Brearley-street West, Birmingham.
1884. †Wright, Professor R. Ramsay, M.A., B.Sc. University College, Toronto, Canada.
WRIGHT, T. G., M.D. Milnes House, Wakefield.
1876. †Wright, William. 31 Queen Mary-avenue, Glasgow.
1871. †Wrightson, Thomas, M.Inst.C.E., F.G.S. Norton Hall, Stockton-on-Tees.
1887. †Wrigley, Rev. Dr., M.A., M.D., F.R.A.S. 15 Gauden-road, London, S.W.
1876. †WUNSCH, EDWARD ALFRED, F.G.S. Carharrack, Scorrier, Cornwall.
1867. †Wylie, Andrew. Prinlaws, Fifeshire.
1883. †Wyllie, Andrew. 10 Park-road, Southport.
1885. †Wyness, James D., M.D. 53 School-hill, Aberdeen.
1871. †Wynn, Mrs. Williams. Cefn, St. Asaph.
1862. †WYNNE, ARTHUR BEEVOR, F.G.S. Geological Survey Office, 14 Hume-street, Dublin.
1875. †Yabbicom, Thomas Henry. 37 White Ladies-road, Clifton, Bristol.
*Yarborough, George Cook. Camp's Mount, Doncaster.
1865. †Yates, Edwin. Stonebury, Edgbaston, Birmingham.
1883. †Yates, James. Public Library, Leeds.
1867. †Yeaman, James. Dundee.
1887. §Yeats, Dr. Chepstow.
1884. †Yee, Fung, Secretary to the Chinese Legation. 49 Portland-place, London, W.
1879. †Yeomans, John. Upperthorpe, Sheffield.
1877. †Yonge, Rev. Duke. Puslinch, Yealmpton, Devon.
1879. *YORK, His Grace the Archbishop of, D.D., F.R.S. The Palace, Bishopthorpe, Yorkshire.
1884. †York, Frederick. 87 Lancaster-road, Notting Hill, London, W.
1886. *YOUNG, A. H., M.B., F.R.C.S., Professor of Anatomy in Owens College, Manchester.
1884. †Young, Frederick. 5 Queensberry-place, London, S.W.
1884. †Young, Professor George Paxton. 121 Bloor-street, Toronto, Canada.
1876. †YOUNG, JOHN, M.D., Professor of Natural History in the University of Glasgow. 38 Cecil-street, Hillhead, Glasgow.
1885. †Young, R. Bruce. 8 Crown-gardens, Dowanhill, Glasgow.
1886. §Young, R. Fisher. New Barnet, Herts.
1883. *YOUNG SYDNEY, D.Sc.. University College, Bristol.
1887. §Young, Sydney. 29 Mark-lane, London, E.C.
1868. †Youngs, John. Richmond Hill, Norwich.
1876. †Yuille, Andrew. 7 Sardinia-terrace, Hillhead, Glasgow.

CORRESPONDING MEMBERS.

Year of
Election.

1871. HIS IMPERIAL MAJESTY THE EMPEROR OF THE BRAZILS.
 1887. Cleveland Abbe. Weather Bureau of the Army Signal Office, Washington, U.S.A.
 1881. Professor G. F. Barker. University of Pennsylvania, Philadelphia, United States.
 1870. Professor Van Beneden, LL.D. Louvain, Belgium.
 1887. Professor A. Bernthsen, Ph.D., Mannheim, L 14, 4, Germany.
 1880. Professor Ludwig Boltzmann. Halbärtgasse, 1, Gráz, Austria.
 1887. His Excellency R. Bonghi. Rome.
 1887. Professor Lewis Boss. Dudley Observatory, Albany, New York, United States.
 1884. Professor H. P. Bowditch, M.D. Boston, Massachusetts, United States.
 1884. Professor George J. Brush. Yale College, New Haven, United States.
 1887. Professor J. W. Bruhl. Freiburg.
 1864. Dr. H. D. Buys-Ballot, Superintendent of the Royal Meteorological Institute of the Netherlands. Utrecht, Holland.
 1887. Professor G. Capellini. Royal University of Bologna.
 1887. Professor J. B. Carnoy. Louvain.
 1887. H. Caro. Mannheim.
 1861. Dr. Carus. Leipzig.
 1887. F. W. Clarke. United States Geological Survey, Washington, United States.
 1855. Dr. Ferdinand Cohn. Breslau, Prussia.
 1871. Professor Dr. Colding. Copenhagen.
 1881. Professor Josiah P. Cooke. Harvard University, United States.
 1873. Professor Guido Cora. 74 Corso Vittorio Emanuele, Turin.
 1880. Professor Cornu. L'École Polytechnique, Paris.
 1870. J. M. Crafts, M.D. L'École des Mines, Paris.
 1876. Professor Luigi Cremona. The University, Rome.
 1889. W. H. Dall. United States Geological Survey, Washington, United States.
 1866. Dr. Geheimrath von Dechen. Bonn.
 1862. Wilhelm Delffs, Professor of Chemistry in the University of Heidelberg.
 1864. M. Des Cloizeaux. Rue Monsieur, 13, Paris.
 1872. Professor G. Dewalque. Liège, Belgium.
 1870. Dr. Anton Dohrn. Naples.
 1882. Dr. Emil Du Bois-Reymond, Professor of Physiology. The University, Berlin.
 1876. Professor Alberto Eccher. Florence.
 1874. Dr. W. Feddersen. Leipzig.

Year of
Election.

1886. Dr. Otto Finsch. Bremen.
 1887. Professor R. Fittig. Strasburg.
 1872. W. de Fonvielle. 50 Rue des Abbesses, Paris.
 1856. Professor E. Frémy. L'Institut, Paris.
 1887. Dr. Anton Fritsch. Prague.
 1881. C. M. Gariel, Secretary of the French Association for the Advancement of Science. 4 Rue Antoine Dubois, Paris.
 1866. Dr. Gaudry. Paris.
 1861. Dr. Geinitz, Professor of Mineralogy and Geology. Dresden.
 1884. Professor J. Willard Gibbs. Yale College, New Haven, United States.
 1884. Professor Wolcott Gibbs. Harvard University, Cambridge, Massachusetts, United States.
 1889. G. K. Gilbert. United States Geological Survey, Washington, United States.
 1870. William Gilpin. Denver, Colorado, United States.
 1876. Dr. Benjamin A. Gould. Cambridge, Massachusetts, United States.
 1884. Major A. W. Greely. Washington, United States.
 1862. Dr. D. Bierens de Haan, Member of the Royal Academy of Sciences, Amsterdam. Leiden, Holland.
 1876. Professor Ernst Haeckel. Jena.
 1889. Horatio Hale. Clinton, Ontario, Canada.
 1881. Dr. Edwin H. Hall. Baltimore, United States.
 1872. Professor James Hall. Albany, State of New York.
 1881. M. Halphen. 21 Rue Ste. Anne, Paris.
 1889. Dr. Max von Hantken. Budapesth.
 1864. M. Hébert, Professor of Geology in the Sorbonne, Paris.
 1887. Fr. von Hefner-Alteneck. Berlin.
 1877. Professor H. L. F. von Helmholtz. Berlin.
 1872. J. E. Hilgard, Assist.-Supt. U.S. Coast Survey. Washington, United States.
 1887. Professor W. His. Leipzig.
 1887. S. Dana Horton. New York.
 1881. Dr. A. A. W. Hubrecht. Leiden.
 1887. Dr. Oliver W. Huntington. Harvard University, Cambridge, Massachusetts, United States.
 1884. Professor C. Loring Jackson. Harvard University, Cambridge, Massachusetts, United States.
 1867. Dr. Janssen, LL.D. The Observatory, Meudon, Seine-et-Oise.
 1876. Dr. W. J. Janssen. Davos-Doerfli, Graubunden, Switzerland.
 1862. Charles Jessen, Med. et Phil. Dr. Kastanienallee, 69, Berlin.
 1881. W. Woolsey Johnson, Professor of Mathematics in the United States Naval Academy. Annapolis, United States.
 1887. Professor C. Julin. Liège.
 1876. Dr. Giuseppe Jung. 7 Via Principe Umberto, Milan.
 1877. M. Akin Károly. 92 Rue Richelieu, Paris.
 1862. Aug. Kekulé, Professor of Chemistry. Bonn.
 1884. Professor Dairoku Kikuchi, M.A. Imperial University, Tokyo, Japan.
 1873. Dr. Felix Klein. The University, Leipzig.
 1874. Dr. Knoblauch. Halle, Germany.
 1856. Professor A. Kölliker. Wurzburg, Bavaria.
 1887. Dr. Arthur König. The University, Berlin.
 1887. Professor Krause. Göttingen.
 1877. Dr. Hugo Kronecker, Professor of Physiology. The University, Bern, Switzerland.
 1887. Lieutenant R. Kund. German African Society, Berlin.
 1887. Professor A. Ladenburg. Kiel.

Year of
Election.

1887. Professor J. W. Langley. Michigan, United States
 1882. Professor S. P. Langley, LL.D., Secretary of the Smithsonian Institution, Washington, United States.
 1887. Professor Count von Laubach. Göttingen.
 1887. Dr. Leeds, Professor of Chemistry at the Stevens Institute, Hoboken, New Jersey, United States.
 1872. M. Georges Lemoine. 76 Rue d'Assas, Paris.
 1887. Professor A. Lieben. Vienna.
 1883. Dr. F. Lindemann, Professor of Mathematics in the University of Königsberg.
 1877. Dr. M. Lindemann, Hon. Sec. of the Bremen Geographical Society, Bremen.
 1887. Professor G. Lippmann. Paris.
 1887. Dr. Georg Lunge. Zurich.
 1871. Professor Jacob Lüroth. The University, Freiburg, Germany.
 1871. Dr. Lütken. Copenhagen.
 1869. Professor C. S. Lyman. Yale College, New Haven, United States.
 1887. Dr. Henry C. McCook. Philadelphia, United States.
 1867. Professor Mannheim. Rue de la Pompe, 11, Passy, Paris.
 1881. Professor O. C. Marsh. Yale College, New Haven, United States.
 1867. Professor Ch. Martins, Director of the Jardin des Plantes. Montpellier, France.
 1887. Dr. C. A. Martius. Berlin.
 1887. Professor D. Mendeléef. St. Petersburg.
 1887. Professor N. Menschutkin. St. Petersburg.
 1887. Professor Lothar Meyer. Tübingen.
 1884. Albert A. Michelson. Cleveland, Ohio, United States.
 1848. Professor J. Milne-Edwards. Paris.
 1887. Dr. Charles Sedgwick Minot. Boston, Massachusetts, United States.
 1877. Professor V. L. Moissenet. L'École des Mines, Paris.
 1864. Dr. Arnold Moritz. The University, Dorpat, Russia.
 1887. E. S. Morse. Peabody Academy of Science, Salem, Massachusetts, United States.
 1866. Chevalier C. Negri, President of the Italian Geographical Society, Turin, Italy.
 1864. Herr Neumayer. Deutsche Seewarte, Hamburg.
 1884. Professor Simon Newcomb. Washington, United States.
 1869. Professor H. A. Newton. Yale College, New Haven, United States.
 1887. Professor Noelting. Mühlhausen, Elsass.
 1887. Dr. Pauli. Höchst-on-Main, Germany.
 1856. M. E. Peligot, Memb. de l'Institut, Paris.
 1857. Gustave Plarr, D.Sc. 22 Hadlow-road, Tunbridge, Kent.
 1870. Professor Felix Plateau. 64 Boulevard du Jardin Zoologique, Gaud.
 1884. Major J. W. Powell, Director of the Geological Survey of the United States. Washington, United States.
 1887. Professor W. Preyer. Jena.
 1887. N. Pringsheim. Berlin.
 1886. Professor Putnam, Secretary of the American Association for the Advancement of Science. Harvard University, Cambridge, Massachusetts, United States.
 1887. Professor G. Quincke. Heidelberg.
 1868. L. Radlkofer, Professor of Botany in the University of Munich.
 1886. Rev. A. Renard. Royal Museum, Brussels.
 1872. Professor Victor von Richter. St. Petersburg.
 1873. Baron von Richthofen. The University, Leipzig.
 1887. Dr. C. V. Riley. Washington, United States.

Year of
Election.

1866. F. Römer, Ph.D., Professor of Geology and Palæontology in the University of Breslau. Breslau, Prussia.
1881. Professor Henry A. Rowland. Baltimore, United States.
1887. M. le Marquis de Saporta. Aix-en-Provence, Bouches du Rhône.
1857. *Professor Robert Schlagintweit. Giessen.*
1857. Baron Herman de Schlagintweit-Sakünlinski. Jaegersberg Castle, near Forchheim, Bavaria.
1883. Dr. Ernst Schröder. Karlsruhe, Baden.
1874. Dr. G. Schweinfurth. Cairo.
1846. Baron de Selys-Longchamps. Liège, Belgium.
1872. Professor Carl Semper. Wurzburg, Bavaria.
1873. Dr. A. Shafarik. Prague.
1861. Dr. Werner von Siemens. Berlin.
1849. Dr. Siljeström. Stockholm.
1876. Professor R. D. Silva. L'École Centrale, Paris.
1887. Ernest Solvay. Brussels.
1888. Dr. Alfred Springer. Cincinnati, Ohio, United States.
1866. Professor Steenstrup. Copenhagen.
1889. Professor G. Stefanescu. Bucharest.
1881. *Dr. Cyparissos Stephanos. 28 Rue de l'Arbalète, Paris.*
1881. Professor Sturm. Münster, Westphalia.
1871. Dr. Joseph Szabó. Pesth, Hungary.
1870. Professor Tchebichef, Membre de l'Académie de St. Pétersbourg.
1852. M. Pierre de Tchihatchef, Corresponding Member of the Institute of France. 1 Piazza degli Zuai, Florence.
1884. Professor Robert H. Thurston. Sibley College, Cornell University, Ithaca, New York, United States.
1864. Dr. Otto Torell, Professor of Geology in the University of Lund, Sweden.
1887. Dr. T. M. Treub. Java.
1887. Professor John Trowbridge. Harvard University, Cambridge, Massachusetts, United States.
- Arminius Vámbéry, Professor of Oriental Languages in the University of Pesth, Hungary.
1889. Wladimir Vernadsky, Keeper of the Mineralogical Museum, University of St. Petersburg.
1887. Professor John Vilanova. Madrid.
1886. M. Jules Vuylsteke. 80 Rue de Lille, Menin, Belgium.
1887. Professor H. F. Weber. Zurich.
1887. Professor L. Weber. Breslau.
1887. Professor August Weismann. Freiburg.
1887. Dr. H. C. White. Athens, Georgia, United States.
1881. Professor H. M. Whitney. Beloit College, Wisconsin, United States.
1874. Professor Wiedemann. Leipzig.
1887. Professor G. Wiedemann. Leipzig.
1887. Professor R. Wiedersheim. Freiburg.
1887. Professor J. Wislicenus. Leipzig.
1887. Dr. Otto N. Witt. 33 Lindenallée, Westend-Charlottenburg, Berlin.
1887. *Dr. Ludwig H. Wolf. Leipzig.*
1876. Professor Adolph Wüllner. Aix-la-Chapelle.
1887. Professor C. A. Young. Princeton College, United States.
1887. Professor F. Zirkel. Leipzig.

LIST OF SOCIETIES AND PUBLIC INSTITUTIONS
TO WHICH A COPY OF THE REPORT IS PRESENTED.

GREAT BRITAIN AND IRELAND.

Admiralty, Library of the.	Linnean Society.
Anthropological Institute.	Liverpool, Free Public Library and Museum.
Arts, Society of.	—, Royal Institution.
Asiatic Society (Royal).	London Institution.
Astronomical Society (Royal).	Manchester Literary and Philosophical Society.
Belfast, Queen's College.	—, Mechanics' Institute.
Birmingham, Midland Institute.	Mechanical Engineers, Institution of.
Bristol Philosophical Institution.	Meteorological Office.
Cambridge Philosophical Society.	Meteorological Society (Royal).
Cardiff, University College of South Wales.	Newcastle-upon-Tyne Literary and Philosophical Society.
Chemical Society.	—, Public Library.
Civil Engineers, Institution of.	Norwich, The Free Library.
Cornwall, Royal Geological Society of.	Nottingham, The Free Library.
Dublin, Royal College of Surgeons in Ireland.	Oxford, Ashmolean Society.
—, Royal Geological Society of Ireland.	—, Radcliffe Observatory.
—, Royal Irish Academy.	Physicians, Royal College of.
—, Royal Society of.	Plymouth Institution.
Dundee, University College.	Royal Engineers' Institute, Chatham.
East India Library.	Royal Institution.
Edinburgh, Royal Society of.	Royal Society.
—, Royal Medical Society of.	Royal Statistical Society.
—, Scottish Society of Arts.	Salford, Royal Museum and Library.
Exeter, Albert Memorial Museum.	Sheffield, Firth College.
Geographical Society (Royal).	Southampton, Hartley Institution.
Geological Society.	Stonyhurst College Observatory.
Geology, Museum of Practical.	Surgeons, Royal College of.
Glasgow Philosophical Society.	United Service Institution.
—, Institution of Engineers and Ship-builders in Scotland.	University College.
Greenwich, Royal Observatory.	Wales (South), Royal Institution.
Kew Observatory.	War Office, Library of the.
Leeds, Mechanics' Institute.	Yorkshire Philosophical Society.
Leeds, Philosophical and Literary Society of.	Zoological Society.

EUROPE.

Berlin	Der Kaiserlichen Akademie der Wissenschaften.	Dorpat, Russia...	University Library.
—	Royal Academy of Sciences.	Dresden	Royal Museum.
Bonn	University Library.	Frankfort	Natural History Society.
Brussels	Royal Academy of Sciences.	Geneva.....	Natural History Society.
Charkow	University Library.	Göttingen	University Library.
Coimbra	Meteorological Observatory.	Halle	Leopoldinisch-Carolinische Akademie.
Copenhagen ...	Royal Society of Sciences.	Harlem	Société Hollandaise des Sciences.
		Heidelberg	University Library.

Helsingfors	University Library.	Paris	Royal Academy of Sciences.
Kasan, Russia ...	University Library.	—	School of Mines.
Kiel	Royal Observatory.	Pultova	Imperial Observatory.
Kiev	University Library.	Rome	Accademia dei Lincei.
Lausanne.....	The Academy.	—	Collegio Romano.
Leyden	University Library.	—	Italian Geographical Society.
Liège	University Library.	—	Italian Society of Sciences.
Lisbon	Academia Real des Sciences.	St. Petersburg .	University Library.
Milan	The Institute.	—	Imperial Observatory.
Modena	Royal Academy.	Stockholm	Royal Academy.
Moscow	Society of Naturalists.	Turin	Royal Academy of Sciences.
—	University Library.	Utrecht	University Library.
Munich	University Library.	Vienna.....	The Imperial Library.
Naples	Royal Academy of Sciences.	—	Central Anstalt für Meteorologie und Erdmagnetismus.
Nicolaieff.....	University Library.	Zurich.....	General Swiss Society.
Paris	Association Française pour l'Avancement des Sciences.		
—	Geographical Society.		
—	Geological Society.		

ASIA.

Agra	The College.	Calcutta	Hindoo College.
Bombay	Elphinstone Institution.	—	Hoogly College.
—	Grant Medical College.	—	Medical College.
Calcutta	Asiatic Society.	Madras.....	The Observatory.
		—	University Library.

AFRICA.

Cape of Good Hope . . . The Royal Observatory.

AMERICA.

Albany	The Institute.	Philadelphia...	American Medical Association.
Boston.....	American Academy of Arts and Sciences.	—	American Philosophical Society.
California	The University.	—	Franklin Institute.
Cambridge	Harvard University Library.	Toronto	The Observatory.
Manitoba	Historical and Scientific Society.	Washington...	The Naval Observatory.
Montreal	McGill College.	—	Smithsonian Institution.
New York	Lyceum of Natural History.	—	United States Geological Survey of the Territories.

AUSTRALIA.

Adelaide The Colonial Government.
Victoria The Colonial Government.

NEW ZEALAND.

Canterbury Museum.

8 JUN 1889



MR. MURRAY'S GENERAL LIST OF WORKS.

- ALBERT MEMORIAL.** A Descriptive and Illustrated Account of the National Monument at Kensington. Illustrated by numerous Engravings. By DOYNE C. BELL. With 24 Plates. Folio. 12l 12s.
-
- **HANDBOOK.** 16mo. 1s.; Illustrated, 2s. 6d.
- ABBOTT (REV. J.).** Memoirs of a Church of England Missionary in the North American Colonies. Post 8vo. 2s.
- ABERCROMBIE (JOHN).** Enquiries concerning the Intellectual Powers and the Investigation of Truth. Fcap. 8vo. 3s. 6d.
- ACLAND (REV. C.).** The Manners and Customs of India. Post 8vo. 2s.
- ACWORTH (W. M.)** The Railways of England. With Illustrations. 8vo.
- ÆSOP'S FABLES.** A New Version. By REV. THOMAS JAMES. With 100 Woodcuts, by TENNIEL and WOLFE. Post 8vo. 2s. 6d.
- AGRICULTURAL (ROYAL) JOURNAL.** (*Published half-yearly.*)
- AINGER (A. C.).** Latin Grammar. [See ETON.]
- ALICE (PRINCESS); GRAND DUCHESS OF HESSE.** Letters to H.M. THE QUEEN. With a Memoir by H.R.H. Princess Christian. Portrait. Crown 8vo. 7s. 6d., or Original Edition, 12s.
- AMBER-WITCH (THE).** A most interesting Trial for Witchcraft. Translated by LADY DUFF GORDON. Post 8vo. 2s.
- AMERICA.** [See BATES, NADAILLAC, RUMBOLD.]
- APOCRYPHA:** With a Commentary Explanatory and Critical. By Dr. Salmon, Prof. Fuller, Archdeacon Farrar, Archdeacon Gifford, Canon Rawlinson, Dr. Edersheim, Rev. J. H. Lupton, Rev. C. J. Ball. Edited by HENRY WACE, D.D. 2 vols. Medium 8vo. 50s.
- ARGYLL (DUKE OF).** Unity of Nature. Third Edition. 8vo. 12s.
- ARISTOTLE.** [See GROTE.]
- ARTHUR'S (LITTLE) History of England.** By LADY CALCOTT. *New Edition, continued to 1878.* With Woodcuts. Fcap. 8vo. 1s. 6d.
-
- **HISTORY OF FRANCE, from the Earliest Times to the Fall of the Second Empire.** With Woodcuts. Fcap. 8vo. 2s. 6d.
- AUSTIN (JOHN).** **GENERAL JURISPRUDENCE;** or, The Philosophy of Positive Law. Edited by ROBERT CAMPBELL. 2 Vols. 8vo. 32s.
-
- **STUDENT'S EDITION,** compiled from the above work, by ROBERT CAMPBELL. Post 8vo. 12s.
-
- **Analysis of.** By GORDON CAMPBELL. Post 8vo. 6s.
- BABER (E. C.)** Travels in W. China. Maps. Royal 8vo. 5s.
- BAINES (THOMAS).** Greenhouse and Stove Plants, Flowering and Fine-Leaved. Palms, Ferns, and Lycopodiums. With full details of the Propagation and Cultivation. 8vo. 8s. 6d.

- BARCLAY (BISHOP).** Extracts from the Talmud, illustrating the Teaching of the Bible. With an Introduction. 8vo. 14s.
- BARKLEY (H. C.).** Five Years among the Bulgarians and Turks between the Danube and the Black Sea. Post 8vo. 10s. 6d.
- Bulgaria Before the War. Post 8vo. 10s. 6d.
- My Boyhood. Woodcuts. Post 8vo. 6s.
- BARROW (JOHN).** Life of Sir F. Drake. Post 8vo. 2s.
- BATES (H. W.).** Records of a Naturalist on the Amazons during Eleven Years' Adventure and Travel. Illustrations. Post 8vo. 7s. 6d
- BATTLE ABBEY ROLL.** [See CLEVELAND.]
- BAX (CAPT.).** Russian Tartary, Eastern Siberia, China, Japan, &c. Illustrations. Crown 8vo. 12s.
- BEACONSFIELD'S (LORD)** Letters, and "Correspondence with his Sister," 1830—1852. A New Edition with additional letters and notes. Portrait. Crown 8vo. 2s.
- BECKETT (SIR EDMUND).** "Should the Revised New Testament be Authorised?" Post 8vo. 6s.
- BELL (SIR CHAS.).** Familiar Letters. Portrait. Post 8vo. 12s.
- (DOYNE C.). Notices of the Historic Persons buried in the Chapel of the Tower of London. Illustrations. Crown 8vo. 14s.
- BENJAMIN (S. G. W.).** Persia and the Persians. With 60 Illustrations. 8vo. 24s.
- BENSON (ARCHBISHOP).** The Cathedral; its necessary place in the Life and Work of the Church. Post 8vo. 6s.
- BERKELEY (HASTINGS).** Wealth and Welfare: an Examination of Recent Changes in the Production and Distribution of Wealth in the United Kingdom, and of the Effect of our National Trade Policy on the General Welfare of the Nation. Crown 8vo. 6s.
- BERTRAM (JAS. G.).** Harvest of the Sea: an Account of British Food Fishes, Fisheries and Fisher Folk. Illustrations. Post 8vo. 9s.
- BIBLE COMMENTARY. THE OLD TESTAMENT. EXPLANATORY and CRITICAL.** With a REVISION of the TRANSLATION. By BISHOPS and CLERGY of the ANGLICAN CHURCH. Edited by F. C. COOK, M.A., Canon of Exeter. 6 VOLS. Medium 8vo. 6l. 15s.
- | | |
|--------------------------------|---------------------------------|
| Vol. I. } GENESIS—DEUTERONOMY. | Vol. IV. } JOB—SONG OF SOLOMON. |
| 30s. | 24s. |
| Vol. II. } JOSHUA—KINGS. | Vol. V. 20s. ISAIAH, JEREMIAH. |
| 20s. | |
| Vol. III. } KINGS ii.—ESTHER. | Vol. VI. } EZEKIEL—MALACHI. |
| 1s. | 25s. |
- THE NEW TESTAMENT. 4 VOLS. Medium 8vo. 4l. 14s.
- | | |
|--|----------------------------------|
| Vol. I. } INTRODUCTION, ST. MATTHEW, ST. MARK, ST. LUKE. | Vol. III. } ROMANS—PHILEMON. |
| 18s. | 28s. |
| Vol. II. } ST. JOHN. | Vol. IV. } HEBREWS — REVELATION. |
| 20s. | 28s. |
| | |
| | |
| | |
| | |
- THE APOCRYPHA. 2 vols. Medium 8vo. 50s.
- THE STUDENT'S EDITION. Abridged and Edited by REV. J. M. FULLER, M.A. Crown 8vo. 7s. 6d. each Volume. OLD TESTAMENT. 4 Vols. NEW TESTAMENT. 2 Vols.
- BIGG-WITHER (T. P.).** Pioneering in South Brazil; Three Years of Forest and Prairie Life in the Province of Parana. Illustrations. 2 vols. Crown 8vo. 24s.

- BIRD (ISABELLA).** Hawaiian Archipelago; or Six Months among the Palm Groves, Coral Reefs, and Volcanoes of the Sandwich Islands. Illustrations. Crown 8vo. 7s. 6d.
- **A Lady's Life in the Rocky Mountains.** Illustrations. Post 8vo. 7s. 6d.
- **The Golden Chersonese and the Way Thither.** Illustrations. Post 8vo. 14s.
- **Unbeaten Tracks in Japan: Including Visits to the Aborigines of Yezo and the Shrines of Nikko and Isé.** Illustrations. Crown 8vo. 7s. 6d.
- BISSET (SIR JOHN).** Sport and War in South Africa from 1834 to 1867. Illustrations. Crown 8vo. 14s.
- BLACKIE (C.).** Geographical Etymology; or, Dictionary of Place Names. Third Edition. Crown 8vo. 7s.
- BLUNT (LADY ANNE).** The Bedouins of the Euphrates Valley. With some account of the Arabs and their Horses. Illustrations. 2 Vols. Crown 8vo. 24s.
- **A Pilgrimage to Nejd, the Cradle of the Arab Race, and a Visit to the Arab Emir.** Illustrations. 2 Vols. Post 8vo. 24s.
- BLUNT (REV. J. J.).** Undesigned Coincidences in the Writings of the Old and New Testaments, an Argument of their Veracity. Post 8vo. 6s.
- **History of the Christian Church in the First Three Centuries.** Post 8vo. 6s.
- **The Parish Priest; His Duties, Acquirements, and Obligations.** Post 8vo. 6s.
- BOOK OF COMMON PRAYER.** Illustrated with Coloured Borders, Initial Letters, and Woodcuts. 8vo. 18s.
- BORROW (GEORGE).** The Bible in Spain; or, the Journeys and Imprisonments of an Englishman in an attempt to circulate the Scriptures in the Peninsula. Portrait. Post 8vo. 2s. 6d.
- **The Zincali. An Account of the Gipsies of Spain; Their Manners, Customs, Religion, and Language.** Post 8vo. 2s. 6d.
- **Lavengro; The Scholar—The Gypsy—and the Priest.** Post 8vo. 2s. 6d.
- **Romany Rye. A Sequel to Lavengro.** Post 8vo. 2s. 6d.
- **WILD WALES: its People, Language, and Scenery.** Post 8vo. 2s. 6d.
- **Romano Lavo-Lil. With Illustrations of the English Gypsies; their Poetry and Habitations.** Post 8vo. 5s.
- BOSWELL'S** Life of Samuel Johnson, LL.D. Including the Tour to the Hebrides. Edited by Mr. CROKER. *Seventh Edition.* Portraits. 1 vol. Medium 8vo. 12s.
- BOWEN (LORD JUSTICE).** Virgil in English Verse, Eclogues and Æneid, Books I.—VI. Map and Frontispiece. Crown 8vo. 12s.
- BRADLEY (DEAN).** Arthur Penrhyn Stanley; Biographical Lectures. Crown 8vo. 3s. 6d.
- BREWER (REV. J. S.).** The Reign of Henry VIII.; from his Accession till the Death of Wolsey. Illustrated from Original Documents. Edited by JAMES GAIRDNER, With Portrait. 2 vols. 8vo. 30s.
- **The Endowments and Establishment of the Church of England.** Third Edition. Revised and Edited by LEWIS T. DIBBIN, M.A., Barrister-at-Law. Post 8vo. 6s.

BRIDGES (Mrs. F. D.). *A Lady's Travels in Japan, Thibet, Yarkand, Kashmir, Java, the Straits of Malacca, Vancouver's Island, &c.* With Map and Illustrations from Sketches by the Author. Crown 8vo. 15s.

BRITISH ASSOCIATION REPORTS. 8vo.

* * * The Reports for the years 1831 to 1875 may be obtained at the Offices of the British Association.

Glasgow, 1876, 25s.	Swansea, 1880, 24s.	Canada, 1884, 24s.
Plymouth, 1877, 24s.	York, 1881, 24s.	Aberdeen, 1885, 24s.
Dublin, 1878, 24s.	Southampton, 1882, 24s.	Birmingham, 1886, 24s.
Sheffield, 1879, 24s.	Southport, 1883, 24s.	Manchester, 1887, 24s.

BROADFOOT (MAJOR W., R.E.) *Record of the Services in Afghanistan and the Punjab of Major George Broadfoot, C.B., Governor-General's Agent on the N. W. Frontier of India.* Compiled from his papers and those of Lords Ellenborough and Hardinge. Maps. 8vo. 15s.

BROCKLEHURST (T. U.). *Mexico To-day: A Country with a Great Future.* With a Glance at the Prehistoric Remains and Antiquities of the Montezumas. Plates and Woodcuts. Medium 8vo. 21s.

BRUCE (Hon. W. N.). *Life of Sir Charles Napier.* [See **NAPIER.**]

BRUGSCH (PROFESSOR). *A History of Egypt under the Pharaohs.* Derived entirely from Monuments, with a Memoir on the Exodus of the Israelites. Maps. 2 Vols. 8vo. 32s.

BULGARIA. [See **BARKLEY, HURN, MINCHIN.**]

BUNBURY (E. H.). *A History of Ancient Geography, among the Greeks and Romans, from the Earliest Ages till the Fall of the Roman Empire.* Maps. 2 Vols. 8vo. 21s.

BURBIDGE (F. W.). *The Gardens of the Sun: or A Naturalist's Journal in Borneo and the Sulu Archipelago.* Illustrations. Cr. 8vo. 14s.

BURCKHARDT'S Cicerone; or Art Guide to Painting in Italy. New Edition, revised by J. A. CROWE. Post 8vo. 6s.

BURGES (SIR JAMES BLAND, BART.) *Selections from his Letters and Papers, as Under-Secretary of State for Foreign Affairs.* With Notices of his Life. Edited by JAMES HUTTON. 8vo. 15s.

BURTON (J. W.), DEAN OF CHICHESTER. *The Revision Revised: (1.) The New Greek Text; (2.) The New English Version; (3.) Westcott and Hort's Textual Theory.* Second Edition. 8vo. 14s.

————— *Lives of Twelve Good Men.* Martin J. Routh, Hugh James Rose, Chas. Marriott, Edward Hawkins, Samuel Wilberforce, Richard Lynch Cotton, Richard Gresswell, Henry Octavius Coxe, Henry Longueville Mansel, Wm. Jacobson, Chas. Page Eden, Chas. Longuet Higgins. 2 vols. Third Edition Crown 8vo. 24s.

BURKE (EDMUND). [See **PANKEHURST.**]

BURN (COL.). *Dictionary of Naval and Military Technical Terms, English and French—French and English.* Crown 8vo. 15s.

BUTTMANN'S LEXILOGUS; a Critical Examination of the Meaning of numerous Greek Words, chiefly in Homer and Hesiod. By Rev. J. R. FISHLAKE. 8vo. 12s.

BUXTON (CHARLES). *Memoirs of Sir Thomas Fowell Buxton, Bart.* Portrait. 8vo. 16s. *Popular Edition.* Fcap. 8vo. 5s.

————— *Notes of Thought.* With a Biographical Notice by Rev. J. LEWELLYN DAVIES, M.A. *Second Edition.* Post 8vo. 5s.

————— (SYDNEY C.). *A Handbook to the Political Questions of the Day; with the Arguments on Either Side.* Seventh Edition. 8vo. 8s.

————— *Finance and Politics, an Historical Study. 1783-1885.* 2 Vols. 26s.

BYLES (SIR JOHN). *Foundations of Religion in the Mind and Heart of Man.* Post 8vo. 6s.

BYRON'S (LORD) LIFE AND WORKS:—

- LIFE, LETTERS, AND JOURNALS. By THOMAS MOORE. One Volume, Portraits. Royal 8vo. 7s. 6d.
- LIFE AND POETICAL WORKS. *Popular Edition*. Portraits. 2 Vols. Royal 8vo. 15s.
- POETICAL WORKS. *Library Edition*. Portrait. 6 Vols. 8vo. 45s.
- POETICAL WORKS. *Cabinet Edition*. Plates. 10 Vols. 12mo. 30s.
- POETICAL WORKS. *Pocket Ed.* 8 Vols. 16mo. In a case. 21s.
- POETICAL WORKS. *Popular Edition*. Plates. Royal 8vo. 7s. 6d.
- POETICAL WORKS. *Pearl Edition*. Crown 8vo. 2s. 6d. Cloth. 3s. 6d.
- CHILDE HAROLD. With 80 Engravings. Crown 8vo. 12s.
- CHILDE HAROLD. 16mo. 2s. 6d.
- CHILDE HAROLD. Vignettes. 16mo. 1s.
- CHILDE HAROLD. Portrait. 16mo. 6d.
- TALES AND POEMS. 16mo. 2s. 6d.
- MISCELLANEOUS. 2 Vols. 16mo. 5s.
- DRAMAS AND PLAYS. 2 Vols. 16mo. 5s.
- DON JUAN AND BEPPO. 2 Vols. 16mo. 5s.
- BEAUTIES. Poetry and Prose. Portrait. Fcap. 8vo. 3s. 6d.
- CAILLARD (Miss E. M.). The Invisible Powers of Nature. Some Elementary Lessons in Physical Science for Beginners. Post 8vo. 6s.
- CAMPBELL (LORD). Autobiography, Journals and Correspondence. By Mrs. Harcastle. Portrait. 2 Vols. 8vo. 30s.
- Lord Chancellors and Keepers of the Great Seal of England. From the Earliest Times to the Death of Lord Eldon in 1838. 10 Vols. Crown 8vo. 6s. each.
- Chief Justices of England. From the Norman Conquest to the Death of Lord Tenterden. 4 Vols. Crown 8vo. 6s. each.
- (THOS.) Essay on English Poetry. With Short Lives of the British Poets. Post 8vo. 3s. 6d.
- CAREY (Life of). [See GEORGE SMITH.]
- CARLISLE (BISHOP OF). Walks in the Regions of Science and Faith—a Series of Essays. Crown 8vo. 7s. 6d.
- CARNARVON (LORD). Portugal, Galicia, and the Basque Provinces. Post 8vo. 3s. 6d.
- CARNOTA (CONDE DA). The Life and Eventful Career of F.M. the Duke of Saldanha; Soldier and Statesman. 2 Vols. 8vo. 32s.
- CARTWRIGHT (W. C.). The Jesuits: their Constitution and Teaching. An Historical Sketch. 8vo. 9s.
- CAVALCASELLE'S WORKS. [See CROWE.]
- CESNOLA (GEN.). Cyprus; its Ancient Cities, Tombs, and Temples. With 400 Illustrations. Medium 8vo. 50s.
- CHAMBERS (G. F.). A Practical and Conversational Pocket Dictionary of the English, French, and German Languages. Designed for Travellers and Students generally. Small 8vo. 6s.
- CHILD-CHAPLIN (Dr.). Benedicite; or, Song of the Three Children; being Illustrations of the Power, Beneficence, and Design manifested by the Creator in his Works. Post 8vo. 6s.
- CHISHOLM (Mrs.). Perils of the Polar Seas; True Stories of Arctic Discovery and Adventure. Illustrations. Post 8vo. 6s.
- CHURTON (ARCHDEACON). Poetical Remains. Post 8vo. 7s. 6d.

- CLASSIC PREACHERS OF THE ENGLISH CHURCH.**
Lectures delivered at St. James'. 2 Vols. Post 8vo. 7s. 6d. each.
- CLEVELAND (DUCHESS OF).** The Battle Abbey Roll. With some account of the Norman Lineages. 3 Vols. Sm. 4to. 48s.
- CLIVE'S (LORD) Life.** By REV. G. R. GLEIG. Post 8vo. 3s. 6d.
- CLODE (C. M.).** Military Forces of the Crown; their Administration and Government. 2 Vols. 8vo. 21s. each.
- Administration of Justice under Military and Martial Law, as applicable to the Army, Navy, and Auxiliary Forces. 8vo. 12s.
- COLEBROOKE (SIR EDWARD, BART.).** Life of the Hon. Mountstuart Elphinstone. With Portrait and Plans. 2 Vols. 8vo. 26s.
- COLERIDGE (SAMUEL TAYLOR), and the English Romantic School.** By PROF. BRANDL. An English Edition by LADY EASTLAKE. With Portrait, Crown 8vo. 12s.
- Table-Talk. Portrait. 12mo. 3s. 6d.
- COLES (JOHN).** Summer Travelling in Iceland. With a Chapter on Askja. BY E. D. MORGAN. Map and Illustrations. 18s.
- COLLINS (J. CHURTON).** BOLINGBROKE: an Historical Study. With an Essay on Voltaire in England. Crown 8vo. 7s. 6d.
- COLONIAL LIBRARY.** [See Home and Colonial Library.]
- COOK (Canon F. C.).** The Revised Version of the Three First Gospels, considered in its Bearings upon the Record of Our Lord's Words and Incidents in His Life. 8vo. 9s.
- The Origins of Language and Religion. Considered in Five Essays. 8vo. 15s.
- COOKE (E. W.).** Leaves from my Sketch-Book. With Descriptive Text. 50 Plates. 2 Vols. Small folio. 31s. 6d. each.
- (W. H.). Collections towards the History and Antiquities of the County of Hereford. Vol. III. In continuation of Duncumb's History. Illustrations. 4to. £2 12s. 6d.
- COOKERY (MODERN DOMESTIC).** Adapted for Private Families. By a Lady. Woodcuts. Fcap. 8vo. 5s.
- CORNEY GRAIN.** By Himself. Post 8vo. 1s.
- COURTHOPE (W. J.).** The Liberal Movement in English Literature. A Series of Essays. Post 8vo. 6s.
- CRABBE (REV. G.).** Life & Works. Illustrations. Royal 8vo. 7s.
- CRAIK (HENRY).** Life of Jonathan Swift. Portrait. 8vo. 18s.
- CRIPPS (WILFRED).** Old English Plate: Ecclesiastical, Decorative, and Domestic, its Makers and Marks. New Edition. With Illustrations and 2010 facsimile Plate Marks. Medium 8vo. 21s
- *.* Tables of the Date Letters and Marks sold separately. 5s.
- French Plate: Its Makers and Marks. With facsimiles. 8vo. 2s. 6d.
- CROKER (RT. HON. J. W.).** Correspondence, &c., relating to the chief Political and Social Events of the first half of the present Century. Edited by LOUIS J. JENNINGS, M.P. With Portrait. 3 Vols. 8vo. 45s.
- Progressive Geography for Children. 18mo. 1s. 6d.
- Boswell's Life of Johnson. [See BOSWELL.]
- Historical Essay on the Guillotine. Fcap. 8vo. 1s.
- CROWE AND CAVALCASELLE.** Lives of the Early Flemish Painters. Woodcuts. Post 8vo, 7s. 6d.; or Large Paper 8vo, 15s.

- CROWE'S** Life and Times of Titian, with some Account of his Family, chiefly from new and unpublished records. With Portrait and Illustrations. 2 Vols. 8vo. 21s.
- Raphael; His Life and Works, with Particular Reference to recently discovered Records, and an exhaustive Study of Extant Drawings and Pictures. 2 Vols. 8vo. 33s.
- CUMMING (R. GORDON).** Five Years of a Hunter's Life in the Far Interior of South Africa. Woodcuts. Post 8vo. 6s.
- CURRIE (C. L.).** An Argument for the Divinity of Jesus Christ. Translated from the French of the ABBÉ EM. BOUGAUD. Post 8vo. 6s.
- CURTIUS' (PROFESSOR)** Student's Greek Grammar, for the Upper Forms. Edited by DR. WM. SMITH. Post 8vo. 6s.
- Elucidations of the above Grammar. Translated by EVELYN ABBOT. Post 8vo. 7s. 6d.
- Smaller Greek Grammar for the Middle and Lower Forms. Abridged from the larger work. 12mo. 3s. 6d.
- Accidence of the Greek Language. Extracted from the above work. 12mo. 2s. 6d.
- Principles of Greek Etymology. Translated by A. S. WILKINS and E. B. ENGLAND. New Edition. 2 Vols. 8vo. 28s.
- The Greek Verb, its Structure and Development. Translated by A. S. WILKINS, and E. B. ENGLAND. 8vo. 12s.
- CURZON (HON. ROBERT).** Visits to the Monasteries of the Levant. Illustrations. Post 8vo. 7s. 6d.
- CUST (GENERAL).** Warriors of the 17th Century—Civil Wars of France and England. 2 Vols. 16s. Commanders of Fleets and Armies. 2 Vols. 18s.
- Annals of the Wars—18th & 19th Century. With Maps. 9 Vols. Post 8vo. 5s. each.
- DARWIN'S (CHARLES)** Life and Letters, with an autobiographical Chapter. Edited by his Son, FRANCIS DARWIN, F.R.S. With Portraits and Woodcuts. 3 Vols. 8vo. 36s.
- **WORKS:—New and Cheaper Editions.**
- JOURNAL OF A NATURALIST DURING A VOYAGE ROUND THE WORLD.** Crown 8vo.
- ORIGIN OF SPECIES BY MEANS OF NATURAL SELECTION; or, the Preservation of Favoured Races in the Struggle for Life.** Library Edition, 2 vols., Crown 8vo. 12s.; or popular Edition, Crown 8vo. 6s.
- DESCENT OF MAN, AND SELECTION IN RELATION TO SEX.** Woodcuts. Library Edition, 2 vols. Crown 8vo. 15s.; or popular Edition, Crown 8vo. 7s. 6d.
- VARIATION OF ANIMALS AND PLANTS UNDER DOMESTICATION.** Woodcuts. 2 Vols. Crown 8vo. 15s.
- EXPRESSIONS OF THE EMOTIONS IN MAN AND ANIMALS.** With Illustrations. Crown 8vo. *[In preparation.]*
- VARIOUS CONTRIVANCES BY WHICH ORCHIDS ARE FERTILIZED BY INSECTS.** Woodcuts. Crown 8vo. 7s. 6d.
- MOVEMENTS AND HABITS OF CLIMBING PLANTS.** Woodcuts. Crown 8vo. 6s.
- INSECTIVOROUS PLANTS.** Woodcuts. Crown 8vo. 9s.
- EFFECTS OF CROSS AND SELF-FERTILIZATION IN THE VEGETABLE KINGDOM.** Crown 8vo. 9s.
- DIFFERENT FORMS OF FLOWERS ON PLANTS OF THE SAME SPECIES.** Crown 8vo. 7s. 6d.

DARWIN—*continued.*

- POWER OF MOVEMENT IN PLANTS. Woodcuts. Cr. 8vo.
- THE FORMATION OF VEGETABLE MOULD THROUGH THE ACTION OF WORMS. With Illustrations. Post 8vo. 6s.
- LIFE OF ERASMUS DARWIN. With a Study of his Works by ERNEST KRAUSE. Portrait. New Edition. Crown 8vo. 7s. 6d.
- FACTS AND ARGUMENTS FOR DARWIN. By FRITZ MULLEP. Translated by W. S. DALLAS. Woodcuts. Post 8vo. 6s.
- DAVY (SIR HUMPHRY). Consolations in Travel; or, Last Days of a Philosopher. Woodcuts. Fcap. 8vo. 3s. 6d.
- Salmonia; or, Days of Fly Fishing. Woodcuts. Fcap. 8vo. 3s. 6d.
- DE COSSON (MAJOR E. A.). The Cradle of the Blue Nile; a Journey through Abyssinia and Scudan. Map and Illustrations. 2 Vols. Post 8vo. 21s.
- Days and Nights of Service with Sir Gerald Graham's Field Force at Suakim. Plan and Illustrations. Crown 8vo. 14s.
- DENNIS (GEORGE). The Cities and Cemeteries of Etruria. 20 Plans and 200 Illustrations. 2 Vols. Medium 8vo. 21s.
- (ROBERT). Industrial Ireland. Suggestions for a Practical Policy of "Ireland for the Irish." Crown 8vo. 6s.
- DERBY (EARL OF). Iliad of Homer rendered into English Blank Verse. With Portrait. 2 Vols. Post 8vo. 10s.
- DERRY (BISHOP OF). Witness of the Psalms to Christ and Christianity. The Bampton Lectures for 1876. 8vo. 14s.
- DICEY (PROF. A. V.). England's Case against Home Rule. Third Edition. Crown 8vo. 7s. 6d.
- Why England Maintains the Union. A popular rendering of the above. By C. E. S. Fcap. 8vo. 1s.
- DOG-BREAKING. [See HUTCHINSON.]
- DRAKE'S (SIR FRANCIS) Life, Voyages, and Exploits, by Sea and Land. By JOHN BARROW. Post 8vo. 2s.
- DRINKWATER (JOHN). History of the Siege of Gibraltar, 1779-1783. With a Description of that Garrison. Post 8vo. 2s.
- DU CHAILLU (PAUL B.). Lald of the Midnight Sun; Illustrations. 2 Vols. 8vo. 36s.
- The Viking Age. The Early History, Manners, and Customs of the Ancestors of the English-speaking Nations. Illustrated from antiquities found in mounds, cairns, and bogs, as well as from the ancient Sagas and Eddas. With 1,200 Illustrations. 2 Vols. 8vo.
- DUFFERIN (LORD). Letters from High Latitudes; a Yacht Voyage to Iceland, Jan Mayen, and Spitzbergen. Woodcuts. Post 8vo. 7s. 6d.
- Speeches and Addresses, Political and Literary, delivered in the House of Lords, in Canada, and elsewhere. 8vo. 12s.
- DUNCAN (COL.) History of the Royal Artillery. Compiled from the Original Records. Portraits. 2 Vols. 8vo. 18s.
- English in Spain; or, The Story of the War of Succession, 1834-1840. With Illustrations. 8vo. 16s.
- DÜRER (ALBERT); his Life and Work. By DR. THAUSING. Translated from the German. Edited by F. A. EATON, M.A. With Portrait and Illustrations. 2 Vols. Medium 8vo. 42s.
- EASTLAKE (SIR C.). Contributions to the Literature of the Fine Arts. With Memoir by LADY EASTLAKE. 2 Vols. 8vo. 24s.

- EDWARDS (W. H.).** Voyage up the River Amazon, including a Visit to Para. Post 8vo. 2s.
- ELDON'S (LORD)** Public and Private Life, with Selections from his Diaries, &c. By HORACE TWISS. Portrait. 2 Vols. Post 8vo. 21s.
- ELGIN (LORD).** Letters and Journals. Edited by THEODORE WALBROND. With Preface by Dean Stanley. 8vo. 14s.
- ELLESMERE (LORD).** Two Sieges of Vienna by the Turks. Translated from the German. Post 8vo. 2s.
- ELLIS (W.).** Madagascar Revisited. The Persecutions and Heroic Sufferings of the Native Christians. Illustrations. 8vo. 16s.
- Memoir. By HIS SON. Portrait. 8vo. 10s. 6d.
- (ROBINSON). Poems and Fragments of Catullus. 16mo. 5s.
- ELPHINSTONE (HON. M.).** History of India—the Hindoo and Mahomedan Periods. Edited by PROFESSOR COWELL. Map. 8vo. 18s.
- The Rise of the British Power in the East. A Continuation of his History of India in the Hindoo and Mahomedan Periods. Edited by SIR E. COLEBROOKE, Bart. With Maps. 8vo. 16s.
- Life of. [See COLEBROOKE.]
- (H. W.). Patterns and Instructions for Ornamental Turning. With 70 Illustrations. Small 4to. 15s.
- ELTON (CAPT.) and H. B. COTTERILL.** Adventures and Discoveries among the Lakes and Mountains of Eastern and Central Africa. With Map and Illustrations. 8vo. 21s.
- ENGLAND.** [See ARTHUR—BREWER—CROKER—HUME—MARKHAM—SMITH—and STANHOPE.]
- ESSAYS ON CATHEDRALS.** Edited, with an Introduction. By DEAN HOWSON. 8vo. 12s.
- ETON LATIN GRAMMAR.** For use in the Upper Forms. By FRANCIS HAY RAWLINS, M.A., and WILLIAM RALPH INGE, M.A., Assistant Masters at Eton. Crown 8vo. 6s.
- **ELEMENTARY LATIN GRAMMAR.** For use in the Lower Forms. Compiled by A. C. AINGER, M.A., and H. G. WINTLE, M.A. Crown 8vo. 3s. 6d.
- **THE PREPARATORY ETON GRAMMAR.** Abridged from the above Work. By the same Editors. Crown 8vo. 2s.
- **FIRST LATIN EXERCISE BOOK,** adapted to the Elementary and Preparatory Grammars. By the same Editors. Crown 8vo. 2s. 6d.
- **FOURTH FORM OVID.** Selections from Ovid and Tibullus. With Notes by H. G. WINTLE. Post 8vo. 2s. 6d.
- **HORACE.** The Odes, Epodes, and Carmen Sæculare. With Notes. By F. W. CORNISH, M.A. Maps. Crown 8vo. 6s.
- **EXERCISES IN ALGEBRA,** by E. P. ROUSE, M.A., and ARTHUR COCKSHOTT, M.A. Crown 8vo. 3s.
- **EXERCISES IN ARITHMETIC.** By REV. T. DALTON, M.A. Crown 8vo. 3s.
- FELTOE (REV. J. LETT).** Memorials of John Flint South, twice President of the Royal College of Surgeons. Portrait. Crown 8vo. 7s. 6d.
- FERGUSON (JAMES).** History of Architecture in all Countries from the Earliest Times. With 1,600 Illustrations. 4 Vols. Medium 8vo. Vols. I. & II. Ancient and Mediæval. 63s.
- III. Indian & Eastern. 42s. IV. Modern.
- FITZGERALD (Bishop).** Lectures on Ecclesiastical History, including the origin and progress of the English Reformation, from Wicliffe to the Great Rebellion. With a Memoir. 2 Vols. 8vo. 21s.

- FITZPATRICK (WILLIAM J.).** The Correspondence of Daniel O'Connell, the Liberator. Now first published, with Notes. With Portrait. 2 Vols. 8vo. 36s.
- FLEMING (PROFESSOR).** Student's Manual of Moral Philosophy. With Quotations and References. Post 8vo. 7s. 6d.
- FLOWER GARDEN.** By REV. THOS. JAMES. Fcap. 8vo. 1s.
- FORD (RICHARD).** Gatherings from Spain. Post 8vo. 3s. 6d.
- FORSYTH (WILLIAM).** Hortensius; an Historical Essay on the Office and Duties of an Advocate. Illustrations. 8vo. 7s. 6d.
- FRANCE (HISTORY OF).** [See ARTHUR—MARKHAM—SMITH—STUDENTS'—TOCQUEVILLE.]
- FRENCH IN ALGIERS; The Soldier of the Foreign Legion—** and the Prisoners of Abd-el-Kadir. Post 8vo. 2s.
- FRERE (SIR BARTLE).** Indian Missions. Small 8vo. 2s. 6d.
- Missionary Labour in Eastern Africa. Crown 8vo. 5s.
- Bengal Famine. How it will be Met and How to Prevent Future Famines in India. With Maps. Crown 8vo. 5s.
- (MARY). Old Deccan Days, or Hindoo Fairy Legends current in Southern India, with Introduction by Sir BARTLE FRERE. With Illustrations. Post 8vo.
- GALTON (F.).** Art of Travel; or, Hints on the Shifts and Contrivances available in Wild Countries. Woodcuts. Post 8vo. 7s. 6d.
- GAMBIER PARRY (T.).** The Ministry of Fine Art to the Happiness of Life. Revised Edition, with an Index. 8vo. 14s.
- GEOGRAPHY.** [See BUNBURY—CROKER—RICHARDSON—SMITH—STUDENTS'.]
- GEOGRAPHICAL SOCIETY'S JOURNAL.** (1846 to 1881.)
SUPPLEMENTARY PAPERS.
- Vol. I., Part i. Travel; and Researches in Western China. By E. COLBORNE BABER. Maps. Royal 8vo. 5s.
- Part ii.—1. Notes on the Recent Geography of Central Asia; from Russian Sources. By E. DELMAR MORGAN. 2. Progress of Discovery on the Coasts of New Guinea. By C. B. MARKHAM. With Bibliographical Appendix, by E. C. RYE. Maps. Royal 8vo. 5s.
- Part iii.—1. Report on Part of the Ghilzi Country, &c. By Lieut. J. S. BROADFOOT. 2. Journey from Shiraz to Jashk. By J. R. PREECE. Royal 8vo. 2s. 6d.
- Part iv.—Geographical Education. By J. S. KELTIE. Royal 8vo. 2s. 6d.
- Vol. II., Part i.—1. Exploration in Southern and South-western China. By ARCHIBALD R. CHAMBERLAIN. 2. Bibliography and Cartography of Hispaniola. By H. LING ROTH. 3. Explorations in Zanzibar Dominion; by Lieut. CHAS. STEWART SMITH, R.N. Royal 8vo. 2s. 6d.
- Part ii.—A Bibliography of Algeria, from the Expedition of Charles V. in 1541 to 1827. By SIR R. LAMBERT PLAYFAIR. Royal 8vo. 4s.
- GEORGE (ERNEST).** The Mosel; Twenty Etchings. Imperial 4to. 42s.
- Loire and South of France; Twenty Etchings. Folio. 42s.
- GERMANY (HISTORY OF).** [See MARKHAM.]
- GIBBON'S History of the Decline and Fall of the Roman Empire.** Edited with notes by MILMAN, GUIZOT, and Dr. WM. SMITH. Maps. 8 Vols. 8vo. 60s. Student's Edition. 7s. 6d. (See STUDENT'S.)
- GIFFARD (EDWARD).** Deeds of Naval Daring; or, Anecdotes of the British Navy. Fcap. 8vo. 3s. 6d.

- GILBERT (JOSIAH).** Landscape in Art : before the days of Claude and Salvator. With 150 Illustrations. Medium 8vo. 30s.
- GILL (CAPT.).** The River of Golden Sand. A Journey through China to Burmah. Edited by E. C. BABER. With MEMOIR by Col. YULE, C.B. Portrait, Map and Illustrations. Post 8vo. 7s. 6d.
- (MRS.). Six Months in Ascension. An Unscientific Account of a Scientific Expedition. Map. Crown 8vo. 9s.
- GLADSTONE (W. E.).** Rome and the Newest Fashions in Religion. 8vo. 7s. 6d.
- Gleanings of Past Years, 1843-78. 7 Vols. Small 8vo. 2s. 6d. each. I. The Throne, the Prince Consort, the Cabinet and Constitution. II. Personal and Literary. III. Historical and Speculative. IV. Foreign. V. and VI. Ecclesiastical. VII. Miscellaneous.
- GLEIG (G. R.).** Campaigns of the British Army at Washington and New Orleans. Post 8vo. 2s.
- Story of the Battle of Waterloo. Post 8vo. 3s. 6d.
- Narrative of Sale's Brigade in Afghanistan. Post 8vo. 2s.
- Life of Lord Clive. Post 8vo. 3s. 6d.
- Sir Thomas Munro. Post 8vo. 3s. 6d.
- GLYNNE (SIR STEPHEN).** Notes on the Churches of Kent. With Preface by W. H. Gladstone, M.P. Illustrations. 8vo. 12s.
- GOLDSMITH'S (OLIVER) Works.** Edited with Notes by PETER CUNNINGHAM. Vignettes. 4 Vols. 8vo. 30s.
- GOMM (F. M. SIR WM.).** His Letters and Journals. 1799 to 1815. Edited by F. C. Carr Gomm. With Portrait. 8vo. 12s.
- GORDON (SIR ALEX.).** Sketches of German Life, and Scenes from the War of Liberation. Post 8vo. 3s. 6d.
- (LADY DUFF), The Amber-Witch. Post 8vo. 2s.
- See also ROSS.
- The French in Algiers. Post 8vo. 2s.
- GOULBURN (E. M.), D.D.,** Dean of Norwich. Three Counsels of the Divine Master for the conduct of the Spiritual Life:—The Commencement; The Virtues; The Confession. 2 Vols. Cr. 8vo. 16s.
- GRAMMARS.** [See CURTIUS—ETON—HALL—HUTTON—KING EDWARD—LEATHES—MAETZNER—MATTHIE—SMITH.]
- GRANVILLE (CHARLES).** Sir Hector's Watch. 2s. 6d.
- A Broken Stirrup-Leather. 2s. 6d.
- GREECE (HISTORY OF).** [See GROTE—SMITH—STUDENTS']
- GREY (EARL).** Ireland: the Cause of its Present Condition and the Measures proposed for its Improvement. Crown 8vo. 3s. 6d.
- GROTE'S (GEORGE) WORKS:—**
- HISTORY OF GREECE.** From the Earliest Times to the Death of Alexander the Great. *New Edition.* Portrait, Map, and Plans. 10 Vols. Post 8vo. 5s. each. (*The Volumes may be had Separately.*)
- PLATO,** and other Companions of Socrates. 3 Vols. 8vo. 45s.; or, a New Edition, Edited by ALEXANDER BAIN, 4 Vols. Crown 8vo. 5s. each. (*The Volumes may be had Separately.*)
- ARISTOTLE.** 8vo. 12s.
- MINOR WORKS.** Portrait. 8vo. 14s.
- PERSONAL LIFE.** Portrait. 8vo. 12s.
- GROTE (MRS.).** A Sketch. By LADY EASTLAKE. Crown 8vo. 6s.
- GUILLEMARD (F. H.), M.D.** The Voyage of the Marchesa to New Guinea. With Notices of Formosa and the Islands of the Malay Archipelago. New Edition. With Maps and 150 Illustrations. One volume. Medium 8vo.

- HALL'S (T. D.) School Manual of English Grammar.** With Illustrations and Practical Exercises. 12mo. 3s. 6d.
- **Primary English Grammar for Elementary Schools.** With numerous Exercises, and graduated Parsing Lessons. 16mo. 1s.
- **Manual of English Composition.** With Copious Illustrations and Practical Exercises. 12mo. 3s. 6d.
- **Child's First Latin Book,** comprising a full Practice of Nouns, Pronouns, and Adjectives, with the Verbs. 16mo. 2s.

HALLAM'S (HENRY) WORKS:—

- THE CONSTITUTIONAL HISTORY OF ENGLAND,** from the Accession of Henry the Seventh to the Death of George the Second. *Library Edition*, 3 Vols. 8vo. 30s. *Cabinet Edition*, 3 Vols. Post 8vo. 12s. *Student's Edition*, Post 8vo. 7s. 6d.
- HISTORY OF EUROPE DURING THE MIDDLE AGES.** *Library Edition*, 3 Vols. 8vo. 30s. *Cabinet Edition*, 3 Vols. Post 8vo. 12s. *Student's Edition*, Post 8vo. 7s. 6d.
- LITERARY HISTORY OF EUROPE DURING THE 15TH, 16TH, AND 17TH CENTURIES.** *Library Edition*, 3 Vols. 8vo. 36s. *Cabinet Edition*, 4 Vols. Post 8vo. 16s.
- **(ARTHUR) Literary Remains; in Verse and Prose.** Portrait. Fcap. 8vo. 3s. 6d.
- HAMILTON (ANDREW).** Rheinsberg: Memorials of Frederick the Great and Prince Henry of Prussia. 2 Vols. Crown 8vo. 21s.
- HART'S ARMY LIST.** (*Published Quarterly and Annually.*)
- HAY (SIR J. H. DRUMMOND).** Western Barbary, its Wild Tribes and Savage Animals. Post 8vo. 2s.
- HAYWARD (A.).** Sketches of Eminent Statesmen and Writers, 2 Vols. 8vo. 28s.
- **The Art of Dining, or Gastronomy and Gastronomers.** Post 8vo. 2s.
- **A Selection from his Correspondence.** Edited with an Introductory account of Mr. Hayward's Early Life. By H. E. CARLISLE. 2 vols. Crown 8vo. 24s.

HEAD'S (SIR FRANCIS) WORKS:—

- THE ROYAL ENGINEER.** Illustrations. 8vo. 12s.
- LIFE OF SIR JOHN BURGoyNE.** Post 8vo. 1s.
- RAPID JOURNEYS ACROSS THE PAMPAS.** Post 8vo. 2s.
- BUBBLES FROM THE BRUNNEN.** Illustrations. Post 8vo. 7s. 6d.
- STOKERS AND POKERS; or, the L. and N. W. R.** Post 8vo. 2s.
- HEBER'S (BISHOP) Journals in India.** 2 Vols. Post 8vo. 7s.
- **Poetical Works.** Portrait. Fcap. 8vo. 3s. 6d.
- HERODOTUS.** A New English Version. Edited, with Notes and Essays by CANON RAWLINSON, SIR H. RAWLINSON and SIR J. G. WILKINSON. Maps and Woodcuts. 4 Vols. 8vo. 48s.
- HERRIES (RT. HON. JOHN).** Memoir of his Public Life. By his Son, Edward Herries, C.B. 2 Vols. 8vo. 24s.
- HERSCHEL'S (CAROLINE) Memoir and Correspondence.** By MRS. JOHN HERSCHEL. With Portrait. Crown 8vo. 7s. 6d.

FOREIGN HAND-BOOKS.

HAND-BOOK—TRAVEL-TALK. English, French, German, and Italian. New and Revised Edition. 18mo. 3s. 6d.

— **DICTIONARY:** English, French, and German. Containing all the words and idiomatic phrases likely to be required by a traveller. Bound in leather. 16mo. 6s.

— **HOLLAND AND BELGIUM.** Map and Plans. 6s.

— **NORTH GERMANY and THE RHINE,**— The Black Forest, the Hartz, Thüringerwald, Saxon Switzerland, Rügen, the Giant Mountains, Taunus, Odenwald, Elsass, and Lothringen. Map and Plans. Post 8vo. 10s.

— **SOUTH GERMANY,**— Wurtemberg, Bavaria, Austria, Styria, Salzburg, the Alps, Tyrol, Hungary, and the Danube, from Ulm to the Black Sea. Maps and Plans. Post 8vo. 10s.

— **SWITZERLAND,** Alps of Savoy, and Piedmont. In Two Parts. Maps and Plans. Post 8vo. 10s.

— **FRANCE, Part I.** Normandy, Brittany, the French Alps, the Loire, Seine, Garonne, and Pyrenees. Maps and Plans. 7s. 6d.

— **FRANCE, Part II.** Central France, Auvergne, the Cevennes, Burgundy, the Rhone and Saone, Provence, Nimes, Arles, Marseilles, the French Alps, Alsace, Lorraine, Champagne, &c. Maps and Plans. Post 8vo. 7s. 6d.

— **MEDITERRANEAN** — its Principal Islands, Cities, Seaports, Harbours, and Border Lands. For Travellers and Yachtsmen, with nearly 50 Maps and Plans. Post 8vo. 20s.

— **ALGERIA AND TUNIS.** Algiers, Constantine, Oran, the Atlas Range. Maps and Plans. Post 8vo. 10s.

— **PARIS,** and Environs. Maps and Plans. 3s. 6d.

— **SPAIN,** Madrid, The Castiles, The Basque Provinces, Leon, The Asturias, Galicia, Estremadura, Andalusia, Ronda, Granada, Murcia, Valencia, Catalonia, Aragon, Navarre, The Balearic Islands, &c. &c. Maps and Plans. Post 8vo. 20s.

— **PORTUGAL,** LISBON, Oporto, Cintra, Mafra, Madeira, the Azores, and the Canary Islands, &c. Map and Plan. Post 8vo. 12s.

— **NORTH ITALY,** Turin, Milan, Cremona, the Italian Lakes, Bergamo, Brescia, Verona, Mantua, Vicenza, Padua, Ferrara, Bologna, Ravenna, Rimini, Piacenza, Genoa, the Riviera, Venice, Parma, Modena, and Romagna. Maps and Plans. Post 8vo. 10s.

— **CENTRAL ITALY,** Florence, Lucca, Tuscany, The Marshes, Umbria, &c. Maps and Plans. Post 8vo. 10s.

— **ROME AND ITS ENVIRONS.** 50 Maps and Plans. 10s.

— **SOUTH ITALY,** Naples, Pompeii, Herculaneum, and Vesuvius. Maps and Plans. Post 8vo. 10s.

— **NORWAY,** Christiania, Bergen, Trondhjem. The Fjelds and Fjords. Maps and Plans. Post 8vo. 9s.

— **SWEDEN,** Stockholm, Upsala, Gothenburg, the Shores of the Baltic, &c. Maps and Plan. Post 8vo. 6s.

— **DENMARK,** Sleswig, Holstein, Copenhagen, Jutland, Iceland. Maps and Plans. Post 8vo. 6s.

— **RUSSIA, St. PETERSBURG, MOSCOW, POLAND,** and FINLAND. Maps and Plans. Post 8vo. 18s.

- HAND-BOOK—GREECE**, the Ionian Islands, Athens, the Peloponnesus, the Islands of the Ægean Sea, Albania, Thessaly, Macedonia, &c. In Two Parts. Maps, Plans, and Views. Post 8vo. 24s.
- TURKEY IN ASIA—CONSTANTINOPLE**, the Bosphorus, Dardanelles, Brousa, Plain of Troy, Crete, Cyprus, Smyrna, Ephesus, the Seven Churches, Coasts of the Black Sea, Armenia, Euphrates Valley, Route to India, &c. Maps and Plans. Post 8vo. 15s.
- EGYPT**. The Course of the Nile through Egypt and Nubia, Alexandria, Cairo, Thebes, Suez Canal, the Pyramids, Sinai, the Fyoom, &c. Maps and Plans. Post 8vo. 15s.
- HOLY LAND—SYRIA, PALESTINE**, Peninsula of Sinai, Edom, Syrian Deserts, Petra, Damascus; and Palmyra. Maps and Plans. Post 8vo. 20s.
- *.* Map of Palestine. In a case. 12s.
- BOMBAY—Poonah, Beejapoor, Kolapoor, Goa, Jubulpoor, Indore, Surat, Baroda, Ahmedabad, Somnauth, Kurrachee, &c.** Map and Plans. Post 8vo. 15s.
- MADRAS—Trichinopoli, Madura, Tinnevely, Tuticorin, Bangalore, Mysore, The Nilgiris, Wynaad, Ootacamund, Calicut, Hyderabad, Ajanta, Elura Caves, &c.** Maps and Plans. Post 8vo. 15s.
- BENGAL—Calcutta, Orissa, British Burmah, Rangoon, Moulmeln, Mandalay, Darjiling, Dacca, Patna, Benares, N.-W. Provinces, Allahabad, Cawnpore, Lucknow, Agra, Gwalior, Naini Tal, Delhi, &c.** Maps and Plans. Post 8vo. 20s.
- THE PANJAB—Amraoti, Indore, Ajmir, Jaypur, Rohtak, Saharanpur, Ambala, Lodiana, Lahore, Kulu, Simla, Sialkot, Peshawar, Rawul Pindi, Attock, Karachi, Sibi, &c.** Maps. 15s.

ENGLISH HAND-BOOKS.

- HAND-BOOK—ENGLAND AND WALES.** An Alphabetical Hand-Book. Condensed into One Volume for the Use of Travellers. With a Map. Post 8vo.
- LONDON.** Maps and Plans. 16mo. 3s. 6d.
- ENVIRONS OF LONDON** within a circuit of 20 miles. 2 Vols. Crown 8vo. 21s.
- ST. PAUL'S CATHEDRAL.** 20 Woodcuts. 10s. 6d.
- EASTERN COUNTIES**, Chelmsford, Harwich, Colchester, Maldon, Cambridge, Ely, Newmarket, Bury St. Edmunds, Ipswich, Woodbridge, Felixstowe, Lowestoft, Norwich, Yarmouth, Cromer, &c. Map and Plans. Post 8vo.
- CATHEDRALS of Oxford, Peterborough, Norwich, Ely, and Lincoln.** With 90 Illustrations. Crown 8vo. 21s.
- KENT**, Canterbury, Dover, Ramsgate, Sheerness, Rochester, Chatham, Woolwich. Maps and Plans. Post 8vo. 7s. 6d.
- SUSSEX**, Brighton, Chichester, Worthing, Hastings, Lewes, Arundel, &c. Maps and Plans. Post 8vo. 6s.
- SURREY AND HANTS**, Kingston, Croydon, Reigate, Guildford, Dorking, Winchester, Southampton, New Forest, Portsmouth, Isle of Wight, &c. Maps and Plans. Post 8vo. 10s.

HAND-BOOK—BERKS, BUCKS, AND OXON, Windsor, Eton, Reading, Aylesbury, Uxbridge, Wycombe, Henley, Oxford, Blenheim, the Thames, &c. Maps and Plans. Post 8vo. 9s.

———— **WILTS, DORSET, AND SOMERSET**, Salisbury, Chippenham, Weymouth, Sherborne, Wells, Bath, Bristol, Taunton, &c. Map. Post 8vo. 12s.

———— **DEVON**, Exeter, Ilfracombe, Linton, Sidmouth, Dawlish, Teignmouth, Plymouth, Devonport, Torquay. Maps and Plans. Post 8vo. 7s. 6d.

———— **CORNWALL**, Launceston, Penzance, Falmouth, the Lizard, Land's End, &c. Maps. Post 8vo. 6s.

———— **CATHEDRALS** of Winchester, Salisbury, Exeter, Wells, Chichester, Rochester, Canterbury, and St. Albans. With 130 Illustrations. 2 Vols. Crown 8vo. 36s. St. Albans separately. 6s.

———— **GLOUCESTER, HEREFORD, AND WORCESTER**, Cirencester, Cheltenham, Stroud, Tewkesbury, Leominster, Ross, Malvern, Kidderminster, Dudley, Evesham, &c. Map. Post 8vo. 9s.

———— **CATHEDRALS** of Bristol, Gloucester, Hereford, Worcester, and Lichfield. With 50 Illustrations. Crown 8vo. 16s.

———— **NORTH WALES**, Bangor, Carnarvon, Beaumaris, Snowdon, Llanberis, Dolgelly, Conway, &c. Maps. Post 8vo. 7s.

———— **SOUTH WALES**, Monmouth, Llandaff, Merthyr, Vale of Neath, Pembroke, Carmarthen, Tenby, Swansea, The Wye, &c. Map. Post 8vo. 7s.

———— **CATHEDRALS OF BANGOR, ST. ASAPH, Llandaff, and St. David's**. With Illustrations. Post 8vo. 15s.

———— **NORTHAMPTONSHIRE AND RUTLAND**—Northampton, Peterborough, Towcester, Daventry, Market Harborough, Kettering, Wellingborough, Thrapston, Stamford, Uppingham, Oakham. Maps. Post 8vo. 7s. 6d.

———— **DERBY, NOTTS, LEICESTER, STAFFORD**, Matlock, Bakewell, Chatsworth, The Peak, Buxton, Hardwick, Dove Dale, Ashborne, Southwell, Mansfield, Retford, Burton, Belvoir, Melton Mowbray, Wolverhampton, Lichfield, Walsall, Tamworth. Map. Post 8vo.

———— **SHROPSHIRE AND CHESHIRE**, Shrewsbury, Ludlow, Bridgnorth, Oswestry, Chester, Crewe, Alderley, Stockport, Birkenhead. Maps and Plans. Post 8vo. 6s.

———— **LANCASHIRE**, Warrington, Bury, Manchester, Liverpool, Burnley, Clitheroe, Bolton, Blackburne, Wigan, Preston, Rochdale, Lancaster, Southport, Blackpool, &c. Maps & Plans. Post 8vo. 7s. 6d.

———— **YORKSHIRE**, Doncaster, Hull, Selby, Beverley, Scarborough, Whitby, Harrogate, Ripon, Leeds, Wakefield, Bradford, Halifax, Huddersfield, Sheffield. Map and Plans. Post 8vo. 12s.

———— **CATHEDRALS** of York, Ripon, Durham, Carlisle, Chester, and Manchester. With 60 Illustrations. 2 Vols. Cr. 8vo. 21s.

———— **DURHAM AND NORTHUMBERLAND**, Newcastle, Darlington, Stockton, Hartlepool, Shields, Berwick-on-Tweed, Morpeth, Tynemouth, Coldstream, Alnwick, &c. Map. Post 8vo. 9s.

- HAND-BOOK—SCOTLAND**, Edinburgh, Melrose, Kelso, Glasgow, Dumfries, Ayr, Stirling, Arran, The Clyde, Oban, Inverary, Loch Lomond, Loch Katrine and Trossachs, Caledonian Canal, Inverness, Perth, Dundee, Aberdeen, Braemar, Skye, Caithness, Ross, Sutherland, &c. Maps and Plans. Post 8vo. 9s.
- **IRELAND**, Dublin, Belfast, the Giant's Causeway, Donegal, Galway, Wexford, Cork, Limerick, Waterford, Killarney, Bantry, Glengarriff, &c. Maps and Plans. Post 8vo. 10s.
- HAYTER LEWIS (J.)** The Holy Places of Jerusalem. Illustrations. 8vo. 10s. 6d
- HISLOP (STEPHEN)**. [See SMITH, GEORGE.]
- HOLLWAY (J. G.)**. A Month in Norway. Fcap. 8vo. 2s.
- HONEY BEE**. By REV. THOMAS JAMES. Fcap. 8vo. 1s.
- HOOK (DEAN)**. Church Dictionary. A Manual of Reference for Clergymen and Students. New Edition, thoroughly revised. Edited by WALTER HOOK, M. A., and W. R. W. STEPHENS, M. A. Med. 8vo. 21s.
- (THEODORE) Life. By J. G. LOCKHART. Fcap. 8vo. 1s.
- HOPE (A. J. BERESFORD)**. Worship in the Church of England. 8vo, 9s.; or, *Popular Selections from*, 8vo, 2s. 6d.
- **WORSHIP AND ORDER**. 8vo. 9s.
- HOPE-SCOTT (JAMES)**, Memoir. [See ORNSBY.]
- HORACE**; a New Edition of the Text. Edited by DEAN MILMAN. With 100 Woodcuts. Crown 8vo. 7s. 6d.
- [See ETON.]
- HOSACK (JOHN)**. The Rise and Growth of the Law of Nations: as established by general usage and by treaties, from the earliest times to the Treaty of Utrecht. 8vo. 12s.
- HOUGHTON'S (LORD) Monographs, Personal and Social**. With Portraits. Crown 8vo. 10s. 6d.
- **POETICAL WORKS**. *Collected Edition*. With Portrait. 2 Vols. Fcap. 8vo. 12s.

HOME AND COLONIAL LIBRARY. A Series of Works adapted for all circles and classes of Readers, having been selected for their acknowledged interest, and ability of the Authors. Post 8vo. Published at 2s. and 3s. 6d. each, and arranged under two distinctive heads as follows:—

CLASS A.

HISTORY, BIOGRAPHY, AND HISTORIC TALES.

- | | |
|---|--|
| SIEGE OF GIBRALTAR . By JOHN DRINKWATER. 2s. | THE WAYSIDE CROSS . By CAPT. MILMAN. 2s. |
| THE AMBER-WITCH . By LADY DUFF GORDON. 2s. | SKETCHES OF GERMAN LIFE . By SIR A. GORDON. 3s. 6d. |
| CROMWELL AND BUNYAN . By ROBERT SOUTHEY. 2s. | THE BATTLE OF WATERLOO . By REV. G. R. GLEIG. 3s. 6d. |
| LIFE OF SIR FRANCIS DRAKE . By JOHN BARROW. 2s. | AUTOBIOGRAPHY OF STEFFENS . 2s. |
| CAMPAIGNS AT WASHINGTON . By REV. G. R. GLEIG. 2s. | THE BRITISH POETS . By THOMAS CAMPBELL. 3s. 6d. |
| THE FRENCH IN ALGIERS . By LADY DUFF GORDON. 2s. | HISTORICAL ESSAYS . By LORD MAHON. 3s. 6d. |
| THE FALL OF THE JESUITS . 2s. | LIFE OF LORD CLIVE . By REV. G. R. GLEIG. 3s. 6d. |
| LIFE OF CONDÉ . By LORD MAHON. 3s. 6d. | NORTH WESTERN RAILWAY . By SIR F. B. HEAD. 2s. |
| SALE'S BRIGADE . By REV. G. R. GLEIG. 2s. | LIFE OF MUNRO . By REV. G. R. GLEIG. 3s. 6d. |
| THE SIEGES OF VIENNA . By LORD ELLESMERE. 2s. | |

CLASS B.

VOYAGES, TRAVELS, AND ADVENTURES.

- JOURNALS IN INDIA.** By BISHOP HEBER. 2 Vols. 7s.
- TRAVELS IN THE HOLY LAND.** By IBBY and MANGLES. 2s.
- MOROCCO AND THE MOORS.** By J. DRUMMOND HAY. 2s.
- LETTERS FROM THE BALTIC.** By A LADY. 2s.
- NEW SOUTH WALES.** By MRS. MEREDITH. 2s.
- THE WEST INDIES.** By M. G. LEWIS. 2s.
- SKETCHES OF PERSIA.** By SIR JOHN MALCOLM. 3s. 6d.
- MEMOIRS OF FATHER RIPA.** 2s.
- TYPEE AND OMOO.** By HERMANN MELVILLE. 2 Vols. 3s.
- MISSIONARY LIFE IN CANADA.** By Rev. J. ABBOTT. 2s.
- LETTERS FROM MADRAS.** By A LADY. 2s.
- HIGHLAND SPORTS.** By CHARLES ST. JOHN. 3s. 6d.
- PAMPAS JOURNEYS.** By F. B. HEAD. 2s.
- GATHERINGS FROM SPAIN.** By RICHARD FORD. 3s. 6d.
- THE RIVER AMAZON.** By W. H. EDWARDS. 2s.
- MANNERS & CUSTOMS OF INDIA.** By Rev. C. AGLAND. 2s.
- ADVENTURES IN MEXICO.** By G. F. RUXTON. 3s. 6d.
- PORTUGAL AND GALICIA.** By LORD CARNARVON. 3s. 6d.
- BUSH LIFE IN AUSTRALIA.** By Rev. H. W. HAYGARTH. 2s.
- THE LIBYAN DESERT.** By BAYLE ST. JOHN. 2s.
- SIERRA LEONE.** By A LADY. 3s. 6d.

* * Each work may be had separately.

HUBNER (BARON VON). A Voyage through the British Empire; South Africa, Australia, New Zealand, The Straits Settlements, India, the South Sea Islands, California, Oregon, Canada, &c. With a Map. 2 Vols. Crown 8vo. 24s.

HUHN (A. VON). The Struggle of the Bulgarians for National Independence: A History of the War between Bulgaria and Servia in 1835, under PRINCE ALEXANDER. With Map. Crown 8vo. 9s.

HUME (The Student's). A History of England, from the invasion of Julius Cæsar to the Revolution of 1688. New Edition, revised, corrected, and continued to the Treaty of Berlin, 1878. By J. S. BREWER, M.A. With 7 Coloured Maps & 70 Woodcuts. Post 8vo. 7s. 6d. * * Sold also in 3 parts. Price 2s. 6d. each.

HUNNEWELL (JAMES F.). England's Chronicle in Stone: Derived from Personal Observations of the Cathedrals, Churches, Abbeys, Monasteries, Castles, and Palaces, made in Journeys through the Imperial Island. With Illustrations. Medium 8vo. 24s.

HUTCHINSON (GEN.). Dog Breaking, with Odds and Ends for those who love the Dog and the Gun. With 40 Illustrations. Crown 8vo. 7s. 6d. * * A Summary of the Rules for Gamekeepers. 1s.

HUTTON (H. E.). Principia Græca; an Introduction to the Study of Greek. Comprehending Grammar, Delectus, and Exercise-book, with Vocabularies. Sixth Edition. 12mo. 3s. 6d.

(JAMES). James and Philip van Artevelde. Two remarkable Episodes in the annals of Flanders: with a description of the state of Society in Flanders in the 14th Century. Cr. 8vo. 10s. 6d.

HYMNOLOGY, DICTIONARY OF. [See JULIAN.]

ICELAND. [See COLES—DUFFERIN.]

INDIA. [See BROADFOOT—ELPHINSTONE—HAND-BOOK—SMITH—TEMPLE—MONIER WILLIAMS—LYALL.]

INGE (WM. RALPH). Society in Rome under the Cæsars. Crown 8vo. 6s.

INGRAM (JOHN K.) A Dictionary of Latin Etymology. 8vo.

IRBY AND MANGLES' Travels in Egypt, Nubia, Syria, and the Holy Land. Post 8vo. 2s. [In the Press.]

IRELAND. [See DENNIS—GREY.]

- JAMES (F. L.).** The Wild Tribes of the Soudan : with an account of the route from Wady Halfah to Dongola and Berber. With Chapter on the Condition of the Soudan, by SIR S. BAKER. Map and Illustrations. Crown 8vo. 7s. 6d.
- JAMESON (MRS.).** Lives of the Early Italian Painters—and the Progress of Painting in Italy—Cimabue to Bassano. With 50 Portraits Post 8vo. 12s.
- JAPAN.** [See BIRD—MOUNSEY—REED.]
- JENNINGS (LOUIS J.),** Rambles among the Hills in the Peak of Derbyshire and on the South Downs. With sketches of people by the way. With 23 Illustrations. Crown 8vo. 12s.
- Field Paths and Green Lanes : or Walks in Surrey and Sussex. Popular Edition. With Illustrations. Crown 8vo. 6s.
- JERVIS (REV. W. H.).** The Gallican Church, from the Concordat of Bologna, 1516, to the Revolution. With an Introduction. Portraits. 2 Vols. 8vo. 28s.
- JESSE (EDWARD).** Gleanings in Natural History. Fcp. 8vo. 3s. 6d.
- JOHNSON'S (DR. SAMUEL) Life.** [See BOSWELL.]
- JULIAN (REV. JOHN J.).** A Dictionary of Hymnology. A Companion to Existing Hymn Books. Setting forth the Origin and History of the Hymns contained in the Principal Hymnals, with Notices of their Authors. Medium 8vo.
- JUNIUS' HANDWRITING** Professionally investigated. Edited by the Hon. E. TWISLETON. With Facsimiles, Woodcuts, &c. 4to. £3 3s.
- KERR (ROBT.).** The Consulting Architect : Practical Notes on Administrative Difficulties. Crown 8vo. 9s.
- KING EDWARD VIth's Latin Grammar.** 12mo. 3s. 6d.
- First Latin Book. 12mo. 2s. 6d.
- KIRK (J. FOSTER).** History of Charles the Bold, Duke of Burgundy. Portrait. 3 Vols. 8vo. 45s.
- KIRKES' Handbook of Physiology.** Edited by W. MORRANT BAKER and V. D. HARRIS. With 500 Illustrations. Post 8vo. 14s.
- KUGLER'S HANDBOOK OF PAINTING.—The Italian Schools.** A New Edition, revised, incorporating the results of all the most recent discoveries. By SIR A. HENRY LAYARD. With 200 Illustrations. 2 vols. Crown 8vo. 30s.
- The German, Flemish, and Dutch Schools. Revised. By J. A. CROWE. With 60 Illustrations. 2 Vols. Crown 8vo. 24s.
- LANE (E. W.).** Account of the Manners and Customs of Modern Egyptians. With Illustrations. 2 Vols. Post 8vo. 12s.
- LAWLESS (HON. EMILY).** Major Lawrence, F.L.S. : a Novel. 3 Vols. Crown 8vo. 31s. 6d. Cheap Edition, 6s.
- LAYARD (SIR A. H.).** Nineveh and its Remains. With Illustrations. Post 8vo. 7s. 6d.
- Nineveh and Babylon : Discoveries in the Ruins, with Travels in Armenia, Kurdistan, &c. Illustrations. Post 8vo. 7s. 6d.
- Early Adventures in Persia, Babylonia, and Susiana, including a residence among the Bakhtiyari and other wild tribes, before the discovery of Nineveh. Portrait, Illustrations and Maps. 2 Vols. Crown 8vo. 24s.
- LEATHES (STANLEY).** Practical Hebrew Grammar. With the Hebrew Text of Genesis i.—vi., and Psalms i.—vi. Grammatical Analysis and Vocabulary. Post 8vo. 7s. 6d.
- LENNEP (REV. H. J. VAN).** Missionary Travels in Asia Minor. With Illustrations of Biblical History and Archæology. Map and Woodcuts. 2 Vols. Post 8vo. 24s.

- LENNEP.** Modern Customs and Manners of Bible Lands, in Illustration of Scripture. Maps and Illustrations. 2 Vols. 8vo. 21s.
- LESLIE (C. R.).** Handbook for Young Painters. Illustrations. Post 8vo. 7s. 6d.
- LETO (POMPONIO).** Eight Months at Rome during the Vatican Council. 8vo. 12s.
- LETTERS FROM THE BALTIC.** By LADY EASTLAKE. Post 8vo. 2s.
- **MADRAS.** By MRS. MAITLAND. Post 8vo. 2s.
- **SIERRA LEONE.** By MRS. MELVILLE. 3s. 6d.
- LEVI (LEONE).** History of British Commerce; and Economic Progress of the Nation, from 1763 to 1878. 8vo. 18s.
- **The Wages and Earnings of the Working Classes in 1883-4.** 8vo. 3s. 6d.
- LEWIS (T. HAYTER).** The Holy Places of Jerusalem. Illustrations. 8vo. 10s. 6d.
- LEX SALICA; the Ten Texts with the Glosses and the Lex Emendata.** Synoptically edited by J. H. HESSELS. With Notes on the Frankish Words in the Lex Salica by H. KERN, of Leyden. 4to. 42s.
- LIDDELL (DEAN).** Student's History of Rome, from the earliest Times to the establishment of the Empire. Woodcuts. Post 8vo. 7s. 6d.
- LINDSAY (LORD).** Sketches of the History of Christian Art. 2 Vols. Crown 8vo. 21s.
- LISPINGS from LOW LATITUDES; or, the Journal of the Hon. Impulsia Gushington.** Edited by LORD DUFFERIN. With 24 Plates. 4to. 21s.
- LIVINGSTONE (DR.).** First Expedition to Africa, 1840-56. Illustrations. Post 8vo. 7s. 6d.
- **Second Expedition to Africa, 1858-64.** Illustrations. Post 8vo. 7s. 6d.
- **Last Journals in Central Africa, to his Death.** By Rev. HORACE WALLER. Maps and Illustrations. 2 Vols. 8vo. 15s
- **Personal Life.** By Wm. G. Blaikie, D.D. With Map and Portrait. 8vo. 6s.
- LIVINGSTONIA.** Adventures in Exploring Lake Nyassa. By E. D. YOUNG, R.N. Maps. Post 8vo. 7s. 6d.
- LOCKHART (J. G.).** Ancient Spanish Ballads. Historical and Romantic. Translated, with Notes. Illustrations. Crown 8vo. 5s.
- **Life of Theodore Hook.** Fcap. 8vo. 1s.
- LONDON: its History, Antiquarian and Modern.** Founded on the work by the late Peter Cunningham, F.S.A. A new and thoroughly revised edition. By JAMES THORNE, F.S.A. and H. B. WHEATLEY. Library edition, on laid paper. 3 Vols. Medium 8vo. [In the Press.
- LOUDON (MRS.).** Gardening for Ladies. With Directions and Calendar of Operations for Every Month. Woodcuts. Fcap. 8vo. 3s. 6d.
- LUMHOLTZ (DR. C.)** Four Years' Travels in Australia, including a Year's Residence among the Cannibals and Little Known Savage Tribes in the N.E. Part of the Continent. With Maps and 100 Illustrations. Medium 8vo. [Nearly Ready.
- LUTHER (MARTIN).** The First Principles of the Reformation, or the Three Primary Works of Dr. Martin Luther. Portrait. 8vo. 12s.
- LYALL (SIR ALFRED C.), K.C.B.** Asiatic Studies; Religious and Social. 8vo. 12s.
- LYELL (SIR CHARLES).** Student's Elements of Geology. A new Edition, entirely revised by PROFESSOR P. M. DUNCAN, F.R.S. With 600 Illustrations. Post 8vo. 9s.
- **Life, Letters, and Journals.** Edited by his sister-in-law, MRS. LYELL. With Portraits. 2 Vols. 8vo. 30s.

- LYELL (K. M.). Handbook of Ferns. Post 8vo. 7s. 6d.
- LYNDHURST (LORD). [See MARTIN.]
- LYTTON (LORD). A Memoir of Julian Fane. Portrait. Post 8vo. 5s.
- MCCLINTOCK (SIR L.). Narrative of the Discovery of the Fate of Sir John Franklin and his Companions in the Arctic Seas. With Illustrations. Post 8vo. 7s. 6d.
- MACDONALD (A.). Too Late for Gordon and Khartoum. The Testimony of an Independent Eye-witness of the Heroic Efforts for their Rescue and Relief. With Maps and Plans. 8vo. 12s.
- MACGREGOR (J.). Rob Roy on the Jordan, Nile, Red Sea, Genesareth, &c. A Canoe Cruise in Palestine and Egypt and the Waters of Damascus. With 70 Illustrations. Crown 8vo. 7s. 6d.
- MAETZNER'S ENGLISH GRAMMAR. A Methodical, Analytical, and Historical Treatise on the Orthography, Prosody, Inflections, and Syntax. By CLAIR J. GRECE, LL.D. 3 Vols. 8vo. 36s.
- MAHON (LORD). [See STANHOPE.]
- MAINE (SIR H. SUMNER). Ancient Law: its Connection with the Early History of Society, and its Relation to Modern Ideas. 8vo. 12s.
- Village Communities in the East and West. 8vo. 12s.
- Early History of Institutions. 8vo. 12s.
- Dissertations on Early Law and Custom. 8vo. 12s.
- Popular Government. I.—Prospects of Popular Government. II.—Nature of Democracy. III.—Age of Progress. IV.—Constitution of the United States. 8vo. 12s.
- International Law. 8vo. 7s. 6d.
- MALCOLM (SIR JOHN). Sketches of Persia. Post 8vo. 3s. 6d.
- MALLOCK (W. H.). Property and Progress: or, Facts against Fallacies. A brief Enquiry into Contemporary Social Agitation in England. Post 8vo. 6s.
- MANSEL (DEAN). Letters, Lectures, and Reviews. 8vo. 12s.
- MARCO POLO. [See YULE.]
- MARKHAM (MRS.). History of England. From the First Invasion by the Romans, continued down to 1890. Woodcuts. 12mo. 3s. 6d.
- History of France. From the Conquest of Gaul by Julius Cæsar, continued down to 1878. Woodcuts. 12mo. 3s. 6d.
- History of Germany. From its Invasion by Marius; continued down to the completion of Cologne Cathedral. Woodcuts. 12mo. 3s. 6d.
- (CLEMENTS R.). A Popular Account of Peruvian Bark and its introduction into British India. With Maps. Post 8vo. 14s.
- MARSH (G. P.). Student's Manual of the English Language. Edited with Additions. By DR. WM. SMITH. Post 8vo. 7s. 6d.
- MARTIN (SIR THEODORE). Life of Lord Lyndhurst. With Portraits. 8vo. 16s.
- MASTERS in English Theology. Lectures by Eminent Divines. With Introduction by Canon Barry. Post 8vo. 7s. 6d.
- MATTHIÆ'S GREEK GRAMMAR. Abridged by BLOMFIELD. Revised by E. S. CROOKE. 12mo. 4s.
- MAUREL'S Character, Actions, and Writings of Wellington. Fcap. 8vo. 1s. 6d.
- MELVILLE (HERMANN). Marquesas and South Sea Islands. 2 Vols. Post 8vo. 7s.
- MEREDITH (MRS. CHARLES). Notes and Sketches of New South Wales. Post 8vo. 2s.

MEXICO. [See BROCKLEHURST—RUXTON.]

MICHAEL ANGELO, Sculptor, Painter, and Architect. His Life and Works. By C. HEATH WILSON. Illustrations. 8vo. 15s.

MILLER (WM.). A Dictionary of English Names of Plants applied among English-speaking People to Plants, Trees, and Shrubs. In Two Parts. Latin-English and English-Latin. Medium 8vo. 12s.

MILMAN'S (DEAN) WORKS:—

HISTORY OF THE JEWS, from the earliest Period down to Modern Times. 3 Vols. Post 8vo. 12s.

EARLY CHRISTIANITY, from the Birth of Christ to the Abolition of Paganism in the Roman Empire. 3 Vols. Post 8vo. 12s.

LATIN CHRISTIANITY, including that of the Popes to the Pontificate of Nicholas V. 9 Vols. Post 8vo. 36s.

HANDBOOK TO ST. PAUL'S CATHEDRAL. Woodcuts. 10s. 6d.

QUINTI HORATII FLACCI OPERA. Woodcuts. Sm. 8vo. 7s. 6d.

FALL OF JERUSALEM. Fcap. 8vo. 1s.

———— (CAPT. E. A.) **Wayside Cross**. Post 8vo. 2s.

———— (BISHOP, D.D.) **Life**. With a Selection from his Correspondence and Journals. By his Sister. Map. 8vo. 12s.

MILNE (DAVID, M.A.). A Readable Dictionary of the English Language. Etymologically arranged. Crown 8vo. 7s. 6d.

MINCHIN (J. G.). The Growth of Freedom in the Balkan Peninsula. With a Map. Crown 8vo. 10s. 6d.

MIVART (ST. GEORGE). Lessons from Nature; as manifested in Mind and Matter. 8vo. 15s.

———— **The Cat**. An Introduction to the Study of Backboned Animals, especially Mammals. With 200 Illustrations. Medium 8vo. 30s.

MOGGRIDGE (M. W.). Method in Almsgiving. A Handbook for Helpers. Post 8vo. 3s. 6d.

MONTEFIORE (SIR MOSES). Selections from Letters and Journals. By LUCIEN WOLF. With Portrait. Crown 8vo. 10s. 6d.

MOORE (THOMAS). Life and Letters of Lord Byron. [See BYRON.]

MOTLEY (JOHN LOTHROP). The Correspondence of. With Portrait. 2 Vols. 8vo.

———— **History of the United Netherlands; from the Death of William the Silent to the Twelve Years' Truce, 1609**. Portraits. 4 Vols. Post 8vo. 6s. each.

———— **Life and Death of John of Barneveld**. With a View of the Primary Causes and Movements of the Thirty Years' War. Illustrations. 2 Vols. Post 8vo. 12s.

MOZLEY (CANON). Treatise on the Augustinian doctrine of Predestination, with an Analysis of the Contents. Crown 8vo. 9s.

MUNRO'S (GENERAL) Life and Letters. By REV. G. R. GLEIG. Post 8vo. 3s. 6d.

MUNTHE (AXEL). Letters from a Mourning City. Naples during the Autumn of 1884. Translated by MAUDE VALERIE WHITE. With a Frontispiece. Crown 8vo. 6s.

MURCHISON (SIR RODERICK). And his Contemporaries. By ARCHIBALD GRIKIE. Portraits. 2 Vols. 8vo. 30s.

MURRAY (A. S.). A History of Greek Sculpture from the Earliest Times. With 130 Illustrations. 2 Vols. Royal 8vo. 52s. 6d.

MURRAY'S MAGAZINE. A New Home and Colonial Monthly Periodical. 1s. Vol. I., Jan.—June, 1887. Vol. II., July—December, 1887. Vol. III., Jan.—June, 1888. Vol. IV., July—December, 1888. 8vo. 7s. 6d. each.

. Forwarded Monthly on receipt of an annual subscription of 13s.

- MUSTERS' (CAPT.)** Patagonians; a Year's Wanderings over Untrodden Ground from the Straits of Magellan to the Rio Negro. Illustrations. Post 8vo. 7s. 6d.
- NADAILLAC (MARQUIS DE).** Prehistoric America. Translated by N. D'ANVERS. With Illustrations. 8vo. 1fs.
- NAPIER (GENERAL SIR CHARLES).** His Life. By the Hon. WM. NAPIER BRUCE. With Portrait and Maps. Crown 8vo. 12s.
- (GENL. SIR GEORGE T.). Passages in his Early Military Life written by himself. Edited by his Son, GENERAL WM. C. E. NAPIER. With Portrait. Crown 8vo. 7s. 6d.
- (SIR WM.). English Battles and Sieges of the Peninsular War. Portrait. Post 8vo.
- NAPOLEON AT FONTAINEBLEAU AND ELBA.** Journals. Notes of Conversations. By SIR NEIL CAMPBELL. Portrait. 8vo. 15s.
- NASMYTH (JAMES).** An Autobiography. Edited by Samuel Smiles, LL.D., with Portrait, and 70 Illustrations. Post 8vo, 6s.; or Large Paper, 16s.
- And JAMES CARPENTER. The Moon: Considered as a Planet, a World, and a Satellite. With 26 Plates and numerous Woodcuts. New and Cheaper Edition. Medium 8vo. 21s.
- NEW TESTAMENT.** With Short Explanatory Commentary. By ARCHDEACON CHURTON, M.A., and the BISHOP OF ST. DAVID'S. With 110 authentic Views, &c. 2 Vols. Crown 8vo. 21s. bound.
- NEWTN (SAMUEL).** First Book of Natural Philosophy; an Introduction to the Study of Statics, Dynamics, Hydrostatics, Light, Heat, and Sound, with numerous Examples. Small 8vo. 3s. 6d.
- Elements of Mechanics, including Hydrostatics, with numerous Examples. Small 8vo. 8s. 6d.
- Mathematical Examples. A Graduated Series of Elementary Examples in Arithmetic, Algebra, Logarithms, Trigonometry, and Mechanics. Small 8vo. 8s. 6d.
- NIMROD,** On the Chace—Turf—and Road. With Portrait and Plates. Crown 8vo. 5s. Or with Coloured Plates, 7s. 6d.
- NORDHOFF (CHAS.).** Communistic Societies of the United States. With 40 Illustrations. 8vo 15s.
- NORTHCOTE'S (SIR JOHN)** Notebook in the Long Parliament. Containing Proceedings during its First Session, 1640. Edited, with a Memoir, by A. H. A. HAMILTON. Crown 8vo. 9s.
- O'CONNELL (DANIEL).** Correspondence of. (See FITZPATRICK.)
- ORNSBY (PROF. R.).** Memoirs of J. Hope Scott, Q.C. (of Abbotsford). With Selections from his Correspondence. 2 vols. 8vo. 24s.
- OTTER (R. H.).** Winters Abroad: Some Information respecting Places visited by the Author on account of his Health. Intended for the Use and Guidance of Invalids. 7s. 6d.
- OVID LESSONS.** [See ETON.]
- OWEN (LIEUT.-COL.).** Principles and Practice of Modern Artillery, including Artillery Material, Gunnery, and Organisation and Use of Artillery in Warfare. With Illustrations. 8vo. 15s.
- OXENHAM (REV. W.).** English Notes for Latin Elegiacs; with Prefatory Rules of Composition in Elegiac Metre. 12mo. 3s. 6d.
- PAGET (LORD GEORGE).** The Light Cavalry Brigade in the Crimea. Map. Crown 8vo. 10s. 6d.
- PALGRAVE (R. H. I.).** Local Taxation of Great Britain and Ireland. 8vo. 5s.

- PALLISER (MRS.).** Mottoes for Monuments, or Epitaphs selected for General Use and Study. With Illustrations. Crown 8vo. 7s. 6d.
- PANKHURST (E. A.).** The Wisdom of Edmund Burke: Being Selections from his Speeches and Writings, chiefly bearing upon Political Questions. Fcap. 8vo. 6s.
- PARIS (DR.).** Philosophy in Sport made Science in Earnest; or, the First Principles of Natural Philosophy inculcated by aid of the Toys and Sports of Youth. Woodcuts. Post 8vo. 7s. 6d.
- PARKYNS' (MANSFIELD)** Three Years' Residence in Abyssinia; with Travels in that Country. With Illustrations. Post 8vo. 7s. 6d.
- PEEL'S (SIR ROBERT)** Memoirs. 2 Vols. Post 8vo. 15s.
- PENN (RICHARD).** Maxims and Hints for an Angler and Chess-player. Woodcuts. Fcap. 8vo. 1s.
- PERCY (JOHN, M.D.).** METALLURGY. Fuel, Wood, Peat, Coal, Charcoal, Coke, Fire-Clays. Illustrations. 8vo. 30s.
 ——— Lead, including part of Silver. Illustrations. 8vo. 30s.
 ——— Silver and Gold. Part I. Illustrations. 8vo. 30s.
- PERRY (REV. CANON).** Life of St. Hugh of Avalon, Bishop of Lincoln. Post 8vo. 10s. 6d.
 ——— History of the English Church. See STUDENTS' MANUALS.
- PERSIA.** [See BENJAMIN.]
- PHILLIPS (SAMUEL).** Literary Essays from "The Times." With Portrait. 2 Vols. Fcap. 8vo. 7s.
- POLLOCK (C. E.).** A Book of Family Prayers. Selected from the Liturgy of the Church of England. 16mo. 3s. 6d.
- POPE'S (ALEXANDER)** Works. With Introductions and Notes, by J. W. CROKER, REV. W. ELWIN, and W. J. COURTHOPE. Vols. J. —IV., VI.—X. With Portraits. 8vo. 10s. 6d. each. (Vol. V., containing the Life and a General Index, is nearly ready).
- PORTER (REV. J. L.).** Damascus, Palmyra, and Lebanon. Map and Woodcuts. Post 8vo. 7s. 6d.
- PRAYER-BOOK (BEAUTIFULLY ILLUSTRATED).** With Notes, by REV. THOS. JAMES. Medium 8vo. 18s. cloth.
- PRINCESS CHARLOTTE OF WALES.** Memoir and Correspondence. By LADY ROSE WEIGALL. With Portrait. 8vo. 8s. 6d.
- PRIVY COUNCIL JUDGMENTS** in Ecclesiastical Cases relating to Doctrine and Discipline. 8vo. 10s. 6d.
- PSALMS OF DAVID.** With Notes Explanatory and Critical by Dean Johnson, Canon Elliott, and Canon Cook. Medium 8vo. 10s. 6d.
- PUSS IN BOOTS.** With 12 Illustrations. By OTTO SPECKTER. 16mo. 1s. 6d. Or coloured, 2s. 6d.
- QUARTERLY REVIEW (THE).** 8vo. 6s.
- RAE (EDWARD).** Country of the Moors. A Journey from Tripoli to the Holy City of Kairwan. Map and Etchings. Crown 8vo. 12s.
 ——— The White Sea Peninsula. Journey to the White Sea, and the Kola Peninsula. Map and Illustrations. Crown 8vo. 15s.
- (GEORGE). The Country Banker; His Clients, Cares, and Work, from the Experience of Forty Years. Crown 8vo. 7s. 6d.
- RAMBLES** in the Syrian Deserts. Post 8vo. 10s. 6d.
- RASSAM (HORMUZD).** British Mission to Abyssinia. Illustrations, 2 Vols. 8vo. 28s.
- RAWLINSON'S (CANON)** Five Great Monarchies of Chaldæa, Assyria, Media, Babylonia, and Persia. With Maps and Illustrations. 3 Vols. 8vo. 42s.

- RAWLINSON'S (SIR HENRY)** England and Russia in the East; a Series of Papers on the Condition of Central Asia. Map. 8vo. 12s.
 [See HERODOTUS.]
- REED (SIR E. J.)** Iron-Clad Ships; their Qualities, Performances, and Cost. With Illustrations. 8vo. 12s.
 ——— Japan: Its History, Traditions, and Religions. With Narrative of a Visit in 1879. Illustrations. 2 Vols. 8vo. 28s.
 ——— A Practical Treatise on Shipbuilding in Iron and Steel. Second and revised edition, with Woodcuts. 8vo. [In Preparation.]
- REJECTED ADDRESSES (THE).** By JAMES AND HORACE SMITH. Woodcuts. Post 8vo. 3s. 6d.; or *Popular Edition*, Fcap. 8vo. 1s.
- REMBRANDT.** [See MIDDLETON.]
- REVISED VERSION OF N. T.** [See BECKETT—BURGON—COOK.]
- RICARDO'S (DAVID) Works.** With a Notice of his Life and Writings. By J. R. M'ULLOCH. 8vo. 16s.
- RIPA (FATHER).** Residence at the Court of Peking. Post 8vo. 2s.
- ROBERTSON (CANON).** History of the Christian Church, from the Apostolic Age to the Reformation, 1517. 8 Vols. Post 8vo. 6s. each.
- ROBINSON (REV. DR.).** Biblical Researches in Palestine and the Adjacent Regions, 1838—52. Maps. 3 Vols. 8vo. 42s.
 ——— English Flower Garden. With an Illustrated Dictionary of all the Plants used, and Directions for their Culture and Arrangement. With numerous Illustrations. Medium 8vo.
 ——— The Vegetable Garden; or, the Edible Vegetables, Salads, and Herbs cultivated in Europe and America. By MM. VILMORIN ANDRIEUX. With 750 Illustrations. 8vo. 15s.
 ——— Sub-Tropical Garden. Illustrations. Small 8vo. 5s.
 ——— Parks and Gardens of Paris, considered in Relation to the Wants of other Cities and of Public and Private Gardens. With 350 Illustrations. 8vo. 19s.
 ——— Wild Garden; or, Our Groves and Gardens made Beautiful by the Naturalization of Hardy Exotic Plants. With 90 Illustrations. 8vo. 10s. 6d.
 ——— God's Acre Beautiful; or, the Cemeteries of the Future. With 8 Illustrations. 8vo. 7s. 6d.
- ROMANS, St. Paul's Epistle to the.** With Notes and Commentary by E. H. GIFFORD, D.D., Archdeacon of London. Medium 8vo. 7s. 6d.
- ROME (HISTORY OF).** [See GIBBON—INGE—LIDDELL—SMITH—STUDENTS']
- ROMILLY (HUGH H.).** The Western Pacific and New Guinea. 2nd Edition. With a Map. Crown 8vo. 7s. 6d.
 ——— (HENRY). The Punishment of Death. To which is added a Treatise on Public Responsibility and Vote by Ballot. Crown 8vo. 9s.
- ROSS (MRS.).** Three Generations of English Women; or, The Memoirs and Correspondence of Mrs. John Taylor, Mrs. Sarah Austin, and Lady Duff Gordon. With Portraits. 2 Vols. Crown 8vo. 24s.
 ——— The Land of Manfred. Picturesque Excursions in Apulia and other little visited parts of Southern Italy, with special reference to their Historical associations. With Illustrations. Crown 8vo.
- RUMBOLD (SIR HORACE).** The Great Silver River: Notes of a Residence in the Argentine Republic. With Illustrations. 8vo. 12s.
- RUXTON (GEO. F.).** Travels in Mexico; with Adventures among Wild Tribes and Animals of the Prairies and Rocky Mountains. Post 8vo. 3s. 6d.
- ST. JOHN (CHARLES).** Wild Sports and Natural History of the Highlands of Scotland. Illustrated Edition. Crown 8vo. 15s. *Cheap Edition*, Post 8vo. 3s. 6d.

- ST. JOHN (BAYLE)** Adventures in the Libyan Desert. Post 8vo. 2s.
- SALE'S (SIR ROBERT)** Brigade in Affghanistan. With an Account of the Defence of Jellalabad. By REV. G. R. GLEIG. Post 8vo. 2s.
- SALMON (PROF. GEORGE, D.D.)** An Introduction to the Study of the New Testament, and an Investigation into Modern Biblical Criticism, based on the most recent Sources of Information. 8vo. 16s.
- Lectures on the Infallibility of the Church. 8vo. 12s.
- SCEPTICISM IN GEOLOGY;** and the Reasons for It. An assemblage of facts from Nature combining to refute the theory of "Causes now in Action." By VERIFIER. Woodcuts. Crown 8vo. 6s.
- SCHLIEMANN (DR. HENRY)** Ancient Mycenæ. With 500 Illustrations. Medium 8vo. 50s.
- Ilios; the City and Country of the Trojans, With an Autobiography. With 2000 Illustrations. Imperial 8vo. 50s.
- Troja: Results of the Latest Researches and Discoveries on the site of Homer's Troy, and other sites made in 1882. With Maps, Plans and Illustrations. Medium 8vo. 42s.
- Tiryns: A Prehistoric Palace of the Kings of Tiryns, discovered by excavations in 1884-5, with Preface and Notes by Professor Adler and Döppfeld. With Coloured Lithographs, Woodcuts, Plans, &c., from Drawings taken on the spot. Medium 8vo. 42s.
- SCHOMBERG (GENERAL)** The Odyssey of Homer, rendered into English verse. 2 vols. 8vo. 24s.
- SCHREIBER (LADY CHARLOTTE)** English Fans and Fan Leaves Collected and Described. With 160 Plates. Folio. £7 7s. Handsomely bound.
- SCOTT (SIR GILBERT)** The Rise and Development of Mediæval Architecture. With 400 Illustrations. 2 Vols. Medium 8vo. 42s.
- SCRUTTON (T. E.)** The Laws of Copyright. An Examination of the Principles which should Regulate Literary and Artistic Property in England and other Countries. 8vo. 10s. 6d.
- SEEBOHM (HENRY)** Siberia in Asia. With Descriptions of the Natural History, Migrations of Birds, &c. Illustrations. Crown 8vo. 14s.
- SELBORNE (LORD)** Notes on some Passages in the Liturgical History of the Reformed English Church. 8vo. 6s.
- SHADOWS OF A SICK ROOM.** Preface by Canon LIDDON. 16mo. 2s. 6d.
- SHAH OF PERSIA'S** Diary during his Tour through Europe in 1873. With Portrait. Crown 8vo. 12s.
- SHAIRP (PRINCIPAL) AND HIS FRIENDS.** By WM. KNIGHT, Professor of Moral Philosophy in the University of St. Andrews. With Portrait. 8vo. 15s.
- SHAW (T. B.)** Manual of English Literature. Post 8vo. 7s. 6d.
- Specimens of English Literature. Selected from the Chief Writers. Post 8vo. 7s. 6d.
- (ROBERT). Visit to High Tartary, Yarkand, and Kashgar, and Return Journey over the Karakorum Pass. With Map and Illustrations. 8vo. 16s.
- SIEMENS (SIR WM.), C.E.** Life of. By WM. POLE, C.E. Portraits. 8vo. 16s.
- Selection from the Papers of. Plates. 3 vols. 8vo.
- SIERRA LEONE;** Described in Letters to Friends at Home. By MRS. MELVILLE. Post 8vo. 3s. 6d.
- SIMMONS (CAPT.)** Constitution and Practice of Courts-Martial. 8vo. 15s.

SMILES' (SAMUEL, LL.D.) WORKS:—

- BRITISH ENGINEERS; from the Earliest Period to the Death of the Stephensons.** Illustrations. 5 Vols, Crown 8vo. 7s. 6d. each.
- GEORGE STEPHENSON.** Post 8vo. 2s. 6d.
- JAMES NASMYTH.** Portrait and Illustrations. Post 8vo. 6s.
- SCOTCH NATURALIST (THOS. EDWARD).** Illustrations. Post 8vo. 6s.
- SCOTCH GEOLOGIST (ROBERT DICK).** Illustrations. 8vo. 12s.
- SELF-HELP.** With Illustrations of Conduct and Perseverance. Post 8vo. 6s.
- CHARACTER.** A Book of Noble Characteristics. Post 8vo. 6s.
- THRIFT.** A Book of Domestic Counsel. Post 8vo. 6s.
- DUTY.** With Illustrations of Courage, Patience, and Endurance. Post 8vo. 6s.
- INDUSTRIAL BIOGRAPHY; or, Iron-Workers and Tool-Makers.** Post 8vo. 6s.
- MEN OF INVENTION.** Post 8vo. 6s.
- LIFE AND LABOUR; or, Characteristics of Men of Culture and Genius.** Post 8vo. 6s.
- BOY'S VOYAGE ROUND THE WORLD.** Illustrations. Post 8vo. 6s.
- SMITH (DR. GEORGE) Student's Manual of the Geography of British India, Physical and Political.** With Maps. Post 8vo. 7s. 6d.
- **Life of John Wilson, D.D. (Bombay), Missionary and Philanthropist.** Portrait. Post 8vo. 9s.
- **Life of Wm. Carey, D.D., 1761—1834.** Shoemaker and Missionary. Professor of Sanscrit, Bengalee and Marahée at the College of Fort William, Calcutta. Illustrations. Post 8vo. 7s. 6d.
- **Life of Stephen Hislop, Pioneer Missionary, and Naturalist in Central India, 1844—1863.** Portrait and Illustrations. 8vo. 14s.
- **(PHILIP).** History of the Ancient World, from the Creation to the Fall of the Roman Empire, A. D. 476. 3 Vols. 8vo. 31s. 6d.

SMITH'S (DR. WM.) DICTIONARIES:—

- DICTIONARY OF THE BIBLE; its Antiquities, Biography, Geography, and Natural History.** Illustrations. 3 Vols. 8vo. 105s.
- CONCISE BIBLE DICTIONARY.** Illustrations. 8vo. 21s.
- SMALLER BIBLE DICTIONARY.** Illustrations. Post 8vo. 7s. 6d.
- CHRISTIAN ANTIQUITIES.** Comprising the History, Institutions, and Antiquities of the Christian Church. Illustrations. 2 Vols. Medium 8vo. 3l. 13s. 6d.
- CHRISTIAN BIOGRAPHY, LITERATURE, SECTS, AND DOCTRINES; from the Times of the Apostles to the Age of Charlemagne.** Medium 8vo. Now complete in 4 Vols. 6l. 16s. 6d.
- GREEK AND ROMAN ANTIQUITIES.** Illustrations. Med. 8vo. 28s.
- GREEK AND ROMAN BIOGRAPHY AND MYTHOLOGY.** Illustrations. 3 Vols. Medium 8vo. 4l. 4s.
- GREEK AND ROMAN GEOGRAPHY.** 2 Vols. Illustrations. Medium 8vo. 56s.
- ATLAS OF ANCIENT GEOGRAPHY—BIBLICAL AND CLASSICAL.** Folio. 6l. 6s.
- CLASSICAL DICTIONARY OF MYTHOLOGY, BIOGRAPHY, AND GEOGRAPHY.** 1 Vol. With 750 Woodcuts. 8vo. 18s.
- SMALLER CLASSICAL DICT.** Woodcuts. Crown 8vo. 7s. 6d.
- SMALLER DICTIONARY OF GREEK AND ROMAN ANTIQUITIES.** Woodcuts. Crown 8vo. 7s. 6d.
- COMPLETE LATIN-ENGLISH DICTIONARY.** With Tables of the Roman Calendar, Measures, Weights, Money, and a Dictionary of Proper Names. 19th Edition. 8vo. 16s.

PUBLISHED BY MR. MURRAY.

SMITH'S (DR. WM.) DICTIONARIES—continued.

SMALLER LATIN-ENGLISH DICTIONARY. 30th Edition. 12mo. 7s 6d.

COPIOUS AND CRITICAL ENGLISH-LATIN DICTIONARY. 5th Edition. 8vo. 16s.

SMALLER ENGLISH-LATIN DICTIONARY. 13th Edit. 12mo. 7s 6d.

SMITH'S (DR. WM.) ENGLISH COURSE:—

SCHOOL MANUAL OF ENGLISH GRAMMAR, WITH COPIOUS EXERCISES and Appendices. Post 8vo. 3s 6d.

PRIMARY ENGLISH GRAMMAR, for Elementary Schools, with carefully graduated Parsing Lessons. 16mo. 1s.

MANUAL OF ENGLISH COMPOSITION. With Copious Illustrations and Practical Exercises. 12mo. 3s 6d.

PRIMARY HISTORY OF BRITAIN. 12mo. 2s 6d.

SCHOOL MANUAL OF MODERN GEOGRAPHY, PHYSICAL AND Political. Post 8vo. 5s.

A SMALLER MANUAL OF MODERN GEOGRAPHY. 16mo. 2s 6d.

SMITH'S (DR. WM.) FRENCH COURSE:—

FRENCH PRINCIPIA. Part I. A First Course, containing a Grammar, Delectus, Exercises, and Vocabularies. 12mo. 3s 6d.

APPENDIX TO FRENCH PRINCIPIA. Part I. Containing additional Exercises, with Examination Papers. 12mo. 2s 6d.

FRENCH PRINCIPIA. Part II. A Reading Book, containing Fables, Stories, and Anecdotes, Natural History, and Scenes from the History of France. With Grammatical Questions, Notes and copious Etymological Dictionary. 12mo. 4s 6d.

FRENCH PRINCIPIA. Part III. Prose Composition, containing Hints on Translation of English into French, the Principal Rules of the French Syntax compared with the English, and a Systematic Course of Exercises on the Syntax. 12mo. 4s 6d.

STUDENT'S FRENCH GRAMMAR. With Introduction by M. Littré. Post 8vo. 6s.

SMALLER GRAMMAR OF THE FRENCH LANGUAGE. Abridged from the above. 12mo. 3s 6d.

SMITH'S (DR. WM.) GERMAN COURSE:—

GERMAN PRINCIPIA. Part I. A First German Course, containing a Grammar, Delectus, Exercise Book, and Vocabularies. 12mo. 3s 6d.

GERMAN PRINCIPIA. Part II. A Reading Book; containing Fables, Anecdotes, Natural History, and Scenes from the History of Germany. With Questions, Notes, and Dictionary. 12mo. 3s 6d.

PRACTICAL GERMAN GRAMMAR. Post 8vo. 3s 6d.

SMITH'S (DR. WM.) ITALIAN COURSE:—

ITALIAN PRINCIPIA. Part I. An Italian Course, containing a Grammar, Delectus, Exercise Book, with Vocabularies, and Materials for Italian Conversation. 12mo. 3s 6d.

ITALIAN PRINCIPIA. Part II. A First Italian Reading Book, containing Fables, Anecdotes, History, and Passages from the best Italian Authors, with Grammatical Questions, Notes, and a Copious Etymological Dictionary. 12mo. 3s 6d.

SMITH'S (DR. WM.) LATIN COURSE:—

THE YOUNG BEGINNER'S FIRST LATIN BOOK: Containing the Rudiments of Grammar, Easy Grammatical Questions and Exercises, with Vocabularies. Being a Stepping stone to Principia Latina, Part I. 12mo. 2s.

THE YOUNG BEGINNER'S SECOND LATIN BOOK: Containing an easy Latin Reading Book, with an Analysis of the Sentences, Notes, and a Dictionary. Being a Stepping-stone to Principia Latina, Part II. 12mo. 2s.

SMITH'S (DR. WM.) LATIN COURSE—*continued.*

PRINCIPIA LATINA. Part I. First Latin Course, containing a Grammar, Delectus, and Exercise Book, with Vocabularies. 12mo. 3s. 6d.

. In this Edition the Cases of the Nouns, Adjectives, and Pronouns are arranged both as in the ORDINARY GRAMMARS and as in the PUBLIC SCHOOL PRIMER, together with the corresponding Exercises.

APPENDIX TO PRINCIPIA LATINA. Part I.; being Additional Exercises, with Examination Papers. 12mo. 2s. 6d.

PRINCIPIA LATINA. Part II. A Reading-book of Mythology, Geography, Roman Antiquities, and History. With Notes and Dictionary. 12mo. 3s. 6d.

PRINCIPIA LATINA. Part III. A Poetry Book. Hexameters and Pentameters; Eclog. Ovidianæ; Latin Prosody. 12mo. 3s. 6d.

PRINCIPIA LATINA. Part IV. Prose Composition. Rules of Syntax, with Examples, Explanations of Synonyms, and Exercises on the Syntax. 12mo. 3s. 6d.

PRINCIPIA LATINA. Part V. Short Tales and Anecdotes for Translation into Latin. 12mo. 3s.

LATIN-ENGLISH VOCABULARY AND FIRST LATIN-ENGLISH DICTIONARY FOR PHÆDRUS, CORNELIUS NEPOS, AND CÆSAR. 12mo. 3s. 6d.

STUDENT'S LATIN GRAMMAR. For the Higher Forms. A new and thoroughly revised Edition. Post 8vo. 6s.

SMALLER LATIN GRAMMAR. New Edition. 12mo. 3s. 6d.

TACITUS, GERMANIA, AGRICOLA, and FIRST BOOK OF THE ANNALS. 12mo. 3s. 6d.

SMITH'S (DR. WM.) GREEK COURSE:—

INITIA GRÆCA. Part I. A First Greek Course, containing a Grammar, Delectus, and Exercise-book. With Vocabularies. 12mo. 3s. 6d.

APPENDIX TO INITIA GRÆCA. Part I. Containing additional Exercises. With Examination Papers. Post 8vo. 2s. 6d.

INITIA GRÆCA. Part II. A Reading Book. Containing Short Tales, Anecdotes, Fables, Mythology, and Grecian History. 12mo. 3s. 6d.

INITIA GRÆCA. Part III. Prose Composition. Containing the Rules of Syntax, with copious Examples and Exercises. 12mo. 3s. 6d.

STUDENT'S GREEK GRAMMAR. For the Higher Forms. Post 8vo. 6s.

SMALLER GREEK GRAMMAR. 12mo. 3s. 6d.

GREEK ACCIDENCE. 12mo. 2s. 6d.

PLATO, Apology of Socrates, &c. With Notes. 12mo. 3s. 6d.

SMITH'S (DR. WM.) SMALLER HISTORIES:—

SCRIPTURE HISTORY. Maps and Woodcuts. 16mo. 3s. 6d.

ANCIENT HISTORY. Woodcuts. 16mo. 3s. 6d.

ANCIENT GEOGRAPHY. Woodcuts. 16mo. 3s. 6d.

MODERN GEOGRAPHY. 16mo. 2s. 6d.

GREECE. With Coloured Map and Woodcuts. 16mo. 3s. 6d.

ROME. With Coloured Maps and Woodcuts. 16mo. 3s. 6d.

CLASSICAL MYTHOLOGY. Woodcuts. 16mo. 3s. 6d.

ENGLAND. With Coloured Maps and Woodcuts. 16mo. 3s. 6d.

ENGLISH LITERATURE. 16mo. 3s. 6d.

SPECIMENS OF ENGLISH LITERATURE. 16mo. 3s. 6d.

SOMERVILLE (MARY). Physical Geography. Post 8vo. 9s.

————— Connexion of the Physical Sciences. Post 8vo. 9s.

————— Molecular and Microscopic Science. Illustrations.

2 Vols. Post 8vo. 21s.

SOUTH (JOHN F.). Household Surgery; or, Hints for Emergencies. With Woodcuts. Fcap. 8vo. 3s. 6d.

————— Memoirs of. [See FELTOE.]

SOUTHEY (ROBT.). Lives of Bunyan and Cromwell. Post 8vo. 2s.

STANHOPE'S (EARL) WORKS :—

HISTORY OF ENGLAND FROM THE REIGN OF QUEEN ANNE TO THE PEACE OF VERSAILLES, 1701-83. 9 Vols. Post 8vo. 5s. each.

LIFE OF WILLIAM PITT. Portraits. 3 Vols. 8vo. 36s.

MISCELLANIES. 2 Vols. Post 8vo. 13s.

BRITISH INDIA, FROM ITS ORIGIN TO 1783. Post 8vo. 3s. 6d.

HISTORY OF "FORTY-FIVE." Post 8vo. 3s.

HISTORICAL AND CRITICAL ESSAYS. Post 8vo. 3s. 6d.

THE RETREAT FROM MOSCOW, AND OTHER ESSAYS. Post 8vo. 7s. 6d.

LIFE OF BELISARIUS. Post 8vo. 10s. 6d.

LIFE OF CONDÉ. Post 8vo. 3s. 6d.

STORY OF JOAN OF ARC. Fcap. 8vo. 1s.

ADDRESSES ON VARIOUS OCCASIONS. 16mo. 1s.

[See also WELLINGTON.]

STANLEY'S (DEAN) WORKS :—

SINAI AND PALESTINE. Coloured Maps. 8vo. 12s.

BIBLE IN THE HOLY LAND; Extracted from the above Work. Woodcuts. Post 8vo. 3s. 6d.

EASTERN CHURCH. Plans. Crown 8vo. 6s.

JEWISH CHURCH. From the Earliest Times to the Christian Era. Portrait and Maps. 3 Vols. Crown 8vo. 18s.

CHURCH OF SCOTLAND. 8vo. 7s. 6d.

EPISTLES OF ST. PAUL TO THE CORINTHIANS. 8vo. 18s.

LIFE OF DR. ARNOLD. Portrait. 2 Vols. Cr. 8vo. 12s.

CANTERBURY. Illustrations. Crown 8vo. 6s.

WESTMINSTER ABBEY. Illustrations. 8vo. 15s.

SERMONS PREACHED IN WESTMINSTER ABBEY. 8vo. 12s.

MEMOIR OF EDWARD, CATHERINE, AND MARY STANLEY. Cr. 8vo. 9s.

CHRISTIAN INSTITUTIONS. Essays on Ecclesiastical Subjects. Crown 8vo. 6s.

ESSAYS ON CHURCH AND STATE; 1850—1870. Crown 8vo. 6s.

SERMONS TO CHILDREN, including the Beatitudes, the Faithful Servant, &c. Post 8vo. 3s. 6d.

[See also BRADLEY.]

STEBBING (WM.). Some Verdicts of History Reviewed. 8vo. 12s.

STEPHENS (REV. W. R. W.). Life and Times of St. John Chrysostom. A Sketch of the Church and the Empire in the Fourth Century. Portrait. 8vo. 7s. 6d.

STREET (G. E.), R.A. Gothic Architecture in Brick and Marble. With Notes on North of Italy. Illustrations. Royal 8vo. 26s.

————— Memoir of. By ARTHUR E. STREET. Portrait. 8vo. 15s.

STUART (VILLIERS). Egypt after the War. With Descriptions of the Homes and Habits of the Natives, &c. Coloured Illustrations and Woodcuts. Royal 8vo. 31s. 6d.

STUDENTS' MANUALS. Post 8vo. 7s. 6d. EACH VOLUME:—

- HUME'S HISTORY OF ENGLAND from the Invasion of Julius Cæsar to the Revolution in 1688. Revised, and continued to the Treaty of Berlin, 1878. By J. S. BREWER, M.A. Coloured Maps and Woodcuts. Or in 3 parts, price 2s. 6d. each.
 * * Questions on the above Work, 12mo. 2s.
- HISTORY OF MODERN EUROPE, from the fall of Constantinople to the Treaty of Berlin, 1878. By R. LODGE, M.A.
- OLD TESTAMENT HISTORY; from the Creation to the Return of the Jews from Captivity. Woodcuts.
- NEW TESTAMENT HISTORY. With an Introduction connecting the History of the Old and New Testaments. Woodcuts.
- EVIDENCES OF CHRISTIANITY. By H. WACE, D.D. [*In the Press.*]
- ECCLESIASTICAL HISTORY; a History of the Christian Church from its foundation till after the Reformation. By PHILIP SMITH, B.A. With numerous Woodcuts. 2 Vols. PART I. A.D. 30—1003. PART II.—1003—1614.
- ENGLISH CHURCH HISTORY; from the Planting of the Church in Great Britain to the Silencing of Convocation in the 18th Cent. By CANON PERRY. 3 Vols. *First Period*, A.D. 596—1509. *Second Period*, 1509—1717. *Third Period*, 1717—1894.
- ANCIENT HISTORY OF THE EAST; Egypt, Assyria, Babylonia, Media, Persia, Asia Minor, and Phœnicia. By PHILIP SMITH, B.A. Woodcuts.
- GEOGRAPHY. By CANON BEVAN. Woodcuts.
- HISTORY OF GREECE; from the Earliest Times to the Roman Conquest. By WM. SMITH, D.C.L. Woodcuts.
 * * Questions on the above Work, 12mo. 2s.
- HISTORY OF ROME; from the Earliest Times to the Establishment of the Empire. By DEAN LIDDELL. Woodcuts.
- GIBBON'S DECLINE AND FALL OF THE ROMAN EMPIRE. Woodcuts.
- HALLAM'S HISTORY OF EUROPE during the Middle Ages.
- HALLAM'S HISTORY OF ENGLAND; from the Accession of Henry VII. to the Death of George II.
- HISTORY OF FRANCE; from the Earliest Times to the Fall of the Second Empire. By H. W. JERVIS. With Coloured Maps and Woodcuts.
- ENGLISH LANGUAGE. By GEO. P. MARSH.
- ENGLISH LITERATURE. By T. B. SHAW, M.A.
- SPECIMENS OF ENGLISH LITERATURE. By T. B. SHAW.
- MODERN GEOGRAPHY; Mathematical, Physical and Descriptive. By CANON BEVAN, M.A. Woodcuts.
- GEOGRAPHY OF BRITISH INDIA. Political and Physical. By GEORGE SMITH, LL.D. Maps.
- MORAL PHILOSOPHY. By WM. FLEMING.
- SUMNER'S (BISHOP) Life and Episcopate during 40 Years. By Rev. G. H. SUMNER. Portrait. 8vo. 14s.
- SWAINSON (CANON). Nicene and Apostles' Creeds; Their Literary History; together with some Account of "The Creed of St. Athanasius." 8vo. 16s.
- SWIFT (JONATHAN). [*See CRAIK.*]
- SYBEL (VON). History of Europe during the French Revolution, 1789—1795. 4 Vols. 8vo. 48s.
- SYMONDS' (REV. W.) Records of the Rocks; or Notes on the Geology of Wales, Devon, and Cornwall. Crown 8vo. 12s.

- TEMPLE (SIR RICHARD).** India in 1880. With Maps. 8vo. 16s.
 ——— Men and Events of My Time in India. 8vo. 16s.
 ——— Oriental Experience. Essays and Addresses delivered on Various Occasions. With Maps and Woodcuts. 8vo. 16s.
- THIBAUT'S (ANTOINE)** Purity in Musical Art. With Prefatory Memoir by W. H. Gladstone, M.P. Post 8vo. 7s. 6d.
- THIELMANN (BARON).** Journey through the Caucasus to Tabreez, Kurdistan, down the Tigris and Euphrates to Nineveh and Palmyra. Illustrations. 2 Vols. Post 8vo. 18s.
- THOMSON (ARCHBISHOP).** Lincoln's Inn Sermons. 8vo. 10s. 6d.
 ——— Life in the Light of God's Word. Post 8vo. 5s.
 ——— Word, Work, & Will: Collected Essays. Crown 8vo. 9s.
- THORNHILL (MARK).** The Personal Adventures and Experiences of a Magistrate during the Rise, Progress, and Suppression of the Indian Mutiny. With Frontispiece and Plan. Crown 8vo. 12s.
- TITIAN'S LIFE AND TIMES.** With some account of his Family, from unpublished Records. By CROWE and CAVALCASELLE. Illustrations. 2 Vols. 8vo. 21s.
- TOCQUEVILLE'S** State of Society in France before the Revolution, 1789, and on the Causes which led to that Event. 8vo. 12s.
- TOMLINSON (CHAS.).** The Sonnet: Its Origin, Structure, and Place in Poetry. Post 8vo. 9s.
- TOZER (REV. H. F.).** Highlands of Turkey, with Visits to Mounts Ida, Athos, Olympus, and Pelion. 2 Vols. Crown 8vo. 24s.
 ——— Lectures on the Geography of Greece. Post 8vo. 9s.
- TRISTRAM (CANON).** Great Sahara. Illustrations. Crown 8vo. 15s.
 ——— Land of Moab: Travels and Discoveries on the East Side of the Dead Sea and the Jordan. Illustrations. Crown 8vo. 15s.
- TWINING (REV. THOS.).** Recreations and Studies of a Country Clergyman of the Last Century. Crown 8vo. 9s.
 ——— PAPERS (Selections from the). Being a Sequel to the "Recreations of a Country Clergyman of the 18th Century." Edited by RICHARD TWINING. Crown 8vo. 9s.
 ——— (LOUISA). Symbols and Emblems of Early and Mediæval Christian Art. With 500 Illustrations. Crown 8vo. 12s.
- TWISS' (HORACE)** Life of Lord Eldon. 2 Vols. Post 8vo. 21s.
- TYLOR (E. B.).** Researches into the Early History of Mankind, and Development of Civilization. 3rd Edition. 8vo. 12s.
 ——— Primitive Culture: the Development of Mythology, Philosophy, Religion, Art, and Custom. 2 Vols. 8vo. 24s.
- VATICAN COUNCIL.** [See LETO.]
- VIRCHOW (PROFESSOR).** The Freedom of Science in the Modern State. Fcap. 8vo. 2s.
- WACE (REV. HENRY), D.D.** The Principal Facts in the Life of our Lord, and the Authority of the Evangelical Narratives. Post 8vo. 6s.
 ——— The Foundations of Faith. Bampton Lectures for 1879. Second Edition. 8vo. 7s. 6d.
 ——— Christianity and Morality. Boyle Lectures for 1874 and 1875. Seventh Edition. Crown 8vo. 6s.
- WALES (H.R.H. THE PRINCE OF).** Speeches and Addresses of H.R.H. the Prince of Wales; During Twenty-five Years, 1863-1888. Edited by JAMES MACAULAY, A.M. With Portrait. 8vo. 12s.
- WELLINGTON (DUKE OF).** Notes of Conversations with the late Earl Stanhope. 1831-1851. Crown 8vo. 7s. 6d.
 ——— Despatches in India, Denmark, Portugal, Spain, the Low Countries, and France. 8 Vols. 8vo. £8 8s.

- WELLINGTON (DUKE OF). Supplementary Despatches, relating to India, Ireland, Denmark, Spanish America, Spain, Portugal, France, Congress of Vienna, Waterloo, and Paris. 15 Vols. 8vo. 20s. each.
- WELLINGTON'S Civil and Political Correspondence. Vols. I. to VIII. 8vo. 20s. each.
- Speeches in Parliament. 2 Vols. 8vo. 4 2s.
- WESTCOTT (CANON B. F.) The Gospel according to St. John, with Notes and Dissertations (Reprinted from the Speaker's Commentary). 8vo. 10s. 6d.
- WHARTON (CAPT. W. J. L.), R.N. Hydrographical Surveying: being a description of the means and methods employed in constructing Marine Charts. With Illustrations. 8vo. 15s.
- WHEELER (G.). Choice of a Dwelling. Post 8vo. 7s. 6d.
- WHITE (W. H.). Manual of Naval Architecture, for the use of Naval Officers, Shipbuilders, and Yachtsmen, &c. Illustrations. 8vo. 24s.
- WILBERFORCE'S (BISHOP) Life of William Wilberforce. Portrait. Crown 8vo. 6s.
- (SAMUEL, D.D.), Lord Bishop of Oxford and Winchester; his Life. By CANON ASHWELL, and R. G. WILBERFORCE. With Portraits and Woodcuts. 3 Vols. 8vo. 15s. each.
- WILKINSON (SIR J. G.). Manners and Customs of the Ancient Egyptians, their Private Life, Laws, Arts, Religion, &c. A new edition. Edited by SAMUEL BIRCH, LL.D. Illustrations. 3 Vols. 8vo. 84s.
- Popular Account of the Ancient Egyptians. With 500 Woodcuts. 2 Vols. Post 8vo. 12s.
- WILLIAMS (SIR MONIER). Brahmanism and Hinduism, Religious Thought and Life in India as based on the Veda. 8vo. 10s. 6d.
- Buddhism in its connection with Brahmanism and Hinduism, and in its contrast with Christianity. With Illustrations, 8vo.
- Sakountala; or, The Lost Ring. An Indian Drama Translated into English Prose and Verse. 8vo. 7s. 6d.
- WINTLE (H. G.). Ovid Lessons. 12mo, 2s. 6d. [See ETON.]
- WOOD'S (CAPTAIN) Source of the Oxus. With the Geography of the Valley of the Oxus. By COL. YULE. Map. 8vo. 12s.
- WORDS OF HUMAN WISDOM. Collected and Arranged by E. S. With a Preface by CANON LIDDON. Fcap. 8vo. 3s. 6d.
- WORDSWORTH'S (BISHOP) Greece; Pictorial, Descriptive, and Historical. With an Introduction on the Characteristics of Greek Art, by GEO. SCHARF. New Edition revised by the Rev. H. F. TOZER, M.A. With 400 Illustrations. Royal 8vo. 31s. 6d.
- YORK (ARCHBISHOP OF). Collected Essays. Contents.—Synoptic Gospels. Death of Christ. God Exits. Worth of Life. Design in Nature. Sports and Pastimes. Emotions in Preaching. Defects in Missionary Work. Limits of Philosophical Enquiry. Crown 8vo. 9s.
- YORK-GATE LIBRARY (Catalogue of). Formed by Mr. SILVER, An Index to the Literature of Geography, Maritime and Inland Discovery, Commerce and Colonisation. Compiled by E. A. PETHERICK, F.R.G.S. Second Edition, greatly enlarged, and Illustrated. 468 pp. Super-royal 8vo. Price 42s.
- YULE (COLONEL). The Book of Ser Marco Polo, the Venetian, concerning the Kingdoms and Marvels of the East. Illustrated by the Light of Oriental Writers and Modern Travels. With Maps and 80 Plates. 2 Vols. Medium 8vo. 63s.
- and A. C. BURNELL. A Glossary of Anglo-Indian Colloquial Words and Phrases, and of Kindred Terms; Etymological, Historical, Geographical, and Discursive. Medium 8vo. 36s.
- (A. F.) The Cretan Insurrection. Post 8vo. 2s. 6d.





